

Personal Computer

LYNX
AND CORVUS
CONCEPT TESTED

Canada \$2.75/US \$2.50/FF 8.80/FI 8.00/SFr 8.00/IR £1.12/
BFr 90.00/Lire 4700/DKr 24.00/NKr 14.55/DM 9.5

World

March 1983 85p

BRITAIN'S LARGEST SELLING MICRO MAGAZINE



IS THIS THE NEXT IBM PC?
We unwrap the Big Blue's new baby

**NEW
MODEL**

**LOWER
COST**



Cromemco System One

MicroCentre introduce Cromemco's new System One computer, available with an integral 5 megabyte Winchester hard disk, at a new low price.

The System One supports the full range of Cromemco interface cards, including high resolution colour graphics, and software packages. The choice of operating systems includes CDOS, CP/M and CROMIX—Cromemco's answer to Unix.

Call MicroCentre for  Cromemco

MicroCentre Ltd
(Complete Micro Systems)

**Britain's independent
Cromemco importer**

**30 Dundas Street
Edinburgh EH3 6JN
Tel: 031-556 7354**

Everything you ever wanted in micros but didn't know who to ask

Digitus SYSTEMS

The 80/20 Solution

Eighty per cent of our customer needs are satisfied by matching requirements to packaged programs and machines.

Business Systems Group offers a comprehensive range of packages for both the Sophisticated User and New User.

Office Systems Group covers wordprocessing and record management needs, with single and multi-workstation systems.



Personal Systems Group helps managers and professionals with Micro Aided Management tools including: financial planning, modelling, linear programming, PERT and personal productivity aids.

Special Systems Group supplies packages to suit particular professions and industries including agencies, printers, manufacturers, distributors, dentists etc.

The Systems Groups install complete solutions, arrange training and hand hold you through to comfortable operation of your system.

The 20/80 Solution

Twenty per cent of our customers needs are satisfied by tailored design, programming, engineering and project management.

Digitus has a five-year record of fulfilling small and large microcomputing projects, e.g.

Technical Projects to take data from (1) solar heating panels (2) weighing machines and (3) oil tankers.

Administrative Projects to organise (1) 2000 bottles of urine per week (2) £1 million of barley receipts and (3) 6000 graduate applicants for 27 sites.



Multi-Machine Projects for (1) the complete computerisation of a City commodity broker and (2) a flight information system in an International Airport to drive 300 information receivers, staff monitors, passenger displays and flapperboards.

The Project Groups take turnkey responsibility and use as many standard software and hardware components as requirement and technical constraints allow.

Digitus PROJECTS

Digitus TRAINING

The 100% Solution

Everyone needs some education and training in micros. Digitus modular training programme provides for executives, managers, technicians, computer and office personnel.

No. Next date

Introductory Courses

1	Introduction to Microcomputers	April 18
2	Business Systems	19
3	Information Management	20
4	Management Aids	21

Skills Training

5	Fundamentals of BASIC	April 10/11
6	Improve your BASIC	12/13
7	Wordprocessing with WordStar	March 29
8	DataStar/SuperSort MailMerge	March 30

Computer Professionals Courses

9	Hardware for Software People	Mar 14
10	Operating Systems and Languages	15
11	Communications & Networks	16
12	Applications Design & Products	17
13	System & Program Generators	18

Computing Management Seminars

14	Micro Technology & Strategy	May 17
15	Local Area Networks	May 18
16	Micro DataBase Managers	May 19

All courses include practical work and advice on microcomputers. Course fees: 1-8 £95 per day; 9-16 £125 per day + VAT, including luncheon and detailed course notes. You save £10 per day by booking more than one day's training at one time.

Request for:

- Quotation
- Response to tender
- Course booking
- Training information
- General information

Company _____
 Address _____
 _____ Phone No _____
 Name _____ Position _____
 Requirement _____ MD

DIGITUS LTD
 LADING HOUSE
 10-14 BEDFORD ST
 COVENT GARDEN
 LONDON WC2E 9HE
 Telephone (01) 379 6968
 Telex 27950 Ref. 3005

CONTENTS

Vol 6 No 3 March 1983



Cover illustration by Mark Watkinson

BENCHTESTS & REVIEWS

DATABASE BENCHTEST 116

This month Kathy Lang looks at DataPrism.

CORVUS CONCEPT 128

Time-honoured Benchtester Dick Pountain gives the Corvus a thorough going-over.

G007 GRAPHICS MODULE 122

A detailed look at the first commercial product from the Notting Dale ITeC.

LYNX BENCHTEST 26

Programs Editor Maggie Burton sets to work on the Computers Lynx — well, several Lynxes, actually. Find out what's beneath the smooth, dove-grey exterior.



WHICH SPREADSHEET? 124

The second in a series on spreadsheets by Mike Liardet. For his first Benchtest he looks at the Prophet II — hardware and software combined in one system.

EASY HANDLING 156

Jane Bird tries out a safe and simple word processing package for the Apple II.



FEATURES

MOUSE MAKES MICROS MANAGEABLE 109

Last month saw the UK announcements of two new user-friendly systems which put the keyboard on one side and replace it with the mouse!

IBM's SECRET MICRO 112

A month after the IBM Personal Computer was officially launched in the UK, Chris Morgan of *Byte* magazine investigates what could be the *next* IBM PC.

Founder Angelo Zgorelec Managing Editor Dick Pountain Editor Peter Rodwell Deputy Editor Jane Bird Programs Editor Maggie Burton Sub Editor Steve Mann Editorial Secretary Tracy Dear Consultant Editor David Tebbutt Art Editor Phoebe Creswell-Evans Design Assistant Richard Gadsby Typesetters Jane Hamnell, Anne Ashby Publishing Manager Fiona Collier Group Advertisement Manager John Cade Advertisement Manager Patrick Dolan Assistant Advertisement Manager Peter Goldstein Sales Executives Herbert Wright, Jan Martin, Gill Harrison, Gayle Thomson, Michael Clarke Micromart Gaye Collins Advertisement Assistant Priscilla Senior Group Production Manager Robert Buggs, Advertisement Production Tony Keefe



SEND IT IN PACKETS 114
Part two of Terry Lang's series demystifying the tangled world of networks.

REGULARS

NEWSPRINT 100
Guy Kewney presents news and views on micros and the world at large.

CTUK! NEWS 111
David Tebbut says goodbye to the ComputerTowns page as we knew it, and lays down the format for the future — providing you cooperate!

BANKS' STATEMENT 134
Will manufacturers fulfill their promises, and are you likely to benefit in 1983? asks the inimitable Banks.

COMMUNICATIONS 149
Your chance to get on the soapbox.

SCREENPLAY 152
Dick Olney presents his monthly review of games, good and bad. This month he concentrates on software for the Atari 800.

TJ'S WORKSHOP 163
A pot-pourri of readers' tips for Terminal Junkies.

COMPUTER ANSWERS 171
Agony Uncle Sheridan Williams and his team of helpers get to grips with your problems.

MICRO CHESS 174
Goodlooking, Sensitive and Intelligent — who can Tony Harrington be talking about?

PORTABLE COMPUTER WORLD 182
Dick Pountain and his loyal band of helpers delve deep into the mysteries of the hand-helds.

NUMBERS COUNT 183
Mike Mudge's monthly mathematical mindbender.

PCW SUB SET 186
Our monthly melange of assembler subroutines.

BREAKING DOWN THE BARRIERS 160
Maggie Burton visits one of the most established ITeCs and finds out what goes on behind its portals — and what comes out.

MAKING THE MOST OF THE MZ-80K 178
Enhance your Sharp Basic... a detailed description of what can be done with this popular machine.



SUBSCRIPTIONS 189
A blatant appeal for your cash. Here's what you get in return.

BEGINNERS START HERE 182
We attempt to explain the jargon in words of one (or two!) syllables.

DIRECT ACCESS 192
Includes In Store, ACC News, Transaction File, ComputerTowns, Network News, and Diary Data.

PROGRAMS 206
Program of the Month this time helps you animate your Atari.

BLUDNERS 225
Mistakes? Us?! Well, at least we admit 'em...

LEISURE LINES 225
Another brain-teaser from JJ Clessa.

BACK ISSUES 226
Find out what you've missed — and where you can get hold of the relevant copies.

CHIP CHAT 328
PCW's irreverent gossip corner.





Now, service as good as your Atari.[®]

Now you can place your ATARI[®] in the safest hands in the country. We've set up a national network of Independent Service Centres to service ATARI Video Computer Systems[™] and Home Computers, in or out of warranty.

Each one has been inspected and the staff have been specially trained by us. So wherever you see the ATARI SERVICE[™] badge, you'll also see some fast service. We're increasing the list all the time, so if there isn't currently one near you, call our Customer Relations Department on **Slough (0753) 24561**.

- | | | | | | |
|---|---|--|---|--|--|
| <p>Avon
Mastercare, Uphill Works,
Hawarden Terrace,
Larkhall,
Bath BA1 6RE.
Tel: 0225 27517.</p> <p>Bedfordshire
Mastercare Service Centre,
Windsor Road,
Mile Road Ind. Estate,
Bedford MK4 29XL.
Tel: 0234 46591.</p> <p>Berkshire
Atari Service Centre,
Atari House, Repair Dept.,
Railway Terrace, Slough,
Berkshire SL2 5BZ.
Tel: 0753 33344.
Mastercare,
Arkwright Road, Reading,
Berkshire RG2 0LX.
Tel: 0734 863186.</p> <p>Buckinghamshire
Mastercare,
653 London Road,
Wycombe Marsh,
High Wycombe,
Bucks HP11 1EH.
Tel: 0494 444704.</p> <p>Cheshire
A.S. Wootons & Sons,
116 Edleston Road,
Crewe,
Cheshire CW2 7HD.
Tel: 0270 214118.
Mastercare,
4 Arkwright Road,
Astmoor Industrial Estate,
Runcorn,
Cheshire WA7 1NV.
Tel: 09285 63772.
*Pooles (Electronic
Specialists) Ltd.,
59-63 Station Road,
Northwich,
Cheshire CW9 5LT.
Tel: 0606 3010.</p> | <p>Cleveland
Mastercare, Lustrum Ave.,
North Teesside Ind. Estate,
Stockton-on-Tees,
Cleveland TS18 2RB.
Tel: 0642 616991.</p> <p>Ciwyd
G.P. Video Systems,
36 Henblos Street,
Wrexham, Ciwyd LL13 8AD.
Tel: 0978 264451.</p> <p>Cornwall
Mastercare, Vean Road,
Camborne,
Cornwall TR14 7TB.
Tel: 0209 714431.</p> <p>Cumbria
Mastercare,
Gilwilly Trading Estate,
Penrith, Cumbria CA11 1EH.
Tel: 0768 62345.</p> <p>Derbyshire
Mastercare, Gosforth Road,
Osmaston Park Ind. Est.,
Derby, Derbyshire DE2 8HX.
Tel: 0332 372221.</p> <p>Devon
Mastercare,
Venny Bridge, Whipton,
Exeter, Devon EX4 8JG.
Tel: 0392 66141.</p> <p>Dorset
Mastercare,
75/77 Windham Road,
Bournemouth,
Dorset BH1 4RN.
Tel: 0202 38347.</p> <p>Dyfed
Mastercare, Electric House,
Castle Street,
Newcastle Emlyn SA38 9AF.
Tel: 02339 710107.</p> | <p>Essex
Maplin Electronics
Supplies Ltd., Unit 'A',
Oak Road South, Hadleigh,
Benfleet, Essex SS7 2BB.
Tel: 0702 552911.
Mastercare, Unit 4,
Hanbury Rd., Chelmsford,
Essex CM1 3AE.
Tel: 0245 83616.</p> <p>Glamorgan South
Mastercare, Unit 2,
Ace Ind. Estate, Ferry Rd.,
Grangetown, Cardiff,
Sth Glamorgan CF1 YJ1.
Tel: 0222 372254.</p> <p>Grampian
Mastercare, Tyock Ind. Est.,
Elgin, Grampian IV30 1XY.
Tel: 0343 3362.</p> <p>Hampshire
Mastercare, Mill Brook
Factory Estate, Mill Brook Rd.,
Southampton,
Hampshire SO9 1LQ.
Tel: 0703 783133.
Microchips,
46-48 St. George's St.,
Winchester,
Hampshire SO23 8BE.
Tel: 0962 55455.</p> <p>Hereford & Worcester
Mastercare, St. Mark's Close,
Cherry Orchard,
Worcester WR5 3DJ.
Tel: 0905 355921.</p> <p>Hertfordshire
Spectrum Service Centre,
2 Lordship Centre,
Howard Dr., Letchworth,
Hertfordshire SG6 2DF.
Tel: 04626 79548.</p> | <p>Isle of Wight
Mastercare,
Riverway, Newport,
Isle of Wight PO30 5UX.
Tel: 0983 524447.</p> <p>Kent
Mastercare, 57 Bower La.,
Maidstone, Kent ME16 8EJ.
Tel: 0622 672921.
Micro Machines Ltd.,
64 Burgate, Canterbury,
Kent CT1 2HJ.
Tel: 0227 69090.
Silica Shop Ltd.,
1-4 The Mews, Hatherley Rd.,
Sidcup, Kent DA14 4DX.
Tel: 01-309 1111.</p> <p>Lancashire
Norman Audio Ltd.,
51 Fishergate, Preston,
Lancashire PR1 8BH.
Tel: 0772 53057.
Gemini Computer
Servicing Ltd.,
50 Newton Street,
Manchester 1,
Lancashire M1 2EA.
Tel: 061-236 3395.
Mastercare,
Manchester Road,
Manchester Road Ind.
Estate, Bolton, Greater
Manchester BL3 2NJ.
Tel: 0204 21724.
Mastercare, 18 Crook St.,
Preston, Lancashire PR1 5LS.
Tel: 0772 796435.</p> <p>Leicestershire
Mastercare,
44 Kenilworth Drive,
Oadby, Leicestershire LE2 5LB.
Tel: 0533 713368.</p> | <p>Lincolnshire
Mastercare,
18 Kingsway, Lincoln,
Lincolnshire LN5 8AH.
Tel: 0522 28148.</p> <p>Lothian
Mastercare, 4 Napier Sq.,
Houston Ind. Estate,
Livingston,
W. Lothian EH54 5DG.
Tel: 0506 30251.</p> <p>Midlands West
Mastercare,
Hampstead Ind. Estate,
Old Walsall Road,
Birmingham,
West Midlands B42 1DU.
Tel: 021-358 5061.</p> <p>Staffordshire
Mastercare,
67/69 Ford Green Road,
Smallthorn, Stoke-on-Trent,
Staffordshire ST6 1NV.
Tel: 0782 88617.</p> <p>Strathclyde
Mastercare, c/o Bridges,
23 Washington Road,
Abbotsinch Ind. Estate,
Paisley, Strathclyde PA3 4EX.
Tel: 041-887 7011.</p> <p>Suffolk
Mastercare, Unit 9,
Farthing Road, Sproughton,
Ipswich, Suffolk IP1 5AP.
Tel: 0473 47101.</p> <p>Surrey
Advanced Electronic
Services Ltd.,
3 Wealdstone Road,
Kimpton Road Estate,
Sutton, Surrey SM3 9QN.
Tel: 01-641 4444.</p> | <p>J.S. Simnett Computers Ltd.,
The Computer Shop,
91 Acre Road,
Kingston-upon-Thames,
Surrey KT2 6ES.
Tel: 01-546 3793.</p> <p>Mastercare,
33/36 Fullerton Road,
Croydon, Surrey CR0 6JD.
Tel: 01-656 4711.</p> <p>Sussex
Gamer,
24 Gloucester Road,
Brighton,
East Sussex BN1 4AQ.
Tel: 0273 698424.
Mastercare, 12 Bear Yard,
Cliffe High St., Lewes,
East Sussex BN7 2BA.
Tel: 07916 3241.</p> <p>Yorkshire
Mastercare,
Millfield Lane,
Nether Poppleton, York,
North Yorks. YO2 6PB.
Tel: 0904 794121.
Mastercare,
Industrial Road,
Carlton Ind. Estate,
Barnsley S71 3PH.
Tel: 0226 723242.
Frank Hepworth Ltd.,
9 Stainland Road,
Greetland, Halifax,
Yorkshire HX4 8AD.
Tel: 0422 72059.</p> <p>Republic of Ireland
Omnitek Ltd.,
45 Cookstown Estate,
Tallaght, Co. Dublin, Ireland.
Tel: (01) 521036.</p> <p>Guernsey
Guernsey Computers Ltd.,
33 Commercial Arcade,
St. Peter Port, Guernsey,
Channel Islands.
Tel: 0481 28738.</p> |
|---|---|--|---|--|--|

Service that's as good as Atari.

® ATARI and Design, Reg. in U.K. TM are trademarks of Atari Inc. SM is a service mark of Atari Inc. *VCS only.

THE COMPUTER FILE

COMPUTER AND ACCOUNTING MACHINE PLACEMENT SERVICE
10 RED LION ROAD - SURBITON - SURREY

Listed below are bargain priced computers available for sale. Call for a list at your leisure or visit us at our premises. You the dealer. Little or no running costs. Fully still in working order. Contract. Some available immediately. Available March/April.

DO YOU WANT TO SELL YOUR COMPUTER

7102 Olivetti: (Berks)
Olivetti Audit 7 machine complete with 128k RAM, 5 mb fixed, 5 mb removable. Offered for sale with 4 floppy drives and fully maintained since new. Available immediately for £2,300. Price to go £2,300.

LISTED EVERY MONTH

BARGAINS GALORE

7103 Olivetti: (Berks)

Olivetti Audit 7 machine complete with 128k RAM, 5 mb fixed, 5 mb removable. Offered for sale with 4 floppy drives and fully maintained since new. Available immediately for £2,300. Price to go £2,300.

7104 Philips P320: (Northampton)
Philips Informa 320, 1978 fully maintained since new and in excellent working order. Also available with machine is the following: 2 ledger card trays, 500 stock ledger cards, 231 purchase ledger cards, 385 nominal ledger cards, 417 payroll cards, 87 VAT analysis cards, 4 copies of Purchase/Nominal/Payroll tape systems, 4 blank ribbon tapes. Available immediately. Offers invited.

7105 Burroughs B80: (Sheffield)
1979 machine, with RAM increased to 128k, cartridge drive, 2 VDU's, integral printer and 18.8 mb fixed disk. 16 serviced cartridges (4.6 mb) are also included. Machine also runs cassette drive. Available immediately. Working life.

7106 Philips P320: (Northampton)
Philips Informa 320, 1978 fully maintained since new and in excellent working order. Also available with machine is the following: 2 ledger card trays, 500 stock ledger cards, 231 purchase ledger cards, 385 nominal ledger cards, 417 payroll cards, 87 VAT analysis cards, 4 copies of Purchase/Nominal/Payroll tape systems, 4 blank ribbon tapes. Available immediately. Offers invited.

7107 Olivetti: (Berks)
Olivetti Audit 7 machine complete with 128k RAM, 5 mb fixed, 5 mb removable. Offered for sale with 4 floppy drives and fully maintained since new. Available immediately for £2,300. Price to go £2,300.

7108 Adler: (Northampton)
10 months old & complete with 128k RAM, alpha numeric keyboard, NP manual, 61 continuous stationery sprocket feed, paper operator program control lights. The following software is available: - Mortgage, Investment Ledger, Dividend and Statement Preparation. Available immediately. £2,500 o.n.o.

7109 Olivetti: (Huddersfield)
Audit 7 machine complete with 2k RAM plus extended memory, 2 floppy drives with sprockets for continuous stationery, front feed facility, side table. Selection of programs and mag. cards included. Available now £850.00.

7110 Olivetti: (Huddersfield)
Audit 7 machine complete with 2k RAM plus extended memory, 2 floppy drives with sprockets for continuous stationery, front feed facility, side table. Selection of programs and mag. cards included. Available now £850.00.

7111 Olivetti: (Huddersfield)
Audit 7 machine complete with 2k RAM plus extended memory, 2 floppy drives with sprockets for continuous stationery, front feed facility, side table. Selection of programs and mag. cards included. Available now £850.00.

7112 Olivetti: (Huddersfield)
Audit 7 machine complete with 2k RAM plus extended memory, 2 floppy drives with sprockets for continuous stationery, front feed facility, side table. Selection of programs and mag. cards included. Available now £850.00.

7113 Olivetti: (Huddersfield)
Audit 7 machine complete with 2k RAM plus extended memory, 2 floppy drives with sprockets for continuous stationery, front feed facility, side table. Selection of programs and mag. cards included. Available now £850.00.

7114 Olivetti: (Huddersfield)
Audit 7 machine complete with 2k RAM plus extended memory, 2 floppy drives with sprockets for continuous stationery, front feed facility, side table. Selection of programs and mag. cards included. Available now £850.00.

7115 Olivetti: (Huddersfield)
Audit 7 machine complete with 2k RAM plus extended memory, 2 floppy drives with sprockets for continuous stationery, front feed facility, side table. Selection of programs and mag. cards included. Available now £850.00.

7116 Burroughs L9000: (Hill-on-Sea)
5 years old, only 3 years used. Fully maintained since new. Programs available: - Mortgage, Investment Ledger, Dividend and Statement Preparation. Available immediately. £2,500 o.n.o.

7117 Olivetti: (Berks)
Olivetti Audit 7 machine complete with 128k RAM, 5 mb fixed, 5 mb removable. Offered for sale with 4 floppy drives and fully maintained since new. Available immediately for £2,300. Price to go £2,300.

7118 Olivetti: (Berks)
Olivetti Audit 7 machine complete with 128k RAM, 5 mb fixed, 5 mb removable. Offered for sale with 4 floppy drives and fully maintained since new. Available immediately for £2,300. Price to go £2,300.

7119 Olivetti: (Berks)
Olivetti Audit 7 machine complete with 128k RAM, 5 mb fixed, 5 mb removable. Offered for sale with 4 floppy drives and fully maintained since new. Available immediately for £2,300. Price to go £2,300.

7120 Olivetti: (Berks)
Olivetti Audit 7 machine complete with 128k RAM, 5 mb fixed, 5 mb removable. Offered for sale with 4 floppy drives and fully maintained since new. Available immediately for £2,300. Price to go £2,300.

7121 Olivetti: (Berks)
Olivetti Audit 7 machine complete with 128k RAM, 5 mb fixed, 5 mb removable. Offered for sale with 4 floppy drives and fully maintained since new. Available immediately for £2,300. Price to go £2,300.

7122 Olivetti: (Berks)
Olivetti Audit 7 machine complete with 128k RAM, 5 mb fixed, 5 mb removable. Offered for sale with 4 floppy drives and fully maintained since new. Available immediately for £2,300. Price to go £2,300.

7123 Olivetti: (Berks)
Olivetti Audit 7 machine complete with 128k RAM, 5 mb fixed, 5 mb removable. Offered for sale with 4 floppy drives and fully maintained since new. Available immediately for £2,300. Price to go £2,300.

7124 Olivetti: (Berks)
Olivetti Audit 7 machine complete with 128k RAM, 5 mb fixed, 5 mb removable. Offered for sale with 4 floppy drives and fully maintained since new. Available immediately for £2,300. Price to go £2,300.

7125 Olivetti: (Berks)
Olivetti Audit 7 machine complete with 128k RAM, 5 mb fixed, 5 mb removable. Offered for sale with 4 floppy drives and fully maintained since new. Available immediately for £2,300. Price to go £2,300.

7126 Olivetti: (Berks)
Olivetti Audit 7 machine complete with 128k RAM, 5 mb fixed, 5 mb removable. Offered for sale with 4 floppy drives and fully maintained since new. Available immediately for £2,300. Price to go £2,300.

7127 Olivetti: (Berks)
Olivetti Audit 7 machine complete with 128k RAM, 5 mb fixed, 5 mb removable. Offered for sale with 4 floppy drives and fully maintained since new. Available immediately for £2,300. Price to go £2,300.

7128 Olivetti: (Berks)
Olivetti Audit 7 machine complete with 128k RAM, 5 mb fixed, 5 mb removable. Offered for sale with 4 floppy drives and fully maintained since new. Available immediately for £2,300. Price to go £2,300.

7129 Olivetti: (Berks)
Olivetti Audit 7 machine complete with 128k RAM, 5 mb fixed, 5 mb removable. Offered for sale with 4 floppy drives and fully maintained since new. Available immediately for £2,300. Price to go £2,300.

7130 Olivetti: (Berks)
Olivetti Audit 7 machine complete with 128k RAM, 5 mb fixed, 5 mb removable. Offered for sale with 4 floppy drives and fully maintained since new. Available immediately for £2,300. Price to go £2,300.

TO ADVERTISE YOUR OLD COMPUTER
Telephone: 01 350 2020

FREE VALUATIONS ★

2k Manual Invoice, Mag. cards. Also available for purchasing invoicing analysis, fully maintained. Available end of January. £1,000.

Commodore Pet 3032 (Manchester)
32k. Dual drive floppy disk 3040. 2 years old. Fully maintained. Available end of January. £1,000.

7110 Olivetti: (Huddersfield)
Audit 7 machine complete with 2k RAM plus extended memory, 2 floppy drives with sprockets for continuous stationery, front feed facility, side table. Selection of programs and mag. cards included. Available now £850.00.

7111 Olivetti: (Huddersfield)
Audit 7 machine complete with 2k RAM plus extended memory, 2 floppy drives with sprockets for continuous stationery, front feed facility, side table. Selection of programs and mag. cards included. Available now £850.00.

7112 Olivetti: (Huddersfield)
Audit 7 machine complete with 2k RAM plus extended memory, 2 floppy drives with sprockets for continuous stationery, front feed facility, side table. Selection of programs and mag. cards included. Available now £850.00.

7113 Olivetti: (Huddersfield)
Audit 7 machine complete with 2k RAM plus extended memory, 2 floppy drives with sprockets for continuous stationery, front feed facility, side table. Selection of programs and mag. cards included. Available now £850.00.

7114 Olivetti: (Huddersfield)
Audit 7 machine complete with 2k RAM plus extended memory, 2 floppy drives with sprockets for continuous stationery, front feed facility, side table. Selection of programs and mag. cards included. Available now £850.00.

7115 Olivetti: (Huddersfield)
Audit 7 machine complete with 2k RAM plus extended memory, 2 floppy drives with sprockets for continuous stationery, front feed facility, side table. Selection of programs and mag. cards included. Available now £850.00.

7116 Burroughs L9000: (Hill-on-Sea)
5 years old, only 3 years used. Fully maintained since new. Programs available: - Mortgage, Investment Ledger, Dividend and Statement Preparation. Available immediately. £2,500 o.n.o.

7117 Olivetti: (Berks)
Olivetti Audit 7 machine complete with 128k RAM, 5 mb fixed, 5 mb removable. Offered for sale with 4 floppy drives and fully maintained since new. Available immediately for £2,300. Price to go £2,300.

7118 Olivetti: (Berks)
Olivetti Audit 7 machine complete with 128k RAM, 5 mb fixed, 5 mb removable. Offered for sale with 4 floppy drives and fully maintained since new. Available immediately for £2,300. Price to go £2,300.

7119 Olivetti: (Berks)
Olivetti Audit 7 machine complete with 128k RAM, 5 mb fixed, 5 mb removable. Offered for sale with 4 floppy drives and fully maintained since new. Available immediately for £2,300. Price to go £2,300.

7120 Olivetti: (Berks)
Olivetti Audit 7 machine complete with 128k RAM, 5 mb fixed, 5 mb removable. Offered for sale with 4 floppy drives and fully maintained since new. Available immediately for £2,300. Price to go £2,300.

7121 Olivetti: (Berks)
Olivetti Audit 7 machine complete with 128k RAM, 5 mb fixed, 5 mb removable. Offered for sale with 4 floppy drives and fully maintained since new. Available immediately for £2,300. Price to go £2,300.

7122 Olivetti: (Berks)
Olivetti Audit 7 machine complete with 128k RAM, 5 mb fixed, 5 mb removable. Offered for sale with 4 floppy drives and fully maintained since new. Available immediately for £2,300. Price to go £2,300.

WORDSTAR* AND CP/M* MADE EASY!

Forget the manuals....use Sound Training Packs

Wordstar and CP/M are respectively one of the most popular word processing packages and most popular operating systems and both are arguably the most powerful.

Users will know that the accompanying manuals are comprehensive and thorough – but not the easiest to understand!



WORD PROCESSING WITH WORDSTAR and INTRODUCTION TO CP/M

enable the user to learn at his own computer, at his own pace, pausing and reviewing whenever necessary. As the user listens to the four sides of the ordinary audio cassettes, he is guided through the facilities available. At the same time he learns not only what Wordstar or CP/M does, but also how it does it.

Price of each Sound Training Pack £33.50 + VAT

*WORDSTAR is a trademark of Micropro International Corporation
*CP/M is a trademark of Digital Research Corporation

WORD PROCESSING WITH WORDSTAR and INTRODUCTION TO CP/M are two interactive Sound Training packs designed by leading UK training communication specialists, which enable users to operate Wordstar and CP/M easily and effectively within only a few hours – without the need to use the Wordstar and CP/M manuals!

The packs consist of:

- Two Sound Training audio cassettes providing an audio instruction course
- A reference manual which reinforces the main points made in the tapes
- A set of easy-reference job aids printed on card for permanent reference
- A smart "book-like" package which can be easily stored

Sound Training packs are designed and produced by consultants at Head Line Communication Limited, the training communication specialists. The packs are already used extensively for in-house training by large British companies and by many large computer dealers to train their customers in the use of software for microcomputers.



NEWTECH PUBLISHING LIMITED,
8 Camp Road, Farnborough,
Hampshire GU14 6EW
Telephone: (0252) 510331/2

ORDER FORM

To: NEWTECH PUBLISHING LIMITED,
8 Camp Road, Farnborough, Hampshire GU14 6EW
Telephone: (0252) 510331/2

- Please send me.....copy/ies of **Word Processing with Wordstar**
 Please send me.....copy/ies of **Introduction to CP/M**

@£40.00 each (including VAT & postage of £1.50)

I enclose my remittance of £.....made payable to Newtech Publishing Limited

or debit my Access Card No.

Name

Title

Company

Address

Date..... Signed

PCW1

BASF WINCHESTERS AND FLOPPY DRIVES AT SPECIAL INTRODUCTORY PRICES

These prices are valid only for orders received by 31.3.83

5 1/4" WINCHESTER HARD DISKS (ST-506 compatible)

- 6182 5.0 Mbyte formatted £499 + £10 Carriage + VAT = £585.35 inc.
- 6183 7.5 Mbyte formatted £575 + £10 Carriage + VAT = £672.75 inc.
- 6184 11.5 Mbyte formatted £650 + £10 Carriage + VAT = £759.00 inc.
- 6185 21.0 Mbyte formatted £799 + £10 Carriage + VAT = £930.35 inc.

Xebec S1410 HD Controller Card £350 + £5 Carriage + VAT = £408.25 inc.

Professional Switched Mode

PSU for HD drives with cover -
+5V @ 2A, +12V @ 4.5A £125 + £5 Carriage + VAT = £149.50 inc.

FLOPPY DISK DRIVES

- 6118-5 1/4" 96TPI DS 1Mbyte £225 + £10 Carriage + VAT = £270.25 inc.
- 6105-8 " Slimline DS/DD direct drive, DC only
1.6Mbyte £375 + £10 Carriage + VAT = £442.75 inc.

21 MBYTE HARD DISK SYSTEM

Super Fast Microcomputer
ONLY £4,000 + Carriage + VAT



- * Uses TALOS 3 Board
- * Z80B 6MHz
- * 20 Mbyte HD - expandable to 80 Mbyte
- * 64K RAM
- * One 8" thin drive for back-up expandable to 4!

WORLD'S MOST POPULAR DOT MATRIX PRINTER

NEC 8023BE-C

NEW LOWER PRICE

Now only £310 plus £8 carriage plus VAT @ £365.70 inc.

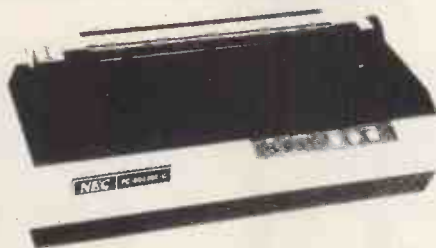

- 100CPS print speed
- Bi-directional logic seeking - increment mode
- 80, 136 column
- High resolution dot graphics - 144 x 160 dots/inch
- proportional spacing
- 7 x 9 dot matrix for alphanumerics & symbols
- 8 x 8 dot matrix for character generator graphics
- Output to printer on character by character or dot by dot basis
- Auto reversal (up to down) of ribbon maintains clarity for long period
- ASCII 96 characters - JIS 160 characters - character generator graphics 64 characters - European 14 characters
- Horizontal & vertical tabbing

FAST 100CPS DOT MATRIX PRINTER/PLOTTER

The Most Advanced Low Cost Printer Outstanding Graphics, Print Quality & Performance

Recommended Price £399 + VAT

Our price only £310 plus £8 carriage & VAT @ £365.70 inc.

Stand Alone Serial Interface (to 9,600 baud) with PSU & 4K buffer £90.00 + VAT = £109.25 inc.

- Lower case descenders
- Superscript subscript, underlining
- Several character sizes & styles (Pica, elite, proportional, reduced, enlarged, enhanced etc)
- 5 unique alphabets
- Greek and Math symbols
- Adjustable tractors
- Single sheet friction feed
- Powerful programmable paper feed
- Special ribbon cartridge
- Backward carriage return
- 4.5" to 10" paper width
- Original plus 3 copies
- Centronics type parallel interface (standard)
- 2K Buffer

THE BIGBOARD OEM - INDUSTRIAL - BUSINESS - SCIENTIFIC SINGLE BOARD COMPUTER PCB

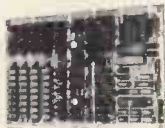

Vast user group & bi-monthly Journal "MICROCORNUCOPIA" details sent with documentation.

- 64K RAM
- 2 x RS232
- 24 x 80 characters
- Parallel ASCII Keyboard Port
- Real Time Clock
- 2K System Monitor
- Size: 8 1/2" x 13 1/2" same size as an 8" drive
- Z80 CPU
- Two Port parallel
- Video Port
- Floppy Disk Controller (1771) for up to 4 8" SSSD drives
- Runs CP/M 2.2
- 2K Character Generator (upper & true lower case)
- Requires +5V @ 3A, +12V @ 0.5A

Available ONLY as blank PCB which comes complete with full documentation, the Character Generator ROM, the PFM 3.3 Monitor ROM and a diskette with the Source of BIOS, BOOT, PFM 3.3 Monitor and Printer Routines

£115 + £5 P&P + VAT = Total £138

UP TO 9600 BAUD
4K BUFFER
ONLY £90 + VAT = £103.50 INC.

STAND ALONE multi Board Interface VL-964K

Recommended for NEC 8023BE-C, EPSON and OKI Series of Printers



Suitable for any Printer with centronics interface and any Computer with serial interface. VL-964K simply plugs into centronics port of the Printer and converts to serial to plug into RS232 port of the Computer.

- 4K Buffer
- Selectable Baud Rates 150 to 9600
- Completely cased
- All IC's socketed
- RS232 Cable (150cm) and Connector
- Self test facility
- Own PSU for 220-240V operation - Mains Cable 200cm ready plugged

VL-964K simply plugs into existing centronics port of the printer and RS232 port of the computer. No installation required! No interference with the Printer Motherboard! Does not invalidate any warranty!

As an official BASF distributor we are pleased to offer special low prices on BASF range of Winchesters and Floppies!

5 1/4" WINCHESTER HARD DISK DRIVES (Seagate ST506 compatible). All Winchesters are fully guaranteed for 12 months

- 6182 5 Mbyte formatted (6.38 Mbyte unformatted) ONLY £545 + £10 carriage + VAT
- 6183 7.5 Mbyte formatted (9.57 Mbyte unformatted) ONLY £599 + £10 carriage + VAT
- 6184 11 Mbyte formatted (14.4 Mbyte unformatted) ONLY £675 + £10 carriage + VAT
- 6185 20 Mbyte formatted (25 Mbyte unformatted) ONLY £899 + £10 carriage + VAT

Please telephone for quantity prices

FLOPPY DRIVES. Full 6 months guarantee!

- 6105 8" Slimline - half height DS/DD 1.6 Mbyte Direct Drive, DC Motor - no belts - no AC power - requires only +5V and 24V ONLY £399 + £5 carriage + VAT
- 6118 5 1/4" 2/3 height, 96 TPI, 80 track DS/DD 1 Mbyte ONLY £225 + £5 carriage + VAT

Please telephone for quantity prices



Vincelord Ltd

Suite 2, 26 Charing Cross Road, London WC2
Tel: 01-240 0213/01-240 0217 Telex: 295173 VILORD G

BASF MEDIA

- | | |
|---|----------------------------------|
| Part No: | 5 1/4" / 8" |
| 1S/SD SSSD per box of 10 | £15 + £1 P&P + VAT = £18.40 inc. |
| 1S/DD SSSD per box of 10 | £20 + £1 P&P + VAT = £24.15 inc. |
| 2S/DD per box of 10 | £25 + £1 P&P + VAT = £29.90 inc. |
| 1/96 TPI DS/DD 80 track ONLY 5 1/4" | £35 + £1 P&P + VAT = £41.40 inc. |
| 2/96 TPI DS/DD 80 track ONLY 5 1/4" | £40 + £1 P&P + VAT = £47.15 inc. |

DEALER ENQUIRY WELCOME

TABS PEACHTREE DBASE II

Rolled into one
gives you

UNEK

A BUSINESS SOLUTION WITH A DIFFERENCE !

"Unek" offers you one of the most comprehensive suits of CP/M based integrated business systems. Only with "Unek" can you customise a package to any degree without one programme change.

Using the "Unek Modifier", systems can be totally tailored or created in a matter of hours; in fact you'll wonder why you ever bothered with other software.

"UNEK" TURNS YOUR SOFTWARE NIGHTMARES INTO DREAMS

APPLICATIONS COVERED:

PRICES FROM: £225

Sales Ledger with Invoicing
Purchase Ledger
Nominal Ledger
Management Accounts
Incomplete Records
Sales Order Processing
Stock Control
Clothing Import/Export
Motor Dealers Package
Freight Forwarding Accounting

TELEPHONE 01-486 7498

SGS SOFTWARE PRODUCTS LIMITED 66 MARYLEBONE LANE,
LONDON W1

NOW AVAILABLE
UNDER 16 BIT
MS DOS

OSBORNE 1

Double density

+ Praxis 35
Daisywheel printer
Lease from **£8.89** per wk
or **£1589+** + vat Cash

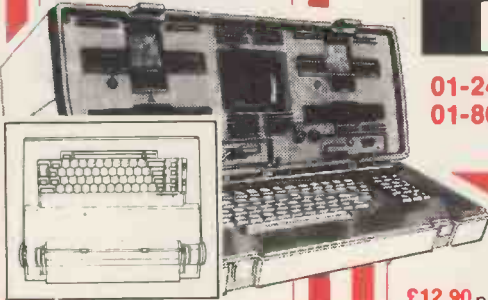

Single Density + Praxis35
£1489 + vat Cash
Osborne 1 + Monitor
£1250 + vat Cash
Osborne 1 Double
density lease from
£6.99 per week

UCSD software
available soon

NEC PC-8000

£397 Colour
Japanese quality &
reliability

cheaper than Atari 800

Authorised Dealer

SILICON VALLEY COMPUTER CENTRE

01-242 2803/6 Manchester **061-228 1686** GLASGOW **041-638 3487**
01-800 8185 792 2773 Birmingham **021-233 1000**
Bristol **0272-214 572**
Edinburgh **031-225 7446**

Victor 9000/ ACT SIRIUS

£12.90 per week for dual
floppy drive system with
1.2 Mbytes

£15.60 per week for double-
sided floppy drive version
offering 2.4 Mbytes

£21.50 per week for
10 Mbytes (formatted)

5 $\frac{1}{4}$ " integral Winchester
drive

From **£2395**
+ vat Cash.

Z80 card available
to allow all standard
CP/M 80.



Authorised Dealer

The Permanent Silicon Valley Computer Show

Group 18 Ltd,
Unit 104/105,
16 Baldwin Gardens,
Holborn,
London EC1N 7RJ



New Apple II e 64K **£845+** vat Cash Authorised Dealer



CAL PC
8-bits better than
IBM PC £1995+ vat cash
One 16 bit Intel 8088
Processor + One 8 bit
Zilog Z80-B Processor
128K Bytes Expandable
Operating systems CP/M
CP/M86 MS-DOS BOS



AMBASSADOR CLASS SERVICE

**Full Software back-up.
Maintenance & full after-sales service.
Installation & demonstration on site.
Personalised advice.**

Call for more
details on our
 $\frac{1}{2}$ day
Seminars.

NEW The Permanent Silicon Valley Computer Show

Manchester:
12 Lever Street,
Piccadilly,
Manchester
061-228 1686
792 2773

EPSON HX 20 **£402**



Dealer
enquiries
welcome

Peripherals:

12" green screen monitor **£79**
TEC-starwriter, Daisywheel
printer. 25, 40, 55, C.P.S.*
New EPSON printers
RX-80 100cps.
FX-80 160cps.
* Price too low
to print.

QX10 available soon.

SOFTWARE:

For Apple, Atari, IBM, Sirius,
Trs 80 & CP/M compatible
machines... New large list
of software available, covering
all popular machines (**over
3000 items**). For full catalogue
tick box in coupon now.
Ashton Tate d-BASE II
£299

Special Offer:
Complete set of
Accounting Software
(Invoicing, Stock Control, Sales
Ledger, Nominal Ledger,
Purchase Ledger, & Payroll)
at giveaway price of **£299**
(normal cost **£1500**) available
with every micro purchased.
On CP/M & Sirius only

Large selection of Books.

For more information FREEPOST My interests are:
to: Silicon Valley - Group 18,
FREEPOST, London N15 6BR

- Please send me further details about leasing.
 Software catalogue. $\frac{1}{2}$ Day Seminars.

Name
Position
Company
Address
Tel



The XEROX 820 series needs _ _ _



_ professional software for business

ISBS-F – the totally integrated business software system for microcomputers. Designed to perform day to day accounting and administrative functions in most business environments.

A few examples of the key business benefits from using ISBS-F are:

- optimum stock holding to keep costs to a minimum
- speedy invoice productions with stock release and posting to the sales ledger
- statements produced quickly at month end
- vat analysis at the touch of a button
- improved credit control
- monitor performance easily using budgets and financial reports.

With over 3000 program modules already being used in many different types of industries and professions, ISBS-F offers reliability, backed-up by support, and at reasonable cost.

ISBS-F is available as individual modules or bundles so that configurations can fit the exact business environment. Each

module is supplied on floppy disk with comprehensive documentation.

ISBS-F can be used on either the 5¼" or 8" versions of the Xerox 820 microcomputer. The system runs under CP/M* with a minimum of 48k memory, dual floppy disks and 132 column printer.

In addition to ISBS-F, to provide for the larger business user, we have the ISBS-W suite. ISBS-W is an advanced integrated business system for users of hard disk microcomputers, operating in a single or multi-user environment.

For further details or a demonstration of any of our software products, call your nearest Xerox Store or Dealer.

Graffcom Business Applications
102 Portland Road London W11 4LX 01-727 5561

Rank Xerox (UK) Ltd
Bridge House Oxford Road Uxbridge
Middlesex UB8 1HS 0895 51133

G R A F F C O M

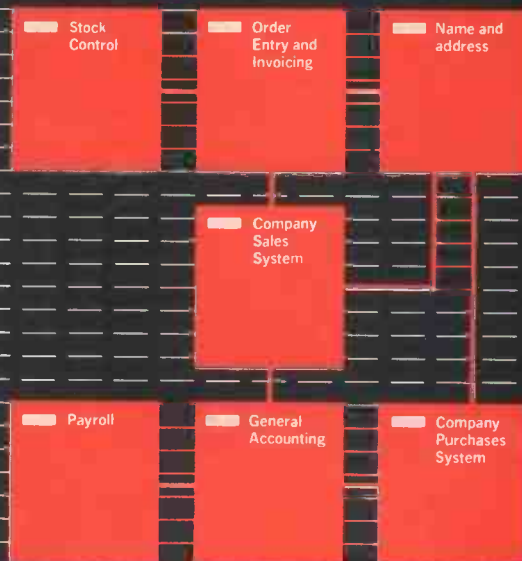

WATFORD ELECTRONICS

33 (PCW) Cardiff Road, Watford, Herts, England
Tel: Watford (0923) 40588. Telex: 8956095

ALL DEVICES FULL SPEC. AND FULLY GUARANTEED. TERMS OF BUSINESS: CASH/CHEQUE/P.O.S. (OR ACCESS) WITH ORDER. GOVERNMENT AND EDUCATIONAL INSTITUTIONS OFFICIAL ORDERS ACCEPTED. TRADE AND EXPORT INQUIRIES WELCOME. (P&P add 50p on all cash orders). Unless stated otherwise.
VAT ALL PRICES ARE EXCLUSIVE OF VAT. PLEASE ADD 15% TO THE TOTAL COST INCLUDING P&P. SHOP HOURS: 9.00am-6.00pm MONDAY TO SATURDAY. AMPLE FREE CAR PARKING SPACE AVAILABLE.
FOR QUANTITY PRICES PHONE WATFORD (0923) 40588

Computer IC's

1702	350	
1802CP	850	
2112-2	250	
2114L-300n	90	
2141L-200n	425	
2147-3	300	
2532-450n	300	
2564	8	
2708	225	
2716-5V	225	
2732-450n	350	
3242	575	
3244	390	
4027	190	
4118-150	85	
4118-200	80	
4118-250	325	
4164-200	425	
4334-3	325	
(CMOS 2114)	325	
4532-3	225	
4816A 100nS	450	
4864 364K	425	
5101	220	
6116-150ns	550	
6116-120nS	550	
6117-100n	490	
6167-6	795	
6502 CPU	600	
6503	600	
6504-250	550	
6521	600	
6522 VIA	215	
6530 RRIOT	600	
6532 RIOT	570	
6545 CRT	895	
6551 ACIA	220	
6592 PC	220	
6800	220	
6802	250	
6803	220	
6804	160	
6805	670	
6808	520	
6809	630	
6810	115	
6820	110	
6821	110	
68821	375	
6840	375	
6843	612	
6845	850	
6847	680	
6850	110	
6852	250	
6854	595	
6875	600	
68000	£78	
74C922	420	
8080A	350	
8085A	350	
8088	18	
81LS95	80	
81LS96	80	
81LS97	80	
81LS98	85	
8118-10	225	
8123	125	
8155	350	
8156	350	
8202	£25	
8205	225	
8212	425	
8214	225	
8215A-300	300	
8216	100	
8224	220	
8226	220	
8228	220	
8243	270	
8250	250	
8251	250	
8253	250	
8255	250	
8256A	400	
8257	395	
8259	395	
8271	32	
8279	385	
8284	350	
8288	10	
8266A	99	
8277	75	
8278A	120	
8281	350	
8295N	90	
8297N	90	
9364AP	550	
9602	220	
AM26LS31C	125	
AM26LS32A	125	
AY-3-101S	300	
AY-3-1270	675	
AY-3-8910	375	
AY-5-1013	300	
AY-5-1350	388	
AY-5-2376	600	
AY-5-3600	750	
COM8017	225	
COM8116	700	
DM8131	275	
DP8304BN	250	
DS3691N	320	
DS88LS120N	275	
DS88LS120N	275	
DS88LS120N	275	
DS88LS120N	275	

TTL74

7400	11	
7402	11	
7404	13	
7406	15	
7407	15	
7408	15	
7409	20	
7410	20	
7411	15	
7412	15	
7413	20	
7414	20	
7415	20	
7416	14	
7417	14	
7418	14	
7419	14	
7420	15	
7421	15	
7422	20	
7423	15	
7424	20	
7425	20	
7426	20	
7427	14	
7428	14	
7429	14	
7430	14	
7431	14	
7432	14	
7433	14	
7434	14	
7435	14	
7436	14	
7437	14	
7438	14	
7439	14	
7440	14	
7441	14	
7442	14	
7443	14	
7444	14	
7445	14	
7446	14	
7447	14	
7448	14	
7449	14	
7450	14	
7451	25	
7452	20	
7453	20	
7454	170	
7455	20	
7456	20	
7457	20	
7458	20	
7459	20	
7460	20	
7461	20	
7462	20	
7463	20	
7464	20	
7465	20	
7466	20	
7467	20	
7468	20	
7469	20	
7470	20	
7471	20	
7472	20	
7473	20	
7474	20	
7475	20	
7476	20	
7477	20	
7478	20	
7479	20	
7480	20	
7481	20	
7482	20	
7483	20	
7484	20	
7485	20	
7486	20	
7487	20	
7488	20	
7489	20	
7490	20	
7491	20	
7492	20	
7493	20	
7494	20	
7495	20	
7496	20	
7497	20	
7498	20	
7499	20	
7500	20	
7501	20	
7502	20	
7503	20	
7504	20	
7505	20	
7506	20	
7507	20	
7508	20	
7509	20	
7510	20	
7511	20	
7512	20	
7513	20	
7514	20	
7515	20	
7516	20	
7517	20	
7518	20	
7519	20	
7520	20	
7521	20	
7522	20	
7523	20	
7524	20	
7525	20	
7526	20	
7527	20	
7528	20	
7529	20	
7530	20	
7531	20	
7532	20	
7533	20	
7534	20	
7535	20	
7536	20	
7537	20	
7538	20	
7539	20	
7540	20	
7541	20	
7542	20	
7543	20	
7544	20	
7545	20	
7546	20	
7547	20	
7548	20	
7549	20	
7550	20	
7551	20	
7552	20	
7553	20	
7554	20	
7555	20	
7556	20	
7557	20	
7558	20	
7559	20	
7560	20	

WE-ROM[®] for Acorn ATOM

A highly sophisticated Acorn ATOM Utility ROM. Plugs straight into floating point Atom's Utility socket. Gives many unique BASIC Extensions: Hi-speed tape interface; 2 Key rollover Keyboard; Full disassembler; Memory dump modify; Error trapping; READ, DATA & RESTORE; Full BASIC Keyboard scanner BBC like; Find line & delete; Auto line numbering; Plus Chain Cursor movement, Loop aborting. Easily extendible further. Manual supplied.

Introductory Offer: £10

JUPITER ACE

Microcomputer that uses FORTH £78

ULTIMUM:

WATFORD's own most versatile MICRO EXPANSION SYSTEM. Ideal for interfacing with APPLE, ATOM, DRAGON, PET, RESEARCH MACHINE, SPECTRUM, SUPERBOARD, UK101 VIDEO GENIE, ZX81, etc.

Low cost, high spec. As published in Practical Electronics starting from November 1982 issue. Send SAE for details.

BBC MICRO & UPGRADE KITS

Upgrade your BBC Micro with our Upgrade Kits and save yourself £55...

- Model A £295; Model B £395 (incl) £18.00
- 16K Memory (8x 4816AP-100nS) BBC1 £8.20
- Printer User I/O Port BBC2 £12.00
- Complete Printer Cable 36" £12.00
- Disc Interface Kit BBC3 £41.00
- Analogue I/O Kit BBC4 £6.75
- Serial I/O Kit BBC5 £7.50
- Expansion Bus Kit BBC6 £6.50
- Model A to Model B Upgrade Kit £45.00
- Joysticks for BBC (per pair) £12.00

Complete range of Connectors & Cables available. Send SAE for list.

We specialise in BBC Peripherals, Software and Accessories. Just phone us for your requirements.

FLOPPY DISC DRIVES



- TEAC FD-50A Single Uncased 40 track S/sided 100K £125
- TEAC FD-50A Single Cased 40 track S/sided 100K £180
- TEAC FD-50A TWIN Cased 40 track S/sided 200K £335
- TEAC FD-50A Single Cased 40 track S/sided 200K £238
- SIEMENS FDD 100-5 Cased, Head Motors, track zero, micro switch motor control PCB with read write and control electronics plus cable. Special Apple Compatible £215
- Apple Disc Interface Card £38
- Apple 80 Column Card £125
- 2 Drives Daisy Chain cable £13
- Single Drive Cable £8
- 10 Verbatim Diskettes 5 1/4" SSSD £20
- 10 Verbatim Diskettes 5 1/4" DSSD £30
- 10 Verbatim Diskettes 8" SSDD £30

SPECIAL OFFER

2532	1+	330p	295p
2732		350p	330p
2764		550p	425p
4116-200n		85p	80p
6116		390p	360p
6522		300p	280p

Just phone your order through, we do the rest.

EPSON PRINTERS



Only £324 (carr £7) Price includes FREE 500 sheets of paper

MX80FT/3 10" Tractor & Friction Feed 9x9 matrix, 80 column, Speed 80CPS, Bi-directional, Centronic Interface Baud Rate 110-9600 (RS232) Hi-res, Bit image, graphics, Subscript & Superscript, Italics & Underlining facility. Fully guaranteed. £324 (carr £7)

MX100FT/3 136 columns, 15" carriage, plus all the facilities of MX80FT/3. Only £425 (carr £7)

ACCESSORIES

- TEX EPROM ERASER. Erases up to 32 ICs in 15-30 min. £33
- TEX EPROM ERASER with incorporated Safety Switch £38
- Electronic Timer Solid state. Connects directly to above Erasers. Protects your expensive Chips from overcooking. Our timer pays for itself in no time. £15
- Tex Eprom Eraser including the Electronic timer. £44
- Spare UV lamp bulbs £9
- POWER SUPPLY Regulated, overload protection. Variable: 5V to 15V @ 4A £38
- Multirail psu kit including Case. Output: +5V/5A; +12V, +25V, -5V, -12V @ 1A. Only £39 (p&p 95p)
- Attractive Beige/Brown ABS CASE for Superboard/UK101 or Home Brew £26
- C12 Cassettes in Library Cases 40p
- 8" Fan fold paper (1000 sheets) £7
- 9 1/2" Fan fold paper (1000 sheets) £7
- Teletprinter Roll 250p
- UHF Modulator 6MHZ 325p
- UHF Modulator 8MHZ 450p
- Stack Pack the unique stackable twin drawer racking system for Computer Cassettes. 5 Drawers (10 sections) including labels. 250p
- Stack Pack incl. 10 off C12 Computer Cassettes. 550p

Europe's most popular Printer

NEC PC8023-C



Bi-directional, 80 column, 100CPS, Logic seeking, Hi-Res, block graphic Forward and Reverse line feed, proportional spacing, true descenders, 2K buffer, as a giveaway price: Only £320 (car. £7)

SEIKOSHA GP100A



Price includes FREE 500 Sheets

Unihammer Printer, gives normal and double width characters as well as dot resolution graphics 10" Tractor feed. Parallel interface standard. £175 (£7 car.) SEIKOSHA GP250X Only £235 (£7 car.)

SOFTY 2

Price includes FREE 2532 Softy is an intelligent EPROM Programmer & Emulator. Has Memory Map TV Display, RS232 & Centronics I/P & O/P. Copies, Emulates and programs EPROMS. RS232/Centronics routines standard includes PSU. £169

CRYSTALS

32 768KH	100	16.0MHz	200
1MHz	275	18.0MHz	180
1.6MHz	392	18.432M	150
1.8MHz	395	19.668M	150
1.843M	200	20.0MHz	200
2.0MHz	225	24.0MHz	170
3 2768M	300	24.830M	325
3.57594	98	48.0M	375
3.6864M	300	100.0M	375
4.0MHz	150		
4.433619	100		
5.0MHz	160		
6.0MHz	140		
6.144MHz	150		
6.5366M	200		
7.0MHz	150		
7.168MHz	160		
7.68MHz	200		
8.0MHz	150		
9.0MHz	200		
9.375M	350		
10.0MHz	175		
10.7MHz	150		
10.24MHz	200		
12.0MHz	175		
12.528M	100		
14.31818	170		

IDC Connectors:

Speed Block type	PCB Plug with latch	Female Header Socket	Female Card-Edge Connectors
Two rows	90p	93p	85p
10 way	100p	130p	100p
20 way	145p	165p	125p
26 way	175p	200p	150p
34 way	205p	236p	160p
40 way	220p	250p	320p
50 way	235p	270p	395p

ENGLAND

AVON
Datalink Micro Computer Systems
Tel: 0272 213427
Decimal Business Machines
Tel: 0272 214093
Delico Information Systems
Tel: 0272 23352 & 299422
Guestel Ltd.
Tel: 0272 277461

BEDFORDSHIRE
Computopia Ltd.
Tel: 0525 376600

BERKSHIRE
Cascade Computers
Tel: 0635 201591
Data Supplies Ltd.
Tel: 02814 2359
Decision Support Systems Ltd.
Tel: 0628 76887/8
Floodream Ltd.
Tel: 0734 583886

Lynx Computers Ltd.
Tel: 07535 56322
ME Electronics
Tel: Reading Berks. 0734 669480
Personal Computer Palace
Tel: 0734 589249
Thames Valley Systems
Tel: Reading Berks. 0734 581829

BUCKINGHAMSHIRE
Actiondata Ltd.
Tel: 0494 716171
Bits & Bytes Ltd.
Tel: 06285 26535
Chiltern Micro Computers Ltd.
Tel: 02813 88832
Computer Modelling Ltd.
Tel: 049481 6181
Milton Keynes Computer Centre Ltd.
Tel: 0908 668811
Neath Hill Professional Workshop
Tel: 0908 660364

CAMBRIDGESHIRE
Eicon Research Ltd.
Tel: 0954 81825
QIS Computer Services Ltd.
Tel: 0733 47191

CHESHIRE
Fairhurst Instruments Ltd.
Tel: 0625 525694
Mid-Shires Computer Centre
Tel: 0270 211086
Northern Computers
Tel: 0928 35110
SSL System Support Services
Tel: 09367 3842
U-Microcomputers Ltd.
Tel: 0925 54117/8

CLEVELAND
Micro-Technic Computer Systems
Tel: 0642 221501

DERBYSHIRE
Datron Micro Centre
Tel: 0332 380085
Donnington Computers
Tel: 0332 49672
Impact Micro Computer Services
Tel: 0773 831547

DEVON
Devon Computers
Tel: 0803 526303
JAD Integrated Services Ltd.
Tel: 0752 662616
Southern Computer Systems & Services Ltd.
Tel: 0803 212957

DORSET
Computacenter
Tel: Christchurch Dorset 0202 476951
Deverill Computer Services Ltd.
Tel: 0202 684441

ESSEX
Clacton Computer Centre
Tel: 0255 23160
Colin Grace Associates Ltd.
Tel: 0799 22532
Compuskill
Tel: 0708 751906
Essex Computer Centre Ltd.
Tel: 0245 358702
Microcore Ltd.
Tel: 0245 64230
Strident Computer Services Ltd.
Tel: 0787 476938 & 476940

GREATER MANCHESTER
Advanced Business Computers
Tel: 061-835 1477
Eclipse Computer Services Ltd.
Tel: 061-793 5622
Professional Data Systems
Tel: 0204 493816
Quodport Ltd.
Tel: 061-969 8729

HAMPSHIRE
A J Hales Computers
Tel: 04215 62366/7
G & M Management Services Ltd.
Tel: 0703 30664
Grist Business Services Ltd.
Tel: 0703 39061/332145
Mitron (Electronics) Ltd.
Tel: 0962 55612

HEREFORDSHIRE
Farmplan
Tel: 0989 64321

HERTFORDSHIRE
HG Services Ltd.
Tel: 0727 30129
Jarman Services Ltd.
Tel: 0442 826841
Local Business Technology Ltd.
Tel: 09924 66157
Lombardy Computers
Tel: 04427 4247

HUMBERSIDE
Saville Data Systems
Tel: 0904 37700
ISLE OF WIGHT
Island Computer Systems Ltd.
Tel: 0983 529744

KENT
M D Wright Data Services Ltd.
Tel: 0227 69090
Microspot
Tel: 0622 858753
Protocol Computer Products
Tel: 01-464 0541

LANCASHIRE
Pete & Pam Computers
Tel: 0706 227011/2/3
Style Systems Ltd.
Tel: 0254 51051

LEICESTERSHIRE
Leicester Computer Centre Ltd.
Tel: 0533 556268

LONDON EAST
The City Computer Centre
Tel: 01-588 5537
Computacenter
Tel: 01-628 3040
CSS (Systems) Ltd.
Tel: 01-254 9293 & 1674
Guestel Ltd.
Tel: 01-583 2255
Keen Computers Ltd.
Tel: 01-248 7307
Personal Computers Ltd.
Tel: 01-377 1200
System Logic Ltd.
Tel: 01-981 7311
Time & People
Tel: 01-242 4706

LONDON NORTH
Computech Systems
Tel: 01-794 0202
Microcomputer Space Dome
Tel: 01-368 9002
Pear Computing Systems Ltd.
Tel: 01-267 0940
Stirling Microsystems
Tel: 01-486 7671
Liaison Microchip Ltd.
Tel: 01-807 1558

LONDON SOUTH
Advanced Micro Products Ltd.
Tel: 01-850 8280
CWP Computers
Tel: 01-828 3127
Logic Computer Systems
Tel: 01-222 1122/5492
Mister Calculator (CSS) Ltd.
Tel: 01-686 9616
Planning Consultancy Ltd.
Tel: 01-839 3143

LONDON WEST
Albion Computer Co.
Tel: 01-580 6787
Applitek
Tel: 01-995 5446

SPEAK TO US AND WE'LL SOON HAVE YOU TALKING TO A NEW APPLE

The above are just a selection of the many helpful Apple dealers around the country.

Most offer training courses as well as a complete back-up service, and many will lease you an Apple for as little as £70 a month.

Remember, whatever you do you do it better with Apple. And with a dealer network like ours it's easy and convenient to get started.

Everybody should have a friend like Apple.

Apple is a trademark of Apple Computer Inc., USA.



Deans of Kensington
Tel: 01-937 7896
Fletcher Dennys Systems Ltd.
Tel: 01-286 7374
General Microcomputer Systems Ltd.
Tel: 01-995 4998
Office Installations Ltd.
Tel: 01-579 6771
Rank Xerox Ltd.
Tel: 01-387 1244
The West London Micro Centre
Tel: 01-743 9000

MIDDLESEX
Fletcher Dennys Systems Ltd.
Tel: 01-570 8999
Hexagon Services
Tel: 0895 36832
Microsolve Computer Services Ltd.
Tel: 01-951 0218/9
Ozwise Computers
Tel: 01-429 1060
Rank Xerox Ltd.
Tel: 0895 51133
Simmons Magee Computers Ltd.
Tel: 01-891 4477
Twickenham Computer Centre Ltd.
Tel: 01-891 1612

NORFOLK
Jorroid Office Equipment
Tel: 0603 60661

NORTHAMPTONSHIRE
Co-Compute Ltd.
Tel: 0604 33767

NOTTINGHAMSHIRE
Keen Computers Ltd.
Tel: 0602 412777

OXFORDSHIRE
Micro Mark
Tel: 04912 77926
Oxford Computer Centre
Tel: 0865 49349

Rocon Ltd.
Tel: 0235 24206

SOMERSET
Taunton Electronics Ltd.
Tel: 0823 433142

STAFFORDSHIRE
Gardner Brown (Computers) Ltd.
Tel: 0283 36181/2
Micro Applications Ltd.
Tel: 0785 43415

SUFFOLK
Blyth Computers Ltd.
Tel: 050 270 371
Database
Tel: 0638 730625
Harram Computers
Tel: 028488 534
Micro Management
Tel: 0473 57871

SURREY
Fergusson Computers Ltd.
Tel: 093 23 45330
JD Financial Advisors
Tel: 09322 47888/9
Micro Facilities Ltd.
Tel: 0784 31333
Microlines Computers Ltd.
Tel: 01-546 9944
Rothwell Data Systems Ltd.
Tel: 0252 519441
Symbiotic Computer Systems
Tel: 01-683 1137
Vega Computers
Tel: 01-680 4484

SUSSEX
Computer Centre (BMS) Ltd.
Tel: 0424 439190
Crowborough Computing
Tel: 08926 63070
Datatech Ltd.
Tel: 0323 36268
Guestel Ltd.
Tel: 0273 695264

Hobbyist Ltd.
Tel: 0273 593345

TYNE & WEAR
Office Equipment Selection Ltd.
Tel: 0632 683333

WARWICKSHIRE
Impulse Micro Systems Ltd.
Tel: 0789 295819/297263
Templeman Software Ltd.
Tel: 0789 66237

WEST MIDLANDS
ABM Computers
Tel: 021-459 7481
Micro Applications Ltd.
Tel: 0922 644234
Micro-Business Centre
Tel: 0902 725687
Second City Software
Tel: 021-707 8739
Stewart Computer Services Ltd.
Tel: 021-632 4822
Westwood Computers
Tel: 021-632 5824

YORKSHIRE
Datron Micro Centre
Tel: 0742 755105
DMS Electronics
Tel: 0909 563918
Natcom Computer Systems Ltd.
Tel: 0532 452928
RAM Computer Services Ltd.
Tel: 0274 391166
Superior Systems Ltd.
Tel: 0742 755005
Taunton Electronics Ltd.
Tel: 0532 458815
Wharnclyffe Business Systems
Tel: 0226 298501

SCOTLAND
BORDERS
McQueen Systems Ltd.
Tel: 0896 4866/7/8

DUMFRIES
Criffel Micro Business Systems
Tel: 0387 69151/2
GRAMPIAN
Abtex Computer Systems Ltd.
Tel: 0224 550074/15/6
HIGHLANDS
Black Isle Systems Ltd.
Tel: 0381 20276
LOTHIAN
McQueen Systems Ltd.
Tel: 0731 2252774
Scotbyte Computers Ltd.
Tel: 031-343 1005
STRATHCLYDE
Masons Computer & Business Equipment Centre Ltd.
Tel: 0563 20985
Scotbyte Computers Ltd.
Tel: 0698 823 486
Strathand
Tel: 041-552 6731

WALES
GLAMORGAN
Cardiff Micro Computer
Tel: 0222 373072
Croeso Computer Services
Tel: 0792 61555/6
South Wales Computers Ltd.
Tel: 0222 490572
GWENT
Acorn Business Systems
Tel: 06333 72429
GWYNEDD
IDC Computer Services
Tel: 0248 724282

NORTHERN IRELAND
CEM Micro Computer Systems Ltd.
Tel: 0232 43564/44111
Imex Digital Ltd.
Tel: 0846 611551
Medical & Scientific Computer Services Ltd.
Tel: 08462 77533

The Dealer list above is not a list of all authorised Apple Dealers.
For a complete list write to Apple Computer (UK) Limited, Eastman Way,
Hemel Hempstead, Herts, HP2 4BR, FREEPOST.

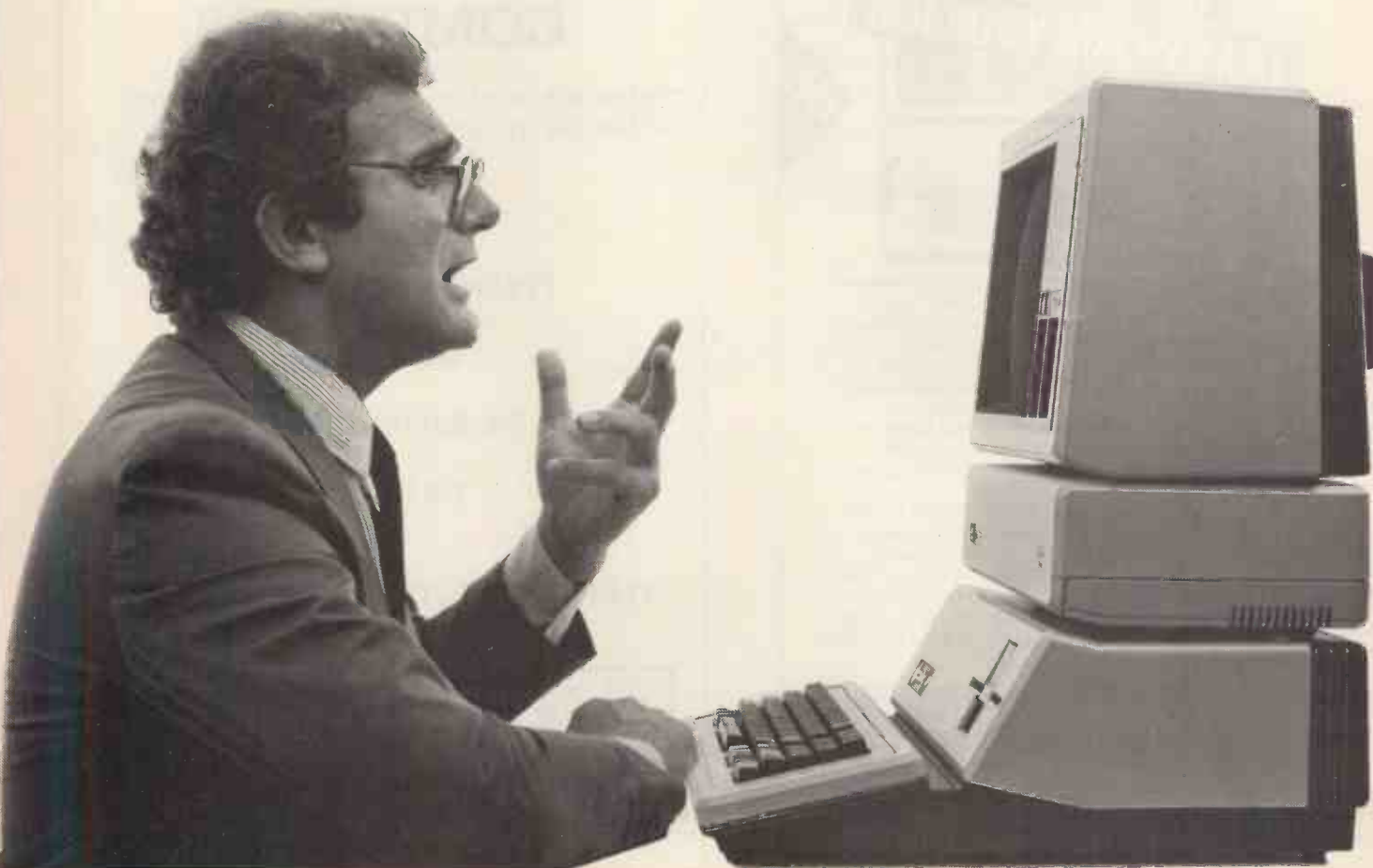

apple goodies from **SPOT**

High Speed Serial Interface Card

With full handshake - no more lost data. Switchable line lengths and Baud rates. DOS, Pascal and CP/M compatible. With full spec.

£75.00

Parallel Card - with lead and plug	£69.00
Numeric Keypad	£75.00
16K RAM Card	£69.00
16 Channel A/D Card	£89.95
8 bit parallel I/O Card	£69.95
EPROM Programmer Card	£69.00
EPROM Reader Card	£59.00
RGB Color Card with selectable text colors	£90.00
Discs - BASF SSSD, per 10	£15.00
Paper - 11 x 9.5", per box of 2000	£12.00

PAYROLL - 200

Very easy to use. Gives full calculation of all pay details. 8 user definable parameters for additions or deductions which may be pre or post tax. Hourly, Weekly or Monthly pay. Uses attractive pre-printed stationary for payslips and Giro's. Full report of dues for N.I. and Tax with coin analysis. Conforms with all IR Tax regulations. £295.00

Other specialist software -

Bar Stock Control	£150.00
Shoe Wholesalers	£350.00
Builders Estimating (CP/M)	£650.00
ZAPPLE - Disc Doctor	£45.00

Please add Postage, Packing plus VAT at 15% to all orders.
Postage £1 per item except paper at £3 per box.

Many Other goodies in stock - please ask for list
Dealer Enquiries Invited

Suppliers or computer systems, software, and for all of your computer requirements.



NEW STREET
KELHAM INDUSTRIAL ESTATE
DONCASTER
☎ Doncaster (0302) 25 159

SYSTEM SCIENCE CP/M SOFTWARE

FROM SOFTWARE TOOLWORKS

C/80 Compiler Ver 2.0 £50.00
Conforms to Kernishan & Ritchie. Lacks long and floating data types. Generates. REL files. Needs 48K.

SPELL £50.00
Fast, easy to use spelling error detection program. Effective dictionary of up to 50,000 words. 48K RAM.

RATFOR £42.00
Pre-processor for FORTRAN-80. Many 'Software Tools' programs inc.

LISP/80 Interpreter £42.00
For AI with examples. Requires 48K RAM.

TEXT-formatter £45.00
With many sophisticated features, including mail list, file inclusion, table of contents.

UVMAC-Z80 macro assembler £35.00
Generates absolute code.

COMPUTER CHEF £35.00
Recipe filer with 70-recipes. also useful for computer and keyboard training.

LABORATORY MICROSYSTEMS

Z80 FORTH Development System £45.00
Includes 90 page Manual and screens of software. Floating point version. £110.00

LYNX £215.00
Friendly overlay linking loader Fortran-80.

All of the above on 8" SSSD disc. Enquire for other formats

FOR THE OSBORNE

MYCHESS - Chess program £35.00
Pack and Crypt - file compression and encryption £30.00
MUNCHKIN and ADVENTURE each £30.00

Please send cheques or PO (add £2.00 postage) to:

SYSTEM SCIENCE

54 Enfield Cloisters, Farnshaw St, London N1 Tel: 01-739 0540



The Apple IIe personal computer was designed to take away your work, not your job. To give you time to produce your best efforts, not tie you up with time-consuming routines.

With the Apple IIe, you can construct and produce reports. Make charts and graphs. Get information from your company's main computer in the form you want, and when you want. Keep accurate lists of customer and business contacts. Plan and prepare budgets and forecasts.

Above all, you can have access to the largest number and variety of ready-made programs available on the personal computer market.

See your Apple dealer today and find out how an Apple IIe can help take a load off your shoulders.



LEICESTER

computer centre limited

67 Regent Road, Leicester LE1 6YF. Tel: 0533 556268

WESTWOOD COMPUTERS

Sales or hire of microcomputer systems, software, training and service support.

ACCOUNTING

FINANCIAL MODELLING

GRAPHICS

WORDPROCESSING

DATABASE

117 TENNANT STREET, BIRMINGHAM



021 632 5824



WORLD'S SMALLEST COMPUTER SYSTEM?

Breast Pocket Computer – A5 Book Size System.
More powerful than pocket computers costing up to twice as much

Sharp PC-1251 Computer **£79.95**
Plus FREE £10 software voucher

CE-125 Printer/Micro Cassette **£99.95**
Plus FREE £10 software voucher

Custom made for Sales Executives. Ideal for Engineers and Hobbyists, or as a starter computer that grows into a powerful, reliable system.

PC-1251. Massive memory: - 4.2K RAM (3.7K user) and 24K ROM for extended BASIC, including DIM, STRING and INKEY\$. Up to 18 programs stored in memory at once, each with its own execute key, plus reserve mode for frequently used commands. One-touch mode selector for Reserve/Program/Run. Full range of math and science functions. QWERTY keyboard. 24 digit dot matrix display. Auto power-off, with memory protection.

CE-125. Half the size of this page and less than 1 inch thick! 24 character thermal-printing of data, computation results, programs, etc. Integral micro cassette recorder for error-free saving/loading, plus built-in interface for standard cassette recorder. Will run existing PC-1211 software but many times faster! Powered by rechargeable NiCad batteries, or mains adaptor (supplied).

MICROL AND SHARP SOFTWARE AVAILABLE SOON
SEND FOR DETAILS



System Price £179.90
Including VAT and FREE £20 software voucher

Dimensions

PC-1251. 135 x 70 x 9.5mm (5 1/16 x 2 3/4 x 3/8"). Weight: 115g
CE-125. 205 x 149 x 23mm (8 1/16 x 5 7/8 x 29/32"). Weight: 550g

SHARP PC-1500 COLOUR COMPUTER

The world's most powerful pocket computer?

PRICES, including VAT and FREE software vouchers

PC-1500 Pocket Computer plus £20 software v **£169.95**
CE150 Colour Printer/Cass interface plus £20 v **£149.95**
CE-155 8K RAM Expansion Module plus £10 voucher ... **£79.95**
CE-159 8K RAM/ROM with battery back up + £10 v **£89.95**
CE-152 Custom Cassette Recorder plus £5 voucher **£39.95**
CE-153 140 key Software Board plus £10 voucher **£79.95**
CE-158 RS-232C Interface plus £20 voucher **£149.95**

SOFTWARE AND ACCESSORY LIST ON REQUEST

PRICES include VAT, P&P. Offers are subject to availability. Send cheques, P.O., or phone your credit card no. to:

MICROMAIL

Dept PCW, 31 Burleigh Street
Cambridge CB1 1DG
Telephone: 0223 312453

THE **ACT Sirius 1**

MICROCOMPUTER
(includes 128K memory, CP/M86, MS.DOS & MS BASIC 86)

plus! The EPSON MX100 Printer (136 column 100 cps)
WORTH £500!

NATIONWIDE
MAINTENANCE
AVAILABLE

LOOK! only £2395.00*

MACHINES ALWAYS EX-STOCK



OFFICE EFFICIENCY MACHINES LTD

ENQUIRIES – CALL OUR WEST LONDON OFFICES ON 01-741 7211/2/3/4

TO ORDER YOUR MACHINE CALL OUR HOTLINE – 01-748 8404 or TELEX 263559 MICRO G



includes
CPM OPERATING SYSTEM,
WORDSTAR, MAILMERGE,
SUPERCALC, M BASIC &
C BASIC WORTH £800 FREE



To: Office Efficiency Machines Ltd.,
1 Lochaline Street, London W6 9SJ
Telex 263559 Micro G

Please send me information on the
 Dealer End User
 Urgent Please phone me

Name _____

Company _____

Address _____

Telephone _____

PCW1

*WHILST OFFER LASTS

DEALERS WELCOME!

**Having
nightmares over**

SSP

sweet
**Here's a dream
of an answer
from**

FAST

© 1982

FINANCIAL ACCOUNTING SOFTWARE from TRIDATA

The FAST payroll package from Tridata, probably the most comprehensive payroll available in the U.K. for microcomputers, now incorporates the necessary procedures for maintaining statutory sick pay records required by the DHSS.

As an employer you are required by law to record this information and be in a position to furnish the details on demand. For information on how the fast payroll package and other modules in the range, can provide a solution, contact your local dealer or send the coupon below to Sales & Marketing Department, FREEPOST address.

**APPLICATIONS ARE INVITED FROM
MICRO COMPUTER RETAILERS AND
DEALERS WISHING TO BECOME
APPROVED SUPPLIERS OF**

FAST

SOFTWARE PRODUCTS.

PLEASE SEND ME DETAILS ABOUT **FAST** BUSINESS SOFTWARE

- SALES LEDGER PURCHASE LEDGER NOMINAL LEDGER
 STOCK CONTROL PAYROLL DEALER PLANS

NAME _____

ADDRESS _____ PCW/02/83

TEL. NO. _____

TRIDATA MICROS LTD., FREEPOST, BIRMINGHAM B5 4BR. TEL: 021-622 6085

TRIDATA SOFTWARE IS GUARANTEED FOR A PERIOD OF 1 YEAR

WHEN IT COMES TO MICROCOMPUTER SOFTWARE WE WROTE THE BOOK

How do you stay up-to-the-minute with the rapidly changing world of microcomputer software? Get the Lifeboat Catalogue.

The latest innovations The new Lifeboat Catalogue is packed with the latest state-of-the-art software. And if we publish a new program after the latest catalogue has gone to press, we enclose a flash bulletin in your copy.

The greatest selection Because Lifeboat is the world's largest publisher of microcomputer software, our catalogue offers you the greatest selection of programs for business, professional and personal use. Our more than 200 programs range from the integrated accounting and professional practice systems to office tools for book-keepers and secretaries to sophisticated tools for programmers. Included are business systems, word processors, programming languages, database management systems, application tools and advanced system utilities.

We specialise in software that runs on most small business computers. Our more than 60 media formats, including floppy disks, data cartridges, magnetic tape and disk cartridges, support well over 100 different types of computer.

Get full service We give the crucial dimension of after-sales service and full support to everything we sell.

That includes:

- An update service for software and documentation.
- Telephone, telex and mail-order services in the London office and at overseas offices in the United States, France, Switzerland, West Germany and Japan.
- Subscriptions to Lifelines™, the monthly magazine that offers comparative reviews, tips, techniques, identified bugs and updates that keep you abreast of change.

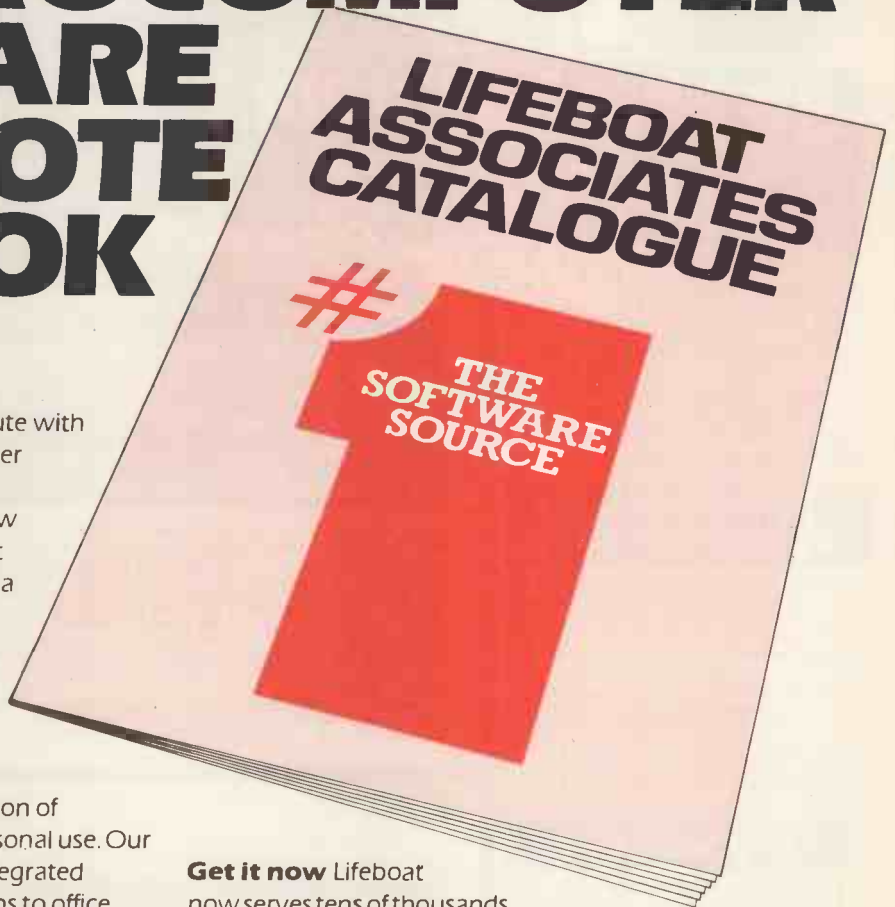

Get it now Lifeboat now serves tens of thousands of satisfied customers with our breadth of up-to-date, fully tested, fully supported and competitively priced software.

You may not need all we offer, but we offer just what you need. After all, we wrote the book.

#1 Lifeboat Associates
World's foremost software source

Mail coupon to: Lifeboat Associates
PO Box 125, London WC2H 9LU or call 01-836 9028

Please send me a free lifeboat catalogue.

Name

Title

Company

Address

Postcode

Copyright © 1981, by Lifeboat Associates.

PCW/3/83

Lifeboat Worldwide offers you the world's largest library of software. Contact your nearest dealer of Lifeboat.

USA Lifeboat Associates 1651 Third Ave. New York NY 10028 Tel (212) 860-0300 Telex 640693 (LBSOFT NYK) TWX 710 581-2524 **JAPAN** Lifeboat Inc. OK Bldg. 5F 1-2-8 Shiba-Daimon Minato-ku Tokyo 105 Japan Tel 03-437-3901 Telex 2423296 (LBJTYO) **ENGLAND** Lifeboat Associates Ltd PO Box 125 London WC2H 9LU England Tel 01-836 9028 Telex 893709 (LBSOFTG) **SWITZERLAND** Lifeboat Associates GmbH Hinterbergstrasse Postfach 251 6330 Cham Switzerland Tel 042-36-8686 Telex 865265 (MICO CH) **WEST GERMANY** Intersoft GmbH Schlossgartenweg 5 D-8045 Ismaning W. Germany Tel 089-966-444 Telex 5213643 (ISOFD) **FRANCE** Lifeboat Associates SARL 10 Grande Rue Charles de Gaulle 92600 Asnieres France Tel 1-733-08-04 Telex 250303 (PUBLIC X PARIS)

SPECTRUM

AN APOLOGY from Spectrum UK

We'd like to apologise on behalf of all SPECTRUM dealers and in fact our suppliers. Unprecedented demand has caused a severe shortage of home computers nationwide. This situation is liable to continue for a few weeks, but as soon as new stocks are available your local SPECTRUM dealer will be among the first to have them.

INTRODUCING SPECTRUM FACTS!

Next to many of our offers, you'll find a few lines tagged SPECTRUM FACT. We pride ourselves on providing you, the customer, with a genuine service as well as the lowest prices, so we want you to know that when you buy from a SPECTRUM dealer, you'll get exactly the right Micro for your needs. SPECTRUM FACTS are there to clarify some of the more obscure bits of computer 'jargon' - so you'll know exactly what each machine can do. SO LOOK OUT FOR YOUR SPECTRUM FACTS!

After Sales care

SPECTRUM service centres will ensure that should your machine 'go-down' we will get it running again as quickly as possible. We also offer extended warranties at reasonable prices too! - ask your SPECTRUM HOME COMPUTER CENTRE for full details.

COMPUTER DEALERS!

(or prospective Computer Dealers!)

If you would like to know more about becoming a SPECTRUM APPOINTED DEALER on an exclusive area basis, please contact MIKE STERN or ALAN WARREN on (07073) 34761.

Spectrum (U.K.) Ltd.,
Burrowfield,
Welwyn Garden City, Herts.

COLOUR GENIE



Here it is - the Micro that's a genius at colour!

The new COLOUR GENIE features powerful and sophisticated COLOUR GRAPHICS, allowing you to create full 8-colour Games, Diagrams and Charts quickly and simply.

For its low SPECTRUM price, the Colour Genie is amazingly versatile - its Powerful 16K RAM memory (expandable internally to 32K) means FULL COLOUR video games and POWERFUL COMPUTING with a full range of inexpensive accessories: 16K RAM pack, Joysticks for TV games, Light Pen, Disk Drive and a Printer.

But that's not all - the Colour Genie also features a 16K ROM Memory with 128 Upper and Lower case Colour Graphics Characters already stored, plus sound, a professional typewriter keyboard, high 160x96 pixel resolution and interfacing with virtually any cassette recorder available.

In use, it's as straightforward as any, thanks to the use of BASIC language and direct keyboard-accessed colour commands.

The superb Colour Genie is at SPECTRUM now - check it out and see our Genius at work!

COLOUR GENIE ACCESSORIES

	Ex. VAT	Inc. VAT
Joysticks - - -	£43.04	£49.49
16 K RAM - - -	£33.48	£38.50
Printer Cable - -	£34.35	£39.50

VISCOUNT-Teach yourself Colour Genie £6.95

Spectrum **LOW Price**

£224.48

Inc. VAT

SPECTRUM FACTS Maximum user RAM 14,200 Bytes approx.



Spectrum **LOW price** **£169.95**

Inc. VAT

VISCOUNT - Teach yourself ORIC BASIC £6.95

ORIC-1

A superbly designed and engineered micro and great value-for-money from SPECTRUM. Offering 48K RAM Colour - (8 foreground and 8 background can be displayed at same time) High resolution graphics User definable Graphics. Full sound (6 octaves of controllable sound.) Easy to use keyboard with moving keys. Standard Centronics parallel interface allows easy connection to a wide range of printers etc. Ask to see the new ORIC-1 at your local SPECTRUM dealer today!

Available late FEB, BBC language £17.95 inc vat

SPECTRUM FACTS Maximum user RAM 47,870 Bytes - in very short supply

New! LYNX



Spectrum **LOW Price**

£225.00 INC VAT

£196.65 ex vat

VISCOUNT - Teach yourself LYNX BASIC £6.95

Just look at this super new LYNX Micro - an incredible 16K + 32K video ram and that's expandable up to or beyond 96K. For just £225.00 INCLUDING VAT the LYNX is exceptionally versatile. All LYNX's 'add-on' connections are standard types. The high definition colour graphics make it a top-value choice for the home or office (with expansion, the LYNX can become an 80 characters-per-line word processor!) Take a look at the LYNX - a memorable bargain from SPECTRUM. But please phone to check stock position before making a journey as this new machine is bound to be in great demand.

SPECTRUM FACTS

Maximum user RAM 13,700 Bytes approx. - in very short supply

JUPITER ACE

Outstanding value-for money! The JUPITER ACE uses easy to understand FORTH language. Connects to your own TV. 3K RAM expandable to 19K. Full moving keyboard with auto repeat and caps lock. Full sound and chunky graphics. Ideal for the home, office or schools etc. Supplied complete with mains adaptor, TV and cassette recorder connection leads etc. See it at your local SPECTRUM dealer NOW!



Spectrum **LOW price** **£89.95** Inc VAT

£76.22 ex vat

SPECTRUM FACTS

Maximum user RAM 1,000 Bytes approx.

HURRY! Limited stocks only-

DRAGON



Inbelievable value at only £199.95 from SPECTRUM! British built and designed it's one of the most impressive micros to appear for quite some time. Extensive facilities include highly advanced colour graphics. Just look at this top specification: Powerful standard 32K RAM (expandable to 64K bytes). 9 Colour, 5 resolution Display. Extended Microsoft colour BASIC (as standard). Advanced sound with 5 octaves - 255 tones. Professional style editing, e.g. extract line, auto find reinsert. Professional quality keyboard. Centronics Paralled printer interface. Serious programmer/user - the BASIC on this machine is similar to that found on machines costing 3 times the price! Uses almost any cassette recorder. Standard file handling ON TAPE.

Spectrum LOW price **£199.95** INC. VAT
(£173.87 exc. VAT)

	EX VAT	INC VAT		EX VAT	INC VAT
ACCESSORIES			Madness and the Minotaur	£6.91	£7.95
Joysticks (pair)	£17.35	£19.95	Examples from		
Assette Lead	£2.35	£2.70	Dragon Manual	£6.91	£7.95
ARTRIDGES			Personal Finance	£6.91	£7.95
eserk	£17.35	£19.95	Dragon Mountain	£6.91	£7.95
osmic Invaders	£17.35	£19.95	Typing Tutor	£6.91	£7.95
eteoroids	£17.35	£19.95	Black Sanctum	£6.91	£7.95
host Attack	£21.70	£24.95			
ave Hunter	£17.35	£19.95			
tarship					
Chamelion	£17.35	£19.95			
ASSETTES					
Galixo Island	£6.91	£7.95			
raphic Animator	£6.91	£7.95			
quest	£6.91	£7.95			

DISCOUNT Software for DRAGON Teach yourself Dragon Basic£6.95

ATARI

ATARI 800 16K RAM



The top selling ATARI 800 at a sensational new LOW LOW price from SPECTRUM. It's the ideal home or business computer with an extensive range of EDUCATIONAL, GAMES, PERSONAL FINANCE and BUSINESS programmes and aids available. It features a typewriter keyboard, 16K memory that's easily expandable to 48K with convenient, slip-in ATARI Memory Modules. It's expandable, which means you can build the computer system you want today, knowing that it will grow to meet your needs tomorrow - making it ideal for the business man. You can add printers, programme recorders, disk drives and more.

Sensational NEW LOW Price
£399.99 INC. V.A.T.
(£347.82 excluding VAT)

SPECTRUM FACTS
Maximum user RAM
13,323 Bytes



ATARI 400
16K RAM
£198.95

INCLUDING V.A.T.
(£173 excluding V.A.T.)

SPECTRUM FACTS
Max. user RAM 13,323 Bytes
BASIC cartridge extra
£39.99 inc. VAT
(£34.77 ex. VAT)

ATARI DISK DRIVE
£299.00
INCLUDING V.A.T.
(£260 excluding V.A.T.)

ACCESSORIES, BOOK & GAMES for ATARI

	EX VAT	INC VAT		EX VAT	INC VAT
Accessories			European Countries & Caps	£13.03	£14.99
Thermal Printer	£173.00	£198.95	Hangman	£13.03	£14.99
16K RAM Pack	£56.52	£65.00	Kingdom	£13.03	£14.99
Paddles (Pair)	£12.17	£13.99	Scram	£17.38	£19.99
Joysticks (Pair)	£12.17	£13.99	States & Capitals	£13.03	£14.99
I/O Cable	£11.30	£12.99	Touch Typing	£17.38	£19.99
Printer Cable	£24.78	£28.50	Music Composer (Cartridge)	£31.30	£35.99
RS232C Cable	£21.74	£25.00	Pop Demonstration Cartridge	£21.73	£24.99
Monitor Cable	£21.74	£25.00			
Thermal Paper	£3.48	£4.00	Home Entertainment (Cartridge except where stated)		
ODS, 2 Master Diskettes	£19.12	£21.99	Asteroids	£26.08	£29.99
5 Blank Diskettes	£13.91	£16.00	Basketball	£21.73	£24.99
Power Adaptor 400/800 9v/6v S00705	£9.35	£10.75	BlackJack (Cassette)	£13.03	£14.99
Mains Adaptor	£4.61	£5.30	Caverns of Mars (Disk)	£26.08	£29.99
5 Pin Din connector	£2.17	£2.50	Centipede	£26.08	£29.99
Books & Manuals			Computer Chess	£21.73	£24.99
Wiley Manual	£5.99	No VAT	Missile Command	£26.08	£29.99
Basic Reference Manual	£5.21	No VAT	PAC Man	£26.08	£29.99
ODS, 2 Manual	£5.21	No VAT	Space Invaders	£26.08	£29.99
Operating System Listing	£10.43	No VAT	Star Raiders	£26.08	£29.99
ODS, Utilities Listing	£3.47	No VAT	Super Breakout	£21.73	£24.99
Home Computer Programs - Home/Office			Video Easel	£21.73	£24.99
Word Processor (Disk)	£88.95	£99.99	Cribbage & Domino	£17.35	£19.95
Graphit	£13.03	£14.99	European Scenic Jig-saw	£17.35	£19.95
Statistics 1	£13.03	£14.99	Hickory Dickory Dock	£17.35	£19.95
Telelink 1	£19.12	£21.99			
Mortgage & Loan	£13.03	£14.99	Programming Languages & Aids		
Microsoft Basic (Diskette)	£52.17	£59.99	Assembler Editor	£34.77	£39.99
Home Study (Cassette except where stated/			Atari Basic Cartridge	£34.77	£39.99
INV, to programming 1	£17.38	£19.99	Macro Assembler (Disk)	£52.17	£59.99
INV, to programming 2	£19.99	£22.99	Pilot (Consumer)	£52.17	£59.99
INV, to programming 3	£19.99	£22.99	Pilot (Educator)	£75.25	£89.99
Conversational French	£34.77	£39.99	Entertainer Kit (Star Raiders Missile Command & Pair Joysticks)	£60.86	£69.99
Conversational German	£34.77	£39.99	Programmer Kit (Basic Cartridge & Manuals)	£43.47	£49.99
Conversational Italian	£34.77	£39.99			
Conversational Spanish	£34.77	£39.99			
Energy CZAR	£13.03	£14.99			

Commodore VIC-20

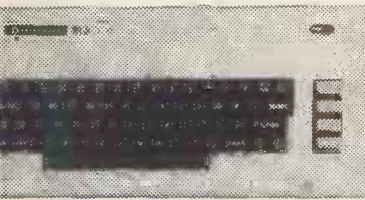

Now a top quality home/business micro for the price of a games machine.

- Memory expandable to 32K
- High resolution (full PET type) graphics
- 16 Screen colours and 8 border colours
- Plugs in to your TV, or monitor
- Add Disk Drive & Printer for impressive 170K Byte system
- Can act as an intelligent terminal for a larger computer.

VISCOUNT SUPER X2
64K DYNAMIC RAM PACK for VIC-20
EXCLUSIVE TO SPECTRUM!

Inbelievable-but-true, now you can upgrade your VIC-20 from 3.5K to a massive 67K RAM. Enables you to load up to 8 games or programs at a time & still select which one you wish to use. Can be used in conjunction with other expansions to increase total memory up to 152K-using the VIC memory expansion board. The SUPER X-2 will make your VIC-20 the biggest little micro in town!

Spectrum LOW price **£114.94** INC. VAT
(£99.95 excluding VAT)

Spectrum LOW Price

£129.90 INCLUDING VAT
(£112.96 Excluding VAT)

SPECTRUM FACTS
Maximum user RAM
3,853 Bytes

TEXAS TI99/4A

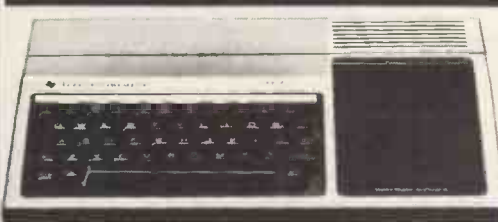

SPECTRUM FACTS
Maximum user RAM
14,500 Bytes approx.

- 16K RAM (expandable to 48K)
- Built-in 14K Byte BASIC interpreter
- 16 Bit Micro-processor
- 16 Colour High Resolution graphics
- Extensive range of solid state software command modules available from games to architectural aids.

Spectrum LOW Price **£154.95** INC VAT
(£134.74 ex. VAT)

	EX VAT	INC VAT		EX VAT	INC VAT
TEXAS PERIPHERALS			Parsel	£23.45	£26.96
Speech Synthesizer	£40.50	£46.58	Car Wars	£23.43	£26.95
Peripheral Exp. System	£122.00	£14.30	Munchman	£23.43	£26.95
Disc Cont. Card	£124.30	£142.95	Adventure & Pirate	£31.26	£35.95
Disc. Drive	£234.74	£269.95	Education		
RAM Exp. Card	£179.57	£206.50	Number Magic	£12.13	£13.95
Matrix printer	£347.78	£399.95	Addition/Subt. 1	£23.43	£26.95
Software Entertainment			Teach yourself beginners BASIC	£8.26	£9.50
TI Invaders	£16.48	£18.95	Home Budget Management	£19.96	£22.95
Tombstone City	£19.96	£22.95	and many more		
Attack	£19.96	£22.95			

MORE SPECTRUM LOW PRICES

SPECTRUM

A few examples from our Software Selection

THORN EMI	
Software for Atari	Inc. VAT
Submarine Commander	£34.44
Jumbo Jet Pilot	£34.44
Soccer	£29.84
Kickback	£29.84
Home Financial Management	£19.49
Darts	£19.49
Snooker & Billiards	£19.49
Pool	£19.49
Cribbage & Dominoes	£14.89
Humpty Dumpty/Jack & Jill	£14.89
Hickory Dickory Dock/Baa Baa	
Black Sheep	£14.89
British Heritage Jigsaw	
Puzzles, Vol. 1	£14.89
British Heritage Jigsaw	
Puzzles, Vol. 2	£14.89
European Scene Jigsaw	
Puzzles, Vol. 1	£14.89
European Scene Jigsaw	
Puzzles, Vol. 2	£14.89
Super Cubes & Tilt	£14.89
Figure Fun	£14.89
Cupute 4 & Reversi	£14.89
Owari and Bull & Cow	£14.89
Software for Commodore	
River Rescue	£25.24
Vic Music Composer	£25.24

GEM	
Software for ZX81, Dragon and Spectrum	Inc. VAT
Monster Mine (for 4ZX 81)	£4.95
Monster Mine (for Spectrum)	£4.95
Monster Mine (for Dragon)	£7.95
Space Mission (for 4ZX 81)	£4.95
Space Mission (for Spectrum)	£4.95
Space Mission (for Dragon)	£7.95
Dragon Golf	£7.95
Dragon Character Generator	£9.95
Games, Pack I	£7.95
Games, Pack II	£7.95

SALAMANDER	
Games for Dragon 32	Inc. VAT
Dragon Trek	£9.95
Wizard War	£7.95

Vulcan D/+	£7.95
Games Compendium DI	£7.95
Golf	£7.95

RABBIT	
Software for Commodore	
VIC20	Inc. VAT
Space Storm	£6.49
Ski Run	£4.49
Dune Buggy	£4.49
Super Worm	£4.49
Jungle	£4.49
Cosmic Battle	£4.49
Frogger (3K)	£9.49
Rabbit Functions	£4.49
Code Breaker	£4.49
Night Flight (3K)	£4.49
Rabbit Writer (16K Cassette)	£19.49
Rabbit Base (16K Cassette)	£14.49
Myriad (3K)	£9.49
Charset/20 (3K)	£4.49
Skramble	£9.49
Space Phreeks	£9.49
Night Crawler	£9.49
Hopper	£9.49
Tank War	£7.49
Rabbit Base (16K Disk)	£16.49
Rabbit Writer (16K Disk)	£21.49
Rabbit Calc (16K Cassette)	£19.49
Rabbit Calc (16K Disk)	£21.49

KUMA	
Software for Sharp	
Electron 22622	£9.20
Cribbage	£12.08
Adventure	£12.08
Chess	£16.68
Map of UK	£12.08
Music Composer	£12.08
Junior Maths/Stepping Stones	£6.33
Home Budget	£6.33

AUDIOGENIC	
Programs for VIC-20	Inc. Vat
Amok	£6.95
Alien Blitz	£7.95
Golf	£7.95
Spiders of Mars	£19.95
Sattelite & Meteorites	£19.95
Bonzo	£7.95
Trashman	£19.95
Boss	£14.95
Tank Attack	£19.95
Word Craft	
Word Processing package	£125.00

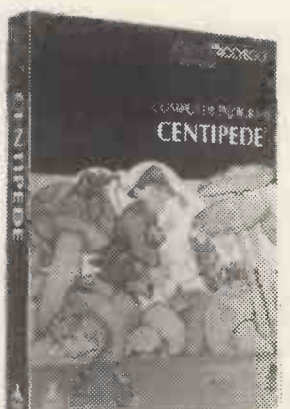

Plus many more at your local SPECTRUM dealer — call in now and see!

BOOKS

SELECTION FROM THE COMPUTER BOOKSHOP		The Zx Spectrum and how to get the most from it	
30 Hour Basic for the B.B.C. Micro	£5.95	Easy Programming for the ZX Spectrum	£5.95
Let your B.B.C. Micro Teach		30 Programmes for the B.B.C. Micro	£4.95
You To Programme	£6.45	CPM Handbook	£11.50
B.B.C. Micro Revealed	£7.95	Programming the Z80	£11.95
Over The Spectrum	£6.95	20 Best Programmes for the ZX Spectrum	£5.95
60 Games and Applications for the Zx Spectrum	£4.95	Getting Acquainted with your Vic 20	£6.95
Programming The 6502	£9.95	Machine Code and Better Basic	£7.50
Programming Your Zx Spectrum	£6.95	The Cambridge Colour Collection (Spectrum)	£6.95
ZAP Pow Boom for the Vic 20	£7.95		
The ZX Spectrum Explored	£5.95	Vic Revealed	£10.00
Vic Innovative Computing	£6.95	De RE Atari	£17.00
Mastering Machine Code on Your Zx81	£7.50	ATARI Operating system listing	£10.43

SEIKOSHA GP-100A Graphic Printer



Now a top quality graphic printer at a price you can afford. The SEIKOSHA GP-100A - Terrific value at under £200 from SPECTRUM. Standard Centronics compatible interface for easy link-up with most micros. Full graphics capability. Printing speed 30 chars/sec. Double width character output under software control. Graphics, character and double width character can be intermixed on same line. Paper width adjustable up to 10" - tractor feed. Print position addressable by character or dot.

Spectrum LOW price £229.94 (Price Ex. VAT £199.95)
Cables and Interfaces available to fit most MICROS.

EPSON PRINTERS

Chosen by SPECTRUM for their reliability, the superb new top quality graphic printers from EPSON. New features include super & subscript, underlining & deletion. If you're looking for an up-market printer at a down-to-earth-price, call in and see the EPSON range at SPECTRUM.

Model	EX. VAT	INC. VAT
MX80-T3	£329.00	£378.35
MX80 F/T Type III	£369.00	£424.35
MX100 Type III	£469.00	£539.35

Please see your SPECTRUM dealer for prices of INTERFACE/CABLE options.



SMITH CORONA TP-1

The Smith Corona tp-1 text printer is a microprocessor controlled high quality daisy wheel printer which delivers fully formed executive quality print-out at a speed of 120 words per minute. It is a LOW cost Daisy wheel printer with Microprocessor Electronics, Serial, parallel or IEEE Interface.



ONLY £557.75
£485.00 ex. VAT.

ACCESSORIES



SANYO Colour Monitor CDD3125N ONLY
£228.85 inc. VAT
(£199.00 ex. VAT)

SANYO	Exc. VAT	Inc. VAT
SANYO 12" green monitor	£79.00	£90.85
Slim 3G Cassette Recorder	£26.04	£29.95
CTP 3131 14" Colour TV Set	£199.96	£229.95
C12 Cassettes	£0.43	£0.50
Single sided, single density disks	£1.70	£1.95
Double sided, double density disks	£2.94	£3.38
Single sided, double density double track disks	£2.57	£2.97
Disk head cleaner	£14.00	£16.10
Single part 11" x 9½" printer paper, box of 2,000 sheets	£11.35	£13.05



FREE!
£75 WORTH
of software
 with every MZ80A
 purchased

SHARP MZ-80A

Desk top genius! - the all-in-one SHARP MZ-80A. A personal computer designed with the serious user in mind, ready to run the moment you get it home. Built-in keyboard, CRT 9" display and cassette data storage with 48K RAM. The BASIC with extra useful additions, offers quite a powerful micro for the home or business. ■ 4K Byte ROM + 48K Byte RAM + 2K Byte Video RAM ■ ASCII profiled keyboard + numeric pad ■ 2 page Video RAM allows screen to be scrolled up or down. ■ CP/M available

Spectrum
LOW Price

£546.25
 Inc. VAT
 (£475.00
 ex. VAT)

Floppy Disks and Accessories for MZ80A

Twin Floppy Disk Unit (inc. I/O Card, Disk, Cable).....	£745.00	£856.75
Single Floppy Disk Unit (inc. I/O Card, Disk, Cable).....	£400.00	£460.00
Twin Disk Unit (only).....	£590.00	£678.50
Single Floppy Disk Unit.....	£400.00	£460.00
Cable for F/D Drive.....	£25.90	£29.79

Printers and Accessories for MZ80A, MZ80B and MZ80K
 80 Col Tractor Feed Printer inc. Cable, I/O Card & Rom..... £415.00 £477.25

SPECTRUM FACTS
 Maximum user RAM
 32,000 Bytes approx.

NEW ACCESSORIES from SPECTRUM

	Ex. VAT	Inc. VAT
POINTMASTER Competition Joystick (For ATARI and VIC Computers)	£13.00	£14.95
VISCOUNT		
Motherboards for VIC 20 Standard (Use 2 or more cartridges at a time)	£21.70	£24.95
As above, with buffer	£26.00	£29.90
16K RAM for VIC 20	£38.22	£43.95
32K RAM for VIC 20	£58.22	£66.95

CURRAH CHATTERBOX
 Voice Synthesiser for VIC 20 £49.95 £57.95
 Full Keyboard for ATARI 400 NOW AVAILABLE

SINCLAIR ZX-81



SINCLAIR ZX. £49.95
16K RAM pack £29.95
ZX Printer . . . £59.95

COMPUTER BOOKSHOP

SOFTWARE FOR SINCLAIR COMPUTERS	INC. VAT
JUMPER 71K ZX81.....	£5.95
AK SUPER TRIO ZX81.....	£7.95
LABYRINTH 16K ZX81.....	£5.95
LIGHTS ARE ON/MUSIC 16K ZX81.....	£8.95
PERSONAL BANKING SYSTEM 16K ZX81.....	£11.44
SPACE INVADERS/RESCUE 16K ZX81.....	£6.95
BREAKOUT 16K ZX81.....	£8.95
HUGGY 16K ZX81.....	£6.95
HERGATROIDS 16K ZX81.....	£6.95
PROMERGE 16K ZX81.....	£6.95
FOOTBALL MANAGER 16K ZX81.....	£7.95

CASSETTES FOR ZX81

TYPE—10	INC. VAT
6 GAMES.....	£3.95
JUNIOR EDUCATION.....	£3.95
BUSINESS & HOUSEHOLD.....	£3.95
SKILL & JUDGEMENT GAMES.....	£3.95
JUNIOR EDUCATION.....	£3.95
FAMILY QUIZ.....	£3.95
TYPE—20	
FANTASY GAMES.....	£4.76
SPACE RAIDERS & BOMBERS.....	£4.76
TYPE—30	
SUPER PROGRAMS Nos. 1-8.....	£4.95
TYPE—40	
BACKGAMMON.....	£5.95
FLIGHT SIMULATION.....	£5.95
TYPE—60	
ENGLISH LITERATURE 1.....	£8.95
ENGLISH LITERATURE 2.....	£8.95
GEOGRAPHY.....	£6.95
HISTORY 1.....	£6.95
MATHS 1.....	£6.95
MUSIC 1.....	£6.95
INVENTIONS 1.....	£6.95
SPELLING 1 (8-11 YEAR OLDS).....	£6.95
CHESS.....	£6.95
BIORHYTHMS.....	£6.95

*Requires 16K Ram Memory Pack

There's a Spectrum Centre near you ...

- ABERYSTWYTH**
 AberData at Galloways, 23 Pier St. 0970 615522 (Just Opening)
- ALDERSHOT**
 David Saunders Computer Centre, 51 Station Rd. 0252 20130 (Just Opening)
- ALFRETON**
 Gordon Herwood, 69/71 High St. 0773 832078
- ASHFORD**
 Ashford Computer Centre, 2 Station Parade, Clarendon Rd. 07842 44955
- BANBURY**
 Computer Plus, 2 Church Lane. (0295) 55890
- BASILDON**
 Godfrey's, 28-32 East Walk. Town Centre. 0268 289379
- BASINGSTOKE**
 Fisher's, 2/3 Market Place. 0256 22079
- BATH**
 Software Plus, 12 York St. 0225 61676
- BEDFORD**
 Stened Ltd., 115 Midland Rd. 0234 49341 (Just Opening)
- BIRMINGHAM**
 Sherwoods, Great Western Arcade. 021 236 7211
- BOSTON**
 Fotosave Computers, 19 Dolphin Lane. 0205 64781 (Just Opening)
- BRADFORD**
 Photosave, 18 Chapside. 0274 308598
- BRIDLINGTON**
 Bridlington Computers 8 Bridge St. 0262 75048 (Opening Soon)
- BRIGHTON**
 Capricorn, 1 Queens Rd. 0273 29634
- CAMBERLEY**
 Camera Arts (Micro Computer Division), 36 High St. (0276) 65848
- CAMBRIDGE**
 KP Ltd., 12a Kings Parade. 0223 68087
- CANTERBURY**
 Kent Micro Systems, Conquest House, 17 Palace St. 0227 50200
- CARDIFF**
 Randall Cox, 18-22 High St. Arcade. 0222 31960
- CHELMSFORD**
 Maxton Hayman Ltd., 5 Broomfield Rd. (0245) 354595
- COVENTRY**
 Coventry Micro Centre, 33 Far Gosford St. (0203) 58942
- DARLINGTON**
 McKenna & Brown, 102 Bondgate. (0325) 59744
- DERBY**
 CTElectronics, at Camera Thorpe, The Spot. 0332 44760
- DONCASTER**
 Briarstar Computer Centre 13 Netherhall Rd. 0302 67135
- DUNSTABLE**
 Dormans, 7-11 Broad Walk. 0582 65515 (Opening Soon)
- DUMFRIES**
 Vennals, 71 English St. 0387 4547
- EDINBURGH**
 The Silicon Centre, 6-7 Antigua St. 031 557 4546
- GLASGOW**
 Victor Morris Ltd., 340 Argyle St. 041 221 8958
- GLOUCESTER**
 The Model Shop, 79-81 Northgate St. 04521 410693
- GRIMSBY**
 R. C. Johnson Ltd., 22 Friargate, Riverbank Centre. 0472 42031 (Just Opening)
- GUILDFORD**
 The Model Shop, 23 Swan Lane. (07072) 0483 39115
- HARROW**
 Camera Arts (Micro Computer Division), 24 St. Ann's Rd. 01-427 5469
- HATFIELD**
 Microworld, 2 Crawford Rd. (07072) 64137
- HITCHIN**
 Camera Arts, 68A Hermitage Rd. 0462 59285
- HORNCHURCH**
 Channel One, 174 High St. 040 24 75613
- HULL**
 The Computer Centre (Humberston) Ltd., 26 Anlaby St. (0482) 26297
- HYDE**
 Paso, 213-215 Market St. 061-366 5935
- IPSWICH**
 Brainwave, 24 Crown St. 0473 50965
- KILMARNOCK**
 Vennals, 49 Foregate 0568 32175
- LEEDS**
 Bass & Bligh, 4 Lower Briggate. 0532 454451
- LEICESTER**
 Youngs, 40-42 Belvoir St. 0533 544774
- LONDON SE1**
 Vic Odden's, 6 London Bdg. Walk 01-407 6833 403 1988 (Mail Order)
- LONDON SE9**
 Squares Deal, 375 Forestway Rd., New Eltham. 01-859 1516
- LONDON SE15**
 Castlehurst Ltd., 152 Rye Lane, Packham. 01-639 2205
- LONDON N1**
 ASP Micro Systems, 185 Upper St., Islington. 01-359 9095
- LONDON N.20**
 Castlehurst Ltd., 1291 High Rd. 01-446 2280
- LONDON W1**
 Devron, 4 Edgware Road. 01-724 2373
- LONDON W3**
 Colomatic Computers, 44 High St., Acton. 01-992 7611
- LONDON W11**
 Electrofuture, 120 Notting Hill Gate. 01-221 7029
- LUTON**
 Terry-More, 49 George St. 0582 23391/2
- MACCLESFIELD**
 Camera & Computer Centre, 118 Mill St. 0625 27468
- MANCHESTER**
 Lomax Ltd., 8 Exchange St., St. Ann's Sq. 061 832 6167
- MANCHESTER GTR.**
 Mr. Micro Ltd., 69 Partington Lane, Swinton. 061 7282282 open Thurs.-Fri.-Sat. till 8 p.m.
- MIDDLESBROUGH**
 McKenna & Brown, 190 Linthorpe Rd. 0642 248345
- NEWCASTLE-ON-TYNE**
 Newcastle Camera & Computer Mart, 16 Northumberland Ct. 0632 327461
- NEW MALDEN**
 Surrey Micro Systems, 31 High St. 01-942 0478
- NEWPORT**
 Randall Cox, 118 Commercial St. 0633 67378
- NORTHAMPTON**
 Basic Computers & Systems Ltd., 72 Kingshorpe Hollow. 0604 710740
- NORTHWICH**
 Camera & Computer Centre, 3 Town Sq. (0606) 45629
- NOTTINGHAM**
 Cameo Computers, 8/9/10 Trinity Walk. 0602 42912
- OLDHAM**
 Home & Business Computers Ltd., 54 Yorkshire St. 061-633 1608
- PAIGNTON**
 Devon Computers, 81 Upper Manor Rd. (0803) 526303
- PEMBROKE**
 Randall Cox, 19 Main St., 064 668 2876
- PRESTON**
 Wilding's, 49 Fishergate. 0772 556250
- READING**
 David Saunders Computer Centre, 8 Yield Hall Place. 0734 580719
- ROCHFORD**
 Channel One, 17 Golden Cross Parade, Ashingdon Rd. 0702 540455
- RUGBY**
 The Rugby Micro Centre, 9-11 Regent St. 0788 70522
- ST. AUSTELL**
 A B & C Computers, 11 Brookstone Rd. (0726) 64463
- STAFFORD**
 Computarama, 59 Foregate St. (0785) 41899
- TEDDINGTON**
 "Andrews", 49 Broad St. 01-977 4716
- WALLINGTON**
 Surrey Micro Systems Ltd., 53 Woodcote Rd. 01-647 5636
- WARRINGTON**
 Wildings, 111 Bridge St. 0925 38290
- WATFORD**
 SRS Microsystems Ltd., 94 The Parade, High St. 0923 26602
- WEST BROMWICH**
 Bell & Jones, 39 Queens Sq. 061 553 0820
- WIDNES**
 Computer City, 78 Victoria Rd. 051 420 3333
- WIGAN**
 Wilding Ltd., 11 Mesnes St. 0942 44382
- WOKING**
 Margars, 71-73 Commercial Way. 04862 61061
- WORCESTER**
 David Waring Ltd., 1 Marmion House, High St. 0905 27551
- GT. YARMOUTH**
 Tony Hood Electronic, 26A Market Gate Shopping Centre 0493 3143
- YORK**
 York Computer Centre, 7 Stonegate Arcade. 0904 641882

Up to £1000 INSTANT CREDIT with a SPECTRUM CHARGECARD
 With a SPECTRUM CHARGECARD you choose the credit limit to suit YOU. e.g. a monthly payment of £10 gives you £200 credit. Ask your nearest SPECTRUM COMPUTER CENTRE for written details on how to apply for your SPECTRUM CHARGECARD - NOW!
 (Typical APR 30.6%)

V.A.T.
 You will see that we quote our prices both including VAT and excluding VAT - no hidden 15% to suddenly up-lift your bill but also making our prices easier to compare with our competitors.

Ø1 COMPUTERS 01-228-2207. Ø1 COMP

**YOU
SIMPLY
CANNOT AFFORD
TO MISS THIS OFFER**

REMEMBER! WE SPECIALISE, YOU BENEFIT

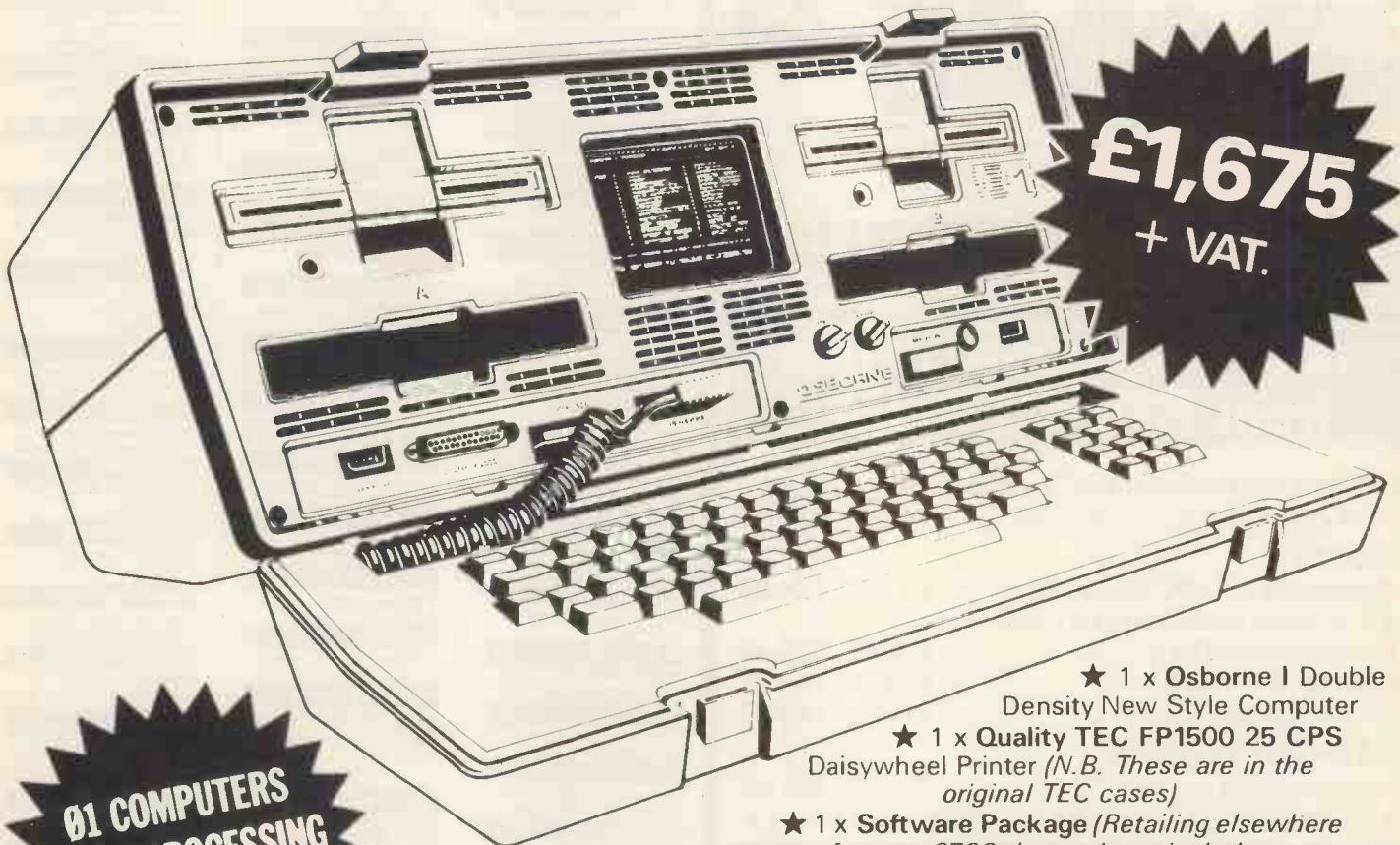

**£1,675
+ VAT.**

**Ø1 COMPUTERS
WORD PROCESSING
WONDER PACKAGE**

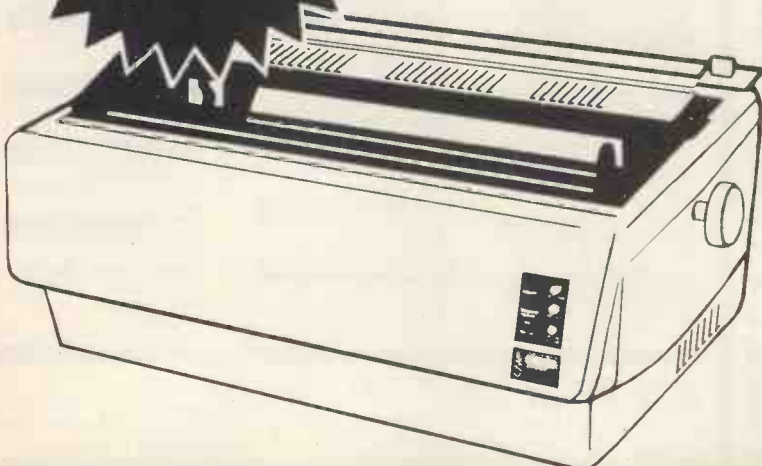

★ 1 x Osborne I Double Density New Style Computer

★ 1 x Quality TEC FP1500 25 CPS Daisywheel Printer (N.B. These are in the original TEC cases)

★ 1 x Software Package (Retailing elsewhere for over £700 the package includes:— CP/M, WORDSTAR/MAILMERCE, C.BASIC and M.BASIC, SUPERCALC).

PLUS ! PLUS ! PLUS!

Only while stocks last, free with double density models – D.BASE II the Ashton Tate Database Management Package.

ALL FROM Ø1 COMPUTERS

Also available

- ★ Extended Warranties
- ★ On Site Comprehensive Maintenance Contracts
- ★ Combined Acoustic Coupler and Modem
- ★ Incomplete Records
- ★ Time & Cost Recording
- ★ Accounts Packages
- ★ Games
- ★ Rentals

CALL NOW

FOR OUR LATEST LIST OF EXTRAS

LONDON SALES OFFICE: 01-228 2207

NORTHERN SALES OFFICE: 0904-470013

Ø1 COMPUTERS 01-228-2207. Ø1 COMPUTERS 01

★ **NEWBRAIN MODEL A** ★
ELSTREE COMPUTER CENTRE £199.50

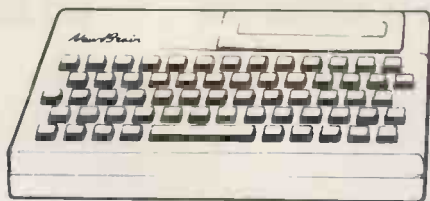

MODEL A.D.

- 80 CHARACTER DISPLAY PER LINE
- 4 CHARACTER SETS
- VERY FAST: ACCURATE KEYBOARD
- IDEAL FOR BUSINESS USE

AD £229 plus VAT £263.25

A £199 plus VAT £228.50

p&p £2.75

★ SOFTWARE JUST RELEASED. SEE LIST ASIDE.

ELSTREE COMPUTER CENTRE

32 DEACONS HILL ROAD

ELSTREE, HERTS, WD6 3HL

Tel: (01) 953 6921

OFFICE HOURS 9-6 MON-FRI.

★ ATTENTION ZX81 OWNERS !! ★

If you own a ZX81 we will offer you up to £40 against a NewBrain (offer extended)

NEWBRAIN SOFTWARE

From the software house of Elstree Computer Centre
A superb range of easy to use programmes
Purpose made and designed for the
fabulous Newbrain Computer

- Word Processor £35.00
- Database £25.50
- Invoice and credit note programme £59.50
- Invoice and credit note review £22.50
- Sales Ledger £65.00
- Stock Control £29.50
- Customer Information File £32.00
- Bank and Cash balance £29.00
- Inventory £29.50
- Mailing List £29.00
- Home Expenses £25.00
- Product Costing £22.50
- Sales Analysis £23.50
- Inventory Analysis £23.50
- Business ratios, for Investment, Sales, Turnover etc £19.50
- Calculate for Costing, Bidding (with your mark-up) £27.50
- Two programs: Mortgage repayment and property investment £21.50

VAT @ 15% should be added to each of the above
(include 90p P&P per program)

Phone for your nearest dealer

Send large S.A.E.
for complete range of programs

ELSTREE COMPUTER CENTRE

32 DEACONS HILL ROAD, ELSTREE, HERTS WD6 3HL

Tel: (01) 953-6921

EXPORT AND DEALER ENQUIRIES WELCOME



OFFICE EFFICIENCY MACHINES LTD

1 Lochaline Street, London W6 9SJ

Tel. 01-741 7211/2/3/4

SPECIAL PROMOTION DEAL!

OSBORNE 1
PORTABLE MICRO-COMPUTER



PRAXIS 35 PORTABLE ELECTRONIC
TYPEWRITER/PRINTER



includes
CPM OPERATING SYSTEM,
WORDSTAR, MAILMERGE,
SUPERCALC, M BASIC &
C BASIC WORTH £800 FREE

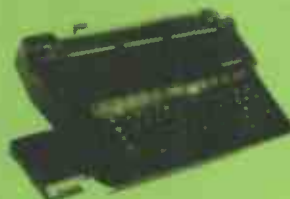

only
£1499.00

OR **OSBORNE 1 PLUS 12" (GREEN OR AMBER)
MONITOR – £1250.00**

ALSO – transfer your files directly on to your
OSBORNE 1.

To order your OSBORNE 1, call our hot line – 01-741 8404.

Enquiries – 01-741 7211/2/3/4.

DEALERS WELCOME!

To: Office Efficiency Machines Ltd.,
1 Lochaline Street, London W6 9SJ
Telex 263559 Micro G

- Please send me information on the
- Dealer End User
- Urgent Please phone me

Name _____

Company _____

Address _____

Telephone _____

PCW1

IT'S NEW SOFTWARE

for business at petty cash prices.



INVOICES AND STATEMENTS . . . £19.95

Compatible with most micros. See table. Ideal for the small business. A complete suite of programs together with generated customer file for producing crisp and efficient business invoices and monthly statements on your line printer. All calculations include VAT automatically, and the program allows your own messages on the form produced. This program gives you superb presentation and saves time on one of the most tedious tasks in the office.



COMMERCIAL ACCOUNTS . . . £19.95

Compatible with most micros. See table. A gem of a program, all for cassette, with the following features:— Daily Journal. Credit Sales. Cash Sales. Credit Purchases. Purchases — other. Sales Ledger. Purchase Ledger. Bank Account. Year to date summary. A fully interactive program suitable for all businesses. Files can be saved and loaded and totals from one file carried forward to another on cassette. Particularly useful from a cash flow point of view, with an immediate accessibility to totals for debtors and creditors. Bank totally supported with entries for cheque numbers, credits and, of course, running balance.



MAILING LIST . . . £19.95

Compatible with most micros. See table. A superb dedicated database to allow for manipulations of names and addresses and other data. Gemini's unique 'searchkey' system gives you a further ten 'user-defined parameters' to make your own selections. Features include the facility to find a name or detail when only part of the detail is known, it will print labels in a variety of user specified formats.



DATABASE . . . £19.95

Compatible with most micros. See table. The program that everyone needs, the most valuable and versatile in your collection. Facilities include sort search, list print if required. Can be used in place of any card index application; once purchased you can write your own dedicated database to suit your particular needs with a limitless number of entries on separate cassettes.



STOCK CONTROL . . . £19.95

Compatible with most micros. See table. Dedicated software with all that's necessary to keep control of stock. This program will take the tedium out of stock control and save time and money. Routines include stock set up, user reference number, minimum stock level, financial summary, line print records, quick stock summary, add stock, delete/change record and more.



HOME ACCOUNTS . . . £19.95

Compatible with most micros. See table. Runs a complete home finance package for you with every facility necessary for keeping a track of regular and other expenses, bank account mortgage, H.P. etc. This program also allows you to plot graphically by Histograms your monthly outgoings.



WORD PROCESSOR . . . £19.95

Compatible with most micros. See table. This program features routines found in much larger and more expensive packages with a typical word length of 5-6 letters it allows for around 1000 words in memory at one time. Ideal for the user who requires a simple program to write letters on his computer. Features include, block delete, block insert, search and replace, edit text, display text and more.

Dealer/Trade enquiries invited — generous trade discounts for quantity
Special ACCESS card instant sales hotline Tel: 03952-5165
 for **GUARANTEED** despatch within **24 hours . . .**
24 hr Ansaphone Service.

All enquiries other than credit card sales to 03952-5832

Gemini. Functional Software Specialists. 9, Salterton Road, Exmouth, Devon.

Tick the box for Program you require. Prices include V.A.T. and Package and Postage.
 Please supply the following cassette software.

Database	£19.95	<input type="checkbox"/>	ZX81 16K Database	£9.95	<input type="checkbox"/>
Stock Control	£19.95	<input type="checkbox"/>	BBC Cash Book disk or tape	£95.00	<input type="checkbox"/>
Mailing List	£19.95	<input type="checkbox"/>	BBC Disks — other titles	£23.95	<input type="checkbox"/>
Invoices and Statements	£19.95	<input type="checkbox"/>	Osborne Disk Database	£23.95	<input type="checkbox"/>
Commercial Accounts	£19.95	<input type="checkbox"/>	Word processor	£19.95	<input type="checkbox"/>
Home Accounts	£19.95	<input type="checkbox"/>	Beebcalc	£19.95	<input type="checkbox"/>
			Dragoncalc	£19.95	<input type="checkbox"/>

Name _____
 Address _____
 Machine Type _____ Memory Size _____
 I enclose _____
 Make cheques and postal orders payable to Gemini Marketing Ltd.
 Diners Card Number _____ Access Number _____
 Signature _____



Gemini. Functional Software Specialists, 9 Salterton Road, Exmouth, Devon.



Sparrow 10

10 MEGABYTE REMOVABLE STORAGE SUB-SYSTEM

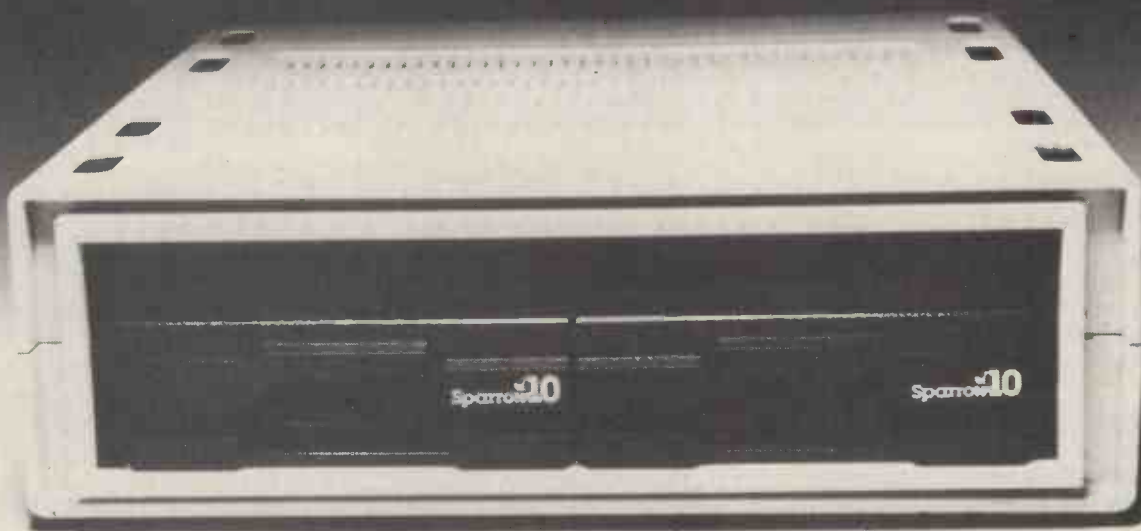

“Unbelievable!” “Incredible!”
“10 Megabytes on a floppy!?”
“It had to happen...”

These are typical comments from people who see our remarkable disc drive for the first time. But seeing is believing...

What did they see? ...

A Low Cost, High Capacity (10 MBytes), Fast (35 msec average access time, 3/6 secs start/stop), removable media, simple in design, shock resistant, contaminant resistant, small (same fit format as an 8" floppy drive), low power consumption (55 watts), integrated I/SI controller, easy to interface disc drive.

Become a believer, come and see the SPARROW 10 for yourself.

Sparrow
Computer

United Kingdom: Tel: (0753) 76533

France: Tel: (33) 1 362 1010

West Germany: Tel: (49) 6121 700862

SPARROW COMPUTER UK OFFICES: 45 Ledgers Road, Slough, Berkshire, England. Telex: 847212

SPARROW COMPUTER BV, a company registered in the Netherlands with limited liability.

New modular interface concept makes the new Qume 11/40 PLUS a technological breakthrough.

The remarkable new Qume 11/40 PLUS modular interface daisywheel printer range is a technological breakthrough.

No more will you need separate printers for each system.

bi-directionally at 40 cps minimum.

With a test proven MTBF rate of 5,500 hours it is equivalent to almost three years service free operation.

And the new 11/40 PLUS range has complete command

cost is. Incorporating all the outstanding Qume advantages.

And for large forms or large format information displays, choose the exclusive

WIDETRACK 11 22" wide chassis printer from Qume,

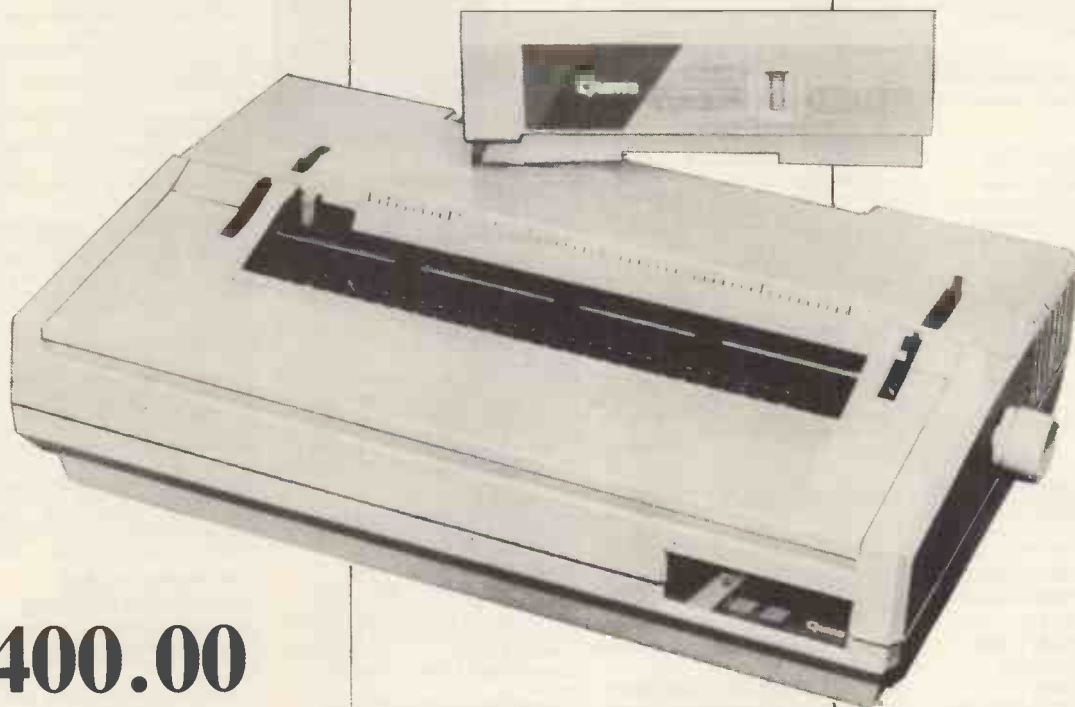

£1400.00

Now you have a highly economic and time saving means of interfacing to most word processing and desk top computers.

The unique interchangeable interface module plugs into the back of the printer, making the new Qume Sprint 11/40 PLUS compatible with most standard word processing application software.

It is the highest reliability daisywheel printer range ever produced by Qume.

It prints letter quality text

set compatibility with the 5 and 9 range.

So now, for around £80 retail – the price of one low cost module – second printer capability can be easily added in a multiple computer operation.

The 11/55 PLUS – a faster version with a minimum speed of 55 cps – is also available, for around £1,500.

The SPRINT 10 is the ideal alternative where high speed is of lesser importance, but where reliability, high letter quality print and even lower

with a choice of 130 or 96 character printwheel.

All immediately available from ISG with full application back up and technical service.

ISG Data Sales Ltd., Unit 5, Wellington Industrial Estate, Basingstoke Road, Spencers Wood, Reading, Berks. RG7 1AW.

Tel: (0734) 884666

Telex: 849110

isg

THE MOST DIFFICULT THING ABOUT GETTING A COMPUTER IS GETTING THE RIGHT ONE.

BBC MICROCOMPUTER

BBC Micro Model B	419.00
Games Paddles	11.30
14" Colour Monitor	250.00
12" Monochrome Monitor	90.00
Single Disk Drive	230.00
Selection of business, educational, graphics & games software available from	3.50



EPSON HX-20 PORTABLE COMPUTER

Diminutive fully featured business computer that is small and light enough to slip into a briefcase. Specification includes integrated LCD screen, printer and microcassette; 16K RAM expandable to 32K and its own rechargeable power supply. Ideal for people on the move - data can be subsequently 'down loaded' on to a larger machine when you return to base.

402.00 ex. VAT



CROMEMCO C-10 PERSONAL COMPUTER

A full feature personal business computer system including software - for the price of a VDU. Also the entry point into the renowned Cromemco range.

1195.00 ex. VAT

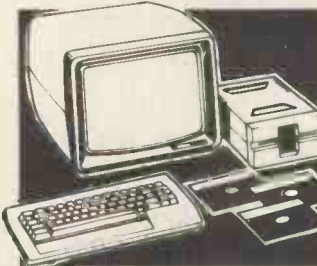

C-10 SP Personal Computer Superspak inc. Z80A Processor, 64K Memory, Single 5 1/4" 390K Byte Floppy Disk, 24 x 80 Screen, CKBA Keyboard, CP/M Compatible Operating System, plus Word Processing, Financial Planning & 32K BASIC Software 1195.00
Additional 5 1/4" Floppy Disk Drive 450.00
120 Word/Min Daisy Wheel Printer 675.00

OSBORNE

Osborne Portable Computer inc. Standard Software - Wordstar, Mailmerge, Supercalc, MBASIC, CBASIC, CP/M 1250.00
Osborne Double Density Version inc. USDC-P System 1375.00
Osborne Starter Kit inc. Daisy Wheel Typewriter Printer 1699.00



OSBORNE

Truly portable personal small computer system housed in a 'snap together' case complete with business programs, so you can start work almost anywhere.

1250.00 ex. VAT

PRINTERS - IMPACT

Anadex DP9500A 132 Coils, 150CPS Matrix Printer with Graphics 10, 12, 5, 13, 3, 16, 4 Char/In, Low Noise	1150.00
Anadex DP9501A 132 Coils, 150CPS Matrix Printer 10, 12, 15, 16, 4 Char/In, Low Noise	1150.00
Anadex DP9620A 200CPS Printer, Low Noise, 10, 12, 15, 16, 4 Char/In 100 CPS in Double Pass Enhanced Mode	1250.00
Anadex WP6000 Dual Mode Printer 132 Coils, 150/180CPS Correspondence Quality, 300/330CPS Draft and Graphics Mode, Diablo 630 Protocol Emulation	1950.00
Epson MX80T/3 Tractor only 80CPS	349.00
Epson MX80F/3 Friction and Tractor	389.00
Epson MX100F/3 Friction and Tractor 100CPS	499.00

PRINTERS - DAISY WHEEL

Brother HR1	650.00
Brother 8300	458.00
Crown Ranier - Brother 19CPS	795.00
Diablo 620R 25CPS	995.00
Diablo 630R	1575.00
Smith Corona TP1	475.00

NORTH STAR ADVANTAGE

Two versatile desk top options to choose from featuring high quality business graphics with either 720Kb floppy or 5Mb hard disk storage.

From 2195.00 ex. VAT



NORTH STAR ADVANTAGE

Advantage Desk-Top System inc. Keyboard, Graphics, Screen (Green), 64K Byte RAM, Z80A Processor, Serial Interface, Dual 350R Byte Diskette Drives and Business Graphics Software 2195.00
Advantage H/D Desk-Top System, as above except single 350K Diskette Drive + 5M Byte 5" Winchester Hard Disk Inc. Business Graphics Software 2995.00
Advantage upgrade to Intel 8088 Processor with 64KB Memory @ 320.00

COMART COMMUNICATOR

Clearly the most price competitive modular computer system on the market with built-in expandability - inside and out.

inc. CP/M. From 1895.00 ex. VAT

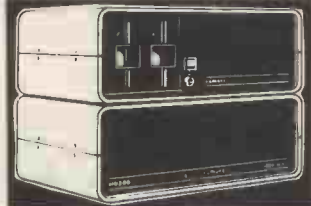

COMART COMMUNICATOR Z80A MODULAR SYSTEMS

Comart CP100 'Communicator' Micro Computer: Z80A Processor, 64K Byte Memory, Dual 5 1/4" Floppy Diskette Drives each storing 390K Bytes of Data. Dual Serial and Parallel Ports. 10 Slot S100 Bus. CP/M Version 2 included 1895.00
Comart CP200 as CP100 except Dual 790K Byte Diskette Drives 2195.00
Comart CP500 as CP100 except one 790K Byte Diskette Drive and one 5" Winchester Drive having 4.8M Bytes of Formatted Data 2995.00
Comart CP520 as CP100 except one 790K Byte Diskette Drive and one 5" Winchester Drive having 19M Bytes of Formatted Data 3995.00

COMART COMMUNICATOR 8086 MODULAR SYSTEMS

Comart CP1100 Communicator Micro Computer: 6MHz 8086 Processor, 128K Byte Memory with Parity, Dual 5 1/4" Floppy Disk Drives each storing 390K Bytes. Dual Serial and Parallel Printer Ports. 10 Slot S100 Bus inc. CP/M86 & MS-DOS 2295.00
Comart CP1202 CP1200 with 256K Byte Memory 2745.00
Comart CP1522 CP1520 with 256K Byte Memory 4545.00

UPGRADE KITS

Wide range of 8 to 16 Bit and floppy to hard disk upgrade kits available for Communicator Systems

COMART MULTI USER CONFIGURATIONS

Comart CP520/M CP520 Communicator System with 256K Byte Memory and 6 Serial Interfaces. Includes CP/M and MP/M11 4995.00
Comart CP1525M CP1520 Communicator with a total of 512K Byte Memory and 10 Serial Interfaces. Includes CP/M86 and MP/M86 5995.00

COMART SUBSYSTEMS

Comart CB200 Cartridge Tape Back-Up Subsystem for Hard Disk 2495.00
Comart HD520 5" x 20M Byte Hard Disk Subsystem (requires HDCONT or can be added to a CP520 or CP1520) 2395.00
Comart HDCONT Winchester Disk Controller for 2, 20M Byte Drives 195.00
Comart FD800 8" Floppy Single Disk Drive Subsystem; Single Sided, Single Density (IBM 3740 Compatible (requires C-IFDC)) 995.00
Comart MP/MSUB Hardware & Software to Upgrade Communicator to MP/M. Includes MP/M, two 48K Byte C-RAM 48 Memory and 4 SIO Serial Interface Card 1150.00

\$100 BOARDS PRICES EXCL. VAT

Comart C-RAM64 64K Byte Dynamic RAM with Bank Select 200.00
Comart C-RAM48 48K Byte Dynamic RAM with Bank Select 180.00
Comart C-RAM256 256K Byte Dynamic RAM with Parity, 8 and 16 Bit Data. IEEE696 Compatible. Also supports 8 Bit Bank Switching 550.00
Comart C-CPU86 8086 Processor Card, with Dual Serial and Parallel Ports. Monitor in 8K EPROM and 4K RAM 300.00
Comart C-IFDC Intelligent Diskette Drive Controller with Z80A Processor 295.00
Comart C-CPU Z80A system Processor Board incl. 2 Serial / 1 Parallel Port 200.00
Comart 4SIO 4 Channel Synch/Asynch Interface Board 250.00
Dual Systems CLK24 Battery Supported Real Time Calendar Disk 295.00
Dual Systems C-MEM32 32K CMOS Battery Supported Memory 1195.00
Dual Systems C-MEM16 16K CMOS Battery Supported Memory 895.00

CROMEMCO 68000/Z80A SUPER MICRO SYSTEMS

Cromemco CS102E System 1 including Dual 390K 5" Floppy Disks, CPU, MCU, 256MSU and 16 FDC Cards in 8 Slot S100 Card, Table Top Enclosure 3620.00
Cromemco CS105E as CS102E but with 512 MSU 4280.00
Cromemco CS1HD2E System 1 including Single 390K 5" Floppy Disk, 5.5M Byte 5" Winchester Disk, CPU, MCU, 256MSU, 16FDC, WD12 5595.00
Cromemco CS1HD5E as CS1HD2E but with 512MSU 6255.00
Cromemco CS305E System 3 including Dual 1.2M Byte Floppy Disk Drives, 21 Slot Card Cage, CPU, MCU, 512MSU, 16FDC 6585.00
Cromemco CS3HD5E as CS305E but with 5" 5.5MB Winchester Disk and WD1 8230.00

CROMEMCO Z80 COMPUTER SYSTEMS

Cromemco CS-1H System One including Z80A Processor, 64K Memory, 390K Byte 5" Floppy, 5.5M Byte 5" Winchester Disk and VDU/Printer Interfaces 4595.00
Cromemco CS-1.8 Slot S100 Bus. Computer System One, with Z80A Processor, Dual 5" Diskette Drives, 64K Memory, VDU/Printer I/F 2630.00
Cromemco CS-2.21 Slot S100 Bus. Computer System Two, Z80A Processor, Dual 5" Diskette Drives, 64K Memory, VDU/Printer Interfaces (19" Rack Mount) 3095.00
Cromemco CS-3.21 Slot S100 Bus. Computer System Three: Z80A, 64K Memory, Dual High Speed 8" Diskette Drives (1.2M Byte each), VDU/Printer Interfaces (19" Rack Mount) 4495.00
Cromemco Z-2H 12 Slot S100 Bus. Hard Disk Computer System with Z80A Processor, Dual 5" Diskette Drives, 10M Byte Winchester Drive, 64K RAM & VDU/Printer Interfaces 6585.00
Cromemco Z-2H/GS Cromemco Graphics System based on Z-2H, together with additional Dual Ported 96K Byte Video Memory, High Resolution Graphics I/F and Bit Pad Interfaces CDOS and SGS Software Included 8560.00

BOOKS

Very wide range of computer books stocked at all shops.

BUG - BYTE SHOPWARE

All Tapes Available For Acorn, VIC, BBC, Z81, Spectrum. Call for availability.

CROMEMCO SOFTWARE FOR 68000/Z80A SERIES

Cromemco CRO-D Cromix (Multi-User/Multi Tasking) Unix Based Operating System 395.00
Cromemco FOR-D Fortran '77 395.00
Cromemco PAS-D ISO Pascal 395.00

Cromemco ASM-D 68000 Macro Assembler 395.00
 Cromemco STB-D 32K Structured BASIC @ 395.00
 Cromemco CCC-D C-Compiler @ 395.00
 Cromemco COB-D Cobol Compiler @ 395.00
 Note: All 68000 Languages (Suffix D) require Cromix (CRO-D). All Software is available on 5" or 8" Floppy Disks - Please Specify.
 @ = Availability early '83

CROMEMCO LANGUAGES (Z80A)

Cromemco FDB 16K BASIC Interpreter 130.00
 Cromemco FDF Fortran IV Compiler 195.00
 Cromemco FDC Cobol Compiler 395.00
 Cromemco STB 32K Structured BASIC (Includes KSAM) 130.00
 Cromemco FDR RATFOR - Rational Fortran IV Compiler & Pre-Processor 260.00
 Cromemco FDA Z80 Macro Assembler 195.00
 Cromemco CCC C Compiler (Requires Cromix) 395.00
 Cromemco RPG RPGII Report Generator 395.00
 Cromemco LSP LSP List Processor 260.00
 Cromemco COL Overlay Link Editor 260.00
 Cromemco IDS I.O.P. Development Software 395.00
 Cromemco CDS Diagnostic Systems Software 130.00
 All software is available on 5" or 8" Diskettes - please specify.

VDU'S & MONITORS

Comart WY100 Visual Display Terminal, Green Display, 24 x 80 and Status Lines, Detached 105 Key Keyboard with Numeric Pad, Function, Cursor and Editing Controls. Swivel and Tilt Display 675.00
 Volkercraig 4404 595.00
 Volkercraig 4404WS 695.00
 Cromemco RGB14LP. High Resolution Colour Monitor 1395.00
 12" Green Screen Monitor 99.00

DISKETTES

Byteshop 5 1/4" Single Sided, Single Density 1.70ea
 Byteshop 5 1/4" Single Sided, Double Density 2.13ea
 Dysan 5 1/4" Double Sided, Double Density 3.90ea
 Dysan 8" Double Sided, Double Density 4.40ea
 Full range of 5 1/4" & 8" Diskettes in stock

CPM SOFTWARE

BASCOM Microsoft Basic Compiler 227.46
 BASIC-80 Microsoft Basic Interpreter 205.27
 BAZIC Micromikes Basic Language 120.00
 BTAM BYROM Software Communications Package* 115.00
 BSTMS BYROM Software Communications Package 115.00
 CALSTAR Micropro Financial Planning Electronic Spread Sheet Package 90.00
 CARDBOX Caxton Store/Search System 155.00
 CB80 Digital Research Basic Compiler 314.00
 CBASIC Digital Research Basic Language 94.00
 CBASIC/86 D/R Basic Language 204.00
 CIS COBOL Microfocus COBOL Language* 425.00
 COBOL-80 Microsoft COBOL Compiler 421.63
 CP/M for SBC Digital Research Operating System 126.00
 CP/M-86 DISPWIR Digital Research Operating System 204.00
 CP/M-86 + CB86 DW Digital Research Operating System + Language 380.00
 DATASTAR Micropro Database Package 175.00
 DBASE II Ashton-Tate Relational Database + ZIP 435.00

SYSTEM SPOTLIGHT IBM PERSONAL COMPUTER

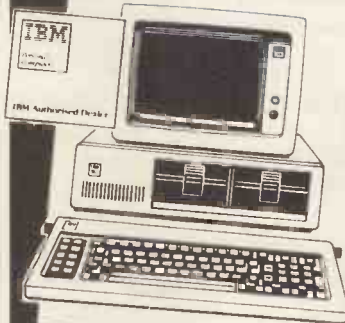

We're delighted to announce that The Byteshops have been appointed IBM Authorised Dealers in the UK for the fantastic new IBM Personal Computer. The most significant microcomputer introduction for years, the IBM PC can be employed by, for example, the small businessman as a stand alone desk top system, or the large corporate user as an intelligent terminal for a main frame. Our 'star' configuration is the 320K Byte Disk model with 128K RAM, UK specified keyboard and screen. At the Byteshop you'll also find that we've given a lot of thought to supporting the IBM PC. Our IBM trained staff can offer you a comprehensive portfolio of IBM PC software and programmes plus add on's and add in's and specialist interfaces for just about every kind of commercial, industrial and laboratory application. Come and talk to us about an inspired machine.

IBM PC Single 160K Byte Disk Drive 64K Byte RAM UK Keyboard and Screen 2080.00
 IBM PC Dual 320K Byte Disk Drives 64K Byte RAM UK Keyboard and Screen 2630.00
 IBM Colour Adapter Card 2973.00
 IBM Printer Inc. Stand and Cable 218.00
 Microvitec Colour Monitor 489.00
 575.00

SOFTWARE FOR THE IBM PC

BTAM Byrom Communications Package 115.00
 CBASIC/86 Digital Research Language Package 204.00
 CCP/M-86 Digital Research Concurrent CP/M Operating system 220.00
 DBASE II Ashton-Tate Database Package 435.00
 EASYFILER IUS Database Package 229.00
 EASYPLANNER IUS Financial Planning Package 143.00
 EASYSPELLER II, IUS Word Processing Package 71.00
 EASYWRITER II, IUS Word Processing Package 200.00
 MAILMERGE Micro Pro Word Processing Enhancement 145.00
 MICROSTAT Ecosoft Statistics Package 195.00
 PASCAL MT + 86 Digital Research Language 377.00
 SPELLSTAR Micro Pro Word Processing Language 145.00
 SUPERCALC Sorcim Financial Planning Enhancement 190.00
 WORDSTAR Micro Pro Word Processing Package 295.00
 WS + MAILMERGE Micro Pro Word Processing Package 390.00
 WS + SPELLSTAR Micro Pro Word Processing Package 415.00
 WS + MM + SP/S Micro Pro Word Processing Package 510.00

TECMAR PC MATE ADD ON'S AND ADD IN'S FOR THE IBM PC

TECMAR Winchester Share/5 Expansion 5M. Byte, H/D with shared system adapter for up to 4 x IBM PC's inc. expansion unit 1995.00
 TECMAR Five in one W/64K Bytes; 64K Byte dynamic memory card c/w serial and parallel ports, clock and calendar 380.00
 TECMAR Five in one W256K Bytes; 256K Byte dynamic memory card c/w serial and parallel ports, clock and calendar 655.00
 TECMAR Dynamic Memory 64K Bytes 260.00
 TECMAR Dynamic Memory 256K Bytes 530.00

The above is just a small selection from the 60 plus Tecmar IBM PC compatible add in's and add on's and specialist interfaces that we offer. There are data storage expansion cards; industrial, scientific and laboratory interfaces; extended input/output expansion cards; general support; communications and software utilities. Please contact us for a full listing.

FILESTAR Microsec's Disk Reformatter CP/M to IBM, DEC, Motorola and Intel Formats 110.00
 FMS-80 DJR Assoc. Database/FM 650.00
 FMS-81/82 from 350.00
 FORMS 2 Microfocus Table Maker 110.00
 FORTRAN-80 Microsoft FORTRAN Compiler 288.48
 GBS Byteshop General Business System 810.00
 INFOSTAR Micropro Database/Reporter 295.00
 ISL Byteshop Accounting Package 1110.00
 KSAM80 EMS Database 350.00
 MACRO-80 Microsoft Macro Assembler 116.50
 MAILMERGE Micropro Wordprocessing Enhancement to link with WORDSTAR 145.00
 MARS Sapphire Business System* 295.00
 MICROSTAT Ecosoft Statistics Package* 195.00
 MILESTONE Organic Software Critical Path Package 225.00
 PASCAL MT + & SPPD/R Pascal Language with Speed Programming Tool 314.00
 PASCAL/MT + D/R Pascal Language 220.00
 PASCAL/MT + 86 Digital Research Pascal Language for 16 Bit Systems 377.00
 PEACHTREE Basic Accounting System per module 325.00
 PEACHTREE Business Management System per module 600.00
 PERSONAL PEARL Pearl Data Base/FM 185.00
 PLANNERCALC Comshare Financial Planning Package 39.00

PL/I-80 Digital Research Language 314.00
 REPORTSTAR Micropro Reporter 210.00
 SPELLSTAR Micropro Proofreading Utility to link with WORDSTAR 145.00
 SUPERCALC Sorcim Financial Planning/Budgeting Spread Sheet Package* 190.00
 SUPERSORT Micropro Sort Utility 145.00
 T/MARKER II Lifeboat Associates Financial Planning/Spread Sheet Package 195.00
 WORDSTAR Micropro Wordprocessing Package* Also available with Mailmerge and Spellstar 295.00
 WP WORKSHOP MAC Ltd Training Guide for WORDSTAR or MAILMERGE 75.00
 X BASIC Xitan Language 185.00
 X CP/M Xitan/DR Operating System 118.00

Many Utilities, Programming Tools and Training Packages available. Also extensive range of diskette formats. Prices include configuration on machines supplied by ourselves. We are totally committed to after sales service and future support.

*These software packages are available for both CP/M And CP/M86.

ALL PRICES EXCLUSIVE OF VAT

* Barclaycard Visa & Access cards taken in payment.
 * Shop opening hours 9 - 5.30, check individual shops for details of Saturday opening times.
 * Phone Mail Orders accepted. Please contact nearest shop for P.P. & Delivery Rates. Regret no C.O.D.

* Some items may be subject to a dollar surcharge if the dollar exchange rate changes more than 5 cents. Prices will be adjusted in line with the rate prevailing at the time of purchase.
 * Prices subject to change without notice
 E. & O.E. and are valid for the cover date life of this magazine. (March 83)
 * Whilst we carry a vast range of stock, we cannot guarantee that every advertised item will be available in each shop.
 * All goods are new and include factory warranties.
 * No refunds on opened software.
 * Orders from Government Depts. & Colleges etc. welcome.
 * Leasing & HP facilities available - apply for written details.
 * Detailed prices available on request.



THE BYTESHOP

Your Specialist Computer Centre

LONDON
 The Byteshop
 324 Euston Road NW1
 Tel: 01-387 0505

GLASGOW
 The Byteshop, Magnet House
 61 Waterloo Street
 Tel: 041-221 7409

NOTTINGHAM
 The Byteshop
 92A Upper Parliament Street
 Tel: 0602 40576

BIRMINGHAM
 The Byteshop
 94-96 Hurst Street
 Tel: 021-622 7149

MANCHESTER
 The Byteshop
 11 Gateway House, Piccadilly,
 Station Approach Tel: 061-236 4737

SOUTHAMPTON
 Also at XITAN Systems
 23 Cumberland Place
 Tel: 0703 334711

Members of the Comart Group of Companies

There are so many micro computers on the market that choosing the right one is far from easy.

And it isn't made any easier when you find them cheek by jowl with cameras, hi-fi and a host of other electrical equipment. What you need is someone that is single minded. And that means us.

Byteshops are totally dedicated to microcomputers. So not surprisingly, we can offer you a wider range because we sell nothing else.

Our prices are keenest too. So are our staff. Each one is an expert who can make sure you get the computer that's exactly right for you - whether it's a home micro or a £20,000 business system.

What's more we'll freely advise you on expanding or upgrading your system as your knowledge grows or your requirements change. While our Microserve Centres offer service and maintenance on site and at our shops.

After all, we are the UK's longest established microcomputer specialists. Come and see us soon.

BBC Micro Computer

Please phone for availability



ACORN WORD PROCESSOR 'VIEW' £52

2nd PROCESSOR 6502/Z80 £170

ACORN SOFT/BBC SOFT/GAMES PADDLES IN STOCK

BBC Model B £399

(inc. VAT) Carr. £8

Model A to Model B upgrade kit £50

Fitting charge £15

Partial Upgrades also available

PRESTEL ADAPTOR

£90

TELETEXT ADAPTOR

£195.00

All mating Connectors with Cables in stock. Full range of ACORN SOFTWARE, PROGRAM POWER & BUGBYTE SOFTWARE AVAILABLE.

Phone or send for our BBC leaflet.

BBC FLOPPY DISC DRIVES

FD INTERFACE £95 INSTALLATION £20
Single Drive 5¼" 100K £235 + £6 carr.
Dual Drive 5¼" 800K £799 + £8 carr.

BBC COMPATIBLE DRIVES

These are drives with TEAC FD50 mechanism and are complete with power supply.

SINGLE: 100K £190; 200K £260; 400K £340
DUAL: 200K £360; 400K £490; 800K £610

OFFICIAL BBC DEALER

MICRODOCTOR

This is not a logic analyser or an oscilloscope. It tests a microsystem and gives a printed reprint on RAM, ROM and I/O - it will print memory map, search for code, check dataline shorts and operates peripherals. Microdoctor complete with PSU, printer probe cable and two configuration board £295.

MONITORS

BMC BM 1401 14" Colour Monitor
RGB input 18MHz bandwidth
£240 plus £8 carr.
Hi Res Green Monitor Antiglare screen £99 plus £6 carr.
MICROVITEC 1431 M/S 14" Colour Monitor RGB Input
£269 plus £8 carr.
RGB lead for BMC. £8.
Composite Videolead £3.50.

ACORN ATOM

Basic Built £135 Expanded £175 (carr £3 per unit)
Atom Disc Pack £299 + £6 carr.
Send s.a.e. for our BBC Atom list

NEC PC 8023 BE-C

100CPS, 80 cols. Logic Seeking, Bidirectional, Forward and Reverse Line Feed, Proportional Spacing, Auto Underline, Hi-Res and Block Graphics, Greek Char. Set. Only £320 + £8 Carr.



PRINTERS

SEIKOSHA GP 100A

80 Cols 30 CPS
Full ASCII & GRAPHICS
10" WIDE paper
Now only £175 + £6 Carr.

Ask for details on GP 250A

Parallel Printer lead for BBC/Atom to most printers £13.50
Variety of interfaces, ribbons in stock
2,000 fan fold sheets 9½" x 11" £13.50 + £3 p&p

EPSON MX80 and 100F/T3

MX 80 80CPS 80 cols
MX100 100CPS 136 cols
Logic Seeking, Bidirectional, Bit Image Printing, 9x9 Matrix, Auto Underline

MX80 F/T3 £320
MX100 F/T3 £430 (£8 Carr/Printer)

RUGBY ATOMIC CLOCK

This Z80 micro controlled clock/calendar receives coded time data from NPL Rugby. The clock never needs to be reset. The facilities include 8 independent alarms and for each alarm there is a choice of melody or alternatively these can be used for electrical switching. A separate timer allows recording of up to 240 lap times without interrupting the count. Expansion facilities provided. See July/August ETI for details. Complete Kit £120 + £2.00 p&p.

CONNECTOR SYSTEMS

I.D. CONNECTORS

(Speed Block Type)

	St. Pin	Recept.	Edge Conn.
10 way	90p	85p	200p
20 way	145p	125p	240p
26 way	175p	150p	300p
34 way	200p	160p	380p
40 way	220p	190p	550p
50 way	235p	200p	600p

JUMPER LEADS

24" Cable with DIP Headers

	14pin	16pin	24pin	40pin
Single End	145p	165p	240p	380p
Double End	210p	230p	345p	540p

Cable with Sockets
20way 26way 34way 40way
Single End 24" 185p 210p 270p 300p
Double End 18" 290p 385p 490p 540p

AMPHENOL CONNS

36 way Solder Type Plug (centronix type)	550p	
36 way Solder Socket (centronix type)	550p	
36 way IDC Plug (centronix type)	500p	
24 way Solder Plug (IEEE type)	500p	
24 way Solder Socket	500p	
24 way IDC Plug	485p	

RIBBON CABLE

	(Grey)
10 way	50p
14 way	60p
16 way	70p
20 way	80p
24 way	115p
26 way	120p
34 way	180p
40 way	210p
50 way	330p
64 way	370p

SOFTY II INTELLIGENT PROGRAMMER

The complete micro processor development system for Engineers and Hobbyists. You can develop programs, debug, verify and commit to EPROMS or use in host computer by using softy as a romulator. Powerful editing facilities permit bytes, blocks of bytes changed, deleted or inserted and memory contents can be observed on ordinary TV. Accepts most +5v Eproms. Softy II complete with PSU, TV Lead and Romulator lead £169.

D CONNECTORS

	9way	15way	25way	37way
Male Solder				
Bucket	95p	135p	160p	250p
Angled Pins	160p	230p	210p	425p
IDC	-	375p	450p	680p
Female Solder				
Bucket	110p	160p	210p	350p
Angled Pins	175p	240p	275p	500p
IDC	-	375p	475p	750p
Hoods	100p	100p	100p	130p

RS 232 CONNS

(25 way D)

24" Single end Male	£5.50
24" Single end Female	£6.00
24" Female-Female	£11.00
24" Male-Male	£10.00
24" Male-Female	£11.50

DIP HEADERS

	Solder Type	IOC Type
14 pin	40p	120p
16 pin	50p	140p
24 pin	100p	200p
40 pin	200p	225p

EUROCONNECTORS

	Plug	Socket
DIN 41617 21 way	180p	180p
DIN 41617 31 way	200p	200p
DIN 41612 2x32 way Straight pins	290p	330p
2x32 way Ang. pin	325p	400p
2x32 way wire wrap	325p	375p
2x32 way St. pins	250p	400p
3x32 way Angled pins	350p	
IDC Connector	-	475p
A+B IDC Connector	-	525p
A+C 2x32 way U Connector	£15	(please specify a+b or a+c)

EDGE CONNECTORS

	0.1"	0.155"
2x 6 way	-	140p
2x18 way	-	140p
2x22 way	200p	250p
2x23 way	200p	-
2x25 way	225p	300p
1x43 way	260p	-
2x43 way	395p	-
2x50 way	600p	-
way way	700p	-

UV ERASERS

UVIB up to 6 Eproms £47.50
UVIT with Timer £60.00
UV140 up to 14 Eproms £61.50
UV141 with Timer £78.00

(Carr £2/eraser)

All erasers are fitted with mains switches and safety interlocks

TRAINER KITS

6502 Junior Computer £85.00
6802 Nancomp I £80.00
6809 Nancomp II £80.00
1802 Micro Trainer £64
Z80 Menta £99

(Fully built and documented)

Full details on request

SPECIAL OFFER

2114L-2	80p
2716 (+5v)	250p
2532	350p
2732	350p
4116-2	80p
4164-15 (TI)	400p
6116P-3	350p

BAUD RATE GENERATORS

4702B	750p
COM 8116	700p
MC 14411	675p

CPU's

1802CE	650p
2650A	£12
6502	350p
6502A	500p
6800	225p
6802	225p
68B02	700p
6809	650p
68B09	£12
6809E	£12
8035	350p
8039	300p
8080A	250p
8085A	450p
INS8060	£11
TMS9800	£20
8086A	£22
8748	£18

COMPONENTS

TMS9995	£12
Z8	£24
Z80	290p
Z80A	320p
Z80B	£12
8088	£18
6875	8250
8205	8250
8212	8250
8214	8250
8216	8250
8224	8250
8250	8250
8251	8250
8255	8250
8256	8250
8279	440p
8288	£11
Z80P10	250p
Z80AP10	280p
Z80CTC	230p
Z80ACTC	280p
Z80ADART	700p
Z80ADMA	£10

SUPPORT DEVICES

CRT 6545	900p
CRT 5027	£18
CRT 5037	£18
EF9365	£48
EF9366	£48
6845	650p
6847	650p
TMS 9927	£18
TMS 9928	£20
TMS 9929	£20
EF 9364	£9

CRT CONTROLLER

Send s.a.e. for our Comprehensive Price List including Books

TECHNOMATIC LTD

MAIL ORDERS TO: 17 BURNLEY ROAD, LONDON NW 10 1ED
SHOPS AT: 17 BURNLEY ROAD, LONDON NW 10
(Tel: 01-452 1500, 01-450 6597. Telex: 922800)
305 EDGWARE ROAD, LONDON W2

PLEASE ADD 40p p&p & 15% VAT (Export: no VAT, p&p at Cost)

Orders from Government Depts. & Colleges etc. welcome.

Detailed Price List on request.

Stock items are normally by return of post.

**kent, micro
systems**

...where expertise comes first!

We know there are many who will be happy to sell you *their machine*, however, we have more to offer you than most other companies.

We have the necessary knowledge to analyse your requirements and then supply a system to the resulting specification, or a ready written business package.

Among our staff are programming experts in the **Scientific and Engineering** fields as well as **commercial programmers**.

XEROX 820 (below)
The desk top microcomputer
for better business decisions.



**ACT
sirius 1**



(left) **ACT SIRIUS 1**
Innovative hardware, state-of-the-art software and total support make this best-selling 16-bit personal computer the *Complete Machine* for business.

olivetti ET35i (below)

The Electronic Memory Typewriter with Display simple to use for editing texts. With interchangeable mini-floppy disks for repetitive correspondence and documents.



Engineers & Scientists!

COME AND SEE
THE NEW

SAGE II

MICROCOMPUTER

More Performance for £2,500
than any Computer in history!

**kent, micro
systems**

...so now you need look no further for genuine professional advice!

**Conquest House, 17 Palace Street,
Canterbury CT1 2DJ Telephone (0227) 50200/50366**

Feel SAFE when you buy your **IBM** Personal Computer

When you buy your IBM PC from OEM, you get one year's full on site maintenance as standard. So if you get a fault of any kind, just one phone call usually brings an engineer to your office or home within 24 hours (often within 2 to 3) anywhere in the UK.

The IBM PC retails at **£2895.00** + VAT with a whole range of software available from £99.00.



To order your IBM PC call our hot line on
01-748 8404, or Telex 263559 Micro G.

DEALERS WELCOME!



OFFICE EFFICIENCY MACHINES LTD

1 Lochaline Street, London W6 9SJ

Tel. 01-741 7211/2/3/4

To: Office Efficiency Machines Ltd.,
1 Lochaline Street, London W6 9SJ
Telex 263559 Micro G

- Please send me information on the
- Dealer End User
- Urgent Please phone me

Name _____

Company _____

Address _____

Telephone _____

PCW1

STARTTECH

Absolutely the lowest prices!

computer apple computer apple computer apple computer z computer apple c

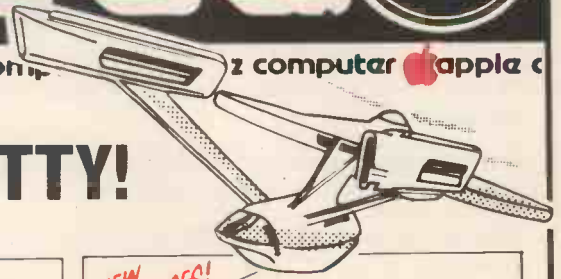

BEAM UP A BARGAIN, SCOTTY!

NEW

pfs™

THE INFORMATION MANAGEMENT SYSTEM WRITTEN IN PASCAL

A powerful, fast, and user-friendly database accounting system now available for your Apple at an incredibly low price.

PFS: DATABASE
£59.95

PFS: REPORT
£49.95

NEW LOW PRICES!

£5 OFF!

16K RAM CARDS
(Pascal CPM: Computer Stop)

WAS ~~£49.95~~ **NOW** **£44.95**

NEW LOW PRICES!

£5 OFF!

ALL VISI PRICES

	WAS	NOW		WAS	NOW
VISICALC, VISICORP	£105.00	£100.00	VISISCHEDULE, VISICORP	£149.95	£144.95
VISIDEX, VISICORP	£127.95	£122.95	VISITERM, VISICORP	£53.95	£48.95
VISIFACTORY, MICRO	£37.95	£32.95	VISITRENO/VISIPLOT, VISICORP	£148.95	£143.95
VISIFILE, VISICORP	£120.95	£115.95	DESK TOP PLAN 11: PERSONAL SOFTWARE	£131.95	£126.95
VISIPLOT, VISICORP	£98.95	£93.95			

NEW LOW PRICES!

MICRO PRO WORDSTAR SIMPLY THE BEST

WAS ~~£49.95~~ **NOW** **£145.95**

ADVENTURE

Adventure (Microsoft): Microsoft	£13.95
Ali Baba + 40 Thieves: Quality Software	£18.95
Castle Wolfenstein: Muse	£13.95
Dark Forest: Sirius Software	£15.95
Wizard & Princess: On line	£14.95
Soft Porn Adventure: On Line	£13.95
Space Adventure: Siera Software	£14.95
Time Zone: On Line	£45.95
Zork 3: Infocom	£19.95
Zork 2: Infocom	£19.95

Tumble Bug: Datasoft	£17.95
Space Eggs: Sirius Software	£12.95
Space Quarks: Broderbund	£13.95
Swashbucker: Datamost	£16.95
Hi-Res Soccer: On Line	£13.95

LANGUAGE

Asm Lang: Development Sys: Hayden	£24.95
Expediter 11 Compiler: On Line	£39.95
Fourth 11 (Language): Softape	£31.95
Lisa 2-5 6502 Assembler: On Line	£45.95

STRATEGY GAME

Air Traffic Controller: Avant Garde	£7.95
Robot Wars: Muse	£18.95
Tigers In The Snow: Strategic Simulations	£17.95

UTILITY

Back It Up: Sensible Software	£30.95
Bag of Tricks: Quality Software	£20.95
Deadly Secrets: Broderbund	£17.95
Dossource 3.3 Dos Listing: Lazer	£18.95
Program Line Editor: Synergistic Software	£18.95

HARDWARE

Excel-9 (6809 With "Flex"): ESD Laboratory Co. Ltd	£164.95
23 Key Keypad (Visicalc): Keyboard Company	£101.95
Omnivision 80/24 Video: Computer Stop	£144.95
U Term 80/24 Video Card: U Micros	£151.95
Z80 Softcard: Microsoft	£203.95
10 Meg Hard Disk System: Computer Stop	£1644.95

Z80 CPM (Z80 Softcard Required)

Wordstar: Micropro	£137.95
D Base 11 Manual: Ashton Tate	£33.95
Alds Z80, 8080 Assembler: Microsoft	£57.95
Bstam Micro To Micro: Byrom	£108.95

BOOK

Beaneath Apple Dos: Quality Software	£9.95
--------------------------------------	-------

BUSINESS

Address Book (List) Muse	£23.95
Data Factory: Micro Lab	£72.95
Data Factory 5.0: Micro Lab	£139.95
DB Master: Stoneware	£104.95
Magic Window (WP): Artsci	£46.95
Easywriter Pro: Info Unlimited	£115.95
Easy Mailer: Info Unlimited	£87.95
Invoice Factory: Micro Lab	£108.95
DB Utility Packs: Stoneware	£47.95

GRAPHICS UTILITY

Arcade Machine: Broderbund	£21.95
A26E1 Graphics: Sub Logic	£32.95
Hi-Res Secrets: Avant Garde	£60.95

HI-RES ACTION

Alien Rain: Broderbund	£13.95
Anti Ballistic Missile: Muse	£12.95
Apple Panic: Broderbund	£14.95
Flight Simulator: Sub Logic	£18.95
Frogger: On Line	£17.95
Gorgon: Sirius Software	£17.95

Please send me:

I enclose cheque/P.O. for

Name:

Address:

Please add V.A.T. to all orders.

Postage paid in U.K. Allow 30 days for delivery. Access & Barclaycard orders welcome on 051-256 8244

PCW.1.83

STARTTECH

63 Lisburn Lane,
Tuebrook, Liverpool L13 9AF

NEC PC-8000 Personal Computer.



NEC turns 28 years of computer experience to your personal advantage.

It takes a great computer company to make a great personal computer. And from the start, NEC has been a pioneer in computer technology. In fact, we invented the all-semiconductor computer in 1959. Now, hundreds of innovations later, we've made it personal.

We present the PC-8000, a powerful and friendly business tool that can help you get more done in a day than you ever could before. It combines some of the most reliable hardware on the market with application packages designed to make the most of its unique features. In addition, the PC-8000 accepts popular CP/M® business software, making its possibilities virtually limitless.

The entire PC-8000 system is now available through better computer dealers across the country. And that means more than hardware. It means effective software, the finest documentation and extensive training to help you get the most from your personal computer. So why not turn our system to your personal advantage now.

(CP/M is a registered trademark of Digital Research Inc.)

NEC
Nippon Electric Co. Ltd.
Tokyo, Japan

NEC BUSINESS SYSTEMS (EUROPE) LTD.
NEC House, 164/166 Drummond Street,
London N.W.1 3HP UK
Telephone: 01-388-6100 Telex: 261914.

Write for more information
about the NEC PC-8000.

NAME _____
COMPANY _____
ADDRESS _____

Attach this coupon to your letterhead and mail it to NEC BUSINESS SYSTEMS (EUROPE) LTD., NEC House, 164/166 Drummond Street, London N.W.1 3HP, U.K.

Personal Computer World

ICE

Welcome to the ICE Age



5¹/₄in. Winchester Sub Systems with a tape streamer back up.
From 3 to 42 Megabyte configurations

Compatible with

Apple II • Apple III • Superbrain • Sirius/Victor • I.B.M.P.C. • S100 • Z80 based Systems

Tapestreamer backup now available for Profile. Apple III hard disc.

For further information or a demonstration contact:— ICE 16/18 Littleton Road, Ashford, Middlesex TW15 1UQ. Telephone Ashford (07842) 47271/47171 Telex 8952042 (DP.CUST.G)

Detail from S1350

A totally portable computer that runs on its own power supply for use anywhere.

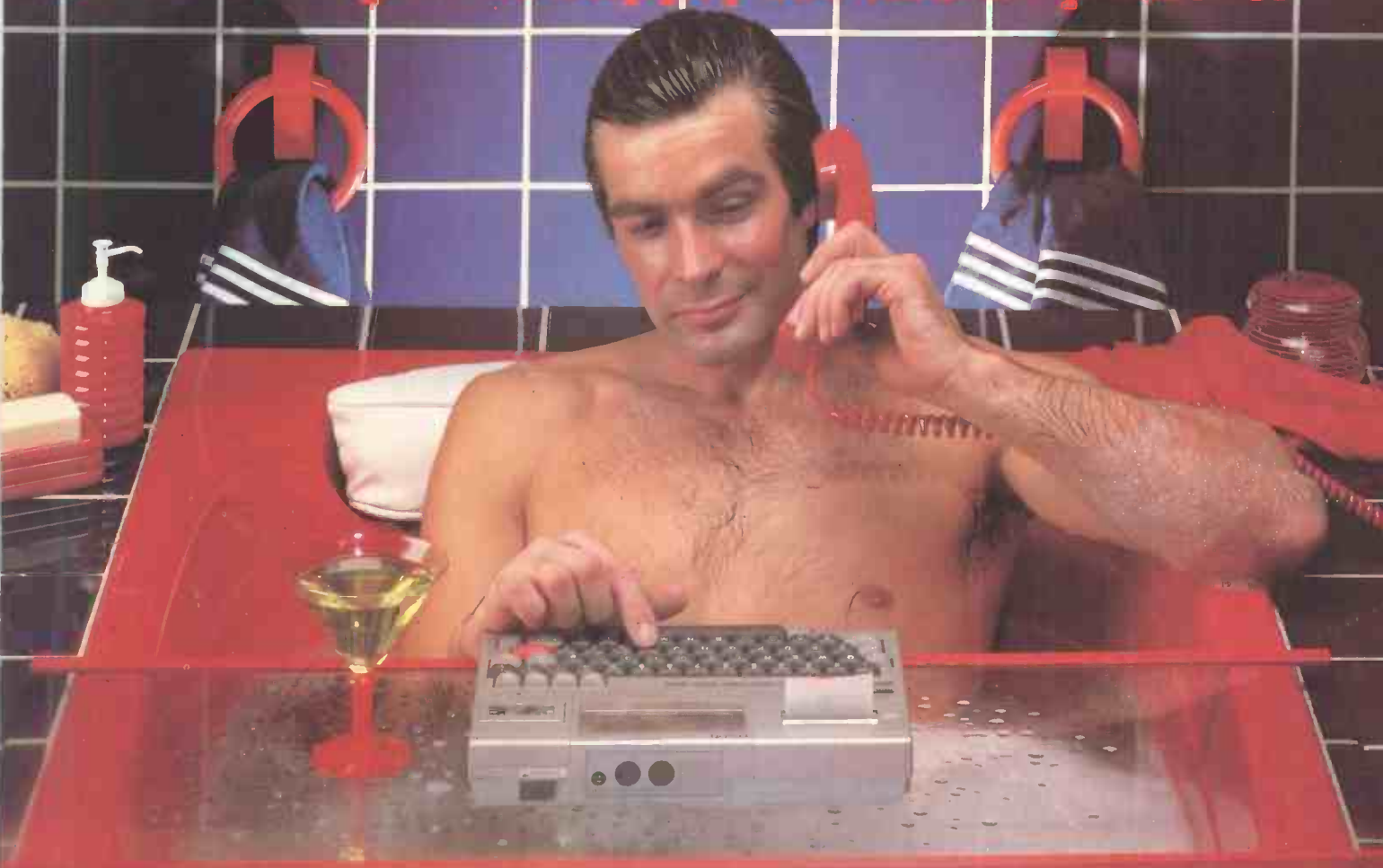

It could mean the end of the rubber duck as we know it.

The HX-20 is a portable computer with a full size typewriter keyboard, LCD Virtual Screen, printer and micro-cassette facility actually built in. A computer with a rechargeable power source that's large enough for writing programs and manipulating data virtually anywhere, yet small enough to carry in a briefcase.

But don't let the size fool you. The HX-20 is not a gimmicky toy or an excuse for a calculator. It's a precision machine using a full extended version of Microsoft BASIC with 16k RAM, optionally expandable to 32k and 32k ROM expandable to 64k, RS-232C and Serial interfaces. The ASCII typewriter keyboard and five programmable keys brings ten separate program functions to your fingertips.

Power to your elbow.

The HX-20 runs on its own power supply for over 50 hours and can be easily recharged overnight, or whilst in use, with the ability to

retain its memory in RAM even when switched off.

Keeping you in the picture.

The LCD screen is unique - showing any 20 characters by 4 lines at a time - enabling you to carry out word processing or data entry as if you are using a large screen.

Print Out. Built In.

The 24 column dot matrix impact micro-printer offers 42 LPM in a crisp, precise 5 x 7 matrix for perfect hard copies. Every time. And you can choose from a wide range of peripherals from bar code readers to acoustic couplers for total capability.

Epson. Reliability through Research.

You'll find our name on a highly successful range of computer printers. So you can be assured of the same quality and reliability through an extensive research programme prior to the launch of any Epson product.

Write or call us for further details and the name of your local stockist (because seeing really is believing).

You'll find that the HX-20 is the most complete portable computer you can buy. It could even change the face of bathtime.

Which is a bad day for ducks.

Epson (UK) Limited
Freepost
Wembley, Middlesex HA9 6BR
Freephone: 2730
Telex: 8814169



EPSON

**Extraordinary product.
Exceptional quality.**

HX-20

PORTABLE COMPUTER

Don't let its size fool you.

If anything NewBrain is like the Tardis.

It may look small on the outside, but inside there's an awful lot going on.

It's got the kind of features you'd expect from one of the really big business micros, but at a price of £269.95 including VAT it won't give you any sleepless nights.

However, let the facts speak for themselves.

You get what you don't pay for.

NewBrain comes with 24K ROM and 32K RAM, most competitors expect you to make do with 16K RAM.

What's more you can expand all the way up to 2 Mbytes, a figure that wouldn't look out of place on a machine costing ten times as much.

We've also given you the choice of 256, 320, 512 and 640 x 250 screen resolution, whereas most only offer a maximum of 256 x 192.

Big enough for your business.

Although NewBrain is as easy as ABC to use (and child's-play to learn to use) this doesn't mean it's a toy.

Far from it.

It comes with ENHANCED ANSI BASIC, which should give you plenty to get your teeth into.

And it'll also take CP/M® so it speaks the same language as all the big business micros, and feels perfectly at home with their software.

NO OTHER MICRO HAS THIS MUCH POWER IN THIS MUCH SIZE FOR THIS MUCH MONEY.

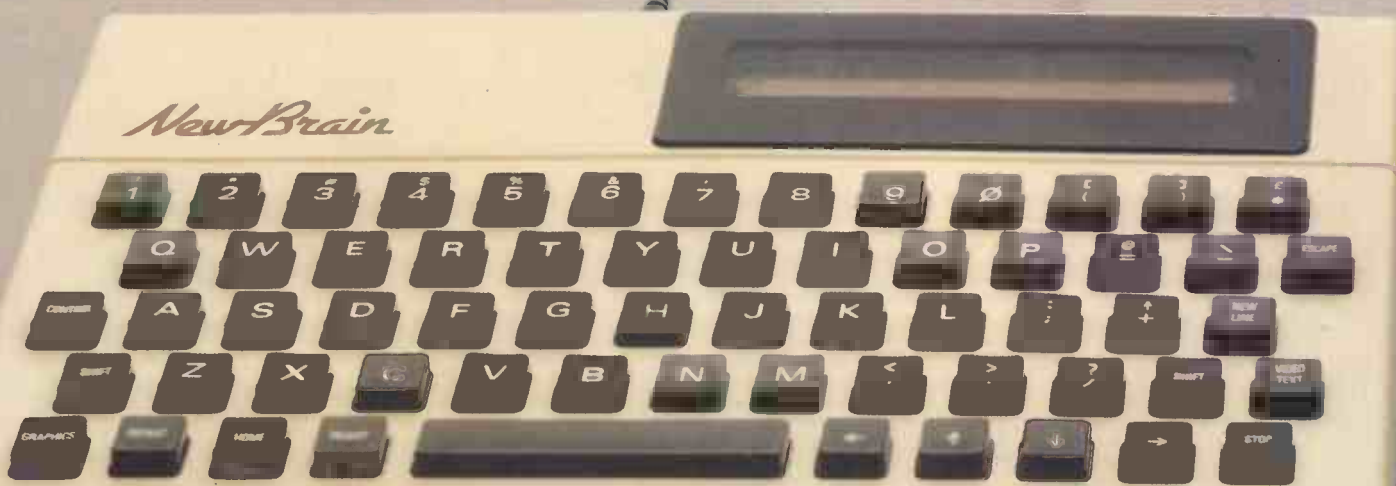

So as a business machine it really comes into its own.

The video allows 40 or 80 characters per line with 25 or 30 lines per page, giving a very professional 2000 or 2400 characters display in all on TV and/or monitor. And the keyboard is full-sized so even if you're all fingers and thumbs you'll still be able to get to grips with NewBrain's excellent editing capabilities.

When it comes to business graphics, things couldn't be easier. With software capabilities that can handle graphs, charts and computer drawings you'll soon be up to things that used to be strictly for the big league.

Answers a growing need.

Although NewBrain, with its optional onboard display, is a truly portable micro, that doesn't stop it becoming the basis of a very powerful system.

The Store Expansion Modules come in packages containing 64K, 128K, 256K or 512K of RAM. So, hook up four of the 512K modules to your machine and you've got 2 Mbytes to play with. Another feature that'll come as a surprise are the two onboard V24 interfaces.

With the aid of the multiple V24 module this allows you to run up to 32 machines at once, all on the same peripherals, saving you a fortune on extras.

The range of peripherals on offer include dot matrix and daisy wheel printers, 9", 12" and 24" monitors plus 5¼" floppy disk drives (100 Kbytes and 1 Mbyte) and 5¼" Winchester drive (6-18 Mbytes).

As we said, this isn't a toy.

It doesn't stop here.

Here are a couple of extras that deserve a special mention.

The first, the Battery Module, means you won't be tied to a 13 amp socket. And, even more importantly, it means you don't have to worry about mains fluctuations wreaking havoc with your programs.

The ROM buffer module gives you a freedom of another sort.

Freedom to expand in a big way. It gives you additional ROM slots, for system software upgrades such as the Z80 Assembler and COMAL, 2 additional V24 ports, analogue ports and parallel ports.

From now on the sky's the limit.

Software that's hard to beat.

A lot of features you'd expect to find on software are actually built into NewBrain so you don't need to worry about screen editing, maths, BASIC and graphics.

However, if you're feeling practical you can always tackle household management, statistics and educational packages. And because NewBrain isn't all work and no play, there's the usual range of mind-bending games to while away spare time.

Waste no more time.

To get hold of NewBrain you need go no further than the coupon at the bottom of the page.

With your order we'll include a hefty instruction manual so you'll know where to start, and a list of peripherals, expansion modules, and software so you'll know where to go next.

© CP/M is the registered trade mark of Digital Research Inc.

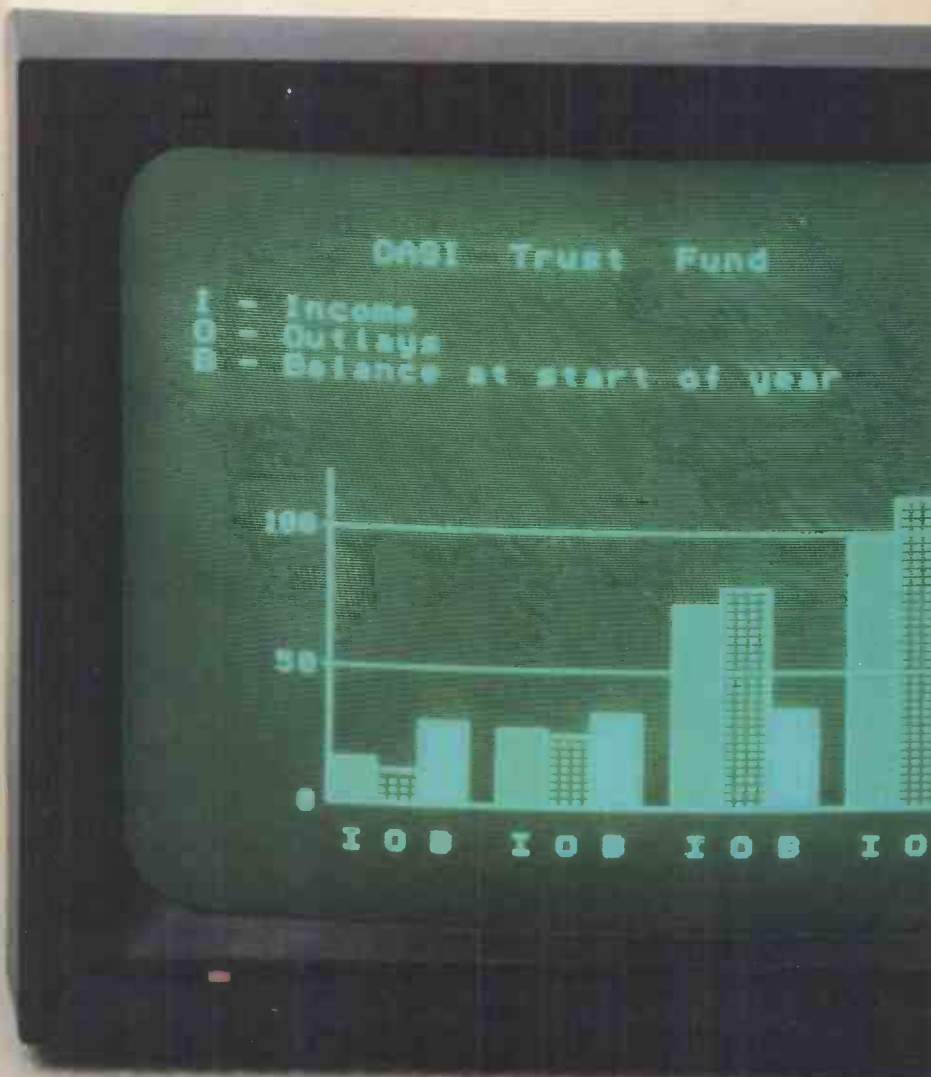

Technical Specifications

The NewBrain is a fully specified professional computer built to the highest standards of engineering and reliability. Chosen by leading OEM suppliers. Designed to facilitate easy expansion for use with the CP/M operating system, and the addition of 5¼ flexible and Winchester disks, 12 green phosphor professional standard monitor, 80 cps professional quality dot matrix printer with pin addressable graphics.

Z80A cpu and COP 420M input/output microprocessors. 32K RAM expandable to 2 Mbytes. 29K ROM. Dual Cassette Ports. UHF TV port. CCITT Monitor Port Video 40/80 Character x 25/30 lines. 256, 320, 512, 640 x 250 Pixels. Expansion Port. V24 Bi-directional Port. V24 Printer Port. 16-character display (AD only).

Software: Enhanced BASIC (ANSI x 3.2/78) Independent Operating System (12 device drivers). Multi Page Screen Editor (32 Control Commands). Maths (10 Significant Figures). Graphics (Absolute & Relative Plotting, Line & Arc Drawing, Shading, 20 English Language Commands).

NewBrain,
Grundy Business Systems Ltd., Grundy House,
Somerset Road, Teddington, TW11 8TD.

To: NewBrain, Grundy Business Systems Limited, Grundy House, Somerset Road, Teddington TW11 8TD.

Please send me a full-colour leaflet, price list, and name and address of my nearest stockist.

Name _____

Address _____

Postcode _____

PCW2

Samurai means to Samurai is built to so

Out of the world's most powerful economy comes the world's most performance-orientated executive computer. It's the Samurai from Micro Networks, a 16 bit business machine with a capability, features and a price that gives it a decisive edge over the competition from the other side of the Pacific.

As well as the thrust of the Intel 8086 power, there's an impressively engineered reliability that's wholly Japanese. 128K bytes of memory, 2.4 megabytes formatted floppy disk storage with standard IBM format compatability, communications



RRP £2795 ex V

erve. The new 16 bit rve today's executive.

and printer interfaces all come as standard. And on top there is a superb range of options.

The software available to Samurai users is extensive. A full library has been developed by Peachtree the world's largest microcomputer software house, for MS DOS* and CP/M86** Samurai's operating systems. It all indicates that here's a machine that's built to work alongside you in the toughest business environment.

The Samurai is backed by an aftersales service programme, the like of which has not yet been in the U.K. executive computer market. Just as an ancient Samurai warrior pledged total loyalty to his lord, so Micro Networks pledges every Samurai customer a total support package. A 12-month guarantee of course, but also a guaranteed no-quibble replacement. Extensive training is available, and a software hotline to enable business users to get fast answers to operating queries.

Micro Networks Limited

382 Kensington High Street, London W14 8NL

Telephone 01-602 7405/9

Ⓢ *The Samurai is a product from Nissei Sangyo which is a subsidiary of Hitachi.*

MICRO NETWORKS



To: Micro Networks Limited
382 Kensington High Street
London W14 8NL

Please send me more details of the 16 bit Samurai.

Name _____

Company _____

Position _____

Address _____

Phone _____ PCW/2

* MS DOS is the registered mark of Micro Soft

** CP/M 86 is the registered mark of Digital Research



ORIC-1 TM

TIMELESS TECHNOLOGY FROM ORIC PRODUCTS INTERNATIONAL

The Computer Challenge

**16 colours
professional keyboard
full graphics
real sound**

- Superb styling
- Choice of 16K RAM or massive 48K RAM
- Ergonomic keyboard with 57 moving keys
- 28 rows x 40 characters high resolution
- Teletext/viewdata compatible graphics
- 6 octaves of real sound plus Hi-Fi output
- Centronics printer interface and cassette port
- Comprehensive user manual

OPTIONAL MODEM OFFERS COMPUTER PHONE LINK FOR:
● ELECTRONIC MAIL ● TELESOFTWARE ● PRESTEL

COMING SOON, TO COMPLETE YOUR SYSTEM: ORIC MICRO-DRIVE DISCS & SPEED PRINTER

THE REAL
COMPUTER SYSTEM
FOR
£ 99.95
incl VAT

FOR HOME: The ORIC-1 is the professional alternative for home computing. Superbly styled, the 57 key layout is based upon computers costing many times more than the ORIC, and will help the whole family to learn and understand computing, right from day one. The ORIC incorporates an improved version of Basic for ease of programming and use. For the enthusiasts the computer has laser zaps, explosions, etc. pre-programmed for games use, with Hi-Fi output for incredible effect. The communications Modem will allow 'Telesoftware', message sending, and Prestel use.

FOR BUSINESS: The ORIC-1 is the answer to many day to day problems. Software is becoming available for payroll, accounts, stock-control, and many more systems to help your day to day business organising and control. In addition, the ORIC COMMUNICATIONS MODEM will allow you to access up to 200,000 pages of Prestel information, to send and receive 'electronic mail', to book hotels, and flights (and pay for them) and to look at the latest stock-market and share indexes.

In short the ORIC-1 is a must for all businesses large or small.

HOW TO ORDER YOUR ORIC-1: By phone: Just ring our telesales number Ascot (0990) 27641.

By post: You can pay by cheque, postal order ACCESS - BARCLAYCARD - AMEX - DINERS.

(Please allow 28 days for delivery).

Money back if not satisfied.

© Copyright ORIC PRODUCTS INTERNATIONAL 1982

ORIC-1

The Real Computer System

ORIC PRODUCTS INTERNATIONAL LTD
Coworth Park, Mansion, Ascot, Berks SL5 7SE

* Please delete/complete as applicable.
* Enclose a cheque/PO payable to ORIC PRODUCTS INTERNATIONAL LIMITED for £

Item	Qty	Price Inc VAT	Total
ORIC-1 16K RAM		£ 99.95	
ORIC-1 48K RAM		£ 169.95	
Postage and Packing		£ 79.95	
Please charge my Access Barclaycard			
Amex, Diners Club account no.			
Name			
Address			
TOTAL		£	5.95

Coworth Park, Mansion, Ascot, Berks, London Road, Sunninghill, Ascot, Berks SL5 7SE

If you require a brochure please tick

PCW 3

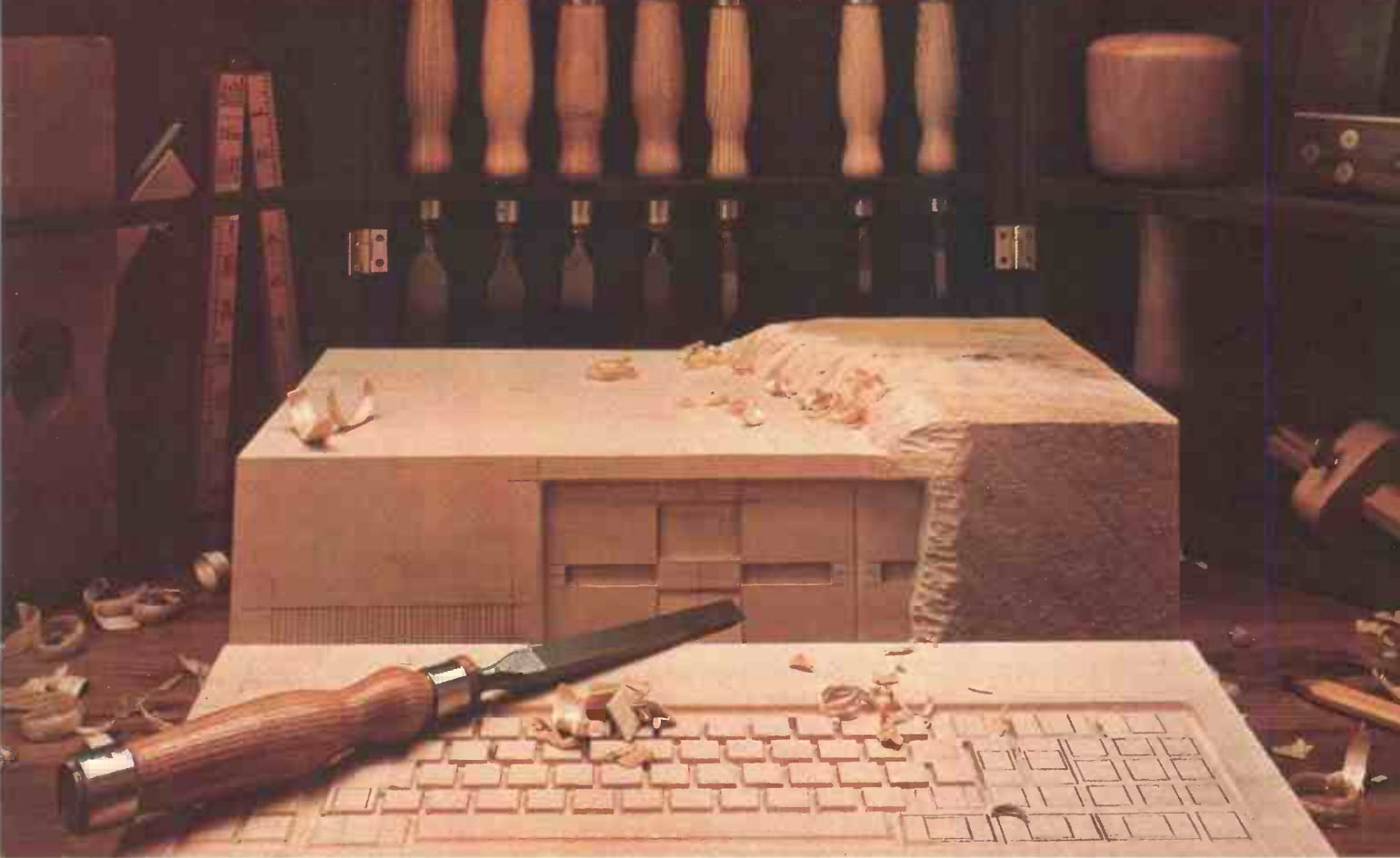

MS-DOS™ gives you the only complete set of software tools for 16-bit systems. Now. From Microsoft.

Systems and Applications. Now. The success of any microcomputer system depends on the amount of software available for it. And, the ease of writing more. Microsoft™ MS-DOS is the only single-user operating system fully supported by Microsoft's 16-bit languages: BASIC Interpreter, BASIC Compiler, COBOL, FORTRAN and Pascal. Plus, the Multi-Tool™ family of applications software... starting with the Multiplan™ electronic worksheet.

More software. Soon. IBM chose MS-DOS as the primary OS for the IBM® Personal Computer. Lifeboat Associates chose MS-DOS as the 16-bit, single-user DOS it will support. And Microsoft will continually introduce new applications and systems software for MS-DOS. The implication is clear: MS-DOS is going to be even better supported. Fast.

Easier conversion. MS-DOS was written to make conversion of CP/M-80® programs simple. Simpler, according to programmers, than conversion to CP/M-86™. Again, the implication is clear.

Better system features. MS-DOS offers features unavailable under either CP/M-80 or CP/M-86: device independent I/O, advanced error recovery, variable length records, and full program relocatability in order to take

MS, Multiplan, Multi-Tool, and Microsoft are trademarks of Microsoft Corporation. CP/M and CP/M-80 are registered trademarks of Digital Research, Inc. CP/M-86 is a trademark of Digital Research, Inc. IBM is a registered trademark of International Business Machines, Corp.



advantage of the extended addressing capabilities of the 8086 and 8088 microprocessors. And MS-DOS' descriptive error messages make it a user-friendly OS.

Leadership in microsystems. Microsoft led the industry into the 8-bit world when we put BASIC on the first microcomputer. Now, we're leading the industry into the 16-bit world with the first complete set of software tools for the 8086 and 8088 microprocessors. The MS-DOS operating system. Languages. Utilities. And, applications software.

Planning an OEM system? Return the coupon below for complete OEM information on MS-DOS and Microsoft's complete set of tools for 8086 systems. Can't wait? Call our OEM Accounts Manager.

MICROSOFT

Microsoft Europe Ltd
Bulbourne House, Gossoms End
Berkhamsted, Herts HP4 3LP

(04427) 75091
TLX: 825888 MICROE G

- Send me information on MS-DOS for OEM's.
 Send me information on applications for MS-DOS.

Name _____
Company _____
Address _____
Town _____ County _____ Postcode _____

In the USA: Microsoft Corporation, 10700 Northup Way, Bellevue WA 98004, U.S.A. Tel: 010.1.(206) 828.8080. Tlx: 328945



NOW: you can make the most of your Apple II and Visicalc.

That's right, 80 column display with bigger memory for Visicalc, now.

The Visicalc Expand Gold Pack includes either 32K, 64K, or 128K RAM cards, an 80 column display card (which is fully compatible with other Apple software including Wordstar, Applewriter 2, PASCAL, CP/M) and our own Versa Visicalc Expand software.

All our own products!!

VEGP 32. Comprising 32K RAM card, 80 column card and Versa Visicalc software. **£280.00**

VEGP 64. Comprising 64K RAM card, 80 column card and Versa Visicalc software. **£369.00**

VEGP 128. Comprising 128K RAM card, 80 column card and Versa Visicalc software. **£450.00**

VAT extra, add £1.00 p&p.



U-MICROCOMPUTERS

U-Microcomputers Ltd, Winstanley Industrial Estate, Long Lane, Warrington, Cheshire, WA2 8PR, England. Tel. 0925 54117 Telex 629279 UMICRO G.

U-Microcomputers Inc, 300 Broad Street, Stamford, Connecticut 06092, USA. Tel. 203 359 4236 & Toll Free (800) 234 2475 Telex 965999 O&S STD.

Apple, trademark Apple Computer Inc.
Visicalc, trademark Visicorp Inc.
CP/M, trademark Digital Research Inc.



The box is not always black ...

At Rair we're continually enhancing and upgrading our Black Box microcomputer range to meet the ever-changing, ever-growing needs of our customers.

That's why you'll often find our systems turning up under different names, different colours—not always black.

Our current Black Box range includes 8- and 16-bit microprocessors, that can be configured from simple

single-user floppy disk systems right up to powerful multi-user systems with Winchester hard disks and tape backup.

So next time you're choosing a microcomputer for a new application, remember to call us first.

With Rair, you can have any colour you like, including black.

United Kingdom RAIR Limited 6-9 Upper St Martins Lane London WC2H 9EQ Telephone (01) 836 6921 Telex 298452
France RAIR Sarl 90 Avenue Champs Elysées 74008 Paris Telephone 010 331 225 4401 Telex 290177
West Germany RAIR Computer GmbH Clemensstrasse 5-7 5000 Köln 1 Telephone (0221) 219811 Telex 8881915
United States RAIR Microcomputer Corp. 4101 Burton Drive Santa Clara CA 95050 Telephone (408) 988-1790 Telex 677038



ZX Spectrum

BLUE EDIT	RED CAPS LOCK	MAGENTA TRUE VIDEO	GREEN INV. VIDEO	CYAN	YELLOW	WHITE	BLACK DELETE
1 !	2 @	3 #	4 \$	5 %	6 &	7 ' ,	8 ()
DEF FN	LINE	OPEN #	CLOSE #	MOVE	ERASE	POINT	FORMAT
SIN	COS	TAN	INT	RND	STR\$	CHR\$	CODE
Q <=	W <>	E >=	R <	T >	Y AND	U OR	I AT
ASH	ACS	ATN	VERIFY	MERGE	ABS	SQR	OUT
READ	RESTORE	DATA	SGN	ABS	THEN	VAL	USR
A STOP	S NOT	D STEP	F TO	G THEN	H ↑	J -	K +
NEW	SAVE	DIM	FOR	CALL	GOSU	LOAD	LIST
IN	EXP	LPRINT	LLIST	BIN	CIRCLE	VAL	SCREEN
Z :	X £	C ?	V /	B *	N .	M PAUSE	L LET
BEEP	INK	PAPER	FLASH	BRIGHT	OVER	INVERSE	ATTR
CAPS SHIFT	COPY	CLEAR	CONT	CONT	CONT	PAUSE	SPACE



Sinclair ZX Spectrum

**16K or 48K RAM...
full-size moving-
key keyboard...
colour and sound...
high-resolution
graphics...**

**From only
£125!**

First, there was the world-beating Sinclair ZX80. The first personal computer for under £100.

Then, the ZX81. With up to 16K RAM available, and the ZX Printer. Giving more power and more flexibility. Together, they've sold over 500,000 so far, to make Sinclair world leaders in personal computing. And the ZX81 remains the ideal low-cost introduction to computing.

Now there's the ZX Spectrum! With up to 48K of RAM. A full-size moving-key keyboard. Vivid colour and sound. High-resolution graphics. And a low price that's unrivalled.

Professional power— personal computer price!

The ZX Spectrum incorporates all the proven features of the ZX81. But its new 16K BASIC ROM dramatically increases your computing power.

You have access to a range of 8 colours for foreground, background and border, together with a sound generator and high-resolution graphics.

You have the facility to support separate data files.

You have a choice of storage capacities (governed by the amount of RAM). 16K of RAM (which you can uprate later to 48K of RAM) or a massive 48K of RAM.

Yet the price of the Spectrum 16K is an amazing £125! Even the popular 48K version costs only £175!

You may decide to begin with the 16K version. If so, you can still return it later for an upgrade. The cost? Around £60.



Ready to use today, easy to expand tomorrow

Your ZX Spectrum comes with a mains adaptor and all the necessary leads to connect to most cassette recorders and TVs (colour or black and white).

Employing Sinclair BASIC (now used in over 500,000 computers worldwide) the ZX Spectrum comes complete with two manuals which together represent a detailed course in BASIC programming. Whether you're a beginner or a competent programmer, you'll find them both of immense help. Depending on your computer experience, you'll quickly be moving into the colourful world of ZX Spectrum professional-level computing.

There's no need to stop there. The ZX Printer—available now—is fully compatible with the ZX Spectrum. And later this year there will be Microdrives for massive amounts of extra on-line storage, plus an RS232 / network interface board.



Key features of the Sinclair ZX Spectrum

- Full colour—8 colours each for foreground, background and border, plus flashing and brightness-intensity control.
- Sound—BEEP command with variable pitch and duration.
- Massive RAM—16K or 48K.
- Full-size moving-key keyboard— all keys at normal typewriter pitch, with repeat facility on each key.
- High-resolution—256 dots horizontally x 192 vertically, each individually addressable for true high-resolution graphics.
- ASCII character set—with upper- and lower-case characters.
- Teletext-compatible—user software can generate 40 characters per line or other settings.
- High speed LOAD & SAVE—16K in 100 seconds via cassette, with VERIFY & MERGE for programs and separate data files.
- Sinclair 16K extended BASIC— incorporating unique 'one-touch' keyword entry, syntax check, and report codes.

Am



ZX Spectrum software on cassettes – available now

The Spectrum software library is growing every day. Subjects include games, education, and business/household management. Flight simulation... Chess... Planetoids... history... Inventions... VU-CALC... VU-3D... Club Record Controller... there is something for everyone. And they all make full use of the Spectrum's colour, sound, and graphics capabilities. You'll receive a detailed catalogue with your Spectrum.

ZX Expansion Module

This module incorporates the three functions of Microdrive controller, local area network, and RS232 interface. Connect it to your Spectrum and you can control up to eight Microdrives, communicate with other computers, and drive a wide range of printers.

The potential is enormous, and the module will be available in the early part of 1983 for around £30.

sinclair

Sinclair Research Ltd, Stanhope Road, Camberley, Surrey GU15 3PS.
Tel: Camberley (0276) 685311.

The ZX Printer – available now

Designed exclusively for use with the Sinclair ZX range of computers, the printer offers ZX Spectrum owners the full ASCII character set – including lower-case characters and high-resolution graphics.

A special feature is COPY which prints out exactly what is on the whole TV screen without the need for further instructions. Printing speed is 50 characters per second, with 32 characters per line and 9 lines per vertical inch.

The ZX Printer connects to the rear of your ZX Spectrum. A roll of paper (65ft long and 4in wide) is supplied, along with full instructions. Further supplies of paper are available in packs of five rolls.



The ZX Microdrive – coming soon

The new Microdrives, designed especially for the ZX Spectrum, are set to change the face of personal computing by providing mass on-line storage.

Each Microdrive can hold up to 100K bytes using a single interchangeable storage medium.

The transfer rate is 16K bytes per second, with an average access time of 3.5 seconds. And you'll be able to connect up to 8 Microdrives to your Spectrum via the ZX Expansion Module.

A remarkable breakthrough at a remarkable price. The Microdrives will be available in the early part of 1983 for around £50.



How to order your ZX Spectrum

BY PHONE – Access, Barclaycard or Trustcard holders can call 01-200 0200 for personal attention 24 hours a day, every day. BY FREEPOST – use the no-stamp needed coupon below. You can pay by cheque, postal order, Barclaycard,

Access or Trustcard.

EITHER WAY – please allow up to 28 days for delivery. And there's a 14-day money-back option, of course. We want you to be satisfied beyond doubt – and we have no doubt that you will be.

To: Sinclair Research, FREEPOST, Camberley, Surrey, GUI5 3BR.				Order
Qty	Item	Code	Item Price £	Total £
	Sinclair ZX Spectrum – 16K RAM version	100	125.00	
	Sinclair ZX Spectrum – 48K RAM version	101	175.00	
	Sinclair ZX Printer	27	59.95	
	Printer paper (pack of 5 rolls)	16	11.95	
	Postage and packing: orders under £100	28	2.95	
	orders over £100	29	4.95	
				Total £ _____

Please tick if you require a VAT receipt

*I enclose a cheque/postal order payable to Sinclair Research Ltd for £ _____

*Please charge to my Access/Barclaycard/Trustcard account no. _____

*Please delete/complete as applicable _____

Signature _____

PLEASE PRINT

Name: Mr/Mrs/Miss _____

Address _____

_____ PCW 903

FREEPOST – no stamp needed. Prices apply to UK only. Export prices on application.

Sinclair ZX Spectrum—technical data.

Dimensions

Width 233 mm
Depth 144 mm
Height 30 mm

CPU/memory

Z80A microprocessor running at 3.5 MHz.
16K-byte ROM containing BASIC interpreter and operating system.

16K-byte RAM (plus optional 32K-byte RAM on internal expansion board) or 48K-byte RAM.

Keyboard

40-moving-key keyboard with full upper and lower case with capitals lock feature. All BASIC words obtained by single keys, plus 16 graphics characters, 22 colour control codes, and 21 user-definable graphics characters. All keys have auto repeat.

Display

Memory-mapped display of 256 pixels x 192 pixels; plus one attribute byte per character square, defining one of eight foreground colours, one of eight background colours, normal or extra brightness and flashing or steady. Screen border colour also settable to one of eight colours. Will drive a PAL UHF colour TV set, or black and white set (which will give a scale of grey), on channel 36.

Sound

Internal loudspeaker can be operated over more than 10 octaves (actually 130 semitones) via basic BEEP command. Jack sockets at the rear of computer allow connections to external amplifier/speaker.

Graphics

Point, line, circle and arc drawing commands in high-resolution graphics.
16 pre-defined graphics characters plus 21 user-definable graphics characters. Also functions to yield character at a given position, attribute at a given position (colours, brightness and flash) and whether a given pixel is set. Text may be written on the screen on 24 lines of 32 characters. Text and graphics may be freely mixed.

Colours

Foreground and background colours, brightness and flashing are set by BASIC INK, PAPER, BRIGHT and FLASH commands. OVER may also be set, which performs an exclusive-or operation to overwrite any printing or plotting that is already on the screen. INVERSE will give inverse video printing. These six commands may be set globally to cover all further PRINT, PLOT, DRAW or CIRCLE commands, or locally within these commands to cover only the results of that command. They may also be set locally to cover text printed by an INPUT statement. Colour-control codes, which may be accessed from the keyboard, may be inserted into text or program listing, and when displayed will override the globally set colours until another control code is encountered. Brightness and flashing codes may be inserted into program or text, similarly. Colour-control codes in a program listing have no effect on its execution. Border colour is set by a BORDER command. The eight colours available are black, blue, red,

magenta, green, cyan, yellow and white. All eight colours may be present on the screen at once, with some areas flashing and others steady, and any area may be highlighted extra bright.

Screen

The screen is divided into two sections. The top section – normally the first 22 lines – displays the program listing or the results of program or command execution. The bottom section – normally the last 2 lines – shows the command or program line currently being entered, or the program line currently being edited. It also shows the report messages. Full editing facilities of cursor left, cursor right, insert and delete (with auto-repeat facility) are available over this line. The bottom section will expand to accept a current line of up to 22 lines.

Mathematical operations and functions

Arithmetic operations of +, -, X, /, and raise to a power. Mathematical functions of sine, cosine, tangent and their inverses; natural logs and exponentials; sign function, absolute value function, and integer function; square root function, random number generator, and pi.

Numbers are stored as five bytes of floating point binary – giving a range of $+3 \times 10^{-39}$ to $+7 \times 10^{38}$ accurate to 9½ decimal digits.

Binary numbers may be entered directly with the BIN function. =, >, <, >=, <= and <> may be used to compare string or arithmetic values or variables to yield 0 (false) or 1 (true). Logical operators AND, OR and NOT yield boolean results but will accept 0 (false) and any number (true).

User-definable functions are defined using DEFFN, and called using FN. They may take up to 26 numeric and 26 string arguments, and may yield string or numeric results.

There is a full DATA mechanism, using the commands READ, DATA and RESTORE.

A real-time clock is obtainable.

String operations and functions

Strings can be concatenated with +. String variables or values may be compared with =, >, <, >=, <=, <> to give boolean results. String functions are VAL, VAL\$, STR\$ and LEN. CHR\$ and CODE convert numbers to characters and vice versa, using the ASCII code.

A very powerful string slicing mechanism exists, using the form a\$(x TO y).

Variable names

Numeric – any string starting with a letter (upper and lower case are not distinguished between, and spaces are ignored).

String – A\$ to Z\$.

FOR-NEXT loops – A-Z.

Numeric arrays – A-Z.

String arrays – A\$ to Z\$.

Simple variables and arrays with the same name are allowed and distinguished between.

Arrays

Arrays may be multi-dimensional, with subscripts starting at 1. String arrays, technically character arrays, may have their last subscript omitted, yielding a string.

Expression evaluator

A full expression evaluator is called during program execution whenever an expression, constant or variable is encountered. This allows the use of expressions as arguments to GOTO, GOSUB, etc.

It also operates on commands allowing the ZX Spectrum to operate as a calculator.

Cassette interface

The ZX Spectrum incorporates an advanced cassette interface. A tone leader is recorded before the information to overcome the automatic recording level fluctuations of some tape recorders, and a Schmitt trigger is used to remove noise on playback.

All saved information is started with a header containing information as to its type, title, length and address information. Program, screens, blocks of memory, string and character arrays may all be saved separately.

Programs, blocks of memory and arrays may be verified after saving to confirm successful saving.

Programs and arrays may be merged from tape to combine them with the existing contents of memory. Where two line numbers or variables names coincide, the old one is overwritten.

Programs may be saved with a line number, where execution will start immediately on loading.

The cassette interface runs at 1500 baud, through two 3.5 mm jack plugs.

Expansion port

This has the full data, address and control busses from the Z80A, and is used to interface to the ZX Printer, the RS232 and NET interfaces and the ZX Microdrives.

IN and OUT commands give the I/O port equivalents of PEEK and POKE.

ZX81 compatibility

ZX81 BASIC is essentially a subset of ZX Spectrum BASIC. The differences are as follows.

FAST and SLOW: the ZX Spectrum operates at the speed of the ZX81 in FAST mode with the steady display of SLOW mode, and does not include these commands.

SCROLL: the ZX Spectrum scrolls automatically, asking the operator "scroll?" every time a screen is filled.

UNPLOT: the ZX Spectrum can unplot a pixel using PLOT OVER, and thus achieves unplot.

Character set: the ZX Spectrum uses the ASCII character set, as opposed to the ZX81 non-standard set.

ZX81 programs may be typed into the ZX Spectrum with very little change, but may of course now be considerably improved. The ZX Spectrum is fully compatible with the ZX Printer, which can now print out a full upper and lower case character set, and the high resolution graphics; using LLIST, LPRINT and COPY. ZX81 software cassettes and the ZX 16K RAM pack will not operate with the ZX Spectrum.

sinclair ZX Spectrum

Whatever the system-insist on Kaga monitors



First choice for quality: Kaga Monitors enjoy a world-wide reputation for superb definition and clarity of image whether in Green, Amber, Black and White or full RGB colour.

First choice for value: Kaga quality at Kaga prices makes Kaga unbeatable.

First choice for reliability: Kaga Monitors are specifically designed for use with computers, custom-built for the functions they perform, with solid state circuitry to ensure utmost reliability.

First choice for compatibility: Kaga Monitors are compatible with all popular micro computers. Apple™, Acorn/BBC™, Commodore Pet™, IBM™, Osborne™, Tandy™, you name it, Kaga's made for it. Kaga RGB Monitors have built-in switchable interface allowing simple plug-in compatibility for most micros with RGB output. And the wide range of Kaga models



means there's a Kaga ideally suited to your individual needs, whatever your computer.

First choice for availability: Wherever you are, there's a Data Efficiency Kaga dealer close at hand to advise and help you before and after you choose your Kaga Monitor. Ring 0442 60155 for details of your nearest stockist.

Kaga Models and Prices:
RGB Monitors from around £264 (retail)
Monochrome Monitors from around £99 (retail)
Apple II RGB Adaptor and RGB Cables for most popular micros are available.

Prices ex-VAT and correct at time of going to press

Trade and OEM enquiries welcome

DON'T SETTLE FOR SECOND BEST - INSIST ON KAGA TO COMPLETE YOUR SYSTEM



For all your Micro needs...and more. (0442) 60155

ATARI 800 Home Computer
 now down in price to **£399-99** S.R.P. INC. VAT



Music Composer

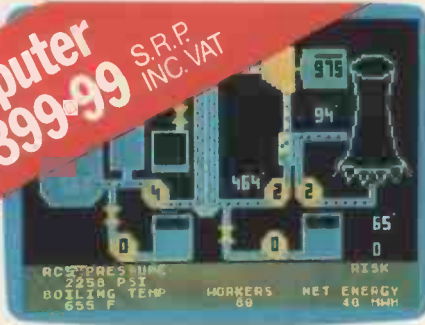

Scram



Graph-it



Intro to BASIC 1



Star Raiders



European Countries



Missile Command



Basketball

3.7 million reasons why the Atari Home Computer is something to see. The display screen used with our computers is composed of 192 horizontal lines, each containing 320 dots. Delivering colour and luminosity instructions to each dot for a second requires 3.7 million cycles...a lot of work for the normal 6502 processor.

That's why the Atari computer has equipped its 6502 with its own electronic assistant. It's called ANTIC, and it handles all the display work, leaving the 6502 free to handle the rest. What this means to you is uncompromisingly spectacular display capabilities without loss of computer power needed to carry out the demands of your program.

That's a quality you just don't find in ordinary home computers. And it's one of the reasons some computer experts say that Atari computers are so far ahead of their time.

There's more...which is what you'd expect from Atari Language. The Atari Home Computer uses several programming languages to give the user maximum control of its extraordinary capabilities. PILOT, Microsoft BASIC and Atari BASIC are understood and spoken by the Atari computer. You'll also find our Assembler Editor cartridge indispensable for machine language programming.

Sound. An Atari computer has four sound generators, or voices, activated by a separate microchip. This leaves the principal micro-processor chips free to perform other tasks. And you can take full advantage of this capability which is designed for easy programming.

Change. Atari Home Computers have been designed to make change and expansion easy. The Atari computer has a modular operating system that can be easily replaced as new technology develops. If you need it, memory expansion requires no more than inserting additional RAM modules.* And the Atari ROM cartridge system also makes it easy to change languages. In short, your Atari computer won't become obsolete by future developments...because it already incorporates the future.

Sharing. To learn more about the amazing capabilities of Atari Home Computers, either visit your local dealer or fill in the coupon below.

THE GRAPHIC DIFFERENCE BETWEEN ATARI COMPUTERS AND ALL THE OTHERS.

*Atari 800SM computer only.



Please send me a FREE brochure, price list and the address of my nearest stockist.

Name _____

Address _____

Atari International (UK) Inc.
 Atari House, Railway Terrace,
 Slough, Berks SL1 5BZ.
 For readers in Eire, send the
 coupon to: Omnitek Ltd,
 45 Cookstown Estate,
 Tallaght, Co. Dublin.

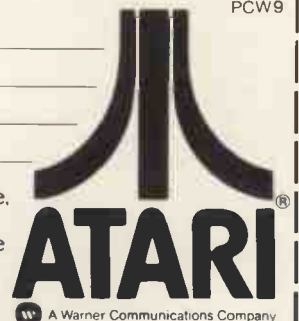

A Warner Communications Company

TOSHIBA DOUBLE SIDED/DOUBLE DENSITY 5 1/4" DISK DRIVES



These are high quality, very reliable, industry standard disk drives. These can be used as single sided/single density, double sided/double density or double sided/double density depending on the host computer disk interface. Compatible with most micro-computers e.g. VIDEO GENOE, ATOM, TRS 80, BBC COMPUTER, SUPER BRAIN, NASCOM etc. If used as double sided/double density then the storage capacity is 3.5 MAGABITS/DRIVE (unformatted), track density is 48 TPI and can daisy chain up to 4 drives. 90 day warranty.

One disk drive only £179 + VAT = £205.85
 Two disk drives £349 + VAT = £401.35
 Single boxed with power supply £214 + VAT = £246.10
 Dual boxed with power supply £389 + VAT = £447.35
 2 Drive Cable £15 + VAT = £17.25
 DS/DD 48 TPI diskettes £2.50 + VAT = £2.88

MITSUBISHI Double sided/double density Double Tracks 1/4" Disk Drives

This is the latest addition to our range of disk drives. The capacity is 1 MAGA BYTES (unformatted) per drive, the track density is 96TPI. Track to track access time is 3 msec. These are compatible with Shugart SA460 (ANSI standard interface). Compatible with BBC COMPUTER, ATOM, NASCOM and lots of other computers.

One disk drive only £219 + VAT = £251.85
 Two disk drives £429 + VAT = £493.35
 Single boxed with power supply £249 + VAT = £286.35
 Dual boxed with power supply £459 + VAT = £527.85
 DS/DD 96TPI diskettes £3.95 + VAT = £4.54 each

PROFESSIONAL MONITORS



• **GREEN MONITOR 12"** green monitors with composite and sync input. Suitable for most computers
 Hitachi MM1216 £89 + VAT = £102.35
 SM12H 18MHZ monitor £89 + VAT = £102.35

• **COLOUR MONITORS 14"** colour monitors, RGB or composite and sync input.
 SCM14N Normal-res 400 dots £199 + VAT
 SCM14M Medium-res 600 dots £339 + VAT
 SCM14H High-res 800 dots £499 + VAT

T199/4A SOFTWARE

SOLID STATE SOFTWARE MODULES

*TI-Invasders £15 + VAT = £17.25
 *Video Games 1 £18 + VAT = £20.70
 *Mind Challengers £10 + VAT = £11.50
 *A-Maze-ing £18 + VAT = £20.70
 *Connect Four £18 + VAT = £20.70
 *Soccer £18 + VAT = £20.70
 *Tombstone City £18 + VAT = £20.70
 *Zero Zap £18 + VAT = £20.70
 *Attack £18 + VAT = £20.70
 *Blasto £18 + VAT = £20.70
 *Hustle £18 + VAT = £20.70
 *Yatzee £18 + VAT = £20.70
 *Black Jack/Poker £18 + VAT = £20.70
 *Car Wars £22 + VAT = £25.30
 *Munchman £22 + VAT = £25.30
 *Chess £28 + VAT = £32.20
 *Adventure & Pirate £28 + VAT = £32.20

ADDITIONAL ADVENTURE PROGRAMS

(Use with Adventure Module)
 *Adventure Land £18 + VAT = £20.70
 *Mission Impossible £18 + VAT = £20.70
 *Voodoo Castle £18 + VAT = £20.70
 *The Count £18 + VAT = £20.70
 *Strange Odyssey £18 + VAT = £20.70
 *Mystery Fun House £18 + VAT = £20.70
 *Pyramid Fun House £18 + VAT = £20.70
 *Ghost Town £18 + VAT = £20.70
 *Savage Island I & II £22 + VAT = £25.30
 *Golden Voyage £28 + VAT = £20.70
 A lot more Software is available. S.A.E. for list.

BBC MICROCOMPUTER

BBC Microcomputer Model B £348 + VAT = £399
 Model B + Econet Interface £389 + VAT = £446
 Model B + Disk Interface £409 + VAT = £469
 Model B + Econet + Disk interfaces £450 + VAT = £516
 Single disk drive (100K) £230 + VAT = £264
 TELETEXT receiver £195 + VAT = £224
 PRESTEL receiver £90 + VAT = £103
 Parallel printer cable £12 + VAT = £103
 Games Paddles (per pair) £11 + VAT = £12.65

SOFTWARE FOR BBC COMPUTER

Desk Diary (Two programmes) £8.65 + VAT = £9.95
 Algebraic manipulation package £8.65 + VAT = £9.95
 BBC Peeko Computer £8.65 + VAT = £9.95
 BBC FORTH language £14.50 + VAT = £16.67
 BBC LISP language £14.50 + VAT = £16.67
 BBC word processing package £52 + VAT = £59.80
 Printer Driver Cass £8.65 + VAT = £9.95

TEXAS INSTRUMENTS T199/4A 16 BIT HOME COMPUTER SYSTEM



This microcomputer is based on TMS9900 16 bit microprocessor. It includes 16K RAM, 16 colour high resolution graphic (192x256). The screen display is 32 characters, 24 lines TI-BASIC. Full size keyboard. For Software there are about 1000 Programs to choose from. There are a lot of peripherals available e.g. Disk Drives, Disk Interface, Speech Synthesizer, Extra RAM. Additional Languages (PASCAL, TI-LOGO, ASSEMBLER). Prices: TI Home Computer £149.95; Peripheral Expansion System £134.95; Disk Controller Card £124.95; Disk Drive £199.95; Speech Synthesiser £41.95. All prices inclusive of VAT. Please send large SAE for full price list.

GUARANTEED LOWEST PRICES

We guarantee that our prices are the lowest on the market. If you can find any item advertised and in stock at less than our price we will match that price.

NEW EPSON TYPE 3 PRINTERS



MX80 F/T-3
 80 column, 80 CPS, super and subscripts, auto underlining, tractor feed, 32 print fonts. Bi-directional printing, logic seeking, 9 x 9 matrix, high res. graphics, centronic parallel interface, tractor or friction paper feed. FREE 500 sheets of paper Price: £325 + VAT = £373.75

MX 100-3
 136 columns, 100 CPS, all other features of MX80 plus true descenders, adjustable paper width up to 15 inches, friction or tractor feed, centronic parallel interface. Price: £429 + VAT = £493.35

SEIKOSHA GP SERIES PRINTERS WITH HIGH RES. GRAPHICS

GP-100A 50 CPS, 80 column, Hi-res graphic line repeat function, adjustable up to 10" paper width, tractor feed, 5x7 dot matrix.
 GP-100A centronic parallel interface £189 + VAT = £217.35
GP-250X New 50 CPS, 80 column, tractor feed, true descenders. 64 user defined characters, double height and/or double width characters, 5x8 dot matrix, parallel and serial (RS232) interface.
 GP-250X £239 + VAT = £274.85



CORDLESS PHONES

Not licensable in UK
Prices from £79.35 inc. VAT for the model shown on the left.



LONG RANGE TELEPHONE

This is a long range (2-5 miles) cordless extension phone with intercom facility between portable hand set and the base station. You can receive all incoming calls and dial out to anywhere in the world from the hand set from any location within 5 mile radius of your home or office. The maximum range is achieved by using roof top optional antenna (not included).
 Long range extension phone £249 + VAT = £286.35
 Optional rooftop antenna £45 + VAT = £51.75

MEDIUM RANGE TELEPHONE

Similar specifications to the above model but with operational range of 1/2 mile to 2 1/2 miles (with rooftop antenna).
 Medium range extension phone £179 + VAT = £205.85
 Optional rooftop antenna £45 + VAT = £51.75

SHORT RANGE TELEPHONE

This is a short range cordless telephone for use within the house or from the garden. You can receive and make calls from the hand set. Range approx. 600 feet.
 Short range telephone £69 + VAT = £79.35

40 MILE RANGE CAR TELEPHONE

This mobile telephone fits into your car and enables you to receive and make calls to anywhere in the world from within 40 mile radius of your home or office (use rooftop antenna).
 Car telephone £1195 + VAT = £1374.25

SILENT ALARM/POCKET PAGER



This is an individually coded 4 WATTS Radio transmitter and pocket pager receiver. The alarm system has connectors for door contacts and vibration sensors. 2 vibration sensors are included. It has a range of 2 miles. Ideal for protection of vehicle or property. Power requirements for transmitter is 12V dc. Not licensable in UK.
 Price £75 + VAT = £89.70

OKI MICROLINE PRINTERS



MICROLINE 80
 Features: 80 columns, 80 CPS, friction and pin feed. Unidirectional block graphics. Centronics parallel interface.
 Price £189 + VAT = £217.35

MICROLINE 82A
 Features: 80 columns, CPS, friction and pin feed, bidirectional printing, parallel and serial (1200 bauds) interface.
 Price £329 + VAT = £378.35

FAST 100 CPS NEC 8023 PRINTER



This is a high speed printer using bi-directional logic seeking operation, 7x9 matrix for alphanumerics, 8x8 for graphics and bit image printing. Programmable paper feed, original plus three copies, Greek characters and high resolution graphics. The print quality is exceptional, and the price is affordable.
 Price £289 + VAT = £332.35

AKHTER INSTRUMENTS LTD.

DEPT CT, UNIT 19, ARLINGHYDE ESTATE, SOUTH ROAD, HARLOW, ESSEX, UK CM20 2BZ
 TEL: HARLOW (0279) 412639 TELEX: 995801 - A18

ORDERING INFORMATION All orders which accompany a cheque or cash are CARRIAGE FREE (UK only). On all other orders a carriage charge of 3% of invoice total is applicable.

G. W. COMPUTERS LTD

G80/86 SOFTWARE

Fully implemented on MS-DOS, CPM 2.2 and CPM 86 (tm)

Works on IBM, Sirius and Victor 9000 and all micro-computers in our price list

Sale ledger (95 pounds)	The invoicer (95 pounds)**
Purchase ledger (95 pounds)	The address mailer (95 pounds)
Nominal ledger (95 pounds)	Quasort/Qnsort (500 records/ 15 seconds) (95 pounds)
Aged analysis (25 pounds)	
Stock control-valuation/re-order (95 pounds)	

Each module is a set of 'task drives' designed for minimal learning curve. This software derives from modules of 'DBMS III' and runs reports without your secretary having to touch a single key

Consider the advantages in these features: The user manual is contained in FIVE pages • All reports are generated by robot functions • Reliability Tested (benchtest PCW June) • Works in a network multi-user environment • Fast easy data entry • Files are re-organised and sorted automatically • Produced by the same people that originated 'BUSINESS', 'DBMS II', 'DB-CALC', 'AUTOLOAD AND RECOVER' etc and sold successfully over the past five years.

Also see our advertisement next page, the software above comes free with a system purchase (excluding items marked ** and DBMS III)

The G80/86 networks

Based upon one hard disk and multiplexor module the G80/86 networks feature full network sharing of data resources by adding different stations that may be as various as Sirius/Victor 9000/IBM/Superbrain/Pet/N'star/Sanyo. The low-cost startup of a network could be simply:

1 hard-disk of 5 mbytes 1750.00	1 multiplexor 695.00	1-2 stations from 795.00
------------------------------------	-------------------------	-----------------------------

We also have a special 'spooler module' as well as software controllable port expanders and modems for output to telephones, printers, and screens so that a number of terminals may share the resources of one printer, as well as be able to send files over the telephone at any time (day/night) to both store on the hard disk and print out as well.

Imagine a terminal at a remote site, being able to send/receive its files to/from the main network's hard disk/printer overnight to be examined and processed the next day.

The commands are literal English. Like: (send file 'ledger' to port 'B' (the modem) at 11.30) only from G.W. Computers (the leaders in database).

Call us on 01-636 8210 or 01-631 4818 and leave your address for our standard 'infopacks'.

MICRO-COMPUTERS

PRINTERS

SOFTWARE

IMAGINE EVENTUALLY BEING ABLE . . .

With an IBM PCM Modem, dot matrix and daisy printer, to start your day with our robot task disks working under CONCURRENT CPM 86 (tm)

Enter virtual console 0 and telephone your head-office to call all yesterday's ledger files and store them locally on your hard disk. Now switch to virtual console 1 and while console 0 runs concurrently for about an hour, get a 1000 mail-shot running to the daisy printer. Now switch to virtual console 2 and while consoles 0/1 run concurrently, get the 'robot task' of producing a stock-re-order report out to the fast dot matrix. Now switch to virtual console 3 and while consoles 0/1/2 run concurrently, do some programming, or file-reorganising, or any other task you might require. Four virtual computers all running concurrently on one computer, batch processing to various devices or else queue-spooling their output through print buffers of up to 500k storage and spreading the load through time on fewer printers.

Advance notice introducing forward developments of DBMS III 'TURN-KEY' software

Three enhancements will be available for DBMS III towards late Spring/Summer 83

- 1) a new 'FORMS DBMS III' will enable you to design your own business forms with embedded formulae (ie: quantity, price for invoices) to suit your own particular stationery
- 2) a new 'EQUATION PARSING DBMS III' will enable you to set up field formulae (as in calc-programs) so that DBMS III will overlap areas of all the 'calc-type' programs currently available
- 3) a new 'TEXT PROCESSING DBMS III' will enable you to set up letter files, that may be merged with address files for mail-shots so that DBMS III will overlap areas of all the 'word-processing type' programs currently available in a rudimentary manner

That means a DATABASE program, totally resident in the RAM of your machine, leaving you with all the disk space for data, capable of 'calc' and 'text' processing as well as the already unsurpassed features incorporated in DBMS III

**PROBABLY THE MOST POWERFUL INDIVIDUAL PIECE OF SOFTWARE
AVAILABLE TODAY**

TERMS & ETC

G.W. Computers Ltd (Grama (Winter) Ltd), 55 Bedford Court Mansions, Bedford Avenue, London WC1, England
Tel: 01-636 8210, 01-631 4818. Telex: 892031 TWC G. Boston office telex: 94-0890

24 hour answerphones - leave address for infopacks

We do not operate a reader's reply card service. Terms: C.W.O. or C.O.D. Prices exclude VAT. No dealers. The above lists are not exhaustive. Please call in only by prior appointment.

G. W. COMPUTERS LTD

LONDON'S WEST END - NATIONWIDE OVERNITE SERVICE
 MORE PRODUCT RANGES - BETTER SERVICE
 PROBABLY THE WIDEST SELECTION OF NETWORKS... MICRO...
 AND PRINTERS ON DISPLAY NATIONWIDE

**** THE NEW DBMS III (series III of the world's first 'task-robot-programs') ****
 **** FEATURES ****

MBasic & word-star compatible
 1400 character record sizes
 mathematical scratchpad
 record relational indexes
 translatable to any language
 User-definable reporting
 field protection/classification
 sorts 'alpha or numeric' any window
 either-or, same as, greater, smaller

32000 records per filename
 20 main/200 sub fields per record
 field and record related formulae
 'Jump-to' any of 32000 records per file
 random/binary/key/multiple field search
 'if-then' questioning
 file protection/password entry
 speed of 500 records per 20 seconds
 range match, not match, integer match

12 online file architectures
 240 fields using cross-referencing
 cross-record calculations
 'Jump-to' any record in 12 files
 User-definable files/field words/sizes
 endless 'either-or' matching
 formulate/recall on selection criteria
 12 interrogation question types
 short filing output/audit trails

ONE OF THOUSANDS OF DIFFERENT TASKS ON WHICH THIS PROGRAM MIGHT BE EMPLOYED

DBMS'S MACROS WORK FROM THE MOMENT YOU INSERT THE 'TASK DISK' IN THE COMPUTER'S DRIVE

Simply design your file, give its fields your words, setup your report mask, and then enter your records. Switch to 'automatic drive' and formulate any task you wish the program to fulfill, the task is stored as a macro. Take a copy of the program on another 'task disk' and from then on, the task disk will function with out a single keystroke. Think of a number of such 'task disks' such as 'stock-re-order reports', 'stock-valuation reports', 'sale-mail-shots', 'production-process-analysis', 'patient history analysis', 'research-analysis', 'budgeting', 'purchase-sales-analysis', 'personnel-file-analysis', 'vehicle-location control', 'librarian analysis', 'pius more?'

Previous issues showed examples of 'employees-short-list', 'garage stock re-order', 'sales analysis', 'librarian's list'. Here is an example of a hospital's patient index and some reports it might generate.

The record may look like this:

- 1- record number (23)
- 2- patient (John Smythe)
- 3- date of birth (1.5.45)
- 4- date of last visit (12.2.82)
- 5- symptom (epigastrum ache)
- 7- diagnosis (peptic ulcer)
- 8- test type (barium meal)
- 9- prescription (100mg carbenoxolone sodium 3' dally)
- 10- effect/other (minor improvements/test for surgical treatment)

One report might be: select??

all records where patients have had symptoms of 'epigastrum ache' associated with nausea or vomiting not diagnosed as peptic ulcer.

Print a list of those where there were barium tests made and the effect.

Another report might be: select??

all records in the file where the diagnosis of ailment was peptic ulcer or duodenal ulcer, and then where the treatment was carbenoxolone sodium and in the first instance list those where there was no improvement; after which list those where there was an improvement

DBMSII (WITHOUT MACROS) AND DBMS III ARE FULLY IMPLEMENTED UNDER CPM-86 (tm) AND MS-DOS (tm) ie: <SIRIUS/VICTOR/IBM> DBMSII IS 395.00 (or 250.00 by mail order ex. training). DBMSIII is 575.00 (or 295.00 by mail order ex. training).

MICRO-COMPUTERS

PRINTERS

SOFTWARE

Q.W.L.	-G80 64K/INTFC PORTS/K BOARD	795.00
	-G80 V.D.U.	150.00
	-G80 DUAL D/DRIVES ENCLOSED	550.00
INTERTEC	-SUPERBRAIN 64K RAM/320K DISKS	1695.00
	-SUPERBRAIN 64K RAM/700K DISKS	2195.00
	-SUPERBRAIN 64K RAM/1.5M DISKS	2595.00
	-SUPERBRAIN 64K RAM/10M DISKS	call.00
	-COMPUSTAR 64K RAM/OK DISKS	1495.00
	-COMPUSTAR 64K RAM/320K DISKS	1995.00
	-COMPUSTAR 64K RAM/700K DISKS	2495.00
	-COMPUSTAR 64K RAM/1.5M DISKS	2895.00
NORTH STAR	-ADVANTAGE 64K RAM/700K DISKS	£2095.00
	-ADVANTAGE 64K RAM/1.5M DISKS	£2995.00
	-HORIZON 64K RAM/6.3M DISKS	3595.00
TELEVIDEO	-802 64K RAM/700K DISKS	1995.00
	-802H 64K RAM/7.3M DISKS	3250.00
	-806 64K RAM/10M DISKS	4595.00
	-816 256K/750K DISKS	£2950.00
ACT	-SIRIUS 1 128K/1.2M DISKS	£2395.00
	-SIRIUS 2 128K/2.4M DISKS	£2895.00
VICTOR OSBORNE	-9000 128K/1.2M DISKS	£2395.00
IBM	-1 64K RAM/200K DISKS	1250.00
	-PC 64K RAM/640K DISKS	£2695.00
	-PC1 330K/640K DISKS	£2995.00
PET	8032 32K RAM	795.00
	8050 1 MEG DISKS	795.00
	64 CBM PERSONAL COMPUTER	call.00
APPLE	II 64K CPM/2 DISK/Monitor	2395.00
ALTOS	ACS800-2 64K RAM/1M DISKS	1995.00
	ACS800-10 208K/10.5MEG DISKS	5495.00
NEC	PC8001/12 64K RAM/350K DISKS	1695.00
	APC 128K RAM/2M DISKS	call.00
CORVUS	CONCEPT 16 BIT PC	call.00
SANYO	G80 64K RAM/320K DISKS	1350.00
	G81 64K RAM NETWORKER	1250.00
ABC	24 64K RAM/700K DISKS	2195.00
	26 64K RAM/2.2M DISKS	3250.00

All computer prices include mbasic as standard
 All prices marked £ are 8/16 bit machines

SYSTEM DEALS

Choose any computer, any printer and 30 diskettes
 add 65.00 for cables and testing
 add 10% warranty for 1 year (optional)
 add 110.00 for delivery & installation (optional)
 training optional extra 100.00

and get completely FREE**		
cpm handbook	50 basic exercises	2000 sheets paper
DBMS III	magic wand w/proc	magic calc
mbasic 80	diagnostics	msort/dsort
recover	autoload	instant basic
cbasic	disk/games	library case

If the system value exceeds 4000.00 then you get the G80/86 software packages value 690.00 also.
 THAT'S OVER 2000.00 POUNDS WORTH OF SOFTWARE FREE

OKI	-MICROLINE 80	295.00
	-MICROLINE 82A	395.00
	-MICROLINE 83	695.00
	-MICROLINE 84	895.00
EPSON	-MX80 FT-3	375.00
	-MX100 FT-3	495.00
ANADIX	-DP 9000	895.00
	-DP 9501	1045.00
	-DP 9501 (A)	1145.00
QUME	-9/45 R/O	1695.00
	-9/55 R/O	1695.00
	-9/35 R/O	1495.00
NEC	-3510 R/O	1395.00
	-7710 R/O	1795.00
	-5520 KSR	2250.00
DRE	-8820	1295.00
	-8830	1695.00
TEXAS	-810	1295.00
	-825	1395.00
DIABLO	-630	1695.00
RICOH	-RP1600	1495.00
OLYMPIA	-ESW 103 14 CPS	975.00
	-ESW ??? 5 CPS	1025.00

PERIPHERALS & ACCESSORIES

CORVUS	-6 MEG HARD DISK	1750.00
	-11 MEG HARD DISK	2750.00
	-20 MEG HARD DISK	3750.00
	-MULTIPLEXOR 7 STATION	695.00
	-MIRROR BACKUP CARD	695.00
INTERTEC	-COMPUSTAR 10 MEG HARD DISK	2750.00
	-CDC 96 MEG HARD DISK	7950.00
N'STAR	-16 BIT U/GRADE	325.00
	-18 MEG HARD DISK	2995.00
RODIME	-6 MEG HARD DISK	1495.00
	-12 MEG HARD DISK	1950.00
MORROW	-26 MEG HARD DISK	3295.00
GENIE	-5MG FIXED/5MG REMOVEABLE DISK	3295.00
CDC	-S/SIDED FLOPPY DRIVES	150.00
	-D/SIDED FLOPPY DRIVES	150.00
	-D/SIDED D/TRACK DRIVES	375.00
MEMOREX	-SOFT/HARD S/SIDED DISKETTES (10)	30.00
SCOTCH	-104/2D DOUBLE SIDED (10)	50.00
S.S.E.	-SOFTBOX PET TO CPM (tm)	495.00
	-SIRIUS 8/16 BIT 5MHZ CARD	365.00
QUADRAM	-64K PRINT SPOOLER/COPIER	250.00
BIZCOMP	-RS232/AUTO-MODEM 1200 BAUD	450.00
ABT	-PORT EXPANDERS (4 TMNLS TO 1 PRTR)	395.00
GIX	-PORT EXPANDER (SWITCHER)	95.00

NOTE CORVUS DRIVES WITH MULTIPLEXOR MAY NETWORK
 SIRIUS...SUPERBRAIN...CONCEPT...PET...VICTOR...IBM

Q.W.L.	-BUS V8.00 (ACCOUNTS)	575.00
	-DBMS II (DATABASE)	£395.00
	-DBMS II (BY MAIL ORDER ONLY)	£250.00
	-DBMS III (DATABASE)	£575.00
	-DBMS III (BY MAIL ORDER ONLY)	£295.00
	-DSORT & MSORT (MBASIC FILES)	£75.00
	-SALES LEDGER	£95.00
	-PURCHASE LEDGER	£95.00
	-NOMINAL LEDGER	£95.00
	-STOCK-CONTROL	£95.00
	-ADDRESS-MAILER	£95.00
	-QASORT/QNSORT (500 RECS/14SECS)	£95.00
	-AUTOLOAD & RECOVER	25.00
MICROSOFT	-MBASIC 80	£150.00
	-FORTRAN 80	200.00
	-COBOL 80	320.00
	-BASIC COMPILER	£190.00
	-MULISP/MU STAR	95.00
MICROPRO	-WORD-STAR	£250.00
	-MAIL-MERGE	£55.00
	-SPELSTAR	100.00
	-DATASTAR	170.00
	-SUPER-SORT	120.00
	-W-STAR/M-MERGE/SP-STAR	350.00
BYROM	-BSTAM (COMMUNICATIONS)	95.00
	-BSTMS (TELE-COMMS)	95.00
DIGITAL	-DESPOOL	30.00
	-CBASIC	75.00
	-PASCAL MT	225.00
F.OELLER	-QUICKSCREEN	95.00
LEXISOFT	-SPELLBINDER	195.00
LIFEBOAT	-TAMAKER	155.00
M'FOCUS	-CIS COBOL	420.00
	-FORMS II	100.00
	-SUPER CALC	185.00
SORCIM	-PASCAL M	250.00
	-QUIC-N-EASY	195.00
STANDARD PEACHTREE	-MAGIC WAND	190.00
	-MAGIC CALC	175.00
	-DIAGNOSTICS	50.00
S'SOFT	-STATPAK	250.00
N'WEST	-PASCAL Z	100.00
ITHACA	-CROSS-TALK (TELE-COMMS)	95.00
MICROSTUFF	-MOVE-IT (MICRO TO MICRO)	45.00
WOOLFE		

Software formats on all micros in our hardware list
 All prices marked £ are available 8/16 bit formats

TERMS & ETC

G. W. Computers Ltd [Grama (Winter) Ltd]
 55 Bedford Court Mansions
 Bedford Avenue
 London WC1 England.
 Tel: 01-636 8210, 01-631 4818. Telex: 892031 TWC G
 Boston office telex: 94-0890

24 hour answerphones leave address for infopacks

We do not operate a reader's reply card service.
 Terms: C.W.O. or C.O.D. Prices exclude VAT.
 No dealers. The above lists are not exhaustive.
 Please call in only by prior appointment.

COMPUTERS BREAKDOWN

'DATACOVER' INSURANCE DOESN'T

'DATACOVER' IS A COMPLETE INSURANCE PACKAGE OFFERING NUMEROUS ADVANTAGES:—

- **SAVINGS** Very significant savings over the cost of a full maintenance contract
- **CHOICE** Repairer of your choice coupled with a speedy, efficient claims service
- **AUTOMATIC ADDITIONAL COVER**
 - a) 'All Risks', including transit, on all equipment
 - b) Additional expenses, including those of hiring alternative equipment and recompiling data etc.

'DATACOVER' IS FOR

- Personal computers, micros, minis, WPs and mainframes
- Users, dealerships, maintainers and software houses

'DATACOVER' is available exclusively through

H **HALSEY & COMPANY**
205 Passage Road,
Bristol, BS10 7DL.
Avon.
Telephone (0272) 503716

Independent Registered Life and General Insurance Brokers

**PLEASE RING
FOR YOUR QUOTATION
BRISTOL
(0272) 503716**

Electronequip

(Authorised BBC Dealer and Service Centre)

SPECIAL OPENING OFFER DUE TO MOVE TO NEW PREMISES. ALL ORDERS RECEIVED DURING NEXT MONTH QUOTING REF. PCW/C WILL BE ENTERED INTO A WEEKLY DRAW AND 2 CUSTOMERS IN EVERY 100 WILL RECEIVE THEIR GOODS FREE OF CHARGE

* THIS MONTH'S SPECIAL OFFERS

BBC1	BBC Micro Model A	299.00
BBC2	BBC Micro Model B	399.00
BBC3	BBC Model A Micro with 32K	333.50
BBC4	BBC Model A Micro 32K & VIA	339.50
BBC21	Upgrade Model A to B	99.82
BBC27	Disc Upgrade for BBC B	109.25
BBC30	14" Colour Monitor for BBC	286.25
BBC33	BMC12A 12" Black/Green Monitor	90.85
BBC36*	14" Monitor/TV. 80 columns	244.95
BBC40	Cassette Recorder for BBC	29.90
BBC41	Single 5.25" Disc Drive 100K	265.00
BBC42	Dual 5.25" Disc Drive for BBC	447.00
BBC45*	New improved Cassette for BBC	35.88
BBC48*	Dual 800K low profile disc drives	897.00
BBC49	5.25" Discs for BBC 40/80 tracks	2.20
BBC50	Epson MX80T type 3 for BBC	373.75
BBC54*	Daisy Wheel printer for BBC	558.90
BBC70	Plinth/Stowage for BBC	29.90
	Torch Colour Machine 800K floppies ex VAT	2795.00
	Torch Colour Machine Hard Disc ex. VAT	4995.00

Large stocks. Prices inclusive of VAT
All prices inclusive of postage except micros 3.00
Access and Barclaycard Welcome



Electronequip **BBC**

36-38 West Street Fareham Hants PO16 0JW
Tel 0329-230670

T199/4A



DRAGON 32

QUALITY SOFTWARE AT SENSIBLE PRICES

DRAGON 32

Order code	Title	Price
DG2	Gamestape 2 (2 arcade games).....	£2.95
DG8	Arcade Action (Meteor Run + Breakout).....	£3.95
DG9	3-D Maze.....	£3.95
Adventures		
DG5	Island Adventure.....	£3.95
DG6	Forbidden City.....	£4.95
DG7	Pharaoh's Curse.....	£4.95
DG10	Devil's Island.....	£4.95

TEXAS T199/4A

GM5	Haunted House/Wumpus.....	£3.95
GM6	Sorcerer's Castle/Lunar Lander.....	£3.95
GM7	3-D Maze/Towers of Hanoi.....	£3.95
GM16	Island Adventure/Four in a Row.....	£3.95
GM17	Forbidden City/Mastermind.....	£3.95
GM18	Pharaoh's Curse.....	£3.95
GM19	Devil's Island.....	£4.95

All prices include VAT and p&p. Send cheque, P.O. or telephone with Access, Barclaycard for immediate despatch. Send s.a.e. for complete list, stating machine.

APEX TRADING LTD

115 Crescent Drive South
Brighton BN2 6SB
Tel: (0273) 36894



DEALER ENQUIRIES WELCOME

Created with a \$48 million investment
by businessmen for businessmen

FORTUNE

it shows

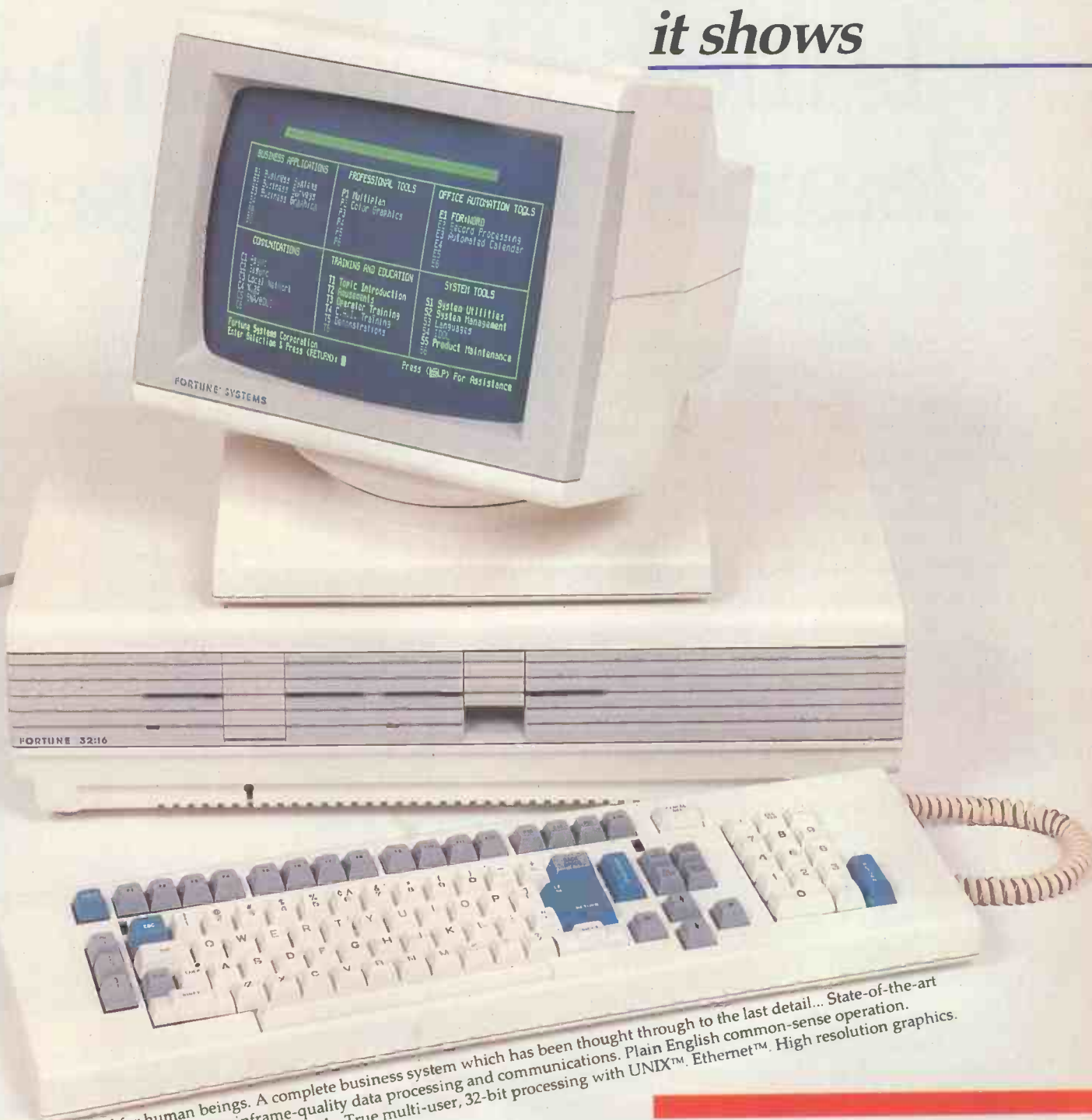

Designed for human beings. A complete business system which has been thought through to the last detail... State-of-the-art word processing with mainframe-quality data processing and communications. Plain English common-sense operation. Ergonomics to Scandinavian standards. True multi-user, 32-bit processing with UNIX™. Ethernet™. High resolution graphics.

National distribution
and hardware engineering support from:
Tetra Data Systems Ltd
Tetra House 14-16 Temple End
High Wycombe Bucks HP13 5DR
Telephone High Wycombe (0494) 448773

Three out of every four computers going into schools are BBC Micros.

Is there a lesson to be learned by every user?

As part of the current government subsidised scheme aimed at introducing micros to schools, the Department of Industry undertook a survey of machines available and made recommendations to education authorities all over the country.

The BBC Micro met their priorities exactly: it is economical yet fast and powerful, and it can justify the investment involved, through its capability to grow with the needs of the user and with the rapid changes in technology.

Teachers and education authorities agreed, and today it represents over three-quarters of all micros being ordered for schools across the country under the DOI scheme.

The BBC's choice too.

In choosing a machine to put their name to for their massive Computer Literacy Project, the BBC had the same set of priorities as the DOI. The BBC Micro is now an integral part of that project, which includes books, software, courses and a number of major television series, one of which, "Making the Most of the Micro" is now being broadcast.

All this for only £399.

The BBC Micro is light and compact. It generates high resolution colour graphics, and is capable of synthesising music and speech using its own internal speaker. The keyboard uses a conventional layout and typewriter feel.

The most sophisticated version (called

Model B) is available for only £399. (There is also a basic model available, the Model A, at £299.)

Designed to grow.

Last year the magazine "Which Micro?" said that the most attractive and exciting feature of the BBC Microcomputer was its 'enormous potential for expansion'.

This is indeed one of the features that sets it aside from the competition.

For example, as well as interface sockets to allow you to connect to a cassette recorder, and to your own television, you can also use video monitors, disc drives, printers (dot matrix and daisy wheel) and paddles for games or laboratory use.

You can also plug in ROM cartridges containing games with specialist application programs.

The Tube. A unique feature.

The Tube, which is unique to the BBC Micro, provides for the addition of a second processor via a high speed data channel. The possibilities are enormous. For example, the addition of a second



3MHz 6502 processor with 64K of RAM doubles processing speed. While a Z80 with 64K of RAM opens the door to a fully CP/M* compatible operating system, with all the benefits for business applications:

Linking up with other computers.

The BBC Micro also offers a facility of immense potential value to schools, colleges and businesses. It's called Econet® – a system which uses telephone cable to link with other BBC Micros. A number of machines can then share the use of expensive disc drive and printer facilities.

Make full use of Prestel & Teletext.

With special adaptors you will not only be able to turn your TV set into a Prestel terminal and Teletext receiver, but you can also take data and programs direct from these services. (The programs, which are known as telesoftware, are already being broadcast by BBC's Ceefax service.) This is another first for the BBC Micro.

BASIC plus.

A sophisticated version of BASIC has been chosen for the BBC Micro, which incorporates features normally found only in more advanced high level languages. However, there is also a facility allowing access through a simple command to another language – for example, PASCAL, FORTH and LISP.

*Trademark of Digital Research.



A full range of software.

Applications software for the BBC Micro already cover a very wide field. Packages covering games, education and business applications are available on cassette. All developed to the same high standards set by the hardware.

The best possible back-up.

Your BBC Micro comes with the backing of the BBC and an extensive dealer and service network.

Each approved dealer is able to offer advice and carry out expansion work and repairs.

BBC Microcomputer – Model A and Model B.
2MHz 6502A Processor.
32K ROM; 16K RAM Model A, 32K RAM Model B.
Full QWERTY keyboard with 10 user-definable function keys.
Mixed high resolution graphics and upper and lower case text.
300 baud and 1200 baud interface for standard cassette recorders.
Three-voice music synthesis with full envelope control feeding internal loudspeaker.
Interface sockets (Model B only) – RS423, for analog inputs centronics and user port.
6502, Z80, 16032 second processors.
Single and Dual Disc Drives with 100 and 800 K-bytes storage.
Teletext unit.
Speech synthesis.
Networking facility – via Acorn Econet®.

How to buy your BBC Micro.

If you are a credit card holder and would like to buy a BBC Micro B, or if you would like the address of your nearest stockist, just phone 01-200 0200.

Alternatively, you can buy a Model B directly by sending off the order form below to: BBC Microcomputers, c/o Vector Marketing, Denington Estate, Wellingborough, Northants, NN8 2RL.

All orders are despatched by fully insured courier and come complete with easy to follow 500 page User Guide and Welcome cassette.



01-200 0200 credit card holders.

To BBC Microcomputers, c/o Vector Marketing, Denington Estate, Wellingborough, Northants NN8 2RL. Please send me _____ BBC Model B Microcomputers at £399 each, inc. VAT and delivery. I enclose PO/cheque payable to Acorn Computers Limited Readers A/C or charge my credit card.

Card Number _____
Amex/Diners/Visa/Access (Delete)

Name _____

Address _____

Postcode _____

Signature _____

PCW3
Registered No. 140 3810 VAT No. 215 400220

The BBC Microcomputer System.

Designed, produced and distributed by Acorn Computers Limited.

The printer that thinks it's a computer!

FACT With internal microprocessor, 8K buffer store and total compatibility, the Ricoh Flowriter range has proved itself the most intelligent and reliable range of printers on the world market.

FACT Ricoh Flowriters can assume the characteristics of any popular 'intelligent' printer and plug into any hardware configuration.

FACT Ricoh Flowriters perform all your processing and printing needs while leaving the host computer free for other work.

FACT Ricoh Flowriters do all this, give you exceptional print quality, yet cost the same as ordinary daisy wheel printers!

- FEATURES**
- Internal microprocessor
 - 8K buffer under full program control
 - Includes RS232, Centronics and IEEE 488 interfaces
 - 60cps print on the RP1600, 37cps on the RP1300
 - Qume, Diablo and NEC Spinwriter wp commands-compatible
 - Auto-bidirectional and logic seeking high-speed printing
 - Graphics capability down to 1/120"

- Built-in proportional spacing tables
- Automatic margin justification, even on proportional spacing
- 128-character printwheels, wide choice of fonts
- Wide range of accessories – sheetfeeds, tractor feeds, ribbons, printwheels
- Detachable keyboard option for using Flowriter as an intelligent typewriter or KSR terminal

For intelligent printing that frees the host computer and gives you exceptional print quality and speed, find out more about the Ricoh Flowriter – the printer that knows it's a computer, yet costs the same as those that aren't!



The RP1600 Flowriter



The RP1300 Flowriter

Dealer Enquiries welcome.
The Ricoh/Flowriter range is only available from APTEC and their authorised dealers, backed by a nationwide service network.



**APPROPRIATE
TECHNOLOGY LTD.**
2-4 Canfield Place
London NW6 3BT
Tel: 01-625 5575/5134
Telex 264538 SSE G

The Ricoh

FLOWRITER

VisiCalc was a good idea for then. Multiplan is a great idea for now.

The first generation electronic worksheets were a good idea. They were early software management tools that could eliminate a lot of hours with a spreadsheet, calculator, pencil and eraser. Enter Multiplan, the next generation electronic worksheet that's as easy to use as it is useful. Compare Multiplan's powerful user-oriented features to any electronic worksheet on the market. If you've been using VisiCalc, Multiplan's ability to directly utilize your VisiCalc files lets you easily upgrade to Multiplan.

**MULTIPLAN - THE ELECTRONIC WORKSHEET
FOR NOW £ 179.00**

TRIPLE YOUR DISK ACCESS SPEED

No hardware modification required

FastDOS

Fast Disk operating system for Apple II computers

Completely compatible with DOS disks

Loads and saves standard DOS files

Completely compatible with all

DOS/APPLESOFT programs that access
DOS through standard hooks, including
FID and MUFFIN

Executes all standard DOS commands

Comparative timings:	DOS	FDOS
Blooding integer basic	13 sec	3 sec
Cataloging a 12 file disk	2 sec	1 sec
Saving a 10 sector program	6 sec	2 sec
Saving a 100 sector program	34 sec	7 sec
Loading a 100 sector program	24 sec	7 sec

Requires 48K

£19.95



RANA SYSTEMS DISC DRIVES

Elite I - £259
Elite II - £339
Elite III - £399



WIZARD BPO

16K and 32K BUFFERED PARALLEL
OUTPUT PRINTER INTERFACE
CARD FOR APPLE II and APPLE II
PLUS COMPUTERS FOR DKI, EPSON
& ANADEX

WIZARD BPO 16K £149.00
WIZARD BPO 32K £169.00

DESKTOP/PLAN II

from Personal Software

A programming language for financial
analysis

★ £79 ★

NEW

MICROSOFT FLIGHT
SIMULATOR FOR IBM PC
£30.95

The
Bufferboard
For Apples and Printers



£99.00

THE NEW CENTRONICS COMPATIBLE
PARALLEL BUFFER FROM ORANGE
MICRO



SPECIAL OFFER
PRICE



ALS Supercalc £59.00

FCL6000



THE NEW INDUSTRIAL MICRO BASED ON THE APPLE II

Dust, dirt and splash proof.

Capable of operating reliably in
aggressive industrial, laboratory
and process plant environments.

Supplied with the
FCL AUTOPROM card, which in
many control situations,
eliminates the need for the often
unreliable disc drive.

FCL Industrial Apple Processor
£1850

FCL Autoprom £180

FCL Industrial Apple Keyboard
£180

FOR THE IBM PC

PARA/RS232/CLOCK CARD FOR IBM	239.00
CLOCK CALENDAR CARD FOR IBM	119.00
PROTOTYPING CARD FOR IBM	25.95
PROM BLASTER FOR IBM	129.00
DBASE II FOR IBM	399.00
CHAMPIONSHIP BLACKJACK (IBM)	24.95
ZORK I FOR IBM	25.95
ZORK II FOR IBM	25.95
DEADLINE	32.95
EASYFILER FOR IBM	249.00
EASYPLANNER FOR IBM	125.00
EASYSPELLER FOR IBM	125.00
EASYWRITER II FOR IBM	225.00
MATHEMAGIC FOR IBM	59.95
GRAPHMAGIC FOR IBM	59.95
WORDSTAR FOR IBM	195.00
MAILMERGE FOR IBM	65.00
CALL TO ARMS FOR IBM	15.95
SUPERCALC FOR IBM	225.00
SUPERWRITER FOR IBM	249.00
I/O IBM INT. (2 SER. PARA. & GM)	195.00
JOYSTICK FOR IBM	160.00
VISICALC 256K FOR IBM	160.00
VISIDEX FOR IBM	160.00
VISITREND/PLOT FOR IBM	210.00
VISIFILE FOR IBM	210.00

FUNCTION STRIP and



ENHANCER II

The Vides Function Strip adds a whole new dimension to your Enhancer II - Apple II Function Keys. Now you can have dedicated keys for your macro definitions. Program often used word processor commands, words or phrases into your Function Strip. Programmers will find it a significant aid to be able to define often used commands and statements. VisiCalc users can define often used commands and file names for single keystroke ease of use.

The Vides Function Strip is a low cost, versatile strip of pressure sensitive switches. The Function Strip adheres to the Apple II's lid - just above the keyboard and connects to the Enhancer II's keypad connector port. The Function Strip is completely compatible with keypads connecting to the Apple II motherboard.

Function Strip £54.95
Enhancer II £99.00
OR BOTH FOR A SPECIAL PRICE OF £149.00

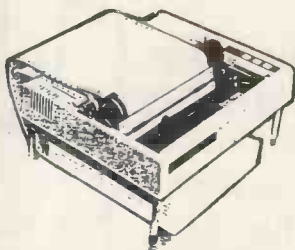

IT'S OFTEN BEEN SAID THAT THE
SIMPLEST IDEAS ARE THE BEST -
AND JUST LOOK AT THIS ONE FOR
PAPER STORAGE.

Pete & Pam Computer's Stits
are four legs which can be
installed on to your Epson
MX80 in seconds - giving you
room for 3 inches of paper.
£5.95

stits

APPLE CARE MACHINE COVERS

APPLE II	5.95
APPLE & 2 DISKS	7.95
APPLE & 12" MONITOR	7.95
APPLE, 2 DK & 12" MON.	9.50
APPLE, 2 DK & 9" MON.	8.95
SINGLE DISK	3.45
2 STACKED DISK	4.45
9" MONITOR	4.95
EPSON MX80/70	5.45
PAPER TIGER 445/60	7.95
APPLE III INC. MON	12.95
MX100	8.95
QUME 5 W/TRACTOR	10.95
NEC 12" MONITOR	7.50
HITACHI 12" MON.	7.50
DECCA RGB MONITOR	8.95
SIRIUS KEYBOARD	4.45
SIRIUS PROC & MON	12.95
HEAD CLEANING	
Clean read/write heads the way leading manufacturers recommend 5 1/4" disk head cleaning kit.	£18.95
DISKS & DISK BOXES	
BASF single sided, single density disks, 10 for £17.90	50 for £84.50
100 for £159	
Kass-ette storage boxes	£2.45



THE SWEET-P

Graphic Plotter, for graph
processing, chart processing,
engineering graphics and
overhead transparencies.

£595



Products available from dealers
throughout the UK.

Pete & Pam Computers

Head Office:
New Hall Hey Road,
Rossendale, Lancs., BB4 6JG
Phone: (0706) 227011
Telex: 635740 Petpam G

Norwegian Agent:
The Norwegian Software House
Oslo 5
Address: Okernveien 145

Telephone 47 2 64 55 77

Prices do not include VAT please add 15% to your remittance
Postage and Packing FREE

London Office:
103 5 Blegborough Road,
London, SW16 6DL
Phone: 01-769 1022/3/4
Telex: 923070 PRCOMP G

Our spreadsheet system But let's start with

There was a time when you could run a business by the seat of your pants.

But the days of trusting to luck and following hunches are gone.

Today, computers, micros and more importantly business planning systems are no longer considered luxuries.

They allow you to keep one step ahead of your business, and one step ahead of the competition.



So it seems odd that most software companies still expect to solve all the problems with one system.

A "jack-of-all-trades" if you like.

Fortunately Comshare are not like most companies. We saw the need for different systems to suit different people.

NEW USERS START HERE

PlannerCalc at £39.00* is now accepted as the first choice for people new to financial planning.

Designed for 8-bit micros, it boasts the kind of features that you'd expect to pay three times as much for. (Buy PlannerCalc's nearest rival and you'll have to.)

Unlike all other 'calc' products it allows you to enter calculation in a language you understand. Plain English.

So it's much easier to use.

It uses the popular "spreadsheet" approach with a window that can be rolled in all directions.

Which means you can enter new figures and rules and immediately see their effect on everything else in the model.

It comes with the best manual on the market and it's suitable for most a™CP/M 2.2 operating system, 64K of memory, giving at least 900 cells, minimum screen width of 80 characters and floppy disc drives.

**MUCH MORE POWER,
NOT MUCH MORE MONEY**
MasterPlanner is the most powerful spreadsheet system currently available with its increased matrix size, 2000-3000



micros with a™CP/M 2.2 operating system, 64K of memory, giving at least 900 cells, minimum screen width of 80 characters and floppy disc drives.

COMSHARE DEALERS

Aberdeen
Ablett Ltd
(0224) 647074

Aldershot
EMS (UK) Ltd
(0252) 313551

Atrincham
Mercator Tech
Services Ltd
(061) 941 4225

Aylesbury
Heistaar Systems Ltd
(0296) 630364

Barnsley
Brook Office Supplies Ltd
(0226) 89916

Bedford
MSC Hiland Ltd
(0234) 50260

Blackburn
BEC Systems
Services Ltd
(0254) 677215

Bradford
Comp'night Ltd
(0274) 668890

Raven Computers Ltd
(0274) 306966

Bristol
Aron Microcentre
Systems Ltd
(0272) 277774

**Mercator Computer
Systems Ltd**
(0272) 731079

Transted Ltd
(0272) 277462

Bury St. Edmunds
S.T.R.C.S. Ltd
(0284) 62022

Canterbury
Kant Micro Systems
(0449) 740046

Cardiff
Bowlings Computer
Services Ltd
(0222) 36825

Clevedon
Bard Computer
Systems Ltd
(0272) 878 157

Crainbrook (UK) Ltd
The Soft Option
(058080) 310

Doncaster
Brianstar Computer
Centre
(0302) 67135

Dublin
Translec Ltd
(0001) 718521

Glasgow
The Prospectus
Partnership
(0236) 211294

Gosport
Yaunberry Ltd
(0379) 235846

Harpenden
Iradion Ltd
(05827) 62421

Hastings
BMS Computer
Services Ltd
(0424) 439190

Hereford
Honeysett Computers Ltd
(0432) 279404

Ipswich
Angla Microsystems
(0449) 740046

Leamington Spa
Words Ltd
(0926) 30209

Leicester
Leicester Micro Centre
(0533) 551869

Lisburn
MKM Electronic Ltd
(08462) 3184/3665

Liverpool
BEC (Liverpool) Ltd
(051) 263 5738

London
BO Computer Systems
01 435 4442

**Business Information
Systems**
01-373 3408

**Denlo Computer
Systems Ltd**
01-670 4202

**Computer Aided
Systems Ltd**
01-487 3869

**Computer Aided
Systems Ltd**
01-518 1414

**Corporate Modelling
Consults**
01-628 4107

Dantedale Ltd
01-519 7004

**DIR Computer
Systems Ltd**
01-439 4354

Equinox Computers Ltd
01-739 7387

Ferran Software Ltd
01-751 5791

Jarrogate Ltd
01-671 6321

Ludhose Computing Ltd
01-679 4321

**Mayfair Business
Systems Ltd**
01-688 3836

MGE Systems Ltd
01-439 9617

Micromes Systems Ltd
01-263 6926

P.W. Hare & Associates
01-551 1988

Salmon Electronics
01-223 1668

Software Ltd
01-387 9927

Spectrum Systems Ltd
01-405 1250

Stag Terminals Ltd
01-943 0777

Stacom Ltd
01-661 2266

Sumlock Boudain Ltd
01-250 0505

**Sun Business
Services Ltd**
01-739 7949

Transam Computers Ltd
01-402 8137

Whisper Ltd
01-556 9151

Louth
Comput-A-Crop
(0507) 604271

Melksham
Cler Systems Ltd
(0225) 706361

ICEN Ltd
(0225) 702133

Midhurst
Wordsall Automation Ltd
(073081) 6641

Milton Keynes
Pencorn Data
Systems Ltd
(0908) 614242

Navan
S. Triple S Ltd
(046) 28472

Nottingham
Micropeople Ltd
(06074) 69117

Oxford
Choice Business
Systems
(049161) 2697

Redcar
Applestop
(0642) 474707

Richmond
Intech Computer Services
01-948 4213

Richmansworth
AI Microcomputers
(09237) 71428

Rutland
Microspecific Ltd
(0572) 2528

Slough
RGB Micros Ltd
(75) 38581

Southampton
Xitan Systems Ltd
(0703) 38740

St Albans
St Albans Computer
Services Ltd
(0727) 77700

St Helier
The Processor Centre
(0534) 77070

Thomas & Company Ltd
(0534) 77700

West Byfleet
Ferguson Computers
Ltd
(91) 41810

Weston-Super-Mare
Eastern Ltd
(0934) 418346

Winchester
Modular Office
Systems Ltd
(0962) 55759

Yeovil
Disk Computer
Systems Ltd
(0935) 72000



Plans start at £39.00. Why you need one.

cells on most 64K micros. (But at £245* it certainly isn't the most expensive.)

Consolidation of models, allows you to create separate plans for each department and then combine them into an overall company plan. Data transfer to word processing and other systems lets you incorporate

figures in reports and output to a data base. It also has extensive formatting facilities which means you can produce reports that wouldn't look out of place in the board room.

It can store up to 25 standard reports to run when you need them. It's got full WHAT IF? analysis and direct editing of both spread sheet and logic display.

JUST AS EASY TO USE

All this increased power doesn't mean you'll need a degree in advanced computing to understand MasterPlanner.

It works on exactly the same system as PlannerCalc and models written on PlannerCalc run without modification on Master-Planner.

16 BIT VERSION

A new version of MasterPlanner has been specifically designed for the 16 bit micros like the Sirius 1 under TMCP/M-86 or the IBM personal using either CP/M-86 or TMMS DOS 1.1. With a vast matrix size of over 7000 cells on 128K and even more with larger memory, you'll at last be able to make the most of your micro.

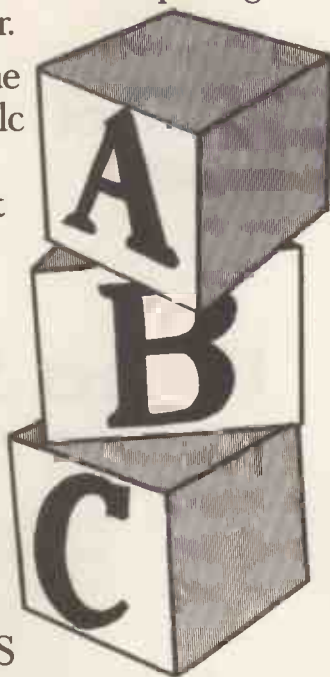

OVER 10 YEARS EXPERIENCE

When you invest in MasterPlanner or PlannerCalc you're not just getting the best software money can buy.



You're also getting the kind of back up and after-sales service that only a company of Comshare's track-record can guarantee.

If you'd like to know more about either product call in at your local dealer or fill in the coupon and send it to us.

* Plus VAT and post & package.

COMSHARE

Making the computer make sense.

CP/M and TMCP/M-86 are the registered trade marks of Digital Research Inc. Comshare Ltd., 32-34 Great Peter Street, London SW1P 2DB. Telephone: 01-222 5665.



To: Department PCW3, Comshare Ltd., 32-34 Gt. Peter Street, London SW1P 2DB.

Please send me:

Qty	Product	Micro	Op System	Disc Size	K	Amount £ p.
	PlannerCalc @ £46.05 (8 bit only)		CPM 2.2	8" / 5 1/4"		
	MasterPlanner @ £282.95		CPM 2.2	8" / 5 1/4"		
	MasterPlanner	IBM PC	MS DOS 1.1	8" / 5 1/4"		
	MasterPlanner		CPM/86	8" / 5 1/4"		
All prices include VAT and postage & packing						TOTAL

I enclose a cheque/postal order for £ _____ made payable to Comshare Ltd.

Please debit my Access Card No. _____ for £ _____

  Barclaycard No. _____ for £ _____

Signature _____

Name _____

Address _____

Tel. No. _____

Please allow 28 days for delivery. VAT No. 238418649. Registered No. 980406.

Comshare reserve the right not to accept any orders. Any acceptance will be subject to Comshare's terms and conditions.

This is what the pros have said about Perfect Writer™

"Perfect Writer lives up to its name . . . It would be my choice for a word processor in my home."

John Ford, Infoworld

"The company is stamping a giant footprint in the market with an aggressive advertising campaign — and with a program that delivers what the ads promise . . . Perfect Writer will likely be the tool I use to construct future documents."

Dona Z. Meilach, Interface Age

"It does things I've seen nowhere else."

James Fallows, Atlantic Monthly

"Capabilities like those in Wangwriter and other sophisticated systems."

Softalk

**Perfect
Writer™**

**Perfect
Speller™**

**Perfect
Filer™**

**Perfect
Calc™**

Perfect Software™

The revolution in software.

1400 Shattuck Ave.
Berkeley, CA 94709
U.S.A.

SALES REPRESENTATIVE
Micro Marketing International
5598 Taft Avenue
Oakland, CA 94618 USA
Telephone: (415)658-5548
Telex: 171 596 AAA COM SUVL

Perfect Writer, Perfect Speller, Perfect Filer, Perfect Calc and Perfect Software are trademarks of Perfect Software, Inc.



OFFICE EFFICIENCY MACHINES LTD

1 Lochaline Street, London W6 9SJ

Tel. 01-741 7211/2/3/4

SPECIAL PROMOTION DEALS!

ACT SIRIUS 1



£2395.00

PLUS EPSON MX100 PRINTER
WORTH £500 FREE

IBM
Personal Computer



£2599.00

(OR £2895.00 INCLUDING 1
YEAR'S ON-SITE MAINTENANCE)

OSBORNE 1
PORTABLE MICRO-COMPUTER



includes
WORDSTAR, MAILMERGE,
SUPERCALC, MBASIC + CBASIC
worth £800 FREE!

£1499.00



PRAXIS ELECTRONIC PORTABLE
PRINTER/TYPEWRITER



OR **OSBORNE 1** PLUS 12" (GREEN OR AMBER) MONITOR – **£1250.00**

TO PLACE YOUR ORDER – CALL OUR
HOT LINE – 748 8404

Telex 263559

OEM ALSO OFFER SOME OF THE BEST
TRADE PRICES IN THE UK ON ALL THE
ABOVE MACHINES

(Prices valid while current stocks last)

To: Office Efficiency Machines Ltd.,
1 Lochaline Street, London W6 9SJ
Telex 263559 Micro G

- Please send me information on the
- Dealer End User
- Urgent Please phone me

Name _____

Company _____

Address _____

Telephone _____

OUR PROFESSIONAL SERIES INTEGRATED

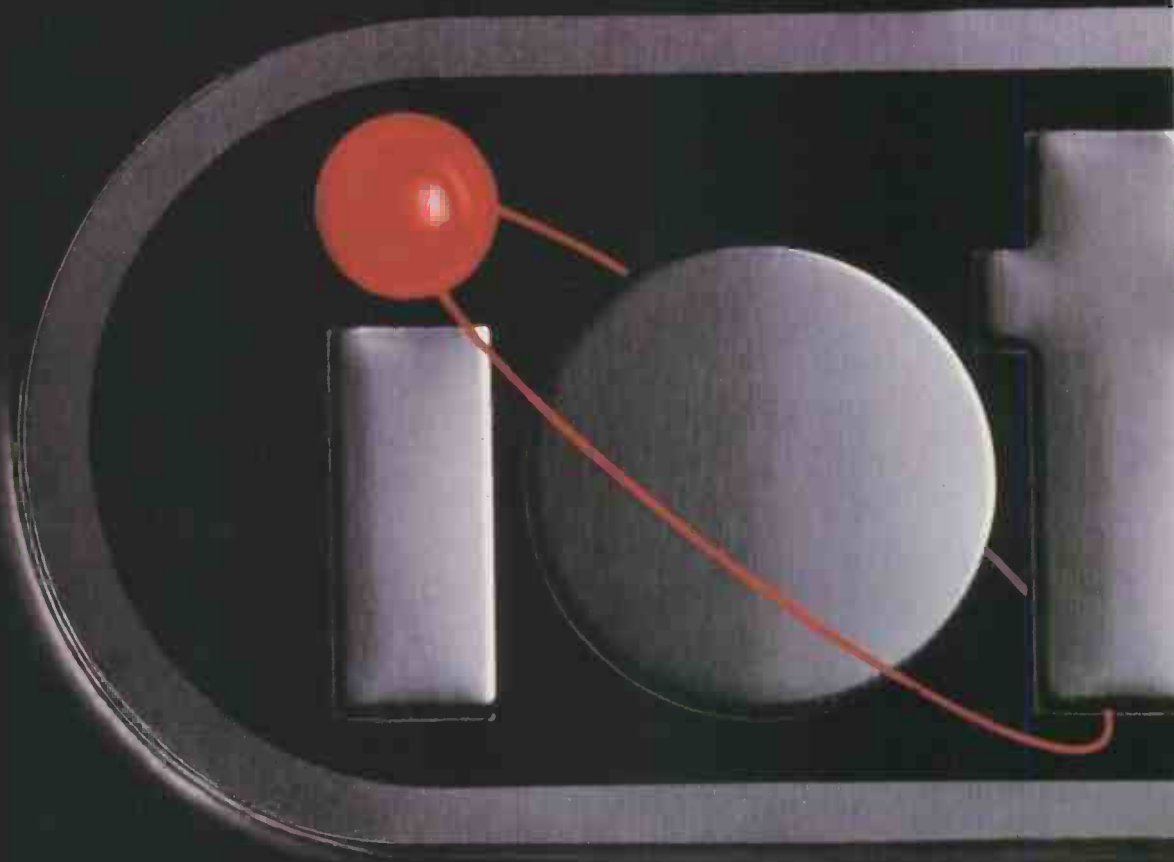

The Hardware

Iona Computer (75K)
Two 5¼" Disk Drives (400K each formatted)
14" Colour Monitor
4 Way Disk Controller
Centronics Printer Controller
Colour CP/M* 2.2 Disk Operating System
CBASIC*

The Professional Series Software

Name and Address System
Stock Control System
Order Entry and Invoicing System
General Accounting System
Company Sales System
Company Purchases System

Other Hardware Products

14" Colour Monitor (Medium Resolution)
14" Colour Monitor (High Resolution)
7 Colour Matrix Printer
*(All Iotec Hardware Products are assembled
in the U.K.)*

Other Languages

Basic 80* 5.2.1

BUSINESS SYSTEMS SOFTWARE IS FREE.

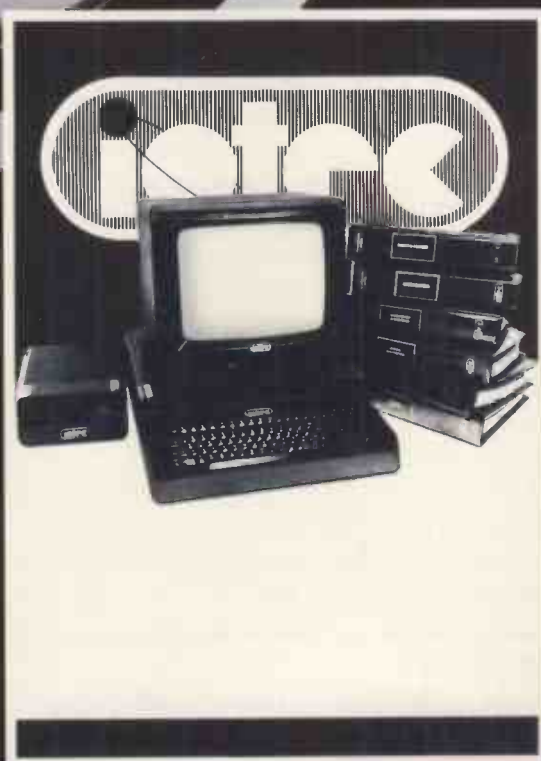
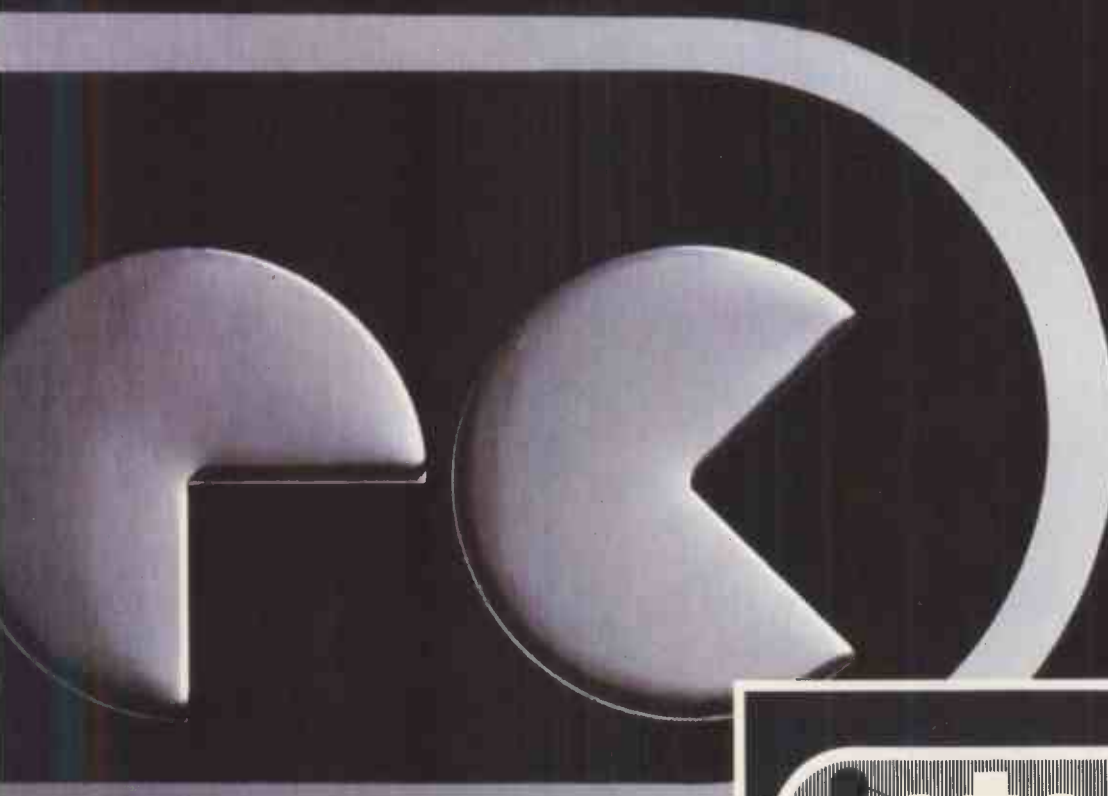

Other Professional Series Software

- Word Processing
- Financial Planning
- Payroll System
- Lease/Rental and Hire Purchase System
- Time Recording System

* CP/M and CBASIC are registered trade marks of Digital Research
* Basic 80 is a registered trade mark of Microsoft Inc.
'Iotec' is the trade mark of IoTechnology plc

For further details including the name and the address of your nearest IOTEC Business Centre, complete this coupon and send it to the address shown below.

Name (PRINT) _____ Type of Business _____

Address _____

Postal Code _____

IoTechnology plc 4 Playhouse Yard Blackfriars Lane London EC4V 5EX

PCW

Now a hard disc system for the same price as a floppy



The Shelton *SIG/NET*

It's here! The new hard disc system that really means business.

From the bewildering range of computers, all claiming a technical advantage, Micropute have selected the machine best suited to the needs of small and medium sized businesses. The requirements of such a system were: Integral Hard Disc, Compact Design, Extremely Competitive Price, The CP/M Operating System giving access to a vast range of programmes for data and word processing, and The Capacity For Ease Of Upgrading To Multi-User. Which all adds up to a fully comprehensive and sophisticated computer.

The price?

From an incredible £2,695 (ex V.A.T.)

Micropute Supercover

As an extra bonus to this amazing package Micropute Supercover will provide a 12 month on site maintenance for only £99.00 parts and labour.

Faster Than a 16 BIT

BENCHMARK TIMINGS			
PRODUCT			
	SIG/NET 8 BIT	IBM 16 BIT	SIRIUS 16 BIT
BM. 1.	1.1	1.5	2.0
BM. 2.	3.7	5.2	7.4
BM. 3.	9.9	12.1	17.0
BM. 4.	9.8	12.6	17.5
BM. 5.	10.5	13.6	19.8
BM. 6.	18.7	23.5	35.4
BM. 7.	29.6	37.4	55.9
BM. 8.	5.1	3.5	4.3

These figures are extracted from a recent article in, 'Personal Computer World' Publication.

Micropute Ltd Catherine Street, Macclesfield, Cheshire SK1 6QY Tel: (0625) 615384.

Name _____ Position _____

Company Name _____

Company Address _____

Tel. No. _____

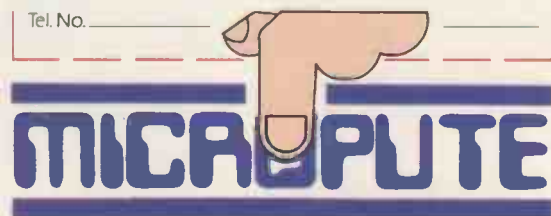

Micropute Ltd., Catherine Street, Macclesfield, Cheshire SK1 6QY Tel: (0625) 615384.

INNOVATIVE TRS 80-GENIE SOFTWARE

from the professionals

DATA-WRITER

Data-Writer is, for most microcomputers, a new concept in Database Management. It adapts techniques which have been known and used on mainframe computers for quite a long time. A "normal" microcomputer Database Management program constructs its file in a single plane and is probably more accurately described as a file handling system. All of the data written into each record is filed away on disk in the same place, and it is all recalled and acted upon by the computer as one chunk of data.

Data-Writer approaches Database Management in an entirely different manner in that, subject to one or two requirements, it is not concerned as to how the database came about or the form of it. Indeed, one of the most attractive features of the program is that the data itself can even be written on a word processor — not by Data-Writer at all. So far as we have been able to ascertain, any word processor may be used that writes a plain ASCII file. Certainly AJEDIT and Scripsit are supported. If you do not have a word processor, or do not wish to use it for the manufacture of your database, then there are sections in Data-Writer which in themselves constitute mini word processors and enable the user to manufacture a database very easily.

In the foregoing paragraph we use the words "word processors" in the plural, and this gives a clue to a rather important feature of Data-Writer. The whole concept of the software is that it is a Management program. A number of earlier databases have suffered very seriously from what the author no doubt thought was economic writing, in that if a section of a program (for instance the word processing section) is used by a number of sections, only one is included and is accessed by various sections. At first sight this might indeed appear to be economic writing and we suppose in fact it is, but the result is that the disks are continually thrashing around as access is made to them. Disk access is probably the slowest task that the CPU carries out and if it is done frequently it slows the program down very considerably. Many past Database Management programs have suffered from this deficiency. Data-Writer on the other hand has a mini word processor in each section of the program where it is needed. This has the great advantage of obviating the necessity for the drives to be thrashing around, but almost as importantly means that the format of the mini word processor can be changed for the various sections of the program, so that the best advantage can be made of it in each. Thus every section is entirely separate and gives a very high degree of efficiency and user friendliness.

There are very few restrictions with Data-Writer. The number of records which one can handle in any given database is, essentially, unrestricted although any that span disks would have to have different names. In any event as the Sort section of the program does have a restriction of sorting 4,500 records at a time, this effectively imposes a restriction on the length of the file if one intends to be able to sort it all at one time. The maximum number of fields permitted to a record is 20 and the maximum number of characters per field depends on whether you use the Entry section of Data-Writer to enter your data or whether you use a word processor. In the latter case the maximum number of characters per field is 240. In the former it is 35. The maximum number of characters per field label or title is 20.

Data-Writer has a very powerful mathematical section whereby many complex mathematical functions can be carried out on your data. Up to 20 equations may be defined per run. The section will have available 10 scratch pad memories for use and as the calculations are carried out in double precision they will be carried to 16 decimal places.

Data-Writer also contains a very powerful "Mail Merge" section. Almost any personalisation can be added to a letter or report, and once again the letter or report may be constructed either on the mini word processor provided in Data-Writer or by way of an external one. Indeed we should make it clear that this remark applies to all data manipulation in Data-Writer. In other words, a word processor may be used at any time when its functions would be helpful in Data-Writer. To return to the Mail Merge feature, Data-Writer supports up to 20 different insertions per letter or report and the form letter may be of any length up to 6,000 characters, which we believe is about two and a half A4 sheets.

The Sort is a two level one and supports the extraction of stipulated data from a field. It is what might be called of fair speed. The two key levels make it powerful but as the Select section is so good, the Sort does not get used as often as would be the case in other Databases.

Data-Writer is made up of 10 sections or sub-programs as follows:

Entry	Manage	Maths	Sort	Letters
Edit	Statistics	Select	Labels	Reports

We have already mentioned many of them, others such as Edit are self-explanatory. The Labels section enables you to create pretty well any form of label required, including the ability to have them printed up in a from one to four across format. The Letters section enables you to create a form letter in Data-Writer if you do not wish to use an external word processor. Statistics is a method for searching the database for errors, and as the title suggests, extracting essential statistics from it.

The important sections not yet touched upon are Manage and Select. Taking the latter first, this section enables you to create a sub-set of the database by selecting from the file contents. It is immensely powerful and supports nine equivalency relationships, such as "less than" or "greater than" etc. Furthermore, the two logical relationships AND and OR may be used freely. In this way one can Select from the database to pretty well any specification required. The Management section of the program enables the user to completely re-structure his database without having to Edit it manually. New fields may be added or old ones deleted. They may be re-arranged or even appended one field to another. Indeed, this can be taken even further in that the whole database may be merged or split as required.

The Reports section enables the user to write reports such as inventories, accounts, bibliographies, insurance coverage report, in fact an endless list of applications. Because the Report section contains its own Text Editor, the report contents and format can be controlled at will and literally an infinite number of formats may be adapted.

Data-Writer is one of the most powerful Database Management systems that we have seen available for a microcomputer and certainly is the most powerful that we have seen for the TRS-80 and Video Genie machines. Once the database has been manufactured, either by Data-Writer or a word processor, one has complete and utter control over it and the ability to manipulate any part of it; not only the ones mentioned above, but many others which we have not had the space to list. Data-Writer is compatible with the Model I and Model III Tandy machine, the original Video Genie, together with the Genie I and II. A version for the Model III Genie will be available shortly.

Data-Writer is Compiled Basic, hence its DOS compatibility is dependent upon the compatibility of the Microsoft Compiler. Due to Microsoft's disinterest in supporting any other DOS apart from TRSDOS and the non availability of a Tandy Model III Compiler, we recommend customers to use Data-Writer with TRSDOS or LDOS on the Model I and the proprietary DOS supplied on Data-Writer for the Model III. Other DOS's may well be compatible after patching and as we have said the criteria is whether they are compatible with the Microsoft Compiler.

Data-Writer — All Models . . . £78.00 + V.A.T. = £89.70

P & P . . . £1.25



MOLIMERX LTD

A J HARDING (MOLIMERX)

1 BUCKHURST ROAD, TOWN HALL SQUARE, BEXHILL-ON-SEA, EAST SUSSEX.

TEL: [0424] 220391 / 223636

TELEX 86736 SOTEX G



TRS-80 & VIDEO GENIE SOFTWARE CATALOGUE £1.00 plus £1 postage.

The WM 2000 prints so fast it's ahead of its time

These are just a few of the specifications of the WM2000 from Walters Microsystems.

It has one of the most advanced specifications of any printer of its kind. And it's British.

It certainly makes sense to build this superior technology into your system. It's used by the Ministry of Defence (NATO Number pending) and by the Department of Industry & Education. Because quite simply any other printer takes second place.



WALTERS MICROSYSTEMS INTERNATIONAL

'Cetec House', Lincoln Road,
High Wycombe,
Buckinghamshire

Simulated print out

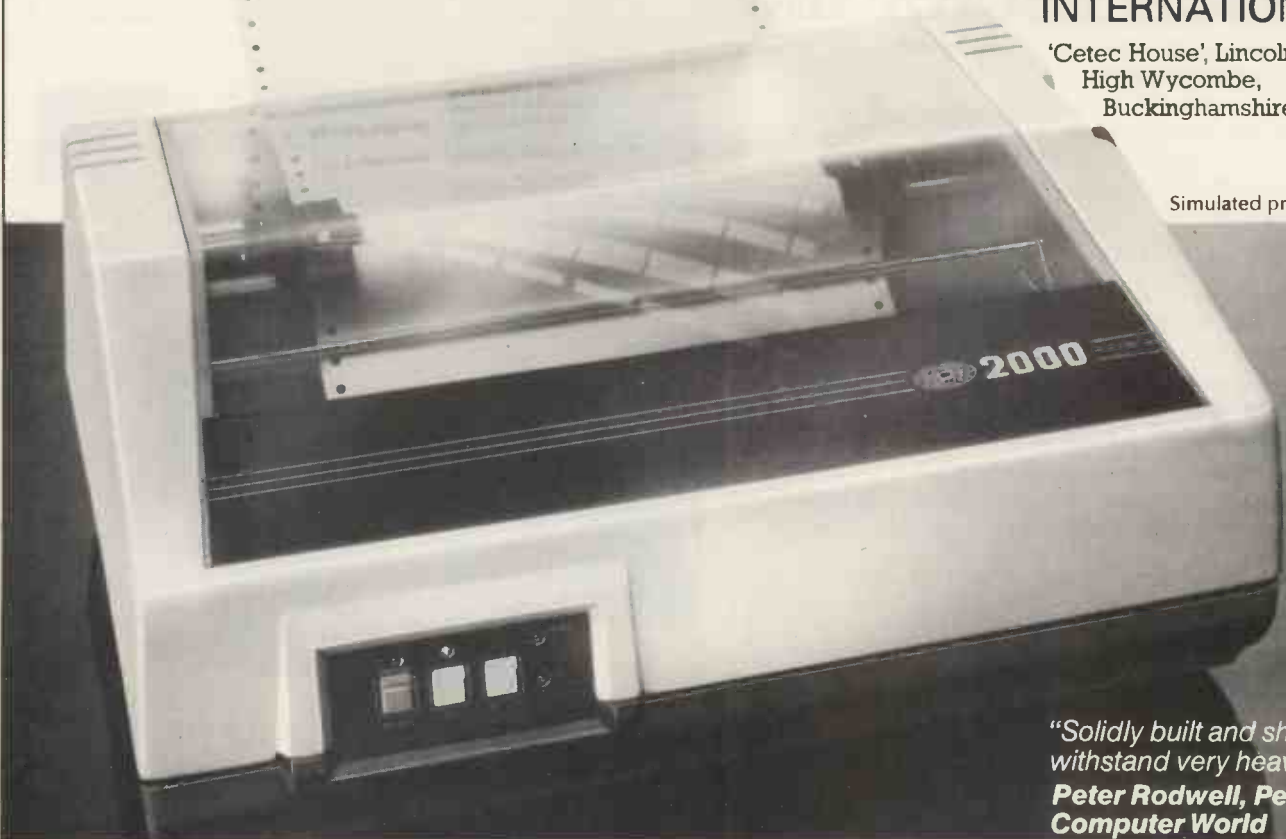

*"Solidly built and should
withstand very heavy use."*
**Peter Rodwell, Personal
Computer World**

To: **Walters Microsystems International Ltd** 'Cetec House' Lincoln Road High Wycombe Buckinghamshire
I want to know more about the world-beating WM2000

Name _____ Address _____ PCW1

Company _____ Position _____ Telephone Number _____

Dealer/OEM enquiries welcomed.

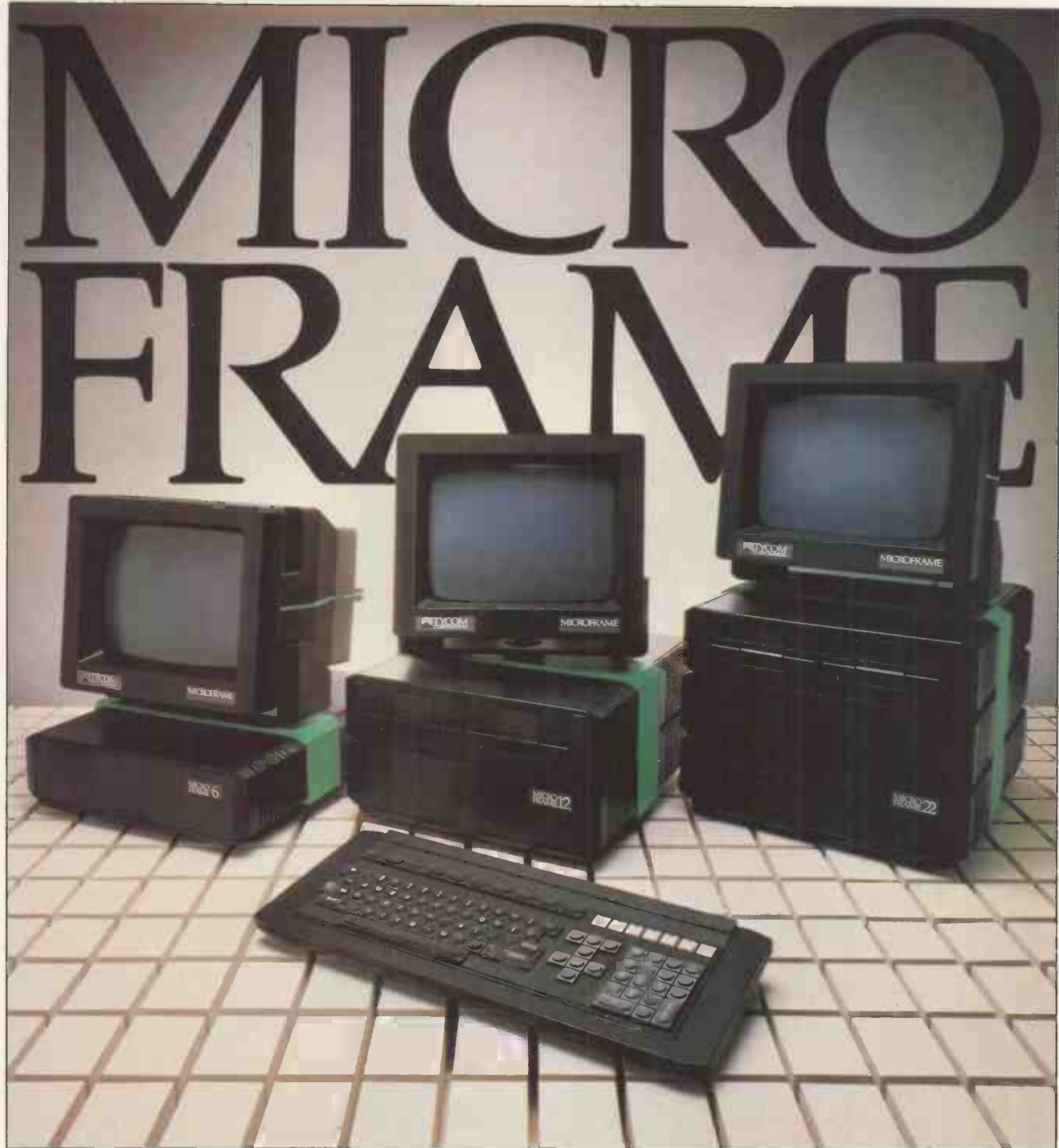

MICROFRAME : FUTURE - PROOF COMPUTING SYSTEMS FROM UNDER £3,000

I want to know more about Microframe and future-proof computing

Please send me literature

Please send me your video package on U-matic VHS BETA

Please send me details about becoming a Microframe dealer

MY NAME IS _____

PCWM1

TITLE _____

COMPANY _____

ADDRESS _____

TELEPHONE _____

Post to:

TYCOM CORPORATION LIMITED, MARKETING DEPARTMENT, 8/12 NEW BRIDGE STREET,
LONDON EC4V 6AL, ENGLAND. TELEPHONE: 01-583 2255. TELEX: 8955166 GESA-UK-G.



UPON REFLECTION

things
couldn't
be better



LOW-COST COLOUR MONITORS

Advanced design and manufacturing techniques put the new colour monitor from DIGIVISION at the top of its class. Produced specifically to compliment the latest generation of micros. In the office, in the home, in the design studio, at college, wherever a micro is at work this new monitor will work happily with it. A 14" screen

gives exceptional display clarity and high-quality colour resolution presented in a two-tone case at optimum cost. At a price of £300 it must be THE monitor for anybody requiring high quality colour communication in its simplest, most effective form.

DIGIVISION with your micro will prove to be a more exciting and rewarding investment.

Cash with order (cheques will not be presented until despatch of goods) or send for further details.

Dealer enquiries welcome

Digivision

**DIGIVISION LTD · PARKER DRIVE ·
LEICESTER LE4 0JP · TEL: 351224 · TELEX 341382**

MICROFRAME DEC IBM APPLE

Choose from the best range
of professional business systems
on the market



A division of the Tycom Corporation Limited

More than just hardware and software.

Guestel care for over 400 companies throughout the UK

8/12 NEW BRIDGE STREET, LONDON EC4V 6AL. TELEPHONE: 01-583 2255
41/43 BALDWIN STREET, BRISTOL BS1 1RB. TELEPHONE: 0272 277461
15 GRAND PARADE, BRIGHTON, SUSSEX BN2 2QB. TELEPHONE: 0273 695264

PLEASE SEND ME YOUR BROCHURE WITH DETAILS OF MICROFRAME <input type="checkbox"/> DEC <input type="checkbox"/> IBM <input type="checkbox"/> APPLE <input type="checkbox"/> PLEASE ASK YOUR SALES STAFF TO CONTACT ME <input type="checkbox"/>		PCWG1
NAME	_____	
TITLE	COMPANY	_____
ADDRESS	_____	
	TELEPHONE	_____
Post to: GUESTEL, 8/12 NEW BRIDGE STREET, LONDON EC4V 6AL		

THE BEST SELLER OF 1982



In 1982 the RICOH 1600S outsold every other comparable printer because of its speed, reliability, intelligence, flexibility and sophistication.

Because it is compatible with all known systems and software packages.

Because of the 12 month warranty that Micropute offer.

Because Micropute are a company who care, who are constantly aware of changing needs and who can fulfill any special requirements.

Not least of all, because of the price

In 1983, there will be thousands more satisfied customers.

We hope that you will be one of them.

ONLY MICROPUTE GIVE YOU SUPERCOVER

As an extra bonus Micropute Supercover will provide a 12 month on site maintenance for only £99.00 parts and labour.

**DON'T
FORGET THE
RICOH 1300S**

...a little bit slower but
every bit as clever.

Please send details of the RICOH 1600S
and 1300S

Name: _____

Position: _____

Company: _____

Address: _____

Telephone: _____

RP2



MICROPUTE

Micropute, Catherine Street, Macclesfield,
Cheshire SK11 6QY. Tel: (0625) 615384.

Linsac's ZX Companion series has received excellent press reviews:

"Far and away the best" — *Your Computer*

"Thoughtfully written, detailed and illustrated with meaningful programs ... outstandingly useful" — *EZUG*

'The Spectrum Games Companion' is the latest addition to the series and is aimed at the games player and programmer alike. Twenty-one games designed specifically for the ZX Spectrum are included, with clear instructions on entry and play. Each program is explained fully with complete details on how it is designed and written. Introductory chapters show how to set up and use the Spectrum and how to create your own games. Later sections cover number games, word games, board games, simulation games, dice games, card games and grid games. If you want to enjoy your ZX Spectrum and learn its secrets at the same time then this is the book for you!

Bob Maunder is co-author of 'The ZX80 Companion' and author of 'The ZX81 Companion'. He is a Senior Lecturer in Computer Science at Teesside Polytechnic, holds an MSc degree in Computer Science, and is a Member of the British Computer Society.

The Spectrum Games Companion is available from good book shops, or send £5.95 to:

LINSAC, (P.C.W.) 68 Barker Road, Middlesbrough, Cleveland TS5 5ES

Postage is free within the U.K. —

add £1 for Europe or £2.50 outside Europe.

THE SPECTRUM GAMES COMPANION

Bob Maunder

LINSAC

ONLY
£5.95

ISBN 0 907211 02 X

Ultra55™

The Legal Limit

FOR THE IBM PERSONAL COMPUTER

Where else can you find:

- Memory Expansion with Parity Detection to 320K Bytes (using 64K DRAMs) to 1280K Bytes (using 256K DRAMs)
- Serial Communications with 2 RS-232 Asynchronous Serial Channels and Keyboard Selectable Addressing
- Parallel Printer Port to drive your IBM printer and Keyboard Selectable Addressing
- Real-Time Clock Calendar with Battery Backup with 10 year estimated retention

and uses only ONE EXPANSION SLOT

Five Rows of RAM and Five Functions — Ultra55 all on a Single High Quality PCB

Competitively Priced

Daystar Systems Inc.

10511 Church Road, Suite L
Dallas, Texas 75238
214-341-8136

in Europe, call or write:
TEXMA INTERNATIONAL
7 Rue des Bas Jaunes
1490 Court St. Etienne, Belgium
00-3210-611628



Don't forget to ask about:

UltraFAST™ — Our Superb Flexible Disk RAM Emulator and

UltraRAM™ — Our Standard 512K-Byte Memory Expansion Board

Ultra55, UltraRAM and UltraFAST are Trademarks of Daystar Systems

BBC Micro SOFTWARE

FROM

FERNLEAF MICROSYSTEMS

- 1. WORD-EDITOR £12.50 (p+p inc) model B**
4 pages of text to write, delete, save, load, insert, draw tables, print etc. Package includes Manual. Ideal for almost all writing needs. Drives any printer for filled printing and special formatting by embedding ASCII codes in text, to printer.
- 2. HOME-FINANCE £12.50 (p+p inc) model B**
Another must of the BBC micro owner. Package manipulates 10 separate accounts; handles direct debit, standing orders, financial forecasts plus printouts, includes manual.
- 3. SKY-BIRD £9.00 (p+p inc) model B**
Incredible game in fast real time graphics, exciting sounds & multi coloured graphics. Guide the flight of the sky-bird behind mountains, avoid the lazer hawk but watch out for unknown dangers behind the hills. Employs skill and returns untold enjoyment for all
- 4. SCREEN DUMP £6.00 (p+p inc) model a & B**
Superfast machine code program. Auto adjusts to any mode of user's screen display and dumps screen in selectable sizes. Includes colour discrimination. Also includes instructions to use any printer.



Orders to:

We offer quality software to complement the quality of this micro.

We also write software to order.

Tele: Brighton (0273) 565303 or 0273 603191.

Enclose SAE.

FERNLEAF MICROSYSTEMS
SILVERGROVE
INNHAMS WOOD
CROWBOROUGH, SUSSEX
TN6 1TE

Retail dealers
offered big
discounts



FULL DETAILS AVAILABLE FROM

Walkbury Consultants
Unit A Alfric Square
Maxwell Road
Woodston Peterborough
Tel No: 0733-235187

CAMBRIDGESHIRE

DIGITAL SOLUTIONS

..... CONTINUE WITH THE LOWEST
COMPUTER PRICES ANYWHERE

- ☆☆ OUR PRICES ARE THE LOWEST ON THE MARKET.
☆☆ OUR SERVICE IS SECOND TO NONE.

EPSON MX80 T3 £265

EPSON MX80 F/T T3 £295

EPSON MX100 T3 £395

SMITH-CORONA TP/1 £415

FUJITSU SPA 830 £1695

ZVM121 12" MONITOR £65

NEC Hi-res COLOUR £460

OSBORNE 1 £960 (INCL. WORDSTAR/MAILMERGE, SUPERCALC,
CP/M, CBASIC, MBASIC)

DOUBLE DENSITY £1150 (AS ABOVE PLUS FREE DBASE 2)

ALL OUR PRODUCTS ARE FULLY GUARANTEED FOR 1 YEAR

MAINTENANCE CONTRACTS ALSO ARRANGED

CALL US TODAY FOR ANY POPULAR MACHINE OR PERIPHERAL

BECAUSE WE DO IT BETTER

CALL 0480/52870

or write to

Digital Solutions Ltd

28 Rowley Road.

St. Neots,

Cambs. PE19 1UF

All prices shown excl VAT and P+P

VIDEO GENIE & TRS 80

EXPANSION!

48K RAM INTERNAL

48K Memory Extension, easily fitted inside the keyboard unit. No Expansion Interface required. £43.50

LOWER CASE HARDWARE VG & TRS

Lower-case Hardware Kit with true descenders, £ sign and ↑ £19.00

The ROM

For TRS80 (3 chip ROM) and Video Genie (remove one I.C. and plug in replacement). Alleviates key bounce. Automatic check for our Feature ROMs improves TRS80 tape loading. Personalised message on power up. Optional lower case driver £14.95

Computers

Genies 1 & 2 £290
Genie 4. The fabulous colour computer with Standard Microsoft Basic £224.50

NEW NEW NEW NEW

DP 1000

Interfaces your TRS80 or Video Genie to Disk Drives and/or Parallel Printer £76.00

fig. FORTH disk

Operating System £25.00

Discover FORTH Book by Thom Hogan £10.95

Printers*****

Epson MX80FT/3 £340 (or £330 cash/chq)
Epson MX80T/3 £310 (or £300 cash/chq)
EG 603 Tractor+Friction+Roll Feed £200
Daisywheels from £480

Disk Drives*****

TEAC from Cumana
40 Track Single Drive £185
40 Track Double Drive £315

Feature ROMs

For TRS80 Model I and Video Genie. Plug-in units fit on expansion edge connector. Compatible with expansion interfaces, using "splitter cable". Plug-in unit including one Feature ROM:

Video Genie £29.95
TRS80 £34.50
Splitter Cable £14.50
Feature ROMs for above £18.95

Feature ROM A includes:-

- 1) Keyboard Inverter (Typewriter style)
- 2) Key Repeat
- 3) Single Key Commands
- 4) Flashing Cursor
- 5) Machine Code Monitor & Editor
- 6) System Load & Save (Back-up facility will save full 16K on cassette)

Feature ROM B includes:-

- 1) Keyboard Invert
- 2) Line Renumber
- 3) Single Key Commands
- 4) Cursor Flash
- 5) Basic Program Merge
- 6) Basic Program Compress

Tantel-Prestel Adaptor

With cuts interface for computers full colour Teletext access. Standard UHF TV connection £160

ALL PRICES ARE EXCLUSIVE OF VAT & CARRIAGE. (TELEPHONE FOR FURTHER DETAILS).

CREDIT FACILITIES AVAILABLE



GENERAL NORTHERN MICROCOMPUTERS LTD.

8 WHITWORTH ROAD, SOUTH WEST INDUSTRIAL ESTATE, PETERLEE, Co. DURHAM SR8 2JJ
TELEPHONE: PETERLEE (0783) 860314



Lost for words?

ENGLISH WORDPOWER

increases vocabulary • improves spelling

Two levels of difficulty

Games or key-in answers

Random choice

(no two games or exercises are the same)

£14.99 inc. VAT

Spectrum • Atari • BBC • Commodore

4 Church Street, Abbey Green, Bath BA1 1NL

☎ (0225) 61929



FULL DETAILS AVAILABLE FROM

Aylesbury Micro Computers
New Street
Aylesbury
Tel No: 0296-87309

BUCKINGHAMSHIRE

I'M HAPPY AND PROUD TO PRESENT:



YOUR FRIENDLY IBM PERSONAL COMPUTER.

You've heard a lot about small computers, but so far you've not actually taken the plunge?

For one thing, you may have felt a little confused at the sheer choice that confronts you. For another, you may have felt put off by the unfamiliar jargon of 'computerese'.

And this is a pity, because a small computer could indeed do a great deal for you. Which is where the friendly IBM Personal Computer comes in.

Not only is it brought to you by one of the better known computer makers in the world, but we've gone out of our way to make it really intelligible.

Its brochures are in lucid English. Its general appearance is clean and un baffling. And whether you're a businessman or a private individual, you'll find it takes no more than a few fascinating hours to strike up a rewarding relationship.

And whether you go to an IBM authorised dealer or IBM Retail Centre, you'll find sympathetic staff who will spell out in human terms exactly what the IBM Personal Computer can do for you.

Your IBM authorised dealers and IBM Retail Centres are here:

ABERDEEN	
Abtex Computer Systems Ltd	0224 647074
BEDFORD	
MMS Ltd	0234 40601
BELFAST	
Medical and Scientific Computer Services Ltd	08462 77533
BELPER, DERBY	
Midlectron Ltd	077-382 6811
BIRMINGHAM	
CPS (Data Systems) Ltd	021-707 3866
The Byteshop Ltd	021-622 7149
BOOTLE, LIVERPOOL	
Stack Computer Services Ltd	051-935 5511
BRADFORD	
RAM Computer Services Ltd	0274 391166
BRISTOL	
Colston Computer Centre Ltd	0272 276619
Datalink Microcomputer Systems Ltd	0272 213427
CARDIFF	
Sigma Systems Ltd	0222 34869
COLCHESTER, ESSEX	
Dataview Ltd	0206 865835
EDINBURGH	
Microcentre (Complete Micro-Systems) Ltd	031-556 7354
FAREHAM, HAMPSHIRE	
The Personal Computer Connection Ltd	0329 230870

GLASGOW	
The Byteshop Ltd	041-221 7409
LONDON	
Bonsai Ltd, WC1	01-580 0902
Currys Micro-Systems Ltd, NW1	01-387 9275
Digitus Ltd, WC2	01-379 6968
Personal Computer Ltd, EC2	01-377 1200
Planning Consultancy Ltd, SW1	01-839 3143
Sumlock Bondain Ltd, WC1	01-250 0505
The Byteshop Ltd, NW1	01-387 0505
MANCHESTER	
Currys Micro-Systems Ltd	061-834 0144
Cytek (UK) Ltd	061-872 4862
The Byteshop Ltd	061-236 4737
NOTTINGHAM	
Keen Computers Ltd	0602 412777
The Byteshop Ltd	0602 40576
PAIGNTON	
Devon Computers	0803 526303
SHEFFIELD	
Datron Micro Centres	0742 585400
SOUTHAMPTON	
Computerland	0703 39574
Xitan Systems Ltd	0703 38740
SWINDON	
Computacenter Ltd	0793 612341
WASHINGTON, TYNE AND WEAR	
Microcomputing Ltd	0632 476018
IBM RETAIL CENTRES	
London SW1	01-828 6640
EC2	01-600 8111
W1	01-486 9487
Birmingham	021-454 7070

Or phone 01-578 4399
for more information
on our expanding
dealer network.





The New British Minstrel *FROM* **£2,455**
with Winchester Drive

Generous Dealer and
Local Authority Discounts

Winchester Drive makes Minstrel the preferred professional Computer

*Read the remarkable specification of this truly professional new British machine,
with unrivalled reliability, versatility, software and support.*

TECHNICAL SPECIFICATION

- Versatile and highly adaptable
- Built for reliability and ease of servicing
- Horizon compatible
- Superlative software: CP/M, MINOS, Turbo-DOS, and multi-user application packages
- British manufacture

CHECK THESE OUTSTANDING FEATURES

Standard system

- S100
- 5-20 Mb Winchester drive
- 64K RAM
- Horizon compatible, 400 Kb - 1.6 Mb floppies
- Z80 Processor

Other Configurations Available

- Multi-user systems
- Multi-processor systems
- 16-bit processor using powerful 68000 processor

Invitation

For more information about the brilliant new British Minstrel computer, or to find out your nearest U.K or European Dealer, write or telephone: Andrew Ward or Tony Harris



Minstrel

Hotel Microsystems Ltd. **01-328 8737**
69 Loudoun Road, London NW8 0DQ Telex: 266828

The Best Vic Software from Kobra

GAMES

All these selected games on cartridge (except Blitz)

AVENGER 'INVADERS' in colour £19.95

SUPER LANDER land the lunar module game £19.95

ALIEN bury marauding aliens in the maze £19.95

STAR BATTLE 'GALAXIANS' in full colour 1 - 2 players £19.85

JELLY MONSTERS is this 'PUCKMAN', or not? £19.95

ROAD RACE drive thro' the night and stay on the road £19.95

RAT RACE VIC's answer to 'RALLY X' £19.95

MOLE ATTACK stop the moles to survive £19.95

SARGON II CHESS the best available, seven playing levels £24.95

SUPER SLOT computerised one armed banditry £19.95

GORF five famous arcade games £24.95

OMEGA RACE sophisticated version of 'ASTEROIDS' £24.95

ADVENTURE GAMES telephone for titles - all £24.95

BLITZ flatten the city before you collide with the skyscraper £4.99

BRIDGE superb version of the card game £24.95



EDUCATION

PROGRAMMING

Enhance your VIC with these programmer's aids - and add memory with the RAM Packs.

SUPER EXPANDER high-res graphics, sound, additional 3K RAM £34.95

PROGRAMMERS AID program development tool £34.95

MACHINE CODE MONITOR simplifies machine code programming £34.95

VIC FORTH fast, compact language cartridge with additional 3K £38.95

VIC REL simple electrical control for up to six pieces of apparatus £28.95

VIC STAT single word commands for statistical calculations with colour displays £28.95

VIC GRAF explores graphs and their equations £28.95

VIC SWITCH allows eight VIC's to use one printer and disk £79.95

16K RAM memory pack £74.95

8K RAM memory pack £44.95

3K RAM memory pack £29.95

Dealer enquiries to Adda Computers, Tel 01-579 5845

RAINBOW TOWERS problem solving to exercise memory and logic (8 upwards) and the whole family) £8.95

CRANKY addition and subtraction practice (5 - 12) £8.95

HIDE & SEEK improves short term memory (5 - 12) £8.95

WORDS WORDS WORDS helps spelling and object identification (5 - 12) £8.95

SHAPE UP teaches shape and pattern recognition (3 upwards) £8.95

G.C.E. 'O' level revision programs (8K/16K) titles: English Language, Maths 1, Maths 2, Biology, Chemistry, Physics, Computer Studies, Geography, History £9.99 each

For 9 - 11 year olds (8K/16K) titles: Arithmetic, Reading, General Knowledge, Spelling £9.99 each

For home or school. Unless shown all need 16K memory. Age range shown in brackets.

FACEMAKER for spelling and observation skills (5 - 12) £8.95

NUMBER CHASER exciting number estimating (5 - 12) £8.95

NUMBER GULPER gobble away at addition, subtraction, multiplication and division practice, (5 - 12) £8.95

WE WANT TO COUNT helps the very young to learn numbers (3 upwards) £8.95

TWISTER Rubik like geometric puzzle with 'SUPER TWISTER' section (8 upwards and the whole family) £8.95

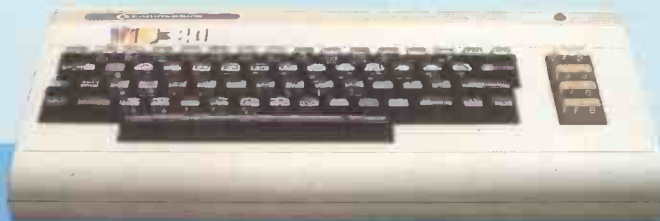

The Vic Centre
154 Victoria Road, Acton
London W3 6UL

Near North Acton tube, just off A40

BY TELEPHONE

Telephone orders 24 hrs a day with Visa, Access, Amex

01-200 0200

HOW TO ORDER:

VISIT YOUR LOCAL VIC DEALER

BY MAIL OR PERSONAL CALLERS

By mail add 50p post and packing per item and make cheques or PO's payable to Kobra Micro Marketing. Send to:

KOBRA

GALAXY COMPUTER SYSTEM

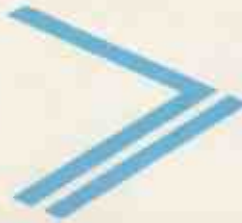

WHATEVER REQUIREMENTS YOU HAVE



GM813 – CPU/ 64K RAM Board

- ★ 4 MHz Z80A CPU
- ★ 64K Dynamic RAM
- ★ RS232 Serial Interface
- ★ Two 8-Bit I/O Ports
- ★ 1200 Baud Cassette Interface
- ★ Extended and Page Addressing Modes

GM812 – IVC Board

- ★ 80x25 Display Format
- ★ On-board Z80A Microprocessor
- ★ Buffered Keyboard Input
- ★ Programmable Character Generator
- ★ 160x75 Pixel Graphics
- ★ Light Pen Input

GM 829 – FDC/ SASI Board

- ★ Single/Double density operation
- ★ Single/Double sided drive operation
- ★ Up to 3 mixed 3.5", 5.25" and 8" drives
- ★ Industry Standard SASI hard-disk Interface

TWO SPARE SLOTS

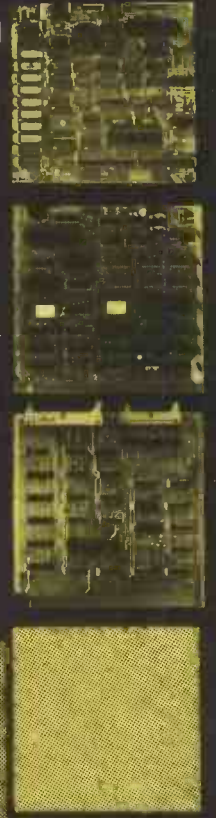

The cost-effective solution to your computer needs for only **£1,495***

For just £1,495 the Galaxy 2 provides the basic requirements for a small business system:

- **Central Processor Unit with 64K of RAM**
- **Twin disk drives (400K storage per drive)**
- **Keyboard and 12" monitor**

But unlike many other small-business systems the Galaxy System is specially designed for expansion and flexibility to meet changing requirements. It uses the world's best selling micro processor, the Z80A, and is based on industry-standard 80-Bus boards. The business system uses only 3 boards in the 5 spaces available, so extra cards can be "plugged-in" to expand the system; for example to expand the memory, or to give a colour facility, or to develop the Galaxy for the particular requirements of education, research, software development etc.

It has a CP/M operating system which gives access to the largest range of software available for any machine. In particular, Gemini can offer QUIBS; a small-business package developed especially for the Galaxy.

The Galaxy has industry-standard interfaces (parallel and serial), and Gemini Microcomputers can supply a full range of compatible hardware including a Winchester sub-system and printer.

The Galaxy offers the most cost-effective way of obtaining a basic unit which is capable of developing to meet your particular requirements; now and tomorrow.

Features include:

- Twin Z80 Processors
- 64K Dynamic RAM
- 800K Disc Based Storage
- 80 x 25 Screen Format
- Dual Printer Interfaces
- Modular Design
- Extra Disc Drives Easily Added
- Winchester Expansion Available
- Net Working System Available
- Additional Slots for 2 Cards
- 12" Green or Amber Monitor



*Price is exclusive of VAT



Gemini Microcomputers

Oakfield Corner Sycamore Road Amersham Bucks HP6 5EQ





COME AND
DISCOVER
WHAT IS
FOR YOU!

To find your way through the "Computer Jungle" we invite you to come on a guided tour of software applications and the hardware you'll need too!

TIES Computer College

runs full day, two day and one week courses designed especially to help you choose computer programs

for your particular needs

OR, learn how to write computer programs in English - courses using the program generator THE LAST ONE, the amazing program that writes programs designed by you from plain English instructions. Send today for our FREE brochure and let us guide you in this new, exciting world.

CALLING ALL EFL TEACHERS - JOIN TIES' DATABASE OF EFL TEACHERS - FOR JOB OPPORTUNITIES AND EFL NEWS FROM AROUND THE WORLD

To: TIES COMPUTER COLLEGE, 16 Broadley Street, London NW8 8AE. Tel: 262 6956, 402 3980, 258 0064
Telex: 296546 TIES G

Please send your 1983 prospectus to:

Name.....Organisation.....
Address.....

PLUS 80 LTD

WELCOME TRADE ENQUIRIES

VIC 16K	£26.00
24K	£41.00
ATARI 16K	£28.00
32K	£38.00
48K	£51.00

*THESE PRICES ARE QUOTED AT
25 UNITS + 1 YEAR GUARANTEE AND
FULL CUSTOMER SERVICE BACK UP
INCLUDED IN PRICE.*

PHONE NOW - 01-575-1908

432 GREENFORD RD., GREENFORD, MIDDX.



FULL DETAILS AVAILABLE FROM

**Microfactor Computer Systems
1 Dunham Road
Altrincham WA14 4W2
Tel No: 061-928 1228**

CHESHIRE

The new Dragon 32. So well designed, you'll even understand this ad.

If you're already a computer expert, may we refer you to the box of technical specifications displayed opposite.

If you're not, may we refer you to the new Dragon 32 Family Computer. A computer so easy to understand, you won't understand why all the others seem so difficult.

And the new Dragon 32 costs under £200.

32K RAM FOR UNDER £200?*

When you're comparing computers, the first thing you need to know is the size of the memory. In plain English, the Dragon has approximately 32 thousand units of Random Access Memory. (32K RAM for those who prefer to be blinded by science.) Giving you all the power you're likely to need and more.

With a memory this powerful, the amount of information the Dragon can store is literally vast. But the Dragon doesn't just make it easy to store information. It makes it easy to use, too.

USER-FRIENDLY?

You may have heard of the term 'user-friendly.' Reverting to plain English once more, this means simply that the computer will go out of its way to understand you, rather than vice-versa.

The Dragon 32 is so user-friendly, it practically licks your hand.

You tap (literally) its vast resources through a beautifully-designed keyboard that's as easy to use as a typewriter.

On this keyboard, you type in a language which is surprisingly close to the English you talk every day. The Dragon 32 will receive your order. Understand it. Send it to the appropriate section of its massive brain. And then display the appropriate information on your screen. All before you can say 'gobbledygook.'



*TV not included in price.

SPECIFICATIONS

6809E MICROPROCESSOR. The most powerful eight bit processor available.

32K RAM (as standard). At least twice the power of most similarly priced machines. Expandable to 64K RAM.

EXTENDED MICROSOFT COLOUR BASIC (as standard). Featuring: ADVANCED GRAPHICS (set, line, circle, paint, print, draw, rotate and print using). ADVANCED SOUND 5 octaves, 255 tones. AUTOMATIC CASSETTE RECORDER CONTROL. FULL EDITING with INSERT and DELETE.

9 COLOUR, 5 RESOLUTION DISPLAY.

USE WITH ANY U.H.F. TV and/or separate P.A.L. monitor.

PROFESSIONAL QUALITY KEYBOARD. Typewriter feel. Guaranteed for 20 million depressions.

PRINTER (Centronics parallel).

JOYSTICK CONTROL PORTS.

FIRE YOUR IMAGINATION.

Learning how to use the Dragon 32 won't cause you to experience any problems. Learning what you can use it for will cause you to experience something entirely different.

Delight. Surprise. Fascination. And challenge.

The Dragon offers a range of some of the most popular computer games in the world. From those celebrated space battles to mind-boggling adventures in seemingly unfathomable dungeons and caves.

As if by magic, a simple typed message will command the Dragon to create your own drawings. Then it will colour and paint them in a variety of colours.

And it's clever enough to create virtually any image you want - circles and arcs as well as straight lines.

The Dragon will also play and compose music with you, with a range of 5 octaves. And it works with any UHF TV or PAL monitor.

LEARNING THROUGH PLAYING.

All of this makes the Dragon the ideal machine to build your children's interest in the world of computers as they become increasingly more vital. School-children already enjoy using computers.

The Dragon is the first computer specifically for the family - so by enjoying yourselves at home, you and your children can soon become expert enough to create your own programs.

Listed here is a sample of some of the more popular cartridges and cassettes available from Dragon's vast range of software.

GHOST ATTACK	Cartridge. An exciting maze game for one or two players.
PERSONAL FINANCE	Cassette. Keep track of family finances, create address lists and directories.
METEROIDS	Cartridge. Guide your ship through the treacherous asteroid belt. Requires skill, fast reactions and concentration.
CHESS	Cartridge. With 9 levels this is nearly impossible to beat.
CALIXTO ISLAND	Cassette. Avoid the eerie goings-on and escape from this evil island.
ASTROBLAST	Cartridge. Shoot the enemy spacecraft before they get you. (Action packed.)
COMPUTA VOICE	Cassette. Make your Dragon speak. Using phonetic sounds, even regional accents can be produced.
TYPING TUTOR	Cassette. Teach yourself to type accurately. Improve your speed and accuracy.
BERSERK	Cartridge. A challenging shooting game based on the popular arcade game.
GRAPHIC ANIMATOR	Cassette. Create simple cartoons on the screen, then animate them.
COSMIC INVADERS	Cartridge. Dragon version of famous arcade game. 15 levels of difficulty.
MADNESS AND THE MINOTAUR	Cassette. A real-time adult strategy game, descend into the labyrinth of King Minos in search of treasure.

BRILLIANTLY SIMPLE GUIDE.

The Dragon is living proof that you don't have to be an expert in computerspeak to be an expert in computers. It comes with the easiest-to-understand instruction manual ever written for a home computer.

Every step, every explanation, is made clear - even if you're a beginner. In minutes, it will show you how to write a simple program. Within hours, you'll be fascinated. And from then on, you'll continue to be astounded by the new world which the Dragon's power and versatility will open up to you.

See the new Dragon 32 in your High Street. At under £200, it's not just the first family computer. It also has all the features an expert could wish for.

Except perhaps the jargon.

DRAGON 32

The first family computer.



BUG-BYTE SOFTWARE, MORE THAN A GAME

All about me was darkness. Tens of thousands of screens stared blankly into space. Minds drifted aimlessly, dulled by lack of stimulation. The world was grey, drab, lacking . . .

Then suddenly it happened. First one, then another, then tens, hundreds, thousands of tired screens felt a surge of power and flickered back into life. They were much as I had seen on my own planet's microcomputers – the ZX 81, ZX Spectrum, Vic 20, BBC Micro and ORIC-1.

The minds paused to take stock. They clustered round the screens, their nimble fingers excitedly flicking the controls back and forth. At last they had found a challenge . . . action and adventure with cunning tests of dexterity and reaction. Everywhere, conversation was of Asteroids, Mazogs, Panic, Another Vic in the Wall.

Unable to resist, I too had a closer look. There before me was vivid colour, high resolution graphics. I could practically feel the spine-tingling

**BUG-BYTE
SOFTWARE**



SPECTRES

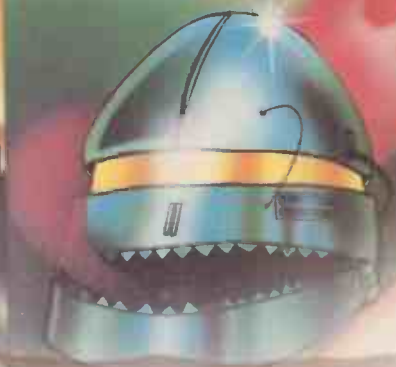

...IT'S A DOOR TO ANOTHER DIMENSION !

sound effects as whole battle fleets of Cosmiads swarmed out of nowhere and attacked. I should have known. As my fingers raced over the controls, and I prepared to stand and fight with only a single laser bolt for protection, I realised I was trapped!

Too late now, I remembered this was no ordinary software. I'd been warned, as I now warn anyone buying from Laskys, W.H. Smith, Currys Micro C, Spectrum and larger

branches of Boots, and a nationwide network of dealers stocking Bug-Byte. Because Bug-Byte is more than a game, it's a door to another dimension. One that I had opened.

**BUG-BYTE
SOFTWARE**



100 The Albany, Old Hall Street, Liverpool L3 3AB

Make Friday you



Friday, March 11th sees the launch of Britain's most exciting microcomputing publication. Big deal.

You've heard all that before, eh? Over the last year, everybody and the cat's mother have been launching microcomputer publications.

And most of them cost the better part of a quid.

And the really good ones are rarer than hen's teeth. So here's the good news.

★ **Personal Computer News** is weekly.

Around a hundred pages printed on glossy paper, much of it in full colour.

★ **Personal Computer News** is only 35p.

★ **Personal Computer News** is edited by the largest editorial team working on any microcomputer publication in Britain. We have individual editors working on hardware, software, peripherals, features, listings and programs - fourteen of them in all. A massive investment of talent and expertise with only one aim. To make **PCN** the finest microcomputing title in Europe.

★ Our deadlines on news and features are short.

That means we get to publish comprehensive hardware tests, software reviews, news and much else besides, weeks and weeks before monthly publications can hope to do so. (For example, this advertisement was prepared at the end of January and we'll be lucky to squeeze it in

day of discovery.



the March issues of those monthlies brave enough to carry it. Get the point?)

Personal Computer News will carry scoop reviews and tests in virtually every issue.

Whatever your particular interest in the world of microcomputing, you'll find it first in **PCN**.

★ **Personal Computer News** comes from the publishers of **Personal Computer World**.

That means you can rest assured on the quality and independence of the editorial package. Certainly we need ads to be able to offer such a package for only 35p, but they won't be allowed to swamp the editorial content.

★ Every issue of **Personal Computer News** carries a pull out 'part-work' which will gradually build into a

comprehensive library on microcomputing.

In addition, you'll find free Readers' Buy and Sell ads, a totally unique programs listing section for the more popular micros, Buyers' Guides, language articles and much, much more.

★ We know you've heard it all before. So we're prepared to put our money where our magazine is.

Collect the first three issues of **Personal Computer News**. Return the coupons you'll find inside to the address published in the fourth issue and we'll send you back £1.00.

Your first three issues will cost you only 5p.

★ Make Friday your day of discovery. Try **Personal Computer News**. The Complete Computing Weekly.

NEW FROM ACT



The 10 Megabyte Winchester Sirius — — £3995.00

Once again, ACT introduces a new price/performance breakthrough in personal computing: An ACT Sirius 1 16-bit personal computer with 128 Kbytes of RAM COMPLETE with integral 10 Mbyte Winchester for just £3995.

And, it's available now. Ready to take on the large business applications that previously called for much more expensive minicomputer systems.

Both access speed and data integrity are enhanced compared with floppy-based systems. The user can divide the disk into multiple volumes each of which appears as a discrete entity. And more than one operating system can access the Winchester.

Like all the Sirius range it's backed by

the strength and resources of ACT: The PULSAR range of true 16-bit application software for accounting, planning and word processing; ACT Training Centres in London and Birmingham open to all; nationwide field service; a full range of printers and consumables. And, the most complete and professional dealer network in personal computing.

The new Sirius Winchester is the latest addition to the 16-bit ACT Sirius 1 family. Prices start at just £2395 for a dual floppy drive system with 1.2 Mbytes and £2895 for the double-sided floppy drive version offering 2.4 Mbytes. All provide an Intel 8088 16-bit processor and 128 Kbytes of RAM.

NEW SIRIUS WINCHESTER: THE FACTS

Winchester Subsystem

- 10.6 Mbyte (formatted) 5¼" integral Winchester drive
- 218 msec average access time
- Intelligent disk controller
- DMA interface to system memory
- Multiple operating systems
- User configurable

General Specifications

- 128 Kbytes RAM
- Intel 8088 16-bit processor unit
- 1.2 Mbyte double-sided floppy disk drive for back-up
- 800 x 400 pixel high resolution graphics
- Multiple operating systems
- Parallel/IEE 488 port
- 2 x RS 232 asynchronous/synchronous ports
- User port

For more information on the new Sirius Winchester clip the coupon and return to

ACT (Sirius) Ltd

FREEPOST

Birmingham B63 1BR

or call

021-501 2284

™ indicates registered trade mark.
Ownership details on request.
Prices exclude VAT.



Please send me further details of the new Sirius Winchester.

Name _____

Position _____

Company _____

Address _____

Tel _____

SC1

A new star is born



pulsar

16 BIT BUSINESS SOFTWARE

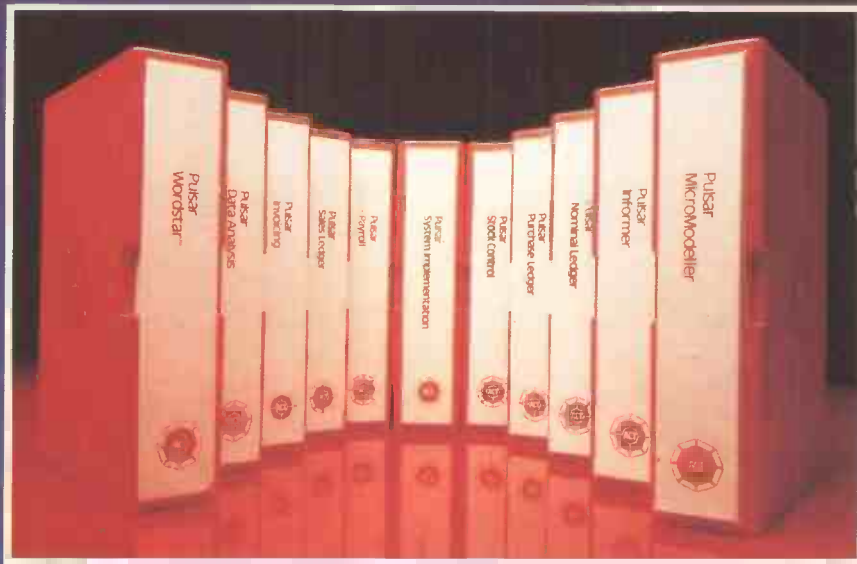

PULSAR business software is the creation of ACT – the company behind the Sirius I and recognised leader in 16-bit personal computing.

The new PULSAR range, developed by ACT at a cost in excess of £1 million, takes full advantage of the power and expandability of 16-bit computers.

It is inherently faster and more powerful than traditional 8-bit software.

And it is a true 16-bit range, designed and developed by ACT's own software engineers.

PULSAR offers more of all the key requirements in business software:

MORE PORTABILITY

Written throughout in machine-independent portable languages to protect your software investment.

LONGER PEDIGREE

ACT has more than 17 years experience in developing business software. Thousands of companies throughout the world use ACT packages.

GREATER INTEGRATION

All the PULSAR packages are designed to share information, avoiding duplication of files and eliminating re-entering of data.

MORE USER-FRIENDLY

ACT's unique UFO (user-friendly origination) routines allow even the inexperienced user to quickly and easily configure a PULSAR system to precise requirements.

BETTER TRAINING

Two training centres, in London and Birmingham are open to all PULSAR users.

MORE SUPPORT

A 'hot line' telephone support scheme to instantly resolve any operating queries.

PULSAR SOFTWARE CENTERS

Only PULSAR is available through the unique network of PULSAR Software Centers. These are hand-picked computer dealers who handle a range of personal computers but who specialise purely in PULSAR to meet all business needs.

THE PULSAR RANGE

Sales Ledger	£195	Informer Database	£295
Purchase Ledger	£195	Micromodeller	£595
Nominal Ledger	£195	SuperCalc™	£150
Payroll	£195	MultiPlan™	£159
Stock Control	£195	WordStar™	£295
Invoicing	£195	Select™	£295
Data Analysis	£195	MailMerge™	£95
		d Base II	£395

**AVAILABLE NOW FOR SIRIUS –
IBM PC and DEC Rainbow
coming soon.**



For more information on the new PULSAR Range clip the coupon and return to

ACT (Pulsar) Ltd
FREEPOST,
Birmingham B16 1BR
or call
021-454 8585

Please send me further details of the new PULSAR Range.

Name _____

Position _____

Company _____

Address _____

Tel _____

SCI

™ indicates registered trade mark. Ownership details on request. ALL prices exclude VAT.

**COMMODORE 700 SERIES
THE BUSINESS
COMPUTER**

80-column display, 128K or 256K user RAM expandable to 896K; tilt and swivel screen. 8088 or Z80 second processor capability giving option of other operating systems such as CP/M. Built-in DMA disk-drives available. IEEE-488 and RS232C interface capabilities.

FROM
£995
EX VAT

*Registered Trademark of Digital Research Inc.



3 great deals.

**COMMODORE 500 SERIES
THE SCIENTIFIC/
PROFESSIONAL COMPUTER**

40-column 16-colour display to monitor or TV. 128K user RAM expandable to 896K. High-resolution graphics and 3-dimensional effect capability. Sound synthesis. Second processor option. Prestel facility available. 8-bit parallel port to interface scientific equipment.

FROM
£695
EX VAT



**COMMODORE 64
THE PERSONAL
COMPUTER**

40-column 16-colour display to monitor or TV. 64K RAM. High-resolution graphics and 3-dimensional effect capability; music synthesiser. Z80 additional processor option.

FROM
£299
EX VAT



WEST COUNTRY

Avon Business Computers Ltd.
(Formerly Calculator Service and Sales (Bristol) Ltd)
192 Wells Road, Bristol, Avon BS4 2AX
Bristol (0272) 779452/3

Currys Micro Systems Ltd.
2 Channons Hill, Fishpond,
Bristol, Avon BS16 2EA
(0272) 650501

Radan Computational Ltd.
19 Belmont, Lansdown Road,
Bath, Avon BA1 5DZ
Bath (0225) 318483

A. C. Systems,
6 Cathedral Lane, Truro,
Cornwall TR1 2QS
Truro (0872) 79727

J. M. Computer Services Ltd.
14-15 Lemon Street, Truro,
Cornwall TR1 2LS
Truro (0872) 71626/70071

A. C. Systems,
53 Magdalen Road, Exeter,
Devon EX2 4TA
Exeter (0392) 211718

A. C. Systems,
75 Mutley Plain, Plymouth,
Devon PL4 7DS
Plymouth (0752) 260861

**J.A.D. Integrated Services
Plymouth Ltd.**
21 Market Avenue, City Centre,
Plymouth, Devon PL1 1PG
Plymouth (0752) 662616

Devon Computers,
The White House, 39 Totnes Road,
Paignton, Devon
(0803) 526303

**South Coast Business
Machines Ltd.**
South Coast House, Wimborne Road,
Ferdow, Bournemouth,
Dorset BH22 9NG
(0202) 893040

Computer Shack Ltd.
14 Pittville Street, Cheltenham,
Glos. GL52 2LJ
Cheltenham (0242) 584343

Milequip Ltd.
7a Hare Lane, Gloucester GL1 2BA
Glos. (0452) 411010

**Somerset Business
Computers,**
25 East Reach,
Taunton, Somerset
(0823) 52149

Computacenter Ltd.
Theatre Square,
Swindon Wiltshire SN1 1QN
Swindon (0793) 612341/2

Whymark Computer Centre,
20 Milford Street, Salisbury,
Wills. ST1 2AP
(0722) 331269/26688

SOUTH AND SOUTH EAST

Currys Micro Systems Ltd.
(inside Currys) Units 91/93,
Amdale Centre, Luton, Beds LU1 1TB
0582 425079

HB Computers Ltd.
40-50 Collingdon Street, Luton, Beds.
(0582) 454466

MMS Ltd.
Ketwell House, 75-79 Tavistock Street,
Bedford, Bedfordshire MK40 2RR
Bedford (0234) 40601

Adda Computers Ltd.
275 Oxford Road, Reading,
Berks. RG1 7PY
Reading (0734) 585928

Adda Computers Ltd.
120 High Street, Slough, Berks. SL1 1JQ
Slough (0753) 72470/77514

Alphascan Ltd.
22 Hambridge Road, Newbury, Berks.
Newbury (0635) 30880

C.S.E. (Computers),
12 Wokingham Road, Reading,
Berks. RG6 1JG
Reading (0734) 61492

Kingsley Computers Ltd.
132 Desborough Road,
High Wycombe, Bucks. HP11 2PU
(0494) 449749

Ampicon Micro Systems Ltd.
Richmond Road, Brighton,
East Sussex BN2 3RL
Brighton (0273) 608331

South East Computers,
15 Castle Street, Hastings,
East Sussex TN34 3DY
Hastings (0424) 426844

**Alphanumeric Computer
Systems Ltd.**
Migate House, 38 Hamlet Court Road,
Westcliff-on-Sea, Essex SS0 7NS
(0702) 43304

Apollo Reprographics,
Unit 15A, West Station Industrial Estate,
Spital Road, Maldon, Essex CM9 6TW
Maldon (0621) 56933

**Computer Sales & Software
Centre Ltd.**
190/192 Cranbrook Road,
Iford, Essex IG1 4LU 01-554 3344

Dataview Ltd.
Portreeves House, East Bay,
Colchester, Essex CO1 2XB
Colchester (0206) 865835

DDM Direct Data Marketing Ltd.
22 Warley Hill, Brentwood,
Essex CM14 5HA Brentwood (0277)
229379/230480/214168

Stuart R. Dean Ltd.
373 Southchurch Road,
Southend-on-Sea SS1 2PY
(0702) 62707

Business Electronics, Rowhams House, Rowhams, Southampton, Hants. SO1 8AH Southampton (0703) 738248 Currys Micro Systems Ltd, (inside Currys) 10/11 Bargate, Southampton, Hants. (0703) 29676 Microchips, 46 48 St. Georges Street, Winchester, Hants. SO23 8BE (0962) 68085 Super-Vision, 13 St. James Road, Shirley, Southampton (0703) 774023 Alpha Business Systems, Electron House, Church Street Industrial Estate, Ware, Herts. SG12 9ES Ware (0920) 68926/7 Brent Computer Systems, 33 Church Street, Rickmansworth, Herts. WD3 1DH (09237) 71306/70329/76102 Vance Business Systems Ltd, Saiter House, 109 High Street, Hemel Hempstead, Herts. HP1 3AH Hemel Hemp. (0442) 40722 Photo Acoustics Ltd, 255a St. Albans Road, (entrance in Judge Street), Watford, Herts WD2 5BQ Watford (0923) 40698 South East Computers, 31 Watling Street, Canterbury, Kent CT1 2UD (0227) 59917 South East Computers, 29 High Street, Maidstone, Kent ME14 1JS (0622) 681263 The Computer Room, 87 High Street, Tonbridge, Kent TN9 1RX Tonbridge (0732) 355962 Alphacans Ltd, Little Bourton House, Southam Road, Banbury, Oxon. OX16 7SR Cropredy (029575) 606/8202 Currys Micro Systems Ltd., (inside Bridgers), 31/35 Blagdon Road, New Malden, Surrey KT3 4BG 01-949 2091 Datalect Computers Ltd, 7 St. Georges Walk, Croydon, Surrey 01-680 3581 Datalect Computers Ltd, 33/35 Portugal Road, Woking, Surrey GU21 5JE Woking (04862) 25995 Micro-Facilities Ltd, 7-9 Church Road, Egham, Surrey TW20 9QL Egham (0784) 31333 Wego Computers Ltd, 22A High Street, Caterham, Surrey CR3 5UA Caterham (0883) 49235	WEST LONDON Adda Computers Ltd, Mercury House, Hanger Green, Ealing, London W5 3BA 01-997 6666 Capital Computer Systems Ltd, 32 Windmill Street, London W1P 1HH 01-636 3863 Database, 30 Wigmore Street, London W1 01-431 3410 GREATER LONDON/MIDDLESEX Advanced Digital Office Systems Ltd, College House, King Edward's Road, Ruislip, Middlesex HA4 7AE (08956) 72661 Cream Computer Shop, 380 Station Road, Harrow, Middlesex HA1 2DE 01-863 0833 Da Vinci Computers Ltd, 65 High Street, Edgware, Middlesex HA8 7DD 01-952 0526 L & J Computers, 192 Honeyput Lane, Queensbury, Stanmore, Middlesex HA7 1EE 01-204 7525 Wego Computers Ltd., 3 Wadsworth Road, Perivale, Greenford, Middlesex UB6 7JP 01-998 9011 EAST ANGLIA Arden Data Processing, 166 Park Road, Peterborough, Cambs. PE1 2UF Peterborough (0733) 47767 Consyst Computer Services, 1 Maris Lane, Trumpington, Cambs. (0223) 841997 Sumlock Bondain (East Anglia) Ltd, 32 Prince of Wales Road, Norwich, Norfolk NR1 1LG Norwich (0603) 26259/614302	WEST MIDLANDS BER Limited, 11 Grosvenor House, Grosvenor Road, Coventry CV1 3FF Coventry (0203) 20246 Camden Computer Systems Ltd, 462 Coventry Road, Small Heath, Birmingham B10 0UG 021-771 3636 CBS Consultants - Computer Business Systems, 75 Watery Lane, Birmingham B9 4HW 021-772 8181 Computer Services Midlands Ltd, Refuge Assurance House, Sutton New Road, Erdington, Birmingham B23 6QX 021-382 4171 Currys Micro Systems Ltd, (inside Currys), 5/11 Martineau Way, Union Street, Birmingham, West Midlands 021 233 1105 Ibek Systems Ltd, 437 Stony Stanton Road, Coventry, West Midlands CV6 5EA (0203) 661162 Micro Associates, 471 Lichfield Road, Aston, Birmingham B6 7SP 021-328 4574 Micro Business Centre, Lewis House, Linthouse Lane, Wednesfield, Wolverhampton, West Midlands Wolverhampton (0902) 725687 Microtrading Ltd, 641 Bromford Lane, Ward End, Birmingham B8 2EP 021-784 0077 Taylor-Wilson Systems Ltd, Oakfield House, Station Road, Dorridge, Solihull, West Midlands B93 8HQ Knowle (056 45) 6192 Walters Computer Systems Ltd, 57 High Street, Stourbridge, West Midlands DY8 1DE Stourbridge (03843) 70811	Rockliff Micro Computers, 2 Rumford Street, Liverpool, Merseyside L2 8SZ 051-521 5830 Stack Computer Services Ltd, 290-298 Derby Road, Bootle, Liverpool, Merseyside L20 8LN 051-933 5511 RPL Microsystems, Goldie House, Upper Church Street, Douglas, Isle of Man Douglas (0624) 4247/8 NORTH EAST Intex Datalog Ltd, Eaglescliffe Industrial Estate, Eaglescliffe, Stockton-on-Tees, Cleveland TS16 0PN (0642) 781193 Microprocessor Services, 77a Beverley Road, Hull, North Humberside HU3 1XR (0482) 23146 Microware Computers Ltd, Priory House, 1133 Hessle High Road, Hull, North Humberside HU4 6SB (0482) 562107 Currie & Maughan, 204-206 Durham Road, Gateshead, Tyne & Wear NE8 4JR Gateshead (0632) 774540 Key Computer Services Ltd, 28 Osborne Road, Newcastle-upon-Tyne NE2 2AJ Newcastle (0632) 815157 Newcastle Computer Services, 906-908 Shields Road, Walkergate, Newcastle-upon-Tyne NE6 4QP (0632) 761168/9 Ackroyd Typewriters Co. Ltd, Atmco House, 57-59 Leeds Road, Bradford BD1 5AF Bradford (0274) 731835 Computer Centre (Sheffield) Ltd, 227 London Road, Sheffield S2 4NF (0742) 53519/588731 Deans Computer Services Ltd, Unit 1, Sheepscar House, Sheepscar Street South, Leeds LS7 1AD (0532) 452966	CHANNEL ISLANDS Channel Data Processing (Jersey) Ltd, 108 Halkett Place, St. Helier, Jersey, Channel Islands Jersey (0534) 24333 SCOTLAND Ayrshire Office Services Ltd, 22 Douglas Street, Kilmarnock, Strathclyde KA1 1RB Kilmarnock (0563) 24255 Criffell Micro Business Systems, Glasgow Road, Dumfries DG2 0NY (0387) 69151/2 Gate Microsystems Ltd, The Nethergate Centre, 35 Yeaman Shore, Dundee, Tayside DD1 4BU Dundee (0382) 28194 Gate Microsystems Ltd, Abbey House, 10 Bothwell Street, Glasgow G2 6NU 041-221 9372 Holdene King Systems Ltd, 48 Great King Street, Edinburgh EH5 6QY 031-557 4060 MacMicro Ltd, Beaufort House, Shore Street, Beaulieu, Inverness IV4 7BX (0463) 782774 Microcom, 89 West Campbell Street, Glasgow G2 6SE 041-204 0812/3 Robit Office Equipment Ltd, Unit 14, Anderston Shopping Centre, Argyle Street, Glasgow G2 7PH 041-221 8413/4-5401/2 NORTHERN IRELAND Northern Ireland Computer Centre, 4 High Street, Holywood, County Down, Northern Ireland BT18 9AZ (02317) 6548 WALES Computer Supplies (Swansea), 82 Gower Road, Sketty, Swansea SA2 9BZ (0792) 290047 North Wales Computer Services, Alliance House, 16 Penrhyn Road, Colwyn Bay Colwyn Bay (0492) 33151 Reeves Computers Ltd, 24 Spilman Street, Carmarthen, Dyfed SA31 1LQ (0267) 32441 Reeves Computers Ltd, 33 Bridge Street, Newport, Gwent NP1 4BH (0633) 212331 Reeves Computers Ltd, 6 Walter Road, Swansea, West Glamorgan SA1 5NF (0792) 468103 Rockliff Micro Computers, Pendre House, High Street, Mold (0352) 59629 Sigma Systems, Computer Centre, 266 North Road, Cardiff, South Glamorgan CF4 3BL Cardiff (0222) 34865/34869
	EAST LONDON Adda Computers Ltd, National Electronics Centre, London World Trade Centre, Europe House, London E1 9AA 01-488 2400 C.S.S. (Systems) Ltd, 502 Kingsland Road, London E8 4AE 01-254 9293/1674 Healey Management Services Ltd, 442-446 London Fruit Exchange, Brushfield Street, London E1 6EL 01-247 2858/3149 Merchant Systems Ltd, 5 New Bridge Street, London EC4V 6AB 01-583 6774 Sumlock Bondain Ltd, 263-269 City Road, London EC1V 1JX 01-250 0505 Sumlock Bondain Ltd, Cannon Street Station, London EC4 01-626 0487	MIDLANDS Davidson-Richards Ltd, 29 Charnwood Street, Derby, DE1 2GU Derby (0332) 683231 Caddis Computer Systems Ltd, 72-74 Trinity Lane, Hinckley, Leics. LE10 0BH (0455) 613544 Currys Micro Systems Ltd, 127 Charles Street, Leicester, Leics. LE1 1JR (0533) 546224 Currys Micro Systems Ltd, Devonshire House, Devonshire Lane, Loughborough, Leics. (0509) 37367 The Computer Supermarket Ltd, Unit 8, Southfold Road, Oakley Hay Estate, Corby, Northants. (0536) 744015 HB Computers Ltd, 104 St. James' Road, Northampton, Northants. (0604) 56544 HB Computers Ltd, 20-22 Station Road, Kettering, Northants. (0536) 520910 A.J.R. Office Equipment Services Ltd, 80 Nottingham Road, Arnold, Notts. NG5 6LF Nottingham (0602) 206647 Betos (Systems) Ltd, Bennett House, 155 Mansfield Road, Nottingham NG1 3FR Nottingham (0602) 48108 Computer Services Midlands Ltd, Abbeyfield Road, Lenton Industrial Estate, Nottingham, Nottinghamshire Nottingham (0602) 866366 Currys Micro Systems Ltd, (inside Currys) 2 Wheeler Gate, Nottingham, Notts. (0602) 412455 Jentech Services Ltd, Rosemary Cottage, Nordley, Bridgnorth, Shropshire WV16 4SU (07462) 5287 Peach Data Services Ltd, 5 Horninglow Street, Burton-on- Trent, Staffordshire DE14 1NJ Burton-on-Trent (0283) 44968 BER Limited, 99 Albert Street, Rugby, Warks. CV21 2SW Rugby (0788) 65756 McDowell, Knaggs & Associates Ltd, Shades House, Mealcheaper Street, Worcester WRI 2DQ Worcester (0905) 28466 Minster Microcomputers Ltd, 12 York Street, Stourport-on-Severn, Worcestershire Stourport (02993) 77098/6706	NORTH WEST Automated Business Equipment Ltd, Mersey House, Battersea Road, Heaton Mersey Industrial Estate, Stockport, Cheshire B93 4EA 061-432 0708/4299 Catlands Information Systems Ltd, 8 Charlotte Street West, Macclesfield, Cheshire SK11 6EF Macclesfield (0625) 615375 Criffell Micros Cumbria 22 Lowther Street, Carlisle, Cumbria (0228) 44044 Holdene Ltd, 82a Water Lane, Wilmslow, Cheshire SK9 5BB (0625) 529486 B & B Computers Ltd, 124 Newport Street, Bolton, Greater Manchester BL3 6AB Bolton (0204) 382741/384599 Currys Micro Systems Ltd., 19 Brown Street, Manchester M2 061-834 0144 Cytek (UK) Ltd, Sandringham House, 9 Warwick Road, Old Trafford, Manchester M16 0QQ 061-872 4682 D. Kipping Ltd, Ralli Building, Stanley Street, Salford, Greater Manchester M3 5FF 061-834 6367/9 Executive Reprographic & Business Consultants Ltd, 2-4 Oxford Road, Manchester M1 5QA 061-2281637 POS Computer Systems Ltd, 50 Gidlow Lane, Wigan, Greater Manchester Wigan (0942) 31464 Computers & Business Systems, 89 Manchester Road, Nelson, Lancs. BB9 7HB (0282) 601191 Datel Computing Ltd, 323 Clifton Drive South, Lyham St. Annes, Lancs. FY8 1HN (0253) 727051 Microrose Ltd, Main Street, Bentham, Lancaster LA2 7HU (0468) 62180 Mipac Services, St. Leonards House, St. Leonardgate, Lancaster, Lancs. LA1 1NN Lancaster (0524) 62033 North West Business Machines Ltd, Curate Street, Great Harwood, Blackburn, Lancs. BB6 7DB Blackburn (0254) 888125 Preston Computer Centre, 6 Victoria Buildings, Fishergate, Preston, Lancs. (0722) 57684/58445 Aughton Microsystems, 29-31 Woodward Road, Kirkby, Liverpool, Merseyside L33 7UZ 051-548 7788/6060	Holbrook Business Systems Ltd, Moss House, High Street, Mosborough, Sheffield S19 5AE Sheffield (0742) 484466 Currys Micro Systems Ltd, (inside Currys), 57-59 Albion Street, Leeds, Yorks LS1 5AA (0532) 446601 Holdene Ltd, Bray House, Leicester Place, Leeds LS2 9BH (0532) 459459 Yorkshire Electronics, Caxton House, 17 Fountain Street, Morley, West Yorks. LS27 9AE Leeds (0532) 522181 Yorkshire Microcomputers Ltd, 28 Ramshill Road, Scarborough, North Yorkshire YO11 2QF (0723) 78136

150 great dealers.



Changing business for the better.

For more information, telephone or write to
 your nearest dealer, or to us at:
 The Commodore Information Centre,
 675 Ajax Avenue, Slough, Berks SL1 4BG.
 Telephone: Slough (0753) 79292
 I am particularly interested in (Please tick box)
 Commodore 700 series
 Commodore 500 series.
 Commodore 64

Name
 (MR/MRS/MISS)

Company

Position

Address

Telephone



Last year, Apple users enjoyed the advantages of over 2,500 Orbit units.

Until recently, it was only the users of Apple II and /// microcomputers who had the advantages of Orbit Business System. And that really meant something.

It meant that Apple users had a fast, flexible, easy-to-use and competitively-priced business system purpose-built to provide them with the broadest possible range of configurations, thanks to the unique combination of hardware and Orbit software products. It meant that accounting, stock control, sales invoicing, payroll and other systems were streamlined to such a degree that the performance was equivalent to that of a large mainframe computer, at a fraction of the cost.

It meant that as an Apple user's company grew, so could Orbit's system capacity. All in all, it meant that Apple users had a tremendous advantage over other microcomputer users.

Until now.

Orbit systems can now be used to complement IBM, Sirius, Victor 9000 and SAGE II microcomputers. This means that you too can benefit from the full Vlasak service which supplied over 2,500 products in the last year. Vlasak dealers provide full product and systems support, both before and after sales, personal instruction on usage, installation and servicing, and advice on up-dating your system so that it grows with your company.

Training facilities are now available for new dealers.

We shall be pleased to send you comprehensive literature on the advantages of Orbit software and how it can benefit you.

Complete the coupon and send to Vlasak Computer Systems, Vlasak House, 8 Stuart Road, High Wycombe, Bucks HP13 6AG. Tel: 0494-448633.

This year IBM, SIRIUS, VICTOR, DEC and SAGE II users can benefit too.

Orbit System — the ultimate purpose-built Accountancy Software for your microcomputer.

I would like further information on Orbit Business System

A demonstration by my local dealer

Name _____

Company _____

Address _____

Tel: No. _____

**Vlasak
Computer
Systems**

BBC
It's a Winner!

GTM

BBC Microcomputer System A & B



BBC Machines
Model 'A' £299
16K RAM 32K ROM. Full colour, high-resolution graphics (+£7 p+p)
Model 'B' 32K RAM 32K ROM £399
16 Colour graphics (+£7 p+p)
14" RGB Colour Monitor (as used in the BBC Computer programme) £279 (+£9.50 courier)
12" Green Monitor £95 (+£6.50 courier)
Cassette Player. Includes DIN to DIN lead £28
Battery mains option (+£2 p+p)
BBC Joystick £13 p.pair (+£1 p+p)
BBC Software
Snapper, Planetoid, Monster, Graphs, Charts and Creative Graphics. All at £9.95
Arcade Action £11.90

Atoms
Atom kit £135 (+£3.50 p+p)
Colour Atom £199
Complete with 4 software cassettes (+£3 p+p)
Atom Disk Pack £335 (+£2.50 p+p)

Atom Software
All the latest Acornsoft software in stock. Atomcalc, electronic spread sheet, FORTH, LISP, Adventure etc.

Accessories for BBC Computers
Cassettes per 10 £4 (+£1 p+p)
Verbatim single sided double density disks, box of 10 £19.99 (+£1 p+p)
GP80 and GP100 ribbon £4.75 (+£1 p+p)
Printer Cable (parallel) £15 (+£1 p+p)
6522 buffers £4.75 (+£1 p+p)
DIN to Jack cassette leads £3.50 (+£1 p+p)
BBC Machine dust covers £3.95 (+£1 p+p)

Books
BBC 30 hour BASIC £5.50 (+£1 p+p)

Practical Programs for Atom & BBC £5.95 (+£1 p+p)
BASIC Programming on the BBC Micro £5.95 (+£1 p+p)
Programming the 6502 £11.75 (+£1 p+p)

All the products are the official versions, beware of imitations, they will invalidate your guarantee

We've also got the complete range of Acorn BBC and Atom products in stock including:

Printers
Acorn GP 80A Printer £199
Lowest ever price! (+£4.50 p+p)
Acorn GP 100A Printer £228 (+£4.50 p+p)

864 York Road, Leeds
Tel: 0532 865118
(Opening 28th February)

Barclaycard and access welcomed

ALL PRICES INCLUDE VAT

PLEASE RING FOR AVAILABILITY OF ITEMS & ALLOW 21 DAYS FOR DELIVERY

GTM

2 ROSE COURT GARFORTH LEEDS LS25 1NS

TEL: 0532 865118

FRASERS

Professional Micro Systems from the computer professionals

OSBORNE 1

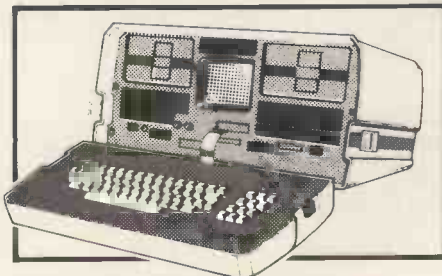

Includes £800 worth of **FREE SOFTWARE** – Wordstar, Mailmerge, Supercalc, Basic, Disc capacities to 1.2M Byte or Winchester

ACT SIRIUS 1



The most popular 16 BIT system

EXACT BUSINESS SYSTEMS

SALES LEDGER
POINT SALE INVOICING
STOCK CONTROL
PURCHASE LEDGER
NOMINAL LEDGER

ALL FOR ONLY

£400 + VAT

Ex demonstration units available at giveaway prices.

91 Station Road, West Drayton, Middlesex UB7 7LT
Telephone: West Drayton 41731

SHARPSOFT

WITH THE SHARP USER IN MIND

JOIN NOW! – 1983 SHARPSOFT USER NOTES (now international). Only £5.50 for a UK Subscription and £10.0 Overseas.

Supporting the Sharp MZ-80A, MZ-80K and MZ-0B Computers.

This 80 page (approx) publication is issued 3 times a year. Each Issue contains programs, programming tips and information, rather than advertising commercially available products.

All Members have the opportunity of purchasing, at competitive prices, peripherals and software.

The **SHARPSOFT USER NOTES** first came into existence in January 1980 and a limited number of Back Issues are still available.

1980 Issues 1/2/3 £3.00 (£6 overseas).

1981 Issues 4/5/6 £7.50 (£12 overseas)
complete with 2 Free MZ-80K/A
FORTH language tapes

CURRENT MEMBERSHIP in excess of 1,000
If in doubt – send for details

SHARP PC 1500 POCKET COMPUTER AND ACCESSORIES

SHARP PC 1500 Pocket Computer	£149.95
SHARP CE 148 RS232 & Centronics Interface Unit	£149.95
SHARP CE 15A Application Tape	£14.95
SHARP CE 150 4 Colour printer/dual compact cassette interface	£132.25
SHARP CE 151 4K Add on memory module	£49.95
SHARP CE 152 Cassette Recorder/Player	£39.95
SHARP CE 153 Add on Soft Card	£79.95
SHARP CE 155 8K Add on memory module	£79.95
SHARP CE 158 8K Add on memory module with battery backup	£89.95
SANYO Small portable compact cassette recorder compatible with PC1500/CE150	£29.95
SANYO Small portable mini cassette recorder compatible with PC 1500/CE 150 and Philips dictating machines	£45.95
SHARP CSR 150 Paper rolls (packed in 10s)	£2.92
SHARP EA 850B 4 Spare black pens for CE 150 printer	£3.09
SHARP EA 850C 4 Spare pens one of each colour red, black, blue & green	£3.09

NEW RELEASE FROM SHARPSOFT

Sharpsoft Information Retrieval System

"SIRS" is a new Database written in modular form. The hub of the SIRS system will allow you to create records, search, sort and allow output to screen or printer. This unique 'add-on' style package will allow you to expand your system with an optional Report Generator or Calculation Pack.

For further information on this package send a stamped addressed envelope for more details or £2.00 for the Operator Manual (this will be refunded on purchase of system).

A full range of CP/M Business Software available:

Accounting – Word Processing – Data Management – Financial Planning

ALL PRICES INCLUSIVE OF V.A.T.

Please send a stamped addressed envelope for FULL Software/Hardware details or phone: 01-739-8559 (24 HRS) leaving your name, address and telephone number with particulars of your interest.

SHARPSOFT LTD. CRISALLEN HOUSE, 2ND FLOOR, 86/90 PAUL STREET, LONDON, EC2.

TEL: 01-739-8559

SHARP MZ-80A 48K RAM Micro Computer	£499.00
SHARP MZ-80AEU Expansion Unit for MZ-80A	£100.00
SHARP MZ-80FB Dual Floppy Disc Drives for MZ-80A complete with interface card, cables, CP/M operating system and Sharp Disc BASIC & Manual	£799.00
SHARP MZ-80B 64K RAM Micro Computer. 320x200 High Res. Screen Software controlled cassette unit	£899.00
SHARP MZ-80EU Expansion Unit for MZ-80B	£50.00
SHARP MZ-80FB Dual Floppy Disc Drives for MZ-80B complete with interface card, cables, CP/M operating system and Sharp Disc BASIC & Manual	£799.00
SHARP MZ-80P4 150 cps Dot Matrix Printer	£845.00
SHARP MZ-80P5 80 cps Dot Matrix Tractor Feed Printer	£415.00
SHARP MZ-80P6 80 cps Dot Matrix Tractor & Friction Feed Printer	£475.00

The **SHARP MZ-80 P4, P5 and P6 PRINTERS** come complete with Interface card, printer cable and ROM. Just specify which computer it is required for.

Buy a Sharp MZ80A now and we will allow you to choose £50.00 worth of games software from our 1983 software catalogue FREE.

For further information send a stamped addressed envelope for "Connecting a Printer to my SHARP" an easy to understand information sheet.

SHARPSOFT DUST COVERS

Keep out harmful dust and grime

SHARP MZ-80K	£5.25
SHARP MZ-80A	£6.00
SHARP P3 Printer	£4.95
SHARP Dual Disc Drive	£4.50
SHARP Dual Disc/Expansion Box	£4.95
SHARP MZ80 P5/6 Printer	£5.25
SHARP MZ80K Expansion Box	£4.00
EPSON MX 80 F/T Printers	£4.95

All Dust Covers made from tough durable plastic.

NEW SHARP PC 1251 £75.00 inc VAT.

A 3K pocket computer for the price of a desk calculator. This unbeatably small computer also has an ADD ON printer/cassette recorder at only £95.00 inc VAT.

BUY THE TWO TOGETHER FOR JUST £159.95 inc VAT.

GAMES

Asteroids – Towering Inferno – World Cup Manager – Ravenous – UFO Phoenix – Cricket – Super Golf – Minopoly – Election '84 – and many, many more plus exciting new additions every three months.

We have undoubtedly the best selection of quality games available for the Sharp MZ-80A, MZ-80K and MZ-80B Computers.

BOOKS

Peeking & Poking the Sharp MZ-80A	£4.30
Peeking & Poking the Sharp MZ-80K	£4.30
Beginners Guide to MZ-80K Micro Computer	£3.95
DISCOVER FORTH	£10.95
INTRODUCTION TO FORTH	£6.95
BASIC for BUSINESS	£11.50
BASIC Programs for Scientists & Engineers	£11.50

INTRODUCING THE NEW **apple IIe** PERSONAL COMPUTER from THE COMPUTER CENTRE **£845** + VAT

**AFTER THE REVOLUTION,
THE EVOLUTION**



Introducing the Apple IIe personal computer, the successor to our worldwide success, the Apple II.

The 'e' stands for 'enhanced', and everything which the Apple II has always stood for. Flexibility. Reliability. Quality.

Apple IIe offers you more features and greater capabilities. Like a 64K user memory, which can be expanded to 128K — so you can create larger files and handle larger numbers of numbers.

It also has a responsive, full-function keyboard. Four arrow keys to speed cursor movement. Upper and lower case

text. Eight internal slots, which let you expand your system, including a multi-purpose video and memory expansion slot for inserting an 80-column display card.

Most important, Apple IIe runs the largest range of ready-made programs on the personal computer market today.

But don't just believe what you read. Make sure you see the Apple IIe for yourself. The Apple IIe. A step ahead.

 **apple computer**
The Personal Computer

- High speed disk loader
- 64K RAM
- Expandable to 128K
- Upper and lower case
- 2 character sets
- Auto repeat on all keys
- Full cursor control
- 2 function keys
- Includes CAPS LOCK, TAB and DELETE
- External hand controller socket
- Self-test diagnostics
- Expansion slot for extra 64K and 80 columns
- 16K ROM with automatic switching between languages
- Lockable system case
- PAL B colour output

STARTER SYSTEM

Apple IIe 64K	845.00
Disk Drive	345.00
Monitor III + Stand	170.00
80-Column Card	80.00

TOTAL bought separately **1440.00**

SPECIAL PRICE **1199.00**

FINANCIAL SYSTEM

Apple IIe 64K	845.00
Disk Drive One	345.00
Disk Drive Two	245.00
Monitor + Stand	170.00
80-Column Card	80.00
Multiplan	185.00

TOTAL bought separately **1870.00**

SPECIAL PRICE **1599.00**

BIG SYSTEM

Apple III 256K	2869.00
Profile One	1795.00
Profile Two	1795.00

TOTAL bought separately **6459.00**

SPECIAL PRICE **4950.00**

ALL PRICES EXCLUDE VAT

Microcomputer Sales... with Service

THE COMPUTER CENTRE (BMS) LTD.

RETAIL: 37 Robertson Street, Hastings, East Sussex TN34 1HT (0424) 439190

MAIL ORDER: Monks Meadow Oast, Appledore Road, Tenterden, Kent TN30 5DB (05806) 4498

PRICES EXCLUDING VAT

Apple II

Apple II+ 48K	675.00
Apple IIe 64K	845.00
80-Column Card	80.00
64K Expansion (+ 80 Col.)	180.00

Disk with Controller	345.00
Disk without Controller	245.00
Monitor III + Stand	170.00
Multiplan	185.00

Apple III

Apple III 128K	2418.00
Apple III 256K	2869.00
Disk III	295.00
Profile 5MB Winchester	1795.00

Printers

Apple Dot Matrix	425.00
Apple Letter Quality	1350.00
Crown Ranier	
Typewriter/Printer	795.00
Silentype (Thermal)	202.00
Star Dot Matrix	
(specify serial or parallel)	219.00

Home Computers

Dragon 32	173.00
Lynx 48K	195.65
Newbrain A	199.00
Newbrain AD	229.00
ORIC 16K	86.91
ORIC 48K	147.78

Send for FACT SHEETS on

Apple/Digico Prince/Dragon/Lynx/Newbrain/ORIC/ZX-81

Please complete this coupon and send to:—
The Computer Centre (BMS) Ltd., Monks Meadow Oast,
Appledore Road, Tenterden, Kent TN30 5DB
No charge is made for postage and packing

Quantity	Item or System	Price per unit	Total

Tick here for:

- Full price list
- FACT SHEET(S) on: _____
- I enclose cheque/P.O. for £ _____ payable to The Computer Centre (BMS) Ltd.
- Please debit my Access*/Barclaycard*/American Express* No. _____ or ring 05806 4498 and tell us your credit card no. (24-hour answering service)

Name _____

Address _____

Postcode _____

*Delete where applicable

Block capitals

P.C.W. Mar.

Guy Kewney provides the latest micro news.



Mad about the Rainbow

Of all the things that I have ever heard about Digital Equipment Corporation (DEC) the one thing I can honestly say has never been said is that its digital equipment failed to work. It nearly always does.

Indeed, there have been times when people wanted DEC minis so badly that they were prepared to order machines 27 months in advance, just to be sure of getting deliveries.

And there have been items of equipment priced at two or three times what outside suppliers could manage, which customers felt morally obliged to buy direct from DEC even though DEC really didn't mind if you bought the comparable add-ons.

The only thing that DEC ever did, publicly, which was a complete fiasco was to

launch a networking system in the days before people needed networks, and fail to make it work. The mistake was withdrawn, and I know of no customer that suffered.

In a week when IBM launched its 'market research exercise gone mad' and DEC launched the Rainbow, there is no obvious reason why the world went wild about the IBM machine.

But there are several reasons why the world should go mad about the Rainbow.

Since we first reported on the machine, things have changed. It has now acquired an impressive list of dealers, an impressive and comprehensive software catalogue (though I have my reservations about a catalogue entry which has identical entries describing both Fortran and Pascal as 'powerful

programming languages for writing structured code'), and has acquired a splendid year's free on-site maintenance.

At £2,400-odd, it is not the cheapest 8-bit CP/M computer on the market. But when you consider that it is (at the same time) one of the cheapest 16-bit machines available, you will begin to understand just why, by comparison, the IBM bandwagon produces such a rotten tooth-grinding sound from behind my typewriter.

Nobody need run away with the idea that DEC has got it all right, and IBM has got it all wrong. Admittedly, DEC has announced a 12-month warranty, has established a phone-in centre for all hardware and software queries, with the phone number on the keyboard of every computer sold (compared with IBM's 6-month, 'bring it back to us yourself' policy).

But there do appear to be flaws to the Rainbow. Not everybody likes the pricing policy on additional memory — a policy easily summarised as 'stupid' — nor is everybody enchanted by the pretty but non-standard disks.

And I'm told that attaching an ordinary Oki or DRE or Epson printer isn't the sort of thing that DEC has planned for, and there will be problems.

There is even a small question mark over the very clever operating system, CP/M-86/80, which combines eight and 16-bit operation, but which is not a bog-standard CP/M-80. In my mind, it's a very small question mark, because DEC does tend to get these things substantially right.

To lovers of the old PDP-11 minicomputer on which DEC founded its fortune, there is another question mark.

The Professional range, originally announced at £2600, now costs around £1000 more than expected. To me, this is a small matter — I was

always more interested in the Rainbow. I don't expect DEC to forgive me for this, however: any disregard for either its RSX family of operating software or for its wonderful senior executives has always struck them as blasphemous.

Despite the blasphemy, I have to admit that things look good. The company says it has had 400 enquiries from people hoping to be dealers. And it plans to have a dealer 'in every major city', according to small systems boss Lawrie Cattell, 'by the end of the year'.

By the end of the year, there will be people buying things like standard 9100 bus CP/M boxes, instead of Rainbows — but I can't think why. I suppose it will be all due to DEC's carelessness in failing to put the ninth, second and thirteenth letters of the alphabet on the box.

Soft options

Three big-name companies have launched computers that we have all been waiting for for at least nine months — DEC's Rainbow, IBM's PC, and Apple's Lisa.

The only software house to have announced working products for all three is British-based Cobol specialist Micro Focus.

In the case of the DEC launch, the Cobol language plus all the specialist add-ons is available not only for the Rainbow, but also for the Professional, and the DEC Mate II.

Behind them comes Peachtree again, with the claim that it is the first company in the UK to form an agreement with Digital Classified Software, and the launch of its full family of applications software for the whole DEC range.

Peachtree's catalogue includes a whole batch of software written in Micro Focus Cobol.

Pascal specialist Systematics International has



DEC's Rainbow



Before you get all hot and bothered, I have to tell you that this isn't the long-awaited, marvellous Commodore 700 range. It's an ordinary PET, the 8032 (with a derisory 8 kbytes! — why do they do it?) in a new 'futuristic-style housing designed to conform to compulsory IEC specifications'.

Naturally, it costs a little more. So lots of people (the dealers tell me) who didn't want an ordinary PET, either 8032 or 8096, are queueing up to buy one.

It's called 'marketing'.

also linked publicity forces with DEC by announcing the availability of its accounting software — 'the first UK software house to sign an agreement for Pascal Basic Accounting software for the Professional'. Obviously I'd be more interested if it were on the Rainbow, especially since DEC says that Pascal is available for the Rainbow.

DEC has its head office in Reading at the Digital Park, PO Box 110 RG2 0TR — phone (0734) 868711 — where enquiries about dealers and software catalogues should be sent.

Protection racket

Software house TABS has decided to make money selling its software protection system to other programmers.

The idea of 'unstealable' software, like the idea of home burglar alarms, is one which has caused more nuisance that it has helped. TABS's system is less annoying than some, in that it isn't intended to prevent the software user from making a safety copy of his own disks.

It uses the 'dongle' idea, with a little computer (a Z80) in it. This fits onto the RS-232 output plughole, and pretends to be a printer cable, unless it spots a program that wasn't licensed to run on it.

And TABS promises that unless your program is one which knows about the device, it will never accidentally send the signal which turns it on, and the cable will be just another printer cable, except that it will need its own power supply, and will take up space on the table.

We'll just have to wait and see what this does to sales of the appropriate products — or, more importantly, to the amount of money that is spent on them.

What happens (I want to know) to the poor blighter with an Apple II, plus CP/M card, who has a TABS-protected accounting program, something like CORP that uses a dongle on the games port, something else that has a competing printer cable dongle, and a special peripheral which uses the RS-232 plug for non-standard purposes — and who has a hardware breakdown.

Which of all these clever folks is going to admit that the fault is on his clever piece of hardware?

And how long will it take to fix? Details on (0264) 58933.

Xenix 16

There are supposedly some 3000 people using a computer called the Tandy Model 16, a

machine which until last month has an almost completely unusable 16-bit Motorola 68000 chip in it. This month, they can buy an operating system, Xenix, from Microsoft, and start using it.

In fact they don't even have to buy it, because Tandy will give it to users. And not before time, one might say.

According to Microsoft founder Bill Gates, this doubles the number of Xenix-based systems. That has surprised several people, since the amount written on Xenix would tend to give the impression that it was a best-seller of far greater proportions.

What it doesn't explain is what possessed those 3000 people to buy a system costing as much as Tandy Model 16, just for the ordinary eight-bit Model II inside it.

Background transmission

Telex preparation and transmission which would normally have interrupted your microcomputer can now be done 'in the background' on stand-alone CP/M machines like the Superbrain and Televideo 802.

The software which does it is produced by Encotel, a Televideo distributor and big Superbrain dealer.

The micro can get on with

— well, whatever it was doing, like the accounts or some text editing — while it operates the Telex. It dials the numbers, checks the answerback, and then finds the right file (even a Wordstar file) and translates the ASCII codes into the Telex Baudot codes. Then it transmits the letter.

Incoming telexes, says Encotel, can be stored automatically, and viewed later.

Encotel also includes a Telex interface unit (a Hasler design) in the price.

Details on 01-686 9687.

Transfer charges

A cable costing £25, and a program (called XMIT) costing £95, are all you need to 'transfer programs or data files between the Superbrain or any CP/M machine, and the 16-bit Sirius or IBM PC,' according to the producer of XMIT, Steer Davies & Gleave.

The company is based at 68 Upper Richmond Road, London SW15 2RP, and can be contacted by phone on 01-874 6583.

Outward Bound

Presumably if all managers had been Girl Guides or Boy Scouts (or whatever they are called today) when they were

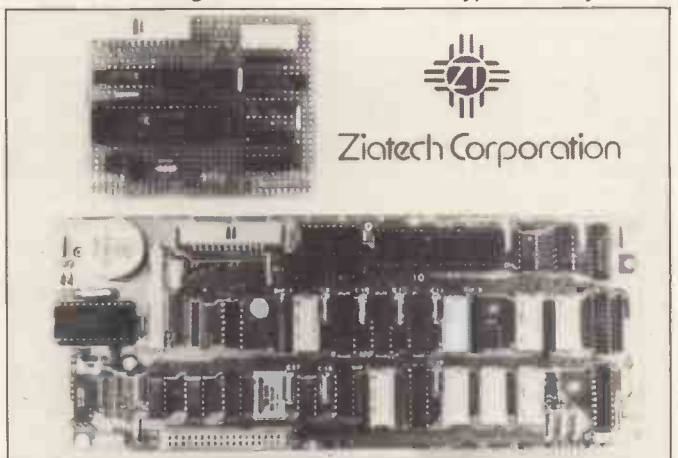

Add-ons to the IBM machine start with the interface bus that is standard on Commodore PETs, Hewlett-Packard micros, and Osborne computers — the general purpose IEEE-488 bus.

This universal method of connecting computers to test and measurement instruments, also usable to connect more orthodox computer peripherals like disks, is available from Data Translation of Slough.

It is built by Ziatech in America, hence its product code ZT 1488. It includes a clock/calendar with its own battery, and can be programmed in Basic, says Data Translation. Data Translation is on (06286) 3412.

little, they would be wonderfully confident, well developed with respect to communication and leadership, and (in a phrase) prime management material.

We have all heard of 'management training' courses which seek to remedy this gap, by taking overweight 30-year-old management accountants down to a gravel pit and making them row across with nothing more than a barbed wire paddle (I think).

One such course, organised by Michael Drayton, has had its hazards noticeably increased.

In addition to rock climbing, caving, canoeing, orienteering, archery, assault course, riding and shooting, there is the testing subject of Management Information Systems. With particular emphasis, they note, 'on microcomputers, distributed systems and communications'.

Anybody fancying a computer course coupled with leadership potential, 'set in ten acres of rocky mountainside and woodland in the Brecon Beacons National Park', should contact the company on 01-439 1379.

Sage or Scimitar?

Lovers of APL (A Programming Language) now have another 68000 based computer on which to exercise their abilities to produce the 'ultimate one-liner' — the Sage II.

The Sage is one of the best-equipped micros in the world when it comes to languages, coming with a very fast Pascal, Basic, Fortran and assembly. MicroAPL has added its pedigree, and calls the result a new computer, the Scimitar.

To produce the Scimitar, says MicroAPL, it has taken the version of APL.68000 produced by 'The Computer Company' and added to it the Mirage operating system (multi-user, multi-tasking) already offered on the Scorpion and Spectrum (not Sinclair's!) machines it sells.

On top of this, says the company, 'full compatibility is retained with the normal SAGE operating system. But we have implemented Mirage as the primary operating system.'

The Scimitar package costs

£5445 including two 720 kbyte floppies, 400 kbytes of internal workspace — plus delivery, onsite maintenance and training. And the maintenance and training is available for a year, not six months (IBM please note). Details on 01-834 2687.

How to succeed in business?

Competitors for the cheap Spectrum — competitors which we expected to appear in large numbers, the Computers Lynx and the Oric — seem to be in short supply still. This is strange, because the makers of the Oric and the Lynx were determined not to make the mistake that Clive Sinclair made.

However, there appears to be a difference in their perception of what that mistake was — from what you and I might have imagined it was.

Clive, you will recall, made the mistake of announcing the Spectrum as 'available' before it was. The Advertising Standards Authority, noting a 'record number of complaints', smacked his wrist firmly with its usual feather.

But at Computers and Oric, it would seem that they had a better understanding of what happened. As far as can be judged by their actions, they believed that what had really happened was that Clive had been unlucky enough to have his misjudgement reported.

So they did exactly the same thing, in that they swore powerful oaths about delivery which they did not keep — but then went to a lot of bother to preserve the illusion of delivery.

Exactly as promised, before Christmas, several trade journalists received samples for review. 'We're sorry,' had been the constant response before, 'but we can't let you have a machine for review until we're in full production. We aren't going to have pre-production faults written up by you irresponsible scribblers.'

Fair enough.

My first Lynx exhibited so many preproduction oddities that I suppose it wouldn't be fair to report them, because Computers promptly took it back and produced another.

'The fact that it won't

automatically switch your tape recorder on and off,' explained a harassed spokesman, 'is due to the fact that the wires to the switching transistor from your tape are back to front. You'll have to replace the transistor with a relay circuit.'

My experiences with the Oric were complicated by the fact that I didn't get one for review. This, Oric told me, was because they'd never heard of me. 'What magazine do you write for?'

However colleagues have steadily worked their way through up to four machines each before getting one that worked, in colour. Even now, in end January, I still don't know anybody with a sample which will load and save programs, but the first ones, just before Christmas ('Yes, the chips are absolutely fully tested,' they said the week before) wouldn't edit programs.

One colleague who rang to ask why was met with blank astonishment. The sample sent was only functional in the hardware sense, he was told. Software would be supplied when it was working — couldn't he admire the neat circuitry and leave it at that?

I mention all this just as some slight explanation of why, despite last month's rumour, you will notice that the Spectrum prices in the shops haven't come down, after all. Wouldn't be much point, really.

Banking on Apple

Banks use 8in disks to transfer money. They have a program called the Bankers Automated Clearing Services (BACS) utility, on which money transfer information is encoded in a standard way, and anybody who can produce credit transfer information in this way can use the system instead of writing cheques, filling in payment slips, and so on.

Apple users, normally, can't use the right 8in floppies. So Eicon has produced a £3000 system, including an Apple II, or else (for those who already have an Apple) a £1250 8in disk add-on for an Apple II, which can produce the right floppies.

And for an extra £150, they will sell you a program to swap money with your bank. And for another £600, you can buy a payroll program called Payman, which will pay



This Trojan computer, noticeably different from most, is more a laboratory instrument than a micro.

'It is designed specifically for the professional user of Microcomputers in measurement and control environments,' says Measurement Systems Ltd, the producer. 'And it offers, for the first time, a low-cost measurement system which provides a wide range of analogue and digital interfaces to a powerful microcomputer.'

The system can read inputs which are not merely digital signals (as from disks, modems and other computer peripherals) but finely graded voltage variations.

The instrument side of this can detect a force of a mere 0.75 microvolts, and since it uses a 16-bit resolution, the digital conversion is very accurate.

Details from the Newbury office on (0635) 45420.

Still Need Convincing?

SOFTWARE FACTSHEET	
Product: CARDBOX	Type: CardIndex
Retail Price: £155	Machine: CP/M & MP/M
File Size: CP/M 800 KB MP/M 1MB	Records: 65,500 maximum
Record Size: 1484 ch maximum	Fields: 26 maximum
Field Size: 1484 ch maximum	Index Lists: None
Notes: Allows complex searching using up to 99 separate criteria. Widely available from distributors in USA, UK and Australia.	
Published by Caxton Software Ltd of London. 01-379 6502	

The Critics Don't....

"Cardbox is your familiar, tried and trusted card index... with most of the features you have always wanted on your manual card index but couldn't have, because of the limitations of pieces of card."

"Cardbox... succeeds extremely well. Its facilities for indexing and searching are good and very fast... the user image of the screen displays and the documentation are in the main excellent."

Personal Computer World, August 1982

"The interesting thing... is the display... Cardbox enables you to draw a form on the screen complete with headings."

"Cardbox is an excellent database manager... its versatility... and its ease of operation make it a useful program for home or business."

InfoWorld, September 13, 1982

InfoWorld Software Report Card	
Cardbox	
	Poor Fair Good Excellent
Performance	<input type="checkbox"/> <input type="checkbox"/> <input type="checkbox"/> <input checked="" type="checkbox"/>
Documentation	<input type="checkbox"/> <input type="checkbox"/> <input type="checkbox"/> <input checked="" type="checkbox"/>
Ease of Use	<input type="checkbox"/> <input type="checkbox"/> <input type="checkbox"/> <input checked="" type="checkbox"/>
Error Handling	<input type="checkbox"/> <input type="checkbox"/> <input type="checkbox"/> <input checked="" type="checkbox"/>

Anyone can use Cardbox. It's a simple yet powerful electronic card indexing system. Easy to learn and easy to use, Cardbox is bringing real computer power to hundreds of new users.

Put yourself in a user's shoes:

- You wouldn't have to change your present working methods or think in computer terms. Cardbox talks to you in plain English.
- If you can do it with a card index you can do it better with Cardbox thanks to its sophisticated automatic cross-indexing.
- Up to 65,500 'cards' can be stored and they can be displayed, printed or passed to other programs in any number of alternative formats.
- Groups of 'cards' can be selected by any word in any field. Your choice can be refined by using up to 99 words in a single search.

Cardbox - the ideal card index system for CP/M users

CP/M, MP/M are trademarks of Digital Research Inc.

I am a End User Dealer Distributor/OEM

Please send further information. Business Card attached

Please send _____ copies @ £157 + VAT (includes P+P)

A cheque for _____ is enclosed. Specify Disk Format _____

Name _____ Position _____

Company _____ Address _____

Telephone _____



employees and write the payslips onto the disk — for up to 8000 employees, they say.

The system can also be used simply to send information to computers that use the standard 8in drives — examples are IBM 3740, DEC RT11, UCSD Pascal, and CP/M operating systems. Details on (0954) 81825.

Mug trapping . . .

Now that the IBM Personal Computer has been launched, let's ask a simple question.

'Would you buy a computer from a typewriter manufacturer, if it was almost 50 percent too costly for what it could do, if you only got a six months' guarantee on the thing, and then only if you sent it back to the head office depot for repairs? Just because it had the three letters IBM on the box?'

Of course not. You'd be a complete mug to do so.

Here is a mug forecast.

The computer market for mugs, which has largely been dormant for the past five years, will show spontaneous and exhilarating growth in 1983, with an estimated 100,000 new mugs expected to swell the ranks of computer users.

So powerful will this trend be that IBM alone is expected to sell up to an estimated 60,000 computers to mugs.

And by the end of the year, there will be so many mugs using computers that they will form an important and powerful software market, which will in turn attract a heavy investment by software producers.

I'm afraid the result may well be that, by 1984, you'll have to be a mug not to buy an IBM Personal Computer, because there will be more software for the thing than almost anything else around.

The irritating thing about this absurd event is that we will all have to grin and bear it all the way to the bank, because it will do us all some good.

Within seconds of the official launch a heavy thud sounded from the bandwagon as over a hundred software producers jumped on.

Hardware producers who have designed machines that will run that same software landed in a slightly heavier heap a moment later. They were headed by a reluctant Digital Equipment, whose superb Rainbow would normally grab all the headlines in the week it was released, but here stands out merely as 'the only

compatible machine that doesn't sell on its compatibility'.

There follows a small roundup of announcements received on the subject, which you are welcome to browse through.

One thing, however, I must say first.

In my opinion, any reputable company which sells a reputable product can guarantee it for at least a year — especially when the product costs £3,000 or more.

If any small-time retailer can buy the things in America, add UK transformer and other electrical equipment, and still sell the machine for £2,400, what's the secret of the £3,000-plus price? And if a workaday retail chain like Laskys can give a two-year warranty on an Apple, what's wrong with the IBM Personal Computer?

The answer is probably 'nothing'. The six months' warranty, like the price and the keyboard, is just God's way of telling the user he's a mug.

. . . wins respect

The whole point of the IBM launch is that it 'makes personal computing respectable'.

If IBM does it, then it can't just be a hula-hoop fad — it must be a good idea. Cautious bank tellers on their way to assistant deputy under-managerial status will suddenly cease warning younger colleagues of the dangers of trusting this new-fangled 'technology'. Instead, they will start diligently reading magazines like this one, and offering their bosses (the deputy under managers) carefully thought-out advice on which system they should consider.

Only the managers are going to get IBM computers, however. Their deputies, assistants and the like, will go into the shop to buy an IBM, and come away with something rather cheaper.

Similarly, with software: people of every sort will push hard to get their software on the IBM PC, so that people who can only afford something better at half the price will still want to run their software.

Top of the tree, from day

one, is Peachtree, which originally provided the first official IBM software in America. On the day IBM announced the machine, Peachtree announced the Nominal Ledger system for it.

The company also released its general accounting packages, and Office Productivity Tools.

Cobol supplier Micro Focus announced a 'fully integrated Cobol programming environment for the IBM PC' called Personal Cobol — sold under the IBM label for £250.

This is 'based on' Level II Cobol — but is slightly more than just a version of Level II loaded onto the IBM. It is 'specifically designed to take advantage of the special keyboard and screen features of the IBM Personal Computer'.

Pete and Pam Computers wasted no time in announcing the full screen of established 'independent' software for the PC.

The list starts with DB Master, from Stoneware Inc, the range of 'Easy' text processing programs, including Easy Writer, Easy Filer, Easy Planner, and Easy Speller, from Information Unlimited Software. These all cost well over £100, with Easy Writer and Easy Filer costing over £200.

Even better, there is a nice cheap game — 'Pig Pen' — a maze game, described by Pete and Pam Fisher as 'boaring'. They summarise the action as 'Basically, you are chased around a maze by wild pigs.'

I'd like to share the rotten puns about giving the game the chop, being amazing, getting trotters on, and so on, but I'm stymied for a good excuse.

Digital Research, however, has not just launched CP/M-86 for the PC. It has declared war. Gary Kildall will market an enhanced version of CP/M-86 himself, not just leaving it to IBM to sell the operating system as an option to its own Microsoft developed PC DOS.

And the price will be £42. That is a quarter of the IBM price, and there are several extra features — such as print spooler, graphics extensions, plus a library of device drivers 'for the most popular graphics printers, plotters and cards — including the HP7220 and



This, you are thinking, looks like a small television set. It is. It's a Teleton 14-inch colour portable. It was sent in by Teleton, a subsidiary of The General Corporation, Japan, to illustrate the strange fact that, although computers are supplied with outputs to TV sets to save money, people are buying TV sets specially for their computers. And Teleton reckons its set is 'compatible with the Sinclair ZX81 and Spectrum'. Sadly, they add, although the company also makes computers, 'the range is currently unavailable in the UK.'

I saw them at Hanover, last year — small, portable, pretty and a bit pricey. Anyone interested could try talking to them in Sutton, on 01-643 9131.



The Microframe — see 'Uneasy Edge'

7470 colour plotters, Epson MX80, Okidata Microline 92, printronix and three IDS printers, the Orchid and Plantronics PC cards, and' — it sounds almost too pedestrian to be true, but there it is — 'and the standard IBM PC monochrome display'.

Digital Research, by the way, now has a UK address at Oxford House, Oxford Street, Newbury RG13 1JB.

And the project which Digital Research is probably more proud of is the arrival of Doctor Logo.

Actually, it's Digital Research Logo, but it will always be DR Logo to me. It will be available in April, they say. See story on Logo below.

IBM itself is not to be left out of the software kitchen. It has promised to open a 'new international software development centre in Dublin, to develop applications software for administrative and control systems,' for export to IBM companies world-wide.

Annoying the pros

Logo is a programming language which people find easier to use than other languages which seem designed more for the convenience of the computer — say its fans.

Logo has now been adopted by CP/M company Digital Research, with a version being

released for the IBM Personal Computer.

Commands in DR Logo include the ones supplied in Apple Logo, which makes one realise that Apple Logo has been more successful than outsiders expected. In addition, DR's version includes others 'which allow users to examine and cross-reference procedures created in the workspace.'

Logo is the language developed at MIT which uses Turtle graphics — the imaginary turtle walks around the screen obeying commands like 'Forward' and 'turn' and leaves a trail behind it. Then it can store the drawing, and reproduce it later.

What is really nice about Logo, however is its unrestricted approach to what professional programmers call 'type'. For example, if I use a formula referring to 'X' in Basic, then X must be a number, not a sentence. In Logo, I can add or divide sentences with the same formula.

'This makes Logo suitable for a wide variety of applications from simple symbolic mathematics to a natural language translation, artificial intelligence and knowledge-based systems, such as artificial tutors,' comments the company announcement.

This also annoys the pants off professional or academic

programmers, who have spent so much of the lives making burnt offerings to inferior compilers that they regard 'strong typing' (which prevent this kind of trick) as a 'useful discipline'.

Uneasy Edge

The 'Future Proof' Tycom Microframe is not meant to be an IBM lookalike, but since one of its options includes an 8088 processor board and both MSDOS and CP/M-86 as operating systems, it will be obvious that dealers will assure customers that they don't need to worry about compatibility.

In fact it is a very ambitious system, and again (no surprise) appears to be clearly superior to the IBM. No-one should be astonished at the number of superior imitations — IBM didn't get where it is today by being a technology leader, and it isn't about to change the successful habits of a lifetime just to please journalists.

The Tycom machine, like Shelton's Sig-Net, and like the BBC-based Torch, is designed to be expandable, with plug-in or bolt-on big processors.

In the words of the well-prepared publicity literature, 'With the versatile base bus connect (VBC), the Microframe treats central processing units not as the heart of the computer, but as

peripherals.'

The idea is that instead of having to convert a program from one processor to another you just plug in the right processor. The only snag is that you then have to plug in a compatible version of the operating software, which isn't always as straightforward as it might be.

Nobody is sticking their necks out and offering clear-cut opinions on the Tycom design. I'm certainly not going to, because of the number of things that would have to be tried out before we have any idea of how well the technology stands up — and at the time of writing, I hadn't even managed to press a single key on the machine.

The reason others may be a little reticent, is that there is significant edginess in the minds of many tradesman in this industry about Guestel, the dealer-based company on which Tycom is based.

This edginess is a sort of schizophrenia. Originally, Guestel set itself up as an Apple dealer, and made powerful enemies by undercutting its rivals. Angry cries for 'an orderly market' were heard, while Guestel, unperturbed, accumulated stock, capital and expertise.

Then, established, Guestel became respectable, and began putting its name to the amalgamated dealers' calls for an orderly market. Since the



Quick off the mark following the launch of the Apple IIe is British add-on manufacturer Digitek, which has announced a series of plug-in cards for the new machine. These include an 80-column card, the Screenmaster 80, and a printer driver, the Super Printmaster. More from Digitek on 0403 66550.

company now claims to be 'the country's largest Apple systems dealer', its desire for an orderly market is understandable enough.

The man in charge of Tycom worries the more established sages, too. Alan Timpany, who set up Guestel in 1979, is in his mid-twenties, and left Bath University a mere four years ago. No matter how clever he may be, older folks feel somehow that if it was so easy to start a company, they'd have done it themselves ten years ago.

Hence, I suppose, the appearance of the ordinary-sounding name of Sir Jack Stewart-Clark on the company letter-head, as the non-executive chairman.

Sir Jack has a background to go with the 'common or garden'-like ring of his name: Balliol College, Oxford, Harvard Business School, Coldstream Guards, managing director of Philips Electrical and of Pye, Member of European Parliament for East Sussex.

There is a lot more to selling computers than designing hardware. Tycom has spent a lot of time and trouble on its business image, and in making sure that not only is the technology pedigree there, but that the pedigree document is well framed and prominently displayed.

Brochures, publicity, management team image — all have been given serious attention. Selling to people who are spending £3000 for a system, all these things, as IBM well knows, as far more important than mere cleverness.

But if you aren't IBM, you have to be twice as careful about the cleverness, too. I look forward to the first user reports with more than usual interest, because this company is clearly aiming very high.

Small is beautiful

A war is on for leadership of the market for extra-small 'microfloppy' disks, and the first battle is the fight to establish standards.

Sony, one of the inventors of a 3½ inch disk, obviously thinks it has won this little point, because it has issued a statement that it and Shugart (amongst others) have 'agreed to support a mutually compatible 3.5 inch floppy disk format'.

Other names attached to the announcement (13 of them) include BASF, Memorex, Verbatim and 3M, but it will be the Shugart name that Sony is proudest to be able to list. Shugart had originally pushed (and hasn't abandoned) a 3¼ inch standard, which had ordinary cardboard envelope protection, rather than the hard covering

of the larger Sony design.

Sony's original design, however, was single-sided, and the new standard is double-sided. So obviously there is still room for negotiation (as fights are often called) over which version of the standard wins, as well as which standard gets more agreements announced.

Sony in the UK can be contacted at Sunbury-on-Thames (09327) 81211.

Covering up

You should be warned that Allrian Data Services has installed a 'modesty switch' in its latest program. The reason is that the user might not want to go through the tedium of explaining why his (or her, though that seems unlikely, really) screen doesn't have the company forecasts, but a partly-clothed female on it.

The package is strip poker, with the added 'incentive' of graphics on the Atari. The Atari graphics are all right, but I can't believe anybody is going to break into a sweat over Atari graphic nipples. . . anyway, details on (0753) 45201.

The promotional brochure, showing some nerd *actually stripping, himself* in front of a computer, is a collector's item of sheer chutzpah.

Audio Visual

They hope, the organisers of Audio Visual 83, to be able to put together an exhibition showing many of the suddenly exploding computer display abilities.

The exhibition is needed because different ways of showing data in pictorial, or graphics, form are becoming more confusing than the number of machines which can do it.

As Maclaren Exhibitions observe, graphics have always been a good way of getting information out of a list of figures. What has been difficult is the problem of getting the graphics out of the information.

The important addition to the art which micros have made possible is the spare processing power needed to actually convert the data into graphics.

Anyway, the exhibition is from 21-24 March, just after

the West Coast Faire in San Francisco from 18-20 March. It's at Wembley Conference Centre. I suppose you can guess which one I'm hoping to get to. . .

Details on 01-688 7788.

IBM vs the Future

The other side of the IBM launch was the appearance of the competitors.

These are the machines which are built to the same specification, more or less. They can run the same software, but cost less, or offer some other advantage (like portability).

Easily the most impressive of these is the Future Computer, designed and just launched in the UK at a very much lower price than IBM can manage. A system which on paper at least offers a lot more than the IBM system, it costs just about exactly half the price.

The Future machine is a lot smaller than the IBM, roughly half the height. It has a much better display, which is easier to adjust.

Most important, the standard operating system offered is CP/M-86 — but not the ordinary one-job after-the-other version. Instead, Concurrent CP/M-86 will be standard — allowing the user to edit a letter, print a form, transmit an invoice down a phone line and look through a database at the same time.

The only thing that really puzzles me about the Future Computer is that it can be made to read standard IBM disks, but that the plan is to sell it with its drives; which don't.

Next in line, a very ordinary lookalike from Computer Ancillaries, which is nonetheless demonstrably more sophisticated than the IBM design.

Like the DEC Rainbow, the CAL-PC has two processors, one 8-bit Z80 (but a fast Z80-B, not the ordinary one) and one 16-bit 8088, as in the IBM machine.

The keyboard is exactly the same as the IBM one. Users tell me that they like it. I don't, because of several surprise keys, but that's the way IBM did it, and that's the way the imitators have to do it, so as not to confuse people reading the IBM manuals.

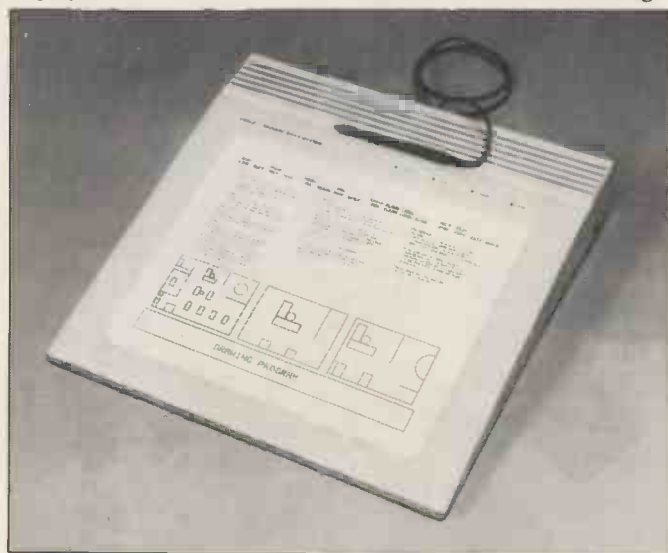

Rapid Recall is now selling this very smart graphics tablet for Hewlett Packard 80 series micros. The tablet — the 9111A — allows you to draw diagrams, maps, etc, and enter them simultaneously into the computer as a series of digitised X-Y coordinates. The computer can then display your masterpiece on the screen or reproduce it on the plotter and, of course, the 'picture' can be stored on disk for later use. Contact Rapid Recall on 0494 35634.



Another 16-bit micro has hit the streets — this time a British one! It's from Future Technology Systems and is being marketed by Office and Electronic Machines (OEM) as the Orion Total Business Management System.

It's 8086-based with 128k of RAM expandable to 896k, and runs 'enhanced versions of CP/M-86 and MS-DOS'. There's a good selection of software available, including the Peachtree range, and a useful collection of expansion options, including hard disks. Starting price is £2950, for which you get 128k, twin 512k disks and EOS-C, the 'enhanced CP/M-86' but no software — everything else costs extra. Contact OEM on 01-407 3191.

One unusual feature of the CAL machine is the decision to offer a full range of applications software based on the Business Operating System (BOS) from MPSL.

Its disks are bigger than the standard IBM ones, at 400 kbytes each, with the option of having twice that per drive, or hard disks instead CAL is in Egham, on Egham 36455.

Joke on Baker

Even the Government got its five cents' worth out of the IBM launch. Minister Kenneth Baker, in charge of Information Technology at the time (information technology is to computers what American bathrooms are to lavatories — a euphemism) said he welcomed the machine.

'I warmly welcome the decision by IBM to manufacture their personal computer for the whole of Europe at Greenock,' Baker said. 'It is further evidence of the company's commitment to this country,' he added.

This presumably refers to the fact that IBM is building

our new driver/vehicle licensing computer (replacing the ICL machines known in the trade as the Swansea Joke Factory) and is building the thing in France.

Double Dealer

Dealers for the IBM Personal Computer were headed by the Comart-owned Byte Shop chain, fresh from an impassioned plea to the Government to ban all American imports.

Comart can plead that IBM intends to make the PC in Scotland — but the peripherals that the group will be distributing won't be made there. They are the Tecmar Inc range of PC-Mate disks, cartridges, memory, colour graphics displays, and industrial control modules. And one of the stores in the group, Xitan, is importing the same range of Easy software that Pete and Pam is selling.

Nice to see that Comart didn't expect the BMMG's lobby to work.

Another announced dealer is Computerland, the

American-owned chain with its first store open in Southampton.

The full dealer list is available from IBM itself in Basingstoke.

16-bit tools

It you're a programmer struggling with CP/M-86, it will scarcely have escaped your notice that there just isn't the wide range of development aids available for this operating system as there is under CP/M-80. Now Island Software has produced a set of five development modules to come to your rescue.

There's a Base Module which includes utilities to convert 8080 and Z80 source code to 8086 source, transfer MS-DOS files to CP/M, turn CBasic programs into Microsoft Basic listings, edit disk sectors directly, reinstate erased files and lots more.

Then there's the Sourcerer module, a 'range of intelligent disassemblers' and TRX, a module allowing files to be transferred between machines using an RS232 link. Screenwright + Keybase is a module which allows you to develop screen formats and file handling facilities and automatically codes these in Basic; and the final module in the range is Screenplot, which allows you to use your machine's graphics capabilities.

If you buy all five modules at once, says the blurb, you save a third of the cost of buying them all separately. The snag is that the brochure doesn't say what they cost. Find out from the importer, Export Software International (you figure it out) in Edinburgh on 031-556 3266.

Free port for job generation

Doyen of the micro industry Clive Sinclair is championing the cause of free ports, claiming that they would stimulate employment.

In a letter to *The Times* earlier this month he suggested that a free port in, say, Dundee could generate 'hundreds, possibly over 1000, new jobs' to meet the needs of Sinclair Research alone.

This suggestion comes hot on the heels of industrial unrest over redundancies at

the Timex plant in Dundee where Sinclair's manufacturing is done.

At one stage Sinclair was threatening to withdraw completely — a move that would lead to hardship in an area already severely hit by unemployment.

Free ports offer great attractions to exporting UK manufacturers. This stems from an anomaly over import duty. Under the weird and wonderful idiosyncrasies of British law it seems that if you want to import a component to build a machine in Britain you pay 17 percent import duty. But if you want to import a complete machine, the import duty is considerably smaller — a mere five percent.

This is an active disincentive to British micro manufacturers, as was highlighted by their trade organisation in an impassioned letter to the Prime Minister last November.

Members of the group claimed that they would soon be forced into the position of shutting down their factories and setting up a business importing foreign micros from their own front rooms.

Although Sinclair sought to disassociate itself from the impassioned letter, and ultimately resigned its membership of the trade organisation, the issue of import duties remains a pressing one.

In Sinclair's words to *The Times*, 'My company sells small computers. The major import cost in these is semiconductors, which for the most part are imported from outside the Common Market at a duty rate of 17 percent, whereas only 5 percent must be paid on finished computers. This places the European-based manufacturer at a disadvantage relative to a foreign producer.'

Another UK micro manufacturer, Torch Computers, was less sure of the benefits of rationalising import duties. 'Even if import duties did go down I'm not sure how much it would be passed on to the computer companies, which mostly get their components from importers who could just increase their profits,' said Torch's chairman Martin Vlieland-Boddy.

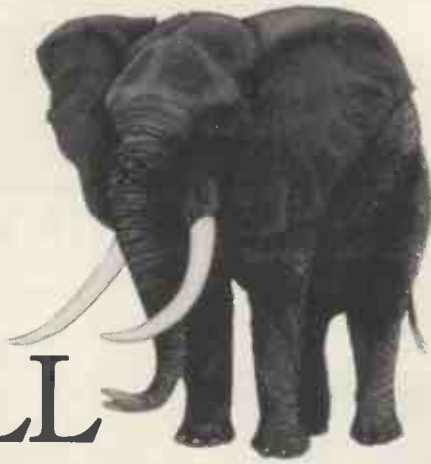

SMALL COMPUTER SYSTEMS FOR BUSINESS

Choose your business computer system in our comfortable office environment where our highly trained staff will demonstrate the best systems and software available in the market.

Be assured that everything you take for granted to be included in your systems package, training, engineering and the right system and software for your specific requirements, will be part of the CIRCULAS promise of satisfaction.

CIRCULAS

LIMITED

69/73 THEOBALDS ROAD LONDON WC1
TELEPHONE 01 242 0223

We supply

FORTUNE

32:16

IBM-PC

apple

Operating system based on UNIX; Multi-user/Time sharing; File management; Multi languages including Basic, C, Cobol, Fortran, Pascal; Sophisticated applications software available.

Operating system PC DOS; CP/M; 620 K Dual disk drive; Winchester disk drives available; Supports Basic, Cobol, Pascal, Fortran, Range of applications software and peripherals.

Operating system Apple DOS, CP/M; Totally modular system; supports pascal, Cobol, C, Fortran, Basic; Vast range of educational and applications software available.

Operating system Apple DOS, CP/M; Totally modular system; supports pascal, Cobol, C, Fortran, Basic; Vast range of educational and applications software available.

Clip this coupon and send to CIRCULAS LIMITED 69/73 Theobalds Road London WC1 for further information and prices of our systems.

FORTUNE 32:16

IBM-PC

APPLE

OSBORNE

NAME _____

COMPANY _____

ADDRESS _____

PHONE _____

KEEP YOUR OPTIONS WITH

MIRAGE

A NEW GENERATION OF DATA BASE

MIRAGE has been thought out on a human scale. Design and set-up of a Data Base take less than an hour.

MIRAGE offers just the right number of features to solve your business problems.

MIRAGE uses relational data management techniques to achieve unique flexibility.

MIRAGE can be accessed directly from your programs. Unlimited on-line addition, retrieval and modification of your informations.

MIRAGE has response time which will surprise you.

MIRAGE enables you to use normal, existing files. Its structure is easy to modify interactively.

MIRAGE main specifications and tools:

99 files of 65535 records

Possibility to have 1 direct access key and 5 chained access keys per file

Independence of data and pointers

Multi-users possibility is under development

For creation:

- DBSCHEMA, design tool
- DBUTIL, preparation tool

For Programming:

- DBPUT, to add a record
- DBGET, to read a record
- DBDELETE, to suppress a record

MIRAGE is programmed entirely in PASCAL and is independent of any Operating System. Initially available under CP/M at £475 excl. VAT. Training and technical support on demand. **MIRAGE** is a product of DATASOFT International.

For additional information, please write to:

DATASOFT INTERNATIONAL

2 YORK ROAD, MAIDENHEAD, BERKS SL6 1LR Tel: (0628 21957)

DEALERS AND OEM ENQUIRERS WELCOME

Somewhere handy to put your mini disks



The Willis Mini-Disk file is the idea you hoped someone would come up with. A handsome virtually indestructible file which holds your valuable programs and data files neatly filed and indexed ready for immediate use.

Disks are stored in 10 sections, each with an ingenious lift mechanism, which enables you to fan display them five at a time, using only the thumb and forefinger.

The file holds fifty 5¼" Mini Disks and you'll wonder how you ever did without it.

Just one of the items from the Willis Catalogue.

To order please use coupon. By taking advantage of this cash with order offer, you are saving £5.55 on the normal price.

*Virtually indestructible with smart cream plastic base and tinted polycarbonate lid. *Lockable for security and easily transportable with carrying handles. *Each disk neatly filed even if box is not fully loaded.

Just £35.00

 (Plus £2p&p)

To: Willis Computer Supplies Ltd., FREEPOST, PO Box 10, Southmill Road, Bishop's Stortford, Herts CM23 1BR. Telephone: Bishop's Stortford (0279) 506491.

Please send _____ Mini Disk File(s) at £35.00 plus £2.00 p&p and your colour catalogue.

Name _____

Address _____

Post Code _____

I enclose my cheque/PO for £_____ or debit my Access or Barclaycard.

Card Number

Signature _____

WILLIS

 Computer supplies

NEWS EXTRA

hinted at cheapness, noting that it wishes VisiOn to become a standard and adopted by as many people as possible.

The IBM Personal Computer and the Digital Equipment Professional are the only machines that VisiCorp has promised will have VisiOn so far — 'but the early indications are that VisiOn will be the next standard for personal computing,' according

to Diamond.

VisiOn, too, is promised for the 'summer' and will come with packages for the standard applications of spreadsheet, database management, graphics and word processing.

Both Apple and VisiCorp believe they have come up with products that will win over the next generation of computer users

— the office professionals. This is a vast potential market with lots of money to spend. Apple admitted rather ruefully that it is investing large sums in general market preparation, the benefits of which might be reaped by other companies. 'There is lots of market education to be done,' said Hall.

Then it's over to you, mouse!

END

CTUK! NEWS

By David Tebbutt

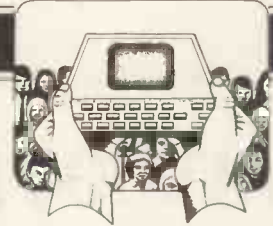

In September 1980 the general public was pretty much in the dark as far as microcomputers were concerned. Certain union leaders were gaining a great deal of publicity by telling people that they would soon be replaced by silicon chips. They were also generating a great deal of fear of the so-called micro-revolution which was about to engulf us all. Government activity at this time was sporadic and it was clearly not going to get its act together for a while. Something definitely needed to be done to counteract the negative feelings surrounding microcomputers. There were a few magazines, (*PCW*, *Practical Computing* and *Computing Today* were the top sellers) but these tended to be bought by the already enlightened. What was needed was a direct approach to the public, to the sort of people who wouldn't be seen dead in a computer shop. It was then that we launched ComputerTown UK.

Loosely based on ComputerTown, USA! which I had discovered on a visit to California that March, ComputerTown was to be a non-profit-making, non-commercial attempt to introduce personal computers to the general public. Derrick Daines was the first brave soul to go to his local librarian and get permission to run ComputerTown sessions at Sutton-in-Ashfield public library. Days later, I plucked up courage to ask the Hillingdon Borough Librarian for similar facilities. So started ComputerTown UK. Since then, volunteers up and down the country have joined the ComputerTown movement and, by all accounts, are having a lot of fun as well as being darned useful to people who just don't know where to start.

Now there are around 40 ComputerTowns, and the number of people wanting to start them up is still growing. This has come as something of a surprise since we thought at the beginning that it would last a couple of years, by which time the newspapers, the television and the government would have made everyone aware of the potential of these little machines. In fact I think that all three have made a very good start but, to date anyway, they have still steered a little towards the 'gee whizz'. This situation is improving all the time but there is clearly a continuing need for a ComputerTown type of activity.

As time has gone by, ComputerTown has changed. Many of them have ended up with so many regular people that they have almost become clubs — which is a shame because they then tend to frighten off the

very people they originally set out to attract. Others have entered a lovely symbiotic relationship with local clubs in which the ComputerTown feeds the interested members of the public into the club and the club sends volunteers to run ComputerTown. That, to my mind, is an almost perfect way of arranging things. The 'Towns in and around Croydon and those around Gateshead are excellent examples of this in action.

Another development was that of ComputerDays. A number of groups decided to have a big one-day event and, in each case, they were wildly successful. The nice thing about these for the volunteers is that they can invest time periodically, whereas a regular fortnightly session sometimes proves too much. Bill Gibbings must take all the credit for the idea — he ran the first ComputerDay in Retford. Frank Fadipe deserves a special mention too because he developed the ComputerDay idea into a ComputerWeek!

And so it goes on. It's impossible to single out all the people involved. They know who they are and they know that their efforts are mightily appreciated, especially by the thousands of members of the public who have passed through their hands.

By now you may be getting suspicious. Why's he going on about the past so much? The answer is that we feel the ComputerTown News page tends to get a bit repetitive and, dare I say it, boring — especially in winter when everyone seems to hibernate. So, we all got together and cooked up a new approach to reporting ComputerTown activities. First of all, this page is to be replaced by a sort of notice board containing announcements of things like people looking for volunteers to start a new 'Town, details of where to get CTUK information and notes of shows, events, good books, programs — anything in fact that you think would help other 'Town organisers. Big news, like new ComputerTowns starting up, will find its way into the News pages of the magazine and articles from ComputerTowns will be published as features providing they pass muster with the editorial department. For this to happen, you must keep us posted about your activities and discoveries, no matter how minor. If you feel you have information which can help others interested in ComputerTown then please write in with the details. I'm sorry we can't take phone calls. The truth is that we, too, carry out all CT activities in our own time. Articles for

publication must be interesting, informative and maybe even inspirational. They will have to be reasonably well structured and written although the editors aren't averse to a bit of rehashing. Finally, the list of ComputerTown contacts will continue to be maintained in the Direct Access section of *PCW*.

This new approach is much more flexible and I'm sure that it will prove to be even more successful than what has gone before. We have secret plans to make sure that the ComputerTown notice board grabs your attention.

Of course, it's all very well to say all this, but it does depend on you to make it happen. If you've learnt something from running your ComputerTown, for goodness' sake share it with the rest of us. You can't say that in the hundreds of thousands of man-hours that have gone into CTs you haven't learnt something that's worth sharing with other readers. Come on, put pen to paper. If you just write the way you feel then you'll find the words will come easily. If you're uneasy about it, *PCW* won't mind giving your work a final polish. After all, it's what editors are paid for, isn't it?

The new approach starts next month. I figure that if you'd like your ComputerTown to be featured in any way, you've got about two days to get the copy to us. Go on, try. We look forward to hearing from you.

END

ComputerTown UK! is an ever-growing network of computer literacy centres where members of the public are given free access to microcomputers, courtesy of those willing to volunteer their time and equipment. ComputerTowns might be found anywhere — in a church hall, a library or perhaps a school after hours. The aim is to make computers enjoyable and non-threatening and, because ComputerTown is entirely non-commercial, overt axe-grinding of any sort is banned. Guidelines are available for those interested in setting up their own 'Towns: Write to CTUK!, *PCW*, 62 Oxford Street, London W1A 2HG. Remember to enclose an A4 SAE for your reply. Please don't telephone *PCW* for information as CTUK! is entirely a spare time activity.

IBM'S 'SECRET' MICRO

Chris Morgan of Byte magazine reports on what could be the basis of IBM's next PC.

IBM 9000 INSTRUMENTATION COMPUTER OR THE NEXT PERSONAL COMPUTER?

The best-kept secret of 1982 may have been that IBM makes a 68000 computer. If that surprises you, you're not alone. The unit, called the IBM 9000 Instrumentation Computer, is IBM's second major micro-computer product — the first, of course, is the IBM Personal Computer. The 9000 made its debut this past summer at the Comdex show in Las Vegas, though it was first announced last May by IBM's subsidiary, IBM Instrument Inc, in Danbury, Connecticut. The May announcement was so low-key that few people took notice.

The machine is marketed as a laboratory instrumentation computer, yet its design innovations and modularity make it a natural candidate for a business or general-purpose computer — with the appropriate engineering and cosmetic changes, of course. IBM has declined to comment on this possibility, however.

In this article I'll describe the features of the machine, which I saw during a recent visit to the IBM Danbury facility, and speculate about the importance of a 68000-based microcomputer from the world's largest computer company.

Why has IBM decided to offer a 68000 computer? To answer that question, we interviewed the machine's designers at IBM Instruments, a recently acquired, wholly-owned subsidiary of IBM. For years it has been active in the design of computer-oriented laboratory equipment. The division's status as a separate profit centre within IBM allows it to experiment more freely with unusual computer designs — in particular, development of a laboratory-oriented microcomputer.

The incentive to do this came after a major change in the instrumentation field. During the 1970s laboratory techniques such as nuclear magnetic resonance and gas chromatography became more popular — techniques that required much sophisticated mathematical calculation. These calculations demanded more in the way of mathematical analysis than 8-bit computers could deliver. For example, Fast Fourier Transform analysis (a common mathematical technique in the laboratory) consumes huge portions of

memory. Thus laboratories had to stick to more expensive but powerful mini-computers. A real need arose for ways to improve the productivity and cost-effectiveness of data acquisition and processing in the laboratory.

So the IBM 9000 was born. It has the memory space (up to 5 Megabytes of RAM!) to handle sophisticated laboratory mathematics. It has modular hardware features needed in the lab, such as a high resolution colour printer to create graphs and charts, a swivelling CRT display, and a movable keyboard that can go where the experiment is. More importantly, it has the Motorola 68000, a powerful 16-bit processor. Long a favourite with many software designers, the 68000 was chosen by IBM despite the fact that the IBM Personal Computer uses the Intel 8088 processor (which is not a true 16-bit processor). The 68000 won out mainly because of its superior Benchmark performance. According to its designers, the 68000 gives the 9000 a better price/performance ratio and provides a standard method to control all IBM instruments. The 9000 has real time multitasking capability — important in data acquisition — and its five I/O interfaces allow it to be easily connected to a variety of laboratory instruments.

The real star of the 9000 is its remarkable state-of-the-art planar processor board. Seven layers deep, it is literally crammed with ICs and VLSIs to the saturation point. IBM says the board could not have been manufactured just over a year ago because of its high chip density. The board has more than 1600 test points. On this single board are the complete computer, five I/O ports, the disk controller, and slots for an auxiliary expansion card that will hold up to five Versabus cards. The advantage of single board construction is the freedom from printed-circuit board connection points — a major reason for computer failure. (Incidentally, IBM will swap processor boards with customers in an overnight service in case of hardware failure.) The 32-bit Versabus insures compatibility with future instruments. In addition, the

Versabus stands an excellent chance of becoming a standard bus in the future.

One look at the 9000's processor board reveals its designers' egalitarian approach: it contains ICs from over a dozen US and Japanese companies — AMD, Signetics, Motorola, National, TI, Intel, Intersil, Hitachi, Western Digital, and others. Each chip was chosen for its spec alone. This would have been unheard of back in IBM's monolithic days, when practically every IC inside an IBM computer was custom-made by IBM.

Hardware

The IBM 9000 is well suited to the laboratory: its modular construction revolves around a basic chassis containing a processor board, a 12in black and white VDU display, and a 57-key keypad, all selling for \$5695. The 9000 has been engineered with the crowded laboratory bench in mind: the modules stack vertically to conserve space. When augmented by the printer/plotter, keyboard, and a host of other options, the 9000 becomes a powerful 16-bit computer system. The basic system module (processor board, VDU, keypad and chassis) measures 22.3in x 17.2in x 23.2in. It weighs in at 31.5lb (main chassis alone) or 78.8lb with VDU, printer and keyboard.

In addition to the RAM and ROM within the machine, there is a 64 kbyte (12 bit word) graphics memory to handle the screen display. The Motorola 6845 video control chip is used in the IBM 9000. Other features include a memory-protect scheme (useful in multitasking applications) and composite video.

The IBM 9000 automatically conducts a power-on diagnostic routine, and a second diagnostic routine can be initiated by the user.

The VDU display has excellent resolution (768 by 480 pixels) and one felicitous feature: a single handle control that lets you quickly shift the position of the display horizontally and vertically by merely pulling the handle toward you and repositioning the screen. Beneath the screen is a row of



user-definable keys like those on Hewlett Packard machines. The printer/plotter is well suited to the 9000, with 220 by 336 dots per inch and excellent four-colour printing.

The 57-key user-definable keypad is perhaps the 9000's oddest feature. Yet having that many user-definable keys could be useful for some applications. One spectator at the Comdex show suggested using

the keys to represent Wordstar commands. Though I'm no fan of this type of touch-sensitive key, I suppose it does the job.

Software

The 9000 operating system (custom designed by IBM) has multitasking capability and a sophisticated I/O manager that queues up all I/O requests. The software is

The complete system (above) and its familiar-looking keyboard (below).

menu-driven with keyword bypass for the expert user. The system features contiguous file allocation to minimise access time, and the various high-level languages (Basic, Pascal, and Fortran 77) all share a common graphics interface — a decided plus.

Laboratory-oriented software includes a

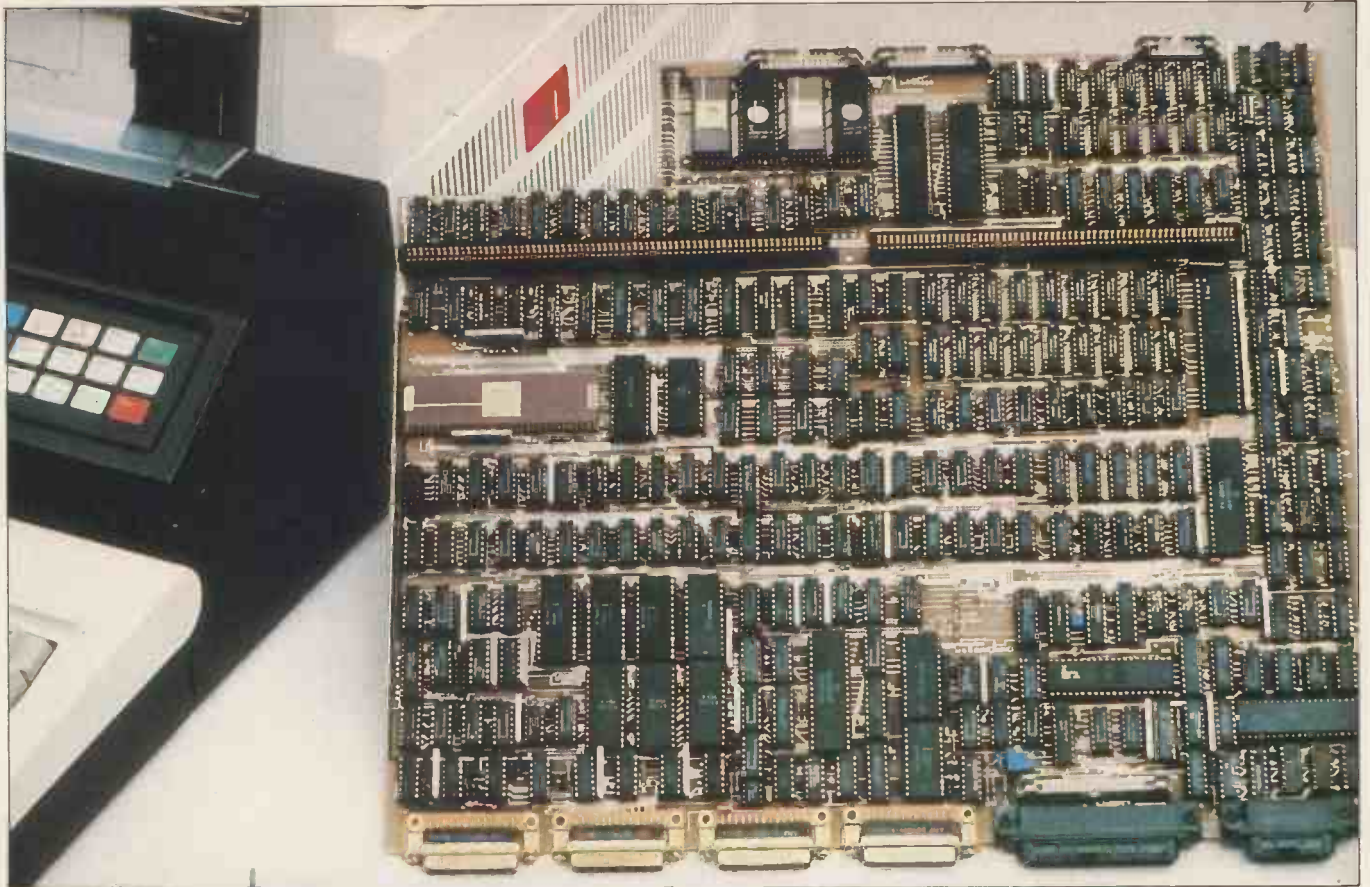

Probably the most crowded PCB of all time.

IBM'S 'SECRET' MICRO

gas chromatography program and a nuclear magnetic resonance station (the latter costs \$250,000).

Conclusions

The IBM 9000 is ideally suited to the laboratory. But it strikes me that the 9000's processor board could become the heart of a general-purpose microcomputer for the business market. As I said earlier, IBM is not commenting on this speculation. (Incidentally, IBM 9000 customer deliveries should have begun by the time you read this.)

I think the 9000 is, in its quiet way, one of the most exciting announcements on today's microcomputer scene. I predict it will start showing up in all sorts of unexpected applications. In one gesture IBM has legitimised a microprocessor that deserves more attention: the Motorola 68000.

END

Technical specifications

Processor	Motorola 68000
ROM	128k
RAM	128k, expandable in 256k units to 5 Mbytes.
Display	12in raster-scan CRT with 768 by 480 pixel bit-mapped display; 80 character by 30 row green on black display.
Keyboard	83 key, full ASCII, auto-repeat on all keys. 10 programmable function keys.
Keypad	57 pressure-sensitive keys in three colour-coded rows. All keys user-definable, six keys have LEDs under software control.
Disk drives	Up to four drives in any combination. 5 ¼in double-sided, double density. 8in doubled-sided, double-density. IBM standard format.
Interfaces	IEEE-488, three RS232C serial ports, one 8-bit parallel bi-directional port with handshaking and TTL-level signals.
System software	IBM custom operating system.
Languages	Basic, Pascal, Fortran 77.

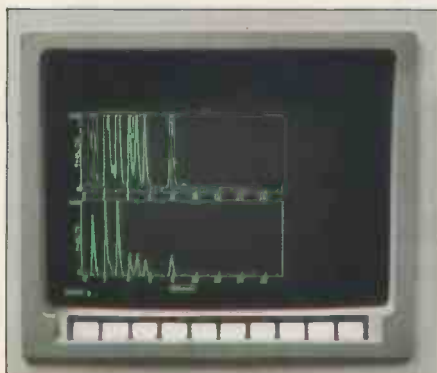

Snaazy graphics for lab work.

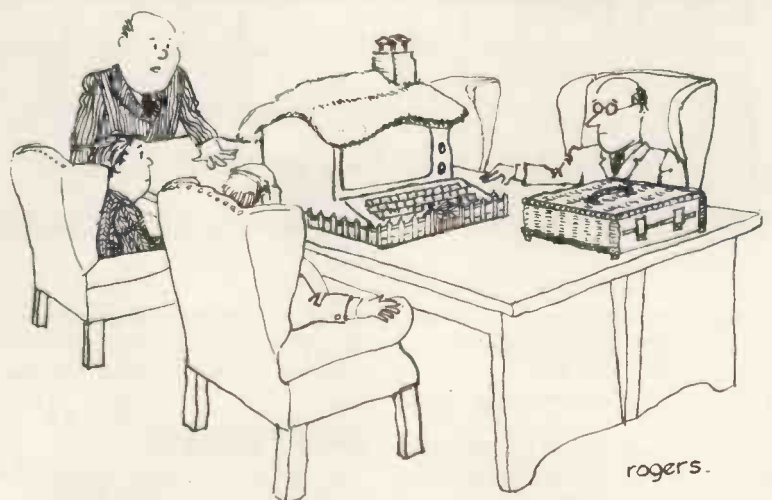

'As you see, gentlemen, our marketing survey produced some unexpected results.'

WINCHESTER KILLER - £750

The incredible Scorpio 6.2 Mbyte hard disk alternative from HAL Computers annihilates small capacity Winchester.

DISTINGUISHING CHARACTERISTICS

Hard disk capacity and speed with the capability of interchangeable media. Scorpio 8 eliminates the worries of head crashes, drive alignments, lost data or backup, with a new application of field proven floppy technology.

Fully Apple II compatible – DOS 3.3, Pascal 1.1 and CP/M. Uses all standard Apple DOS commands – appears to Apple as a massive 8 inch floppy.

HOW SCORPIO 8 IS KILLING THE SMALL WINCHESTER

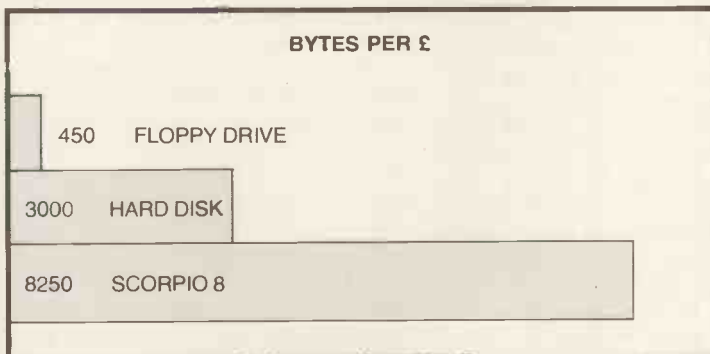
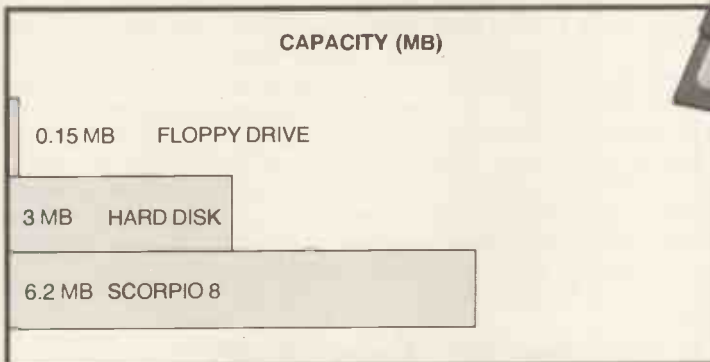

REWARDS

- Winchester capacities on floppy disks.
- Removeable media – a cartridge pack of five 5.25 inch diskettes each of 1.2 Mb capacity.
- High speed DMA data transfer.
- Cost effective and software compatible disk memory expansion.
- Removeable media means separate packs can be kept for different applications.
- All this for £750 complete.

To claim your rewards contact us at the address shown below.

HAL
HAL Computers Limited
Invincible Road, Farnborough
Hants. GU14 7QU
Telephone (0252) 517175
Telesales (0252) 517171

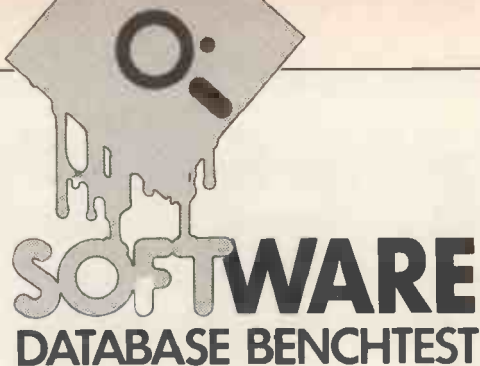

**SOFTWARE
DATABASE BENCHTEST**

DATA PRISM

Kathy Lang reports on a multi-version general purpose data management package.

This month we are back with general purpose data management packages, looking at DataPrism, which comes in three versions and runs under CP/M (the manual also mentions versions for CP/M-86 and Unix). The simple version has facilities for storing information in individual files, which can then be edited, displayed on the screen or printed. This version permits access to data only by key; keys are used both to find particular records and to determine the order in which records are to be displayed or printed. Screen and report formats are provided by DataPrism, but the user also has a limited facility for printing output in formats of his or her own design.

A more sophisticated reporting facility,

allowing full screen formatting as well as formats for printed reports, is an optional extra, which can be further enhanced by a feature which allows you to select items for printing from more than one file.

Finally, for the experienced programmer, there is an option which gives access from users' programs to all the screen handling and file management features of DataPrism, and also allows the tailoring of menus and gives some protection against unauthorised access to files and functions.

In this review you can assume that the features being described are those of the basic package, except where I explicitly mention one of the more advanced (and more expensive) options. Throughout I shall also describe the features of the CP/M-80 version of the package which I tested (the manual refers also to a CBasic version, which is more restricted in its ability to handle large records and files).

DataPrism is operated by a combination of menus and questions-and-answers. The main menu is shown as Figure 1; those features which are available only with optional additions are indicated (DataPrism actually displays on the main menu only those functions which are available to your particular version of the package.)

Before a data file can be used, its structure must be defined with the File Definition function. Once defined, the structure may be modified, but if the data file already contains records then the file must be copied and the indexes rebuilt if the package is to work properly. Each file description is given a number as it is defined, and throughout the package the file is then referred to by this number. This saves typing in the name each time, but it gives rise to other complications, which I'll talk about under 'Reporting' later on. All the keys through which a file is to be accessed are

defined at this initial stage; they can be changed or modified later, but only if the indexes are rebuilt before the file is used again. This can be a quite lengthy process for a large file, as the Benchmark results show. The data itself is stored in a standard ASCII file, which can be created or read by many packages such as Wordstar, and by most programming languages including MicroSoft Basic.

The key facilities are very powerful. You can define a key as unique or duplicate; for a unique key field, an operator will not be allowed to enter a value which already exists in the file for that field. Duplicate keys may be single fields, or composites of up to 10 fields or parts of fields. If a key is composed of several fields, you must specify a value for each field when accessing records through that key. These features speed access to individual records, but they put a premium on getting the file structure right early on, especially for large files. However, the fact that the complete index (on all keys) is kept up to date automatically is a very valuable feature, and is rarely found even in much more expensive packages.

Constraints

The major constraints on the use of DataPrism are shown in Figure 2.

The limit of 35 characters in an alphabetic field could be a problem in some applications. On the other hand, DataPrism allows you a much larger record than is common. The actual maximum depends on the available memory, as the limit is 256 characters plus 200 characters for each 1k of your micro's memory above 48k. So a typical CP/M system with 56k (64k less 8k for the operating system) could handle records of up to 1856 characters. Key lengths are also restricted: unique keys may be up to five characters, and each field forming part of a duplicate key may be 20 characters long. If longer fields are specified as keys, only the first part of the field is used.

Every field in the record must have two names: the first, limited to eight characters, is used when abbreviated names are needed, for instance in reports where space does not

MASTER MENU

Bonsai — DataPrism
06/30/82

Select function:

M = Maintain Files
B = Browse Files
L = List Files

F = Forms Print
R = Report Print

D = Set Today's Date
E = Set Environment
U = Utilities

D = Define Files
DM = Define Menus
DP = Define Passwords
CR = Compile Reports

Enter desired selection or 'END':

Fig 1 DataPrism main menu

Max file size	CP/M limit or disk size, whichever is smaller
Max size record	256-9999 characters, depending on memory size — see text
Max no fields	999
Max field size	35 characters, 14 digits
Field types	Character, numeric, date (month/day/year), monetary (dollar), yes/no, auto-index

Fig 2 Constraints

MAG/base FILE DEFINITION DETAIL PRINT

File Attributes: File Number 3 — Bench Test file for PCW Review

File Number	3
1. File ID	PCWBTDPM
2. File Description	Bench Test file for PCW Review
3. Disk Drive ID	B
4. File Storage Mode	E
5. Next Auto Index	2
6. Auto Index Increment	1
7. Number of Fields	21
8. Number of Keys	1
9. Record Length	154

Fig 3 File definition — attributes

Field Number	9
1. Field ID	SUPP2
2. Field Description	Supplier2
3. Field Type	N
4. Minimum Field Length	5
5. Maximum Field Length	5
6. Decimal Places	0
7. Minimum Value	0
8. Maximum Value	0

Fig 4 File definition — example field.

permit the use of the extended description of the field, which may be up to 30 characters. It is useful to be able to specify a longer description, but I would have preferred this to be optional — often the short name is self-explanatory, and it is tedious to be obliged to type it twice.

File creation and deletion

Files are created by setting up a file definition, and then adding data to the file. Indexes specified in the file definition are set up and maintained automatically as part of the file maintenance process. File definition is a rather tedious process — all information is entered on a message line near the bottom of the screen in response to a question from DataPrism, and the file definition is assembled from the replies. One screen is devoted to a description of the file (as shown in Figure 3) and then one screen to each data item (a typical description is shown in Figure 4).

After each description has been entered, you have the option of changing any item before saving — but the method used is to specify the number of the item to be changed and then to enter the whole of the corrected value. No actual editing of the definition list is possible, either on the response line or — much better — *in situ* in the body of the screen; indeed DataPrism makes no use of the keyboard's cursor movement keys at all. During file creation this might not be a great hardship, as you will not want to create new file descriptions very often, but the same method is used during data entry, which could be exceedingly tedious.

If you already have information in a data file, DataPrism makes it easy but rather slow to bring this data into its filing system. DataPrism stores its data in ordinary ASCII sequential files, using separate files

for file definition and for indexing. So you just have to make sure that your data is either in fixed field format or in the usual Basic variable format (fields comma delimited, strings enclosed in quotes), describe its structure to DataPrism, and build an index. I found this quite straightforward to do for my Benchtest file, but it was quite slow — see BM10 in Figure 7.

Once the file definition file has been created, it can be amended, but only within quite severe limits even if no data file has yet been linked with it. For instance, I was able to change the type of a field, but not its length without changing other fields in a complementary way, so that the record length remained the same. If you need to make more major changes, such as adding an extra field to each record, you must create a new file definition. Any fields which are to be taken from the old file must be defined in the order in which they appear in that file, with new field(s) at the end. (This involves typing in the file definition all over again — I couldn't find any way to copy a file definition before amending it.) You then replace the old data file with the new (DataPrism puts blanks in each new field), and rebuild the index. The time taken to do this for my Benchtest file is shown as BM1 in Figure 7.

Screen display

When displaying data in order to amend it, you must access the record you want to change by a specific key. Matching occurs if DataPrism finds a record with the key field equal to or greater than the value specified. Once the record has been displayed, you can then browse through the file in the order given by that key. For instance, if you are looking for a customer called Smith, but don't know his initials, you can request a match on surname Smith (assuming surname is a key field). If the first Smith is not the right one, you can

scroll through looking at each Smith in turn to find the right one.

Once the record is found, it is displayed in a standard format, with 16 fields on each screen; each line consists of the field description followed by the value in the current record, and each line is numbered in sequence starting from 1. To amend a data item, you specify the number of the line on which the field is listed, and give the value which is to replace the current field value. No editing is allowed. The way the screen looks during this process is shown in Figure 5.

When you are adding a record, once you've begun to enter fields you must enter a complete, valid record — you can't change your mind after the first field is entered. All field values must be entered from the keyboard: there is no facility to calculate the value of a field and embed that calculation in the file description, nor to 'echo' a previous field value or record.

If you want to display a record, but don't want to change it, you can get more sophisticated data displays by using the optional Report Writer. This allows you to specify the positions in which fields are to be displayed, by setting up a report format file which is then applied to the data file and the results shown on the screen or printed, as you wish. It is used in exactly the same way whether screen or printed output is required, so I shall describe it in more detail in the next section.

Printed reports

The simple version of DataPrism has two functions which give printed reports. The List function gives the ability to print one or more fields from each record, and to total those which are numeric. All formatting is carried out by DataPrism, with assumptions about standard page size, etc. Records may be selected by specifying a range within which one or more key field variables are to lie. You may also specify

FILE MAINTENANCE CHANGE

Bonsai — DataPrism
06/30/82

Display/key description/ /key value/:

1.	/field description/	/field value/
2.	/field description/	/field value/
3.	/field description/	/field value/
4.	/field description/	/field value/
5.	/field description/	/field value/
6.	/field description/	/field value/
7.	/field description/	/field value/
8.	/field description/	/field value/
9.	/field description/	/field value/
10.	/field description/	/field value/
11.	/field description/	/field value/
12.	/field description/	/field value/
13.	/field description/	/field value/
14.	/field description/	/field value/
15.	/field description/	/field value/
16.	/field description/	/field value/

Enter change number, N=Next,
RETURN=Page or 'End':

Fig 5 Record Change screen format

DATAPRISM

that only certain fields are to be listed — but to select these, you are given the name of each field in the file in turn, and asked if this field is to be listed. . . The Forms function gives more flexibility about layout, in that it permits the user to design a format within which fields are to be printed. This can be used for standard letters, labels and so on, rather in the manner of packages such as Wordstar's Mail/Merge option. However, the format for printing cannot be set up within DataPrism, as it has no editing facilities. You have to set up the format file with an editor such as CP/M Ed (ugh!) or a word processor such as Wordstar, which rather diminishes the point of the exercise, as Wordstar Mail/Merge can read DataPrism Normal-Format files.

The method of creating a format file with an editor and processing it in DataPrism is also used by the Report Writer optional package, but here there is a further complication in that the report definition must be 'compiled' before it is run. Any errors found during this compilation are flagged for you to correct; but of course to do this you must leave DataPrism, edit the report format file, return to DataPrism and recompile. I expect my resistance to this approach was heightened by finding a couple of apparent bugs in the report format compiler, but I felt it would have been tedious in any case.

The report format takes the form of a list of command lines, each prefaced by a two character command which shows what kind of line this is to be. The command lines may be instructions (such as 'Define Page Size') or layout models showing where field values or results of calculations are to be printed. Such command lines or statements may not exceed 135 characters. Nor may they span more than one text line, so you would need to use an editor capable of constructing lines of the maximum width you wanted to use.

Facilities include the ability to select particular records with the full range of comparison operators (such as 'less than') and of Boolean operators (such as OR and NOT), with comparison among constants, field values from the current or previous record, and calculation results. You can also perform calculations using memory variables; these calculations may be carried out on every record, when particular field values change, and when all records have been processed. Calculations may use all the usual arithmetic operators and *real brackets*. You can have these reports displayed on the screen or printed, and leave the decision about which mode you require until run time.

I found the syntax of the Report Writer rather tedious, but quite easy to learn; an example is shown in Figure 6, showing the instructions used to carry out BM9. The first line defines the file to be processed, by number in Dataprism's internal directory. (Unfortunately, when you delete a file the numbers of all the later files are changed so that the numbering remains continuous — so any report formats referring to these files would have to be changed too to reflect the

MAG/base-REPORT COMPILER — PCWBT92 Test 50 version (PCWBT92T)

```
1: DF:4/1
2: DP:P20
3: CD:C01+F008! COMMENT
4: CD:C02+F010! COMMENT
5: CD:C03+F012! COMMENT
6: PG:Price1 Total:@C01 Price2 Total:@C02 Price3 Total:@C03
```

>> NUMBER OF ERRORS: 0

Fig 6 Report format for BM9

BM1	Time to add 1 new field to each of 1000 records	3 mins + BM6
BM2	Time to add 50 records interactively	scrolling time
BM3	Time to add 50 records 'in a batch'	1 min + BM6
BM4	Time to access 50 records from 1000 sequentially on 25-character field	18 mins
BM5	Time to access 50 records from 1000 by index on 25-character field	3 secs + scroll
BM6	Time to index 1000 records on 25-character field	1 hr 40 mins
BM7	Time to sort 1000 records on 5-character field	22 mins
BM8	Time to calculate on 1 field per record and store result in record	na
BM9	Time to total 3 fields over 1000 records	20 mins
BM10	Time to import a file of 1000 records	as BM6

Note: na=not available except in Advanced Programming Aids module

Fig 7 DataPrism Benchmark timings

new sequence.) All fields within records in the file are referred to by number (eg, F008). I couldn't get calculation lines to compile if they ended with a field specification — hence the rather unhelpful comments on each calculation line, which I put in simply to get the statements compiled. . .

The @ sign indicates that the calculation variables are to be printed in exactly the position shown on the printed line. Another special character used to 'picture' the display of numeric variables is the £ sign. In theory, this character only has special meaning inside the 'picture' brackets, but I couldn't get the Report Writer to interpret it properly outside those brackets either — it just refused to print it or the remainder of the line on which it occurred. This is of course likely to be a little unfortunate in commercial environments in the UK. DataPrism does provide the ability to print a dollar symbol and to have it 'float' in front of a printed sum of money — what a pity the designers couldn't have implemented a currency symbol in that way, which could be defined by the user as \$, £, F(ranc) or whatever.

Selection

In the simple version of DataPrism, you can select for screen display only by specifying a value to be matched with the current key (the key may of course be a composite of several fields, and in that case you are asked for a match for each). A match is signalled if a value equal to or greater than the comparison value is found, and you may then browse through the file from this point on. The time shown to choose records based on key value is shown in BM5, while BM6 shows the time which would have been needed to create the necessary index, had the fields not been specified as key fields in the original file specification. When listing or form print-

ing, you may specify a range between which the key value(s) must lie. In the Report Writer, the facilities are much more extensive, giving full comparison on any field in the record using the usual range of comparison and Boolean operators, provided only that a selection can be fitted into 132 characters. BM4 shows the time taken to select 50 records which match two criteria on non-key fields.

Sorting

Records automatically appear to be sorted in the order of whatever key is currently in use. You can sort on non-key fields as part of the Report Writer, specifying up to ten fields for the sort. BM5 shows the time taken to sort 1000 records on one field.

Calculations

With the simple package, the only calculation possible is totalling when printing reports. With the Report Writer, you can do any calculations you like on any field, using all arithmetic operators and brackets, and then display or print the results. The time shown for the Report Writer to calculate the total values of three fields is given in BM9. Only one of the totals was correct, but from the symptoms I couldn't see how the Report Writer could have made the errors, nor could I see how my data or instructions could have been responsible.

Without using the advanced programming features you can't store the results of calculations in records in a file, which is why BM8 wasn't done.

Security

Within the basic package, there are no security provisions. The advanced version, the one with programming aids, provides the ability to confine an operator to par-

ticular files and specified functions, and permits the use of passwords to identify operators when initiating a run of the package.

Tailoring

To use DataPrism, you must tailor it to match your terminal features. This seemed a pretty straightforward process, although like most packages you only find out if you have carried it out correctly when you actually try to run DataPrism. This tailoring does not include telling DataPrism about the cursor arrow keys, and these are therefore not available in any of the three versions of DataPrism.

As to tailoring while the package is in use, the most advanced version of DataPrism allows the programmer to access DataPrism files in the same way as DataPrism itself, to design menus of his or her own choosing, and to use all the screen control features to give terminal independence. Included with the advanced module is the MAGSAM/E file management system, which can be used either with DataPrism files or with files created by user programs. Finally, the format of the DataPrism data files means that they can be accessed from most programming languages quite independently of DataPrism if needed. However, since the main focus of these articles is upon the needs of the serious user who is nevertheless not likely to be an experienced programmer, I did not feel it appropriate to cover this area in more detail.

Within DataPrism, you can process up to five files together with the advanced version of the Report Writer. (This option comes with the Report Writer at the same price, but needs a substantial amount of memory to run it, so not all systems would be able to support it.) This gives the facility for reporting on several files linked together, for instance on family/child data files or on stock/supplier files. Beyond that, you would need to use the Advanced Programming Aids module to carry out more advanced linkages, such as updating several files in the same operation. Relations with other packages and files are covered by DataPrism's ability to read and write standard ASCII sequential files in either fixed or comma-delimited format.

Stability/reliability

If there should be problems with data corruption (perhaps with a user switching off without properly leaving DataPrism), there are two functions to enable the user to rebuild the data file. I didn't have any problems with data during my use of the package. However, I did manage to get thrown out of DataPrism on two occasions with different errors, getting error messages of the kind 'Func=RG Error=EOF Data File ID=PCWBTDPM'. I also found the three apparent bugs in the Report Writer which I have already mentioned.

User image

The user image of the software — that is, how the package appears in use — is very

mixed. DataPrism is menu-driven, with clear well-designed menus and mnemonic single-letter codes for menu options. Its approach to file and key selection is sensible. But getting into a function is much better catered for than getting out of one; I never found it possible to by-pass unwanted questions, and often found I needed to type the word 'end' three times to get back to the main menu. This lack of imagination is found, too, in data entry, where one must enter values for each item even if they are mostly zero for a particular record, and in file definition, where I couldn't find a way to copy a file definition if I wanted to create a file similar to one I already had. The problem reaches the really irksome level when referring to files by number — this saves time at the keyboard, but could waste much more if you forgot to change the file number in a report after you had deleted a file and hence had the reference numbers to other files change.

Again, the general screen layout is good, particularly in being consistent about its placing of file names, instructions, current data, message lines and so on. But DataPrism is highly unimaginative in its handling of screen input. In particular, it is very irksome to be obliged to type the numbers of variables one wants to change, followed by the new values, rather than just whizzing the cursor down the screen, pausing only to change fields on the way. Presumably the reason is that there must be terminals somewhere (though I have never come across any) which allow cursor co-ordinate positioning, clear and home screen and so on, but don't have cursor arrow keys on the keyboard — but even then one could permit the user to specify the use of control keys along the Wordstar lines as a substitute if necessary. This is particularly serious in DataPrism, since there is no forms design facility for screen data entry — so you cannot provide a neater user image for yourself or your employees, except by programming it using the advanced module.

This 'curate's egg' syndrome is reflected too in the documentation. The manual is very full — to the point of being so verbose that it is hard to find your way around or to get a picture of the overall model of the package. The only reference I could find to DataPrism's quite considerable ability to display formatted reports on the screen comes in one line in the middle of the Report Writer description, where the screen is mentioned as one option among four for display of the report. On the other hand, there are a large number of helpful examples, which makes a welcome change. On the minus side again, it does add insult to injury to find an index listed in a table of contents (of the Report Writer manual) and no index in the manual (or in the main manual for that matter).

Costs

The basic version of DataPrism costs £175. With the Report Writer the package costs £325, and with the Advanced Programming Aids module £525. As to the more hidden costs, the most noticeable was the amount of disk space needed. The pac-

kage itself is quite large — it seems you would have difficulty accommodating the basic package plus the Report Writer in less than 370k. Indexing space could also be a problem — my data file used 152k of disk for a file where each record has 154 characters, while its index file, for keys totalling 25 characters, used 52k. As to performance, you should find some indications from the Benchtests which are shown in Figure 7. As usual, these were carried out on our Sirius using the (6MHz) Z-80 card and running under CP/M-80.

The package originates in America, and is distributed in this country under licence by Bonsai Ltd, telephone 01-580 0902. I would like to thank Bonsai and Michael Kraftman in particular for help with this review.

Conclusions

If your requirement is for a simple file handling package for under £200, with good facilities for listing files in key order as well as retrieving them by key, then DataPrism should do a straightforward job for you, albeit without any screen formatting of your own, but with quite flexible forms output to the printer. You should compare it with packages like Cardbox and Pearl to see whether it gives the particular mix of features you need. The DataPrism Report Writer gives access to much more sophisticated report functions for display on both screen and printer, but this addition brings the price of DataPrism up close to that of some very strong competitors such as dBaseII, Condor, DMS and the cheaper version of FMS-80. I hope I've given you some idea of DataPrism's strengths and weaknesses; I suggest you compare those with my comments on these other comparable packages. **END**

Missing data

In the excitement of putting together the results of testing nine packages for the December summary of data management systems, I made some omissions, for which my apologies. (The original articles included the information — it was just the summary that left them out). You should note that:

Condor can display selected records interactively (with DISPLAY) — you don't have to create a subfile first. You may also enter (with ENTER) and edit (with UPDATE) records interactively. The emphasis in the manual is on a 'transaction processing' approach, but the commands are there for you to choose the interactive method if you wish.

Personal Pearl stores its information in variable length records of variable format, allows you to design report formats on the screen ('paint-a-screen') and keeps all its indexes up to date automatically. Maximum field size is the maximum width of a screen line, up to 132 characters (not 80, as Figure 1 suggested). Importing of 'foreign' files should be available by the time you read this, and I hope to Benchmark Pearl in the next couple of months.

THE DESK TOP GENIUS.

Now from Sharp, the Sharp MZ 80A. A personal computer that is ready to run the moment you own it. Because the CRT display, the typewriter-style keyboard and the cassette-based data storage are all integrated into one complete system that leads the operator, either amateur or professional, into an incredible new computer world.

For this computer has the power to do virtually anything within the range of Personal Computers. In it, Sharp has combined all its fine electronic technology in the field of information engineering to create



*MZ 80FB
Twin Mini Floppy Disc Unit.*

*MZ 80P6
Character Graphic Printer.
Also available MZ 80P4 and MZ 80P5*

a marvel of precision. Plus, when you purchase you get a valuable software package absolutely free.

The superb Sharp MZ 80A. Among its competitors, it is rated as a genius. To you, it will become a desk-top companion you will treasure, an invaluable part of your daily life.

Bringing to your school, office or home, the high-speed skills and advanced technology of the world of Sharp. Where great ideas come to life.

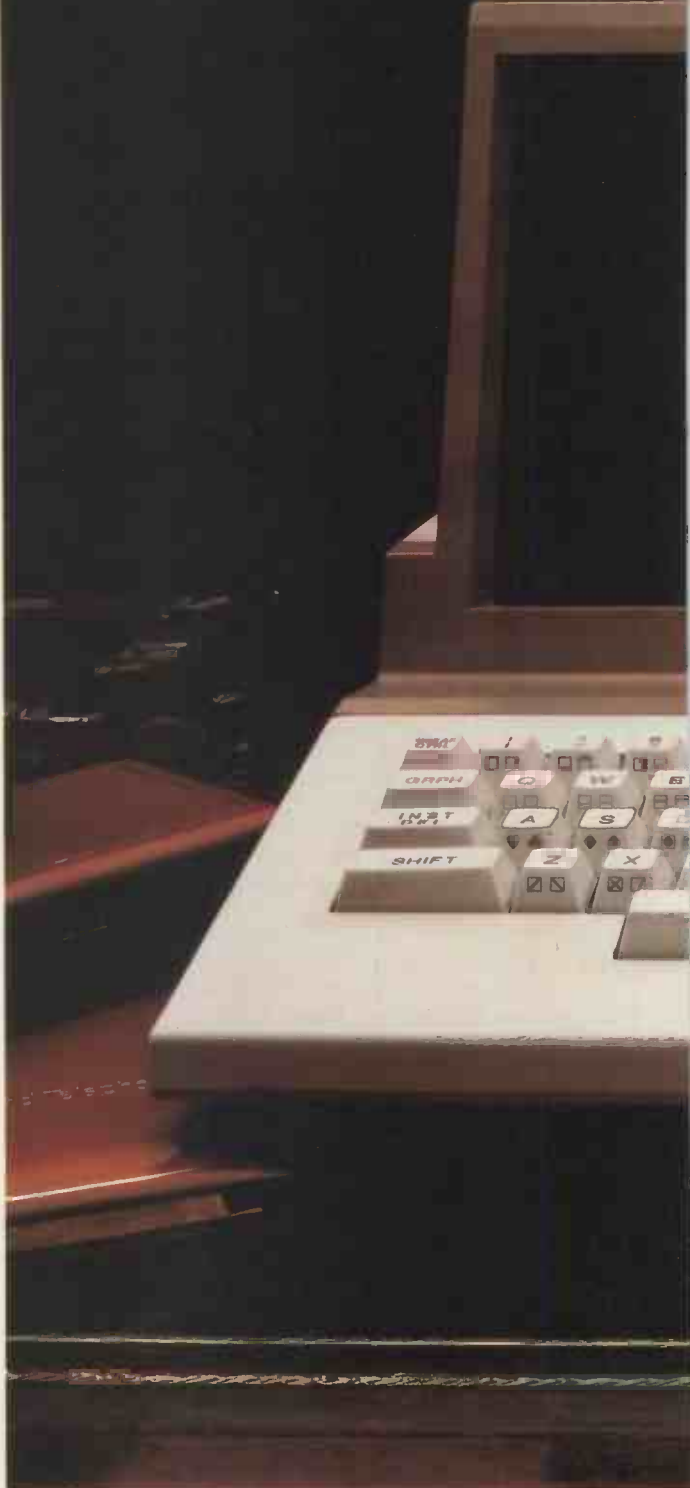

Specifications MZ 80A

CPU	Z 80
Memory	4K-byte ROM; 48K-byte RAM; + 2K-byte Video RAM.
Display	9 inch (23 cm); 40 characters x 25 lines. Green screen.
Cassette	Manual control; standard audio cassette tape. Data transfer (Sharp PWM system) 1,200 bits/sec.
Keyboard	ASC11 keyboard; upper-/lower-case alphabet; graphic symbols; numeric keypad.
Other features	Built-in clock and music function. Auto repeat on all keys. 2-page video RAM (allows the screen to be scrolled up and down). *CP/M available.
Options available	Tape based Pascal Interpreter. Tape based Machine Language package. Sharp FDOS including BASIC compiler. Tape based Z-80 Assembler package.



Printer specifications	Optional Printers		
	MZ 80P4	MZ 80P5	MZ 80P6
Printing method	Serial impact dot matrix		
Feed method	Variable sprocket; Friction	Variable sprocket	Variable sprocket; Friction
Kinds of characters	230		
Character make-up	9(W) x 8(H) dot matrix (normal-size characters)		
Number of digits	136/68 per line 160/80 per line	80/40 per line 136/68 per line	
Printing speed	150 cps (normal-size characters)	80 cps (normal-size characters)	
Head sweep direction	Bi-directional		
Other functions	<ul style="list-style-type: none"> • Software-controlled full graphic function • Programmable number of lines per page • Battery-operated memory of HOME position (MZ 80P4 only) 		

Design and specifications subject to change without notice.

Floppy Disc Unit (MZ 80FB)

Two drives per unit; 5.25" dual-sided, double density; 70 tracks; soft-sectored; 16 sectors per track.

Memory capacity 280K bytes per diskette.

To: Sharp Electronics (UK) Ltd, Computer Division, Sharp House, Thorp Road, Newton Heath, Manchester M109BE. Tel: 061-205 2333.

Please send me details of the Sharp MZ 80A

Type of application: _____

Name: _____

Address: _____

Tel No: _____

The world of
SHARP
 where great ideas come to life.



*CP/M is a trademark of Digital Research Ltd.

G007 GRAPHICS MODULE

Maggie Burton takes a close look at the Notting Dale Information Technology Centre's G007 graphics board for the ZX81.

The pictures on this page were all produced using a ZX81 upgraded with a simple, inexpensive add-on. In that light they're quite striking, especially when the resolution is considered. It's 256 x 192 pixels, which compares favourably to the Spectrum's maximum of 256 x 176 when programmed in Basic.

This add-on is the G007 Module from Notting Dale ITeC — the first product they've put on the market. It was designed by a student, Gary Keall, while he was on holiday, using equipment at Notting Dale, and was originally a hobby project. Keall wanted to increase the graphic capability of his ZX81 and eventually he handed production rights over to Notting Dale.

Originally it was felt that the board should be uncased. The version I have used is one of these earlier ones and it connects horizontally to the back of the ZX81, lying flat behind it. Production models are enclosed in a smart black box which snaps into the '81 in the same way, standing vertically.

The uncased board is rather unstable to use. As it doesn't lie absolutely flat but tilts downwards a little it is very prone to jolts and nudges which have the undesirable effect of crashing the computer. The cased version stands more firmly, although in some circumstances — for instance, when a ZX Printer is being used — it could need propping in place in some way or another. An idea of its shape can be gained from a look at its dimensions. It's rectangular in shape, being 16.6cm from left to right, 6cm high and 2.7cm from front to back (4cm if the edge connector is included).

There are some conditions for using the board which should be borne in mind, especially if your ZX81 is in any way modified.

The module will only work if the ZX81's 1k of internal memory is in place and extra RAM of at least 8k is connected. The ideal RAM pack to use is naturally the Sinclair one, but Notting Dale has tested several other makes and found these all work, including some 64k ones. If in any doubt, of course, it would be advisable to consult them. Other hardware add-ons apart from the ZX Printer are not guaranteed to be compatible so again it would be wise to check. The ZX Printer connects between the board and the RAM pack.

Hardware modules and machine code programs which use the area of memory 2000 to 3000 hex should not be used with the G007 (wouldn't work, in fact) as the board reserves this area for its own use.

Using the board

When the ZX81 is first switched on, the inverse video 'K' cursor appears as normal.

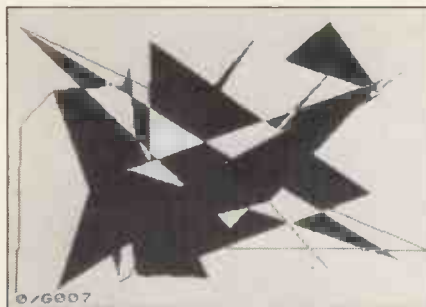
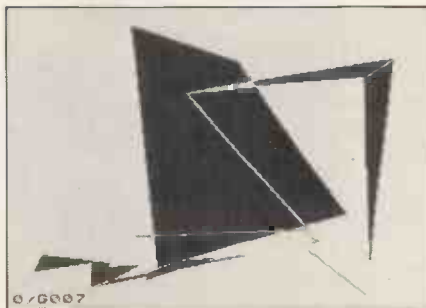
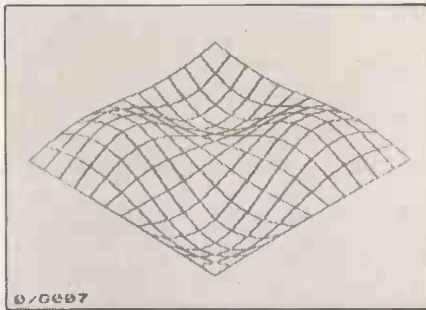

Effects generated with the G007.

The first unusual thing to get used to is the fact that the ZX81 effectively now has two screens: the low-res one which is exactly the same as the basic ZX81 and the high-res one on which all G007 specific commands are executed. You can change between the two at will. The ZX81 defaults to the low-res screen initially and all program entry and editing is done using this display. Typing SLOW or FAST, followed by a number in the range of one to six, will change the display over to high-res, and typing SLOW will take you back to low-res. Changing from one mode to the other has no effect on the contents of either display.

This is a bit strange at first, but the more confusing (initially) aspect of the module

lies in its modifications to Sinclair Basic (Figure 1). Rather than adding new keywords, it has added parameters to the existing graphic-related ones and this is probably because of the ZX81's single-key keyword entry. An example of this is the use of SLOW as outlined above. A better one is the G007's use of PLOT. The ZX81 uses the format PLOT x,y — x and y being the coordinates of the pixel to be shaded. For G007 purposes the formal PLOT n,x,y is used; with n specifying one of 115 separate plotting functions available — hardly a capability to be sneezed at.

Although this is confusing at first, your only real problem lies in remembering which value of n specifies which function — or looking them up all the time as I did. They are summarised at the end of the manual.

As mentioned before, the 'old' ZX81 capabilities have all been retained. The first command specific to the G007 in a program sets the display to high-res mode. UNPLOT on the high-res screen has been replaced by PLOT 0,x,y. When a program is listed (which can only happen in low-res mode) the message 'G007' is displayed rather than the usual '0/0'.

Some slight disadvantages are encountered in the use of the high-res screen. The first of these is the rather common one of being able to see only one command line at the bottom of the screen, as per RML 480Z, among others. It can become rather tedious changing mode every time you want to make a modification to a program, but this is cosmetic more than anything else. The second of these is the fact that re-running a high-res program does not automatically clear the screen. Unless a CLS command is inserted, re-running a drawing program will simply overwrite what was there before, making a really messy screen. Lastly, the display sometimes tends to waver to the right at the top. Remedying this is simple enough. In high-res mode you just type POKE 8833,0. POKEing 8833 with any value other than 0 or 237 crashes the computer.

Programming

The G007 manual contains several demonstration programs which quickly illustrate the capabilities of the module.

A quick look at the summary of commands will show that the PLOT command is the one around which most of the G007's functions are centred. For the sake of clarity I'll go through the PLOT functions one by one and outline what they do.

Points can be plotted in any position on the screen either relative to the graphic origin (the bottom left point) or to absolute coordinates. These can be in black, white or inverse video. PLOT 12,x,y is the equi-

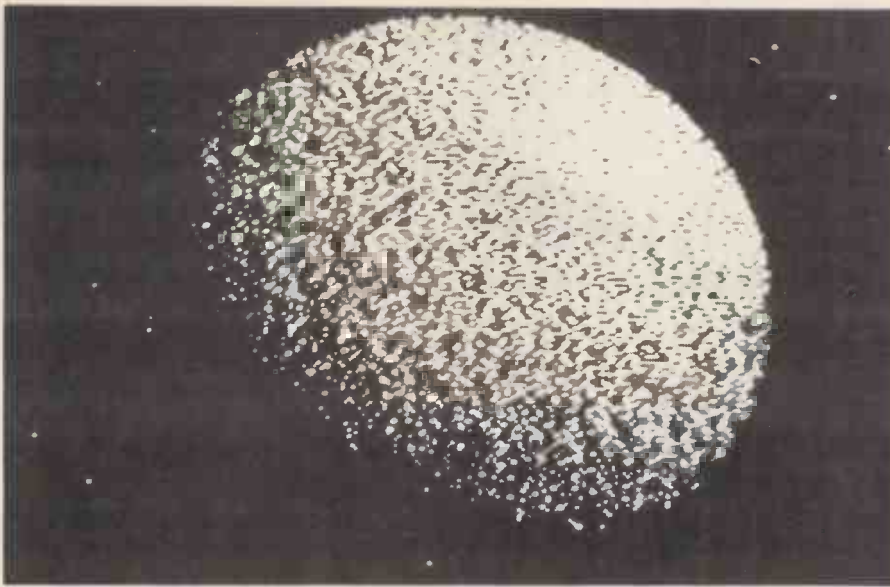

This globe picture took 40 minutes to construct.

valent of a MOVE command.

Lines are drawn from the last point plotted (or the original if no points have yet been plotted) to the point specified. Again these can be to either absolute or relative coordinates, in black, white or inverse or with the last point missing. A useful provision is that of three line types apart from solid ones. These could not only lend variety and texture to a picture, but are also useful in drawing graphs. The three types are coarse, fine or chain-dotted and all are obtained by adding 32, 64 or 69 respectively to the basic line drawing values for n.

It is also possible to fill and texture triangles in a similar way to that in which lines are drawn. Vertices are the last two points plotted (or the two ends of the last line) and the current one. Texturing is not possible on an inverted screen. The default texture (given by putting n in the range 73-80) is a chequered pattern which is quite effective. This can be changed by inserting POKE statements into a program to change the values of the two bytes determining texture. Left or right diagonal shading, cross-hatching or fine dots can be obtained in this manner, although the relevant bytes must not be changed directly from low-res mode.

User defined characters

Defining your own characters with the G007 is, unfortunately, not the easiest of tasks. It is made possible by the fact that the module enables direct conversion between normal and inverse video — therefore the ZX81's inverse video character set is no longer needed. Custom-made characters can be designed on an 8x8 grid, translated from binary numbers into decimal ones, POKEd into memory and then stored in a REM statement at the beginning of a program. The inverse character set vector is moved (again using POKE) to the address containing the first part of the user-defined character. The addresses containing all subsequent parts of the character must be consecutive. Characters are printed using CHR\$.

It's plain that this is not the easiest way to define characters. But it's effective and is protected from NEW as the area of memory between 8448 and 8703 decimal is reserved for storing the necessary data. It is possible to redefine the whole of the ZX81 character set in this way, but extra memory must be reserved to do this.

User-defined characters are complemented by the facility to mix predefined characters and graphics on the high-res screen. This is a flexible capability, especially when compared to the normal ZX81 facilities. Six printing modes are provided, specified by the value of n following a SLOW or FAST command. These modes are quite versatile and you can switch from one to another within a program using SLOW and FAST.

Text is treated as having a foreground and a background. The foreground can be in black, white or inverted and the background can be inverted. This means you can contrive things so that characters are invisibly printed on the screen.

Documentation

An attractively bound manual is provided with the G007. While it is easy to follow and quite friendly, it isn't ideal reading for the beginner. All you need to know about the module is within it, with plenty of

details in appendices at the back on the ins and outs of the memory, calling routines and system variables. It is, though, a manual which needs a fair amount of knowledge of normal Basic before it can be fully understood. This, however, is mostly due to the method of operating the board.

It begins with a list of operating conditions, and an introduction to the G007's capabilities. It then goes step by step through each command used and finishes with a summary and technical details. In spite of the fact that it is in no way aimed at a naive user, it is quite adequate.

Conclusion

There are other graphics boards for the ZX81. Digital Integration makes one which costs £38.95, and provides lower case as well. The G007, however, has the edge in the price department, costing just £32 + £4.80 VAT. It's only available by mail order and 75p postage has to be paid.

It has to be said that operating it is not as simple as it might be. It provides very fast and crisp plotting and outputs well to the ZX Printer, but using it to the full really does take some careful thought and possibly background reading. This means it would be a useful educational tool once a beginner has got past the very first stages, and the possible results make the challenge of a bit of mental activity very worthwhile, as the display photos show.

Notting Dale guarantees the board for 12 months and will repair it (if repair is possible) after that time. A demonstration tape is supplied with it containing some games, more of which will be available in the near future. I'm told that they are 'open to suggestions', according to production manager William Haynes, on the subject of software written for the G007 and would consider using any good ideas which come from customers.

All things considered, the G007 module is a worthwhile buy for any serious-minded ZX81 owner. It's especially good value from the point of view of someone who can't afford a more powerful computer because it makes high resolution computing possible for under £110 (at an educated guess, based on the cheapest available RAM pack prices).

Command	New Format	New Functions
SLOW	SLOW n (n=1 to 6)	Sets display &
FAST	FAST n	PRINT modes
CLS	CLS n (n=1 to 3)	Clears high/low res screen, inverts display.
COPY	COPY n (n=0 or 1)	copies high/low res display to ZX Printer.
PLOT	PLOT n (n=-1 to 130)	Plots points, draws lines, moves graphic origin, unplots, fills & textures triangles, specifies line types.
PRINT	Syntax as before. One of six print modes set by value of n in SLOW/FAST commands.	Prints as normal, prints with black/white/inverted foreground or inverted background depending on mode.

Fig 1

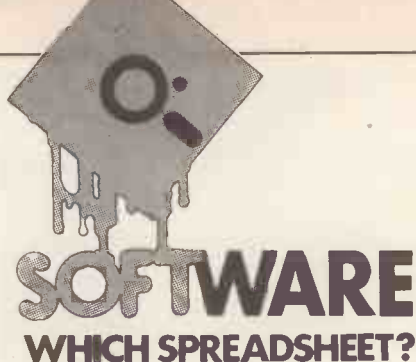

PROPHET II

Mike Liardet reviews an all-in-one spreadsheet system which combines hardware and software in a budget-price package.

My first encounter with the Prophet II system was a rather energetic one: carrying it down three flights of stairs from the PCW offices, into the car, then back up three flights of stairs into my flat. 'So what?', I hear you say, 'Liardet must be pretty feeble if he can't manage to carry a software package a few yards.' Ah! but this package includes the hardware, doesn't it? And it's a particularly 'hard' piece of 'hardware', too!

Basically Prophet II comes as a complete dedicated spreadsheet system — hardware, software, everything you need (bar a printer) at a very modest price of just £795+VAT. The actual physical components of the system are a modified Acorn Atom computer, a Ferguson 12in black and white television and a Pearlcorer microcassette recorder — all fairly lightweight items. However, in an intriguing attempt to marry Victorian engineering with the marvels of today's silicon revolution, Busicomputers — the supplier of the system — has housed all these components in what can best be described as a robust metal case. The case comes complete with carrying handle, but no rubber feet — so if you buy one, don't be like me and plonk it straight down on a polished table. Any other complaints? Well, yes there are, actually: there's no on/off switch — you have to use the plug, and the case obstructs the aerial socket of the TV, making it difficult to use as a conventional TV, should you wish to do so. At least the microcassette is detachable and can be used independently if so desired, and the computer can be used as a straightforward Acorn Atom in addition to its spreadsheet function by simply flicking a switch.

Getting started

Anyway, having got the system home, where do you start? Well, quite simply, plug in the single mains plug, switch on the TV (the Prophet II one, that is), twiddle the tuning dial and with minimal fuss you are faced with the spreadsheet display. Refer to the manual and off you go!

To anyone who has seen a number of spreadsheet systems, the initial display has a fairly reassuringly familiar look about it. The bottom 13 lines of the screen (out of 16) are dedicated to the spreadsheet window. The top left hand corner of the spreadsheet is currently 'in-window', with the cursor (displayed using inverse video) at the very top left hand cell. Also in inverse video, down the left hand side are listed the row coordinates (numbers), and along the top are the column coordinates (letters). The top three lines of the screen are also in inverse video, but are reserved for special messages, and so on.

Moving the cursor around the spreadsheet is very simple. The Atom has four keys (up, down, left and right) at the side of the keyboard and simply pushing these moves the cursor in the obvious directions. Moving the cursor off the right or bottom edge of the screen causes a rapid screen redraw — the window position is being adjusted to follow the new cursor position. The cursor actually remains physically where it was before, but the coordinates have changed. Moving off the bottom of the screen causes row 1 to disappear, and be replaced by row 13 at the bottom — row 2 being the new top row on the display. A similar thing happens to the column coordinates when the cursor moves off the right hand side of the screen. Holding the arrow keys down causes very rapid cursor movement, with lightning-fast screen redraws. Unfortunately, this redrawing is accompanied by a somewhat disturbing 'tracer-storm' on the display. As soon as you let go of the key the display returns to normal.

By continually moving the cursor away from the top left hand corner, the overall boundaries of the spreadsheet can be established: 255 rows by 63 columns (columns after the 26th are identified as AA..AZ, BA..BK). Attempts to move any further than this are flagged with beeps from the Acorn speaker. The system provides a direct cursor 'jump' facility: a few keystrokes and we have leapt back to the top left hand corner. Actually there is also a

rapid cursor move facility: holding 'shift' and an arrow key simultaneously, the cursor leap-frogs ten cells at a time, which is quite useful for middle distance 'jumps'.

Entering numbers and text in the spreadsheet is very straightforward: simply move the cursor where you want, and type away, terminating with 'return' to 'fix' it there. (Terminating with an arrow key results in the cell being left blank and the text being moved with the cursor to an adjacent cell.) If you enter a decimal number it is a little bit disconcerting: at switch-on the display format for numbers is integer-only and consequently your decimal number is displayed rounded to the nearest integer. After some scouring of the manual, it transpires that all is in order — if you change the display format (fairly easy to do) you will see your number correctly displayed. Regardless of display, the system has correctly 'remembered' your original entry.

Doing calculations

Setting up a calculation is almost as easy as entering numbers and text: Prophet II uses the fairly standard notation already familiar to anyone who has ever written a program, and picked up easily by anyone versed in most basic mathematics. Cells are identified by their coordinates, '*' is used to signify 'multiply' and '/' for 'divide' — thus expressions can be built up like '(A1*B3+(C4-A1))'. So to get Prophet II calculating simply move the cursor to the required cell, type in the expression and see the instant results of the calculation. Jump back to any of the referenced cells, change a value, and see the new recalculated value instantly displayed. Change one of the referenced cells from numeric to text data, and we can quickly verify that Prophet II does not go haywire (good!).

Prophet II comes with an extensive range of other functions, apart from the elementary arithmetic: square roots, logs, trig, degrees to radians, a random number generator — in fact just about everything



So simple a hamster can use it?

you could possibly want in this respect. Special functions, not normally encountered outside the world of spreadsheets like 'SUM', 'MAX', 'COUNT', 'net present value' and others have all been implemented to operate on a rectangular block of cells as well as being capable of dealing with a simple row or column. There is also a function called 'TOP' which returns the amount of memory still available. Unfortunately, the display itself does not provide this information automatically, so if you are reaching the point where memory is getting scarce you must keep referring to this

function. (Incidentally the system does not 'crash' if you attempt to exceed its memory capacity — it merely displays 'E' (for 'exceeded?') and refuses to allow you to do anything that would consume any more memory.)

Special facilities

Much to my relief, the system comes well equipped with a formula replication facility — the Benchmark tests involve filling the system up to saturation point, easily done with replication, but a major cause of

'reviewer's digit' if you have to do it manually! Incidentally, most of the extra facilities, such as replication, format changes, and others yet to be mentioned, are invoked by hitting the '/' key, followed by a sequence of mnemonics — eg, '/FA A1L9' means 'Format Area from A1 to L9'. Although the facilities are all well described in the manual, and there is also a reference card stuck on the case, it was sometimes difficult to remember or find the correct sequence. Unfortunately the system provided very little prompting, most of the time keystrokes being passively dis-

PROPHET II

played at the top of the screen with no additional information. Obviously these difficulties pass once complete familiarity with the system has been gained, but a little more help at the learning stage would have been appreciated!

There are also adequate facilities for deleting and inserting rows and columns, or rather crossing out and inserting lines and columns (since the delete mnemonic is 'X' for 'cross out' and the row mnemonic is 'L' for 'line').

Prophet II provides a facility for editing formulae or whatever may have already been entered into a cell. It was only when I reached this point in the manual, where an exercise is set to change 'PROFIT' to 'PROPHET' by editing, that I appreciated the product name is in fact a pun — obviously based on the old joke about the monk who was expelled from the monastery for fiddling with the profit!

The cassette

At this point, I must say that although somewhat disappointed by the overall weight of the system, once permanently stationed on a table it seemed to be performing fairly well: documentation well written, consistent and clear, all facilities you can reasonably expect, low price, etc. First surprise: a 60-minute microcassette set me back £2.50. As it is not recommended to store more than one spreadsheet on each side of a cassette, this works out several times more expensive than floppy disk storage (where a £3 disk can usually manage 10-20 spreadsheets or more). Still we can buy a fair number of cassettes with money saved on the overall purchase price of the system! Anyway, having set up the Benchmark test, I got the system to do a 'save' to cassette. Having done this sort of thing many times before, with other floppy-based spreadsheet systems, I am used to just a few seconds pause for even the largest spreadsheet to get written to disk. In the event, Prophet II took 32 minutes to do the 'save', spending the last two minutes on 'borrowed time' and finishing just before the tape ran out! I gather that the system uses the standard Acorn Atom cassette tape protocol and appears to be able to save about a thousand characters of data a minute. Tape read and write speed being the same, the 'load' time is identical. Anyone contemplating using the system for medium to large spreadsheets (and applications can grow big very easily) had better be prepared to do loads and saves during his lunch-hour.

Display and formatting

Having dealt with the only major problem so far, I moved on to check out the layout and formatting facilities: These proved to be very flexible. Columns can have individually differing widths ranging from zero (yes zero! — useful for 'hiding' intermediate work-columns, etc) right up to 29, which fills the entire screen width.

Numbers can be formatted using normal decimal, integer or the scientific 'E' notation. Display within a column can either be left or right justified — this facility is particularly useful for correctly aligning text used for column headings, where, in contrast to row headings, right justification provides a neater display. Finally, Prophet II does not provide the 'split-screen' facility seen on some spreadsheet systems — perhaps the Acorn Atom 16x32 character screen is too small to make this of any real value, but it does provide a useful alternative. The system maintains four different cursor positions (initially all identical), and it is possible to flip around each of them very rapidly. Once the cursor positions are at different points on the spreadsheet it is possible to effect a very rapid scan through four completely different (and quite probably very distant) parts of the tableau. These different positions are labelled, a little misleadingly, as 'Screen A', 'Screen B', etc. I prefer to think of them as 'positions', since they are in fact all on the same spreadsheet — my initial impression was that the system maintained four different spreadsheets.

Other facilities

Two other useful facilities: cell protection and titling. Cell protection prevents inadvertent modifications to a cell and the titling facility enables what would typically be the first column and top row to be kept continually on-screen, even when the cursor is miles away from the top left hand corner. As this is where you normally place your row and column headings, this provides a great deal of help finding your way round the spreadsheet ('Is is row 78 or 79 that has the sales figures?').

Checklist

Documentation: One manual of 67 pages, no index, no contents page, sparsely illustrated. Written as a tutorial with embedded reference material. Easy reference card affixed to case. Documentation generally clear, consistent and well-written.

User-friendliness: System was easy to use. More help-prompts would be of value.

Error-handling: Hardly any error messages, but the system handled all keyboard error conditions correctly.

Facilities: Extensive arithmetic, very primitive graphics, can handle spreadsheet overlays. Turnkey system. Can insert, delete and replicate rows and columns. Very flexible display facilities — no split screens but useful alternative. Can protect cells and do titling, edit formulae, switch between automatic and manual recalculations. Provides 'long jump' facility, and deals satisfactorily with 'out of memory'. Searching and logic also provided.

Benchmarks and other measurements:

Measurements: Up to 255 rows and 63 columns. Columns can be up to 29 characters wide. Screen dimensions are 16 rows x 32 columns. Numeric precision is 9 digits.

Benchmark 1: (a) 87 rows; (b) 34 seconds; (c) 34 seconds; (d) 6 columns/second, 6 rows/second (21 columns/second, 64 rows/second using 10 cell at a time 'leap-frog' moves).

Benchmark 3: 123 rows.

For an explanation of Benchmark timings see 'Which Spreadsheet' — PCW February 1983.

Supplier and price:

£795+VAT — includes all hardware (except printer), software, manuals.

Basicomputers Ltd, Polebrook Hall, Peterborough PE8 5LN. Tel: Oundle (0832) 75052/73049.

As the system was supplied without a printer, I did not have the opportunity to test printout facilities, but examining the manual suggests that everything is quite satisfactory in this department.

Really that just about covers everything in the system. There are some other special operations and functions which can be of use in special circumstances: a search facility, arithmetic comparison ('less than', etc), a conditional (IF(x,y,z) results in y if x is true, but z if it is false), and a fairly primitive facility for graphics. Basically a cell can be given the 'graphics' format, and this causes it to display a text character (which character depends on the value in the cell) instead of its value. As the Atom hardware provides a set of graphics characters it would be possible, eventually, to set up a bar graph, or some other fairly simple display.

Conclusion

It should be remembered that this system provides a fairly inexpensive way of obtaining a sound and reasonably well-presented spreadsheet system. Most of the price-savings arise from the fact that the system functions without the need for disk drives. Whilst this saves something on price, it does penalise the user in convenience, with up to half hour waits for saving the biggest spreadsheets onto the audio-cassette. Spreadsheet purchasers on a very limited budget should give this system serious consideration, but should also take a close look at the competition — eg, the disk-based Osborne 1, or the new Epson HX-20, to name but two inexpensive systems with spreadsheet facilities, both recently reviewed by PCW.



32/16-bit power and unique versatility at your fingertips.

Using the advanced Motorola 68000 micro-processor, the Corvus Concept puts minicomputer power on your desk-top for around £5,500!

with UCSD extensions, P-code and Assembler – making the Concept a very powerful development tool. Applications software available

now includes Edword word processor and LogiCalc spread-sheet planner. And the Concept's value in scientific applications is further enhanced by four 50-pin peripherals slots and two RS-232 connectors.

UNIQUE SCREEN OPTIONS AND POWERFUL DISPLAY

The Concept features a unique dual-orientation high-resolution screen which can be rotated instantly for either full A4 portrait (90 characters x 72 lines) or landscape format (120 characters x 56 lines). The 720 x 560-pixel bit-mapped display can present text and graphics in a multiple-window format.

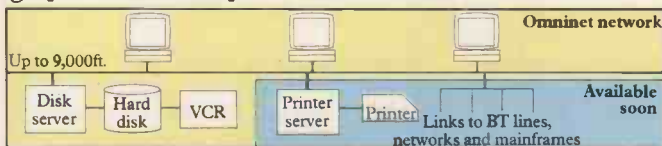

ECONOMICAL NETWORKING

A built-in network transporter enables the Concept to plug straight into a 64-node Omnet network. This high-speed (1 megabaud) system can give access to several 80Mb hard-disc drives, with all the economies of low-cost micros sharing expensive peripherals, ease of installation and straightforward access to mainframes and telephone networks.

MASSIVE RAM, INNOVATIVE SOFTWARE AND EASY EXPANSION

Standard 256K RAM (easily upgradable through 512K to 1Mb) gives full scope for Fortran 77, ISO Pascal

TOTAL USER SUPPORT – NATIONWIDE

The Corvus Concept is available through a nationwide network of Micro Systems Centres, and quality is endorsed by the 'Microcover' full on-site warranty and maintenance scheme.

Come and see the exceptional Corvus Concept in action – ring now for details of the next seminar on Concept.

**London 01-236 9942
Nottingham 0602 412777**

I want to know more about the Corvus Concept

- Please send me more information
- I would like a demonstration – please contact me
- Please send me details of my nearest Micro Systems Centre

My application interest is _____

Name _____

Position _____

Company/Establishment _____

Address _____

Tel: _____

**Keen
Computers**

Please post to Keen Computers Ltd.,
Marketing Department,
6 Giltspur Street, London EC1A 2DL.

CORVUS CONCEPT

Dick Pountain tests another entrant in the 68000 supermicro stakes.

The introduction to the Corvus Concept User Guide begins 'Congratulations, with the Corvus Concept you have entered the next generation of computing'. It seems like only yesterday that I entered the third generation of computing with the ACT Sirius, which makes it clear that microcomputers reproduce on a timescale closer to that of the rabbit than to homo sapiens.

Inspection of Corvus's claim, though, reveals that it has much merit. The presence of the MC 68000 processor alone is not quite enough to constitute a new generation, shared though it be by the Fortune 32:16, Sage II and a host of other new machines, but the claim is strengthened by the overall design of the Concept. It is basically designed from scratch as a powerful network work-station which can if desired be used as a stand-alone computer. It makes use of high resolution graphics and a full A4 display only previously found on expensive dedicated word processors. It is entirely winchester-based, floppy disks being used solely for distributing software. The system software and programming facilities are entirely based around Pascal, with Fortran as a second option for the scientists and engineers; for use as a management tool it comes ready equipped with a spreadsheet and word processor which are integrated into the system firmware. All of this certainly adds up to something which feels like a next generation compared to the CP/M-based standard which still prevails among business machines. The refinement does not come for nothing, though; the Concept is more than twice the price of a top end CP/M computer.

Hardware

The Concept was Benchtested as a stand-alone computer system using a 10Mb winchester disk for storage and a single 8in floppy for loading extra software to the winnie. The system consists of five units; a processor housing on top of which sits the monitor, a separate keyboard on a coiled lead, and the floppy and winchester housings. The units are boxed in well-finished glass-reinforced plastic cases in Apple grey/beige.

The processor housing is a flat box whose sole visible feature is a cooling grill through which the very quiet fan draws its air. At the rear of this box is a panel which mounts two RS-232 sockets and the connectors for keyboard, monitor and Omninet, the Corvus network. A large section of this panel is removable by loosening two screws; it slides out like a drawer, revealing

the main board to which it is attached. This board, a multi-layer PCB, contains the 68000 and all the support chips as well as four Apple-style expansion slots. These are more than just Apple-style, they are Apple-compatible: the controller boards for the Corvus winchester and the floppy plug in here, their ribbon cables leaving through a vertical slot — again Apple-style. The winchester controller will reputedly plug straight into an Apple and work (I didn't have a chance to try it). The compatibility is limited since the 68000 will not run 6502 code.

Memory is contained on a second board, piggy-backed on 2in stilts, and consisted of 512k of static RAM on the review machine (256k is standard). This is organised as four banks of 64k devices, each bank being further split into upper and lower bytes for the 68000's benefit when performing 16-bit accesses. 55k of the memory is used to bit-map the video monitor with Direct Memory Addressing to allow writing to the screen at 32 Megabits/sec.

The huge monitor sits on top of the processor housing and tilts and swivels in the modern fashion to any convenient position. The real novelty though is that the monitor can be lifted off its pedestal and turned on its side so giving the option of a 'portrait' (full A4-sized display) or a 'landscape' (extra-wide display for spreadsheet work). The monitor is locked or released from the pedestal by a sliding catch under the front edge; having changed its orientation a switch on the rear panel is flipped to change the orientation of the display to match. This operation has to be done with power off and the monitor unplugged so it is not advisable in the middle of an editing session.

The two different display modes require different display drivers, the loading of which is controlled by the switch; one consequence of this is that the manner of scrolling varies. In the portrait position scrolling involves a rather disconcerting rewrite of the whole page at each line so that I generally preferred to work in the landscape position where the scrolling is more normal. The monitor displays 560x720 dots in black and white; the picture being sharp and steady apart from a very slow ripple which is not obtrusive. The display can be reversed to a white background by toggling one of the function keys, and is divided into windows which are controlled by the system software — of which more later. One surprising omission is that the screen is of bare glass with no anti-reflection coating; handy for combing your hair but annoying in a machine of this price.

The keyboard unit is small by comparison with the surfboards we have seen from IBM and DEC; it has 91 keys and features a numeric keypad which also contains the cursor keys and is separated from the main keyboard by a narrow fixed bar. The feel of the keys is excellent and they make a most satisfying click. All keys auto-repeat and there is a FAST key which steps up the repeat rate to rat-up-a-drainpipe proportions. All input is via a sizeable type-ahead buffer so that you can type a whole string of commands without having to wait for, say, a series of disk accesses to finish between commands. A proper caps lock is fitted along with the usual ESC and CTRL, though the latter is placed at the bottom right. Two special shift keys sit on either side of the space bar; COMMAND shifts to a new set of function key labels while ALT gives an extra set of characters from the keyboard, including in the standard set Greek and European accented characters. Concept character sets are software loaded and user-definable, as will be seen under 'Software' below. Along the top is a row of ten function keys which are extensively used by the operating system and are the main means of entering commands. In all, this is a high class keyboard which is a pleasure to type on.

Software

When you have said 'software' you have said almost everything about the Concept; remarkably little is contained in ROM. As it is intended to be used exclusively with a winchester, all its device drivers, character sets, and most of the operating system reside on disk and are loaded as needed. Only the self-test routines, some machine level I/O routines and the boot code are in ROM.

Given the size of much of the software (the operating system occupies 96k) it is clear that floppies were never a real option. On the 512k machine the user is left with 275k of program and 121k of data space, on the 256k you get 83k of program and 57k of data.

The single-user Concept uses an operating system which is called Merlin but which the manuals consistently refer to as CCOS. This is a volume oriented system which bears strong influences from Unix but lacks the latter's multi-tasking abilities (that is, the ability to run two or more programs simultaneously).

When powering up the Concept, following a self-test report, a menu invites you to choose the source for booting, the options being Debugger, Floppy disk, Local and



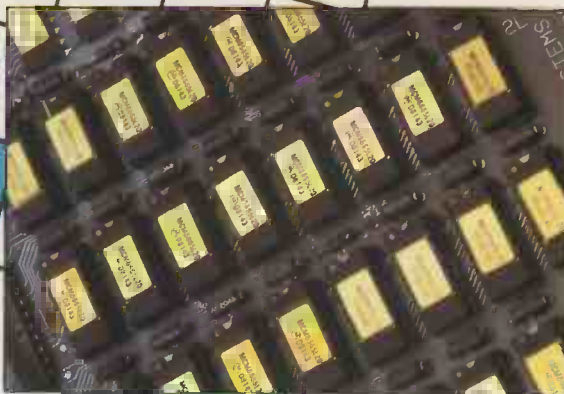

CORVUS CONCEPT

Omninet. In our case Local is chosen for the local hard disk drive. The Debugger (not fitted to the test machine) resides in PROM for use in development systems. Once booted, the Corvus logo is displayed and then you are asked for your user name and password; while this is hardly necessary on a single-user machine it has immense psychological value. You really feel as if you're playing with the grown-ups. CCOS then looks for a file called CC.SETUP which contains a command sequence to execute. On the review machine this mounts a selection of volumes, but it could be made to go on to run a program for turnkey applications.

A volume, in Unix-speak, is any physical device which is on-line, like a printer, a floppy drive or the console or keyboard. Volumes used for storage are called blocked volumes, because they are written to and read in blocks, whilst the others are serial volumes. A floppy drive is treated as a single volume whereas the winchester is divided up into several volumes, of sizes chosen by the user. One of these is selected to be the current volume, which is rather like having a particular floppy loaded in a drive. The current volume can only be selected from those which are mounted (ie, recognised by the system).

Once into the operating system proper, one is confronted with a screen divided into three windows: a large box where the business is actually done, under which is a narrow box, the command window, where all system prompts and user replies are typed, and below that ten labels which show the current function assigned to each function key. As on the Hewlett Packard HP125, these labels are arranged in hierarchical fashion so that pressing one often leads to a new level of labels. In addition, each single label can carry four different functions by virtue of the two shift keys, SHIFT and COMMAND — pressing either or both of which presents a new set of labels.

The actual operating system shell, which is very Unix-like, need not be seen since all necessary commands are available through the function key program, which is called the 'Dispatcher'. If it is required or desired (say by an experienced Unix user) to enter the actual shell this can be done by pressing the Execfile key without any argument; this takes you out of the Dispatcher level and puts the '%' prompt up in the scrolling window ready for typed commands. Execfile is a utility like CP/M's SUBMIT (but more general) which normally takes as argument a file of operating system commands which are then executed in order.

The first level of Dispatcher labels contains the names of various application tasks which are available — viz CP/M (the Corvus CP/M Emulator), Logicalc (the spreadsheet), EdWord (the word processor), plus the commands to list the directory of the current volume, change the current volume, clear the current window, change the

current window and Help. Help gives access to an on-line manual; press it followed by the key for the function you wish to enquire about and an explanation is loaded from disk and displayed.

The second level is reached by pressing COMMAND and contains the various manager programs; FileMgr, WndowMgr, SystmMgr and MountMgr. FileMgr leads to a new level where all the utilities for copying, listing, deleting, renaming and concatenating files are found; additional facilities are Makefile which can construct a directory header and Crunch which is necessary to gather up free disk space into a contiguous block when files have been deleted.

Directories in CCOS are not nested beyond one level (one per volume), unlike Unix. A directory listing shows file names, date last updated, size in blocks, number of bytes in the last block, starting block address on the disk and type (there are only two types, text and data, ie, binary) — which is quite a screenful for a humble CP/M user. Free spaces are shown in a volume directory listing as files with the name < . . . > and Crunching the volume will place all the space as the last entry.

Output redirection a la Unix is allowed with ListVol and ListFile; to send the listing of a volume called Myprogs to the printer you would type '/Myprogs > /Printer', where the slash denotes a volume name and > means 'send output to . . .'. To access a file on a volume which is not current you type a 'pathname' such as '/Myprogs/Myfile'.

WndowMgr leads to a level where alternative character sets can be loaded from disk either to the keyboard or the display or both. Also, windows can be created, deleted and selected in the main part of the screen (the command and label windows are fixed); up to 17 windows can be made but, since CCOS is only single-tasking, one of them must be selected as the active one where display occurs while the others are frozen.

SysMgr gives access to utilities for setting the time and date on the real-time clock calendar (which has built-in battery backup), for setting printer parameters and assigning device drivers; it also contains the program EdChrSet which lets you create new character sets. This program works rather like EDOT (or Cedit or whatever they call it now) on the Sirius, being a screen-oriented editor whereby you draw the characters on a supplied grid using the cursor and filling in squares on a much enlarged scale. It is more flexible than the Sirius version, though, in that the size of character you can produce is not limited to the standard 8x10 grid but can have any height and width in the range 1 to 16 dots.

Finally, MountMgr contains the utilities needed to mount and unmount volumes. This has only scratched the surface of the Concept operating system but there is so

much to describe that it could take up the whole Benchtest. In particular, I haven't mentioned printer spooling and despooling. At first I was rather intimidated by the beast, not having had any Unix experience, but once the system of Dispatcher labels had sunk in I began to find it easier and easier and soon started to regret the absence of many of its better features in CP/M. In particular, the error reporting is clear and intelligible and invariably fail-safe — eg, 'Vol. not on-line'. The only real gripe I have is that there are some inconsistencies in the ways of quitting functions: sometimes you hit Exit, sometimes Q for Quit, Cancel or Cncl, sometimes ESC and Return, sometimes Return on its own, and very occasionally you have to reboot. This is about par for the course on most micros but the rest of the Corvus ergonomics are so good that it stands out as a source of irritation here.

Talking of CP/M, the Concept has an Emulator program in which the 68000 pretends, through software, to run 8080 instructions. Separate volumes have to be set up in CP/M format; pressing the CP/M key then brings up the dreaded A> and away you go. It runs very slowly but I managed to install and run a database program called Rescue successfully from the floppy drive. It flatly refused to run Z80 Forth, though, presumably because some Z80-only instructions are used.

EdWord is Corvus's text-editor/word processor program and its fame has already spread in advance of the machine that supports it. It is entered from the top Dispatcher level by pressing its own key. The program then prompts for the name of the workspace you wish to use. A workspace is not merely a text file; rather it is a structured collection of text files which is saved as a total environment each time you exit from EdWord. This means literally that when you reopen a workspace weeks later, the cursor will still be at the place in the text where you left off (it also means that you never have to worry about saving your text as you do in Wordstar). If the workspace you name does not exist, EdWord asks you for the size you require and creates it on the current volume if there is room (the size cannot be altered once set). The workspace I am typing this in occupies 700 blocks — ie, 350k — which should be enough!

Each workspace is structured into named workpads which are the actual text areas; some of these, like the ones for printer output and the Undo and Redo functions, are created by the system and others by the user. The workspace is organised by hierarchical directories (more like Unix than CCOS itself is). You can create new directories at will and new workpads within them. Workpads can be written to disk as CCOS files, which is the format required when using EdWord as a Pascal or Fortran editor; it is unnecessary when word processing as they are saved in the workspace anyway. Equally, a CCOS text file can be

TRUE 16 bit!



Olivetti M20

The new Olivetti M20 provides everything the modern businessman is likely to need in a desktop computer

- * **SPEED:** fastest of 62 'Personal Computer World' Benchmark timings. Faster than Sirius and IBM. True 16 bit data bus + screen RAM.
- * **MEMORY EXPANSION:** 128k up to 512k RAM
- * **DISK STORAGE:** Standard 320k or 640k floppies with optional 10MB hard disk (built-in). Faster disc access
- * **BUSINESS SOFTWARE:** Full Range. Integrated Accounts, Stock control, Payroll, or separate packages. Wordprocessing, Financial planning, Specific packages e.g. Solicitors' accounts, Engineering design, etc.
- * **GRAPHICS:** High resolution standard on all versions. About 3 times Apple II resolution for NO loss of user memory. Colour version available. 512 x 256 dots, full flexibility
- * **COMMUNICATIONS:** Programmable RS232 interface built in plus parallel printer output, IEEE 488 option. Software available for IBM etc protocols, Videotex. Extra RS232 option
- * **CP/M:** Not an ideal 16 bit operating system but optionally available. Olivetti's PCOS system is supplied as standard and is faster and more powerful. EMBED system commands in Basic
- * **SERVICING:** Direct from Olivetti Service Centres
- * **FINANCE:** Lease or Rent through Olivetti Finance
- * **COMPETITIVE PRICING (Includes PCOS and MBasic 5.2):**

M20S: 128k RAM 16k screen, Single disk, monochrome:	£1895
M20D: 160k RAM 16k screen, Dual disk, monochrome:	£2395
M20C: 16k RAM 32k screen, Dual disk, 8 colour:	£3262
M20H: 160k RAM 11 MB, Hard disk, 1 Floppy, monochrome:	£4295

Brighton Computer Centre

130 Lewes Road, Brighton BN2 3LG
(0273) 688946 Mon-Sat 10am-6pm

Please send me further details of the Olivetti M20

Name.....
 Company.....
 Address.....
 Tel.....
 Application..... PCW 3

Superscript

The Ultimate CBM Word Processor

A Commodore enthusiast wanted a word processor that was simple, fast and easy to use. He wanted to handle up to 20,000 characters of text, to use a wide screen format of up to 240 characters, with full window scrolling in all directions, and be able to use the screen while printing. He wanted a word processor at a reasonable price. The enthusiast, Simon Tranmer, couldn't find one... so he wrote

Superscript

Superscript does everything he wanted... and much more. It provides a complete document preparation and storage system, making optimum use of memory and disk space. It gives full access to all the letter quality printer features, such as boldface and ribbon colour change. In short, it provides all of the advantages of a dedicated professional word processor.

Superscript

is easy to instal, because there's nothing to instal! Just load the SuperScript diskette, and your PET becomes a world quality word processor. Superscript runs on the CBM 2001, 3016, 3032, 4016, 4032, 8032 and 8096 computers, on the CBM 2040, 3040, 4040, 8250 and 8050 disk drives, all Commodore printers, and on a wide range of letter quality printers.

Superscript

does everything Commodore wanted... which is why they are adopting it for all of their forthcoming models. And finally, the magic ingredient...

Superspell

a 30,000 word disk-dictionary with automatic spelling checker, that will verify the largest SuperScript (or Wordpro) document in under two minutes... and you can easily modify the dictionary, or add your own words.

SuperScript and SuperSpell are just two of our fine Commodore products... please phone or write for our free comprehensive data sheets on any of the products listed below:

SUPERSCRIPT The Ultimate CBM Wordprocessor	£249.00
SUPERSPELL Disk Dictionary/Spelling Checker	£150.00
SUPERSCRIPT Educational Price (Send Official Order)	£50.00
MASTER Write your own database	£295.00
PM96 Memory Management + Extra Basic for CBM 8096... ..	£99.50
KRAM Keyed Disk Access (state which disk)	£59.50
COMMAND-0 (for Basic IV, state which Pet)	£59.95
DISK-0-PRO Adds Basic IV to Basic II, to clear.....	£29.95
SPACEMAKER 4-Rom adaptor (not for 8096)	£34.95
VISICALC 32K/96K RRP £200.00, our price	£160.00

ORDERING INFORMATION: Add 15% VAT to quoted prices. Order by post/telephone/Prestel, using cheque, Access, Barclay Card or Official Order. Telephone (01) 546-7256 for same-day service. For over-the-counter sales, see your CBM Dealer. (Ref All)

Calco Software

LAKESIDE HOUSE, KINGSTON HILL, SURREY, KT2 7QT. TEL 01-546-7256

CORVUS CONCEPT

read into a workpad — the system does this initially with a pad called 'HELLO' which is an interactive EdWord tutorial. Later on you will delete this facility to save time. A nice touch is the provision of two graphic 'thermometer' style indicators on the screen which show you where you are in the current workpad and how much of the workspace has been used up.

The actual editing functions are a joy to use, controlled as they are from the function keys with no control codes to remember. Basic editing is done with the cursor and the Insert and Delete line and character keys while a key called Zip allows fast movement about the workpad with GOTO a given line number or the beginning or end of file or backward and forward a page. Adjust automatically formats paragraphs, preserving any indents (great for Pascal source code). Automatic wordwrap is featured but, unlike Wordstar, EdWord does not justify text on the screen; justification occurs on the printed output using dot commands. Search and replace can remember four 'patterns' to search for, either literal or token search, and also remembers the last pattern you searched for and offers it as the default. Cut and Paste commands for moving blocks of text work through a system workpad called Copy which holds the text to be moved; this allows copying or moving to other workpads and editing of the copy text in its buffer. The maximum width available is 150 columns; this requires sideways scrolling even with the landscape screen.

It is when using EdWord that the combination of winchester, fast processor and fast screen is most noticeable; everything happens almost instantly compared to a floppy system running Wordstar, and what small delays there are, are absorbed by the type-ahead feature.

The feature which has excited most comment, though, is Undo/Redo, which allows you to undo all the changes you have made to a text, generation by generation, restore them to the original form, and also to redo them again (this is done by saving the edits in special system workpads). Undo means that when a horrible mistake is made all can be made well at a keystroke.

Full background printing is supported, as the formatted text lives in a separate workpad called PRINT; you can carry on working in another pad while it happens. Printing can be arranged so that the formatted version of your text can be inspected in the PRINT pad before committing it to paper, and printing starts automatically when you leave the pad; the formatted file can be edited for last-minute changes.

In short, this is the best editor I have ever used and I grind my teeth audibly at the thought that I have to give it back! My only disappointment, perhaps rather a churlish one, is that given the amount of memory and the ability for soft character sets, surely it should have been possible to display bold and italic on the screen, rather than relying

like everyone else on embedded escape codes.

Logicalc is a competent but unexceptional spreadsheet program, which, by dint of the half a meg of memory, can hold a huge worksheet. A pity that Corvus couldn't have signed up Multiplan whose powerful multi-file capabilities would have suited CCOS a treat.

And so on to programming. Although a Fortran compiler is included, the Concept is every inch a Pascal machine in that Merlin (or CCOS) is written entirely in Pascal except for a few lines of assembler for raw I/O routines. The entire programming environment is the work of Silicon Valley Software Inc and consists of the Pascal and Fortran compilers, a 68000 Assembler, a Linker and a Librarian which can handle relocatable modules produced by any of the language processors. A system library contains Pascal and Fortran routines to control all the hardware including the high res graphics, turtle graphics, the sound generator for music, and the function key system. The graphics primitives include plotting a point, drawing a line, filling a block, moving a block and writing a string of bytes. No raster operations as such are included but the design of the machine would lend itself to writing some. The graphics are easily incorporated into a Pascal program by declaring 'USES CCgrFIO'.

The Pascal compiler (SVS Pascal) broadly follows the ISO standard with some extensions drawn from UCSD Pascal. Its file structure is UCSD-compatible. It generates 68000 native code and as you will see from the Benchmarks it is a bit quick (roughly the same times as the PDP 11/34), especially when compared to p-code systems.

It shares with UCSD the restriction to eight significant characters in identifier names and the implementation of Library Units and the USES declaration and Interface and Implementation sections. It adds an 'Otherwise' clause to Case statements, hexadecimal constants, and the passing of procedures and functions as parameters but lacks the reserved word 'segment' (the effect of segmentation can be had through a compiler option \$\$). Interesting additions are the predeclared variables ARGV and ARGV which contain the values and number of arguments passed from the command line to a running program and @ which when placed in front of a user declared variable, function or procedure returns its address.

The compiler prints the numbered source line when a compilation error is encountered but does not invoke the editor as does UCSD. Nevertheless EdWord's capacity for remembering where you were, plus its single keystroke entry, makes for debugging which is just as fast, and there is no doubt that though the UCSD editor is good, EdWord is better. The Linker is very easy to use as it is menu-driven; all Pascal programs require a run time library PASLIB to

be the last item linked, regardless of any Library Units that might be in use. PASLIB contains all of the maths, including transcendental functions, whereas these are in a Library unit in UCSD.

Having no expertise whatsoever in either Fortran or 68000 Assembler I cannot comment any further on these except to point out that the Fortran compiler is too big to run on the 256k model without fiddling with stack pointers and one who should know says that it generates code which runs slower than the Pascal.

Expansion

The system tested had the full complement of RAM — ie, 512k. The winchester could have been replaced with a 20Mb model and up to four drives (including any floppies) could be daisy-chained onto it. But the most obvious expansion is to add the Omninet network and more Corvus Concepts to share the expensive bits, like the winchesters and daisywheel printers, between them. Each machine remains a single-user, single-tasking machine but the spool/despool facility of Merlin allows the printer to be shared while individuals maintain their own volumes on the disk. Obvious applications for this kind of network are for word processing and spreadsheet planning in a large office or for programmers in a software house. It is not very suitable for shared database work or systems where security is involved because of the relatively free access of all users to the data, and the degradation of disk access times that would be involved if the users were constantly on the net. Since Omninet uses a simple twisted pair cable and requires no interface hardware but that which is built in it should prove much cheaper to install than more sophisticated network systems such as Ethernet.

For multi-user, multi-tasking under Unix, Corvus is working on a new (incompatible) model of Concept which will also

GOTO page 224

Pascal Benchmarks

magnifier	0.15
forloop	1.33
whileloop	1.51
repeatloop	1.23
literalassign	1.73
memoryaccess	1.81
realarithmetic	19.75
realalgebra	17.88
vector	11.47
equalif	2.46
unequalif	2.44
noparameters	0.95
value	1.30
reference	1.38
maths	11.93

For a full explanation and listing of the Benchmark programs see PCW May 1982.

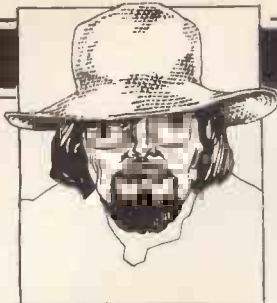

BANKS' STATEMENT

BELLS, WHISTLES & GIZMOS

Martin warns: don't build your hopes on manufacturers' castles in the air.

By the time you read this, the new year will have already taken shape and be well on its way. At the time of writing, however, it is still a fond gleam in a politician's eye. This is a time when it is worth considering what the next 12 months will bring, and whether you will benefit from it anyway.

Such thoughts may seem strange when the world and its uncle suddenly wants to buy a home computer for itself and its children. Both the users, and the industry, should benefit greatly from such an arrangement. Unfortunately, it is exactly this demand from users and potential users that can create problems — problems that can cause those users disquiet, distress and aggravation.

Not least of such problems is the one outlined by my colleague, *PCW's* news-hound Guy Kewney, in the January issue of this august magazine. He pointed out the number of products — both complete machines and add-on bits and pieces — that should have been available by Christmas time. Unfortunately, they were not available.

Now this is a fairly common occurrence in the computer business, where pre-announcement of hardware and software has been used for years as a legitimate, if unfair, marketing tool. With mainframe computers especially, where the purchase price is large and the purchaser's lead time on the decision-making process long, there is an arguable justification for a major manufacturer to pre-announce a new product, even though it may not be available for 18 months. Okay, so it's unfair not to tell people it won't be available, but with large purchases, the time scales involved make such tactics tolerable at least.

But now, as Guy pointed out, many of the manufacturers in the personal computer business are doing the same thing. They are not, however, doing it for the same reasons, at least not always, for with the mainframe manufacturers the ploy is consciously used to prevent a potential customer from placing an order with a rival.

In the personal computer business it would appear to be, as much as anything, an over-enthusiastic desire on the part of some companies to be seen in the marketplace with the latest gizmo. It is, to me at least, one of the saddest aspects of the personal computer business that it seems so intent of fostering the 'techno-freak' aspects of users. It is therefore imperative, in the manufacturers' eyes, to appear to the users as *the* company with all the latest bells and whistles. (In this context, one

important bell and/or whistle is cost — or the lack of it.) Sadly, some companies could even be accused of announcing a new product before they have actually really cracked the problems of making its predecessor.

At the low end of the market, where machines cost between £50 and £150, this techno-freak marketing approach is quite noticeable. Virtually every issue of this, and other magazines, contains at least one advert for an entirely new product, the latest gizmo that technology can bring. It usually comes from a company that no one has heard of that is wishing to join a market that is already crowded with other similar companies that are under-financed and waiting to become cannon-fodder for the Japanese.

All these companies now face major problems. The size and growth-rate of the market for small home computers has taken many by surprise, including the manufacturers themselves. This would seem at first sight to indicate that there should be plenty of room for allcomers in the marketplace. Unfortunately, things don't normally work out that way. In a market that is large, rapidly growing, and oriented towards high-volume merchandising techniques, the fact that a new manufacturer on the scene has the best product is actually irrelevant. What counts is being able to manufacture it in high volume, coupled with the finance, ability and skill to support the distribution network.

Such requirements demand, in the end, the capabilities of a big company, and the majority of the minnows just do not match up, no matter how good their products may be. In the high-volume home computers marketplace, there is room for only a handful of successful manufacturers, yet the UK has thrown up more contenders than that itself.

By this time next year it would seem highly unlikely that many, if any, will have advanced much further than they are at present. Some inevitably, will have regressed significantly.

Such problems do prompt the general question of when is it a good time to purchase a system: should a user jump in now or wait for something better? In the home computer area, perhaps more so than anywhere else, the answer is to buy what is available on the shelf. There will always be something better coming along, and even if you wait for that to actually appear, something better will by then be coming.

The same is true for the bigger personal

computer systems, those that find their way into the professions and small businesses. The main 'something better' in this area is, of course, tangible, for it is the IBM Personal Computer, due to finally and formally appear in this country about now (that's now as you read this, not now as I write it).

For better or worse, IBM's machine has already become the up-market hardware equivalent of CP/M, the *de facto* standard against which all others are compared and evaluated. IBM has a habit of assuming that level of significance in the computer industry.

The official marketing of the Personal Computer will at last regularise a hotch-potch situation in the sale of the machine in the UK, it having been available from an ever-growing number of suppliers — both respectable and dubious. Many of the 'back-doors' through which the machine has crept into this country will probably become superfluous, and may well consequently wither away. For the IBM PC, it must be assumed that the formalisation of its UK marketing will be one of the better events of the coming year, certainly from the user's point of view. It goes without saying that there is a certain assumption that IBM, as a company mainly experienced in marketing other types of system, will actually manage the event correctly.

The same remarks, if to a lesser degree, can be made about the appearance of the DEC family of machines, though these have so far failed to promulgate quite the excitement of the IBM system, through not generating a 'black market'.

Both of these machines have been launched long enough to become known to the users. More interesting in terms of speculation are the products from those two stalwarts of the personal computer industry, Commodore and Apple.

The former, even just a year ago, looked remarkably moribund. The PET was long in the tooth and the VIC not yet too significant. Announcements were rumoured to be around the corner, but had not yet arrived and all that was available was gossip. Now the company's dealers should be starting to sell the subjects of that gossip: the 500 and 700 series machines.

It is early days yet (though much later than expected — another example of pre-announcement of new products) but the company may well have come up with a couple of interesting systems. The interest comes from the fact that they combine the best bits of the PET, which in this case

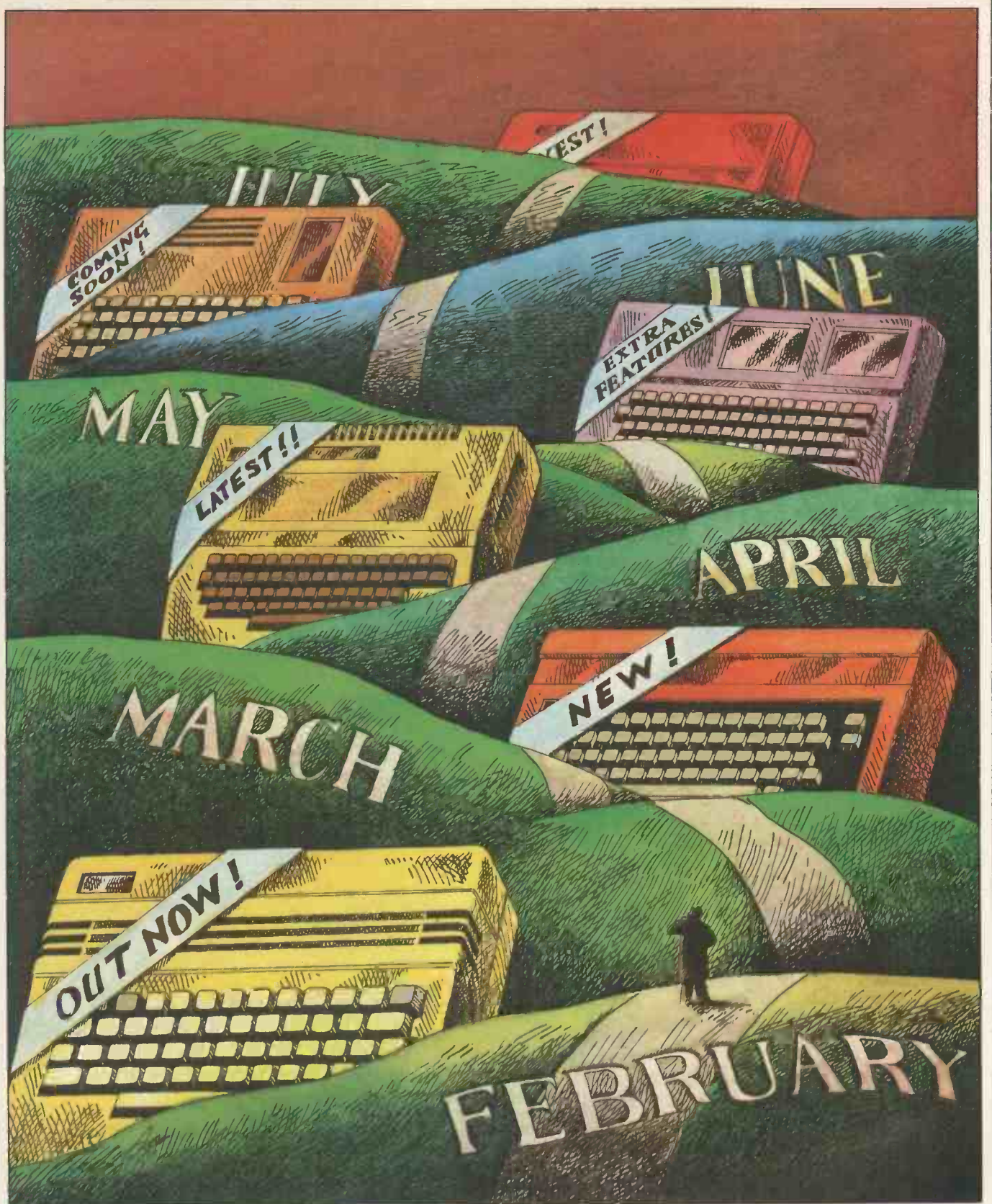

Illustration by Ingram Pinn

means much of the software and data files already established by users, with greater processing power, and the opportunity to add-on second processors that allow the machines to emulate such as the IBM PC.

If it works well, this could prove to be a good trick, and one that the users could find very helpful. Many will find it has been worth waiting for.

The same may be true in a year's time of that other company, Apple. Apple II, till now arguably the most successful single system produced, is as long in the tooth as

ever the PET was. Apple III, through its early problems and the subsequent appearance of rival and superior 16-bit machines, has never managed to take the world by storm.

Now, however, there is Lisa, a system about which there is (at the time of writing) only conjecture. The main platform of that conjecture, however, is that it will incorporate an operating system that will at last give true meaning to that oft-maligned term 'user-friendly'. It will allow users to perform tasks in the way they think of them, rather than demanding the opposite of

the user.

As with so many manufacturers, not least of which has been Apple itself, the announcement of the machine may not mean too much to the user for a while. Machines do have a habit of not appearing on time. That is usually a good reason for the user to purchase what is actually available — it does at least exist. Both the Commodore and Apple machines show however that with technology there *is* also always something better coming over the horizon.

END

BENCHTEST

THE LYNX

We've been expecting this machine for a while. But is it as slick a cat as it's cracked up to be? Maggie Burton finds out.

Everybody must have seen the adverts by now. 'How to increase the size of your memory.' 'Expandable to 192k.' The Lynx, expected in November, is now just about to go on sale. And having been proclaimed in advance for several months, is it what it claims to be?

Computers was formed in winter 1981 under the name Camtronic Circuits. Brought together by the Lynx, the company comprises nine members and its sister company, GW Design, about 16. The Lynx itself is subcontracted and the original machines were designed and put together by Computers and GW.

The machine offers both colour and high resolution graphics. It also offers a 'grow with the user' type of quality that many machines cannot boast. It is theoretically possible to set it up as a small-scale business micro.

Hardware

To look at, the Lynx is very pleasing. It's cased in arty dove-grey injection-moulded ABS and is that rather familiar home micro 'wedge shape' seen from the side. It's about the same size as the VIC-20 but a bit more angular, like an Acorn Atom. The dimensions are 34.5cm wide, 21.5cm from front to back and 6.5cm at the highest point.

The casing is substantially built although there are one or two areas where it 'gives', most notably on either side of the space bar and above the ports at the back. These areas could have done with a little more reinforcement but it could take quite some bashing nevertheless.

A metal-cased PSU plugs in through a DIN socket at the back on the left. The PSU itself is roughly as heavy as the Lynx, weighing just over three pounds on my bathroom scales (the Lynx weighs just under four pounds). The lead between it and the computer is a little short, but the lead from PSU to mains is much longer. The PSU becomes almost painfully hot to the touch after being switched on for more than an hour or so, and at one stage I even warmed my feet on it while computing! The rivets holding it together & the bottom really do get too hot to touch. This could easily have been rectified by cutting ventilation slots in the PSU case and electrically insulating the whole thing from within.

Amusingly, the Lynx comes complete with an optional set of stick-on rubber feet for the PSU (I think they'd possibly melt if you stuck them on to the rivets). Otherwise,

they stick like limpets; I stuck some onto a Sirius and I think they're there to stay.

The I/O connectors are nice and solid although you can see into the machine above them. From left to right (with the front of the machine facing you) there's power, expansion bus, cassette, RS232, light pen and composite video, RGB and, on the far right, the TV socket.

The keyboard comes in the same grey colour with white lettering on all character keys and red on the control ones. There is a total of 57 keys, 12 being devoted to control. These are: ESC, Control, up and down arrows, Shift Lock and Shift on the left; Break, Delete, left and right arrows, Shift and Return on the left.

Escape is used to exit a program in the middle of execution. The Break key is used (to quote the manual) 'within certain specialised programs' but it does not go into any further explanation. Apparently this key will be used in future applications. There is no reset key, which proved to be a nuisance — to get out of an infinite loop or to recover from a total crash, you have to unplug the PSU.

I noticed with some amusement that the Return key is labelled 'Control' even though there's a Control key, too. This is almost certainly a mistake as other Lynxes I've seen don't have this peculiarity. The big disadvantage with the Return key is that it's parked right next to the Shift key. If you're typing away enthusiastically it's very easy and extremely exasperating to hit Return instead of Shift — which, of course, means you have to retype the whole line. This would have been better placed where the Delete and arrow keys are and would thus prevent a lot of lost time.

Typing on the Lynx keyboard is quite a pleasant exercise. It has a crisp feel to it and responds well. It's endowed with auto-repeat, although this is a little slower than is necessary, and is fully debounced.

Inside

The machine reviewed here is the standard 48k machine; 92k, 128k and 192k versions are available and smaller machines can be fully upgraded internally. An upgrade to either 128 or 192k will increase the screen resolution from 248 x 256 to 248 x 512 and give an 80-column display as well but you'd have to buy a monitor for this.

In spite of the fact that I'm hardly either a stickler for tidiness or a hardware designer, I did feel that the design of the PCB was a little inelegant. This is probably made

worse by the fact that the Lynx uses no ULAs and therefore has to employ a larger number of smaller chips to do the job. RAM is not grouped in any apparent logical order on the board — 16k of it is in front of the keyboard plug, 16k is haphazardly arranged on the right of the Basic interpreter chips and 16k comes on a cute little plug-in board which goes just in front of the TV socket.

The 4MHz Z80 sits between the keyboard plug and the Basic interpreter. The Basic interpreter comes on two EPROMs (socketed, of course) which will probably turn into ROMs before too long. A third socket is provided, presumably for the insertion of dedicated ROMs/EPROMs.

To the far left at the back of the Lynx sits a fairly large speaker (through which the Lynx beeps disconsolately when switched on), cushioned by a circular piece of plastic foam.

RAM expansions almost certainly plug in where the aforementioned memory board does, but there is a plug just in front of the parallel expansion bus which is probably also designed for extras. In fact, as there's a good bit of fresh air above that plug, you could conceivably fit in a substantial cartridge or circuit board — an indication of room being made for the future.

All in all, it's a solidly put together but really somewhat dated piece of computer engineering. All soldering is precise, components are firmly fitted and wires properly trimmed. Compared to, say, the Spectrum, it's a rather clumsy outfit when you consider the fact that the two machines have similar capabilities, but size and appearance really aren't everything.

Display

When you first switch on, the Lynx prints its logo at the top left of the screen (complete with the little pawprint) in white on a black screen. Underneath this it puts the prompt 'Ready!' and a 'greater than' sign followed by a flashing block cursor.

The display is quick to appear and very crisp. Initial tuning in is very simple and, once set, it rarely drifts off frequency. The only problem here is that the display is rather too sensitive to the position of the TV leads. Jerking this or loosening it slightly (as on occasions when the TV gets knocked) can cause the screen to waver. The colours are very vivid and crisp and, once you have the machine tuned right, they never drift. Full upper and lower case lettering is provided directly from the keyboard.

Photography by Karin Craddock

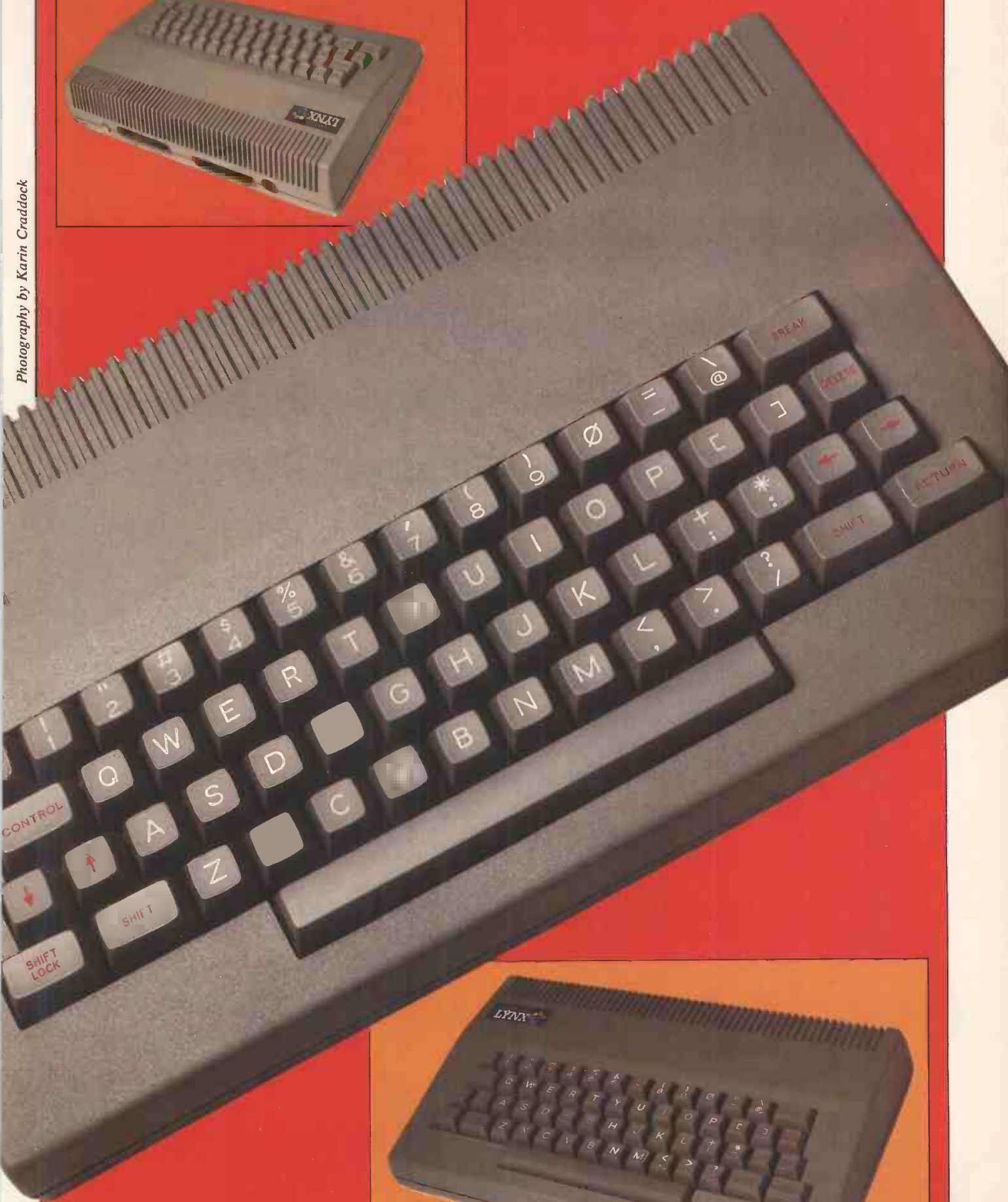

Performance varies from TV to TV. I found the Lynx wouldn't produce colour at all on a nine-year-old Ferguson (but then neither would the Spectrum) but it worked well with a Sony Trinitron and even better with a small Hitachi portable. If in any doubt — for instance, if your TV is ancient or a little-known model — some consultation with a dealer would be wise.

Lynx Basic

David Jansons, who designed Lynx Basic, had a lot of experience of Microsoft and TRS-80 Basic. 'I don't like them', he said. His aim in putting together a highly non-standard Basic was to make it 'as structured as possible'. Considering he put the original interpreter together in a little over four months, it's quite an achievement, though it has been regularly amended since the machine was announced in September.

It includes some very odd qualities indeed, the reasoning behind which seems a little strange. First and foremost, it won't allow multi-statement lines. Now, quite a few older machines are the same, and Jansons explained he did this to improve readability of listings. But the alternative in the area of code-cramming is to use line numbers with a *decimal point!* This means you can have a

THE LYNX

huge number of lines in a program — four figures after the point are allowed — and this is far more than you could ever need.

Not only is this facility negated by the Lynx's RENUM command (which will deal with GOTOs and GOSUBs as well), but it also makes for hideously untidy listings as the Lynx does not justify lines for you. Imagine beginning a program with lines 100-150 in increments of 10 and then adding 120.1234, 120.1235, 130.12, 130.13, 130.44, 140.5 and 141.444 (which you'd have to be mad to do). Write it down — unjustified — if you want to see the effect it would have on readability.

Furthermore, had you been enough of a lunatic to number your lines in increments of one (or even 0.0001) and you wanted to add more lines, all you'd need to do would be to type RENUM 1,100 (ie, from line 1 at an increment of 100) to rectify the situation.

The next oddity in Lynx Basic lies in the number of loops and conditionals provided.

As well as the conventional IF...THEN...ELSE, FOR...TO...STEP...NEXT, GOTO, GOSUB...RETURN, you are armed with labels (for use with GOTO and GOSUB), procedures, WHILE...WEND, REPEAT...UNTIL and three logical operators — AND, OR and NOT. This is actually a good idea: you can plough through your algorithms, relentlessly structuring as you go and then understand them afterwards.

A lot of really odd facilities are provided. These include (most notably) the ability to change the cursor character and the rate at which it flashes. The flashing effect is produced by a block character and a space being printed alternately very fast (there is no way to make characters flash from Basic apart from using this idea with PRINT), so using the CCHAR command you specify two characters which alternate. CFR (cursor flash) ranges from incredibly slow (CFR65535) to incredibly fast (CFR1).

Debugging is made easier not only by a flow trace, but also by a command, SPEED, which sets the rate of program execution. This simply increases the delay between program lines and you can then see exactly what's going on.

This leads us logically on to editing. I found this fairly easy, but with one or two inevitable disadvantages (the perfect screen editor has yet to be invented). Control 'E' gives you the response 'line number?' and expects either a line number, label name or procedure. Inputting one of these and pressing Return gives you the specified piece of code with the cursor at the beginning of it. You then move the cursor to the place where the correction is needed and delete/insert as necessary. The up and down arrows can move you either to the beginning or to the end of the line. Control 'Q' will allow you to edit a line, entry of which has just given an error message without specifying its number.

It would have been a little more logical to add the ability to move up and down, using the arrow keys, line by line, although the Control 'E' idea can save time in long programs. What really is a bit of a nuisance is the use of 'DEL'. You can't just type in a line number, hit Return and see it magically disappear as you can with most micros, although you can overwrite lines. You can delete blocks of lines using the format DEL first line number, second line number. The only real advantage with this method is that you have less chance of erasing lines by just typing in the numbers, although you could still overwrite lines by using the wrong numbers for new ones.

A 'shorthand' facility can be used when entering programs. It is effectively divided into two different methods. One method is referred to in the manual as 'single-key' keyword entry but is in fact double key entry. It works like this: You hold down the ESC key and type one letter standing for the reserved word you want to enter. Not all words are provided for in this manner, but all the common ones — eg, PROC, GOTO, STOP, REM, etc — are. The trouble is that you have to remember which letter is which word, although most of these are logical.

The other abbreviation facility is far



DOUBLE DENSITY OSBORNE AND PRAXIS

1

The heart of this office of the future is the powerful new "double density" Osborne 1 portable computer with 64k memory, two 200k disc drives and built-in monitor. The Osborne is linked to an Olivetti Praxis 30 11cps daisy-wheel printer/typewriter for printing your work superbly. In addition you get software (sold elsewhere for up to £800) to make your office of the future into a word-processor or a financial planner.

And as a special bonus we add the exciting new UCSD Pascal.

3

The Olivetti Praxis 30 is a new style electronic typewriter with its own memory, automatic erase, and a double keyboard which gives you 14 extra characters. Use your Praxis on its own as a prestige easy-to-use typewriter, or plug it into your Osborne and use it as a high quality computer printer.

THE OFFICE OF
THE FUTURE TODAY

2

Your Osborne and Praxis are a remarkable combination. The machines are so portable you can carry them both home instead of working late. Plug them together slip the Wordstar/Mailmerge disc into the drive and you have a word-processor with twice the capacity of earlier Osbornes. Change discs for Supercalc and you have the power of a dozen clerks for your budgets. Then Osborne types your work perfectly on Praxis.

O-COMPUTERS

A member of the C/WP Group
104-106 Rochester Row, London SW1
Telephone: 01-828 9000

£1599
+VAT

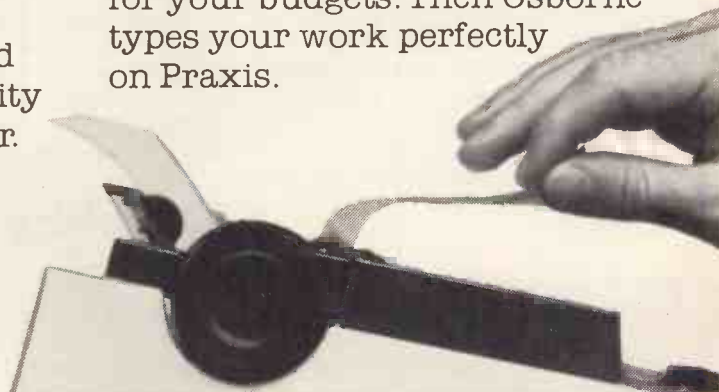
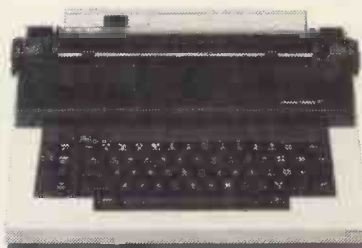

more reasonable. You simply type in enough letters of a reserved word (the first two are usually enough) to make it distinguishable from any other command and follow them with a full stop. Once you get used to this it is very useful. In addition, you can use '?' instead of the word PRINT.

String handling is very odd. For a start there is the glaring omission of STR\$ which converts a numeric variable into a string. In spite of this, VAL is included, which does the opposite. All the old faithfuls — LEN, ASC, LEFT\$, RIGHT\$, MID\$ and CHR\$ — are there with the addition of UPC\$, an oddity which will convert all letters in a string to upper case.

String arrays were, incredibly, nearly left out altogether originally. Computers plans to introduce a string/data file handling package on either EPROM or ROM cartridge in the near future. The situation now is this: you can type DIM A\$(6) which allows you to input a string of up to six characters — rather pointless in the face of such commands as INPUT A\$. DIM A\$(6)(12) dimensions a 12 element array, each array consisting of up to six characters. The largest eight-character/element array that the 48k Lynx will accept is 1000 elements. Only single dimensional string arrays are allowed.

While still on the subject of arrays, two-dimensional numeric arrays can be wangled with DIM A(R*C). Selection of a particular element — say 3,4 — is done using the format A(3*C+4). A bit weird really, all things considered.

A positive arsenal of numeric functions is provided. Among the more bizarre of these are INF, which returns the largest number the Lynx can process, 9.9999999E+63, and FRAC which is the direct opposite of INT. Arcsines, cosines and tangents are available (as well as SIN, COS and TAN). Two functions I've never encountered before on a standard machine are DIV — integer division (dividing without leaving a remainder) and MOD, its opposite, which gives just a remainder. Logarithms and Antilogarithms (and natural logs, too) can be used. Another Lynx oddity is the command pair ROUND and TRAIL. ROUND OFF will switch off the computer's automatic rounding facility. Internally, the Lynx works on an accuracy of eight digits and round this off to six when final values are printed on the screen. Therefore you have the choice between six and eight digit accuracy. TRAIL ON allows you to put trailing zeros on to bring accuracy up to whatever ROUND has dictated. Following either of these commands with OFF sets the machine to its default of six-digit accuracy with no trailing zeros.

Again, another omission: that of DEF FN. You can't have everything but this command is a rather powerful one and can save a lot of work. It's one which is frequently invaluable and which very few Basics leave out these days.

I/O control

The Lynx is fully disk-compatible — CP/M is about to be launched for it — and the disk operating system is called up by one command — DISK. This is, of course, a

THE LYNX

stupid thing to type in if you have no disks as it crashes the system.

Three printer commands can be used — the obvious LLIST and LPRINT; and the addition is that of LINK, which displays simultaneously on printer and screen. This is handy, can be impressive in graphics programs, and is unusual on home computers. I must point out here that I was unable to run a printer from the Lynx and can only judge these commands from the manual.

Cassette handling is good. For a start the baud rate is user-specifiable in increments of 300 from 600 to 2100 baud. This is done simply by typing TAPE followed by a number from zero to five (zero being 600 baud, the default). The manual states, however, that to use the higher baud rates you have to have a 'good quality cassette player and tapes'.

LOAD, SAVE and VERIFY are, of course, provided, with the interesting and useful addition of APPEND. This allows you to add a program stored on tape to one already in memory — provided the first line number of the program to be loaded is higher than the last one of the program in memory. Cassette recorders with a remote control facility are controlled by the Lynx — although only certain types or remote control will work.

Machine code programs must be loaded using the command MLOAD, which is otherwise exactly like LOAD.

One of the major disadvantages of the Lynx is the fact that it will only accept single-letter variable names, although the interpreter distinguishes between upper and lower case. Therefore you could use A, a, A\$ and a\$ in the same program. The disadvantage here does not lie in numbers as much as in distinguishing one variable from another. Very few Basic programs will need more than 52 numeric and 52 string variables. The problem really lies in being unable to read a program and understand variable names logically, so a stringent record would have to be kept of which variable stores what. Two-letter names would have been more logical, and long variable names better still.

SWAP is a really useful command which allows you to simply swap the values of two variables.

The RESTORE command can be reset to any line number which contains data. This adds versatility to DATA statements because you can use some data once, some twice and some over and over again as necessary without having to repeat data items in later lines.

Graphics and sound

I've already mentioned the surprising crispness of the colour display. The Lynx provides eight colours (including black and white) and these are coded from 0 to 7 (0 is black and 7 is white). Interestingly, you can

use the colour's name as well as its number — eg, PAPER BLACK or INK GREEN which I found myself using far more than the numbers. This also improves program readability.

PROTECT is a command which can generate some interesting visual effects. The Lynx sends colour signals as a mixture of three primary colours: red, blue and green. If you type in PROTECT RED, anything in red already on the screen will be left there and cannot be cleared or overprinted. But any new characters or lines with an element of red in their colour will have the red removed. You can also protect sub-colours like magenta or cyan — which means you can only print on the screen in one colour. PROTECT 0 (black) returns you to a three-colour mix again. Protecting white will stop anything from being written to (or erased from) the screen.

This is lots of fun and it can even be unnerving if you forget that anything already on the screen in the protected colour cannot be moved. It actually looks as if the computer's crashed (hard crash I mean) if you've just listed a program and then run it with a PROTECT statement before a CLS statement.

Colour mixing is possible using a fine chequered graphics character (CHR\$(242)) as it is on the Spectrum. Although you can only do this in squares, it's very striking because of the crispness of colour.

CHR\$(242) is one of 26 predefined graphics characters listed in the manual. You can obtain these from the keyboard by locking the shift and typing CTRL 1 followed by 'Return'. Exiting graphics mode is done in exactly the same way. The keys used are the '£' key and letters A-Y.

You can also define your own characters. The Lynx character matrix is 6x10 which is unusual and leads to rather elongated lettering, which is not unattractive. Therefore each character takes up 10 bytes of memory and this has to be reserved before you start inputting the data. I'll deal with that in more detail later, along with machine code.

Once you've reserved your memory, the binary digits to make up the character's bit pattern can be read from DATA statements using the command BIN — not a la Spectrum but to the format POKE address, BIN(A) after the data has been read. The Lynx has two pointers and one read-only variable in memory, ALPHA — the beginning of the conventional character set, GRAPHIC — the beginning of the duplicate character set and HIMEM which tells you the first free address after the stack. This can be moved about using RESERVE. These three numbers are all important in defining your own characters. GRAPHIC points to where a new character is stored and ALPHA is used in modifying letters — changing the typeface, for example.

There are easier ways to design characters, but this is adequate once you've got the hang of it.

The Lynx's screen resolution is 256x248. This allows for some impressive drawing effects. DOT, DRAW, MOVE and PLOT are the relevant commands: DOT does the obvious thing — puts a dot on the screen at the specified coordinates; DRAW puts a

C/WP BITES £200 OFF APPLE II E

Meet the Apple II E, the brand new much improved version of the tried and trusted Apple II. The "E" has (almost) everything you ever wished the Apple had. The memory has been increased to 64k with an optional expansion to 128k. The keyboard has sprouted extra keys, making 63 in all, with proper shift keys and four arrow keys to drive the cursor round the screen. The screen boasts capitals and lower case letters (40 to a line—or 80 with a low cost optional add-on). And for brilliant colour the "E" has a built-in PAL encoder—just add a modulator and it plugs straight into your colour television set.

The 80 column card is only £70 (no, it won't work with the Apple II Europlus). For £150, you can buy another card which provides both 80 columns and an extra 64k of memory which switches in and out as required.

Apple II has joined the big league.

But there's one thing Apple Computer has not changed. The "E" still runs all (or almost all) Apple II's enormous library of software without reprogramming or adaptation. Alas, the "E" costs more than its predecessor. But C/WP has had its way and is cutting £200 off the recommended retail price. The "E" is yours for a modest £645 plus VAT.

Or if you prefer it, we can still sell you an old-fashioned Apple II Europlus at the old-fashioned price—£499 plus VAT.



Prices do not include VAT.		RRP	C/WP Price
Apple II E		£845	£645
80 column card		£80	£70
80 column card + 64k		£180	£150
Monitor and stand		£170	£130
Disc drive with controller		£345	£270
Disc drive without controller		£245	£220
C/WP Contour	3 Mb	—	£995
	6 Mb	—	£1195
	12 Mb	—	£1495
	21 Mb	—	£1995
Multiplan		£185	£175

C/WP

**OUR PRICES STILL
TURN OTHERS GREEN**

108 Rochester Row,
London SW1.
Telephone: 01-828 9000

THE LYNX

line on the screen from the last point plotted (or the last position of the graphic cursor) to the point specified; MOVE simply moves the invisible graphic cursor to where you tell it to go. PLOT struck me as being rather unnecessary because it has five modes combining all the other graphics commands along with a relative move and draw, ie, the coordinates represent the amount by which the cursor moves, not the position at which it ends up.

Line drawing is crisp, clear and fast. Lines can be put on the screen at quite steep diagonals without an ugly 'stepping' effect becoming too apparent. My big reservation about Lynx graphics is that there is no easy way to fill a shape. The only way I could find to do this was by plotting individual dots, which is slow and inaccurate. It may not have been possible, but a PAINT or FILL command would have made a good replacement for the rather obsolete PLOT (or PLOT alone could have been used and all the other words scrapped, perhaps). Pixels are individually colour-definable and, when the DOT command is used, they prove to be very fine although they are clear in any colour.

An interesting idea is the use of PRINT @ and WINDOW. PRINT @ uses columns two pixels wide (as does WINDOW) and rows to the highest resolution of 248 to put letters exactly where you want them on the screen. This is far more versatile than using character squares. You can therefore mix text and graphics tidily if you want to. WINDOW specifies the size of the text area. You specify the first column and the last column + 1 and the first row and the last row + 1 to change the part of the screen on which you want to print. Some fascinating effects can be achieved here by using WINDOW in conjunction with PROTECT. Again, there is one reservation in my attitude to this command: some kind of quick normalising command would have been handy to reset the window to its default. As it stands, you have to remember the coordinates of the normal text window and use those numbers to put things back to normal.

Another Lynx oddity is VDU. This uses CHR\$ (ASCII) codes 0 to 31 to perform cursor movements and other graphics commands as well as to perform the power-up beeping noise. You can use PRINT CHR\$ to do the same thing, so I found VDU rather unnecessary, although it is quicker to enter than PRINT CHR\$. Three of the facilities here are really striking. The first of these is VDU 21 — overwrite. This is like the Spectrum's OVER command and is turned off by inputting VDU 20. Secondly, there's

VDU 24 — double-height characters (turned off by VDU 25). These are really fun to use and striking effects can be obtained by mixing single and double height text. Lastly, and more subtly, you can employ superscript and subscript on text. This simply means moving the cursor up or down three pixel lines, giving a peculiar overlapping effect. This command has to be repeated for each line of super/subscripted text. The other VDU codes do things like carriage return, colour changes, line feeds and backspace.

Sound is based on a digital/analogue conversion principle and is used with two commands, BEEP and SOUND. BEEP is followed by three figures broken up by commas; these stand for wavelength, number of cycles and volume. Volume is specifiable from 0 to 63 and wavelength and number of cycles from 0 to 65535. High wavelengths are high-pitched sounds (for those of you who didn't do physics at school), so to make a high note of the same duration as a low one, the result of multiplying the number of cycles by wavelength must be the same. The large number of parameters available makes for an impressive range of sounds.

SOUND is a machine code based command. You can POKE several consecutive addresses with appropriate values, type in SOUND followed by the first of these addresses and the computer will read them, converting the values within to sounds as it goes, stopping when it reaches a value of 0. This could conceivably be used to synthesise speech.

Machine code is well provided for, with DPOKE and DPEEK complimenting POKE and PEEK by enabling you to read or write to two consecutive addresses with one word. Using both you specify the first address. DPOKE loads the least significant byte into the address and the most significant byte into the address+1.

PRINT# is a decimal-hex converter. It works to four digits and the largest decimal number which can be converted is 9,999,999. Only the integer part of the number is used. Hex can be input directly by prefixing the Hex number with '&'.

Binary And, Or and Exclusive Or are provided and a command, CODE, allows you to incorporate machine code into Basic programs by prefixing each line with CODE. INP and OUT read or send data from/to specified Z80 ports.

A machine code monitor is accessible from Basic by typing MON (and exited by typing 'J'). This includes a breakpoint facility as a debugging aid.

The Benchmark timings tell a lot, in this case, about the machine. The first two are fairly fast but BMs 7 and 8 are really slow. BM8 involves finding functions and the Lynx obviously does this rather too slowly. It's turned out slower overall than many other Z80 machines and is certainly in the lower end of the overall timings range.

To conclude on the subject of Lynx

Basic, I've really got no choice but to express stern reservations. Some of the effects which can be obtained with ease are really striking, but the overall structure is not in keeping with the reasoning behind it. At first sight it looks fantastic from a programming point of view, but using it for a while reveals serious disadvantages.

To a naive user, in any case, the importance rests far more on things like the efficiency of the screen editor than the intricate sophistication of the Basic. I'll make a huge criticism here while I'm at it: the screen does not scroll. It goes up to the top line and overwrites what was there before. This makes for either a hideously untidy screen or for the hassle of using CLS every time you want to list a program. And if your program is more than one screenful you've got real readability problems.

Lynx Basic has several omissions which appear to have been replaced by unnecessary trimmings. It repeats itself — as in the use of VDU and CHR\$ — thereby leaving out more important things. The lack of a reset key makes it possible to get into a terminal crash very easily — for instance, if you get stuck in an input loop you can't use ESCape to get out of it (it has no effect, more to the point) and you have therefore to switch the machine off. A little thought here would have made all the difference.

Documentation

A paperback user manual comes with the machine, written in the familiar home micro 'step-by-step' style. It's illustrated with bizarre pictures of little robots wearing Elizabethan-style breeches which drew chuckles of not-too-complimentary amusement from me as I read it.

I'm not too happy about it, either. It starts on a good note, takes you through the fine basics in a readable manner and is written in a friendly style. It has some attractive demonstration programs in it but it does not go into enough depth.

Some explanations are sadly lacking — for instance that of user-defined characters — and others still have mistakes in them. I understand, however, that the manual will be amended.

Furthermore, no useful memory addresses are provided — for instance, video RAM start and end addresses — which would make the enthusiast's endless pursuit of machine gymnastics a great deal easier. As with many machines a manual twice as long would have been a great deal more helpful and the addition of more involved technical information a blessing. But other machines are guilty of the same fault and I must confess to being rather a documentation fundamentalist, especially where micros for beginners are concerned. Ideally you shouldn't, in these cases, have to buy other books to explain the bits your computer leaves out. With the Lynx (among others), you do.

Software

There's not a lot to be said about this outside of speculation. Computers tells me the machine is aimed at the 'Sinclair graduate'.

Benchmark timings

BM1	1.7
BM2	4.3
BM3	12.4
BM4	8.9
BM5	10.4
BM6	16.3
BM7	29.9
BM8	86.6
Average	34.1

For a full explanation of Benchmark timings, see PCW, Nov 82.

GOTO page 158

GOODBYE TO FLOPPIES C/WP INTRODUCES A HARD DISC FOR £995.



C/WP have done it again. We proudly announce the C/WP CONTOUR, a range of British-made high technology 5-inch Winchester discs at prices starting below £1000.

Suddenly your micro-computer has come of age. One little box, not much larger than a floppy disc drive, stores up to 21 million characters. That size costs £1995 and stores the equivalent of more than 160 floppy discs, or 35 full-length books. And in a maximum of around a fifth of a second the C/WP CONTOUR finds any piece of information your computer asks for.

C/WP CONTOUR is available now for your APPLE II, IBM Personal, Sirius, Superbrain and many other CP/M and S100 machines. On APPLE the C/WP CONTOUR supports DOS 3.3, Pascal and CP/M operating systems.

Write or telephone for full details of this great price breakthrough. Now you can afford the luxury of a Winchester.

C/WP CONTOUR PRICE LIST

3Mb (formatted)	£995
6Mb (formatted)	£1195
12Mb (formatted)	£1595
21Mb (formatted)	£1995
Tape streamer back-up (21Mb 4min)	£1495

All prices exclude VAT

C/WP FOR BIG VALUE IN HARD DISCS

C/WP

C/WP Computers
108 Rochester Row, London SW1 1JP
Telephone 01-828 9000

SEND IT IN PACKETS

Terry Lang continues his series on networking with a look at packet switching.

This is the second in a short series of articles which aim to describe simply some of the problems and the solutions of networking. The previous article discussed the need for networking, and the criteria by which a network might be described as 'good'. It concluded by considering one of the simplest of networks, a 'star' of lines all connected to just one central switch or node, which was operated as a multiplexor to switch signals between pairs of those lines. The present article will examine the more sophisticated techniques of 'packet switching'. (Here we use the word sophisticated in its popular sense as 'technically advanced', though for some it may hold a touch of its more original usage as 'fashionable air of worldly wisdom'!)

Use of packets for error detection

Our simple star network just switched signals and hence characters between

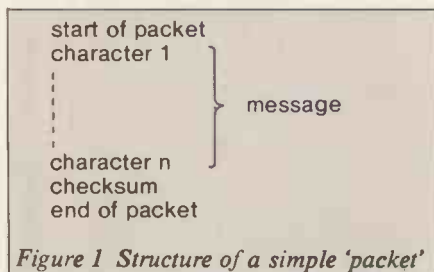

Figure 1 Structure of a simple 'packet'

communications lines, and did nothing about checking the accuracy with which transmitted characters were finally delivered to a receiver. Suppose now that we have the basic case of one computer communicating with another, and that because of the long distance involved and/or because of the 'noisy' electrical environment it is important to check, and if necessary to correct, the corruption of data during transmission. In the general networking situation the use of a single parity bit associated with each character will not give sufficient protection, because the whole character could be lost without trace, parity bit and all. It seems a natural step therefore to transmit a whole group of characters together (eg, a record from a file or a line of terminal input), and to send along with the group some kind of checksum, computed from all the characters. The receiver will recompute the checksum from the received characters, and compare this with the received checksum; if the two checksums match, then uncorrupted transmission may be assumed. At the same time it will be sensible to add a special 'start of packet' marker to the front of the packet and an 'end of packet' marker to the end, to make it clear to the receiver exactly when and where the check should be applied, as shown in Figure 1.

At this stage we should note that if the packets are too short then the overheads of the 'envelope' surrounding the packet will

be high in proportion to the characters in the message itself, whilst if the packet is too long then any noise in the system may prevent it ever being received without corruption. For obvious reasons, the upper limit of the number of message characters is generally set to a power of two, usually within the range 64 to 512. Typically two bytes are used for the checksum, which will not be just a simple arithmetic sum but some more complex algebraic function chosen for its ability to detect most of the data corruptions typical on communications lines. (As a matter of fact, we can never choose a checksum which guarantees to detect every conceivable corruption; the best we can do is to confirm that if the checksum received matches the message, then any corruption is extremely unlikely to have taken place. Even if as an extreme we sent the full message itself five times, and the destination received identical messages five times, the receiver could still not be a full 100 percent certain that the message contents were not identically corrupted on all five occasions.)

To return to our simple case of two communicating computers, when the receiver recognises an incoming packet it will compare the transmitted checksum with the checksum re-computed from the received message. If the checksums match, it will return an acknowledgement of successful receipt to the sender. If the checksums do not match, it would be possible for the receiver to return a 'pardon?' message to the sender. Alternatively the receiver could simply maintain a dignified silence, as it would have to do if the whole packet were lost (or were so corrupted that it could not be recognised as a packet). If the sender receives a positive acknowledgement of its first packet, it can simply follow up with the second. If on the other hand the sender receives no reply at all after some pre-agreed time (known as a 'time-out'), or if the receiver gets back a 'pardon?' it can repeat its original packet instead.

This process has strong similarity with a telephone call between two people. The listener may interject with 'yes' or 'uh-huh' from time to time to confirm that he or she is hearing the speaker. If noise on the line intervenes, the listener may respond with 'pardon?'. If the noise increases further, the 'pardon' may itself get distorted, and the speaker then 'pardon?'s the 'pardon?' — at this point complete confusion will probably set in! It is for this reason, when working where there may be severe noise problems, that the simplicity of using only positive acknowledgements, and of making no response on receipt of an error, will generally be beneficial. (Of course there is always the possibility that a positive acknowledgement

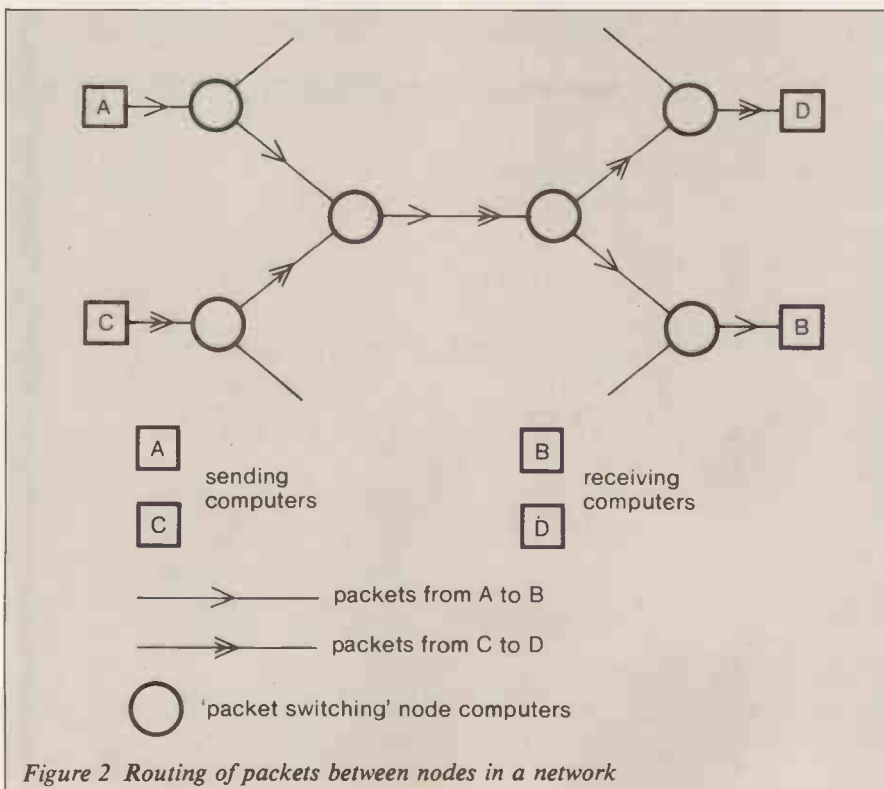
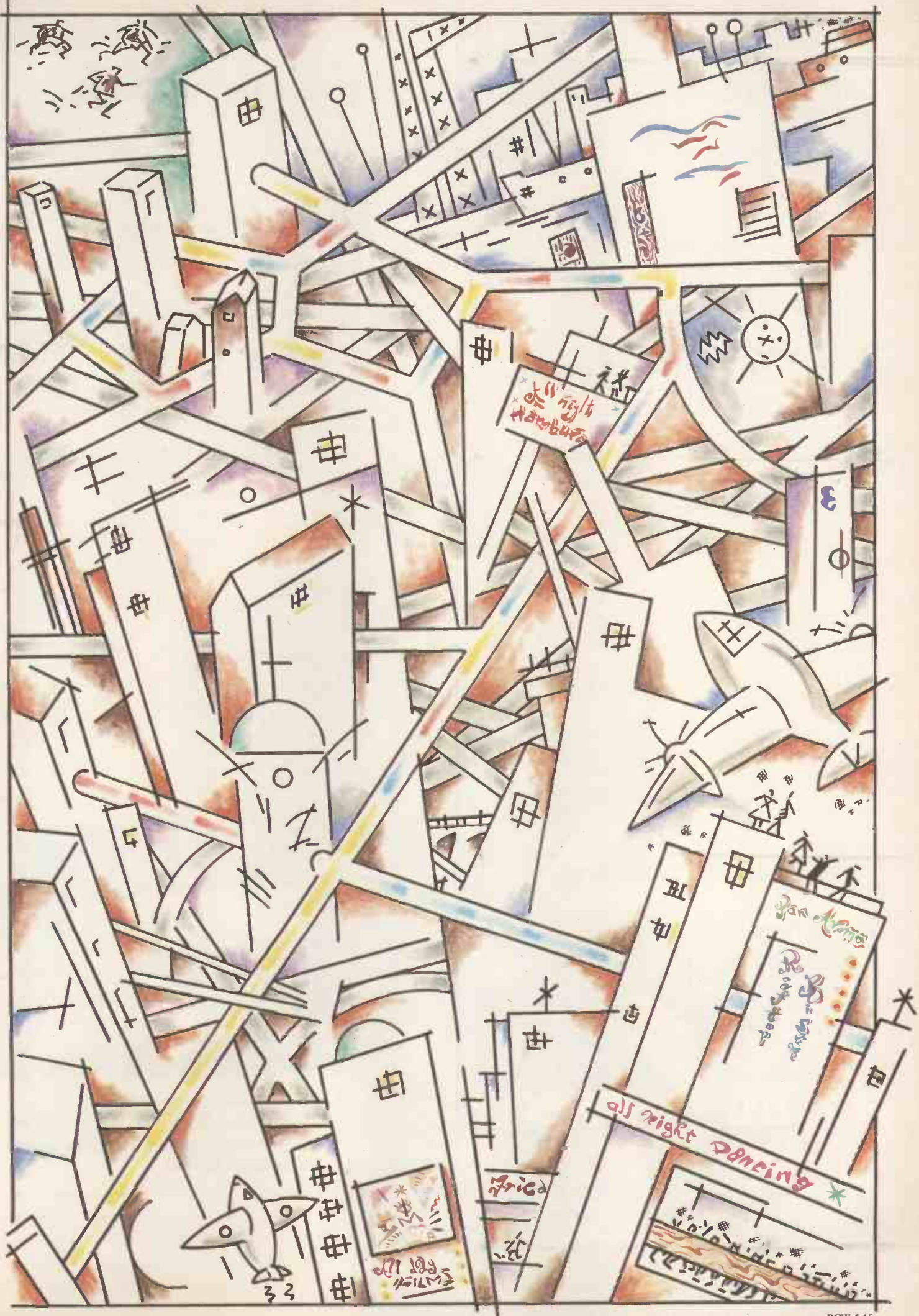

Figure 2 Routing of packets between nodes in a network



What do Miss World and the new Epson printers have in common?

World Beaters. All of them.

World beating Miss Dominican Republic, below, sits with two of her counterparts. For beautiful styling that is. And a lot more besides. Which brings us neatly to the two new printers from Epson. Namely, the RX-80 and FX-80.

Faster

The RX-80 and FX-80 print at speeds of 100 and 160 characters per second, respectively.

More Value

Yet both machines are better value than their predecessors. With features like dot addressable graphics, standard Centronics compatible interface and optional RS-232C and IEEE interfaces.

The FX-80 Printer takes a lead with the addition of various extra built-in features. And we've designed the RX-80 with tractor feed for perfect alignment, and the FX-80 with both tractor and friction feed.

When you have Epson style teamed with Epson quality, your company will be well equipped for a successful and profitable future.

So now we've whet your appetite - isn't it about time you seriously considered buying one of our remarkable machines.

But act now, because with our amazing track record, there's going to be a great demand for these new world beaters.



RX-80
FX-80
PRINTING MACHINES

EPSON

**Extraordinary product.
Exceptional quality.**

Epson (UK) Limited,
Freepost, Wembley,
Middlesex HA9 6BR.
Freefone: 2730.
Telex: 8814169

- I would like a demonstration of the Epson RX-80 and FX-80 printers.
- Please send me details and the name of my local stockist.

Name _____

Position _____

Company _____

Address _____

Telephone _____

SEND IT IN PACKETS

ment will itself be corrupted, and the sender will then re-transmit the packet which the receiver has already just successfully received. As they sometimes do in the harder textbook, 'we will leave as an exercise for the reader' the design of a mechanism whereby the receiver can recognise this event, and not treat the second packet as just the next in the sequence from the sender).

Routing packets through a network

Since we have gone to the trouble of tying up a packet, it seems a small extra step to add to the front of the packet the identity of the sender and the identity of the intended receiver. In fact this opens up a whole new way of working. Suppose, for example, that in our basic illustration the receiver was connected not just to the sender, but to two other computers as well. On the successful reception of a packet, the receiver could inspect the identifier of the intended destination and, if the packet was not for itself, simply pass it on to whichever of the other two neighbours it should have gone to. This can be generalised to a network of many computers and many links, as illustrated in Figure 2.

The first thing to note about this generalised scheme of 'packet switching' is the way in which any one link between nodes is shared. At any specific moment, a link will be dedicated to just one packet en route between a specific pair of correspondents. However, when that packet is dealt with, another packet for a different pair may share this same leg for part of its journey — as illustrated in Figure 2.

By what mechanism is a node to decide how to route a packet which it has just received? It should immediately recognise packets for which it is the terminal destination. Other packets have to be passed onwards, and the question is to decide which of the possibly many links also connected to the node should do this task. Perhaps the simplest way is to have a table stored within the node, listing for every possible receiver the link on which a packet should be passed on. (Clearly every node will need a different table, depending on its position in the network.) If the network is at all extensive, then a full table could be prohibitively large, and in this case it would be necessary to distinguish within a destination identifier 'sub-addresses' denoting area codes and local identifiers (just as one could break down a telephone number into its national, city, district and local components).

A very important feature of this system is its flexibility and its resilience. It is a relatively straightforward matter to add or remove nodes and links to match changes in traffic patterns, and to update the routing tables in existing nodes accordingly. There is no problem in connecting links and nodes in parallel to relieve congestion. In the short

term, a node can quickly detect if a particular link or a neighbouring node fails, as it will receive no acknowledgement messages. When a failure is detected by a node, packets that would have been passed that way can quickly be redirected — though a number of routing tables will need to be updated consistently to ensure that re-routed packets do not end up shunted into some endless loop. It is also possible to regard over-loading or 'traffic congestion' in the same way, and to adapt routing strategies to bypass any overloaded areas. (To assist in all these re-routing situations, it is possible to arrange for nodes to exchange status messages with each other, or with some central network control node.)

Making a call

Usually a complete message between two correspondents will involve the transmission of a whole sequence of packets (eg, many records forming a large file), and often long messages will pass in either direction (eg, messages between a terminal and an on-line system). The network could treat every packet as if it were a small message in its own right (sometimes called a 'datagram'). This would have the considerable advantage that if there were a network failure at any stage in the 'conversation' or if congestion developed in some area, all further packets would simply find their way round these obstructions. However, because of the different routes which might be taken, there would be no guarantee that packets leaving the sender would arrive at the receiver in the same sequence as they were first transmitted. This would need to be overcome by including a sequence number in the header of each packet; either the receiver or the network node serving the receiver would then need to store the arriving packets and to re-sort them into correct order. Another basic problem with this approach is of course the overheads incurred in the routing process itself, which has to be invoked for every packet and at every node through which it passes.

An alternative approach to the routing problem is to tackle routing just once, when communication between two parties first starts. The sender or source starts by sending off a packet to the intended receiver, asking if the receiver will accept a 'call'. As the call request packet is routed through the network, each node through which it passes keeps a record of the details. By the time the receiver gets the call request packet, the details of the route taken stretch out behind it, like string through a labyrinth. When the original sender gets back an acceptance of the call, subsequent packets simply follow the string to pass along the same route. Because they follow the same route, and because two packets for the same link will not pass each other, the ordering of all packets is maintained.

This approach is frequently referred to as

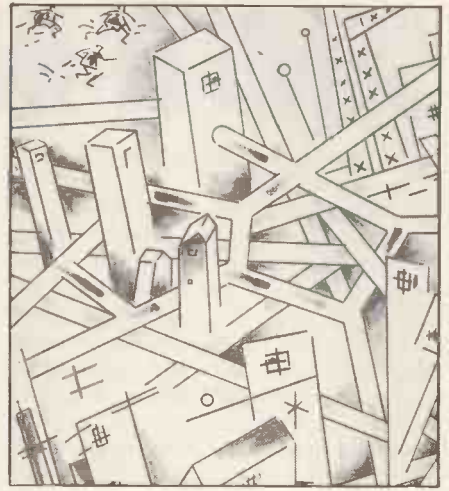

a 'virtual circuit' or 'virtual call'. This is because the string defines a path or circuit which will be used for the whole duration of the call. In some respects this is similar to an ordinary telephone call. For the telephone call, however, a reserved circuit with fixed communication capacity ('bandwidth') is maintained throughout the call, whether or not this circuit is actually being used — this is known as 'circuit switching'.

However, for our packet switching the virtual circuit is simply the definition of a potential route. If sender and receiver are quiescent, the full bandwidth on every one of the links on that route remains available for use by other packets between other pairs of correspondents. It is for this reason that packet switched networks will usually charge the user according to the amount of information transmitted (ie, no links are used if there is no transmission). (The only overhead for a quiescent virtual call is in fact the very small amount of routing data stored by each node on the route.) Conversely, circuit switched networks charge according to the duration of the call (ie, bandwidth is always tied up, whether it is used or not.)

At the end of a virtual call, or if the original call is rejected by the nominated receiver, then the string of the virtual call is simply rolled up to remove all trace of it from the network.

Unlike the datagram approach, the advantage of the virtual call is the minimising of routing activity and the maintenance of packet sequencing. On the other hand, if a permanent fault develops on the route of a call, then the whole call has to be forcibly requested, and the network will automatically establish a new route for the new call. (Transient faults are still dealt with entirely automatically by the individual nodes.)

Flow control

A basic feature of packet switching as described here is that a complete packet has to be received and checked by a node before it can be passed on over the next link. Often queues of packets will form for transmission over one link (packets from the same call or from a mixture of a number of calls). Thus there will always be some delay at every node along a route. Whilst the network may be designed to run with small delays, the exact timing of 'deliveries' cannot be guaranteed — and that may affect

SEND IT IN PACKETS

the kinds of application for which the network can be used.

In general, there may be several packets en route between a sender and a receiver. However, the number of such packets must be carefully controlled. Otherwise, if the receiver were slow in accepting delivery and in removing packets from the network, the sender could still continue injecting packets at high speed. This could fill all the queuing space in intermediate nodes, with the net result that these nodes would effectively be put out of action. Therefore a requirement is generally imposed whereby after a sender has injected a number of packets it must wait for an acknowledgement from the receiver. The number of unacknowledged packets waiting in the network is thus restricted. This is known as 'flow control'. This is imposed at two levels, both at the call level (ie, end to end between sender and receiver) and at the individual link level (ie, between neighbouring nodes).

The foregoing has special implications for terminals connected through a network to a computer, when handling user input from a keyboard. If the terminal is working in 'full duplex mode', then when the user types one character this is immediately transmitted to the computer, which will interpret it and decide on the appropriate 'echo' to be returned to the terminal for display on the screen. (This type of working could be particularly appropriate for word processing or for graphics applications.) As far as the network is concerned, this would demand that for each character typed one (very small) packet be transmitted from terminal to computer, and another small packet returned from computer to terminal. The overheads of this could be extremely high (and probably the charges levied as well); further-

more any transmission delays could upset the 'user image'.

For these reasons, it is more usual to operate the terminals on a 'line at a time' basis, where the user assembles a whole line of input at a time before sending it off to the computer (making any corrections or amendments before finally requesting transmission). To support terminals not already capable of working in this way, it is common to provide a packet assembler/disassembler (usually abbreviated to PAD) which takes care of building up the packet from single characters of input before transmission, and the unpacking of packets from the computer back into single characters. The PAD may be a separate small computer or alternatively a part of a network node, and will generally be capable of interfacing a number of terminals to the network.

Conclusions

By the apparently simple device of including in a packet header the source and destination identifiers or addresses, we have thus developed a whole methodology of networking. Given a good implementation, the packet-switched network can be very flexible and resilient, reliable, and accurate in the face of transmission noise. This approach is therefore popular for 'wide area' networks where long distances are involved. The best possible use is made of transmission links, and bandwidth does not have to be held reserved for quiescent calls.

There is, of course, another side to the coin. The network nodes are necessarily somewhat complex, and still relatively expensive. However, this is a situation which is changing rapidly: for some time it

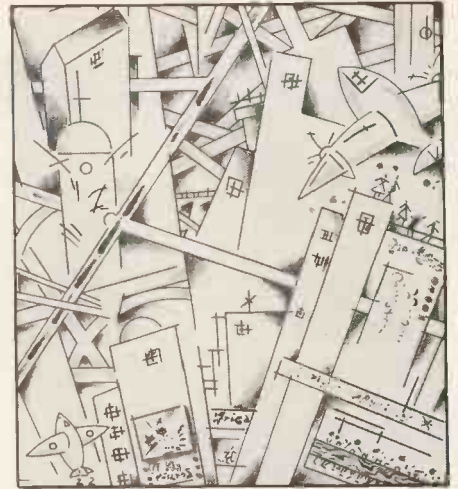

has been possible to get on a single chip a driver for one link. The overheads of dealing with packets are significant — these include the header, trailer and checksum processing, packet acknowledgement, end-to-end and link flow control, routing, inter-node status and management messages. Fortunately this is handled by distributed hardware rather than by a central bureaucracy!

Packet switched networks have been in operation for many years. Perhaps the best known of the early systems was ARPANET, first set up on an experimental basis to link educational and scientific research institutes across the United States, and which subsequently added links to Europe. British Telecom has already launched its Packet Switched Service, initially on a restricted basis, but destined for widespread use. Happily this is based on standards now internationally agreed for packet switched networks, based on the original 'X25' standard.

The next article in this series will look at ring networks (in which the nodes are connected to make a continuous ring) and the Ethernet approach, where all nodes share a single common transmission link or medium.



PCW welcomes approaches from would-be writers, even those who have never appeared in print before. In this game it's often those with practical experience who have important things to say so we don't mind if your prose is less than perfect — providing submissions have a sensible structure and follow a logical sequence, we can take care of the polishing.

If your article is already written, send it in — taking care to ensure that your name and address, together with a daytime phone number if possible, appears on both the covering letter and the manuscript. Manuscripts should, preferably, be typed or printed out (dot matrix output is quite acceptable) but *must* be double line-spaced with ample margins top and bottom and on each side.

We can now accept articles on a limited number of disk formats: standard IBM 3740 single-sided, single-density 8in, and the following 5¼ in formats: Superbrain SSSD 35-track; RML380Z SSSD; Sharp

MZ-80K/A DSSD, Cromemco SSSD, Nascom DSSD, Rair/ICL DSDD, SD Sales SSSD, Triton 35 track SSDD and ACT Sirius 1 (CP/M-86 or MS-DOS) single-sided. By prior arrangement we can accept stuff over the phone by modem using BSTAM at 300 baud but as we can only do this during office hours (10am to 6pm) it's not exactly a cheap way of getting your article to us! In the near future we hope to be able to accept material by The Source and Rewtel. Please note that if you want to send your article in this way, it should be as an ASCII file rather than as a 'work file' for any one type of word processor — ie, use your word processor to print the text to disk instead of to paper.

Please note that we cannot undertake to return manuscripts, diagrams and photographs, although we always try to return the latter. We can only return disks if they are accompanied by adequate postage and packaging.

If you have an idea for an article or a

series, write us a letter outlining your ideas. A one- or two-page synopsis giving the proposed structure, sequence and content is what we're looking for. But before you send anything to us, take a good look through PCW to see what sort of articles get published and to see what style of writing we prefer (basically, avoiding pomposity at one extreme and flippancy at the other). Also take a look through the Back Issues advert to see what sort of things we have already published — no point in re-inventing the wheel.

Once you've sent off your article or proposal, please don't hassle us for a decision. We receive far more submissions than we can ever use and it takes us a while to sort through them, acknowledge receipt and give an opinion one way or the other. Please be sure to tell us if you've sent the article to another magazine — it would be very awkward indeed if the same article appeared simultaneously in two publications! Frankly, we're more likely to accept something which has been offered exclusively to us.

Finally, we do pay for published work but please be patient! Payment *normally* follows about 4-6 weeks after publication.



PCW welcomes correspondence from its readers but we must warn that it tends to be one way! Please be as brief as possible and add 'not for publication' if your letter is to be kept private. Please note that we are unable to give advice about the purchase of computers or other hardware/software — these questions must be addressed to Sheridan Williams (see 'Computer Answers' page). Address letters to: 'Communications,' Personal Computer World, 62 Oxford Street, London W1A 2HG.

Stamp on Acorn

Since last July I have written three times to Acorn Computers, each time enclosing a stamped addressed envelope. So far I have had no reply to any of my correspondence. I have also written to the BBC (who did reply), in the hope that they might be able to stir Acorn into some activity, but this also proved fruitless.

Might I invite someone at Acorn to reply, through your columns, offering some excuse for their arrogance.

Alternatively, if there is no excuse, may I suggest, in the Aberdonian tradition, that their accountant pop two stamps in an empty envelope and return it to the address below.

R Ferguson, 43 Craighton Terrace, Aberdeen AB1 7RN.

How about it Acorn? — Ed

NEC PC8000 lacks software bite

I read with interest the item in Newsprint about the NEC PC8000.

I bought one of three computers recently and would like to make one or two observations.

I think some of the lack of interest is due to the poor support for the system. Ever since I purchased mine I have been trying to obtain information on the computer to help me write software.

Neither IBR (the distributor) nor NEC have been forthcoming. They promise you the earth and nothing happens.

Much more use could be made of the excellent hardware if the information available was as extensive as that for the Apple, for example.

Sales are generated by interest, and little interest is generated without attractive

software — and software needs information to enable it to be written.

I think that I have made a serious error in purchasing the PC8000 because of this poor support for software writers.

The Basic is okay but the machine code routines in the 'N-Basic' would save much time and increase speed if they were accessible.

I would be interested in hearing from anyone who can provide me with any details of the 'N-Basic' interpreter and perhaps you could print a little of this letter.

Bob Weston, Two Boats, Ascension Island, South Atlantic Ocean.

Tremors on the Spectrum

I was interested by your review of ZX Spectrum games software (January PCW).

However I have found several problems with this computer and feel that anybody intending to buy one should be made aware of them.

When after the usual wait I received a Spectrum, I was disappointed to find it did not give an acceptable colour picture with my TV set. On contacting Sinclair I was told that they were aware of this incompatibility, but it was incurable. They admitted that the same problem occurs with several other makes of television; but this is not even hinted at in their advertising or specifications.

Resigned to black and white or Blurrivision computing, I later ordered two of the Sinclair/Psion games tapes, from a leaflet which said they were 'immediately available'. Again there was a long wait, and again I was disappointed. Neither tape would load on my equipment, which however copes perfectly well with programs of my own; with software from an independent supplier (Bug-Byte); and with

the Sinclair/Psion 'Horizons' introductory cassette. I therefore sent back the tapes with an explanatory letter.

This was in November and I have received no replacement tapes, explanation or even acknowledgement. I have tried to contact Sinclair but their 'customer service' phone number is continually engaged. I am left to wonder if this is deliberate policy, or just incompetence. In either event these experiences have just about killed my interest in home computing.

As a postscript: I have now received through the post a total of 10 reels of printer paper for a ZX printer which I do not possess — and now have no intention of ordering. N P W Watson, London NW3

August Ada

The article on Charles Babbage, 'The Nearly Man', in the January issue does a considerable injustice in omitting all mention of the contribution to the design of the Analytical Engine made by Augusta Ada, Countess of Lovelace.

This highly gifted young woman, daughter of Lord Byron, was a self-taught mathematician of outstanding ability. She helped Babbage in a small way at first, but later appeared to have played a large part in directing the progress of the design. She suggested the use of subroutines for frequently used mathematical functions and carried out the necessary computations, often working long hours at high speed. She saw, perhaps more clearly than Babbage himself, the potentialities of a computer, and made statements on this subject which were not matched until the early 1950s.

After the tragically early death of Lady Lovelace at the age of 36, Babbage seemed to become irresolute, and the momentum of the work disappeared, perhaps lacking her

guiding hand and breadth of vision. At one stage, he even gave up the project and started on the design of a second Difference Engine, which again got nowhere.

It is worth noting that some recognition of Lady Lovelace's work has been made by the United States Department of Defense in naming their new computer language 'Ada' in her honour. L E Weaver, St Leonards-on-Sea, East Sussex

Atari losses

I see that Atari is still running those advertisements threatening divine retribution on those who dare write programs that resemble Atari games.

I wrote to Graham Daubney some 10 weeks ago, saying I was developing programs that he might consider would contravene Atari's copyright. If this 'Graham Daubney' does indeed exist, he might as well not, because I have yet to receive a reply to my offer of royalties on any program that could be considered to infringe Atari's copyright.

My suggestion to any other mug tempted to be honest about it is — forget it! These expensive advertisements are probably just designed to frighten the competition, or to make 'Graham Daubney' look more important so that his boss will give him a key to the executive washroom.

I hate to think how much money Atari are wasting, when they could just be sitting back raking royalties off programs which are often far better than theirs anyway.

Andrew Denny, London SW6

Clock on

I wish to make a few points concerning Mr D N Anderson's criticism (Letters, January 1983) of the cost of my clock card design ('Clock it to Me', October/November 1982) and the relative virtues

of a clock card marketed by Namal Associates.

Mr Anderson quite incorrectly states that the kit does not contain a battery, and having re-read the articles I can find no ambiguity to account for this. I did however use the term 'Nicad' and I can only assume that Mr Anderson is not aware that this is the commonly used abbreviation for nickel-cadmium battery.

Mr Anderson is quite right that the Namal card at 'around £70' is indeed cheaper than the Mountain Computer board at £149; it is however in the same price range (£50 — £80) as the CCS Clock Module, Superclock II, Thunderclock, March Microclock(s) and Time Machine II. All these boards have their strengths and weaknesses, and that marketed by Namal will be no different. What prompted the design of my own card was that *all* the above clock cards had the common weakness of being too expensive for me to justify purchasing and yet the concept was potentially very useful.

I note that the Namal card features a 4k operating system. Because of space limitations I was unable to discuss this approach in my original articles. Suffice it to say that if the 2k memory space starting at \$C800 is used, conflicts can arise with 80-column cards, etc. (See 'Three Real Time Clocks'; D P Rivas, *Applesauce*, February 1981.) The solution is to stay within the normal \$CN00 PROM space constraints and page memory — but not all clock cards do this. This is clearly important and I have been unable in the time available to find any details on this aspect of the Namal card (having checked the Advertisers Index in both *PCW* and *PC* for the last six months and having tried to find Namal's telephone number through directory enquiries).

Mr Anderson always prefixes his prices by 'around' — 'around £70', 'around £40', etc. It has been my experience that values quoted thus are nearly always too low. I myself first quoted a target price of 'just over' £30 for my design, and most people must recall the BBC's target price for its computer. . .

At the end of the day my clock card design, together with disk software and manual, is available at £36. Mr Anderson's Namal card is not comparable since it is not actually available as a kit and even if it were it would be more expensive (although by exactly how much is difficult to say, given his reluctance to quote specific values). In addition, Mr Anderson's letter ignores the fact that the articles in themselves contained *all* the information to build a clock card and provide it with a software base — there is no compulsion to buy the kit and for those with the necessary wherewithal considerable savings could be made.

In conclusion I can only assume that in Mr Anderson's rush to publicise the Namal card ('soon to be released for the BBC it is rumoured' indeed!) he lost touch with normal standards of criticism. I trust that in future he will check his facts, provide proper pricing details and actually compare one real product with another.

B Marriott, Slough, Berks.

Videx cards

In the early part of last year you published a letter of mine which explained how it was possible to duplicate program lines in Microsoft Basic-80 using the Edit command and Ctrl-A.

I tested the routine out on a Vector Graphics System-B and the office Apple II with an 80-column card and it worked perfectly on both.

Recently, however, we have bought some new Apple IIs with Z80 Softcard and Videx Videoterm 80-column cards. When I tried my little routine on these machines, however, it didn't work! Why? you may ask. Simple, Videx cards use Ctrl-A as an upper/lower case toggle. Why use Ctrl-A? Over to you Videx.

P H Elliott, Thundersley, Essex

Sinclair satisfies

Earlier this year I ordered a Sinclair Spectrum, to be delivered to my hotel address in London during my visit there in November. Upon arrival I called Sinclair and discovered to my dismay that there had been some serious misunderstanding with respect

to my order. Then, remembering all the complaints published in *PCW*, referring to Sinclair's attitude in such cases — what could I expect?

Naturally, I was anxious to obtain delivery while in London and had to call Sinclair on the telephone a few times, mostly being attended to by Elizabeth or Barbara — always in a polite, friendly and helpful way. But it was not only the 'words' — they delivered!

My experience is — and I am confident I can say so also on behalf of an overwhelming majority of 'happy' Sinclair customers — that the people at Stanhope Road do their best to satisfy. Most happy customers probably don't bother writing letters like this, but it would be a great pity if only the few dissatisfied ones have their views published.

Finally, I am also a happy subscriber and reader of an excellent magazine — keep up the good work!

Oivind Grenness, Horten, Norway

A fan writes. . .

Together with my subscription to your excellent magazine, I'd like to give you a little feedback. The first reason why I subscribe is that your magazine is only sold in one bookstore in Stockholm.

There, it is always sold out. I think you should take up a serious discussion with your Swedish agent to spread the product to more bookstores, so it at least are as widespread as *Practical Computer*.

Since I am a proud owner of a Sharp PC-1500 I'd like to see more material about that machine, and short programs, especially applications for business and administration. I personally use my computer (or super-calculator if you like) as a very versatile tool at all the office meetings which fill my day as an administration in the local city council.

What I like in your magazine are all the good articles dealing with programming techniques and features of general interest for the owner of a small personal computer, as well as these dealing with how to link them to bigger systems. I also like 'Brain Dump', which often

opens up new fields of study and is composed in a short, clear style summing up the main points.

It is all too easy to get flimsy and 'false-artistic'. One who has fallen deeply in this trap is Guy Kewney, the 'Newsprint' regular. It is certainly the worst news review I have ever seen in any of the computer magazines I read regularly. It is flimsy, disinterested and written in an arrogant style, leaving the reader who is not an insider in a total confusion. In such a fast growing sphere as the computer-market you need a clear, sharp-eyed guide who can tell you what is coming, when, and what could be the main advantages and disadvantages of the products. To be able to give clear and neutral news reviews you need a staff of competent and independent newshunters, but I'm sure that with your vast amount of advertisements you could afford it.

Crister Skoglund, Jarfalla, Sweden

Beeb disk restrictions

I wrote to Acorn Computers Ltd with reference to the limitation of 31 entries on the disk drive for the BBC Computer.

The answer I received was as follows:

'As you have discovered, only 31 files can be created on each side of the disk, and unfortunately, no change will be made to this as this is obviously due to software code in the 8k disk operating system. I know the above information is really of no help and I therefore apologise that there are no suggestions I can make.'

This letter indicates no concern for the problem. I had hoped to receive some suggestions — perhaps a software program or perhaps some application notes.

Can you or any of your readers provide any assistance?

The difficulty is that a number of short items will fill the catalogue but will leave a lot of unused space on the disk.

I shall be grateful for suggestions.

George H Foot, Tamar, Town Row Green, Rotherfield, Sussex.

CHARTMAN is here!

BONSAI BRINGS YOU THE LEADING BUSINESS GRAPHICS SOFTWARE for the IBM Personal Computer.

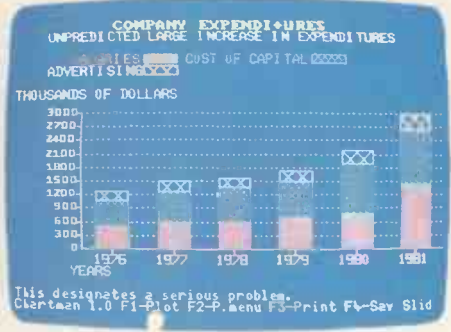
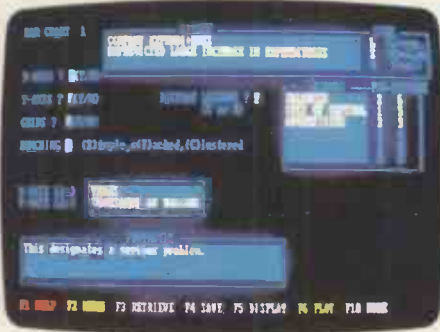

CHARTMAN brings out the messages buried in piles of data by turning columns of numbers into quickly and easily understood graphics. CHARTMAN will produce top quality horizontal and vertical Bar Charts, 2- and 3- dimensional Pie Charts, linear and logarithmic Line Charts, text pages and signs. You can display them on screen, print them on a graphics printer, and plot them onto paper or acetate transparencies.

CHARTMAN is a really easy-to-use, menu-driven program that allows you to produce presentation quality graphics immediately with little or no training. You either enter data through simple fill-in-the-blanks screen layouts, or interchange rows or columns with programs like Visicalc, MicroPlan ver 4, TK!Solver, and many others that support DIF.

CHARTMAN was designed specifically for the IBM Personal Computer to utilise its powerful features. Once charts have been created, they can be stored, then retrieved and edited later. CHARTMAN even has a slide presentation feature where charts can be saved as slides for a manually stepped or automatically timed "slide show" on the screen.

CHARTMAN I: displays everything on the screen in monochrome high resolution, prints charts on the IBM Personal Computer printer or Epson MX80 and 100 printers (all need the Epson Grafix option), and can plot on HP7470 2-pen and HP7220 8-pen plotters. **£295**

CHARTMAN II: in addition to all the features of CHARTMAN I, CHARTMAN II can display charts in colour on RGB monitors, can print colour charts on IDS Prism colour printers, and can plot on IBM XY750 plotters. **£395**

Give Bonsai a ring, or cut the coupon, to order your copy of CHARTMAN, to receive further information, or to arrange a demonstration of CHARTMAN on the IBM Personal Computer at our London showrooms.

IBM Authorised Dealer—IBM Personal Computer

Chartman is a product of Graphic Software Inc., distributed in the UK by Bonsai Ltd., IBM and IBM Personal Computer are trademarks of International Business Machines Corp.; HP is a trademark of Hewlett Packard Company; Visicalc and DIF are trademarks of Visicorp; MicroPlan is a trademark of Chang Labs; TK!Solver is a trademark of Software Arts; Epson and Grafix are trademarks of Epson.

© Copyright Bonsai Ltd, 1983.



MICROCOMPUTER SYSTEMS FOR PEOPLE IN BUSINESS.

Bonsai Limited.
112-116 New Oxford Street,
London WC1A 1HJ.
(01) 580-0902.

Please (tick as appropriate) Send me CHARTMAN I @ £295 (+ £5 P&P + VAT = £345)
 Send me CHARTMAN II @ £395 (+ £5 P&P + VAT = £440)
 Enclose a cheque for _____ Please debit my Access/Visa Account No _____
 Send further details of CHARTMAN. Contact me to arrange a demonstration.

Name _____
 Company _____
 Position _____
 Address _____
 Phone _____
 Signature _____

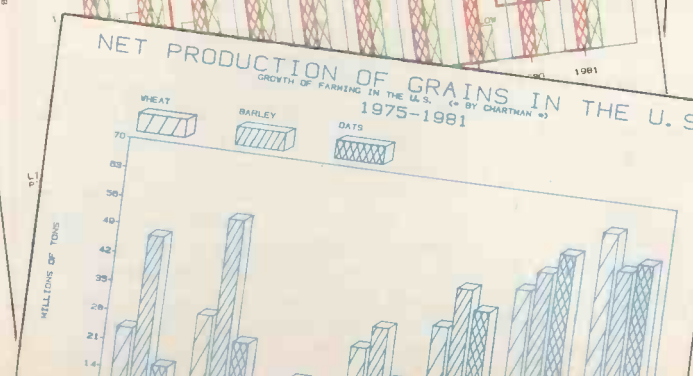
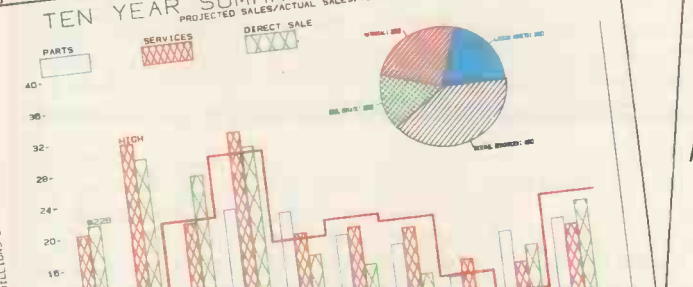
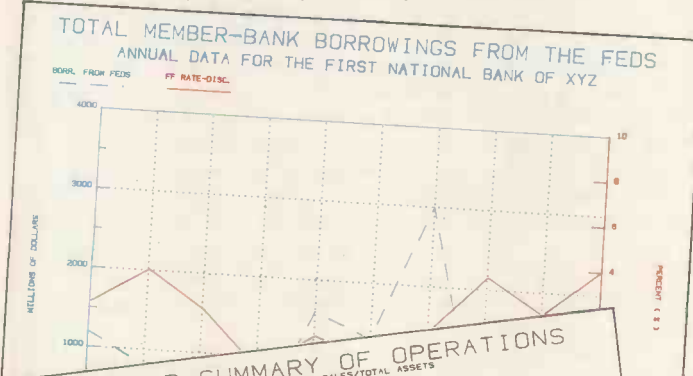

SCREENPLAY

Dick Olney investigates

games for the Atari 800.

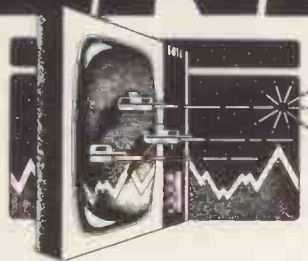

As promised, this month I've had a look at a selection of games running on an Atari 800. Except for Centipede, all of these are disk-based, although some of them are available on cassette as well. It is possible to attach a disk drive to the Atari 400 of course but it invalidates your guarantee, since to make it worthwhile you'll need to upgrade the machine to 32 or 48k and Atari itself won't support this configuration. Anyway, by the time you've paid for the upgrade and the extra RAM you might as well have bought an 800, now costing £400 (maybe less by the time you read this!). The 810 disk drive will set you back a further £300, with each joystick costing around £7. In total, the hardware I used would cost around £714 — unfortunately still outside the range of all but the most affluent home users in the country.

The vast selection of classy games available for the 800 these days is staggering. I've covered a few of the most popular.

Nearly all the games here are real time arcade type games (with the notable exception of Eastern Front), but I should mention the series of graphics adventures available for the Atari from Adventure International. Basically the adventures are of Scott Adams' usual high quality, with the addition of an illustration for each location. Unfortunately on most TVs these graphics have an appalling flicker, but it's a nice idea.

Atari, with its history of arcade successes, can undoubtedly lay down to being one of the leaders in computer games.

As I said last month, the BBC Computer is the only machine I've seen that can match the Atari graphics, and the chances are that it will attract education rather than games software. It may be that, for the time being at least, we've reached a peak of sophistication in arcade style games, which will now cease to show any signs of real progression. Certainly I haven't seen any new ideas in the arcades for a while, and consequently people are now much less willing to part with their ten pences. Most manufacturers are aware that from now on educational rather than games software will become increasingly important in selling machines. Games will, of course, always be an important aspect of home computing, but it is important to bear in mind that they remain the most trivial way in which microcomputers can change our homes.

All software supplied by The Silica Shop, tel 01-309 1111 and Calisto Computers, tel 021-632-6458.



Game: Stellar Shuttle
Supplier: Broderbund
Price: £19.75

I always felt that the arcade version of this game (whose original name escapes me) was underrated in many respects. It appeared some time after Space Invaders but was quickly eclipsed by games like Asteroids and Defender. The game

begins with a mother ship carrying a shuttle travelling back and forth across the top of the screen with a planet's surface below it. Between the two are numerous asteroids, represented just as in the game of that name.

On the planet's surface there are two landing bays, with a raised platform between them and three men standing in wait on either side. Your first task is to release the shuttle from its carrier using the fire button and then guide it through the asteroids onto one of the landing bays. During the descent the shuttle can be slowed by firing the thrusters.

Upon landing, one of the men runs across from the appropriate side into your shuttle, and the graphics of him running and jumping are undoubtedly one of the most impressive features of the game. When the 'refugee' has boarded, the shuttle begins to ascend — and at this point it is possible to fire at the asteroids

above to try and blast your way back to the mother ship which is waiting patiently in the same position it was in when you left it.

Things are further complicated by indestructible comets which drop down on you during the ascent, and by little orange dragons which will eat the refugees unless you can fry them with a blast from your rockets on the way down. Stellar Shuttle is a one-player game with no options, which has good graphics but fairly uninspired sound. Like many of the arcade type games I've looked at on the Atari, it's not original, but it is a good implementation of a game I've always found fairly attractive.

Presentation: ██████████
Addictive quality: ██████████
Use of graphics: ██████████
Value for money: ██████████



Game: Eastern Front
Supplier: Atari Program Exchange
Price: £23.99

This is one of a large selection of packages distributed by Atari but written by non-Atari personnel. Atari does apparently pay quite good royalties if the program sells and it's a good way of making available software which might otherwise never be published (or which might fall into the hand of competitors?). Eastern Front has achieved such fame and success, in fact, that Chris Crawford, its creator, has now been given a job with Atari's elite software development team in California.

The game is a one-player simulation of the German invasion of Russia during World War II, in which you have the job of controlling the German forces. The playing field is a map of Western Russia,

covering three or four screens' length in each direction. Using a joystick, you move a purple square around the map which scrolls over if you reach the edge of the screen. Cities, mountains, swamps and rivers are depicted with various colour devices across the map.

Russian military units are seen as red squares, whilst German ones are white. In order to identify any unit and its strength you must position your purple square over it and press the fire button on your joystick. Each turn you may give up to eight 'orders' to each German unit. These basically amount to instructions for movement in a particular direction. Orders are given by pressing the fire button whilst your square frame is in

SCREENPLAY

position over the appropriate unit, and — keeping the button pressed — moving the joystick in the direction you wish the unit to move (not diagonally).

When you have completed your orders, pressing the start button initiates the procedure which figures out their results. A unit will not carry out all your orders exactly for a number of reasons. Firstly it may come into conflict with an enemy unit by trying to move into the other's space. In this case, the result of the conflict will be determined by the fighting strength of each unit along with various random factors and one unit will be forced to withdraw. Associated with this is the inability — under certain conditions — of your unit to move through a Russian unit's 'zone of control', the rules for which are too complex to get into in this review.

Secondly, a German unit cannot move into a space already occupied by a friendly force, and will merely wait until the other has moved. Finally, the number of spaces which a unit can move each

turn is limited by its own nature (ie, infantry or tank regiment), the terrain it is crossing, and the season of the year in which the move occurs. The game runs from 22 June 1941 to 29 March 1942, with each turn representing one week (the current date is displayed at the top of the screen). Your score appears in the bottom left hand corner and is reassessed each turn, with the idea being to end the game with the highest score possible (out of 255). Since this score fluctuates in both directions there is no point in playing part of a game so as there is no game-save feature you'll either have to leave your computer on or allocate several hours each time you boot up the disk.

I have covered only the barest essentials of the game, and the real thing is extremely sophisticated. The graphics are the most obviously impressive feature, with the colours changing according to the season, but there can be no doubt that this is an admirable piece of programming. According to the manual the

final product is the 317th version and the whole thing took eight months to complete. Rumour has it that, either as a result or prerequisite of this work, Mr Crawford is a rather strange fellow. Certainly an obsession with military matters in general and World War II in particular would considerably enhance your appreciation of this game. Because of a deficit of time and patience, a tendency to avoid long-term solitary leisure activities, and a total lack of interest in wars generally (beyond sheer horror), I wouldn't touch this game with a barge pole. I don't, however, wish to offend the doubtless numbers of devotees who could with some justification claim that this was one of the best games of its type ever devised. Eastern Front and Chris Crawford demand respect, if not approval.

Presentation: ██████████
Use of graphics: ██████████
Complexity: ██████████
Value for money: ██████████

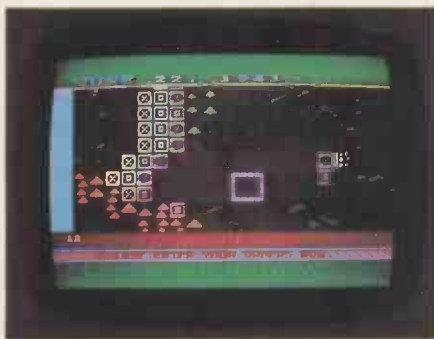

Game: Preppie
Supplier: Adventure International
Price: £21.99



Game: Frogger
Supplier: On-Line Inc
Price: £22.75

These two are essentially the same game, both being glossy versions of the arcade favourite, which I reviewed last year. Frogger, as you might guess by the name, is the original copyright version, while Preppie is an amusing variation (though with the traditional impertinence of direct rip-offs it is, of course, also copyrighted).

For any of you who have yet to sample its delights, Frogger involves manoeuvring a frog first across a busy

road and then across a river in order to reach a home base at the top of the screen. There are four lanes of traffic on the road, two lanes in each direction, and the speed of this increases as the game progresses. The frog must avoid touching any of the vehicles. On the river the opposite applies, since the frog must leap onto moving streams of logs, turtles and crocodiles to get across. Believe it or not, the frog drowns if it falls in the water. Things are made more difficult still by deadly snakes which wander across the grass between the river and the road, and by various creatures which lie in wait at your home base ready to gobble you up.

The version of Frogger for the Atari is, from what I can remember, fairly true to its ancestry, except that it is only a one-player game, and each game consists of five frogs. There are also 'lady frogs' which wait on logs for your controlee (which is presumably considered a gentleman frog) to escort them home. Leaping on top of this frog of the fairer sex allows you to control the happy pair as if they were a single creature. The game can be played at two different speeds.

Preppie has a similar layout but with only three lanes of traffic both on the road and on the river. In fact the road is a fairway and is actually populated with lawnmowers, golf cars and bulldozers. The river starts off with boats only on it, but logs and crocodiles appear later on (though there are no turtles). Instead of a frog you control a young student ('preppie' is an American term for rich spoiled kids who have attended private — in our terms public — schools) whose name is given in the extensive story which accompanies the game as Wadsworth Overcash.

Because of a bizarre college tradition Wadsworth has the job of retrieving

golfballs on a very dangerous course. In the first frame there is only one golfball, lying just the other side of the green, which must be retrieved and carried back to the starting zone. As the game progresses more balls appear. Only one ball can be carried at a time and, of course, there is a limited time to do it. Incidentally in Preppie, instead of a snake threatening you in the central reservation there is, to add insult to injury, a giant frog!

Preppie can be played by one or two players using either just one or a pair of joysticks. In both Preppie and Frogger the graphics are superb, and they both include melodic but repetitive tunes which are amusing to begin with but soon drive you mad (luckily the music can be turned off without losing the other sound effects by pressing 'select' on Frogger or CTRL? SHIFT and 'm' on Preppie). I like both of these games, and to be honest there is not much to choose between them. Preppie certainly wins out in terms of presentation, but the long sequences between each term make it slower-moving. It also includes the option of starting at any level between one and nine, which can be useful once you start to master the game.

Preppie

Presentation: ██████████
Addictive quality: ██████████
Use of graphics: ██████████
Value for money: ██████████

Frogger

Presentation: ██████████
Addictive quality: ██████████
Use of graphics: ██████████
Value for money: ██████████

SCREENPLAY



Game: Chopper Rescue
Supplier: Microprose Software
Price: £24.75

Chopper Rescue is one of the few games this month which needs the Basic cartridge, and is not to be confused with Chop Lifter, a game based on the abortive attempt to rescue the American hostages in Iran. Although I couldn't get hold of a copy of the latter to review, the few games I played were very impressive and it's well worth a try if you get the chance. In Chopper Rescue you use the joystick to control a helicopter (surprise, surprise) whose task is to rescue 10 prisoners from a colourful and heavily defended labyrinth.

The game can be played with one to

four players, and there are three difficulty levels. If more than one player is taking part two different variations are possible. A solo mission involves the first player finishing one card or losing all three helicopters before the second player takes his turn, and so on (they both use the same joystick). A team mission involves one player controlling movement with the first joystick while another player uses the button on the second joystick to fire, thus giving a possibility of two pairs. This second option is awkward to begin with but can be a lot of fun when you get the hang of it.

The labyrinth has a selection of defences. These are devices that release mines which float upwards towards you, or similar objects which shoot streams of coloured fireballs horizontally across the screen. In addition the labyrinth is populated by several different kinds of 'droid defenders' which fire directly at your helicopter if they catch up with it. These can be pretty sneaky and will take cover in the most awkward places to prevent you reaching one of the prisoners. To add to your problems the helicopter must not touch any of the walls and has a limited amount of fuel (in effect, time), although I never found the latter a problem.

Your defences are two-fold. The joystick button releases a bullet which travels horizontally in the direction the helicopter is facing. If you pull the joystick down (ie, towards you) while simultaneously pressing the button the helicopter drops a bomb onto whatever is below. The bomb can also be dropped at an angle by pulling the joystick down and to one side.

After all 10 prisoners have been rescued a similar labyrinth with a different configuration appears, and there are three different scenarios. I don't know what happens if you finish the third frame since I didn't get that good, but I assume it reverts to the first configuration and throws in a lot more 'droids'. This is one of the most addictive games I've played, and offers plenty of scope whilst being easy to come to grips with. Good use is made of the Atari graphics and the sound is realistic if a little limited. Flying the helicopter demands plenty of concentration and care, and the game should occupy anyone long enough to feel they have got their money's worth.

Presentation: ██████████
Addictive quality: ██████████
Use of graphics: ██████████
Value for money: ██████████



Games: Stratos
Supplier: Adventure International
Price: £25.49

Stratos is a rapid-action space battle game with some stunning graphics and a number of interesting features. The play itself is fairly standard. Your joystick controls a cross-hair sight targeting two guns (termed 'Armageddon war devices',)

situated at the lower corner of the screen. Groups of three craft (M'korg star-jammers) appear, growing from small points of colour, and swoop down in a variety of formations to attack your city.

The city is made up of eight power towers, which feed your defences, and a small flying saucer. It is protected by a horizontal force field lying a few inches above the bottom of the screen. As you might guess, the object is to shoot down the M'korgs before they destroy your city with their streams of bombs ('ravagers' or 'atomic core disruptors').

The game happens in waves, with each one consisting of fifteen triplets of M'korgs, and the action is extremely fast. Between each wave you have the opportunity to repair or replace damaged sections of your force field by pressing the space bar and manoeuvring the flying saucer out of the city and over its defences. Care must be taken to return the saucer to the city before more M'korgs arrive, however, or you'll lose your

repair capability.

The interesting features I referred to earlier are mostly concerned with the setting up procedures. You can change the background colour through a selection of shades from light blue to black by pressing 'B'. The 'C' key gives a variety of different foreground colour combinations, whilst the 'S' toggles the two available skill levels.

Stratos is a satisfying and spectacular space battle game, whose colourful graphics are enhanced by the optional variations of shade. The principles are hardly inspired, but this game should keep most arcade freaks happy for a few months.

Presentation: ██████████
Addictive quality: ██████████
Use of graphics: ██████████
Value for money: ██████████

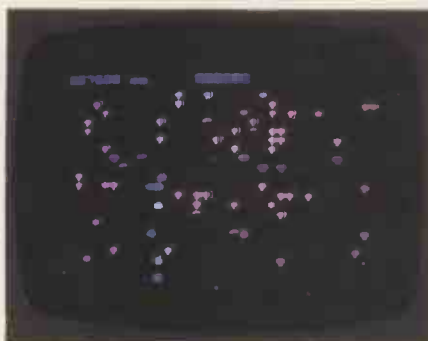

Game: Centipede
Supplier: Atari
Price: £30

This is one of Atari's latest offerings, and was heavily promoted in the latter part of last year. As with most of Atari's ROM-based games Centipede started life in the arcades, where it achieved a significant following. Although in its basic principles the game is not far removed from a simple Space Invader scenario, the details are rather more complex, making for a colourful and

attractive game.

The playing field consists of a black screen with a large number of coloured mushrooms scattered randomly across it. You control a small oval object, described as a 'bug blaster', which can move in any direction within a strip of a few inches wide running across the bottom of the screen (note that its upper boundary is not actually visible). The blaster gives standard auto-repeat vertical firing. Throughout the game four types of creature emerge, any one of which will

destroy your bug blaster if they touch it.

The most prolific beast which attacks you is of course the centipede itself, one of which is always on the screen. It moves horizontally across the screen, moving down and changing direction whenever it encounters a mushroom or the edge of the playing field. Your blaster can destroy one segment at a time, which generally has the effect of splitting the creature up. As the segments reach the bottom of the screen the number of centipedes increases, eventually making it impossible for you to continue.

Next comes the jumping spider, which regularly hops across the bottom of the mushroom patch and which can be quite tricky to destroy. It can appear from either side at any time, taking you unawares, so it's essential to keep your bug blaster clear of the edges as much as possible. Spider movement is not inhibited by mushrooms, though it will occasionally cause them to disappear as it passes.

As the game progresses, increasing

numbers of 'frenzied fleas' drop straight down from the top of the screen at your blaster. These little demons take two shots to destroy them, and they often leave a trail of fresh mushrooms in their wake. Remember that the mushrooms restrict the bug blasters' movement, and allowing too many of them within your area is extremely hazardous. They can, of course, be destroyed, but it takes four shots to do it.

The last creature to make its presence felt is the 'poisonous scorpion' which occasionally dashes from one side of the screen to the other changing the colour of any mushrooms it encounters. If a centipede touches one of these 'poisoned' mushrooms it changes course and makes a bee-line for the bottom of the screen. If you're lucky this can make it easier to hit it — but you'll need to be quick.

Centipede comes complete with a fully illustrated booklet describing the 'enchanted mushroom patch' (what *kind* of mushroom could this be, I wonder?), ostensibly written by one Lord Motley

Bugnut, the well known bug expert. One or two players can take part and the game requires one joystick per player. As with most of Atari's games the sound and graphics are impeccable, with the colour scheme (though not the background) changing each time a centipede is completely eliminated. This game is highly recommended, though I must say I'm surprised that ROM packs (and not just Atari's) are still so expensive.

Incidentally Silica Shop sent me a disk-based version of Centipede called 'Bugg Attack', which has a slightly different selection of creatures and is interesting though rather too manic. This is produced by the Cavalier Computer Corporation, which is, I suspect, well aware of the fact that Atari is willing to ignore copyright infringements of the game on its hardware.

Presentation: ██████████
Addictive quality: ██████████
Use of graphics: ██████████
Value for money: ██████████



Game: Seafox
Supplier: Broderbund Software
Price: £19.75

I've been disappointed with many of the submarine games I've played in the past, but this one is an exception, providing an interesting arcade-style game which is easy to play but not so easy to master. Seafox is a one-player game where the joystick controls a submarine which can fire torpedoes vertically toward the surface. The sea takes up about four-fifths of the screen (and is green) with a strip at the top representing the surface (blue).

On the surface three types of ship appear. At the very top is a row of merchant ships, and sinking these is the main object of the game. Next comes a row of hospital ships, from which your torpedoes are reflected back toward you (it being against international law to sink them!); and which thus provide effective cover for your targets. After the first wave of merchant ships has been cleared, a third row of destroyers appears; these drop depth charges randomly into the water.

In the sea itself there is a stream of enemy submarines, which to begin with rely solely on kamikaze collision tactics, but after the second 'mission' begin to

fire torpedoes from their bows. To add to your problems in later missions, magnetic mines appear floating around the water.

At the bottom of the screen is a status display which shows your fuel, number of torpedoes and score. If you run out of fuel the submarine is destroyed, so both this and your ammunition must be frequently replenished. This is achieved with the help of a supply sub and a friendly dolphin. The sub travels across the bottom, and as it nears the edge the dolphin appears carrying its relief package. Your task here is to make contact with the dolphin before the supplies are stolen by the inevitable giant clam which rushes across the centre of the screen. Quite what the poor creature does with a load of diesel and oil and 30 torpedoes is anybody's guess!

It is possible to injure the dolphin during the link-up, in which case a huge

fish appears and destroys you by way of revenge. Although this happened to me several times I was never quite sure what I'd done wrong — and when I attempted to do in the dolphin on purpose nothing seemed to happen. A standard three submarines are allowed each game, with each one starting out with a full load of fuel and torpedoes.

As I said at the outset, I thoroughly enjoyed playing this game, even though the stiff joysticks combined with the slow movement of the sub gave me blisters after a while. The game is fairly limited, however, and would be unlikely to stand the test of time as well as some of its more sophisticated contemporaries.

Presentation: ██████████
Addictive quality: ██████████
Use of graphics: ██████████
Value for money: ██████████

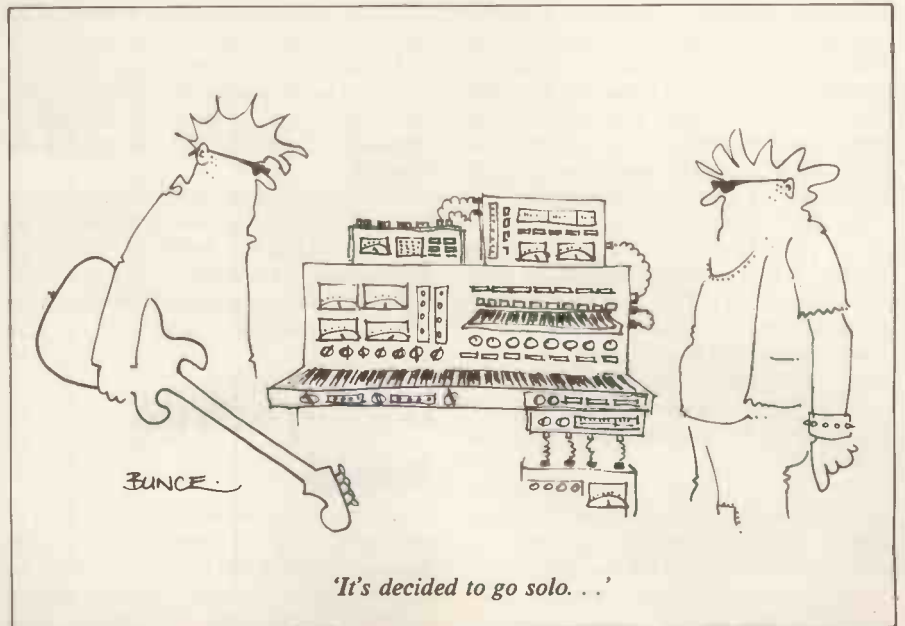



SOFTWARE APPLE WORD HANDLER

EASY HANDLING

Jane Bird proves there's still life in the Apple with this word processor Benchtest.

The Apple II is never going to be the ideal machine for word processing. It has a consummately uncomfortable keyboard with no function keys, and the standard system allows a maximum of 66 characters across the screen. However, there is an enormous number of Apple II users (about 750,000 worldwide) and these people may be very glad of an inexpensive word processing package which offers all the basic facilities.

Which is how you could describe Word Handler II, designed by Silicon Valley Systems (SVS), California and available from Pete and Pam Computers in the UK.

The oddity of the package is that SVS doesn't seem to have decided who it is aimed at — the manual talks at one moment to the complete novice who has no understanding of computers and the next moment recommends use of the DOS 3.3 manual for details of how to format disks.

My overall impression was that it is the user of the DOS 3.3 manual who will enjoy this package, not a secretary or manufacturer with no understanding of computers. I definitely see Word Handler being appreciated by a two-finger programmer who wants a go at exercising his literary skills.

I have said that Word Handler is a very minimal system. This is good in that it exercises the smallest possible number of command keys to perform the greatest possible number of tasks. There is a relatively small number of functions — so they are easy to remember. However, it does lead to confusion because the same keys perform different functions — so they are easy to remember. However, it does lead to confusion because the same keys perform different functions depending on whether you are in 'insert' or 'edit' mode. Some useful functions have also been missed out.

The most glaring omission must be the cursor control. The cursor can only be moved by first pressing the left or right arrow, then using CTRL W, L or P depending on whether you want to move by words, lines or pages. To keep moving you either have to keep on bashing this sequence of two keys or else use REPEAT which means holding down three keys at once!

Also absent are some of the facilities we have come to regard as standard on sophisticated word processing packages — namely dictionaries and spelling checkers.

But Word Handler does provide some unusual and extremely useful features —

including the display, on screen, of bold, underline and superscript. In other systems these often cannot be viewed until they actually appear on the printed page. Instead you see the control characters denoting the special format and these take up space on the line. Word Handler, however, gives an unmistakable visual representation of underlining, superscripting and bold, although characters appearing in bold are almost completely illegible. You can even set and display bold superscript — should you have such an eccentric requirement.

Documentation

The documentation is to a high standard. 'There is nothing you can do that will unintentionally ruin things,' says the manual. But it does shoot off course occasionally into the realms of bytes and operating systems.

The manual includes a tutorial program but it is emphasised that you do not need to work through this to learn the system. Instead you can plunge straight into the 30-page reference section which is written in the order that you would need to know things on first using the machine. SVS claims that 'the manual will have you operating Word Handler like a professional in 20 minutes', and this is indeed true. But a novice might have a problem in the initial stages of using the system because on booting it asks which slot the printer is in. At this stage you might have to power-down, take the machine apart and check this out.

The list of printers can be a problem, too — it may not be easy to decide if your printer is 'auto-lf, no bkspace', or 'auto-lf, w/ bkspace'. 'Find this out,' commands the manual.

The manual also warns that the only confusion it is likely to cause will come from the user reading too much into the text. I also found this to be true — if you want to follow the manual you really do have to put previous experience right out of your head.

Learning with the tutorial

Using the tutorial takes longer but makes an agreeable way of putting the system through its paces and finding out just what its limitations are. The tutorial, though generally sympathetic, does throw in the

occasional piece of jargon which is totally at odds with the pervasive user-friendly approach. For example, it reassuringly comforts the user in the main part of the manual that 'bringing a document to the screen is like getting papers from a filing cabinet and putting them on your desk; making changes is the "editing" process and CTRL E is putting them away'. Yet in the initial 'Setting Up' chapter of the manual you read: 'A newly initialised Apple II disk has a capacity of about 123 kbytes depending on the size of the Hello program.' This gives no indication of how much space that might mean in terms of A4 pages. And what is the newcomer supposed to make of the 'Hello' program?

I came across another difficulty in the tutorial when I tried to set up a document with the very same name that I had already allocated to the disk. The system was unable to tell me what I had done wrong and could only display the message 'Name is on file but is not a document. Press any key to begin again.'

In addition to the problems I have already mentioned with using the Apple keyboard, there is also the procedure for generating upper case. On the 48k system I used the keyboard had not been modified and upper case letters could only be generated by first pressing ESCape. This would be especially tedious if you wanted a whole word to be in upper case, but fortunately Word Handler allows you to use CTRL K to switch upper case on permanently until you switch it off with CTRL K again. One further complication: the ESCape for SHIFT does not apply to the top row of keys which are numbers and special signs. For those you use the ordinary SHIFT key. This is very awkward, especially for anyone who is a touch-typist.

Using the system

The focal point of the system is the 'idling' stage where your documents are closed and the screen displays a list of options to you. There are seven of these: INDEX, PRINT, USE DISK /, ERASE, RENAME, BACKUP and FILL-IN. The first four of these appear at the bottom of the screen and their functions are self-explanatory and hence easy to learn. Also on the screen is the instruction 'Enter name of old or new document', which is what you do if you want to start editing an existing document or creating a new one.

The document-naming facility is one of

the unequivocal plus points for this system. Your name can be up to 30 characters long, which allows it to describe its contents very accurately. At the same time, the document name can be abbreviated by using a semi-colon — the letter(s) to the left of the semi-colon must be unique on the index and can be used to call up the document. For example, your full document name might be: NEW: THIS IS A TEST, but you could call up the document by typing just NEW.

Editing

Once you have called up your document its first page will appear on the top two-thirds of the screen. At this stage you are in 'edit' mode and in order to start creating text you have to change to 'insert' mode.

Word Handler requires you to swap fairly frequently from edit mode to insert mode and back. 'It is a natural assumption that you use insertion for new documents and editing for old ones,' says the manual. 'In fact you need both for both'. This design leads to abundant confusion in the early days, especially as the same keys perform different functions in different modes.

Before I describe insert mode I will mention that you can stay in edit mode to make simple changes to existing text — for example, overtyping. You can type a character over a character or a space over a space. It is less congenial to try to type a space over a character or a character over a space since you precipitate a total screen refresh which is very irritating to watch and definitely not the best way to edit text. You can also delete while in edit mode.

Like cursor movement, deletion is also executed by character, word, line and page. You use CTRL D to get into delete once you have positioned the cursor at the start of the section you want erased. Then you move the cursor forwards by whatever increment and, once the piece is defined, pressing the RETURN key will execute the deletion. This is irreversible, which is rather alarming. However, you can abort the deletion at any time prior to pressing RETURN by pressing the left arrow instead.

One real drag about editing is that you cannot easily redefine words as in the alternative case, or in bold, superscript or underlined. You have to delete the word in its old form, then go into insert mode, switch on the relevant formatting facilities, and retype the word. Conversely, overtyped characters in edit mode retain any special format qualities that have been set already.

The main way to edit your document is in insert mode, however. If it is a new document then obviously you will want to start right there at the top of the screen, so all you need to do is type the logical CTRL I and you can set off.

However, if it is a long document entered on a previous occasion then you will have to locate the point you wish to add to or expand on. This is where the limitations of the system become apparent. There is no facility for calling up either the end of a document or a specific page by number, and although you can scroll through the

document a page at a time this becomes very laborious. Then, if you want to find a specific point on a line, you have to arrive at it by using the CTRL Line and CTRL Word facilities — an activity which requires a much more intense level of concentration than simply holding down cursor direction keys until the right location is reached.

Once you have positioned the cursor in the right place you press CTRL I to get into 'insert' mode and you will stay in that mode until you press the right arrow which instantly saves the insertions and puts you back into edit. One minor gripe about using CTRL I is that the two keys are so far apart that unless you are a concert pianist you'll need two hands to press them simultaneously. Since the command has to be used so often it's annoying that it can't be done with one hand.

As I have said, one confusion with the system is that the same keys perform different functions depending on whether you are in insert or edit mode. Probably the first you'll notice is that the backwards arrow, instead of just moving the cursor backwards, has become a backwards delete or backspace key.

While in insert mode you have a number of formatting facilities at your disposal. CTRL V is used for — guess what? — vertical spacing. Well, it's a reasonable acronym isn't it? (Another system I've seen uses L for Line and another uses S for Spacing). Vertical spacing is operated in a manner that is typical of the Word Handler approach. As with cursor movement, you are given a series of sensible options. In the case of the vertical spacing facility it rotates round a set of options in the left hand margin each time you press CTRL V. They are ½, 1, 1½, 2, 2½, then back to 1 again. The rotating options make vertical spacing easy to remember and to use. You simply stop when you reach the appropriate reading. Like CTRL K, CTRL V affects all subsequent text but can be reset at any stage. Both should be thought of as switches to change the current mode: *change case* or *change vertical spacing*. CTRL L can also be used to insert a blank line when in insert mode, but the advantage of CTRL V is that it doesn't actually occupy any extra space on the screen.

The COPY statement is an example of exercising one function to maximum effect. There is no separate command to MOVE text — you simply COPY and then DELETE the original. The process is logical, but rather cumbersome, especially if you're used to finer things.

Justification can be done on screen. It divides space left over at the end of the line equally between words. When you have the justification switched on it is pleasing to note that the word 'justification' appears — small but legible — at the bottom right hand corner of the screen in the status line.

One horrible thing about the justification feature, at least until you get used to it, is that if you leave it until the editing stage it can only be called up a paragraph at a time. As the manual admits, 'It's a good idea to decide in advance whether you want your document to be justified — especially if it's a long one.' If you've left the justification

for later then you'll have to go through the document paragraph by paragraph putting on the justification.

Other facilities for use during insertion are CTRL B for Bold, CTRL S for Superscript and CTRL Y for Underline. When any of these are switched on, the relevant word appears in the bottom right hand corner of the screen.

All these conditions are nullified by CTRL N, which takes you back to normal text.

Page breaks are indicated by a broken line across the centre of the screen and page numbers are given in the page status field at the bottom of the screen. But when you type across a page boundary the page break doesn't appear until you end the insertion and return to editing mode.

Stray beginnings of paragraphs at the bottom of a page — widows — or stray ends of paragraphs at the top of a page — orphans — are automatically taken care of by Word Handler. You can enforce a page break with the command CTRL P while in insert mode. But it is best to avoid doing this until the document is in its final form.

Search and Replace

So far all the acronyms I have mentioned have been logical, but in every word processing system I've ever tested there have been some howlers. In this case it is the use of CTRL T for search 'Til', which I found over-contrived but I daresay that it works as a mnemonic — people will remember it if only because it is contrived. (CTRL S has already been pre-empted for superscript.)

The SEARCH command is operated when in editing mode and allows you to search for a string up to 46 characters long. However, it only works for words or phrases and you can't go down to the level of parts of words.

To replace the string with something else you use the CTRL R command. One annoying thing about the replace command is that you can't set it off from anywhere in the document. You have to go back to the beginning if you want to pick up early occurrences of the string.

One formatting character which can be employed only during Insert mode is the unbreakable space. This may be because it uses CTRL W — the same keys that define a Word in edit mode. The unbreakable space is ungainly because it inserts an extra space, so if you are at the editing stage you also have to delete the space that was there before. All this leads to a clumsy command sequence CTRL DIW- to replace an ordinary space with an unbreakable one.

Printing

My own printing experiences with Word Handler were unfortunate since I was using Apple's thermal Silentype printer. This was unable to cope adequately with my text and frequently truncated or otherwise mutated the letters of the alphabet.

I was able to produce only draft quality printing which would have been illegible to anyone other than myself.

But Word Handler does include some useful printing functions. Pages to be printed can be specified in a flexible format:

EASY HANDLING

2,3-5, 3,4 and 5 or 2,5,8. The numbers have to be in ascending order and any that represent a descending order will cause the printing process to abort.

One idiosyncrasy is that you can't tell the printer to print to the end of the document. Instead you either remember the number of the last page and specify that or else you input an absurdly high number.

With Word Handler the user has the option to change the format specification. The format menus are a little opaque. The units they use are actually in inches although there is no indication on screen that this is the unit of measurement.

One very useful printing feature is that you can order alternate margins for the left and right hand sides of pages. This is designed to prepare documents that will be bound.

General points

A distinct drawback is that back-up files are

not automatically created and you have to create any back-ups manually. Another worrying point is that the ERASE command is disturbingly literal. Once you have input the ERASE command the system does not come back to you for confirmation. It goes blithely ahead.

A lively if irritating feature of the system is the audible warning effect. This makes Space Invader sounds by repeating if you persist in foolish activities! The audible warning is activated when you try to move the cursor beyond the end of a document while in edit mode, or when you set up margins, or headers and footers, that are physically impossible.

Merging of two files for applications such as mailing lists is also included in the system. This facility would be extremely useful to somebody trying to run a small business on his Apple II and who wanted to send mail shots.

Beyond that there is little more I can say. I was impressed with Word Handler as a basic word processing tool that was extremely quick to use and simple to learn.

The package includes a convenient and concise memo card which summarises the commands and facilities of the system at a glance.

Clearly Word Handler is a very limited tool and provides no facility for drawing tables on the screen or adding up columns of numbers. The unaccommodating keyboard would be a nightmare to somebody used to keys you only need 'stroke'. And if the system were to be used by a serious typist then the keyboard would have to be modified so that the SHIFT keys could be used for upper case. The restricted cursor movement, carefully controlled in increments of character, word, line or page, not even paragraph, is guaranteed to send an experienced word processor user crazy with fatigue and frustration.

Within these limits Word Handler offers all the basics of word processing in a very user-friendly format.

And it is good value at £109.

END

THE LYNX

Continued from page 142

This should therefore mean that sophisticated games and home software are published for it. At present three sets of games are on their way — and these will probably speak for themselves if you read a few adverts. There are also plans for educational software. Computers sees the Lynx as having a future in schools. There is, though, no software currently available for the machine apart from a demonstration tape given with the machine when it is purchased.

It's claimed that disk drives will be launched for the Lynx in March/April. If the Lynx itself is any guide, this could turn into August. The machine is CP/M compatible and this, coupled with upper-range memory expansion and therefore 80-column display, could make the Lynx into a true dual-personality machine. Computers is working on a manufacturer agreement with a software house (I'm not told which one) to put word processing and accounting software on the Lynx. Pascal, Forth and Comal compilers will also arrive, initially on cassette and then on disk.

EPROM additions and ROM cartridges are planned for the near future. One of these is a data file handling package which will also be available on cassette. A full graphics/sound add-on is also on the cards.

The Lynx is a very 'soft' machine and

many of its capabilities depend on the quality of software produced for it. Its impact on the market also depends on its resident software — ie, Basic — which does leave more than a little to be desired. It will probably happen that other Basics (and other languages as well) are written to replace what is there already if people feel a demand for it.

Expansion

I've already mentioned the disks. These, says Computers, will be single-sided, double-density with a capacity of 250k per drive. There's the option of either single or twin disk units and a disk unit includes a Centronics interface. As well as CP/M, a 'primitive' Lynx DOS has been pointed at for the future but it's probably better to go for CP/M when it's available (which will be at the same time as the disks).

Memory expansion is great on the face of it but it's essential to remember that if you buy a 192k machine you only have 64k of RAM immediately available for programming. The rest is video/graphics RAM but this can, apparently, be accessed using machine code. Details on how this is done will be made available to users.

The Lynx printer will be a tiny printer of the 'till roll' type and will cost in the region of £60. For more serious minded people, the recommended printer, the Seikosha 250X, can be run from a Lynx through the RS232 using a special lead and software available from Computers. Prices of these are not available yet.

A light pen is also on its way but Computers will not commit itself to a date

on that. It will be connected to the Lynx through the port marked 'LP' which also runs a black & white monitor. An RGB port is provided for a colour monitor.

A look at the prices listed will reveal that you can set yourself up with a theoretically decent business machine for £299 (96k Lynx with 64k user RAM) + approx £400 (twin disks) + approx £100 (black & white monitor) + approx £250 (Seikosha printer) which comes to about £950. Then on top of that you've got to buy software. Better deals have been known. Unless you've had a Lynx for a while and don't want to sell it this can't be said to be the best proposition if you only want to do stock control or whatever.

Support and availability

Computers has made dealer agreements with Spectrum Computer Centres and Lasky's who should have the Lynx in stock by the time this Benchtest is published (and don't write to me if they haven't. . .). No plans for further dealers are in the air as Computers doesn't want to encounter stock flow problems. It plans to have 40,000 Lynxes produced by the end of this year.

A 12 month warranty is wisely tacked onto the whole package but this excludes labour. Servicing after that will be carried out by the subcontractors and by 'one of the retailers'. Just which one will soon become apparent.

A Lynx newsletter will be published and sent out to every user who sends back the guarantee card.

Technical specifications

CPU:	4 mHz Z80A
RAM:	48k (16k graphics, 16k user) expandable to 192k total
ROM:	16k
I/O Ports:	Expansion bus, cassette, RS232, RGB, Composite video
Disks:	Single or Twin, SS/DD, 250k/drive
O/S:	CP/M-80
Languages:	Basic. Pascal and Forth to come.

Conclusions

I'll begin by saying that Computers has, as a company, the best intentions and follow that up with 'the best-laid plans of mice and men. . .'. You see, there have been problems. So far the machine itself has been late and there are no definite dates on other hardware to come. If you bought one now

GOTO page 223

Moore on Kuma



Filing with New Brain

Good news for New Brain users. KUMA has two new programmes to help you with your filing. Card index is a versatile multi-purpose data management package offering search, sort, amend and delete. Just think of it as an electronic filing cabinet for £35.

The second package is called File Manager and is for sequential tape file handling. It can be used as a standar M programme or incorporated with one of the users.

Ring 0628 71778 for more details.

Royal Quiz

Kings and Queens is the latest educational programme from KUMA and is written for the New Brain. In keeping with KUMA's policy of offering learning programmes that are fun to use, Kings and Queens provides facts and figures on the monarchs of England using a 3 ability level quiz system and randomising technique that ensures a different quiz every time.

It is suitable for users of 8 years and upwards, and no previous computing experience is necessary. But don't be fooled into thinking it is child's play, even 'A' level students have trouble with Level 3.

Is there an author in the house

If you have written a useful programme for the Sharp, Series Osborne 1 New Brain or the Epsom HX 20, contact KUMA. As a leading publisher of software for these machines, we are always interested in new talent.

Unique 4th for Osborne 1

A 4th that conforms to the international standard 6th forth is available from KUMA for the Osborne 1. It operates under CPM and incorporates a unique Z 80 assembler using standard dialogue mnemonics.

Other features include screen editor floating point operators, use of CPM 4 all purpose, and a comprehensive editorial manual that offers a starting point to newcomers to 4th, and progresses to advanced use of the language.

KUMA 4th also allows the user to exploit the machine's excellent parallel IEEE and serial RS 232 interfaces. At £85 the 4th will have a major impact on development times and batch assembly.

We're backing the HX 20

KUMA has examined the new Epsom HX 20 in depth and has found it to be a very very pleasing machine for authors to work with. The excellent basic coupled with the ability to insert large sections of machine code sub routines for enhanced performance have proved very attractive.

One of the great benefits of the HX 20 is that when you power down the machine, all the information is still in it. This opens up possibilities which we are sure many people haven't even considered yet.

Every feature we have found on the HX 20 has proved to be user friendly. We are putting in a great deal of effort to enhance it with our own style of software and make it truly the machine to have on your office table or to take with you on your travels, as this is a very portable computer.

Kuma is going all the way with this small but power-packed desk top machine, and our enthusiasm is assured by PCW which in its HX 20 bench test said: "for tasks such as stock control, sports result calculations and sales records, as well as general scientific and engineering work, it is an excellent tool and an impressively well made one at that".

CPM Recovery Service

All new product has been launched with the Sharp MZ 80 B. Called DISMOD, it is one of the standard CPM tool kits and allows every single bite on the disc to be inspected, altered and saved to anywhere else on the disc sector by sector.

It, in fact, allows track sector and bite inspection and modification. Also it allows the copying of certain sectors — a most useful aspect of it is for recovering accidentally erased CPM files or offering the best possible means for recovering after a disc crash. Discmod is for CPM base MZ 80 Bs and is priced at £39.50.

WD Pro 2.24

WD Pro, the market leader in Sharp word processing software, has been enhanced to version 2.24. This latest version allows a re-entry possibility for users who have accidentally exited from a programme and have a larger amount of data still locked inside. A re-entry command has now been added to make the programme even more friendly.

WD Pro 2.24 costs £39.50 on cassette or £79.95 on disc, but if you have a previous version KUMA will update it for just £5.

Kuma Computers Limited

11 York Road, Maidenhead, Berks, SL6 1SQ
Tel: (0628) 71778/9 Telex: 849462 TELFAC KUM



PROFESSIONALS IN SOFTWARE APPLICATIONS: INTERFACING

Sirius - 1.

The best price/performance you've ever seen on a personal computer: £2395 + VAT For 128K, 1.2 Mbyte, 16 bit, available software includes:- CP/M86, MSDO, Mbasic, COBOL, PASCAL, FORTRAN. etc.

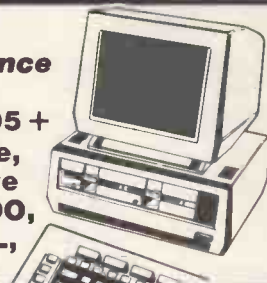

Osborne - 1: You can take it anywhere. CP/M + 64K RAM, Dual discs interfaces and Wordstar, Super Calc, Mbasic. All for £1250.00 + VAT. Ask us about additional software.



ANNOUNCING THE NEW HX20



Newbrain:

The only professional micro of this size: Phone us for immediate FREE delivery + SOFTWARE CATALOGUE Newbrain AD with onboard display £229. + VAT.



SHARP A + B;

Computers and systems with a Wealth of software applications programs. "WDPRO" Wordprocessing, Database, Accounts, Mail Lists etc. Phone Now for our new Autumn 170 Program Catalogue.



SHARP ≡ KUMA ≡ SOFTWARE

Printers:

Matrix - from £380.00 + VAT.

Epson Mx 80F/T3 NEC (C.itoh)

Daisywheel - from £476.50 + VAT.

Brother 8300 Tec Star Writer

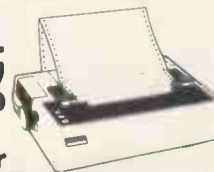

Applications:

Direct experience of office applications, phone us for advice on ledgers, stock control, payroll and word processing.

Software: the established leader for Sharp Computers.

MAIDENHEAD (0628) 71778

Kuma Computers Ltd., 11 York Road, Maidenhead, Berks. SL6 1SQ.

Tel: (0628) 71778/9 Telex: 849462 TELFAC KUM



PLEASE SEND ME MORE DETAILS ON: Software Hardware

Sharp Osborne Name
Newbrain Sirius-1 Address

BREAKING DOWN THE BARRIERS

In the wake of Information Technology Year, Maggie Burton takes a look at one of the Department of Industry's ITEC projects.



Drilling PCBs

IT Year achieved its purpose. It made people aware of the importance of electronic technology, and helped to bring it into people's lives for their benefit. But many more changes and adaptations need to be made.

There is still a need for the public to become familiar rather than fascinated with IT. The educational system is one of the most prominent areas for the application of microelectronics. Youngsters need to be taught now what they can do in the future with computers. And to cope with today's problems, the underqualified, disillusioned and unemployed members of the population need to be brought up to date — in the way which will most benefit them.

Perhaps one of the biggest steps in this direction is the formation of the ITEC (Information Technology Centres) project.

The first ITEC was at Notting Dale in West London. It began as an 'Urban Studies Centre'. This, says director Chris Webb, was 'a response to local job skills mismatched with the kind of jobs which were available in new technology'. Notting



A prototype music synthesiser, an EPROM burner & one of Notting Dale's staff.



One room at Notting Dale contains a pre-operational Econet of BBC Micros.

Dale ITeC now forms a model for other more recent centres. It is also the home base for Webb's Department of Industry Consultancy Team, which acts as a focal point for ITeCs nationwide, helping with any problems which might arise and also advising groups on how to set up an ITeC.

Webb's ideas came to fruition when Information Minister Kenneth Baker paid a visit to Notting Dale in 1981. The sight of several hitherto unemployed and under-occupied young people training to use microcomputers was a justifiable inspiration. He asked Webb to lead the project further using DoI and later Manpower Services Commission funds after hearing what Webb describes as 'some fairly unconventional proposals'.

Originally 20 ITeCs were allowed for. This number grew to 50, then 100 and now there are plans to cater for about 150 nationwide. Of this number, roughly 70 are in various stages of existence and several more are at the blueprint level.

Funding does not only come from the government. Local businesses are encouraged to sponsor ITeCs in various ways, be it with financing, donations of equipment or secondment of expert staff. Government funding for one ITeC usually runs to '£55,000 over the first three years,' says Webb. When it is considered that setting up an ITeC can mean an outlay of £250,000 (although it is often less than this), it becomes plain that sponsorship provides a great deal of the necessary capital.

The idealism that surrounds ITeCs is based on a three-pronged system. In the first place, ITeCs are a training base for the unemployed — particularly those under 25. Trainees stay in an ITeC for a year on a £25 per week allowance and are then theoretically better able to seek permanent work.

Secondly, centres provide an 'access base for the community'. This means that all sorts of people are able to carry out their own projects, learn about microelectronics or, in some cases, run business enterprises, using ITeC equipment. Thirdly, ITeCs are expected to provide some of their own capital by designing, floating and drawing profits from various products. An example of this is Notting Dale's G007 graphics board for the ZX81.

The third part of this system is strengthened by Webb's recommendation that ITeCs become limited companies. He describes this as a 'vehicle'. It gives protection if anything goes wrong with a product and it gives 'independence and autonomy — which is very important for ITeCs'. Profit is, naturally, channelled back into the centre.

This is a radical way in which to approach education. Webb, who had experience as a department head in a comprehensive school in the early 70s, is a self-confessed radical educationalist. He acknowledges that his ideas are a definite deviation from the norm, but he believes firmly in what he has done. He is anxious that ITeCs shouldn't become 'an aggregate part of the further education system in this country and take on some of its very different (and sometimes, in my view not very good) habits'. In 1978 he published a paper under the heading 'Dancing with the Silicon Devil' and many of the ideas put forward then are implicit now in the ITeC project. One of his feelings then was that microtechnology would be a 'job killer in the immediate sense' and that to counteract and combat this a local approach was needed both to education and to providing worthwhile employment. He is fascinated by the cottage industry characteristics of microcomputing and feels that it lends itself well to his educational philosophy. 'But I'm

not a whoopee merchant about IT. A lot of very important issues have been ignored by people,' he says.

Hand in hand with his ideas on micro-technology come Webb's ideas on teaching it. He describes the ITeC approach as 'modular hands-on'. 'Most teaching', he says, 'is still a number of kids going into a unit of space and a unit of time to study a unit of subject supposedly at the same speed. There are enormous failure rates in inner city schools. Literally 40-50 percent of kids have no qualifications at all, not even miserable little CSEs. They become disenchanted, they abscond, but within that we know there are many kids who are immensely bright but immensely disenchanted.'

In an ITeC, youngsters learn what interests them at a speed which is in keeping with their ability. Furthermore, they learn by doing rather than by listening. Experts are on hand to answer any questions, get projects started and provide fresh ideas. Webb calls it 'person-shaped', with the big emphasis being on using computers and putting newly acquired knowledge to good use.

The only prerequisite a young person needs when looking to join an ITeC is self-expressed interest. Under no circumstances are interested youngsters turned away if there are places for them. Notting Dale works on a first-come-first-served basis and other ITeCs follow this example.

Trainees begin by discovering the basics. At the same time, they learn fast by doing. 'Our kids build a power supply for their own use in virtually their first week at Notting Dale,' Webb explains. They are taught how to get software up and running, Prestel editing and alpha-mosaic graphics, etching PCBs and fitting components, keyboard skills. . . the list is a very long one. And Notting Dale ITeC is full of electronic

BREAKING DOWN THE BARRIERS

equipment and youthful enthusiasm. From talking to trainees it's plain that they enjoy their work, even if, as one says, 'the money's a joke'. A small price to pay, all the same, for learning a skill.

At Newcastle ITeC, which has been running for about seven months, trainees are interested enough to bring in their brothers and sisters. There is plenty to do in the way of commercial enterprise — making PCBs, installing programmable controllers and developing software, most notably for the Rediffusion Teleputer. This is an example of an ITeC which is a viable limited company. Manager Mike Pedersen says, 'We're not sponsored by anyone. We're always within budget and we're hoping for some kind of income in the next year.' He is fully in agreement with Webb's ideas. He explains that 'training in real-life projects is the priority, not artificial situations', and adds 'we're all having a good time and that matters'.

The amazing thing about ITeCs is that all of them are different. Their individual characteristics depend on who is running them and what equipment they have. An ITeC starts when a group of people approach their local Manpower Services Commission office and express an interest in setting one up. This group can be a Chamber of Commerce, a group of concerned teachers, a computer club, a local authority or a combination of these.

If the MSC has not allowed for an ITeC in that area then, Webb says, 'There's usually little point in pursuing the application any further.' But if it deemed appropriate a management committee is formed which meets with Webb's consultancy team to organise the 'nuts and bolts of the thing'.

'A lot of people are desperately worried about what's happening to kids in their locality,' says Webb. 'You find a lot of groups are lay-groups. They don't know anything about the new technology and they find that disturbing. They're trying to manipulate something they don't really understand.' The consultancy team explains to these groups exactly what an ITeC is and helps it to control its understandably large capital outlay. It's surprising how very many things have to be considered in painstaking detail before an ITeC can be considered mobile and operational. The hands-on characteristic of entries means a great deal of equipment is needed and therefore complicated insurance procedures. Premises have to be found, sponsors interested and equipment chosen. It's not an overnight job.

Several large companies are involved in sponsorship. Of course, it's a mutually beneficial thing, because the company involved cannot fail to gain from acting to improve the workforce in its locality. Rank Xerox, for instance, has donated £20,000 to Camden ITeC. DEC's DECmate word processor is a favoured piece of equipment in the Consultancy Unit's latest equipment update. DEC is involved in Reading ITeC. And GEC, ICL and IBM are all making donations — to Coventry, Gateshead and Portsmouth respectively.

Sponsors are not always companies. Universities, education authorities and local government all make contributions. Webb describes this category of sponsor as 'a mainstay'. Neither do sponsors restrict their donations to money or machinery. Some provide premises, others provide staff and still others act in an advisory capacity by joining the management committees. A great deal of help is also given voluntarily.

The last way in which money is provided to run a centre, community enterprise, is perhaps the most unusual. This does not simply involve the ITeC itself manufacturing and marketing products. It encourages anyone who wants to get involved as well. Webb feels there is 'an enormous range of potential developments here'. 'If, he explains, 'you make equipment available to different user groups things will start to happen.' Sometimes use of ITeC equipment is granted free, sometimes engineers use it and pay a fee and sometimes companies enter into contracts with ITeCs. But it could lead in future (and indeed already is leading) to many educational, social and commercial developments. Each ITeC determines how it uses its own resources, which means that new ideas are constantly being thrown into the pool. Mike Pedersen in Newcastle says 'You'll find that every ITeC is different. They all develop their own characteristics.' Webb's attitude to community enterprise is a little more concrete: 'We can be very competitive in a volatile marketplace to get products up to the production stage. The challenge for us is to productionise and market them properly.'

Notting Dale ITeC has about six products in various stages of completion. Among these are an EPROM programmer and a laboratory interfacing system called Isis which will intelligently control and monitor experimental machinery. It also boasts a near-operational Econet for which it has written the software. Webb is naturally anxious to see that these products are viable.

In its main aim — helping young unemployed people to find work — Notting Dale is already a successful model. Some of the trainees have moved on to interesting and rewarding occupations. An example of this is one youngster who found work as a prototype wireman. Not a production line

worker, note, but someone who is given an idea on paper and is there to turn it into reality ready for the production line. Others have found work servicing equipment such as computers, typewriters and copiers. And others still are now working in teletext editing and software modification. 'Some of the kids have taught themselves two or three programming languages. They're fearless within it. It's just what we're not in our generation.'

Webb claims a 65-70 percent job placement rate for Notting Dale so far. When considered against the profile of youngsters there is no way in which that could be deemed a failure. Many trainees are utterly unqualified when they join an ITeC.

To the speculative mind it is plain that Information Technology Centres will have their casualties. Webb's ideas are unconventional and uncompromising — and they are not for everyone. He is the first to admit that, and also the first to admit that ITeCs have not been in existence long enough to be judged in terms of winning or losing. 'In a few years maybe we'll learn some lessons from ITeCs,' he says, 'but it's too early yet.' Notting Dale, the oldest centre, has only existed as it is today for just over a year. Others are only now beginning to take on trainees and many more are still to be set up.

But the project cannot simply be laughed off or dismissed as a silly idea. If it teaches 20 youngsters in the whole country something they would not otherwise have learned, it is ethically something of a success. It has implications for all of us, for our micro-electronic industry and the initiatives within it, for our economic climate therefore, and so for our future. Microelectronics is the only real growth industry in Britain and it needs imagination, inspiration and financial courage to keep it going and make the best of the many useful ideas which will come forth from it.

I'll finish on a similar note to that on which I began. IT Year achieved its purpose. It broke down some of the barriers which separated Joe Public from the computer expert and gave microelectronics its aura of secrecy and dubious practice. ITeCs, given the right combination of finance, government backing, expertise and motivation, will break down still more of those barriers and make it possible for anyone who is sufficiently motivated to use and learn from the silicon chip.

END



A trainer (left centre) conducts an informal session.

TJ's WORKSHOP

Our monthly pot-pourri of hardware and software tips for the popular micros. If you have a favourite tip to pass on, send it to 'TJ's Workshop', PCW, 62 Oxford Street, London W1A 2HG. Please keep your contributions as concise as possible. We will pay £5-£30 for any tips we publish. PCW can accept no responsibility for any damage caused by using these tips, and readers should be advised that any hardware modifications may render the maker's guarantee invalid.

ZX81 ROUND-UP

Having had some problems rounding off decimals in programs, I have consequently worked out this subroutine, to round off decimals with optimal reliability.

A routine like this unfortunately is not built in the ZX81 from start, and the approximate function INT, unfortunately, is too inconsistent and does not work when there is an exponent after the figure. The routine which I have constructed is not very fast in SLOW, but lasts less than 1 sec during FAST — on the other

hand it saves time in more extensive programs when the computer does not have to use so many decimals.

The program is constructed so that you yourself can decide how many decimal places you want, by adjusting the variable Z for the wanted decimals. The figure that you want to round off is to be placed in the variable X and then returned to the variable Y.

As the program is a subroutine it is called by means of GOSUB 9000.

Jens Bang Petersen

```

9000 FAST
9010 LET X2 = 0
9020 LET BXY = 0
9030 DIM A$(14)
9040 DIM B$(1)
9050 IF X<0 THEN LET X2 = 1
9060 IF X<0 THEN LET X = X*-1
9070 LET A$(2 TO) = STR$ X
9080 FOR N = LEN A$ TO 2 STEP -1
9090 IF CODE A$(N) = 42 THEN DIM B$(4)
9100 IF CODE A$(N) = 42 THEN LET B$ = A$(N TO)
9110 IF CODE A$(N) = 27 THEN GOTO 9140
9120 IF N = 2 THEN GOTO 9440
9130 NEXT N
9140 LET AXY = N + 1 + Z
9150 IF CODE A$(AXY) >= 33 THEN LET BXY = CODE A$(AXY-1)
9160 IF BXY< 27 THEN GOTO 9250
9170 LET A$(AXY-1) = CHR$ 27
9180 IF CODE A$(AXY) >= 33 THEN LET BXY = CODE A$(AXY-2)
9190 LET BXY = BXY+1
9200 IF BXY = 38 THEN LET BXY = 28
9210 LET A$(AXY-2) = CHR$ BXY
9220 IF BXY< 28 THEN GOTO 9430
9230 LET CXY = 2
9240 GOTO 9320
9250 IF CODE A$(AXY)< 33 THEN LET A$ = A$(TO AXY-1)
9260 IF CODE A$(AXY)< 33 THEN GOTO 9430
9270 LET BXY = BXY+1
9280 IF BXY = 38 THEN LET BXY = 28
9290 LET A$(AXY-1) = CHR$ BXY
9300 IF BXY< 28 THEN GOTO 9430
9310 LET CXY = 1
9320 FOR N = AXY-2 TO 2 STEP -1
9330 LET CXY = CXY+1
9340 LET BXY = CODE A$(AXY-CXY)
9350 IF BXY = 27 THEN NEXT N
9360 LET BXY = BXY+1
9370 IF BXY = 1 THEN LET BXY = 29
9380 IF BXY = 38 THEN LET BXY = 28
9390 LET A$(AXY-CXY) = CHR$ BXY
9400 IF BXY< 28 THEN GOTO 9430
9410 IF CODE A$(2) = 28 THEN LET A$(1) = CHR$ 29
9420 NEXT N
9430 LET A$ = A$(TO AXY-1)
9440 LET C$ = A$+B$
9450 SLOW
9460 LET Y = VAL C$
9470 IF X2 = 1 THEN LET Y = Y*-1
9480 RETURN

```

ATOMFORTH LIBERATOR

ATOMFORTH users who have RAM above the system at address hex 3C00 may like to try the following definition, which will give a noise-free display as well as liberating the entire graphics memory.

The example works where there is continuous RAM from hex 8000 to hex 8000, though other configurations may be

catered for by adjusting the values of UP, LIMIT and FIRST. If Top is the address of the last byte of RAM plus one, UP and LIMIT equal Top minus 60, and FIRST equals Top minus 576. The new FORGET behaves, for better or worse, exactly like the old one.

Saving a modified system is more tricky, not least because of the uncertain copyright position.

Adrian Taylor

```

SCR # 998
0 ( ATOMFORTH SYSTEM CHANGE - SCREEN 1 )
1 FORTH DEFINITIONS HEX
2 : MAGIC
3 3C00 DUP 281C ! 281E ! ( Reset FENCE, DP )
4 7FC4 DUP 2810 ! 2E04 ! ( Reset UP, LIMIT )
5 7DC0 2DF8 ! ( Reset FIRST )
6 3AC2 DP ! ( Initialise DP in FORGET )
7 -->

SCR # 999
0 ( ATOMFORTH SYSTEM CHANGE - SCREEN 2 )
1
2 3E20 2F45 3774
3 378C 3C00 2828
4 6 0 DO , LOOP ( Store six new codes )
5 C EMIT ( Clear screen )
6 COLD ( Cold start )
7 ;

```

BLUDNER

With reference to 'ZX Spectrum Bug' in PCW, January 1983, let us hope that the Spectrum designers do not try to 'fix' it. The bug is in the method, not the machine, and shows once again how lack of a proper understanding of computer science can lead people astray.

The proper way to decompose a positive integer X into its digits base B, within the limitations of the Basic language, is to repeat the sequence:

```
LET X1 = INT(X/B)
```

```
LET D = X - B * X1
```

```
LET X = X1
```

until X is zero, with each D being the successive

digits from the least significant end.

As has been pointed out over and over again, the values 0.1, 0.01, 0.001, etc, are recurring binary fractions so any machine that uses binary arithmetic (as opposed to binary coded decimal) cannot accurately represent these numbers. This is not a bug, it is a well known fact about this type of number representation. Hence any operation such as $10 * (X/10)$ may well not equal X on such machines, and if the result is just under X and X was a positive integer then $\text{INT}(10 * (X/10))$ may equal X - 1. This explains the so-called 'bug'.

D Broughton

NEWBRAIN DISPLAY CASE

The Newbrain, with its easy portability and integral display, has many applications for obtaining data in the field. Sometimes it is important to retain and check the use of upper and lower case, but the display window shows both as capitals. The following routine displays the data held in memory with an additional special character after every capital, without keeping this in memory. This is introduced as part of an editing routine to check, and correct if necessary, the data input. It is designed with minimal prompts in

view of the limited 16-character display. A longer line can, of course, be real using the cursor control keys.

Newbrain Basic beholds all input strings of initial spaces, so that if any are required (eg, in the letters to be replaced) an introductory non-space character must be used, and edited out later if necessary.

The flag input routine in lines 250 to 280 is useful wherever a menu requires an alphabetical answer, and line 270 is a general lower to upper case conversion if followed by `Z$=CHR$(S)`.

A Sandison

```

1 REM Routine to Display Input with Caps Markers, and Edit as necessary
2 REM For Newbrain, Model Ad
4 REM Copyright A. Sandison, 1982, London, WC1E 7AZ
10 REM Set for Window display
20 OPEN £D,3
30 REM Input Test Line
40 INPUT("ENTER LINE-")AS
50 GOSUB 110:GOTO 40
60 END
100 REM Edit Test Line, AS
110 GOSUB 210:REM Display
120 ?"CHK!"+"DS"+"Y/N-";:GOSUB 260
130 IF S=89 THEN RET
140 INPUT("WRG CHCS-")XS
150 Z=INSTR(AS,XS)
160 IF Z=0 THEN ?"NOT THERE":GOTO 140
170 INPUT("RPLMT-")YS
180 AS=LEFT$(AS,Z-1)+YS+MID$(AS,Z+LEN(XS))
190 GOTO 110
200 REM Display with Caps Markers
210 DS="":FOR N=1 TO LEN(AS)
220 Z$=MID$(AS,N,1):DS=DS+Z$
230 IF Z$>"D" AND Z$<"I" THEN DS=DS+CHR$(124)
240 NEXT N:RET
250 REM Input a String Flag
260 INPUT(" ")Z$:S=ASC(Z$)
270 IF S>96 AND S<123 THEN S=S-32
280 RET
290 END

```

MZ80B CURSE

I have always thought it a pity that the special cursor symbols of the Sharp MZ80K are not available on the 80B. I think they make for easy programming and they certainly make a program neater and much shorter and easier to read than their equivalents on the 80B.

This little program will display the MZ80K cursor symbols on the MZ80B.

- 1) Type in MON to get into machine code.
- 2) Type M and then enter the machine code pro-

gram at \$CF01. This will switch-in the video RAM.

- 3) Return to Basic and enter the Basic program.

To use the program:

- 1) Press DEFKEY 1 and line 10010 will appear at the top of the screen.
- 2) Enter appropriate values for V and H into the equation.
- 3) Press the required DEFKEY and the symbol will appear at the correct position on the screen.

Sounds a bit clumsy, but with the screen controls on the MZ80B it is very easy to use.

John Hunt

```

1 REM PROGRAMME TO PRINT MZ-80K CURSOR SYMBOLS 0 0 0 0 0 0
ON MZ-80B
2 PRINTCHR$(6):CONSOLECB0:LIMIT$CF00
3 DEF KEY(2)=10010 S=53440+80*V + H*7
4 REM 0 :DEF KEY(3)=RUN100007
5 REM 0 :DEF KEY(4)=RUN100017
6 REM 0 :DEF KEY(5)=RUN100027
7 REM 0 :DEF KEY(6)=RUN100037
8 REM 0 :DEF KEY(7)=RUN100047
9 REM 0 :DEF KEY(8)=RUN100057
10 REM ENTER MZ-80K PROGRAMME BETWEEN 10 & 10000:END
10000 D=1:GOTD10010
10001 D=2:GOTD10010
10002 D=3:GOTD10010
10003 D=4:GOTD10010
10004 D=5:GOTD10010
10005 D=6:GOTD10010
10010 S=53440+80*V + H
10011 USR($CF01)
10012 POKES,D
10013 END

```

```

MACHINE CODE PROGRAMME TO SWITCH VIDEO RAM
MON
M
M-ADR,$CF01
CF01 DB
CF02 EB
CF03 CB
CF04 FF
CF05 D3
CF06 EB
CF07 C9
*J
J-ADR,$12B0
Ready

```

TANDY TIPS

I have noticed that the good old Tandy TRS-80 Level II seems to have been neglected of late. So here are a few of my favourite and useful tips which may or may not be known by other owners.

The current position of the cursor is held in locations 16416 and 16417 (4020H and 4021H). This is useful for positioning the cursor during a machine-code program but it can also be used from Basic.

If you have a printer there has, doubtless, been a time when you need to output to the printer instead of the screen. There is an easier method than going through the program and physically changing the program statements. Here is the solution: `POKE 16414,141 : POKE 16415,5`

However, when you have finished outputting to the printer, it is important that the following is executed: `POKE 16414,88 : POKE 16415,4`

Here is an idea for all budding machine-code programmers. When you have finished a machine-code routine and want to return to Basic 'READY', may I suggest that you jump location 0072 Hex. This has the advantage of not affecting any registers which are altered by jumping to some other locations.

When retrieving data from cassette using the command `INPUT#`, the maximum number of bytes which can be read using one `INPUT#` statement is 248 and not 255 as stated in the Level II manual.

Also, after using the `INPUT#` statement, all DATA will be RESTORED

automatically after each READ. To prevent this, `POKE 16553,255` before each READ.

If you've got tired of debugging your master program and typed NEW in frustration, you will immediately think 'I wish I'd SAVED it first'. But all is not lost. Before you enter any new line numbers, execute the following: `POKE 17130,1` then SYSTEM.

When the monitor prompt appears, enter — /11395. You can now list your program. However, when you've done this, I advise you only to use the commands 'LIST' or 'CSAVE' otherwise you may be treated to a system crash and you won't be able to get your program back this time.

To alter the top of memory without switching off your

machine, use the following. `POKE 16561,LS` (least significant byte) `POKE 16562,MS` (most significant byte)

Immediately after entering the above, you must use the 'CLEAR' command to allow the computer to check the new location of RAMTOP. It doesn't actually matter how much string space you clear — 'CLEAR 50' will do.

To get a SYSTEM tape to start immediately after Cload-ing, enter the following: `POKE 16866,195` then `POKE 16867,LS` (least significant byte) `POKE 16868,MS` (most significant byte)

The 'LS' and 'MS' refer to the entry address of the program, not the start address.

Dave W. Winnett

TANDY SOFTWARE COPIER

Recently I bought some foreign system tape programs for the TRS-80 Level II (Model II), and because of their poor quality I needed a method to copy them on to more reliable tapes.

Copying the tape with a second cassette recorder is a possibility, but the results are even worse than the original tape. The only good way of copying them is with software, but this is not included in the ROMs. Tandy doesn't sell such programs

because of the bad guys, who would copy their software and sell them. But my object was honest, so I developed a copier that copies system tapes as well as Basic and Tiny Pascal tapes. In fact it copies a tape bit by bit, puts it all in RAM and writes it back on cassette. The only condition is that the tapes must be 500 baud.

The assembly program listing is shown below. I hope this program can be useful for other TRS-80 users.

Danny Smalle

```

00100 *****
00110 'COPIER' COPY PROGRAM V1.0
00120 (C) 1982 DANNY SMALLE
00130
00140 START: SYSTEM #/
00150 COPIES ALL TAPES FROM CASSETTE TO CASSETTE
00160 *****
00170
00180 ORG 32000
00190 COPIER JP START ;SYSTEM #/32000 IS ALSO USEABLE
00200 BEGIN EQU 17135
00210 EINDE DEFS 2
00220 ERR DEFS 1
00230 M1 DEFM ' TRS-80 COPY PROGRAM'
00240 M1L EQU $-M1
00250 M2 DEFM '(C) 1982 DANNY SMALLE'
00260 M2L EQU $-M2
00270 M3 DEFM 'SET TAPE TO COPY READY'
00280 M3L EQU $-M3
00290 M4 DEFM 'PUSH <PLAY> ON CASSETTE, AND <ENTER>'
00300 M4L EQU $-M4
00310 M5 DEFM 'TAPE LOADED'
00320 M5L EQU $-M5
00330 M6 DEFM 'SET EMPTY TAPE READY'
00340 M6L EQU $-M6
00350 M7 DEFM 'PUSH <PLAY> AND <RECORD> ON CASSETTE, AND <ENTER>'
00360 M7L EQU $-M7
00370 M8 DEFM 'TAPE COPIED'
00380 M8L EQU $-M8
00390 M9 DEFM 'ANOTHER COPY (Y/N)?'
00400 M9L EQU $-M9
00410 M10 DEFM 'END OF COPIER'
00420 M10L EQU $-M10
00430
00440 START CALL CLS ;CLEAR SCREEN
00450 LD HL,M1 ;OUTPUT OF MESSAGES
00460 LD BC,M1L
00470 CALL OUTP
00480 LD HL,M2
00490 LD BC,M2L
00500 CALL OUTP
00510 LD HL,M3
00520 LD BC,M3L
00530 CALL OUTP
00540 LD HL,M4
00550 LD BC,M4L
00560 CALL OUTP
00570 ENTI CALL 0384H ;READ KEYBOARD CHAR.
00580 CP 13
00590 JR NZ,ENTI ;MUST BE <ENTER>
00600 CALL CLS ;CLEAR SCREEN
00610
00620 LD HL,BEGIN ;START OF COPY-MEMORY
00630 LD A,B
00640 LD (ERR),A ;ERR CONTAINS 1 IF EOF IS REACHED
00650 PUSH HL
00660 CALL 0212H ;CASSETTE ON
00670 CALL 0296H ;SEARCH DRIVER
00680 POP HL
00690 PUSH BC
00700 LD BC,3C00H ;START OF VIDEO MEMORY
00710 LOOP PUSH HL
00720 CALL READB ;READ ONE BYTE, SPECIAL ROUTINE
00730 LD (BC),A ;PUT BYTE ON SCREEN
00740 INC C ;NEXT VIDEO LOCATION
00750 PUSH AF
00760 LD A,(ERR)
00770 CP 1
00780 JR Z,ENDCLP ;IF ERR=1 THEN STOP READING
00790 POP AF
00800 POP HL
00810 LD (HL),A ;SAVE BYTE IN MEMORY
00820 INC HL ;NEXT MEMORY LOCATION
00830 JR LOOP ;READ NEXT BYTE
00840 ENDCLP POP AF
00850 POP HL
00860 POP BC
00870 LD (EINDE),HL ;LAST MEMORY LOCATION
00880 CALL 01FBH ;CASSETTE OFF
00890 CALL CLS ;CLEAR SCREEN
00900 LD HL,M5 ;MESSAGES
00910 LD BC,M5L
00920 CALL OUTP
00930
00940 COPY LD HL,M6
00950 LD BC,M6L
00960 CALL OUTP
00970 LD HL,M7
00980 LD BC,M7L
00990 CALL OUTP

```

```

01000 ENT2 CALL 0384H ;READ KEYBOARD
01010 CP 13
01020 JR NZ,ENT2 ;MUST BE <ENTER>
01030 CALL CLS ;CLEAR SCREEN
01040 LD HL,(EINDE) ;CALCULATE
01050 LD DE,BEGIN ;NUMBER
01060 SBC HL,DE ;10F BYTES TO COPY
01070 EX DE,HL ;--> DE
01080 LD A,#2
01090 LD (15422),A
01100 LD A,0
01110 CALL 0212H ;CASSETTE ON
01120 CALL 0297H ;WRITE LEADER AND SYNC BYTE
01130 LD HL,BEGIN ;START OF COPY-MEMORY
01140 WLOOP LD A,(HL)
01150 PUSH HL
01160 PUSH DE
01170 LD (15423),A
01180 CALL 0264H ;WRITE ONE BYTE
01190 POP DE
01200 POP HL
01210 INC HL
01220 DEC DE
01230 LD A,D
01240 OR A
01250 JR NZ,WLOOP ;DE=0 --> END OF WRITING
01260 LD A,E
01270 OR A
01280 JR NZ,WLOOP ;ELSE WRITE NEXT BYTE
01290 CALL 01FBH ;CASSETTE OFF
01300 CALL CLS ;CLEAR SCREEN
01310 EINDC LD HL,M8 ;MESSAGES
01320 LD BC,M8L
01330 CALL OUTP
01340 LD HL,M9
01350 LD BC,M9L
01360 CALL OUTP
01370 YNLOOP CALL 0384H ;READ KEYBOARD
01380 CP B9
01390 JR Z,COPY ;IF 'Y' --> NEXT COPY
01400 CP 7B
01410 JR NZ,YNLOOP ;IF NOT 'N' --> READ AGAIN
01420 CALL CLS ;CLEAR SCREEN
01430 LD HL,M10
01440 LD BC,M10L
01450 CALL OUTP
01460 JP 1A19H ;RETURN TO BASIC
01470 OUTP LD DE,(16416)
01480 LDIR
01490 LD A,13
01500 CALL 33H
01510 RET
01520 READB PUSH BC ;SPECIAL READ-BYTE ROUTINE
01530 PUSH IY
01540 LD B,0BH
01550 LD C,0
01560 LOOP1 CALL BITL ;READ-BIT ROUTINE
01570 PUSH AF
01580 LD A,C
01590 CP 1
01600 JR Z,ENDR
01610 POP AF
01620 DJNZ LOOP1
01630 IY POP BC
01640 POP BC
01650 RET
01660 ENDR LD (ERR),A
01670 POP AF
01680 POP IY
01690 POP BC
01700 RET
01710 BITL PUSH BC ;THIS ROUTINE READS THE TAPE
01720 PUSH AF
01730 LD BC,6000H ;IF BC COMES 0000, EOF IS REACHED
01740 LOOP2 IN A,(0FFH)
01750 PUSH AF
01760 DEC BC
01770 LD A,B
01780 OR A
01790 JR NZ,VT
01800 LD A,C
01810 JR Z,ENDTP ;BC=0000 --> END OF TAPE
01820 VT POP AF
01830 RLA
01840 JR NC,LOOP2
01850 LD B,60H
01860 LOOP3 DJNZ LOOP3 ;LOOP FOR 500 BAUD
01870 CALL 021EH ;KEEP RELAY ON
01880 LD B,85H
01890 LOOP4 DJNZ LOOP4 ;LOOP FOR 500 BAUD
01900 LD A,(0FFH)
01910 LD B,A
01920 POP AF
01930 RL B
01940 RLA
01950 PUSH AF
01960 CALL 021EH
01970 POP AF
01980 POP BC
01990 RET
02000 ENTP POP AF
02010 POP AF
02020 POP BC
02030 LD C,1
02040 RET
02050 CLS LD A,2B ;CLEAR SCREEN ROUTINE
02060 CALL 33H
02070 LD A,31
02080 CALL 33H
02090 RET
02100 END COPIER

```

BBC HEX INPUT

If you have ever wanted to get a hex number input into your BBC Computer for disassembly, etc, try the following:
10 INPUT A\$

20 A%=EVAL("&"+A\$)
A% now has the value of A\$.

L Kellett

SIRIUS WITH ITOH

The article 'Sing and Dance' (PCW, Jan) made me look at my own combination of a Sirius 1 with an Itoh printer.

The CP/M ED and TYPE utility is quite useful as a simple word processor and print-out facility. Unfortunately some of the printer directives are incompatible with the ED and TYPE utilities. For example, control L cannot be written into the text since it is a new-line command. This is the printer form feed directive.

There are other directives which cause the system to fail.

The simple Basic program overcomes these difficulties. Control characters are normally entered from the keyboard as a single byte and appear on my system as ^L for example. If this is entered as two characters the program will locate and then print the following character with an ASCII code value less 40 hex. Escape sequences can be entered in the same way by choosing the appropriate

```
10 PRINT CHR$(27);"E"
20 PRINT TAB(20);"TEXT PRINTING PROGRAM WITH PRINTER DIRECTIVES"
30 PRINT:INPUT"Enter name of text file ' ',N$
40 ON ERROR GOTO 200
50 OPEN"1",1,"B:"+N$
60 IF EOF(1) THEN SYSTEM
70 LINE INPUT I,A$
80 WHILE INSTR(1,A$,"^")
90 LX=INSTR(1,A$,"^")
100 LPRINT LEFT$(A$,LX-1);
120 M%=ASC(MID$(A$,LX+1,1))
140 LPRINT CHR$(M%-64);
150 A$=RIGHT$(A$,LEN(A$)-LX-1)
160 WEND
170 LPRINT A$
180 GOTO 60
200 PRINT"No file of that name":RESUME 30
```

character, which for my machine is [. This will give 1B hex, the escape byte.

The method has the advantage that the text containing the printer directives looks identical to the true text. Those control sequences which

are known to be compatible can be entered in the usual way.

Would the query raised by the author in table 1 be overcome?

P W Roberts

ATOM STRING-ALONG

The following information, which is not documented by Acorn, extends the facilities available on the Atom for the handling of strings. A demonstration of all the points is included.

When strings are dimensioned in a program, memory space is reserved for them, starting at TOP. This is sometimes an inconvenient location — for example, when machine code is assembled there. This can be overcome by defining where the dimensioning is to start by setting the free space pointer. The low byte of this memory space is stored in location 35 and the high byte in 36. (Line 10 of the program. The values stored in these locations are given by PRINT &LL7 after assembly.) This also has the added advantage that *RUN can be used to load and run the program automatically without causing an error which would otherwise occur when line 10 is omitted.

Although it is possible to use string arrays on the Atom they have to be dimensioned in a rather inconvenient way using a dummy string variable. It is easy, however, to dimension string arrays directly as shown in the example. The array AA has six elements AA0-AA5;

each of which can point to the first character of a string in a vacant section of RAM. Line 40 thus allocates space for \$AA0 starting at #2800, \$AA1 at #8200 and \$AA2 at #8400. Lines 50-70 show how the three strings AA3, AA4 and AA5 can be sequentially dimensioned. Lines 90-120 input data to be stored in the six strings. Note that if all of the strings were to be located directly above the elements of the array AA then four bytes for each element must be allowed — ie, if array AA is dimensioned from TOP, AA0=TOP+24 should be used to contain the first character of the string.

Although the Atom can handle strings up to 255 characters in length, in practice a limit of 64 is imposed by the size of the input line buffer. This can be overcome with the assembler routine shown. If this facility is not required line 110 should be changed to 'INPUT \$AAN' and subroutine 'a' omitted. The value of W should be chosen so that there is room for 255 bytes and so that it will not overwrite other data, #3B00 is used here. This can be thought of as an input line string buffer in which the data is entered and terminated with a CR, the contents of \$W are then transferred to \$AAN, line 110.

A final point concerning strings is that the base

address can be used directly without the need to dimension — that is, a string can be entered by typing, for example, \$#2800="A STRING" and can be displayed by entering PRINT \$#2800. This can be useful for displaying from one program

the lines of another program which are effectively strings; they start with a line number and end with a CR. After entering the example try PRINT \$#2901 or PRINT \$#8200, for example.

T Rae

```
10 REM 735=#7B1736=#2C
20 REM REMOVE REM L.10 AND INSERT VALUE OF LL7 AFTER ASSEMBLY
30 DIM AA5,LL7,P-1;W=#3B00
40 AA0=#2800;AA1=#8200;AA2=#8400
50 FOR N=3 TO 5
60 AAN=AA(N-1)+256; REM DIM EACH STRING ARRAY OF SIZE 255
70 NEXT N
80 GOSUB a
90 FOR N=0 TO 5
100 PRINT"INPUT STRING"N'
110 LINK LL1;$AAN=$W
120 NEXT N
130 FOR N=1 TO 5
140 PRINT $AAN'
150 NEXT N
160 END
170a FOR M=1 TO 7;LLM=#FFFF;NEXT M
180 PRINT $21
190 FOR M=1 TO 2
200
210:LL1 LDX#0
220:LL2 JSR#FFE6 \ OSECHO
230 CMP#1B \ ESC?
240 BEQLL5
250 STAX,X \ STORE VALID
260 INX \ CHARACTER AT W+X
270:LL3 CMP#0D \ 7CR
280 BEQLL6
290 JMLL2
300:LL5 LDA#0 \ RETURN
310 STAS \ CONTROL TO
320 LDA#29 \ BASIC INTERPRETER
330 STA6 \ AND TEXT SPACE
340 JSR#C2F2 \ #2900
350:LL6 RTS
360:LL7 NOP
370\ GIVES FIRST FREE MEMORY LOCATION AFTER MACHINE CODE
380J
390 NEXT M
400 PRINT $6
410 RETURN
420 END
```

PRINT USING PET

I offer the following program as a simple method of setting up a 'Print

Using' facility on a PET. 50000 X=LEN(STR\$(INT(V)));REM V=VALUE 50010 IF INT(V)=0 THEN X=X-1 50020 PRINT TAB(T-X)V: REM T=TAB OF "" 50030 RETURN

To demonstrate this program in action enter:

```
10 T=24
20 FOR A=1 TO 20
30 V=RND(1)*10↑INT(10*RND(1))
40 GOSUB 50000;REM PRINT USING ROUTINE
50 NEXT
```

This routine does not accommodate more than two noughts after the decimal point, but this would not interfere with its use in formatting accounts.

J L Dunscombe

Tandy TRS-80 Means...

These three printers offer a "Triple Mode" punch! You can have a Bit-Image for impressive graphics, a Word Processing mode to give you more professional-looking high-density correspondence, quality characters, and a Data Processing mode with bold and elongation modes for maximum speed.

10 CPI STANDARD	***226***
12 CPI ELITE	***228***
10 CPI CORRESPONDENCE	***225***
PS MODE	ABCDEFGHI abcdefgh vwxyz
16.7 DPI DUMBED	***111***
10 CPI BLOCK GRAPHICS	***
All Fonts: Bold & Elongate	



A.

£1099

Inc. V.A.T.



C.

£699

Inc. V.A.T.



B.

£499

Inc. V.A.T.

A. New! All-Business Printer. DMP-500. Prints original, plus three copies. Adjustable tractor adjusts from 4" to 15". Line feed in 1/6, 1/8, 1/72, 1/216 increments. Paper advance in fine-line-increments for aligning preprinted forms. Parallel interface. 26-1252

B. New! Full Performance 9 1/2" Printer. DMP-200. A versatile, compact dot-matrix impact printer! Prints 80 characters at 16.7 on an 8" line. Features selectable parallel and serial interfaces (600/1200 baud). Line feed in 1/6, 1/8, 1/72 increments. On/off line, restart and paper feed controls. Power-on indicator. 26-1254

C. New! Superb 15-Inch Wide Printer. DMP-400. Cover design aids in noise reduction. Line feed in 1/6, 1/8, 1/72, 1/216 increments. Tractor allows use of 4" to 15" fanfold paper. Friction platen for single-sheet paper. Selectable parallel and serial interfaces (600/1200 baud). 26-1251

...A Full Range of Printers

HERE IS A SELECTION



A.

£249 Inc. V.A.T.

£149

Inc. V.A.T.



D.

- DMP Means Dot Matrix Printer
- DWP Means Daisy Wheel Printer

A. New! Low-Cost Printer With Dot Addressable Graphics. DMP-100. Prints high-density graphic information or standard 10 cpi alphanumerics. 480-byte full-line dot-buffer, selectable parallel and serial interfaces (600/1200 Baud) and adjustable tractor, 4 1/2 to 9 1/2". Uses fanfold paper. With ribbon cassette. 26-1253

B. New! Low Cost Daisywheel Printer. Select 10 or 12 characters per inch or proportional spacing. Features 1/2 line feed, underline, boldface and programmable backspace. You also get 1/120" space and 1/48" line feed. With Courier 10 print wheel and carbon ribbon. 26-1250

C. Our Finest Word Processing Printer. Allows 10 or 12 cpi or proportional spacing, 43 characters per second (500 plus words per minute), forward and reverse paper feed and 1/2 line feed, underline, boldface, backspace, interchangeable print wheels. Adjustable for up to five carbons. 15" platen. Includes ribbon. 26-1158

D. New! CGP-115 Colour Graphics Printer. Creates beautiful graphics in red, blue, green and black, plus prints alphanumerics. Built-in commands simplify drawing and plotting. Text mode prints 40 or 80 characters per line at 12 characters/sec. Software controls additional character sizes and rotation. 26-1192



B.

£999

Inc. V.A.T.

C.



Tandy COMPUTER CENTRES

YOUR NEAREST COMPUTER CENTRE

Birmingham: 021-455-9175 021-643-5368 5362-5380	Liverpool: 051-708-0133	Nottingham: 0602-412144
Bradford: 0274-728431/2	London: 01-836-1327 (WC2) 01-428-1423 (SW1) 01-242-9425 (WC2) 01-626-6886/9 (EC2) 01-238-9453 (E2) 01-248-5313-4 (EC4) 01-236-1326/7/8 (EC4)	Reading: 0734-580050 589770
Bristol: 0272-214721/2 0272-298101	Manchester: 061-832-2242/ 5314 061-833-0259 061-834-0053 061-236-2122	Sheffield: 0742-752858 752848
Croydon: 01-680-1852	St Helens: 0744-30774	Southampton: 0703-36492
Dundee: 0382-25026	Southsea: 0705-738916/ 738949	Tunbridge Wells: 0892-46120
Edinburgh: 031-225-9337/ 8854-8985		
Glasgow: 041-221-4132 5378 041-333-9531		

YOUR NEAREST COMPUTER DEALER

Abergele: 0745-826020	Dublin: 0001-720688
Ashtford: 07842-53024	Guildford: 0483-504801
Bangor: 0247-66656	Hatfield: 0702-556522
Blairford Forum: 0258-53737	London W.1.: 01-388-6991
Binham: 08045-6565	St. Helens: 0534-74000
Cambridge: 0223-65334	Windsor: 07535-58077
Chichester: 0243-781722	
Cork: Cork 22954	

..STOP PRESS..

Diskette SALE!

SAVE £1- ONLY £1.49 EACH

Single-Sided Double Density 5 1/4" Diskettes
Reg. Price £2.49.

OFFER VALID AT ALL STORES AND
PARTICIPATING DEALERS, UNTIL 30th MARCH

For the best hardware, the best software.

The BBC Microcomputer system is generally regarded to be the best micro in its price range you can lay your hands on. So, if you're thinking of buying one or already own one, you'll want to know about the software that's been specially designed for it.

Not surprisingly, it's made by Acornsoft, the software division of Acorn Computers Ltd., who designed and built the BBC Microcomputer. So naturally you can expect the highest quality software with the built-in ingenuity to fully exploit the BBC Micro's potential.

Further education for everyone.

Creative Graphics, which includes the book 'Creative Graphics on the BBC Microcomputer' (price £17.45), provides 36 programs on cassette producing a spectacular range of pictures and patterns in full colour, including animated pictures, recursively-defined curves and three dimensional shapes.

Word Sequencing (price £11.90) contains three word sequencing programs on cassette. Each program presents a series of jumbled words which must be arranged on screen to form

either a proverb, nursery rhyme title or a sensible sentence.

Learn more languages.

LISP (price £24.35) is the fundamental language of artificial intelligence research.

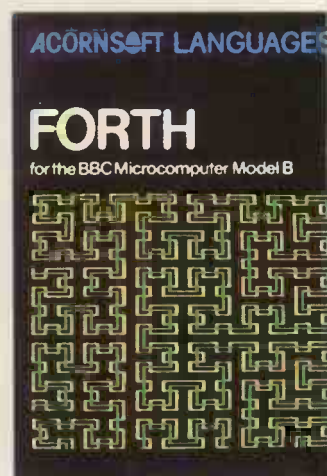
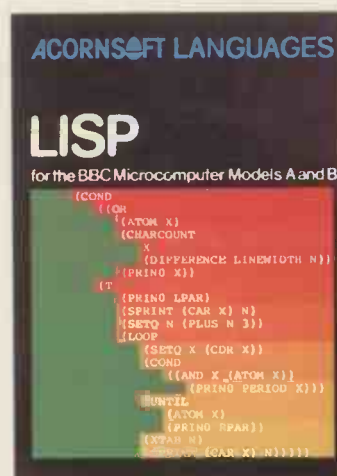

It consists of 5.5K of machine code interpreter plus 3K of initialised LISP work-space containing utilities and constants. It comes complete with a book that introduces you to programming in LISP, as well as some fascinating applications.

FORTH (price £24.35) is a complete implementation of the FORTH language to the 1979 standard specification for the BBC Microcomputer Model B. This much acclaimed programming language is also accompanied by a specially written book explaining all you need to know.

Mind-boggling games.

Philosopher's Quest (price £9.95) is an advanced adventure in which you tell the computer what you want to do and it

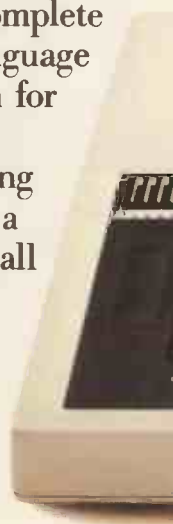
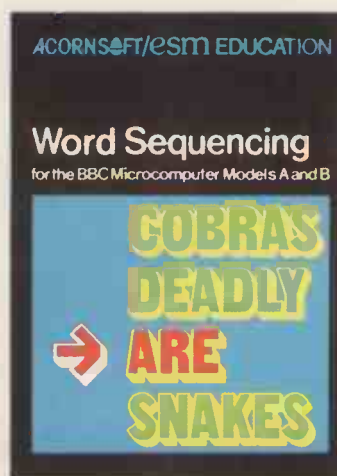
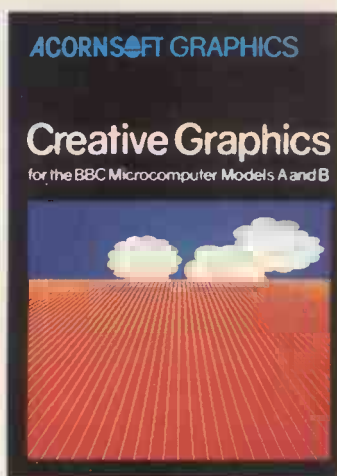

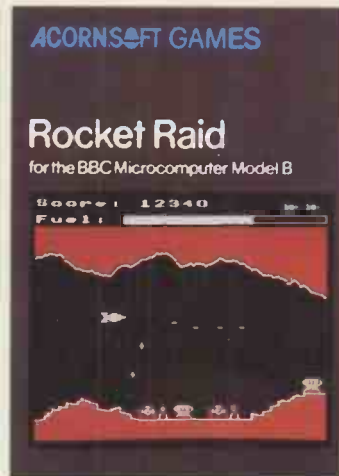
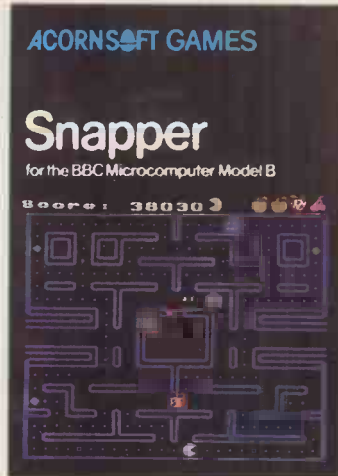
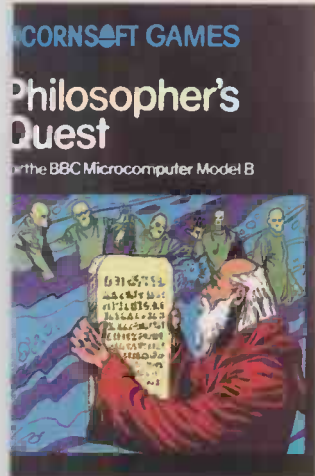

more by sending for our free catalogue.

How to get Acornsoft programs.

If you're a credit card holder and would like to buy cassettes of the programs shown in this advertisement, or if you would like to know the address of

describes back in plain English your progress through a fascinating world of fiendish puzzles to be solved.

Snapper (price £9.95) is a colourful game where you guide your 'snapper' through the maze, eating dots and fruit and avoiding the creatures that chase you. Complete with full sound effects, score and a ladder of high scores.

Rocket Raid (price £9.95) sends you on a mission to raid a heavily guarded Martian fuel depot. You must fly your rocket over mountains and through caverns, avoiding enemy missiles and dodging convoys of deadly fizzers.

Increase your business acumen.

Desk Diary (price £9.95) is an indispensable program that can hold a file of several hundred names, addresses and telephone numbers.

And View, a program that enables your machine, together with a printer, to operate as a fully operational word processor. (The program is in ROM, but can easily be fitted to most BBC micros by your local dealer.) You can find out

your nearest stockist, just phone 01-200 0200.

Alternatively, you can buy the cassettes directly by sending off the order form below to:

Acornsoft, c/o Vector Marketing, Denington Estate, Wellingborough, Northants NN8 2RL.

Also use this form if you would like to receive the current free Acornsoft catalogue.

Please allow 28 days for delivery.

☎ Credit Card Holders. Ring 01-200 0200.

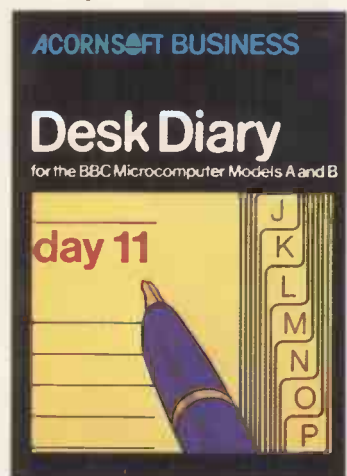

To: Acornsoft, c/o Vector Marketing, Denington Estate, Wellingborough, Northants NN8 2RL.

Please send me the following:-

PROGRAM	PRICE	QUANTITY	TOTAL	(Code Acornsoft use only)
Creative Graphics	£17.45			(SBX01/SBD01)
Word Sequencing	£11.90			(SBE06)
LISP	£24.35			(SBL02/SBD04)
FORTH	£24.35			SBL01/SBD03)
Philosphers Quest	£9.95			(SBC01)
Snapper	£9.95			(SBC04)
Rocket Raid	£9.95			(SBC05)
Desk Diary	£9.95			(SBB01)

TOTAL _____

I enclose PO/cheque payable to Acornsoft Ltd. Or charge my credit card.

Card Number _____
Amex/Diners/Visa/Access (Delete)

Please send me the Acornsoft brochure.

Name _____

Address _____

Postcode _____

Signature _____
Registered No. 1524763 VAT No. 215 8123 85



ACORNSOFT

'Now the world's most ingenious database program writes letters, you've found the ultimate business solution. And the Delta is a true transactional database – this is the biggest breakthrough for microcomputer users to date'

Nick Horgan, Managing Director, Compssoft Ltd.



If part of your microcomputer's job is to store information, you need Compssoft's Delta.

Compssoft DMS is already Britain's No. 1 record keeping program. And with 4000 users to our credit, we can honestly say we know more about information storage & retrieval than anyone else. We listen to your comments & requests and now we've produced a world first – the Delta – a true transactional database.

If you'd like to know more, we have general brochures, full technical specifications & free

guides to DMS handling a multitude of business situations from order processing, invoicing & stock recording, through to library, personnel & hospital record management.

Find out more about the database revolution. Either telephone the office or clip the coupon now.

Compssoft's Delta – taking microcomputers into the third dimension.

Compssoft Limited
Hallams Court
Shamley Green
Nr Guildford, Surrey
England GU4 8QZ
Telephone: Guildford (0483) 898545
Telex: 859210 CMPSFT



Please send me further details

Company

Contact

Address

Tel No.

COMPUTER ANSWERS

Send your queries to: Sheridan Williams, 35 St Julian's Road, St Albans, Herts. Please note that Sheridan can no longer answer questions on an individual basis, so please don't send an SAE with your query.

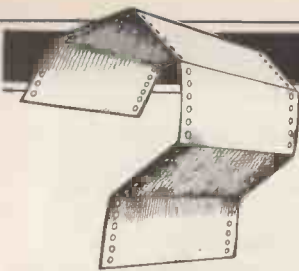

Mask ask

Please can you tell me about a technique called 'masking'? A friend said that you can use this technique for converting all lower case letters to upper case letters when entered on the keyboard of a computer; unfortunately he didn't know how to do it.

R Nicholls, Westminster

Suppose your computer uses the function GET\$ to get a character from the keyboard; then to print the correct letter regardless of whether a lower or upper case letter was pressed use this program:

```
10 A$=GET$
20 PRINT CHR$(ASC(A$)
AND 223);
30 GOTO 10
```

Now whatever you type will appear as upper case letters. The masking takes place in line 20. It will be easier to understand masking if you work in binary. 223 in binary is 11011111. A 'mask' works by masking out (erasing) those bits within the number that are not wanted. You will see that the third digit of the mask is a 0, this will replace the third digit with a zero if it is ANDed with the number to be masked. For example if the binary number 10101010 is masked by ANDing with 11011111 then you get 10001010, ie:

```
10101010
AND 11011111
10001010
```

Up until now you have probably not noticed that there is any connection between the ASCII codes for a lower and an upper case letter A. They are 97 and 65 respectively; however, if you work in binary these become 01100001 and 01000001 respectively. It is now easier to see that the only difference is that the third bit from the left is changed. To summarise: if the third bit from the left is a 1 then we want to mask it out to convert

it to upper case; the mask is 11011111 which is 223 in denary. If you wanted to reverse procedure (always getting lower case letters) then you will have to force the third bit to a 1. This can be done by using the OR operator with a 1 in the third bit and zeros elsewhere. For example:

```
20 PRINT CHR$(ASC(A$)
OR 32)
```

I am afraid that there is not space to go into the details of the logical operators AND and OR here, but the following tables should help you understand what happens when two bits are ANDed or ORed:

A	B	A AND B	A OR B
0	0	0	0
0	1	0	1
1	0	0	1
1	1	1	1

Sheridan Williams

Drive doubts

I require some disk drives for my BBC Micro. According to the original BBC specification most makes of drive should connect directly to the BBC machine. Which types are preferable? It appears to me that there are two main types — 40 and 80 track. It would be most useful for me to be able to read both of these formats on any disk drive that I buy. D C Adams, Shirley, Croydon

You are wise to be a little wary. Not all drives will connect straight to the BBC micro. However, if you look through the advertisements for suppliers of BBC compatible disk drives then you should have no problems. At the present time (January 1983) Acorn still has the policy that it will not supply you with a 'Utilities' disk, or a disk operating system manual, unless you buy its own disk

drives. So you must check that the supplier that you choose will let you have his version of these items.

We reviewed five different disk drives in our December newsletter, and the only one that will allow you to use both 40 and 80 track was supplied by Microware Ltd, 637 Holloway Road, London (01-272 6237). These performed very well, but we are unable to give any long-term report on them as yet. **BEEBUG** — Independent User Group for the BBC Micro.

Getting the lowdown

I reckon I am a typical PCW reader — use mathematics in my work, program mainframe machines, am getting interested in micros, but know nothing of the hardware jargon. Is there a good cheap book or a dictionary which I could readily keep to hand telling me what RS232 interfaces, ULA, Centronics-type parallel printers, etc, all mean? Michael Batty, Cowbridge, S Glamorgan

As far as I'm aware the best value for money currently around is *International Microcomputer Dictionary* 2nd Edition by the staff of Sybex. It is available by mail order from Mine of Information, 1 Francis Avenue, St Albans, Herts for £4.70 (includes postage and packing).

Sheridan Williams

Resolving the question

In Computer Answers in the May 1982 issue of PCW, you gave a method for calculating monitor bandwidth.

I have ordered a Newbrain

model A, and am looking for a monitor which will give good resolution at 640 dots to a row. On a 12in monitor with an active screen width of 21cm it seems a bandwidth of 20 MHz would be needed. Grundy appear to be using a BMC monitor at 18 MHz in their literature on the Newbrain. Could I get away with 18 MHz? M Stabb, Bristol

As the earlier reply indicated, the calculated bandwidth is only a guide to the sharpness of resolution actually achieved, as many other factors affect this. I would not expect much degradation when using an 18 MHz monitor for an application calculated as needing 20 MHz. In fact my own calculations on your intended application suggest that a bandwidth of 16 MHz should be adequate. Bearing in mind these various factors I would not expect a limitation of 18 MHz on the specification of a monitor to render it unsuitable for the display of lines at 640 dots. However, that is not to say that all 18 MHz monitors will give the same quality picture, and it would be wisest, even if the delay is frustrating, to wait till you have your Newbrain, and then try it out with various monitors, before you decide which one to buy. The portability of the Newbrain should make this easier. P L McIlmoyle

Beeb m/c

Do you know of a book that will introduce assembly language programming to me? I am currently using the BBC Computer, so one aimed at this machine in particular would be especially useful. George Nicholls, Watford, Herts

We have been looking at a book called *Assembly*

Language Programming for the BBC Micro by Ian Birnbaum, published by Macmillan at £8.95. It seems to be the best book on the market at the present time. It contains 300 pages and is clear, thorough, methodical, and BBC-specific. It also contains some useful machine code programs, including a monitor and string sort. It appears to be far more useful than even classics such as Zak's *Programming the 6502*. **BEEBUG**

False economy

I bought 20 second hand disks that had been used previously on another system. I am using them on a double-sided drive even though they are clearly labelled single-sided disks. How can this be? Surely if they were double-sided they would have been sold as such. *David Moss, Smethwick, W Midlands*

Your very last statement is the truth of the matter. The other side of the disk did not pass the verification checking process. There must be a dropout, scratch, or poor quality magnetic coating somewhere on the surface. The fact that you have not encountered it yet does not mean it's not there.

It really is *false economy* to use disks that are not the specified ones for your particular drives. One program or data file can be worth many times the cost of the disk, and you may have several on one disk.

Sheridan Williams

Simulator sought

As I am taking flying lessons, could you tell me if there is a program to simulate flying on instruments, etc, which will run on a Sharp MZ-80K (tape-based 48k)?

D G Annes, Retford, Notts

'Airport '83' from Highlight Software of 3 Nether Court, Halstead, Essex C09 2HE; tel (0787) 475714 is stated to be a 'Full and exacting aircraft simulator'. You could also try D TEC Digital Technology of

254 Bridle Road, Eastham, Merseyside L62 8BX, which, like Highlight Software, advertises a wide range of software for both the Sharp MZ-80K and MZ-80A. *P L McIlmoyle*

Cable query

I have recently bought a Texas Instruments computer, and find that a cassette cable is not included. Could you please advise the location of my nearest dealer, and as regards the price of this cable?

A Bell, Blyth, Northumberland

Newcastle Camera & Computer Mart, 16 Northumberland Ct, Newcastle-on-Tyne (0632 327461) is a Spectrum Home Computer Centre, and hence should be able to help as they are dealers for the Texas Instruments TI99/4A micro computer. You would have to phone for a precise price, but I would expect something in the region of £5.

P L McIlmoyle

Newbrain streams

I am using a Newbrain for a business application. By using different 'streams' it is easy to build up, store, and retrieve screens containing different information, thus allowing very rapid switching from one display to another. Can you please tell me how well the Newbrain compares in this ability with other micros?

D A Symington, London SW15 3NY

This 'data stream' feature of the Grundy Newbrain is extremely powerful, allowing up to 255 data sets to be routed to or from a number of devices and ports. I have not met an exactly similar feature on any other micro, although that is a rather rash statement, with so many machines on the market these days (and more appearing each month!). If you have a disk drive, then it is always possible to change screens by pulling a new one in off the disk (as WordStar does with its help screens), but this is obviously not as

fast as the Newbrain transferring from memory to screen. A closer approach could be made using 'bank switching' memory, and swapping from bank to bank, but, for example, CP/M does not support bank switching (although it seems likely that CP/M version 3 will do so, when it is released). You could also emulate this feature using machine code routines. But I do not know of another micro which offers such a facility from within Basic.

P L McIlmoyle

Winchester problems

Now that 5¼in winchester drives can be obtained in the same size mountings as 5¼in floppy drives, is it possible to change to a winchester just by undoing the appropriate bolts and plug connections, removing the floppy drive, and inserting and connecting the winchester drive in its place?

D N Shepherd, Sheffield

Unfortunately things rarely seem to be that simple and this is no exception. Firstly, most winchester drives will need an additional power supply, which is more substantial than that for 5¼in floppy drives. Secondly, the disk controller circuitry is different,

so that another disk controller will be needed. Having done these modifications to the hardware it will then be necessary to provide additional software to get data to and from the hard disk.

If you have an S100 based computer, then it is possible to get extra circuit cards to plug in to provide both the power supply, and the hard-disk controller. You may also be able to buy appropriate software to go with these, especially if your system runs under CP/M.

Similar facilities are sometimes available for other computers that can take plug-in cards. If you have a single board machine (and many 64k CP/M machines are now of this type), or other computer that does not have appropriate plug-in cards available, you would be better considering one of the externally mounted 'stand alone' 5¼in winchester disk drive units which are available. These usually include the power supply, disk controller and disk drive all in one cabinet, and exchange data with the computer via one of its existing ports. Suitable software is usually supplied with these units.

Alternatively, it may be possible to get your computer upgraded by your supplier to take a built-in 5¼in winchester.

P L McIlmoyle



I'm the last person to question a chap's credibility but let's face it — he's not being sued by Atari.

Whatever your system





**I promise
to tell the truth
the whole truth
and nothing but the truth
time, after time, after time....**

DYSAN diskettes, acknowledged to be the industry leader in quality and data integrity, tested on and between the tracks to be 100% error free. When you commit your business to magnetic media, commit to DYSAN and judge the difference for yourself.

 DISC PACKS AND CARTRIDGES ALSO AVAILABLE

 TECHNICAL SUPPORT FROM HAL'S ENGINEERING TEAM  QUANTITY DISCOUNTS

 FOUR HOUR ORDER TURNROUND  EX STOCK AVAILABILITY

Please tell me more about the range of Dysan Media for my system.

Name _____

Address _____

Telephone No. _____

Computer System _____

Ring the Dysan hot line now on Farnborough 517171 or complete the coupon.

HAL Computers Limited
Invincible Road, Farnborough
Hants. GU14 7QU
Telephone (0252) 517171



MICRO**CHESS**

GOOD LOOKING, SENSITIVE AND INTELLIGENT

No, not the ever-modest Tony Harrington. . . we're talking about the Conchess range of machines under investigation this month.

Conchess is a relative newcomer to the chess computer market. The first sets went on sale in the UK just in time for the 1982 Christmas shopping spree.

The idea for the machine originated in Germany, though the manufacturing — and the UK marketing — is carried out by a Dublin-based company, Waltham Electronics.

Like so many computer chess ventures, the starting point here was once again an entrepreneur looking for a product to sell for a profit. Peter Gericke, a German-marketing man, put together a small team of backers to provide the finance for the initial research and design. They formed a company called Consumenta Computers.

Gericke then hired a German electronics engineer to design a magnetic sensitive board and chassis and asked a Swedish computer engineer and programmer, Ulf Rathsmann, to write the chess program and software.

The Dublin company got into the act through the Irish Development Agency's German office. Gericke was looking for a suitable site to manufacture the machine and the IDA was offering very attractive grants for hi-tech ventures.

According to Brian Reddy, one of the directors at WE, the Irish government provides grants to cover the cost of training the workforce from scratch up to the necessary level of technical proficiency required to manufacture the machine. It also provides up to 35 percent of the operating cost.

Production went fairly smoothly and, according to Conchess design and production manager, Dominic Murphy, the company is now geared to producing 2000 units a week if demand warrants this kind of effort. 'It is almost impossible to anticipate what the level of demand will be. We're at trade shows in Amsterdam and Nuremberg in the next few months and we're doing our best to get the name known. If things go well we could sell 50,000 units in the UK by the end of the year. But we might finish up with half that number,' he told me.

There are three models: the Monarch at £249.00, the Ambassador at £199 and the Escourter at £159.95. All the models have the same program — the difference is in the quality of the chassis. The Monarch is a good-looking wooden board and chassis. The Ambassador has a wood veneer while

the Escourter has an aluminium-type chassis and board.

From the start, Conchess decided to have the program load in cartridge fashion in a slot under the board. By separating the program from the firmware and electronics, it has made it possible for updates and improved versions of the program to be added at a later date.

In fact it is possible to plug in two cartridges simultaneously. According to Murphy, the company is currently working on an improved version of the program, to be released in June this year. It also plans to release a second cartridge at around the same time which will give the machine a greater depth of search — and so add to its playing strength.

The US Chess Federation has given the machine a provisional rating of 1720, though the current version of the program did not do too well at the Third European Microcomputer Chess Tournament, in September 1982. It only achieved two-and-a-half points out of seven. (One of its wins there, incidentally, is given in the games section below.)

It plays a reasonable game, though, and it has one feature which all the other machines I've looked at lack — and that is a built in timer for lightning chess. This is absolutely murderous. You have three minutes to play the whole game and when time's up the machine beeps and refuses to play on. There's no appeal. It concentrates the mind wonderfully.

Recent tournaments

Now for some tournament news. In October 1982 Competence (a London computer-chess shop) arranged for three different suppliers' chess computers to be entered in the last four rounds of the North London Autumn Chess Congress, held at the Sir William Collins School. The machines were the Mephisto II, the Conchess Ambassador and Fidelity's Sensory 9.

Four machines of each type were entered to give a useful spread of results. The first two rounds were played in the open and major sections of the tournament and the results look somewhat unhappy for the computers. They played 21 games, lost 15, drew 2 and won 4. But, according to

Competence managing director Terry Knight, the games all showed the computers holding their own until the late middle game, and then being gradually outplayed in the ending. (Two of the wins, by the way, were by Conchess, with the Sensory 9 and the Mephisto each scoring one win.)

For the final two rounds, the computers played in the minor section only, which had an upper limit of BCF135, or ELO rating of 1680. Of 17 games they scored 7 wins, 6 draws and 4 losses. A BCF official grade gave the three machines a provisional rating on the basis of this tournament. This was a little distorted by the number of losses the machines suffered in the open and major sections of the tournament. The provisional BCF grades are: Conchess 132; Mephisto II 121; and Sensory 9 120

Games section

In addition to the Conchess game from the 3rd European Microcomputer Tournament, I have included a game from the North London Congress (my thanks to Competence for providing the scoresheet). According to Richard Parker, who played and beat the Sensory 9, the game was his best for the season. It consists of a fairly even struggle which Parker brings to an abrupt end by a crushing Queen sacrifice.

It provides a nice contrast to the slogging match fought out by the two computers. This game, between Competence and a private entry, White Knight Mk10 (which eventually took the prize for the best amateur entry) had, unfortunately to be adjudicated on move 53 with Competence two pawns up. Whether the computer would have been able to force a win in a Rook and Pawns ending is another story.

	Conchess	White Knight (MK10)
1	e4	e6
2	d4	Nc6
3	Nf3	d5
4	exd5	exd5
5	Qe2+	Be6



The Conchess Ambassador

R. Parker Sensory
9

1	e4	e5
2	Nf3	Nc6
3	Bb5	a6
4	Ba4	Nf6
5	O-O	Be7
6	Re1	b5
7	Bb3	O-O
8	c3	d6
9	h3	Na5
10	Bc2	c5
11	d4	Qc7
12	Nbd2	cx d
13	cx d	Be6
14	d5	Bd7
15	Nf1	Rac8
16	Bd3	Nc4
17	b3	Nb6
18	Be3	Qd8
19	Qd2	Nbx d
20	ex d	e4
21	Be2	ex f
22	Bxf	Bf5
23	Rac1	RxR
24	RxR	Be4
25	BxB	NxB
26	Qd4	Nc5
27	b4	Bf6
28	Qd1	Ne4
29	Rc6	Qa8
30	Qd3	Re8
31	Bd4	Be5
32	Bxe	Rxe5
33	Ne3	Qb7
34	Qd4	Ng5
35	Qa7	Nxh3
36	gxh	Qxc6
37	dxc6	Resigns

6	Qb5	a6
7	Qb3	Na5
8	Qa4+	c6
9	Bd2	Nc4
10	BxN	dx c4
11	Ba5	Qf6
12	c3	b5
13	Qc2	Bf5
14	Qe2+	Be7
15	Nd2	Bd3
16	Qe3	Qg6
17	Rg1	Rc8
18	O-O-O	Nf6
19	Ne5	Qf5
20	g4	Qe6
21	g5	Nd5
22	Qf3	Qf5
23	NxB	QxQ
24	NxQ	d3
25	Rxd3	h6
26	h6	g6
27	Kb1	O-O
28	Ng5	BxN
29	RxB	Rfe8
30	Re5	RxR
31	e5	Re8
32	Rd4	Rxe
33	c4	c4
34	Rxc	Re6
35	Rh4	Kh7
36	f4	Re4
37	Bc3	g5

38	Rh5	NxB+
39	c3	f4
40	h4	f6
41	Rf5	Kg6
42	h7	Re1+
43	Kc2	Kxh
44	Rxf6	Re2+
45	Kb3	Kg7
46	Rxf	Re5
47	Rc4	c5
48	Ra4	Re6
49	Rc4	Re5
50	Ka4	Re2
51	a3	Re5
52	Ka5	Kf6
53	Kxa	Ke6

Adjudicated a win for White



Subscribe to PCW and get a free copy of the new 1983 Benchtest Special

CONFUSION NOW HATH MADE HIS MASTERPIECE!

(Macbeth II.iii.)

Hardly a month goes by without news of another launch issue of a new computing title. We stopped counting earlier this year when the total reached more than 25 regular microcomputing magazines in the UK.

To read them all would, by our calculations, take approximately a fortnight each month. And that would be a superficial reading only! Confusion indeed.

As the first microcomputing magazine in Europe (launched way back in 1978) we welcome competition. But, frankly, there are only so many good editors in the business. Only so many experienced editorial staff. Only so many first class contributors. Somewhere, quality must suffer.

One place where you can be certain editorial quality will never be allowed to fall off is Personal Computer World. PCW is one of the finest microcomputing journals in the world. We constantly strive to stretch our own and our reader's abilities and comprehension of the subject. We will *not* lower editorial standards in the mad scramble to gain new readers.

The truth is, astonishingly, that we do not have to. Despite the plethora of magazines that cater only to gamesplaying and yet another 'learn Basic course' and

despite the fact that we know that many of our readers find PCW a challenge to read, sales of our magazine continue to outstrip every other competitor in the business. We thank you for that.

And as a concrete way of showing our thanks (and, let's be honest, of keeping our subscriptions growth rate) we are offering a free copy of the new 1983 PCW Microcomputer Benchtest Special. Whether you are taking out a new subscription or wish to renew your subscription use the coupon opposite and we'll send you your free 1983 Benchtest Special immediately. And to show that we care for those of you who have already subscribed and who still have several months of your subscription to run, if you renew now we will add the copies still outstanding onto the new subscription so that you can benefit from the offer.

But don't delay. The offer is only open for as long as we have copies of the 1983 PCW Benchtest Special. The last such Special sold out in a very short time. Send off the coupon, today. And thank you for reading Personal Computer World.

For a limited period only, here are the special offer rates for a subscription to Britain's largest selling microcomputer publication.

Year Subscription (U.K. only)	£11.50	In addition to 12 issues of PCW we will send you a copy of the 1983 Microcomputer Benchtest Special completely free of charge.
Year Subscription (U.K. only)	£19.50	(You receive 24 issues, saving yourself £3.50 off the full current subscription price. Plus you protect yourself against future increases in cover prices and postal rates which will probably amount to a saving of £5.00 over the period, plus, of course, the 1983 Microcomputer Benchtest Special.)
Year Subscription (U.K. only)	£29.50	(You receive 36 issues, saving yourself £5.00 off the full current subscription price. Plus you protect yourself against future increases in cover prices and postal rates which will probably amount to a saving of £7.00 over the period, plus, of course, the 1983 Microcomputer Benchtest Special.)

PLUS

We have now arranged for special 'first-off-the-press' copies to be mailed direct to subscribers which will ensure that they arrive either on the same day or one or two days in advance of national distribution in the U.K.

PLUS

Existing subscribers can take advantage of any of the offers above. Just tick the 'this is an extension subscription' box on the coupon and enclose your payment. The additional copies will be added to your existing subscription automatically. You do not have to wait until it is time to renew (by which time this offer will probably have been withdrawn). Save money by extending your subscription today!

PLUS

We have completely reorganised our Subscriptions Department and any problems, change of address, special requests etc. etc. will be promptly dealt with by an extremely 'user-friendly' human being should you need to write to us.

PLUS

We send subscription copies of PCW in a tough polythene wrapper. It will reach you promptly every month, unfolded and in good condition.

PLUS

You can pay for your subscription to PCW by cheque, postal order or by using Barclaycard (Visa)/American Express or Access. And you don't even need a stamp for your envelope. Use the coupon on the right.

Why do more people read PCW than any other microcomputing magazine in Europe? Subscribe today!

Great memories run in our family.

Making your personal computer even more valuable.

Now E.O.S. offers you and your IBM powerful memory-expansion PCBs with up to 512Kb storage per board.

With these versatile add-ons, you can increase your computer's memory to the highest, practical level of current technology—and do it with minimal demands on space and power.

Because only the finest-quality materials and construction go into our multi-layer boards, you are assured of both the lowest signal distortion and the best RFI performance.

Mapping ROM makes set-up fast and easy, with a choice of flexible memory configurations.

And you don't wait for delivery. Our five PCB memories are available now—in 64, 128,

192, 256 and 512Kb. Each can be obtained in an expandable version.

Whatever your needs may be, you'll find that our "product-family" approach to memory design and manufacture backs you with total operating-system support—before and after sale.

For complete details on our family's great memories, don't forget to return our coupon.

Dealer inquiries are welcome.

64K—£255.00

128K—£395.00

192K—£505.00

256K—£575.00

512K—£995.00

All prices exclusive of V.A.T.

All prices include carriage.

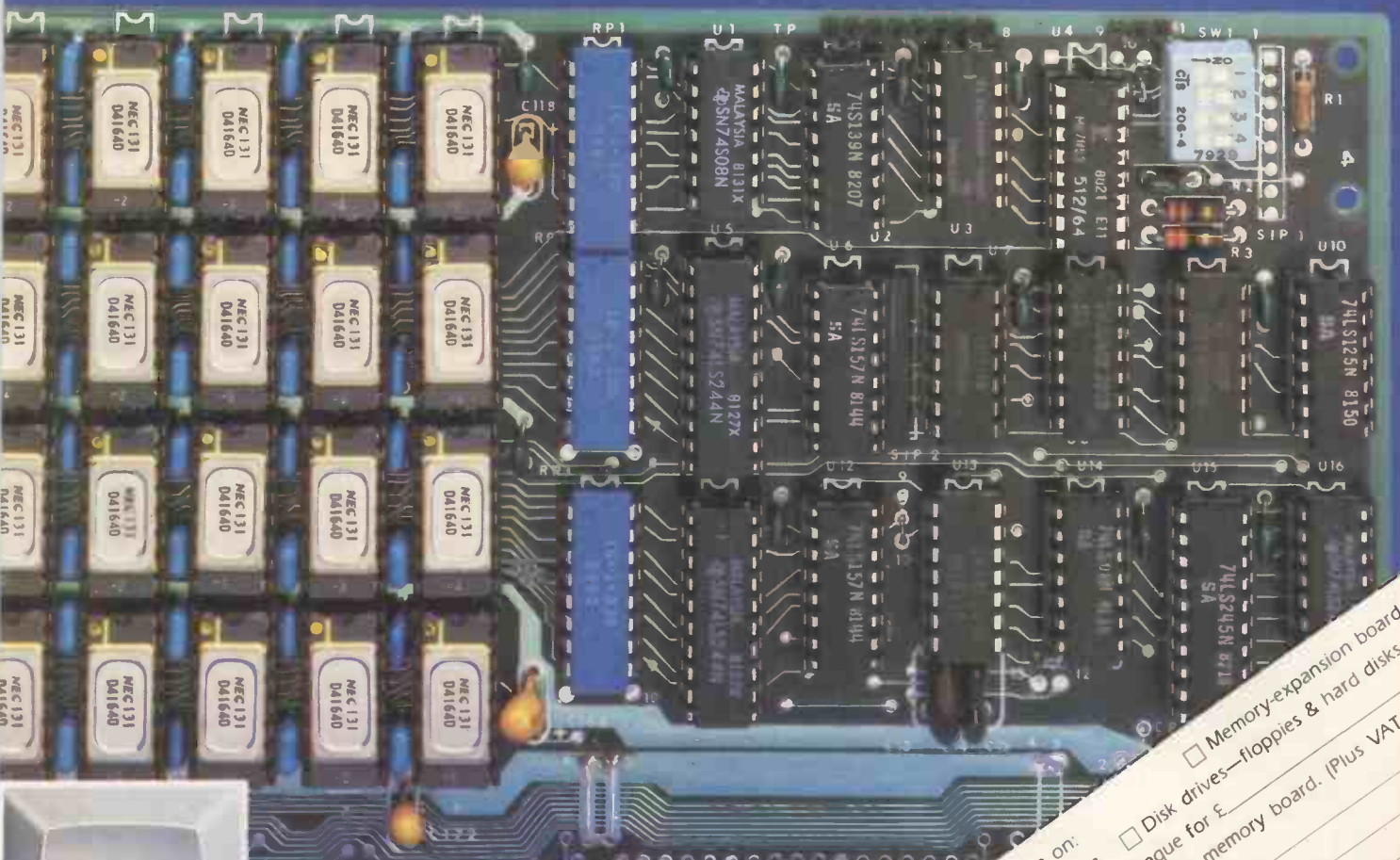

EOS

INFORMATION TECHNOLOGY

Electronic Office Services (U.K.) Ltd.

235/241 Blackfriars Road

London SE1 8NW. Telephone 01 928-3377

I'd like to know more. Send information on:
 Future IBM add-ons now in planning
 Dealer sales kits. Enclosed is my cheque for £ _____
Please rush me one _____
Name _____ Company _____ Address _____
 Memory-expansion boards
 Disk drives—floppies & hard disks
_____ kb memory board. (Plus VAT.)

A105

MAKING THE MOST OF THE MZ80K

Maurice Hawes delves into Sharp's popular home micro.

The Sharp MZ-80K is a reliable microcomputer with a good built-in cassette system, a clear VDU and a sound channel all in one economical package. The recent introduction of the MZ-80A seems to make the MZ-80K somewhat out-dated.

There must be an understandable reluctance to part with a 'K', especially if the owner has invested in one or more of the specially designed peripherals such as the I/O box, printer or disk unit. The temptation to trade-in a 'K' arises mainly on two counts. First, that the Basic interpreter supplied with the machine is somewhat limited; and second, that the keyboard, though it has a large number of extra keys dedicated to graphics, lacks one or two useful features which can be found on many similar machines, including the MZ-80A.

Thanks to the 'soft' design of the MZ-80K most of the deficiencies may be remedied by modifying and extending the interpreter, either on tape or disk. Sharp itself markets a package for the disk-based machine which remedies many of the weaknesses in the disk Basic (SP-6015) and also provides double-precision arithmetic. But this has not been done for the tape Basic (SP-5025) and it has been left to other software houses to fill the gap. At least five packages exist, but unfortunately there is no single package which provides what might be considered a totally satisfactory group of enhancements.

The purpose of this article is to describe how the MZ-80K under a tape-based interpreter may be enhanced to a very satisfactory degree by modifying and extending SP-5025, utilising the best features from three packages already on the market, other published material and some ideas of my own.

Limitations of SP-5025

No Basic is perfect, but SP-5025 has a number of obvious weaknesses. The list below contains what seem to me to be the most needed missing features:

PRINT @
RENUMBER and DELETE
APPEND
COPY
POINT

Full string comparisons
Flexible screen/printer O/P handling
REPEAT on all keys
PAUSE on LISTing
A numeric keypad

You may or you may not agree entirely with this list, but there cannot be any doubt

that an MZ-80K with the above features added would be much more powerful, more flexible and more convenient to handle than the normal model.

There are three packages which between them contain all of the features listed above. They are:

Extensions to Sharp Basic SP-5025 by Dr B R Gladman (about £14.95);
Basic Plus by C D Hearn (about £13.80);
Speed Basic (author unnamed) (about £11.50).

The facilities offered by the three packages are shown in Table 1, which is aligned to illustrate where features are duplicated. The initial task is to decide which of these duplicated features we wish to incorporate.

Duplicated features

STEP in Basic Extensions is intended to perform essentially the same function as SLOW in Speed Basic. Of the two I prefer SLOW because the delay between lines is automatic and pre-settable. STEP is not automatic; stepping between lines involves pressing a key. Furthermore, the current line number in STEP is printed after the current cursor position and this can confuse the display; whereas the current line number in SLOW is printed in the top left corner of the screen and thus is less likely to interfere with the display.

AUTO, AND, OR and DELETE are essentially the same wherever they occur, although the syntax for DELETE differs as indicated above.

RENUMBER is more powerful in Basic Extensions than it is in Speed Basic. RENUMBER mm-nn/new, inc allows renumbering in blocks anywhere within a program; whereas RENUMBER start, inc will only renumber a whole program.

PRINT @ differs between Basic Extensions and Speed Basic in that the X and Y coordinates are reversed. PRINT @ X, Y; is more common but the reversed form as used in Basic Extensions is in fact more logical for text work. The difference is not significant once the user has adjusted to his version.

LINK in Basic Plus has the same purpose as APPEND in Speed Basic. However, LINK is more convenient in practice as it allows the use of program names and will ignore other programs if found first, in the way that the Sharp LOAD command does. APPEND does not allow the use of program names, and in fact it fails if they are used at all, which means that all programs

have to be positioned correctly in the cassette deck before pressing PLAY. This is sometimes inconvenient.

OFF is not really a duplicated feature as it has its own special function(s) in each of the packages. However, the author of Basic Plus has taken care to ensure that his OFF command as it is used does not clash with the OFF command in Basic Extensions. PAUSE in Basic Plus operates only when LISTing; whereas in Speed Basic it operates when LISTing, when tracing a program in SLOW, or when using DUMP to dump the values of variables to the screen.

From the comparisons above it is clear that, ideally, we should take RENUMBER from Basic Extensions and LINK from Basic Plus. The remaining differences are either insignificant or do not apply to our list of most needed features.

Adding Basic Extensions and Basic Plus

There is no difficulty in arranging to include RENUMBER from Basic Extensions and LINK from Basic Plus; the Basic Plus package includes an alternative version called Basic Plus 2 which loads at a different location from Basic Extensions and is compatible with it.

It is only necessary to load Basic Extensions and then follow the instructions that come with Basic Plus 2 to synthesise an interpreter which combines all the features of the two packages with SP-5025. This produces an interpreter with many of the features we require, including LINK and the preferred version of RENUMBER. The next step, incorporating the other required features on our list, is a little more difficult.

Making room for extra features

Assuming that you have purchased Basic Extensions and Basic Plus and followed the instructions provided to combine both with SP-5025, you will at this stage have an interpreter which includes PRINT @ Y,X, RENUMBER mm-nn/new, inc, DELETE, LINK, SET(X,Y), RESET(X,Y), REPEAT on all keys, PAUSE on LISTING and a NUMERIC KEYPAD from our original list of desirable features, plus a number of others as a bonus. This is a good start, but we are still looking for full string comparisons, COPY, and flexible screen/

printer output handling.

These are all available in Speed Basic or elsewhere, and we must now find a way of incorporating them. We cannot do it by simply loading the Speed Basic package as instructed, because this would overwrite Basic Extensions.

In order to understand the problem, let us examine the memory map of the MZ-80K at each stage we have been through so far, in diagrams 1 to 3 below:

Diagram 1 shows the map with SP-5025 loaded alone. Important points are:

- a) The block of redundant code from 3DDCH to 43FFH.
- b) The start of the Basic program space at 4806H.

The block of redundant code is a curious feature of SP-5025 for which there has never been an explanation; but it has encouraged the writing of packages to improve SP-5025 without increasing its apparent size, such as Basic Extensions, Speed Basic, and even Basic Plus when it is used on its own.

Figure 2 shows the map with Basic Extensions added to SP-5025. The redundant block of code has been almost completely replaced by the extensions, which run from 3DEDH to 43FCH. Note that the start of the Basic program space is not changed in this case and is therefore still at 4806H.

The addition of any other *single* extension package, such as Speed Basic or Basic Plus on its own would produce a very similar map, with the block of redundant code more or less completely replaced by the new code, and the start of the Basic program space unchanged at 4806H.

Figure 3 shows the map with Basic Plus 2 added after Basic Extensions. Note that the start of the Basic program space has been moved up to 4C8FH to make room for the Basic Plus 2 code, which runs from 4806H to 4C8EH.

This gives us the clue we need to make room for further additions of our own. The start of the Basic program space is defined as 4C8FH at the following locations within the new interpreter:

17A9 1839 1AA6 1CF1 1FCF 29C8
2A13 2AC3 2ADC 2AE8 2B49 2B61
410F 4290 and 4820 (all in hex).

In decimal these locations are:
6057 6201 6822 7409 8143 10696 10771
10947 10972 10984 11081 11105 16655

17040 and 18464.

Each of these locations is the first of a pair which contains the relevant address (4C8FH) in lo-hi order, ie, 8F 4C. We can change this value to any higher value we choose and this will create room within the interpreter for more code. In my own case I chose 5200H (00 52) as this gave plenty of room for the additions I had in mind, and is easy to remember.

It leaves 32,126 bytes free, which is enough for most applications. If you feel that this is too generous, and do not foresee additions other than full string handling, COPY, and flexible screen/printer output handling (see below), you may put the start of Basic at 4DB6H (B6 4D), leaving 33,224 bytes free.

The chosen value may be poked into the various locations by a short Basic program; but this operation and the subsequent work of adding new code in the space created is very much easier if you have the machine code Monitor/Disassembler mentioned in the next paragraph, and a printer.

The monitor/disassembler

This Monitor/Disassembler, written by R Tanswell, is a very good investment for anyone interested in enhancing an MZ-80K. It sits near the top of memory (BA00-CDD3H on a 48k machine) and may therefore be used to disassemble any part of the interpreter.

It may also be used to write machine code to any location, to search for specified bytes, to dump any section of memory to screen and to save machine code programs in object code or ZEN-compatible source code.

Security copies

At this stage you will need a security copy of the interpreter with the new high start of Basic program space at 5200H or wherever you have chosen. This is easily done using the Monitor/Disassembler 'C' command which will ask for START, FINISH, LOAD and EXECUTE addresses before displaying the instruction to press record/play. At this stage it is theoretically adequate to record up to 4C8EH, but I am in the habit of copying a few extra bytes

because, on my machine, the last byte of a copy sometimes gets corrupted.

The memory map now looks like this:

	D000
BASIC TEXT & VARIABLES	5200
SPARE	4C8F
BASIC PLUS 2	4806
(below 4806 is unchanged)	

Fig 4 Start of Basic text moved up to 5200H.

There is now a spare area within the interpreter starting at 4C8FH and running up to 51FFH (or wherever).

NB: If you do not have the Monitor/Disassembler, the security copy as above may be made by `USR(33):USR(36)` providing that you first enter a suitable name into `HEADBUFFER` at 10F1H — 1101H and the file size, start and execute addresses into 1102H, 1104H and 1106H respectively.

Adding extra routines

We may now fill the gap we have created within the interpreter with any routines we choose. To start with, let us consider the problems involved in adding full string handling, COPY (in the form of PRINT/S) and the flexible screen/printer output handling (in the form PRINT/A/N/O/Bnn). These features will complete the set defined as most needed in the second section of this article.

The implementation of the screen/printer output handling commands is the more straightforward and is therefore dealt with first.

a) COPY and flexible screen/printer output handling:

These are all available in Speed Basic as PRINT/S and PRINTA/N/O/Bnn. The code is relocatable as it stands and may therefore be copied directly into its new location, in this case 4C90H to 4CECH is suitable.

The procedure is as follows:

- 1) Return to the monitor and load SP-5025 and Speed Basic.
- 2) Copy* the code from 40A8H to 4104H to load back in at 4C90H.
- 3) Return to the monitor and load your copy of the new interpreter — ie, the one that includes space from 4C8FH up to 51FFH (or wherever).
- 4) Load in the new code at 4C90H to 4CECH.
- 5) Change the address at 1C41H, from 138EH to 4C90H (remember that the code is in lo-hi order — ie, change 8E 13 to 90 4C).
- 6) Take a security copy of this interpreter. For safety copy up to 4CEFH.

PRINT/S/A/N/O/Bnn should now all be working on the new interpreter.

*On my copy of Speed Basic there appeared to be a bug in the PRINT/Bnn routine at 40C2H. The code there should be 5CH (on my copy it was 61 H). Change it as you are copying the routine, if necessary.

b) Full string handling:

	D000		D000		D000
BASIC TEXT & VARIABLES		BASIC TEXT & VARIABLES		BASIC TEXT & VARIABLES	4C8F
	4806		4806	BASIC PLUS 2	4806
FLAGS/BUFFS	4400	FLAGS/BUFFS	4400	FLAGS/BUFFS	4400
SPARE	3DDC	BASIC EXTNS	3DDC	BASIC EXTNS	3DDC
SP-5025	1200	SP-5025	1200	SP-5025	1200
FLAGS/BUFFS	1000	FLAGS/BUFFS	1000	FLAGS/BUFFS	1000
SP-1002	0000	SP-1002	0000	SP-1002	0000

Fig 1 SP-5025 alone

Fig 2 SP-5025 + Basic Extns.

Fig 3 SP-5025 + Basic Extns + Basic Plus 2

MAKING THE MOST OF THE MZ80K

There are two sources for this routine — Speed Basic and *Knight's Newsletter* (Issue No. 3 inside back cover). Unfortunately neither is exactly suitable as they stand because both are written on the assumption that the starting point is unadulterated SP-5025, whereas our starting point is SP-5025 plus Basic Extensions and Basic Plus. In this context the difference is important.

There are many ways of tackling this problem and I tried two or three before arriving at my answer. It is possible to reinstate the relevant SP-5025 code and then add Knight's routine as it stands, but this method has the disadvantage that it cuts out AND, OR and NOT from Basic Extensions. It is possible to incorporate the Speed Basic routine by rewriting it so that it does not clash with buffers in Basic Extensions, but this method cuts out NOT from Basic Extensions, and is also rather complicated.

There is another factor to be considered. The two routines do not handle string comparisons in quite the same way. The Speed Basic routine treats strings according to length before content and therefore will not give a true alphabetic sort unless strings are first padded out (or truncated) to the same length. Knight's routine, on the other hand, treats strings letter by letter and then treats a longer string as greater. This gives a true alphabetic sort whatever the length of the string.

In the end I decided to leave Basic Extensions intact and offer Knight's routine as an optional alternative. Knight's routine depends on a short section of original SP-5025 code which has been overwritten by Basic Extensions. It is therefore necessary to provide this code at a new spare location and add Knight's routine to it. Both sets of code have to be altered very slightly to suit the new location. To complete the job, two very short new routines with associated keywords are added to provide easy selection of one option or the other from the keyboard or within a program.

The procedure is as follows:

- 1) Load the MZ-80K with an unmodified version of SP-5025.
- 2) Copy the code from 2257H to 2271H to load back in at 4CF0H.
- 3) Return to the monitor and load your copy of the new interpreter (ie, the one with PRINT/S/A/N/O/Bnn and space up to 51FFH or wherever).
- 4) Load in the above code at 4CF0H — 4D0AH.
- 5) Alter the code at 4CFE — 4CFFH from 72 22 to 10 4D.
- 6) Alter the code at 4D03 — 4D04H from 5B 22 to F4 4C.

(The steps above reinstate and modify the necessary short section of SDP-5025 in its new location, 4CF0H to 4D0AH.)

- 7) Return to the new Basic at 1200H.
- 8) Type in the data lines from Knight's Basic program *except* for the last two figures which should be changed from 91,

34 to 244, 76.

9) Add a short Basic program to poke this data into locations 19728 to 19838. Use Knight's checksum technique (with the total suitably amended) but leave out all other lines in Knight's program.

10) RUN this program.

(The three steps above add Knight's routine at 4D10H to 4D7EH.)

We now have a full string handling routine at 4CF0H and available as an alternative to the Basic Extensions Boolean routine at 2257H. All we have to do is arrange that, if we wish to compare strings, any calls or jumps to the routine at 2257H are directed instead to corresponding points in the routine at 4CF0H.

In most cases the entry point is 2257H, and these may be dealt with by inserting a jump instruction there (C3 F0 4C). In one case the IF routine enters at 2258H and the best way to deal with this is to change the address in the IF routine (at 2183 — 2184H) from 58 22 to F1 4C.

All these changes could be made by a series of five POKEs but, to simplify things and remove the chances of errors, I decided that it was better to write two machine code routines to do the work, under the control of two new keywords. I chose COMP\$\$ to select Knight's routine at 4CF0H, and LOGIC to select the Basic Extensions routine at 2257H.

The routines for these two new keywords are given in Figure 5. Copy these routines into the locations given.

The keywords themselves and the addresses of the routines may be inserted in place of unused keywords and addresses in the Basic Plus tables. You may use your own words, but they *must* have the right number of letters. For example, APPEND at 4C54H may be changed to COMP\$\$, and MERGE at 4C5A may be changed to LOGIC (note that all keywords have the last letter set 'high' — ie, increased by 80H). The corresponding addresses at 4C81H and 4C83H should then be changed from 8E 13 (ERROR) to the addresses of the routines in Figure 5.

When this has been done, COMP\$\$ or LOGIC entered from the keyboard in direct mode, or used in a program, will switch the interpreter accordingly.

If you do not wish to upset the Basic Plus tables you can use the USR command instead of keywords — USR(19840) for COMP\$\$ and USR(19867) for LOGIC.

Take a final security copy of the new interpreter, up to 4DBFH for safety.

If you hope to purchase the supplementary Basic Plus package when it appears, you should leave the Basic Plus tables as they are and be prepared to relocate all the new code suggested in this article to a higher location when the time comes.

Further possibilities

You now have an interpreter which incorporates Basic Extensions, Basic Plus, and PRINT/S/A/N/O/Bnn from Speed Basic. It also has Knight's full string handling routine as an optional alternative to Basic Extensions' Boolean.

Your MZ-80K is now a much more powerful and flexible machine but, if you

are willing to get really involved in machine code, you can with the aid of the Monitor/Disassembler do even better.

For example, there are three other useful routines in Speed Basic which we have not implemented and which add considerably to the power of the MZ-80K. They are SLOW nn, DUMP n, and the fast data filing routine from which Speed Basic gets its name.

The fast data filing routine is easy to deal with. It is a relocatable replacement for PDATA at 0024H, and sits in Speed Basic at 43C2H to 43FFH. It may be copied to any other spare location and called at 2C63H.

SLOW and DUMP are more difficult for two reasons. First, the code is not relocatable and uses buffers and subroutines in Speed Basic for which equivalents have to be created in the new area of code. Second, even when the code has been properly relocated, it will not respond correctly to a new keyword inserted in the Basic Plus table because it picks up the text pointer from the wrong register.

The first problem may be overcome by disassembling the relevant parts of Speed Basic, rewriting the code for whatever location you choose, and adding the relevant buffers and subroutines. The complete new code may then be loaded at the new location. (Note that the code for DUMP must be relocated so that all the final subroutines start on the same hex page.)

The second problem may be overcome by using spare locations in Basic Plus 2 for SLOW, DUMP, and a new keyword to turn off SLOW (I used NORMAL), and then changing the first instruction in SLOW and DUMP from EB to 00 so that the text pointer is picked up from the correct register.

It is also possible to make SLOW and

COMP\$\$	ADDRESS	4D80 H
4D80	PUSH HL	E5
4D81	LD HL,2257	215722
4D84	LD (HL),0C3H	36C3
4D86	INC HL	23
4D87	LD (HL),0F0H	36F0
4D89	INC HL	23
4D8A	LD (HL),4CH	364C
4D8C	INC HL	23
4D8D	LD (HL),00H	3600
4D8F	LD HL,2183	218321
4D92	LD(HL),0F1H	36F1
4D94	INC HL	23
4D95	LD (HL), 4CH	364C
4D97	POP HL	E1
4D98	JP 19B5	C3B519

LOGIC	ADDRESS	4D9B H
4D9B	PUSH HL	E5
4D9C	LD HL,2257	215722
4D9F	LD (HL), 23H	3623
4DA1	INC HL	23
4DA2	LD (HL),0CDH	36CD
4DA4	INC HL	23
4DA5	LD (HL),69H	3669
4DA7	INC HL	23
4DA8	LD (HL),22H	3622
4DAA	LD HL,2183	218321
4DAD	LD (HL),58H	3658
4DAF	INC HL	23
4DB0	LD (HL),22H	3622
4DB2	POP HL	E1
4DB3	JP 19B5	C3B519

Fig 5

NORMAL programmable by stacking the text pointer before entering the LDIR routine in each case and then retrieving it just prior to the final jump, which should be changed to go to 19B5H instead of 124BH.

I have successfully incorporated SLOW, NORMAL, DUMP, and SPEED DATA in my own interpreter and thus, for about £50 (including the Monitor/Disassembler), have an MZ-80K with all the features listed in Table 1. Note, however, that SLOW clashes with BREAK/TRACE/STEP and they must not be called simultaneously.

Finally, it is of course possible to add your own routines. If you have put the start of Basic text at 5200H as suggested there will still be plenty of room for these to be incorporated as a permanent part of your interpreter, even if you have made all the additions described above.

Examples of my own routines are given in Figure 6. &D and &H perform conversions between decimal and hexadecimal integer numbers in the range 0-65535 (0-FFFFH) and are very useful when writing machine code or calculating POKE addresses and data. I purposely chose short keywords so that they could be fitted into spare locations at the end of the Basic Plus tables. If you think that you may need several new routines and keywords of your own it would be a good idea to extend these tables before you start adding any of the code mentioned in this article. This is easy to do as they sit at the very end of the Basic Plus 2 code, just before the erstwhile start of Basic at 4C8FH.

Conclusions

I bought my MZ-80K over two years ago and in that time have had to do no more than clean the tape heads three or four times. Given that sort of reliability, I find myself reluctant to part with the machine in

&D (DECIMAL TO HEX)		:Origin 0000H — put it where you like	
0000	CALL 198C	CD8C19	:Get decimal integer (0-65535) after keyword as
0003	EX DE,HL	EB	:hex in DE and then transfer it to HL
0004	CALL 03BA	CDBA03	:Print HL as hex number
0007	LD A,48H	3E48	:Add an H
0009	CALL 0012	CD1200	:Print it
000C	LD A,11H	3E11	:11H = Cursor Down
000E	CALL 0012	CD1200	:Do it
0011	JP 1274	C37412	:Exit
&H (HEX TO DECIMAL)		:Origin 0020H — put it where you like	
0020	CALL 162D	CD2D16	:Skip blanks after keyword
0023	EX DE,HL	EB	:DE now points to next character
0024	CALL 0410	CD1004	:Read 4 chars from (DE) into HL as hex number
0027	JP C, 138E	DA8E13	:Error if not proper hex string
002A	LD DE,4400	110044	:DE now points to textbuffer
002D	PUSH DE	D5	:Stack pointer
002E	CALL 16F7	CDF716	:Convert HL to ASCII decimal string at (DE)
0031	POP DE	D1	:Get Pointer back
0032	INC DE	13	:Skip sign
0033	CALL 0015	CD1500	:Print string (ASCII decimal number) from (DE)
0036	LD A, 11H	3E11	:11H = Cursor Down
0038	CALL 0012	CD1200	:Do it
003B	JP 1274	C37412	:Exit

Fig 6

spite of its limitations. It seems rather strange that Sharp Electronics (UK) Ltd has not yet taken the seemingly logical next step, after designing such a 'clean' machine, and introduced a better interpreter than SP-5025 for tape-dependent users.

However, it is possible to achieve a great deal with currently available software and a little patience and ingenuity, as I hope I have demonstrated. In particular, it is a great boon to have a comprehensive RENUMBER command, PRINT @, a numeric keypad, REPEATING keys (especially those cursor keys and the space bar), a PAUSE facility, a command for LINKING named programs, and flexible screen/printer output handling including PRINT/S to copy the screen to the printer; not forgetting SPEED DATA filing at three times normal speed. And space for as

many more routines as you can devise if you are so inclined.

If you do not need the printer commands, you can obtain most of the other features simply by buying Basic Extensions and Basic Plus 2 and loading them as directed.

Last, but by no means least, you may find, as I have done whilst carrying out the developments described above, that the MZ-80K, in some mysterious way, encourages you to explore and learn the intricacies of machine code. In this connection the Monitor/Disassembler by R Tanswell has proved 'worth its weight in gold'; it is usually advertised and sold as a Disassembler, but it is much more than that, as its full name implies.

Postscript

While I was writing this article, Crystal Research Ltd announced the launch of XTAL Basic 3(K) for the MZ-80K, on tape or CPM/disk. The 14k tape version provides most of the facilities I have been describing, plus a number of other features, many of which are unique, at approximately the same total cost as the packages mentioned above. It merits serious consideration, providing a somewhat different and in many ways superior operating system to that created by SP-5025 even with its various supplements.

There are, however, weaknesses in XTAL Basic for some applications. I use my MZ-80K for financial work, and find the XTAL six-figure limit too low in many situations (there is a lot of difference between £9999.99 and £999999.99). Furthermore, though XTAL Basic 3(K) redefines a number of keys (eg, ESCAPE, CONTROL, Upper/Lower Case toggle), it does not provide a numeric keypad, and I find this an annoying omission. If Crystal Research eventually offers higher accuracy and a numeric keypad facility for XTAL Basic 3(K) then it could be argued that such an interpreter would provide a better and more standard all-round solution to the problem of making the most of the MZ-80K than any solution involving a multiplicity of additions and improvements to SP-5025.

Basic Extensions	Basic Plus	Speed Basic
(BREAK or STEP)+TRACE AUTO start,inc A\$<>B\$	AUTO start,inc	SLOW nn AUTO start,inc
AND OR NOT SET(X,Y) RESET(X,Y) DELETE mm-nn RENUMBER mm-nn/new, inc		A\$>B\$, A\$<B\$, etc AND OR
USR(X) USR(X,Y) PRINT @ Y,X;	display ERROR line PAUSE on LIST	DELETE mm, nn RENUMBER mm,nn
OFF	SINGLE keyword entry NPAD (Numeric PAD) REPEAT on all keys LINK ('Prognam')	PRINT @ X,Y; PAUSE on LIST,SLOW, DUMP
	OFF CLS.	APPEND OFF
		PRINT/S PRINT/A PRINT/N PRINT/O PRINT/B nn DUMP n Fast data filing

Table 1

HEXADECIMAL MADNESS



This month's column is devoted to long lists of figures and funny symbols, as part of my continuing vendetta against our typesetters. These lists should be of some interest to some of you out there, though, as they represent complete hex listings of the instructions and character sets of the Casio fx602p and the Sharp PC1211/Tandy PC.

The Casio listings were obtained by Malcolm Ray of Godalming who used the crafty device of downloading to his UK101. The Tandy list is from Nicholas Bodley of New York. Nicholas also informs me of the existence of an excellent US magazine called *Pocket Computer Newsletter*. I shall investigate this further and report in due course.

Dick Pountain

Malcolm Ray writes:

One of the first things I did after buying my FA-1 cassette interface was to try reading the tapes into my UK101 computer. Sure enough, it worked, and I was able to build up a picture of how programs and data were held in the calculator. Now, thanks to Messrs Smithurst and McLeod I have been able to fill a few gaps in the scheme, and I

have drawn up a table giving the internal hex codes of all the instructions and characters. This table is reproduced below.

In this table, the first column is the hex code. The next two columns give the corresponding instruction and alpha character respectively. Most of this will be self-explanatory, but there are one or two points to note:

- (i) Most of the characters appear more than once. The 'extra' appearances are showing in square brackets where it has been possible to determine which is which.
- (ii) Unknown instructions are marked '???'.
- (iii) Some of the alphas appear to be ARs of illegal memories — not, I think, the L registers or program memory so this is probably not very useful.
- (iv) The calculator also has an open-single-quote (‘) character, but I have been unable to pin this down. My guess is that it is at EA or EB. I discovered this character while messing around with LOAD — rewinding while loading, in fact. The calculator suddenly displayed CF ‘6’. Assuming this is a feature

rather than a bug, what does that C stand for? Perhaps Casio are going to release a magnetic card reader in the near future!

- (v) The compound prefixes are used with memory reference instructions. For example, 2C 64 is Min24, 2D F7 is MR5F, etc. 2C is also used to turn RND into FIX.

So there you have it. I haven't included details of how programs appear on tape or how numbers are represented in the registers, since this will only be of interest to those who can find out for themselves anyway. If only I could get the 602 to read cassettes produced by the computer I might have come up with something interesting, but unfortunately this won't work. I think the frequencies used for '0' and '1' are slightly different, with the UK101's interface being more tolerant. As soon as the computer comes out of dry dock I intend tweaking the interface to confirm this; I realise this is cheating, but I must have those extra instructions!

If anyone else has a 602P and a computer with a 300 baud CUTS cassette interface try to get the two of them on speaking terms, and let me know the results. Happy bug hunting!

00	P0	} 7-segment digit codes	33	GOTO3	D	67	Min07	AR07	9A	'DEL	k	CE	1/x	[=]
01	P1		34	GOTO4	E	68	Min08	AR08	9B	SAC	l	CF	x!	[space]
02	P2		35	GOTO5	F	69	Min09	AR09	9C	ENG	m	D0	M-10	[.]
03	P3		36	GOTO6	G	6A	???		9D	o''	n	D1	M-11	[■]
04	P4		37	GOTO7	H	6B	DSZ	AR??	9E	10 ⁸	o	D2	M-12	[?]
05	P5		38	GOTO8	I	6C	x=0	AR??	9F	e'	p	D3	M-13	[]
06	P6		39	GOTO9	J	6D	x=F	AR??	A0	X-M10	q	D4	M-14	[μ]
07	P7		3A	'd	K	6E	RAN#	AR??	A1	X-M11	r	D5	M-15	[<]
08	P8		3B	SAC	L	6F	π	AR??	A2	X-M12	s	D6	M-16	[>]
09	P9		3C	ENG	M	70	MR00	0	A3	X-M13	t	D7	M-17	[∞]
0A	0	D (as in DEL)	3D	''''	N	71	MR01	1	A4	X-M14	u	D8	M-18	[()]
0B	1	10 (as in 10 ⁸)	3E	LOG	O	72	MR02	2	A5	X-M15	v	D9	M-19	[)]
0C	2	L (as in DEL)	3F	LN	P	73	MR03	3	A6	X-M16	w	DA	DEG	[°]
0D	3	in (as in Min)	40	GSBP0	Q	74	MR04	4	A7	X-M17	x	DB	RAD	[π]
0E		(3rd row, 5th column)	41	GSBP1	R	75	MR05	5	A8	X-M18	y	DC	GRA	[E] (exponent)
0F	EXP	[space]	42	GSBP2	S	76	MR06	6	A9	X-M19	z	DD	SINH	[.]
10	RND0	[a]	43	GSBP3	T	77	MR07	7	AA	ABS	/	DE	COSH	[#]
11	RND1	[b]	44	GSBP4	U	78	MR08	8	AB	INT	*	DF	TANH	[space]
12	RND2	[c]	45	GSBP5	V	79	MR09	9	AC	FRAC	←	E0	M+10	A (as in AR)
13	RND3	[d]	46	GSBP6	W	7A	ISZ		AD	SIN ⁻¹	→	E1	M+11	R (as in AR_)
14	RND4	[e]	47	GSBP7	X	7B	x ≥ 0		AE	COS ⁻¹	≈	E2	M+12	√
15	RND5	[f]	48	GSBP8	Y	7C	x ≥ F		AF	TAN ⁻¹	≠	E3	M+13	+/-
16	RND6	[g]	49	GSBP9	Z	7D	x		B0	Min10	AR10	E4	M+14	≠
17	RND7	[h]	4A	+/-	x	7E	0 ⁿ		B1	Min11	AR11	E5	M+15	σ
18	RND8	[i]	4B	(+)	7F	0 ⁿ⁻¹	space	B2	Min12	AR12	E6	M+16	π
19	RND9	[j]	4C)	+	80	M-00		B3	Min13	AR13	E7	M+17	(as in x ²)
1A	4	[k]	4D	SIN	-	81	M-01		B4	Min14	AR14	E8	M+18.	-1 (as in SIN ⁻¹)
1B	5	[l]	4E	COS	=	82	M-02		B5	Min15	AR15	E9	M+19	-1 (as in on-1)
1C	6	[m]	4F	TAN	[space]	83	M-03		B6	Min16	AR16	EA	???	
1D	7	[n]	50	X-M00	:	84	M-04		B7	Min17	AR17	EB	???	
1E	8	[o]	51	X-M01	■	85	M-05		B8	Min18	AR18	EC	password end -	
1F	9	[p]	52	X-M02	?	86	M-06		B9	Min19	AR19	ED	SINH ⁻¹	(as in e ^x)
20	LBL0	[q]	53	X-M03	!	87	M-07		BA	x ^{1/y}	AR??	EE	COSH ⁻¹	(as in x ^{1/y})
21	LBL1	[r]	54	X-M04	μ	88	M-08		BB	x ^{1/y}	AR??	EF	TANH ⁻¹	space
22	LBL2	[s]	55	X-M05	<	89	M-09		BC	R-P	AR??	F0	X-MF	[ARF]
23	LBL3	[t]	56	X-M06	>	8A	PAUSE	D (as in DEL)	BD	P-R	AR??	F1	MinF	[ARF]
24	LBL4	[u]	57	X-M07	∞	8B	IND	L (as in DEL)	BE	%	AR??	F2	MRF	[ARF]
25	LBL5	[v]	58	X-M08	(8C	SAVE	in (as in Min)	BF	invEXE	AR??	F3	M-F	[ARF]
26	LBL6	[w]	59	X-M09)	8D	LOAD	(3rd row, 5th column)	C0	MR10	[Q]	F4	M+F	[ARF]
27	LBL7	[x]	5A	x		8E	MAC		C1	MR11	[R]	F5	X-MIF	[ARIF]
28	LBL8	[y]	5B	+/-	π	8F	SAC	space	C2	MR12	[S]	F6	MinIF	[ARIF]
29	LBL9	[z]	5C	+	E (exponent)	90	M+00	a	C3	MR13	[T]	F7	MRIF	[ARIF]
2A	HLT	[*]	5D	--	:	91	M+01	b	C4	MR14	[U]	F8	M-1F	[ARIF]
2B			5E	=	#	92	M+02	c	C5	MR15	[V]	F9	M+1F	[ARIF]
2C	compound-20 empty		5F	EXE	empty	93	M+03	d	C6	MR16	[W]	FA	AC	???
2D	compound-40 empty		60	Min00	AR00	94	M+04	e	C7	MR17	[X]	FB	???	
2E	compound-60 empty		61	Min01	AR01	95	M+05	f	C8	MR18	[Y]	FC	???	
2F	???		62	Min02	AR02	96	M+06	g	C9	MR19	[Z]	FD	???	
30	GOTO0	A	63	Min03	AR03	97	M+07	h	CA	GSB(0)	[x]	FE	???	
31	GOTO1	B	64	Min04	AR04	98	M+08	i	CB	X-Y	[+]	FF	???	
32	GOTO2	C	65	Min05	AR05	99	M+09	j	CC	√	[+]			
			66	Min06	AR06				CD	x ²	[-] (minus)			

Casio Fx602p code listing.

PORTABLE COMPUTER WORLD

Hex Byte	Displayed Form	Meaning	Hex Byte	Displayed Form	Meaning	Hex Byte	Displayed Form	Meaning	Hex Byte	Displayed Form	Meaning
00	00	end of line (Basic)	4A	.4	.	A1	1.	COS	D8	8¥	GOSUB
11	11	SPC (space code)	4B	E4	E	A2	2.	TAN	D9	9¥	CHAIN
12	21	"	51	15	A	A3	3.	ASN	DA	. ¥	PAUSE
13	31	?	52	25	B	A4	4.	ACS	DB	E ¥	BEEP
14	41	!	53	35	C	A5	5.	ATN	DC	% ¥	AREAD
15	51	#	54	45	D	A6	6.	EXP	DD	¥ ¥	USING
16	61	%	55	55	E	A7	7.	LN	DE	\$ ¥	RETURN
17	71	¥	56	65	F	A8	8.	LOG			
18	81	\$	57	75	G	A9	9.	INT			
19	91	π	58	85	H	AA	..	ABS			
1A	.1	√	59	95	I	AB	E.	SGN			
1B	E1	,	5A	.5	J	AC	%.	DEG			
1C	%1	:	5B	E5	K	AD	¥.	DMS			
1D	¥1	;	5C	%5	L	B0	0E	RUN			
30	03	(5D	¥5	M	B1	1E	NEW			
31	13)	5E	\$5	N	B2	2E	MEM			
32	23	>	5F	π5	O	B3	3E	LIST			
33	33	<	60	06	P	B4	4E	CONT			
34	43	=	61	16	Q	B5	5E	DEBUG			
35	53	+	62	26	R	B6	6E	CSAVE			
36	63	-	63	36	S	B7	7E	CLOAD			
37	73	*	64	46	T	C0	0%	GRAD			
38	83	/	65	56	U	C1	1%	PRINT			
39	93	>	66	66	V	C2	2%	INPUT			
3A	(.3)	[]	67	76	W	C3	3%	RADIAN			
40	04	0	68	86	X	C4	4%	DEGREE			
41	14	1	69	96	Y	C5	5%	CLEAR			
42	24	2	6A	.6	Z	D0	0¥	IF			
43	34	3	82	28	>=	D1	1¥	FOR			
44	44	4	83	38	<=	D2	2¥	LET			
45	54	5	84	48	<>	D3	3¥	REM			
46	64	6	90	09	TO	D4	4¥	END			
47	74	7	91	19	STEP	D5	5¥	NEXT			
48	84	8	92	29	THEN	D6	6¥	STOP			
49	94	9	A0	0.	SIN	D7	7¥	GOTO			

Hex digits >9 as displayed

HEX	DISPLAY
A	(DEC.PT)
B	E
C	%
D	¥
E	\$
F	π

This list is not necessarily complete; it simply shows the codes discovered so far. Unlisted codes are either unused or have functions not yet discovered.

PRINT USING } These commands are represented by two consecutive bytes. For instance, PRINT USING is C1 followed by DD.

Tandy Pocket Computer/Sharp PC1211 code listing.

HOW LUCKY ARE LUCKY NUMBERS?

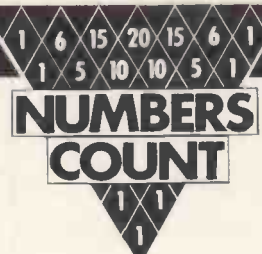

Mike Mudge sets another poser for all you maths freaks.

The positive integers consist of 1,2,3,4,5,... The removal of the even integers from this sequence produces the sequence of odd integers: 1,3,5,7,9,... The removal of every third integer then yields: 1,3,7,9,13,15,19,21,... The removal of every seventh integer then yields: 1,3,7,9,13,15,19,21,25,31,33,37,43,49,... (ie, this process will remove 1,118 terms from the first 10,000 integers).

In 1956 Stanislav M Ulam, then director of the Mathematics Division of the Los Alamos Scientific Laboratory, formulated this 'sieving' algorithm and coined the name Lucky Numbers for those integers 'fortunate enough' to survive it — eg, the fifth lucky number is 13, the tenth 33, the hundredth 613, and the one-thousandth 809.

Many questions arise concerning lucky numbers, parallel to the classical ones asked about prime numbers; the latter being those positive integers exactly divisible by themselves and unity viz

2,3,5,7,11,13,17,19,23,29,... eg, the fifth prime is 11, the tenth 29, the hundredth 541, and the one-thousandth 7919. There are 1,229 primes less than 10,000.

Problem

Can every positive integer be expressed as the sum of two lucky numbers?

Historical note

In a letter to Leonhard Euler written on 7 June 1742, Charles Goldbach conjectured that every positive integer greater than four could be expressed as the sum of two odd prime numbers. This conjecture has yet to be proved (or disproved).

Submit a program which generates all of the lucky numbers less than or equal to a given integer and counts them — together with the number of twin luckies (that is, pairs of lucky numbers differing by two, eg, 67-69, 2113-2115); these counts to be available for comparison

with the known results for primes and twin primes.

Use the output of the program to attempt to represent every positive integer greater than 4 as a sum of two lucky numbers. This representation need not be unique, but the upper bound to which it is completely achieved is an essential part of the output.

All submissions should include program listings, hardware descriptions, run times and output; they will be judged for accuracy, originality and efficiency (not necessarily in that order) and it is hoped to award a suitable prize to the 'best' entry.

Entries, to arrive by 1 April, to: Mr M. R. Mudge BSc FIMA FBCS, Room 560/A, Department of Mathematics, The University of Aston in Birmingham, Gosta Green, Birmingham B4 7ET.

Note: Submissions will only be returned if suitable stamped addressed envelopes are included.

Let Commodore expand your horizons.

VIC 20 is the finest home computer that money can buy.

And the better you get to know it, the more confident, adventurous and ambitious you'll become.

You'll want to take advantage of the vast range of VIC software: a superb and constantly-growing selection of programs, embracing business systems, entertainment, education and many applications in the home.

Every program in the series has been designed by experts, and chosen for its quality and value for money.

VIC business software covers a wide range of applications, including spread-sheet analysis, stock control, information handling and word-processing.

A mind-blowing range of games including Scott Adams' world-famous 'Adventure' series.

Advanced space games, including the sophisticated 'Omega Race'.

Learn subjects as diverse as English Language, programming, and biology.

And 'home' software ranges from IQ tests to Robert Carrier menus.

In addition, there is a range of VIC software, like programmers' aids and graphics packages—



to add to your understanding and enjoyment of computers and computing.

There's even a special 'VicSoft' Club for VIC 20 enthusiasts, with many advantages including special offers to club members.



VIC software will expand your horizons. And your mind.

PRICES RANGE FROM £4.99 to £24.95 INC. VAT.

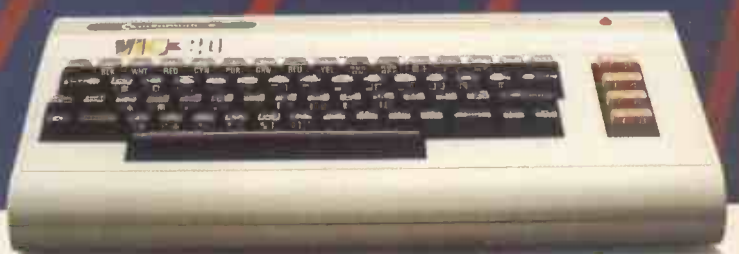

commodore
VIC 20

For more information, a catalogue of VIC software and details of your local retailers or dealers, please phone or complete the coupon and send to:
The Commodore Information Centre,
675 Ajax Avenue, Slough, Berkshire SL1 4BG.
Telephone: Slough (0753) 79292.

Name _____
(MR./MRS./MISS)
Address _____

Postcode _____

VCPCW0383

PCW SUBSET

Alan Tootill and David Barrow present more useful assembler-language subroutines. This is your chance to help build a library of general-purpose routines, documented to the standards we have developed together in this series. You can contribute a Datasheet, improve or develop one already printed or translate the implementation of a good idea from one processor to another. PCW will pay for those contributions that achieve Datasheet status. Contributions (for any of the popular processors) should be sent to SUB SET, PCW, 62 Oxford Street, London W1A 2HG.

6502 SQUARE ROOTS

For the method of extracting square roots, we refer you to Sub Set for August 82 and to Sub Set for January 83 for the improved Z80 code to implement it. This month we have Datasheets SQR16 and

SQR32, both from John Kerr of Glasgow, for two byte and four byte integer square roots in 6502 code. Newcomers please note that 16 bytes of zero page RAM are reserved for Sub Set 6502 routines. These are referred to as M0 to MF in the mnemonics and as ZZ in the machine code.

Datasheet

```

:= SQR16 - Two byte integer square root
// CLASS: 2
// TIME CRITICAL ? No
// DESCRIPTION: Calculates the square root of a positive 16-bit
//              two's complement binary number, giving remainder.
// ACTION: Terminate if input is negative
//              Store input in 24-bit working accumulator X,Y,M3
//              Initialise subtrahend in M1,2 = 0040 hexadecimal
//              If M1,2 < X,Y then let X,Y = X,Y - M1,2
//              Rotate left M1; if the subtraction was performed,
//              this will move '1', otherwise '0', into the LSB
//              X,Y,M3 := 4 * X,Y,M3. Repeat to eight times.
// SUBR DEPENDENCE: None
// INTERFACES: None
// INPUT: M2,1 contains input number ( M2 is the MSB )
// OUTPUT: N Flag set if input was negative; otherwise,
//         M2,1 = 8-bit square root, M4,3 = 9-bit remainder
// REGS USED: A,P,X,Y,M1-4
// STACK USE: None
// LENGTH: 64
// T-STATES: 615 max, ignoring page boundaries.
// PROCESSOR: 6502
    
```

```

SQR16 LDA M2 ;find sign of input number A5 ZZ
      BMI END16 ;and terminate if negative. 30 3B
      TAY ;input moves to 24-bit AB
      LDA M1 ;working accumulator A5 ZZ
      STA M3 ;in X,Y,M3. B5 ZZ
      LDY #0 ;clear MSByte of accumulator A2 00
      STX M1 ;and of subtrahend M1,2. B6 ZZ
      LDA #8 ;set loop A9 08
      STA M4 ;counter in M4. B5 ZZ
SQR16: CPX M1 ;if the subtrahend E4 ZZ
      BBC SQRJ5 ;in M1,2 is greater 90 0E
      BNE SQR53 ;than X,Y then 00 04
      CPY #340 ;skip over the C0 40
      BCC SQRJ5 ;subtraction. 90 08
SQR53: TYA ;X,Y := X,Y - M1,2 98
      SBC #340 ;condition codes ensure E9 40
      TAY ;that the carry flag is set
      TXA ;on entry to 8A
      SBC M1 ;this subtraction E5 ZZ
      TAX ;and also on exit. AA
SQRJ5: ROL M1 ;rotate carry status into 26 ZZ
      ASL M3 ;answer, modifying subtrahend. 06 ZZ
      TYA ;multiply working acc. by four 98
      ROL A ;to get next bit pair into 2A
      TAY ;place. AB
      TXA ; 8A
      ROL A ; 2A
      TAX ; AA
      ASL M3 ;second shift left begins. 06 ZZ
      TYA ; 98
      ROL A ; 2A
      TAY ; AB
      TXA ; 8A
    
```

```

      ROL A ; 2A
      TAX ; AA
      DEC M4 ; C6 ZZ
      BNE SQR16 ;do eight times; DO D8
      STX M3 ;low order remainder in M3. B6 ZZ
      ROL M4 ;MSBit of remainder in M4. 26 ZZ
      STY M2 ;clear MSByte of result. 84 ZZ
END16: RTS ;end of SQR16. 60
    
```

The comparison between the 6502 and Z80 code is interesting. In the 16-bit versions, the Z80 routine takes 35 bytes and 843 maximum T-states against the 6502's 64 bytes and 615 maximum T-states. In the 32-bit versions, the Z80 routine takes 50 bytes and 2792 maximum T-states against the

6502's 75 bytes and 4350 maximum T-states. Z80 processors generally run faster than 6502 processors. The Z80 routines differ in method by subtracting and adding back if the subtraction doesn't go, whilst the 6502 routines compare and subtract if the subtraction will go.

Datasheet

```

:= SQR32 - Four byte integer square root
// CLASS: 2
// TIME CRITICAL ? No
// DESCRIPTION: Calculates the square root of a positive 32-bit
//              two's complement binary number, giving remainder.
// ACTION: Terminate if input is negative
//              Clear M6,5 ( high order word of 48-bit accumulator M6,1 )
//              Initialise subtrahend in MA-7 = 00 00 40 00 hexadecimal
//              If MA-7 < M6-3 then let M6-3 = M6-3 - MA-7
//              Rotate left MA,9; if the subtraction was performed,
//              this will move '1', otherwise '0', into the LSB
//              M6-1 := M6-1 * 4. Repeat to sixteen times.
//              Move answer from MA-9 into M2,1
// SUBR DEPENDENCE: None
// INTERFACES: None
// INPUT: M4-1 contains input number ( M4 is the MSByte )
// OUTPUT: N flag set if input was negative; otherwise,
//         M4-1 = 16-bit square root, M8-5 = 17-bit remainder
// REGS USED: A,P,X,Y,M1-A ( M1-6 assumed contiguous, as are M7-A )
// STACK USE: None
// LENGTH: 75
// T-STATES: 4350 max, ignoring page boundaries
// PROCESSOR: 6502
    
```

```

SQR32: BIT M4 ;find sign of input number 24 ZZ
      BMI END32 ;and terminate if negative; 30 46
      LDA #0 ;prepare to clear subtrahend A9 00
      LDY #5 ;& high order accumulator M6,5. A2 05
      CLR M5,X ;clear areas. For this short 95 ZZ
      DEX ;form of clear procedure, M6 CA
      BPL CLRL1 ;& M7 must be contiguous. 10 FB
      LDA #340 ;low order subtrahend := A9 40
      STA M8 ;4000 hexadecimal. B5 ZZ
      LDY #510 ;Y is loop counter. A0 10
      BITL2: LDY #3 ;compare subtrahend A2 03
      CMLP3: LDA M3,X ;with accumulator M6 to M3 B5 ZZ
      CMP M7,X ;byte by byte and D5 ZZ
      BCC NOSUB ;skip subtraction 90 10
      BNE SUBOK ;if it is greater. DO 03
      DEX ; CA
      BNE CMLP3 ;do for 3 bytes if necessary. DO F5
      SUBOK: LDY #3FD ;prepare to subtract 3 bytes, A2 FD
      SUBL4: LDA M6+1,X ;carry will be '1' B5 ZZ
      SBC MA+1,X ;after subtraction. F5 ZZ
      STA M6+1,X ; 95 ZZ
      INX ; E8
      BNE SUBL4 ; DQ F7
    
```



Saunderson speaking...

This is the first of a series of columns I am writing to keep you up to date with the latest developments on Commercial Microcomputers and Software. A good place to start seems to be the 8 versus 16 bit debate. Is the 16 bit really better or is it just marketing puff devoid of any substantial proof and put out purely to persuade the market to spend more money?

I reckon that at KGB we have as much experience as anyone in this field. We sell both 16 bit — Sirius and IBM — and 8 bit — Superbrain and Apollo. As usual, the truth appears to lie somewhere between the two. If you want to do conventional things, such as Word Processing it would seem quite unnecessary, certainly as far as we are concerned, to purchase a 16 bit machine. A much better buy would be the Apollo with dedicated function keys, detachable keyboard and green screen.

Where the 16 bit machines score is in the spreadsheet programs. Supercalc has 55,000 characters of memory free on a Sirius compared with 33,000 on the 8 bit Superbrain. Actually, it's rather difficult to put that statement into a form that can be easily grasped but, for instance, I use Supercalc to produce our price lists at KGB. It takes one spreadsheet on the Sirius (a 256K one) but three on the Superbrain! Again the Sirius also has very large floppy disks which makes it suitable for programs that require a lot of storage such as accounting systems about which, incidentally, I shall be writing more in my next column. In the end, like all good things, it comes down to value for money. The Sirius is excellent at £2395.00 but if you don't need the features why pay for them? Try the Superbrain at £1650.00 instead.

Talking of value for money reminds me that we have just dropped our LSI dealership for reasons I need not go into here. This leaves us with a twin 5¼ inch 700K Floppy Disk CP/M machine. It is about twelve months old and has had little use! I'd like to sell it for around £1250.00 including a three months return-to-base warranty. The list price is currently £1995.00. In fact, I wouldn't refuse any reasonable offer on the grounds that if I did it wouldn't be reasonable!

Must go. The phone is ringing. Perhaps somebody already wants the LSI! Incidentally all prices in this column are exclusive of VAT.

Sandy Saunderson.

Sandy Saunderson is Managing Director of KGB Micros Limited, the fast growing commercial microcomputer company based in Slough. He has extensive knowledge of the microcomputer industry and if you would like to speak to him, either on general computer matters or particularly about his own products at KGB, give him a call on Slough (0753) 38581/38319 or drop him a line at KGB Micros Limited, 14 Windsor Road, Slough SL1 2EJ.

```

NOSUB:  ROL  M9      ;rotate carry status into      26 ZZ
         ROL  MA      ;answer, modifying subtrahend.      26 ZZ
         TYA                      ;bit 7 of Y used as counter in A.      98
ROLAC:  LDX  #SFA      ;rotate left working accum.        A2 FA
FLAL5:  ROL  M6+1,X    ;(all 48 bits).                    36 ZZ
         INX                      ;                               E8
         BNE  RLAL5    ;                               DO FB
         EOR  #S80     ;toggle bit 7 of A and              49 80
         BMI  ROLAC    ;repeat rotation if it is '1'.      30 F5
         DEY                      ;                               88
         BNE  BITL2    ;do sixteen times.                 DO D5
         LDA  MA      ;put answer in M2,1.                 A5 ZZ
         STA  M2      ;(high order answer M4,3            85 ZZ
         LDA  M9      ;is already clear).                  A5 ZZ
         STA  M1      ;                               85 ZZ
         STY  M8      ;clear remainder MSByte.             84 ZZ
         ROL  M7      ;MSBit of remainder in M7.           26 ZZ
END32:  RTS          ;end of SQR32.                        60

```

FOR THE RECORD

Last month's BINX, binary to any base conversion, attributed to Dennis May, was in fact a synthesis of two routines, Dennis's original version and a version from Vincent Fojut. Although specified in the action section, the original version omitted to terminate the ASCII string with a carriage return character. The neat method of doing this, by initially pushing ODH onto the stack to mark the end of string and then stacking converted ASCII digits which can not be confused with it, was taken from Vincent's version.

OSBORNE 1 CP/M

A note from Jim Chance of Birmingham University

advised that his file handling package (Sub Set Jan 82), successful on a number of different microcomputers, crashed on an Osborne 1. CP/M is an 8080 system and one would assume that it would either not use the Z80 specific IX and IY registers or would make their use transparent to the programmer. In fact, if you call Osborne's CP/M, you will find that the IX and IY registers contain Osborne's values, not yours. This might affect other Z80 commercial software running on the Osborne 1.

The remedy is to save the IX and IY registers before entry to Osborne's CP/M and restore them afterwards. Jim offers this register saving subroutine and redefinition of "ENTRY" for incorporation into his file handling package:

```

ENTRY1  EQU 5          ;CP/M entry
ENTRY:  PUSH IX
        PUSH IY
        CALL ENTRY1
        POP IY
        POP IX
        RET

```

Z80 DIVISION

John Kerr of Glasgow has sent an improvement to the signed 32-bit division routine SDIV4 given in Sub Set June 1981. At the cost of one extra byte it saves between 1760 and 2048 T-states.

The original routine used the sequence:

```

EX (SP),IX
EX (SP),HL
ADC HL,HL
EX (SP),HL
EX (SP),IX

```

To effect an "ADC IX,IX" which is not included in the Z80 instruction set. John's improvement takes advantage of the fact that the value in A at this time does not exceed 32 and temporarily stores Cy in Bit 0,A by rotation. The ADD IX,IX instruction can then be used and at the earliest opportunity the Cy bit is rotated back out of A, restoring A to its original value, and IX is incremented if Cy is set.

```

SDIV4  (section improvement)
LOOP4: ADD  IY,IY      ;shift left dividend into 32-bit  FD 29
         RDA          ;accumulator, saving Cy out from  17
         ADD  IX,IX    ;IY in a spare bit of A          DD 29
         ADC  HL,HL    ;                               ED 6A
         EX  (SP),HL  ;                               E3
         ADC  HL,HL    ;                               ED 6A
         EX  (SP),HL  ;                               E3
         RRA          ;recover saved Cy from IY and    IF
         JR   NC,SKIP4 ;add it to IX                   30 03
         INC  IX      ;                               DD 23
         CCF          ;reset Cy for subtraction        3F
SKIP4:  SBC  HL,DE    ;                               ED 52

```

PCW SUBSET

The improved section replaces lines 33 to 43 of the original routine. The relative jump displacements in lines 18,19,26 and 55 of the original routine need to be adjusted to take account of the extra byte.

THE LONG AND THE SHORT OF IT

If you have ever tried to disentangle the workings of your monitor or any other piece of code from a hex dump of 8 or 16 bytes to a line, then you will appreciate the last datasheet this month which comes from Bruce Tanner of Malvern.

Bruce provided us with TOKEN in November 1982 which expanded text that had been 'tokenised' with common letter groups given a single byte token for economical storage. Now he provides us with LENGTH, a routine to determine the length of Z80

instructions, and suggests three different applications in which it could be used.

The immediately obvious use for LENGTH is in formatting hex dump for easier examination of machine code during debugging or, as implied above, filching ideas for Sub Set from your monitor (please don't send anything that may be copyright).

Bruce has sent the following piece of code which uses LENGTH to get the number of bytes of the instruction pointed to by HL and then print out the address and instruction bytes. It is not system specific but does require routines 'BYTE', 'SPACE' and 'CRLF' which will print the two hex digits in A, print a space, and perform carriage return line feed respectively. Routines to perform these three tasks are to be found in most monitors but before using them make sure that they do not alter any important register contents.

```
FRMTZ: LD B,NN ;desired no. of lines to output
LOOP1: PUSH HL ;save HL and BC which get altered
        PUSH BC ;in LENGTH
        CALL LENGTH ;get E= no. of bytes in instruction
        POP BC ;
        POP HL ;
        LD A,H ;print 4 hex digit
        CALL BYTE ;address
        LD A,L ;in
        CALL BYTE ;HL
        CALL SPACE ;followed by a space
LOOP2: LD A,(HL) ;get instruction byte
        INC HL ;point to next
        CALL BYTE ;print 2 hex digits of byte
        CALL SPACE ;followed by a space
        DEC E ;repeat for all bytes
        JR NZ,LOOP2 ;in instruction
        CALL CRLF ;new line
        DJNZ LOOP1 ;repeat for no. of lines
        RET ;or JP MONITOR or whatever
```

The second use suggested by Bruce is really an up-market version of this first use: LENGTH is a handy routine for a disassembler.

It is Bruce's third use of LENGTH that is really exciting. As his Sharp MZ-80K does not have the necessary hardware to cause an interrupt after every instruction, he has to use a software method of single-stepping through a program when testing. LENGTH provides the information which enables his single step program to set a software breakpoint after each instruction in turn.

Single-stepping is not just a matter of determining the

length of the next instruction to be executed and then substituting a RST to a breakpoint routine for the first byte of the following 'instruction. A jump, call or return instruction may mean control passing to another part of the object program. The single step program has to test for this type of instruction and use whatever information is necessary to put the RST in the location at which the Program Counter will point.

WANTED: a routine to match LENGTH and determine what the contents of the Program Counter will be after the next instruction is executed. Any offers?

Datasheet

```
= LENGTH -Instruction length calculator
/ CLASS: 2 (not position independent, registers not saved)
/ TIME CRITICAL?: No
/ DESCRIPTION: Returns byte length of any valid instruction
/ ACTION: IF instruction uses IX or IY registers THEN
           IF instruction includes a displacement THEN
           Length = 2 bytes more than equivalent HL instruction
           ELSE Length = 1 byte more than equivalent HL instruction
           ELSE IF instruction begins with OEDH THEN THEN
           Length = 2 or 4 bytes
           ELSE Length = 1, 2 or 3 bytes.
/ SUBR DEPENDENCE: None
/ INTERFACES: None
/ INPUT: HL points to instruction whose length is required
/ OUTPUT: E = byte length of instruction
           A BC HL altered
/ REGS USED: A E BC HL
/ STACK USE: 2
/ LENGTH: 137
/ PROCESSOR: Z80

;no. of bytes in tables 1,
TLEN1 EQU +14 ;2,
TLEN2 EQU +6 ;3 and
TLEN3 EQU +25 ;4
TLEN4 EQU +26 ;4

LENGTH: LD E,+1 ;initialise length to 1
LEN1: LD A,(HL) ;get 1st byte
        INC HL ;point to next
        INC E ;add 1 to length in case it's an
        CP ODDH ;index instruction
        JR Z,LEN2 ;branch if IX
        CP OFDH ;
        JR NZ,LEN3 ;branch if not IY
LEN2: PUSH HL ;process index instruction
        LD A,(HL) ;2nd byte
        LD HL,TAB1 ;start of index table
        LD BC,TLEN1 ;size of index table
        CPJR ;search table for 2nd byte
        POP HL ;restore pointer to instruction
        JR Z,LEN1 ;if found, length 1 more than
        INC E ;equiv. HL instr., else 2 more
        JR LEN1 ;process rest of instruction
LEN3: CP OEDH ;is it an ED instruction?
        JR NZ,LEN4 ;if not it's 1, 2 or 3
        LD A,(HL) ;get 2nd byte of ED instr.
        LD HL,TAB2 ;start of ED 4-byte table
        LD BC,TLEN2 ;size of table
        CPJR ;see if 4-byte instr.
        RET E,+4 ;setting E = 4 for if found
        ;exit if found
        JR LENS ;else length is 2
LEN4: LD HL,TAB3 ;start of 2-byte table
        LD BC,TLEN3 ;size of table
        CPJR ;search table and
        RET Z ;exit if 2-byte instr.
        INC E ;else set E=3 for 3-byte test
        LD BC,TLEN4 ;size of TAB4, HL already at start
        CPJR ;search table and
        RET Z ;exit if 3 bytes long
        DEC E ;otherwise it's a 1-byte
        DEC E ;instruction
        RET ;
TAB1: DEFB 9,19H,21H,22H ;table of index instr. which are
        DEFB 23H,29H,2AH,2BH ;one byte longer than equiv.
        DEFB 39H,0E1H,0E3H,0E5H ;HL instruction
        DEFB 0E9H,0F9H ;
TAB2: DEFB 43H,4BH,53H,5BH ;table of 4-byte ED instr.
        DEFB 73H,7BH ;
TAB3: DEFB 6,0EH,10H,16H ;table of 2-byte instructions
        DEFB 18H,1EH,20H,26H ;excluding index or ED
        DEFB 28H,30H,36H ;
        DEFB 38H,3EH,0C6H,0CBH ;
        DEFB 0CEH,0D3H,0D6H,0DBH ;
        DEFB 0DEH,0E6H,0EEH,0F6H ;
        DEFB 0FEH ;
TAB4: DEFB 1,11H,21H,22H ;table of 3-byte instructions
        DEFB 2AH,31H,32H,3AH ;excluding index or ED
        DEFB 0C2H,0C3H,0C4H,0CAH ;
        DEFB 0CCH,0CDH,0D2H,0D4H ;
        DEFB 0DAH,0DCH,0E2H,0E4H ;
        DEFB 0EAH,0ECH,0F2H,0F4H ;
        DEFB 0FAH,0FCH ;
```





Discover our range of CP/M software.

Although we must admit we have not yet found the cure to the common cold, we have found the solution to a problem that's almost as daunting. The task of choosing and buying your CP/M software.

We hold one of the largest ranges of CP/M software, covering most applications and uses. These are supplied over various formats including: I.C.L. Personal Computer, I.B.M., Rair, Sirius, Superbrain, Apple, etc.

So if you are fed up with suffering, when all you really need is sound advice and off-the-shelf service, then give us a call.

Telephone: 01-387 8832 or 01-388 9927.



Software Limited, Duchess House, 18/19 Warren Street,
London W1P 5DB.

It's rather like finding the remedy to the common cold!

CP/M is the trademark of Digital Research.

Attractive quantity & dealer discounts available

NEWCOMERS START HERE

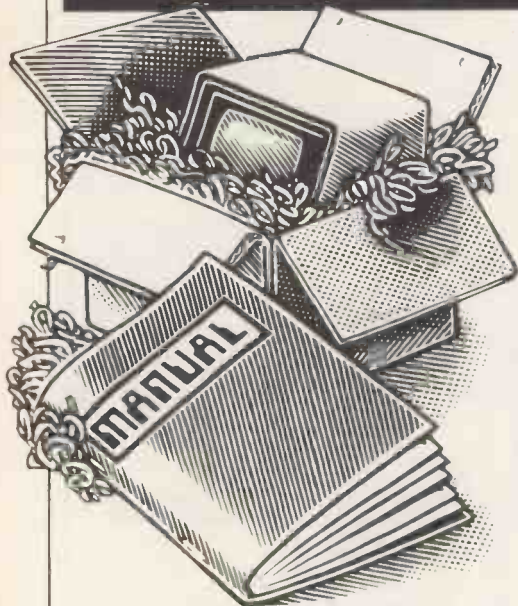

This is our unique quick-reference guide, reprinted every month to help our readers pick their way through the most important pieces of (necessary) jargon found in PCW. While it's in no way totally comprehensive, we trust you'll find it a useful introduction. Happy microcomputing!

Welcome to the confusing world of the microcomputer. First of all, don't be fooled; there's nothing complicated about this business, it's just that we're surrounded by an immense amount of necessary jargon. Imagine if we had to continually say 'numbering system with a radix of 16 in which the letters A to F represent the values ten to 15' when instead we can simply say 'hex'. No doubt soon many of the words and phrases we are about to explain will eventually fall into common English usage. Until that time, PCW will be publishing this guide — every month.

We'll start by considering a microcomputer's functions and then examine the physical components necessary to implement these functions.

The microcomputer is capable of receiving information, processing it, storing the results or sending them somewhere else. All this information is called **data** and it comprises numbers, letters and special symbols which can be read by humans. Although the data is accepted and output by the computer in 'human' form, inside it's a different story — it must be held in the form of an electronic code. This code is called **binary** — a system of numbering which uses only 0s and 1s. Thus in most micros each character, number or symbol is represented by eight binary digits or **bits** as they are called, ranging from 00000000 to 11111111.

To simplify communication between computers, several standard coding systems exist, the most common being **ASCII** (American Standard Code for Information Interchange). As an example of this standard, the number five is represented as 00110101 — complicated for humans, but easy for the computer! This collection of eight bits is called a **byte** and computer freaks who spend a lot of time messing around with bits and bytes use a half-way human representation called **hex**. The hex equivalent of a byte is obtained by giving each half a single character code (0—9, A—F): 0=0000, 1=0001, 2=0010, 3=0011, 4=0100, 5=0101 E=1110 and F=1111. Our example of 5 is therefore 35 in hex. This makes it easier for humans to handle complicated collections of 0s and 1s. The machine detects these 0s and 1s by recognising different voltage levels.

The computer processes data by reshuffling, performing arithmetic on, or by comparing it with other data. It's the latter function that gives a computer its apparent 'intelligence' — the ability to make decisions and to act upon them. It has to be given a set of rules in order to do this and, once again, these rules are stored in **memory** as bytes. The rules are called **programs** and while they can be input in binary

or hex (**machine code programming**), the usual method is to have a special program which translates English or near-English into machine code. This speeds programming considerably; the nearer the programming language is to English, the faster the programming time. On the other hand, program execution speed tends to be slower.

The most common microcomputer language is **Basic**. Program instructions are typed in at the keyboard, to be coded and stored in the computer's memory. To run such a program the computer uses an interpreter which picks up each English-type instruction, translates it into machine code and then feeds it into the processor for execution. It has to do this each time the same instruction has to be executed.

Two strange words you will hear in connection with Basic are **PEEK** and **POKE**. They give the programmer access to the memory of the machine. It's possible to read (PEEK) the contents of a byte in the computer and to modify a byte (POKE).

Moving on to **hardware**, this means the physical components of a computer system as opposed to **software** — the programs needed to make the system work.

At the heart of a microcomputer system is the central processing unit (**CPU**), a single microprocessor chip with supporting devices such as **buffers**, which 'amplify' the CPU's signals for use by other components in the system. The packaged chips are either soldered directly to a printed circuit board (**PCB**) or are mounted in sockets.

In some microcomputers, the entire system is mounted on a single, large, PCB; in others a **bus system** is used, comprising a long PCB holding a number of interconnected sockets. Plugged into these are several smaller PCBs, each with a specific function — for instance, one card would hold the CPU and its support chips. The most widely-used bus system is called the **S100**.

The CPU needs memory in which to keep programs and data. Microcomputers generally have two types of memory, **RAM** (Random Access Memory) and **ROM** (Read Only Memory). The CPU can read information stored in RAM — and also put information into RAM. Two types of RAM exist — static and dynamic; all you really need know is that dynamic RAM uses less power and is less expensive than static, but it requires additional, complex, circuitry to make it work. Both types of RAM lose their contents when power is switched off, whereas ROM retains its contents permanently. Not surprisingly, manufacturers often store interpreters and the like in ROM. The CPU can only read the ROM's contents and cannot alter them in any way. You can buy special ROMs called **PROMs** (Programmable ROMs) and **EPROMs** (Erasable PROMs) which can be programmed using a special device; EPROMs can be erased using ultraviolet light.

Because RAM loses its contents when power is switched off, **cassettes** and **floppy disks** are used to save programs and data for later use. Audio-type tape recorders are often used by converting data to a series of audio tones and recording them; later the computer can listen to these same tones and re-convert them into data. Various methods are used for this, so a cassette recorded by one make of computer

won't necessarily work on another make. It takes a long time to record and play back information and it's difficult to locate one specific item among a whole mass of information on a cassette; therefore, to overcome these problems, **floppy disks** are used on more sophisticated systems.

A floppy disk is made of thin plastic, coated with a magnetic recording surface rather like that used on tape. The disk, in its protective envelope, is placed in a disk drive which rotates it and moves a **read/write head** across the disk's surface. The disk is divided into concentric rings called **tracks**, each of which is in turn subdivided into **sectors**. Using a program called a **disk operating system**, the computer keeps track of exactly where information is on the disk and it can get to any item of data by moving the head to the appropriate track and then waiting for the right sector to come round. Two methods are used to tell the computer where on a track each sector starts: **soft sectoring** where special signals are recorded on the surface and **hard sectoring** where holes are punched through the disk around the central hole, one per sector.

Half-way between cassettes and disks is the stringy **floppy** — a miniature continuous loop tape cartridge, faster than a cassette but cheaper than a disk system. **Hard disk** systems are also available for micro-computers; they store more information than floppy disks, are more reliable and information can be transferred to and from them much more quickly.

You, the user, must be able to communicate with the computer and the generally accepted minimum for this is the visual display unit (**VDU**), which looks like a TV screen with a typewriter-style keyboard; sometimes these are built into the system, sometimes they're separate. If you want a written record (**hard copy**) of the computer's output, you'll need a **printer**.

The computer can send out and receive information in two forms — **parallel** and **serial**. **Parallel input/output (I/O)** requires a series of wires to connect the computer to another device, such as a printer, and it sends out data a byte at a time, with a separate wire carrying each bit. **Serial I/O** involves sending data one bit at a time along a single piece of wire, with extra bits added to tell the receiving device when a byte is about to start and when it has finished. The speed that data is transmitted is referred to as the **baud rate** and, very roughly, the baud rate divided by ten equals the number of bytes being sent per second.

To ensure that both receiver and transmitter link up without any electrical horrors, standards exist for serial interfaces; the most common is **RS232** (or **V24**) while, for parallel interfaces to printers, the **Centronics** standard is popular.

Finally, a **modem** connects a computer, via a serial interface, to the telephone system allowing two computers with modems to exchange information. A modem must be wired into the telephone system and you need British Telecom's permission; instead you could use an **acoustic coupler**, which has two obscene-looking rubber cups into which the handset fits, and which has no electrical connection with the phone system — British Telecom isn't so uppity about the use of these.

What do you do if your BBC Micro goes wrong?

If you value your BBC Micro and your money you can now purchase extra one and two year full guarantees direct from us or via most Acorn dealers.

If your Micro is still under warranty, just fill in the expiry date on the coupon* and the guarantee will start from that date.

We carry a full stock of parts and should your computer malfunction we will repair it within five days of receipt.



A full one year guarantee costs just **£18.40**
And a full two year guarantee costs just **£27.60**

If your Micro is already faulty, and out of guarantee, we will repair it on receipt and issue a full years guarantee for **£29.90** or a full two years guarantee for **£39.10**. Please state fault when sending micro.

For you and your BBC Micro's peace of mind send the coupon today

<input checked="" type="checkbox"/> Please tick service required.	Warranty Expiry* Date / /83 If applicable
<input type="checkbox"/> I enclose £18.40 for a full 1 years guarantee	
<input type="checkbox"/> I enclose £27.60 for a full 2 years guarantee	
<input type="checkbox"/> I enclose £29.90 for an immediate repair and a full 1 years guarantee	
<input type="checkbox"/> I enclose £39.10 for an immediate repair and a full 2 years guarantee	
Surname	Access Card No
Initials	Make/Model
Address	Serial No.
.....	Send remittance to:
.....	Cambridge Processor Services,
.....	25 Parsonage Street, Dept.PCW
.....	Cambridge CB5 8DN.
or telephone your access card number to Madingley 210212	

This offer applies to mainland UK only. This guarantee does not apply to major damage caused by abuse.

OMICRON DESIGN

TRULY INTEGRATED ACCOUNTING SOFTWARE

- Sales Invoicing
- Sales & Purchase Ledgers
- Nominal Ledger
- Stock Control
- Job Costing

Backed by Omicron's promise of full support, an extensive network of dealers throughout the U.K. are ready to demonstrate the Omicron suite of quality accounting programs.

Contact us now for your nearest Omicron Dealer.

THEOMICRON DESIGN CO. LTD.

27, High Street, Egham, Surrey TW20 9DT.
Telephone: Egham (0784) 31809/34121

DEALER ENQUIRIES INVITED



Easy to install, simple to use, Omicron offers the professional businessman a comprehensive suite of proven accounting packages, specially developed for the No 1 16 bit microcomputer the ACT Sirius 1.

Please send me further details

Literature Dealership

Name

Company

Address

TelNo.

TEL: 0784 31809
or 34121

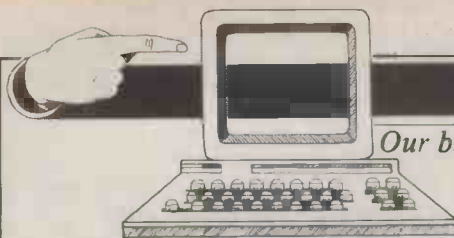

IN STORE

Our bi-monthly guide to microcomputing systems. Updates should be sent to:
Dick Olney, PCW, 62 Oxford Street, London W1A 2HG.

Machine (Price from)	Main Distributor/s (No. of Dealers)	Hardware	Software	Miscellaneous (Documentation)
ABC 26 (£4500)	AI 09237-70578(19)	64k RAM: Z80A: dual 8" F/D (2.3Mb): 12", 24 x 80 VDU: 2 x RS232 ports: 3 x P/P	CP/M: <i>MP/M Basic:</i> <i>Cobol: Fortran: Pascal.</i>	Options: 10Mb H/D £4000. BT 4/81 (S).
ABC 80 (£738)	Datormark Ltd: 97 44896	16-40k RAM: Z80A: C: 12", 16 x 40 b&w VDU: 4680 bus: 1EE 488: RS232 port.	DOS Basic (16k ROM): <i>Fortran: Pascal: A:</i> <i>Multi user Basic.</i>	Colour video graphics with UHF output. Viewdata compatible. Loudspeaker. Numeric keypad. Options: dual 5 1/4" F/D (320k) £895: dual 8" F/D (2 Mb). BT 1/80. (I)
Acclaim (£3650)	Country Computers 0527 29826	64k RAM: Z80: 24x80 VDU: single 5 1/4" F/D (140k): 5 MB H/D: RS232 port. Option: P/P	CP/M: <i>Basic: Cobol:</i> <i>Fortran: Pascal</i>	Various integral H/D options up to 21MB (£4450)
ACT Sirius 1 (£2395)	ACT 021 501 2284 (50)	128-512k RAM: 8088: dual 5 1/4" F/D (1.2M): 12", 25 x 80 VDU: 2 x RS232 ports: 2 x P/P	CP/M 86: U: <i>Basic 86</i> <i>Cobol: Fortran: Pascal</i>	High res graphics. Options: 10 Mb H/D: dual 5 1/4" F/D (2.4 M) BT 2/82.(S)
Adler Alphatronic (£1895)	Adler 01-250 1717	48-64k RAM: 8085A: dual 5 1/4" F/D (1Mb): 12", 24 x 80 VDU: S/P: P/P	CP/M: <i>Basic: CBasic:</i> <i>Fortran: Cobol</i>	With 80 cps printer and dual F/D £2345 (inc CP/M). (S)
Altos ACS 800-2 £2995)	logitek: 0257 426644 (33)	64k RAM; Z80A; dual 8" F/D (1 Mb): 2 x RS232 ports: 2 P/P.	CP/M: <i>Basic: CBasic:</i> <i>Cobol.</i>	Single user. Options: DMA. Floating point processor. Phototyping board.
Altos ACS 8000- 10 (£6675)	As above.	280k RAM: Z80A: single 8" F/D (500k): 10 Mb H/D: 6 x RS232 ports: P/P: network RS422 port: DMA	CP/M: <i>MP/M: Basic:</i> <i>Cobal: Fortran: APL:</i> <i>Pascal.</i>	Multi-user/multi tasking. Up to 4 users. Options: 10 Mb: mag tape backup (S + H).
APL Signet (£1750 or £130pm)	Micro APL: 01-834 2687	64k RAM: Z80A: dual 5 1/4" F/D (380k): 2 x RS232 ports.	CP/M: <i>APL: Basic: U:</i> <i>Fortran: Cobol: Algol:</i> <i>Forth</i>	Desktop APL computer with self teaching course. (S)
Apple II (£695)	Apple (UK) 0442 48151 (200 +)	16-48k, RAM: 6502: 8 I/O slots.	OS: <i>Basic: Pascal:</i> <i>Fortran: Cobol: Pilot</i>	280 x 192 high resolution graphics: Option: single 5 1/4" F/D (116k) £349.
Apple III (£2496)	As above	128-256k RAM: 6502B: dual 5 1/4" F/D (286k): 12", 24x80 VDU: RS232 port: P/P.	SOS: <i>Basic: Pascal:</i>	Options: single 5 1/4" F/D (143k) £384: 5Mb H/D £2256. (E) BT 5/82
Atari 400 (£200 inc VAT)	Atari UK: Slough 33344	16k RAM: 6502: C int: cartridge slot: 24 x 40 TV int: touchpad k/b: Opt: C £50	OS (10k ROM): <i>Basic (8k ROM).</i> <i>Pilot: A:</i>	High resolution colour graphics. 4-channel sound. Four games controller/light pen sockets. BT 10/80. (I/B).
Atari 800 (£500 inc VAT)	As above.	16-48k RAM: 6502: C int: 2 x cartridge slots: 24 x 40 TV int: Opt: single 5 1/4" F/D (90k) £300: 16k RAM £65.	OS(10k ROM) <i>Basic</i> (8k ROM): <i>Pilot</i> <i>A: Forth: MBasic</i> (I/B).	As above. Software & RAM on cartridge modules. Up to 4 disk drives RS232C int £135. BT 10/80.
Atom (£120)	Acorn: 0223 245200 (160)	2-12k RAM: 8-16k ROM 6502: Full K/B: C int: TV int: 20 I/O lines: 1 P/P. Options: 80 col printer £199, Prestel adaptor £120.	Basic in 8k ROM: A Cass O/S: <i>Lisp:</i> <i>Forth</i>	High resolution graphics on bigger model: Single 5 1/4" F/D £297 B/ 7/80 (B)
BASF 7120 (£4400)	BASF: 01-388 4200 (12)	88k RAM: 2xZ80A: 3 x 5 1/4" F/D (480k): 12", 24 x 80 VDU: RS232 port: P/P	DOS: (OASIS) <i>Ex Basic:</i> <i>Cobol U. A: CP/M</i>	H/D available. Also 7125 with 960k F/D £4900 and 7130 with single F/D (430k) & 5Mb H/D £6300. Disk controller has own Z80A. BT 9/80
BBC Micro (£299 inc VAT)	BBC Micro Systems 0933 79300	16-32k RAM: 32k ROM 6502: C int: TV int: RS423 port: P/P: Option: single 5 1/4" F/D (100k) £230	MOS: <i>Basic A: Pascal</i> <i>Logo: Forth: Lisp</i>	Video text & second processor int. 32k model with Econet and disk interface £399. BT 1/82 (I)
Bonsai SM3000 (£1995)	Bonsai 01-580 0902	64k RAM: Z80: dual 5 1/4" F/D (700k): 12", 24x80 VDU: RS232 port: P/P	CP/M: <i>Basic: Cobol:</i> <i>Pascal: Fortran.</i>	Many floppy and hard disk options. Applications software avail. from Bonsai.
Computers Lynx (£225 inc VAT)	Computers Ltd 0223 315063 (TBA)	48-192k RAM: Z80A; 24x40 TV int: C int: RS232 port	<i>Basic</i>	248 x 256 colour graphics (8 colour). CP/M compatible 5 1/4" F/D & printer avail soon. (B)
Canon BX-3 (£3000)	Canon 01-680-7700.	32k RAM: 6809: dual 5 1/4" F/D (640k): 28 char display: 80 cps printer: 3 x RS232 port: P/P.	OS: <i>Basic: A.</i> <i>Cobol: Pascal</i>	Fully integral unit. Extensive applications support offered on all Cannon Machines. Options: dual dual 5 1/4" F/D (640k) £1500.
Canon CX-1 (£2500)	As above.	32k RAM: 6809: dual 5 1/4" F/D (640k): 12", 24 x 80 VDU: 3 x V24 ports: P/P: light pen.	OS: <i>Basic: A: Cobol:</i> <i>Pascal</i>	Price includes installation & training. Extensive application support offered. Options: dual 8" F/D (1Mb) £3300.(S)
Canon TX-25 (£1450)	As above.	16-32k RAM: 6809: C: 20 char display: 26 col, 2.4 lps printer. Option: 2 x RS232 port.	<i>Basic: A</i>	Fully integral unit. Cassette is Cannon's own design (8k). Can be used with communications. (S).
Cleno Pronto (£2825)	Cleno Computing Systems Ltd: 01-670 4202 (TBA)	64k RAM: Z80: dual 8" F/D (1 Mb): 3 S/P: 2 P/P.	CP/M: <i>CBasic-2:</i> <i>Pearl 1: U Fortran:</i> <i>Cobol: Pascal</i>	With 2.4Mb F/D £3105. Also H/D systems with 5-20 Mb H/D & tape drive £5430.

List of Abbreviations

A Assembler	G/C Graphics card	M/A Macro assembler	S Software
BT Bench Tested	H Hardware	N/A Not available	S/P Serial port
C Cassette	H/D Hard disk	N/P Numeric pad	T/E Text editor
E Extensive	I Introductory	O/S Operating system	TBA To be announced
F/D Floppy disk	Int Interface	P/P Parallel port	U Utility

Please note: Software items listed in *italic* are not included in the basic price of the equipment. All prices are *exclusive* of VAT.

IN STORE

Machine (Price from)	Main Distributor/s (No. of Dealers)	Hardware	Software	Miscellaneous (Documentation)
Cleno Table Top 525 (£1750)	As above	64k RAM: Z80 dual 5 1/4" F/D: 2xS/P	CP/M: MBasic: W/P	Wordstar & Logical included in price. Many options
Colour Genie (£200 inc VAT)	Low Electronics 0629 2430 (100+)	16-32k RAM: Z80: 16k ROM: C int: 24x40 TV int: Audio port: RS232 port: P/P	ExBasic	160x96 colour graphics. 16k RAM £30. Many options inc joysticks and light pen. F/D avail soon. (B)
Columbia PC (£2800)	Icarus 01 485 5574 (50)	128k RAM: 8088: dual 5 1/4" F/D (640k): 24x80 VDU: 2xRS232 ports: P/P: 8 expansion slots	MS-DOS: CP/M 86: Basic: Cobol: Fortran: Pascal	IBM PC compatible. With integral H/D (5 Mb) £4200 or (10 Mb) £4550 (S)
Comart Communicator (£1895)	Comart 0480 215005 (25)	64k RAM: Z80A: dual 5 1/4" F/D (780k): 2 S/P: P/P.	CP/M: MP/M Basic: Cobol: Fortran: Pascal	With 1.5 Mb F/D £2195. With 4.8 Mb H/D & 790k F/D £2995. Option: 18 Mb H/D. £3895 Also CP100 range with 8086 & 128k-1Mb RAM from £2295. Expandable to multiuser/multitasking. (S).
Commodore PET 16k, & 32k (£550, £695)	Commodore: 0753 79292 (150)	16-32k RAM: 6502: C: 12" 25x40 VDU: IEEE-488 port: Options: dual 5 1/4" F/D (343k) £695: same but (1018k) £895	O/S: Basic (in 8k ROM): Forth: Pilot: Pascal: Comal: Lisp: A	CBM 8032 with 80-col screen (32-96k) BT 12/80. £895 Field service avail. (1).
Commodore Vic 20 (£200 inc VAT)	Commodore: 0753 79292 (150)	5-32k RAM: 6502: C int: 22 x 23 TV int: S/P: P/P: Games int.	Basic	Graphics 3 tone sound generator. Will interface to PET. Option: single 5 1/4" F/D (170k). BT 9/81(S).
Commodore 500 Series (From £659)	As above	128-896k RAM: 6509: 25x40 TV int: P/P	O/S: Basic: CP/M: Pascal: Forth: Cobol: Fortran	High res. 16-colour graphics. Second processor option: Prestel facility avail.
Commodore 700 Series (From £995)	As above	128-896k RAM: 6509: 24x80 VDU: Option: dual 5 1/4" F/D (1Mb): IEEE-488 port: RS232C port.	As above	8088 or 280 second processor option Tilt and swivel screen.
Commodore 64 (£299)	As above	64k RAM: 6509: 25x40 TV int: C int: RS232 port: P/P	Basic	Second processor option. 320x200 colour graphics. Option: Joystick: Light pen
Compucorp 625 (£6000)	Compucorp: 01-907 0198 (17)	48-60k RAM: Z80: dual 5 1/4" F/D (630k): 9". 16x80 VDU: 40 col printer: RS232 port, P/P.	Basic: A: Fortran: Pascal: U	IEEE-488 Controller and S100 int. Many applications packages avail. (E).
Compucorp 655/665/675/685 (from £5050)	As above	60k RAM: Z80: Up to 4x5 1/4" F/D (160k-2.4 Mb): 9", 20x80 or 12" 20x80 or 20" 60x80 VDU: 40-col printer: RS232 port.	As above	Prices incl installation and training. Opt: 10-20 Mb H/D
Cromemco System Zero/DDF, System 2, System 3, System Z2H. (£1975/£3095/£4495/£6585).	Datron: 0742 585490. Comart: 0480 215005 (25) MicroCentre: 031-556 7354 (18)	64k RAM: Z80: dual 5 1/4" F/D (390k) on System Zero, System 2 & Z2H: dual 8" F/D (1.2 Mb) on Sys 3: 10 Mb-H/D on Z2H: S/P: P/P.	CDOS: Basic: Cobol: Fortran: RPG II: Lisp: A: W/P: Multi-user Basic. Cromix. CP/M	System 2 & 3 expandable to Multi-user (max 7) Also 'D' series with 6800/ Z80A dual processor from £3620. Options: dual 8" F/D (996k): 11.2Mb H/D. BT 10/79 (E).
DAI (£595)	Data Applications (UK): 0285 2588 (7)	48k RAM: 8080: C int: 24x60 VDU int: RS232 port: over 20 industrial ints. option: dual 5 1/4" F/D £595	Basic (ROM): U	Colour graphics up to 255 x 335: 3 notes & noise generator: PAL O/P to TV: Paddle int: H maths option. (1). BT 10/80.
Diablo 3000 (£6250)	Business Computers Ltd: 01-207 3344	32k RAM: 8085: dual 8" F/D (1.3 Mb): 12", 24x80 b&w VDU: 45 cps printer.	DOS: Basic: DACL: A: U.	Selection of business packages included (S).
Digital Micro-systems DMS-3 (£3530)	Digital Microsystems 0734 343885 (14)	64k RAM: Z80A: dual 8" F/D (1.14Mb): 3xRS232 ports: 1xRS422 port: P/P.	CP/M: CBasic: Cobol: Fortran: Pascal: PL/I	Expandable to multi-user system with 10-28 Mb H/D. Extensive software avail. (S).
Digital Micro-systems DMS-4 (£4395)	As above	128-512k RAM: Z80A: single 8" F/D (500k): 11 Mb H/D: 4x RS232 ports: P/P.	CP/M: Basic-E: CBasic: Cobol: Fortran: Pascal.	Port expander to enable up to 10 workstations under M/PM. Options: 128k RAM £1295: up to 96Mb H/D. (H).
Dragon 32 (£200 inc VAT)	Dragon Data 0792 580651 (50+)	32-64k RAM: 6809E: 16x32 TV int: C int: P/P	Basic	9 colour 256x192 high resolution graphics. Option: Joysticks BT 8/82
Durango F-85 (£4995)	Comp Ancillaries: 0784 36455 (12)	64k RAM: 8085: dual 5 1/4" F/D (1 Mb): 9", 16x64 green VDU: 132 col 165 cps printer: N/P.	O/S: D Basic: CP/M: CBasic: Micro Cobol.	Up to 5 work stations: fully integrated system. Options: additional dual 5 1/4" F/D (1 Mb): 12-24 Mb H/D.(S).
Eagle II, III and IV (from £2350)	Mediatech Bus Syst 01 903 4372	64k RAM: Z80A: dual 5 1/4" F/D (768k and 1.5Mb) or single 5 1/4" F/D (784k) with 10Mb H/D: 2xRS232 ports: 2 x P/P	CP/M: CBasic: Cobol: Pascal: Fortran	Many different configurations available. Full range of applications software
Equinox 200 (£7500)	Equinox: 01-739 2387 (N/A)	64-512k RAM: Z80: 10 Mb-1200 Mb H/D: 6xS/P: 1 P/P.	CP/M: CBasic: Cobol: Fortran.	Multi-user MVT/FAMOS available in place of CP/M. 16-bit version (Equinox 300) £10,000. (S&H).
Fortune 32:16 (£4375)	Fortune Systems 01 938 1721	256-512k RAM: MC 68000: dual 5 1/4" F/D (800k): 12", 25x80 VDU: S/P: P/P	FOS: CP/M: Basic: Pascal: Cobol: Fortran: C	Expandable to full multi-user system. High res colour graphics
Gecas 64/2 (£3305)	Grecas Micros 01 629 3758	64k RAM: Z80A: dual 8" F/D (2.4 Mb): S100 bus.	CP/M: Cobol: Basic: Pascal: Fortran	Up to 4.8 Mb F/D. Expandable to multi-user/multitasking system.
Gemini Multiboard (£500)	Micro Value 02403 28321(7)	64k RAM: Z80: 25 x 80 VDU int (with Z80): Option: dual 5 1/4" F/D £690.	CP/M: Basic: Cobol: Pascal: Fortran: AP/L:	Modular system. Other options inc ROM board & EPROM programmer. BT 2/82 (H&S).

List of Abbreviations

A Assembler
BT Bench Tested
C Cassette
E Extensive
F/D Floppy disk

G/C Graphics card
H Hardware
H/D Hard disk
I Introductory
Int Interface

M/A Macro assembler
N/A Not available
N/P Numeric pad
O/S Operating system
P/P Parallel port

S Software
S/P Serial port
T/E Text editor
TBA To be announced
U Utility

Please note: Software items listed in *italic* are not included in the basic price of the equipment. All prices are *exclusive* of VAT.

IN STORE

Machine (Price from)	Main Distributor/s (No. of Dealers)	Hardware	Software	Miscellaneous (Documentation)
Gemini Galaxy 2 (£1495)	As above	64k RAM: Z80A: dual 5 1/4" F/D (800k); 12", 25x80 VDU: RS232 port: P/P: C int	CPM: <i>Basic: Cobol; Fortran: Pascal; AP/L: A</i>	Options: dual 5 1/4" FD (800k): dual 8" F/D (2.4Mb)
Gimix System 68 (£2000)	SEED: 05433 78151; Windrush 0692 505189	16-64k RAM: 6800/6809: dual 5 1/4" F/D (500k): 2xRS232 ports.	OS-9: <i>Flex Basic: Pascal; A: Dis A: T/E:U</i>	With dual 8" F/D (2 Mb) £2900. Designed as development system for industrial control. (H).
Genie I (£299)	Lowe Electronics: 0629 2430 (N/A)	16k RAM: Z80: 500bps C: 16 x 64 TV int: extra C int: 1 P/P	Basic (12k ROM): <i>Pascal: A M/A: Fortran</i>	Options: single 5 1/4" F/D (184k) £220; dual 5 1/4" F/D (368k) £375 (I) Also Genie II with numeric keypad and function keys but no cassette (same price as I).
Genie III (£1900)	As above (26)	64k RAM: Z80A: dual 5 1/4" F/D (1.25 Mb): 24x80 VDU: RS232 port: P/P	NewDOS 80: <i>CP/MZ: Basic: Cobol: Fortran Pascal</i>	System complete with business applications software, maintenance contract and choice of printer £3250 (S).
Grundyl 8200 (£1850)	M-Tech Comp Serv. 0603 870620	64-256k RAM: Z80A: dual 8" F/D (2Mb): 24x80 VDU: RS232 port: P/P	CP/M: <i>Basic: Cobol; Fortran: Pascal; Forth: PL/I: Ada</i>	Various hard disk options up to 26Mb
Haywood 9000 Composite (£1795)	Haywood: 01- 428 0111. (TBA)	64-192k RAM: Z80A: dual 5 1/4" F/D (640k); RS232 port: P/P. 15" 28x80 VDU.	CP/M: <i>Basic: Cobol; Fortran: Pascal: W/P.</i>	Graphics avail. Expandable to 18 Mb H/D. Networking version planned (H&S)
Haywood Hinet (£7500)	As above	64k RAM: Z80A: dual 8" F/D (2Mb): 11Mb H/D: RS232 port: RS422 port: P/P. 24x80 VDU	CP/M: <i>HiNet: Basic: Cobol: Fortran: Pascal</i>	Local area network, up to 32 users. Range of H/D avail. Local disks & printers if required. Work station £2050 (H&S)
HP 75C (£728)	As above	16-24k RAM: 48k ROM: CPU: 32 char display: mag card reader	Basic	8k RAM £142. Video interface £221. Thermal printer £371. (E) BT 11/82
HP 85 (£2013)	Hewlett Packard Ltd: 0734 784774 (16)	16-32k RAM: C.P.U.: 5", 16x32 VDU: C(200k): 64 cps printer: 4 P/P. Options: dual 5 1/4" F/D (540k) £1610; fusi 8" F/D (2.4 Mb) £4108.	Basic (ROM)	Full dot matrix graphics. Complete range of interfaces, peripherals and application packages avail. 16k RAM £142. (S).
HP86 (£1314)	As above	80k RAM: C.P.U.: 48k ROM. Options: 12", 24x80 VDU £238; 9", 16x80 VDU £216; 5 1/4" F/D (207k) £622	ExBasic	Many expansion possibilities including CP/M module (£362), RS232 port (£289) and up to 576k user RAM. 400x240 graphics. BT 10/82 (E)
HP 125 (£2479)	As above	64k RAM: 2xZ80A: 12", 24x80 VDU 2xRS232 ports: HP-1B port. Options: dual 5 1/4" F/D (500k) £1693	CP/M: <i>Basic: Cobol; Fortran: Pascal</i>	Integral thermal printer £629. Also available with dual 8" F/D (2 Mb). (S). BT 3/82
IMS 5000 (£1500)	Equinox: 01-739 2387 (20)	16-56k RAM: Z80: dual 5 1/4" F/D (320k): 2xS/P: 1 P/P	CP/M: <i>C/Basic: Cobol, Fortran.</i>	3 drives option: (S&H).
IMS 8000 (£2500)	As above	64-256k RAM: Z80: dual 8" F/D (1 Mb): 2xS/P: 1 P/P	CP/M: <i>CBasic: Cobol; Fortran: MicroCobol</i>	Multi-user MVT/FAMOS available in place of CP/M. (S&H).
Jupiter Ace (£90 inc VAT)	Jupiter Contab.	3k RAM: 8k ROM: Z80A; 24x32 TV int: C int: loudspeaker.	Forth	Has 140 Forth words defined in ROM
Kemitron K2000 E (£2300)	Kemitron 0244 21817 (3)	64k RAM: Z80A: single 5 1/4" F/D (150k): 12", 24x80 VDU: 2xS/P: P/P	CP/M: <i>Basic: Cobol; Fortran Pascal: A</i>	Extensive range of support cards and industrial interfaces.
Kemitron K3000 E (£3300)	As above	64k RAM: Z80A: dual 8" F/D (2Mb): 2xS/P: P/P	CP/M: <i>MP/M: Basic: Cobol; Fortran: Pascal: A</i>	Up to four screens and four printers can be attached. Options: 10Mb H/D.
LSI M-Two (£6000)	LSI Computers 04862 23411 (20)	64-128k RAM: 8085A: dual 8" F/D (1.2 Mb): 12", 24x80 VDU: 60 cps printer	Elsie: <i>CP/M: Basic: Cobol; Fortran: Pascal: A: U</i>	Max 8 VDUs and 4 printers. Many applications packages available. Option: 10 Mb H/D £2600. (S).
LSI M-Three (£1700)	As above	64k RAM: Z80A: dual 5 1/4" F/D (350k): 12", 24x80 VDU: RS232 port: P/P	CP/M: <i>Basic: Cobol; Fortran: Pascal: A</i>	Option: Dual 8" F/D, 10 Mb H/D (E)
LSI M-four (£2175)	As above	128-256k RAM: Z80B: 8088: dual 5 1/4" or 8" F/D 3xRS232 ports: RS422 port: P/P 12", 24x80 VDU	MS-DOS: <i>CP/M-86 Basic: Cobol; Fortran: Pascal; MP/M-86</i>	Operates on either 8-bit or 16-bit applications software. Option: 10 Mb H/D
Macro 1 (£3950 or £294 pm).	Micro APL Ltd. 01-834 2687 (TBA)	64k RAM: Z80A: dual 8" F/D (1 Mb): 4xRS232 ports.	CP/M: <i>APL: U: Basic: Fortran: Cobol: Wordstar Algo: Pascal: Forth.</i>	Designed as timesharing replacement. Macro 2 with 2 Mb F/D £4750 or £334 pm.
Marinchip M9900 (£4990)	Microprocessor Eng. 0703 775482	128k RAM: 9900: dual 8" F/D (2Mb): 4xRS232 ports.	NOS: <i>Basic: Pascal: W/P; SPL: Forth: Meta</i>	Multi-user/multi-tasking OS. Options: H/D up to 120 Mb.
Micro Trainer 1 (£650)	Hewart: 0625 22030 (N/A)	16-32k RAM: 6800/6809: 10" 16x24 VDU: 2xC int: Opt: dual 5 1/4" F/D (160k) £59 8k RAM £17.	Basic: <i>A: Pascal: PL/M: W/P</i>	SS50-based system. Graphics avail. Int card with real time clock £17. (1).
Millbank Sys 10 (£2395)	Millbank: 01-891 4691(6).	65k RAM: Z80: dual 5 1/4" F/D (700k): 12", 24x80 VDU: 2x RS232 ports: RS449 port: P/P.	CP/M: <i>Basic: Cobol; Fortran: Pascal: PL: W/P.</i>	12-month warranty. Main-frame comm. package. Maintenance contracts. Options: 1.6 Mb F/D. 5-50 Mb H/D. (S&H)
Munroe EC8800 (£2150)	Fi-Cord Int. 061 445 7716	128k RAM: Z80A: single 5 1/4" F/D (320k): 3xRS232 ports: P/P	Munroe Multitasking System: <i>CP/M: Basic: Cobol: Fortran: Pascal</i>	High res colour graphics. Option: single 5 1/4" F/D. (320k). £495
Munroe OC8820 (£2990)	As above	128k RAM: Z80A: dual 5 1/4" F/D (640k): 9", 24x80 VDU: 3xRS232 ports: P/P	As above	5Mb H/D avail soon. BT 4/82.

List of Abbreviations

A Assembler
BT Bench Tested
C Cassette
E Extensive
F/D Floppy disk

G/C Graphics card
H Hardware
H/D Hard disk
I Introductory
Int Interface

M/A Macro assembler
N/A Not available
N/P Numeric pad
O/S Operating system
P/P Parallel port

S Software
S/P Serial port
T/E Text editor
TBA To be announced
U Utility

Please note: Software items listed in *italic* are not included in the basic price of the equipment. All prices are exclusive of VAT.

SUPERBRAIN II



—THE BEST THING
SINCE SUPERBRAIN I!

- OFFERS:** — *Basic Interpreter.*
 — *Full Reverse Video and True Descenders.*
 — *Superbly Improved Circuitry.*

ALL AT REDUCED COST!

Choose From:

- THE JUNIOR (JR) WITH 350K FLOPPY DISKS
- THE QUAD DENSITY (QD) WITH 750K FLOPPY DISKS
- THE SUPER DENSITY (SD) WITH 1.5MB FLOPPY DISKS

SUPERBRAIN CAN NOW BE CONNECTED TO HARD DISKS
 FROM £2228 FOR 10MB OF EXTERNAL HARD DISK STORAGE

FROM **£1458**

MAINTENANCE CONTRACTS
AND SOFTWARE AVAILABLE

EXCL. VAT

+ COMPUSTAR

— LETS 255 USERS SHARE 10 OR 144MB
OF WINCHESTER DISK

CompuStar II Terminals look and act exactly the same as Superbrain and with prices from £1125 excl. VAT low-cost multi user systems are now a reality



KCB
MICROS LIMITED

word processing + accountancy + financial modelling + calculation
record keeping + sales office management + accounts + payroll + graphics
engineering + communications + languages + solicitors + CAD

14 Windsor Road Slough SL1 2EJ Tel: Slough (0753) 38581/38319. Telex 23152 KMICRO
and in Scotland: Micro Change Ltd. Telfer House, 74/80 Miller Street, Glasgow Tel: 041 204 1929

IN STORE

Machine (Price from)	Main Distributor/s (No. of Dealers)	Hardware	Software	Miscellaneous (Documentation)
Nascom 3 (£549)	Lucas Logic 0926 59411	48-60k RAM: Z80: dual 5/4" F/D (700k); RS232 port: P/P.	Basic: <i>Pascal: A: CP/M: Cobol Fortran</i>	Options dual 5/4" F/D (700k) £685; 48k RAM £130.
NEC PC 8001 (£599)	IBR 0734 664111	32k RAM: Z80A: P/P Option: dual 5/4" F/D (326k) £699	Basic N: (24k ROM) <i>CP/M: Fortran: Cobol: Pascal.</i>	Colour monitor £359 (low res) or £579 (high res) both 12", 25x80 many expansion units avail. (E) BT 6/81
Newbrain Model A (£199)	Grundy: 0223 350355 (TBA)	32k-2 Mb RAM: Z80A: Nat 420: 2xC int: TV int: 2xV24 ports.	CBasic (29k ROM): A.	Graphics. Battery or mains. Options: 1/2 Mb RAM £450. Also Model AD £299.(E).
North Star Horizon (£1975)	Comart: 0480 215005. (25) Trader Comp. 01-328 3484 (60)	32-64k RAM: Z80A: dual 5/4" F/D (360k); 15", 24x80 VDU: 150 cps printer: 2 S/P: 1 P/P.	DOS: Basic: CP/M: <i>Cobol: Fortran: Pascal.</i>	Options: 5-18 Mb H/D, Multi-user.
North Star Advantage (£2195)	As above	64k RAM: Z80A: dual 5/4" F/D (720k); 12", 24 x 80 VDU: S/P.	GDOS: CP/M: <i>CBasic: MBasic: Fortran: Cobol: Pascal</i>	Price includes business graphics & demo software.
Oki if 800 (£3000)	Encotel. 01 686 9687	64k RAM: Z80A: 2k ROM: dual 5/4" F/D (768k); 12", 24x80 VDU: 80 col printer: loudspeaker: RS232 port: 20k ROM cartridge.	Basic: A: <i>CP/M Cobol: Fortran:</i>	Fully integral unit. Graphics. Options: dual 5/4" F/D (£60k); RS232 port: PP. (1). BT 10/81
Olivetti M20 (£2395)	Olivetti 01 785 6666	128k-512k RAM: Z8001: 2-8k ROM: dual 5/4" F/D (640k); RS232 port; P/P	Basic: <i>PCOS: A</i>	Alternative 8086 processor board to run CP/M86 & MS-DOS. Options: 11 Mb H/D (integral): printer £738. (S) B/T 9/82
Onyx C8000 (£6875)	Onyx Dist Ltd: 09066-5432 (TBA)	64k RAM: Z80: 12 Mb Cartridge: 10 Mb H/D: 4 S/P: P/P	CP/M: <i>MP/M Oasis: Unix: Fortran: Pascal: W/P</i>	C8001 with 128k RAM £8220. Multi-user version avail. using Oasis.(E) BT 3/81.
Oric 1 (£100 inc VAT)	Oric Products Int 0990 27641	16-48k RAM: 6502A: 28x40 TV int: C int: S/P: P/P: Loudspeaker	Basic (16k ROM): <i>Forth</i>	With 48k RAM and Forth on cassette £170 inc VAT. 240x200 colour graphics. Micro disk and modem avail soon. Viewdata compatible.
Osborne 1 (£1250)	Osborne 0908 615274(40)	64k RAM: Z80A: dual 5/4" F/D (200k); 5", 24x52 VDU: RS232 port: P/P	CP/M: W/P: <i>Cobol Fortran: Pascal CBasic: MBasic: Wordstar: Mailmerge: Supercalc Forth</i>	Integral system in weatherproof carrying case. Will run on battery pack. Option: dual 5/4" F/D (400k). BT11/81.
Oscar (£2560)	IDS Ltd: 0908 313997(30)	64k RAM: Z80: dual 5/4" F/D (800k); 12", 25x80 VDU: RS232 port: 1 P/P	CP/M: <i>Basic: Pascal Fortran: Cobol: W/P:A</i>	Also avail. with dual 5" F/D(1.6Mb) £2905 and 8" F/D(2 Mb) £3380. Advanced video board. S&H.
Panasonic JD 800M, JD850M (£3300, £4350)	Panasonic Business Equipment: 0753 75841 (10 regional dist)	64k RAM: 8085A: 4k PROM: dual 8" F/D JD800M (500k); JD850M (2 Mb): 12", 24x80 VDU: 3xRS323 ports. P/P	CP/M: Basic: A <i>Micro-Cobol.</i>	Option: 8.4 Mb H/D £2725 (up two). BT3/80(S).
Pascal Microengine (£2295)	Pronto Electronic Systems Ltd: 01-554 6222	64k RAM: MCP 1600: 2x RS232 ports: 2 P/P.	Pascal.	CPU instruction set is P-code: no interpreter needed. Available with dual 8" F/D (2 Mb) £3900.
Pasca 640 (£1900)	Westrex Ltd: 01-578 0957 (TBA)	64k RAM: Z80A: dual 8" F/D (512k); 12", 24x80 VDU: RS232 port: P/P	CP/M: <i>Basic: Cobol: Fortran: Pascal: A: W/P: U</i>	Maintenance contracts avail. Option: 5-20 Mb H/D. (S) BT 5/18
Philips P2000 (£2444)	Philips Data	16-48k RAM: Z80: dual 5/4" F/D (140k); 12", 24x80 VDU: RS232 port.	PDOS: UCSD p-system: <i>Pascal: Basic Fortran:A.</i>	With 48k RAM, Pascal and Basic £3300; BT 12/81.(S).
Position 900 (£1950)	Position Comp. 09252 29741 (10)	64-512k RAM: 6809: 4xRS232 ports: IEEE-488 port: 1200 band C: dual 5/4" F/D (720k)	OS-9: Basic 09: <i>Pascal: C: A: Cobol: U FLEX O/S</i>	Supports 4 users, expandable to 8. Networking allows 28 users on 7 Options dual: 5/4" F/D (1.4 Mb): 5-40 Mb H/D (E)
Position 9000 (£1536)	As above	64-512k RAM: 6809: 4xRS232 ports: IEEE-488 port: 1200 band C.	OS-9: Basic 09: <i>Pascal C: A: Cobol: U</i>	240x240 high res colour graphics. Viewdata compatible. Disk options as above. Supports 5 users. Networking allows 35 users on 7 systems (E) BT 10/82.
Prince (£3045)	Digico: 04626 78172 (50)	64k RAM: 3xZ80A: dual 5/4" F/D (800k); 2xRS232 port: P/P 12", 25x80 VDU	CP/M: <i>Basic: Pascal: Fortran: Cobol: W/P:A: T/E:U</i>	High res graphics. Options: single 5/4" F/D (400k) £600; dual 8" F/D(2 Mb) £2000 5-10Mb H/D. Rentals avail. (S).
Quantum 2000 (£2250)	Quantum Comp Sys 0532 458877	64k RAM: Z80A: dual 8" F/D (2.4Mb): 12", 24x80 VDU: C int: P/P	CP/M <i>Basic: Cobol: Fortran: Pascal: A</i>	Many expansion boards avail inc high res colour graphics. Option: 5-10Mb H/D.
Rair Black Box 3/30 (£3750)	Rair: 01-836 6921 (N/A)	64-512k RAM: 8085: dual 5/4" F/D (500k); 6 Mb H/D: 2xRS232 ports.	CP/M: Basic: Cobol: <i>Fortran: M/A</i>	64k RAM expansion £500. 256k RAM £1250. Up to 16 RS232 ports.
Research Machines 380Z (£1867)	Research Machines: 0865 49866 (N/A)	16-56k RAM: Z80A: dual 5/4" F/D (300k) RS232 port. P/P.	ExBasic: A: T/E: U: <i>CP/M: Fortran: Cobol: Algol: Pascal.</i>	High res colour graphics. Many possible systems. With 56k RAM & dual 8" FD (1 Mb) £3347.
Research Machines Link 480Z (£550)	As above	32-64k RAM: Z80A: C: 2xS/P: P/P	Basic: A: T/E	High res colour graphics. Network station.
SEED System 1 (£1900)	Strumech: 05433 78151 (5)	32-56k RAM: 6800: various disk options: 12", 24 x 80 VDU: RS232 port: P/P	DOS: Basic: <i>M/A: CBasic: A: T/E</i>	Graphics. PROM programmer Also system 19 multi-user (£3000). (E)

List of Abbreviations

A Assembler	G/C Graphics card	M/A Macro assembler	S Software
BT Bench Tested	H Hardware	N/A Not available	S/P Serial port
C Cassette	H/D Hard disk	N/P Numeric pad	T/E Text editor
E Extensive	I Introductory	O/S Operating system	TBA To be announced
F/D Floppy disk	Int Interface	P/P Parallel port	U Utility

Please note: Software items listed in *italic* are not included in the basic price of the equipment. All prices are *exclusive* of VAT.

IN STORE

Machine (Price from)	Main Distributor/s (No. of Dealers)	Hardware	Software	Miscellaneous (Documentation)
Sharp MZ-80K (£460-34k)	Sharp Electronics (UK) Ltd: 061-205 2333 (22)	6-48k RAM: Z80: C: 10" 24 x 40 VDU: Option: dual 5 1/4" F/D (289k) £695	Basic, A. <i>CP/M: Pascal: Fortran: Forth</i>	Graphics: loudspeaker. BT 10/79 (B)
Sharp MZ80A (£549)	Sharp Electronics (UK) Ltd 061 205 2333 (22)	48k RAM: Z80: 25x40 VDU: C: P/P. Options: single 5 1/4" F/D £400: dual 5 1/4" F/D £590: RS232 port	Basic: <i>CP/M: A: Pascal: Fortran: Cobol</i>	Expansion unit needed for disks (£100) Low res (80x50) graphics. Loudspeaker Numeric pad (B)
Sharp MZ-80B (£1095)	As above	64k RAM: Z80A: C: 9", 25 x 80 VDU: RS232 port: P/P.	Basic: <i>A: Pascal: FDOS</i>	High res graphics. Options: dual 5 1/4" F/D (560k) £800: 80 cps printer £415. (S)
Sharp PC1500 (£150)	As above	3-11k RAM: CPU: 16k ROM: 26 char LCD:	Basic	Full system with dual cassette int. and miniature four colour plotter £375. RS232 port avail. soon. (B). BT 6/82
Sharp PC3201 (£2995)	As above <i>CP/M: Cobol</i>	64k RAM: Z80A: dual 5 1/4" F/D (500k): C int: 12", 25 x 80 VDU: 70 lpm printer.	DOS: U: Basic: <i>CP/M: Cobol.</i>	Various expansion cards avail. BT 7/81 (I&B)
Sig/Net 100ZS (£1299)	Shelton 01 278 6273 (5)	64k RAM: Z80A: dual 5 1/4" F/D (400k): 2xRS232 ports	<i>CP/M: Basic: Cobol: Fortran: Pascal</i>	Various disk options, up to 16 Mb H/D
Sinclair ZX81 (£50 inc VAT)	Sinclair: 0276 66104 (300 +)	1-16k RAM: Z80A: C int: TV inb: full K/B: 44-pin expansion port.	Basic (8k ROM).	Advanced 4-chip design. Printer now avail. BT 6/81
Sinclair ZX Spectrum (£125 inc VAT)	Sinclair 0276 685311	16-48k RAM: Z80A: 16k ROM: T.V. int: C int	Basic	Options: 32k RAM £60. RS232 port and microdrive disks avail soon. BT 6/82
Smoke Signal Chieftan (£1800)	Windrush 0692 40518 (TBA)	32-64k RAM: 6800/6809: dual 5 1/4" F/D (500k): 2 x RS232 port.	DOS: 68/FLEX: <i>Basic: Fortran: Cobol: A: Disc A: Pascal: U.</i>	With dual 8" F/D (2 Mb) £2600. Designed as development system for industrial control. (H)
Sorcerer (£790)	EMG 0293 519211 0736 798157 (27)	48k RAM: Z80: RS232 port: 1 P/P: S100 connector: 30x64 VDU int. N/P.	O/S: Basic (ROM): <i>A: Algol: Fortran: MBasic: ExBasic: 80. Pascal: W/P.</i>	High-resolution graphics capability: user programmable character set, Option: single 5 1/4" F/D (316k) £600 Video disk unit (1.5Mb) £1890
Sord M100 ACE (£2339)	Midas Computer Services Ltd: 07917 64686 (10)	48k RAM: Z80: 8k ROM dual 5 1/4" F/D (245k): 24 x 64 green VDU: RS232 port: N/P	O/S: Basic: <i>A: Fortran: Pascal.</i>	Up to 3 drives possible. Colour graphics avail. Option S100 bus. (I)
Sord M223 Mk II-VI (£4078)	As above	64k RAM: Z80: 8k ROM: dual 5" F/D (700k): 12", 24 x 80 green VDU: RS232 ports: S100 bus: N/P	O/S: Ex Basic: <i>CBasic: Multi-User Basic: Fortran: Cobol</i>	Expandable to 4 Mb F/D. 32 Mb, H/D, 5 screens, 2 printers. M243 with 192k RAM & 1.4 Mb F/D £5087.
SPC/1 (£3140)	Digital Data: 01- 573 8854	96-1056k RAM: 8085 A-2: dual 5 1/4" F/D (280k): 12", 24 x 80 VDU: 2 x RS232 ports: Option: Up to 106 Mb H/D	Mikados, Comal: Pascal: A.	Expandable to multi-user system (8 users). BT 7/80 (S).
Superbrain (£1750)	Icarus: 01-485 5574 (45)	64k RAM: 2 x Z80: dual 5 1/4" F/D (320k): 12" 25 x 80 VDU: 2 x RS232 port.	<i>CP/M: A: Basic: Cobol: Fortran: APL: Pascal</i>	Limited graphis, Mainframe int avail. With 676k F/D £2090, 1.5Mb £2345. With 5Mb H/D & single 338k F/D £3950. BT 8/80. (S&H)
System 10 (£2995)	Millbank 01-788 1083 (TBA)	64k RAM: Z80: dual 5 1/4" F/D (700k): 12", 24 x 80 VDU: 2 x RS232 port: P/P	<i>CP/M: Basic: Fortran: Pascal: Cobol: PL/I: W/P</i>	12 month warranty. Maint. contracts. Applications packages avail. Choice of high level language in price. (E)
Tandberg EC10 (£3250)	Tandberg: 0532 774844 (N/A)	64k RAM: 8080 A: single 8" F/D (250k): 12" 25 x 80 VDU: 7 x RS232 ports: printer int.	<i>CP/M: Ex Basic (24k) Multi-user Basic: Pascal: Cobol: A: U:</i>	Up to 7 terminals. Includes V28 comms port. (S&H)
Tandy PC-2 (£179 inc VAT)	As above	3-11k RAM: CPU: 16k ROM: 26 char LCD	Basic:	System with dual cassette int. and miniature four colour plotter £338 inc VAT. RS232 port aval. soon. (B)
Tandy TRS-80 Model I (£174)	Tandy: 0922 648181 (200)	16-48k RAM: Z80: C: 12", 16 x 64 VDU: RS232: P/P	Basic (12k ROM): A.	Fully expandable. Option: single 5 1/4" F/D (175k) £320 (up to 4). Many extras available. 32k RAM £260. (I)
Tandy TRS-80 Model II (£2347)	As above	64k RAM: Z80: single 8" F/D (500k) 12" 24 x 80 VDU: 2 x RS232 port: P/P	Basic M/A <i>Fortran: Cobol 3-32 Mb H/D</i>	Option: single 8" F/D (500k) £782 (subsequent £391, up to 4). 8-32Mb H/D
Tandy TRS 80 Model 3 (£434-£1477)	As above	See Model I Levels I and II		Fully integral unit. Up to 2 integral and 2 external 5 1/4" F/D. BT 8/81
Tandy TRS-80 Colour (£209)	As above	16-32k RAM: 6809: 8-16k ROM: C: 16 x 32 TV int: RS232 port.	Colour Basic.	With 16k RAM, 16k ROM & Extended Colour Basic £261 (I). BT 9/81.
Tandy TRS-80 Model 16 (£3651)	As above	128-512k RAM: Z80A 68000: dual 8" F/D (1-2Mb): P/P: 2xRS232 port.	TRSDOS: A: <i>Cobol Basic</i>	Will run all Model II software. System with single 5 1/4" F/D (600k) and 8Mb H/D £5911. Options: 8Mb H/D £2173 (up to four): 640x240 high res graphics: Multi-user system avail. soon. (S)
Tele Video TS800 (£3100)	Colt 01-577 2686	64k RAM: Z80A: dual 5 1/4" F/D (700k): P/P: S/P: 24x80 VDU: 80 cps printer.	<i>CP/M: Basic: Cobol: Fortran: Pascal</i>	Fully expandable to local area network with 16 users. 8 and 16 bit versions avail. and full set of application software. (S)
Terodec PBM-1000 (£4020)	Terodec: 0734 664343 (40)	80k RAM: Z80A: single 5 1/4" F/D (819k): 6Mb H/D: 2xS/P: P/P	<i>CP/M CP/Net CBasic: Fortran: Pascal: Cobol</i>	System with Okidata 80 printer: TV1 910 VDU: W/P and various application packages £5995 (S&H)

List of Abbreviations

A Assembler
BT Bench Tested
C Cassette
E Extensive
F/D Floppy disk

G/C Graphics card
H Hardware
H/D Hard disk
I Introductory
Int Interface

M/A Macro assembler
N/A Not available
N/P Numeric pad
O/S Operating system
P/P Parallel port

S Software
S/P Serial port
T/E Text editor
TBA To be announced
U Utility

Please note: Software items listed in *italic* are not included in the basic price of the equipment. All prices are *exclusive* of VAT.

IN STORE

Machine (Price from)	Main Distributor/s (No. of Dealers)	Hardware	Software	Miscellaneous (Documentation)
TI 99/4A (£199 inc VAT)	TI: 0234 67466 (TBA)	16-48k RAM: 26k ROM: 9900: 2 x C int: 24 x 32, 16 colour TV int: 3 tones & noise: P/P.	OS: Basic.	12 month guarantee. Options 32k RAM: 2 x RS232: 3 x 5 1/4" F/D (92k each): Speech Synthesiser.
Tuscan CP/M Starter (£999)	Transam: 01-405 5240 (N/A)	24k RAM: Z80: single 5 1/4" F/D (190k): Cint: TV int: RS232 port: P/P: N/P.	CP/M: Basic: Fortran: Pascal: Cobol:	Options: single 5 1/4" F/D (190k) £155: single 5 1/4" F/D (370k) £285: 16k RAM £162: 3 Mb H/D £1450: 20 Mb H/D £2970 (S&H)
Tuscan Starter Kit (£299)	As above	8k RAM: Z80: Cint: 56-key K/B Options: Case £110: 5 x S100 sockets £20: TV int £3.50	8k Basic	Fully assembled version £499 BT 1/81 (H&S)
Vector MZ (£2650)	Almarc: 0602 52657 (3)	56k RAM: Z80A: dual 5 1/4" F/D (630k): 3 S/P: 2 P/P.	CP/M: Basic: Algol: Cobol: Pascal: Fortran: Coral: CBasic: A.	High resolution graphics. Also system B with video board & terminal £3450. (E)
Vector System 2800 (£4600)	As above	56k RAM: Z80A: dual 8" F/D (2.4 Mb): 3 S/P: 2 P/P	As above	High-res graphics. Many Options. Fully expandable to 5005 multi-user system (max 5) £5400.
VIP (£2650)	Almarc 0602 52657 (3)	64k RAM: 3k ROM: Z80B: single 5 1/4" F/D (630k): 12", 24 x 80 VDU: RS232 port, 3 x P/P	CP/M: Basic: fortran: Cobol: Pascal: A.	Up to 3 additional F/D drives. Options: dual 8" F/D (2 Mb) £1063, 32 Mb H/D (TBA). (H&S). BT2/81
Windrush 6809 (£2418)	Windrush 0692 405189	56k non-volatile CMOS RAM: 6809: 2xRS232 ports: 2xP/P: dual 5 1/4" F/D (700k)	OS-9: Flex: Uniflex Basic: A: PL9: SPLM: Cobol: Fortran: Pascal	Designed as development system for industrial control/computer station for commercial OEM's. With dual 8" F/D (2 Mb) £2953. (E)
Xerox 820 (£1845)	Business Comp Sys 01 207 3344	64k RAM: Z80: single 5 1/4" F/D (162k): 12", 24 x 80 VDU: 2 x RS232 ports: P/P	Monitor: CP/M: Basic: Cobol: Fortran: Pascal.	With 8" F/D (500k) £2250. CP/M £95. BT 1/82 (S + H)
Zenith WH-11A (£2673)	Zenith Data Systems 0452 29451 (TBA)	LSI 11: 16-32k RAM: 25 x 80 VDU: S/P: P/P.	O/S: Basic, Fortran: A: U.	PDP 11-compat. Option: 2 x 8" F/D (1 Mb). £1717 (S&H).
Zenith Z89 £1570-£1710	As above	16-48k RAM: Z80: single 5 1/4" F/D (102k): 12" 24 x 80 b&g vdu: RS232.	Basic: A: iHDOS: CP/M: MBasic: CBasic: Fortran.	3 x 5 1/4" F/D possible. Options: dual 8" F/D (1 Mb) £1717, 20 Mb H/D.
Zilog MCZ 1/05 (portable): MCZ 1/20A (£3250)	Thames Systems: 084421 5471 (N/A)	64k RAM: Z80: dual 8" F/D (600k): RS232 port: MCZ1/20A only 1 P/P: Option: 10 Mb H/D £7100	RIO: O/S: Cobol: Basic: Fortran: Pascal: M/A: U.	Available desk top or rack mounted. Debug in 3k PROM. 1/20A runs multi-user Cobol, up to 5 terminals with 40 Mb H/D. (S&H).

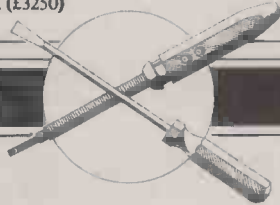

ACC NEWS

Rupert Steele presents his monthly round-up of news from the Amateur Computer Club.

If you are really quick off the mark, there is still time to register for the inaugural editors' conference for Club Spot 800. This, as I'm sure you know, is the chance for the hobbyist on the bus to play with the big bad system, Prestel. Not only will there be a wealth of interesting information on Club Spot 800, and generally on the ACC, as the space on Club Spot 800 will be allocated to clubs, not individuals).

Anyway, the conference is on Saturday 26 February, at the Institute of Grocery Distribution, George Lane, Letchmore Heath, Watford. Admission is free by registration in advance (contact me on Oxford 0865 512811) or £5 on the door, subject to space being available. It kicks off at 2pm, and the provisional programme looks like this:

2pm Registration and coffee.
2:30 Introduction to Club Spot

800 — Robin Wilkinson (Editor-in-chief, Micronet 800).
3:00 Editing on Prestel: Introduction to the mechanics
4:00 Hands on session and coffee.
5:00 Organisation of Club Spot 800.
5:30 Summary and questions.

If you can't make it, or don't feel like editing yet, please look in at what's up by keying *8008# on your Prestel machine.

The North West Association of computer clubs has recently elected some officers (at least provisionally), so you have somebody to contact — namely the secretary, Clive Tallon, 27 Bassett Street, Burnley, BB10 3EQ; phone (0282) 34638. All clubs in the Manchester area (presumably Merseyside as well) should have been contacted by the Association; if your club hasn't, then you might wish to contact him. A meeting of the Association is scheduled to have taken place on 20th January, at which the detailed arrangements of the association will have been worked out.

At this meeting, they are aiming to have sorted out various forms of cooperation, including exchange of information about each other's activities, exchange of computing information, a lecturer list, attending exhibitions (it's a considerable strain on a club's active members to attend every exhibition in the area, but shared stands for the less major events may well be the answer). They may well be considering ways to help new clubs flourish in centres that are remote from existing clubs, and will be generally finding ways to support each other's activities.

This cosy little arrangement was all set up using the clubs listed on the ACC database, so if your club isn't on there, then you won't be contacted, nor will we be able to point any local clubless individuals in your direction. Get the message? To get on the database, simply write to me and tell me what you're doing — we have an information pack to help new clubs start up.

According to Robin Bradbeer, personal computing is

taking off in the UK in a really big way. Plastic computers, such as those made by Uncle Clive, Commodore and others, have been very popular indeed, with predictions of at least 1.2 million sold by the end of '83. This could make the UK the country with more personal computers per capital than any other in the world. If the opportunity were taken, we could be one of the most computer literate societies in the world, which might just be important economically. But this country has a very strong record for missing opportunities; I'm sure that they'll contrive to pull it off again.

Personal computers, particularly the mass-market ones (ie, those costing less than the BBC machine), seem to be becoming the next 'train set'. Just as Daddy bought son a train set and then had at least as much fun with it as the son did, now he buys son a computer ('After all, it must be good for his school work'), and plays with it for hours. This trend is particularly noticeable at the smaller regional exhibitions, where bewildered but keen parents

ACC NEWS

are whisked from one stand to another by excited junior. I think that the decision of many major shopping chains to stock simple personal computers is a welcome one, and my spies tell me that 'own brand' plastic computers, similar to Uncle Clive's machines, may soon be appearing.

A quite extraordinary computing black hole has come to my notice. Birmingham may well be a black hole for other reasons but I would really expect to find more computer clubs in the area of the UK's second largest city (not to mention Coventry and all the places around Brum). So, if you're involved with a computer club in the Midlands, send me information and we'll put you on the database.

Down in Zomerset, where the zyder apples grow, a Mr D G Carrington, of 2 Romsey Road, Yeovil, Somerset, BA21 5XN has had his arm twisted

into becoming Secretary of the Yeovil Home Computer Users' Club. So write now to him for more information if you're a Yeovilite in need of a computer club.

Moving north, but staying west, we find the Worcester and District Computer Club: contact Mr D J Stanton, 55 Vauxhall Street, Rainbow Hill, Worcester — or pick up the dog and bone and dial (0905) 22704.

In a close scrape with Wales, we move to Hereford, to visit the Hereford Amateur Computer Club (or HACC for short: I like the acronym!). The guy who's getting this new group together goes under the totally appropriate name of Stuart Edinborough, and he lives at 3 Warwick Walk, Bobblestock, Hereford, HR4 9TG. Tel: (0432) 269700 to help him get the club together.

Even further west, you may meet Mr Thomas Moriarty, whose club appeals to

hardware hackers, programming purists (alliteration addicts?) and game players; Mr Moriarty lives in Eire, at 'Tiger Bay', Rochestown Road, Douglas, Cork and his phone number is 021-293651.

Going from west to north, we find the 'Skye and Lochalsh Computer Society' (can anybody think of a catchy acronym for that?), a group operating on the Isle of Skye, with a widely scattered population in an area 80 miles (including a ferry) from end to end. Mr C J Manvell is the man to contact, living at 'Tigh na Paire', 25 Brealais Isal, Isle of Skye, IV42 8QA.

Not quite so near the Arctic Circle is the Stockton Amateur Computer Club, or SACC for short. They have 37 members rising weekly (rising weekly to do what?), according to the letter I received from their inappropriately-named organiser, Mr P J Cheshire, of

60 Croft Road, Eaglescliffe, Stockton-on-Tees, Cleveland, TS16 0DY. They meet Mondays in Stockton YMCA at 7pm.

Back south of Watford Gap, we get to Luton, where a Mr J P Fletcher, of 1 Trowbridge Gardens, Luton, Beds, LU2 7JY is in the process of starting a computer club. So if the sound of jets overhead is boring you in Luton, why not drop Mr Fletcher a line and see how his venture is going.

Better stop plugging now; next month there will probably be an instalment from the south, yes those nasty personal computer things are beginning to penetrate the conservative fortress that is Surrey.

For more information on the ACC, or Club Spot 800, please contact me: Rupert Steele, (ACC), St John's College, Oxford, OX1 3JP; telephone Oxford (0865) 512811.

TRANSACTION FILE

Readers will be pleased to know that, due to our clever layout ideas, the Transaction File is up-to-date and waiting cut down considerably. Ads are accepted only on the form below for a flat fee of £2.50. Please don't specify issues as we can't oblige. Ads cannot be repeated unless separate forms are sent in. We will only accept entries from non-commercial readers. Thank you for cooperating.



- Green Screen Monitor, 12in Nec Audio Channel, best available, brand new boxed, list price £172, sell for £95, Hitachi Micro compatible cassette, unused, boxed £20 Burgh Heath 50318.
- Superboard II 8k RAM 32x32 display, Cegnon cased, power supply, modulator built in £75. Maidstone 678782 Eve.
- Commodore CBM 4032, wide screen, new cassette recorder. Basic and MC-Code teaching courses, manual etc. £150 of software, absolutely perfect condition, worth £1000, 9 months old. Offers? Tel 0458 42389
- Acorn Atom 12k+ Ross toolkit 8 months old new keyboard excellent condition PSU+ leads+£100 software Acornsoft packs 1,4,8,9,11+ adventures Invaders Defender offers around £220 phone Steve (eve) 0775 840607
- MZ-80K programs. Alien attack. Fruit Machine, Music Box, PUC, Monster, Cross-words. £5.00. House accounts, gas, electric £4.00. Cheque +50p postage to Phelps, 5 Sinclair Drive, Hampton Dene, Hereford.
- 8032 Software Word Pro 4+ £185.00. Visicalc £75.00, Petaid £145.00. Quick sale — buying house. Simon, Redhill 0737 60986.
- Offers for Surplus Petic 9 track tape transporters model T7840/9/12.5 C/W Formatter Interface +PSU one unit cabinet mounted. One set of 4 items boxed. Tel 06076 66539 day 0602 392802 Eve
- IC Logic Tutor, large plugboard, patch leads, many logic modules, 2 manuals. By Feedback Ltd CK356 £140 tel 0438 67829 (Herts).
- Sharp MZ-80K -48k guaranteed till Nov '83. Green screen, software valued at £400 includes languages, calc 3.1, home budget and 55 games. Computer/software manuals. £350 for the lot. Tel 01-368 7197 eve.

- Apple II accessories Microsoft 80 software W/manuals £120. Parallel printer card (Apple) £50, cable for card £10. Apple project manager program W/manual £80 tel: 06751 2204 eve (Hampton in Arden).
- CBM PET 32k. New ROM, as new, audio cassette with counter, toolbox & arrow chips, tons programs: Games, utilities, education, manual & PET revealed £495. — Might deliver 01-856 3477.
- TRS80 model 1 level 2 16.K CPU VDU cassette leads games. User group newsletters, other mags. all for £300 one. Stafford 0785 823499
- Billings BC-12F see 'In Store' PCW Sep '82 described 'Which Computer?' Aug '80. 2 Basics Fortran Cobol Assembler Screen Editor Document Processor, Advanced System Files, especially suitable confidential records. Decwriter IV. Offers (workdays) Dr Bevans Leeds 0532 433144.
- Sharp MZ-80 P3 printer and alternative CG ROM £275. including interface card manual. Universal interface cards fitted with 4 ports, expandable to 8. £20 tel 0706 40877 (S.Fielding)
- VIDEO GENIE 16k with Scramble Star Trek. T Bug Cosmic Fighter and many more £240 one tel Ascot 21290 (with cassette recorder) vgc.
- Transect 12in green screen monitor, excellent condition, little used. Cost £115, bargain at £80 Contact Keith Larkin 31 Hendley Drive, Cranbrook Kent TN17 3DY.
- Acorn ATOM, 12KRAM 16k ROM including: toolbox, RP ROM, good PSU, books, leads and much software:— Galaxians, Maths, Pack, etc. 1 year old, cost £300+ accept £125 Tel: Guildford 898438.
- ASR33 Teletype for sale. Needs slight attention, hence cheap. Will deliver in Aylesbury or Desidide areas. Tel: Wendover 0296 625156 eve or weekends.

- Sharp MZ80A 48k practically unused and brand new with Pascal Parallel card (Apple) £50, dust cover, + Sharp software package £500 Tel Anurag on 01-651 3642 eve only.
- For sale: "Teach Yourself Typing In 8 Hours". (Teaches correct use of letters on computer keyboard) £7.50. Wanted Sinclair SPECTRUM and printer. Tel 01-304 1946
- Sharp SP4015 Pascal with manual for MZ-80k. As new. £35 one Tel 02816 (Fulmer) 2015 after 7pm.
- Acorn ATOM 12k + 12k, FP, PSU, connectors, manuals, games and data base tapes. Less than 1 year old, hardly used. still in manufacturers carton. Only £128. 01-449 8462 eve.
- ZX81 with 32k RAM includes leads, adaptor, manual, some software, and book on machine code. Good condition, still with original packaging. £70 the lot, Tel: Peebles 0721 21340
- BBC model B + cassette, leads, user guide, dust cover and BBC programming book, £370. Owner buying Kettleford instead. Tel Mark Smith 01-855 3701 weekends or after 6pm.
- Texas TI-58 programmable, 480 program steps £60 memories + master library module containing 24 programs, + charger RRP. £65 unused, 6 months old, excellent condition only £45 Petersfield 3345 (Hants).
- VIC 20 — cassette unit, joystick, 8k RAM pack, and manual. Over £70 of games, all boxed, as new for only £135 one. Tel: 01-907 9516.
- Acorn ATOM 12k RAM floating joint EXT power supply. Handbook, magic book; Acornsoft games, business tapes. £140 Longfield 04747 2620 Kent.
- Sharp MZ80k -48k Sharp interface unit and P3 printer. Basic, Pascal, machine code, word processor, Arcade games, and 100's other pro-

- grams. All excellent condition. £550 ono Tel Glasgow 041 956 1689.
- HP41C hand held computer complete with Quad Memory module, manuals overlays. As new only 8 weeks old. Genuine reason for sale, will accept £175 Tel eve 051-356 4790.
- Sharp MZ80k 48k. Price includes Knights Commander and 100+ programs. Manual, Basic, complete with box. £300 Tel 0259 51793 after 6pm.
- Atari 400 48k Basic T Horn Jumbo Jet ROM, 410 recorder, joystick, manuals £279. 810 disc drive almost new £249. 01-680 5642.
- Osborne I protable computer. Little used, 64k twin disks, complete with all software, original packing and extra leads. All as new, save £500. £880 tel: Weaverham 0606 853570.
- BBC micro model B cassette recorder, Basic programming book, Ghost maze, Beebug issues £349. Tel 0378 76144 day or 0422 51263 eve.
- Teach your child to tell time, count money. SPECTRUM 16k. £5.50 for 2 fun programs on cassette, super graphics and sound. Vera Sampson, Richmond House, Ingleton, Carnforth, Lancs LA6 3AN.
- Wanted Superbrain computer; Also Dot Matrix printer, Tel Jenny Carr Kenilworth 0926 55064 eve/weekends or work 0203 418938.
- Nascam 2 computer 32k RAM 8k Microsoft Basic. PSU. Cased and ready to run, complete documentation, £195 or offer. Tel Clevedon 878238.
- TRS 80 L2 48k, VDU disc drive, system desk, all cables and manuals. Software on disc, Arcades Adventure etc. £550 for quick sale. Tel 022143176 eve or weekends Tom heydon.
- PET 4032 4.0 Basic, 12 months old, +cassette, Epson MX80F/T printer, toolkit. Software includes Chess, Wordpro, Startrek,

- Strathclyde, Zombie, Pools. 3 manuals. Demos given. £800 ono. Tel Stanton St John 285.
- Sharp MZ80k with Quantum Hi-Res graphics, Zen assembler, Shappsoft Forth, Reset button, green screen, dust cover, manuals, many programmes Inc. Chess Cribbage Super Copy £350 Reading 0734 585565.
- Acorn ATOM fully expanded + floating point, 2 utility ROMS, and over £150 of software. Also includes power supply, leads, and manual: Worth £400 want £260. Reigate 04065 (after pm).
- Wanted Apple II Europlus with disk drives, Printer etc. Tel Boston Spa 0937 843661.
- UK101 8k RAM new monitor power supply cased and compshp built; All unused and in perfect condition with manual £150 ono Simpson 12 Station Rd Upminster Essex Tel 04022 21150 or 50615.
- Sharp MZ-80B 64k CPM dual floppy disks virtually unused complete with original packing £1400 ono Tel Newbury 35734.
- Acorn Atom 12k RAM 12k ROM 4k toolbox ROM via new style keyboard. 5V 5 Amp PSU lots of software upgradeable to BBC Basic and colour £195 tel 01-464 1031 after 5pm.
- Nascam 1 T4 monitor. Tiny Basic ROM 32k expansion board. Mounted standard ack, separate cased keyboard, 8k Basic tape. £125. Desk £25 Staples 39 Park View, Sudbury Chestport Gwent. Tel 029 12 70715.
- 32k Pet must go! £300+ free software including Invaders, Super Glooper, 3D Startek, Acrobat, Extramoon. Also reset key and manuals. Software on disc. Arcades Adventure etc. £550 for quick sale. Tel 022143176 eve or weekends Tom heydon.
- PET 4032 4.0 Basic, 12 months old, +cassette, Epson MX80F/T printer, toolkit. Software includes Chess, Wordpro, Startrek,

512 x 512 GRAPHICS

Digisolve offer you a way to increase your graphics speed and resolution. Using a high speed graphics processor our cards draw lines and characters FAST. The graphics processor works in parallel to the host machine, and gives you the power of using a co processor specifically designed for graphics. With drawing rates of up to 1,500,000 pixels per second lines appear instantly to speed up your plotting.

With the resolution, we offer new possibilities for software and systems. No longer is it necessary to consider one of the new 16 bit personal computers because of their better graphics. Digisolve offer a card designed for the Apple II to give 512 x 512 monochrome graphics. With the development of an 80 x 57 line Visicalc and Applewriter pre-boot serious business users are no longer finding 80 column cards good enough. We also offer a colour unit designed to connect to any computer and give the same resolution but with 64 colours.

Digisolve are committed to the development of graphic systems and character display equipment and have a rapidly growing soft-ware base to help you use better graphics.



APPLE II CARD

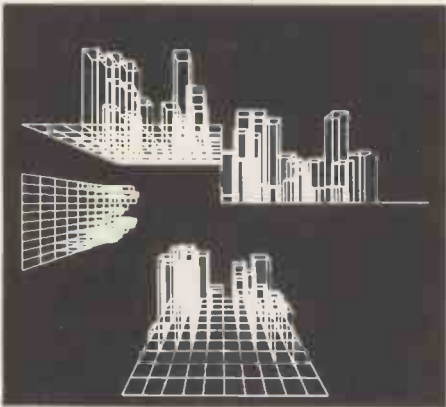

APPLE II

Digisolve's Apple II High Resolution Vector Graphic Processor Card quadruples the screen resolution and saves using up your Apple's memory space. With enhancements to Applesoft that use our card to provide powerful graphic functions software conversion is simple.

- * Draws vectors at up to 1,500,000 pixels per second
- * 512 x 512 pixels resolution
- * Graphics and characters mixed, allows proportional spacing and up to 85 characters by 57 lines of text
- * 64K bytes of on board memory will store two pictures for animation or have one text and one graphics page
- * 4 different line types for clarity
- * Blocks of variable sizes may be drawn to speed up area filling
- * Read modify write mode for drawing cursors
- * Screen read mode for dumping drawings to a printer
- * £399 + VAT + P&P

SOFTWARE: Visicalc and Applewriter pre-boot. Architectural Design & Modelling. Kitchen Design. Draughting. Report Presentation.

Turtle Graphics, TASC & Apple Soft software support.

VGP 64

Digisolve offer you high resolution colour graphics too. Designed to plug into any computer with a bus host adapter. The VGP 64 gives you 512 x 512 pixels in 64 colours. With its own vector processor and 384 K bytes of memory your computer can become a sophisticated graphics system.

- * 64 colours that may be expanded with a palette or extension video ram card
- * 512 x 512 pixels resolution with fast vector processor
- * 384 K bytes of video ram on board
- * 2 pictures may be stored simultaneously in full colour for animation
- * In monochrome 12 pictures may be stored and selected for display under software control
- * Available as a boxed unit complete with power supply, or in board form to oem customers
- * Will plug into Apples, IBMs, S100 systems, PDPIIs or any computer with a bus
- * Available in several versions: 8 colour £799 64 colour £899

COMING SOON: Terminal emulations including TEK 4010 in monochrome and colour. Character displays 80 x 24 and A4 size.

VDU BOARD

Digisolve offer you the cheapest way to make a scrolling VDU with our intelligent 80 x 24 VDU card. With over 50 control functions the card works at up to 19.2 K band.

- * 80 Characters x 24 lines of text
- * Characters are properly formed with descenders
- * Block graphics option
- * Fully scrolling at 19.2 K band
- * Keyboard and RSZ 32 data input

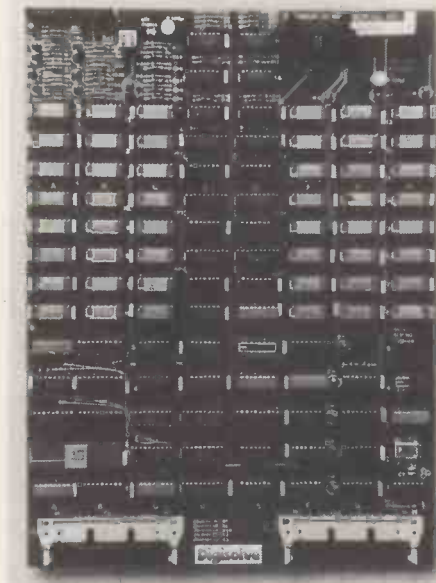

VGP64

Digisolve

AIRE & CALDER WORKS
CINDER LANE, CASTLEFORD
WEST YORKSHIRE
TELEPHONE: (0977) 513141
TELEX: 557661 AGRAM
A MEMBER OF THE LAMBSON GROUP



APPLE II is the Trade Mark of Apple Computers Inc.

CTUK! CONTACTS

J M A Kilburn (Headmaster)
Shawfield Norden,
Community Middle School
Shawfield Lane
Norden
Rochdale OL12 7QR

Robin Bradbeer
Polytechnic of North London
Holloway Road
London N7

Derrick Daines
18 Cuttings Avenue
Sutton in Ashfield
Notts

Patrick Colley
52 Queensway
Caversham Park Village
Reading
Berks RG4 0S

Philip Joy
130 Rush Green Road
Romford
Essex

Peter Herring
Ordnance Road Library
Ordnance Road
Enfield Middx

Ted Ellerton
25 Beachdale
Winchmore Hill
London N21

David Sharp
5 Bridgenhall Road
Enfield
Middx

Rex Shipton
17 Woodlands Avenue
Eastcote
Middx

Susan Kelly
Head of Reference Services
PO Box 4
Civic Centre
Harrow
Middx

Andrew Holyer
10 Masons Road
Mannings Heath
Horsham
Sussex RH13 6JP

Derek Moody
2 Victoria Terrace
Dorchester
Dorset DT1 1LS

Pam Pollicott
South Ruislip Library
Victoria Road
South Ruislip
Middx

John Stephen Bone
2 Claremont Place
Gateshead
Tyne & Wear
NE8 1TL

Derek Knight or Bob Carter
Rayners Lane Library
Imperial Drive
Rayners Lane
Middx

Ray Skinner
62 Central Avenue
Billingham
Cleveland TS23 1LN

Brian Taylor
Tonbridge Area Library
Avebury Avenue
Tonbridge
Kent

Paul Maddison
Gardenways
Chilworth Towers
Chilworth
Southampton SO1 7JH

Peter Jarvis
c/o Health Dept
Corporation of London
Guildhall
London EC2

Vernon Gifford
111 Selhurst Road
Croydon
London SE25 6LH

Peter Stone or
Alan Strangman
Computing and Maths Dept.
The Polytechnic
Wulfruna Street
Wolverhampton WV1 1LY

Lyn Antill
1 Defoe House
Barbican
London EC2

Keith Taylor
Carter Hydraulic Works
Thornbury
Bradford BD3 8HG

Alan Hooley
21 Brammay Drive
Tottington
Bury BL8 3HS

Vernon Quaintance
50 Beatrice Avenue
Norbury
London SW16 4UN

BJ Candy
9 Oakwood Drive
Gloucester GL3 3JF

Roger Shears
18 Woodmill Lance
Bitterne Park
Southampton SO2 4PY

Chris Woodford
31 Hopley Road
Anslow Burton-On-Trent
Staffordshire

Mike Perry, Steve Collas
or Dave Lee
The Library
Ealing Road
Wembley
Middlesex HA0 4BR

Tony Cartmell
54 Foregate Street
Worcester WR1 1DX

R L Saunders
14 St Nicholas Mount
Hemel Hempstead
Herts

Brigitte Gordon
18 Purbright Crescent
New Addington
Croydon CR0 0RT

Richard Powell
22 Downham Court
South Shields
Tyne & Wear

Peter Earthy
46 High Street
Church Stretton
Shropshire SY6 6BX

Alan Sutcliffe
4 Binfield Road
Wokingham
Berks RG11 1SL

Allan Porten
14 Foxmede
Rivenhall End
Witham
Essex

E N Ryan
15 Queens Square
Eastwood
Nottingham
NG16 3BJ

NETWORK NEWS

These are all the European networks of which we're aware. Most are free — but phone them for details.

Forum-80 Hull ... (Forum-80 HQ)
Tel: 0482 859169, System operator:
Frederick Brown. International
electronic mail, library for
up/down loading software.
Forum-80 Users Group, Pet Users
section shopping list system hours,
7 days a week midnight to 8.00am,
Tues/Thurs 7.00pm to 10.00pm
Sat/Sun 1.00pm to 10.00pm.

Forum-80 London ... Tel: 01-747

3191. System operator: Leon Jay.
Electric Mail, library for
downloading. System hours:
Tues/Fri/Sun 7.00pm to 11.00pm.

Forum-80 Milton ... (TRS-80
Users Group 80-Net) Tel: 0908
566660. System operators: Leon
Heller and Brian Pain. Electronic
mail, library, newsletter, TRS-80
information system hours: 7 days a
week 7.00pm to 10.00pm.

Forum-80 Holland ... Operator:

Nico Karssemeyer, Tel: 01 313 512
533. Facilities: electronic mail,
program up/downloading,
shopping list. Hours: Tues-Sat
1800-0700 nightly, continuous from
1800 Sat-0700 Tues.

CBBS London ... Operator: Peter
Goldman, Tel: 01-399 2136.
Facilities: electronic mail, program
downloading. Hours: Wed
0700-0930 & 1900-2200, Fri
1900-2200, Sun 1600-2200.

Mailbox-80 Liverpool ... 051-220

9733. System operator: Peter
Toothill. Electronic mail, down-
loading TRS-80 information.
ACC ... members bulletin board,
Peter Whittle (0908 44262).

ABC-80 ... Stockholm (Sweden).
Tel: 010-468 190522.

University Research Computer ...
Sweden. Tel: 010-468 23660, guests
use password "66,66" for access.

Elfa ... Sweden 010-468 7300 706.
Tree Tradet ... Sweden 010-468
190522.

DIARY DATA

Readers are strongly advised to check details with exhibition organisers before making arrangements to avoid wasted journeys due to cancellations, printer's errors, etc.

London	(Barbican Ctr) Inform'n Tech'y Office Autom'n Exbn 7 Conf — INFO — Contact BED Exbns Ltd 01-647 1001	22-25 Feb
London	(Bloomsbury Centre Hotel) Mailing Efficiency Exbn. Contact: Business Equipment Trade Ass 01-405 6233	1-3 March
London	(Royal Lancaster Hotel) Local Area Networks & Distributed Office Systems. Contact: J Street 09274 28211	8-10 March
Birmingham	(NEC) Daily Telegraph Business Enterprise Show. Contact: NEC Birmingham 021-780 4141	22-26 March
Doncaster	(Exbn Centre) Business Show. Contact: Helmar Business Services 0462 54812	3-4 March
Glasgow	(Albany Hotel & Holiday Inn) Scottish Computer Show. Contact: Clapp & Poliak Europe Ltd 01-747 3131	15-17 March
Preston	(Guildhall) Business Show. Contact: Helmar Business Services 0462 54812	15-16 March
Manchester	(Belle Vue) Computer Aided Design Exbn-CAD North. Contact: IPC Exhibitions Ltd 01-643 8040	1-3 March
Ipswich	(Gt White Horse Hotel) Computer Open day Exbn. Contact: Couchmead Communications Ltd 01-778 1102	10 March

At KGB, we believe in putting pen to paper

MICROPLOT is a CP/M Graph Drawing Package

interfacing with A4 size flat bed plotters
Ideal for business and engineering applications

A comprehensive GRAPH configuration

- * axes may be user defined or automatically fixed
- * data points may be defined or suppressed
- * straight joining lines or curves, the latter from complex calculations automatically executed
- * up to eight colours available
- * up to seven broken line patterns

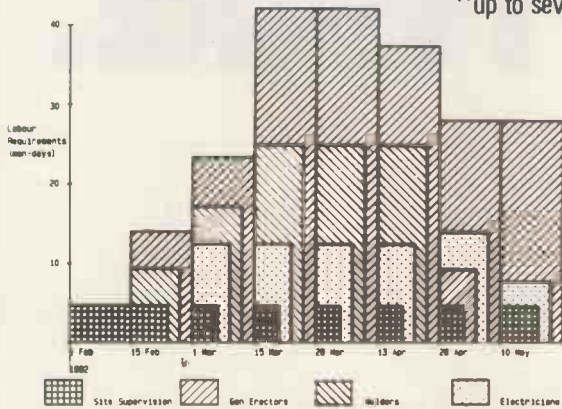

Example of a Numerical Axes Graph.

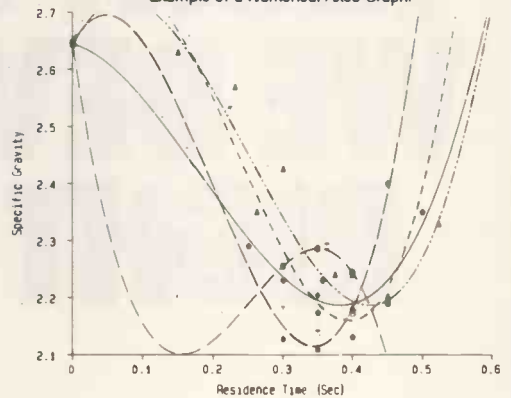

A correctly proportioned HISTOGRAM configuration

- * operates like GRAPH but structures in block format
- * various shading patterns available

A quickly drawn PIE configuration

- * created from very simple input
- * legends located in or outside boundary
- * segments can be shown withdrawn
- * various shading patterns offered
- * up to eight colours available

No screen necessary **MICROPLOT** draws on paper for reports or on film for overhead projection. Will also interface with Supercalc and Micro Modeller. Single or multi coloured plotters supplied.

Call us for literature. Ask for a demonstration.

* All three diagrams reproduced directly from Microplot.

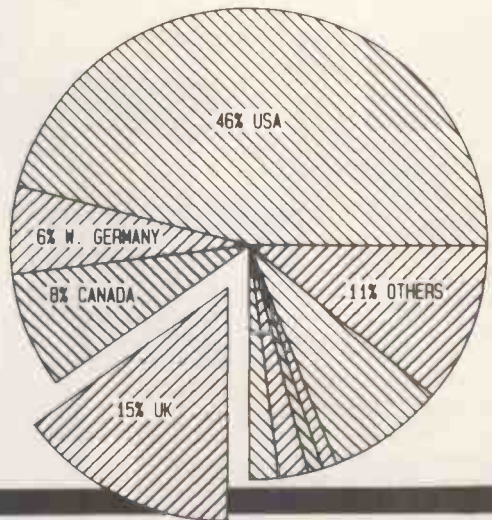

MICROPLOT – A NEW DIMENSION IN VISUAL PRESENTATION – AT ONLY £395 + VAT

KGB

MICROS LIMITED

To KGB Micros Ltd – Please send me full details of Microplot.

Name: _____ Position: _____

Company: _____

Address: _____

Tel No: _____

14 Windsor Road Slough SL1 2EJ Tel: Slough (0753) 38581/38319. Telex 23152 KMICRO
and in Scotland: Micro Change Ltd. Telfer House, 74/80 Miller Street, Glasgow Tel: 041 204 1929

WHILE YOU WAITED FOR THE RIGHT HARDWARE, WE DEVELOPED THE RIGHT SOFTWARE.

Choosing IBM's Personal Computer from all the rest was the right choice.

You need to show the same discriminating taste in choosing the right software.

We make that choice easy.

Our EasyFamily™ software is written specifically for your IBM PC, and designed to take full advantage of all the features that made IBM's PC the right choice. We let you make full use of the function keys, screen graphics, cursor control and the built-in power that IBM provides. We let you accomplish all that very easily.

Simply adding EasyWriter II™ means that you now have stand-alone word-processing performance, but at a PC price. It gives you "page orientation," a feature preferred by novice and veteran alike. You can move blocks of text with just a few keystrokes. Move a letter, a word, a line, a page, a paragraph, instantly.



Adding EasySpeller II™ to your IBM PC gives you an 89,000 word vocabulary that can be consulted

with a single keystroke to check a word, a line or a page. EasySpeller II doesn't just catch spelling errors, it also helps even the best speller find those embarrassing typos.

You get dramatic results when you combine EasyWriter II with EasySpeller II, and add them both to your IBM PC. They let you check suspect words as you write, or the entire document when finished. All without changing programs—and the only current micro-computer software that offers this capability.

All our programs are easy to learn, easy to use and easy to buy. We make your work simpler, easier and more productive. So make it easy on yourself.

**EasyWriter
EasyWriter II
EasySpeller
EasySpeller II
EasyFiler
EasyPlanner**

For more information regarding EasyWriter II and EasySpeller II, contact Xitan Systems, Ltd.

23 Cumberland Place
Southampton SO1 2BB
England (0703) 38740
Icarus Computer Systems, Ltd.
27 Greenwood Place
London NW5 1NN England
(01) 485-5574

Timon Associates
21 College Hill
London EC4 England
(01) 248-8720

or write
Information Unlimited Software, Inc.
2401 Marinship Way
Sausalito, CA 94965
U.S.A.



THE PERSONAL COMPUTER WORLD SHOW COMES TO SCOTLAND



16-18 April 1983

in

The MacRobert Pavilion, Ingliston, Edinburgh

You heard how good the London edition of the show was in September? Well, it's coming to Edinburgh. Your chance at last to see more micros, software and peripherals than you could see in a year, without going South of the Border.

Micros for business, for the home, the trade and education . . . and experts on hand to answer your questions. Don't miss the first-ever Personal Computer World Show in Scotland. Especially if you're going to the Ideal Home Exhibition during holiday weekend. We're right next door!

Telephone Jenny King on 01-486 1951 for further details

IBS Ltd.

S100 64K STATIC RAM/PROM CARD ONLY £299.00

A superior Quality Ram/Prom board will accept either H6116-3 (2K x 8) Ram chips or 2716 EProms.



- ★ S100 IEEE (696) Compatible
- ★ 24 Bit Addressing
- Can be used with any CPU
- Runs at 6Mhz with standard Rams
- Wait state generation for Proms
- Phantornable ★ Low power
- Prom/Ram selectable on 2K boundary
- Prom/Ram can be disabled to suit popular memory mapped devices

All this at an unbelievable price of £299 + VAT.

BARE BOARDS AVAILABLE AT £65.

Irvine Business Systems Ltd
1 Montgomery Place, Irvine, Ayrshire KA12 8PN
Telephone: 0294 75000/218888
Dealers enquiries invited

* Reference Number 5837

SPECTRUM BBC

Make the most of your Spectrum or BBC Microcomputer with our proven books.

- () PROGRAMMING YOUR ZX SPECTRUM — Tim Hartnell and Dilwyn Jones. 230 pages, over 100 programs and routines. £6.95.
- () THE SPECTRUM SOFTWARE LIBRARY — 60 Games and Applications listings for the Spectrum — David Harwood. £5.95.
- () LET YOUR BBC MICRO TEACH YOU TO PROGRAM — Tim Hartnell. "Points are well illustrated by programs . . . quite comprehensive . . . many of the programs are useful and interesting . . . will take you further into the cloudy areas of the BBC micro than anything else I have so far read . . ." (Computer and Video Games). £6.45.
- () THE BBC MICRO REVEALED — Jeremy Ruston. The full inside story, for those who have mastered the manual. £7.95.

Interface, Dept. PCW, 44-46 Earls Court Road, London, W8 6EJ

Please send me the books indicated above. I enclose £_____.

Name _____

Address _____

MICROMART

CAMPBELL SYSTEMS

The very best in machine code for the Sinclair ZX Spectrum

SPECTRUM 48K MASTERFILE business and domestic filing system for mailing lists, catalogues, stock recording, almost any kind of file.

Dynamic file with user-defined data and display formats, sophisticated search and sequence facilities, numeric total/average, printing. Independent file save/load, and we'll support Microdrive when they come.

People have gone out to buy Spectrum having seen what MASTERFILE can do.

Comes with 24-page manual and example file. Price: £15.

SPECTRUM 16K GULPMAN arcade game, already an established best-seller. £5.95.

Programs are mailed first class by return

Campbell System (Dept PM)

15 Rous Road, Buckhurst Hill, Essex IG9 6BL
Tel. 01-504 0589



is Axon's choice for business and professional use.

For systems, software, supplies and support consult:



PO Box 12
Bentham
Lancaster
Tel: 0468 61848



R.J.L. SOFTWARE Announce IOSUBS for the ACT Sirius 1

A complete set of subroutines written in BASIC allowing the programmer to easily develop professional user friendly software.

Subroutines allow:-

- 1) Alphanumeric, numeric, date, password data to be input/output anywhere on the screen.
- 2) Automatic validation of input data.
- 3) Reverse video, Highlighted, Underlined attributes on input/output fields.
- 4) Full editing facilities available during data input mode.

Price £55 with demo software. inc VAT
£40 without demo software. inc VAT

For further details please contact:

R.J.L. Software Ltd, Southgate Chambers,
37-39 Southgate St, Winchester,
Hants SO23 9EH. Tel. Winchester (0962) 60738

RS 232
OLIVETTI
PRAXIS 35
INTERFACE

£70 (excl. VAT)
@ 15%

NP CONTROLLED UNIT

Turns your Praxis 35 into a high quality (12 cps) Daisy Printer. Boxed, tested, with complete installation instructions (2 sets of 13 easy soldering joints).

Also available fitted for £390 (excl. VAT).

TIMTOM MICRO
9 ILTON RD
PENYLAN
CARDIFF

Also available for
Praxis 30
S.A.E. for details



PROGRAMS

PCW is interested in programs written in Basic, Pascal, Forth, Logo and Comal — all of which being languages we've covered in previous issues. Please supply your programs on disk or cassette with all necessary documentation (so we've got a good idea what it's about and how much memory it uses) and, if you can, a clear listing on plain white paper.

As all programs in PCW are checked either by a referee or by one of the editorial staff, it can take some time for a program to actually appear. If you don't hear from us within two months or so, it usually means your contribution is in the referee pipeline. It's essential to ensure that your program is fully debugged before you send it in — get a friend to try it out first — and all programs we publish are paid for at a regular rate. Send contributions to: Maggie Burton PCW Programs, 62 Oxford Street, London W1A 2HG — and please enclose an SAE if you want material returned.

Atari Animation

By Cliff Hatch

Program of the month this month will run (without REMs) in 16k on an Atari 400/800. I'll let the author take over here and explain his own composition.

The animation package presented here is intended to assist users of Atari Basic in the production of animated displays and games. The package sets up a machine code routine which looks after those aspects of animation requiring high speed and precise timing, leaving the user's Basic program free to concentrate on tasks such as checking joystick position, 'steering' the players, launching missiles, checking for hits, etc. Basic programmers may use the package effectively, without understanding the machine code.

In this description some background knowledge is assumed on the part of the reader, in particular an understanding of the way in which shapes may be defined using a series of bytes, and an, at least, superficial appreciation of Atari's player-missile graphics system.

The package performs the following tasks:

- 1) Sets up player-missile graphics in 1 or 2 line resolution and clears the player-missile table.
- 2) Defines a set of shapes, which may be assigned to players and missiles. The package, as listed in Table 1, defines only two 'space ships' and one, single byte, missile

'shape', but it is written in a way which allows the user to easily change these and add more definitions.

3) Sets up a machine code routine called 'MYVBI' which carries out the movement of all players and missiles. The key to the package's ability to produce smooth fast animation is the fact that this routine is tagged onto the end of the operating system's vertical blank interrupt routine (see Figure 1). This causes it to run 50 times per second, and enables it to maintain the continuous motion of all players and missiles without interfering with the operation of Atari Basic. The user's Basic program constitutes the foreground program, with MYVBI running in background. Both apparently run simultaneously and independently. A further advantage of using the vertical blank interrupt routine in this way is that all movement takes place during the blank period between television picture scans, so players and missiles move without flickering.

4) Each time MYVBI runs it picks up values for the speed, position, shape, etc, of all players and missiles from a data table. By POKEing to this data table the user's Basic program may control the motion of all players and missiles. The package initialises a set of mnemonic pointers to help the user POKE to the correct locations.

OCTOPUS

Are running Easter holiday computer courses.

Personal supervision, small group sizes and unlimited access to our computers, mean everyone can pursue their own interests.

For details:

Oxford Computer Training Services
St Joseph Hall, Junction Road, Oxford
OX4 2UJ

Tel: 0865 711829

BUSINESS HOME COMPUTER DESK

A choice of laminated finishes.

Other sizes.

Single draw, roll under draw pack and shelves.

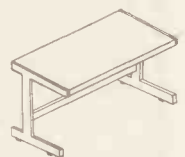

As seen £96.00 inc. VAT & delivery.

BETA PRODUCTS

Tel: 061 747 9260. For 99" x 24" (standard).

PROGRAMS

Normal Vertical Blank Interrupt processing

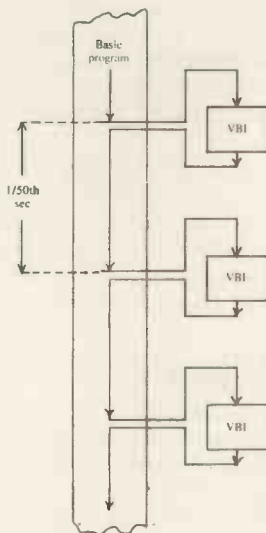

Addition of a user's Vertical Blank Interrupt routine

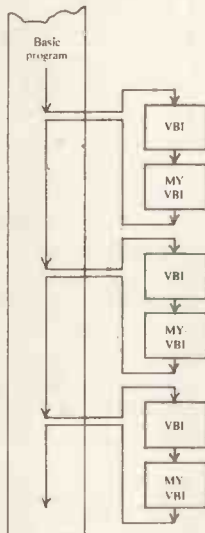

Fig 1 The system's Vertical Blank Interrupt Routine (VBI) runs every 1/50th of a second, diverting the processor from Basic program execution. By tampering with interrupt vectors we may arrange to run the user's routine (MYVBI) every 1/50th of a second as well.

5) MYVBI provides automatic wrap-around for all players and missiles; that is, a player leaving one edge of the playfield will automatically re-enter from the opposite edge.

6) MYVBI automatically performs masking operations when moving the 2-bit missiles. As far as the user is concerned missiles behave in exactly the same way as players.

7) MYVBI provides the means to launch missiles (and players) which are set to disappear from the screen after a precise time has elapsed. This is primarily intended as an efficient means to limit the range of missiles.

To use the package, firstly key in the Basic coding in Table 1 and save it on tape or disk. (Save it before attempting to run it because typing errors, particularly in the machine code data, may cause it to crash irretrievably.) Secondly, check that your version works by adding the test program in Table 2, and running it. After an initialisation period of about 20 seconds this program should make one player and one missile appear, moving, on the screen.

The test program illustrates the general procedure for using the package. The user's program first calls the package as a sub-

routine (by GOSUB 11228). This call (which should be made before any DIM statements) sets up player-missile graphics and starts MYVBI. MYVBI continues to run until the system is reset. The package also sets up seven mnemonic pointers for the control of each player and missile (see 4 above). The user's program may achieve control by using these pointers in POKE commands, as follows:

1) Number of bytes: (POKE to: BYP0, BYP1, BYP2, BYP3, BYM0, BYM1, BYM2, BYM3.)

Before using any player or missile, inform MYVBI how many bytes will be used to define its shape (this should correspond to the number of bytes in the object definition you intend to use). For example, the following line informs MYVBI that player 2 is to be defined as an 8-byte object: 10 POKE BYP2,8

2) Player and missile shapes: (POKE to: DFP0, DFP1, DFP2, DFP3, DFM0, DFM1, DFM2, DFM3.)

Each player or missile may be given a shape, chosen from the set of object definitions contained in the package. (Note that the four missiles are each two bits wide and their definitions are combined.) Shapes are assigned using pointers. For example, the

MICROMART

GAMER

VIC	£129 plus VAT
DRAGON 32	£173 plus VAT
SHARP MZ80A	£433 plus VAT
ATARI 400 (16K)	£164 plus VAT
ATARI 800 (16K)	£390 plus VAT
EPSON HX20	£402 plus VAT
VIDEO GENIE (16K)	£299 plus VAT

Coming soon ORIC 1.

- + software, books, chess computers
- + Intellivision + Ace TV games
- + SF, Fantasy & Wargames

BRIGHTON 24, GLOUCESTER
TEL 0273 698424

WORCESTER COLLEGE OF HIGHER EDUCATION

SUMMER SCHOOL 1983

Using Microcomputers (5th-12th August)

A practical course on using small computers for business, administrative, education and domestic purposes.

Offers intensive hands-on experience with a wide range of computer systems. Alternative modules for beginners and those with some experience.

Micro-electronics (29th July-5th August)

The Course aims to provide a wide range of experiments and ideas for school projects. Most of the course time will be spent on experimental and practical work.

For further information please write to the Director of Summer School, Worcester College of Higher Education, Henwick Grove, Worcester WR2 6AJ. Telephone No. (0905) 428080.

Residential accommodation is available at the College.

BiBi Data

Computer Cassettes & 5 1/4" Diskettes

We manufacture computer cassettes using batch certified HM-1260 tape available in fully packaged C5, C12, C15, C20 and C15 leaderless, or we can supply custom wound lengths with or without boxes. Our 5 1/4" diskettes also available ssdd and dsdd.

Wholesale and Dealer enquiries welcome.

Contact Nigel Boyle.
Tel: 01-223 5955, or write to:
BiBi Magnetics, Freepost, London SW11 2BR

BiBi Magnetics Ltd, 101-105 Plough Road, London SW11 2BJ. Telex: 917732.

3 COMPUCOLOR
AVAILABLE
ANY OFFER
QUERY
PHONE

0858 - 65894

Printer Stands



- Handsomely crafted in 6mm tinted Perspex
- PSS model for Microline 80/82/83, Epson MX-80, Sheiksha GP100 etc. 15" x 12" x 4.5" £16.95 + VAT.
- PSL for Microline 84, Epson MX82 etc. 17" x 14.5" x 3.75" £19.95 + VAT.
- POT Printer Output Tray for 11" fanfold paper £16.95 + VAT.

Packing + Postage £3.50



CAMBRIDGE MICROELECTRONICS LTD
One Milton Road Cambridge CB4 1UY
(0223) 314814

ZX81 (16K) SPECTRUM (48K) STARTREK

Features an 8x8 Galaxy, Klingons and Starbases, short and long range scans, torpedoes and phasers, computer etc. PLUS normal or hyperdrive: choose your speed but watch the energy level. Galaxy Map: keep track of where you have been and whether there are any Starbases or Klingons there. Visual display of Enterprise's position and movement, and of the path of torpedoes. Messages from crew members. A user friendly long range scan. Five levels of play. And much more. Cassette with full instructions.

ZX81 £4.95

SPECTRUM £5.95 (Colour and sound too)

Gemini Software
36 Badminton Road
LEICESTER LE4 7RQ
Tel: 0533 64915

SUPERPLAN FOR ZX SPECTRUM

Put your ZX Spectrum to serious use in the home, school, club or small business.

Create and update an analysis sheet or spreadsheet within the Spectrum's 48K RAM.

SUPERPLAN. The complete do-it-yourself analysis chart generator and processor £12.00 inc.

SUPERPACK 1. Four ready-made charts for business - sales daybook, purchase daybook, cash book and petty cash book £7.00 inc.



Video Software Ltd
Stone Lane, Kinver
Stourbridge, West Midlands
TEL: 038-483 2462

Cash with order for immediate delivery
Price includes VAT, p&p

DRAGON STICKS!



Top quality joysticks for the Dragon owner who demands arcade action. Ultra-sensitive, but tough and reliable, Dragon Sticks will keep on zapping when others fail! £19.95, incl VAT and postage.

The Dragon Dungeon deals exclusively in peripherals and software for the Dragon 32. We publish 'Dragon's Teeth', a monthly Club Letter, full of news, views, tips and products for the Dragon enthusiast. If you have identified any of those elusive addresses, have spotted any programming quirks of the 6809 or have any tips to assist fellow Dragon-bashers, send them along to the Dungeon!

We are also searching for software, which exploits the Dragon's colour and sound potential, against royalty, outright purchase or sales agency.



The Dragon Dungeon

PO Box 4, Ashbourne
Derbys
Tel: Ashbourne 44626

PROGRAMS

following line assigns the shape, with pointer 'SHIP1', to player two. 20 POKE DFP2, SHIP1

3) X speed and Y speed:
(POKE to: XSP0, XSP1, XSP2, XSP3, XSM0, XSM1, XSM2, XSM3, YSP0, YSP1, YSP2, YSP3, YSM0, YSM1, YSM2, YSM3.)

The X and Y speed of any player or missile may be set to any value in the range 0 — 255. 128 is stationary, 0 is full speed in the minus direction, and 255 is full speed in the plus direction. While 128 may seem an illogical number for zero speed it is convenient to have it in the middle of the allowable range (numbers outside the range 0 — 255 cannot be POKEd). Each value in the range 0 — 255 corresponds to a different speed, to make player 2 stand still: 30 POKE XSP2, 128:POKE YSP2, 128

So to give player 2 10 speed units in the positive Y direction (downwards) and 5 speed units in the negative X direction (to the left); 30 POKE XSP2, 123:POKE YSP2, 138.

4) X positions and Y positions:
(POKE to: XPP0, XPP1, XPP2, XPP3, XPM0, XPM1, XPM2, XPM3, YPP0, YPP1, YPP2, YPP3, XPP0, XPP1, XPP2, XPP3.)

The X position of any player or missile may be set to any value in the range 0 — 255 (left to right). The Y position may be set to any value in the range 0 — 255 (top to bottom) in 1 line resolution, and 0 — 127 in 2 line resolution. In 2 line resolution Y positions in excess of 127 are still valid, but are automatically wrapped around, so that 128 is the same position as 0, 138 is the same as 10, and so on. The following line would put player 2 in the middle of the screen (in 2 line resolution); 50 POKE XPP2, 128:POKE YPP2,64.

5) Flight time:
(POKE to: FTP0, FTP1, FTP2, FTP3, FTM0, FTM1, FTM2, FTM3.)

If you require a player or missile to continue flying across the screen for a limited time only (ie, to have a limited range) then you may assign it a flight time. For example, the following line would cause player 2 to disappear from the screen after exactly 2 seconds: 60 POKE FTP2, 100

The flight time may be set to any value in the range 1 — 255, and it represents the number of 1/50ths of a second for which the player or missile will remain on the screen. Each time it runs, MYVBI decrements the

flight time, and at the transition from 1 to 0 removes the player or missile from the screen by redefining it as a blank. The user's program may put it back at any time by reassigning it a shape. players and missiles which have not been assigned a flight time, remain on the screen indefinitely. After use, the flight time must be set to zero.

The user's program may use the above commands in any order to POKE any values, and MYVBI will accept them as valid data. However, to make the best use of the package the guidelines in the following section should be adhered to.

Guidelines

1) Do not indicate to MYVBI that any player or missile is to be defined as a zero byte object, eg 10 POKE BYP2,0.

A zero in this context is interpreted by MYVBI as a terminator and it will exit without animating any remaining players or missiles (the order of movement is P0, P1, P2, P3, M0, M1, M2, M3).

The following line has the obscure (but possibly useful) effect of freezing all player and missile movement until repeated with a non-zero number of bytes: 10 POKE BYP0,0

2) As far as possible keep all player object definitions to the same number of bytes (even if this means padding out the definitions of small objects with blanks). Also avoid changing the number of bytes assigned to a player or missile once set. Not only will this procedure simplify your program, but it will also reduce the possibility of leaving 'stray bits' in the player missile table. For example, suppose player 2 is initially defined as an 8-byte object, and is subsequently redefined as a 3-byte object. MYVBI will then immediately cease to recognise 5 bytes of the original object, and these may be left behind as player 2 moves across the screen.

3) When launching a moving object, define its X and Y speed first and its X and Y position and shape last. This prevents the object moving to far from its intended position as a blank, before appearing on the screen. Note that all players and missiles which are not on the screen at any one time, are in fact present and being maintained by MYVBI, but are defined as blanks and so cannot be seen. Adopting this slightly primitive arrangement reduced the amount of coding required to write MYVBI.

SuperBios 1.8
FOR 
SUPERBRAIN

PRICE
£78
+VAT

MICROMODS LTD.
53 ACTON RD. LONG EATON NOTTINGHAM
NG10 1FR TEL: 06076 64264

SuperBios 1.8
FOR 
SUPERBRAIN II

PRICE
£78
+VAT

MICROMODS LTD.
53 ACTON RD. LONG EATON NOTTINGHAM
NG10 1FR TEL: 06076 64264

PROGRAMS

4) Use traps to handle attempts to POKE values outside the range 0 — 255. This is much more efficient than the alternative of testing values before POKEing.

5) The control of players and missiles by POKEing to specific locations has been described. Similarly the user's program may PEEK any of these locations to determine the current position, speed, shape, etc, of any player or missile. MYVBI continuously updates X and Y positions according to each object's X and Y speed.

6) Use player missile graphics, colour, size and collision registers in the normal way. The package sets up mnemonic names for these ready for your use.

7) The package works with any graphics mode, but care must be taken to ensure that the player-missile table does not encroach on screen memory. More RAM may be made available for graphics by subtracting more pages in line 11336, Table 1. Subtract multiples of 4 pages and 2-line resolution, and multiples of 8 pages for 1-line resolution. Fortunately, if the player-missile table does overlap screen memory. The normal effect seems to be corrupted screen images rather than a system crash. In this case a suitable number of pages to subtract may be found by trial and error. Changing from 2 line to 1 line resolution doubles the size of the player-missile table, and this too may cause overlapping with screen memory. The same solution applies.

8) Faster speeds for players and missiles may be achieved by modifying lines 12201, 12202 and 12211 in the package as follows:

12201 DATA 104, 168, 76, 3, 6, 200, 177, 203, 73, 128, 16, 8, 162, 240, 142, 203

12202 DATA 6, 76, 185, 6, 162, 0, 142, 203, 6, 170, 10, 10, 10, 10, 24, 200, 113

12211 DATA 203, 145, 203, 8, 138, 74, 74, 74, 74, 9, 255, 40, 200, 113, 203

This modification may be of value to compensate for the effective halving of Y speed when changing from 2-line to 1-line resolution.

9) The package makes heavy use of variable names. It uses 108 in all which is only 20 short of the maximum. However, most of these variables are mnemonic pointers, set up specifically for use in the user's program, and the demand for additional variables should not be high. The use of mnemonic pointers improves the readability

of the user's program and enhances its speed (POKEing to named locations is faster than obtaining an address for each POKE by evaluation or array access).

If you run out of variable names (and get an 'ERROR4') it is extremely unlikely that you will be using all the variables set up for your use by the package. In this case the problem may be overcome by the following procedure:

a) Remove references to any unused colour, size or collision registers by selectively deleting lines 11238 to 11284. Up to 25 variable names may be saved.

b) Selectively delete lines 11477 to 11492 to remove references to any unused players or missiles, saving 7 variable names apiece. For example if you are not using missile 2 then you may delete lines 11489 and 11490.

c) Remove deleted names from Basic's variable name list. This is done by saving the untokenised form of the program and reloading it. For example, using the cassette recorder: SAVE with list "C:", type NEW, and reload with enter "C;".

10) The priority for players' missiles and playing fields are not set in the program, so the user's program must set GPRIOR itself otherwise players 3 and 4 will be lost.

Limitations

The use of Basic to control animation is worthwhile because of its simplicity, popularity, and ease of use. However, it is not an ideal language for this type of application. With the assistance of machine code routines like MYVBI its capabilities can be improved, but the main factor limiting the complexity of dynamic games is still likely to be the speed of the user's Basic program.

The machine code routine MYVBI was written in a deliberately simplified and generalised form (mainly so that it would conveniently fit onto page 6 of memory, which is left free by Atari Basic). As a result the routine is not as efficient on processing time as it could be, and causes an apparent slowing down of the user's Basic program. This effect may be minimised by avoiding the use of excessively large players and missiles. Single object definitions for players and missiles may be as large as 128 bytes, but it is recommended that a working maximum of 16 bytes be adopted.

A further minor limitation of the package

MICROMART

BBC CONTEX BBC

Professional software for the BBC computer

TYPING TUTOR Model B or A with 32K
Learn the skill of touch typing. 90 smoothly graded lessons. Keyboard display highlights each lesson. Analyses performance and errors, makes recommendations. Audio keyboard feedback. User configurable. Add own lessons or try free form practice. Instruction booklet supplied. **£10 inc**

GAMES PACK ONE Model A or B
Two colourful and educational games on one cassette. SIMON with 3 skill levels for 1 to 8 players. HANGMAN with over 400 words, two groups, junior and adult, 1 or 2 players. **£6 inc**

Cheque/PO payable to
'Contex Computing'
(PCW3) 15 Woodlands Close, Cople,
Bedford MK44 3UE

*** For the Best Prices Ever ***
STOP & PHONE US NOW * 01-683 1181 (PBX)
We can match any price advertised

Croydon Micros

Computers:
Dragon 32 £170 Sharp MZ80A £434
Sharp MZ80B £869 Osborne 1 £1206
Sirius 1 £2215 IBM PC £2620
Seikosha GP100 £176 Smiths Corona TP1 £430
Epson MX80FT3 £325, MX82FT £355, MX100 £420
OK1 80 £210, 82A £299, 83 £431, 84A £795
RICOH FLOWriter £1350 TEC Stanwriter F10 ... £950

Cables:
Standard £20 Special £35
Drives: 5 1/4" Top Quality Please add V.A.T.
SS 48 tpi £137.50 and delivery:
DS 48 tpi £162.50 Computers £15.00
SS96 tpi £187.50 Printers £10.00
DS96 tpi £200.00 Paper (Box) £2.00
Cases and PSU available. Disks (Box) £1.50
Please ring for prices.

** Wide range of paper, diskettes and software available **
for immediate delivery on MAIL ORDER

Ring now for help

THE MICRO-COMPUTER PROFESSIONALS

Cheques to: Croydon Micros or
20-28 Whitehorse Road, VISA ACCESS
Croydon, Surrey CR9 2HQ AMEX DINERS

Showroom open: Tuesday to Saturday 10 to 1 & 2 to 6pm
Proprietor: Frontream Ltd (T/A) Incorporated in England No: 1593574

SuperBios 1.8

BOOTS BOTH
MACHINES

PRICE
£78
+VAT
MICROMODS LTD.
53 ACTON RD. LONG EATON NOTTINGHAM
NG10 1FR TEL: 06076 64264

OSBORNE 1

- Monitor + cable £104
- Adler/Epson/OK1 ECALL
- Olivetti ET121+RS232 £799
- OSBORNE ECALL
- Games for Osborne from £19.95

We specialise in Osborne &
hold large stocks of above.
CALL FOR SUPERB PRICES

FRASER ASSOCIATES
Buckingham (02802) 6087

Splice Video

FOR
CUMANA & MICROVITEC
COLOUR MONITORS
FROM £199.00 +VAT
BANDWIDTHS UP TO 15MHz
5 1/4" DISC DRIVES
FROM £155.00 +VAT
BBC COMPATIBLE DISCS AND
MONITORS IN STOCK
Telephone: 01-845 6705

MICROMART

UK 101 SOFTWARE ON TAPE

from the guy who wrote "Le Passe Temps"

- GALACTIC HITCHHIKER (8K). An adventure, all in machine code. A beauty! (£7.00)
- SUPERTREK (8K). Sail boldly through the universe, zap-ping moving Klingons in real time. Superb graphics. (£7.00)
- STARTREK (8K). The old favourite, beautifully presented. (£6.00)
- LUNAR LANDER. A real challenge. You won't get down in less than 3 hours. (£3.00)
- HANGMAN. Excellent graphics. P.E. said so! (£3.00)
- BASIC TUTOR (8 x 4K). The only way to learn—at the keyboard. (£12.00)
- LE PASSE-TEMPS. You NEED this, if you haven't already got it. (£3.00)
- MAD MONK (8K). It's ready at last! A machine code adventure with some truly remarkable graphics, this programme is in a class by itself. (£9.50)

These ORIGINAL PROGRAMS are compatible all 2K Monitors and are available for 16 x 48 and 32 x 43 displays (including enhanced Superboards).

HARDWARE

These kits are complete in every way. Full socketed high quality PCB, all components, switches etc. plus preformed cable assembly for easy interconnection to J1, or our MOTHERBOARD SYSTEM. Now you can add on all those extras easily. Provides eight, yet EIGHT, fully buffered J1 type sockets. (£19.50)

8K STATIC RAM BOARD (£39.50)

HI-SPEED CASSETTE INTERFACE. At last, a system that works COMPLETELY RELIABLE 4000 baud (8000 with reasonable cassette) plus software for named file handling. A delight to use. (£19.50). For software in EPROM, add £8.00.

VIDEO ENHANCEMENT. Switch selectable 16 x 48 or 32 x 48 displays without butchering your computer. (£19.50)

Monitor EPROMS re-load to suit for just £2.50.

8K EPROM BOARD (£19.50). A 2K Extended Monitor is available in EPROM FOR 4cc.00 plus, coming soon, TOOLKIT in EPROM and BASIC V.

MONITOR BOARD. Plug into Monitor socket to provide switch selection of up to 4 EPROMS. (£9.50).

AVAILABLE SHORTLY: EPROM Programmer, PIA/ Sound Board. Analogue Board and something rather nice on the graphics side.

All inclusive. Please add 15% VAT. Write or phone for further details.
MERLIN MICRO SYSTEMS LTD.
 93 High St., Eston, Cleveland. Tel: (0642) 454883.

PRINTERS FOR SHARPS

Most dot matrix and daisy wheel printers available for MZ80K & MZ80A.

Our package includes printer, cable, interface and software. Centronics for RS232, automatic conversion of Sharp codes to standard ASCII. All printer control codes can be used with BASIC. Other boards available include EPROM memory storage and programmers, ADC's etc.

Details from:-

PETERSON ELECTRONICS LTD
 Academy Street
 Forfar
 Angus DD8 2HA
 Telephone Forfar (0307) 62591

16K ZX81/SPECTRUM MANAGEMENT GAMES

DALLAS. A game of oil exploitation in Texas. Decisions are required on purchasing concessions, the movement and use of drilling rigs, and the building of production facilities and pipelines. Can you take-over the Euing Empire?

AIRLINE. You must decide on number of aircraft to operate, loan and fuel contracts, whether to buy or charter, and levels of staffing and maintenance.

AUTOCHEF. As MD you must negotiate for leases, decide on menu prices, level of wages, advertising and dividends and forecast levels of inflation. If you are not successful you will be made to resign!

FOR THE EXPERT

PRINT SHOP. As owner of a printing company you have to decide on staffing, paper stocks, quotations, work schedule. £5.00 for one, £8.50 for any two, £12.00 for three or £15.50 for the four.

C.C.S.
 Please state computer type and send cheque to Dept. PCW
 14 Langton Way
 London SE3 7TL

OSBORNE 1

FREE!! D Base 2 with double density machine £1375.00 + VAT

4B microcentres

North Bar, Banbury, Oxon. OX16 0TF Telephone (0295) 66555

PROGRAMS

is that any event which disturbs normal vertical blank interrupt processing (eg, the execution of error traps) will disturb the motion of all players and missiles. Fortunately events of this type appear to be infrequent and their effects minimal.

around the screen in 1 or 2 line resolution. Smooth continuous movement is maintained by the machine code routine MYVBI.

Although the complexity of dynamic games is practically limited by the speed of the user's Basic program, good results should be obtained by either limiting the number of players and missiles used (eg, games like Space Duel, Moon Landing, Tanks etc) or by limiting the amount of controlled movement taking place at any one time (eg, Adventure-type games).

Conclusions

The animation package enables animated games and displays to be created with Atari Basic. Players and missiles with intricately defined shapes may be moved freely

- 10991 RE1 *****
- 10992 RE1 *
- 10994 RE1 *
- 10995 RE1 * A BASIC LANGUAGE
- 11000 RE1 * ANIMATION PACKAGE FOR THE
- 11002 RE1 * ATARI 400/300.
- 11005 RE1 *
- 11010 RE1 * CLIFF HATCH. JULY 1982.
- 11020 RE1 *****
- 11021 RE1
- 11022 RE1 CALLED ONCE (BY GOSUB 11228) AT START OF USER'S PROG.
- 11025 RE1
- 11026 RE1 SETS UP PLAYER MISSILE TABLE AND ENABLES PLAYER
- 11028 RE1 MISSILE GRAPHICS IN 1 OR 2 LINE RESOLUTION.
- 11029 RE1
- 11030 RE1 INITIATES A MACHINE CODE ROUTINE, CALLED "MYVBI",
- 11035 RE1 WHICH ANIMATES ALL PLAYERS AND MISSILES IN
- 11040 RE1 "BACKGROUND MODE". "MYVBI" IS A "USER VERTICAL BLANK
- 11045 RE1 INTERRUPT ROUTINE", READ FROM DATA STATEMENTS AND
- 11047 RE1 LOADED INTO PAGE 6 OF MEMORY. IT USES 2 DATA
- 11048 RE1 TABLES STORED IN THE STRING ARRAYS "ITABS" AND "OBS".
- 11050 RE1
- 11055 RE1 THE ARRAY "ITABS" CONTAINS A TABLE OF "MOVE DATA",
- 11060 RE1 THAT IS, INFORMATION USED IN THE ANIMATION OF EACH
- 11065 RE1 PLAYER AND MISSILE. THE USER'S PROGRAM MAY CONTROL
- 11070 RE1 THE NO OF BYTES, FLIGHT TIME, X SPEED, X POSITION,
- 11072 RE1 Y SPEED, Y POSITION AND OBJECT DEFINITION OF ALL PLAYERS &
- 11080 RE1 MISSILES BY POKING INTO ARRAY "ITABS". POINTERS
- 11082 RE1 ARE SET UP TO ASSIST IN THIS (EG. FOR PLAYER 0: BYP0,
- 11084 RE1 FTP0, XSP0, XPP0, YSP0, YPP0 AND DFP0)
- 11090 RE1
- 11095 RE1 THE ARRAY "OBS" CONTAINS A SET OF OBJECT DEFINITIONS.
- 11200 RE1 THESE CAN BE CHANGED BY THE USER TO PROVIDE PLAYERS
- 11203 RE1 AND MISSILES OF ANY CHOSEN SHAPE. A POINTER IS
- 11204 RE1 SET UP FOR EACH OBJECT DEFINITION.
- 11205 RE1
- 11207 RE1 TO CHANGE FROM 2 LINE RESOLUTION TO 1 LINE RESOLUTION
- 11209 RE1 CHANGE LINES: 11349, 11350, 12183 & 12193 AS INDICATED.
- 11210 RE1
- 11211 RE1 BASIC OCCUPIES APPROX 9K (REMS INCLUDED). "MYVBI" MACHINE
- 11212 RE1 CODE OCCUPIES PAGE 6 LOCATIONS 1536 - 1761 AND USES PAGE 0
- 11213 RE1 LOCATIONS 203 - 207 (DECLIAL). THE PACKAGE WORKS
- 11214 RE1 UNCHANGED FOR ANY MEMORY SIZE GREATER THAN 16K.
- 11215 RE1
- 11218 RE1 *****
- 11220 RE1 INITIALISE PLAYER MISSILE GRAPHICS MONITOR NAMES
- 11222 RE1 *****
- 11228 COLR4=712:RE1 BCKRND COLOR
- 11230 COLR0=708:RE1 PLYFLD0 COLR
- 11232 COLR1=709:RE1 PLYFLD1 COLR
- 11234 COLR2=710:RE1 PLYFLD2 COLR
- 11236 COLR3=711:RE1 PLYFLD3 COLR
- 11238 PCOLR0=704:RE1 P0/10 COLOR
- 11240 PCOLR1=705:RE1 P1/11 COLOR
- 11242 PCOLR2=706:RE1 P2/12 COLOR
- 11244 PCOLR3=707:RE1 P3/13 COLOR
- 11246 SDMCTL=559:RE1 D4A CONTROL
- 11247 GRACCTL=53277:RE1 GRPHIC CONTR
- 11248 P0PF=53252:RE1 P0,PLFLD HIT
- 11249 P0PL=53260:RE1 P0,PLYER HIT
- 11250 P1PF=53253:RE1 P1,PLFLD HIT
- 11252 P1PL=53261:RE1 P1,PLYER HIT
- 11254 P2PF=53254:RE1 P2,PLFLD HIT

DRAGON - ATOM - BBC

GAMES-UTILITIES-PROGRAMME GENERATORS

For the DRAGON: MAZE RUNNER

The Maze is tortuous, the exit is closed, time is short, you MUST find a control panel.....
 A High-Res. 3D Game £3

For the ATOM: MEANIES

A High-Res. Arcade Action Game! Stop the Meanies landing or they'll turn into a Super-Meanie, and then you really have got trouble!!! £3

for catalogue, send S.A.E. to

QUODLIBET

QUODLIBET
 2, Victoria terrace,
 Dorchester,
 DORSET DT1 1LS

The POWER BANK

system compatible sine wave output

Plug your microcomputer, VDU and Printer into the POWER BANK and forget about a disabling break in the electricity supply. This unit will continue to run your system in the event of a mains failure... WITH NO INTERRUPTIONS TO YOUR WORK!

Vital when running business. This unit will of course suppress MAINS SPIKES and SURGES. Batteries included (sealed for life). 120 V.A. and 250 V.A. (output units available).

120 VA Unit £320
 250 VA Unit £450

Power Testing (Sales) Ltd

65a Shenfield Rd, Shenfield, Brentwood, Essex CM15 8HA
 Tel Brentwood (0277) 233188 Telex 24224586

PROGRAMS

```

11256 P2PL=53262:REM P2,PLYER HIT
11258 P3PF=53255:REM P3,PLFLD HIT
11260 P3PL=53263:REM P3,PLYER HIT
11262 P4BASE=54279:REM P4BASE ADDR
11264 GPRIOR=623:REM PRIORITY SELECT
11266 RA4TOP=106:REM TOP RA4 POINTER
11268 SIZEM=53260:REM MISSILE SIZES
11270 SIZEP0=53256:REM P0 SIZE
11272 SIZEP1=53257:REM P1 SIZE
11274 SIZEP2=53258:REM P2 SIZE
11276 SIZEP3=53259:REM P3 SIZE
11277 M0PF=53248:REM M0,PLFLD HIT
11278 M0PL=53256:REM M0,PLYER HIT
11279 M1PF=53249:REM M1,PLFLD HIT
11280 M1PL=53257:REM M1,PLYER HIT
11281 M2PF=53250:REM M2,PLFLD HIT
11282 M2PL=53258:REM M2,PLYER HIT
11283 M3PF=53251:REM M3,PLFLD HIT
11284 M3PL=53259:REM M3,PLYER HIT
11285 HITCLR=53278:REM CLEAR HITS
11304 REM *****
11308 REM SET UP PLAYER MISSILE GRAPHICS & CLEAR P4 TABLE.
11316 REM *****
11336 A=PEEK(RA4TOP)-8:REM SUBTRACT PAGES BELOW RA4TOP P4 TABLE STARTS
11346 POKE P4BASE,A:ADDR=A*256
11349 DIS=128:REM 128 2 LINE RES, 256 1 LINE RES *****
11352 REM CLEAR P4 TABLE
11356 FOR I=ADDR+3*DIS TO ADDR+8*DIS-1:POKE I,0:NEXT I
11360 POKE SD1CTL,46:REM 46 2 LINE RES, 62 1 LINE RES *****
11364 POKE GRACL,3:REM ENABLE P4 GRAPHICS
11370 REM *****
11372 REM SET UP ARRAYS "ITABS" & "OBS" AND START ADDR PTRS
11374 REM *****
11376 DI4 OBS(256),ITABS(105)
11378 OBJ=ADR(OBS):ITABJ=ADR(ITABS)
11471 REM *****
11472 REM SET UP "MOVE DATA" TABLE POINTERS
11473 REM & OBJECT DEFINITION TABLE POINTERS.
11474 REM *****
11477 J=ITABJ:REM *** PLAYER 0 "MOVE DATA" PTRS ***
11478 BYP0=J:FTP0=J+1:XSP0=J+6:XPP0=J+8:YSP0=J+9:YPP0=J+11:DFP0=J+12
11479 J=ITABJ+13:REM *** PLAYER 1 "MOVE DATA" PTRS ***
11480 BYP1=J:FTP1=J+1:XSP1=J+6:XPP1=J+8:YSP1=J+9:YPP1=J+11:DFP1=J+12
11481 J=ITABJ+26:REM *** PLAYER 2 "MOVE DATA" PTRS ***
11482 BYP2=J:FTP2=J+1:XSP2=J+6:XPP2=J+8:YSP2=J+9:YPP2=J+11:DFP2=J+12
11483 J=ITABJ+39:REM *** PLAYER 3 "MOVE DATA" PTRS ***
11484 BYP3=J:FTP3=J+1:XSP3=J+6:XPP3=J+8:YSP3=J+9:YPP3=J+11:DFP3=J+12
11485 J=ITABJ+52:REM *** MISSILE 0 "MOVE DATA" PTRS ***
11486 BYM0=J:FTM0=J+1:XSM0=J+6:XP0=J+8:YSM0=J+9:YPM0=J+11:DFM0=J+12
11487 J=ITABJ+65:REM *** MISSILE 1 "MOVE DATA" PTRS ***
11488 BYM1=J:FTM1=J+1:XSM1=J+6:XP1=J+8:YSM1=J+9:YPM1=J+11:DFM1=J+12
11489 J=ITABJ+78:REM *** MISSILE 2 "MOVE DATA" PTRS ***
11490 BYM2=J:FTM2=J+1:XSM2=J+6:XP2=J+8:YSM2=J+9:YPM2=J+11:DFM2=J+12
11491 J=ITABJ+91:REM *** MISSILE 3 "MOVE DATA" PTRS ***
11492 BYM3=J:FTM3=J+1:XSM3=J+6:XP3=J+8:YSM3=J+9:YPM3=J+11:DFM3=J+12
11498 GOSUB 12618:REM OBJ DEFN POINTERS
11500 REM *****
11505 REM POKE MACHINE CODE AND DATA TABLES.
11510 REM *****
11520 FOR I=1536 TO 1761:READ J:POKE I,J:NEXT I
11530 FOR I=ITABJ TO ITABJ+104:READ J:POKE I,J:NEXT I
11540 FOR I=OBJ TO OBJ+NBYTS-1:READ J:POKE I,J:NEXT I
11634 REM *****
11635 REM INIT PTRS TO INDIVIDUAL P4
11636 REM PARTS OF P4 TABLE. SAVE IN "ITABS"
11637 REM *****
11639 ADDR=ADDR+DIS+DIS+DIS:GOSUB 12040
11640 POKE ITABJ+96,HPTR:POKE ITABJ+95,LPTR:REM MISSILE 3
11650 POKE ITABJ+83,HPTR:POKE ITABJ+82,LPTR:REM MISSILE 2
11660 POKE ITABJ+70,HPTR:POKE ITABJ+69,LPTR:REM MISSILE 1
11670 POKE ITABJ+57,HPTR:POKE ITABJ+56,LPTR:REM MISSILE 0
11680 ADDR=ADDR+DIS:GOSUB 12040
11690 POKE ITABJ+5,HPTR:POKE ITABJ+4,LPTR:REM PLAYER 0
11700 ADDR=ADDR+DIS:GOSUB 12040
11710 POKE ITABJ+18,HPTR:POKE ITABJ+17,LPTR:REM PLAYER 1
11720 ADDR=ADDR+DIS:GOSUB 12040
11730 POKE ITABJ+31,HPTR:POKE ITABJ+30,LPTR:REM PLAYER 2
11735 ADDR=ADDR+DIS:GOSUB 12040
11740 POKE ITABJ+44,HPTR:POKE ITABJ+43,LPTR:REM PLAYER 3
11749 REM *****
11750 REM REASSEMBLE "4YVBI" PTRS TO "ITABS" & "OBS", & SET VBI VECT.
11762 REM *****

```

MICROMART

Programming the PET/CBM

The Reference Encyclopedia
for Commodore PET and CBM Users

Comprehensive teaching and reference book on
programming Commodore's 2000, 3000, 4000 and
8000 microcomputers and peripherals.

Many programs, charts and diagrams. 17 chapters,
appendices, and index. iv + 504 pages. Paperback.
ISBN 0 9507650 07. Price in U.K. and Europe
£14.90 each (includes post and packing).

LEVEL LTD

PO Box 438, Hampstead, London
NW3 1BH Tel: (01) 794 9848

Five or more £12.90 each. Plastic covers 45p each.
From dealers and booksellers or direct:

Send orders to:

LEVEL LTD (PCW), PO Box 438,
Hampstead, London NW3 1BH

Send copy/ies Programming the PET/CBM at £14.90

Enclose cheque/P.O. for £

NAME

ADDRESS

SEARCHING FOR 'BEST PRICE'

FOUND 'BEST PRICE'...GOTO

PET	TAPE	RRP
C2N	64K	£55
CBM	64K	£299
4032	32K	£695
8032	32K	£895
8096	96K	£1195

Our own transport delivers nationwide weekly. All you need is our Best Price Quotation. Contact us Now! For Super Service.

DISK DRIVES

2031	170K	£395
4040	343K	£695
8050	1M	£895
8250	2M	£1295
9060	5M	£1995
9090	7.5M	£2495

PRINTERS

4022P	80COL	£395
8023	136COL	£895
8300	DAISY	£1395

VAT TO BE ADDED @ 15%

CARRIAGE - £5 PER ITEM

IF YOU KNOW WHAT YOU WANT WHY

WAIT?

THESE ARE THE PRICES YOU NEED

ORCHARD COMPUTER SERVICES

Orchard House, 21 St Martins St

Wallingford, Oxon

Tel: Wallingford (0491) 35529

Open 6 days per week



CBM/PET PROGRAMS

2001/3000/4000/8000/CBM 64

GAMES + TUTORIALS + UTILITIES
BUSINESS + EDUCATIONAL
HUNDREDS OF TITLES TO CHOOSE FROM
- INCLUDING SOME YOU THOUGHT HAD
GONE FOREVER - (GOT COMPU/THINK?)

SOFTWARE/FIRMWARE/ HARDWARE

ALL THE NAMES YOU KNOW, PLUS
SOME EXCITING NEW ONES.
SEND 25p STAMP(S) FOR CATALOGUE::

CORALSOFT

65 CECIL AVENUE, HORNCHURCH, ESSEX
RM11 2NA MAIL ORDER ONLY

Sole Distributors

Softcentre

Programs

• INCLUDES FREE VOUCHER WORTH UP TO £5

APPLE II STATISTICS PACKAGE

A suite of 14 programs, including the following statistical routines:-

Means, standard deviations and variances, Mann-Whitney U, Wilcoxon test, Spearman rank correlation, product moment correlation, linear regression, scattergrams, t-tests and one way analysis of variance for independent and related samples, chi-square, Kruskal-Wallis test, Friedman test.

The package includes a data entry and editing program which allows a worksheet of up to 50 samples of data to be stored on disk and analysed by the statistical routines. Samples are named, and can be modified, joined together, etc.

Distributed on disk for DOS 3.3. Price includes 43 pages of documentation and post and packing. It is thus quite remarkable value at only £25!!!

Cheque or P.O. to:

Dr JB Brooke, 37 Main St, EAST BRIDGFORD,
NOTTINGHAM NG13 8PA

ASCII KEYBOARDS

- Parallel 7 bit TTL output
- 5v Positive Strobe
- Full ASCII character set
- 62 keys inc. ESC, CAPS, REP, DEL, TAB etc.
- Single +5v supply required
- Circuit diagram supplied
- New - Unused - Guaranteed

Cased (685 x 232 x 78mm) | £34.50
Uncased (333 x 175 x 40mm) | £32.20
Inclusive of VAT and Postage (UK only).

Nameworth Limited

31 Barnfield, Hemel Hempstead, Herts,
HP3 9QJ (0442-66878/48460).

MICROMART

UCSD p-system for Nascom

The renowned UCSD p-system has now been adapted for Nascom microcomputers with virtually any combination of Nascom or Gemini drives, 5" or 8".

A complete operating system, with screen editor, macro assembler, optional Pascal, BASIC and FORTRAN, Native Code Generator and TurtleGraphics, there is a comprehensive and highly portable range of business and applications software available and virtually complete software compatibility with other computers running UCSD - including Sirius, IBM, Apple and Sage.

Basic p-system (Includes screen editor and macro assembler) £225

Compilers:
Pascal £140 BASIC £125
FORTRAN £195 Add VAT at 15%

Gemini / Galaxy / Quantum versions soon

Large SAE to:

Mike York, 9 Rosehill Road, London SW18 2NY Tel. 01 874 6244

for further details

Software for TRS80®

Crops, Yields, Livestock, Students, Courses, Subjects, Rooms, Teachers, Classes, Customers, Addresses, Mailing-dates, Orders, Purchases, Salesmen, Appointments, Names, Dates, Times, Drugs, Patients, Doctors, Nurses, Beds, Wards, Schedules, Cheques, Payees, Categories, Notes, Invoices, Receipts, Tips, Accounts, Estimates, Hunts, Posters, Side-effects, Contacts, Lecturers, Course-material, Exam-results, Clients, Houses, Properties, Preferences, Acreeage, Bedrooms, Hotels, Symposia, Menus, Proteins, Nutrients, Shopping-lists, Budgeting, Record-collections, Tapes, Rock-groups, Cars, Horse-races, Handicaps, Places, Discounts, Goods, Patterns, Graduations, Stocks, Shares, Interest-rates, Payments,

ELECTRIC ENOTE Book

You name it... ENB can tame it!

The All-Purpose Data-Manager for TRS-80 (Mod I or III, or Video Genie).

Minimum System - 48K, 1Disk £69.95

southern software

PO Box 39, Eastleigh, Hants, England, SO5 5WQ

VDU DESK

TEAK LAMINATE FINISH

Assembly in seconds without tools

Other sizes

TRADE ENQUIRIES WELCOME



Details Available
£37.97
FOR 24"x24" size

+ VAT WITHOUT TOP SHELF



65 TREDEGAR SQ. LONDON E3 54E
Tel: 01-981 7301

PROGRAMS

- 11770 ADDR=ITABJ:GOSUB 12040:POKE 204,HPTR:POKE 203,LPTR
- 11790 ADDR=OBJ:GOSUB 12040:POKE 1683,HPTR:POKE 1682,LPTR
- 11860 J=USR(1751):REM SET USER VERT BLANK INTERRUPT VECTOR.
- 11990 RETURN
- 12010 RE4 *****
- 12015 RE4 SUBROUTINE TO CALC HI & LO BYTES OF ADDRESS POINTERS.
- 12025 RE4 *****
- 12040 LPTR=ADDR-INT(ADDR/256)*256:HPTR=INT((ADDR-LPTR)/256):RETURN
- 12110 RE4 *****
- 12120 RE4 "MYVBI" MACHINE CODE IN DECIMAL, STORED IN MEMORY PAGE 6.
- 12130 RE4 *****
- 12151 DATA 216,160,0,177,203,208,3,76,98,228,56,233,1,133,207,200
- 12152 DATA 177,203,240,21,56,233,1,145,203,208,14,152,24,105,11,168
- 12161 DATA 169,3,145,203,152,56,233,11,168,200,177,203,141,128,6,200
- 12162 DATA 177,203,141,115,6,73,255,141,149,6,200,177,203,133,205,200
- 12171 DATA 177,203,133,206,32,165,6,141,212,6,200,200,200,177,203,141
- 12172 DATA 211,6,136,136,136,32,165,6,141,213,6,200,177,203,141,214
- 12181 DATA 6,200,152,72,166,207,172,211,6
- 12183 DATA 192,128,144
- 12184 RE4 LINE 12183: 192,128,144 2 LINE RES. 76,114,6 1 LINE RES*****
- 12185 DATA 5,152,56,233
- 12187 DATA 128,168,169,255,49,205,145,205,200,202,16,237,174,212,6,142
- 12191 DATA 255,208,172,213,6,174,214,6
- 12193 DATA 192,128,144
- 12194 RE4 LINE 12193: 192,128,144 2 LINE RES. 76,145,6 1 LINE RES*****
- 12195 DATA 5,152,56,233,128
- 12197 DATA 168,189,0,97,41,255,17,205,145,205,200,232,198,207,16,232
- 12201 DATA 104,168,76,3,6,200,177,203,73,128,16,8,162,248,142,203
- 12202 DATA 6,76,185,6,162,0,142,203,6,170,10,10,10,24,200,113
- 12211 DATA 203,145,203,8,138,74,74,74,74,9,255,40,200,113,203
- 12212 DATA 145,203,96,255,255,255,255,160,0,162,6,169,7,32,92,228
- 12221 DATA 104,96
- 12303 RE4 *****
- 12304 RE4 "MOVE DATA" TABLE, INITIAL VALUES, STORED IN "ITABS"
- 12305 RE4 *****
- 12310 RE4 SOME OF THESE VALUES ARE DUMMYS, OVERWRITTEN LATER
- 12450 DATA 1,0,0,0,0,154,0,0,0,0,0,0,0,0
- 12452 DATA 1,0,1,0,128,154,0,0,0,0,0,0,0,0
- 12454 DATA 1,0,2,0,155,0,0,0,0,0,0,0,0
- 12456 DATA 1,0,3,0,128,155,0,0,0,0,0,0,0,0
- 12458 DATA 1,0,4,252,128,153,0,0,0,0,0,0,0,0
- 12460 DATA 1,0,5,243,128,153,0,0,0,0,0,0,0,0
- 12462 DATA 1,0,6,207,128,153,238,0,0,0,0,0,0,0
- 12464 DATA 1,0,7,63,128,153,0,0,0,0,0,0,0,0
- 12466 RE4 TERMINATOR
- 12468 DATA 0
- 12482 RE4 *****
- 12484 RE4 OBJECT DEFINITION TABLE, STORED IN "OBs"
- 12486 RE4 *****
- 12490 RE4 1ST OBJ SHOULD BE A BLANK, AS MANY BYTES AS LARGEST OBJ
- 12491 RE4 BLANK
- 12492 DATA 0,0,0,0,0,0,0,0
- 12493 RE4 SHIP1
- 12494 DATA 24,60,102,255,219,153,129,129
- 12495 RE4 SHIP2
- 12496 DATA 0,24,60,102,60,255,153,24
- 12500 RE4 MISSILES
- 12502 DATA 255
- 12612 RE4 *****
- 12614 RE4 SUBROUTINE TO SET POINTERS TO OBJECT DEFINITIONS
- 12616 RE4 *****
- 12618 BLANK=0
- 12620 SHIP1=BLANK*8:SHIP2=SHIP1*8:MISSL=SHIP2*8
- 12630 NBYTES=25:REM TOTAL BYTES IN OBJ DEFINITIONS, MAXIMUM 256
- 12650 RETURN

TABLE 2. TEST PROGRA1.

- 5 PRINT "INITIALISING"
- 10 GOSUB 11228:REM CALL PACKAGE
- 15 PRINT "OK"
- 20 RE4 START PLAYER 0
- 40 POKE BYP0,8:POKE XSP0,150:POKE YSP0,128
- 50 POKE XPP0,128:POKE YPP0,64:POKE DFP0,SHIP1
- 60 RE4 START MISSILE 3
- 70 POKE PCOLR3,140:POKE BY13,1:POKE XS13,120:POKE YS13,255
- 80 POKE XP13,128:POKE YP13,64:POKE DM13,MISL
- 90 GOTO 90

TAPE DUPLICATING PROBLEMS?

PCS duplicator, up to 50 outputs. Eliminates faulty recording duplication

- Amplification of signal, switchable 19KHZ signal disables cassette ARL.
- Channel monitor (LED) flashes output no. and audible alarm if fault occurs.
- Allows for computer-cass/cassette-cass recordings.
- Suitable for cuts based micros inc. ZX and many others.

£830 + VAT. Units starting at £380 + VAT

For details:

ZX MICRO-PRO

Tape Duplicating Systems, London WC1N 3XX
24Hr. Answer Phone Service 01-404-5011

Designers and Doodlers

No programming for you with a 32k BBC Micro plus Epson MX80III to do all this:

Write text small text

Large Text

Draw lines

doodles

shapes

Make your own characters

Bar Chart

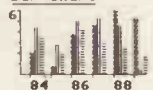

Graph

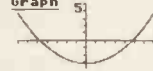

Then print it out in two sizes, photocopy it, photo it, project it, even record it on tape and play back. Use it.

Tape only £9.50 from DESIGN, 26 Hilton Road, Seamer, Middlesbrough TS9 5LU

PROGRAMS

Chinese Horoscope

by Richard Lee

Are you a Goat or a Pig? This program for the MZ-80K will tell you, and give you a run-down on the derivation of Oriental astrology. To add to the complexity, the date of the Chinese New Year changes from year to year — it can start any time between mid-January and mid-February. Richard has included New Year dates for most years of this century. When you have discovered your sign, you enter the number listed for the relevant animal — eg, for a Goat, press 8. You are then presented with a list of options. You can find out the

personality associated with your sign and you are given a list of famous people who supposedly share your characteristics — did you know Prince Charles was a Rat? — or find your ideal partner's sign.

Although written for the MZ-80K, there are no PEEKs, POKEs or USR statements. So there should be no problem in converting it for any micro with at least 23k RAM. If you do convert it, leave out line 30 — this is only there to make the program auto-run on loading.

```

10 REM ** CHINESE HOROSCOPE **
20 REM ** BY RICHARD J. LEE **
30 POKE10682,1
40 DATA Rat, Buffalo, Tiger, Cat, Dragon, Snake, Horse, Goat, Monkey, Rooster, Dog, Pig
50 DIMA$(12):FORI=1TO12:READA$(I):NEXT
60 DATA J31,F19,F08,J29,F16,F04,J25,F13,F02,J22,F10,J30
70 DATA F18,F06,J26,F14,F03,J23,F11,F01,F20,F08,J28,F16
80 DATA F05,J25,F13,F02,J23,F10,J30,F17,F06,J26,F14,F04
90 DATA J24,F11,J31,F19,F08,J27,F15,F05,J25,F13,F02,J22
100 DATA F10,J29,F17,F06,J27,F14,F03,J24,F12,J31,F18,F08
110 DATA J28,F15,F05,J25,F13,F02,J21,F09,J30,F17,F06,J27
120 DATA J16,F03,J23,F11,J31,F18,F07,J28,F16,F05,J25,F13
130 DATA F02,F20,F09,J29,F17,F06,J27,F15,F04,J23,F10,J31
140 DIMD$(95):FORI=0TO95:READD$(I):NEXTI
150 PRINT"E":S=53248:M=1000
160 S$="Successful marriage combinations:"
170 PRINT"  "
180 PRINT"  "
190 PRINT"  "
200 PRINT"  "
210 PRINT"  "
220 PRINT"  "
230 PRINT"  "
240 PRINT"  "
250 PRINT"  "
260 PRINT"  "
270 PRINT"By Richard J. LEE"
280 PRINT"Press any key to continue."
290 GETA$:IFA$=""THEN310
300 GOTO330
310 Z=S+M*RND(1):IFPEEK(Z)THEN290
320 FORN=1TO99:NEXTN:POKEZ,107:GOTO290
330 PRINT"###";TAB(13):"THE HISTORY###"
340 PRINT"The Chinese Horoscope is based on the
350 PRINT"legend of how an ancient Chinese
360 PRINT"Emperor called all the animals to his
370 PRINT"palace, and the first twelve to arrive
380 PRINT"became the signs of the Chinese Horo-
390 PRINT"scope. Unlike the English horoscope
400 PRINT"the Chinese have a twelve year cycle
410 PRINT"and whichever animal was having its
420 PRINT"year when you were born is your sign.
430 PRINT"Another difference is that the years
440 PRINT"change with the Chinese New Year which
450 PRINT"can start at some date between mid-
460 PRINT"January to late February, depending
470 PRINT"on the lunar cycle."
480 PRINT"###Press any key"
490 GETA$:IFA$=""GOTO490
500 PRINT"###Here is a table of the 12 animals with their years.###"
510 FORI=1TO12:PRINTA$(I):NEXTI:PRINT"###":VA=1912:VB=1963
520 T=1:FORI=VATOVBSTEP12
530 FORJ=1TO12:PRINTTAB(T*5+2):J+I-1:NEXTJ:PRINT"###":T=T+1:NEXTI:PRINT
540 PRINT"#####To obtain earlier dates,press Z and for"
550 PRINT"later dates press X.Otherwise press any"
560 PRINT"key to continue. *NB:- if your birthday"
570 PRINT"occurs in January or February your sign"
580 PRINT"may or may not be the previous year's."
590 PRINT"Press any key to check."
600 GETA$:IFA$=""GOTO600
610 IFA$="Z"THENVA=VA-12:VB=VB-12:PRINT"###":GOTO520
620 IFA$="X"THENVA=VA+12:VB=VB+12:PRINT"###":GOTO520
    
```

MICROMART

BRAIN SURGEON

Anita Electronic Services (London) Ltd are specialists in the repair and service of Superbrain I and II and associated printers including Apple silent type, Centronic, Anadex, NEC, QUME, Ricoh and Empson.

We also specialise in the repair of Commodore, Apple, Sirius, Osborne, Alpha Tronic, and Adler computers.

We offer a fast on-sight service or alternatively repairs can be carried out at our workshops should you wish to bring in your machine.

Maintenance contracts are available at very competitive prices. Trade enquiries welcome.

For further information telephone or write to:

MR D. WILKINSON
Anita Electronic Services Ltd.,
 15 Clerkenwell Close,
 London E.C.1.
 01-253 2444

AT LAST, A
 SIMPLE A/D



for £49.95 INC VAT & P&P.

- 8-bit precision — 33K samples/sec. ^(max)
- Single address operation, any slot.
- Real-Time CRO diskette for APPLE II — £19 inc. extra.

Also Signal processing system available.

(Fourier Transforms, Homomorphic analysis etc. with superb graphics) £174 inc.

Sig. proc. system requires PASCAL. Details:-

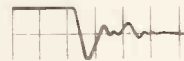

Cybermation Limited
 CONSULTANTS TO INDUSTRY

P.O. Box 168
 Hatfield
 Hertfordshire AL10 9PE

NEC PC-8000

OSBORNE 1

IN THE NORTH

NMR Tel: (0484) 892905
COMPUTERS (Holmfirth)

OSBOURNE 1

INESSEX	£ask
PRAXIS 35+ Cent	£425
MX80F/T III	£ask
ADLER TRD 170S DAISY	£675
ET 121	£ask
01 Printer Cables	£17.00

Trade enquiries for cables welcomed

MESHURST LTD

Tel: 01 590 2111

PRICES EXCLUDE VAT & DELIVERIES

P/X CONSIDERED

DEMONSTRATION MODELS

SUPERBRAIN QD1 ... £1100.00

SUPERBRAIN QD11 £1300.00

FULLY GUARANTEED

CAMBRIDGE DATA LTD

Telephone (01) 348 3298

If interested in advertising in Micromart please call Gaye Collins on 01-636 6890

MICROMART

northern computers offer even more

Apple II
Apple III
BBC micro computers
Acorn Atom
VIC-20
Newbrain
Prestel adaptors

Software
Disk Drive
Printers
Second Hand Computers
Tape
Recorders
Books

ALL ACCESSORIES SALES AND SERVICE

Easy parking off the M56
(Junc. 12)



northern computers

Tel: **Frodsham (0928) 35110**

micro computer systems for all applications

Churchfield Rd., Frodsham, Cheshire
WA6 6RD

M & J SOFTWARE

DRAGON COMPANION BOOK £10
Discover 7 extra graphics modes. Take complete control of video memory mapping. Increase the processor speed (not a hardware mod.). Append programs from tape. Study the workings of BASIC with the disassembler. Incorporate useful routines from BASIC in your mic prog. Add commands to BASIC.

FORTH listings £7
6502, 8080/280, 6809, 6800, 1802 in stock.

INSTALLATION MANUAL £5
Necessary for implementing FORTH and its editor.
6502 MACRO ASSEMBLER £5
This assembler is written in fig-FORTH and will run on any fig implementation with only one alteration.

MICROTAN IMPLEMENTATION OF FORTH £15
This is a cassette based implementation which consists of the language, its editor and M & J SOFTWARE's 6502 macro assembler.

M & J Software
34 Grays Close
Scholar Green
Stoke-on-Trent ST7 3LU

Send your cheque or postal order for £8 and really start to enjoy the Dragon
Tel (0782) 517876

PUREPAR

PURE GENIUS FOR THE UNEXPANDED

VIC-20

TOWER MAN

The tower is being invaded by monsters. You must stop them by digging holes and burying them. Your only tools are a ladder and a spade ... £4.50

ARADILLO

Save the Aradillos. Help them cross the busy road and avoid the alien on the centre island ... £4.50

SEA WAR

You are in command of your first battleship in a war where everything is against you. Sail past the mine-field. Ward off attacks from the air and beneath the waves ... £4.50

GOBBLER

Help the hunger-crazed food-addict eat the eggs before the angry chicken gets you ... £3.99

PONTOON

Pit your wit against the Vic-Kid (fastest dealer in town). Plays to all the rules of this well known card game ... £3.99

TRACK TRIALS

Test your driving skills. See how far you can get round the course without skidding or driving into the woods ... £3.99

SKI RUN

Race against the clock in this downhill time-trial. Watching out for trees and rocks ... £3.99

ONE-ARM-BANDIT

Full nudge-and-hold. Independent reel spin. Break the bank before he breaks you ... £3.50

All these games are for the unexpanded VIC-20 with high grade user-defined graphics, realistic sound effects and full instructions. They are a must - even for the first time buyer.

Orders over £10.00 save £1.00 with this advert.
Send P.O./cheque to
PUREPAR LTD, 440 Cherry Lane, Liverpool 4.

PROGRAMS

```

630 PRINT"8"
640 PRINT"If you want more exact dates so that you";
650 PRINT"can find out what animal sign you have";
660 PRINT"then press D otherwise press any other";
670 PRINT"key.
680 GETA$:IFA$=""GOT0680
690 IFA$="D"GOT0710
700 GOT0800
710 PRINT"88Enter the year you require without the";
720 PRINT"19; es for 1982 just enter 82."
730 INPUT"Year ? 19";A:IF(A<0)+(A>95)THENPRINT"Sorry, not known":GOT0730
740 PRINT"8":SPC(20):PRINT" In 19";STR$(A):" the Chinese New Year was on
750 A$=D$(A):IFLEFT$(A$,1)="F"THENM$="February":GOT0770
760 M$="January"
770 PRINT" :M$:UAL(RIGHT$(A$,2)):". So if your birthday is
780 PRINT" before that date, then your animal
790 PRINT" is that of the previous year."
800 PRINT:PRINT"If you wish to see the table of signs";
810 PRINT"again then press T otherwise press any";
820 PRINT"key to continue."
830 GETA$:IFA$="T"GOT0500
840 IFA$=""GOT0830
850 PRINT"8"
860 PRINT"Here are the twelve animals again :8
870 FORI=1TO12:PRINTTAB(3);I:TAB(8);A$(I):NEXT
880 PRINT"8Enter the number in front of the animal.
890 PRINT"that you would like to no more about.
900 INPUT"8Animal no :";N
910 IF(N<1)+(N>12)THENPRINT"Try again":SPC(20);"88":GOT0900
920 PRINT"88What would you like to know about the
930 PRINTA$(N);" ? Here's a list of the options88
940 PRINT" 1. The ";A$(N);" personality
950 PRINT" 2. The ";A$(N);" with other animals
960 PRINT" 3. Famous ";A$(N);"s
970 PRINT" 4. The ";A$(N);"s lines"
980 PRINT"8Enter the number corresponding to the
990 PRINT"details of what you want. Or else press:
1000 PRINT"8 C to Change animal
1010 PRINT" T to go to table of animals & dates
1020 PRINT" E to End program 8
1030 GETA$:IFA$=""GOT01030
1040 IFA$="E"THEN7550
1050 IFA$="C"GOT0850
1060 IFA$="T"GOT0500
1070 IF(ASC(A$)<49)+(ASC(A$)>52)THEN1030
1080 S=UAL(A$):ONSGOTO1100,1110,1120,1130
1090 GOT01030
1100 ONNGOTO1150,1270,1350,1430,1530,1620,1690,1810,1890,2000,2110,2190
1110 ONNGOTO2270,2440,2590,2740,2910,3060,3220,3380,3540,3690,3850,4010
1120 ONNGOTO4170,4330,4510,4670,4810,4970,5140,5300,5430,5570,5690,5830
1130 ONNGOTO5960,6100,6240,6380,6510,6640,6770,6900,7020,7160,7300,7430
1140 REM ** PERSONALITIES **
1150 PRINT"8++ THE RESOURCEFUL RAT ++
1160 PRINT"88The Rat appears calm on the surface,but88
1170 PRINT"underneath is anxious, nervous and even88
1180 PRINT"quick-tempered. Rats are charming and88
1190 PRINT"honest, imaginative and opportunist.88
1200 PRINT"Mr. Rat is a gambler and a drinker and88
1210 PRINT"he is an excellent sentimental lover;88
1220 PRINT"he may also be a good lover and poli-88
1230 PRINT"tician. Female Rat is often a career88
1240 PRINT"woman as well as a superb housewife and88
1250 PRINT"hostess.
1260 GOT07580
1270 PRINT"8++ THE BLITHE BUFFALO ++
1280 PRINT"88 Buffaloes are quiet, patient, with a88
1290 PRINT"gift for inspiring confidence. The88
1300 PRINT"Buffalo man knows how to love a woman88
1310 PRINT"and is kind to children. The female88
1320 PRINT"Buffalo likes to stay at home & often88
1330 PRINT" wears the trousers.88
1340 GOT07580
1350 PRINT"8++ THE TEMPESTUOUS TIGER ++
1360 PRINT"88 All tigers are noble and courageous88
1370 PRINT"and have a natural air of authority.88
1380 PRINT" They are generous, polite, passionate88
1390 PRINT"and sensitive but also can be vain88
1400 PRINT"and argumentative. 88 Some make money88
1410 PRINT"without really trying.88
1420 GOT07580
1430 PRINT"8++ THE CONVIVIAL CAT ++
1440 PRINT"88 Also known as the rabbit, Cats love88
1450 PRINT"company and are great mixers and ent-88
1460 PRINT"ertainers. They make cautious and88
1470 PRINT"astute business people. They tend to88
1480 PRINT"cry easily, but are quickly cheered88
1490 PRINT"up. Cat men are worldly and snobbish.88
1500 PRINT"women like to show off their newly88

```

Very latest SHARP pocket computer!

Powerful 4.2K RAM PC1251
pocket computer - only £79.95
plus FREE 128-page book
"Pocket Computing made easy"

Companion CE125 printer/micro cassette -
only £99.95 plus 3 FREE cassettes.

PC1500 pocket computer - our price £159.95
CE1504-colour printer - our price £139.95

Send cash, cheque, Access or Visa card no.
to ELKAN ELECTRONICS (Dept PCW),
FREEPOST, 11 Bury New Road, Prestwich,
Manchester M25 6LZ or tel. 061-798 7613
(24 hour service)

Ask for our latest ELKAN FILE for all our
computer books, software and hardware.

BASF DISKS BASF

- Individually tested by manufacturer
- 5 1/4" single sided, single density, soft sector
- Same day dispatch by first class post

In boxes of 10

£14.95 plus £1.00 p&p per box

10 in library case

£16.85 plus £1.50 p&p per box



Please add 15% VAT to total

STOCK ELECTRONICS

Plot 8, Forest Vale Road, Forest Vale Industrial Estate
Cinderford, Glos GL14 2PH (0594) 25360

PROGRAMS

- 1510 PRINT" acquired possessions.£
- 1520 GOTO7580
- 1530 PRINT"++ THE DEMANDING DRAGON ++
- 1540 PRINT"## Dragons are idealists, sifted intell-£
- 1550 PRINT" isent and generous. The male is over-£
- 1560 PRINT" proud, often stubborn and irritable.£
- 1570 PRINT" He shines in his career and does not£
- 1580 PRINT" usually marry young. The Dragon lady£
- 1590 PRINT" is a sophisticated, strong minded and£
- 1600 PRINT" prudent person.£
- 1610 GOTO7580
- 1620 PRINT"##++ THE SEDUCTIVE SNAKE ++
- 1630 PRINT"### Snakes have powerful personal mag-£
- 1640 PRINT" netism. They like money and are very£
- 1650 PRINT" lucky but are jealous and bad losers.£
- 1660 PRINT" Snake men dress well and females are£
- 1670 PRINT" beautiful.£
- 1680 GOTO7580
- 1690 PRINT"##++ THE HOT-BLOODED HORSE ++
- 1700 PRINT"## Quick - witted, charming, extremely£
- 1710 PRINT" popular and hard working. Horses are£
- 1720 PRINT" capable of paying a complement and£
- 1730 PRINT" turning a pretty phrase and love the£
- 1740 PRINT" arts. They tend to be impatient and£
- 1750 PRINT" yet very ambitious. The male makes£
- 1760 PRINT" an excellent father and provider.£
- 1770 PRINT" The Female is methodical and fares£
- 1780 PRINT" well in her career. The final third£
- 1790 PRINT" of their lives is tranquil & serene.
- 1800 GOTO7580
- 1810 PRINT"##++ THE GRACIOUS GOAT ++
- 1820 PRINT"## Goats are elegant, charming and art-£
- 1830 PRINT" istic but pessimistic and worriers£
- 1840 PRINT" who need security. The female Goats£
- 1850 PRINT" dreams of marriage with a rich man.£
- 1860 PRINT" the male makes noises like a leader£
- 1870 PRINT" but fools no one.£
- 1880 GOTO7580
- 1890 PRINT"##++ THE MERRY MONKEY ++
- 1900 PRINT"## Monkeys in general are vain, high£
- 1910 PRINT" spirited, egotistical, inventive and£
- 1920 PRINT" original. They have a quick and ready£
- 1930 PRINT" wit and can succeed in any profession£
- 1940 PRINT" and may become famous. Male monkeys£
- 1950 PRINT" fall in love easily but do not always£
- 1960 PRINT" find happiness. Miss Monkey appeals£
- 1970 PRINT" to the protective man. The men are£
- 1980 PRINT" jokers and a lot of fun but devious.£
- 1990 GOTO7580
- 2000 PRINT"##++ THE RECKLESS ROOSTER ++
- 2010 PRINT"## Roosters are reckless show offs who£
- 2020 PRINT" speak their minds bluntly, but do not£
- 2030 PRINT" really care about other's feelings.£
- 2040 PRINT" While dreaming of being rich, they£
- 2050 PRINT" are unable to economise. The Female£
- 2060 PRINT" rooster likes the company of other£
- 2070 PRINT" women. The male Rooster disappoints£
- 2080 PRINT" his loved one although he makes sti-£
- 2090 PRINT" mulating company.£
- 2100 GOTO7580
- 2110 PRINT"##++ THE DEVOTED DOG ++
- 2120 PRINT"## Worriers, a bit introverted, anti£
- 2130 PRINT" social but most loyal. Dog lady needs£
- 2140 PRINT" constant encouragement and is a doer.£
- 2150 PRINT" Dog men are wary of strangers but£
- 2160 PRINT" will do anything for their friends.£
- 2170 PRINT" They are not too bothered with money.£
- 2180 GOTO7580
- 2190 PRINT"##++ THE PASSIVE PIG ++
- 2200 PRINT"## Pigs are plagued by romantic troubles£
- 2210 PRINT" and are innocent. Pig ladies need to£
- 2220 PRINT" be comforted: they are leaners and£
- 2230 PRINT" dependents and seek no glory and make£
- 2240 PRINT" good mothers. The male pig works hard£
- 2250 PRINT" and is a success.£
- 2260 GOTO7580
- 2270 REM ** COMPATIBILITY **
- 2280 PRINT"###THE RAT AND OTHERS ...
- 2290 PRINT"-----
- 2300 PRINT"###Rat :
- 2310 PRINT"1. Gets on well with horses
- 2320 PRINT"2. Does not like other rats
- 2330 PRINT"3. Cooperates mutually with dogs
- 2340 PRINT"4. Matches with the dragon
- 2350 PRINT"5. Is friendly with cats
- 2360 PRINT"6. And is moderately happy with pigs.
- 2370 PRINTS£
- 2380 PRINT"RAT + OX (Wife)
- 2390 PRINT"RAT + TIGER

MICROMART

COMPUTER CASE

UK101
NASCOM
MANY
OTHERS
5 1/4" drives
8" drives



SUPER
BOARD
TANGIERINE
TUSCAN
BIGBOARD
MICROTAN

All single board computer housing problems are over. All your existing and future expansions will find a neat home for life. The case will house two 5 1/4" drives. Enquire for 8" drives. For fuller details and photo enclose SAE. Case size 24" deep 21" wide 8 1/4" high at the rear.

DISK DRIVES, BBC — all above named computers 5 1/4 inch SS. £139.00. SAE for DS Drives price lists.

MAIL ORDER
ONLY
VIEWING
BY
ARRANGEMENT

**SILENT
COMPUTERS
LTD**

27 WYCOMBE RD
LONDON N17
9XN
01-801 3014
24 hour
ANSAPHONE

pet/vic printer.

For £79.90 (inc. VAT)

Put a ZX Printer (£59.95 from Sinclair) on your PET/VIC using the SOFTEX PRINTERFACE — costing only £19.95 plus £1 p&p.

- * Very high-resolution graphics
 - * Full VIC/PET characters
 - * 42 column printer with superb formatting facilities
 - * Use as normal PRINT/LIST syntax
- Send orders/enquiries to
SOFTEX COMPUTERS,
37 Wheaton Road, Bournemouth BH7 6LH
Telephone 0202 422028
Please state exact computer model.

A.I.M. Research

GOOD SOFTWARE NEEDN'T COST THE EARTH

Forth
Forth is our highly praised implementation of the Forth-79 international standard. It is fast, extensible and fully CP/M compatible, with many enhancements. Used by professionals, but at prices for everyone. From £48.

Word Processing
by Mark of the Unicorn: available for CP/M, Unix and many other operating systems. Screen editor Mince £105*. Paginator Scribble £105*. Both £195*. Mince demo disc & manual £25 (£15 refundable against order).

The Final Word — word processing that goes beyond the Stars! Similar features to Mince and Scribble, in a single package, plus features like recovery from hardware crashes. £195*

Spelling Checker
The Word — best by far, yet cheapest. See Byte review. £49*

Database
dBase II, 30 day trial period! £370

Accounts
Exact Business Systems — complete accounting package, including payroll. £500

Prices marked * assume £1 = \$1.80; All prices are subject to availability and for North Star DD discs. For Superbrain, 8", Apple CP/M, and Torch formats and £5 each to xForth, Mince and Scribble and £10 to Finalword.

Add £3 p&p to all orders and 15% VAT
Dealer enquiries welcomed.

20 Montague Road,
Cambridge CB4 1BX
Tel: (0223) 353985



Exclusive U.K. Distributors — Dealer Enquiries Invited

COMPUSENSE THE 6800/6809 SPECIALISTS



At last — an electronic spreadsheet especially for FLEX and UNIFLEX. Dynacalc does everything you would expect of a 'CALC' program, but it includes row and column sorts and an extensive 'Help' feature which

makes it child's play to handle even the most arduous problems. Flex Version £150.00 excl. VAT Uniflex Version £340.00 excl. VAT Demon Machine Code Monitor cartridge for Dragon 32 £18.40 inc. VAT

We can demonstrate almost every 6800/9 Software item on the market for FLEX. Callers by Appointment.
P.O. BOX 169 LONDON N13 4HT Tel: 01-882 0681



RADEC

ASCII Keyboards



- Upper & Lower Case plus Control
- Low Power Consumption
- Shift & Alpha Lock
- Autorepeat (Model 777)
- Parallel Data Output
- Metal Mounting Frame
- Suitable for Tuscan, Tangerine etc.

Model KB756A	56 key	£39.50
KB710	Numeric Pad	£ 7.50
KB771	72 key	£55.00
KB777	77 key	£62.50

Accessories available include:-

Metal Case	£ 14.95
Edge Connector	£ 1.95
DC to DC Converter	£ 5.00

(for operation off single 5V supply)

High Performance Monitor

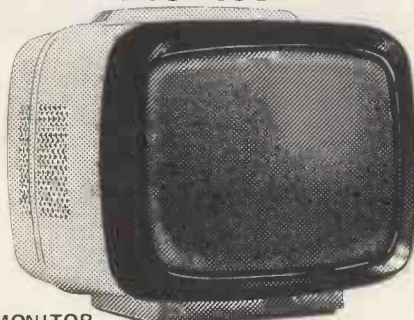

MONITOR

- 12" Green P31 Phosphor
- MULLARD C.R.T.
- 80 Character Line Capability
- 24MHz Video Bandwidth
- 240V AC Input
- Toroidal Transformer
- Composite Video Input
- Ideal for Apple, B.B.C., Micro, Gemini, Nascom, Tuscan, Newbrain etc.

NewBrain

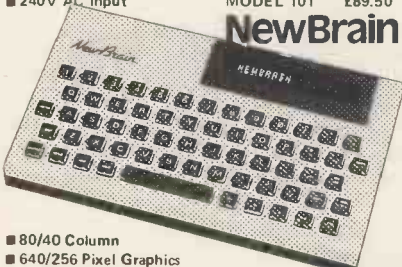

- 80/40 Column
- 640/256 Pixel Graphics
- Z80 with 32K RAM
- Printer Port
- Ideal with above Monitor
- Free Software Cassette and Beginners Guide
- Expansion Port for CPM, Floppies, Winchester and up to 2M Bytes RAM.

MODEL A £199.00
POST FREE

U.K. Orders add 15% VAT on order total
Orders under £50 add £2.00 p&p plus VAT
Orders over £50 add £3.50 p&p plus VAT
Overseas orders add £5.00 to cover part cost postage and documentation.

FULL DATA SHEETS ON REQUEST

Citadel Products Ltd

Dept. PCW, 50 High Street, Edgware, Middlesex, HA8 7EP. Tel: 01-951 1848

```

2400 PRINT"RAT + DRAGON
2410 PRINT"RAT + CAT
2420 PRINT"RAT + DOG
2430 GOTO7500
2440 PRINT"###THE BUFFALO AND OTHERS ...
2450 PRINT"-----
2460 PRINT"### Buffalo
2470 PRINT" 1. Is a good partner for a rooster
2480 PRINT" 2. Should not get involved with Tisers or monkeys
2490 PRINT" 3. Respects dragons
2500 PRINT" 4. Just tolerates a sheep
2510 PRINT" 5. Is very compatible with rats
2520 PRINT" 6. But has no real future with horses
2530 PRINTS$
2540 PRINT"BUFFALO + SNAKE
2550 PRINT"BUFFALO + TIGER
2560 PRINT"BUFFALO + ROOSTER
2570 PRINT"BUFFALO + PIG
2580 GOTO7500
2590 PRINT"###THE TIGER AND OTHERS ...
2600 PRINT"-----
2610 PRINT"### Tiger
2620 PRINT" 1. Trusts a horse
2630 PRINT" 2. Respects dragons
2640 PRINT" 3. Likes the company of dogs
2650 PRINT" 4. But dislikes snakes
2660 PRINT" 5. And is uncooperative with cats
2670 PRINT" 6. Although doesn't mind roosters
2680 PRINTS$
2690 PRINT"TIGER + DRAGON
2700 PRINT"TIGER + TIGER
2710 PRINT"TIGER + PIG
2720 PRINT"TIGER + HORSE
2730 GOTO7500
2740 PRINT"###THE CAT AND OTHERS ...
2750 PRINT"-----
2760 PRINT"### Cat
2770 PRINT" 1. Settles down well with goats
2780 PRINT" 2. Enjoys the presence of pigs
2790 PRINT" 3. Distrusts dogs
2800 PRINT" 4. Hates snakes
2810 PRINT" 5. Likes to be with other cats
2820 PRINT" 6. Never goes near tigers
2830 PRINTS$
2840 PRINT"CAT + CAT
2850 PRINT"CAT + GOAT
2860 PRINT"CAT + ROOSTER
2870 PRINT"CAT + HORSE
2880 PRINT"CAT + PIG
2890 PRINT"CAT + MONKEY
2900 GOTO7500
2910 PRINT"###THE DRAGON AND OTHERS ...
2920 PRINT"-----
2930 PRINT"### Dragon
2940 PRINT" 1. Is a good match for rats
2950 PRINT" 2. Goes well with snakes
2960 PRINT" 3. Cares for roosters
2970 PRINT" 4. Okay with monkeys
2980 PRINT" 5. Dislikes dogs
2990 PRINT" 6. Is respected by most
3000 PRINTS$
3010 PRINT"DRAGON + RAT
3020 PRINT"DRAGON + DRAGON
3030 PRINT"DRAGON + PIG
3040 PRINT"DRAGON + GOAT
3050 GOTO7500
3060 PRINT"###THE SNAKE AND OTHERS ...
3070 PRINT"-----
3080 PRINT"### Snake
3090 PRINT" 1. Is happy with a buffalo
3100 PRINT" 2. Likes goats
3110 PRINT" 3. Prefers to be with other snakes
3120 PRINT" 4. Does not like tigers
3130 PRINT" 5. Is suspicious of dogs
3140 PRINT" 6. Is compatible with dragons
3150 PRINTS$
3160 PRINT"SNAKE + GOAT
3170 PRINT"SNAKE + PIG
3180 PRINT"SNAKE + SNAKE
3190 PRINT"SNAKE + BUFFALO
3200 PRINT"SNAKE + HORSE
3210 GOTO7500
3220 PRINT"###THE HORSE AND OTHERS ...
3230 PRINT"-----
3240 PRINT"### Horse
3250 PRINT" 1. Goes best with a goat
3260 PRINT" 2. Is happy with dragons
3270 PRINT" 3. Likes the rat
3280 PRINT" 4. Likes female cats
    
```

COMPUTER CASSETTES

Screw cassettes with Agfa tape

C5 - 37p	C20 - 43p
C10 - 39p	C25 - 45p
C12 - 40p	C30 - 46p
C15 - 41p	C40 - 49p

plus P & P £1.50 (or 10% if larger).

COMPUTER LEADS

BBC1 7 pin to 2 x 3.5mm, 1 x 2.5mm	£2
BBC2 7 pin to 5 pin, 1 x 2.5mm	£2.50
DRAGON 5 pin to 2 x 3.5mm, 1 x 2.5mm	£2 inc. P & P.

COMPUTER SOFTWARE

ZX81, Spectrum, Vic, Atom, Dragon (soon) BBC.....
We now stock software from all the famous names.
COME AND BUY IN CENTRAL LONDON

data-asette.

Dept. PCW 1

44 Shroton Street, London NW1, 01-258 0409



TELEPHONE OR MAIL OR COME AND SEE US.

PROGRAMS

- 3290 PRINT" 5. Avoids monkeys
- 3300 PRINT" 6. Likes other horses
- 3310 PRINTS\$
- 3320 PRINT"HORSE + DRAGON
- 3330 PRINT"HORSE + GOAT
- 3340 PRINT"HORSE + SNAKE
- 3350 PRINT"HORSE + HORSE
- 3360 PRINT"HORSE + CAT
- 3370 GOTO7580
- 3380 PRINT"GOAT THE GOAT AND OTHERS ...
- 3390 PRINT"-----
- 3400 PRINT"GOA Goat
- 3410 PRINT" 1. Likes horses very much
- 3420 PRINT" 2. Has trust in a drayon
- 3430 PRINT" 3. Enjoys the company of cats
- 3440 PRINT" 4. Is no match for the monkey
- 3450 PRINT" 5. Will not cooperate with pigs
- 3460 PRINT" 6. Is cautious of other goats
- 3470 PRINTS\$
- 3480 PRINT"GOAT + DRAGON
- 3490 PRINT"GOAT + RAT
- 3500 PRINT"GOAT + HORSE
- 3510 PRINT"GOAT + CAT
- 3520 PRINT"GOAT + SNAKE
- 3530 GOTO7580
- 3540 PRINT"MONKEY THE MONKEY AND OTHERS ...
- 3550 PRINT"-----
- 3560 PRINT"MONA Monkey
- 3570 PRINT" 1. Gets on well with drasons
- 3580 PRINT" 2. Is friendly to roosters
- 3590 PRINT" 3. Likes snakes
- 3600 PRINT" 4. Should avoid tigers
- 3610 PRINT" 5. Doesn't mix with many goats
- 3620 PRINT" 6. Dislikes other monkeys
- 3630 PRINTS\$
- 3640 PRINT"MONKEY + DRAGON
- 3650 PRINT"MONKEY + PIG
- 3660 PRINT"MONKEY + SNAKE
- 3670 PRINT"MONKEY + CAT
- 3680 GOTO7580
- 3690 PRINT"ROOSTER THE ROOSTER AND OTHERS ...
- 3700 PRINT"-----
- 3710 PRINT"ROO Rooster
- 3720 PRINT" 1. If female enjoys being with other
- 3730 PRINT" 2. Is compatible with the horse
- 3740 PRINT" 3. Likes drasons
- 3750 PRINT" 4. If female distrusts male roosters
- 3760 PRINT" 5. Never mixes with piss
- 3770 PRINT" 6. Is okay with buffaloes
- 3780 PRINTS\$
- 3790 PRINT"ROOSTER + DRAGON
- 3800 PRINT"ROOSTER + DOG
- 3810 PRINT"ROOSTER + CAT
- 3820 PRINT"ROOSTER + GOAT
- 3830 PRINT"ROOSTER + BUFFALO
- 3840 GOTO7580
- 3850 PRINT"DOG THE DOG AND OTHERS ...
- 3860 PRINT"-----
- 3870 PRINT"DOA Dos
- 3880 PRINT" 1. Is blissfully happy with horses
- 3890 PRINT" 2. Is friendly with other doss
- 3900 PRINT" 3. Makes a good companion for goats
- 3910 PRINT" 4. Totally distrusts cats
- 3920 PRINT" 5. Respects drasons
- 3930 PRINT" 6. Is no partner for tigers
- 3940 PRINTS\$
- 3950 PRINT"DOG + BUFFALO
- 3960 PRINT"DOG + GOAT
- 3970 PRINT"DOG + DOG
- 3980 PRINT"DOG + HORSE
- 3990 PRINT"DOG + DRAGON
- 4000 GOTO7580
- 4010 PRINT"PIG THE PIG AND OTHERS.
- 4020 PRINT"-----
- 4030 PRINT"PIA Pig
- 4040 PRINT" 1. Likes the company of cats
- 4050 PRINT" 2. Goes well with drasons
- 4060 PRINT" 3. Doesn't mind being with a horse
- 4070 PRINT" 4. Is no match for a goat
- 4080 PRINT" 5. Tries not to be with other piss
- 4090 PRINT" 6. Never trusts a snake
- 4100 PRINTS\$
- 4110 PRINT"PIG + DOG
- 4120 PRINT"PIG + CAT
- 4130 PRINT"PIG + DRAGON
- 4140 PRINT"PIG + HORSE
- 4150 PRINT"PIG + BUFFALO
- 4160 GOTO7580
- 4170 REM ** FAMOUS ANIMALS **

* CASES *

Foam insert easily cut
to suit your micro

23 1/2" x 15" x 4 1/2" £36
30" x 18" x 6 1/2" £45

Made from aluminium/ply

Post and package 10%. VAT extra

Cowfold Cases

Redlion Stables, Cowfold
West Sussex RH13 8BT
Tel: Cowfold 760

★★ GROWN OUT OF YOUR MACHINE?? ★★

We want secondhand
microcomputer
hard- and soft-ware

Write with details or telephone

Business Education Ltd (Microcomputing Division)

103 Great Russell Street
London WC1

01-437 4043/6425

MICROMART

BUSINESS SOFTWARE

INTEGRATED ACCOUNTS

Prepares daybooks, cash books, sales,
purchase, nominal ledgers, trial
balance, profit and loss accounts.

Normal price £1200.
SPECIAL OFFER £895.

PAYROLL

All valid PAYE codes are catered for.
Facilities for different companies and
branches. Cash analysis, payslips,
P45 P60 etc. Normal price £500.

SPECIAL OFFER £395.

HARDWARE

North Star Horizon and Advantage
Superbrain. All hardware and soft-
ware are under warranty for 12
months.

MICROSYS LTD.

58 High Street, Prescott L34 6HQ
051-426 7271/051-430 6650

AT LAST! REAL COMPUTER INSURANCE. (MARTIN BANKS PLEASE NOTE)

EQUIP VALUE UP TO	(1) ALL RISKS X/S £10	(2) BREAK- DOWN X/S £25	COMBINED (1 + 2)
£1000	£12.50	£17.50	£25.00
£1500	£15.00	£37.50	£45.00
£2000	£17.50	£50.00	£60.00
£2500	£21.00	£62.50	£75.00

RATES FOR DOMESTIC AND HOBBY USE

PROFESSIONAL AND BUSINESS RATES ON APPLICATION
COVERS C.P.U. AND PERIPHERALS.

DESIGNED FROM THE FLOOR UP FROM THE COMPUTER
USER.

ALSO, SPECIAL SCHEME OBTAINABLE FROM US FOR
REPAIR/COMPUTER ENGINEERS. SEND FOR DETAILS.

ALL OF THE ABOVE UNIQUE INSURANCE COVER,
OBTAINABLE ONLY FROM US.

PETER DAVIES ASSOCIATES

INSURANCE PENSIONS FINANCE

29 DALTON STREET, CATHAYS, (0222) 394277
CARDIFF CF2 4HB

DISCS . STATIONARY . PRINTERS .

Floppy diskettes in boxes of 10

5 1/4" s/s s/density s/sectorod only £15.00
8" s/s s/density s/sectorod only £15.00

(Add £1.00/box P & P + Vat.)

Continuous stationery- 1000 sheets

9 1/2" x 11" Plain single part only £4.95
9 1/2" x 11" Plain (with 1/2" margins) only £5.96
14 1/2" single part only £7.00

(Includes delivery, excludes Vat.)

Printers from Newbury Labs

Special Introductory Offer

A free box of 9 1/2" x 11" Stationery with every
Newbury Printer purchased

The 8510 (11" carriage) only £480.00
The 1550 (15" carriage) only £650.00

Printer ribbons

8510/1550 only £7.50
Epsom MX80 only £4.56
Centronic 700 (zip pack) only £3.08

Price - single item but sold in boxes of 5
(Add £1.00 P & P + Vat.)



CDP Consultants Limited
Clavering 079985-617

Every computer needs a
CHATTERBOX!

"OK Spock, you win this time..."

NEW!

SAVE ££££

ONLY

£49

for
**ZX81
SPECTRUM**

NASCOM, VIC, PET,
BBC, APPLE, TRS80,
IBM, CRAY, ETC.
(Please state)



At last! Genuine phonetic synthesis at a sensible price. Gives your computer an *unlimited* vocabulary (nothing more to buy!). Self contained speaker/amplifier, Sinclair connector etc, **PLUS** Expansion socket for **BIG EARS AND** Monitor socket for Music Board. Full instructions, technical notes and programme examples supplied with this outstanding educational unit.

OR COMPLETE D.I.Y KIT **£39**
DEALER ENQUIRIES WELCOME

As seen on BBC TV "Computer Programme"

*** BIG EARS ***

SPEECH
INPUT
FOR ANY
COMPUTER



Hugely successful Speech Recognition System, complete with microphone, software and full instructions. **BUILT TESTED & GUARANTEED**

ONLY **£49**

PLEASE STATE COMPUTER: UK101, SPECTRUM, ATOM, NASCOM2,
Vic 20, Micron, ZX80/81, PET, TRS80, MZ80K, APPLE II, BBC MICRO
NEW: FAST MACHINE CODE FOR ZX SPECTRUM **£7.40**

ZX81/SPECTRUM

MUSIC SYNTHESISER (STEREO)

+ 16 LINE CONTROL PORT



Play 3-part music, sound effects, drums etc. Full control of attack, decay and frequency. Input/Output lines provide control and monitor facility for Home Security, Robot Control, Model Railway etc. etc. Works with or without 16K RAM.

Add keyboard to make a live performance polyphonic synthesiser! Full instructions/software included.

AMAZING VALUE AT ONLY **£19.50** (KIT)
Extra 23 way connectors at £2.60 **£25.50** (BUILT)

THE COMPOSER

Music Programme for above synthesiser.

Enter and play 3 part harmony.

Includes demonstration tunes. Recommended **£7.40**



COLOUR MODULATOR KIT **£15**

RGB in, PAL/UHF out (not for ZX) BUILT **£20**

SPECIAL OFFER I.C. **£18**

SPEECH OUTPUT CHIP SX-01

Phoneme Speech Processor DATA **£0.60**

Please add VAT at 15% to all prices.
Barclay/Access orders accepted by telephone

All enquiries
S.A.E. please

**WILLIAM
STUART
SYSTEMS Ltd**

Dower House, Bittericay Road,
Herongate, Brentwood,
Essex CM13 3SD, England
Telephone: Brentwood (0277) 810244

- 4180 PRINT"GB ## FAMOUS RATS ##
- 4190 PRINT"GB Lucrezia Borgia
- 4200 PRINT"James Callaghan
- 4210 PRINT"Pope John Paul II
- 4220 PRINT"William Shakespeare
- 4230 PRINT"Jimmy Carter
- 4240 PRINT"Doris Day
- 4250 PRINT"Marlon Brando
- 4260 PRINT"Charlotte Bronte
- 4270 PRINT"Mozart
- 4280 PRINT"Yves St. Laurent
- 4290 PRINT"Leo Tolstoy
- 4300 PRINT"Jules Verne
- 4310 PRINT"Prince Charles
- 4320 GOTO7580
- 4330 PRINT"GB ## FAMOUS BUFFALO ##
- 4340 PRINT"GB Walter Disney
- 4350 PRINT"Emperor Hirohito
- 4360 PRINT"Richard Nixon
- 4370 PRINT"Gerald Ford
- 4380 PRINT"Vincent van Gogh
- 4390 PRINT"Sammy Davis Jr.
- 4400 PRINT"Peter Sellers
- 4410 PRINT"Richard Burton
- 4420 PRINT"Marsaret Thatcher
- 4430 PRINT"Melina Mecoird
- 4440 PRINT"Robert Redford
- 4450 PRINT"Vanessa Redgrave
- 4460 PRINT"Dustin Hoffman
- 4470 PRINT"Adolf Hitler
- 4480 PRINT"Charlie Chaplin
- 4490 PRINT"Princess Diana
- 4500 GOTO7580
- 4510 PRINT"GB ## FAMOUS TIGERS ##
- 4520 PRINT"GB Charles de Gaulle
- 4530 PRINT"Ludwig van Beethoven
- 4540 PRINT"Dwight Eisenhower
- 4550 PRINT"Princess Anne
- 4560 PRINT"Stevie Wonder
- 4570 PRINT"Simon Bolivar
- 4580 PRINT"Alec Guinness
- 4590 PRINT"Queen Elizabeth II
- 4600 PRINT"Valerie Giscard D'Estains
- 4610 PRINT"St. Francis Xavier
- 4620 PRINT"Marylyn Monroe
- 4630 PRINT"Emily Bronte
- 4640 PRINT"Diana Rigg
- 4650 PRINT"Rudolf Nureyev
- 4660 GOTO7580
- 4670 PRINT"GB ## FAMOUS CATS ##
- 4680 PRINT"GB Jomo Kenyatta
- 4690 PRINT"Kins Olav U of Norway
- 4700 PRINT"Benjamin Spock
- 4710 PRINT"Orson Welles
- 4720 PRINT"David Rockefeller
- 4730 PRINT"Insrid Bersman
- 4740 PRINT"Fidel Castro
- 4750 PRINT"George Scott
- 4760 PRINT"Albert Einstein
- 4770 PRINT"Joseph Stalin
- 4780 PRINT"Queen Victoria
- 4790 PRINT"David Frost
- 4800 GOTO7580
- 4810 PRINT"GB ## FAMOUS DRAGONS ##
- 4820 PRINT"GB Kings Constantine
- 4830 PRINT"John Lennon
- 4840 PRINT"Ringo Starr
- 4850 PRINT"Francisco Franco
- 4860 PRINT"Jimmy Connors
- 4870 PRINT"Joan of Arc
- 4880 PRINT"Salvador Dali
- 4890 PRINT"Frank Sinatra
- 4900 PRINT"Edward Heath
- 4910 PRINT"Vehudi Menuin
- 4920 PRINT"Harold Wilson
- 4930 PRINT"Anthony Quinn
- 4940 PRINT"Kirk Douglas
- 4950 PRINT"Walter Mondale
- 4960 GOTO7580
- 4970 PRINT"GB ## FAMOUS SNAKES ##
- 4980 PRINT"GB Picasso
- 4990 PRINT"Maao Tse-Tuns
- 5000 PRINT"Paul Getty
- 5010 PRINT"Howard Hushes
- 5020 PRINT"Greta Garbo
- 5030 PRINT"Schubert
- 5040 PRINT"Henry Ford II
- 5050 PRINT"John F Kennedy
- 5060 PRINT"Gamal Nasser
- 5070 PRINT"Indira Gandhi
- 5080 PRINT"Abraham Lincoln
- 5090 PRINT"Edsar Allan Poe
- 5100 PRINT"Kins Hassan
- 5110 PRINT"Jacqueline Onassis
- 5120 PRINT"Princess Grace of Monaco
- 5130 GOTO7580
- 5140 PRINT"GB ## FAMOUS HORSES ##
- 5150 PRINT"GB Neil Armstrong
- 5160 PRINT"Lord Snowdon
- 5170 PRINT"F D Roosevelt
- 5180 PRINT"Barbra Striesand
- 5190 PRINT"Paul McCartney
- 5200 PRINT"Raueal Welsh
- 5210 PRINT"Rembrandt
- 5220 PRINT"Leonid Brezhnev
- 5230 PRINT"Duke of Windsor
- 5240 PRINT"Chris Evert-Lloyd
- 5250 PRINT"Theodore Roosevelt
- 5260 PRINT"Kurt Waldheim
- 5270 PRINT"Helmut Schmidt
- 5280 PRINT"Anwar Sadat
- 5290 GOTO7580
- 5300 PRINT"GB ## FAMOUS GOATS ##
- 5310 PRINT"GB Andy Warhol
- 5320 PRINT"Muhammad Ali
- 5330 PRINT"Billie Jean Kins
- 5340 PRINT"Kins George IU
- 5350 PRINT"Michelangelo
- 5360 PRINT"James Michener
- 5370 PRINT"Sir Laurence Olivier
- 5380 PRINT"Pierre Trudeau
- 5390 PRINT"Tan Smith
- 5400 PRINT"The Shah of Iran
- 5410 PRINT"Tan Flenins
- 5420 GOTO7580
- 5430 PRINT"GB ## FAMOUS MONKEYS ##
- 5440 PRINT"GB Leonardo da Vinci
- 5450 PRINT"Charles Dickens
- 5460 PRINT"Edward Kennedy
- 5470 PRINT"Harry Truman
- 5480 PRINT"Eleanor Roosevelt
- 5490 PRINT"Mick Jagger
- 5500 PRINT"Duchess of Windsor
- 5510 PRINT"Paul Gausin
- 5520 PRINT"John Milton
- 5530 PRINT"Bette Davis
- 5540 PRINT"Federico Fellini
- 5550 PRINT"Mary Heminsway
- 5560 GOTO7580
- 5570 PRINT"GB ## FAMOUS ROOSTERS ##
- 5580 PRINT"GB Prince Philip
- 5590 PRINT"Peter Ustinov
- 5600 PRINT"Alex Haley
- 5610 PRINT"Elton John
- 5620 PRINT"D K Ludwis
- 5630 PRINT"Paul Gallico
- 5640 PRINT"Baron Guy Rothschild
- 5650 PRINT"Andrei Gromyko
- 5660 PRINT"Katherine Hepburn
- 5670 PRINT"Errol Flynn
- 5680 GOTO7580
- 5690 PRINT"GB ## FAMOUS DOGS ##
- 5700 PRINT"GB David Niven
- 5710 PRINT"Charles Bronson
- 5720 PRINT"Pierre Cardin
- 5730 PRINT"Ava Gardner
- 5740 PRINT"Voltaire
- 5750 PRINT"Sir Winston Churchill
- 5760 PRINT"Elvis Presley
- 5770 PRINT"Brigitte Bardot
- 5780 PRINT"Sophia Loren
- 5790 PRINT"Carol Burnett
- 5800 PRINT"Ilie Nastatie
- 5810 PRINT"Liza Minelli
- 5820 GOTO7580
- 5830 PRINT"GB ## FAMOUS PIGS ##
- 5840 PRINT"GB Ronald Reagan
- 5850 PRINT"Henry Kissinger
- 5860 PRINT"Kins Hussein
- 5870 PRINT"Julie Andrews
- 5880 PRINT"Woodr Alien
- 5890 PRINT"Ernest Heminsway
- 5900 PRINT"Humphrey Bosart
- 5910 PRINT"Alfred Hitchcock
- 5920 PRINT"John D Rockefeller
- 5930 PRINT"Prince Rainier of Monaco

BDB Computer Consultants

The Last one	£186	Winchester	from £607
Mailing List	£15	Apple Compatible 6.7MB	£1195
Stop Control	£20	MX80 MF3	£325
		Olivetti praxis	£399
Disk Drives	from £145	Oric 16K	£86
Apple Compatible	£180	Oric 48K	£147

Carriage and VAT extra.
Send for details

Mail order Warehouse
New Street, Cockenzie, East Lothian

NEWBRAIN

- Full Hex Monitor - Including Load and Save Routines to Tape.
- Disassembler - Disassembles Machine Code to Standard Z-80 Mnemonics
- Space Chase - Fast Machine Code Game Offering 9 Skill Levels
- Pontoon - Cards Displayed Graphically. Plays Standard Rules.

Programs on one Cassette, with full instructions. £5 including p & p. Cheques/Postal Orders to: M. Robinson, Flat 2, 5 Eastern Villas Road, Southsea, Hants.

OSBORNE 1

- Monitor + cable **£104**
- Adler/Epson/OK1 **£CALL**
- Olivetti ET121+RS232 **£799**
- OSBORNE **£CALL**
- Games for Osborne **from £19.95**

We specialise in Osborne & hold large stocks of above.
CALL FOR SUPERB PRICES

FRASER ASSOCIATES
Buckingham (02802) 6087

PROGRAMS

```

5940 PRINT"Prince William
5950 GOTO7580
5960 REM ** LINES **
5970 PRINT"### THE RAT"
5980 PRINT"
=====
5990 PRINT"###I am the self proclaimed acquisitor.
6000 PRINT"I am a link yet I function as a completeunit.
6010 PRINT"I aim at encompassing heights
6020 PRINT"And strike my target
6030 PRINT"Sure and steady.
6040 PRINT"Life is one joyous journey for me.
6050 PRINT"Each search must end with a new quest.
6060 PRINT"I am progress, exploration and insight.
6070 PRINT"I am the womb of activity.###
6080 PRINT" I AM THE RAT.
6090 GOTO7580
6100 PRINT"### THE BUFFALO
6110 PRINT"
=====
6120 PRINT"###Mine is the stabilizing force
6130 PRINT"That perpetuates the cycle of life.
6140 PRINT"I stand immobile against the
6150 PRINT"The test of adversity,
6160 PRINT"Resolute and unimpeachable.
6170 PRINT"I seek to serve Intensity,
6180 PRINT"To bear the burdens of righteousness.
6190 PRINT"I abide by the laws of nature-
6200 PRINT"Patiently pushing the wheel of Fate.
6210 PRINT"Thus I shall weave my destiny.
6220 PRINT"### I AM THE BUFFALO.
6230 GOTO7580
6240 PRINT"### THE TIGER
6250 PRINT"
=====
6260 PRINT"###I am the delightful Paradox.
6270 PRINT"All the world is my stage.
6280 PRINT"I set new trails ablaze;
6290 PRINT"I seek the unattainable;
6300 PRINT"And try the untried.
6310 PRINT"I dance to life's music
6320 PRINT"In say abandon.
6330 PRINT"Come with me on my carousel rides
6340 PRINT"See the myriad of colours,
6350 PRINT"The flickering lights.
6360 PRINT"All hail me the unparalleled performer."
6370 GOTO7580
6380 PRINT"### THE CAT
6390 PRINT"
=====
6400 PRINT"###I am in tune with the
6410 PRINT"Pulse of the universe.
6420 PRINT"In my quiet and solitude
6430 PRINT"I hear the melodies of soul.
6440 PRINT"I float above commonplace
6450 PRINT"Dissent and decay.
6460 PRINT"I subdue by my ability to conform
6470 PRINT"In delicate pastel hues.
6480 PRINT"I epitomize harmony and inner peace."
6490 PRINT"### I AM THE CAT.
6500 GOTO7580
6510 PRINT"### THE DRAGON
6520 PRINT"
=====
6530 PRINT"###I am an unquenchable fire.
6540 PRINT"The centre of all energy,
6550 PRINT"The stout heroic heart.
6560 PRINT"I am the truth and light,
6570 PRINT"I hold power and glory in my sway.
6580 PRINT"My presence
6590 PRINT"Disperses dark clouds.
6600 PRINT"I have been chosen
6610 PRINT"To tame the Fates.
6620 PRINT"### I AM THE DRAGON.
6630 GOTO7580
6640 PRINT"### THE SNAKE
6650 PRINT"
=====
6660 PRINT"###Mine is the wisdom of the ages.
6670 PRINT"I hold the key to the mysteries of life
6680 PRINT"Castings my seeds on fertile ground
6690 PRINT"I nurture them with constancy and
PURPOSE.
6700 PRINT"My sights are fixed.
6710 PRINT"My gaze unchangins.
6720 PRINT"unyielding, inexorable and deep
6730 PRINT"I advance with steady, unslackened gait.
6740 PRINT"The solid earth beneath me.
6750 PRINT"### I AM THE SNAKE
6760 GOTO7580
6770 PRINT"### THE HORSE
6780 PRINT"
=====
6790 PRINT"###I am the Kaleidoscope of the mind."
6800 PRINT"I impart light, colour and perpetual motion.
6810 PRINT"I think, I see, I am moved by electricalfluidity.
    
```

MICROMART

PET HI-RES!

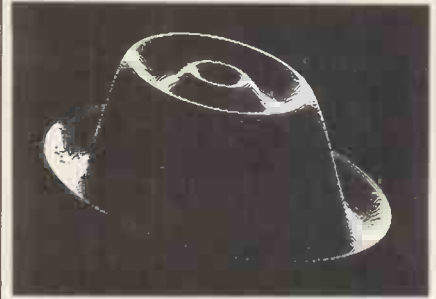

£149 plus VAT brings you 320 by 200 dot resolution on your PET/IBM screen. No soldering is necessary - SUPERSOFT graphics boards just plug in!

Three models are available: for 80 column machines specify the HR80 board; large screen 40 column machines need the HR40B board; for other machines (except very early PETs with no Rom sockets) order the HR40 board. All three boards add 8k of RAM and include GRAPHIX machine code utility software in EPROM. Over 500 boards have been installed in the UK - by schools, colleges, hospitals, research establishments, even home users - and hundreds more are being exported worldwide.

SUPERSOFT are Commodore specialists. We have a large range of software, accessories, and supplies for existing COMMODORE machines and will be supporting new machines as they are launched. Our 20 page catalogue is free to owners and users of PET/IBM machines - but here's a selection of products to whet your appetite! Add 15% VAT to all prices.

VISICALC	£148	VISICALC 96	£170
SIMPLICALC TAPE	£26	SIMPLICALC DISK	£32
COMMAND-O CHIP	£59.95	MICROSCRIPT	£425
PAPERMATE PLUS	£45	DTL COMPILER	£99.50

SUPERSOFT

Winchester House, Canning Road, Walsstone, Harrow Middlesex, HA3 7SJ, England, Telephone 01-861 1166

ELIMINATE FAULTY CASSETTE!

The Specialists in Software Duplication

DataClone is the first company in the UK established specifically for the duplication of data cassettes.

All other duplicating houses are audio orientated - only DataClone has a duplicating system designed from scratch purely to handle computer information.

The result?

Greatly improved reliability in data transfer rates from 300 to beyond 2400 baud - previously unattainable.

All formats catered for. Quantities from 100 to infinity.

Contact us now for brochure.

DataClone - the first specialist service for computer cassettes.



DATACLONE

1-7 Harewood Avenue,
London NW1 6LE
Tel 01-724 3768 Telex 21879

SECOND USER EQUIPMENT BARGAINS

01-450 2417 01-450 9763

Samples of stock

IMS System £4000.00
comprising Intertec VDU, 12 flask S100
Slot card cage and power supply with ZXA.
64K dynamic RAM 2 RS232 port.
120 CPS by directional printer,
three 8" floppy disk drives with controller,
all in attractive teak finish desk.
OUR PRICE £1850.00

Zilog NCZ 10 flask, 5 systems specification as
above except not S100 bus, and CIFER VDU.
OUR PRICE £1700.00

Various other well known makes of second use
Micro Systems and Mini Systems. All at amazing
prices. Prices exclude VAT and delivery.

PRINTERS

The OKI MICROLINE Range

Speeds from 80-200 CPS
Prices from under £200

For details and
demonstration contact:

MICROFARM

The Old Farmhouse, Jasons Hill,
CHESHAM, Bucks. HP5 3QW
Tel. 0494-783915

MICROCOMPUTER INSURANCE

Comprehensive cover at a reasonable premium:-

- All Risks Cover (incl Transit) – up to £8,500 for £20
- Increased Cost of working – to reinstate lost data
- Breakdown and Derangement md alternative to maintenance agreement

Write with details to:

Geoffrey Hoodless & Associates
 Freepost (no stamp required)
 Woking, Surrey GU21 3BR
 Tel: Woking (04862) 61082
 Answering Service

software for SHARP MZ-80A and MZ-80K

DUSTCOVERS — £5.95. For the MZ-80K or MZ-80A computers and the P3 and P6 printers. Black, waterproof, tailored. A must for every Sharp owner.

CONTRACT BRIDGE — £12.95. Complete 4-handed contract bridge — you against the computer. Full bidding, superb play, this is absolutely outstanding! Ruffs, slams finessees. Blackwood — they're all there. You can even bid or play a hand again, or even define your own hands! Unbeatable value — you'll play this time and time again. Order now, you won't find this program anywhere else.

FOOTBALL MANAGER — £8.95. Brilliant simulation of this, the most hazardous profession of all. Trade players, play matches, decide tactics. Build a team of world repute. But beware — we don't make it easy. You'll have to cope with injuries, the bank manager and, not least, irate Directors. Can you stand the pressure? Or will you fall, like so many before?

COSMIAD — £6.95. First Space Invaders, now Cosmiad! Watch out for the aliens peeling off to attack! Excellent.

AIRPORT '83 — £5.50. Full and exacting aircraft simulator. Pilot your plane to a safe landing.

COMPUTER ASSISTED LEARNING. Whole range of superb, meticulously assembled programs. Send for full details.

MZ-80K only — MOONLANDER £5.50.

BIORHYTHM £4.95, **BANK ACCOUNT** £5.50.

BACKGAMMON £5.50. Many more.

PRICES FULLY INCLUSIVE



Write or phone for full catalogue
 Cash with order or ACCESS
 Orders despatched by return

HIGHLIGHT SOFTWARE

3 Nether Court, Halstead, Essex CO9 2HE
 Telephone (0787) 475714

OSBORNE 1

FREE!! D Base 2 with double density machine £1375.00 + VAT

4B microcentres

North Bar, Banbury, Oxon. OX16 0TF Telephone (0295) 66555

PET PET PET PET PET PET

*** HI-RESOLUTION GRAPHICS ***

A high resolution graphics board that gives a 64,000 dot (320 x 200) resolution. Versions available for any dynamic ram Pet. BASIC 2.3.4, FAT40 & 80 columns. No soldering or track cutting required, supplied complete with fast GRAPHIX software in ROM and full fitting & operating instructions. £149.00

*** SUPER ROM SELECTOR ***

A high quality printed circuit board giving 64K of utility ROM space, software selectable!!! Allows 16 x 4K ROMs/EPROMs to reside in the expansion area of your PET. One "POKE" enables any two ROMs at a time. Suitable for bank-switched software. £75.00

*** PET UPGRADES ***

WHILE-U-WAIT service! (Dynamic ram pets only.)
 Memory expansion: 8K - 32K. £59.90
 16K - 32K. From £48.70
 8K - 16K. £38.26

40 column (12" VDU only) to 80 column conversion. 40 to 80 column. £89.00
 40 to 80 column switchable (two machines in one!) £105.00
 Full keyboard functions:- i.e. TAB, ESC, REPEAT, SCROLL up/down, define WINDOW, lower case/graphics mode & DELETE from/tocursor. All available in direct or program mode.

*** REPAIRS AND SERVICING ***

Fast and efficient repairs to all Commodore computers at reasonable prices. WHILE-U-WAIT service whenever possible.

Please add VAT to the prices shown at the current rate.

Telephone Mick Bignell for more details at:-

MICROPORT

7 Clydesdale Close,
 Borehamwood, Herts. WD6 2SD.
 Tel: 01-953-8385

PROGRAMS

- 6820 PRINT"Constant only in my inconstancy
- 6830 PRINT"I am unshackled by mundane holds,
- 6840 PRINT"Unchecked by sturdy, bindings soals.
- 6850 PRINT"I run unimpeded by virgin paths.
- 6860 PRINT"My spirit unconquered -
- 6870 PRINT"My soul forever free.
- 6880 PRINT"### I AM THE HORSE
- 6890 GOTO7580
- 6900 PRINT"### THE GOAT
- 6910 PRINT"=====
- 6920 PRINT"#####I am nature's special child.
- 6930 PRINT"I trust and am rewarded by trust.
- 6940 PRINT"Fortune smiles upon my countenance.
- 6950 PRINT"All things blossom
- 6960 PRINT"In the gentleness of my love.
- 6970 PRINT"I strive to find beauty in all I behold
- 6980 PRINT"I am fare of face
- 6990 PRINT"And full of grace.
- 7000 PRINT"### I AM THE GOAT
- 7010 GOTO7580
- 7020 PRINT"### THE MONKEY
- 7030 PRINT"=====
- 7040 PRINT"#####I am the seasoned traveller
- 7050 PRINT"Of the labyrinth.
- 7060 PRINT"The genius of alacrity.
- 7070 PRINT"Wizard of the impossible.
- 7080 PRINT"My brilliance is yet unmatched
- 7090 PRINT"In its originality.
- 7100 PRINT"My heart is filled with potent magic
- 7110 PRINT"That could cast a hundred spells.
- 7120 PRINT"I am put together
- 7130 PRINT"For mine own pleasure.
- 7140 PRINT"### I AM THE MONKEY
- 7150 GOTO7580
- 7160 PRINT"### THE ROOSTER
- 7170 PRINT"=====
- 7180 PRINT"#####I am on hand
- 7190 PRINT"To herald in the day,
- 7200 PRINT"And to announce its' exit.
- 7210 PRINT"I thrive by clockwork and precision.
- 7220 PRINT"In my unending quest for perfection
- 7230 PRINT"All things will be restored to their rightful place.
- 7240 PRINT"I am the exacting taskmaster.
- 7250 PRINT"The ever watchful administrator.
- 7260 PRINT"I seek perfect order in my world.
- 7270 PRINT"I represent unflinching dedication.
- 7280 PRINT"### I AM THE ROOSTER
- 7290 GOTO7580
- 7300 PRINT"### THE DOG
- 7310 PRINT"=====
- 7320 PRINT"#####The martial strains have summoned me";
- 7330 PRINT"To hear your sorrows.
- 7340 PRINT"Still your pain."
- 7350 PRINT"I am the protector of justice;
- 7360 PRINT"Equality - my sole friend.
- 7370 PRINT"My vision never blurred by cowardice,
- 7380 PRINT"My soul never chained.
- 7390 PRINT"Life without honour
- 7400 PRINT"Is life in vain.
- 7410 PRINT"### I AM THE DOG
- 7420 GOTO7580
- 7430 PRINT"### THE PIG
- 7440 PRINT"=====
- 7450 PRINT"#####of all God's children
- 7460 PRINT"I have the purest heart.
- 7470 PRINT"With innocence and faith,
- 7480 PRINT"I walk in Love's protective light.
- 7490 PRINT"By siving of myself freely
- 7500 PRINT"I am richer and twice blest.
- 7510 PRINT"Bounded to all mankind by common fellow-ship.
- 7520 PRINT"My goodwill is universal
- 7530 PRINT"And knows no bounds."
- 7540 GOTO7580
- 7550 PRINT"#####Thank you."
- 7560 FOR I=1 TO 2000:NEXT
- 7570 RUN
- 7580 PRINT" Press any key"
- 7590 GETA\$: IFA\$="GOTO7590
- 7600 GOTO920

: GO FORTH &*;

Complete OIY FORTH kit
 Installation manual £10
 How to do it + model + definitions + editor
 Source code listing for one processor. . . £10
 6502, 6800, 6809, 8080/Z80, 8086/8088,
 9900, 1802
 Manual + one listing £19
 Ready to run
 Lab Microsystems Z80 FORTH FOR CP/M
 £45 + VAT
 includes editors, assemblers, utilities, and
 games; good documentation; 8" or 5" formats
 FORTH on disc for most machines inc. PET,
 TRS80, FLEX, CP/M, IBM, and more
 from £50



MicroProcessor Engineering Ltd
 21 Hanley Road Shirley
 Southampton SO1 5AP
 Tel: Southampton 775482

OPEN HOUSE FOR COMPUTER NOVICES

Choose your time — day or evening.
 Learn at your own pace on Apple, Pet or CP/M
 Computers BASIC programming and
 Business Packages
 including
 Trial Course £15 — 4 hours computing
 practice.

Brochure from:
MICROCOMPUTER ADVISORY CENTRE,
 Polytechnic of the South Bank,
 Borough Road, London SE1 0AA.
 Tel. 01-928 8989 Ext. 2468.

PET Patience

By Richard Still

Patience games (card games for one player) go back a long time, but new ones are still being invented, and there must by now be some hundreds known. Here is one thought to be at least a century old, but brought right up to date by being programmed for a PET 3032. It occupies about 7k and should run on old or new ROMs.

The same requires constant vigilance, and some skill in judging whether or not to

move a card at a particular time. The PET gives a complete shuffle and re-deal in 8 seconds, and it moves each card of sequence with only two keystrokes. It will not countenance the slightest attempt at cheating, and it never drops the cards on the floor! When all hidden cards have been uncovered, the PET will take over automatically and complete the foundation sequences for you.

```

10 REM*****STILTON PATIENCE*****
20 REM*****BY R.W.STILL*****
30 REM*****INITIALISE*****
40 POKE836,0:POKE837,0:GOTO1400
50 CLR:RESTORE:PRINT"
60 PRINT" I'M SHUFFLING THE PACK "
70 PRINT"
80 DIMF$(12),P$(52),S$(4),N$(13),A$(7,20):FORN=1TO7:TP(N)=N:BP(N)=N:NEXT:L=1
90 DIMF(4),FP(4):A=RND(-1):P=0
100 C$="
110 D$="
120 E$="
130 DE$="
140 REM*****SHUFFLE PACK*****
150 FORI=1TO4:READS$(I):NEXT:FORI=1TO13:READN$(I):NEXT
160 DATA"♠","♥","♦","♣",A,2,3,4,5,6,7,8,9,T,J,Q,K
170 CAS$="AA#A#A#A#2#2#2#2#3#3#3#3#4#4#4#4#5#5#5#5#6#6#6#6#7#7#7#7#8#8#8#8"
180 CAS$=CAS$+"9#9#9#9#T#T#T#T#J#J#J#J#Q#Q#Q#Q#K#K#K#K":C=52
190 FORI=1TO52:A=INT(RND(1)*C)+1:P$(I)=MID$(CAS$,2*A-1,2)
200 L$=LEFT$(CAS$,A-1)*2:R$=RIGHT$(CAS$,LEN(CAS$)/2-A)*2:CA$=L$+R$:C=C-1:NEXT
210 REM*****PRESENT LAY-OUT*****
220 PRINT"♠":FORI=1TO7:FORJ=1TOI:PRINT"♠":;FORK=1TOJ:PRINT"♠":;NEXT
230 FORK=1TOI:IFK=1THEN250
240 PRINT"♠";
250 NEXT
260 IFJ=BP(I)THENPRINTP$(L):A$(I,J)=P$(L):L=L+1:NEXT:NEXT:GOTO280
270 A$(I,J)=P$(L):PRINT"♠":;L=L+1:NEXT:NEXT
280 FORI=29TO52:DE$=DE$+P$(I):NEXT
290 PRINT"♠"TAB(27)"":FORI=1TO13:PRINTTAB(27)"":;
300 NEXT:PRINTTAB(27)"":;
310 PRINT"♠ 1 2 3 4 5 6 7 8 9 T J Q K"
320 REM*****MAIN LOOP-FIRST INPUT*****
330 IFD$<">"THEN360
340 FORI=1TO7:IFBP(I)>1THENI=8:NEXT:GOTO360
350 NEXT:GOTO1720
360 PI=0:X=0:Y=0:T=0:TT=0:PRINTD$;E$;D$;"FROM ";
370 FORI=1TO10:GETQ$:NEXT
380 GETA$:IFA$=""THEN380
390 IFA$="D"THEN1270
400 IFA$="E"THEN1110
410 IFA$="P"THENPI=1:GOTO480
420 REM*****SET UP X AND Y*****
430 IFA$>"7"ORAF$<"1"THEN460
440 T=VAL(A$):X=T:Y=BP(X)
450 IFY=0THEN330
460 IFT=0THEN380
470 REM*****SECOND INPUT*****
480 PRINTA$ TO ";
490 GETB$:IFB$=""THEN490
500 IFB$="F"THENNT=8:GOTO520
510 TT=VAL(B$)
520 IFTT=0THEN490
530 IFTT=TTTHEN490
540 PRINTB$;
550 IFTT=8THENY=TP(X)
560 IFPI=1THENX$=H$:GOTO580
570 X$=A$(X,Y)
580 GOSUB970
590 IFTT=8THEN830
600 IFTP(TT)=0ANDINU<13THEN330
610 IFTP(TT)=0THENBP(TT)=1:GOTO670
620 S1=SU:N1=NU
630 X$=A$(TT,TP(TT))
640 GOSUB970
650 IFNU-1>CN1OR1-SU>S1THEN50
    
```

MICROMART

Due to our part exchange bonanza 01 Computers can now offer the following systems.

1. Exdemonstration Apple 3 with extra disk drive £2000.00
2. Sharp MZ 80B £650.00
3. Sharp MZ80K with interface and turn drive £675.00
4. Sharp PC 1500 £150.00
5. Hewlett Packard HB 83 £945.00
6. Microtan Tangerine £35.00
7. HP41C £55.00
8. Tandl Model level 2 with twin disk drives and 32K expansion £625.00
9. Exdemonstration IBM PC £1995.00
10. Assorted Apple 2. £ offers
11. Exdemonstration Osbourne 1 new style £ offers

Above prices exclude VAT and systems can be split. All carry minimum of 30 days return to base warranty.

If you do not see what you want please call for details of our other part exchange bargains.

01 Computers
Southampton House
192-206 York Road
Battersea
London SW11 3SA
Tel. 01-228 2207

calcsheet78

financial planning and modelling for the CBM 8032 and CBM 8096.

NOT JUST ANOTHER SPREADSHEET PROGRAM BUT A COMPREHENSIVE SUITE OF PROGRAMS.

IT WILL sense automatically if you have a 32K or 96K machine.

IT WILL create dt (TM) data transfer files which can be accessed directly, via the calcsheet78 (TM) or word processing programs (eg WordPro).

IT INCLUDES a specimen VAT spreadsheet which will calculate tax paid and received and how much tax due to or from the Customs for each quarter.

IT INCLUDES examples of invoicing and book-keeping using the spreadsheet.

Concise, comprehensive manual supplied. All this for just £75 inc VAT (plus £1 p&p). Manual only £5 plus 50p p&p (deductible if calcsheet78 (TM) is ordered subsequently).

Also available: USING VISICALC, a simple guide to the world's most famous spreadsheet program (£5 plus 50p p&p).

Available soon: VICTORY over B*A*S*I*C, a programming manual for the VIC20 user (£2.50 plus 50p p&p if ordered now, £4 plus p&p if ordered after publication).

ESSENTIAL SOFTWARE
4 Fanshaw Avenue, Barking, Essex

SERVICE AND REPAIR IN MANCHESTER

Media Maintenance Ltd are specialists in the service and repair of most makes of microcomputer.

Please call or telephone:

MEDIA MAINTENANCE LTD
31 Mill Brow
Chadderton
Lancs
Tel: 061 678 9121

FLOPPY DISKS

Top quality disks from the leading American company "NASHUA". Boxed in 10's in plastic library cases with reinforcement rings. Sample prices for 10 disks:-

	5.25"	8"
Single sided, single density	£16.70	£21.50
Double sided, double density	£19.15	£24.00

Soft & hard sectored disks available; specify when ordering, or enquire by phone for full catalogue of products. Add 15% VAT and £1.00 per box post & packing.

J&M Computer Accounting,
9 The Beeches, Station Road, Sutton Coldfield,
West Midlands B73 5JZ. Tel 021-355-5162

INSURE YOUR COMPUTER

Impact damage, Fire, Theft & Transit Insurance for your Computer Equipment:

£1 to £1,500 cover	£8.00 pa	£10 (excess)
£1,500 to £2,500	£16.00 pa	£15 (excess)
£2,500 to £8,000	£16.00 pa	£25 (excess)
£10,000	£20.00 pa	£25 (excess)

Ask for details

KGJ Insurance Brokers
6 Hagley Road, Stourbridge
West Midlands DY8 1QG
Tel (03843) 5333/2545

MICROMART

COLOUR
and
SOUND



'SIMPLY FILE' RECORDS SYSTEM (DBMS). Select by any key. Print alphabetic lists, mailing labels. Calculate, total, average columns. Fast, easy, robust and VERY versatile. DISK ONLY: £65
'SIMPLY WRITE' FAST WORD PROCESSOR. Some £300-£400 programs have no more facilities. Tape or disk, any printer, 40-80 column PET. Needs 16K. TAPE £40, DISK £45

GOTTA PET? ADDA VIC! High resolution graphics, programmable characters, colour and sound on your PET? All this PLUS a complete extra computer using your PET's drives, printer etc? Under £200 including VIC and our super PET-VIC LINK! (Available separately)

PRICES PLUS VAT BUT INCLUDING P&P. SEND FOR DETAILS, MORE UNUSUAL ITEMS. GET OUR FREE 'MICROMART' PET NEWSLETTERS.

SIMPLE SOFTWARE LTD.
15 HAVELOCK ROAD
BRIGHTON SUSSEX BN1 6GL
(0273) 504879



upgrade your EPSON printer

MICROBUFFER

- Speeds up your print processing
- All special printer functions retained
- No software changes required
- Designed for Model II/III MX80, MX100
- Easy installation - just plug in
- Model MBS, 8k RAM, RS232C serial
- Model MBP, 16k RAM, Centronics parallel
- Ex-stock; post free in U.K.
- Only £125 + VAT, total £143,75

Order from:

A>Line Computer Systems

24 Horsendale Avenue, Nuthall
Nottingham NG16 1AN
(0602) 276445

BBC

INVADERS £5.00

A FAST MACHINE CODE GAME USING HI-RES COLOUR GRAPHICS FOR MODELS A & B



Features 1 or 2 player games, name registration on high score, fine laser base movement, extra base at 1500, mystery scoring and flashing UFOs, aimed bombs, fountains and amazing sound effects. The game becomes progressively harder introducing new sheet layouts at lower levels, UFOs dropping invaders into gaps and certain invaders splitting into two mutants when hit. Supports 22-14 counting system and all other minor details.

PET VERSION AVAILABLE FROM SUPERSOFT

DAVID MCKERAN
23 WARWICK DRIVE, EAST HERRINGTON
SUNDERLAND, TYNE & WEAR, SR3 3PU

PROGRAMS

```

660 REM*****MAIN MOVE ROUTINE*****
670 GOSUB1040:F=1
680 IFPI=1THENF=2:F$(1)=H$:GOSUB1380:P=P-1:GOTO740
690 FORI=BP(X)TOTP(X):F$(F)=A$(X,I):A$(X,I)="" :F=F+1
700 PRINT"  " :NEXT:XX=X:YY=Y
710 BF(X)=BP(X)-1:TP(X)=BP(X)
720 IFBP(X)>0THENG=1
730 IFTP(TT)=0THENX=TT:Y=0:GOSUB1040:GOTO750
740 X=TT:Y=TP(TT):GOSUB1040
750 PRINT"  " :FORI=1TOF-1:PRINTF$(I)"  " :A$(X,TP(X)+1)=F$(I)
760 IFF$(I)<>" " THENTP(X)=TP(X)+1
770 NEXT
780 FORI=1TO12:F$(I)="" :NEXT:F=1
790 IFG=1THENH=0:X=XX:Y=YY-1:GOSUB1040:PRINTA$(X,Y)
800 IFPI=1THEN1310
810 GOTO330
820 REM*****MOVE TO FOUNDATION*****
830 IFF(S2)>NU-1THEN330
840 FP(S2)=FP(S2)+1:F(S2)=NU:PRINT"  "
850 FORI=1TOF(S2):PRINT"  " :NEXT:FORI=1TOF(S2):PRINT"  " :NEXT
860 IFY=0THEN880
870 IFA$(X,Y-1)<>" " THENG=1
880 PRINTX$
890 IFPI=1THENH=0:GOSUB1380:P=P-1:GOTO1310
900 GOSUB1040:PRINT"  " :A$(X,Y)="" :IFY=0THENTP(X)=TP(X)-1
910 IFTP(X)=BP(X)-1THENBP(X)=BP(X)-1
920 IFG=1THENH=0:PRINT"  " :A$(X,Y-1)
930 GOTO330
940 REM*****ERROR ROUTINE*****
950 IF1-SU<>S1THENPRINTD$;E$;D$"WRONG COLOUR":FORI=1TO1000:NEXT:GOTO330
960 PRINTD$;E$;D$"WRONG VALUES":FORI=1TO1000:NEXT:GOTO330
970 REM*****TO RETURN VALUE AND NUMBER OF X*****
980 RESTORE:FORI=1TO4:READW$:IFRIGHT$(X$,1)=W$THENSU=1-INT(1/2)*2:S2=I
990 NEXT
1000 FORI=1TO13:READW$:IFLEFT$(X$,1)=W$THENU=I:I=14
1010 NEXT
1020 RETURN
1030 REM*****MOVE CURSOR TO X,Y*****
1040 X1=X:Y1=Y:PRINT"  "
1050 X1=X1*3-3:IFX1=0THEN1070
1060 FORZL=1TOX1:PRINT"  " :NEXT
1070 IFY1=0THENRETURN
1080 FORZL=1TOY1:PRINT"  " :NEXT
1090 RETURN
1100 REM*****END ROUTINE*****
1110 FORI=1TO4:IFFP(I)<>13THEN1160
1120 NEXT:PRINTC$"TTTTT YOU'VE WON!!!"
1130 FORI=1TO1200:NEXT
1140 POKE836,PEEK(836)+1
1150 GOTO1190
1160 PRINTC$"ITSORRY, YOU'VE LOST"
1170 FORI=1TO1200:NEXT
1180 POKE837,PEEK(837)+1
1190 PRINT"  " :PRINT"  " SCORES  " :PRINT:PRINT"WINS  " PEEK(836)
1200 PRINT:PRINT"LOSSES  " PEEK(837)
1210 PRINT"  " PLAY  " "GAIN ?"
1220 GETP$:IFP$="" THEN1220
1230 IFP$="Y" THEN50
1240 IFP$<>"N" THEN1220
1250 PRINT"GOODBYE!!!" :END
1260 REM*****DEAL ROUTINE*****
1270 P=P+3
1280 IFDE$<>" " THEN1310
1290 FORI=1TO7:IFBP(I)>1THENI=8:NEXT:GOTO330
1300 NEXT:GOTO1720
1310 IFF=0THENH$="" :GOTO1360
1320 IFLEN(DE$)/2=P-1THENF=LEN(DE$)/2:GOTO1350
1330 IFLEN(DE$)/2=P-2THENF=LEN(DE$)/2:GOTO1350
1340 IFF=LEN(DE$)/2THENP=0:GOTO1270
1350 H$=MID$(DE$,2*(P-1),2)
1360 PRINTD$"  " H$:GOTO330
1370 REM*****CLOSE UP REMAINING CARDS*****
1380 L$=LEFT$(DE$, (P-1)*2):R$=RIGHT$(DE$, (LEN(DE$)/2-P)*2):DE$=L$+R$:RETURN
1390 REM*****INSTRUCTIONS*****
1400 PRINT"  "
1410 PRINT"  " *****STILTON*****
1420 PRINT"  " FROM ONE TO SEVEN CARDS ARE DEALT TO
1430 PRINT"  " SEVEN COLUMNS, THE LAST CARD ONLY OF
1440 PRINT"  " EACH COLUMN BEING FACE UPWARDS.
1450 PRINT"  " EXPOSED CARDS ARE MOVED IN ASCENDING
1460 PRINT"  " SUIT SEQUENCE TO ACES AS THESE APPEAR,
1470 PRINT"  " AND IN DESCENDING SEQUENCE OF ALTERNATE
1480 PRINT"  " COLOURS TO THE BOTTOM CARDS OF COLUMNS.
1490 PRINT"  " COMPLETE SEQUENCES OF SEVERAL CARDS
1500 PRINT"  " MAY BE MOVED BETWEEN COLUMNS.
1510 PRINT"  "
1520 PRINT"  " PRESS SPACE TO CONTINUE  " ;
1530 GETA$:IFA$(X)" " THEN1530
    
```

Personal and Business Micro
Retailer requires 3 Junior
Programmers to work on production
of fast arcade type software on
popular personal computers. Experts
required on BBC, DRAGON, VIC etc.
Competent Machine Code essential.

Send details of types of programs
written to date plus C. V. to

Mr. M.J. Mahony,
SUPERIOR SYSTEMS LTD.,
178 WEST STREET,
SHEFFIELD S1 4ET

ACT SIRIUS 1

"EDDIE"

THE NEW POWERFUL MAINFRAME STYLE
PROGRAM TEXT EDITOR FOR THE SIRIUS 1.
THIS FRIENDLY EDITOR FEATURES FULL
SCREEN DISPLAY & ONE TOUCH EDIT KEYS.

FUNCTIONS: Change, Delete, File, Find, Input,
Quit, Repeat lines, Repeat find, Scroll, Top, Bottom,
Up, Down, Get file, etc. Plus full line control.
Supplied on CP/M 86 diskette that can be copied
for running under MS-DOS.
Price inclusive of diskette, documentation and VAT
£29.95.

Send cash with order or enquire for further details
to JOHN BARRETT,
60 MILL LANE, DORRIDGE,
WEST MIDLANDS B93 8NW.
Tel 05645 78458.

PROGRAMS

```

1540 PRINT"  EMPTY COLUMNS MAY BE FILLED ONLY BY
1550 PRINT"KINGS OR BY SEQUENCES HEADED BY KINGS.
1560 PRINT"  THE REST OF THE PACK IS DEALT, THREE
1570 PRINT"CARDS AT A TIME, TO A WASTE PILE, THE
1580 PRINT"TOP CARD OF WHICH IS ALWAYS AVAILABLE;
1590 PRINT"ANY NUMBER OF RE-DEALS IS ALLOWED.
1600 PRINT"  CARDS ARE MOVED BY SIMPLY TYPING THE
1610 PRINT"ORIGINAL COLUMN NUMBER, OR P FOR WASTE
1620 PRINT"PILE, FOLLOWED BY THE DESTINATION COLUMN";
1630 PRINT"NUMBER OR F FOR FOUNDATION SEQUENCE.
1640 PRINT
1650 PRINT"  D DEALS A FRESH GROUP OF THREE CARDS. AND E ENDS THE GAME";
1660 PRINT" AT ANY TIME."
1670 PRINT"
1680 PRINT"          3 PRESS SPACE TO START  ";
1690 GETA$:IFA$(A)="" THEN1690
1700 GOTO50
1710 REM*****AUTOMATIC FINISH*****
1720 FORI1=1TO7:IFTP(I1)<>0THENI1=8:NEXT:GOTO1740
1730 NEXT:GOTO1110
1740 FORI1=1TO7:X=I1:Y=TP(I1):X$=A$(X,Y):GOSUB970
1750 IFF(S2)<>NU-1THENNEXT:GOTO1720
1760 FF(S2)=FF(S2)+1:F(S2)=NU:PRINT"#####";
1770 FORI1=1TOF(S2):PRINT"  ";NEXT:FORI1=1TOS2:PRINT"  ";NEXT
1780 PRINTX$
1790 GOSUB1040:PRINT"  ";A$(X,Y)="":IFY<0THENTP(X)=TP(X)-1
1800 IFTP(X)=BP(X)-1THENBP(X)=BP(X)-1
1810 NEXT:GOTO1720
    
```

THE LYNX

Continued from page 158

you'd find you could have lots of fun with it but there'd be little or no software for a while.

In spite of this, I enjoyed using the Lynx. It can produce impressive visual effects easily and has a good range of useful functions, although these are not performed particularly fast.

The Lynx has lots of potential. Being much more than a beginner myself I'd seriously consider buying one. It has possibilities as a CAL machine, as a small business micro, as a good home computer. But these possibilities depend solely on Computers' ability to follow through fast with its plans. They also depend on other companies developing products for the

machine and giving users lots of choice.

All computers have disadvantages. Most of them have problems. Some of them don't live up to expectations and the eventual conclusion here on the Lynx is that only the next few months will tell how much it fits into each category.

Prices

48k Lynx	£225 inc
96k Lynx	£299 inc
128k Lynx	£345 inc
192k Lynx	£395 inc
(Smaller machine upgrades will work out to roughly the same overall prices).	
Computers Single Disks	£250 approx
Computers Twin Disks	£400 approx
RS232 Lead	n/a
Printer	£60 approx
Light pen	n/a
CP/M	n/a

END

CORVUS CONCEPT

Continued from page 133

have the ability to use Apples as dumb terminals.

Documentation

The Concept manuals I received were at what one could call a 'late preliminary stage' with the exception of the Pascal and

Operating System Guides. There were 14 of them altogether, covering everything from the application programs to the system library and disk installation. They are well written and comprehensive, though most are quite technical and explicitly say that they are not tutorials. The Concept User and EdWord Guides are the nearest to tutorials, and they are good. They use a very clear convention to distinguish what is typed from what is obtained by pressing a function key and always give examples of the screen displays, including function key labels. In some places the operations des-

SCHOOL LEAVER required

Interested in micro electronics to work on both hardware and software. Some knowledge of Z80 assembler languages would be an advantage.

This is a trainee position.

Phone 01-986-8137 for an application form.

UK101 Programs SPRING SALE!

Tape 1 : 12 games, usual price £7.00
Tape 2 : 12 games, usual price £7.00
Tape 3 : 11 games, usual price £7.00
Sale Price : All three tapes for £10.00!

Machine Code Programs:
Pacman, Asteroids, Life, Space Invaders, Assembler. Usual price : £3.95 each
Sale Price : All five for £10.00!

(Please state screen size, 48x16 or 48x32)

Mr. M. Ward, 9 St. Andrews Ave.
CREWE, Cheshire, CW2 6JJ

MICROMART

BUSI OR VISI?

Whether you use your computer in an office or at home, in industry or university, BUSICALC can make it an even more powerful tool. It can handle jobs that would otherwise require a specially written program - or hours and hours of tedious paperwork. Just fill in the numbers that you know, then tell BUSICALC how to work out the others by entering simple formulae. BUSICALC can add or subtract, multiply or divide, calculate roots or powers, and perform special functions like totalling or averaging rows and columns. You can enter text on the sheet (for column headings, titles etc) and specify the number of decimal places for each calculated value - so with the help of a printer you can produce really smart reports. BUSICALC 'sheets' can be saved to disk or tape for subsequent reworking, or access by other programs. It all sounds so simple that you wonder why somebody didn't think of it before. Actually they did - we're just doing it for a quarter of the price!

BUSICALC is available now for 40 and 80 column PET/CBM models and for the Commodore 64. At just £39 plus VAT (£40.50 on disk) it really is incredible value for money! Please give details of your equipment when ordering.

SUPERSOFT

Winchester House, Canning Road,
Wealdstone, Harrow, Middlesex HA3 7SJ,
England. Telephone 01-861 1166

SYSTEM

easytext



APPLE II

Text Editor/Formatter

- * Full text editing & formatting
- * Prepare data & documentation
- * Edit programs & diagrams
- * True lower case
- * Mailing list facility
- * Works with any printer
- * Simple English commands
- * Detailed user guide

£25 + VAT inc. p&p.

South Yorkshire Systems Ltd., Dept. PCW,
Weston House, West Bar Green, SHEFFIELD S1 2DA

APPLE is a registered trade mark of Apple Computer, Inc.

OSBORNE 1

FREE!! D Base 2 with double density machine £1375.00 + VAT

4B microcentres

North Bar, Banbury, Oxon. OX16 0TF Telephone (0295) 66555

BBC Computer Software

SECTA INVADERS

Machine Code

Model B or 32K Model A

Mode 5

Joysticks or Keyboard.

Crumbling Walls. Saucer.

Unique Explosion Graphics.

Fast/Slow Bombs. High Score.

64 Invaders. Moving Legs. ETC.

Only £5.95 inc.

SECTA SOFTWARE

187-195 BROAD STREET,
COVENTRY. CV6 5BN

MICROMART

HOMAC £12.50

ZX81 Accounting System

- Database of up to 1,000 records for bookkeeping and financial forecasting.
- Fast data entry.
- Manages most accounts: bank, credit card, savings, standing orders, direct debits etc.
- Predicts credit card bills.
- Up to 94 account headings covering an eighteenth month period with annual carry-forward.
- Printed or displayed summaries and statements for any account or period.
- Uses any single currency as base.

ALSO

MULTIPLE REGRESSION ANALYSIS £10.00

ZX81 Implementation of statistical technique

- Stepwise insertion and deletion of variables.
- Lagging of variables.
- Full statistics and tables of residuals.
- Range of matrix sizes:
2 x 623
5 x 190
9 x 33
- Sample data on UK Money Supply figures included.

Both programs for 16K RAM, prices include Cassette, Instructions, and P&P.

David Martin Associates

71A Princes Road, Richmond, Surrey
TW10 6DQ
Telephone: 01-948 1053

BUFFER MICRO SHOP

(NEAR STREATHAM S.R. STATION)
THE BEST OF THE MAIL ORDER ITEMS
AVAILABLE OVER THE COUNTER FOR

ZX81 & SPECTRUM BBC, VIC & DRAGON

OPEN 10.30 to 5.30 TUES TO SATS

NEW BIGGER SHOP NOW OPEN

TEL. ORDERS USING
ACCESS OR VISA WELCOME

310 STREATHAM HIGH RD. LONDON SW16
01-769 2887

KEMPSTON
MICRO ELECTRONICS
Dept PCW3, 180a Bedford Road, Kempston, Bedford MK42 8BL

Continued from previous page

cribed vary in detail from the release of software which I had — in the case of MountMgr, for example — but hopefully the manuals will coincide with the release which the public eventually receives. An interesting discrepancy in the operating system manual is that reference is made to up to 10 concurrent processes being allowed in CCOS and to the action of a (non-existent) SUSPEND key. None of this is true of the version tested but presumably another version is planned which has these features (which would be very welcome).

Prices

Concept with 256k (Includes op. system, Pascal, Assembler, Omninet Interface)	£4250
Concept with 512k	£5100
Corvus winchester	
6 Mb	£1995
10 Mb	£3395
20 Mb	£4295
Corvus 8in Floppy Drive	£1165
EdWord	£385
Logicalc	£195
Fortran compiler	£155
CP/M Emulator	£175

Conclusions

I found the Concept a delight to work with in all but a few niggly details, and worthy of its description as a new generation computer. I am a little worried about how a totally inexperienced end-user would cope with an operating system more powerful and complex than CP/M but the Dispatcher labels ensure that he/she can use the applications programs without needing to know too much about the rest. For

experienced computer users a network of Concepts is a much more attractive idea than a multi-user system groaning under a poor little overworked CPU, so long as sharing of data is not a major part of the job. As a stand-alone computer the Concept is a refined but rather expensive way to go, probably one for the MD to have as a status symbol, though a work-at-home Pascal programmer or word processor could find it a good investment if sufficient funds are available. As a hope for the future, I would like to see Corvus introduce a multi-tasking version of Merlin//CCOS to take full advantage of the 68000's power and allow real multi-window working along Xerox Star lines.

Thanks to Keen Computers for the loan of the review machine and particularly to Richard Scorer for his assistance in setting up the system.

Benchmark timings

magnifier	0.15
forloop	1.33
whileloop	1.51
repeatloop	1.23
literalassign	1.73
memoryaccess	1.81
realarithmetic	19.75
realalgebra	17.88
vector	11.47
equalif	2.46
unequalif	2.44
noparameters	0.95
value	1.30
reference	1.38
maths	11.93

For a full explanation and listing of the Benchmark programs see PCW May 1982.

Technical specifications

Processor	Motorola MC68000 8MHz
RAM	256k standard, 512k optional.
ROM	32k
Keyboard	ASCII standard with numeric keypad and 10 function keys.
Screen	Monochrome monitor, 720x560 dots. Format alterable between horizontal and vertical. User defined char. sets of variable size.
Disk	5,10 or 20 Mb winchester, 8in floppy drive optional.
Ports	2 RS232 serial ports; Apple compatible expansion bus (4 slots).
Operating system	Merlin, CP/M emulation.
Languages	SVS Pascal, Fortran, 68000 Assembler
Network interface	Corvus omninet

VIC-20 SOFTWARE £4.00

VIC ASTEROIDS - 100% machine code, with thrust, hyperspace, multiple bolts, high score, double size screen, sound-effects, joystick options etc.

VIC INVADERS - The meanest game of Space Invaders you'll ever play. Feature packed, with double size screen, hi-res, and all the usual refinements.

ASTRO SLED - Pilot your sled through the jagged space canyon. With over 50 skill levels.

SPACE FIGHTER - A space dogfight simulator entirely in machine code. With 9 skill levels.

All programs are available on cassette for the unexpanded VIC-20, at £4.00 each (post free). Please state VIC-20 and mention PCW when ordering. For more information (with photos) send an SAE.

Excellent dealer discounts available

ARCADIA SOFTWARE
FREEPOST (no stamp required) SWANSEA, SA3 4ZZ

LEADS

AT LAST! THE RIGHT LEADS AT THE RIGHT PRICES

FULL 36 WAY CENTRONICS PRINTER	£11.95
FULL 25 WAY RS2 32C (V24)	£13.95
(add £2 per metre for custom lengths of the above)	
REDUCED RS2 32C (6 main signals)	£11.95
BBC MICRO TO CENTRONICS PRINTER	£11.95
BBC MICRO TO RS2 32C	£8.50
DRAGON TO CENTRONICS PRINTER	£11.95
EPSON HX-20 TO RS2 32C	£7.95
EPSON HX-20 TO HX-20 VIA HIGH SPEED I/F	£5.95
ORIC-1 TO CENTRONICS PRINTER	£11.95
(add £1 per metre for custom lengths of the above)	

ALL STANDARD LEADS ARE 1 METRE LONG
LEADS MADE TO ORDER AND VOLUME DISCOUNTS AVAILABLE
ALL PRICES INCLUDE VAT BUT ADD 75p FOR P&P
CHEQUE WITH ORDER PLEASE TO:

HIGH TECH DEVELOPMENTS LTD.,
46 THE TININGS, CHIPPENHAM,
WILTS. SN15 3NA. TEL. 0249 - 650326

LEISURE LINES

by J J Clessa



Quickie

Which weighs more — a pound of feathers or a pound of gold? The answer is *not* that they both weigh the same.

Prize Puzzle

X and Y are integers. Use them to generate

- A = X+Y (addition)
- B = X-Y (subtraction)
- C = X*Y (multiplication)
- D = X/Y (division)

Then write down a single Basic expression which uses each of the values A, B, C, D once only, together with any of the following symbols.

+ () - * /

which will most nearly approximate to 27.38104965.

For example, if X=2, Y=3, A=5, B=-1, C=6 and D=2/3 then A*C+B/D = 28.5, which is getting close to the

required answer — but we're sure you can do better.

Answers on postcards please to arrive not later than last post 31 March 1983.

J J Clessa

December prize puzzle

Barely 100 entries this month — although I don't think that the problem was too difficult. Perhaps most readers were grappling with Xmas problems, or perhaps writing abusive letters to me about the Manhunt competition.

Anyway, the answers to the problem were 5777 and 5993. These are neither prime, nor the sum of a prime and twice a square.

The winning entry came from Mr Robert Cork of Colne in Lancashire. Congratulations Mr Cork — your prize will be with you by the time you read this.

BLUDNERS



A few errors crept into the Digital Video article in January's issue. In Figure 1 the negative line on the package diagram should have been labelled '-6v', and the IC labelled 740D should in fact have been 7400. In Figure 2 the V and H sync signals should have been shown as going to the computer along with the video. In Figure 6A it was not made clear that the output of 74LS244 is an 8-line data bus. The CRT controller used by Clayton Abrams is 6845, not 6843 as we stated. We also omitted the value of the 'W' potentiometer (5k) and the fixed resistor at input (1k).

In 'TJ's Workshop' in the same issue, we published a routine 'PET DO-UNTIL'. Its author, J D Slodzik, writes to tell us that he made a few mistakes in the listing. The relevant lines, with corrections are:

```
0342 C9 3A B0 0A C9 20 F0 07
0352 70 00 BA BC 01 01 CO F9
0372 A9 F9 48 A5 78 48 A5 77
03BA 68 85 36 68 85 37 68 85
03F2 E8 E0 11 D0 F5 4C 77 C3
```

Also in January's 'TJ's' we made a terrible mess of David Julien-Waring's

'BBC Bad Program Fix'. The first section of code, starting A=&E00 was okay, with the exception of A=A=B, which should of course be A=A+B. The correct versions of the second and third chunks are as follows:

```
A=&E04: REP.A=A+1: U?: A=13:
P.~ A-&E00<RETURN>
and
! &E00=&6101000D <RETURN>
```

In last month's User Group Index, the telephone number for the Sevenoaks School Computer Club was incorrect — proper number is 456340, and please note that this is a private club for the school only.

FOOTBALL POOLS

Professor Frank George's famous Football Pools Forecasting system is now available for microcomputers.

The program (and useful booklet) is supplied in the following versions:-

Apple II, Pet, TRS-80, NewBrain, Video Genie, Spectrum, ZX81, BBC 'B', Sharp MZ80K, MZ80A.

Obtainable from Dealers, or write to: Professor F.H. George,

Bureau of Information Science
Commerce House, High Street,
Chalfont St. Giles, Bucks.

Horse race Forecast Program ready.

DRAGON 32

or

TANDY TRS-80

Colour?

Lots of programs —

lots of useful hints and information EVERY single month in "RAINBOW", an exciting new 200-page magazine from U.S.A.

Send £1.95 (plus large 56p s.a.e.) for sample issue to ELKAN ELECTRONICS (Dept. PCW), FREEPOST, 11 Bury New Road, Prestwich, Manchester M25 6LZ or telephone 061-798 7613 (24 hour service).

MICROMART

OPUS DESKING

AT LAST COMPUTER FURNITURE MADE BY A COMPUTER COMPANY

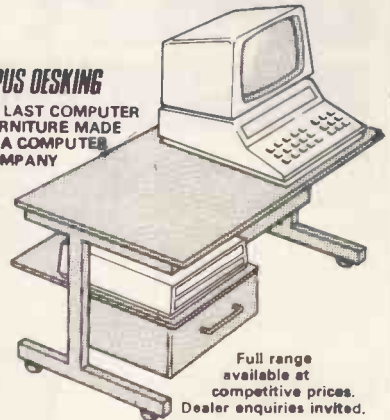

Full range available at competitive prices. Dealer enquiries invited.

RAM BARGAINS

	1 OFF	25.99	100
4116.20ns	.80	.75	.68
4116.250n/s	.75	.70	.55
2114.300n/s	.85	.80	.75
2114.L.200n/s	.95	.87	.83
4516.100us.BBC Ram	3.10	2.95	2.80
4164.200us	4.80	4.60	4.20
6116.150us C. Mos	4.20	3.95	3.50
2716.5v.450n/s	2.40	2.15	2.00
2716.Triple rail	6.00		
2732-450us	3.95	3.75	3.25
2532-450us	3.95	3.75	3.25

Other IC's available. Add 50p p&p + VAT @ 15%.

ATHANA FLOPPIES

Minis with free plastic library case + hob rings.			
S/S S/D	£17.95 for 10	8" DISCS	
S/S D/D	£19.95 for 10	S/S S/D	£15.50 for 10
D/S D/D	£23.50 for 10	S/S D/D	£24.50 for 10
S/S T/Track	£26.50 for 10	D/S D/D	£25.50 for 10
S/S 9C Track	£28.50 for 10		

All other discs available. Add 85p P&P + VAT @ 15%.

OPUS SUPPLIES

10 BECKENHAM GROVE
SHORTLANDS,
KENT



01-464 5040
01-464 1598

TRS80 - VIDEO GENIE SOFTWARE



We offer a great selection of games and utilities from many leading software companies at reduced prices. As a special introductory offer we are giving away, well almost, a software pack; on it are a super variety of 25 full length programmes and all for only £7.50!!! Don't miss out — send for our illustrated catalogue today. Please enclose ans. a.e.

SPARTAN SOFTWARE
Department PCW, 9 Cotswold Terrace
Chipping Norton, Oxon.
Telephone: 0608-3059

BACK ISSUES SERVICE

Here is a complete guide to all available back issues of *PCW*. A quick guide to their contents is shown below. Check the coupon overleaf for the issues you require.

Volume 1 No 1, 1978

The 77-68/Practical hints on kit building/Nascom 1/Charity case study/Flowcharting/Pontoon flowchart.

Volume 1 No 2 1978

Kit building Basic — first steps/Case study — a software house/PET 2001/Research machines 380Z/School computing/E78 — Europa Bus.

Volume 1 No 3, 1978

More efficient programs/Cosmac 1802/The PDP11 Part 1/Small business computing — an approach/The Z80/EPROM programmer construction.

Volume 3 No 6

June 1980

Benchtest: Tandy TRS-80 Model II/Benchtest: Sintrom Periflex 630/48/Staff case study/Checkout: Softy Intelligent EPROM Programmer/Checkout: Exatron Stringy Floppy/Practical examples of the IEEE-48 bus use/Programs: Naming Nascom files/380Z Pictures/Fuel tank calculations — PET/PET large numerals/PET tank battle/Basic string handling.

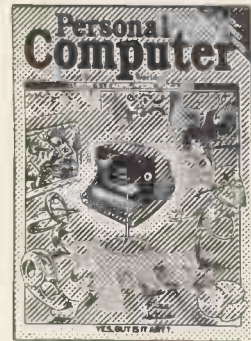

Volume 3 No 12

December 1980

Benchtest: Microwriter/Printerfac: Series — Part 1/Sharp PC-1211 speed-up/Programs: TRS-80 Tarot, PET Cat & Mouse, PET Rebound, MZ-80K Alligator Swamp, PET Connect, UK101 Minefield, PET Simon Benchtest: Raand SP1

Volume 4 No 1

January 1981

Benchtest: Transam Tuscan/Real-time control using trains — part 1/Recover from a data tape disaster/PET Music Multi-user systems — part 1/Programs: TRS80 Four in a row, TRS80 Target Practice, PET Convoy, PET Wire, PET Maze Chase, PET Android Attack, PET Anagram

Personal Computer



Personal Computer



Volume 4 No 3

March 1981

Benchtest: Onyx C8002/Benchtest: Bigboard/Micro music software package/ALC circuit/Commons report/HP 43C/Programs: TRS80 Show Jumping, PET Grand Prix, PET Aircraft landing, PET Bouncy.

Personal Computer



Volume 4 No 5

May 1981

Benchtest: Pascal 640/WP Benchtest: Magic Wand/PET colour/Low-cost digital tape system/Using calculator printers on micros/Apple music-making/Multi-user Benchtest: MVT-Famos/Programs: PET Grand Prix, PET Aircraft Landing, PET Bouncy.

Personal Computer



Volume 4 No 6

June 1981

Benchtest: NEC PC-8001/Multi-user Benchtest: MP/M/Benchtest: Sinclair ZX81/West Coast Faire report/Radio Teletype/WP Benchtest: Wordpro 4 plus/Budget tape interface/Further Casio quirks/Programs: UK101 Zor, PET Chords.

Personal Computer



Volume 4 No 7

July 1981

Benchtest: Sharp PC-3201/Multi-user Benchtest: Acorn Econet/Case study: Accident investigation on TRS-80/Zilog Z8 family/WP Benchtest: Format-80/Pascal Benchmarks: readers letters/Quicker Casio computations/Programs:

ZX80 Sliding letters, UK101 Car Rally, TRS-80 Calendar, UK101 m/c code to Basic converter, PET Exam Questions, MZ-80K Designer, ZX91 Sketch Pad.

Personal Computer

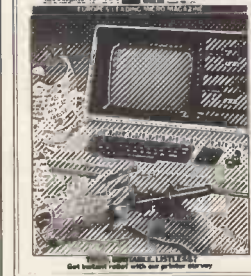

Volume 4 No 8

August 1981

Benchtest: Tandy Model III/Viewdata update/WP Benchtest: Spellbinder/Printer survey/Microholism/Programs: ZX80 Othello; Easter Sunday; Apple Mondrian; MZ-80K Duck Shoot; PET Gomoku; MZ-80K Football.

Personal Computer



Vol 4 No 12

December 1981

Benchtests: Sharp MZ-80B Philips P2000/School network/BBC Micro inside story/'Turtle' Graphics for Apple/Forth language/Curve fitting/Calc corner: HP14C review/programs: PET Fantasy, ZX81 Battleships and cruisers.

Personal Computer



Vol 5 No 1

January 1982

Benchtests: BBC Micro Xerox 820/Frames of Reference (new series)/ZX81 printer Checkout/Digital Drummer for PET/Calc Corner: benchmarks/Programs: MZ-80K Fortune, TRS-80 Reaction Timing, ZX80 Laybrinth, Apple Letters.

Personal Computer



Vol 5 No 3

March 1982

Benchtests: Texas Instruments 99/4A, Hewlett-Packard 125/Choosing a Database/Compoft DMS REVIEWED/Screenplay (new series)/Calc Corner: Hewlett-Packard Interface Loop/Programs: TRS-80 Solitaire, TRS-80 Ducks, Nascom Business Documents, MZ-80K Race Chase, ZX81 Graphplot.

Personal Computer



Volume 5 No 4

April 1982

Benchtest: Monroe OC8820/DB Benchtest: FMS-80/Checkout: Sid 1/Generating screen forms/Comal/Logo/Brain Dump-New series/Calc Corner: Casio FP-10 printer/Programs: TRS-80 Maths & Trig, PET Boot the Cat, ZX81 Resistor & Res code.

Personal Computer



Vol 5 no 6

June 1982

Benchtests: Sharp MZ-80A/ZX Spectrum/Database Benchtest: DBMS2/West Coast Fire Report/Lisp/VIC 20 games/Calc Corner: Sharp PCI500/Programs: RML Altered Basic/VIC-20 Large Characters/BBC Breakout/VIC20 Trailblazer/MZ-80K Next-to-Last-One/MZ-80K Tarot.

PCW SPECIALS

1983 Microcomputer Benchtest Special. 20 leading micros reviewed by the *PCW* team. Desk Top Computing £2.25.

Comprehensive guide to using micros to help you in your business.

BINDERS

Keep your copies in order with these strong, attractive yellow binders. £3.95 each (inc P&P)





**Vol 5 No 7
July 1982**
 Benchtests: Mimi 801/Newbrain/
 Database Benchtest: Silicon Office/
 UCSD p-System/BBC
 Computer-in-Depth/Apple II games/
 Calc Corner: T188/Programs:
 ZX81 Hypocycloids/BBC Character
 Generator/TRS-80 Truth/PET Doc/
 TRS-80 Screen Dump/UK101
 Screen Converter/PET boxes/Atari
 Earth.

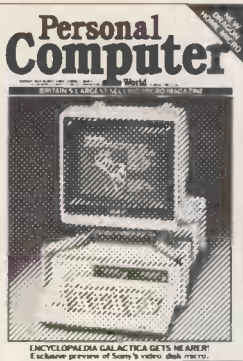

**Vol 5 No 8
August 1982**
 Benchtests: Sort M23/Dragon 32/
 Database Benchtest: Cardbox/
 Preview: Sony SMC-70/UCSD
 p-System/RS232 Interface/Sirius
 graphics/NCC Show report/ZX81
 Speech Checkout/Calc Corner:
 Casio fx602p/Programs: TRS-80
 Quadrangle/UK101 Conversion of
 units/PET Mopup/Apple Lifespan/
 Apple Trees/Nascom Snail Racing/
 UK101 Long Multiplication &
 addition.



**Vol 5 No 9
September 1982**
 Benchtest: Olivetti M20/Word Pro-
 cessor Benchtest: Select for NEC/
 Database Benchtest:
 Aquila/Checkouts: Microwriter
 Revisited, E40 Data Compression/
 Screenplay: ZX81 Pt II/DIY Logo/
 P for Perfect/Beeb Colour Hi
 Res/RS232/Calc Corner: HP15 and
 16C reviewed/programs: Video
 Genie Extended Basic, ZX81
 Alphabetising, PET File Com-
 parison, BBC Music Player, PET
 Virus, BBC Radar, PET German
 Game, TRS-80 Cardshuffler.



**Vol 5 No 10
October 1982**
 Benchtests: HP-86; Positron 9000/
 Database Benchtest: Personal Pearl/
 3D Graphics for BBC
 Computer/Hashing Techniques/
 Designing your own Database/CP/
 M-86 v MSDOS/Clock-Calendar
 Card for Apple II/Calc Corner:
 hints for Sharp PC122/Programs:
 ZX81 Star Trek; PET Knockout;
 PET Trains.



**Volume 6 No 1
January 1983**
 Benchtests: Jupiter Ace/Torch/
 Database Benchtest: Superfite/
 Warnier-Orr programming
 techniques/Expert systems/Tokyo
 Data Show report/Forth
 Benchmarks/Digital Video/The
 Nearly Man — Charles Babbage/
 Portable Computer World — Con-
 tinued Fractions/Micro
 Chess/Screenplay — Spectrum/
 Programs: VIC Connect-4/
 VICMon/Atari character set
 mover/VIC UFO/PET Forth
 Teacher/VIC Doppler/BBC
 Gomoku.

BACK ISSUES CENTRE

We have a complete selection of all available PCW back numbers in our flashy new Back Issues Centre in the West End of London, just half a minute's walk from Oxford Street (close to Tottenham Court Road tube station). Of course, you could order them from our excellent mail order service using the coupon below, but by visiting in person you save on postage costs. The Back Issues Centre also often has back numbers of PCW on sale which we cannot offer through the mail order service because of shortage of stock. Our receptionists will also be happy to sell you a set of binders to take your subscription. And there's a range of interesting computer books on sale as well. Drop by next time you're in the West End. We're open Monday to Friday, 10am to 6pm. The address is 14 Rathbone Place, London W1P 1DE.

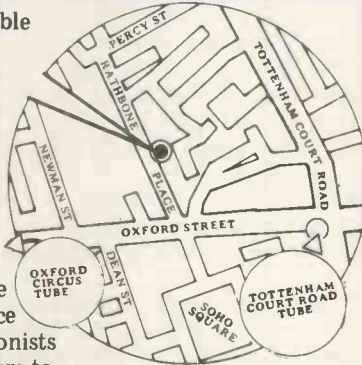

**Vol 5 No 11
November 1982**
 Benchtests: Canon CX-1; Hewlett
 Packard HP75/Database Benchtest:
 Condor/Apple II Clock Calendar
 Card Part — Algebra checking/
 Benchmarks summary/Bit Stik
 graphics for Apple/Calc Corner —
 HP41C, Casio fx702p programs/
 PCW Show report/Tiny printing on
 Centronics 739/Screenplay — Acom
 Atom/Programs: Apple Piano;
 Apple Moon Module; PET Letter-
 writer, UK101 Logic; Atari Walls;
 Sharp MZ80K Area-filling, RML
 380Z Restore.



**Volume 6 No 2
February 1983**
 Benchtest: Sage/Database
 Benchtest: BusiPost/Which
 Spreadsheet — new series/Networks
 — new series/Expert systems/BBC
 graphics revealed/Logo Turtle/
 Micro Chess — Fidelity's Prestige/
 Portable Computer World — Sharp
 PC1251 Benchtested/Numbers
 Count/Screenplay — BBC games/
 Programs — UK101 Vocabulary
 Test/PET Race Chase II/Apple
 Character Plotter/Variable
 Checkchart/ZX81 hex calculator/
 Atom Backgammon/Video Genie
 Aircraft Lander/Atari Flashback/
 MZ Text Analysis.



**Come up and
see us...
Mon-Fri
10am-6pm
Saturday
11am-6pm**

CHANGE OF ADDRESS

Readers should note that all mail order subscriptions, binders and back issue enquiries must now be addressed to 55 Frith Street, London W1.

However, for personal callers only, a selection of PCW back issues, binders, micro-computing books etc can be purchased from the shop at 14 Rathbone Place, London W1.

Any one issue £1.50; all additional issues £1.00 each.
 Benchtest special £1.80. Desktop Computing £2.25.
 Binders £3.95 each. All prices include post and package.
 *Overseas orders requiring Air Mail postage add £1.00 per copy. Cheques/P.O. payable to Computing Publications Ltd,

53/55 Frith Street, London W1A 2HG Please allow up to 3 weeks for delivery and don't forget to state your name and full address with your order. Please send me the following copies of PCW. I enclose a cheque/P.O. for £. . . Please tick appropriate boxes.

Volume 1	Volume 3	Volume 4	Volume 5	Volume 6	Benchtest Special
1 <input type="checkbox"/> 2 <input type="checkbox"/>	6 <input type="checkbox"/>	1 <input type="checkbox"/> 3 <input type="checkbox"/> 5 <input type="checkbox"/> 6 <input type="checkbox"/>	1 <input type="checkbox"/> 3 <input type="checkbox"/> 4 <input type="checkbox"/> 6 <input type="checkbox"/> 7 <input type="checkbox"/>	1 <input type="checkbox"/> 2 <input type="checkbox"/>	<input type="checkbox"/>
3 <input type="checkbox"/>	12 <input type="checkbox"/>	7 <input type="checkbox"/> 8 <input type="checkbox"/> 12 <input type="checkbox"/>	8 <input type="checkbox"/> 9 <input type="checkbox"/> 10 <input type="checkbox"/> 11 <input type="checkbox"/>		Desk Top Computing <input type="checkbox"/>
					Binder <input type="checkbox"/>

Name _____ Address _____

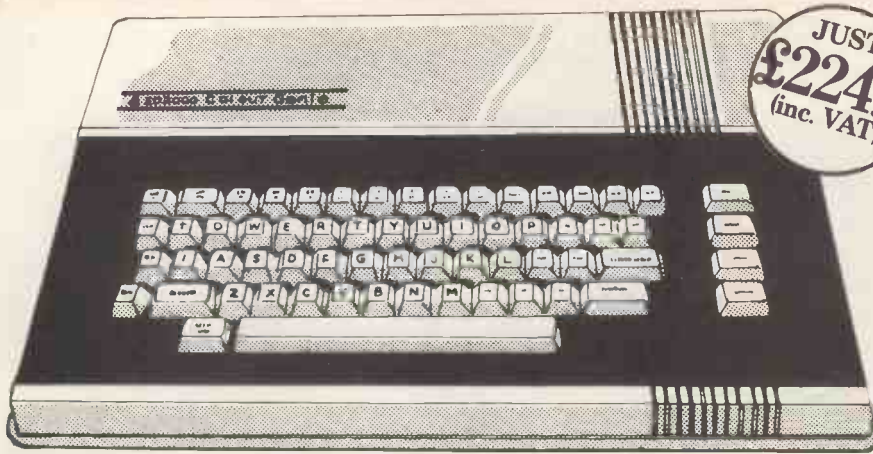

GENIE I

Tried and trusted! - The Genie I is one of Britain's best-selling small computers, with over 14,000 sold, and it's easy to see why! Software compatibility with Level 2 BASIC means there are literally 1000's of programs on the market ready to run on the Genie, including educational, leisure and small business applications. It's easy to expand, with a vast range of accessories to perform many functions you only have to read this ad!

Genie I is the ideal computer for the first time buyer, to use at home, at school or at work. The simple BASIC language enables you to write your own programs with ease, and the Microsoft Extended BASIC offers many powerful extra features.

So, if you are not lucky enough to own a Genie I, or if you have a less powerful small computer and want to upgrade, along to your local Genie dealer, or phone us for advice. It could be your first step into the enthralling world of microcomputers. £330.05 (inc. VAT)

COLOUR GENIE - AVAILABLE NOW!

Colour Genie is the powerful new piece of home computing magic from Lowe Electronics, and it's available NOW from your local stockist, or by mail order in less than 3 weeks!

In no time at all you could be connecting the Genie to a standard colour TV. Its 16K RAM, 16K BASIC ROM and full size typewriter keyboard instantly connecting you to a whole new dimension of vivid colour, high resolution graphics and fabulous 3 channel music synthesiser, with pre-settable tempos.

The whole family will be enthralled by its possibilities. Add the EG2016 MATCHING CASSETTE



£28.75 (inc. VAT)

RECORDER for instance, and right away you can either load pre-recorded software onto your Genie, or store your own programs. Then, if you fancy a spot of intergalactic travel, or a battle for the planets Genie will lay on the transport. When you get tired of the kids beating you at Space Invaders you can always turn their attention to schoolwork. Colour Genie uses the popular Z80 Central Processing Unit, and is fully programmable in level II BASIC, the most popular home computer language in the Western world.

£49.49 (inc. VAT)



For the committed games player the next 'must' will probably be the EG2013 JOYSTICKS. They're sturdy, accurate and, with digital and manual operation, are a step up again from arcade controls.

However the more serious user might prefer to invest his money first on the addition of an EG2011 16K RAM CARD which slots in and effectively doubles the Random Access Memory £38.50 (inc. VAT). Or perhaps the EG2014 LIGHT PEN, which plugs straight into the side of the Genie £17.25 (inc. VAT). Both are extremely effective ways to enhance the colour graphics facility.

Finally, if you really intend to put your machine to work, at home or in your business, you'll need a printer like the EG603 MICROPRINTER. It's a quality dot matrix printer with an impressive specification... simple to operate, reliable and extremely versatile. Should you require it, the printer will accept paper whether in roll or single sheet form with one or even two copies attached. Full 80 column width in any of the 3 different typesizes available. £270.25 (inc. VAT)

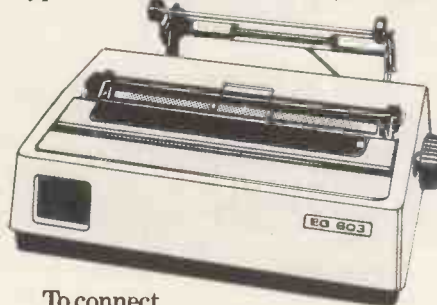

To connect this, or any other compatible printer, you also need the EG2012 PRINTER INTERFACE CABLE. £39.50 (inc. VAT).

So there you have it - a home microcomputer system that expands a computer for the creative mind right up to a realistic business machine. We not only deliver the best specification but we deliver the ColourGenie fast, so why wait?



GENIE II

Equally popular and totally reliable! - The Genie II is a breakthrough for small business computers. Harnessing all the advantages of the Genie I, including its low price, Genie II adapts perfectly to commercial functions with the addition of the following features:

- * Numeric Keyboard
- * Four User-Definable Function Keys
- * Expandable via the same Genie peripherals
- * RS232 Terminal Driver.

Genie II is an ideal, first-entry, computer for the small business. Cornershops, professional practices and small manufacturers can all benefit from a Genie II business system. £299 (inc. VAT)

GENIE III

The latest addition to the exciting Gen range! Genie III really is the key to successful business. A powerful 64K Micro with built-in screen, 700K each dual disk drives and a full size, detachable typewriter keyboard. Business software packages are available from most dealers, and the Genie III can be supplied with the option of a dot matrix or daisywheel printer. £2,242.50 (inc. VAT). For further advice, see your local dealer or contact Lowe Electronics direct for advice.

GENIE I & II ACCESSORIES

PRINTERS

The EG 3085 is quiet, fast and efficient. Print speed is 120 characters per second and printing is bi-directional with 6 different character pitches from 40 to 136 characters per line, 3K Print Buffer. Forward and Reverse Line Feed, Software adjustable line spacing, Bit Image Graphics and Proportional Printing. Suitable for use with other systems, it has three styles, adjustable pin or friction feed and angle sheet or roll paper facilities. £410.55 inc. VAT.

The EG 603 is an ideal choice if you don't want to pay that much for a printer. It doesn't match the EG 3085 in certain areas, but you will still get 80 characters per second, a range of character styles, and pin/friction feed, with 96 characters and 64 graphic patterns. £270.25 inc. VAT.

BROTHER HR-1 Daisywheel Printer

You can now buy a superior daisy wheel printer for a price only previously associated with dot matrix models.

The Brother HR-1 is an enticing addition to your system. It has a print speed of 16 cps, bi-directional, range of 8 typefaces, and a choice of two models with either parallel or RS232 interfaces. This model also enjoys a 2K PRINT BUFFER as standard.

computers YOUR COMMAND

Reliability, durability and attractive appearance make the Brother HR-1 probably the best printer buy this year! £747.50 inc. VAT.

EG 3016 PARALLEL PRINTER INTERFACE AND CABLE

The EG 3016 is an interface allowing a Centronics parallel compatible printer such as an EG 603, EG 3085 etc to be connected directly to the Genie keyboard without the need for an expander box. £43.70 inc. VAT.

MONITORS

GENIE MONITORS

Two good performance, low priced 12" monitors, either to match your Genie or compatible with a wide range of other systems. Good resolution and band width and, of course, they free your television set for the other type of programmes you like to watch!

The EG 100 12" in black & white cost £77.05 inc. VAT.

The EG 101 12" with green phosphor is £90.85 inc. VAT.

A.V.T. MONITORS

Available in 9" and 12" sizes, with white, green or amber display, A.V.T. monitors are sturdy, attractive, easy to operate and feature an easy-view screen with smoked anti-glare display filter. Compatible with most popular micros on the market. From £98.90 inc. VAT.

NOVEX MONITORS

12", green, metal cased, high resolution monitor with an anti-glare screen. Excellent value at £113.85 inc. VAT.

EXPANSION BOX

The updated EG 3014 expansion box allows for up to four disk drives and printer with optional double density, RS232 or S100 interface. Not bad value at £218.50 inc. VAT. (16K version) or £230 inc. VAT (32K version).

*The EG 3014 will work with TRS 80 using the EG3023 Tandy Adaptor.

EXPANSION OPTIONS

EG3020 SERIAL INTERFACE

Allows the Genie owner to communicate with other computers, use serial printers and telephone modems; in fact to talk to the world!

The EG3020 is a bidirectional RS232 serial interface for the EG3014 allowing baud rate of 110 to 19200. Word length is selectable between 5 and 8 bits. Parity and stop bit settings are switch selectable. Price £45.54 inc. VAT.

DISK DRIVES

If you want fast reliable program storage, true random access to many computer languages, we can meet your needs. The EG 400T provides storage of up to 184320 bytes per floppy disk and comes complete and tested in a stylish colour-matched cabinet. £253 inc. VAT.

The EG 401 AT offers dual disk drive with 368640 bytes of useable storage and comes complete with a power supply ready to connect to an expansion box. £425.50 inc. VAT.

DOUBLE DENSITY ADAPTOR

Allows the use of standard minidisk drives in double density, with virtually double storage capacity. The EG 3021 is equally at home in the Genie or TRS-80 expansion boxes. Double Density Adaptor £82.80 inc. VAT.

For the above, a double density disk operation system will be required. One such system is Smal-LDOS.

Powerful, yet reasonably priced, the Genie Smal-LDOS contains 21 library commands, 7 utilities, LBASIC, disk basic and bags of information, including a reference manual and 40 page beginners guide to disk usage £40.25 inc. VAT.

EG3022 BUS ADAPTOR

Gives full S100 capability to the Genie computers. The EG3022 supports any two S100 cards. Price £73.37 inc. VAT.

BUS EXTENDER

A most useful accessory, allows two bus using devices to be connected simultaneously to the Genie - when using the Hi Res and expander for instance. £24.15 inc. VAT.

EPI, EP3

Are 1.5 K additional EPROMS for Genie I & II. EPI Adds all Genie I software facilities to other Genies: lower case driver, machine language monitor, renumber facility, keyboard repeat and screen print.

EP3 Has HI-RES driver software with 10 extra HI-RES commands which prevent the need to load HI-RES software from tape. All at £13.80 inc. VAT. For Video Genie Systems, the LE-19 connects direct to the Genie bus and allows one of these EPROMS to be fitted externally. £30.47 inc. VAT.

TANDY BASHER

If you are a TANDY user read on! The EG 3023 is bus converted to allow Genie peripherals to be used with Tandy Model I computers. £18.40 plus VAT.

(Just in case there might be a few strange souls who want to convert in the the opposite direction there is the 50/40 converter which generates a Tandy compatible 40 way bus from a Genie. £21.16 inc. VAT.

BUSINESS SOFTWARE

Specifically written for the Genie II computer, with disks and a suite of packages from the renowned house TRIDATA. The suite includes SALES LEDGER, PURCHASE LEDGER, PAYROLL and STOCK CONTROL. Each package is a very reasonable £155.25 inc. VAT. Full details on request.

TECHNICAL MANUALS

Full technical details of Genie Hardware (all you ever wanted to know about Genie).
Genie I/II Technical Manual £10 - No VAT.
Expander and accessories (EG3014).
£10 - No VAT.

EQUIPMENT COVERS

Beat the dirt, coffee spills and sticky fingers when your computer and monitor are not in use with these top quality black pvc covers.

Genie CV1 £5.75 inc. VAT.
12" monitors CV6 £7.13 inc. VAT.
9" monitors CV3 £4.83 inc. VAT.
Centronics Printer CV5 - £4.83 inc. VAT.

SYSTEMS DESK

Even a compact modular computer system like the Genie benefits from being used on a custom designed system desk. The SD1 system desk is designed to accommodate a complete Genie System and has a special upper shelf to support the display monitor at the best level. The desk is flat packed for easy delivery and finished in attractive teak and charcoal colours. £93.61 inc. VAT.

U.K. Distributors

LOWE electronics

Chesterfield Rd, Matlock Derbyshire DE4 5LE.
Tel: 0629 4057 Telex: 377482 Lowlec G.

We have over 100 dealers throughout the U.K. (including Northern Ireland). For advice on your nearest stockist ring us on 0629 4995. In cases of local difficulty, we will supply direct AND FAST! Just fill in the coupon below. *LOWE ELECTRONICS HAVE NEVER YET FAILED TO DELIVER WITHIN 3 WEEKS! Some Microcomputer Companies, mentioning no names, are reputed to take more than three months to deliver your computer. Buy direct from us, and we guarantee not to cash your cheque until 7 days prior to the despatch of your order (this is to satisfy cheque clearance requirements). If, in the extremely unlikely event we, for the first time in our company's history, cannot deliver within 3 weeks, we'll contact you immediately and offer to return your cheque *uncashed*.

Unlike most of our competitors, all our prices shown INCLUDE VAT. No hidden extras, just great value.

Please send me details of my nearest Genie dealer

I enclose 30p p&p for Genie Colour Brochure

I enclose Cheque/PO for _____
or _____

Please debit my Credit Card No: _____

Please send me the following items:

All items are despatched via Securicor, please add £5 p&p and delivery to your total bill.

Name _____

Address _____

Tel: _____



PCW,3.83



MICROCOMPUTER SALES, LEASE OR RENTAL AND OTHER SERVICES

A comprehensive rental/hire service, featuring the ACT Sirius 1, the SUPERBRAIN, BBC, ICL, APPLE & IBM range of microcomputers. **PLUS** a full range of PRINTERS & SOFTWARE.

- Short term rental available • Rental fee refundable against purchase • Very competitive costs • Plus our own low cost 24 hour maintenance service • Phone 01-458 5845 or write to our central office for details.

ACT SIRIUS 1



- THE COMPLETE BUSINESS MACHINE
- CALL FOR PRICES
- FULL SUPPORT OF THE PULSAR SOFTWARE

PRINTERS

New EPSON Type III Series



- Available for Apple, BBC, Tandy, PET NASCOM, Sorcerer & other Micros.
- MX80FT₃ = £310
- MX 100 = £425

COLUMBIA



MAIN FEATURES	CDP-MPC	IBM-PC*	OTHERS
Microprocessor	16-Bit 8088 8-Bit Z-80 (Opt)	16-Bit 8088	?
USER Memory	128K-1 Mbytes	18K-256 Kbytes	?
IBM-PC Compatible Expansions Slots Beyond Professional Configuration ¹	8 Slots	0	?
Resident Floppy Disk Storage	Dual 320K (std)	Dual 160K (Opt) Dual 320K (Opt)	?
Resident Cache Buffer Hard Disk Storage	5M/10M	-	?
OPTIONAL OPERATING SYSTEMS (Supported by Company) ²			
MS-DOS (PC-DOS)	Yes	Yes	?
CP/M 86	Yes	Yes	?
MP/M 86	Yes	-	?
OASIS-16	Yes	-	?
XENIX	Soon	-	?
OPTIONAL HARDWARE EXPANSION BOARD (Supported by Company)			
RS-232 Communications	Yes	Yes	?
B/W and Color Display Controller	Yes	Yes	?
Expansion Memory	Yes	Yes	?
Z-80 CP/M 80 Board	Yes	-	?
Cache Buffer Hard Disk	Yes	-	?
Time/Calendar Board	Yes	-	?
IEEE Bus Controller	Yes	-	?
8" Floppy Disk System	Yes	-	?
8" Hard Disk System	Up to 40 Mbytes	-	?
Tape Cartridge System	Yes	-	?

OTHER MODELS AVAILABLE

£175 Silentye 80-Col Graphics Printer	£460 Paper Tiger 455
£1300 Flowriter 1600 RP	£560 Paper Tiger 460
£795 ET121 KFR Olivetti Daisy Wheel printer includes parallel RS232 & IEEE 488	£725 Paper Tiger 560
£1050 QUME 35 KSR	£760 Anadex DP9500
£110 QUME Form Tractor TEC	£795 Anadex CP9001
£1000 Starwriter 70/40	£900 Anadex DP9501
	£1200 Colour Prism 132 Printer

CP/M SOFTWARE - Available for both ACT Sirius 1 & Superbrain

LANGUAGES	STANDARD	ACCOUNTANCY
PASCAL	WORDSTAR	INCOMPLETE RECORDS
FORTRAN	MOBSIII	INTER ACCOUNTS
CIS-COBOL	DBII	SALES LEDGER
COBOL	MAILMERGE	PURCHASE LEDGER
FORTRAN	DATASTAR	NOMINAL LEDGER
MBASIC	SUPERSOFT 1	INVOICING
CBASIC 86	SUPERCALC	PAYROLL
APL	MULTIPLAN	STOCK CONTROL
MPM	OASIS 16	DS
C		PULSAR SOFTWARE
MS-DOS		
CPM 86,80		



HARDWARE AVAILABLE • Call for Prices
APPLE 48K VIDEO OUTPUT ONLY U.H.F. £480
DISC DRIVE WITHOUT CONTROLLER £220
DISC DRIVE WITH CONTROLLER £260
MONITORS - FULL RANGE, BMC £80



Details of IBM & ICL range of P.C. and expansion hardware, software, ring for sales or lease or short term rentals.

¹For companson purposes, typical professional configurations consists of 16-Bit 8088 Processor, 128K RAM with Parity, Dual 320K 5-inch Floppies, DMA and Interrupt Controller, Dual RS-232 Serial Ports, Centronics Parallel Port and Dumb Computer Terminal or Equivalent.

²Columbia Data Products also supports CP/M 80 with an optionally available Z-80 CP/M Expansion Board.

*As advertised in BYTE Magazine, August 1982

For all Mail Orders, Rental Orders, Price Details or Further Information — Contact our Central Office:

MICROCOMPUTER SPACEDROME

3 WESTHOLM, HAMPSTEAD, LONDON NW11 Tel: 01:458 5845

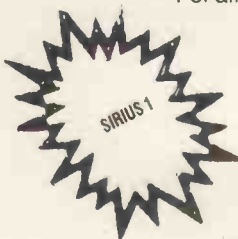

We only handle top quality hardware and software

VISION-80 80 column card for Apple II Computer

Features 9 x 11 dot characters, automatic source switching of graphics, full implementation of Apple's text window as well as HGR, TEXT, HOME, INVERSE, TAB; CP/M and Pascal fully compatible. Works with ZARDAX, SANDY's WP, WORDSTAR, APPLEWRITER II, EASYWRITER, LETTER PERFECT and now FORMAT 80. Communications facility present in hardware on the board. **RRP £195 + VAT**

SCREENMASTER 80

Similar to Vision-80 in software and hardware. 9 x 10 dot characters and extra character set as standard. 3 scrolling speeds, unique on screen editing commands. Can dump screen contents to Printer. Lacks on board communication software. **RRP £185 + VAT**

80-COLUMN VISICALC

Pre-boot utility for all versions of 16 sector Visicalc. Simply the best visicalc 80 column display - Inverse and flashing characters as standard for VISION-80 or SCREENMASTER 80. **RRP £29.50 + VAT**

80/COLUMN VISICALC EXPAND

Pre-boot utility which gives 136K memory with Visicalc and 80 columns when using 128K RAM cards with your VISION-80. **RRP £39 + VAT.**

80-COLUMN APPLEWRITER II

Pre-boot utility from PYNWON SOFTWARE, giving a beautiful display with APPLEWRITER II for the VISION-80 or SCREENMASTER 80 - the resultant display is better than an Apple III running Applewriter. **RRP £18 + VAT**

ROSETTA

DOS/PASCAL utility. This superb Australian program is written in PASCAL and allows movement of any sort of DOS or PASCAL programs in any direction. A library unit called QUASIDOS is included for the user to link to other PASCAL programs so PASCAL can read and write to DOS discs. **RRP £35 + VAT.**

PYNWON SOFTWARE HOLDS WORLD-WIDE DISTRIBUTION RIGHTS TO THE ABOVE SOFTWARE. DEALER AND OVERSEAS DISTRIBUTOR ENQUIRIES INVITED.

Distributor in UK:

PYNWON COMPUTER SERVICES

Laurie and Elizabeth Boshell, 17 Watermill Lane,
Edmonton, London N18 1SU. (01) 884 0879

The people who put the extra byte
back into Apple II and VisiCalc



VISION-80 rated no. 1 by Byte, Softalk,
Your Computer and Call A.P.P.L.E.
and highly rated by Windfall.

COMPUTER BONANZA!

COMPUTERS
AT UNBEATABLE PRICES



EPSON HX20

Portable Computer All prices + VAT
With carry case **£385.00**
Without carry case **£380.00**
Micro-cassette Drive **£71.50**
1 Year Guarantee Parts and Labour.



All prices + VAT

ACT SIRIUS 1 128K with 1.2mb S/S Disks **£2075**
ACT SIRIUS 1 128K with 2.4mb D/S Disks **£2525**
ACT SIRIUS 1 128K with 1.2mb D/S Disks
and 10mb Winchester **£3975**
10mb Hard Disk **£2525**
128K Extra Memory **£340**
384K Extra Memory **£775**



90 Days Guarantee Parts and Labour.
Add £3.00 to delivery charge for system.

IMMEDIATE
DELIVERY.

Payment by Cheque, Access, Visa etc.
All prices Apply to 31st March 1983.



Shipments throughout UK. We can export to most countries in the world.
Please phone for Access or Visa buying details.

Micro-Spares

We cannot and will not be beaten on Price!

Note our change of address
104-106 Hanover Street, Edinburgh EH2 1DR
031-226 3345

patriarch of Constantinople (428-43)
Ne'storian (adj)
nēt (net) (n) 1. an openwork fabric of
string, rope, wire, etc; mesh. 2. a device
made of net, used to protect or enclose
things or to trap animals. 3. a thin light
mesh, fabric of cotton, nylon or other
fibre.



APPLE IBM PC SIRIUS CP/M

G. W. COMPUTERS LTD

LONDON'S WEST END - NATIONWIDE OVERNITE SERVICE
MORE PRODUCT RANGES - BETTER SERVICE
PROBABLY THE WIDEST SELECTION OF NETWORKS... MICROS...
AND PRINTERS ON DISPLAY NATIONWIDE

FORMS/TEXT/CALC/DBMS IV

Contains the highest state of the art software available today
ALL IN ONE PROGRAM.

When you budget for a complete system of software you eventually end up with a host of packages like, Sales, Purchases, Nominal, Data, Text, Calc, Mailshot, Invoice, Order, Workflow, Personnel, and so on.
The list is endless and the outlay several thousands of pounds.

DBMS IV

Has most of the features you need from the above list in one program !!!!.

Features. Design a form as wide as a window of 250 characters, long as needed. Cursor movements are 'left, right, up, down, delete left delete right, tab right-left-up-down' Paint your form as you like directly on the screen.

Text..... Write a letter as you see it on the screen, edit it then simply enter ^P to print.

Calc..... Set into the form, your data fields, "#####" and specific file-related activities, formulae and validation checks. Enter values and see the spreadsheet calculate itself.

Database. Search files for data to be inserted to fields specified. All the features of DBMS III, explained elsewhere in our ad.

Here's an example of an invoice you might design for your stationery..... You could design your own spreadsheet, order form, statement, or any other kind of form that is required to fit your existing stationery.

INVOICE		<0>#####		
To <1>#####	<2>#####	From: G.W.Ltd	55 Bedford Court Mans.	
<3>#####	<4>#####	Bedford Avenue	London W.C.1.	
<5>#####		Tel:01-636-8210		
Date <6>££.££	Tax point <7>££.££	Agent <8>£££		
Quantity	Description	Cost	Tax	Total
<9>££	<10>#####	<11>££	<12>££	<13>£££
<14>££	<15>#####	<16>££	<17>££	<18>£££
and so on.....				
Total.....<19>£££££		Tax.....<20>££££		

<??> items <1> to <5> internal command to request name input, and then search an address file for details.
<??> items <6> to <7> request date input and validate.
<??> item <8> request agent number and validate range.
<??> item <9> request quantity, validate range.
<??> item <10> request description, search file, accept, and calculate fields <11>, <12>, <13>, if finished invoice then calculate fields <19> and <20>

Now comes the more valuable facility, You can provide the 'FORM' with file-related instructions, not only to request a 'console' input for a file search against names, and stock, but after the invoice is finished the fields you have selected may be passed to related files.

EG: Send fields <0>, <1>, <6>, <7>, <11>, <12>, <13>, <19>, <20> to a sales ledger.

Then send fields <9>, <10>, <11> to product analysis file.

Then send fields <0>, <1>, <7>, <19>, <20> to V.A.T. file.

Then send fields <10>, <11>, <12>, <13> to Nominal ledger.

The program is only available from G.W.Computers Ltd <U.K.> with a system purchase at 575.00, note DBMS III comes free with system deals.
or by mail order transaction at 395.00.

SSP

If you are an employer

STATUTORY SICK PAY

is a **PROBLEM** -- and

we have the **SOLUTION**

SSP is applicable from 6 April 1983. Failure to keep records can lead to a fine of £200 plus £20 per day. All the information required to operate SSP is in DHSS publication NI.227: sixty pages of red tape.

- * Hilderbay SSP will tell you what to do before starting to operate SSP.
- * Hilderbay SSP will work out whether an employee is eligible for SSP.
- * Hilderbay SSP will compute an employee's SSP and all necessary information for your records.
- * Hilderbay SSP is compatible with your existing manual or computer payroll system (so long as your system allows you to enter the SSP just calculated).

Hilderbay SSP is available NOW on Apple II & IIe (£70 + V.A.T.) Also available: 48K Spectrum version (P.O.A.). Coming soon: CP/M version.

Other Hilderbay software: Apple Payroll (£60). Apple Bookkeeper (£30.44). For 48K Spectrum: Payroll, Stock Control, Critical Path Analysis, etc. Further information is available on request.

HILDERBAY LTD
Professional Software

8/10 Parkway, Regents Park, London NW1 7AA
Telephone 01-485 1059 Telex 22870

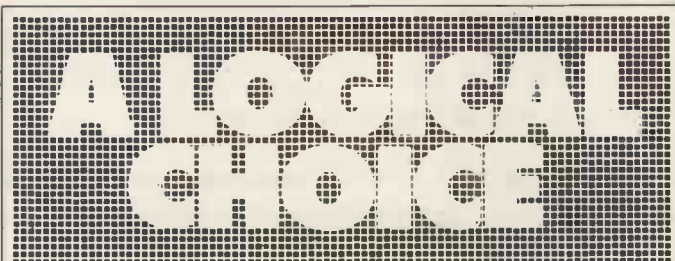

- Come on in and talk to us, we take the hard work out of choosing the right system, whether its for personal, educational or business use.
- Highly competitive prices.
- No obligation demonstration.
- 12 months parts and labour guarantee and a full after sales service back-up.
- Apple Level I Service Centre.
- Mail order service.
- Apple Business Systems.

THE APPLE BUSINESS CENTRE
In stock now the latest Apple IIe Microcomputer - perfect for the business user, with a full range of business software. Prices start at **£1,500** for a complete business system. For the larger business user the Apple III is also available: the complete system from **£2,500**.

THE 6809 CENTRE
We are the specialists, carrying the widest range of 6809 based Hardware and Software. Hardware products include:-
DRAGON 32 the best value home computer **£199.50**. Including a wide range of Software.
POSITRON British built multi-user machine, at a very competitive price, running Flex and OS-9 Software systems prices start at **£3,400**.

S.W.T.P.C. the Industry Standard, bus-oriented, 6809 based system with full expansion capabilities. Software on Flex or Uniflex.

STIRLING 77-68 6809 based, Kit System on a range of 8" square boards, with 64K memory boards, cassette interfaces, memory mapped VDU boards, more boards under development. Design notes each **£1.00**. 64K board **£28.75**, other boards **£12.00**.

Software products include:-
FLEX SYSTEM SOFTWARE Full range always in stock, with simulators, 68000 cross assemblers, Fortran 77, all for 6809 Flex machines.

OS-9 SYSTEM SOFTWARE. With more interest in this 6809 multiuser, multitasking operating system, we are increasing our stock of programs using this system.

DYNACALC, the 6809 spreadsheet programme, at **£161**.

STYLOGRAPH, the 6809 word processing package, **£200**.

Ring us for full information and prices on our 6809 products.

STIRLING MICROSYSTEMS

The logical answer to buying computers

241 Baker St., London NW1 6XE Mail Order Hot Line 01-486 7671

hairs on the leaves — (*vt*) irritate
provoke. — **net'tle rash** (*n*) skin disorder
like nettle stings.

net'work (*n*) 1. chain of interconnected
persons, operations, or electrical
conductors, group of broadcasting
stations connected for simultaneous
broadcast. 2. *electronics*. a system of
interconnected components or circuits.

ASCAL DOS APPLE IBM P

**COMPUTING
MICRO'S ? RESEARCH
BUSINESS PLEASURE**



The answer's a
**commodore
COMPUTER**

**commodore '64'
NOW IN STOCK**

L&J COMPUTERS

192 HONEYPOT LANE, QUEENSBURY, STANMORE, MIDDX HA7 1EE. 01-204 7525
THE "PET" SPECIALISTS

**We specialise in PACKAGE DEALS – from beginners to big users
you may lose out if you don't contact us before you buy!**

IF YOUR CALL IS URGENT, RING OUR HOT-LINE 01-206 0440



**NOW THE NEW 700 & 500 COMMODORE RANGE AND
8032/8096 IN NEW STYLE.**

COME AND TRY THEM AND SEE FOR YOURSELF.

- Comfortable, easy to use
- Tilt and swivel greenscreen
- Special function keys
- BASIC 4.0
- BASIC programs up to 64K in length
- Up to 896K RAM
- Access to CP/M programs
- IEEE-488, RS. 232C, CBM cassette
- 8 bit parallel, cartridge slot, networking
- Sound synthesis chip.

HARDWARE

CBM MICRO-COMPUTERS	16K	4016
	32K	4032
	32K	8032
	96K	8096
SUPER-PET		9000
DISK DRIVES (5.25")	2M/B	8250
	1M/B	8050
	340K	4040
	170K	2031
HARD DISKS CBM	5 M/B	9060
	7.5M/B	9090
**MATOR 23/30/60	M/B	SHARK
**MATOR BACK-UP		SHARKIVE
(**APPROX 8 WEEK DELIVERY)		
PRINTERS (MATRIX)	CBM	4022
	CBM	8023
	CENTRONIC	150
	CENTRONIC	737
(DAISY WHEEL) CBM		8300
	NEC	7730
	QUME	SPRINT

SOFTWARE

**SILICON OFFICE : WORDCRAFT : WORDPRO
D.M.S.V. : ADMINISTRATOR : DATALEX
BASIC & SUPERPAY : ACCOUNTS : VISICALC
ALL IN STOCK**

CASH BOOK

Enter daily-weekly amounts—printout and totals, weekly/monthly analysis, totals and balances. 3032, 4032 & 8032 versions from £90 to £150

STOCK TAKING for the licensing trade
Superb new program for 8032

£240
£420

OUTSIDE SERVICES (For Mini-Cabs, etc.)
New 8032 Version at 3032 price

£220

BITS AND PIECES

RAM/ROM FOR YOUR CBM AT ONLY £39 + VAT.
REMAINS PROGRAMMED FOR UP TO 7 DAYS
EVENT WITHOUT USING YOUR MACHINE!

For those with 3032s who want 4032s and those with 4032s who sigh for 3032s, all is not lost! HAVE BOTH, at the flick of a switch — CHIPSWITCH for £57 + ROMs for £50 (with de-glitching facility built-in).

TOOL KITS (BASIC 2 & 4), SUPERCHIPS,
... AND ALL SORTS OF OTHER CHIPS...
UPGRADE YOUR PET EVEN MORE!!

PERSONAL SHOPPERS WELCOME
Phone & Mail Orders accepted.

ALL GOODS SENT SAME DAY WHEREVER POSSIBLE
LARGE S. A. E. FOR LISTS ETC.



ORIC-I 48K



£169.95 inc. VAT

It's easy enough to buy a computer but how do you know it's the right one?

MOVIESCOPE offer you the assistance of a trained computer consultant who will be pleased to discuss and demonstrate the system that will meet your needs, and offer you full after sales advice.

Opening hours: Mon-Sat 10am-7pm
Sun 1.30-4pm

ORIC-I 48k	£169.95
COLOUR GENIE	£224.00
DRAGON 32	£198.95
COMMODORE 64	£344.99
VIC. 20	£129.95
ATARI 800	£399.99
ATARI 400	£198.95
Jupiter Ace	£89.95
Sinclair ZX 81	£49.95
TEXASTI99/4a	£159.95

All prices inclusive of VAT

COMPREHENSIVE SELECTION OF SOFTWARE, ACCESSORIES, BOOKS AND GAMES

Moviescope service centre will ensure that should your machine 'go-down' we will get it running again as quickly as possible.

MOVIESCOPE
90 HIGH ST. BARNET. HERTS
01-449 8329

NEW FOR NASBUS/GEMINI The MAP V.F.C.

80 Column x 25 line screen, and Floppy disk controller on a single 8" x 8" professionally built plus in card. Fully compatible with the current range of NASCOM and GEMINI products.

FEATURES: 80 x 25 paged memory mapped screen
Flicker free display
Standard ASCII character set
128 graphic chars or inverse video
Onboard software
Video switch & keyboard port options
5 1/4" floppy disk controller

Available separately as kits or built boards

VIDEO CARD	£89 KIT	£110 BUILT
FLOPPY CONTROLLER	£95 KIT	£115 BUILT
VIDEO & FLOPPY	£165 KIT	£199 BUILT
OPTION & EXPANSION KIT	POA	

We are pleased to announce that we are supporting our new VFC with a 5 1/4" floppy disk drive system using 96 TPI, SS/DD Teac half height drives, in a slim case complete with power supply and all cables.

SINGLE DRIVE SYSTEM (500Kb)	£299 BUILT
DOUBLE DRIVE SYSTEM (1Mb)	£499 BUILT
256K RAM CARD - 64K Ver	£105 KIT £150 BUILT
(Expandable to 256K - expansion kits POA)	

SOFTWARE - We can support most systems with CP/M software - Ring for details.

ALL PRICES EXCLUDE P&P (£1.50) & VAT

MAP 80 SYSTEMS LTD

333 GARRATT LANE, LONDON SW18 Tel 01-874 2691

Franciscus Sylvius (died 1672), German anatomist. *sym. abbrev for.* 1. symbol. 2. *chem.* symmetrical. 3. symphony. 4. symptom.
sẏmbiosis (n) 1. living together in harmony of two organisms of different kinds *esp* to their mutual benefit.
sẏmbiotic (adj) - symbiotic computer systems manufacturers of *sẏmbnet (n)*
sẏmbfile (n) (see over).

RIUS CP/M PASCAL DOS

Qume® +
AUTHORISED
DISTRIBUTOR



= the perfect
partnership

● If you want the best in letter quality printing then a Qume is the daisywheel for you.

● If you want the best in pre and after sales service then make sure you buy your Qume from Access Data Communications, the authorised Qume distributor.

● At Access Data all Qume printers, both past and present, are backed in the field and at our extensive workshops by a team of engineers who know Qume from the inside out.

● Service to us also means that our engineers are available to you. That's why we operate from two centres; Uxbridge in the South and Hull in the North, making 24 hour call-out a reality.

● When you think daisywheel, think Qume, when you think Qume think Access Data Communications.



SPRINT 9

access data communications ltd.

Eskdale Road, Uxbridge Industrial Estate, Uxbridge, Middlesex. UB8 2RT Tel: (0895) 59781 (10 lines) Telex: 267336
Northumberland Avenue, Hull, North Humberside, HU2 0LN Tel: (0482) 223379 Telex: 52269

A.C.G.

ASHBY COMPUTERS
& GRAPHICS LTD

PRINTER BUFFERS

— AT UNBEATABLE PRICES!

New RS232 serial Printer Buffer's, that plug directly into your EPSON matrix printer, without modification!

- Baud rates from 50 to 19,200
- Odd/ Even or no parity
- 7 or 8 bit word length
- 1 or 2 stop bits

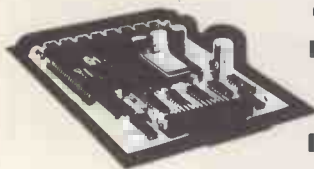

■ **EB16** 16K plug in printer buffer,
£94.95 plus V.A.T. FROM A.C.G.

■ **EB60** A MASSIVE 60K bytes of
plug in printer buffer,
£139.95 plus V.A.T. FROM A.C.G.

(Approx size EB16 - EB60, 100mm x 130mm)

New STAND ALONE RS232 printer buffers

- Baud rates from 50 to 19,200
- Odd/ Even or no parity
- 7 or 8 bit word length
- 1 or 2 stop bits



■ **SB16** 16K stand alone printer buffer,
£149.95 Plus V.A.T. FROM A.C.G.

■ **SB60** 60K stand alone printer buffer
£189.95 plus V.A.T. FROM A.C.G.

(Approx size SB16 - SB60, 130x70x218mm)

12 THE GREEN, ASHBY-DE-LA-ZOUCH
LEICESTERSHIRE. LE6 5JU. TEL (0530) 411485

INTERFACE



ANALOGUE 8/8

8 Channel input plus 8 Channel output. Optional 10v. or 5v. F.S.; 8 bit resolution.....£179 + VAT

ANALOGUE 12/12

12 bit analogue input converts in 20uS. 10v. or +5v. F.S. plus 12 bit analogue output and 16 bit parallel I/O and timers.....£195 + VAT



ANALOGUE 1208

8 Channel differential analogue input, 12 bit conversion accuracy, gain programmable 0 -> +5mv to 0 -> +10v.....£220 + VAT

EDC PHOTONIC LTD
Tector House, 103 Washway Road, Sale,
Cheshire. Tel: 061-973-8367
DEALER ENQUIRIES WELCOME

PHOTONIC

symb/net. (n) (see fig 1) 1. speedy long range, local area network system, capable of ranges to 9km. utilises fibre optic cable and semi conductor laser to transmit data; **symbnet** enables user to link various microcomputers supported by **symbfile** (see below) 2. compatible with DOS,PASCAL,CP/M; transfer rate 50 kHz, transmission power 800 micro W cable, fire retardant P.V.C. grade 32, signal insensitive to electrical noise, ∴ cannot be corrupted; system nucleus **symbfile** (see below).

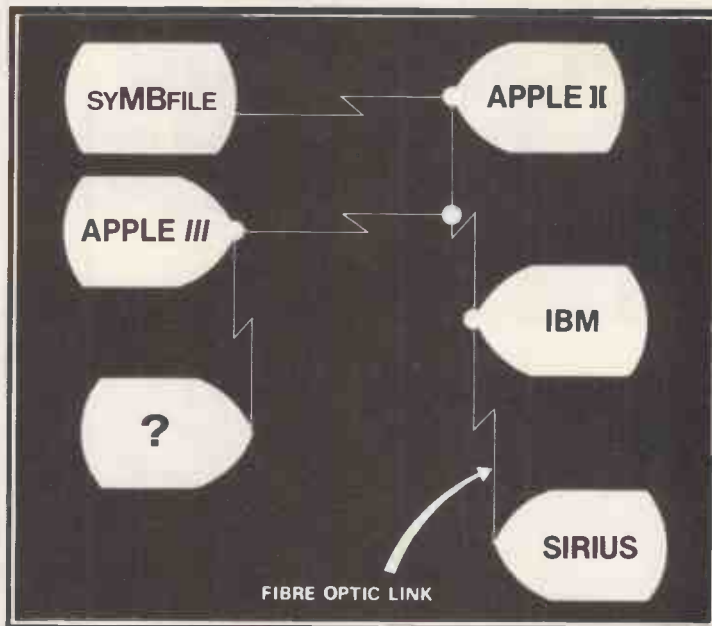

fig 1 symb/net.

symb/file (n) (see fig II) 1. high capacity, high quality, 5¼" Winchester sub-system, compatible with most microcomputers including APPLE II, III, IBM PC, and SIRIUS. Other features include 2. a cold booting facility 3. one year's full warranty. Also available on **symbfile** top quality software including database, word processing and accounting packages. 4. capacities range from 3-84 megabytes; average speed of access 90ms, 32 sectors per track; rotational speed 3600 (rpm) 5. used at the centre of network system — **symbnet** (see above).



fig II symb/file



Symbiotic Computer Systems Ltd.

32 Elmwood Road, Croydon, CR9 2TX. Telephone: 01-683 1137 (PBX) Telex: 893815

APPLE IBM PC SIRIUS CP/M PASCAL DOS

THE INTERFACE FOR YOUR INDUSTRIAL NEEDS

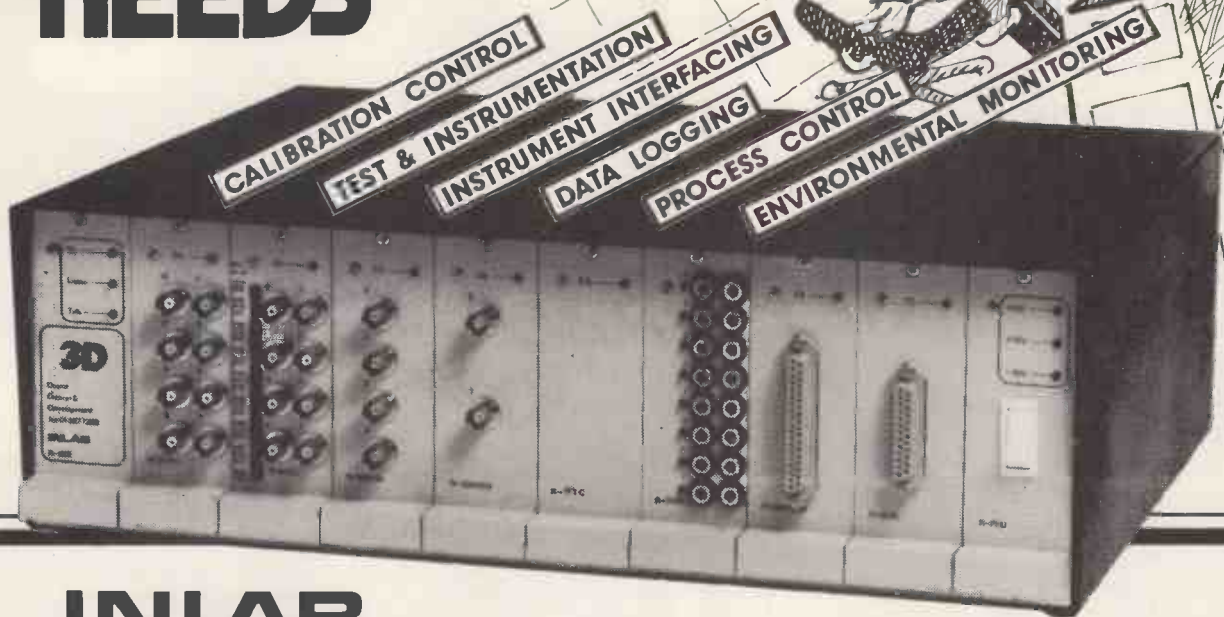

INLAB

Make your micro work for you with our high performance low cost interface system. Compatible with . . .

CBM 500/700

Sirius 1

HP 85 (IEEE 488) 86/87

BBC Micro

Apple II/III

Superbrain

Sharp MZ 80A/80B

TRS-80

S-100 Computers

RS232/V24

or 20mA current loop

8 channel programmable gain amplifier
8 channel relay (3A at 240V ac) control unit

Bi directional RS232C/V24 + current loop with handshake

Programmable multi purpose function generator

Programmable stepper motor controller + power supply.

Choose any combination of our standard modules for a custom designed multi channel rack system with integral power supply connectors, ribbon cable, etc.

12 months warranty plus full hardware and software support.

Available models include:

16-, 8-, 4-channel analog multiplexers

16-, 14-, 12-bit A/D converters

13-bit integrating A/D converter

12-bit 4 channel D/A converter

6BCD digits optoisolated inputs with full handshake

3D

DIGITAL DESIGN and DEVELOPMENT
18/19 Warren Street London W1P 5DB
Tel: 01 387 7388

For more information POST to PCW 3

3D Digital Design
and Development

18/19 Warren Street London W1P 5DB

My interests are:

NAME:

POSITION:

COMPANY:

ADDRESS:

TEL:

Intelligence Research for Memory

**BUY YOUR ADD-ON MEMORY FROM BRITAIN'S PREMIER
MANUFACTURER OF MICRO COMPUTER MEMORY BOARDS**

★ *WE OFFER THE MOST COMPETITIVE PRICES IN THE U.K.* ★

APPLE	SIRIUS/VICTOR	IBM
16K	128K	64K
64K	256K	128K
128K		192K
256K		256K

GENEROUS DEALER DISCOUNTS GIVEN



**Intelligence
Research
Limited**

**NELSON HOUSE
271 KINGSTON ROAD
LONDON SW19 3NW
Telephone 01-543 3711**

INTELLIGENCE RESEARCH

APPLE BOARDS FOR DATA ACQUISITION AND CONTROL

We now have available a range of Apple interface boards suitable for use in university and industrial applications. We also offer a technical enquiry service to advise those who wish to connect various pieces of equipment to an Apple.

In addition, if we do not stock a particular interface board we will be happy to quote for its development. We provide a rapid turnaround on all orders.

EPROM PROGRAMMER

Will program 2758, 2716, 2732, 2732A and the new 64K bit single 5V supply EPROMS

**RECOMMENDED
RETAIL PRICE**

£89.00

VIA BOARD

Provides Apple II with two 8 bit input/output parallel ports, a serial port and two timers – including a Real Time Clock

£47.50

EPROM EXPANSION BOARD

Holds up to six 2716 EPROMS

£39.00

SINGLE CHANNEL ADC

140 micro-second conversion time 8 bit ADC provides full 8 bit resolution between any two levels within 0-+5V range

£29.00

16 CHANNEL 8 BIT ADC

Less than 100 micro second conversion time 8 Bit ADC

£49.00

SINGLE CHANNEL 12 BIT ADC WITH SAMPLE AND HOLD

20 micro second conversion time, external trigger on board sample and hold, Unipolar or Bipolar range adjustable to $\pm 10V$ Bipolar or +20V Unipolar

£160.00

SINGLE CHANNEL DAC

8 Bit adjustable 0-+10V full scale buffered voltage output DAC (settling time 500 nano seconds)

£28.00

★ **Dealer Discounts Available. Tel: 01-543 3711**

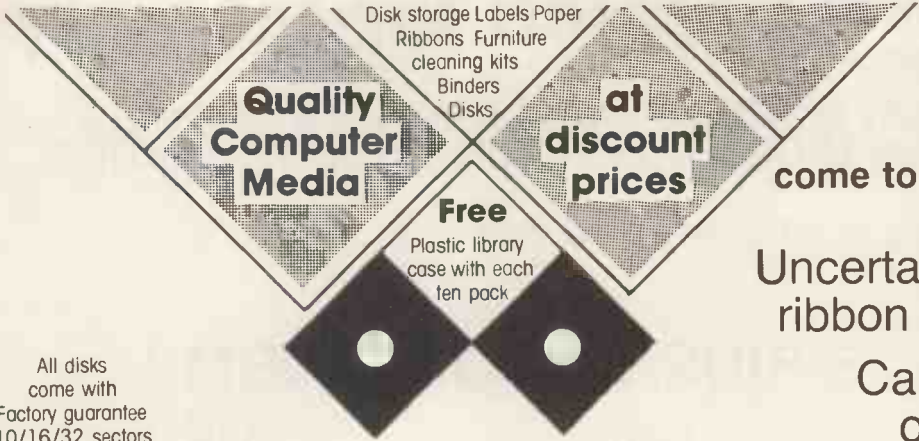

come to **Password**

Uncertain about the disk or ribbon for your machine?

Call Password for online advice.

All disks come with Factory guarantee 10/16/32 sectors available at the same price

Verbatim Datalife

The industry standard All mini disks are double density with hub rings

5 1/4"			
MD525	SS	40 track	£18.95*
MD550	DS	40 track	£24.95
MD577	SS	77 track	£26.95
MD557	DS	77 track	£34.95

* Single density compatible

8"			
FD1500	SSDD		£22.95
FD9000	SSDD		£28.95
FD8000	SSDD		£29.95
DD4001	DSDD		£34.95

BASF Disk Media

These disks are high quality at low prices

5 1/4"		
SSSD		£16.75
SSDD		£20.75
DSSD		£22.75
DSDD		£25.75

8"		
SSSD		£21.90
SSDD		£25.90
DSDD		£28.80
SSSD 32 sector		£27.35



cheap paper can damage your printer

Our stationery is superior heavyweight low dust paper. We have over 30 formats to choose from. Labels available on request.

- ◆ One part music ruled 65gsm
2000 11 x 9 1/2 £10.95 2000 11 x 14 1/2 £12.90
2000 11 x 15 1/6 £13.50
- ◆◆ New mini packs for the small user.
Plain 70gsm with perforated edges (72 cuts/inch gives ultra smooth edge). Ideal for letters/ forms and archive listings.
1000 11 x 9 1/2 £8.36 1000 12 x 9 1/4 £8.67

◆ **Disk storage**

Egly Plastic library cases 5 1/4" holds 10 £2.00 8" holds 10 £2.20
Plastic flip top large storage easy access 5 1/4" holds 30 £4.35
8" hold 60 (lockable) £18.95

◆◆ **Professional ribbons from GEHA**

Richo RP 1600	M. Strike	£3.36
NEC Spinwriter	M. Strike	£3.32
Diablo H/type II	M. Strike	£2.60
Seikosha GP100A	Nylon	£6.25
Epson MK80	Nylon	£5.32
Commodore PET	Nylon	£5.32
Sharp CE/MZ	Nylon	£5.32
Centronics zip pack	Nylon	£2.69

We have ribbons for most popular machines

UK Postage and packing

Disks 8" £1.30 each pack
5 1/4 £0.95 each pack
Library cases (EGLY) £0.50 each
(30) £2.60 each
(60) £2.60 each
Ribbons £0.35 each
Binders £2.60 each box
Paper (1000) £2.60 each box
(2000) £3.50 each box
Cleaning kit £1.30 each
Disks 95p each pack 10
Add 15% VAT to total price

◆◆ **Verbatim Disk Drive Head Cleaning Kit**

Now anyone can clean heads safely and quickly. No messy fluids, use as a normal disk.
Cleaning Kit £6.25 Extra Disks (10) £11.50 Specify 8" or 5 1/4"

FREEPOST Southampton SO9 1BG

◆ **Printout binders**

Paper Size	Vinyl	Pressboard
12 x 9 1/4	£25.00	£23.00
11 x 9 1/2	£25.00	£26.00
11 x 14 1/2	£30.50	£28.50

All prices are for 10 packs. Other sizes available

Cheques/Postal Orders to

Password Electronics Ltd

68 Commercial Road, Wyndham Place, Southampton, Hants SO1 0GD

Tel: 0703 332130



CONCURRENT CP/M™

Multiplies the power of your microcomputer.

If you have to wait impatiently for your personal computer to finish a job before moving on to another task, you need Concurrent CP/M. This new software technology from Digital Research increases the productivity of your microcomputer by allowing you to do more than one thing at a time.

Using Concurrent CP/M, you can run several programs simultaneously, switching instantly from one program to another. For the first time you can write a letter while you do your financial planning. For the first time you can write text while printing other documents. For the first time you can edit programs while your program compiles. Concurrent CP/M is the best investment you can make in micro-

computing because it multiplies the value of your hardware and lets you use all the CP/M compatible programs. And if you're developing software, it ensures that you're on the crest of the hottest new wave in the business.

There's nothing like Concurrent CP/M in the personal computer world, and you can get it only from Digital Research.

For more information, contact:

Digital Research (UK) Limited
Oxford House
Oxford Street
Newbury
Berkshire
RG13 1JB

Telephone: 0635 35304



DIGITAL RESEARCH™

The creators of CP/M™



UK Distributors

Tamsys Limited
Tel: Windsor 56747

The Software
Connection Limited
Tel: Fareham 239025

Xitan Systems Limited
Tel: Southampton 334711

The logo, tagline and names of DRI products are either trademarks or registered trademarks of Digital Research Inc.

DAMS BUSINESS COMPUTERS

Not Simply a Computer Dealer

VIC/ COMMODORE 64 IEEE CARTRIDGE

A breakthrough for all VIC/64 users. The DAMS IEEE Cartridge interface which slots into the back of your VIC/64 and links it to disk drives, language packs, printers and other peripherals. Run several VIC/64's from one disk drive.

**£49.95
+ VAT.**

(Price including VAT. £57.44).

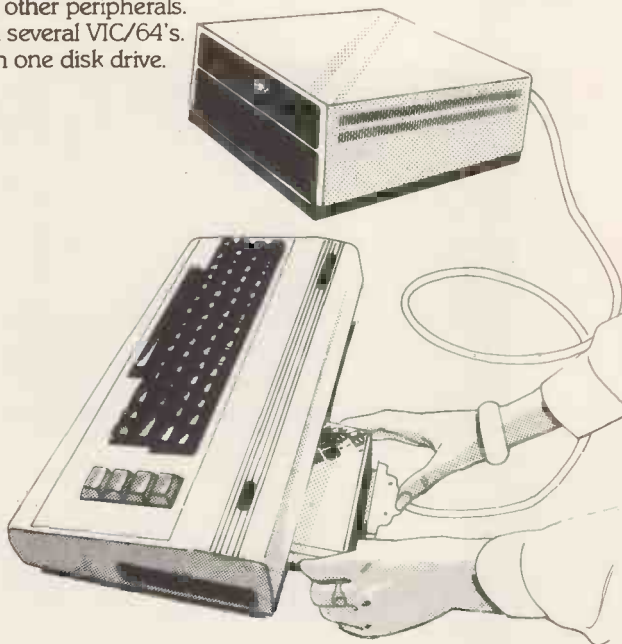

VIC/COMMODORE 64 RAM'N ROM BOARD

Doubles the memory capacity of your VIC/64 and gives you the facility to fit extra functions (VIC AID, VIC MON etc). Comes complete with specially designed cover.

£22.95 + VAT. (Price inc. VAT. £26.39).

'CLEAR-VIEW' ANTI-GLARE SCREEN

This exciting new product from DAMS is the answer to eye fatigue, headaches and migraine - symptoms regularly encountered by VDU operators. The 'Clear-View' screen can be fitted in seconds to most leading brands of computer monitors or microcomputer screens, and immediately reduces unwanted glare and reflection to a minimum. Suitable for use with mono or colour displays.



up to 12" **£19.95 + VAT.** (Price inc. VAT. £22.94).

13" to 20" **£24.95 + VAT.** (Price inc. VAT. £28.69).

20" and larger by special order.

(Leaflet available on request with full technical specification).

VIC AID Commodore 64 version available now!

Vic Aid is a chip which slots easily into the DAMS RAM'N ROM Board, and offers two sets of Utilities in one for the keen programmer:

Programmers Tool Kit

Gives extra commands: Auto, Number, Help, Delete, Change, Trace, Step, Light Pen, Break etc.

Machine Code Monitor

Gives Save, Memory, Display, Load, Verify etc. (similar to TIM on PET).

£19.95 + VAT. (Price inc. VAT. £22.94).

VIC MON Commodore 64 version available now!

Another fine product to enhance the machine - code capabilities of the VIC, VICMON is the ultimate programming aid, incorporating: Assembler, Dissassembler, Fill, Re-Locate, Identify, Exchange, Compare, Printing, Display Status Register, Display Memory with pause facility, Full Screen Assembly Edit, Software re-set from loops, Single step with variable speed etc. Slots into the DAMS RAM'N ROM board or similar.

£19.95 + VAT. (Price inc. VAT. £22.94).

**da
dams
dams**
BUSINESS COMPUTERS

**DAMS BUSINESS
COMPUTERS LIMITED**

GORES ROAD,
KIRKBY INDUSTRIAL ESTATE,
KIRKBY, NEAR LIVERPOOL. L33 7UA.
TEL: 051-548 7111

CREDIT CARD TELEPHONE ORDERS
WELCOME (Normal Office Hours).



DEALER ENQUIRES WELCOME

Send your business card, and receive our dealer
'fact pack' NOW!
12 months parts & labour guarantee on all products.

Please send me the following items

I enclose cheque/P.O. OR please debit my:

Access No. _____

Barclaycard No. _____

Name _____

Address _____

Tel: _____

(Prices inc. p.p.)

PCW383

**- HP - HP -
 NEWBRAIN - NEW
 ADVANTAGE -- TRS80 --
 OSBORNE -- COMMUNICATOR
 SIRIUS - APPLE - QUME**

and we also stock
 a unique selection of
 low cost systems in our
 'budget micro' department



Cambridge Computer Store

1 Emmanuel Street
 Cambridge CB1 1NE
 Telephone (0223) 65334/5
 (closed 12.30 - 1.15 except Saturday)



**ACT
 Sirius 1**



COMMODORE 700 SERIES

CBM 64

ALSO:

APPLES



SYSTEME

SEE THE NEW SYSTEME
 S500. MULTI-USER, MULTI-
 TASKING 16BIT MICRO.
 VERY FAST & POWERFUL.

FOLLOW THE STAR



SOFTWARE

Word-processing
 Payroll
 Incomplete Records
 Book-keeping
 Invoicing
 Stock Control
 Sales Ledger
 Purchase Ledger
 Record Keeping
 Financial Packages
 Time Recording
 Data Base
 Professional Advice Given

ACCESSORIES

Floppy Discs
 Printer Ribbons
 Stationery
 Labels
 Installation & Training
 Maintenance

**MATRIX
 PRINTERS**

EPSONS 100 CPS

MX80FT-3

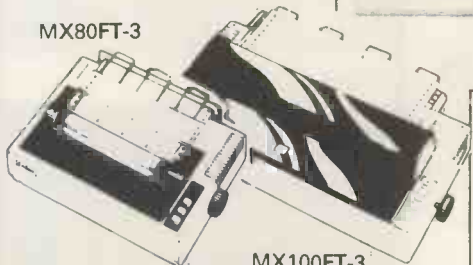

MX100FT-3
 OPTIONAL
 16K BUFFER

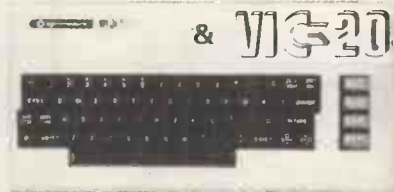

**DAISY
 WHEEL
 PRINTERS**

FLOWRITER
 RP 1600
 60 CPS + 2K or
 8K BUFFER



BROTHER HR-1
 DAISYWHEEL PRINTER
 16-20 CPS
 + 2K BUFFER

WE HAVE A CONSTANT
 CHANGING RANGE OF
 2nd HAND AND EX-
 DEMO EQUIPMENT.
 CALL US ON
 01-952 0526
 FOR LATEST STOCK.

BOOKS

Full range of Computer
 Books on Show

**DEMONSTRATIONS
 AT YOUR PLACE**

Please call for an
 appointment, anytime.

**DAVINCI
 COMPUTER
 SHOP**

65 High Street,
 Edgware, Middx.
 HA8 7DD.

OPEN:
 Mon-Fri 9.00-5.30
 Sat 9.30-5.00
 TEL: 01-952 0526



Da Vinci Computer Shop

ATA THE PRICE BEATERS



A Fresh new 48K Apple

Only **£579**
(While stocks last)

Software

PFS	£75
PFS Report	£59
DB Master 3	£139
Data Factory 5	£199
Mathemagic	£55
Graphmagic	£55
Locksmith 4.1	£65
DosTool Kit	£42
Apple Pascal	£149
Applewriter	£39
Applewriter II	£85
Wordstar 3.0	£155
Mailmerge	£59

Viasac Orbit Accounting Modules:
Prices on application - Please
phone for list.

Visicalc

Latest packaging
versions

Visicalc	£121
Visitrend/Plot	£149
Visidex	£149
Visifile	£159
Visischedule	£180

Disk Drives

Apple disk drives at these
incredible low prices!

With Controller	£270
Without Controller	£220

Apple III

128K	£1995
256K	£2495
Secondary Disk Drive	£240
Profile Hard Disk	£2095

Please phone for comprehensive list.

**APPLE II REV E
AVAILABLE NOW
ONLY £649**
phone for details

Hitachi 12" Green Screen
Monitors Only £90 FREE

Anti-Glare
Screen

Interfaces

Parallel Printer Card	£70
Serial Printer Card	£105
Pascal Card	£105
Digitek Colour Card	£99
Z80 System (New version)	£220
80 Col System (Videx)	£200
Soft Switch (Videx)	£25

16K RAM Card£48
128K RAM Card£350

Epson Printers Unbeatable Value!

MX80T (Type 3)£290
MX80F / T (Type 3) ..£315
MX100F / T (Type 3) £420
Other printer prices on
application

Accessories

Numeric Keypad	£75
Joystick (TKC)	£29
Paddles	£19
Cooling Fan	£55
10BASF 5 1/4" Disks	£20
Listing Paper	£18
Locking Disk Box	£20

Hewlett Packard

7470A Plotter

RS 232 or HPIB

Interfaces

Outstanding Value
@ £975

Complete range
of Desktop Computer
in stock



ACT Sirius I 128K with 1.2 mb S/S Disks	£2095
ACT Sirius I 128K with 2.4 mb D/S Disks	£2549
ACT Sirius I 128K with 1.2 mb D/S Disks and 10 mb Winchester	£3995
External 10 mb Winchester Hard Disk	£2549
128K Additional Memory	£349
384K Additional Memory	£795

Software

C Basic 86	£159
Level III Cobol with forms 2	£549
Microsoft Basic Compiler	£239
Microsoft Pascal Compiler	£299
Microsoft Fortran Compiler	£299
Microsoft Cobol Compiler	£439
CP/M Programmers Kit	£169
MS6 Dos Programmers Kit	£169
IEEE 488 Package	£169
Graphix / Bisigraf Graphics Pack	£169

ACT Pulsar Software at unbeatable prices

Commodore COMPUTERS

4016 16K	£495
4032 32K	£625
8032 32K	£799
8096 96K	£1075
Super Pet 9000	£1345

DISK DRIVES

2031 171K Single D/Drive	£349
4040 343K Dual D/Drive	£625
8050 950K Dual D/Drive	£799
8250 2 mb Dual D/Drive	£1195
9060 5 mb Hard Disk	£1795
9090 7.5 mb Hard Disk	£2245
C2N Cassette Unit	£36

Software prices on application

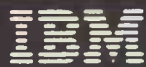

IBM PC 64K UK Spec -
240v power supply £2749

System Expansion

64K Memory Board	£277
128K Memory Board	£382
192K Memory Board	£476
256K Memory Board	£572
512K Memory Board	£980
Baby Blue	£392
Big Blue	£392

Hard Disks

5 mb Winchester	£1648
12 mb Winchester	£2197
20 mb Winchester (with tape backup)	£2699

Other Accessories

Mono Graphics Monitor	£155
Colour Monitor	£625
Colour / Graphics Card	£340
Asynchronous Comms Card	£170
Printer adapter	£63
IBM Joysticks	£42
Light pen	£159

Unbeatable
Value

IBM Software

IBM Pascal Compiler	£359
IBM Cobol Compiler	£838
IBM Fortran Compiler	£420
IBM Basic Compiler	£409
IBM Macro Assembler	£119
UCSD P - System Pascal	£749
UCSD P - System Pascal Compiler	£210
UCSD P - System Fortran 77	£749
Fortran Compiler 77	£210
CP/MC86	£287
Visicalc 256K	£159
Supercalc	£175
Time Manager	£108
Volkswriter	£146
Easywriter II	£229
Wordstar	£245
Mailmerge	£89
dBase 2	£329
Desktop Plan	£196
Graph Magic	£99
Visitrend/Plot	£189
Visidex	£166
Visifile	£156
Micro-finesse	£499

Phone us
for a
Better Deal

All M.P.S.L. Business
Accounting Software in stock
at unbeatable prices, please
phone for list.

While
Stocks
Last

Games

Championship Black Jack	£28
Microsoft adventure	£42
Deadline	£42
Zorks I to 3 (each)	£29

Come in
& Take away
Mail Order

We accept both Access
and Barclaycard subject
to a 5% surcharge.

Telephone orders are
welcome on

01-278 3838



All prices plus 15% VAT
E. & O.E.

Delivery

Please add 1.5% to your order for UK delivery charge.
Payment accepted by cash/bankers draft/building society
cheque for immediate despatch.

All goods are normally in stock, however, please confirm before
collecting.

We are open from 9.30am to 5.00pm Mondays to Saturdays.
Credit of 30 days is available on official orders from PLCs, Hospitals
and educational establishments, subject to a 5% surcharge.

Otherwise cheque with order. Please allow 10 days for cheque clearance.

Export orders welcome!

ata systems

4, ALBION HOUSE, 1, BACK HILL LONDON EC1
01-278 3838/01-278 5285 Telex 25102 Albeta G

Please phone
free price!

Mini Micro or Super Micro?

Only Cromemco offer this depth of choice

Two solutions representing the extremes of microcomputer evolution—both from the Cromemco stable—both breaking new ground in microcomputer technology—both unbelievably cost competitive in their specific areas of application.



**ON THE ONE HAND
THE RIGHT CHOICE
AT THE RIGHT PRICE**

C10 Mini Micro- The Manager's Micro for just £1195 complete. Designed for the Manager's Desk, or his staff. A stand-alone Desk Top 64K, Z80A, single board Personal Computer—with 12" easy to read, green phosphor screen, detachable keyboard with optional function keys and numeric pad, plus 390K floppy diskette drive; supplied complete with CP/M compatible operating system, easy to use word processing and financial planning/spread sheet application software and 32K structured BASIC. The Cromemco C10 is the first stand-alone micro to make computer power cost effective at an individual by individual desk top level throughout an organisation or company, with the opportunity of adding full networking capabilities at a later date.



**ON THE OTHER
THE RIGHT CHOICE
AT ANY PRICE**

68000 Super Micro- The DP Professional's Dual Processor Micro. The Dual Processor Micro-computer with a Motorola 68000 16 Bit processor plus an on-board software selectable 8 Bit Z80A. You have a choice of S100 bus systems with comprehensive I/O options for business, scientific and research applications, and memory expansion of up to 4M Bytes. You have the option of 5" or 8" floppy diskette drives, or Winchester Hard Disk subsystems up to 70+M Bytes, with a choice of CP/M compatible system software or Cromemco's Cromix; a 12 station Unix-like multi-user, multi-tasking operating system. Cromemco's comprehensive 16 Bit and 8 Bit development language library includes FORTRAN, BASIC, PASCAL, COBOL, C, RPG11, Assembler, LISP and RATFOR.

If hardware and software compatibility, and future networking potential are prime considerations for your organisation, then Cromemco must be the first and only choice.

Comart are Cromemco's longest standing, most experienced European Distributor. So with Cromemco choice, and Comart support you won't have to write off the past to step on forward into the future.

comart

Specialists in microcomputers

Please send me full details on Cromemco Systems. I am particularly interested in The C10 Manager's Micro, The 68000 DP Professional Computers All Cromemco products.

Name _____

Position _____

Company _____

Address _____

Tel _____

PCW/3



Cromemco
Developing through evolution

Unix is a trademark of Bell Telephone Laboratories.

CP/M is a trademark of Digital Research Incorporated.

Z80A is a trademark of the Zilog Corporation.

Cromemco and Cromix are trademarks of Cromemco Incorporated.

Comart Limited,
Little End Road,
Eaton Socon, St. Neots,
Huntingdon,
Cambridgeshire PE19 3JG.
Telephone 0480 215005.
Telex 32514 Comart G.

A member of the  Comart group of companies

LONDON COMPUTER CENTRE



ACT Sirius 1

1.2 Mb Disk Storage £2395
2.4 Mb Disk Storage £2895

Now available
Z 80 CP/M Add-on board
to run all CP/M 8 bit or
16 bit software

NEW

**Sirius
Hard Disk 10 Mb
Available Now!**

Wordstar Magic Wand Spellbinder
Spellstar D Base II T/Maker Calcstar
Milestone Datastar Microstar
Fortran Cobol Pascal or any CP/M
software

NEW



EPSON QX10

the revolutionary
small Business
Computer

In Stock
NOW!

TELE-VIDEO SINGLE-USER TO MULTI-USER



CP/M Software

Wordstar £195
Spellstar £130
Grammatik £65
Foot Note £75
CPM/IBM £99
CPM/DEC £99
T Maker II £150
D Base II £395
Autocode £120
Milestone £195
Task £195

NEW

EPSON HX20
the Portable
Computer £402

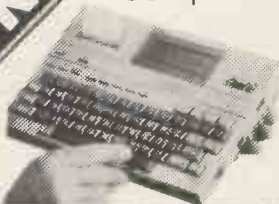

Epson Type3 MX 80/FT
MX 100

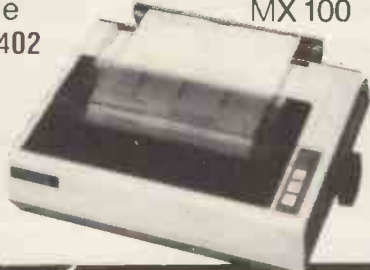

NEW

New Superbrain 2
from £1595
Dedicated Wordstar Keypad



**AUTO SHEET
FEEDER £580**
New! 12" Wide
Automatic
Sheet Feeder
fits all below



NEW

AUTHORISED TANDY DEALER
11 Mb Hard Disk model 11/16
runs CP/M & TRS DOS £1895

Model 16
128K
from £3129

Model II
with TRS DOS
and CPM at
no extra charge
from £1995

Model III
16K £599
48K £649
48K with 2 disk
drives £1395



DAISY WHEEL PRINTERS LETTER QUALITY PRINTING



- * **FLOWRITER RP 1600. 60 CPS** The most intelligent Daisy. Proportional spacing with Right Justification on WORDSTAR, WORDPRO, APPLE WRITER, SCRIPSIT etc. £1500.
- * **TEC 40. 40 CPS** JAPANESE DIABLO 630 uses Diablo Daisy Wheel & Ribbons £1135.

HARD DISKS

for Superbrain,
TRS 80 Model II, Apple

Model 6 6 Mb Formatted £1595
Model 12 11.5 Mb Formatted £1895

- * Specially designed Hybrid heavy duty power supply
- * Data Error Recovery



All prices are Exclusive of VAT and Delivery. Dealer Enquiries invited on all Products.
Large range of CPM Software available. Please phone for Prices.

Demonstrations on all models.

43 GRAFTON WAY, LONDON W1P 5LA (Opposite Maples)
OPENING HOURS: 11-7 MON-FRI 12-4 SAT Tel: 388 6991/2
24 hour answer phone: 01-388 5721

SOLVE THE "WHICH MICROCOMPUTER TO BUY" PUZZLE IN SIX EASY MOVES

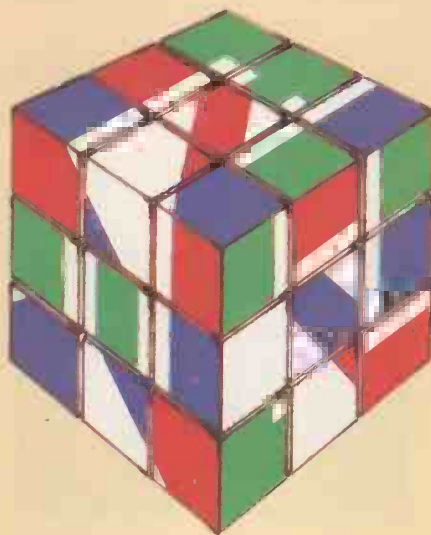

1. 16 BIT MICROPROCESSOR
2. 128K RAM
3. DUAL FLOPPY DISKS
4. 12 INCH MONOCHROME VDU
5. MSDOS OPERATING SYSTEM
6. APPROXIMATELY £1400 (EX. VAT)

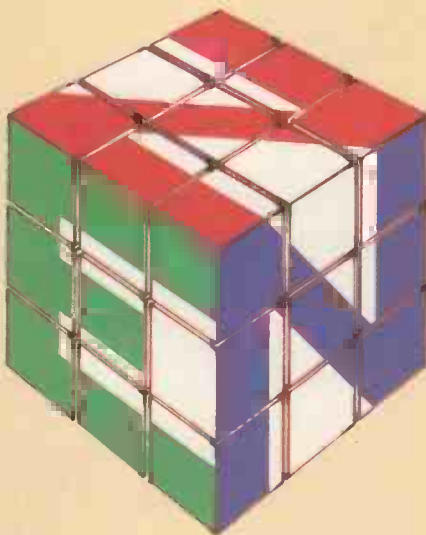

ZEN MICROCOMPUTERS LTD.

Please write for further details to:
ZEN MICROCOMPUTERS LTD, 5 ENGAINE, ORTON, LONGUEVILLE, PETERBOROUGH PE2 0QA

Name

Company

Address

Tel:

Come to

MICROAGE for sensational value packages*

ELECTRONICS



BBC + Disk Interface, 800k Disk Drive, Word Processing ROM, Epson Printer, Dust covers for all units, Basic Programming Book, Cassette lead, Paper & Cable.
 Normal Price £1748.80
 Our Price **£1599.00**
 Saving **£149.80** **FREE COURIER**

BBC MACHINES

- Model A, 32K RAM & 6522 Chip **£329.00**
- Model B **£399.00**
- Model B + Disk Interface **£494.00**
- BBC Dust Covers **£3.95**
- BBC Compatible Single Disk Drive* (100K) **£235.00**
- BBC Compatible Dual Disk Drive* (200K) **£389.00**
- BBC Dual Slimline Disk Drive* (Double Sided & Density 800K) **£799.00**
- Verbatim Single Sided Diskettes 10 for **£22.50**
- Verbatim Double Sided Diskettes 10 for **£39.95**
- Let us fit a disk interface in 24hrs **£95.00**
- Second processor Z80 **£195.00**
- Teletext receiver **£225.00**
- RH Electronics colour light pen **£37.00**

BBC MONITORS

- 14" RGB Microvitec Colour Monitor (as used in the BBC Computer Prog.) Including lead **£284.00**
- Microvitec High Res. Colour Monitor **£575.00**
- 12" Zenith High Res. Green screen Monitor **£95.00**
- BNC Cable for above **£4.95**
- BBC Compatible Cassette Player price on application
- Blank Data Cassettes 10 for **£3.50**
+ £1.30 p&p
- DIN to Jack Lead **£2.00**
+ 75p p&p
- Official Joysticks per pair **£13.00**
+ £1.30 p&p

*All Drives include manual and utility Disk.
 All items subject to availability.

All the products are the official versions, beware of imitations, they will invalidate your guarantee.

We accept official orders from educational establishments, - send large S.A.E. for lists and info pack.

Credit card holders can phone in for express despatch.

ACORNSOFT FOR BBC

Snapper, Planetoid, Monsters, Rocket Raid, Philosophers Quest, Sphinx Adventure, Arcadians, Lisp Cassette, Peeko Computer, Creative Graphics Tape, Graphs and Charts Tape, Desk Diary, Arcade Action, View (on ROM) and Printer Drive Cassette.

All Acornsoft at £9.95 each, except Arcade Action (£11.90), Lisp (£16.85), View and Printer Drive (£69.90), Wordwise word Processing ROM (£46.00) + £2.00 p+p.

Only a selection of Acornsoft available.

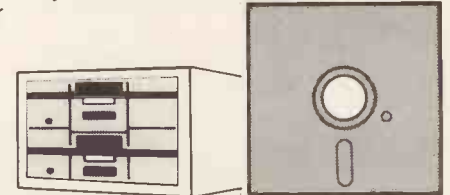
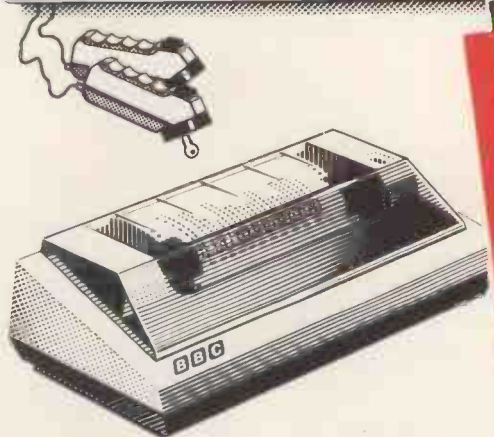

BBC compact, slimline Disk Drive.

BOOKS

- Practical Programs for BBC & Atom **£5.95**
- BASIC Programming on the BBC Micro **£5.95**
- Assembly language programming for BBC **£8.95**
- BBC Micro Revealed **£7.95**
- Creative Graphics, Graphs & Charts, LISP all at **£7.50** each
- 30hr. BASIC **£5.95**
- Let your BBC Micro teach you to program **£6.45**

BBC Model 'B' wordprocessing pack at a low price of **only £699**. Save **£44**. Normal price £743. The Pack consists of: BBC Model 'B' GP100 Printer Cables, Cassette Player Word Processing ROM 1,000 sheets of paper. Then add the GP100A Printer at only £215. The lowest price ever. **FREE COURIER**

PRINTERS

- See advertisement opposite for full details
- Acorn AP-80A now down to **£189.00**
 - Acorn AP-100A now down to **£215.00**
 - AP-80A Ribbons **£4.95**
 - AP-100A Ribbons **£5.95**
 - Epson MX-80 F/T 111 (new model, Dot matrix High res. graphics, 80 or 132 chars. per line) **£390.00**
 - All printers include cable & paper
 - Epson Dust Cover **£3.95**
+ 75p p&p
 - Parallel printer cable **£15.00**

POSTAGE RATES

Small items such as Ribbon, books & software: - 1 item **£1.00**, 2 items or more All Dust Covers **£1.00** p&p **50p** per unit

BY COURIER TO YOUR DOOR

Large items such as Computers, Disk Drives & Monitors: - 1 item **£7** 2 items **£10** 3 or more **£13**

ATTENTION!!

All Linx, Oric, BBC, Commodore 64 owners, we pay top royalties for quality software programs. Please write or phone for details.

Barclaycard and Access welcomed All prices include VAT



ALL PRICES INCLUDE VAT. FOR FURTHER DETAILS AND MAIL ORDER LIST SEND LARGE S.A.E.
Open Mon-Sat 9.15am-6.00pm. Thurs 9.15am-1.00pm.

MICROAGE ELECTRONICS

135 HALE LANE EDGWARE MIDDLESEX HA8 9QP
 TEL: 01-959 7119 TELEX 881 3241

Ninety-nine percent of PCW readers, please do not apply...

MicroScope is the fortnightly newspaper for the microcomputing industry, published under strictly controlled circulation conditions.

If you are professionally involved in any way with the microcomputing industry, as a retailer, importer, manufacturer, programmer, owner proprietor or in any other capacity, you should be reading *MicroScope*. And, if, by chance, you're one of the few people we've missed, why not fill in the Freepost coupon.

We regret that unless you are a bona fide member of the trade, your application cannot be accepted.

SUBSCRIPTION APPLICATION

To: Pamela Harbord, Subscriptions Manager, *MicroScope*, Freepost 7, London W1E 4EZ. Tel. 01-631 1433

Please send me *MicroScope* for the next twelve months.

I understand that I may claim a refund of the unused portion of my subscription at any time if not completely satisfied. I enclose a cheque/please invoice my company. (Cheques payable to SportsScene Specialist Press Ltd.)

UK £35.00

Overseas (airmail) £50.00

Please send me a sample issue & further details.

Name _____

Title _____

Company _____

Address _____

Tel No _____

Description of business _____

Trade or Bank Reference _____

Signature _____

③

NOT VALID UNLESS COMPLETED IN FULL



MicroScope

The eyes and ears of the microcomputing community.

Any four colours can be selected at a time from the palette of 255 available.

Automatic character magnification.

Random breakdown in High voltage capacitors

5-Sep-83

User-defined shading patterns.

Fast block fill facilities provided.

100 CLEAR 200
110 DIM H(7)
120 TEXT
130 PUT 12
140 CALL "RESOLUTION", 0, 2
150 I=6
160 REM DEFINE COLOURS
170 CALL "COLOUR", 0, 0, 0, 0
180 CALL "COLOUR", 1, 6, 0, 0
190 CALL "COLOUR", 2, 2, 0, 0

Ready:

Enter week number -- 35
Enter year -- 83
Enter station number -- 3

Text in 40 character mode with 80 character mode overlaid.

Characters can be oriented in any of four directions.

'Windows' can be defined and scrolled independently.

A picture may be worth a thousand words but it still tells only half the story about graphics on the 380Z.

For a start, our standard graphics functions include point plotting, line drawing, instant block fill, block copying, offsetting, and Exclusive Or Plotting.

Then there is the important fact that our High Resolution Graphics is supported by Basic, Algol and Fortran. And since the Graphics is contained in its own 16K of RAM, every byte of user memory remains available for applications program use.

It is also worth noting that 380Z graphics are equally effective in monochrome — for 'colour' just read 'shades of grey'. Again there are 255 shades available, and there's also a very useful facility for fading up and down throughout the grey scale.

There are also the special effects — such as moving between graphics 'pages' for pseudo-animation, or the

ability to produce 'instant' graphics by drawing them with the colour 'switched' off and then 'switching' on.

Next, not only can 380Z graphics pictures be saved on and retrieved from disc, they can also be output to one of a range of popular dot matrix printers.

Remember, too, that HRG is not a third-party add-on but designed, developed, and supported by Research Machines itself as an integral part of the 380Z.

And finally, we've now implemented GINO. So for the first time this well-established, professional suite of flexible, device-independent graphics software from the CAD Centre is available on a micro.

If you are interested in graphics — for scientific, technical, and industrial research; or in secondary or higher education; or for design, engineering, or control, then you will be interested in the 380Z.

GRAPHICS MACHINE



RESEARCH MACHINES
MICROCOMPUTER SYSTEMS

RESEARCH MACHINES LTD Mill Street, Oxford OX2 0BW, Tel: (0865) 249866

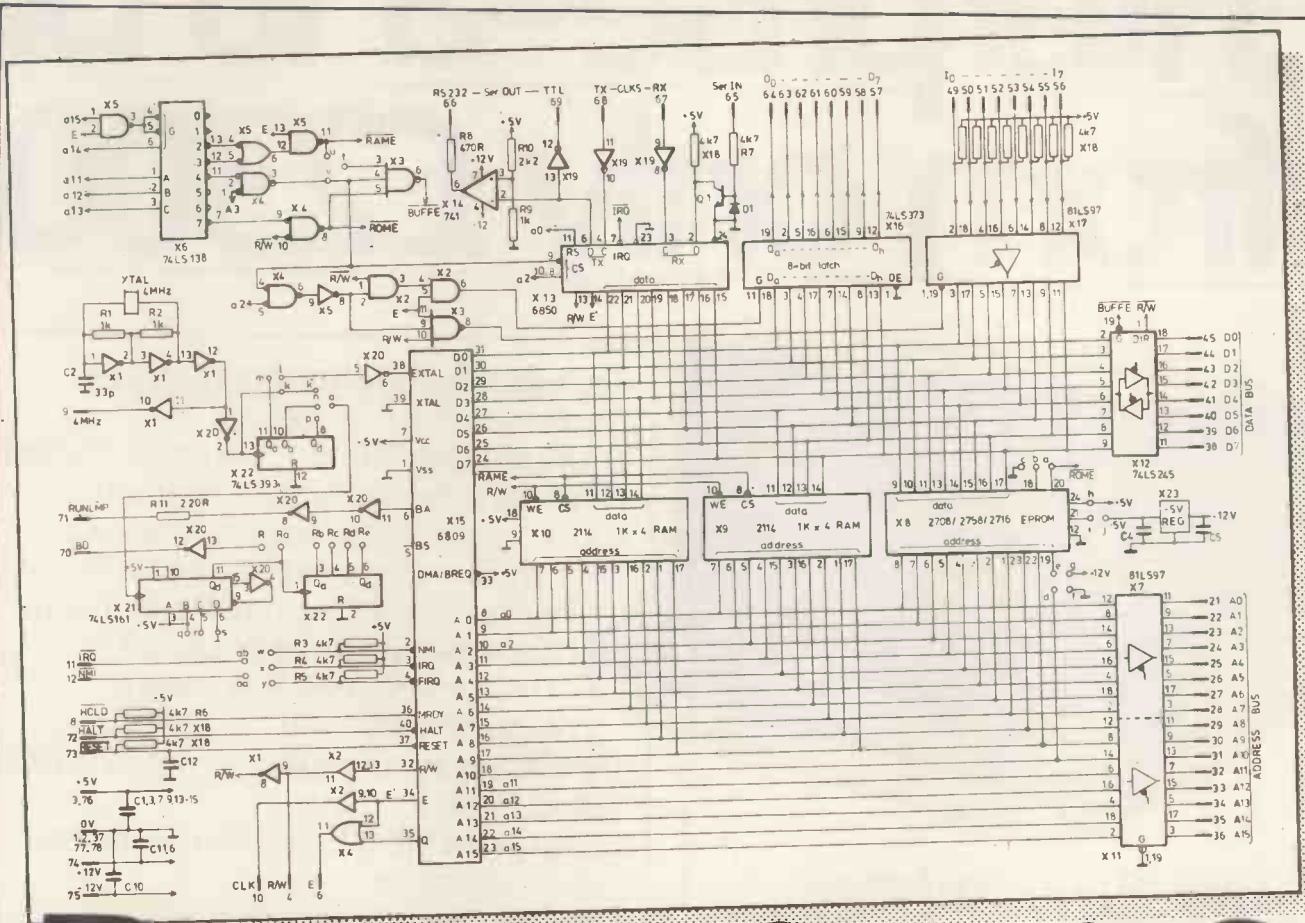

Recognise it?

If you know the 6809 CPU circuit when you see it, then you'll be interested in looking at micros in a new way. The way Electronics and Computing magazine looks at them. To us, a micro is more than a binary-cruncher. It's a piece of electronics with huge potential to link up other circuitry to open up new dimensions of computer fascination.

For example, we show you how to build an infra-red remote controller for your micro, and Phil Barker explains dialogue programming, using the PILOT system to show how it works. Also this month we start a new series to help you understand digital electronics, and the fun you can have linking logic circuits to your computer. Each month, project by project we help you expand your micro with new applications.

Some of our projects are simple and only cost pennies to build. Others are advanced and cost pounds. Indeed, we are even running a series which shows you how to build your own hi-res graphics computer from scratch (using a 6809 CPU, naturally).

Take a look at Electronics and Computing Monthly and take a new look at your micro. All you need is a hot soldering iron and a cool 75p.

WHERE ELECTRONICS AND COMPUTING INTERFACE

Electronics & Computing
MONTHLY

At your newsagent from Feb 12th

Britain's First Electronics & Computer Monthly

Enterprise—a 16 bit from only £2300.



Data General pioneered small computers. With over 14 years' experience, over 120,000 installations worldwide, and a range of compatible systems from the micro to the super-mini – we understand the needs of the business user.

Our 16 bit Enterprise business computer has been designed as a fully compatible extension to our range. Its ease-of-use, range of software, level of support and competitive price make it **the** answer for small businesses and for departments of larger organisations.

**Data General
Enterprise helps
small businessmen
grow.**

Technical highlights and features

Processor 16 bit microNova

Disk capacity 716KB – 30.7 MB formatted

Keyboard Typewriter style plus numeric, cursor control and special function keys

Display 80 x 25 green phosphor 12" screen

Printer 150 cps high quality dot matrix

Communications RJE/80, 3270, HASP, RS232, V24. Two integral programmable ports

Operating systems Enterprise O/S, MP/OS, BOS/5, M/BOS

Languages Basic, Cobol, Fortran, Pascal, MacroAssembler

Expansion Numerous interfaces, peripherals, etc

More software. Better software.

A broad range of application software packages is available to meet most requirements: accounting, word processing, financial modelling, and many others including specific 'industry' packages ensure that the Enterprise can solve **your** problems.

The software is flexible, easy to use and clear documentation is provided.

In addition, three powerful full-feature operating systems and a range of

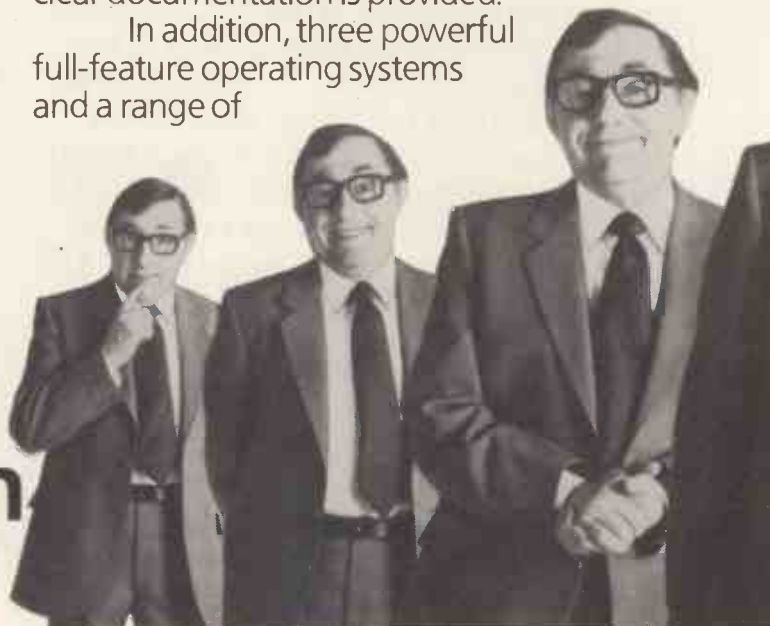

Business computer

ware utilities ensure that the Enterprise is h fast and efficient, and programs may be eloped using any of the well-known high l languages. Communication software en- es the Enterprise to talk to other computers oth Data General and many others. a General software is, of course, compatible oughout our range of systems.

Quality support

Support is always on tap from our net- rk of carefully selected local dealers. Expert ice, installation, training and continued stance are there when you need them from perienced computer professionals – all kked by one of the industry's largest and st experienced manufacturers.

Field service where you need it.

Every Enterprise comes with a Data General Site warranty. Over 250 service staff and 15 UK vice centres mean fast response.

We respond to your service call within e working day der warranty service ntract.

The computer answer.

All in all, the Enterprise adds up to a great deal – more than most competitors can offer. When you look at the price you know it's a great deal. For much less than you could pay for 'just another micro'.

Data General Enterprise helps small businessmen grow.

To Enterprise Marketing, Data General Ltd., Hounslow House, 724-734 London Road, Hounslow, Middlesex TW3 1PD. Tel. 01-572 7455.

Rush me the name of my local dealer; I want to see the Data General Enterprise in action.

Name _____

Position _____

Company address _____

Tel: _____

PCW/3/83

 **Data General**
COMPUTERS



TEA BREAK?



... OR WAITING FOR YOUR PRINTER?

GRAM HAVE A DATA BUFFER FOR YOU.

As fast as your computer may be, your printer is slow. Take a look at the work of your computer operator, see how much time is consumed waiting for printouts. GRAM's intelligent printer buffer range is designed to eliminate this wasted time and our buffers are proving time and again in business and industry, that they pay for themselves.

IPB-16K 16K buffer card plugs into Apple II chassis. Serial and parallel outputs. Many other features.	IPB-16K parallel cable	RRP 129.95 13.45
Typeslave SA models - 32K buffer with centronics input for speed. Many software selectable features.		
SA/S serial (RS232) output	SA/S	229.95
SA/P centronics (parallel) output	SA/P	229.95
EIPB 16K or 32K models fit inside Epson MX printers.	EIPB 16K/S	119.95
EIPB/S serial (RS232) input	EIPB 16K/P	119.95
EIPB/P centronic input	EIPB 32K/S	149.95
	EIPB 23K/P	149.95
Pager Addon unit for Typeslave and EIPB models for manual sheet feeding from buffer output. Also paper feed and buffer clear controls and status leds. Allows two operators on one machine!	Pager	49.95

Contact your local dealer or GRAM direct for details.

GRAM

BUSINESS SYSTEMS LTD.

48 Hedley Street, Maidstone
Kent ME14 5AD

Tel: Medway (0634) 666496
or Maidstone 679595.

PLUTO

A BREAKTHROUGH IN COLOUR GRAPHICS

PLUTO is an intelligent, high performance colour display controller that is both compact and affordable:

Technical Profile:-

- 8" x 8" PCB
- 640 (H) x 576 (V) x 8 colours
- 16 bit 8 MHz Intel 8088 microprocessor
- 192 Kbytes of dual ported memory
- Fast parallel I/O interface for connection to most computers

PLUTO interfaces to a host computer over just 2 I/O ports.

PLUTO'S in built software gives fast access to a comprehensive command set:-

- High level software protocol.
- High speed vector drawing. (over 150,000 pixels per sec.).
- Built-in character display freely mixable with graphics.
- On-board storage of user-defined symbols.
- Raster operations with rotation in multiples of 90*.
- Complex polygon colour and pattern fills.
- Circles and arcs.

PLUTO is the first in a range of compatible boards that combine to provide a graphics or image processing system tailored to your requirements.

Prices:-

PLUTO £559 + VAT
MANUAL £6

(OEM Discounts Available)

i research Ltd.

6 Laleham Avenue · Mill Hill London NW7 3HL
Telephone: 01-959 0106

When it's time to stop playing games and get down to business...

Unfortunately, many of today's desk top computers are designed with too much emphasis on home use. That's fine, if you want to balance your checkbook, play "space war" or draw pictures. But when you have serious business requirements for a computer, you want one designed specifically for business.

The RAIR Business Computer is just that. A computer designed specifically for business applications, incorporating a host of features—optimised for the business environment. 8- and 16-bit microprocessors allow users to run available 8-bit—plus newer 16-bit—applications software simultaneously. And an integral high-capacity Winchester disk drive—plus provision for additional hard disk support—provides sufficient on-line storage for virtually any business application.

Advanced communications software allows the RAIR Business Computer to connect to mainframe systems and networks. And expanded RAM memory supports simultaneous access from up to four user workstations, each including an ergonomically designed, detached keyboard, high-resolution colour display, and optional workstation printer.

So if you're serious about a computer for business, call RAIR for details about our Business Computer. We're not playing games.

RAIR Limited
6-9 Upper St. Martins Lane
London WC2H 9EQ
Phone (01) 836 6921, Telex 298452

SYSTEM SPECIFICATION

Microprocessors: Concurrent 16-bit 8088 plus 8-bit 8085
RAM Memory: 256 kbytes expandable to 1024 kbytes
Integral Disk Storage: 19-Mbyte Winchester drive plus 1-Mbyte floppy drive
Storage Options: Up to 4 add-on Winchester drives plus streaming tape backup
Communication: 4 workstation ports (RS-422-compatible), plus 2 synchronous/asynchronous programmable RS-232 ports

WORKSTATIONS (up to 4)

Keyboard: Ergonomic, low-profile, 83 keys, 10 programmable function keys, 10-key numeric keypad (with cursor/editing functions)
Color Display: High-resolution, 80 characters x 25 lines, upper and lower case, 8 programmable foreground/background colors
Printer: Bidirectional, 80 characters-per-second, friction and tractor feed

SOFTWARE

Operating System: User-friendly, multi-tasking, CP/M, MP/M, PC-DOS compatible
Languages: BASIC, COBOL, Pascal
Applications: Spreadsheet, Database, Text Processing
Communications

CP/M and MP/M are trademarks of Digital Research
PC-DOS is a trademark of IBM

the RAIR Business Computer.



IF YOU WANT TO HELP BUY SOMEONE ELSE

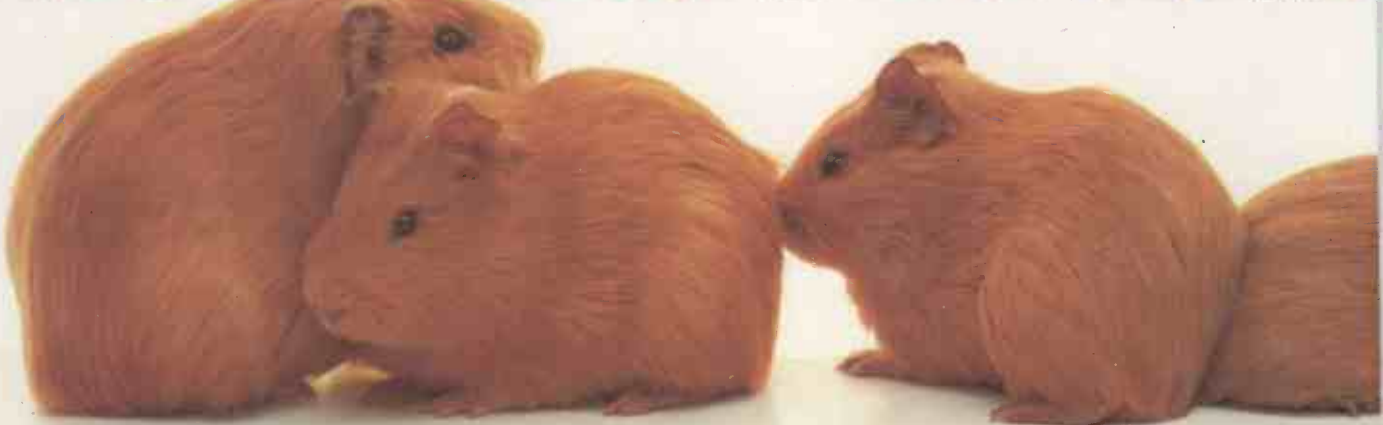

IF YOU WANT HELP BUY A COMPLETE

One of the best ways to become a human guinea-pig, is to buy one of the latest micro-computers.

Months after launch, the manufacturer can still be chasing bugs out of the system, and chasing the software writer for that long-overdue business package. Leaving you to search high and low for usable programs.

With a new Globe system, you don't have any of those problems.

Because Globe gives you fully-proven hardware together with outstanding, easy-to-use software, in complete systems that you can have up and running and improving your business, right from Day One.

THE BEST FEATURES OF THE WORLD'S BEST 8-BIT MICROS.

Look at what goes into a Globe Micro-computer, and you'll see why.

Every single part has proved itself - not just in research, but also in day-to-day use in thousands of the world's most successful business systems. Including quite a few of the most expensive ones.

Yet in many cases, our systems cost up to 50% less than those of our competitors.

Each Globe system comes complete with software. Up to £1900 worth.

And because all Globe systems use the famous CP/M 2.2 Operating System, they also give you immediate access to nearly all the best 'off-the-shelf' business packages.

A NEW WORLD OF VALUE-FOR-MONEY COMPUTING STARTS AT £1,850.

There are three Globe 'package deals', to cover most business needs. Including the need for realistically low prices.

PACKAGE A (£1,850+VAT)

This includes the basic Globe machine, the 101, plus 'Wordstar' and 'Mailmerge' software.

The 101 has 64K of RAM and two 5¼in disc-drives, to

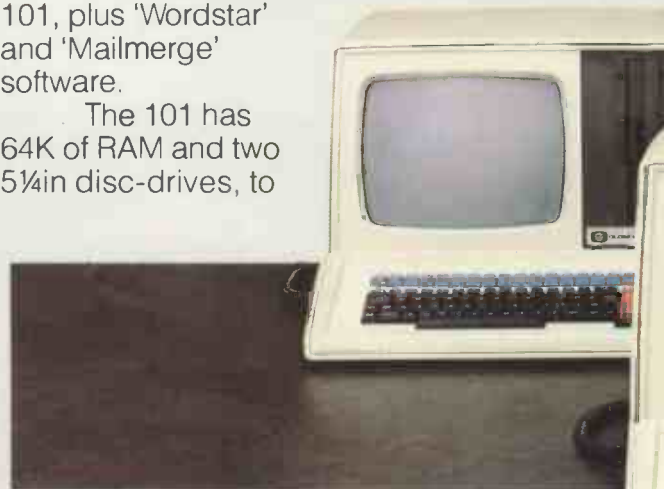

GLOBE BUSINESS MACHINES LTD · SMITH'S FORGE

P WITH RESEARCH, S NEW COMPUTER.



WITH YOUR WORK, PACKAGE FROM US.

give a further 650K of backup memory.

'Wordstar' is the world's most widely-used word-processing package. To make it even easier to use, all our machines have dedicated word-processing key-pads.

PACKAGE B (£2,495+VAT)

This package has everything in Package A, plus 'Financial Director' and 'Plannercalc' software. 'Financial Director' ('The Accountant in a Briefcase') is written for, and approved by accountants for such jobs as Nominal Ledger, Bought Ledger, Sales Ledger, Management Accounts and Cash Book. A very powerful package, yet superbly simple to use.

'Plannercalc' lets you carry out spreadsheet programming for



more straightforward tasks like cashflow reports and budget forecasts.

PACKAGE C (£3,200+VAT)

This gives you the same software as Package B - but based on the Globe 102 computer. This has 8in disc-drives, giving you very fast access to information, and four times as much storage (2.4mb) as the 101.

If you wish, you can buy a Globe 101 now, and upgrade it to the Globe 102 later.

A BETTER BACKUP SERVICE.

All our systems are supplied through a rigorously-selected network of expert dealers - so you won't run into costly hassles when you want to expand or upgrade.

There's a full 12-month labour-and-parts warranty, and a complete set of manuals with every machine and every piece of software.

And we organise seminar programmes throughout the country, to help you make even better use of your system as your experience grows.

Write or phone for a demonstration now. And discover for yourself how much better-off you'll be, all round, with Globe.

NORTH END RD · YATTON AVON · (0934) 835222.

the 8" Apple

Eicon's dual 8" floppy disk drive system gives the Apple over 2 Megabytes of on-line capacity, enough, for instance, for 15000 items in stock control, or an integrated business system with several thousand accounts.

Of if you need the extra capacity of a hard disk, a single 1" Megabyte floppy disk drive can be an ideal back-up medium.

Eicon's intelligent disk controller, with its unique EDOS firmware, provides complete integration with standard Apple software. DOS, Pascal and CP/M are all fully supported.

With additional software, Eicon drives allow the Apple to read and generate both IBM and DEC floppy disk files.

S100 Bus floppy disk systems are also available.

Eicon disk systems have a full 12 months warranty, and are supported by the larger Apple Computer dealers throughout the UK. On-site maintenance is available if required.

Franchised distributor:

Access Data Communications Limited,
Tel: (0895) 30831, 59016, 59205

**Apple make the computer . . .
Eicon make the difference.**

EICON

RESEARCH

Eicon Research Limited, Viking Way, Bar Hill, Cambridge CB3 8EL. Telephone 0954-81825
Apple II is a trademark of Apple Computer Inc. CP/M is a trademark of Digital Research Inc.

PRICES
DOWN
£200
Ask for details

OPUS SUPPLIES

SPECIAL OFFERS

DISC DRIVE DISCOUNTS

5 1/4" S/S D/D only £99.95.
 FD200. Formatted 175K. Byte.
 8" S/S D/D only £149.00.
 FD 514. Formatted.
 8" D/S D/D only £199.00.
 FD650. Formatted 1.2 Megabyte.
 Manufactured by Pertec Corporation. Factory fresh – 90 day warranty.
 Shugart compatible.

22 INCH RGB COLOUR MONITOR ONLY £99.95

We have available a limited quantity of VMC 22 Colour Monitors with free isolating transformers. The monitor has a 22" Mullard 110°C CRT and for shipping purposes the CRT and Scan Coil Assembly are separate from the chassis. The lugs of the CRT allow it to be mounted in a standard 22" colour TV cabinet or a unit of your own design. The unit is assembled by plugging the wires from the chassis to the tube and soldering the power connector, input connector and isolating transformers.

A comprehensive instruction sheet and circuit diagrams are included.

NEW TEAC DISC DRIVES

TEAC 55E. Mini S/S 80 track. Formatted single density 200K. Double density 400K. Only £179.00.
 TEAC 55F mini D/S 80 track. Formatted single density 400K. Double density 800K. Only £229.00.
 ★ Ideal for use with BBC Micro.
 ★ Full warranty.
 ★ Low power consumption.
 ★ Slimline – latest technology.

NEW COMPUTER FURNITURE

For home use – houses your Micro/Monitor/Cassette Player/Drives etc
 Send for details. Computer furniture – for the office. 10 Models Available.

DEALER ENQUIRIES INVITED

LOOK A DAISYWHEEL PRINTER ONLY £499.00

TEC Starwriter FP - 1500 - 25.
 25 CPS - Friction Feed - Serial Interface.

To Order: Add carriage at the following rates: Monitor £10.00, Other Goods £7.00 and 15% VAT to total.

And send your order to: OPUS SUPPLIES, 10 BECKENHAM GROVE, SHORTLANDS, KENT. TEL. 01-464-5040 or 01-464 1598



SKYMAN 2001

Intelligent Printer Interface for your APPLE II to connect to EPSON and CENTRONIX printers.

Allows graphics output, screen dumps, text printing with justification, paper forward and reverse and line widths or more than 40 characters; all controlled by parameter codes.

Package comes with a demonstration disk giving examples of output. Easy to install with full instruction booklet on all available facilities.

ONLY £85.00, including VAT and Packing and Postage

Please supply Skyman 2001.
 I enclose my remittance of £ or
 alternatively, please charge to my
 Access/Barclaycard No.

CAPS Ltd.,
 28 The Spain,
 PETERSFIELD,
 Hampshire, GU32 3LA.
 Tel. Petersfield (0730) 67221



FULL DETAILS AVAILABLE FROM

Hinckley Micro Systems
Edwards Centre
Regent Street
Hinckley
Tel No: 0455-616147

LEICESTERSHIRE

SOFTWARE FOR CP/M COMPUTERS

	Software & Manual	Manual Only		Software & Manual	Manual Only		Software & Manual	Manual Only
ANTHONY ASHPITEL TYPING MASTERS				INFORMATION UNLIMITED			MICROSOFT INC.	
BASIC VERSION	50		WHATSIT (Database Management System)	80		BASIC-80 5.21	218	
BUSINESS VERSION	125	25	KLH SYSTEMS			BASIC Compiler 5.3	241	
BYROM SOFTWARE			Spooler for CPM systems v3.0	82	7	FORTRAN-80 3.44	306	
BSTAM—Utility to link one micro-computer to another also using BSTAM	112	7	MAGIC CIRCLE SOFTWARE			COBOL-80 4.60	447	
BSTMS—Utility to link a micro to a mini or mainframe	112	13	CPM SIM	141		M/SORT 1.012	88	
CP/M USER LIBRARY			MICRO-AP			EDIT-80 2.02	76	
51 Volumes—Price per volume			SELECTOR-V 1.6	324	29	MACRO-80 3.43	124	
8" disc (one volume per disc)	5		MPI LTD.			MULISP 2.12	124	
5" disc (one volume per 2 disc's)	10		FORTH	85	23	MUMATH 2.12	153	
Index		2	PAYROLL	500	15	OSBORNE & ASSOCIATES		
DIGITAL RESEARCH			SALES LEDGER	200	15	ACCOUNTS PAYABLE & ACCOUNTS RECEIVABLE	50	15
BT-80	165	24	PURCHASE LEDGER	200	15	GENERAL LEDGER	50	15
CBASIC v 2.08	76	16	NOMINAL LEDGER	200	15	PHOENIX SOFTWARE ASSOCIATES		
CB-80 1.3	312	21	INCOMPLETE RECORDS	1200	20	PLINK—Disc to disc link loader	85	18
CP/M86	171	32	MATHSPACK	120		PASM—Macro Assembler	85	18
CP/M 2.2	103	24	STATSPACK	120		PEDIT—Line editor with Macros	85	18
CP/NET	126	16	MICROFOCUS			BUG—Very powerful debug	85	18
DESPOOL	31	7	CIS COBOL v 4.5	425	25	PDEVELOP Package with all the above	227	39
MAC	62	16	FORMS 2	110	10	PLINK—2 Overlay Link Loader	218	18
MP/M 1.1	138	21	ANIMATOR	225	25	SAPPHIRE SYSTEMS LTD.		
MP/M 2.0	288	35	FILESHARE	250	20	MARS	295	25
PASCAL MT	206	24	MICROLOGY			STRUCTURED SYSTEMS (All converted to UK Standard)		
PASCAL MT WITH SPP	297	35	FTNUMB (FORTRAN-80 RENUMBER & REFORMATTER)	50		SALES LEDGER	350	20
PASCAL MT LIB SOURCES	129		MICROPRO INC.			PURCHASE LEDGER	350	20
PASCAL MT SPP ONLY	147	12	WORDSTAR 3.0	294	45	NOMINAL LEDGER	350	20
PL/1-80	315	32	MAIL MERGE 3.0 (requires Wordstar)	88	12	STOCK CONTROL	350	20
SID 1.4	50	16	SPELLSTAR 1.2 (requires Wordstar)	147		LETTERIGHT	112	13
TEX3.0	65	16	WORDSTAR TRAINING MANUAL	59	21	ANALYST (File management Reporting System)	147	13
XL786	94	8	WORDSTAR CUSTOMIZATION NOTES	88	26	NAD (Name and Address selection system)	65	13
ZSID 1.4	65	16	WORD-MASTER 1.7A	44	20	QSORT	65	13
ELECTRONIC ACCOUNTING SERVICES			TEX-WRITER 2.6	147	26	SUPERSOFT INC.		
LINEAR & GOAL PROGRAMMING	200	10	SUPER-SORT 1.6	206	29	DIAGNOSTICS 1	53	11
FOX & GELLER			DATASTAR 1.101	59		TERM	85	8
QUICKSCREEN FOR DBASE-II	103	14	DATASTAR CUSTOMIZATION NOTES	176	29	SYNTAX SOFTWARE LTD.		
QUICKSCREEN FOR CBASIC/CB-80	103	14	CALCSTAR 1.2	176	29	CP/M TUTOR	55	
QUICKSCREEN FOR MBASIC	103	14	APPLE VERSIONS			TDL SOFTWARE (Technical Design Labs)		
QUICKCODE FOR DBASE-II	182	21	WORDSTAR 3.0	221	44	BUSINESS BASIC	80	
GRAM BUSINESS SYSTEMS LTD.			MAILMERGE 3.0 (requires Wordstar)	74	12	ZTEL (Text Editing Lang.)	35	
DISKREV	65	13	SPELLSTAR 1.2 (requires Wordstar)	115		LINKER	35	
DISKLENE	40	6	DATASTAR 1.101	174	29	DISKTOOLS		
DISKORG	50	6	SUPERSTAR 1.6	118	26	Disktools are a family of sophisticated programs designed to support CP/M based systems. The family consists of the Disk Reviewer (DISKREV) - A simple to use program for recovering erased or corrupted files from disk - anyone who has had files erased or made unrecoverable by system failures will know how useful DISKREV can be!		
DISKED-2	65	8	CALCSTAR 1.2	115	29	The Disk Reorganiser (DISKORG) This reorganises the files on a disk to present the most efficient usage of disk space. A detailed manual is supplied with this.		
DISKTOOLS-1 (DISKREV & DISKORG)	90	15	MICROTECH EXPORTS			The DISKLENE This examines all of the disk surface and assigns the bad areas to a special file. Any user who has had to discard potentially usable disk because of media surface faults will appreciate the savings this can make.		
DISKTOOLS-2 (DISKTOOLS-1 & DISKED-2)	145	19	REFORMATTER CPM→IBM	147	20			
			REFORMATTER CPM→DEC	147	20			

Retailer and OEM terms available

Full descriptive Catalogue available

ORDER INFORMATION

When ordering CP/M software please specify the format you require. All software items are subject to VAT. Manuals, when purchased separately, are not subject to VAT. Please add £3.75 (plus VAT) for postage and packing for the first item purchased, and then £1.00 for each extra item. For overseas please add £6.50 per item and then £1.50 for each extra item required. Most software in this advertisement is available from stock and a 72 hour return service is thereby offered on most prepaid orders. These details and prices are all current as of November 1982. Our prices reflect an exchange rate of U.S. \$1.7 to £1.00. (Telephone at time of purchase to confirm latest prices.) All payments must be in Sterling and drawn against a U.K. bank.

MAIL ORDER - TELEPHONE ORDER - VISIT - Send Cash. Cheque. Postal Order. IMO, Access or Barclaycard/Visa number to Microcomputer Products International Ltd., Room PCW, 8 Cambridge House, Cambridge Road, Barking, Essex IG11 8NT.

*** ATTENTION ALL TORCH USERS! ALL OUR SOFTWARE IS AVAILABLE IN TORCH FORMAT ***



The Disk Edit 11 (DISKEDIT 11)

This is a powerful tool, allowing modification of any byte in any sector on the disk surface. It has many uses ranging from being able to examine and restore erased files to edit corrupted files or directory entries.

MEDIA AND FORMATS

Altos	Cromemco System 2 DD/SS	RX	IMSAI VDP-80	A1	Nascom/Lucas	N1	SD Systems 5.25in	R3
APPLE CP/M-80 13 Sector	CSSN Backup	T1	Industrial Microsystems 5000	RA	NCR 8140/9010	A1	SD Systems 8in	A1
APPLE CP/M-80 16 Sector	Cyler 8	A1	Industrial Microsystems 8000	A1	NNC-80	A1	Sharp MZ-80B	R9
Blackhawk Micropolis Mod II	Datapoint 1550/2150	A1	Intel MDS SD	A1	NNC-80W	A1	Sharp PC-3201	R8
British Micros M1m1	Dec VT 180 SSSD	RV	Intertec Superbrain SSDD	RK	North Star Advantage	P2	Shelton Signet	RK
California Computer Sys 8 in	Delta Systems	A1	Intertec Superbrain QD	RS	North Star Horizon SSDD	P1	Spacebyte	A1
CDS Versatile 4	Dynabyte DB8/4	A1	ISC Intercolor 8063/8360/8963	A1	North Star Horizon SSDD	P2	Tarbell 8in	A1
Columbia Data Products 8 in	Exidy Sorcerer CP/M-80	Q2	ITT 3030 DSDD	R1	North Star Horizon QD (MPI CP/M)	P3	TEI 8in	A1
Comart Communicator CP50	Exidy Sorcerer CP/M-80B	A1	Micromail	A1	North Star Horizon QD (Other CP/M)	P2	Televideo DSDD	N5
Comart Communicator CP100	EXO	A1	Micropolis Mod II	Q2	Osborne-I	RP	TRS-80 Model I Shuffle-	S2
Comart Communicator CP200	Gemini Galaxy I	NI	Morrow Discus	A1	Pertec PCC 2000	A1	board 8in	A1
Comart Communicator CP500	Health H8 H47	A1	Mostek	A1	Rade 1000 SSDD	RL	TRS-80 Model II	A1
Compal-80	Hewlett-Packard 125.8in	A1	Multi-Tech 1	C1	Rade 1000 DSDD	RM	Vector MZ	Q2
CPT 8000	IBM PC-DOS SSDD	C2	Multi-Tech 2	C3	Rair Black Box	RE	Vector Systems 2800	A1
Cromemco System 3	IBM PC-DOS DSDD	C2	Micromail	C3	Research Machines 5.25in	RN	Vector Systems B	Q2
Cromemco System 2 SD/SS	IBM CP/M-86 SSDD	C4	Micropolis Mod II	C4	Research Machines 8in	A1	Vector VIP	Q2
	IBM CP/M-86 DSDD	RE	Morrow Discus	A1	Robotron 5"	N3	Xerox 820 5.25in	S6
	ICL-PC	A1	Mostek	R7	Robotron 8"	A1	Xerox 820 8in	A1
	ICL DRX Series	A1	Nascom (Gemini Drives SSDD)					
	ICOM 3712	A1	Nascom (Gemini Drives DSDD)					

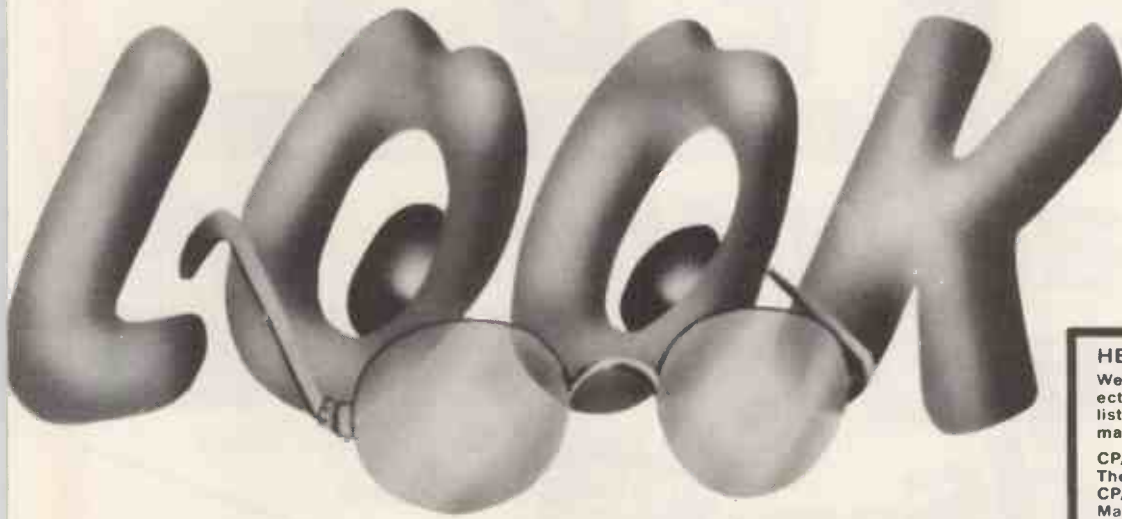

HELPFUL BOOKS:

We have a wide range of books, selected to support our comprehensive list of software. Four books which may interest you are:

- CP/M User Guide £11.10
- The CP/M Handbook with MP/M £12.10
- CP/M Primer £10.95
- Mastering CP/M £12.95

IT'S NEW!

We are constantly adding to the wide range of packages, and are pleased to advise you of these ones below. Please don't hesitate to give us a ring for any further information. Flysheets and current prices are available on request.

- | | |
|---|---|
| <p>ADDRESS BOOK - Mailing list management. Flexible and powerful sorting on up to 10,000 addresses in each datafile</p> <p>ALL-STAR DATA PACK - Comprises of DATASTAR, Supersort and Calcstar, at a 20% discount when purchased as this special pack</p> <p>ALL-STAR WORD PACK - Comprises of WORDSTAR, Mailmerge and Spellstar at a 20% discount when purchased as this special pack</p> <p>BISYNC/80 - Protocol emulation packages for HASP, 2780, 3270 and Async protocols. CP/M</p> <p>LEVEL 2 COBAL - Microfocus Level 2 ANSI '74 Cobol. This Cobol has been certified by the American GSA to the Federal High Level. CP/M, CP/M-86 and MP/M-86</p> <p>LEVEL 2 FORMS 2 - A screen layout generator and Indexed file generator, for running with CIS COBOL LEVEL 2 (CP/M-86 and CP/M-80).</p> <p>LEVEL 2 ANIMATOR - A COBOL Visual Debugging tool for running with CIS COBOL LEVEL 2. (CP/M-86 and CP/M-80).</p> <p>CORAL 66 - Microfocus Coral 66 Compiler. CP/M</p> <p>COSTING/STOCK CONTROL - Job cost estimation with stock control</p> <p>CP/M TUTOR - Menu driven tutorial course on CP/M</p> <p>DBASE II - Database generator. Powerful English like language for designing and implementing relational databases. CP/M, MS-DOS and Cromix</p> <p>AUTOCODE - Automatic code generator for DBASE II</p> <p>ENGINEERING SOFTWARE - A variety of Engineering applications including:-</p> <ul style="list-style-type: none"> - Calculation of Earthwork Quantities - Design of Highways - Surveying - Stability of Slopes - Finite Elements - Plastic Analysis of Portal Frame - Design of Sheet Pile Walls - Design of Standard | <p>MICROPERT - Very powerful critical path and project management package</p> <p>MILESTONE - Pert and Critical Path Analysis package. CP/M and CP/M-86</p> <p>PARAGRAB - Grabs paragraphs from a standard library for Insertion in documents. Works with all well known CP/M Word processing packages including Wordstar</p> <p>PERSONAL PEARL - Database generator. CP/M</p> <p>PEARL-3 - CBASIC code generator. Application generator for CBASIC. Menu led generation of business applications. CP/M</p> <p>PMATE - Word processing package with text buffers and a 'garbage' stack</p> <p>POLICY MASTER - Insurance Broker package. Covers client accounts and policy renewals</p> <p>PRINT ESTIMATING - All aspects of estimating the cost of printing a specific job. Menu lead</p> <p>PROPERTY MANAGEMENT - Comprehensive system covering all aspects of property management</p> <p>PROPERTY MATCHING - Estate Agents system matching property against demand. Commercial and Domestic versions available</p> <p>RESCUE - Database, menu lead. Very powerful Wordstar Interface</p> <p>TYPING MASTER - BASIC version and BUSINESS version, can now run under CP/M-86</p> <p>WORDSTAR - A version is now available for running on the IBM PC-DOS. Mailmerge and Spellstar have also been developed for this</p> |
|---|---|

MAIL
ORDER
TELE-
PHONE
CREDIT
CARD
ORDER

• VISIT •

Trade
Enquiries
Welcome

The LEEDS

COMPUTER CENTRE

For all your computer needs

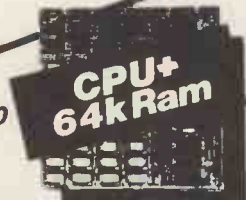

CPU £125.00
plus V.A.T.

CPU plus 64k RAM
£225.00 plus V.A.T.

64k RAM £125.00 plus V.A.T.

COMPLETE TWIN DISK SYSTEM

£675.00 plus V.A.T.

I/O Card £125.00
plus V.A.T.



80 x 25 Video Controller

MULTIBOARDS use 80-Bus and are fully Nascom compatible e.g. disks, enhanced video, Input/Output or Ram expansion.



Floppy Disc Controller

MULTIBOARDS make computers **MULTIBOARDS** enhance:-

GEMINI, Nascom or QUANTUM
Send for full details

The QUANTUM 2000



is ideal for business applications. It can have up to THREE drives giving 2.4 megabytes of disk storage. Its expansion capabilities are almost infinite, thanks to the flexibility of Multiboard plus 80-Bus.

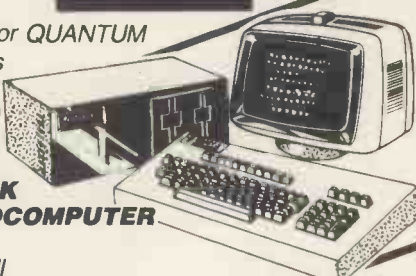

GEMINI GALAXY 64K 2.2 CP/M MICROCOMPUTER

A cost effective solution to the small business, educational or home user requiring a reliable Z80 based CP/M computer
From **£1,450.00** plus V.A.T.

Only the new HX20 portable computer from Epson fulfils these requirements

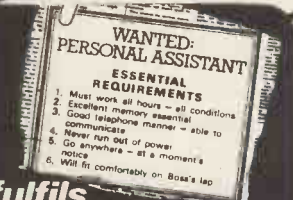

- WANTED: PERSONAL ASSISTANT ESSENTIAL REQUIREMENTS**
1. Must work all hours - all conditions
 2. Excellent memory essential
 3. Good telephone manner - able to communicate
 4. Never run out of power
 5. Go anywhere - at a moment's notice
 6. Will fit comfortably on Boss's lap



From **£402** plus V.A.T.

HX-20 PORTABLE COMPUTER

The first truly portable computer with full size keyboard, built-in printer, micro cassette drive, high resolution display, rechargeable batteries give hours & hours of use and give enough power to retain memory when computer is switched off, and is only 1.7ins thick and about A4 size.
THINK it in England. COMPUTE it over France. PRINT it in Saudi and SAVE it on your main system back in England. That's what HX20 can do for you - and it's cheaper too. For a standard desk top of roughly the same power as HX20 you could pay about twice as much - that's real value for money!

We are an official Sharp computer centre

As one of SHARP'S biggest distributors, we always have stocks. We have the expertise to advise you on interfaces and software. We developed the QUANTUM MZ 80k Hi-Res which gained official SHARP approval.

PLEASE CALL FOR LATEST PRICES.

MZ80A with £75.00 free software **£475.00** plus V.A.T.

MZ80B with 64k plus GRAPHICS RAM

£850.00 plus V.A.T.

PC1211 **£65.00** plus V.A.T.

CE122 PRINTER **£60.00** plus V.A.T.

PC1500 **£145.00** plus V.A.T.

CE150 PLOTTER **£130.00**

plus V.A.T.

QUANTUM MZ80k

HI-RES **£100**

plus V.A.T.

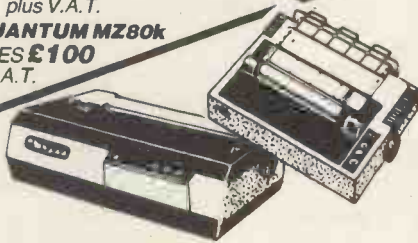

We stock the following printers:- EPSON, SEIKOSHA, and more important, we know how to interface them to a variety of computers.

BITS & PCS

COMPUTER PRODUCTS LTD

Trading as Leeds Computer Centre.
Please call or write for full details
Leeds Computer Centre, The Balcony,
60/62 Merrion Centre, LEEDS.
Tel: 0532-458877



MIDAS S100 SYSTEMS

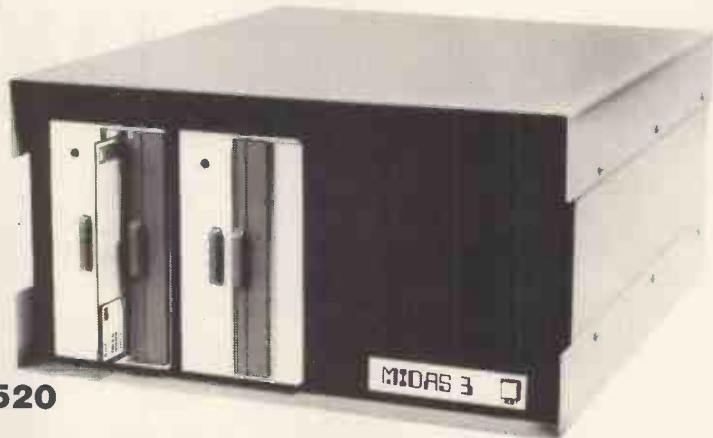

MIDAS 1 : From £895

MIDAS 2 : From £1,890

MIDAS 3D : From £3,100

MIDAS 86 — 16 Bit : From £3,520

- Our versatile Z80 Microcomputers are available as standard units or custom configured to your exact specification from a comprehensive range of stocked S100 boards.
- Disc storage capacity of the **MIDAS 3** can be 2M Bytes, expandable to over 80M Bytes with a Winchester Hard Disc Unit in our **MIDAS 3HD** range.
- **MIDAS** runs CP/M and MP/M. Other Software includes M-BASIC, C-BASIC, FORTRAN, COBOL, CIS-COBOL, and Word Processing.
A **MIDAS 3D** with 64K RAM and 2M Bytes on two 8" drives with two Serial I/O Ports and CP/M only **£3,100**
- Printers, VDUs and other peripherals stocked to give complete package system at keen prices.

BOARDS

We stock over 50 different S100 Boards all from quality manufacturers, such as Godbout, SSM, Micromation, Dual, Ithaca, Vector, S.D. Systems, Morrow, Pickles & Trout, etc.

PROCESSOR

Z80 Starter Kit
Single Board Computers
8085/8088 CPU
Z80A CPU 4MHz (4 types)
8086

EPROM

2716 EPROM (2x16K)
2708/27 16/2732 Programmer

VIDEO BOARDS

24x80 I/O Drive
24x80 Memory Mapped

DISK CONTROLLERS

Single Density 5" or 8"
Double Density DMA
Floppy or Hard Controllers

RAM

Static RAM 16-64K 24 Bit addressing
Static RAM 8x64K or 16x32K RAM/
Battery Back-up
Memory Manager

I/O BOARDS

2S/2P or 4S/2P or 3P/1S etc
A/D & D/A or 12 bit
IEEE 488 Interfaces

MISCELLANEOUS

Real Time Clocks
Graphics 512x256 (b/w)
Colour Graphics 312x290
Maths Board AMD 9511
Extender Boards/Logic Probe
Motherboards 7-20 slot

MAINFRAMES

We are the sole distributor for Integrand Mainframes and Disc Enclosures, available in nine models including Desk Top and Rack Mounting, with or without provision for Disc Drives. All units totally enclosed, painted on all external surfaces and complete with power supply etc.

SOFTWARE

CP/M 1&2, MP/M, PL/1, C-Basic 2, M-Basic V5, XYBasic, Fortran 80, Cobol 80, Cis-Cobol, Pascal/Z, Pascal M/T, Forth, MAC, ZSID, Disassembler, Wordstar, Datatar, Wordmaster, Supersoft etc etc.

We are pleased to discuss your requirements and will advise you as to whether your needs can be met with one of our computers.

All of our systems are specials as they are configured to suit your specification, thus ensuring that you get what you want rather than what happens to be available.

Write or phone for a catalogue.

Unit 14, 29 Willow Lane, Mitcham, Surrey
Telephone: 01-640 6931/2/3

How to make work like a

First, neatly cut out the "370" label.

Now, when nobody's looking, nonchalantly tape it to your terminal, just under the "IBM," as if it really belonged there.

Then wait for your chance and quickly slip a dBASE II™ disk into your main drive.

That's it.

Your IBM Personal Computer is now ready to run a relational database system, the kind that IBM has

on their mainframes. And you're ready with more data handling power than you would have dreamt possible before dBASE II.

You'll wonder how you managed without it.

You'll find that dBASE II, because it's a relational database management system (DBMS), starts where file handling programs leave off. dBASE II handles multiple databases and simplifies everything from accounting to department staffing to monitoring rainfall on the Upper Volta.

With a word or two, you CREATE databases, APPEND new data instantly, UPDATE, MODIFY, and REPLACE fields, records and entire databases. Organize months worth of data in minutes with the built-in REPORT. Do subfield and multi-field searches, then DISPLAY some or all of the data for any condition you want to apply.

And you've just begun to tap the power of dBASE II.

Easy to look at, easy to use.

Input screens and output forms couldn't be easier—just "paint" your format on the screen



and what you see is what you'll get.

You can do automatic calculations on fields, records and databases, accurate to 10 digits.

And you can use dBASE II interactively for answers right now. Or save your instructions, then repeat everything with two words: DO Manhours, DO Project X, DO whatever has to be done.

Use dBASE II to help make your choice:

Instead of just poring over a manual, you can check out dBASE II by running it on your own system free for 30 days.

e your micro mainframe.



Visit your dealer and run through a hands-on demonstration. Then buy a package and use it on your IBM PC, Sirius or CP/M computer. If you don't like it, return it and you'll get your money back, no questions asked.

But if you do that, you'll have to remove that label. Because nothing short of a mainframe works like dBASE II.

For the name of your nearest dealer, contact one of our distributors: Encotel Systems 01-686 9687. Ferrari Software 01-751 5791. Interam 01-675 5325. Pete & Pam (0706) 227011.

Ashton-Tate

dBASE™

©1983 Ashton-Tate
dBASE II is a registered trademark of Ashton-Tate
CP/M is a registered trademark of Digital Research

Home Computer - Starter Packs

THE BEST PRICE & ADVICE FOR THE BEGINNER

NEW

The exciting new personal computer from Commodore

Commodore 64

- ★ 64K RAM
- ★ 16 colours, dedicated video chip
- ★ 62 pre-defined graphics characters, 3 voices, 9 octaves. Music synthesizer. dedicated sound chip
- ★ 40 x 25 display. 320 x 200 for high resolution
- ★ Powerful graphics commands
- ★ Supports CP/M[®] and others. complete range of peripherals



Printer - £230.00
Disk Drive - £299.00
Cassette Unit - £44.95

VIC 20

STARTER PACK 1.
VIC 20 + Cassette Unit + Intro to Basic + 10 x C12 Cassettes - £189.00

STARTER PACK 2.
VIC 20 + Floppy + Printer - £550.00

DRAGON

★ Britain's newest Personal Computer using the latest 6809E processor.
★ Full 32K Specification
★ Microsoft Basic, Advanced Graphics, Sound, Editing.
★ 9 colour display.
★ Professional quality keyboard.
★ Plug-in connection for Joystick, Cassette, Printer, Games.



Cartridges - Ghost Attack £24.95
Octaves £19.95. Cassettes £6.95

★ DRAGON 32K - £199 ★
inc. VAT.

BBC

Model B - £399
Upgrade A to B - £95
Disk Drive - £265
Disk Interface £97.75 including fitting.



ALL PRICES INCLUDE VAT

SINCLAIR

ZX81 - £49.95
Printer - £59.95
16k RAM - £29.95

STARTER PACK 1.
ZX81 + 16k RAM + Printer + 10 x C12 Cassettes + 2 Rolls Paper - £146.95

STARTER PACK 2.
ZX81 + 16k RAM + 10 x C12 Cassettes - £81.95



ATARI

AM400 - £189.95
A800 - £399.00
Recorders - £49.95
Basic - £49.95

STARTER PACK 1.
AM400 + Cassette Deck + 10 FREE C12 Cassettes - £239.



STARTER PACK 2.
AM400 + Cassette Deck + Basic - £275.

NEW from ONLY £99.95

ORIC 1
Choice of 16K or 48K RAM
16 Colours. Full Graphics.
Real Sound.

EXPORT

Single or QUANTITY EXPORT orders welcome. NO VAT.
Experience of exports worldwide - full documentation
MONITORS, PRINTERS, SOFTWARE.
Popular prices on all popular Computers.
Send: A4 S.A.E. for latest FREE Brochures & Pricelists

CASTLE ELECTRONICS

(0424) 437875

CASTLE ELECTRONICS Dept. PCT.
7 CASTLE STREET, HASTINGS, E. SUSSEX.

Our Sister Company SOUTH EAST COMPUTERS, is No.1 in the South for Business Systems

ZX81 MACHINE CODE?

ZX.ASZMIC rom transforms ZX81 into an Assembly Language programming unit

Ø FULL-SCREEN EDITOR

Sixteen shift keys take you into a world with a word processor feel. A blink cursor moves at your command to control insertion, rubout, line or string deletion, auto-scroll & page flip up or down. Text block operations. Ultra-fast editing.

Ø MULTI-FILE SYSTEM

Declare as many files as you like, with any names you like, & they are automatically handled by the Operating System. Merge them, delete them, print, save & load them, & edit them by name. Superb flexibility with a simple but powerful system.

Ø TOTAL ASSEMBLER

Full Z80 mnemonics, unlimited length labels, ORG & EQU directives, proper assembly listings with errors flagged on screen or printer. Relocatable object code & options to facilitate cross-assembly. Interpretive immediate execution available.

Ø POWERFUL DEBUG

All the usual dump, modify, fill & copy commands; plus breakpoints, single stepping, context control, the convenience of interpretive execution mode, full use of the names in your program, Command Macros, autodump, and full operating system interface.

Ø HI-RES GRAPHICS

255 x 144 resolution under program control to give you truly convincing graphics. With the power & flexibility of assembler you can really use this high definition.

Ø MUCH, MUCH MORE

Repeat function on all keys. Double height & fine pitch on printer. Cassette catalogue. 120 page "ASZMIC GOLD" manual with training exercises, discussion chapters, sample programs, documented monitor routines & much reference information. Communicate with Basic via cassette (skeleton programs with machine code in REM) or via memory using the optional software switchable dual Rom board available from Capital Computers Ltd (£9+vat). ASZMIC redefines the ZX81 hardware to give you an integrated development system with professional facilities which rival even very expensive systems. Why not get in touch for more details?

DEMO .PROG
DEMONSTRATION PROGRAM FOR ASZMIC
DEMONSTRATION OF A SIMPLE ASSEMBLE

ORG : 7000
NRM2 : 492

```
INIT=$ HL, TABLE-1
LD B, TABLE-1
LOOP LD A, (HL) ; GET A CHARACTER
PUSH BC ; SAVE CONTEXT
CALL NRM2 ; WRITE TO SCREEN
POP BC ; RESTORE CONTEXT
POP HL ; RESTORE CONTEXT
DJNZ LOOP ; LOOP TILL DONE
RST 0 ; SIMULATE BREAK
```

TABLE=\$ "ASZMIC AT YOUR SERVICE"
DEFB DEFB : 76; NEWLINE
TABLEND

DEMONSTRATION OF A SIMPLE ASSEMBLY USING ASZMIC

ORG : 7000
NRM2 : 492

```
INIT=$ HL, TABLE-1
LD B, TABLE-1
LOOP LD A, (HL) ; GET A CHARACTER
PUSH BC ; SAVE CONTEXT
CALL NRM2 ; WRITE TO SCREEN
POP BC ; RESTORE CONTEXT
POP HL ; RESTORE CONTEXT
DJNZ LOOP ; LOOP TILL DONE
RST 0 ; SIMULATE BREAK
```

TABLE=\$ "ASZMIC AT YOUR SERVICE"
DEFB DEFB : 76; NEWLINE
TABLEND

£39.95

incl. p&p

Comprocsys limited

I enclose £39.95. Please rush me ZX.ASZMIC + manual

NAME

Address

Sole UK agents: - CAPITAL COMPUTERS LTD.

1 Branch Rd, Park St, St Albans AL1 4RJ.

Phone 0727 72917. Cheques payable to Comprocsys Ltd

r q FORTH BBC FORTH TOOLKIT

"r q FORTH" runs on 16K or 32K BBC micros and costs £15. It:

- * follows the FORTH-79 STANDARD and has fig-FORTH facilities;
- * provides 260 FORTH words;
- * is infinitely extensible;
- * has a full-screen editor;
- * allows full use of the M.O.S.;
- * permits use of all graphic modes, even 0-2 (just!);
- * provides recursion easily;
- * runs faster than BBC BASIC;
- * needs no added hardware;
- * includes a 70 page technical manual and a summary card;
- * has hundreds of users.

Level 9 Computing are pleased to announce a new toolkit for "r q FORTH" on 32K BBC micros. It costs only £10 and adds the following facilities to FORTH:

- * a 6502 assembler, providing machine-code within FORTH;
- * turtle graphics, giving you easy-to-use colour graphics;
- * decompiler routines, allowing the versatile examination of your compiled FORTH programs;
- * the full double-number set;
- * an example FORTH program and demonstrations of graphics;
- * other useful routines.

nascom

Extension Basic . £15/£30 ROM
Adds 30 new keywords to BASIC
Compression Assembler 2 . £12
Small source + high speed

Asteroids m/c,g £7.90
Galaxy Invaders . m/c,g £5.90
Missile Defence . m/c,g £7.90
Super Gulp eb,g £4.90
5-games cassette . misc £5.90
(FULL RANGE IN CATALOGUE)

adventures Spectrum BBC nascom

- 1) COLOSSAL ADVENTURE: The classic mainframe game "Adventure" with all the original treasures & creatures + 70 extra rooms.
- 2) ADVENTURE QUEST: Through forest, desert, mountains, caves, water, fire, moorland and swamp on an epic quest vs Tyranny.
- 3) DUNGEON ADVENTURE: The vast dungeons of the Demon Lord have survived His fall. Can you get to their treasures first?

Every Level 9 adventure has over 200 individually described locations and is packed with puzzles - a game can easily take months to complete. Only sophisticated compression techniques can squeeze so much in! Each game needs 32K and costs £9.90

ALL PRICES INCLUDE P&P AND VAT - THERE ARE NO EXTRAS. Please send order or SAE for catalogue, describing your micro, to:

LEVEL 9 COMPUTING

Dept W, 229 Hughenden Road, High Wycombe, Bucks. HP13 5PG



FULL DETAILS AVAILABLE FROM

Ace Mailtronix Ltd
23 Commercial Street
Batley
Tel No: 0924-441128

WEST YORKSHIRE

PORTABLE MICRO'S

TAKING THE COMPUTER A STEP FURTHER

EPSON HX20

A computer small enough to fit into a briefcase yet with a full size typewriter keyboard, LCD virtual screen, printer and microcassette facility actually built in. High speed serial communication with other computers plus the Epson reliability - a world beater.

A FULL SIZE QWERTY KEYBOARD WITH 68 KEYS INCLUDING 5 FUNCTION AND 13 SPECIAL KEYS. LCD DISPLAY WINDOW SHOWING ANY 20 COLUMN BY 4 LINE PART OF A VIRTUAL SCREEN UP TO 255 CHARACTERS WIDE. 50 HOURS BATTERY LIFE WITH MAINS ADAPTER FOR OVERNIGHT CHARGING. BUILT IN PRINTER 5 x 7 MATRIX, 24 COLUMN WITH BIT ADDRESSABLE GRAPHICS. OPTIONAL BUILT IN MICROCASSETTE OR ROM PACK.

HX20JA PORTABLE MICRO UNIT WITH OPERATING MANUAL £402.00
HX20MC-SA MICROCASSETTE DRIVE £75.00



NEWBRAIN

You thought it would never arrive, but here it is with all those promises fulfilled. We never appreciated the full computing potential of the NEWBRAIN but suffice to say, it's a machine with a great future. We'll be able to tell you how to fully utilize the considerable power of the NEWBRAIN and take advantage of all that CP/M software.

THE NEWBRAIN IS A FULLY SPECIFIED PROFESSIONAL COMPUTER BUILT TO THE HIGHEST STANDARDS OF ENGINEERING AND RELIABILITY. CHOSEN BY LEADING OEM SUPPLIERS DESIGNED TO FACILITATE EASY EXPANSION FOR USE WITH THE CP/M OPERATING SYSTEM AND THE ADDITION OF 5 1/4" FLEXIBLE AND WINCHESTER DISKS; 12" GREEN PHOSPHOR PROFESSIONAL STANDARD MONITOR; 80 CPS PROFESSIONAL QUALITY DOT MATRIX PRINTER WITH PIN ADDRESSABLE GRAPHICS.

NEWBRAIN MODEL A £199.00
NEWBRAIN MODEL AD £229.00



HEWLETT PACKARD

HP75C A TOTALLY NEW PORTABLE PERSONAL COMPUTER.

An executive tool for the man in a hurry, 600 appointments can be held in memory. Never miss a board meeting or a birthday. In addition, - an impressive scientific aid to engineers and Scientists with magnetic card strips for handy programs and a magnificent BASIC.

HP75C SPECIFICATION 5" x 10" x 1" WEIGHING 26 oz. 16K RAM EXPANDABLE TO 24K. 48K OPERATING SYSTEM WITH 187 KEYWORDS AND FULL SCIENTIFIC BASIC. 8 BIT CPU, 32 CHARACTER LCD DISPLAY WITH SCROLLING TO 96 CHARACTERS; FULL INSTRUMENT AND PERIPHERAL CONTROL USING THE HPIL INTERFACE LOOP. 30HR BATTERY LIFE WITH RECHARGER. 3 PLUG IN 16K ROM MODULES. A FULL REDEFINABLE TOUCH TYPE QWERTY KEYBOARD WITH EDITING KEYS AND HIDDEN NUMERIC PAD. A BUILT IN PROGRAMMABLE ALARM/TONE GENERATOR AND APPOINTMENT CALENDAR. THIS IS ONE OF THE MOST COMPACT AND POWERFUL PORTABLES WITH HP'S SCIENTIFIC AND TECHNICAL BACKGROUND AND SUPPORT DOCUMENTATION. ITS POWER IS YOURS TO APPLY.

HP75C PORTABLE COMPUTER £728.40
HP-82700A 8K MEMORY MODULE £142.75

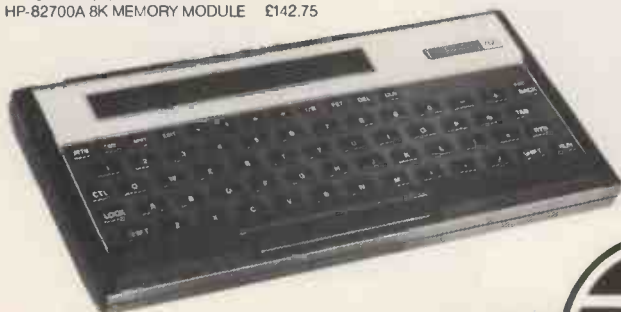

SHARP PC1500

This machine is the least expensive portable on the market. It is ideal for salesmen, contract engineers and anyone wanting to produce figures or small graphics for clients. Its 4 colour printer is a masterpiece of simplicity and it offers a medium speed BASIC for keeping standard programs in RAM. It is particularly useful for engineers who wish to do 'set calculations' on site and produce results on the spot. Great value for money.

WITH 16K BYTES OF ROM AND UP TO 11.5K BYTES OF RAM MEMORY, WITH BATTERY PROTECTION. UP TO 36 PROGRAMS STORAGE CAPACITY. BASIC PROGRAM LANGUAGE WITH TWO DIMENSIONAL ARRAYS AND VARIABLE STRINGS. QWERTY KEYBOARD WITH UPPER AND LOWER CASE. FULL RANGE OF SCIENCE AND MATHS FUNCTIONS (STATISTICS WITH MICROL SOFTWARE) ALARM CLOCK AND CALENDAR, MULTI TONE GENERATOR, MINI GRAPHIC 7 x 156 DOT MATRIX DISPLAY, ALL UNDER BASIC PROGRAM CONTROL. LINE WIDTH 26 CHARACTERS.

CE-150 FOUR COLOUR GRAPHIC PRINTER/TWO CASSETTE INTERFACE.

PC 1500 COMPUTER £147.78
CE150 PRINTER/TAPE INTERFACE £130.39
CE155 8K RAM MEMORY MODULE £69.52



Visit our Portable Micro Centre
or contact us for further
information.

Telephone and mail orders
accepted on Barclaycard
or Access
All prices exclude carriage and VAT



59/61 Theobald's Rd. London WC1X 8SF. Tel: 01-405 5240/2113. Telex: 24224 (Ref. 1422).

For full proposed range of Portable Computers and typewriters, including the Osborne, Kaypro II, Teleram, Panasonic, Toshiba, Andromeda, Brother, Husky, please contact us for price and availability. Not all items are yet in production so it is best to telephone for delivery details.

SNAPSHOT

Not just another Apple bit copier

SNAPSHOT removes copy protection, and copies most programs that no bit copier can touch — including the bit copiers themselves!

Got the back-up blues? Is Locksmith letting you down? You need SNAPSHOT! SNAPSHOT will copy any memory-resident program that runs on a 48K Apple II. **For example, SNAPSHOT will copy any bit copier now sold, in less time than it takes you to read this paragraph.** SNAPSHOT is a peripheral card that uses your language card* to interrupt a running program and dump the entire contents of 48K and registers to an unprotected, copyable backup disk.

Unlike bit copiers, SNAPSHOT requires no complex parameter changes or trial-and-error tedium. SNAPSHOT is also ideal for debugging your own programs or analyzing others' programs. And SNAPSHOT can be used to suspend your work with one program while you use another program. For example, you could interrupt word-processing a letter to look up an address in a database, then resume processing the letter exactly where you left off. Shooting down space invaders and the phone rings? Interrupt your game until later, or tomorrow! Save your high scores! Freeze-frame your game, print the graphics on your Epson, and resume play!

- Full normal use of your other hardware and software; never open the Apple's lid.
- Repeatedly interrupt and resume any program
- Faster and far easier to use than any bit copier
- Full monitor capabilities to examine, modify, trace, single-step or disassemble any interrupted program, or print graphics on Epson printer.
- Copies protected programs from 13-sector to 16-sector disks
- List 'unlistable' Basic programs; Make custom modifications
- Suspend work with any program; resume where you left off
- Move protected programs to hard disk or 8" disk as normal files
- Backups run without SNAPSHOT present; most run without 16K card.

And there's more! Write or ring for complete technical information

PRICE: £95.00
from your local dealer or Dark Star Systems

Terms: Payment with order. Add 15% VAT. P&P included. Foreign orders: No VAT. Add £2 postage to Europe, £7 elsewhere. VISA/Barclaycard and American Express accepted. Dealer enquiries invited.

*One drive and Language Card/16K card required.

Works with most popular cards, including Apple, Microsoft, Ramex, Digitek, MPC, RH Electronics, Orange, Franklin, etc. Other brands: specify when ordering.



54 Robin Hood Way, Greenford, Middx. UB6 7QNP Tel: 01-900 0104

Cumana drives BBC Micro best!



**CUMANA DRIVES +
OWN POWER SUPPLY
=BIG PLUS FOR
BBC MICRO USERS
... JUST FOR
STARTERS**

The 'ice on the cake' is that because the Cumana Drive has its own power supply, it can be used with many other Micros when connected via the appropriate cable. Cumana supply a Drive connecting cable which has a standard 34 way edge connector plus 34 way BBC connector in the same cable length. This allows the Cumana Drive to be connected to numerous makes of micro without the need to change connecting cable. And the Japanese manufactured disk drives are quiet and utterly dependable.

**12 MONTH
FULL WARRANTY**

**£199
100K**

**£619
800K**



CS50A Single 40 track drive 100K £199
CD50F 2 double sided 80 Track TEAC Drives
with cabinet and power supply 800K £619

Disk formatter and instructional manual £15
Model A-B upgrade kits £65

**Many other Disk Models available for BBC.
Call or write for Data Sheet.**

CUMANA LTD

Unit 1, The Pines Trading Estate, Broad Street,
GUILDFORD, Surrey GU3 3BH (0483) 503121
Telex: 859380 CUMANA

Please add VAT to all prices

**DEALER & EDUCATIONAL ENQUIRIES WELCOME -
GENEROUS DISCOUNTS AVAILABLE**

Big game thrills for Dragon owners!



GOA
3

Flipper

Microdeal

MICRODEAL

Inscrutable oriental electronic strategy!

Find your way through the endless mazes - but do it right or you're doomed!

ESCAPE

DRAGON 32

MICRODEAL

Find your way through the endless maze - but do it right or you're doomed!

Monopolise the Milky Way - become a galactic megabillionaire!

SPACE MONOPOLY

DRAGON 32

MICRODEAL

Monopolise the Milky Way - become a galactic megabillionaire!

The clues are there; so is the treasure ... but can you find it? For one player.

MANSION ADVENTURE 1

DRAGON 32

MICRODEAL

The clues are there; so is the treasure ... but can you find it?

Bust out and beat the Minotaur ...

ALCATRAZ II

DRAGON 32

MICRODEAL

Bust out and beat the Minotaur ...

If you own a Dragon 32 Family Computer this is especially for you. Microdeal have on offer another 5 great games, games to get you guessing with ruthless opponents to test your every reflex, fortunes to be won and lost. These games are also available for the TANDY COLOR computer.

Cassette price £8.00 including VAT and postage.

You'll find them in dealers nationwide; or order direct from: Microdeal, Deal House, Bridges, Bodmin, Cornwall PL30 5EF. Tel: 0726 850821. TANDY & VIDEO GENIE owners send for our software lists.

NOW AVAILABLE IN SELECTED
 STORES

M I C R O D E A L



Business Blueprint

See us on Stand 720/4
**THE WHICH?
COMPUTER?**
SHOW
National Exhibition
Centre Birmingham
18-21 January 1983



THE VECTOR 4

From the small business to the large multi-national, Almarc provide one of the largest selections of quality business, scientific and industrial applications software available today, including:

Wordprocessing/Mailing,
Financial Modelling, Solicitors
Package, Financial & Arable
Management, Printers
Estimating/Costing,
Phototypesetting/Wordprocessing
Interface, Data Base
Management, Estate Agents
Package, Manufacturing
Software, Critical Path Analysis,
Motor Trade Package, Planning
Application Monitoring,
Estimating, Data Logging,

Graphics Packages, Business
Accounting, Accounts Receivable/
Payable, Payroll, Stock Control,
Invoicing, Ordering, Purchase
Control, Clothing Industry
Software, Network & Resource
Analysis, Job Costing, Insurance
Brokers.

All available on probably the
most advanced, 'New
Generation', micro-computer
system produced today.

The Vector 4, is an advanced
8/16 bit desk top computer. It
allows you to take advantage of
the existing 8 bit CP/M programs,
while also providing 16 bit
processing power. The future is
built into the Vector 4, with its
Z-80 and 8088 processors, 128K
of main memory (expandable to
256K), 3 S-100 expansion slots
and standard software facilities
with high resolution graphics
that are second to none. Floppy
disc and hard disc systems are
available.

At Almarc, we pride ourselves
in our systems and our high level
of customer support. We can offer
back-up and training which is
second to none, with 24 hour on
site maintenance available in all
areas.

Almarc

DATA SYSTEMS

HEAD OFFICE
Almarc Data Systems Ltd,
Great Freeman Street,
Nottingham NG3 1FR.
Tel: (0602) 62667.
Telex: 37407 Almarc/G.

Almarc Data Systems Ltd,
18A Spittal Street,
Marlow,
Bucks. SL7 1DB.
Tel: (06284) 6419.

IN FOUR DAYS WE'LL TRAIN YOU ON SIRIUS, COMMODORE, APPLE XEROX, IBM OR SUPERBRAIN

When you come on one of our 4-day training courses you'll be able to choose which machine you'd like to see our fully integrated, modular accounting software running on. You'll be able to discuss which micro will be most suitable for your application and you will have the confidence that with TABS you'll get total, friendly support during our introductory seminar and demonstration, throughout our training course *and* after you've purchased a system from us.

We've even made sure that our high standards will be maintained when you visit our Accredited Dealers who have each attained TABS approval to advise on and to install our software.



TABS software is the biggest selling fully integrated, modular accounting software on the market. With well over 2,000 systems installed and over 14,000 modules running throughout the UK, we are confident that we have unrivalled experience in microcomputing applications and installation.

TABS modules include: Sales Ledger, Purchase Ledger, Nominal Ledger, Job Costing, Stock Control, Payroll, Fast Data Entry, Sales Order Processing, Management Accounts, Invoice Compiler, Mail List, Word Processor.

Free seminars and demonstrations are held at the World Trade Centre in London each Thursday, and at our resources centre in Andover each Friday.

TABS also provide:

- Unbiased advice on complete systems and software from our Applications Desk.
- Free lunches each day!
- Hotline telephone support.
- Video Training Tapes on most modules.

Free London Demonstrations and Seminars are held at the World Trade Centre within a few minutes walk of Tower Hill tube station.

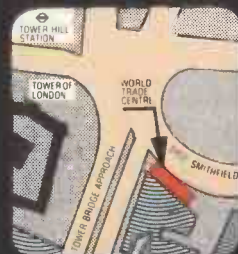

Accounting
Business Systems

TABS

Please send more details about TABS business systems and services.

- | | |
|---|--|
| <input type="checkbox"/> 32 page Introductory booklet | <input type="checkbox"/> Details on Free Seminars and demonstrations |
| <input type="checkbox"/> User book (please send (inc. P & P)) | <input type="checkbox"/> Price List |
| <input type="checkbox"/> Dealer plans | <input type="checkbox"/> Video Training Tapes |

I enclose cheque/postal order for £ _____

Name _____

Address _____

Tel. No. _____

MYOB 7 Andover (0264) 58933

TABS Ltd, Sopers House, Chantry Way, Andover, Hants. SP10 1LS

Buy our
£475*
 Daisy Wheel Printer
 for your computer
 and you have an
 Electronic Typewriter
 absolutely **FREE**



The T/Printer 35 is the lightest weight and lowest cost daisy wheel printer you can buy for your computer. So it will fit within your budget and you can carry it wherever you take your micro. Yet it is tough enough to give years of reliable service. Interchangeable typefaces (standard Olivetti 100 character daisy wheels), variable pitch, multiple copies—all the features you would expect of more expensive word processing printers.

Yet the T/Printer 35 costs only £475 with parallel interface. Operating speed under computer control is approximately 120 words per minute of letter perfect output. What typist can equal that?

Then when you're finished using it as a computer printer, the T/Printer 35 is ready to go right on working as an electronic typewriter.

That's the dual-purpose T/Printer 35—the versatile computer printer that fits your budget.

**The T/Printer 35 costs £475 with Centronics compatible parallel interface. With RS-232C interface it costs £535. Prices listed are exclusive of VAT.*



Datarite Terminals Ltd
 Caldare House
 144-146 High Road
 Chadwell Heath, Essex RM6 6NT
 Tel: 01-590 1155

CHANNEL 8 SOFTWARE
 PRESENT



"THE ONLY WAY TO DRAW P.M. GRAPHICS"
 "THE ULTIMATE P.M. GRAPHICS TOOL"
 "THE BEST ATARI UTILITY EVER"

These are just some of the comments
 that will probably be made by users about the constructor

The constructor a 48K menu driven player missile graphics utility that will allow the user to design and edit player shapes very easily and then save the relevant bit map data to disk so that it can be merged with the users own programme. It is even possible to animate and overlay the players in single or double line resolution while they are still 'on the drawing board'.

The Constructor sells at £24.95 Disk Only

For further details contact John H. Williams on Preston (0772) 53057 or write to:

CHANNEL 8 SOFTWARE Department PCW,
 51 Fishergate, Preston, Lancs
 PR1 8BH
 The Atari Centre of the North

CHANNEL 8 SOFTWARE HAVE A GROWING RANGE
 OF SOFTWARE FOR BOTH VIC AND ATARI
 DEALER ENQUIRIES WELCOME



FULL DETAILS AVAILABLE FROM

Gem Systems Ltd
 2 Crawford Road
 Hatfield
 Tel No: 30-64137/66148

HERTFORDSHIRE

The Rainbow 100 provides the flexibility for 8 and 16 bit programs in one personal computer from £2,300.

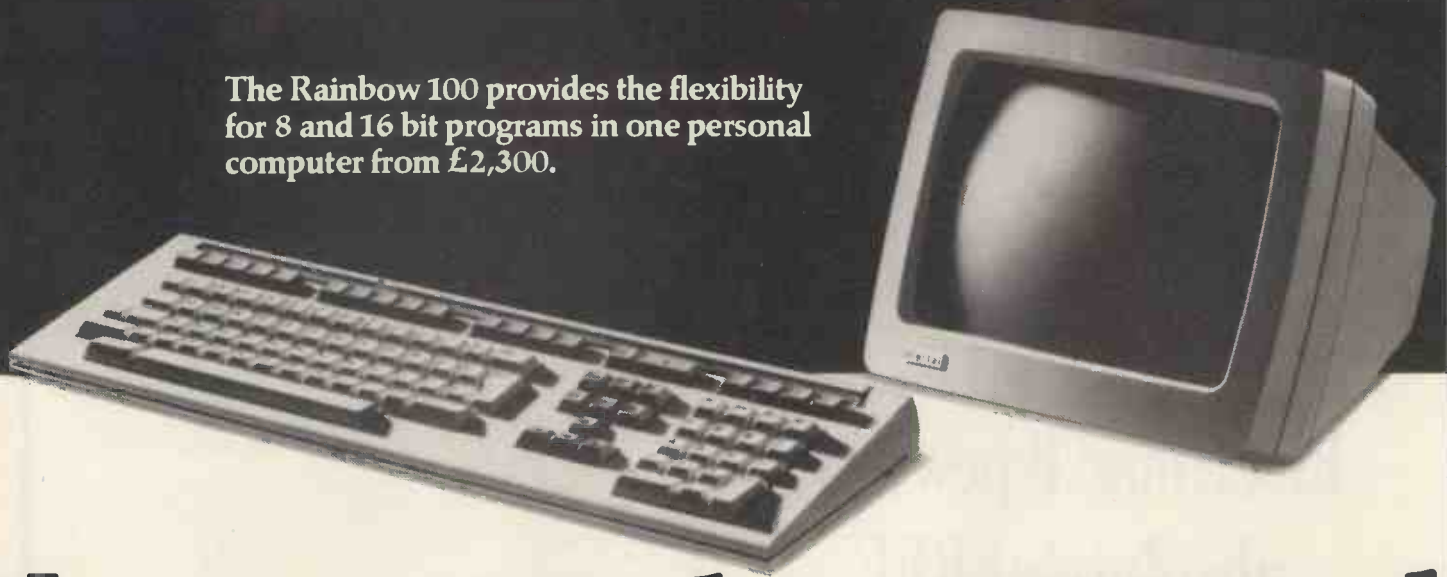

New personal computers do And dealers chosen for

AUTHORISED
digital
PERSONAL COMPUTER
DEALER

Bartholomews Business Systems Ltd., Portfield,
Chichester, Sussex. Tel: 0243 784171.

Beauchamp Computer Systems Ltd.,
115 Fulham Road, London SW3.
Tel: 01-581 8134.

4B Microcentres Ltd., 13/14 North Bar, Banbury,
Oxon OX16 0TF. Tel: 0295 66555/50796.

Computacenter, Theatre Square, Swindon,
Wiltshire SN1 1GN. Tel: 0793 612341/2.

Computerland (Sperrings Computer Shops Ltd.),
Spencer House, 12-14 Carlton Place,
Southampton. Tel: 0703 39571.

Cytek (UK) Ltd., Sandringham House,
9 Warwick Road, Old Trafford,
Manchester M16 0QQ. Tel: 061-872 4682.

Dataview Ltd., Portreeves House, East Bay,
Colchester, Essex CO1 2XB. Tel: 0206 865835.

Demotab Ltd., 99-101 Regent St., London W1.
Tel: 01-439 3971.

Ferrari Software Ltd., 683 Armadale Road,
Feltham, Middlesex. Tel: 01-751 5791.

GSI Ltd., Stanhope Road, Camberley, Surrey.
Tel: 0276 62282.

Guestel Ltd., 6-12 New Bridge St., London EC4.
Tel: 01-583 2255.

Guestel Ltd., 41/43 Baldwin Street, Bristol.
Tel: 0272 277461.

Guestel Ltd., Grand Parade, Brighton.
Tel: 0273 695264.

Key Computer Centres, Enterprise House,
Terrace Road, Walton-on-Thames, Surrey.
Tel: 09322 42777.

MMS Ltd., Ketwell House, 75-79 Tavistock St.,
Bedford MK40 2RR. Tel: 0234 40601.

Matmos Electronics Ltd., 14-16 Child's Place,
London SW5 9RX. Tel: 01-373 6607.

Micro Business Systems plc,
119-120 High St., Eton, Berks. Tel: 07535 55211.

Micro Business Systems plc,
Birchwood Science Pk., Warrington.
Tel: 0925 822261.

Micro Business Systems plc, Wirksworth,
Derbyshire. Tel: 062-982 3120.

Micro Business Systems plc, Turnhouse Airport,
Edinburgh. Tel: 031-333 1000.

Micro Business Systems plc, Cannon Street,
London EC4. Tel: 01-621 1122.

Micro-Centre (Complete Microsystems) Ltd.,
30 Dundas Street, Edinburgh EH3 6JN.
Tel: 031-556 7354.

Microfacilities Ltd., 7-9 Church Road, Egham,
Surrey. Tel: 0784 31333.

Microware Computers Ltd., Diamond House,
Whitelock Street, Leeds. Tel: 0532 434377.

Microware Computers Ltd., Priory House,
1133 Hessle High Road, Hull HU4 6SB.
Tel: 0482 562107.

Personal Computers Ltd., 220-226 Bishopsgate,
London EC2. Tel: 01-337 1200

Pilgrim Business Machines Ltd.,
30 Northfield Place, Aberdeen. Tel: 0224 645100

We expect our new personal computers to set quite a few standards.

So it's only natural that the dealers we have selected to sell them are, to say the least, out of the ordinary.

It's a fact.

Our accountants, for instance, have examined their books. And we've listened closely to their salesforce.

We've even checked that their customers have been completely happy with the advice they have been given.

It means you can be sure of getting the right solution to your business problems. Today and tomorrow.

After all, the best computer in the world is of no value if it doesn't do what you want it to. Or can't change as your business does.

The Professional series brings new standards
for business applications from £3,348.



Designed to set new standards. The standards they set.

Pilgrim Business Machines Ltd., 28 Walker St.,
Edinburgh, Tel: 031-226 5528.

Planning Consultancy Ltd., 46/47 Pall Mall,
London SW1Y 5JG. Tel: 01-839 3143.

TC Micros, West Rd., Harlow, Essex CM20 2BP.
Tel: 0279 443421.

Sigma Systems Ltd., 266 North Road, Cardiff
CF4 3BL. Tel: 0222 34865/69.

Software Sciences, Abbey House,
82-292 Farnborough Road, Farnborough,
Hants. Tel: 0252 544321.

Software Sciences, Thorn EMI House,
4 Old Park Lane, London W1.
Tel: 01-499 7099.

Software Sciences, 88 Old Street, London EC1.
Tel: 01-253 1480.

Software Sciences, Unit 39, Southfield Road,
Nailsea, Near Bristol. Tel: 0272 851462/3.

South Coast Computers Ltd.,
South Coast House, Wimbourne Road,
Ferndown, Dorset. Tel: 0202 893040.

South East Computers Ltd., 15 Castle Street,
Hastings, Sussex. Tel: 0424 426844.

South East Computers Ltd., 29 High Street,
Maidstone, Kent. Tel: 0622 681263.

South East Computers Ltd., 31 Watling Street,
Canterbury, Kent. Tel: 0227 59917.

Sumlock Bondain Ltd., 263-269 City Road,
London EC1V 1JX. Tel: 01-250 0505.

Sytec Products Ltd., Cord House,
The Causeway, Staines, Middlesex.
Tel: 0784 63911.

Sytec Products Ltd., 25 Bruton Lane,
London W1. Tel: 01-409 1244.

The Computer Terminal, 44 Cathedral Place,
London EC4. Tel: 01-236 2187.

Whessoe Technical & Computing Systems
Ltd., Brinkburn Road, Darlington,
Co. Durham DL3 6DS. Tel: 0325 60188.

Whymark Computing, 20 Milford Street,
Salisbury, Wiltshire SP1 2AP. Tel: 0722 331269.

Zygal Dynamics PLC, Zygal House, Telford Rd.,
Bicester, Oxon OX6 0XB.
Tel: 08692 3361.

Rank Xerox (UK) Ltd. (Professional only.)
The Xerox Store, 84 Piccadilly,
London W1V 9HE. Tel: 01-629 0694/5.

The Xerox Store, 110 Moorgate,
London EC2M 6SU. Tel: 01-588 1531/2.

The Xerox Store, 76-77 Holborn,
London WC1V 6LS. Tel: 01-242 9596/7.

The Xerox Store, 3/4 William Street,
Slough, Berks. SL1 1XY.
Tel: 0753 76957.

The Xerox Store, Pearl Assurance House,
Derby Square, Liverpool L2 9QR.
Tel: 051-236 7512.

The Xerox Store, 166 Hope Street,
Glasgow G2 2TG. Tel: 041-333 0495.

The Xerox Store, South Gate House,
Wood Street, Cardiff CF1 1EW.
Tel: 0222 40118.

The Xerox Store, Bristol & West House,
Broad Quay, Bristol BS99 7AX.
Tel: 0272 277828.

Northern Ireland
Systems Plus Limited, 19 Glengormley Park,
Newtownabbey, N. Ireland. Tel: 02313 42117.

Our Authorised Personal Computers Dealers can
offer you advice, demonstrations and can undertake to
train your staff or introduce your executives to computers.

They can also offer you all the service and support
you'd expect from the world's largest manufacturer of
minicomputers.

Not to mention a year's free on-site service warranty.

And new machines destined to set new standards in
personal computing.

Doing more. The Digital difference.

digital

OLIVETTI M20 16-BIT MICRO

- Engineering
- Business
- Education
- Science



only
2395.00

or LEASE from **17.68** per week

EPSON HX-20 MICROCOMPUTER

Portability for programmability anywhere.
Built-in printer and LCD screen.
Ask us about EPSON HX-20 accessories.



only
402.00

OFFICIAL BBC MICROCOMPUTERS DEALER

BBC Model A	P.O.A.
BBC Model B	P.O.A.
Model A to Model B Upgrade Kit	P.O.A.
Analogue Port Kit	P.O.A.
Memory Upgrade	P.O.A.
BBC Floppy Disc Drive	P.O.A.

Full range of Acornsoft Software available

RANK XEROX 820-II



Wordprocessing
Forecasting
Budgeting
Planning

only
2100.00

or LEASE from **£17.68** per week

For the businessman looking for a superb business-oriented microcomputer system.

PRINTERS

EPSON MX-80 T/3 Dot Matrix	P.O.A.
EPSON MX-80 FT/3	£320.00
EPSON MK-100/3 100 c.p.s.	£420.00
SEIKOSHA GP100	£195.00
Paper Tiger 450	4399.00
APPLE Interface Cable	P.O.A.
RS232 Interface	P.O.A.
Sharp Printers	See Sharp

SHARP PC-1500 COLOUR COMPUTER

16K ROM, Extended BASIC, with 3.5K usable RAM, expandable to 11.5K.

PC-1500	£139.95	CE152	£34.75
CE150	£124.95	CE153	£69.55
CE158 RS232	£130.45	CE155 8K	£69.55



CP/M 80 SOFTWARE FOR POPULAR MICROS

Word Star Spell Star
Mailmerge dBase II
Pro-Pascal Microsoft Basic

A full range of business software available from the highly reliable PEACHTREE originals to run under CP/M.

Nominal Ledger System Purchase Ledger System
Sales Ledger System Stock Control System
Payroll Word Processing
Supercalc

The above are available on 5 1/4" or 8" standard densities.

COMMODORE 64

Colour and sound at our lowest price yet!



VIC 20 Software	P.O.A.
COMMODORE VIC 20	£113.00
	P.O.A.

SHARP MZ-80A COMPUTER

Z80A CPU, 48K RAM,
4K ROM, 9" Green CRT



FREE SOFTWARE!
Home budget,
banking, etc

only
479.95

APPLE II BUSINESS SYSTEM



- 64K Apple Computer
- 12" Green Monitor
- Disk Drive with Controller
- 80 Col Card

Special Price

1199.00

Limited Offer - Hurry

LEASE from
£8.85 per week

ATARI 400 COMPUTER



Wide range of Software available

16K Computer

only
156.55

SINCLAIR SPECTRUM

£108.75

ZX81	£43.43
ZX Printer	£52.13
64K RAM	£79.00
32K RAM	£49.95
16K RAM	£26.04
Hi-Res	£52.00
Software	£3.95



APPLE SOFTWARE AND HARDWARE

Apple Writer II	DOS 3.3 Tool Kit
Apple Plot	3.3 Disk O/System
Apple Pascal	Visicalc Apple II
Apple Fortran	Visicalc Apple III
Apple Logo	Business Graphic
Euro Colour Card	Dot Matrix Printer
Language Card	Apple III 128K
Contronie Card	1995.00

ATARI 800 COMPUTER



16K Computer + BASIC Cartridge
only 313.95

CASIO

FX702P	£69.55
FX700P	£69.55
PC-100	£43.66
FX3600P	£19.95
FX801P	£303.85



FX702P
only
69.55

BOOKS

At DEANS we stock a complete range of books for computer users. Whether you want to learn about machine-language or BASIC, games programs or business programs, we probably have the book for you.

Why don't you come in and have a look at our fine selection? If you're out of town, or can't get to Kensington, then send us an S.A.E. and we'll rush you our books catalogue.

Remember: it's books for learning, and it's DEANS for the best in computer books!

DRAGON 32



only
169.20

HEWLETT PACKARD

HP-10C	£65.20	Printer ...	£290.95
HP-11C	£61.95	Cassette	£329.95
HP-15C	£86.95	HP-32C	£39.95
HP-12C	£96.95	HP-75	P.O.A.
HP-16C	£91.95		
HP-41CV	£169.95	Plus full range of Accessories	Available
HP-41C	£119.95		

DEANS
of Kensington

191, Kensington High Street
London W8
200 Yards from High Street Kensington
Underground Station

Send orders with cheque payable to DEANS. State goods required. SECURICOR delivery add £6.00

Prices are subject to change without notice. Add 15% VAT.

Tel 01-937-7896/938-1588

£1,495*

The MIMI 802 is a supreme example of high quality British engineering. It is a truly professional microcomputer that really does meet all the criteria of a sophisticated business machine - at a price you can afford.

Our competitors expect you to make do with the basics and then buy expensive extras in order to fulfil your needs. The MIMI 802 has all the 'extras' as standard - so when you buy a MIMI you really are getting a microcomputer that will do the job from the outset.

The MIMI's operating system OS/M[†] is fully CP/M[‡] compatible so you have access to a very comprehensive range of software, extending from word processing to accounting.

During the next few months we will be announcing the availability of TROJAN - a major software innovation that totally simplifies the learning process and use of micros, and dramatically eases the creation of new applications programs. We are using it and generating applications software in record time - so we can guarantee its performance.

Don't settle for less... contact us or one of our dealers now.

Features include:

- Z80A at 4MHz
- 64K Dynamic RAM
- Integral D/S - D/D 5 1/4 ins floppy discs - 700Kb.
- Full RS232C and Centronics parallel ports.
- 96 Key ASCII keyboard - colour coded.
- 17 programmed function keys.
- Light pen socket.
- Elegant compact and light - 24 lbs.
- OS/M operating system - fully CP/M compatible.
- Disc format conversion facility.
- Wide range of software, utilities and languages.
- Super high resolution graphics (512 x 256 pixels).

And now with:

- Winchester disc option.
- Choice of orange or green display.

MONITOR SUPPLIED BY PHILIPS

NOW ALL OTHER MICROS ARE LESS THAN PERFECT

† OS/M is the trademark of Scifax Microsoftware.

‡ CP/M is the registered trademark of Digital Research Inc.

*Monitor extra, from £132.

Some of our dealers

Anita Electronic Services
34 Musters Road West Bridgford Notts
Tel: 0602 813204
Contact: Steve Conroy

Apollo Information Systems Ltd.
13 Southend Road Grays Essex RM17 5NH
Tel: (0375) 33088
Contact: Ronald Burrell

Belmondo Research Ltd
68 Maple Road Horfield Bristol BS7 8RG
Tel: 0272 427428
Contact: Roger Banfield

Broadway Systems (BCSS) Ltd
5-7 Mariner Street Swansea W Glam Wales SA1 5BA
Tel: 0792 462279/474598 01-997 4764/0498
Contact: Philip Gittoes

Procon Ltd
19 Lawrence Road Fleet Hampshire
Tel: (02514) 7759
Contact: Arthur Thomas

City Microsystems Ltd
65 London Wall London EC2
Tel: 01-588 7272
Contact: Anthony Coulson

Computer Graphics Workshop
38 Ullett Road Sefton Park Liverpool 17
Tel: 0507 604271
Contact: Noel Runnels-Moss

Comput-A-Crop
3 Cornmarket Louth Lincolnshire LN11 9P
Tel: (0507) 604271/2 Telex: 56332
Contact: Jenny Wilson



Penfold Works Imperial Way Watford Herts. WD2 4YY Tel: Watford (0923) 48222/439



A Hegotron Group Company



Kyle Data Services Ltd
37 High Street Ayr Scotland KA7 1LU
Tel: (0292) 285411
Contact: Alex Gardiner

Easibee Computing Ltd
133-135 High Street North East Ham London E6 1HZ
Tel: 01-471 4884
Contact: Computer Sales Director

John Elmer Office Equip
105-107 Church Road Burgess Hill Sussex
Tel: 04446 5670
Contact: John Elmer

Leicester Micro Centre
59 Regent Road Leicester
Tel: 0533 551869
Contact: Ray Beresford

Malvern Micro Systems
Wych Cutting Upper Colwall Malvern Worcestershire
Tel: (06845) 68500
Contact: Barry Lewis

B & D Computing
8 Sheep St. Highworth Swindon Wilts
Tel: 0793 762449
Contact: David Wakley

Microcosm Research
26 Danbury Street London N1 8JU
Tel: 01-226 9092
Contact: Jerry Karlin

Synergy Computer Systems
'E' Bk University Village UEA Norwich
Tel: (0603) 50301/6/7
Contact: Sonia Kennedy

Dantre Business Systems
67 High St. Daventry Northants NN11 4BQ
Tel: 03272 77239
Contact: Mike Griffin

Telex: 946024 Contact: Julie Hissey

mimi 802

RABBIT SOFTWARE

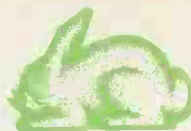

380 STATION ROAD,
HARROW, MIDDX.
HA1 2DE.

Tel: 01-863-0833



Rabbit-Calc

'Rabbit-Calc is an Electronic Worksheet that will replace the old fashioned pencil, paper and calculator methods of before. You can do complex financial models and then at a touch of a button, change the entire model to suit future trends. Has many built in functions for fast calculation plus utilities for saving, loading, replicating etc..

RETAIL PRICE £19.99

Night-Crawler



Venture into the "Green Forest" but beware of the alien creatures especially the Night Crawler! 39 levels: The fastest game you'll ever see on your VIC-20

RETAIL PRICE £9.99*

Skramble



Fight your way across the rugged terrain to your home base while fighting off attacks from the aliens. 8 different phases: Tunnel, Cavern, City etc.. just like the popular arcade game and just as difficult.

RETAIL PRICE £9.99*

All machine code for fast, smooth action.
* For the unexpanded machine.

Rabbit Software Ltd.
380 Station Road,
Harrow, Middlesex HA1 2DE.

Telephone: 01-863 0833
Credit Cards Accepted



RABBIT SOFTWARE



Myriad

Face a Myriad of cosmic creatures as you voyage through the galaxies. A fast exciting arcade game that requires extremely fast reactions to survive, requires 3K add on.

RETAIL PRICE £9.99

Frogger

Bring the famous pub game home. First cross the motorway without getting run over and then home across logs and turtles. But beware of snakes, crocodiles and submerging turtles. incredible multi-colour mode graphics written in machine code. (3K)

RETAIL PRICE £9.99



Space Phreeks

Your mission: - colonize a new planet but to do so you must face a universe full of strange creatures known only as Space Phreeks. 15 alien attack patterns, great graphics, you've got to be good to play this game.

RETAIL PRICE £9.99*



Tank-War

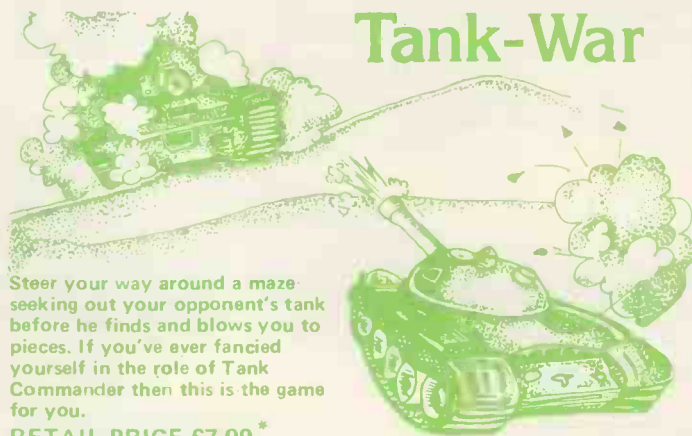

Steer your way around a maze seeking out your opponent's tank before he finds and blows you to pieces. If you've ever fancied yourself in the role of Tank Commander then this is the game for you.

RETAIL PRICE £7.99*

Please send me _____
I enclose cheque/PO for _____
OR Please debit my Access 5224 _____
Barclaycard 4929 _____ Expiry date _____
Name _____
Address _____
Code _____

Dealers discount available
ACCESS, BARCLAYCARD ORDERS WELCOME
Mail to: RABBIT SOFTWARE LTD,
380 STATION ROAD, HARROW,
MIDDLESEX HA1 2DE



WE PROUDLY PRESENT, FOR THE
BBC MICROCOMPUTER

(MODELS A & B)

THE INTERNATIONALLY SUCCESSFUL

**MYSTERIOUS
ADVENTURES**

These superbly written, 16k Machine Code Adventures have been enjoyed by TRS80/VIDEO GENIE owners in Britain for well over a year now and are currently taking the U.S. by storm. The Author has now implemented these absorbing programs on the BBC Microcomputer.

ALL ADVENTURES IN THIS SERIES INCLUDE:-

Split screen display, Ultra fast Machine code response, Save game to Cassette feature, simple two word command entry, approx. 70 Locations to visit, 30 Objects to manipulate, 20 or more "problems" to overcome.

ADVENTURES PRESENTLY AVAILABLE:-

- 1). **THE GOLDEN BATON** — Venture into a strange province of danger and evil magic to retrieve the stolen Baton of King Ferrenuil.
- 2). **THE TIME MACHINE** — As a newspaper reporter you have been sent to the old house on the moors to investigate the eccentric Dr. Potter
- 3). **ARROW OF DEATH (Part I)** — In the first part of this epic Adventure you must find and destroy the source of the evil blight which has befallen your homelands.

These are the first three of a series which should ultimately total more than 20 Adventures.

WARNING! — Only supreme courage and low cunning can ensure eventual success on these dangerous missions!

Available soon for ZX Spectrum, ZX81 (16K), Apple II, Atari 400/800. Write for details.

EACH ADVENTURE COMES ATTRACTIVELY PACKAGED FOR JUST £8.95 inc. SEND CHEQUE OR P.O. TO:

DIGITAL FANTASIA DEPT. DWL

24, NORBRECK ROAD, NORBRECK, BLACKPOOL, LANCs.

GSL

Geophysical Systems Limited

OFFICIAL REGISTERED DEALERS
FOR ACORN/BBC

ON DISPLAY IN OUR SHOWROOM

- * BBC MODEL A. £260.00
- * BBC MODEL B. £365.94
- * BBC MODEL B WITH DISC INTERFACE £408.00
- * PRINTERS — NEC 8023 BE — C £320.00
- DOT MATRIX 80 COLUMN
- * ANALOGUE SIGNAL ANALYSER £299.00
- * DISC DRIVES — SHUGART 5¼" 100K £147.00
- METAL CASED — BBC COMPATIBLE
- * MICROVITEC COLOUR MONITOR, R.G.B. £249.00
- INPUT (AS USED IN THE BBC PROGRAMME)
- * HITACHI 12" GREEN HIGH RES. MONITOR £89.07

IN STOCK

- * ALL THE ABOVE ARE IN STOCK, PLUS —
- * SOFTWARE
- * SCREEN DUMP SOFTWARE
- * LEADS
- * EPROMS

*WE CONSIDER OUR DISC DRIVES
TO BE INCREDIBLY LOW PRICED*

PRICES EXCLUDE CARRIAGE + VAT

Geophysical Systems Limited
2 North Way Andover Hants SP10 5AZ
Telephone Andover (0264) 58744 Telex 47166 GSLG

BUY THE BEST TWILLSTAR COMPUTERS



BBC

BBC MOD A 299.80
BBC MOD B 399.00

DISK DRIVES

Business Software
Educational Software
Entertainment Software

ORIC-1

THE REAL COMPUTER SYSTEM
FROM £99.95
INCL VAT

COMPUTERS
LYNX

Dragon 32

EPSON HX-20

PORTABLE COMPUTER

The little computer with
big performance

PRINTERS

Dot Matrix
Epson MX 80 FT III
Epson MX 100 FT III
Seikosha GP100 A
BEST PRICES EVER

commodore COMPUTERS

Printer Cables, Leads, Disks, Stationery,
Cassettes, Ribbons, Dust Covers and
Wide Range of Software for all
Computers.

COLOUR MONITORS
14" Microvitek £250
GREEN MONITORS
Sanyo £99.00 Hitachi £99.00

**COMPUTER BOOKS & ELECTRONIC MAGAZINES
SOFTWARE, HARDWARE SUPPORT/SERVICES/RENTALS**

CALL IN FOR FURTHER DETAILS

TWILLSTAR COMPUTERS LTD

17 REGINA ROAD, SOUTHAL, MIDDX
TEL: 574-5271/2 (24 hours)

OPEN 10am-8pm SIX DAYS A WEEK



FULL DETAILS AVAILABLE FROM

Kingston Computer Centre
59 Surbiton Road
Kingston-upon-Thames
Tel No: 01-549 9414

SURREY

**INTEREST
FREE
CREDIT
NOW! ON:-**

Atari VIC 20. and Dragon

If your order contains over £120 worth of computer hardware apply now for interest free credit by telephoning: Mail-order: (0702) 552911. London Shop: 01-748 0926. Birmingham Shop: 021-356 7292. Southend Shop: 0702 554000 or write to P.O. Box 3, Rayleigh, Essex SS6 8LR.

You pay 10% down, then 10% per month for a further nine months (to nearest penny). Example: Atari 400 48K. Cash price £299. Credit terms: £29.90 down, then £29.90 per month for nine months. Total £299. Credit quotations on request. This offer subject to approval which can take up to 48 hours (APR = 0%).

THE NEW COMMODORE 64

The incredible new computer from Commodore comes with 64K RAM fitted! Plus 16 colours hi-res graphics, 320 x 200 pixels, 40 columns by 25 lines, Z80 micro processor can be added — that means you can run CP/M software, 8 independently movable Sprites with collision detection, and a sound generator with 3 voices, 4 wave-forms, envelope and filter to rival some dedicated music synthesisers. And all this at the most incredible price ever. (AF56L) Only £339.00

DRAGON 32

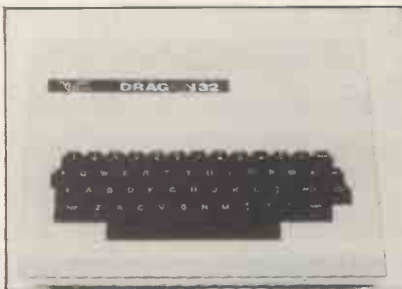

The amazing new British computer with a full-travel standard keyboard, a 16-bit microprocessor, 32K RAM fitted (expandable to 64K and later to 256K!), 9 colours, hi-res graphics and Microsoft extended colour BASIC (the very best BASIC to learn with). It can be used with virtually any ordinary cassette recorder, it has a printer interface (Centronics-type), joysticks are available and it's incredible value for money. (AF57M) Only £199.50.

Lots of new Dragon software available.

THE AMAZING ATARI COMPUTERS

4 Consoles Available:
Atari 400, 16K RAM (AF36P) £249.95
Atari 400, 48K RAM (AF37S) £299.00
Atari 800, 16K RAM (AF02C) £399.00
Atari 800, 48K RAM (AF55K) £440.00

* All above with BASIC & handbooks
Carriage free, delivery next day
by Datapost

Other hardware:		
Cassette Recorder	(AF28F)	£50.00
Disk Drive	(AF06G)	£299.95
Thermal Printer	(AF04E)	£265.00
Epson MX80T Mk III	(AF38R)	£399.95
Epson MX80F/T Mk III	(AF40T)	£447.35
Printer Interface for 400	(AF41U)	£59.95
Printer Interface for 800	(AF42V)	£59.95
Interface Module	(AF29G)	£135.00
Versawriter	(AF43V)	£199.95
16K RAM Module	(AF08J)	£55.00
48K RAM Module for 400	(AF44X)	£99.95
48K Upgrade for 400	(AF45Y)	£75.00
Floppy Disk	(YX87U)	£2.50
Le Stick	(AC45Y)	£24.95
Joystick Controllers (Pair)	(AC37S)	£13.95
Paddle Controllers (Pair)	(AC30H)	£13.95

For full details ask for our hardware leaflet (XH54J) SAE appreciated

JOIN THE U.K. ATARI COMPUTER OWNERS' CLUB

An independent users' group. Four issues of the club magazine for only £3.00! Address your subscription to Ron. Issue 1 of the club magazine featured a tutorial on character set redefinition and contained a collection of demonstration and games programs and lots more. Issue 2 featured a tutorial on player/missile graphics, an article about graphics on computers, a selection of members' contributions to the program library and much more.



THE FINEST SELECTION OF ATARI SOFTWARE

Teach Yourself Programs

Conversational French	-5C-16K-YG44X	£39.95
Conversational German	-5C-16K-YG45Y	£39.95
Conversational Spanish	-5C-16K-YG46A	£39.95
Conversational Italian	-5C-16K-YG47B	£39.95
Touch Typing	-2C-16K-YG49D	£19.95
Slates & Capitals	-1C-16K-YG56L	£14.95
Euro Countries & Capitals	-1C-16K-YG57M	£14.95
*Kids 1 (3 Programs)	-1C-16K-BG00A	£11.75
*Kids 2 (3 Programs)	-1C-16K-BG00B	£11.75
My First Alphabet	-1D-32K-KB23A	£29.95
Learn Programming		
Invitation To Programming 1	-1C-8K-YG43W	£19.95
Invitation To Programming 2	-2C-8K-BQ67X	£22.95
Invitation To Programming 3	-2C-8K-BQ68Y	£22.95
*Basics of Animation	-1C-16K-BQ57M	£14.50
*Player Missile Graphics	-1C-32K-BQ59P	£21.25
*Display Lists	-1C-16K-BQ51F	£14.50
*Horiz/Vertical Scrolling	-1C-16K-BQ53H	£14.50
*Page Flipping	-1C-16K-BQ55K	£14.50
*Sounds & Music	-1C-16K-BG04E	£14.50
*Tricky Tutorials First 6	-3C-32K-BG06G	£89.95
Page 6	-1D-24K-KB24B	£27.50
Business Programs		
Visicalc	-1D-32K-YL39N	£119.95

Atari Word Processor

Text Wizard	-1C-32K-BQ99H	£75.00
*Mini Word Processor	-1C-32K-BG09J	£14.50
File-It 2	-1D-48K-BG10L	£33.87
Filemanager 800	-1D-40K-BG59P	£75.00
Graph-It	-2C-16K-YG51F	£14.95
Statistics	-1C-16K-YG52G	£14.95
Mortgage & Loan Analysis	-1C-16K-BQ68W	£14.95
*Bob's Business	-1C-32K-BG11M	£10.59
Adventure Games		
Galactic Empire	-1C-32K-BQ14D	£14.50
Galactic Trader	-1C-32K-KB25C	£14.50
*Galaxy	-1C-16K-BG75S	£14.95
*Rescue At Rigel	-1C-32K-BQ21X	£20.75
*Dates of Ryn	-1C-32K-BQ22Y	£13.80
*Star Warrior	-1C-32K-BQ24E	£27.45
*Voyager I	-1C-32K-BQ95D	£14.95
*Invasion Orion	-1C-24K-BQ23A	£17.25
*GFS Sorceress	-1C-48K-KB25D	£21.95
*Planet Miners	-1C-24K-BG89W	£11.95
*Star Flight	-1D-40K-BG26D	£14.95
*Journey To The Planets	-1C-32K-KB28F	£20.45
*Crash, Crumble & Chomp	-1C-32K-KB28E	£20.45
Mission Asteroid	-1D-40K-BQ91Y	£17.19
Wizard & The Princess	-1D-40K-BQ25C	£21.79
Ulysses & Golden Fleece	-2D-40K-BQ92A	£20.64

Dr Goodcode's Cavern

Escape From Vulkan's Isle	-1D-48K-KB04E	£21.95
Zork I	-1D-40K-KB30H	£20.75
Zork II	-1D-32K-BQ94C	£29.95
Zork III	-1D-32K-BQ95D	£29.95
All Baba & The 40 Thieves	-1D-32K-BQ78K	£25.93
*Temple Of Apshai (Part 1)	-1C-32K-BQ85G	£27.45
*Upper Reaches (Part 2)	-1C-32K-BQ87U	£13.80
*Curse Of Ra (Part 3)	-1C-32K-BQ89W	£13.80
Dragon's Eye	-1D-40K-KB32K	£20.75
Crypt Of The Undeard	-1D-40K-KB33L	£20.75
*Empire Of The Overmind	-1C-40K-BG73Q	£21.95
King Arthur's Herma	-1D-40K-KB34M	£20.75
*Lords Of Narnia	-1C-40K-BG79U	£14.95
Nightmare	-1D-40K-KB35Q	£20.75
Analogue Adventure	-1D-32K-BQ33L	£16.95
Adventure Land	-1C-24K-BQ00A	£17.95
Pirate Adventure	-1C-24K-BQ01B	£17.95
Mission Impossible	-1C-24K-BQ02C	£17.95
Voodoo Castle	-1C-24K-BQ03D	£17.95
The Count	-1C-24K-BQ04E	£17.95
Strange Odyssey	-1C-24K-BQ05F	£17.95
Mystery Fun House	-1C-24K-BQ06G	£17.95
Pyramid Of Doom	-1C-24K-BQ07H	£17.95
Ghost Town	-1C-24K-BQ08I	£17.95
Savage Island I	-1C-24K-BQ09J	£17.95
Savage Island II	-1C-24K-BQ10L	£17.95

Golden Voyage

Treasure Quest	-1C-24K-BQ11M	£17.95
Sofftop Adventure	-1C-16K-KB36P	£10.95
Deadline	-1D-40K-BQ93B	£20.64
Starcross	-2D-32K-BQ96E	£37.35
Energy Czar	-1D-32K-KB37S	£29.95
Kingdom	-1C-16K-YG53H	£14.95
Space Shuttle Module I	-1C-8K-YG55K	£14.95
Space Shuttle Module II	-1D-32K-BG65V	£18.95
War Games		
The Shattered Alliance	-1D-48K-BQ98G	£28.95
Legionnaire	-1C-16K-KB00A	£25.95
The Battle Of Shloh	-1C-40K-BG63T	£28.95
*Onsper River Line	-1C-48K-BG71N	£18.95
*Tankies	-1C-24K-BG93B	£17.95
*Nth Atlantic Convoy Raider	-1C-16K-BG83E	£11.95
*Midway Campaign	-1C-32K-BG81C	£11.95
*Battle For Normandy	-1C-32K-KB38P	£28.95
*Tigers In The Snow	-1C-40K-KB01B	£28.95
War	-1D-32K-KB40T	£17.95
*B1 Nuclear Bomber	-1C-16K-BG68Y	£11.95
*Nukewar	-1C-16K-BG85H	£11.95
*Conflict 2500	*1C-32K-BG85G	£11.95
*Cyron Masters	-1C-32K-KB41U	£28.95
Arcade Games		
Star Raiders	-1E-8K-YG66W	£29.95
Choplifter	-1D-48K-KB12N	£27.50

Commodore 64 32 computer hardware

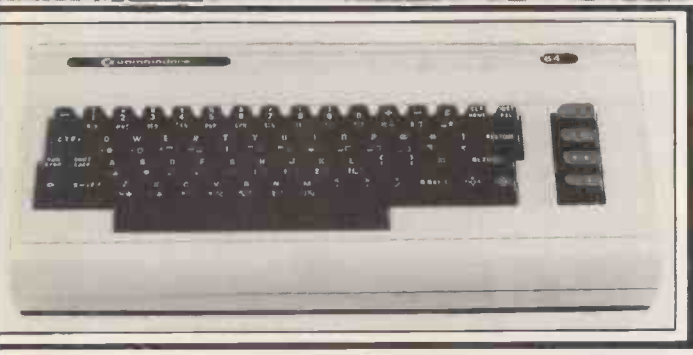

THE NEW MAPSOFT CATALOGUE

48 full colour pages of Atari, Dragon and VIC 20 hardware and software. A comprehensive guide to what's available. Price £1.



THE NEW MAPLIN CATALOGUE

contains full details of all the computers and most of the software shown here and much more. On sale now in all branches of W.H. Smith price £1.25. Or send £1.50 to P.O. Box 3, Rayleigh, Essex.

ATARI SOFTWARE continued

- Embarco -1E-8K-K843W £29.95
- Caverns Of Mars -1D-16K-B069A £29.95
- K-Star Patrol -1E-8K-BG52G £29.95
- Protector -1C-32K-BG24B £27.50
- Space Chase -1C-16K-BG42V £10.95
- Gorf -1E-16K-K844X £29.95
- Andromeda -1D-24K-K817T £22.50
- Bomber Attack -1C-16K-BG70M £11.95
- Asteroids -1E-8K-YG60Q £29.95
- Stellar Shuttle -1C-16K-K845Y £23.50
- Race In Space -1C-16K-BG35Q £14.95
- Missile Command -1E-8K-YG64U £29.95
- Space Invaders -1E-8K-YG70M £29.95
- Deluxe Invaders -1D-16K-BG34M £29.95
- K-razy Kritters -1E-8K-BG51F £29.95
- Rear Guard -1C-16K-K847B £14.50
- Shootout At OK Galaxy -1C-16K-BG37F £14.95
- Beta Fighter -1C-16K-K849D £15.50
- Rocket Raiders -1C-24K-K851F £18.50
- Stratos -1C-16K-K853H £24.95
- Galactic Chase -1C-16K-B062S £16.95
- Threshold -1D-40K-BG18U £27.54
- Space Games (3 Programs) -1C-24K-BG18S £10.95
- Lunar Lander -1C-32K-K813P £27.50
- Nautilus -1D-48K-K867M £23.50
- Sealox -1C-16K-K858N £24.95
- Sea Dragon -1C-16K-BG44X £29.95
- K-razy Shoot Out -1E-8K-BG64M £29.95
- Shamus -1C-16K-KB20W £27.50
- Serpentine -1E-8K-K860Q £23.50
- Centipede -1E-16K-B071M £29.95
- Angle Worms -1C-8K-BG50E £10.95
- Bug Off! -1C-16K-K861R £21.95
- Bug Attack -1C-24K-BG36P £23.95
- Tutti Frutti -1C-16K-K863T £17.95
- Genetic Drift -1C-16K-K865V £23.50
- Haunted Hill -1C-16K-BG38R £19.95
- Clam Jumper -1E-16K-K867X £33.95
- Chicken -1C-16K-BG27E £27.50
- Canyon Climber -1C-16K-BG44X £23.50
- Frogger -1C-16K-K868H £22.95
- Prep! -1C-16K-K807H £21.95
- Pacific Coast Highway -1C-16K-BG13P £23.50
- Fare Bird -1E-4K-K870M £27.95
- Apple Panic -1D-32K-K806Q £23.50
- Track Attack -1D-32K-K805F £23.50
- Pac-Man -1E-8K-B071M £29.95
- Ghost Hunter -1C-16K-BG64U £19.95
- Jawbreaker -1C-16K-BG17T £20.64
- Mouskattack -1D-32K-BQ77J £22.95
- K-razy Antiks -1E-8K-K816S £29.95
- Pathfinder -1D-32K-BG33L £26.66
- Crossfire -1C-16K-KB71N £23.50
- Labyrinth -1C-16K-BG32V £20.64
- Tumble Bugs -1D-24K-BG48A £23.50
- Wizard Of Wor -1D-32K-KB03Q £29.95
- Time Bomb -1C-16K-BG40T £10.95
- Thunder Island -1C-16K-BQ37S £10.95
- TT Racer -1C-16K-KB73Q £19.95
- Dodge Racer -1C-16K-BG29G £27.50
- Matchracer -1C-16K-BG31J £22.50
- Base Buggers -1C-16K-KB74R £22.95
- Hazard Run -1C-16K-KB76H £21.50
- Roadacer/Bowler -1C-16K-BG99H £11.95
- Shooting Gallery -1C-16K-BQ36P £14.95
- Shooting Arcade -1C-16K-BG15R £23.50
- Rasterblaster -1D-32K-BG35Q £22.95
- David's Midnight Magic -1D-48K-KB78Y £27.50
- Super Breakout -1E-8K-YG67X £24.95
- Clowns & Balloons -1C-16K-KB79L £23.50
- Guns Of Fort Defiance -1C-32K-BG78K £14.95
- Mountain Shoot -1C-16K-BQ12N £10.95
- Tank Trap -1C-16K-YL34M £8.95

- Gomoku -1C-16K-BQ18U £14.95
- Reversi -1C-16K-BQ19V £14.95
- Acquire -1C-16K-BG66V £14.95
- Stocks & Bonds -1C-32K-BG91V £14.95
- Cribbage & Dominoes -1C-16K-BQ43W £14.95
- Poker Solitaire -1C-16K-BQ17T £14.95
- Blackjack -1C-8K-YG62S £14.95
- Hangman -1C-8K-YG64J £14.95
- Wordrace -1D-32K-KB09K £19.65
- Wordrace (Part 2) -1D-32K-KB10L £15.66
- Abuse -1D-40K-KB11M £19.65
- Super Cubes & Tilt -1C-16K-BQ48C £14.95
- Humpty Dumpty Jack & Jill -1C-16K-BQ38R £14.95
- Hickory Dickory & Baa Baa -1C-16K-BQ39N £14.95
- European Scene Jigsaws -2C-16K-BQ40T £14.95
- British Heritage Jigsaws -1E-8K-BQ72P £24.95
- Video Easel -1D-48K-BG56L £27.50
- Micro Painter -1E-8K-BQ72P £24.95
- Music Composer -1E-8K-YG48C £35.95
- Movie Themes -1C-8K-BQ34M £9.95
- Computer Languages -1C-16K-YL32K £21.95
- Assembler -1D-48K-KB88E £39.95
- Syn Assembler -1E-8K-KB89F £39.95
- Assembler Editor -1D-32K-BQ73Q £59.95
- Macro Assembler -1D-48K-BQ32K £59.95
- Basic A* & Op System A* -1D-32K-BQ74R £59.95
- Microsoft Basic -1E & 2C-16K-BQ75S £89.95
- Pilot (Educator) -1E-8K-YG69A £59.95
- Pilot (Consumer) -1D-24K-YL29G £62.95
- OS Forth -1D-48K-BG62S £87.80
- Tiny-C -1D-48K-BG61R £99.00
- Inter-Lisp/65 -1D-32K-KB15R £47.19
- SAM (Speech Synthesiser) -1C-16K-BG60Q £10.95
- Programming Aids Pack -1E-8K-KB84F £24.95
- Basic Routines -1C-8K-YL30U £9.95
- 8502 Disassembler -1D-40K-BQ27E £47.96
- Atari World -1D-40K-BQ29G £31.95
- 3D-Supergraphics -1D-32K-BG64U £27.54
- The Next Step -1D-32K-KB86T £17.95
- K-DOS -1D-32K-BG58N £27.50
- Diskey -1D-32K-KB86T £17.95
- Disk Manager -1D-16K-BG57M £23.50
- Disk Detective -1D-32K-BQ30H £59.95
- MAC 65 & Op System A* -1E-8K-YG59P £21.95
- Teletink -1E-8K-YG59P £21.95

- *Disk versions also available though price and memory size may be different.
- Books -XH57M £4.00
- Master Memory Map -WG56L £16.95
- De Re Atari -WA46A £16.95
- Operating System User's Manual & Hardware Manual -WA47H £4.45
- Atari Basic-Learning By Using Games For The Atari -WG05F £8.80
- Atari Basic -WA39N £8.25
- Atari Sound & Graphics -WA40T £13.45
- Your Atari Computer -WA05F £12.45
- 6502 Assembly Language Subroutines -WA41U £11.45
- Advanced 6502 Interfacing -WA45Y £13.00
- Beyond Games (6502) -WA00A £8.25
- Computers For People -WA00A £8.25
- Analogue The Magazine For Atari (6 issues) Annual Subscription -GG24B £9.00

Send see now for our new software leaflet with details of most of the above programs.
Order As XH52G - Issue 3.
 Key: C = Cassette, D = Disk, E = Cartridge.
 2C = 2 Cassettes etc. 8K, 16K shows minimum memory requirement

Note: Order codes shown in brackets. Prices correct at time of going to press. (Errors excluded).

VIC20 COLOUR COMPUTER

- | | | | |
|---|-----------------|---|----------------|
| Hardware | (AF47B) £169.99 | Simplicast Cassette (-16K) | (AC93B) £19.95 |
| VIC20 Console | (AF48C) £44.95 | VIC Stock Control Cassette (-8K) | (AC94C) £19.95 |
| C2N Cassette Unit | (AF49D) £230.00 | VIC File Disk (+16K) | (AC95D) £24.95 |
| VIC Printer | (AF50E) £396.00 | VIC Writer Disk (-8K) | (AC96E) £24.95 |
| VIC Disk Drive | (AF51F) £29.95 | VIC Writer Cassette (-8K) | (AC97F) £19.95 |
| 3K RAM Cartridge | (AF52G) £44.95 | Education (CSE & GCE 'O' Level Revision) | |
| 8K RAM Cartridge | (AF53H) £74.95 | All cassette based and require at least 8K expansion memory | |
| 16k RAM Cartridge | | English Language | (AC98G) £9.99 |
| | | Mathematics 1 | (AC99H) £9.99 |
| Joysticks and Paddles | | Mathematics 2 | (BC00A) £9.99 |
| Single Joystick | (AC53H) £7.50 | Biology | (BC01B) £9.99 |
| Pair of Joysticks | (AC37S) £13.95 | Chemistry | (BC02C) £9.99 |
| Le Stick | (AC45Y) £24.95 | Physics | (BC03D) £9.99 |
| Pair of Paddles | (AC30H) £13.95 | Computer Studies | (BC04E) £9.99 |
| | | Geography | (BC05F) £9.99 |
| Programming Aid Cartridges | | History | (BC06G) £9.99 |
| Super Expander 3K RAM and Hi-res graphics | (AC54J) £34.95 | Arithmetic for 9 to 11 year olds | (BC07H) £9.99 |
| Programming Aid Additional commands. | | Reading for 9 to 11 year olds | (BC08J) £9.99 |
| Function Key programming etc. | (AC55K) £34.95 | General Knowledge for 9 to 11 year olds | (BC09K) £9.99 |
| Machine Code Monitor | (AC56L) £34.95 | | (BC10L) £9.99 |
| | | Home Programs | |
| Software (all 3K unless stated) | | All cassette based and require at least 8K expansion memory | |
| Introduction to BASIC Cassettes | | Quizmaster | (BC11M) £9.99 |
| Part 1 | (AC57M) £14.95 | Know Your Own IQ | (BC12N) £9.99 |
| Part 2 | (AC58N) £14.95 | Junior IQ | (BC13P) £9.99 |
| | | Know Your Own Personality | (BC14Q) £9.99 |
| Game Programs | | The Robert Carrier Family Menu Planner | (BC15R) £9.99 |
| Avenger Cartridge | (AC59P) £19.95 | VIC Money Manager | (BC16S) £9.99 |
| Star Battle Cartridge | (AC60Q) £19.95 | VIC Road User & Highway Code | (BC17T) £9.99 |
| Super Slot Cartridge | (AC61R) £19.95 | Garden Planner | (BC18U) £9.99 |
| Jelly Monsters Cartridge | (AC62S) £19.95 | Interior Designer | (BC19V) £9.99 |
| Alien Cartridge | (AC63T) £19.95 | BBC "Ask The Family" | (BC20W) £9.99 |
| Super Lander Cartridge | (AC64U) £19.95 | BBC "Mastermind" | (BC21X) £9.99 |
| Road Race Cartridge | (AC65V) £19.95 | "Mastermind" additional General Knowledge | |
| Rat Race Cartridge | (AC66W) £19.95 | Data 1 | (BC22Y) £2.50 |
| Blitz Cassette | (AC67X) £19.95 | Data 2 | (BC23A) £2.50 |
| Mole Attack Cartridge | (AC68Y) £19.95 | Data 3 | (BC24B) £2.50 |
| Adventureland Cartridge | (AC69Z) £24.95 | Data 4 | (BC25C) £2.50 |
| Pirate Cove Cartridge | (AC70A) £24.95 | "Mastermind" additional Specialist Knowledge | |
| Mission Impossible Cartridge | (AC71B) £24.95 | Wine & Food | (BC26D) £2.50 |
| Voodoo Castle Cartridge | (AC72C) £24.95 | Music | (BC27E) £2.50 |
| The Count Cartridge | (AC73D) £24.95 | Sport & Games | (BC28F) £2.50 |
| Sargon 2 Chess Cartridge | (AC74E) £24.95 | Films & TV | (BC29G) £2.50 |
| Golf Cartridge | (AC75F) £24.95 | | |
| Omega Race Cartridge | (AC76G) £24.95 | Books About VIC | |
| Another VIC in The Wall Cassette | (AC77H) £7.00 | Learn Programming on the VIC | (WA31J) £2.50 |
| | | VIC Revealed | (WA32K) £10.00 |
| VIC Panic Cassette | (AC78K) £7.00 | VIC Programmers Reference Guide | (WA33L) £9.95 |
| Cosmads Cassette | (AC79L) £7.00 | VIC Graphics | (WA48C) £10.00 |
| Backgammon Cassette (-3K) | (AC80M) £7.00 | | |
| VIC-Men Cassette | (AC81C) £7.00 | | |
| VIC Asteroids Cassette | (AC82D) £7.00 | | |
| | (AC83E) £7.00 | | |
| Business Programs | | | |
| Simplicast Disk (+16K) | (AC92A) £24.95 | | |

Lots of new VIC20 software now available.

MAPLIN

Maplin Electronic Supplies Ltd., P.O. Box 3, Rayleigh, Essex. Tel: Southend (0702) 552911/554155.

Demonstrations at our shops NOW. See the computers in action at 159-161 King St., Hammersmith W6. Tel: 01-748 0926
 284 London Road, Westcliff-on-Sea, Essex. Tel: (0702) 554000
 Lynton Square, Perry Barr, Birmingham. Tel: (021) 356 7292.

ADD-ONS, ADD-INS AD INFINITUM

Tecmar's PC-Mate Add-ons will transform your IBM Personal Computer. They add breadth to its possible applications and depth to its capabilities. You can choose from over 60 PC-Mate Add-ons - all fully compatible with your IBM PC. You can improve your standard facilities, or add new specialised functions. You can share data storage and output resources between several PC's, or eliminate the need to purchase new PC's for more occasional and less demanding requirements.

Tecmar Add-ons are already proven in thousands of applications world wide, and are now available in this country from Comart - Tecmar's Sole UK Distributor.

Just look at the possibilities for expansions and enhancement - then send for further information, or talk to your local PC-Mate dealer. The possibilities are infinite.

1 DATA STORAGE EXPANSION UNITS

Add Data Storage as Fixed Disk Winchester 10 or 15M Byte Units, or Removeable Cartridge Winchester 5M Byte Units, or twin 8" Floppy Diskettes - or any combination of all three in one neat visually co-ordinated unit. Shared System Adaptors and Software will allow data storage to be shared between up to 4 IBM PC's with full data integrity.

2 MEMORY EXPANSION

Add dynamic memory as individual 64K, 128K, 192K or 256K cards, or as integrated All-In-One cards with serial and parallel ports, plus calendar and clock. Add development capability with 32K CMOS Memory Cards with battery backup, EPROM and EEPROM Programmer/Readers and Expansion Cards, and Static RAM/ROM Cards.

A visually compatible expansion chassis provides up to 11 expansion slots to accommodate PC-Mate Add-ons, keeping your system looking neat and tidy and the expansion slots in your IBM PC free and available for future needs.

3 EXTENDED I/O CAPABILITY

Add-on multiple Input/Output capabilities in a single expansion slot; medium speed serial and parallel ports

emulate IBM ports, and are fully IBM software compatible. Add Communications potential with multiple RS232 ports with optional DMA high speed data transfer capabilities. Add a further shared resource facility for up to four IBM PC's sharing a common printer.

4 INDUSTRIAL/SCIENTIFIC/LABORATORY INTERFACES

Add-on a full range of industrial, research and laboratory equipment and test device capabilities via an IEEE-488 Interface with an optional Software sub-routine library. Add-on multi-channel 8 & 12 Bit Digital/Analog converters, 8 to 16 Bit Analog/Digital converters or a Digital Input/Output option. Add-on stepper motor controllers, timers, counters and other aids to advanced data acquisition and process control functions.

5 GENERAL SUPPORT

Add-up a whole armory of special purpose cards for voice mail, cursor movement, external device control, and many other applications. You can also benefit from the software for all PC-Mate Add-ons including useful sub-routine routines.

Please expand my information on PC-Mate Add-ons and Add-ins specifically developed by Tecmar for the IBM Personal Computer

Name _____

Position _____

Company _____

Address _____

Tel No: _____

I am particularly interested in: (Please tick as appropriate) PCW/3

Data Storage Expansion Memory Expansion Extended I/O Capability

Industrial/Scientific/Laboratory Interfaces General Support

To: Ken Goddard, Sales Manager PC-Products, Comart Limited, Little End Road, Eaton Socon, St. Neots, Huntingdon, Cambs PE19 3JG or call me today on 0480 215005.



Comart Limited, Little End Road,
Eaton Socon, St. Neots, Huntingdon,
Cambridgeshire PE19 3JG
Telephone 0480 215005.
Telex 32514 Comart G.

comart

A member of the  Comart group of companies

Specialists in microcomputers

PC-MATE is the registered trademark of
TECMAR Inc; Comart are the sole UK distributors
for PC-Mate Add-ons produced by TECMAR.

When we say- 'We're the Biggest Apple Dealer in the South West' -some people get funny ideas...

It does, however, happen to be true. In three short years we have grown to handle more Apple systems than anyone else in the region.

Why? - Knowledge, genuine interest, hard-nosed realistic pricing and good old-fashioned hard work - that's why.

If you want to climb on the wagon - contact us today and we'll put you in the picture.



DATALINK

Microcomputer Systems (U.K.) Limited
10 Waring House, Redcliffe Hill, Bristol BS1 6TB
Tel: Bristol (0272) 213427 Telex: DATAL G 44807

 **apple computer**
Authorised Dealer and Service Centre
24hr answering service

LOOK! . . . FOR ALL YOUR

apple ACCESSORIES



PA

🍏 All items fully guaranteed for one year
 🍏 Free postage and packing on all orders within UK

🍏 Immediate delivery
 🍏 Many more items available

BUSINESS SOFTWARE

	NET	INC. VAT
Access	162.00	186.30
Business Forecasting Model (Reqs. Visicalc)	63.00	72.45
Calcastar (CP/M) (80 column spread sheet)	59.00	67.85
dBase II (CP/M)	325.00	373.75
Data Star (CP/M) (powerful data entry)	122.00	140.30
Data Perfect	67.00	77.05
D.B. Master (version 3.02)	102.95	118.39
D.B. Master statistics	47.95	55.14
D.B. Master utilities (links with visi's)	47.95	47.95
Desk Top Plan II	110.00	126.50
Dutil (for dBase II)	61.00	71.15
Graphmagic (bar graphs, pie charts, etc)	52.00	59.80
Mathemagic	52.00	59.80
Msort-80 (stand alone CP/M sort)	125.00	143.75
Multiplan (Microsofts superior spreadsheet)	155.00	178.25
PFS Filing system	59.00	67.85
PFS Graph	59.00	67.85
PFS Report	47.00	54.05
Quick Code (for dBase II)	189.00	217.35
Supersort (CP/M)	85.00	97.75
Supercalc (CP/M spreadsheet)	115.00	132.25
The General manager	68.00	78.20
The Last One (programme generator)	260.00	299.00
Versaform (form generator in Pascal)	192.00	220.80
Visicalc	122.00	140.30
Visi + (visicalc consolidation)	19.45	22.37
Visicalc utilities	34.00	39.10
Visidex	135.00	155.25
Visilite	135.00	155.25
Visiplot	99.00	113.85
Visitrend/plot	155.00	178.25

WORD PROCESSING

	NET	INC. VAT
Applewriter II	72.00	82.80
Executive Secretary	145.00	166.75
Executive Speller	45.00	51.75
Format 80	195.00	224.25
List Handler (Mailer & Form Letter)	63.00	72.45
Magic Mailer	45.00	51.75
Pie Writer (40/80 columns)	85.00	97.75
Sensible Speller (new fast proof reader)	69.00	79.35
Sensible Speller (CP/M)	69.00	79.35
Screenwriter II (70 col w/out 80 col card)	75.00	86.26
SuperText 40/80	109.00	125.35
Wordstar 3.01 (CP/M) (enhanced features)	135.00	155.25
Word Handler (does not req. 80 col. card)	99.00	113.85
Zardax (40/80 & inc. form letter)	125.00	143.75

PRINTERS

	NET	INC. VAT
Epson MX80T-3 (up to 132 col & hi-res)	305.00	350.75
Epson MX80FT-3 (as above & friction drive)	339.00	389.85
Epson MX82FT (very hi-res graphics)	359.00	412.85
Epson MX100FT-3 (100 cps & wide carriage)	429.00	493.35

Mannesmann Tally MT1201 (160 cps)	365.00	419.75
Nec 8023 (100 cps & prop. spacing)	339.00	389.85
Silentyte & interface	159.00	182.85
Smith Corona TP-1 (daisy wheel printer)	449.00	516.35
Tec 1500-25 (25 cps daisy wheel)	525.00	603.75

PRINTER INTERFACE CARDS

Aristocard Parallel	69.00	79.35
Aristocard Serial	75.00	86.25
CPS Multifunction Card (inc. real time clock)	119.00	136.85
Digitek Printmaster (BASIC/CPM/PASCAL)	69.00	79.35
Digitek Printmaster III with memory mang	159.00	182.85
Grappler + (Epson/Anadex/Cent/Nec)	95.00	109.25
IPB-16K (serial/parallel card & buffer)	125.00	143.75
MBP-16K (Epson 16K buffer)	96.00	110.40
Wizard 16K Buffer & graphics interface	143.00	164.45

80 COLUMN CARDS & ACCESSORIES

Softswitch (for Videx Videoterm)	21.95	25.24
U-Term (inc. shift mod. & font editor)	127.00	146.05
Videx Enhancer II	83.00	95.45
Videx Inverse Eprom	18.45	21.22
Videx Utility Disc (inc. font editor etc)	24.45	28.12
Videx Videoterm	169.00	194.35
Visicalc preboot disc (80 col with videx)	32.00	36.80
Vision-80 (inc. softswitch & inverse)	185.00	212.75

MONITORS/COLOUR CARDS

Digitek Colour Card (excellent colour on TV)	95.00	109.25
Microvitec colour monitor	275.00	316.25
Microvitec colour card (use with above)	35.00	40.25
Prince 12" Green Screen	105.00	120.75
Zenith 12" Green Screen (very good value)	79.00	90.85

GRAPHIC UTILITIES & MUSIC

Arcade Machine (game designer)	23.50	27.03
Bit Stik (Robocom)	245.00	281.75
Complete Graphics System (Penguin)	85.00	97.75
Digitizer II	189.00	217.35
E-Z Draw 3.3 (excellent graphic utility)	25.95	29.84
Graforth (fast 3D utility plus music)	43.00	49.45
Graphics Magician (Penguin)	39.00	44.85
Graphic package Sublogic (detailed 3D pack)	74.75	85.96
Higher Text II (many diff. fonts, sizes, cols)	25.45	29.27
Pascal Animation	41.00	47.15
Pilot Animation tools	41.00	47.15
Special Effects (Penguin)	27.00	31.05
The Artist	55.00	63.25
Versawriter (graphic digitizer)	165.00	189.75
Versawriter expansion pac I	24.00	27.60
Zoom Grafix (similar to zoom on Bit Stick)	23.95	27.54
Alf Music System (9 voice)	85.00	97.75
Audex	14.95	17.19
Electric Duet (creates 2 part music)	18.95	21.79

Forte (4 voices & 9 octaves)	15.95	18.33
Music Machine 9 Voice (Vista)	69.00	79.35
Music System (Mountain Computer 16 Voice)	211.00	242.65
Mutek VoxBox (speech synthesis)	49.00	56.35
S.A.M. (software automatic mouth)	69.00	79.35
Zapple Sound Effects & Music Board	49.00	56.35

UTILITIES

Aplus (Applesoft structured Basic)	18.95	21.79
Appleguard (provides software protection)	175.00	201.25
Apple Mechanic (Beagle Brothers)	25.00	28.75
Assembly lang. Dev. (6502, Z80 or 8080)	75.00	86.25
Bag of Tricks	24.95	28.69
B.E.S.T. (Enhanced Software Tool)	23.95	27.54
Build Using (Provides 'print using' command)	23.95	27.54
Copy II Plus	35.00	40.25
Disc Doctor (CP/M disc recovery)	68.00	78.20
Disc Library (inc. CP/M & Pascal)	35.00	40.25
Dos 3.3 Tool Kit	41.00	47.15
Dos Boss (modifies Dos Commands)	15.00	17.25
Edit Soft (powerful macro line editor)	19.95	22.02
Fast DOS	19.45	22.37
Global Program Line Editor (supports 80 col)	34.50	39.68
Image Printer-Epson (flexible hi-res dump)	32.00	36.80
Isa (Assembly lang. dev. system)	57.00	65.55
Isa (Educational system)	75.00	86.25
List Master (inc. smart renumbering)	23.95	27.54
Locksmith 4.1 (bit copier for most discs)	61.00	70.15
Merlin Macro Assembler (editor & utilities)	45.00	51.75
Munch A Bug	24.00	27.60
Printographer (supports almost any printer)	27.95	32.14
Speed Star (compiles 1200 lines per mln.)	75.00	86.25
Super Disc Copy III	25.00	28.75
Tasc Compiler (handles V. large programs)	95.00	109.25
The Bug (Assembly Language debugger)	38.00	43.70
The Inspector (disc snooper, needs 16K cd)	35.00	40.25
The Routine Machine (mach. lang. routines)	36.45	41.92

SYSTEM EXPANSION

16K Ramcard Digitek	75.00	86.25
16K Ramcard Ramex	65.00	74.75
16K Ramcard Samram	55.00	63.25
32K Ramcard Saturn	135.00	155.25
128K Ramcard Saturn	299.00	343.85
128K Ramcard card	275.00	316.25
Cool stack (holds 2 drives & monitor + fan)	65.00	74.75
DDS upgrade kit (3.2 to 3.3)	36.00	41.40
E-Z Port (game socket extenders)	11.45	13.17
E-Z Port II (2 games socket extenders)	19.00	21.85
Eprom Card (holds 6)	52.00	59.80
Keyplus Numeric Keypad	83.00	95.45
Lower case adapter W/shift (rev 7+)	34.00	39.10
Pact clip on fan	46.00	52.90
The Mill 6809 with Pascal speed up	189.00	217.35



DIGITEX COLOURCARD

This amazing card gives a high quality colour and includes a wide band modulator, simply plug in your TV or monitor. Just £95.00 + VAT.



IPB-16K SERIAL/PARALLEL INTERFACE & BUFFER

Now you need only one interface card to support both your daisywheel and dot matrix printers plus the benefits of a 16K buffer to speed things along. £129 + VAT.



SMITH CORONA TP-1 DAISY WHEEL PRINTER

A microprocessor controlled high quality printer which delivers fully formed executive print at a speed of 120 words/min. Price £449 + VAT.



ROBOCOM BIT STIK GRAPHICS SYSTEM

The Robocom BIT STIK graphics system is the first in a new generation of low cost computer graphics controllers that eliminate the time consuming inputting of instructions via a keyboard.

It opens up exciting new possibilities for inexpensive computer graphics by enabling micro-computer users to create multi-colour graphics, sketches, technical drawings, circuit diagrams, typography, etc., plus a host of visual effects, quickly and simply with the minimum of computer knowledge. Price £245 + VAT.



MICROVITEC 14" COLOUR MONITOR

Besides offering a crystal clear display in either text, hi-res or low-res modes. It also includes the following features, 16 text colours, b/grd colours, 80 column card compatibility. A superb colour monitor for £275.00 + VAT.



12" PRINCE MONITOR

Features 24 M/Hz bandwidth, giving a very clear display, and contained in a neat Apple compatible case, available with either Green or Amber screen. £105 + VAT.

CE

0274 575973

Kit	55.00	63.25
Expand/80 (up to 145K Visicalc & 80 col)	65.00	74.75
Expand Ramex (loads 136K visi in 20 sec)	40.00	46.00
ix Enhancer II	83.00	95.45
x Function Strip (req Enhancer II)	49.00	56.35
8522 Card	59.00	67.85
card U-micro (card only)	73.00	83.95
card Microsoft (CP/M & Mbasic)	185.00	212.75

GUAGES		
le Logo	115.00	132.25
le Pascal	145.00	166.75
le Pilot	79.00	90.85
ol 80 (CP/M)	345.00	396.75
h II (Integer only)	39.00	44.85
ran 80 (CP/M)	103.00	118.45
apin Logo	95.00	109.25
sforth (full floating point Forth)	68.00	78.20

CELLANEIOUS ITEMS		
Drive (Fully Apple Compatible)	199.00	228.85
Drive Controller Card	54.00	62.10
Head Cleaning Kit (50 discs & fluid)	19.95	22.94
tray (40 discs & lockable)	17.45	20.07
es Paddles	25.00	28.75
port	38.45	44.22
stick (self centering)	38.00	43.70
ster Diagnostic Disc	48.00	55.20
stic Disc Box	2.50	2.88
n Card utility (permits s/ware backup)	59.00	67.85
ckBall (the ultimate game controller)	55.00	63.25
x Ball (TG Products)	45.00	51.75
ing Tutor II	14.95	17.19
ash 5.25 Discs Pack of 10	17.95	20.64
dcard (permits software backup)	93.00	106.95

ITEK COLOURCARD
Amazing card gives high quality colour and includes a wide bandulator. Simply plug in your TV or PAL monitor. £95.00+VAT

EBIT STIK GRAPHICS SYSTEM
Large smooth tracking hemisphere with adjustable back pressure and ably the most powerful microcomputer graphics software available. £245+VAT

16K SERIAL/PARALLEL INTERFACE & BUFFER
You need only 1 interface card to support both your daisywheel 1 dot matrix printers plus the benefits of a 16K buffer to speed things up. £129+VAT

TIH CORONA TP-1 DAISY WHEEL PRINTER
Microprocessor controlled high quality printer which delivers fully med executive print at a speed of 120 words/min. £449+VAT

CROVITEC 14" COLOUR MONITOR
Slides offering a crystal clear display in either text, hi-res or low-res modes, it also includes the following features: 16 text colours, b/grd colours, 80 column card compatibility. A superb colour monitor for 75+VAT

PRINCE MONITOR
Features 24 M/Hz bandwidth, giving a very clear display, and contained a neat Apple compatible case. Available with either green or amber screen. £105+VAT

Please make your order by completing the coupon and returning to us - or you can phone **DAVE** or **SHERIDAN** on **0274 575973** and your enquiry will receive a friendly and speedy response.

PACE-SOFTWARE-SUPPLIES

Rose Bank, 130 Clayton Road,
Bradford BD7 2LY, West Yorks.

Please rush me the following items.

	£	p
1		
2		
3		
4		
5		
TOTAL		

I enclose my cheque made payable to **PACE SOFTWARE** (Export licence arranged)

Name _____
Address _____
Town _____
County _____
Postcode _____ Tel. No. _____

PCW/14

infomatics

MICRO BULLETIN

BE UP-TO-DATE WITH ALL THE VITAL NEWS IN THE MICRO COMPUTER INDUSTRY.

In our fast-moving business the right piece of news can often put you ahead of your competition ... alter your plans ... even the very strategy of your business ... but only if it reaches you in time.

The Infomatics group of publications is launching a new weekly newsletter to cater specifically for people in the micro computer industry. Published every Monday, the Infomatics Micro Bulletin will be packed with information about what is happening on the micro front - both hardware and software. Produced by the same publisher as Personal Computer World and MicroDecision, the micro newsletter will carry up-to-date information on what is happening in the US and Japan, as well as news from the UK.

We'll be talking about new products coming along from the Japanese and American manufacturers and spotting those who want representation in the UK and Europe. And we'll be reporting on those companies abroad which want to market British systems and software.

The information will be aimed at people in the business - software houses, dealers and manufacturers - rather than hobbyists and users. It will therefore be essential reading for those who want to stay up-to-date with events and pick up the best deals first.

Annual subscription to the Micro Bulletin is £85, and will include an automatic subscription to Infomatics magazine.

So send off now for this week's FREE issue of the Micro Bulletin and for details on how to subscribe.

To: Infomatics Micro Bulletin,
VNU Business Publications B.V.,
FREEPOST 38, London W1E 6QZ

Yes, please send me my free issue of Infomatics Micro Bulletin.

**FREEPOST
NO STAMP NEEDED**

Name _____
Company _____
Position _____
Address _____
Postcode _____
Telephone _____

An Apple on its own is great but an Apple with Digitek cards really shines!



Pal Encoder Card

Gives you such superb colour display on your T.V. or monitor. It brings a new dimension to all your T.V. games and graphic software programs. Installation is easy and simple. Only £105.00

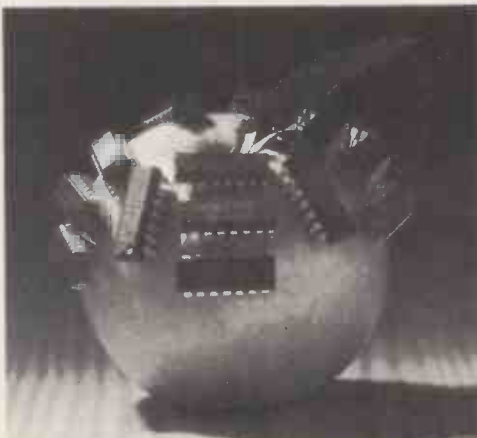

Ram-Master 16K, 64K and 128K

Three cards that allow you to handle so much more data and are compatible with the Superprintmaster III for buffering. We also provide, with every 64K and 128K ramcard, a demonstration and utility disk (operates with IIE). From only £85.00

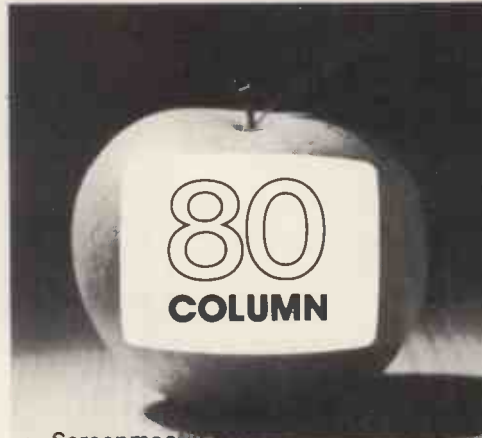

Screenmaster 80

The most sophisticated 80 column card available for the Apple II and IIE computers. Providing you with all the advantages of word processing on screen, plus many additional features. Included with every card is a demonstration and utility disk. Only £185.00

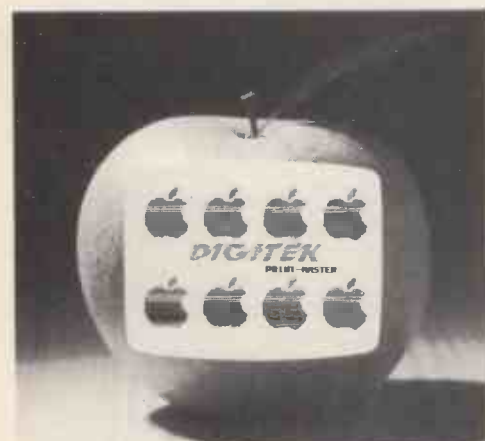

Printmaster Interface

This economically priced printer interface is compatible with CP/M and PASCAL and operates with most popular dot matrix printers. Features include inverse printing, double density, double size and 90 degree picture rotation. Only £79.00



Super Printmaster III

The most revolutionary printer card for the Apple II, IIE, includes quadruple size printing, dumping in Hi-Res and Lo-Res graphics. £105.00. Other versions provide memory management, buffering and a full colour version for the IDS PRISM.

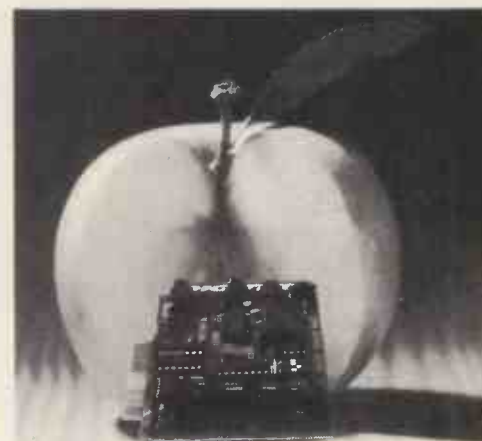

RS232

Digitek's RS232 will give you all the necessary support when expanding your Apple system. The addition of an on-board DIP switch allowing you to select the BAUD rates certainly makes the Digitek card a must. Only £85.00.

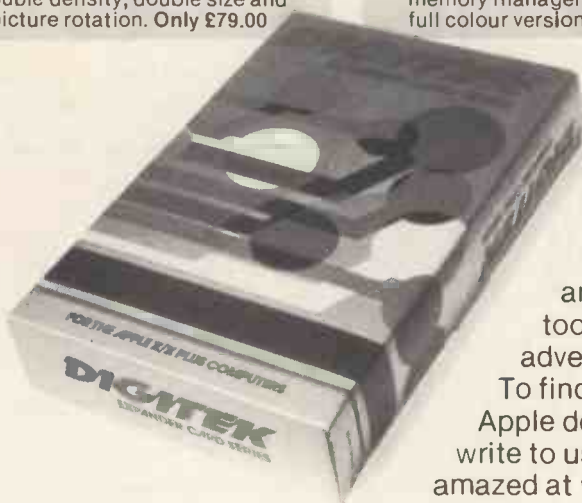

In your business, or at home, being able to use your Apple II and IIE computer and software programs to the full is essential. Our range of expander cards and utility programs will do just that. All the cards are packed with on-board features too numerous to mention in this advertisement.

To find out more ask your local Apple dealer for a leaflet, or write to us direct. You'll be amazed at what we can do for your Apple.

Digitek, Super Printmaster III, Screenmaster 80, and Ram-Master are trademarks of Digitek (International) Ltd. Apple is a trademark of Apple Computers Incorporated.

DIGITEK
EXPANDER CARDS

DIGITEK (INTERNATIONAL) LIMITED
37c West Street, Horsham, West Sussex, RH12 1PP
Tel: (0403) 66581 Telex: 859634 OKWDHL G

I am interested in (Indicate expander card)
My printer is _____
Name _____
Address _____
Post code _____

Telephone Order 0403 66550
VISA
MasterCard

Digitek (International) Ltd. 37c West Street, Horsham, Sussex RH12 1PP



PROGRAMS WITH A DIFFERENCE

from



WORD HANDLER II



LIST HANDLER

SILICON VALLEY SYSTEMS, INC.

!! 66 COLUMNS ON-SCREEN!!

PLUS Full and Powerful Word Processing **WITHOUT ANY EXTRA HARDWARE**

Will run on standard 48K Apple with one or two disk drives. With direct-to-disk editing its possible to have single documents larger than memory. PLUS all underlining, justification etc appears on the screen. **£109**

(£125.35 Inc.VAT)

upto 3000 records on ONE DISK

PLUS sorting on up to **8 DRIVES** allowing say, a Mailing List of **24000!!** Lists are totally user defined and can have as many as 255 fields!

PLUS full merging with Text files to produce form-letters, price-list, in fact the only restriction is the users imagination. **£65**

(£74.75 Inc.VAT)

STUDYING FOR EXAMS?

Simply type your notes into our **E-Z LEARNER** program, and the computer will throw random questions at you until you have learned each subject thoroughly. **£25**

(£28.75 Inc.VAT)

LOTS OF READING TO DO?

Then you need a copy of our **RAPID READER** You decide on the speed you want to practice at and the computer will give you words sentences and paragraphs to read and then tests you for comprehension. **£25**

(£28.75 Inc.VAT)

Apple III

FREE WITH THESE APPLES!

Apple II



Complete start-up business systems at the same cost as the hardware only

Unlike the 'discount boys' this offer includes

ON-SITE INSTALLATION

2 hours BASIC INSTRUCTION and FULL AFTERSALES BACK-UP



SALES LEDGER
PURCHASE LEDGER

PLUS APPLEWRITER III

SYSTEM COST (as Illustrated) £2418

FREE SOFTWARE VALUE £659

OFFER ENDS 24th February 1983

24-hour ON-SITE MAINTENANCE AVAILABLE

(Prices quoted DO NOT INCLUDE VAT)

WORD HANDLER II LIST HANDLER

THE LAST ONE VISICALC

SYSTEM COST (with Hitachi monitor) £1602

FREE SOFTWARE VALUE £519

NewBrain

AT LAST ...



FULL STAFF TRAINING BY TABS IS AVAILABLE IF REQUIRED



FOR POWERFUL FINANCIAL MODELLING For ALL CP/M systems £295
(£339.25 Inc.VAT)

WE ARE ACCREDITED DEALERS We will assist you all the way through with installation

SOME SOFTWARE!

GAMES All NEWBRAIN PRICES include VAT

GOBBLER The well-known Arcade game of eat and be eaten **£10.00**

TYCOON/PELMANISM TYCOON requires you to buy and sell shares with the computer throwing in random factors that affect prices. PELMANISM is the game that test your memory making cards into pairs. **£12.00**

WORMS Chasing your own tail can be very tricky **£9.95**

HOME & BUSINESS

HOME BUDGET **£12.00** Keep track of the family finances quickly and easily.

DIARY **£12.50** 12 months appointments birthdays etc.

WORD WORKER **£29.95** A very efficient word processor. Ideal for students and people who write

DATA BASE **£31.50** Store up to 800 records and sort on up to 11 fields.

INVOICE & CREDIT NOTE Issues and keeps track of all your invoices. **£69.95**

INVOICE REVIEW Analyses and reports all Invoices issued. **£27.50**

(if both programs bought together, DEDUCT £12.45 from total)

NEWBRAIN Model AD £263.35 (with LCD display)

Model A £228.85

Full product support and Guarantee

Mail Order

Prices include Post & Packing

Full after-sales service is included with all Software

Callers very welcome.

Our retail shop is open from 10 till 6 (Closed Wednesday all day)

10 Eastfield Parade
Forbes Avenue, Potters Bar
Herts. EN6 5ND
Potters Bar (0707) 44808

24hr Telephone ordering service on 0707 59669

NAME	Qty.	Item	Cost	P&P
ADDRESS				
Postcode				
Telephone				
MAKE				
MODEL				
ACCESS				
BAR CARD				
Cheque/P-Order/Cash/Card No. for				
Sub-totals				

NO STAMP REQUIRED! just place in an envelope and post to:-



Potters Bar computers

FREEPOST 9009 Potters Bar, Herts., EN6 2BR

NewBrain

**professional quality and features –
– hobby price!**

- * 40/80 character line, full screen editor.
- * Keyboard with standard key spacing and nice 'feel'.
- * 32K RAM and 29K ROM. Both expandable.
- * High resolution graphics, graph plotting, etc.
- * CP/M and networking capability.
- * Compact – will fit neatly on your desk or lab bench.
- * High quality construction.

From £199 +VAT

angela enterprises support the *NewBrain*

Personal service – evenings and weekends too!
Help is just a 'phone call away! Our service starts with the sale. We are engineers and programmers – not just a sales outlet.

NewBrain Model A £199 } + VAT
Model AD (with line display) £229 } (free delivery)

130 page Beginners Guide and program tape with every machine, plus our own hints and tips from time to time.

Contact us for the latest information on hardware, software, monitors, printers, User Group, etc.

To obtain your NewBrain ring us on Stevenage (0438) 812439 (Access accepted) or send cheque/Access number to:

**SOFTWARE
Prices include VAT, P+P**

Home Budget	£9.95
Tycoon/Pelmanism	£9.95
Gobbler (Gollum)	£9.20
Card Index (DataBase)	£40.25
File Manager	£26.45
Pages (W/P, Window display etc.)	£35.00
Word Worker (WP)	£25.00
Diary	£10.00
Worms (Game)	£7.00
Chase (sim. to Gobbler)	£7.00
Telephone	£10.00
Directory	£10.00

We are also developing our own software for the NewBrain. Please contact us for latest details

Software authors – if you have something good for the NewBrain please get in touch!

**HARDWARE
Prices include delivery in UK.
All with 12 month warranty (not the more usual 90 days!)**

NewBrain EPROM BOX	£55.00+VAT
SANYO or HITACHI Monitors (Hi. res. 12", Green phosphor)	£109.00+VAT
OKI Printers eg. 82A (Other OKI models available)	£349.00+VAT
AMBER 2400 Printer with special interface/cable for NewBrain	£102.15+VAT
SEIKOSHA GP 250X	£260.00+VAT

Other printers (Epson etc.) – please ask.

ANGELA ENTERPRISES

4 Ninnings Lane, Rabley Heath, Welwyn, Herts. AL6 9TD

Tel. 0438 812439

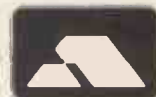

ANIROG Computers

ONE STOP SHOP FOR SOFTWARE AND BOOKS
SPECTRUM — VIC 20 — ZX81-C-64 — DRAGON 32

VALUE FOR MONEY SOFTWARE BY ANIROG. FOR VIC-20
Our packs of seven games contain a balanced mixture of action packed arcade style, board and adventure games. All are in Hi-res Graphics for unexpanded VIC and offer exceptional value for money at only £6.

PACK OF SEVEN (VOL 1) — PACK OF SEVEN (VOL 2) — TINY TOTS SEVEN - Games for young children. Bright colour graphics and exciting sound effects are special features of these specially written programmes.

PUZZLE — ADVENTURE DRACULAR (3K EXP)
The Count is resting, find the things you need to do the deed. After sundown which is soon!

ARCADE MACHINE CODE PROGRAMS: /FOR STD VIC-20)
SPACE RESCUE A belt of orbiting asteroids has trapped your crew. To rescue them you must pilot the shuttle to the planet surface and beam them up one at a time, fuel is limited too! JS/Keys.

CRAWLER Centipedes in the mushroom garden move at a fantastic speed, they must be destroyed. Mushroom planting fleas will box you in! Watch out for spiders! Shoot fast to survive. JS.

CAVERN FIGHTER An exciting version of scramble many hazards in a random course. Fuel shortages will of course add to your problems. JS

NEWMULTI SCREEN GAMES.
Coming next month 16K games for the Vic-20 with full graphics and sound: PHARAOHS TOMB; ZOKS KINGDOM; and SPACE ADVENTURE XNENOS II

**ALL ANIROG TITLES ARE ONLY £6 EACH
TWO OR MORE ITEMS 7.5% DISCOUNT. 5 ITEMS -
£1.00 EXTRA DISCOUNT. ANY MIX OF BOOKS OR
SOFTWARE ACCEPTED**

Mail Order
Payment by cheque,
P.O. or Visa



26 Balcombe Gardens,
Horley, Surrey.
Horley (029 34) 2007/6083

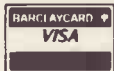

Personal Shoppers Welcome at

CO-OP CRAWLEY



Full range of software by leading software houses in the country. **BUG BYTE, QUICK SILVA, RABBIT, AUDIOGENIC, ARCTIC, A.S.K., SILVER SOFT, ROMIC, J.K. GREY PROGRAMME POWER, LLAMASOFT, SOFTEK, VIDEO SOFTWARE, COMMODORE, DRAGON,** and many others.
Huge selection of computer books. Massive stock of books and software. Despatch within 48 hours of receipt of order.

SEND S.A.E. FOR CATALOGUE. PLEASE STATE THE COMPUTER TYPE.

VIC-20 NEW RELEASE FROGGER,
Help our frogs cross the motorway. Then negotiate the river with the floating logs, Turtles, alligators to the safety of his hole. There are PERKS!



Mole Computer Products Ltd
offer

BBC Microcomputer

Compatible
Disk Drives

Now offered to you at a price you can afford

Mole 100 Subsystem
£148.00 (incl. VAT)
Single drive system
containing 1 x 100K
single sided disk drive

Mole 200 Subsystem
£299 (incl. VAT)
Dual drive system
containing 2 x 100K
single sided disk drive

- Fully compatible with your BBC model B
- Powered from your BBC microcomputer
- Come complete with all necessary connecting leads, utility discs, and full operating instructions

Mole Computers Products Ltd 1 St. Albans Road
Kingston KT2 5HQ Surrey

	Unit Cost	Quantity	Total
Mole 100	£148		
Mole 200	£299		

Interface & utilities £83.00

Postage & package £6.80

All prices inclusive of VAT

Please allow 28 days approximately for delivery

I enclose a cheque to the value
of

Name

Address



FULL DETAILS AVAILABLE FROM

Central Financial Services

Dunallen

Stirling Road

Dunblane

Tel No: 0786-824595

PERTSHIRE

Salamander Software PRESENTS

EDG GRAPHICS PACKAGE

Salamander Software has recently obtained sole U.K. marketing rights to a sophisticated graphics package for use with the BBC Model B microcomputer. The package was developed by a firm of consultants and design engineers to the oil and utility industries for in-house use, and has now been assembled in commercial form for applications in the home, business and schools.

The package consists of an advanced picture drawing system controlled entirely by normal keyboard input and using cassette tapes for software and pictures storage, so that no additional hardware is required.

THE MAIN SYSTEM FEATURES ARE:

- * Picture drawing in mode 0, 1 or 2
- * Actual and Logical colour changes at any time
- * Drawing functions include lines, boxes, circles, arcs, text and shape repetition
- * Drawing aids include grid, elastic band, save and home cursor (5 positions)
- * Colour fill
- * Text window showing X, Y cursor position, length, angle, colour menu and current colour
- * Saving and loading of pictures using cassette tapes
- * Multi file picture
- * Flashing crosshairs cursor
- * User instructions/prompts
- * Spiral bound manual

PRICE £24.95 inc VAT

Available from:

Salamander Software
27 Ditchling Rise
Brighton
East Sussex
BN1 4QL

or ask at your local Acorn dealer
Trade enquiries: Tel: B'ton (0273) 771942

Send stamped s.a.e. for full catalogue

Value - MicroValue - Micro

80-BUS MULTIBOARDS

The Gemini Multiboard Microsystem provides a large and growing range of fully compatible microcomputer boards. Around these boards you can configure a solution to satisfy your own particular microprocessor needs, whether you need as many as 10 boards or as few as one. This flexibility is made possible by Gemini's adoption of a number of accepted industrial standards; especially the 80-BUS, specifically designed for the Z80A

The Z80A (the high speed version of the Z80) is now the largest selling microprocessor worldwide, and forms the heart of the MultiBoard system. The principal advantage of a Z80A based system is the abundance of software that is available, and the majority of those packages operate under the CP/M disk operating system. With CP/M software becomes machine independent; providing the user with literally the widest range of software available.

With MultiBoard an almost unlimited number of system permutations are possible. Seven of the most popular boards are shown here, but there is a range of 15 available from your MicroValue dealer; together with mother boards, frames, cables, power supplies, keyboards and compatible software if required.

Your MicroValue dealer can advise you on suitable permutations to suit your requirements, whether building a system from scratch or expanding your Galaxy or Nascom computer.



GM 816 - MULTI I/O Board

- ★ Six 8-Bit I/O Ports
- ★ 4 Counter/Timer Channels
- ★ Real Time Clock

- ★ Further expansion capability

Daughter boards also available for further expansion.

£125
(£143.75 inc. VAT)

EV 814 - IEEE 488 Controller

- ★ Cost-effective Controller
- ★ Comprehensive software supplied

Controls equipment fitted with IEEE488 or GPIB interface.

£140
(£161.00 inc. VAT)

PLUTO - Colour Graphics Processor Board

- ★ 640 x 576 Bit mapped display
- ★ On-board 16-Bit microprocessor
- ★ Comprehensive on-board software

IO 828 A: 192K RAM
IO 828 B: "BABY PLUTO"
PLUTO" **£399** 96K **£299**
(£458.85 inc. VAT) (£343.85 inc. VAT)

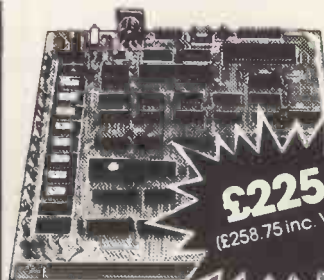

GM813 - CPU/64K RAM Board

- ★ 4 MHz Z80A CPU
- ★ 64K Dynamic RAM
- ★ RS232 Serial Interface
- ★ Two 8-Bit I/O Ports
- ★ 1200 Baud Cassette Interface
- ★ Extended and Page Addressing Modes

£225
(£258.75 inc. VAT)

The Gemini GM813 is an 80-BUS compatible CPU card incorporating 64K dynamic RAM and utilising the powerful Z80A microprocessor running at 4MHz. Extended addressing and page mode facilities allow for future memory expansion up to 2 megabytes. Input and output capabilities include both programmable serial and parallel interfaces - RS232, 1200 baud CUTS cassette interface and the Z80A PIO. When used with the GM812 video card, the GM813's unique RP/M monitor allows the creation of cassette or EPROM based programs or files which are upwards compatible with a disk based CP/M system.

GM811 - CPU Board

- ★ 4MHz Z80A CPU
- ★ Four 'Byte-wide' Memory Sockets
- ★ Two 8-Bit Input/Output Ports
- ★ 8 Bit Input Port
- ★ RS232 Serial Interface
- ★ 1200 Baud CUTS Cassette Interface

£125
(£143.75 inc. VAT)



GM812 - IVC Board

- ★ 80x25 Display Format
- ★ On-board Z80A Microprocessor
- ★ Buffered Keyboard Input
- ★ Programmable Character Generator
- ★ 160x75 Pixel Graphics
- ★ Light Pen Input

£125
(£143.75 inc. VAT)

GM 829 - FDC/SASI Board

- ★ Single/Double density operation
- ★ Single/Double sided drive operation
- ★ Up to 4 mixed 3.5", 5.25" and 8" drives
- ★ Industry Standard SASI hard-disk interface

Other boards available in the Multiboard range include:

GM802	64K Dynamic RAM Board	£125	(£143.75 Inc. VAT)
GM803	EPROM/ROM Board	£65	(£74.75 inc. VAT)
MP826	32K Static RAM Board	£185	(£212.75 inc. VAT)

All MultiBoards are Nasbus* compatible
Ask for latest catalogue for full details.

*Trademark of Nascom Microcomputers Division of Lucas Logic

MicroValue

REAL value - from the Professionals

Value - MicroValue - Micro

COMPUTERS

New from Gemini

Gemini Galaxy 2

- * Twin Z80A Processors
- * CP/M 2.2 Operating System
- * 64K Dynamic RAM
- * 800K Disk Capacity
- * 80x25 Video Display
- * Serial and parallel printer interfaces
- * Cassette and light pen interfaces
- * User definable function keys
- * Numeric key pad
- * 12" Monitor included

£1495
(£1719.24 Inc. VAT)

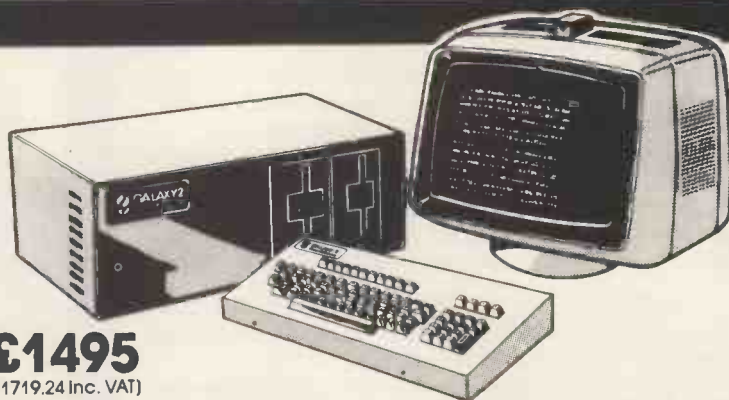

Total support for Gemini & nascom Products

nascom 3 available from MicroValue

Based around the successful Nascom 2 computer, this new system can be built up into a complete disk based system. Supplied built and tested complete with PSU, Nas-Sys 3 and Nas-Gra.

48K System
£549 (£631.35 Inc. VAT)

CP/M 2.2
£100 (£115 Inc. VAT)

NASCOM 2 KIT
£225 (£258.75 Inc. VAT)

Built & Tested
£285 (£327.75 Inc. VAT)

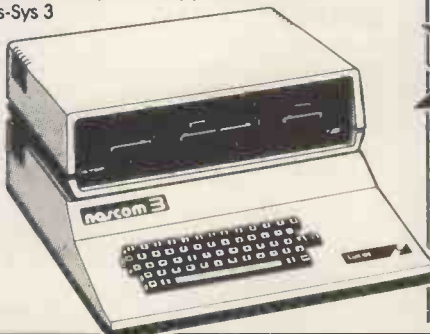

80x25 Video for nascom

£125
(£143.75 Inc. VAT)

Nascom owners can now have a professional 80x25 Video display by using the Gemini G812 Intelligent Video Card with on-board Z80A. This card does not occupy system memory space and provides over 50 user controllable functions including prog character set, fully compatible with Gemini G805 and G815/809 Disk Systems. Software supplied on Gemini system disks. Built and tested.

Nascom 1 Printed Circuit
(Inc. parts list)

£25 (£28.75 Inc. VAT)

GM802 64K RAM Card **£125**
(£143.75 Inc. VAT)

GM802K 16K RAM KIT **£80**
(£92 Inc. VAT)

Disk System for Gemini & nascom

GM825 Disk Drive Unit - The GM825 floppy disk housing is supplied with either one or two 5.25" single sided, double density, 96TPI high capacity Micropolls 1015F5 disk drives. These provide 400K bytes of formatted storage per drive. (Gemini QDSS format). The CP/M2.2 package available supports on-screen editing with either the normal Nascom or Gemini IVC screens, parallel or serial printers.

An optional alternative to CP/M is available for Nascom owners wishing to support existing software. Called POLYDOS 4, it includes an editor and assembler and extends the Nascom BASIC to include disk commands.

Single Drive System **POLYDOS 4**
GM825-1S for Nascom

£350 (£402.50 Inc. VAT) **£90** (£103.50 Inc. VAT)

Dual Drive System **GM809 Disk Controller Card**
GM825-2S for 8" and 5.25" drives

£575 (£661.25 Inc. VAT) **£125** (£143.75 Inc. VAT)

CP/M2.2 Package **GM829**
(GM 532 for Gemini) for 8", 5.25" and Winchester Drives

£90 (£103.50 Inc. VAT) **£145** (£166.75 Inc. VAT)

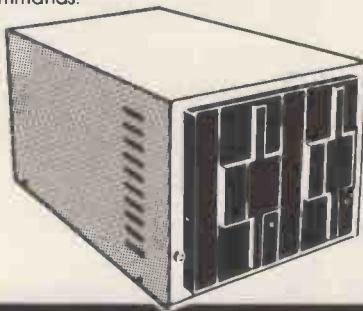

At last - a Winchester Drive for your Gemini / nascom System!

GM835 Winchester Drive Sub-system.

- * 5.4 Megabyte Formatted Capacity
- * Rodime Drive
- * Industry Standard SASI interface
- * Integral Controller and power supply

£1450
(£1667.50 Inc. VAT)

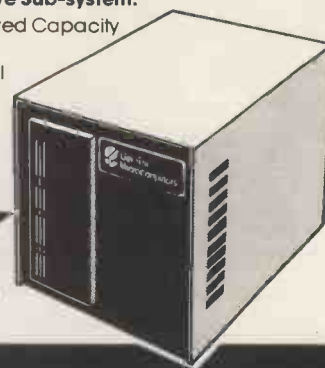

SOFTWARE

CP/M Software Compas

is totally different from other compiler based Pascal systems, as it allows you to create, edit, run, and debug Pascal programs in a highly interactive manner.

£120
(£138 Inc. VAT)

'The Last One' is used in conjunction with Microsoft's MBASIC*. No knowledge of BASIC programming is required since all input is performed using question and answer routines written in plain English.

£330
(£379.50 Inc. VAT)

*MBASIC - MicroValue Price if purchased with 'The Last One' - £178.95 Inc. VAT

VIZ:APL is a high level language system. It can be used to develop small programs faster and large programs in limited memory. The language can be enhanced almost indefinitely and the user's own operators and functions can be built up.

£255
(£293.25 Inc. VAT)

Gemini Software:

- GEM PEN** Text Editor **£45** (£51.75 Inc. VAT)
 - GEM ZAP** Assembler **£45** (£51.75 Inc. VAT)
 - GEM DEBUG** Debugging Utility **£30** (£34.50 Inc. VAT)
 - WORDSTAR** Word Processor **£215** (£247.25 Inc. VAT)
 - GEM GRAPHIC** Links with MBASIC **£35** (£40.25 Inc. VAT)
- A wide range of software for Nascom also available. When ordering disks, please specify format.



Value - MicroValue - Micro

LOW COST SYSTEMS

Dragon 32

A powerful colour computer for under £200.

- * 32K RAM
 - * 6809E Microprocessor
 - * Extended Microsoft Colour BASIC
 - * 9 Colour, 5 Resolution Display
 - * Sound through TV 5 octaves, 255 tones
 - * Advanced Graphics
- Full range of Dragon software available.



£173⁴⁷
(£199.50 inc. VAT)

Sinclair ZX81

Now available through MicroValue—a real computer for less than £50!

- * Sinclair ZX81 Computer **£43.43** (£49.95 inc. VAT)
 - * Sinclair ZX Printer **£52.13** (£59.95 inc. VAT)
 - * 16K ZX RAM PACK **£26.04** (£29.95 inc. VAT)
 - * ZX81 Learning Lab **£17.35** (£19.95 inc. VAT)
- ★ Software for Sinclair **from £3.43** (£3.95 inc. VAT)



THE NEW

SHARP MZ80A

Electronic magnificence from Sharp

Z80A C.P.U. · 48K RAM · 4K ROM · Industry standard Qwerty keyboard with numeric pad · 9" GREEN C.R.T. · 1200 baud cassette · Music and sound · Real time clock · Enhanced BASIC · Full editing facilities · Internal expansion.



£475 (£546.25 inc. VAT)

FREE SOFTWARE!

Home budget, bank reconciliation, SPACE INVADERS, STAR TREK, SCRAMBLE, bank loan calculator, mortgage calculator + 7 other games.

Educational — Geography, Maths., Spelling + 4 part BASIC tutorial.

PRINTERS

- Epson MX80 Type III **£348** (£399.95 inc. VAT)
- Epson MX80 FT Type III **£388** (£445.95 inc. VAT)
- Epson MX100 Type III **£496** (£569.95 inc. VAT)
- NEC 8023A **£339** (£389.95 inc. VAT)
- SEIKOSHA GP100A **£215** (£246.95 inc. VAT)

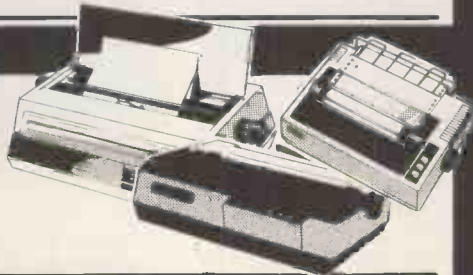

Daisy Wheel Printer:

Smith-Corona TP-1 **£485** (£557.75 inc. VAT)

Quantum OM 2000 COMPUTER SYSTEM

- * Twin Z80A Microprocessors
- * 64K Dynamic RAM
- * 2.4 megabytes of formatted disk storage capacity
- * 80 x 25 screen format
- * 160 x 75 pixel graphics
- * Programmable character generator
- * Cassette interface
- * RS232 serial printer interface
- * Centronics parallel printer interface
- * Light pen interface
- * 128 Character buffered keyboard input
- * CP/M 2.2
- * Extensive in-built expansion capability
- * Modular design for reliability and ease of maintenance

Phoenix P12 Monitor

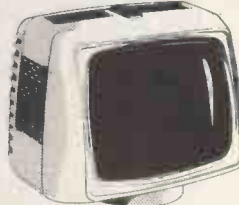

A high quality data display monitor, ideal for all Nascom and Gemini systems. 20MHz resolution. Available in amber or green phosphor.

£110
(£126.50 inc. VAT)



£2250
(£2587.50 inc VAT)

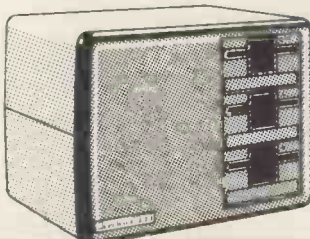

MICROVALUE DEALERS:

AMERSHAM, BUCKS

Amersham Computer Centre, Oakfield Corner, Sycamore Road. Tel: (02403) 22307

BIRMINGHAM B5

Skytronics MBM, 80 Bristol Street, Tel: 021-622 6436

BRISTOL

Target Electronics Ltd., 16 Cherry Lane. Tel: (0272) 421 196

COLCHESTER

Emprise Electronics Ltd., 58 East Street. Tel: (0206) 865926

EGHAM, SURREY

Electrovalue Ltd., 28 St. Judes Road, Englefield Green. Tel: (07843) 3603

IPSWICH

MDW (Electronics), 47/49 Woodbridge Road East. Tel: (0473) 78295

LONDON W2

Henry's Radio, 404 Edgware Road. Tel: 01-402 6822

LONDON SW11

OFF Records, Computer House, 58 Battersea Rise, Clapham Junction. Tel: 01-223 7730

MANCHESTER M19

EV Computing, 700 Burnage Lane. Tel: 061-431 4866

NOTTINGHAM

Computerama, (Skytronics Ltd.) 357 Derby Road. Tel: (0602) 781742

Telephone orders welcome



**BUY FROM THE
COMPUTER
PROFESSIONALS**

MicroValue

REAL value — from the Professionals

NOW... FOR ZX SPECTRUM USERS EVERYWHERE THE FULLER BOX...

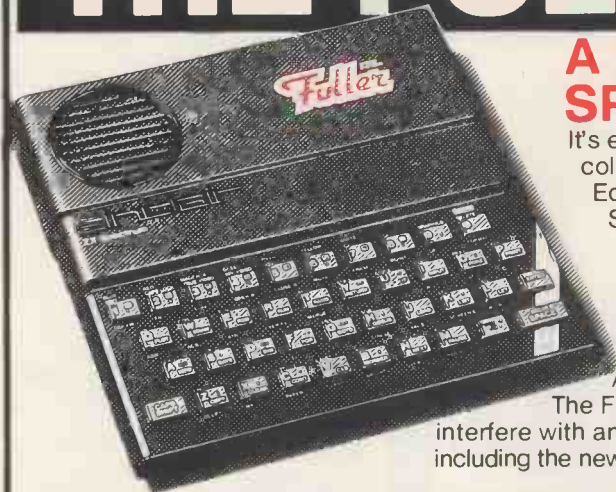

A NEW DIMENSION IN SPECTRUM CAPABILITY

It's easy to see why the ZX Spectrum is outselling all the other small colour computers, it really is a marvel of new technology.

Equally marvellous is the new 'Fuller Box' for your Spectrum.

Sound Quality is improved enormously with the built in *Audio Amplifier* which works with all Spectrum programs. *The Sound Synthesiser* will make any sound you want to design: explosions, laser blasts, trains, birds etc. It's based on the popular G1-AY-3-8912 chip, and is supplied with a demo program.

Finally, the *Joystick Port* enables you to use any low-priced Atari/Commodore joysticks with your programs.

The Fuller Box fits neatly on to the back of your ZX Spectrum, and does not interfere with any peripherals, including the new Spectrum microdrives.

PRICE (INC. VAT)

£29.95 + 80p p&p

But the story doesn't end there! The Fuller Box has been designed to perform many other functions, and extra, expanded versions are already available.

The Fuller Orator turns the Spectrum sound effects into speech! It plugs easily into the Fuller Box, and can say anything typed on the keyboard or from your programs, via the ALLOPHONE synthesiser. Complete with Demo cassette:

£39.95 + 80p p&p

Fuller Sound Amplifier Box, including Audio Amplifier (non-expandable) **£6.95 + 80p p&p**

Fuller Orator upgrade kit - to fit inside Fuller Box **£24.95** (postage free, does not include Fuller box)

Fuller 'Master Unit' - including Orator, synthesiser, amplifier and Joystick port in Fuller Box **£54.95 + 80p p&p**

Fuller FD42 System NOW FOR ZX81 or ZX SPECTRUM



This famous, best selling product immediately converts your ZX Computer into a sturdy, attractive and professional unit,

with full size typewriter keyboard. A tough plastic case encloses the keyboard, P.C.B. and power supply. It has 42 keys including all the ZX81/Spectrum graphic characters printed on them. The full travel key switches have gold plated contacts and guaranteed life of 10⁶ operations. IT'S SO EASY TO INSTALL! You simply unscrew the ZX PCB from its case, screw it to the FD case, and plug in the keyboard. No soldering or technical knowledge required.

NOW ALL ONE PRICE! £29.95 (inc. VAT) + £2.50 p&p
16K Expansion. Fits onto back of case or inside using a RAM Adaptor Board. **£9.75 extra.**

Fuller FDS Keyboard for the ZX81 or ZX Spectrum

Our new advanced keyboard has the same, fine specifications as the FD42 system, but with a new, re-designed case, space bar and double-sized shift and enter keys. A must for the discerning ZX81 or Spectrum user.

SPECIAL LOW PRICE £39.95 (inc. VAT) + £2.50 p&p.

Fuller ZX Spectrum Upgrade Pack

16K Spectrum owners - upgrade to 48K with a Fuller Spectrum Upgrade Pack - Complete with full assembly instructions. Model 2 or 3 only. **£34.95** (inc. VAT) p&p **FREE!**

COMPUTER DEALERS!

Contact us for a Special Fuller Introductory Pack. We are looking for dealers throughout the U.K.!

Fuller

MICRO SYSTEMS

Mail to: FULLER MICRO SYSTEMS,
The ZX Centre, Sweeting Street, Liverpool 2.
Telephone: 051-236 6109

Please supply the following items:

ITEM	QUANTITY	PRICE	POSTAGE	TOTAL

I enclose cheque/p.o.

Or, please debit my Access/Barclaycard No. _____

Name _____

Address _____

Please send me further details, I enclose S.A.E.

PCW.383

What can sixteen CP/M* users have in common?



- 17 Z80s running at 4 Megahertz
- 1 Megabyte of 200 Nsec RAM
- 18 Serial Input/Output Ports
- 1 Centronics-type Parallel Port
- 90 Megabyte Shared Cartridge Disks
- 2 Megabyte Shared Floppy Disks
- 4 Shared (Spooled) Printers
- Optional Private Printers
- Running under Standard CP/M 2.2

All in one box!

ACCRON—Multi Processor Series—Microsystem

The ACCRON—Multi Processor Series—microsystem is a breakthrough in low cost high performance multi-user S100 micro computers. Based on the Service/User Processor principle, a single ACCRON—MPS system supports up to 16 users, where each user has its own Z80A, 64KB RAM and an RS 232 I/O Port on a single S100 board. Each User Processor runs under its own dedicated copy of the CP/M operating system. All users share the common resources such as disks, magnetic tapes and system printers. These shared resources are controlled by the Service Processor with its own dedicated Z80A and 64KB RAM running under DPC/OS, a proprietary Distributed Processing Operating System.

Zero CPU Degradation!

Unlike single-CPU timesharing multi-user systems (e.g. MP/M, OASIS, MVT-FAMOS etc.) where system throughput degrades as additional users are added, the ACCRON-MPS system has no CPU degradation at all. Since each user has its own self-contained processor and memory you can now have minicomputer performance at micro computer prices.

It's Expandable

You can start with a single-user floppy disk system and (field) upgrade it to multi-user by simply adding a Service Processor running DPC/OS and more User Processor boards as and when required. Large capacity hard disks, magnetic tapes and more printers may be added at any time without any hardware or software redundancy.

CP/M Compatible

Use of the industry standard CP/M operating system means that a wealth of readily available, reasonably priced, system and application software will run on your ACCRON microsystem without any modification. Upgrade to multi-user, where simultaneous access of shared data files is required, is easily supported by the inclusion of simple file or record locking routines.

User Friendly DPC/OS

The Service Processor and DPC/OS provide an easy to understand and user friendly interface for common access to shared resources such as disks, magnetic tapes, up to four spooled system printers or any other peripheral that may be attached to your system (such as a telex-tape punch). Simple routines handle record and/or file locking and prevent "interleaved" or "fatal embrace" file update sequences. DPC/OS allows for both private and shared disk space. Interprocessor message communications, scheduling and batch-submit facilities are also provided.

Complete Range of Peripherals

NEWTONS Laboratories prides itself in offering you the largest choice of microsystems presently made or distributed in Britain. Three distinctive ranges, based on 5-inch, 8-inch or 14-inch magnetic media, utilizing both sealed (winchester) or removable cartridge disk techniques are supported and available NOW! In addition, the ACCRON offers a full blown, industry standard, 9-track reel-to-reel magnetic tape subsystem. So you can store, retrieve and process vast amounts of data using standard 800 or 1600 BPI magnetic tapes that can also be used to interface with most major mainframe computers.

Maintenance

Any system is only as good as its individual components. The likelihood of downtime is minimised through high quality control and testing standards at our UK manufacturing base. Each individual part goes through a rigorous testing procedure during every stage of assembly, and before shipping and installation, the completed machine will have run continuously for 72 hours or more, at temperatures much higher than the average office. However, like all good things in life, sometime or the other your machine will stop working. Our own nationwide maintenance service can, for a fixed charge provide you with a comprehensive maintenance and 24-hour repair service which includes all parts and labour, and,

since we manufacture ACCRON ourselves here in Britain, there is never a delay over waiting for a replacement part.

Stability

NEWTONS Laboratories has been trading (profitably) for more than 7 years. We supply copies of our accounts on request. The computer division specialises in multi-user micro systems, developed and supported by UK based professionals. Its customers include British Telecom, the DHSS, Local Councils, small businesses and large businesses such as BTR and Plessey. NEWTONS Laboratories is involved in continuous research and development.

Dealers and OEM's, Get The Facts

Fill in this coupon now and send it to: NEWTONS Laboratories, 111-113 Wandsworth High Street, London SW18 4JB. Tel: 01-874 6511 (5-lines). Telex: 21768 (NEWTON G).

Name _____

Address _____

NEWTONS
LABORATORIES

PCW1

*CP/M is a trademark of Digital Research Inc. DPC/OS is a trademark of ACE Inc. ACCRON is a trademark of NEWTONS Laboratories.

100 FREE PROGRAMS

FROM SILICA SHOP — WITH EVERY PURCHASE OF AN

ATARI 400

800



ATARI PRICES REDUCED!

We at Silica Shop are pleased to announce some fantastic reductions in the prices of the Atari 400/800 personal computers. We believe that the Atari at its new price will become the U.K.'s most popular personal computer and have therefore set up the Silica Atari Users Club. This club already has a library of over 500 programs and with your purchase of a 400 or 800 computer we will give you the first 100 free of charge. There are also over 350 professionally written games and utility programs, some are listed below. Complete the reply coupon and we'll send you full details. Alternatively give us a ring on 01-301 1111 or 01-309 1111.

ATARI 400 with 16K	£199
ATARI 400 with 32K	£248
ATARI 800 with 16K	£349

400/800 SOFTWARE & PERIPHERALS

Don't buy a T.V. game! Buy an Atari 400 personal computer and a game cartridge and that's all you'll need. Later on you can buy the Basic Programming cartridge (£35) and try your hand at programming using the easy to learn BASIC language. Or if you are interested in business applications, you can buy the Atari 800 + Disk Drive + Printer together with a selection of business packages.

Silica Shop have put together a full catalogue and price list giving details of all the peripherals as well as the extensive range of software that is now available for the Atari 400/800. The Atari is now one of the best supported personal computers. Send NOW for Silica Shop's catalogue and price list as well as details on our users club.

THE FOLLOWING IS JUST A SMALL SELECTION FROM THE RANGE OF ITEMS AVAILABLE:

ACCESSORIES Cables Cassettes Diskettes Joysticks La Stick - Joystick Misc Supplies Paddles	Mountain Shoot Rearguard Star Flite Sunday Golf	BUSINESS Calculator Database Management Decision Maker Graph-It Invoicing Librarian Mort & Loan Anal Nominal Ledger Payroll Personal Finl Mgmt Purchase Ledger Sales Ledger Statistics 1 Stock Control Teletink 1	DYNACOMP Alpha Fighter Chompelo Crystals Forest Fire Intruder Alert Monarch Moonprobe Moving Maze Nominoes Jigsaw Rings of The Emp Space Tilt Space Trap Stud Poker Triple Blockade	Maths-Tac-Toe Metric & Prob Solv Mugwump Music Terms/Notatn Musical Computer My First Alphabet Number Blast Polycalc Presidents Of U.S. Quiz Master Starware Stereo 3D Graphics Three R Math Sys Video Math Flash Wordmaker	Scram States & Capitals Touch Typing	Castle Centurion Checker King Chinese Puzzle Codecracker Comedy Diskette Dice Poker Dog Daze Domination Downhill Eastern Front Galahad & Holy Gr Graphics/Sound Jax-O Jukebox Lookahead Memory Match Minotaur Outlaw/Howitz Preschool Games Pro Bowling Pushover Rabbotz Reversi II Salmon Run 747 Landing Simul Seven Card Stud	Sleazy Adventure Solitaire Space Chase Space Trek Sultans Palace Tacti Trek Terry Wizards Gold Wizards Revenge	Jawbreaker Mission Asterold Mouskattack Threshold Ulysses/Golden Fl Wizard & Princess Wizard's Revenge	PROGRAMMING AIDS from Atari Assembler Editor Dsembler (APX) Microsoft Basic Pascal (APX) Pilot (Consumer) Pilot (Educator) Programming Kit
ADVENTURE INT Scott Adams Adv No 1 Adventure/Ind No 2 Pirate Adv No 3 Mission Imp No 4 Voodoo Cast No 5 The Count No 6 Strange Ody No 7 Mystery Fun No 8 Pyramid of D No 9 Ghost Town No 10 Sav Island 1 No 11 Sav Island 2 No 12 Golden Voy Angle Worms Deflections Galactic Empire Galactic Trader Lunar Lander	AUTOMATED SIMULATIONS Crush Crumble Cmp Datesions of Ryn Dragons Eye Invasion Orion Rescue at Rigel Ricochet Star Warrior Temple of Apshei Upper Reaches Aps	BOOKS Basic Ref Manual Compute Atari DOS Compute Bk Atari Compute Magazine De Re Atari DOS Utilities List DOS2 Manual Misc Atari Books Op System Listing Wiley Manual	EDUCATION from APX Algicalc Atlas of Canada Cubbyholes Elementary Biology Frogmaster Hickory Dickory Inst Cogpzy Dem Lemonade Letterman Mapware	EDUCATION from ATARI Conv French Conv German Conv Italian Conv Spanish Energy Czar European C & Caps Hangman Invit To Prog 1/2/3 Kingdom Music Composer	ENTERTAINMENT from APX Alien Egg Anthill Atlantek Avastance Babel Blackjack Casino Block Buster Block 'Em Bumper Pool	ENTERTAINMENT from ATARI Asteroids Basketball Blackjack Centipede Chess Entertainment Kit Missile Command Pac Man Space Invaders Star Raiders Super Breakout Video Easel	ENTERTAINMENT from ATARI Program Recorder RS232 Interface Thermal Printer 16K Memory RAM 32K Memory RAM Chess Entertainment Kit Missile Command Pac Man Space Invaders Star Raiders Super Breakout Video Easel	PERIPHERALS Centronics Printers Disk Drive Epson Printers Program Recorder RS232 Interface Thermal Printer 16K Memory RAM 32K Memory RAM	SANTA CRUZ Basics of Animation Bobs Business Display Lists Graphics Machine Kids 1 & 2 Horizontal Scrolling Master Memory Map Mini Word Processor Page Flipping Player Missile Gr Player Piano Sounds Vertical Scrolling
		CRYSTALWARE Beneath The Pyram Fantasyland 2041 Galactic Quest House Of Usher Sands Of Mars Waterloo World War III				ON LINE SYSTEMS Crossfire Frogger	PERSONAL INT from APX Adv Music System Banner Generator Blackjack Tutor Going To The Dogs Keyboard Organ Morse Code Tutor Personal Fitness Prg Player Piano Sketchpad	SILICA CLUB Over 500 programs write for details	

FOR FREE BROCHURES - TEL: 01-301 1111

For free brochures and reviews on our range of electronic products, please telephone 01-301 1111. To order by telephone, just quote your name, address, credit card number, and order requirements and leave the rest to us. Post and packing is FREE OF CHARGE in the UK. Express 74 hour delivery available at an additional charge.

- **SHOP DEMONSTRATION FACILITIES** — we provide full facilities at our shop in Sidcup, Monday to Saturday 9am to 5.30pm (closing Thursday 1pm Friday 8pm)
- **MAIL ORDER** — we are a specialist mail order company and are able to supply goods direct to your door
- **MONEY BACK UNDER TAKING** — if you are totally unsatisfied with your purchase, you may return it to us within 15 days. On receipt of the goods in satisfactory condition we will give you a full refund.
- **PART EXCHANGE SECOND HAND MACHINES** — we offer a part exchange scheme to trade in many makes of TV, game for personal computers.
- **COMPETITIVE PRICES** — our prices, offers and service are very competitive. We are never knowingly undersold, and will normally match any lower price quoted by our competitors.
- **HELPFUL ADVICE** — available on the suitability of various computers
- **AFTER SALES SERVICE** — available on all computers out of guarantee
- **VAT** — all prices quoted above include VAT at 15%
- **CREDIT FACILITIES** — we offer credit over 12, 24 or 36 months, please ask for details

SILICA SHOP LIMITED
Dept PCW 0383, 1-4 The Mews, Hatherley Road, Sidcup, Kent DA14 4DX.
Telephone 01-301 1111 or 01-309 1111.



FREE LITERATURE

I am interested in purchasing an Atari 400/800 computer and would like to receive copies of your brochures and test reports as well as your price list covering all of the available Hardware and Software:

Name

Address

Postcode

PCW 0383

SOLO SOFTWARE

for the SHARP
MZ-80K
and
MZ-80A
from £4.95 each

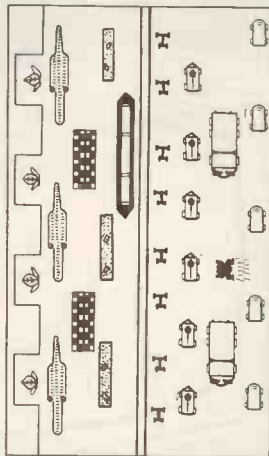

Frogger



Mountain Rescue

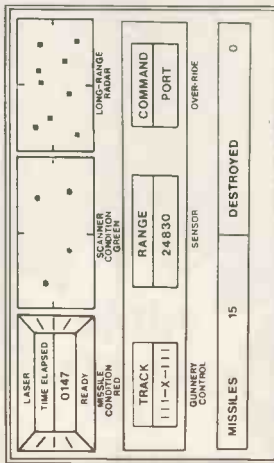

Fighter Command



TOMBS OF KARNAK

PLUS MANY MORE

Send for our catalogue NOW

SOLO SOFTWARE

192 Malvern Road, St. John's
Worcester WR2 4LL

Telephone (0905) 424152

All prices include postage and packing



PRINTER BONANZA!

EPSON

PRINTERS AT UNBEATABLE PRICES



Total Price
MX 80 FTIII £299 +£44.85 VAT **£343.85**
MX82 FTIII Product discontinued by EPSON
MX100 FTIII £399 +£59.85 VAT **£458.85**

Interfaces to any machine supplied - please ask for price.



All printers carry a 1 Year Guarantee and come with paper. Shipment is by TNT Overnight Express to your door - Please add £7 + VAT carriage.

Payment by Cheque, Access, Visa etc.
All prices Apply to 31st March 1983.

Shipments throughout UK. We can export to most countries in the world.

Please phone for Access or Visa buying details.

STOP FLASH: N.E.C. 8023 £307.00 + VAT

Micro-Spares

We cannot and will not be beaten on Price!

Note our change of address
104-106 Hanover Street, Edinburgh EH2 1DR
031-226 3345

IMMEDIATE
DELIVERY.



ASK ABOUT
THE SPECIAL
FREE SOFTWARE OFFER.

FULL DETAILS AVAILABLE FROM

Tomorrow Micro Systems
2 Bridge Street
Hadleigh
Ipswich
Tel No: 0473-823698

SUFFOLK

AT THESE PRICES YOU CAN SWITCH OVER TO A PROFESSIONAL VIDEO MONITOR

The Kaga range of monitors is designed specifically for use with micro-computers, offering flicker-free character and graphic displays. There is a Kaga monitor suitable for use with your system, be it an Apple, Commodore, BBC Acorn, Osborne, Tandy, NEC, Sharp or any other popular micro.

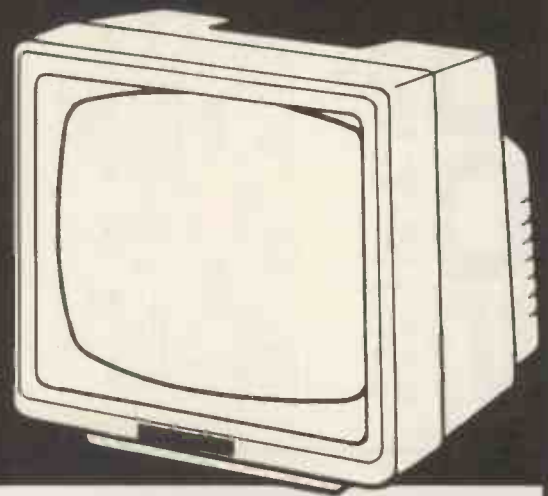

PHONE FOR LATEST LOW PRICES

- High-res. 12" B/W inc. Cable £86
- High-res. 12" Green inc. Cable £96
- High-res. 12" Amber inc. Cable £102
- 12" RGB Colour Monitor (med. res.) £225
- 12" RGB Colour Monitor (high res.) £276
- Apple II or IIe RGB Card + Cable £75
- RGB Cable for Apple III £8
- RGB Cable for IBM P/C £8
- RGB Cable for BBC £8

PRINTERS

EPSON PRINTERS		£
MX82	345	
MX80 Type III	296	
MX80FT Type III	330	
RS232 Interface	30	
RS232 Interface with 2K Buffer	53	
MX100 Type III	420	
Serial Interface Type III	60	
IEEE - 488 Parallel Interface	37	
Apple Interface (Non-Graphics) + Cable	49	
Apple Interface (Graphics) + Cable	57	
TRS80 Interface	22	
Ribbon for MX80/82 Series	5	
Ribbon for MX100 Series	9	
CENTRONICS PRINTERS		
737 - 2 Parallel	299	
150 - 2 Parallel	430	
150 - 4 Serial	553	
152 - 2 Parallel	495	
152 - 4 Serial	558	
1 Cartridge Ribbon for 150/152	4	
1 Zippack Ribbon for 737/739	3	
ANADIX PRINTERS		
DP9000A Serial/Parallel (Graphics)	945	
DP9001 Serial/Parallel	1000	
DP9001A Serial/Parallel (Graphics)	945	
DP9500L Serial/Parallel	948	
DP9500 Serial/Parallel (Graphics)	1024	
DP9500A Serial/Parallel (Graphics)	1006	
DP9501 Serial/Parallel (Graphics)	1076	
DP9501A Serial/Parallel (Graphics)	1006	
DP9620A Serial/Parallel (Graphics)	1093	
Ribbon for DP9000/9500 Series	11	
Apple II Graphics Interface Card	120	

APPLE INTERFACE CARDS AND ACCESSORIES

MC 8-Slot Expansion Chassis	361
Clock Calendar Card	149
Supertalker - for talking programs	151
ROM - Plus Board	84
RAMplus	99
ROMwriter	96
Copyplus ROM	33
Ramex 128K	245
Ramex 16K	64

WALTERS PRINTER - BRITISH MADE

120 - Parallel	377
I.D.S. PRISM PRINTERS	
Prism 80 Full Option inc. Colour	1334
Prism 80 - Graphics/Sprint/Auto Sheet Feed	1092
Prism 80 - Graphics/Sprint	999
Prism 132 Full Option inc. Colour	1514
Prism 132 - Graphics/Sprint/Auto Sheet Feed	1270
Prism 132 - Graphics/Sprint	1043
Black Ribbon for Prism	11
4 Colour Process Ribbon for Prism	22
4 Colour Primary Ribbon for Prism	22

INTEGREX COLOUR PRINTERS

CX80 Colour - Parallel	707
Apple II Interface Card	88
CX80 Colour - RS232 Serial	767
CX80 Colour - IEEE	755
CX80 Colour - RS232 3.7K Buffer	830

SMITH CORONA DAISY WHEEL PRINTERS

TP1 Daisy Wheel - Parallel	430
TP1 Daisy Wheel - Serial	430
IEEE Interface Box for TP1	67

PRINTER INTERFACE CARDS FOR APPLE II

CCS Serial Printer Card	100
CPS Multifunction Card	108
CPS Printer Cable (Please Specify)	10

MONITORS

KAGA VIDEO MONITORS		£
High - res. 12" B/W Inc. Cable	86	
High - res. 12" Green Inc. Cable	96	
High - res. 12" Amber Inc. Cable	102	
12" RGB Colour Monitor (med. res.)	225	
12" RGB Colour Monitor (high res.)	276	
Apple II or IIe RGB Card + Cable (Pls. specify)	75	
RGB Cable for Apple III	8	
RGB Cable for IBM P/C	8	
RGB Cable for BBC	8	

APPLEFAN & ACCESSORIES

Applefan Standard Unit	58
Cassette Connector Set	4
Disc Drive Connector Set	14
Eurocolour TV Output	4
Games Connector Set	9
Monitor 40/80 Char. Display Switch	9
Mains Output Set	7
Printer Connector Set	14
Graphics Tablet Connector	13

DEMONSTRATION/TRANSIT CASE

For Apple + 2 Disc Drives	49
---------------------------	----

Terms of business: Cash/cheque/P.O.S. with order.

P & P: Interface cards and ribbons - per unit £1

Printers, monitors, and cases - per unit £6

VAT: All prices are exclusive of VAT. Please add 15% to the total cost including P & P.

Goods damaged in transit will be replaced FOC.

Please send me the following goods:

Total (inc. P&P) _____ 15% VAT _____

I enclose cash/cheques/P.O.S. for sum of _____

Name _____

Address _____

PCW 3/83

AIMGRAM

AIMGRAM LTD 31 Roman Gardens,
Kings Langley, Herts WD4 8LG Tel: Kings Langley

(09277) 68211

COMPUTER BOOKS

PHONE BEFORE YOU BUY ELSEWHERE
01-441-4130

Over 1200 Titles

We have concluded agreements with some major book suppliers around the world that allow us to offer immediately the biggest computer book list in Europe. We have a 200-page, cross referenced, catalogue with editorial on hundreds of titles that will give you a bookshop of your own. This catalogue costs £1.00. We know our prices are better than elsewhere and we can still offer a monthly service of new books to those on our mailing list. We are equally willing to talk to computer shops where our range and customer use of our catalogue will allow them to offer a much greater service to their customers.

JUST COMPARE THESE PRICES

This cross section was selected to cover hardware, software, programming techniques, etc. and the more complex as well as popular titles.

S 100 Bus Handbook	10.40	6502 Software Design	8.60
Apple II Users Guide	11.25	6502 Instruction Handbook	3.25
Atari BASIC	5.55	6502 Assembly Language	
Atari Assembler	8.60	Programming	11.30
A Young Persons Guide to Computers	5.25	6809 Assembly Language	
How to Computerise Your Small Business	5.25	Programming	11.30
6809 Microcomputer Programming and Interfacing	9.90	8080A/85 Assembly Language	10.70
68000 Principles and Programming	10.90	Programming	5.95
Osbourne 16 Bit Micro Handbook	13.30	Z 80 Assembly Language	
Princ. of Firmware Engineering in Microprogram Control	15.95	Programming	11.30
The S 100 and other Micro Buses	6.60	Programming the Z80	10.55
Microcomputers for Engineers and Scientists	19.85	Z 8000 Assembly Language	
BASIC Business Software Assemblers, Compilers and Program Translation	7.95	Programming	13.20
High Level COBOL Programming	16.60	Programming the Z 8000	10.55
Software Psychology: Human Factors in Computer and Information Systems	16.60	68000 Assembly Language	10.55
Effective Data Base Design	18.70	Programming	8.75
CP/M Handbook	9.95	Microsoft BASIC	8.60
Using the UNIX System	12.55	ANS COBOL 2nd Edition	
How to Get Started With CP/M	8.50	COBOL for Students: A Programming Primer	10.55
Beginners Manual for the UCSD PASCAL System	7.95	Structured COBOL	5.95
Programming the 6502	9.30	Introduction to PASCAL	10.55
		Introduction to Programming and Problem Solving with PASCAL	13.95
		Invitation to FORTH	11.65
		The Micro Millennium	7.30
		Business System Buyers Guide	6.60
		Computer Dictionary	10.55
		Computer Dictionary	3.95
		Build Your Own Working Robot	4.55
		Experiments in Artificial Intelligence for Small Computers	5.95

DR. WATSON

Computer Learning Series



BOOK AND TAPE LEARNING COURSE

This expanding series of books on computer languages is carefully graded to suit different abilities and written specifically for the new micros. The whole series is presented in a consistent style and every book is accompanied by a cassette (or disc) containing all the major programs developed in the book for hands on learning while reading.

BASIC - SPECTRUM or DRAGON or BBC
The books starts assuming absolutely no knowledge and the chapters are in sections that allows those with some knowledge to progress faster. The games that you write, the music programs and the Adventure game that you eventually structure and expand are all covered on the tape.

ASSEMBLY LANGUAGE — PET 2,3,4, & 8000, VIC 20, SPECTRUM, BBC.
This course again assumes absolutely no knowledge. Using the assembler that is supplied on the cassette, and is utilised in all the demonstration routines, you will learn much more about the computer as well as the programming. The cassette, also includes a tutor to show you how the noughts and ones of binary and the Es and Fs of Hex work.

The series is professionally written and the books are between 200 and 300 pages. They include all the necessary tables and diagrams and are crammed full of examples, programs and exercises.

IF YOU ARE STARTING, STUCK
OR SIMPLY PROGRESSING
THEN THIS BOOK IS FOR YOU.

BOOK AND SOFTWARE

£14.95
INC VAT & POST

PROFESSIONAL SOFTWARE FOR THE

VIC 20

RESEARCH ASSISTANT

It takes a competent programmer to write the program to create and control the necessary data files that will let you recall specific data at will. Here are three programs that will allow you to compile information from books, periodicals, accounts, dates in fact any data you wish to keep, to organise it and, most important of all, to create cross reference lists by keyword to help you locate the right reference when you need it.

£16.95

PAYROLL ^{NEW}

- Up to 25 employees
- Employee files including tax code, N.I., week number, pay rate, plus 20 other options
- Weekly input in hours of standard and overtime (various)
- Up to 4 adjustments
- Full wage slip display and print out (if printer available)
- Hard copy of employees files for records
- Mods to files at any time
- Cash analysis for bank
- Automatic analysis of hours worked and wages
- Automatic analysis of cumulative and weekly value of PAYE and N.I.
- Upgrade program tapes at minimal charge if tax or N.I. alter
- A payroll for around 20 people including printout of payslips and file copies will take between 20 and 30 minutes dependant on complexity of input and skill of operator
- New payroll tape dumped to both sides of tape and old tapes can be stored weekly if required.

NEEDS 16K EXPANSION

£19.95

TOTL TEXT

SIMPLY THE BEST: Page numbering • Right and left margins • Skip to top of page • Centered title lines • Character and line spacing • Graphics characters • Full cursor control in editing • Add, change, delete characters • Specify printer device number • Print mailing labels • Paragraph control • VIC 1515 expanded characters • Single, double, triple spacing • Tab position control • Upper and/or lower case • Full screen editing • Scroll up and down through text • Insert, delete blocks of text • Multiple copies of document

Up to 4 heading lines per page • Footing line at bottom of page • Up to six 80 column lines may be entered and printed within the body of a document • Footnotes • Keyboard inputs

£16.95

HONEYFOLD

Honeyfold Software Limited
Standfast House, Bath Place,
High Street, Barnet, London.

THE LAST ONE
(c) Copyright D.J.'AI' Systems Ltd

<DISKBOX> FLOWCHART CREATION

LIST FLOWCHART.....<1>	SPECIAL FUNCTIONS.....<10>
MODIFY FLOWCHART.....<2>	CLEAR DATA.....<11>
CODE THE PROGRAM.....<3>	SET FILE POINTERS.....<12>
MERGE TWO FLOWCHARTS...<4>	READ FROM FILE.....<14>
ABORT FLOWCHARTING.....<5>	WRITE TO FILE.....<15>
INPUT FROM KEYBOARD....<6>	SEARCH OR SORT A FILE..<16>
DISPLAY DATA.....<7>	EQUATE FILE FIELDS.....<17>
BRANCHES.....<8>	CHECK/AMEND A RECORD...<18>
CALCULATIONS.....<9>	DELETE A FILE.....<19>

COMMAND REQUIRED

Program coding is now as easy as 1,2,3...

It's not writing programs that takes the time, it's coding them – every comma, bracket and filename has to be exactly right, just one of those obscure symbols adrift is enough to crash the biggest, toughest program in town!

How much easier it would be to say "Search that file" and "Display Fred's record" instead of having to write a dozen or more lines of faultless BASIC whenever you want to find something. Well, now you can.

The menu shown above is one of the central screen displays in THE LAST ONE. By combining any of the options shown it is possible to create simple or complex programs with no more than a few, carefully selected, keystrokes. THE LAST ONE does the rest, only asking you to answer its questions from time to time so that it can be sure that the program it is writing does exactly what you want. And all this in (more or less) plain English.

Now you can design, write, amend (and sell!) perfect, customised programs without ever typing a line of code. A godsend for the business micro user, a phenomenally powerful tool for the professional programmer, a delight to all; THE LAST ONE allows anyone to write computer programs.

Finished programs can handle up to 15 files simultaneously (9 on the Commodore machines), they can include *any* feature found

in *any* application program you've ever seen, and they run first time – every time. Following a year of extensive field trials, THE LAST ONE has grown from a simple (though advanced) program generator into the one of the most powerful micro tools available. It is in use in thousands of installations around the world including banks, airlines and scientific and educational establishments as well as being available on countless small business machines.

THE LAST ONE runs on the APPLE II, the COMMODORE 4032 and 8032/96, the TRS-80 Model II (TRSDOS or CP/M), most CP/M, CPM-86 and MS-DOS machines including the IBM PC and the SIRIUS.

Whatever you use your computer for, you owe it to yourself to find out what THE LAST ONE can do for you – to see it in action. To order or to find out more, write to:

D.J.'AI' Systems Ltd, Station Road, Ilminster,
Somerset, TA19 9BQ

Telephone: Ilminster (04605) 4117

THE LAST ONE[™]

Nominated 'SOFTWARE PRODUCT OF THE YEAR 1982', and selected as finalist in Recognition of Information Technology Achievement Awards (RITA).

from small systems.....

PET HARD DISKS HARDBOX/CORVUS

The Small Systems HARDBOX acts as an intelligent controller for up to 4 Corvus Winchester drives.

- PET DOS 1 and 2 compatibility
- Multi user capability on Corvus Drives
- 16 Megabyte max file size
- 65535 max records per relative file
- Over 2000 files on 5 MB drive

Price £495

MINI-WINI

The MW-1000 Mini-Winchester is a compact desk-top unit that just plugs into the PET - gives you up to 12 Mb of hard disk storage under CP/M or PET DOS or both!!

At the flick of a switch, this amazing unit allows you to have:-

- The whole disk under CP/M (plus 60K of RAM and Z80)
- The whole disk under PET DOS
- Half of the disk under PET DOS and half under CP/M!!

No changes to the PET or ROMS are required - just plug in and go.

3Mb £2538
6Mb £2837
12Mb £3360

Prices include CP/M Utilities, 60K RAM and Z80.

PET CP/M

SOFTBOX and CP/M SOFTWARE

SOFTBOX allows the PET to run the worlds most popular operating system for micros. Operates with PET floppies and/or a Hard disk system.

Comprehensive range of CP/M software available - ask for our Catalogue.

Softbox (with RS232 + Hard disk interfaces as standard) £495

IEEE-488

IEEE-488 SERIAL INTERFACE £120
TYPE C100

IEEE-488 SERIAL INTERFACE £186
TYPE B300

IEEE-488 ADDRESSABLE PARALLEL INTERFACE £106
TYPE A100
40 char input buffer

TYPE G.P.I. AP MICROPROCESSOR BASED £275
IEEE-488 BI DIRECTIONAL INTERFACE

1K input buffer standard 59K max. £46

TV/VIDEO MONITOR INTERFACES £17.50
RS 232C TO 20mA CURRENT LOOP

ADAPTER £240

PETSPEED

Optimising Basic Compiler

DEVELOPMENT TOOLS

8048 family in circuit emulator £550
8748 programmer £395

Range of cross assemblers for most popular micros. £95

small systems engineering limited

2-4 Canfield Place, London NW6 3BT. Telephone: 328 7145 Telex 264538

DISKS DISKS DISKS

*** LOWEST PRICES - FAST DELIVERY ***

PRICE PROMISE

We will match any other lower price advertised in the current issue of PCW for single boxes in stock

5.25" DISKS - BOXES OF 10

VERBATIM

	Price per Box (£)		
	1-4	5-9	10+
MD525 S-Side/S or D-Den/S-Sec (40TR)	17.25	16.60	15.80
MD550 D-Side/S or D-Den/S-Sec (40 TR)	25.25	24.50	23.75
MD577 S-Side/D or Q-Den/S-Sec (77/80 TR)	25.00	24.10	23.20
MD557 D-Side/D or Q-Den/S-Sec (77/80 TR)	34.30	33.30	32.30

* 10 and 16 Sectors at above prices * Add £1.35 for Plastic Box

MEMOREX

3401 S-Side/S Den/S-Sec	15.00	14.50	14.00
3421 D-Side/D Den/S-Sec	20.00	19.50	19.25

BASF

1X S-Side/S Den/S-Sec	15.00	14.60	14.00
1D S-Side/D Den/S-Sec	19.00	18.50	18.00
2D D-Side/D Den/S-Sec	24.50	22.90	21.80
Head cleaning kit with fluid	16.30		
Library case	2.10		

8" DISKS - BOXES OF 10

VERBATIM

FD34-1500 S-Side/S Den	20.50	19.75	19.00
FD34-9000 S-Side/S Den 26 Sect	26.50	25.00	23.00
FD34-8000 S-Side/S Den Unitial	27.00	25.50	24.50
FD10-4008 D-Side/D Den 8 Sect	32.00	30.00	29.00
DD34-4001 D2TM D-Side/D Den	31.00	28.50	27.00

* Other types available on request

POSTAGE/PACKING (UK)

5.25" Disks/Cleaning Kit £1/Box (75p/Box 10+)

8" Disks £1.30/Box (85p/Box 10+)

Library Case 50p/Box (35p/Box 10+)

* Add 30p per box for 1st Class Delivery

Total Exc. VAT

VAT 15%

Total Payable

Please contact us for Quantity Discounts (10+ Boxes) and Trade Accounts. Official Orders welcomed.

Name Tel: No.

Address

Access/Barclaycard/Cheque No.

If you do not wish to cut out form send order separately

34 Cannonbury Avenue, Pinner, Middx HA5 1TS

Telephone orders any time - we do the rest - 01-868 9548



Pinner Wordpro



FULL DETAILS AVAILABLE FROM

Bourne Computer Centre

70 North Street

Bourne

Tel No: 07782-4566

LINCOLNSHIRE

FOR BBC MICRO

FORTH ROM £34.72

Includes fitting instructions, manual for BBC version
Full manual (not necessary if already conversant
with Forth) £6.75
Colour Monitor/TV (switchable) £226.00

ACOUSTIC COUPLER £49.72

Send programs and data over your telephone –
works via the cassette interface.
Add VAT to the above (not for manual) – carriage free
in UK.

Coming soon!

Fast cos
Modem
Prom Blower
Computer aided learning package

Also: Sales & Service on the following:

Acorn, BBC, Commodore, Apple,
Dragon, Epson HX20, SWTPC, Epson,
Seiksha, Smith Corona (Daisy Wheel)

Supply:

Chips, paper, tapes, disks, cables,
connectors

H.C.C.S. Associates

533 Durham Road, Low Fell
Gateshead, Tyne & Wear NE9 5EY
Tel: (0632) 821924

Exclusive!

THE BEST VALUE WORDPROCESSOR
PACKAGE IN THE UK!

80
COLUMN CARDS
NOW AVAILABLE!

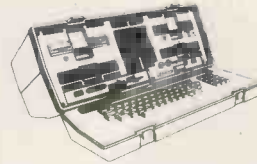

Ø1 Computers have made a bulk purchase of letter quality
printers and are offering the remaining 25 in the following
unbeatable package:

- A new style, double density, Osborne Computer,
software package of Wordstar/Mailmerge, Supercalc, CP/M,
C Basic and M Basic.
- A robust letter quality, 20 C.P.S., Bi Directional,
14" carriage, printer (originally retailing for over £1000).
- PLUS! dBase II, the Ashton Tate Data Base Management
System (until January 30th).

TOTAL PACKAGE PRICE ONLY £1595 + V.A.T.

Please note there are only 25 of the above systems and therefore
this offer cannot be repeated.

Fully comprehensive on site maintenance contracts
available on the above equipment.

REMEMBER: We are the Osborne specialists. We specialise
you benefit.

TELEPHONE: Ø1 Computers on 01-228-2207

Southampton House, 192/206 York Road,
Battersea, London SW11 3SA.

The Race Goes On . . .

For better prices, for better service, for that personal touch

★

OSBORNE I + DD Disk Drives + All the standard software (Wordstar, Mailmerge, D Base II, Supercalc, M Basic, C Basic etc). With the superb new Silver Reed EX44 for letter quality output. All at £1550

★

IBM PC's at unbelievable prices! Any make of computer supplied . . . Word processors . . . minis . . . micros . . . home computers

★

FREE Consultancy service for end users. We visit you. Our policy is to supply the most suitable micro/mini/mainframe for your needs. Experienced programmers are available for your software and engineers/designers for your hardware.

★

Silver Reed EX 44 portable typewriter with serial interface, 2000 character buffer, selectable baud rates from 50 to 9600 baud, External 6000 character memory option with true decimal tab, all the features you'd expect from the latest in electronic self correcting typewriter technology, and space-age looks – silver/grey with tinted transparent cover. All for an unbelievable £450 !!! (Or if you really want we can sell you an Olivetti Praxis with no buffer, same print speed and no external options for £475).

DEALER ENQUIRIES WELCOME

SHADOW DATA – 189 Hanworth Road, Hounslow Middx TW3 3TT
Telephone: 01-572 7279 or 01-560 2784

ZX81



High Resolution Graphics

£32

- * Stylish case fits neatly between ZX81 and Ram pack of 8K or more.
- * 256 x 192 pixels.
- * Hi res display file independent of old display file.
- * Very fast and powerful graphics commands as extensions of Sinclair basic: SLOW / FAST CLS COPY PRINT PLOT all extended to hi res.
- * 114 PLOT modes including:
 - Points and various line types
 - Textured triangle fill
 - Absolute and relative co-ordinates
 - Line drawing to points off screen
- * Mixed text and graphics including PRINT at graphics cursor.
- * User defined graphics for space invaders etc
- * Screen COPY to printer
- * Extensive manual, excellent for school and home use, and full guarantee.
- * Arcade games available soon!

Post to:- Notting Dale Technology Centre (Ltd)
T.F.L. (ZX 81)
189 Freston Road
London W10 6TH (01-969 8942)

Please send me board(s) @ £32.00 each
+ £4.80 VAT plus 75p P&P

I enclose Cheque/P.O. for
Or I wish to pay by Access/barclay Card/Visa.

Card Number

Name and Address (PRINT)

Name

Address

Credit card holder's signature.

SINCLAIR OWNERS READ THIS FROM



You've probably heard about MACHINE CODED PROGRAMS and thought "so what! How can they help me?"

Well now you can find out and taste the very real difference by purchasing our latest MACHINE CODED application program. This emulates features of the most modern professional computers (12 years writing machine coded programs for IBM, ICL, UNIVAC and Sinclair means we know what we're talking about).

Just read the specification and you'll see what we mean.

ADDRESS MANAGER.....

Works on the 16K and 48K Spectrum, in 48K it will store, file, select and retrieve over 400 full addresses (over 1500 individual names); Dynamic Memory Management and compression techniques makes all this possible and there's a lot more:

- **FULL SCREEN INPUT and EDITING** — see it as a page as it happens with insert, delete and TAB Commands.
- **MULTIPLE INDEXING** — 3 way user-defined index enables you to define, catalogue, select and print entries as needed. (essential for the more sophisticated applications.)
- **INSTANT RESPONSE** — yes, this program is very very fast.
- **SUPER FRIENDLY** — crash-proof, extremely easy to use and efficient in a way that BASIC can never be.

MANY USES

- **AT HOME** — (storing addresses, printing out Xmas Card lists etc.)
- **AT WORK** — for mail-order work, internal telephone directory, sorting customers into types, areas, size . . . you choose.
- **CLUBS** — print-out members list, sort different categories etc.

This program contains over 3000 MACHINE CODE instructions, yet uses little valuable memory space . . . a very powerful recommendation.

OR IF YOU WANT TO WRITE YOUR OWN MACHINE CODE PROGRAM

MACHINE CODE TEST TOOL

The ultimate professional tutor and de-bug program, we wrote this to help us write our own programs.

- **TEST** and display machine code instructions as they're written.
- **IDEAL** for both the novice and the expert.
- **FULLY** documented with a 32 page tutorial
- **HEX:DECIMAL** conversion as standard.
- **CHARACTER GENERATOR** — of unbelievable quality!!! supplied free with the Spectrum version.

Available for the 16K ZX81 and 16/48K Spectrum. If you're looking to write machine code this is THE program, we know we use it ourselves.

MACHINE CODE..IT MAKES ALL THE DIFFERENCE.....

Post order to: Oxford Computer Publishing Ltd., P.O. Box 99, Oxford.

Please rush me: ADDRESS MANAGER at £8.95 each. Spectrum only.

MACHINE CODE TEST TOOL at £9.95 each.

Tick box for edition required: ZX81 Spectrum

Send cheque, postal order or ACCESS No. to above address. Or telephone order with ACCESS No. to (0735) 888866 (Ansaphone available)

NAME:

ADDRESS:

POSTCODE:



ACCESS Card No.:



You'll be glad you chose a personal computer with power enough to grow with your needs.



The ICL Personal Computer with power to grow as you need it.

Choosing the wrong personal computer can work out very costly, because though they grow to meet your needs, they just don't grow enough.

The new ICL Personal Computer gives you more.

It's a versatile, professional personal computer. It can start with a single Visual Display Unit, naturally, and it has a wide range of functions to meet your increasing requirements. And it can grow larger than most other personal computer systems, because its capacity for additional hardware is greater.

Starting at £2,895 with one VDU

The ICL Personal Computer provides a range of options enabling you to

have a system tailored to meet your changing needs.

For example, by adding a fixed-disc, you can have eight times the original storage capacity, and support up to 4 VDUs. And there is an extensive range of Personal Computer hardware.

Wide range of integrated accounts and other application software available, providing limitless possibilities.

So your secretary can do her word processing, you can do your forecasts, your accountant can do the invoicing, and your programmer can do his own thing, all at the same time.

That's what makes the ICL Personal Computer more than just a personal computer.

And because ICL is Europe's leading computer company, with thousands of satisfied users in over 80 countries worldwide, we can offer ICL Trader Point service and maintenance back-up that's second to none.

What more could you ask for, apart from a demonstration?



Johnson microcomputers

Johnson House · 75-79 Park Street · Camberley · Surrey
Telephone 0276 20446

Robophone Answering 24 hrs. Prestel page No. 200632
Mailbox No. 027620448
48 Gloucester Road · Bristol · Telephone 0272 422061
113 Stratford Road · Shirley · Birmingham B90 3AY
Telephone (021) 745 3246

COPPICE SOFTWARE



Software for: "Apple II programmers from Micro Spark inc"

GALE	– Global Applesoft Line Editor	£27.95
Directory Master	– disc/catalog utility	£20.95
Ampersoft	– increase the power of Applesoft using the ampersand command set. Includes print using, sort, matrix handling and more	£34.95
VIP111	– print out formatted reports of your spreadsheet data	£20.95

All software requires 1 disc drive and 48K RAM with DOS 3.3 (Ampersoft also requires a memory expansion card). Documentation provided with disc. Please add 15% VAT + £1.00 postage and packing.

NIBBLE MAGAZINE

1983 orders for this most useful of magazines for the APPLE user still being taken. 8 issues per year (the first one in March) for £20.80 inclusive.

**Coppice
Software**

7 March Street, Kirton in Lindsey,
Gainsborough, Lincs. DN21 4PH.
(0652-648550)

NAMAL ASSOCIATES

Gatehouse,
25 Gwydir Street,
Cambridge CB1 2LG
Tel: (0223) 355404
Telex: 817445

14" COLOR MONITOR for BUSINESS & PERSONAL COMPUTERS £189.00

Video & audio inputs and 2W
audio output.



B/w monitors
with green display
9" screen—**£79.00**
12" screen—**£85.00**

(carriage £6.00 per monitor).

NAMAL SUPERTALKER

for Sinclair ZX81	£49.95
for Sinclair Spectrum	£69.95
RS232 version for any computer	£89.95

Products for ZX81

Ram Pack 16K	£17.00
Ram Pack 64K	£59.95
24 line I/O port	£17.50

Products for APPLE COMPUTER

Eprom programmer card	£95.00
Real Time clock card	£74.00
PIA card	£29.50
Parallel interface (centronic)	£69.50
RS232 Serial interface card	£49.95

Payments to Namal Associates.
Prices exclude V.A.T.



DEALERS CP/M* SOFTWARE

NOW AVAILABLE
Concurrent CP/M-86
on the IBM
Personal Computer

DIGITAL RESEARCH

Operating Systems

CP/M 2.2 ● CP/M-86 ● CP/M-86 for SBC ●
MP/M II ● MP/M-86 ● CP/M-86 for Displaywriter
CP/NET ● CP/M-86 + CBASIC-86 DV

Languages and Programming Tools

PL/I-80 ● CBASIC ● CBASIC-86 ● CB-80
PASCAL/MT+ ● PASCAL/MT+ with SPP
● RMAC, LINKLIB & XREF
● LINK-80, PLILIB & XREF
BT-80 ● XLT 86 ● SID ● ZSID



Wordstar – Word Processing
Spellstar – Proof Reading
Mailmerge – Merge-Print
Datastar – Data Base
Supersort – Data File Sort
Calcstar – Spreadsheet
Coming shortly: Infostar

Other Products

Byrom BSTAM & BSTMS for communications
EcoSoft MICROSTAT statistics package
(needs MBASIC)
WP Workshop Wordstar training guide
CPFILT, CDOS simulator for CP/M
Avocet cross-assemblers for CP/M
Sapphire MARS Management Accounting
and Report System
Xitan XBASIC – our very own Basic

Most products are supplied on IBM 8", CDOS
5.25", SS/SD, CP/M 5.25", CP 100 and NSDD
formats. A wider range will be available in the
near future, and every effort will be made to
meet your specific format requirements.

Established dealers wishing to become
registered Xitan Software Dealers are invited
to write or phone for full details.

* CP/M is the registered trademark of Digital Research Inc.

Xitan Systems offer an ever-growing range of software products, with attractive discounts and credit terms for registered dealers – backed by prompt and friendly service. Xitan Systems are the systems software house and CP/M distributors of the Comart Group, and have recently signed up as Main UK Distributors for Digital Research Inc.

XITAN Xitan Systems Limited 23 Cumberland Place
Southampton SO1 2BB Telephone 0703 38740

FULLY AND PARTLY INTEGRATED ACCOUNTING SYSTEMS FOR COMMODORE 4032, 8032 or 8096

Full system – a very flexible system with invoices laid out to suit almost any invoice form, sales ledger, purchase ledger, nominal ledger, cash book etc.
£900 + VAT

Purchase ledger, nominal ledger and cash book
£400 + VAT

Sales ledger and invoicing
£680 + VAT

Sales ledger and invoicing with foreign currency facility
£750 + VAT

Write or phone for full details and a demonstration or diskette

Trade enquiries welcome

**ELECTRONIC AIDS
(TEWKESBURY) LTD**

Mythe Crest, The Mythe, Tewkesbury,
Gloucestershire, GL20 6EB
Tel: 0386 831020/0684 294003



FULL DETAILS AVAILABLE FROM

Independent Systems Ltd
21-23 Holloway Chambers
27 Priory Street

Dudley
Tel No: 0384-237538

WEST MIDLANDS

Preventative Medicine

COST EFFECTIVE COMPUTER HEALTH CARE*



WARNING: Unfiltered power can damage your computer's health.

Symptom

Unexplained software errors and apparently intermittent hardware malfunctions.

Diagnosis

The computer system is being subjected to unsuppressed mains borne electrical noise and transients - Dirty Power.

Treatment

Filter the mains power supply by replacing the existing 13 amp plugs with Power Internationals 'THE PLUG', a mains borne noise and transient suppression device incorporated within a modified 13 amp plug case. (Available from Dealers or direct from the manufacturer).

Should this treatment provide only limited relief, you should seek specialist advice from:-

Power International Limited 2A Isambard Brunel Road, Portsmouth, Hampshire. PO1 2DU. Tel: (0705) 756715



* R.R.P. £15.50 including p.p.

Eltec HOME & BUSINESS TECHNOLOGY computers

Probably the widest selection of software available by mail order.

All the top manufacturers including Acorn Soft, IJK (Sinclair), Superior Software, Bug Byte, Program Power, Hessel, Procyon.

HERE IS A SELECTION

Peeko Computer	9.95
Junior Maths Pack	6.84
Philosopher's Quest	9.95
Planetoid	9.95
Meteors	9.95
Arcadians	9.95
Swoop	7.99
Chess Model B	7.99
Space Invaders Model B The best	6.95
Atlantis - Superb fast Action 32K	6.95
Hyperdrive 32K	5.95
Stratobomber	6.95

Send SAE for full list.

HARDWARE EXPANSION

Sound pick-off module (simple to fit)	6.95
Amplifier and loudspeaker suitable for above	37.50
Light pen	34.50
X-Y digitiser	80.00

SUPER ACCESSORIES

Cover Polyester Cotton	3.97
Cover Soft PVC	4.45
Carrying Case for Computer, Cables, Cassette/ Disc Drive	55.20
Carrying Case a soft supported nylon version of above	23.00

BBC models A & B in stock:
A - £299 B - £399

DISK DRIVES FOR BBC

BBC 100K Single drive (Requires discs (a))	265.00
TORCH Z80 800K Disc pack includes Z80 proc'r + 64K (b)	897.00
BBC/LVL 200K Twin Drive (a)	397.00
TEAC 200K Single Drive (a)	304.75
TEAC 400K Twin Drive (a)	569.25
TEAC 400K Single Drive (b)	396.75
TEAC 800K Twin Drive (b)	711.85
Connecting cable for TEAC drives	17.25
(a) SCOTCH Single sided discs Box of 10	28.75
(b) SCOTCH Double sided discs Box of 10	39.80

BBC UPGRADES

Full upgrade kit (fitting £31.00)	69.00
Disc interface (fitting £15.00)	109.25

The above prices are VAT inclusive. Add £1.00 p&p for orders below £100.00 and £10.00 (Securicor delivery) for orders above £100.00.

Access and Barclaycard accepted on all items except BBC computers.

ELTEC COMPUTERS
217 Manningham Lane, Bradford, BD8 7HH.
Tel (0274) 722512.



SINCLAIR COMPUTERS

UK prices are shown first. The bracketed prices are export prices which include insured air-mail postage to all the countries of Europe including Norway, Sweden, Finland and Denmark. For overseas customers outside Europe an extra £5 postage per item is charged. zx81 £43.43 (£52). zx printer £52.13 (£61). zx spectrum 16K £152 (£160). zx spectrum 48K £202 (£210). zx microdrive n/a (n/a). zx rs232c n/a (n/a). 5 printer rolls £10.43 (£16). Ram packs:- 16K £26.04 (£28). 32K £39 (£41). 56K £49 (£51).

DRAGON 32 £173

COMMODORE COMPUTERS

Commodore 64 £299. Vic 20 £130. Kit to allow the use of an ordinary mono cassette recorder with the Vic 20 and the Commodore 64 £6. Commodore cassette recorder for these computers £36.50. Super expander high resolution cartridge £27.95. We stock most accessories.

BBC MICROCOMPUTERS

A Model £260. B Model £347.

GENIE COMPUTERS

New colour Genie £173.50, cassette recorder £25, 16K ram card £33. Light pen £15. Accessories for Genie 1 and Genie 2:- EG3014 32K £189. Disc drives single £199, dual £369. Double density converter £72. High resolution graphics £82. Printer interface £36.

UK101 AND SUPERBOARD

32 x 48 display expansion kits UK101 £9, Series 1 Superboard £14. 32K memory expansion board £60. Cegmon £22.50. Word processor prog £10. Centronics interface kit £10. Cased disc drives with DOS single £275, double £415. Stand alone floppy disc controller £85.

ORIC-1 48K COMPUTER £147.78



PRINTERS

Olivetti Praxis 30 Byewriter: the latest miracle, a combined daisy wheel printer and electric typewriter for only £418. Epson MX80FT3 £324. Epson MX100/3 £425. Oki Microline 80 £199. Oki Microline 82A £333. Oki Microline 83A £446. Oki Microline 84 £656. Oki Microline 92 £429. Oki Microline 93 £586.

5V POWER KITS

Fully stabilized 5V computer and TTL power kits. 1.5A £7.83, 3A £12.17, 6A £20.87.

SHARP COMPUTERS

We can supply Epson MX80 and MX100 printers to run direct from the MZ80K (i/o box not needed) for £39 plus printer price. We also specialize in interfacing printers to the MZ80K, MZ80A and MZ80B both with and without the i/o box.

Postage £1 on Sinclair products (UK), £3.50 on other computers, £4.50 on printers and 50p on other orders. Please add VAT to all prices. Official credit and overseas orders welcome.

SWANLEY ELECTRONICS

Dept PCW, 32 Goldsel Road, Swanley
Kent BR8 8EZ

Tel Swanley (0322) 64851

FOR THE FIRST TIME ANYWHERE IN THE WORLD!

ASTROLOGY ON YOUR SINCLAIR ZX81 (16K) OR SPECTRUM

USER PROMPTING PROGRAMS: merely key in birth information as requested by the computer - READ OUT (and/or PRINT OUT) what is normally the result of many hours of painstakingly tedious and complex mathematical calculations using tables, ephemeris, etc.

Cassette I ZODIAC ONLY £10.00
makes truly AVAILABLE AT YOUR FINGERTIPS
THE SIDEREAL TIME OF BIRTH.

THE ASCENDANT AND MIDHEAVEN in Sign, Degrees, Minutes, and Seconds for EQUAL HOUSE SYSTEM.

THE SIGNS AND POSITIONS OF THE HOUSE CUSPS in Sign, Degree, and Minutes for the PLACIDEAN SYSTEM.

THE SUN AND MOON POSITIONS in Sign, Degree, Minutes, and Seconds.

ALL THE PLANETS POSITIONS in Sign, Degrees, and Minutes. THE LUNA NODE - THE PART OF FORTUNE - THE VERTEX, AND A HOST OF OTHER BIRTHCHART INFORMATION AT THE TOUCH OF A KEY.

Cassette II ZODIAC II ONLY £8.00
GIVES YOU THE ASPECTS AND MIDPOINTS

Cassette III ZODIAC F combine cassettes I and II for ONLY £15.00
SPECTRUM 48K

Other programs in course of preparation include: PROGRESSING THE HOROSCOPE; RECTIFICATION OF THE BIRTH TIME, etc.

STELLAR SERVICES

8 FIR TREE VALE, LEEDS LS17 7EY
Tel: (0532) 692770

TECHNEG CLWYD TECHNICS LTD



SPECIAL OFFER

FOR FEBRUARY & MARCH ONLY

Epson MX82 F-T III	£350 Carr. £5
BBC Micro Model 'A'	£261.30 Carr. £3
BBC Micro Model 'B'	£348.26 Carr. £3
BBC 16K RAM Upgrade	£25 + p&p £1
BBC Printer interface	£10 + p&p £1
Acorn System 3 with 32K Memory	£1,400 Carr. £10
Zenith Z100 16 bit System	from £2,072 Carr. £12

ALL PRICES EXCLUDE VAT

We are the Acorn Econet specialist.
Let us quote you for your system.
Education discounts available

Coach House, Kelsterton Road, Flint
Clwyd
Tel: DEESIDE 810518



ASK ABOUT THE SPECIAL FREE SOFTWARE OFFER.

FULL DETAILS AVAILABLE FROM

CSE (Computers) Ltd
12 Woking Road
Reading
Tel No: 0734-61492

BERKSHIRE

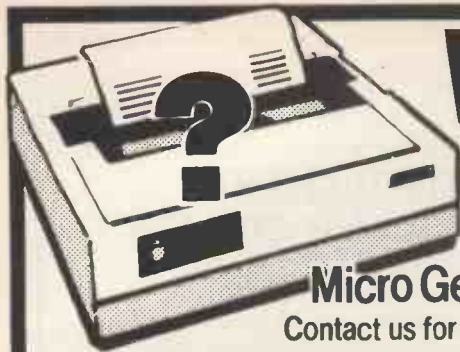

Which PRINTER FOR What COMPUTER?

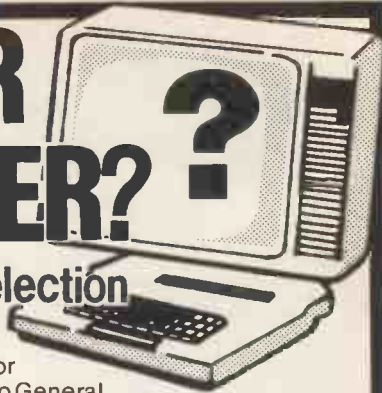

Micro General the specialists for Printer Selection

Contact us for our expert advice on all your Interfacing problems

It's not just a question of plug in and lets go. There are now over 200 different connector situations. How do you know that your computer will accept the printer of your choice? We at Micro General do not sell boxes off the shelf. As computer engineers we help you to choose and install the right printer for your computer. The advice is free and it could save you some embarrassing mistakes - Buy from us for peace of mind.

MICROLINE RANGE

From **£199 + vat**

Microline 80 80 cps £199 + vat
Microline 82A 120 cps £349 + vat
Microline 83A 120 cps £499 + vat
Microline 84 200 cps £799 + vat
(The M84 has High Res. Graphics plus Near Letter Quality print)

NEW ADDITIONS TO THE MICROLINE FAMILY
(All with Near Letter Quality printing and High Resolution Graphics)

Microline 92 160 cps £449 + vat
(80 cols. at 10 cpi)
Microline 93 160 cps
Full Width (136 cols. at 10 cpi) £649 + vat

EPSON TYPE III

SPECIAL OFFER
for 1 month only -
£50 OFF all EPSON Printers



The Type III printers now have Auto-underline, Super-scripts, Sub-scripts & High Resolution Graphics.

		NORMALLY	NOW ONLY
MX-80T	Tractor only	£349 + vat	£299 + vat
MX-80F/T	Friction/Tractor	£389 + vat	£339 + vat
MX-82T	Tractor only	£360 + vat	£310 + vat
MX-82F/T	Friction/Tractor	£409 + vat	£359 + vat
MX-100	100 CPS Full width	£499 + vat	£449 + vat

TRIUMPH-ADLER TRD 170S DAISY WHEEL PRINTER

**£695
+ vat**



**HIGHLY
RECOMMENDED
LOW COST QUALITY PRINTER**

- Amazingly quiet for the office environment.
- Serial or Parallel Interface.
- Tractor Feed & Single Sheet Feeder available.
- Character Pitch 10, 12, 15 cpi & Proportional.

Micro General

■ Always call for the best possible price  Access/Visa

(Dept PCW3) 6 The Birchwoods, Tilehurst, Reading, RG3 5UH Tel: 0734 25226

POWER FAILURE "SPIKES" "GLITCHES"



A disaster for companies running computers.
"NOT" if you have "BATTPOWER" - the uninterruptable power supply.

When Battpower is between the mains and your computer all your worries are over.

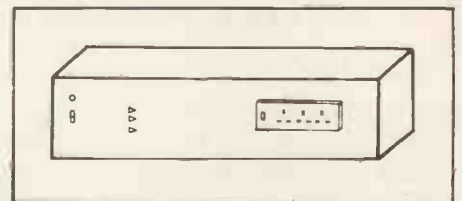
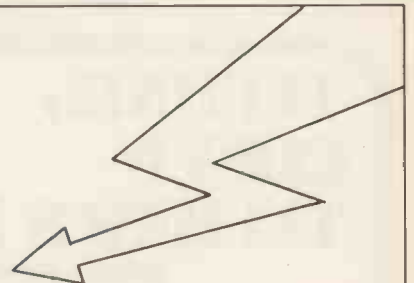

In the event of a power failure you may carry on operating your computer and ancillaries for at least one hour with our basic unit, costing only £599.00 plus VAT. Featuring:

- ★ QUARTZ FREQUENCY CONTROL
- ★ REGULATED SINE WAVE OUTPUT
- ★ INTERCHANGEABLE BATTERY PACK
- ★ TOROIDAL TRANSFORMER TECHNOLOGY
- ★ 300 VA OUTPUT
- ★ EASY TO INSTALL

Alternative units, with longer operating times, also available.



We also specialise in the VIC 20 and Commodore 64 Computers.
LOW, LOW PRICE OF: £120.00 inc. VAT.

We also carry a comprehensive stock of hardware and software for the above computers at very competitive prices. i.e. COMMORE VIC 20 GAMES CARTRIDGE FOR £18.95 INC. VAT. COMMODORE 64 also in stock. Price on application.

EE RING US FOR OUR LATEST PRICES
ECCLESTON ELECTRONICS

8 LEGGE LANE, BIRMINGHAM B1 3LG.
TELEPHONE: 021-236 6220/1226

3D COMPUTERS



THE  ACORN SPECIALISTS

BBC Micros Ex-stock

PERIPHERALS

PRINTER
COLOUR MONITOR
DISK DRIVE
TORCH Z80 DISK
CASSETTE RECORDER

SOFTWARE

ACORN SOFT
BBC SOFT
PROGRAM POWER
BUG-BYTE

ADD-ONS

JOYSTICK
LIGHT PEN
GRAPHICS TABLET
TELETEXT
Z80 PROCESSOR
6502 PROCESSOR
MEMORY UPGRADE
DISK INTERFACE

BOOKS

30 HOUR BASIC
BBC BASIC
BBC MICRO REVEALED
LET YOUR BBC TEACH
LEARNING TO USE BBC
ASSEMBLY LANGUAGE

AGENT FOR WARRANTY REPAIRS & SERVICE

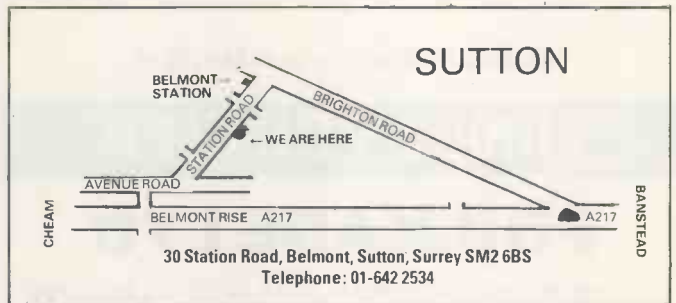
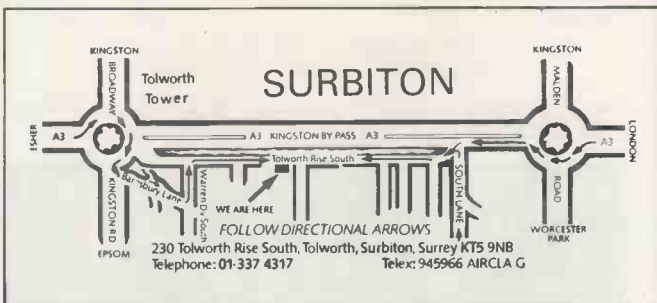

PCS PEDRO COMPUTER SERVICES

PET HARDWARE

Controllable Write Protect Switch and Disk Alert	£20.00
Pet T.V. Interface	£35.00
Relay Switching Unit 30V - 240V 5A - 6 Channels	£50.00
Disk on/error indicator	£7.50
Screen Dump	£10.00
6550 Ram, 6520, 6522, 2114 Chips	
Pet Edge Connectors	User Port £4.00 Cass Port £2.50

INTERFACE AIDS

T-Switch for 25 line RS 232 Cable Switches 2 Devices. Share one printer or VDU with two computers.

RS 232 AND PRINTER LEADS

Male-Female	Sirius - Centronic type interface
Male-Male	BBC - Centronic type interface
Male-Female	BBC - Research 380Z
Female-Female	BBC - RGB monitor BMC Microvitec
IBM-Epson Printer	BBC - Cassette Lead
Sirius-Epson Printer	BBC - Centronic 737
IBM-Centronic type interface	BBC - Epson Serial

FOR LENGTHS AND PRICES - PLEASE RING

TI 99 Cassette Lead

RS 232 TEST ADAPTOR

Connects between your main RS 232 lines and displays status of 7 important lines. Pins 2, 3, 4, 5, 6, 8, 20.

VIC 20 SOFTWARE

Big Four (3.5K)	£5.00	VIC HARDWARE
Startrek (3K and 8K)	£9.57	VIC 20
Database (8K+)	£9.57	VIC Cassette
Defenders (3.5K)	£7.00	VIC Joystick
Roadtoad (5K or Joystick)	£7.00	VIC 3K Ram Cartridge
VIC CARTRIDGES	£24.96	VIC 8K Ram Cartridge

FOR PRICES PLEASE RING

Please add 15% VAT and £1.50 p&p on all orders.

Overseas orders add £2.50 p&p.

Please send a large s.a.e. for information of all our other products.

ALSO!

BBC COMPUTER

Full repair service, A to B upgrades and disk upgrades at low rates.

4 Cowcross Street London EC1 Telephone: 01-250 1481



FULL DETAILS AVAILABLE FROM

Integer Micro Systems
Fairfax House
Causton Road
Colchester
Tel No: 0206-42315

ESSEX

ZX81-16K/DRAGON 32/BBC A+B SPECTRUM 16/48

ADVENTURE 200 (16k)

OVER 200 PLACES to explore. Written in machine code and using advanced data compression techniques it squeezes a true fixed-map adventure into just 16K – all held in ram – no extra cassette reads or books of text. Unlike a randomly generated maze type game this is a real test of your tactical skill. It starts easy but the further you progress the more dangerous and difficult the problems become as you use objects around you to overcome obstacles and evade enemies! More like a thriller than an arcade game – and you are the hero! Flexible command format allows abbreviations and multiple word lines.

Other games from Foilcade include:-

AWARI – Ancient African game of logic

FANTASTIC VOYAGE – (ZX81 16K only) Real-time simulation of micro-sub in human body. Real vascular map and fast m/code graphics.

THE FOILKADE CHALLENGE: Buy both Adventure and Awari and enter our prize competition. SAE for details.

All games £5.95 inc. 2 for £9.95 3 for £13.95

£1000 IN PRIZES

FOILKADE LTD

'PCW3', 66 LITTLEDEAN, YATE, BRISTOL BS17 4UQ

THIS MONTH'S BRAINWAIVES FOR NEWBRAINS

TAPE LIBRARY Allows you to create 200 files – each up to a full screen in size. (It is possible to have more than 200 if they are smaller). Having created your Data Base, this program allows you to search for any word, name, or number that is listed in your Tape Library.

When the required word is found, the program will list every occurrence of it, by listing the whole file, in order, either on the screen or by output to a suitable printer. Files can be saved to or loaded from tape. In addition, the whole file can be listed on the screen, or printed out, starting at any point you choose. A superb program, with many uses in business or the home. **CASSETTE £10.00.**

WORDWORKER Only requires an inexpensive cable to turn your NewBrain and printer into a word processor. Includes word-rollover, left and right margin setting, and allows you to save or load to tape. Enables you to print letters, circulars, etc. **CASSETTE £25.00.**

DIARY A program to store a whole year's appointments, including person's name, company, date, time, and a short comment about each. Allows searching by: Person's Name, Company, Date, or to list everything on a particular day, or even list the whole year's appointments in order. Saves and loads to tape. Invaluable to the busy manager or salesman! **CASSETTE £10.00.**

ALL THE ABOVE PRICES INCLUDE FIRST CLASS
POSTAGE AND PACKING : SENT BY RETURN

Other programs available – including TELEPHONE, PAGES, WORMS, and CHASE. Please send stamp for further details.

BRAINWAVE COMPUTING LTD
TILBURY-JUXTA-CLARE
ESSEX CO9 4JT
0787-237831

MICROAGE ELECTRONICS

BIG value in small printers

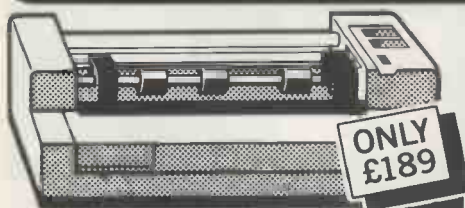

The Incredible Seikoshia AP80

The AP80 is probably the world's LOWEST COST, compact 80-column graphic dot-matrix printer available.

It can produce single and double width characters and has the ability to produce any pattern through its dot-matrix capability.

The AP80's robust construction and its unique "unihammer" make it an extremely cost effective and efficient printer.

Its features include

80 Cols 30 cps ● Dot Matrix Unihammer action ● 96 ASCII standard characters ● Up to 8" paper width ● Upper and lower case ● Double width printing ● Standard interface: Centronics

The Amazing Seikoshia AP100

Big brother to the AP80 the AP100 is a wider more sophisticated version of the AP80 with a full graphics capability and the ability to take standard width computer stationery, the AP100 is an ideal choice for anyone with a microcomputer.

Its features include:

80 cols 30 cps ● Dot Matrix Unihammer action ● 116 ASCII standard characters ● Full graphics capability ● Up to 10" paper width ● Upper and lower case ● Double width printing ● Centronics interface: Only £215.



Official Orders Accepted

At Microage you can now get the very best value in microcomputer printers. We've selected only the best printers available so you can choose confidently, knowing you're getting the best value for money.

Free Cable + paper
with printers

Accessories

Seikoshia GP-80 Ink Ribbon £4.75 (75p p+p)
Seikoshia GP-100 Ink Ribbon £5.75 (75p p+p)
Dust and sound Cover £3.95 (75p p+p)
Friction feeds for 80/100 £25.00 (£1.50 p+p)

Please Rush me details of all Printers.

Name _____

Address _____

The computer I shall be using it with is: _____

PCW 3/83

MICROAGE ELECTRONICS

135 HALE LANE EDGWARE MIDDLESEX HA8 9QP TEL: 01-959 7119 TELEX 881 3241

Open Mon - Sat 9.15 am - 6.00pm. Thurs 9.15 am - 1.00pm.

DEALER ENQUIRIES WELCOME
CALL 01-959 7119
FOR TRADE PRICES

WANTED!

Intelligent Software Ltd., internationally renowned producer of microcomputer and games software, is looking for exceptionally talented programmers to join its team of software designers and writers.

Experience of assembly language is essential, but a willingness to work hard and boundless enthusiasm are much more important than formal qualifications.

Intelligent Software is particularly interested in programmers who have proven abilities in the design and programming of video games.

We believe in outstanding pay for outstanding programmers.

Please write to:

David Levy,
Intelligent Software Ltd.,
Dept PCW,
21, Store Street,
London WC1E 7DH.

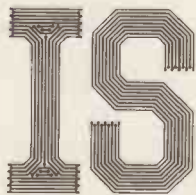

INTELLIGENT SOFTWARE LTD

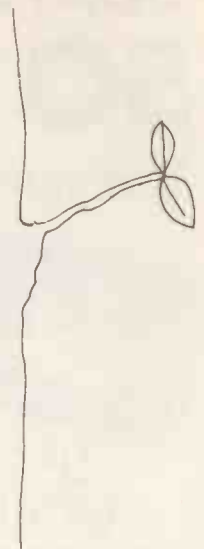

Available in
NORTH LONDON
NOW



ACT SIRIUS 1

16 BIT MICRO

with wide range of business software
Leasing facilities available

TOWN & COUNTRY COMPUTER SYSTEMS

Systems House, 489a Hertford Road, Enfield, Middx
Tel: 01-805 0903, Open until 10pm Tue, Wed, Thur & Sat until 1pm
for demonstrations.



FULL DETAILS AVAILABLE FROM

Video Shack
16 Crown Street
Aberdeen
Tel No: 0224-571767

GRAMPIAN AREA

DON'T MISS THIS INCREDIBLE OFFER!

50 GAMES £9.95!

ZX spectrum Cazzette = Fifty



great games!

- | | | |
|-------------------|-------------------|---------------|
| GALACTIC ATTACK | MAZE EATER | SUBMARINES |
| SPACE MISSION | ORBITTER | ROCKET LAUNCH |
| LUNAR LANDER | MOTORWAY | PLANETS |
| PLASMA-BOLT | FORCE-FIELD | BLACK HOLE |
| STARTREK | NIM | DYNAMITE |
| RADAR LANDING | TUNNEL ESCAPE | DO YOUR SUMS |
| ATTACKER | BARREL JUMP | DERBY DASH |
| GALACTIC DOGFIGHT | CANNONBALL BATTLE | SPACE SEARCH |
| ZION ATTACK | OVERTAKE | UNIVERSE |
| IVASIVE ACTION | SITTING TARGET | RATS |
| OXO | SMASH THE WINDOWS | TANKER |
| BOGGLES | SPACE-SHIP | PARACHUTE |
| PONTOON | JET FLIGHT | JETMOBILE |
| SKI-JUMP | PHASER | HIGH RISE |
| HANGMAN | INTRUDER | THE FORCE |
| OLD BONES | INFERNO | EXCHANGE |
| THIN ICE | GHOSTS | |



apple Business Disc

TEN POPULAR BUSINESS PACKAGES ON ONE DISK: **ONLY £19.95**

STOCK CONTROL	FILING CABINET
MAILING LIST	YEAR PLANNER
SALESMAN	STATISTICS
LIBRARY INDEX	ALPHABETIC ORDER
BANK ACCOUNT	GRAPH PLOT

UTS means low prices!

apple super disc 2

- | | | |
|---------------|--------------------|----------------|
| SPACE-SHIP | SPACE INTRUDER | SITTING TARGET |
| LUNAR LANDER | GALACTIC CHALLENGE | PONTOON |
| JET FLIGHT | SNOOKER | OXO |
| STARTREK | SPACE DOGFIGHT | HANGMAN |
| RADAR LANDING | PHASER | NIM |
| INFERNO | SPACE SEARCH | DO YOUR SUMS |
| CROSSWORD | | OVERTAKE |

20 games only £9.95

coming soon 50 games for the BEEB



POSTAGE FREE TO U.K.
ORDER DIRECT TO:
U.T.S.
P.O. Box 96
HARROGATE
NORTH YORKSHIRE
HG3 2UZ

PLEASE SEND ME

CHEQUE ENCLOSED, VALUE

NAME

ADDRESS

POSTCODE

COMPUTASOLVE LTD.

MICRO COMPUTER SYSTEMS FOR THE MODERN BUSINESS

8 Central Parade, St. Marks Hill, Surbiton, Surrey TEL 01-390-5135
(100 yards from Surbiton Station)

FOR ALL YOUR COMPUTING REQUIREMENTS

BUSINESS SOFTWARE BY TABS, PEACHTREE, COMPSOFT
HARDWARE FROM ACT (SIRIUS 1), OSBORNE

If you are despairing of ever finding the right package to suit your business needs why not let us quote you a price for writing the program. We are CIS COBOL fanatics, and will quote you a fixed price, fixed timescale, all-in cost.

- NO late delivery
- NO unexpected or hidden extra costs
- NO ties to one particular machine – code is transportable between all leading business micros.

P.S.

We haven't forgotten the home computer user.

We stock DRAGON NEWBRAIN VIC-20 ORIC computers and games by THORN-EMI BUG-BYTE ROMIK BRAINWAIVE & MICRODEAL in our home computer section, together with a good selection of books and consumables.

KNIGHTS GUARANTEE LOWEST PRICES ON SHARP AND ATARI

Deal S1 — SHARP 54K MZ-80A with BASIC plus 24 programs including Geography, Arithmetic, Basic Tutorials, Startrek, Invaders, Breakout etc

£419

DEAL S2 — MZ-80A, BASIC, PASCAL language and 36 programs including all those in deal S1 plus 2 PASCAL programs

£429

DEAL S4 — MZ-80A with BASIC, PASCAL, FORTH and MACHINE CODE languages plus 40 programs

£449

DEAL A1 — MZ-80A with BASIC, PASCAL, FORTH, MACHINE CODE and the programs to get you off to a flying start.

£475

DEAL B1 — MZ-80B, 76K powerhouse with 64,000 point graphics, with BASIC MACHINE CODE

£747

DEAL B11 — MZ-80B system, printer, floppy disk, expansion unit all cables, cards and manuals.

£1899

DEAL 400 — ATARI 400 with BASIC, manuals etc — choose from 16 colours and eight brightness levels, 320x192 definition plus 63 programs

£199

DEAL 800 — ATARI 800 with BASIC cartridge, four voice sound, superb ultrafast moving graphics with ATARI's dual processor system plus 63 programs

£429

DEAL AT3 — ATARI DISK UNIT — plugs straight into the 400 or 800 — great value at KNIGHTS GUARANTEED LOWEST PRICES.

£257

All our prices exclude VAT but include UK delivery by Securicor. No surcharge on ACCESS or VISA orders

Knights T.V. &
COMPUTERS

108 ROSEMOUNT PLACE,
ABERDEEN AB2 4YW
Telephone: 0224 630526

Adding high resolution colour graphics to your Nascom or Gemini system need not cost more than £199.

Introducing the new **Microvector MV256** adding a high Resolution Colour Graphics capability to your **NASCOM** or **GEMINI** computer system.

- ★ High resolution display. 256 x 256 x 4 planes (16 colours).
- ★ 32k of display memory with flicker-free update (Outside of the host computers memory address space).
- ★ Non-interlaced 50Hz CCIR 625 line display format.
- ★ High Quality PAL UHF output with intercarrier sound facility.
- ★ Composite B/W video 75 ohm output (16 grey levels).
- ★ Red, Blue & Green video 75 ohm outputs (sync mixed on each) available on MV256B only.
- ★ Audio & light pen inputs

The **MV256** uses the **Thomson EF9365** graphics display processor to provide high level graphics functions in hardware.

- ★ Ultra fast vector and character generation give full animation capability (typ 800 000 pixels/sec. max 1300 000 pixels/sec).
- ★ Selectable line types (continuous, dotted, dashed, dotted-dashed).
- ★ 96 ASCII character set, Programmable character sizes and orientations.
- ★ Rectangle fill, clear screen and scan screen operations.
- ★ Host computer access to display memory via registers.
- ★ Comprehensive display status information.
- ★ Light pen control.
- ★ NMI interrupt generation (on board link option).

MV256A **£199** + VAT MV256B **£220** + VAT

Both the **MV256A** and **MV256B** are supplied built and tested with comprehensive documentation and programming examples, Postage & Packing free.

Colour Video monitor 10 inch 0.6 mm pitch tube 9MHz bandwidth, suitable for use with MV256B. Also has PAL decoder enabling direct connection to domestic video recorder.

Arfon Light pen, Plug in, compatible with Micro Vector board.

£199 + VAT
& CARR.

£50 + VAT

Cable Accessories available.

For further information please contact

CLIMAX COMPUTERS LTD
17a Broad Street, South Molton, Devon. Tel: (07695) 2314



New Generation Software

From M. E. Evans the author
of the highly acclaimed
3D MONSTER MAZE and
3D DEFENDER



3D TUNNEL (16K & 48K Versions on one tape)
What lies in the depths of the tunnel? Flapping bats, leaping toads, scurrying rats, crawling spiders, all appear live in the 3D TUNNEL as it weaves about. We leave the last object to your imagination. (Not in 16K version). Price £5.95, special introductory offer at £4.95 until February 28th.

TWO
GAMES
FOR THE
SPECTRUM



ESCAPE (requires only 16K)
Can you escape from the dinosaur infested maze? 3D grandstand view provides dinosaurs with the opportunity to hide behind the hedges or to soar over them to swoop down on you. "One of the best and most original games we have seen for the Spectrum so far". SINCLAIR USER. Price £4.95

FOR 16K-SPECTRUM

For instant CREDIT CARD Sales by phone only ring 01-930-9232

Orders to: NEW GENERATION SOFTWARE dept **PCW**
FREEPOST (BS 3433) (no stamp required in UK)
OLDLAND COMMON, BRISTOL BS15 6BR

Please send s.a.e. with all enquires and for lists of stock-ists. TRADE ENQUIRIES WELCOME AT ADDRESS ABOVE.



FULL DETAILS AVAILABLE FROM

Crystal Research Ltd
40 Magdalene Road
Torquay T21 4AP
Tel No: 0803-22699

DEVON



Who Else
Guarantees
**YOU CANNOT
BUY CHEAPER**



If You Can Purchase Immediately At A Lower Price,
We Will Beat It !!

1. Visicalc	£99.00	Padmede, the well known reliable software	
2. Visiplot	£89.00	27. Incomplete records	£438.00
3. Visi-Trend/Plot	£115.00	28. Time & Cost Recording	£438.00
4. Visidex	£99.00	29. Contract Costings	£289.00
5. Visi-Desk Top Plan	£89.00	30. Quotation & Estimating	£289.00
6. Visi-CCA Data Management	£115.00	31. Purchase Ledger	£289.00
7. Easywriter Professional	£114.00	32. Sales Ledger	£289.00
8. Easywriter	£45.00	33. Invoicing System	£289.00
9. Easymailer	£33.00	34. Stock Control	£289.00
10. Typing Tutor	£19.00	35. Payroll-Computech 350emp	£275.00
11. Data Factory	£69.00	36. The Cashier	£195.00
12. Data Factory (V.S)	£135.00	(Retail Store Management)	
13. Apple Fortran	£89.00	37. Supertalker MHSD200/MHPX06	£139.00
14. Apple Pilot	£69.00	38. Speechlink H2000	£137.00
15. Apple Tool Kit	£33.00	(Talk To Your Apple)	
16. Apple Post	£24.00	39. Decca Colour Viewdata VDU	£298.00
17. Apple Plot	£29.00	40. Prism IDS 560	£795.00
18. Integer Card	£75.00	(Graphics/Printer)	
19. D.O.S. 3.3	£34.00	41. Infocan Display M3	£130.00
20. Communication Card	£98.00	(Computerized Moving Screen)	
21. Centronics Printer Card	£98.00	42. Nat/Pan 100E	£138.00
22. Parallel Printer Card	£78.00	(Tele/Ph. Answering Machine)	
23. Apple II Dust Covers	£7.50	Verbatim Diskettes 5 yr Warranty	
24. Apple Siletype Dust Covers	£7.50	With Mini Plastic Cases	
25. Apple Disk Drive Dust Covers	£7.50	43. MD525.16 (Mini Disks)	£16.95
26. Centronics Dust Cover	£7.50	44. MD550.10	£22.95
		45. MD550.16	£22.95
		46. FD-34-2000 (Flexi Disks)	£29.95
		47. FD-32-9000	£24.95



All Orders Received By 7/3/83 Will Receive A
Superb Diary Or An Apple Manual. ACT NOW.
Even Our Massive Stocks Are Disappearing Fast.

Phone Us Now (24 hrs) With Your Access Or Barclaycard No
Or Simply Print Your Name, Address, Phone No. In The
Margin & Mark Or List The Items & Mail Together With Your
Cheque/P.O. Plus VAT & £2.50 P&P.

ACCENT ON
EXCELLENCE



I.C.E.N. LIMITED

INTERNATIONAL COMPUTERS
EQUIPMENT NETWORKING
MAPLECROFT HOUSE, LOWBOURNE,
MELKSHAM, WILTS

0225 - 702133/707575



Diskwise Ltd.
Computer Centres

SOUTH WEST & NORTH WEST

Computer enthusiasts look no further

WE STOCK THE FOLLOWING PRODUCTS:

Dragon 32K	£174
Colour Genie 16K	£174
Commodore 64	£299
Newbrain 'A'	£234
Newbrain 'AD'	£260
Apple II E	£845
Apple III	£2418
Act Sirius I	£2395
Microline 80 Dot Matrix Printer	£220
Epson MX80 Dot Matrix Printer	£389
Smith Corona Daisy Wheel Printer	£485

... AND LOTS MORE ...

Above prices plus VAT

A large selection of Games for the most popular
computers plus Paper, Discs, Books etc.
We are business systems specialists and
can provide software for most applications.

STOCKPORT
68-70 Lower Hillgate
Stockport, Cheshire
Tel: 061 477 5931

PLYMOUTH
Deptford Place
North Hill, Plymouth
Tel: 0752 267000

NOW WE'RE UNBEATABLE !



PRINTERS

Epson MX80 III	£265
Epson MX80 F/T	£295
Epson MX82 F/T	£325
Epson MX100 F/T	£395

All 12 months warranty

OKI M80A	£215
OKI M82A 120 cps	£299
OKI M84A	£745
Diablo 630	£1345
Qume 9/45 RO	£1425
Fujitsu SP830	£1595

Any printer supplied at the lowest U.K. price
with full warranty.

OSBORNE 1 PORTABLE COMPUTER

FROM £1095 (with software)

**BRITISH MICRO 64K
DUAL FLOPPY CP/M***

THE LATEST 803 £1395 (with graphics)

APPLE II COMPLETE SYSTEM

48K COMPUTER, TWO DISC DRIVES,
MICROLINE PRINTER AND MONITOR £1295

- * **SOFTWARE** We supply most CP/M and Apple software at the lowest prices. We also offer highly specialised packages for specific professional applications.
- * **TORCH COMPUTERS** Talk to us about this revolutionary British machine with amazing communications capability. Definitely the office machine of the future.
- * **MINSTREL COMPUTERS** A superbly designed professional machine of British origin which offers incredible performance with Winchester storage and multi-user facilities at a price previously unheard of in the market place.

NOTE: Prices shown do not include VAT. Please add 15% to your order total. Carriage is charged at £10 to any destination on the mainland.

*CP/M is a trademark of Digital Research



**DEATH VALLEY
COMPUTERS**

P.O. BOX 54 WORCESTER WR2 6QA
TEL: 0905 640400
TELEX: 337300 TAYLER G

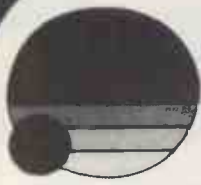

ACT SIRIUS 1

AVAILABLE IN

KENT

FROM

THE DATA PROCESSING CO.

BARTON HOUSE
69 SANDGATE ROAD, FOLKESTONE
KENT CT20 2AF
TELEPHONE (0303) 41618

★★ PACKAGED SOFTWARE ★★

Packages for information management, word processing, financial forecasting and accounting, including sales ledger with invoicing, purchase ledger, nominal ledger, stock control with parts explosion and bill of materials, job costing and payroll.

★★ BESPOKE SOFTWARE SERVICE ★★

We have experienced programmers available who are able to undertake software development for both commercial and engineering applications, including graphics and process control. Written in fast and efficient UCSD Pascal, Fortran and Machine Code.

★★★★★★★★★★★★★★—

NOW ON THE SIRIUS

★★★ ACCSYS ★★★

The incomplete records accounting system written in fast efficient UCSD Pascal with screen displays driven by SuperScript.

★★★ SUPERSCRIPT ★★★

A UCSD unit providing procedures and functions for controlling the Sirius graphics display in high speed text mode. SuperScript features a character set editor with facility to change character sets at run-time.

★★★ AQUILA ★★★

An advanced text data base generation and retrieval system suitable for use in libraries, etc.

DEALER ENQUIRIES WELCOME



CYBER 3 ROBOT

£650 plus VAT

The Cyber 3 robot has been developed for the educational and light industrial market. It has been designed to meet the requirements for a robot which will emulate, in behaviour and physical attributes, larger industrial robots.

Constructed in black satin anodised aluminium and driven by stepping motors. The arm can access 350 degrees, with a reach of 50 cm and a lift of 250 gm.

Now featuring FORTH driven software; increasingly recognised as the robot language for simplicity and ease of use. Free FORTH compiler provided.

The Speakeasy

A low cost speech synthesizer complete with VOTRAX speech output chip, unlimited vocabulary, power supply, speaker and case all for only plus VAT; p&i: £2.50.

£69



For further information contact:

CYBER ROBOTICS LTD

61 Ditton Walk, Cambridge.

Tel: CAMBRIDGE (0223) 210675.



FULL DETAILS AVAILABLE FROM

**South West Office Equipment
Pednan and Drea
Redruth**

Tel No: 0209-213299

CORNWALL

EPSON HX-20

at

VISION STORE

NOW!

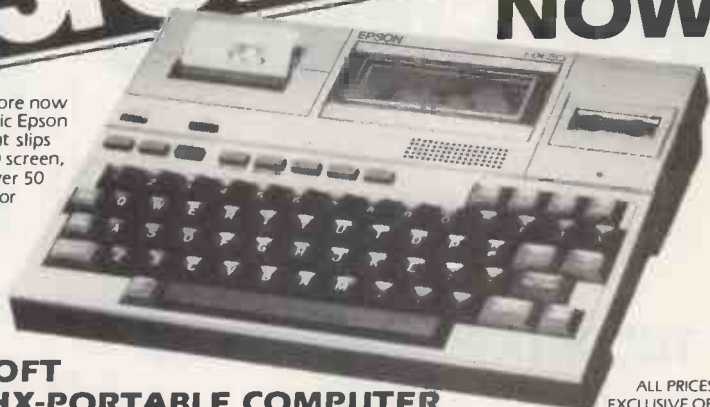

Vision Store now have in stock the fantastic Epson HX-20, the totally portable computer that slips easily into a briefcase and yet incorporates its own LCD screen, full typewriter keyboard, printer and microcassette. It runs for over 50 hours on its own power supply, which can be easily recharged overnight, for use anywhere. Come in and try the Epson HX-20 at Vision Store today.

EPSON HX-20 COMPUTER SYSTEM

HX-20 UA The HX-20 portable computer complete with integral printer and display
with transit case **£411.00**
without transit case **£402.00**

HX-20 MC-SA Optional Microcassette drive for HX-20 **£75.00**

HX-20 EU-SA Expansion unit for HX-20 contains 16 KB of RAM, or may be used with up to 32K ROM **£80.00**

HX-20 RC-SA optional ROM cartridge for HX-20 may contain 8K pre-programmed ROM (not supplied) **£45.00**

EPSON HX-20 ACCESSORIES

HOO-AAU Spare mains adaptor **£8.50**

HOO-RP Paper rolls for HX-20 pack of 5 **£2.60**

HOO-CR-RA Cartridge ribbons for the HX-20 (each) 1,000,000 character life **£2.20**

HOO-CT EPSON MC-30 Microcassette tapes **£1.60**

EPSON HX-20 LEADS & CABLES

702 Cable to connect an external audio cassette **£5.70**

714 Cable to connect an external EPSON terminal printer (serial) **£15.00**

716 Cable to connect 2 HX-20 computers using 8 pin RS232 sockets **£15.00**

717 Cable to connect 2 HX-20 computers using the High Speed serial interface (5 pin sockets) **£15.00**

EPSONSOFT

EPSON HX-PORTABLE COMPUTER

D.I.Y.

A programme generator system, for the user who wishes to write data capture and data handling systems without learning BASIC

Microcassette **£30**
Pre Programmed ROM **£75**

EPSON SIMPLICALC A spread'sheet system to create financial reports and forecasts from complex formulae **£30** **£85**

THE PERSONAL OFFICE This suite of programs provides a 3 month rolling diary. A card index system, including a standard form and graphics option **£20** **£75**

CORRESPONDENT A powerful word processing system, specifically designed for the HX-20, may be linked to an external printer, text files are stored on microcassette **£50** **£105**

MLIST A complete mailing list system, including a selection code, complete with a link into the Correspondent system **£25** **£75**

SALES ORDER ENTRY SYSTEM Allows the collection of sales orders and the downloading of a stock file from a central computer. **£40** **N/A**

COMMUNICATION **N/A** **£30**

ALL PRICES ARE EXCLUSIVE OF VAT

VISION STORE

3 Eden Walk Precinct, Kingston-on-Thames, Surrey
Tel: 01-546 8974

OSBORNE

£995 INC. SOFTWARE

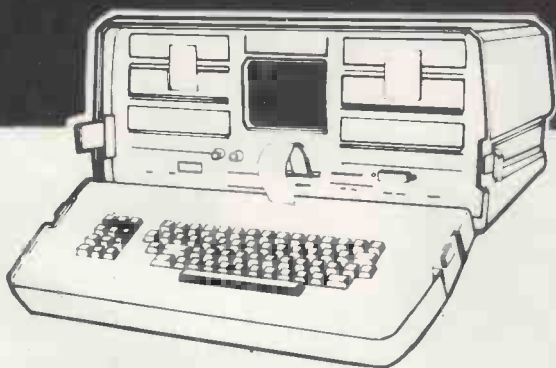

Latest Osborne Mark II

- Z80A 64K CP/M Computer
- Dual 100KB drives (upgradable)
- Typewriter keyboard + numeric pad
- Integral 52 column monitor
- Fully portable - weighs 24 lbs
- RS232/Centronics/IEEE Ports
- Software Wordstar/Mailmerge, C Basic - M Basic, Supercalc - CP/M

Also Sanyo Monitors **£89**

Olivetti Daisywheel Printers **£455**

Epson Dot Matrix Printers **£349**

Send for list Osborne software and peripherals

All prices exclusive of VAT and delivery. Cheque with order.

Also available Double Density Model **£1160**

Delta Systems Limited

32 Finch Road, Douglas, Isle of Man. Tel: 0624-27522.

C. J. E. Microcomputers

BBC
SPECIALISTS

VAT included where applicable

QUALITY DISK DRIVES

Single drive 40 track single sided 1 x 100k	£210.00
Dual drive 40 track single sided 2 x 100k	£350.00
Dual drive 80 track double sided 2 x 400k	£799.25

All drives are cased with own PSU for reliability, and include connecting cables and utilities disk.
Delivery £4.00

SOFTWARE FOR THE BBC MICRO

MISSILE CONTROL the first implementation on the BBC Micro of the popular arcade game. (32K)	£9.00
MAZE MAN an authentic version of the popular arcade game. (32K)	£6.00
BALLOONS a highly original game that soon becomes compulsive playing. (32K)	£6.00
DISSASSEMBLER the memory dump routine includes a scrolling back in memory facility. (16K)	£5.00
MISSILE CONTROL, MAZE MAN & BALLOONS use the Keyboard or Joysticks for control	

30+ PROGRAMS FOR THE BBC MICROCOMPUTER

This Book contains program listings, with explanations & tips on using the BBC Micro

GAMES UTILITIES GRAPHICS & MUSIC

Most programs will run on Model's A & B

Edited by C.J. Evans, various Authors.

A pair of cassettes with all the programs is available.

BOOK	£5.00
BOOK & CASSETTE SET	£9.00

LEADS

The BBC Micro comes without a cassette lead

7Pin DIN to 2x 3.5mm & 1x 2.5mm minijacks	£4.00
7Pin DIN to 5Pin DIN & 2.5mm minijack	£4.00
7Pin DIN to 7Pin DIN	£4.00
7Pin DIN PLUGS	Two for £0.65
6Pin DIN PLUGS (for RGB socket)	Two for £0.65
5Pin DIN PLUGS (360° for RS232)	Two for £0.65

RS423 TO RS423 (BBC Micro to BBC Micro)

Two metre cable	£4.00	Four metre cable	£5.00
-----------------	-------	------------------	-------

TELEVISION/MONITOR LEADS full range available

Phono plug to Co-ax with high quality cable 3 metres	£3.00
BNC Plug to BNC Plug	£3.10
BNC Plug to Phono Plug (i.e. BBC Micro to Rediffusion TVRM)	£2.20
RGB 6PIN DIN to 6PIN DIN 1 metre	£4.00
2 metre	£5.00

PRINTER CABLES

BBC to 36 way Centronics Type connector	£17.50
BBC to 25 way D Type (for use with RS232)	£9.50
BBC to 40 way edge connector (Centronics 739)	£20.00
TORCH to 36 way Centronics Type connector	£20.00

Blank C15 and C30 Computer Cassettes

Ten for £4.50 any mix

15 Way D type Plug with Cover	£2.75
Computer graphics design pads 100 sheets	£4.00

BBC UPGRADE KITS

RAM UPGRADE (100ns)	£23.00
KIT A Printer & I/O Port	£9.50
KIT B Analogue Port	£8.00
KIT C Serial I/O & RGB	£10.00
KIT D Expansion Bus/Tube	£8.00
Full Upgrade Kit (Model A to B)	£60.00
6522 VIA: (Included in Kit A)	£4.50

All components full specification

STAR DP8480 PRINTER

From £250.00 Inc VAT

80 CPS : 80/96/132 COLS
BIDIRECTIONAL LOGIC SEEKING
TRACTOR WITH FRICTION FEED

CENTRONICS version	£217.39 + £32.61 VAT = £250.00
RS232 version	£235.00 + £35.25 VAT = £270.25

High Res Graphics option to allow BBC Screen dumps £15.00/£20.00
(24HR SECURICOR DELIVERY FOR PRINTERS £8.00)

VAT Included where applicable

Send SAE for full Price List of our large range of accessories.

POSTAGE Add 50p per order or as stated

C. J. E.
Microcomputers

Dept (PCW), 25 HENRY AVE, RUSTINGTON,
W. SUSSEX. BN16 2PA (09062) 6647

Call Scotbyte Computers and print-out a bigger slice of business.

If you're making a small business larger — or a big business bigger, call Tom Spence or Frank Webb at Scotbyte. Here's Why —

- Scotbyte know the computer market and deal only in the latest technologies.
- Scotbyte offer the most versatile and complete computers you'd ever need.
- Scotbyte offer a total software/hardware service.
- Scotbyte after sales back-up ensures that you're never without the machine for the job.
- With offices in Edinburgh and Glasgow Scotbyte is ideally placed to serve you — fast.

For these and all other computer needs — 031-343 1005

SCOTBYTE

COMPUTERS



Thain House, 226 Queensferry Road,
Edinburgh EH4 2DQ
Also at Blantyre Industrial Estate,
Blantyre, Glasgow, G72 0UP.
Tel. 0698 823486



FULL DETAILS AVAILABLE FROM

RAK Computer Services
Britannia House
43/53 Prince of Wales Road
Norwich
Tel No: 0603-617361

NORFOLK

C.C.S. ANNOUNCES:

The "Artery" Suite of Programs for the Revolutionary Epson HX20

First to be launched will be "EXSOCOM" (Executive Sale Order Communications) covering – Order Taking – Stock Availability – Modem Communications – Quotations – Standard Letters – Electronic Mail. (Available January 1983)

We Specialise in the production of Hardware-Software Solutions, from Interfacing to Bespoke Software.

We Have "In House" Expertise in Software and Hardware Maintenance.

We Oblige our Customers with "On Site" Demonstrations.

We Offer our Customers Competitive Prices on all the Equipment.

We Sell including Apple II & III – Sirius – BBC – Commodore – Sharp – Epson – Qume IDS Prism – Microline – Strobe – SuperBrain – Diablo – Anadex – Olympia – Corvus.

We Understand The Hardware We Sell And Our Customer's Requirement.

Any hardware however brilliantly designed is only as good as the software which drives it. – We know how to drive Hardware.

C.C.S. Launches in Jan/Feb
Philips P3500 Multi Station Micro
Epson QX10 "Japans Answer"
CP/M Card for Apple III.
For further details
or demonstrations
please call
Gillian Hendry.

MISTER CALCULATOR [CCS]
C.C.S. 19 Park Street
Croydon CR0 1YD
Tele 01-686-9616/9
Telex 299944

THE HR1 THE FINEST PRINTER/TYPEWRITERS MONEY CAN BUY.

Only £650 + VAT



The HR1

Bi-directional – 17 CPS – some features as below, but without keyboard and lift off facility.

Compatible with
SHARP
OSBORNE
APPLE II
APPLE III
TELEVIDEO
TANDY
BBC
MIMI
TEXAS 30/30
PET
HEWLETT PACKARD
SUPERBRAIN
SIRIUS
XEROX
IBM

In fact most computers!

THE CROWN RANIER ONLY £795 + VAT

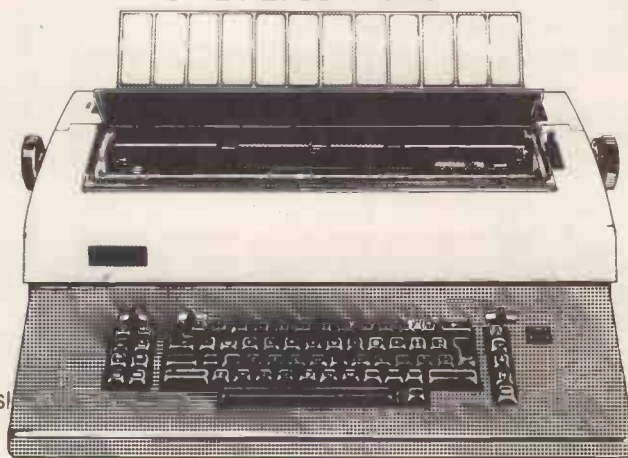

CROWN RANIER – The leader of all interfaced daisy wheel printer/typewriters: Here's why:

The unbeatable Crown Ranier is the only heavy duty daisy wheel printer/typewriter which runs on a linear motor – no belts or cables to break, stretch or wear – and uses the IBM ribbon and lift off correctors. The reliability has become legend in these days of expensive electronic typewriter breakdowns.

CENTRONIC – IEEE – RS232 INTERFACES – No external boxes – interchangeable daisywheels – variable pitch – three free daisy wheels – automatic whole line correction – easily copes with standard printed forms – 195,000 characters per ribbon (at least twice the average character length) – standard lift off correctors – a printer/typewriter at the flick of a switch.

Perfection as a typewriter (now used by local authorities and multi-nationals), perfection as a printer.

Beware of lightweight, low cost machines – these can never give long term reliable service. **THIS MACHINE WILL!!** The professional machine.

Ask your local computer or office equipment dealer for further information. EX STOCK DELIVERY.

SOLE UK DISTRIBUTOR. TRADE ENQUIRIES INVITED



CROWN BUSINESS CENTRE

**56-58 SOUTH ST., EASTBOURNE,
SUSSEX. (0323) 639983.**

ARBORCRAFT

Micro Computer Mobile Work Stations

High quality 'lo glare' melamine finished work surface with post formed long edges. Reinforced polyester coated steel support frames and large twin wheeled castors for ease of movement. Keep your micro off the dining room table and always available.

Choice of 3 models from £98.85 plus VAT. (Access). Money back guarantee. Allow 21 days delivery. Business enquiries welcomed. Phone or send for detailed brochure and order form.



Arborcraft Limited, 137 Watling Street, Radlett, Herts WD7 7NQ
Telephone Radlett (09276) 3126. 24 hour answering service.

Please send me your illustrated brochure and order form for the Arborcraft Micro Computer Mobile Work Stations.

Name _____

Address _____

Post code _____

AMBER 2400

- Plain Paper Printer
- 24 Columns wide
- Full upper and lower case characters
- Graphics capability
- Serial and parallel inputs as standard
- Built-in mains power supply
- Very low cost

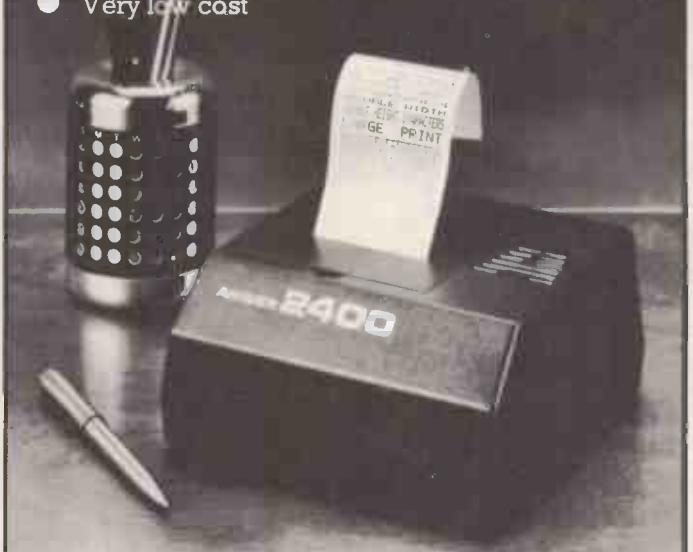

send large s.a.e. for details to:
**AMBER CONTROLS LTD., CENTRAL WAY,
ANDOVER, HAMPSHIRE**

NEW FROM MICROTEK

C/PM PAYROLL

**£375 + VAT
(£450 with SSP)**

A complete and comprehensive Payroll system that includes:

- ★ Statutory sick pay records and calculations
- ★ Payslips on plain paper
- ★ Accountant-approved analyses and reports
- ★ Hourly/Weekly/4 Weekly/Fortnightly/and Monthly employees
- ★ Full password protection
- ★ Up to five rates of overtime
- ★ Payment by cash, direct debit, Giro or Cheque
- ★ Simple, menu-driven use
- ★ Full tax & NHI routines
- ★ Extensive provision for additions & deductions

THIS MUST BE THE SIMPLEST OF ALL THE COMPLETE PAYROLL SYSTEMS

MICROTEK Ltd

15 Lower Brook Street
Ipswich, Suffolk IP4 1AQ

Tel: Ipswich (0473)
50152/52466



FULL DETAILS AVAILABLE FROM

Merit Computers Ltd
4 Caroline Street
Wigan
Tel No: 0942-495821

LANCASHIRE

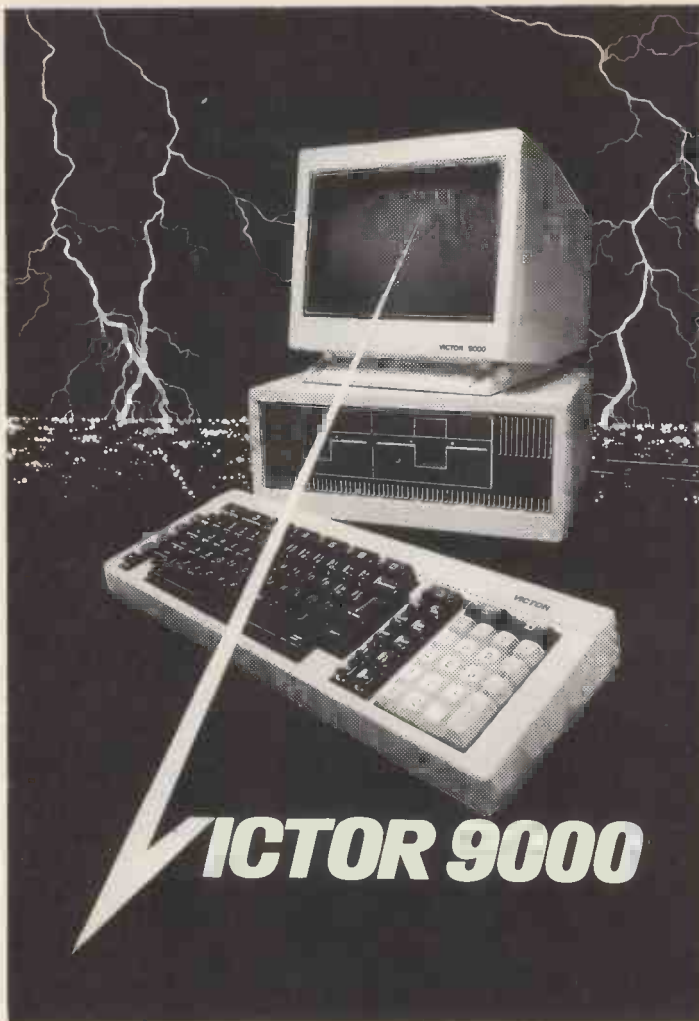

At last a fully integrated computer that is versatile and big enough for any business but small enough for a desk.

The latest 16 bit technology gives mini-computer performance at a fraction of the cost. Only £2395 or about £12.00 per week.

Performs all accounting functions, provides sophisticated management reports, grows as your business does and is simple to operate.

There is nothing like the **Victor 9000**. See one in action and you will be conquered too.

Computer Plus

47 Queens Rd, Watford, Herts. Tel: WATFORD (0923) 33927

VICTOR 9000

THE ALL CONQUERING BUSINESS SYSTEM.

NOW
BETTER
THAN EVER

Now You Can Back-Up Your Protected Software

COPY II PLUS

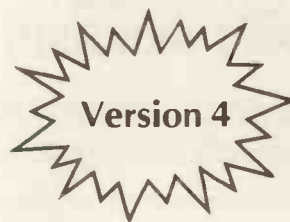

The Ultimate Utility for the Apple® II

Versatile

Back-up Visicalc and all your Visis, PFS and PFS Report, . . . and many, many more

Fast

Only 45 seconds for Fast Copy
Less than 3 minutes for Bit Copy

Easy to Use

Menu driven for ease of use. Full instructions on backing up dozens of popular programs.

Comprehensive

Includes all the file handling and DOS utilities you will ever need

- change booting program
- copy or remove DOS
- verify and compare files for differences
- analyse disks with the nibble editor
- check disk drives

Best Value

All this at a price which makes Copy II Plus better value than ever

Send cash with order, or quote your Access or Diners Card to:

**ORCHARD
SOFTWARE**



17 Wigmore Street
London W1
Tel: 01-580 5816



Amazing Value at
£35 + VAT
Why Pay More?

Dealer Enquiries Welcome

Current Copy II Plus Owners: Send your original disk with £15 + VAT for an update to Version 4

Get the NEW EPSON mk III from



Quickly. Reliably.

Quickly because as one of the UK's largest Epson distributors we have ample stocks.

In London, Birmingham, Manchester, Newcastle and St. Ives (Huntingdonshire).

Reliably because we are a *major Epson distributor* you get super service *all the time*.

Get it You can by contacting

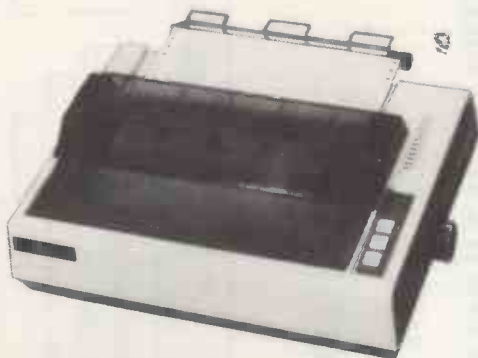

Westrex Co. Ltd.
Bilton Industrial Estate Fairway Drive
Greenford Middlesex UB6 8PW

Telephone: London: 01 578 0957
Birmingham: 021 554 5827
Manchester: 061 764 0324
Newcastle: 0632 326551
St. Ives: 0480 66343

HAPPY MEMORIES

Part type	1 off	25-99	100 up
4116 200ns	.77	.69	.66
4116 250ns	.70	.63	.60
4816 100ns For BBC comp	2.25	2.01	1.95
4164 200ns	3.99	3.58	3.42
2114 200ns Low power	1.15	1.00	.90
2114 450ns Low power	.95	.85	.80
4118 250ns	3.25	2.85	2.65
6116 150ns CMOS	3.55	3.20	2.95
2708 450ns	2.60	2.25	2.10
2716 450ns 5 volt	2.35	2.10	2.02
2716 450ns three rail	5.75	5.00	4.65
2732 450ns Intel type	3.50	3.15	3.00
2532 450ns Texas type	3.70	3.30	3.00

Z80A-CPU	£3.95	Z80A-PIO	£2.99	Z80A-CTC	£2.99
6522 PIA	£3.70	7002 A-D	£4.60	3691	£2.75
88LS120	£2.20	7805 reg	£0.50	7812 reg	£0.50

Low profile IC sockets:

Pins	8	14	16	18	20	22	24	28	40
Pence	9	10	11	14	15	18	19	25	33

Soft-sectored floppy discs per 10 in plastic library case:

5 inch SSSD	£17.00	5 inch SSDD	£19.25	5 inch DSDD	£21.00
				5 inch DSQD	£26.35
8 inch SSSD	£19.25	8 inch SSDD	£23.65	8 inch DSDD	£25.50

74LS series TTL, large stocks at low prices with DIY discounts starting at a mix of just 25 pieces. Write or 'phone for list.

Please add 50p post & packing to orders under £15 and VAT to total.

Access & Visa welcome, 24hr service on (054 422) 618.

Government & Education orders welcome, £15 minimum.

Trade accounts operated, 'phone or write for details.

**Happy Memories (PCW), Gladestry, Kington,
Herefordshire HR5 3NY. Tel: (054 422) 618 or 628**



FULL DETAILS AVAILABLE FROM

Belmondo Research Ltd
68 Maple Road
Horfield
Bristol

Tel No: 0272-427428

AVON

OSBORNE USERS

SPECIAL OFFER*

WHY PAY MORE FOR STATESIDE ANCILLARIES

COMMAND OVERLAYS FOR:-

D-BASE/WORDSTAR/MAILMERGE/SUPERCALC

M . BASIC

ALL THE COMMANDS ARE THERE AT YOUR FINGER TIPS
AND ITS FULLY TRANSPORTABLE

*INTRODUCTORY SPECIAL OFFER

ALL FIVE COMMAND OVERLAYS

£50.00 INC.

SINGLE PRICE £15 EACH INC.

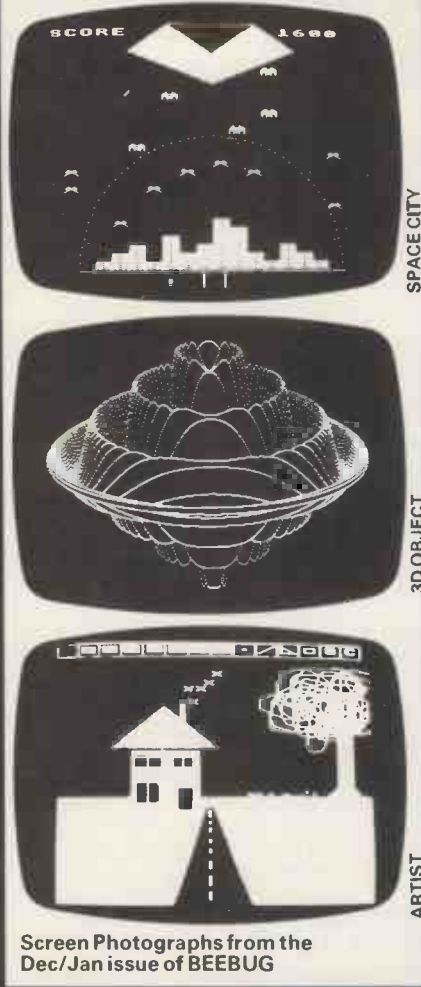
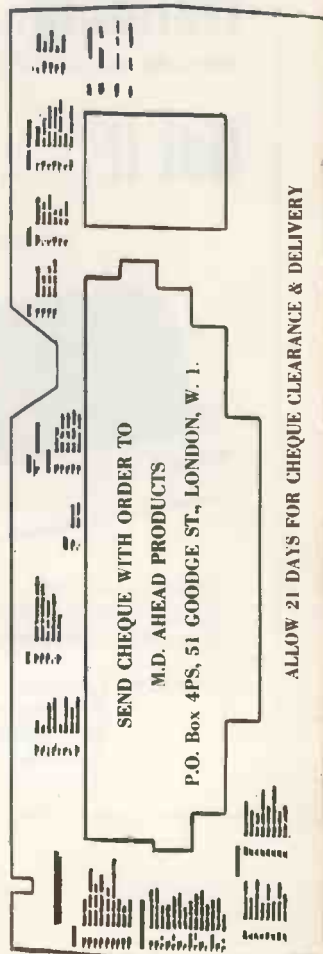

BBC MICRO

REGISTERED REFERRAL CENTRE FOR THE BBC PROJECT

BEEBUG FOR THE BBC MICRO

BRITAIN'S LARGEST SINGLE-MICRO USER GROUP

MEMBERSHIP NOW EXCEEDS 13,000

13,000 members can't be wrong - BEEBUG provides the best support for the BBC Micro. BEEBUG Magazine - now 54 pages - devoted exclusively to the BBC Micro. Programs - Hints & Tips - Major Articles - News - Reviews - Commentary. PLUS members discount scheme with National Retailers. PLUS members Software Library. 10 Magazines a year. First issue April 1982. Reprints of all issues available to members.

September Issue: High/Low Card Game, and Hangman Programs. Articles on Logic on the Beeb, Debugging, Moving multicoloured characters, creating new colours, Operating system 1.1. Plus Postbag, Hints and Tips, and Procedure Library.

October Issue: Program Features: Alien Attack; Calendar Generator; Union Jack; Memory display utility. Plus articles on Beebugging; Improving Key Detection; Acorn Press Release on O.S.H.2.; and Issue II Basic; The Tube and Second Processor Options; or New Series for less experienced users; and Software Reviews.

November Issue: Program Features: Racer (excellent 16K racing car game), Mini Text Editor (Mk2), Transparent Loader, Music with Memory, Harmonograph Emulator, New Character set for Modes 2 & 5; and cassette block-zero - bug retrieve. Plus articles on sound and envelope design - includes indispensable envelope editor program; Debugging Part 3, BBC Basics - Memory Maps and addressing explained; Serial Printer Port (RS423) and RGB upgrade. Plus a large number of Hints & Tips, and a guide to our past issues and their contents.

December/January Issue: Program Features: Space City (invader-type game), Breakout, Artist (Joystick painting program); Rescue (miraculously retrieves programs after bad loading or 'Bad Program' message); and Pack - a program to compact Basic programs. PLUS Disc System Review, Software reviews - including Wordwise, Book reviews, Adding Joystick interface to model A; How to access the video controller chip; and ideas for the newcomer; plus a new crop of Hints and Tips.

SOFTWARE DETAILS

BEEBUGSOFT : BEEBUG SOFTWARE LIBRARY

offers members a growing range of software from £3.50 per cassette. 1. Starfire (32K). 2. Moonlander (16K). 3D Noughts and Crosses (32K). 3. Shape Match (18K). Mindbender (16K). 4. Magic Eel (32K). 5. Cylon Attack (32K). 6. Astro-Tracker (32K). Utilities: 1. Disassembler (16K). Redefine (16K). Mindi Text Ed (32K). Applications: 1. Superplot (32K). 2. Masterfile (3K).

13% DISCOUNT TO MEMBERS ON THE EXCELLENT WORDWISE WORK PROCESSING PACKAGE - THIS REPRESENTS A SAVING OF OVER £5.00.

Send £1.00 for SAE for Sample

Membership: UK £5.40 for six months, £9.90 for one year.

Overseas one year only: Europe £16.00, Middle East £19.00. Americas & Africa £21.00. Other Countries £23.00.

Make cheque to BEEBUG and send to: BEEBUG Depot 6, 374 Wandsworth Rd, London SW8 4TE

For editorial material send to: The Editor, BEEBUG, PO Box 50, St. Albans, Herts AL1 2AR

Come to Kenilworth for
SHARP
OFF-THE-SHELF
RELIABILITY

We have MZ80 A & B and PC 1500 with Software back-up expertise to advise you on your requirements. See the advanced technology of SHARP on demonstration.

— THE LARGEST U.K. NASCOM DEALER —

Come to Kenilworth
THE LARGEST UK
NASCOM DEALER

We are the largest NASCOM distributors in the U.K. and are up-to-date with all the latest hardware and software. Colour, Sound, Speech, Educational, Business, Home, or any application you have in mind.

Kit Computers with power supply, £260 excl. VAT.
Built Computers with power supply, £375 excl. VAT.

— SHARP OFF-THE-SHELF RELIABILITY —

Come to Kenilworth for
DRAGON
FANTASTIC VALUE FOR MONEY

British built and designed. 32K RAM as standard, (expandable to 64K Bytes). Plus extensive facilities for colour graphics. 9 colour, 5 resolution display. Advanced sound. Prices from only £199. inc. VAT.

Full ranges of Software – tapes, cartridges, joysticks, books etc.

— THE VERY POPULAR —

Come to Kenilworth for
QUIBS
BUSINESS SYSTEMS

An integrated Nominal, Purchase and Sales Ledger with optional invoicing and stock packages using the QUANTUM (British) with up to 2.25M BYTE of floppy discs. Very competitive prices. But best of all friendly, professional advice on the best system.

— THE WELSH DRAGON —

Come to Kenilworth for
SINCLAIR
A MOST POPULAR MODEL

SINCLAIR ZX81 at £49.95
16K RAM PACK at £29.95
SINCLAIR PRINTER
at £59.95

XZ81 1K RAM, one-touch Keyboard, complete with all connecting leads. 16K RAM pack plugs into expansion port enabling use of sophisticated ZX Software. ZX printer had full alphanumerics and graphics, 50cps, 32 characters per line.

EDUCATIONAL USES—

Our main product line – Nascom – will act as an excellent stand-alone system, optionally with High Resolution Colour Graphics and will attach to an economical Local Area Network. Ask for details of our recent installations in the educational field.

Come to Kenilworth for
WORD
PROCESSING

We can offer a choice of low cost systems that will cut the cost of business letters and documents; repeat letters; speedy correction from video screen. Prices from as little as £1,600 incl. VAT.

— QUIBS BUSINESS —

Yes...come to Kenilworth
Business & Leisure
Micro Computers

16, The Square, Kenilworth,
Warwickshire CV8 1EB.
Telephone: (0926) 512127.

Software package transforms efficiency



Plastics Technology of Lewes, Sussex
Manufacturers of high quality transformers

Everyone knows reliable accounting software is an asset to any business. Sadly really good packages are not so easy to find.

But Plastics Technology have got just such a package from Open Computer Services. It's easy to use and offers a comprehensive programme that can readily be updated.

Contact Open Computer Services for quality software. And don't forget, should you find a bug in one of our packages, we'll give you £100.

OPEN COMPUTER SERVICES

Aqua House Old Steine Brighton BN1 1EL
Tel. (0273) 672191 Telex 878195

Software systems for most 8 bit and 16 bit micro-computers including IBM Personal, Sirius and Xerox using CP/M and MS/DOS operating systems.
DEALER ENQUIRIES INVITED

THE REAL INVESTMENT

**NEW:
THE X-ROMCARD
FOR YOUR ZX81**



**WHAT IS SO
SPECIAL ABOUT
THE
SPECIAL RAMPACK?**

WHAT IS SO SPECIAL ABOUT AUDIO'S 16K SPECIAL RAM PACK?

THE SPECIAL RAM PACK (16K) is the latest design of its kind, following at least a dozen similar products. It has many of the good points of its predecessors, including packs manufactured by Sinclair Research, Memotech, Bygbyte and Econotech to cite a few of the best known.

With the experience we have gained with memories both for the ZX 81 and a wide range of other Micros, we are also able to offer some exclusive new features:

THE CASE: The SPECIAL RAM PACK has been designed to overcome the infamous 'wobbling' problem associated with many other packs, and does not resort to temporary solutions such as Velcro, Blutak, adhesive strip or a huge, unsightly case. It clamps positively to the ZX 81 by means of a special built in ridge aided by a resilient spring effect in the connection socket (see figure 1).

EXPANSIBILITY: The SPECIAL RAM PACK is not only compatible with all software and hardware produced for the ZX 81, such as the ZX printer, but it also has the edge over other packs with its expansibility. You will find it interesting that the keyboard sounder option is already included in the SPECIAL RAM PACK. It also has expansion pins, ready to receive — in the same case — the most advanced add-on ever designed for the ZX 81 — the X ROM CARD (see figure 2).

WHAT DOES THE X-ROM CARD OFFER?

1. The X-ROM CARD has a built in autostart ROM. Programs can be run automatically every time the ZX 81 is switched on. This will result in a huge increase factor for ROM based software, since all software houses are currently very aware of copyright piracy problems.

2. The X-ROM CARD has a built in printer interface, necessary if you wish to use a printer other than the ZX printer. This is invaluable for any serious applications, including word processing, where careful presentation is of the utmost importance.

3. The X-ROM CARD has a built in EPROM burner. This means that you can save Basic or Machine code programs onto silicon chips and play them back at any time.

4. You may of course buy the X-ROM CARD to use with other Ram Packs such as the Sinclair Ram Pack. However, when you purchase the X-ROM CARD with the SPECIAL RAM PACK, you will have the advantage of lower cost, greater reliability and neatness, since the whole system is nicely housed within a single case.

IN CONCLUSION, The SPECIAL RAM PACK, is the best immediate investment for your ZX 81. The availability of the X-ROM CARD opens the way to new software development such as languages programming and is the guarantee that your system will never be obsolete.

**THE BEST GUARANTEE
THAT YOUR ZX81 WON'T BE
OBSOLETE FOR ONLY:**

£ 19 .95

19

including VAT

fig. 1

fig. 2

TECHNICAL SPECIFICATIONS:

- **SPECIAL RAMPACK:**
 - Memory capacity: 16K bytes.
 - Maximum speed: 200 ns access time.
 - Power requirement: Use exclusively Sinclair PSU.
- **X-ROMCARD:**
 - **Autostart ROM:** 4K byte, exchange for 8K bytes and software switch possible. Displays memory size, checks for byte "00" (identifies ZX basic) @ 2000H. Loads program if found, checks for byte "C3" and jumps (2000H) if found. Checks for presence of ROM in socket n.3 and ROM catalog, displays catalog if found. Contains also machine code monitor and printer utility.
 - **Preprogrammed ROM:** Catalog available on request. Use only 2732 or 2764 ROM/EPROM.
 - **Blank EPROM:** Use only 2764 — 8K bytes per device — in socket n.3. 3 x 9V, PP3 size batteries are needed to burn EPROM.
 - **Printer connection:** 16 pin DIL output, use standard IDC ribbon cable. Outputs include DO to D7, Strobe, Reset, Inputs include No-fault and Busy.
 - **Documentation:** Schematic diagram included, full listings of Autostart ROM extra (only for X-ROMCARD user, £1.50 + large SAE)

AUDIO-COMPUTERS

87 BOURNEMOUTH PARK ROAD,
SOUTHEND ON SEA — ESSEX SS5 2JJ

THE REAL INVESTMENT
SOLIDISK TECHNOLOGY LIMITED
87 Bournemouth Park Road,
Southend-on-Sea, Essex. SS5 2JJ Tel: 0702 613081

Item	Qty	Price inc VAT	Total
SPECIAL RAMPACK 16K		£19.95	
X-ROMCARD		free	
Preprogrammed ROM		£ 9.95	
BLANK EPROM 2764		£ 1.00	
Postage and packing			
Please charge my Account, Barclay account:			TOTAL £
NAME			
ADDRESS			

* Please delete/complete as applicable
P.O. payable to:
SOLIDISK TECHNOLOGY LTD
for: £

You'll manage better with an Apple beside you



Whatever you do, you'll do it better with an Apple Desktop computer. Over 400,000 businessmen throughout the world have found how an Apple can put enjoyment back into their work.

The friendly computer.

With an Apple on your desktop, you can handle amazing feats of calculation, financial projections, as well as storing, organising and retrieving information the way you need it.



For little more than the price of a photocopier, Apple helps take the drudgery out of office routine.

It's good for business. And any business.

Whatever you do—from accounting or farming to medicine or retail—there's a vast range of software specially written for Apple.

Apple can even do word processing. And now there's Apple III, a new big brother for Apple II. So that you can choose the Apple that's right for your business.



Your personal Apple dealer.

Personal Computers Limited is the nation's longest established Apple dealer and as a result, we at Personal Computers have had plenty of experience cutting big problems down to size . . . with microcomputer systems. Our highly trained staff will be very happy to give you the benefit of that experience on any problem — big or small, together with full support from our excellent maintenance department. Come and see us — we will help you to get the most from an Apple.

Personal Computers

218 & 220/226 Bishopsgate,
London EC2M 4JS Tel. 01 377 1200