

57 ✓ VIL

# Personal Computer

PLUS  
GEMINI  
BENCHTEST

Canada \$2.75/US \$2.00/FF 8.80/FL 4.00/SFr 7.20/IR £1.06/  
BFr 87/SKr 13.55/DKr 21.00/Lire 3000/DM 5.50

World February 1982 75p

**BRITAIN'S LARGEST SELLING MICRO MAGAZINE**



**FROM THE MAN WHO GAVE YOU PET...  
Sirius: The 3rd Generation Micro**

**NEW  
MODEL**

**LOWER  
COST**



## ***Cromemco System One***

MicroCentre introduce Cromemco's new System One computer, available with an integral 5 megabyte Winchester hard disk, at a new low price.

The System One supports the full range of Cromemco interface cards, including high resolution colour graphics, and software packages. The choice of operating systems includes CDOS, CP/M and CROMIX—Cromemco's answer to Unix.

**Call MicroCentre for  Cromemco**

**MicroCentre Ltd**  
(Complete Micro Systems)

**Britain's independent  
Cromemco importer**

**30 Dundas Street  
Edinburgh EH3 6JN  
Tel: 031-556 7354**



# MICRO TRAINING FOR COMPUTER USERS

# 6 Micro courses



Which would you like to attend?

Digitus is running a number of courses to train users and potential users in the basic skills of micro-computing. Conducted at our Central London Workshop, the courses provide hands-on experience of microcomputers, demonstrations of working systems and tutorials on your particular needs.

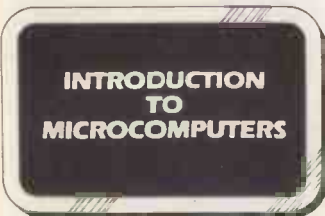

One day's concentrated information on microcomputing aimed at the potential user in small and large organisations. A practical course which includes business applications of micros, guidelines on selecting microcomputer systems and an introduction to programming.

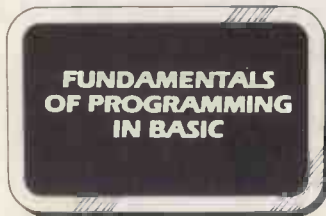

A two day course designed to teach the first principals of programming in BASIC. Aimed at those with some understanding of micros who want to learn how to instruct their computer to perform tasks.



A two day course for those who have learned Basic from hands-on experience and want to brush up their BASIC techniques and learn some timesaving software tools.

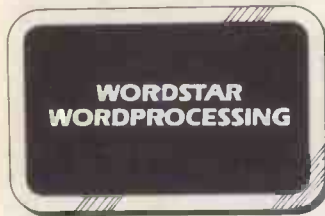

A one day course for people who want to learn the fundamentals of wordprocessing. Uses the popular Wordstar wordprocessing package available on most CP/M micros and teaches by hands-on use.



The DataStar data entry, retrieval and management system is a powerful aid which enables the educated user and computer professional to build information systems economically and rapidly.

**Training for Computer Professionals**  
Course in: Micro Technology for Management • Local Area Networks • Micros for Computer Professionals.  
Courses are run at the Workshop or on site. Telephone or write for details.

**Micro Technology Workshop** Set in 8,500 sq.ft in Central London, the Workshop is a few minutes from Covent Garden, Trafalgar Square, Charing Cross, Embankment and Waterloo stations. Specialist areas include: Personal Computers, Technical Systems, Business Systems, 16 bit and Local Network Systems, Bookstore and Training Rooms.

**Booking and Fees** The fee for all courses is £80 per day plus VAT, payable 14 days prior to starting date.



In addition to Wordstar, Micro-Pro Inc have produced a variety of aids to improve productivity in offices and systems departments. This one day course includes: Mail-Merge linked to Wordstar • Supersort sorting utility • CalcStar rows and columns manipulation • DataStar information manager • harnessing the 'Star' products together.

All courses provide access to an extensive range of micro hardware, software and expertise.

Note: Wordstar and DataStar are registered trademarks of Micro-Pro Inc.

**Booking Form** (Please complete in BLOCK capitals)  
To Digitus Ltd, 10-14 Bedford Street, London WC2E 9HE. Tel 01-379 6968

Please send me further information     Reserve places as follows:

Name of delegate ..... Date .....

Name of delegate ..... Date .....

Name of delegate ..... Date .....

**Courses/dates**

Introduction to Microcomputers	<input type="checkbox"/> Feb 8	<input type="checkbox"/> Apr 19
Fundamentals of Programming in Basic	<input type="checkbox"/> Feb 9/10	<input type="checkbox"/> Apr 20/21
Improve your Basic	<input type="checkbox"/> Feb 11/12	<input type="checkbox"/> Apr 22/23
Wordstar Wordprocessing	<input type="checkbox"/> Feb 23	<input type="checkbox"/> May 11
Micro-Pro Software Tools	<input type="checkbox"/> Feb 24	<input type="checkbox"/> May 12
DataStar Information Management	<input type="checkbox"/> Feb 25	<input type="checkbox"/> May 13

Company/address .....

Name ..... Position .....

Signature ..... Tel.No. ....



PCW

Cover photography by Chris Stevens  
Photographs of Chuck Peddle by Tony Sleep



## 60 NEWSPRINT

All the micro computing news that fit to print plus some that isn't; brought to you by Guy Kewney.

## 74 BANKS' STATEMENT

A gripping tale of governmental tyranny and bureaucratic obfuscation as told to Martin Banks by the legendary 'Bumper' Harris.

## 77 CTUK! NEWS

The latest news from Britain's own grass roots computer literacy movement — ComputerTown UK!

## 78 COMMUNICATIONS

Negative and positive feedback from PCW's readers.

## 82 SCRIPSIT 2.0

Tandy's popular word processing package reviewed by Jane Bird.



See page 86

## 86 FRAMES OF REFERENCE

Continuing Alan Woods series on the implications of the personal computer for the traditional data processing industry. This month a look at the micro manufacturers and software suppliers.

## 93 WATANABE PLOTTER

Editor Rodwell checks out an expensive but tempting peripheral, Watanabe's intelligent plotter.

## 99 CALCULATOR CORNER

An airline pilot describes how, despite all his modern navigation aids, a programmable calculator finds a place on his flight deck.

## 100 PATTERNS

Alan Sutcliffe considers the place of mirror images in computer graphics, with programming examples to achieve image reversal.

## 104 SIRIUS BUSINESS

Chuck Peddle's new 16-bit business computer looks set to make massive waves in the marketplace offering exceptional value for money. We present Britain's first Benchtest of the ACT Sirius-I.

## 109 BOOKFARE

Malcolm Peltu reviews books ranging from psychology to typography, but all with a computing angle.

## 117 GEMINI MULTIBOARD

Benchtesting a new low price modular micro computing system which will interest hobbyist and professional alike. Neil Cryer investigates.



## 122 CASIO fx - 9000p

Dick Pountain tries out the first desk top computer from Casio; a powerful mathematics engine with some unusually hardware features.

## 131 HIGH DENSITY VDU CARD

Our hardware feature for this month; B J Hawkins tells how to design and build a display controller to give 80x24 character screens.

## 138 FREQOUT!

David Ellis checks out a sophisticated new music synthesiser package for Apple.



## 142 ANS BASIC

The American National Standard for the Basic language contains some powerful and, to those reared on Microsoft products, unfamiliar feature features. Mike Parr outlines them.

## 148 TJ'S WORKSHOP

Terminal Junkies get their monthly hardware and software fixes here.

## 154 THE MAN BEHIND THE WEST COAST FAIRE

A personality profile by Dave Tebbutt of one of the founders of personal computing; Jim Warren who gave the US Dr Dobbs, The West Coast Faire and Info World.



## 157 PCW SUBSET

More useful assembler subroutines for popular processors.

## 162 COMPUTER ANSWERS

Readers' queries answered by Sheridan Williams and his band of experts.

## 164 NEWCOMERS START HERE

Our quick intro for those new to computing.

## 165 DIRECT ACCESS

In Store, Transaction File, User Groups Index Update, Network News Diary Data and CTUK! centres.

## 177 LEISURE LINES

J J Clessa's latest brain teasers.

## 177 PROGRAMS

More readers' programs for popular machines.

## 191 BLUNDERS

Everyone makes mistakes but only PCW publicises them!

## 192 BACK ISSUES

Catch up with what you missed (if we haven't sold out of it).

## 255 CHIPCHAT

Read how PCW publisher won a computer in an Asteroids tournament, plus the usual industry gossip, slander etc.

Founder  
Angelo Zgorelec  
Managing Editor  
Dick Pountain

Editor  
Peter Rodwell

Programs Editor  
Maggie Burton

Consultant Editor  
David Tebbutt

Art Director  
Paul Carpenter

Art Editor  
Phoebe Creswell-Evans

Typesetter  
Jane Hamnell

Advertisement Director  
Stephen England

Advertisement Manager  
Patrick Dolan

Assistant Advertisement  
Manager  
Claire Fullerton

Publicity/Press Relations  
Penny Flood

Production Manager  
Stephen Rowe

Advertisement Production  
Vic Lime  
Anna Williamson

Advertisement Design  
Nicole Reehal  
Kate Goode

Subscriptions Manager  
Alexandra James

Subscription rates  
UK: £10.00  
Overseas: £17.00

Address  
14 Rathbone Place,  
London W1P 1DE  
01-631 1433  
(10am - 6pm)

Published by SportsScene  
Publishers (PCW) Ltd,  
14 Rathbone Place,  
London W1P 1DE,  
England.  
Tel: 01-631 1433  
Telex: 8954139  
BUNCH G London

Personal Computer World  
is published by SportsScene  
Publishers (PCW) Ltd. ©  
1981 Felden Productions.  
No material may be  
reproduced in whole or  
part without written  
consent from the copy-  
right holders.

Printed by Riverside Press,  
Whitstable. Distributed  
by Seymour Press, 334  
Brixton Road, London  
SW9. Tel: 01-733 4444

ABC

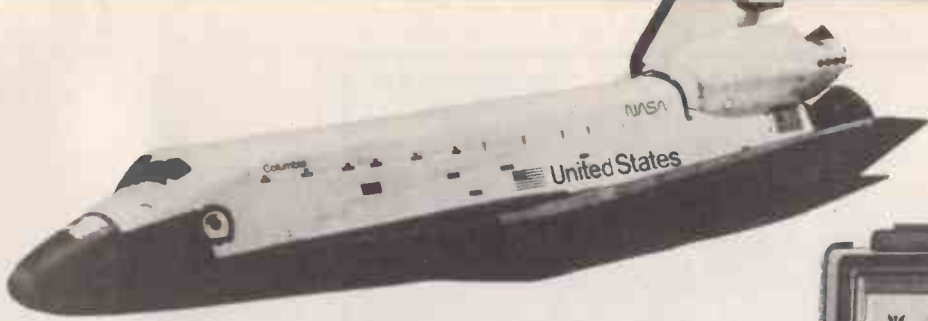

On the edge of the atmosphere, space shuttle Columbia was about to lose all contact with Earth: for 21 agonising minutes, touch-down would be touch-and-go. As the world held its breath, the £4½ billion project relied on a £165 hand-held calculator, small enough to live in the pocket of Robert Crippen's flight suit. The Hewlett-Packard HP-41C. Unmodified. Just as you buy it today. . .

# Astronaut quality. Everyday simplicity. The HP-41C. £184<sup>inc</sup> VAT\*

Sooner or later, a basic calculator is too basic.

Suddenly you need to 'compute'—but with a 'computer' that's as simple and pocketable as a hand-held calculator. And, as NASA found, that means an HP-41C.

Today, a broad-ranging companion to an A-level course.

Tomorrow, a fully-fledged, advanced programmable system for the businessman, analyst, researcher, technician, engineer or scientist.

Whatever your job, here's a calculator that will grow with you and your needs step-by-step into a complete calculating system—yet will always stay simple, manageable and portable.

## The friendly calculator with power in reserve.

As a straightforward calculator, the HP-41C is a masterpiece of compact power.

It gives you read-out in letters, as well as figures and symbols, so the display can talk to you in an easy, simple way.

Yet, inside, it has the effortless, problem-solving power normally associated with computers.

Among other things, that means the HP-41C is fully programmable. You can feed its built-in 400-line memory with ready-made programs or develop your own. Its friendly style makes it surprisingly easy. And, because the memory is continuous, what you put into it stays in—even when you switch off.

But that's not the end of the story by any means. Because, unlike any other advanced programmable calculator you are likely to see, the HP-41C has behind it a highly developed package of software support representing many years of heavy investment by Hewlett-Packard. So when you buy the HP-41C you don't just *own* a powerful system; you can put it powerfully to *work*.

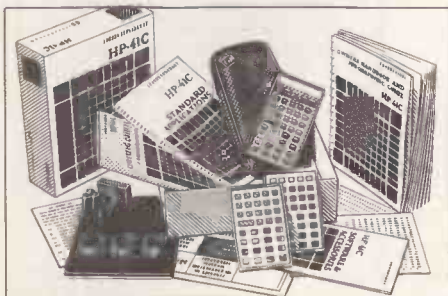

The HP-41C hand-held 'computer' in a box. £184 brings you the calculator, a comprehensive 270-page manual, owner's handbook, and programming guide, a standard applications handbook, customising overlays. HP Users' Library membership reply card, free one year's subscription to HP's User's Newsletter, batteries, carrying pouch and 12 months' full guarantee.

## Proven software support – at your fingertips.

Here, the HP-41C really comes into its own with an unrivalled range of software support.

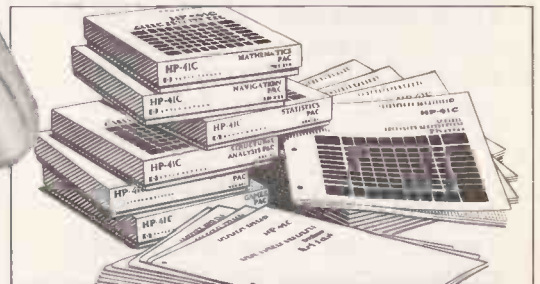

**17 Application Modules** – miniature plug-in solutions: maths, electrical engineering, financial decisions, games . . .

**29 Solutions Books** – each with up to 15 programs drawn from the best of 10,000 user-submitted programs. Each book provided with Bar Codes – for instant program entry with the HP wand.

**11 Application Pacs** – pre-recorded magnetic cards covering over 2,000 programs, entered through the card reader.

All software and peripherals are optional extras.

\*Price correct at time of going to press.



## Two ways to make your system grow...

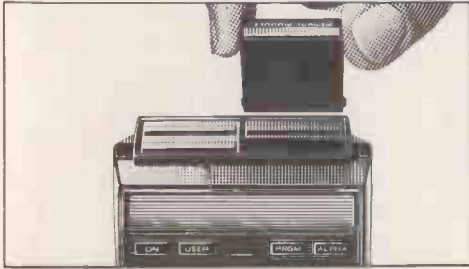

**Snap-in more memory.** A single module will double the memory available. A quad module adds no fewer than 256 registers at once. Suddenly you've got over 1800 lines of memory at your command.

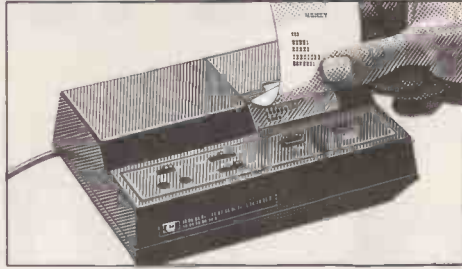

**Plug-in a printer.** The HP-41C printer handles upper and lower case, in alpha, numeric and graph-plotting modes. Use it for final hard copy, or to follow program execution.

## Four ways to program your HP-41C...

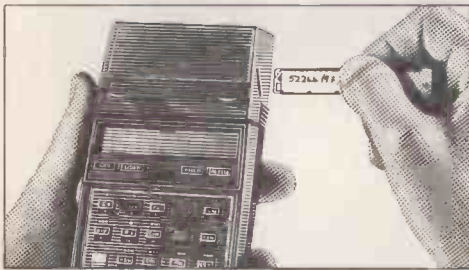

**Card reader.** This reads pre-programmed magnetic cards. It can also record and read your own programs and data.

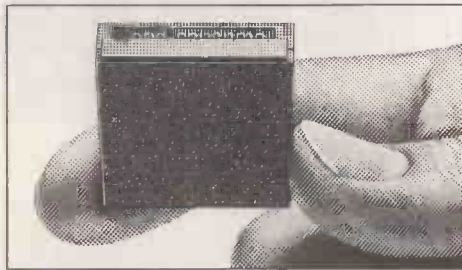

**Application modules.** These are plug-in modules each containing a whole range of ready-made programs on your chosen subject.



**Bar code reader.** A quick and easy way of loading any one of the software packages. The wand simply 'lifts' the coded program straight off the page of your HP-41C solution books.

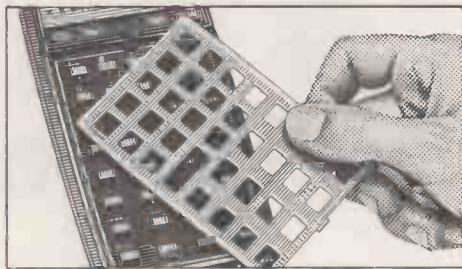

**Keyboard customising.** Develop your own programs and enter them through the keyboard. You can assign any function or program to any key and mark them on your own customising overlay.

## Thousands of easy ways to solve problems.

Think of a problem! As an HP-41C owner you won't have far to look for the solution—or long to wait before it's locked in your system's memory. Any of HP's hundreds of pre-programmed solutions can be easily entered in any of the four ways we illustrate above. You'll certainly want to devise your own solutions, too. The guidance manual in your basic pack tells you how. If you develop an original one you could submit it to the HP-41C Users' Library. It already contains thousands of tested programs which 10,000 users worldwide are happy for you to share.

## Quality from HP—the big computer manufacturer.

The HP-41C is made from the chip upwards by Hewlett-Packard, a world leader in computers. And you can tell! By the detail like the permanent inlaid key notations, tough ABS case, and gold-plated port contacts. By the elegant simplicity designed into the HP-41C's operating style. By the sort of software support only a computer giant would be capable of. By the utter reliability that is the HP hallmark throughout the world of computers.



## See the HP-41C at Comet, Xerox Stores, Wilding, Sumlock-Bondain, Landau or these other Appointed Dealers:

- Aberdeen Tyseal Office Equipment.
- Bath Wilding Office Equipment.
- Belfast Cardiac Services Company.
- Birmingham John Mabon Associates; Research Micro System.
- Bolton Wilding Office Equipment.
- Bournemouth South Coast Business Machines.
- Brighton Office Machinery Engineering Co.
- Bristol Decimal Business Machines; Wilding Office Equipment.
- Bromley Wilding Office Equipment.
- Cambridge W. Heffer & Sons; Wilding Office Equipment.
- Canterbury R. E. Typewriters.
- Cardiff Sigma Systems (Calculators).
- Carlisle Thos. Hill International.
- Colchester Wilding Office Equipment.
- Croydon Wilding Office Equipment. Derby Office Machines.
- Dundee Tayside Office Equipment.
- Edinburgh Business & Electronic Machines; Holdene; Robox.
- Folkestone R. E. Harding. Glasgow Robox.
- Gloucester Wilding Office Equipment.
- Gravesend Wilding Office Equipment.
- Grimby Teesdale Office Equipment.
- High Wycombe Wilding Office Equipment.
- Hornchurch Wilding Office Equipment.
- Ilford Wilding Office Equipment.
- Ipswich Anglia Business Machines; Wilding Office Equipment.
- Kingston-upon-Thames Wilding Office Equipment.
- Leeds Holdene; Wilding Office Equipment.
- Leicester A. C. Barratt & Co.; Sumlock Services.
- Lichfield Anglo American Computing.
- Liverpool Rockliff Brothers.
- London AEC—2 Shoreditch High Street; City Business Machines—57 Houndsditch, Bethnal Green Road; Concept Business Systems; Dixons. Photographic—123 Holborn, 64 New Bond Street; Euro-Calc—128-132 Curtain Road, 224 Tottenham Court Road, 55 High Holborn; Landau Calculators—Bourne's Oxford Street, 227 Tottenham Court Road; McDonald Stores—78 Oxford Street; Metyclean—137 The Strand, 92 Victoria Street; Mountaine—22 Cowper Street; Sumlock-Bondain—263-269 City Road, 360 Euston Road, Cannon Street Station; Wallace-Heaton—127 New Bond Street; Wilding Office Equipment—7 The Arcade Hoe Street, 21 Thomas Street, 120 The Broadway, Wimbledon; 199 Parrock Street, Gravesend. The Xerox Store Piccadilly—76 High Holborn, 110 Moorgate.
- Luton Wilding Office Equipment.
- Maidstone Wilding Office Equipment.
- Manchester Automated Business Equipment; Holdene; Wilding Office Equipment. Matlock Derby Office Machines.
- Middlesbrough Thos. Hill International.
- Newcastle Thos. Hill International.
- Northampton A. C. Barratt & Co.
- Norwich Leamons Office Machines; Sumlock-Bondain.
- Nottingham Bennett's (Typewriter & Office Suppliers); Trent Office Equipment. Oxford Reid's Office Equipment; Science Studio. Plymouth JAD Integrated Services.
- Reading Central Southern Equipment; Reid's Office Equipment; Caversham, 38 Market Place, Reading.
- Romford Wilding Office Equipment. Royston Herts Electroplan.
- Sheffield Butlers Office Equipment.
- Slough Wilding Office Equipment.
- Southampton Leicester Typewriters.
- Southeast Wilding Office Equipment.
- Sunderland Thos. Hill International.
- Sutton Landau Calculators.
- Swindon Wilding Office Equipment.
- Waltham Cross Wilding Office Equipment.
- Watford Automatic & Electronic Calculators; Wilding Office Equipment.
- Worthing Office Machinery Engineering Co.
- CHANNEL ISLANDS: Guernsey A. E. S. Ltd.
- Jersey A. E. S. Ltd. EIRE: Dublin Abacus Systems.

All UK Comet branches.

# MORE ROOM AT THE TOP!

## The 5th Personal Computer World Show

**BARBICAN CENTRE  
CITY OF LONDON  
9 - 12 September 1982**

If you came to the 4th Personal Computer World Show this year you'll know exactly what we mean.

If you didn't, then you missed the spectacle of over 16,000 people cramming themselves into two halls filled with the most up-to-date hardware, software and peripherals going.

But we won't be caught again. For 1982 we are moving to the Barbican Centre in the City of London — *the* new exhibition venue with everything going for it. Excellent location, superb facilities, and lots of room for more exhibitors and more visitors.

Just like this year there will be one floor devoted to business and professional microcomputing and one devoted to home and hobbyist applications. But overall there will be almost twice as much exhibition space. And we're opening for four days instead of three.

Judging by the level of advance reservations from the 1981 Show, space is still going to be in short supply. So phone or return the coupon to Timothy

Collins now. If you don't, you can be sure your competitors will.

Tim Collins Montbuild Ltd, 11 Manchester Square  
London W1 01-486 1951

Please rush me details of exhibiting at the  
5th Personal Computer World Show

Name .....

Position .....

Company .....

Address .....

.....

.....

Tel No .....



# MICROCOMPUTERS

# AT LASKYS

PRICES JANUARY/FEBRUARY 82

# 10 Shops Nationwide

## Birmingham Manchester

19/21 Corporation Street, Birmingham, B2 4LP.  
Tel: 021-632 6303. Manager: Peter Stallord.  
300 yards from Bullring Centre.

12/14 St. Mary's Gate, Market Street,  
Manchester, M1 1PX. Tel: 061-832 6087.  
Manager: Lesly Jacobs. Corner of Deansgate.

## Bristol Glasgow

16/20 Penn Street, Bristol, BS1 3AN.  
Tel: 0272 20421. Manager: Steve Heynes.  
Between Holiday Inn and C & A.

22/24 West Nile Street, Glasgow, G7 2PF.  
Tel: 041-226 3349. Manager: David Livingstone.  
Between Buchanan Street and Central Station.

## Chester Sheffield

The Forum, Northgate Street, Chester, CH1 2BZ.  
Tel: 0244 317667.  
Manager: Jeremy Ashcroft. Next to the Town Hall.

58 Leopold Street, Sheffield, S1 2GZ.  
Tel: 0742 750971. Manager: Justin Wozles.  
Top of the Moor, opposite Town Hall.

## Edinburgh Liverpool

4 St. James Centre, Edinburgh, EH1 3SR.  
Tel: 031-556 6217. Manager: Colin Draper.  
East end of Princes Street, St. James Centre.

33 Dale Street, Liverpool, L2 2HF.  
Tel: 051-236 2828. Manager: Mark Butler.  
Between the Town Hall and Magistrates Courts.

## Preston London

1/4 Guildhall Arcade, Preston, PR1 1HR.  
Tel: 0772 59264.  
Manager: Jim Comisky. Directly under Guild Hall.

42 Tottenham Court Road, London, W1 9RD.  
Tel: 01-636 0845.  
Manager: Vass Demosthenis.

## Terms & Conditions

### Our Conditions of Business

In addition to cash we accept Access, Barclaycard, Stereo Club, American Express, Diners Club and cheques covered by a bankers card. Official orders over £50 are welcome, with normal 30 days credit extended to bona-fide commercial and government organisations. All prices, specifications and terms are subject to change without notice at the discretion of the management. Offers subject to availability. All previous Laskys Advertisements are superseded by this. Not all stores carry every advertised item. Prices correct at time of going to press. E & O.E.

### Computer Retailers Association

We are founder members of the Computer Retailers Association a voluntary organisation of leading micro-computer dealers and service organisations. The purpose of this Association is to maintain and improve standards of trading and customer support within the industry and to present the industry's case to the outside world. The Association also acts as a forum where members can discuss common problems.

### A Better Guarantee

The products are warranted against defects in material and workmanship for a period of one year from the date of purchase, two years for Apple and Sharp products. During the warranty period, the company will repair (or at its own option, replace) at no charge, components that prove defective. This is provided the product is returned, shipping prepaid, or by person, stating when it was bought and enclosing proof of purchase. This warranty does not apply if, in the opinion of the company, the product has been damaged by accident, misuse or misapplication.

### Laskys Stereoclub

— the handy way to buy, from Laskys. Multiply your monthly payment by 24 to find out your credit limit. For instance, for the minimum monthly payment of £5 you would get credit up to £120. In some cases you may be able to get instant credit by paying a deposit of 10% of a purchase price. Current Stereoclub interest rate is 2.75% monthly — equivalent to an APR of 33.5%. Rates may vary. If you pay by Bankers' Order, apart from the extra convenience, you'll enjoy a LOWER INTEREST RATE — currently 2.45% monthly, equivalent to an APR of 33.7%. As a Stereoclub member we'll send you regular news and literature from Laskys. Laskys Stereoclub is probably the best thing that's happened to Microcomputers since the invention of the chip!

### Head Office

Accounts administration and engineering are at:  
Microcomputers at Laskys, 14 Castle Street, Liverpool L2 0TA. Telephone 051-227 2535.  
General Manager: Bruce Evers, Operations Manager: Graham Jones.



Laskys, the retail division of the Ladbroke Group of Companies

# MICROCOMPUTERS

# AT LASKYS



## OSBORNE

The Osborne 1 is a new concept in microcomputing — selling at a price of £1,250. This includes £800 worth of software, comprising CP/M, MBASIC, CBASIC, Supercalc and Wordstar/Mailmerge. The machine itself is based on a Z80 microprocessor with 64 KBytes of RAM as standard. The twin built-in floppy disk drives afford 100K of storage each. RS232 and IEEE ports are both incorporated. The 5" screen acts as a window of 52 x 24 characters onto a background of 128 x 32. An external full size monitor may be plugged in.

	NETT	V.A.T.	TOTAL
Osborne 1 Computer	1250.00	187.50	1437.50



## APPLE

	NETT	V.A.T.	TOTAL
Apple III Information Analyst	2695.00	404.25	3099.25
Disk III	385.00	57.75	442.75
Silentype III	222.00	33.30	255.30
● Apple II + 48K	675.00	101.25	776.25
● Disk Drive Plus Controller (3.3)	375.00	56.25	431.25
● Disk Drive	295.00	44.25	339.25
Programmer's Aid	26.00	3.90	29.90
Autostart Rom Pack	33.00	4.95	37.95
Graphics Tablet	485.00	72.75	557.75
● Silentype	195.00	29.25	224.25
Apple Tel System	575.00	86.25	661.25
Black and White Modulator	14.00	2.10	16.10
Pascal Language System	245.00	36.75	281.75
Applesoft Firmware Card	95.00	14.25	109.25
Integer Card	95.00	14.25	109.25
● 16K Ram Card (48K — 64K)	60.00	9.00	69.00
Language Card	97.50	14.63	112.13
Apple Pilot	79.00	11.85	90.85
Apple Fortran	105.00	15.75	120.75
Apple Prototype/Hobby Card	12.00	1.80	13.80
Vero Prototype/Hobby Card	10.00	1.50	11.50
Parallel Printer Interface Card	87.50	13.13	100.63
Communications Card	103.00	15.45	118.45
High Speed Serial Interface Card	94.75	14.21	108.96
Centronics Card	103.00	15.45	118.45
Controller Card	100.00	15.00	115.00
● Eurocolour Card	69.00	10.35	79.35
B/W Modulator	14.00	2.10	16.10
IEEE 488 Interface	230.00	34.50	264.50
Thermal Paper for Silentype	2.75	0.41	3.16

Vinyl Carrying Case	16.00	2.40	18.40
Apple Ties	6.00	0.90	6.90

### Aif

MC1 - 9 Voice	99.00	14.85	113.85
MC16 - 3 Voice	123.00	18.45	141.45
10-1-17 Timing Mode Input	11.30	1.70	13.00

### Heuristics

Speech Lab	135.00	20.25	155.25
Controller 70	60.00	9.00	69.00
Speechlink 2000	185.00	27.75	212.75

### Mountain Hardware

Clock/Calendar	173.00	25.95	198.95
Supertalker	185.00	27.75	212.75
Romplus + Keyboard Filter	127.00	19.05	146.05
Rom Writer	105.00	15.75	120.75
Music System Complete	330.00	49.50	379.50
Copyplus Rom	34.00	5.10	39.10
AD + DA 16 Channel	210.00	31.50	241.50
● CPS Card	160.00	24.00	184.00

### Other Items

● Omnivision	185.00	27.75	212.75
Numeric Keypad	85.00	12.75	97.75
Sup 'R' Terminal	195.00	29.25	224.25
Z80 Softcard	179.00	26.85	205.85

### Interactive Structures

AO-03/4 Analog Output 4 Chan	195.00	29.25	224.25
AO-03/8 Analog Output 8 Chan	299.00	44.85	343.85
A1-02 Data Aquisition	210.00	31.50	241.50
D1-09 Digital Interface	235.00	32.25	270.25
● A1-13 Analog Input 16 Chan	395.00	59.25	454.25

### March Communications

Micro Clock	49.95	7.49	57.44
Micro-Port	49.95	7.49	57.44
Micro-Synth	49.95	7.49	57.44
Micro-Talker 1	85.00	12.75	97.75

## APPLESOFTWARE

● Micro Modeller	425.00	63.75	488.75
● Visicalc (3-3)	105.00	15.75	120.75
Visidex	110.00	16.50	126.50
Visiplot	98.00	14.70	112.70
Visi Trend/Plot	140.00	21.00	161.00
Visi Term	82.00	12.30	94.30
Desktop Plan II	110.00	16.50	126.50
CCA Datamanagement	56.00	8.40	64.40
● D.B. Master V.2.4.	105.00	15.75	120.75

### Word Processing

Apple Writer	39.00	5.85	44.85
Magic Window Text Editor	49.00	7.35	56.35
Easywriter (80 Col.)	155.00	23.25	178.25
Mailmerge (80 Col.)	68.50	10.28	78.78
Easywriter (40 Col.)	51.30	7.70	59.00
The Address Book	27.00	4.05	31.05

### Games/Aids

Animation Pac	31.00	4.65	35.65
Saturn Navigator	15.00	2.25	17.25
Higher Graphics II	20.50	3.08	23.58
Higher Text	20.50	3.08	23.58
3D Super Graphics	22.25	3.34	25.59
Apple World	33.00	4.95	37.95
Memory Management System	25.25	3.79	29.04
Alien Rain/Typhoon	15.43	2.32	17.75
Sneakers	16.30	2.45	18.75
● Gorgon	16.30	2.45	18.75
Galaxy Wars	14.28	2.14	16.42
Raster Blaster	16.30	2.45	18.75
A.B.M.	15.22	2.28	17.50
Falcons	16.30	2.45	18.75
Pegasus II	17.17	2.58	19.75
Space Raiders	16.30	2.45	18.75
MyChess	23.00	3.45	26.45

# MICROCOMPUTERS



## APPLE BOOKS

	NETT	V.A.T.	TOTAL
Apple II Reference Manual	11.00	-	11.00
6502 Hardware Manual	9.00	-	9.00
6502 Software Manual	9.00	-	9.00
Apple II Basic Program Manual	6.00	-	6.00
Applesoft II Reference Manual	6.00	-	6.00
DOS 3.2 Manual	6.00	-	6.00
Apple II Basic Tutorial Manual	6.00	-	6.00
Pascal Reference Manual	8.50	-	8.50
Autostart ROM Manual	4.50	-	4.50
Fortran Reference Manual	12.00	-	12.00
Pascal Reference Manual	9.00	-	9.00
Pascal Operating Manual	11.50	-	11.50
Graphics Tablet Manual	5.00	-	5.00
Silentype Manual	3.00	-	3.00
DOS 3.3 Manual	5.00	-	5.00
Pilot Language Reference Manual	9.00	-	9.00
Pilot Editors Manual	7.00	-	7.00



## HEWLETT PACKARD

HP-80 Series Mainframes	NETT	V.A.T.	TOTAL
HP-83 Computer	1486.35	222.95	1709.30
HP-85 Computer	2146.95	322.04	2468.99
16K Memory Module	194.88	29.23	224.11
ROM Drawer	29.73	4.46	34.19

### ROMS

Mass Storage ROM	98.19	14.73	112.92
Plotter/Printer ROM	98.19	14.73	112.92
Input/Output ROM	199.77	29.97	229.74
Matrix ROM	98.19	14.73	112.92
● New Advanced Programming ROM	98.19	14.73	112.92
Assembler ROM	199.77	29.97	229.74

### Interfaces & Accessories

HP-IB	260.94	39.14	300.08
RS232 Serial Int.	260.94	39.14	300.08
GP-IO	335.21	50.28	385.49
BCD	335.21	50.28	385.49
Parallel Printer Int.	199.77	29.97	229.74
HP-IB 1/2 metre cable	47.00	7.05	54.05
HP-IB 1 metre cable	47.00	7.05	54.05
HP-IB 2 metre cable	50.00	7.50	57.50
HP-IB 4 metre cable	57.00	8.55	65.55
<b>Plotter &amp; Accessories</b>			
Plotter	1619.00	242.85	1861.85
Personality Module	496.00	74.40	570.40
Overhead Transp. Kit	83.00	12.45	95.45
Digitizing Sight	27.60	4.14	31.74
Vinyl Carrying Case	151.80	22.77	174.57
100 sheets Engl.	4.83	0.72	5.55

# MICROCOMPUTERS





# MICROCOMPUTERS

## AT LASKYS

100 sheets Metric	4.83	0.72	5.55
50 sheets blank (E.F.)	2.76	0.41	3.17
50 sheets blank (A4)	2.76	0.41	3.17
4 Colour pen pack	4.49	0.67	5.16
5 red pens	4.49	0.67	5.16
5 blue pens	4.49	0.67	5.16
5 green pens	4.49	0.67	5.16
5 black pens	4.49	0.67	5.16
100 Transp. films	18.48	2.77	21.25
Transp. Solvent	2.76	0.41	3.17
Transp. Pens (B,R,B,G)	5.87	0.88	6.75
Transp. Pens (B,O,B,V)	5.87	0.88	6.75
Transp. Pens wide (B,R,B,G)	5.87	0.88	6.75
Transp. Pens wide (B,O,B,V)	5.87	0.88	6.75

### Printers & Accessories

Printer Line	2611.00	391.65	3002.65
Printer Stand	227.00	34.05	261.05
Sound Abatement Cover	69.00	10.35	79.35
Wire Paper Basket	35.00	5.25	40.25
Printer Ribbon - Pack of 2	43.00	6.45	49.45
Printer Impact	637.81	95.67	733.48
Printer Ribbon - Pack of 2	26.00	3.90	29.90
Print Head	37.50	5.63	43.13

### Additional Accessories

Tape Cartridge (Pack of 5)	64.50	9.68	74.18
Thermal Paper Blue (Box of 2)	20.32	3.05	23.37
Thermal Paper Black (Box of 6)	60.95	9.14	70.09
Cartridges and Manual holder	6.77	1.02	7.79
HP83/85 Carrying Case	81.26	12.19	93.45
3-ring lit. binder	6.77	1.02	7.79
Dust Cover	10.16	1.52	11.68

### Manuals

Owners Manual HP83/85	17.25	-	17.25
Pocket Guide	3.45	-	3.45
Mass Storage ROM Manual	6.90	-	6.90
Plotter/Printer ROM Manual	6.90	-	6.90
I/O ROM Manual	20.70	-	20.70
Matrix ROM Manual	6.90	-	6.90
Assembler ROM Manual	13.80	-	13.80
Flexible Disc Operating Manual	3.45	-	3.45
HP-IB	6.90	-	6.90
Serial Installation Manual	6.90	-	6.90
GP/IO Manual	6.90	-	6.90
B.C.D. Manual	6.90	-	6.90
Parallel Printer Manual	6.90	-	6.90

### Application packs

Standard Pack	64.33	9.65	73.98
Basic Training	64.33	9.65	73.98
General Statistics	64.33	9.65	73.98
Finance	64.33	9.65	73.98
Math	64.33	9.65	73.98
Circuit Analysis	64.33	9.65	73.98
Games	64.33	9.65	73.98
Linear Programming	64.33	9.65	73.98
Text Editing	64.33	9.65	73.98
Wave Form Analysis	64.33	9.65	73.98
Basic Stat. & Data	64.33	9.65	73.98
Regression Analysis	64.33	9.65	73.98
Graphics Presentation	135.44	20.31	155.75
VisiCalc Plus	135.44	20.31	155.75
Surveying	135.44	20.31	155.75

### Flexible Disc Unit

Dual Master (540K Bytes) 5 1/4 Disk	1693.00	253.95	1946.95
Dual Add-On (540K bytes) 5 1/4 Disk	1489.84	223.48	1713.32

# MICROCOMPUTERS

## AT LASKYS

Single Master (270K bytes) 5 1/4 Disk	1015.80	152.37	1168.17
Single Add-On (270K bytes) 5 1/4" Disk	858.78	128.82	987.60
Dual Master (2400K bytes) 8" Disk	4515.00	677.25	5192.25
Dual Add-On (2400K bytes) 8" Disk	3821.00	573.15	4394.15
Single Master (1200K bytes) 8" Disk	3299.00	494.85	3793.85
Single Add-On (1200K bytes) 8" Disk	2605.00	390.75	2995.75
Flexible Disk 5 1/4 (Pack of 10)	50.50	7.76	58.08
Flexible Disk 8" (Pack of 10)	71.50	10.73	82.23
<b>Graphics Tablet</b>	1355.00	203.25	1558.25

## MZ-80K SPECIAL OFFER!

A proper full size microcomputer for less than the real cost of a toy microcomputer. The Sharp comes with **48k** of RAM and the screen and cassette are built in, instead of being expensive extras.

<b>Nett</b>	<b>VAT</b>	<b>Total</b>
347.00	52.00	399.00



## SHARP

### PC 1211

	NETT	V.A.T.	TOTAL
PC1211 Pocket Computer	69.52	10.43	79.95
CE121 Cassette Interface	11.00	1.65	12.65
CE122 Printer/Cassette Interface	52.13	7.82	59.95
CSR 700 Paper Rolls (40)	5.00	0.75	5.75
EA 800R Ink Ribbons	1.80	0.27	2.07

### MZ 80K

MZ 80K Computer 48K	347.00	52.00	399.00
MZ 80FD Dual Disks	560.00	84.00	644.00
MZ 80P3 Dot Matrix Printer	365.00	54.75	419.75
MZ 80F I/O Disk Interface	52.00	7.80	59.80
MZ 80 FMD Master Disk and Manual	20.00	3.00	23.00
MZ 80 F15 Disk Cable	8.00	1.20	9.20
MZ 80 F05 Extra Disk Cable	7.00	1.05	8.05
MZ 80 I/O Expansion Box	96.00	14.40	110.40
MZ 80 BM Basic Manual	6.60	-	6.60
MZ 80 TIOB Basic Tape	9.50	1.43	10.93
MZ 80 T20C Machine Language	18.00	2.70	20.70
MZ 80 TU Assembler	36.00	5.40	41.40
MZ 80 I/O-1 Universal Interface Card	40.00	6.00	46.00
MZ 8T70 AE FDOS for MZ 80K	67.00	10.05	77.05
MZ 8T70BE Basic Compiler for MZ80k	40.00	6.00	46.00
MZ 8T40E Pascal for MZ80K	40.00	6.00	46.00

### MZ 80B

MZ 80B Computer 64K	1095.00	164.25	1259.25
MZ 80 FD Dual Disks	560.00	84.00	644.00
MZ 80 P5 Dot Matrix Printer	387.00	58.05	445.05
MZ 80 P6 Dot Matrix Printer	440.00	66.00	506.00
MZ 80 FI Disk Interface	94.00	14.10	108.10
MZ 80 MDB Master Disk and Manual	30.00	4.50	34.50
MZ 80 F15 Disk Cable	8.00	1.20	9.20
MZ 80 F05 Extra Disk Cable	7.00	1.05	8.05
MZ 80 BJC Disk Cable Joiner	15.00	2.25	17.25
MZ 80 EU Expansion Box	47.00	7.05	54.05
MZ 80 GMK Graphics Option	112.00	16.80	128.80
MZ 80 I/O-2 Universal Interface Card	40.00	6.00	46.00
MZ 80 T10C K - B Converter	7.00	1.05	8.05
MZ 8 BD02 FDOS for MZ 80B	67.00	10.05	77.05
MZ 8 BT03 Basic Compiler for MZ80B	40.00	6.00	46.00
MZ 8 BT02 Pascal for MZ 80B	40.00	6.00	46.00



## ATARI

400 16K Computer	300.00	45.00	345.00
800 16K Computer	560.87	84.13	645.00
410 Tape Recorder	43.48	6.52	50.00
810 Disk Drive	300.00	45.00	345.00
822 Thermal Printer	230.43	34.57	265.00
825 80 Column Printer	478.26	71.74	550.00
850 RS 232 Interface	117.39	17.61	135.00
16K RAM Upgrade	56.52	8.48	65.00
Light Pen	39.13	5.87	45.00
Pair Paddles	10.43	1.57	12.00
Pair Joysticks	10.43	1.57	12.00
I/O Cable	8.26	1.24	9.50
Printer Cable	24.78	3.72	28.50
Interface Cable	20.43	3.07	23.50
RS 232 Cable	20.43	3.07	23.50
Monitor Cable	20.43	3.07	23.50
Thermal Paper	3.48	0.52	4.00
Master Disk	13.91	2.09	16.00
5 Blank Disks	13.91	2.09	16.00
Word Processor	73.91	11.09	85.00
Inv. Prog. 1	10.39	1.56	11.95
Conversational French	28.26	4.24	32.50
Conversational German	28.26	4.24	32.50
Conversational Spanish	28.26	4.24	32.50
Conversational Italian	28.26	4.24	32.50
Music Composer ROM	28.26	4.24	32.50
Touchtype	13.00	1.95	14.95
Calc/Tor	14.74	2.21	16.95
Graphit	10.39	1.56	11.95
Statistics	10.39	1.56	11.95
Eng. Czar	7.78	1.17	8.95
Hangman	7.78	1.17	8.95
Kingdom	7.78	1.17	8.95
States and Capitals	7.78	1.17	8.95
States Europe	7.78	1.17	8.95
Scram	11.26	1.69	12.95
Tealink ROM	13.00	1.95	14.95
Asteroids ROM	26.04	3.91	29.95
Bask/Ball ROM	21.30	3.20	24.50
Blackjack	7.78	1.17	8.95
Chess ROM	21.30	3.20	24.50
Missile Command ROM	26.04	3.91	29.95
Space Invaders ROM	21.30	3.20	24.50
Space Invaders	11.26	1.69	12.95
● Star Raiders ROM	26.04	3.91	29.95
Super Breakout ROM	21.30	3.20	24.50
Assembler Editor ROM	30.00	4.50	34.50
Pilot ROM	43.04	6.46	49.50
Microsoft Basic	43.04	6.46	49.50
Technical Notes	14.74	-	14.74
Operating System Lists	9.52	-	9.52
DOS Lists	2.61	-	2.61
DOS 2 Manual	6.04	-	6.04

## The Memory

Guaranteed quality - thousands already supplied. Any faulty chips should be returned to us within 12 months of purchase with proof of purchase for replacement by return of post.

4116 66p + VAT 200 nanoseconds  
2114 Low power 300 nanoseconds  
100p + VAT.

## PRICE WAR



## PRINTERS

● Microline 80	270.00	40.50	310.50
● New Microline 82A	395.00	59.25	454.25
Microline 80 Tractor	45.00	6.75	51.75
Diplomat Card (Apple-Microline)	85.00	12.75	97.75
Microline Ribbons	2.25	0.34	2.59

# MICROCOMPUTERS

## AT LASKEYS

### Epson

MX80 T Newtype 2	415.00	62.25	477.25
MX80 FT/1	399.00	59.85	458.85
MX80 FT Newtype 2	465.00	69.75	534.75
MX100	575.00	86.25	661.25

### Epson Interfaces

Epson/Sharp Cassette	65.00	9.75	74.75
Epson/Sharp Disk	120.00	18.00	138.00
Epson/Apple	85.00	12.75	97.75
Epson/TRS 80 Bus	59.00	8.85	67.85
Epson/TRS 80 Expansion	25.00	3.75	28.75
Epson Ribbons	7.00	1.05	8.05
Epson MX100 Ribbons	8.50	1.28	9.78

### Seikosha

● Seikosha GP80A	195.00	29.25	224.25
● Seikosha GP80D (for MZ-80)	245.00	36.75	281.75

### Seikosha Interfaces

Seiko/Apple	59.00	8.85	67.85
Seiko/Pet	59.00	8.85	67.85
Seiko/Video Genie (EG3016)	33.00	4.95	37.95
Seiko/RS232	79.00	11.85	90.85
Seiko/TTL Serial	43.00	6.45	49.45
Seiko/IEEE 488	59.00	8.85	67.85
Seiko/Sharp (Disk)	59.00	8.85	67.85
Seiko/Ribbons	4.00	0.60	4.60
Seiko Paper 8 1/2" x 11" 2000 Sheets	12.00	1.80	13.80
Paper 9 1/2" x 11" 2000 Sheets	12.00	1.80	13.80
Paper Delivery	3.00	0.45	3.45

## VIDEO MONITORS

New 12" Green Screen	125.00	18.75	143.75
● BM12E 12" Green	150.00	22.50	172.50
VM129 12" B/W	183.00	27.45	210.45
VM906 9" HI-RES B/W	150.00	22.50	172.50
VM910 9" B/W	125.00	18.75	143.75
9" B/W Monitor	85.00	12.75	97.75
Cables	5.00	0.75	5.75

### Colour Monitors 14" New!

● MP 14N (NTSC) TTL, RGB	285.00	42.75	327.75
● MP 14P (PAL) TTL, RGB	285.00	42.75	327.75

## SUNDRIES

QED Mains Suppressor 3 amp	12.80	1.92	14.72
QED Mains Suppressor 6 amp	17.30	2.60	19.90
Mini Floppy Head Cleaning Kit	19.50	2.93	22.43
C15 Cassette	0.80	0.12	0.92
C15 Cassettes Box 10	5.20	0.78	5.98
C15 Cassettes Box 50	25.00	3.75	28.75
C15 Cassettes box 100	45.00	6.75	51.75
● C15 Cassettes Box 1000	370.00	55.50	425.50
Mini Floppy SS/DD	2.50	0.38	2.88
Mini Floppy SS/DD x 10	20.00	3.00	23.00
Mini Floppy SS/DD x 50	87.50	13.13	100.63
Mini Floppy SS/DD x 100	150.00	22.50	172.50
Mini Floppy DS/DD	4.00	0.60	4.60
Mini Floppy DS/DD x 10	33.00	4.95	37.95
Mini Floppy DS/DD x 50	150.00	22.50	172.50
Mini Floppy DS/DD x 100	275.00	41.25	316.25
● 4116, 200 N.S.	0.66	0.10	0.76
● 2114, 300 N.S.	1.00	0.15	1.15
TI Programmer Calc.	45.00	6.75	51.75
Paper 8 1/2" x 11" 2000 Sheets	12.00	1.80	13.80
Paper 9 1/2" x 11" 2000 Sheets	12.00	1.80	13.80
Paper Delivery	3.00	0.45	3.45

# MICROCOMPUTERS

## AT LASKEYS



# New-fangled hardware old-fashioned value at NSC Computer Shops!!!

## PRINTERS



**SEIKOSHA GP80A**  
Cheapest dot matrix printer. Recommended by Acorn and Commodore.  
New low price. £179.00

**SEIKOSHA GP100A**  
Wider version of GP80A £199.00

**SEIKOSHA 8510**  
New friction/tractor printer with graphics £475.00

**OKI MICROLINE 80** Low cost, 80 column, upper/lower case with pin and friction feed. £275.00

**OKI MICROLINE 82** Bi-directional printing, programmable form length, serial and parallel. £399.00

**OKI MICROLINE 83** 120 cps bi-directional on 15 inch paper. £759.00

**SERIAL INTERFACE** RS-232 interface for M 80 £105.00

**HI-SPEED INTERFACE** High Speed RS-232 interface for M 80/82 £185.00

**TRACTOR** Tractor for M 80/82 £55.00

**TYMAC INTERFACE** Apple interface and cable for M 80 series £89.00

**EPSON MX 80** 80 column tractor fed printer £358.00

**EPSON MX 80FT** As MX 80 but with friction and tractor £399.00

**EPSON MX 80FT II** As MX 80FT but with hi-res dot graphics £449.00

**EPSON MX 82** Friction and tractor feed £399.00

**EPSON MX 82FT** Graphics, friction and tractor feed £449.00

**EPSON MX 100** As MX 80FT but with full 15 inch platen £575.00

**APPLE INTERFACE** Apple interface and cable for MX series £89.00

**SERIAL INTERFACE** Serial interface and RS-232 cable for MX £59.00

**BUFFERED INT.** As above with 2K buffer £79.00

**RIBBONS** Ribbons MX 80/82 £9.00

**RIBBONS** Ribbons MX 100 £13.00

**CENTRONICS 737-2** Letter quality printing - parallel version £425.00

**CENTRONICS 737-4** Serial version £475.00

**CENTRONICS 737P** Pet version £485.00

**CENTRONICS 739-2** As 737-2 but with high res graphics £495.00

**CENTRONICS 739-4** Serial version £544.00

**CENTRONICS 150-2** 150 cps, bi-directional, logic seeking £499.00

**CENTRONICS 150-4** Serial version £544.00

**CENTRONICS 779** Due to a bulk purchase, NSC are able to offer you this DP quality, upper case only printer with infinitely variable print size (10 to 16.5 cpi) and full logic seeking head at less than half the normal trade price £295.00

**INTEGREX CX80** Full colour printer for Apple, VIC etc. £895.00

**COLOUR INTERFACE** Apple colour dump card for above £125.00

**RIBBONS** Tricolour ribbons for above £5.00

**QUANTEX 6000** 150 cps matrix printer £875.00

**ANADEX DP 9500L** 150 cps, 15 inch platen, serial and parallel £895.00

**ANADEX DP9501** As DP9500 with graphics and other features £1045.00

**RIBBONS** Ribbons for Anadex DP9000 series £14.00

**TEXAS 820 RO** High quality for 150 cps programmable printer £1300.00

**OLYMPIA EK100KSRA** typewriter and letter quality printer all in one package at the amazing price of £995.00

**DIABLO 630 RO** High quality daisy wheel printer capable of using metal or plastic daisy wheels B.D.T. Cut sheet feeder for Diablo and other daisy wheel printers P.O.A.

**FUJITSU SP830** 80 cps daisy wheel - the fastest around! from £650.00

**80 cps daisy wheel** - the fastest around! £1995.00

On all printers please add £6.00 for carriage. All other items please add 50p for p&p.

## COMPUTERS

### ACORN ATOM

Available ex stock in any configuration - 8K+2K kit or assembled in any size up to 12K+12K. New ROM enables compatibility with BBC machine.  
PRICES INCLUDING VAT & P&P  
8K+2K Kit £140.00 8K+2K Assembled £174.50  
Colour Atom inc PSU £204.00  
12K+12K Assembled £289.50 Power Supply £10.20

### VIC 20

Fast becoming the most popular home computer. Price including VAT £189.95 (p&p £3.00 extra).

### PET

Britain's best known micro computer. Our prices start from £375.00

### APPLE II

Our best selling medium priced computer. Start with the basic unit and build up your system with disk drives, Pascal system, graphics tablet, voice recognition card, Visicalc, etc. Phone for our latest prices on all these items.

### APPLE III

128K computer + Monitor III and Apple III Software comprising Business BASIC, Sophisticated Operating System (SOS) and Apple II emulation. £2545.00.

### COMART COMMUNICATOR

4MHz, Z80A, S100 Computer with choice of twin 170K, 390K or 720K disk drives or one floppy and one 5Mb Winchester hard disk. Also available 20Mb hard disk which can be added to any of the above. This computer has been designed with communications in mind and we can offer an interface to Prestel as well as the usual accounting packages. Prices start at £1750.00.

### NORTH STAR

Come and see the Advantage, a major new system from a well established manufacturer. £2195.00. We can also supply the Evergreen Horizon.

### RAIR (THE ICL PERSONAL COMPUTER)

The D.P. Manager's favourite micro. The 3/20 machine has twin 250K floppy disk drives and the 3/30 has one floppy and one 5Mb Winchester hard disk. Also available is a 10Mb hard disk drive which can be added at the time of purchase or at a later date. M/PM for multi user environments. Programming languages available include basic Fortran, Pascal, Cobol and Assembler. Prices start from £2,750 and rental terms are available.

### CROMEMCO

If you're looking for a 'Unix' like operating system, look no further. Cromemco's Cromix offers you up to 63K memory space per user with the ability to run C/PM programmes if required. Choose from System zero, one, two, three or Z-2H.



If you are looking for a VDU to complement your system, NSC can supply any one from a variety of manufacturers at prices ranging from £400 - £2,500.  
LEAR SIEGLER, TELEVIDEO, VOLKER CRAIG, BEEHIVE, DEC, IBM.

## FLOPPY DISCS

Most manufacturers now recommend Dyan floppy disks with their computers. We stock Dyan at the following prices: S/Sided S/Density suitable for Apple etc. £25.00 per 10 (plus 50p p&p).

D/Sided D/Density suitable for Rair, Cromemco, Comart, North Star £40.00 per 10 (plus 50p p&p)

We recommend Dyan floppy disks to all our customers. Other brands and sizes are available upon request.



## BOOKS

### + FANFOLD PAPER

Readily available in a variety of widths. C12 Cassettes, Printer Ribbons and most computer accessories



## 12" BLACK AND WHITE TV MONITOR

By adapting 12" TV sets to accept composite video input we are able to bring you 12" black and white monitors at a saving of almost 100% over competitive equipment. Price including a cable to your Apple, or similar, only £99.95 (plus £6.00 carriage).



NSC are a BBC Micro Computer dealer, come in, see and buy your computer peripherals.

### ORDER BY POST WITH CONFIDENCE

Instead of calling personally at NSC Computer Shops you can send cash with order. Please complete the order form below.

All prices are exclusive of VAT except where otherwise stated. Prices correct at time of going to press.

# NSC COMPUTER SHOPS

NSC Computer Shops, 29 Hanging Ditch, Manchester M4 3ES. Tel: 061-832 2269

Please send the following order:

NAME \_\_\_\_\_

ADDRESS \_\_\_\_\_

POSTCODE \_\_\_\_\_

PRICE \_\_\_\_\_

\_\_\_\_\_

\_\_\_\_\_

\_\_\_\_\_

P&P \_\_\_\_\_

TOTAL \_\_\_\_\_

Most of our prices are heavily discounted and therefore payment must accompany the order. Credit card payments will be accepted. Please quote credit card number and type of card. Cheques payable to NSC Computer Shops.

I wish to pay by Access\* Barclaycard\* Diners Card\* (\*delete as applicable)

CARD NO \_\_\_\_\_

DATE \_\_\_\_\_

SIGNATURE \_\_\_\_\_

NSC Computer Shops, 29 Hanging Ditch, Manchester M4 3ES. Tel: 061-832 2269

# MicroValue

# MONEY SAVERS

MicroValue  
Exclusive

with the exclusive  
MicroValue  
12 Months  
Warranty\*

**MV1 - a Z80 computer**

**SAVE  
£107.50**

The MV1 computer kit uses the ubiquitous Nascom 1 Pcb and the Z80 CPU. Interfaces are included for television, printer and cassette. 2K memory, Gemini power supply (drives up to 3 extra boards). Cherry full ASCII keyboard and Quantum Graphics are also included. Available with either an ASCII version of the Nas-Sys 3 monitor, or a Tiny BASIC. MV1 is expandable to Gemini 80-BUS specification.

MicroValue  
Exclusive

MicroValue's  
'Nascom Special'

**SAVE  
OVER £65**

We've put together a microcomputer kit containing the Nascom 2, Nas-Sys 3, Graphics ROM, Bits & P.C.'s programmers aid, Gemini 3 APSU, 1.6K RAM Board and mini motherboard. The result is a powerful micro using market proven boards and components.

RRP OVER £405 + VAT

MicroValue  
Exclusive

**SHARP MZ80K with  
Super Graphics**

**SAVE  
£200!**

The 48K RAM System is offered at a rock bottom price with the Quantum Micros Hi Res Graphics which gives resolution down to a single dot and high res. plotting. Characters are user definable and the pixel characters actually join. Five free games packages are included too!

RRP £645 + VAT

MicroValue price

**£445 + VAT**

**SHARP**

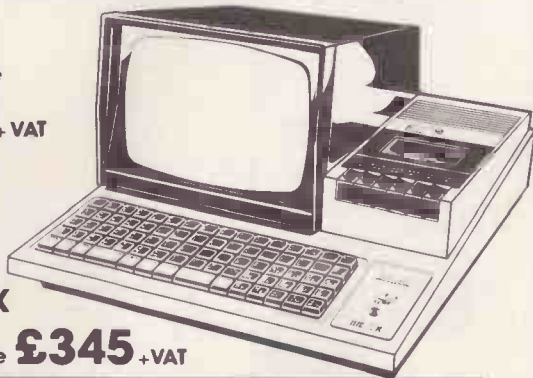

**48K MZ 80K**

RRP £460 + VAT

MicroValue price **£345 + VAT**

**£30** worth of accessories  
**FREE** with every  
Epson Printer

MicroValue price

Epson MX80T.....	£359 + VAT
Epson MX80FT1 .....	£399 + VAT
Epson MX80FT2 .....	£465 + VAT
Epson MX100.....	£575 + VAT

Buy one of the above Epsoms from MicroValue and we'll give you a Pack of Fanfold paper, Interfacing Document and Connecting Cord for Multiboard or Nascom. The accessories are worth £20 but you can have them absolutely FREE.

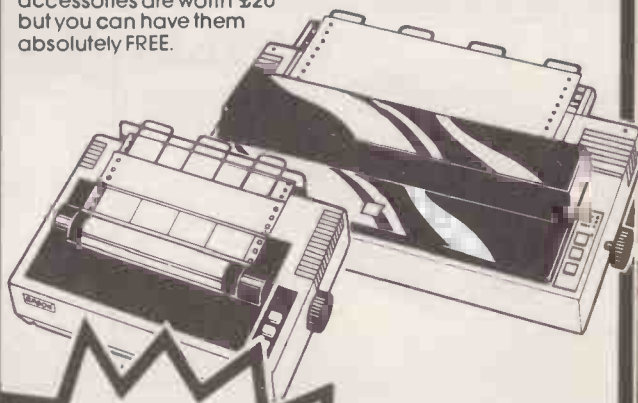

**Cheapest  
Printer in the UK!**

**Nascom IMP + Graphics  
Only £199 + VAT**

**SAVE  
£156**

MicroValue has slashed the price of the 80cps, 80 column IMP dot matrix printer. And added Imprint's high res. graphics and double width character option. IMP has bi-directional printing and friction/tractor feed.

RRP £355 + VAT

MicroValue price  
**£199 + VAT**

Subject to only 6 months' warranty.

**NASBUS Compatible DOUBLE  
DENSITY Disk System -  
Available Ex Stock**

With hundreds in daily use the Gemini Disk system is now the standard for Nascom and Gemini Multiboard systems. Single or twin drive configurations are available, giving 350K storage per drive. The CP/M 2.2 package supplied supports on-screen editing with either the normal Nascom or Gemini IVC screens, parallel or serial printers, and auto single-double density selection. An optional alternative to CP/M is available for Nascom owners wishing to support existing software. Called POLYDOS 2 it includes an editor and assembler and extends the Nascom BASIC to include disk commands.

Single drive system  
(G809, G815/1)

**£450 + VAT**

Double drive system  
(G809, G815/2)

**£675 + VAT**

CP/M 2.2 package  
(G513)

**£100 + VAT**

Polydos 2

**£90 + VAT**

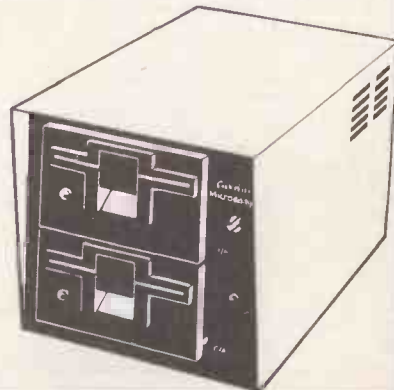



# MicroValue

# MONEY SAVERS

with the exclusive  
MicroValue  
12 Months  
Warranty\*

## New CP/M System based on Gemini Multiboard

Gemini Microcomputers is launching at Which Computer? Show a new system based around its successful MultiBoard range, and MicroValue dealers will have first deliveries in February. It will have:

### HARDWARE

- \* Twin Z80A CP/M System
- \* 64K Dynamic RAM
- \* 700K Disk Storage (Formatted)
- \* 80 x 25 Screen Format
- \* Inverse Video

- \* Prog. Character Generator
- \* 160 x 75 Pixel Graphics
- \* Centronics Parallel I/O
- \* RS232 I/O
- \* Light pen interface
- \* 59-Key ASCII Keyboard

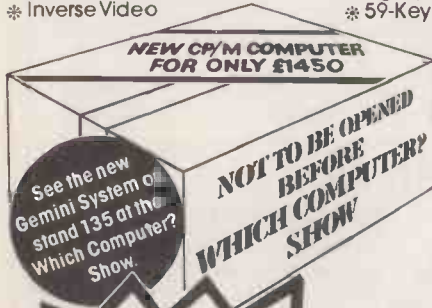

### SOFTWARE

- \* Full 64K CP/M 2.2 with screen edit facility
- \* Comal-80 structured BASIC
- \* GEM-ZAP Assembler/Editor
- \* GEM-PEN Text editor
- \* GEM-DE BUG debugging software

MicroValue price  
**£1,450**  
+VAT

MicroValue  
Exclusive

## 80 x 25 Video for Nascom

Nascom owners can now have a professional 80 x 25 Video display by using the Gemini G812 Intelligent Video Card with onboard Z80A. This card does not occupy system memory space and provides over 50 user controllable functions including prog character set, fully compatible with Gemini G805 and G815/809 Disk Systems. Built and tested.

**£140** + VAT

MicroValue  
Exclusive

## NEW

## I/O Board for Nascom & Gemini Multiboard Systems Quantum I/O

The new Quantum Micros I/O board takes the unique approach to the problems of interfacing your Nascom or Gemini Multi-board to external devices. This 80 Bus and Nasbus compatible card is supplied fully built, populated and tested and includes three Z80 PIOs, a CTC and a Real Time Clock with battery back-up. In addition, a range of "daughter" boards that attach straight to the I/O board are under development catering for a wide variety of interfacing requirements.

Quantum I/O board                      MicroValue price - **£140** + VAT  
Prototyping daughter board          MicroValue price - **£20** + VAT

## IEEE-488

The EV Computers' IEEE-488 card is an 80 Bus and Nasbus compatible card designed to fully implement all IEEE-488 interface functions. This built and tested card gives the user a very cost effective and versatile method of controlling any equipment fitted with a standard IEEE-488 or GPIB interface.

MicroValue introductory price  
**£140** + VAT

MicroValue  
Exclusive

## New Software for Nascom Systems

- POLYDOS 1A disk operating system for use with Nascom 1 or 2 and Gemini G805 Disk Systems. An incomparable and extremely well presented DOS that includes an editor and assembler and adds disk commands to the Nascom BASIC.      MicroValue price **£9.90** + VAT
- MATHSPAK Double precision maths package on tape.                      MicroValue price - **£13** + VAT
- MATHSPAK Handler Used in conjunction with MATHSPAK.      MicroValue price - **£9.95** + VAT
- Command Extender For use with MATHSPAK it extends BASIC's reserve word list.      MicroValue price **£9.95** + VAT
- Logic Soft Relocater An integrated assembler and disassembler package which allows disassembly and reassembly from anywhere on the memory map.      MicroValue price **£13** + VAT

## SAVE MORE MONEY

### Standard Firmware for Nascom at Reduced prices

NASPEN.....	RRP £30 . VAT	MicroValue price <b>£20</b> + VAT
Nos-Sys 3.....	RRP £25 . VAT	MicroValue price <b>£20</b> + VAT
NasDis - D-Bug (EPROM).....	RRP £50 . VAT	MicroValue price <b>£30</b> + VAT
NasDis - D-Bug (TAPE).....	RRP £40 . VAT	MicroValue price <b>£20</b> + VAT
Imprint.....	RRP £30 . VAT	MicroValue price <b>£20</b> + VAT
Bits & PC's Prog. Aid.....	£28 . VAT	MicroValue price <b>£20</b> + VAT

## \*MicroValue Warranty

All products, except kits and Nascom Imp, sold by MicroValue dealers are supplied with 12 months warranty and will be replaced or repaired by any dealer (even if you didn't buy it from him) in the group in the event of faulty manufacture.

## YOUR LOCAL MICROVALUE DEALER

All the products on these two pages are available while stocks last from the MicroValue dealers listed on right. (Mail order enquiries should telephone for delivery dates and post and packing costs.) Access and Barclaycard welcome.



**BITS & PC'S**  
4 Westgate, Wetherby, W. Yorks.  
Tel: (0937) 63774.

**TARGET ELECTRONICS**  
16 Cherry Lane, Bristol BS1 3NG.  
Tel: (0272) 421196.

**ELECTROVALUE LTD.**  
700 Burnage Lane, Burnage,  
Manchester M19 1NA.  
Tel: (061) 431 4866.

**INTERFACE COMPONENTS LTD.**  
Oakfield Corner, Sycamore Road,  
Amersham, Bucks.  
Tel: (02403) 22307. Tlx: 837788.

**28 St Judes, Englefield Green,**  
Egham, Surrey TW20 0HB.  
Tel: (0784) 33603. Tlx: 264475.

**HENRY'S RADIO**  
404 Edgware Road, London W2.  
Tel: (01) 402 6822.  
Tlx: 262284 (quote ref: 1400).

**SKYTRONICS,**  
2 North Road, The Park,  
Nottingham.  
Tel: (0602) 45053/45215

**LEEDS COMPUTER CENTRE,**  
62 The Balcony,  
Merrion Centre, Leeds.  
Tel: (0532) 458877

# PRINTERS

## SEIKOSHA GP-80

**The Smallest 80 Column Dot Matrix Printer.**

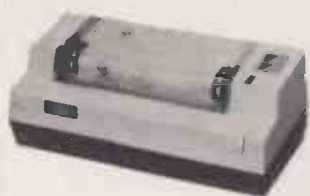

Unique printer principle. 80 col lines. 30 cps. 12 cpl. Plain Paper. Tractor drive. Weight 2.5 kg. Footprint 12.6 sq. ins. Bit addressable graphics. Parallel interface standard. RS 232 Apple Pet TRS 80 options

£199

## OKI MICROLINE 80 & 82A

**Compact 80 Column Printer.**



80-120 cps. Uni direction ML 82A bi-direction). Parallel interface. Serial interface option. (ML 82A standard). Pin and friction feed. Tractor option. Condensed and expanded characters. 80, 40, 66 and 132 cpl.

ML 80 £299  
ML 82A £437

## EPSON MX SERIES



**Low Noise, Low Price-High Performance Printer**

Six models. 80 cps. Bi-directional. Parallel interface. RS232 Pet Apple TRS 80 Video Genie Sharp options. Letter quality. Lower case descenders. Condensed enlarged and bold characters. Models provide tractor roll and sheet feed - bit image graphics - up to 15 ins Paper.

MX-80 £353

MX-80 F/T £399

MX-82 £447

MX-80 II £399 MX 80 F/T-II £447 MX-100 £569

## OKI MICROLINE 83A

**Medium Speed 15" Printer.**



120 cps. Bi-direction. Pin and friction feed. Tractor option. 132 cpl at 10 cpi. 4 character sizes. Graphic characters. Parallel and serial interface. Fast serial interface option.

£827

## ANADEX DP-9000 RANGE

**Fast, Versatile Printers.**



Seven models. Up to 15 inch paper width. Lower case descenders. 160-220 cps bi-directional printing. RS232 current loop & parallel interface. X on X off. Optional 2K buffer. Multiple print densities. Fast print of high-density bit image graphics.

DP-8000 £541

DP-9000L £747

DP-9001 £888

DP-9500 £935

DP-9000 £841

DP-9500L £841

DP-9501 £982

## TEC STARWRITER

**Best-Buy Daisy Wheel Printer.**



Bi-direction. 25 cps. Low cost supplies. Standard Daisy Wheel. Carbon and fabric ribbons. Parallel or RS232 interface. Sheet feeder options.

Parallel Interface £1020  
Serial Interface £1067

## LEAR SIEGLER 310

**Professional Dot Matrix Printer.**



High throughput. 180 cps. Bi-direction. Fast head travel. Space skip over. Lower case descenders. Enlarged and bold fonts. Parallel RS232 and current loop interfaces. X on X off. Condensed character option. Sound reducing option.

£1386

FROM

# RIVA

**RIVA TERMINALS LTD.**

New Head Office: Woking Business Park  
Albert Drive, Woking, Surrey GU21 5JY  
Tel: Woking (04862) 71001 Telex: 859502  
Northern Office: Tel: Harrogate (0423) 503867

- Authorised distributor
- Rapid delivery
- Dealer educational & quantity discounts
- Prices exclude VAT



# MICROCOMPUTERS AT LASKYS

## 10 Shops Nationwide Birmingham

19/21 Corporation Street, Birmingham, B2 4LP.  
Tel: 021-632 6303.  
Manager: Peter Stallard. 300 yards from Bullring Centre.

## Bristol

16/20 Penn Street, Bristol, BS1 3AN. Tel: 0272 20421.  
Between Holiday Inn and C & A.

## Chester

The Forum, Northgate Street, Chester, CH1 2BZ.  
Tel: 0244 317667.  
Manager: Jeremy Ashcroft. Next to the Town Hall.

## Edinburgh

4 St. James Centre, Edinburgh, EH1 3SR. Tel: 031-556 6217.  
Manager: Colin Draper.  
East end of Princes Street, St. James Centre.

## Preston

1/4 Guildhall Arcade, Preston, PR1 1HR.  
Tel: 0772 59264.  
Manager: Jim Comisky. Directly under Guild Hall.

## Manchester

12/14 St. Mary's Gate, Market Street, Manchester, M1 1PX.  
Tel: 061-832 6087.  
Manager: Lesly Jacobs. Corner of Deansgate.

## Glasgow

22/24 West Nile Street, Glasgow, G7 2PF. Tel: 041-226 3349.  
Manager: David Livingstone.  
Between Buchanan Street and Central Station.

## Sheffield

58 Leopold Street, Sheffield, S1 2GZ. Tel: 0742 750971.  
Manager: Justin Rowles. Top of the Moor, opposite Town Hall.

## Liverpool

33 Dale Street, Liverpool, L2 2HF. Tel: 051-236 2828.  
Manager: Mark Butler.  
Between the Town Hall and Magistrates Courts.

## London

42 Tottenham Court Road, London, W1 9RD.  
Tel: 01-636 0845. Manager: Vass Demosthenis.  
**Official Orders** over £50 are welcome with normal 30 days credit extended to bona-fide commercial and government organisations.



Laskys, the retail division of the Ladbroke Group of Companies

# MICROCOMPUTERS AT LASKYS

# WORLD BEATING MICRO ACCESSORIES



## Memory Chips

Guaranteed quality - thousands already supplied. Any faulty chips should be returned to us within 12 months of purchase with proof of purchase for replacement by return of post.

4116 200 nanoseconds	Nett: 0.66	Vat: 0.10	Total: 0.76
2114 low power 300 nanoseconds	Nett: 1.00	Vat: 0.15	Total: 1.15

## Cassettes

We are probably the largest supplier of microcomputer cassettes in the country and have them specially manufactured to our quality specification

- C15 Agfa Tape • Special Labels • Cellophane wrapped • Precision transport mechanism • Leaderless • Insert Cards • Proven performance
- |                        |              |            |               |
|------------------------|--------------|------------|---------------|
| One cassette           | Nett: 0.80   | Vat: 0.12  | Total: 0.92   |
| Box of ten cassettes   | Nett: 5.20   | Vat: 0.78  | Total: 5.98   |
| Fifty cassettes        | Nett: 25.00  | Vat: 3.75  | Total: 28.75  |
| One hundred cassettes  | Nett: 45.00  | Vat: 6.75  | Total: 51.75  |
| One thousand cassettes | Nett: 370.00 | Vat: 55.50 | Total: 425.50 |



## Monitors

Visit one of our shops and see our range of low cost high quality Video Monitors.

## Disks

Manufactured to our specification by Dennison Kybe, imported by us direct from the manufacturer to give superior quality at a sensible price

- Free library cases with tabs • All disks have reinforced centres • Double density quality - soft sectored • Anti-static envelopes, labels and write protect.
- |                                |              |            |               |
|--------------------------------|--------------|------------|---------------|
| Mini Floppy 5 1/4" DD          | Nett: 2.50   | Vat: 0.38  | Total: 2.88   |
| Mini Floppy 5 1/4" DD x 10     | Nett: 20.00  | Vat: 3.00  | Total: 23.00  |
| Mini Floppy 5 1/4" DD x 50     | Nett: 87.50  | Vat: 13.13 | Total: 100.63 |
| Mini Floppy 5 1/4" DD x 100    | Nett: 150.00 | Vat: 22.50 | Total: 172.50 |
| Mini Floppy 5 1/4" DS/DD       | Nett: 4.00   | Vat: 0.60  | Total: 4.60   |
| Mini Floppy 5 1/4" DS/DD x 10  | Nett: 33.00  | Vat: 4.95  | Total: 37.95  |
| Mini Floppy 5 1/4" DS/DD x 50  | Nett: 150.00 | Vat: 22.50 | Total: 172.50 |
| Mini Floppy 5 1/4" DS/DD x 100 | Nett: 275.00 | Vat: 41.25 | Total: 316.25 |

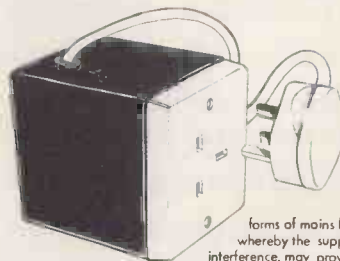
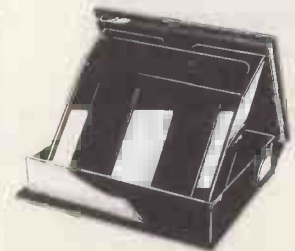

## QED Mains Interference Suppressor

For use when mains interference is causing your computer problems. Simply plug the equipment into the suppressor and plug the suppressor into the wall socket (see specification for maximum power). Inserted in this way, most forms of mains borne interference will be cured. An alternative method of fitting, whereby the suppressor is connected to the mains circuit of the appliance causing the interference, may prove to be more effective in some cases.

QED Mains Suppressor 3 amp	Nett: 12.80	Vat: 1.92	Total: 14.72
QED Mains Suppressor 6 amp	Nett: 17.30	Vat: 2.60	Total: 19.90

## Printers

Established quality printers - at competitive costs.

- |                                |              |            |               |
|--------------------------------|--------------|------------|---------------|
| <b>Microline</b>               |              |            |               |
| Microline 80                   | Nett: 270.00 | Vat: 40.50 | Total: 310.50 |
| Microline 82A                  | Nett: 395.00 | Vat: 59.25 | Total: 454.25 |
| Microline 80 Tractor           | Nett: 45.00  | Vat: 6.75  | Total: 51.75  |
| <b>Epson</b>                   |              |            |               |
| MX80 T Newtype 2               | Nett: 415.00 | Vat: 62.25 | Total: 477.25 |
| MX80 FT/1                      | Nett: 399.00 | Vat: 59.85 | Total: 458.85 |
| MX80 FT Newtype 2              | Nett: 465.00 | Vat: 69.75 | Total: 534.75 |
| MX100                          | Nett: 575.00 | Vat: 86.25 | Total: 661.25 |
| <b>Seiksha</b>                 |              |            |               |
| Seiksha GP80                   | Nett: 195.00 | Vat: 29.25 | Total: 224.25 |
| <b>Seiko Paper</b>             |              |            |               |
| 8 1/2" x 11" 2000 Sheets       | Nett: 12.00  | Vat: 1.80  | Total: 13.80  |
| Paper 9 1/2" x 11" 2000 Sheets | Nett: 12.00  | Vat: 1.80  | Total: 13.80  |
| Paper Delivery                 | Nett: 3.00   | Vat: 0.45  | Total: 3.45   |





# "WORDSTAR" GOES APPLE!

**Q:** What additional equipment do I need to run WordStar on my Apple computer?

**A:** WordStar 3.0 and later versions require a Microsoft SoftCard and a minimum of 48K RAM. Earlier releases of WordStar require both, plus an 80-column VIDEX Videoterm card.

**Q:** What about "shift-key" modifications to the 80-column video board? Do I need these to run Wordstar?

**A:** Not necessarily. All WordStar functions run without modification. Upper/lower case characters can be generated using the escape key.

**Q:** What Disk-Sector format do I need to run WordStar on the Apple computer?

**A:** WordStar is available on both 13-Sector and 16-Sector Apple formats — but please specify when ordering.

**Q:** Are there any differences between the Apple version and the standard CP/M version of WordStar?

**A:** No, there are no functional differences between the two versions. The Apple version supports all WordStar and MailMerge functions. The Apple version can be installed only on Apple computers.

**Q:** What printers are compatible with WordStar on the Apple?

**A:** WordStar supports letter-quality and teletype-like printers, including dot-matrix, line, and thermal devices. While WordStar provides full functions for quality daisy-

wheel printers (e.g. NEC, Ricoh, TEC, Qume, and Diablo), it can also take advantage of many lower priced non-daisy-type printers.

**Q:** Why is WordStar considered the "ultimate" word processor?

**A:** Strength, versatility and many useful features position — WordStar as the leading word processing package. WordStar offers:

1. Screen orientated editing — when you add, delete, or manipulate text, all changes are displayed on the screen.
2. Install program — WordStar can be user installed for many configurations of VDU's, video boards, and printers.
3. Extensive menus — comprehensive prompting reduces the need to refer to the manual, and you can choose between one of four help levels.
4. Disk-biffered text entry — the size of your document is limited only by the storage capacity of your disk.
5. Incredible features — video editing, word-wrap, powerful editing commands, dynamic page-break display, print enhancements, decimal tabbing, paragraph indent, global search and replace, on-screen flexible page formatting, horizontal scrolling, block and column moves, and many more.

**WordStar has been enhanced by other MicroPro products that work together to provide complete text and data-handling solutions for business:—**

**MailMerge:** A powerful data and text merging tool that enables WordStar to produce personalised form letters.

**CalcStar:** NEW: — "Electronic Spread Sheet" and financial modelling program.

**SpellStar:** A one-step "proofreader" that exposes misspellings and typos. Provides a compressed 20,000 word dictionary, and allows user-created supplementary dictionaries.

**DataStar:** Fast, accurate data entry, retrieval and updating system.

**SuperSort:** Sophisticated data sorting, merging and selecting power for DataStar and other file structures.

**WordMaster:** Comprehensive text and data editor designed for programmers.

WordStar . . . . .	£205.00	APPLE WordStar . . . . .	£145.00
MailMerge . . . . .	£ 60.00	APPLE MailMerge . . . . .	£ 50.00
SpellStar . . . . .	£110.00	APPLE SuperSortl. . . . .	£ 85.00
DataStar . . . . .	£160.00	APPLE SpellStar . . . . .	£ 75.00
SuperSortl. . . . .	£110.00	VIDEX Videoterm Card . . . . .	£185.00
WordMaster . . . . .	£ 60.00	MicroSoft SoftCard . . . . .	£195.00
CalcStar . . . . .	£125.00	APPLE CalcStar . . . . .	£ 75.00

### TRADE ENQUIRIES WELCOME

All prices exclude VAT. Prices and specifications are subject to change without notice.

Apple Computer is a trademark of Apple Computer Inc. CP/M is a trademark of Digital Research. SoftCard is a trademark of Microsoft Inc.



**INTERAM COMPUTER SYSTEMS LTD.**  
46, Balham High Road,  
London, SW12 9AQ.  
Telephone: 01-675 5325/6/7





# INNOVATIVE TRS 80-GENIE SOFTWARE

*from the professionals*

## Looking for a SPELLING CHECKER?

```
PRESS: (L) LEARN WORD (R) REPLACE WORD (S) SKIP WORD
WORD IN ERROR: misstake
```

This is an example of a text being checked by HEXSPELL. The text scrolls up the screen as it is checked. When an error is detected, you have three choices.

1) REPLACE the incorrect word. The replacement word is INSTANTLY RE-CHECKED for correctness, then inserted in the text.

2) The word is correct, leave it as it is.

3) Tell HEXSPELL to LEARN this word for future reference, with just one keystroke.

Hexspell requires just one step to check and correct a text, and learn new words. Your document is ready to print as soon as Hexspell is finished. A word that is in error e.g. misstake, is highlighted in the text for easy correction.

```
HEXCON - HEXAGON CONTROL FILE EDITOR
```

```
SET HEXSPELL OPTIONS
```

```
A) Work File Name = DOCD:1
B) Input File Name = TEST
C) Next Program Name = NONE
D) Alternate Char. Set = 0
E) Extended Word List = N
F) Auto Learn On = N
G) Wait For SPELL disk = N
Press appropriate key to change an option.
Press (X) to exit edit.
```

Get more than just a spelling checker —

# HEXSPELL 2™

the EVERYTHING checker.

**HEXSPELL CHECKS:** product codes • zip codes • French words • engineering formulae • typesetting commands • German words • numbers • addresses • chemical formulae • Greek words • names • amounts • printer commands • Japanese words • acronyms • dimensions • mathematical formulae • values . . . and of course plain old English words.

Hexagon Systems is proud to announce another first in text checking — an everything checker. Hexspell 2 checks not only dictionary words, but learns and checks codes, formulae and numbers which are so essential in many commercial and technical documents. With Hexspell 2 you define which characters make up a "word", then teach Hexspell the new "words" it needs to check your text. This advanced system builds on the unique features of the original Hexspell (the first TRS-80 spelling checker).

When we introduced Hexspell nearly a year ago, it was the world's first adaptive learning spelling checker. Hexspell constantly adapts its wordlist to your usage. No complicated editing of the wordlist. Hexspell remembers words as long as you use them. If you never use a word again Hexspell will eventually forget it to make room for new words. Extending this feature in Hexspell 2 gives you a text checker that can learn to check everything that you write.

Hexspell 2 is the product of nearly three years research and experience. Unlike other microcomputer spelling checkers Hexagon Systems didn't simply rewrite the multi-step batch process found on large computers, we invented a simple one-step process that capitalizes on the Interactive strengths of the personal computer. Hexspell's simple one-step process makes it practical for daily use on all your letters and documents.

**HEXSPELL VERSION 1 USERS — GET THESE HEXSPELL 2 ENHANCEMENTS:** Programmable character set - Disk error trapping - Extendable word list, up to 50,000 words - Speed control - Longer words, up to 40 characters - Auto learn function - User settable system options - Control file editor - Built in lower case driver.

Hexspell 2 ..... £52.00 + V.A.T. = £59.80



# MOLIMERX LTD

## A J HARDING (MOLIMERX)

1 BUCKHURST ROAD, TOWN HALL SQUARE, BEXHILL-ON-SEA, EAST SUSSEX.

TEL: [0424] 220391/223636

TELEX 86736 SOTEX G

TRS-80 & VIDEO GENIE SOFTWARE CATALOGUE £1.00 [refundable] plus 50p postage.

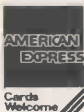



# INNOVATIVE TRS 80-GENIE SOFTWARE

*from the professionals*

# LDOS

First there were the TRSDOS's, 2.0, 2.1, 2.2 and 2.3. Then came Newdos+, essentially a patched version of the TRSDOS's but with a number of very useful commands and utilities added. Then VTOS 3.0 and VTOS 4.0. These constituted a departure from the earlier DOS's and featured Device Independence so that devices such as the keyboard, printer, VDU and disk drives could interact directly together. Then came Newdos80 which is a rewrite of Newdos+, adding new utilities and new Basic commands, its main features being the ability to mix different capacity drives on the same cable and the ability to use variable length records. Now from LOBO International comes LDOS, the fifth generation disk operating system for the TRS-80 microcomputer. It combines most of the advantages of the preceding disk operating systems and unlike some of them, is accompanied by a complete and readable set of documentation, which includes a Technical Section containing relevant addresses.

It is impossible to describe all of the features of LDOS in an advertisement. For instance it includes no less than 35 library commands as follows:—

APPEND	COPY	DEVICE	DIR	DO	FILTER	KILL
LIB	LINK	LIST	LOAD	MEMORY	RENAME	RESET
ROUTE	RUN	SET	SPOOL	ATRIB	AUTO	BOOT
BUILD	CLOCK	CREATE	DATE	DEBUG	DUMP	FREE
PROT	PURGE	SYSTEM	TIME	TRACE	VERIFY	XFER

All of the useful abbreviations in Newdos are included and the System Commands in Basic (CMD) now number eleven. A program called LBASIC/FIX is included, with which the normal TRSDOS Disk Basic may be patched to include a number of new commands and features. A Job Control Language is included and in fact is one of the most powerful features of LDOS. It allows the user to compile a sequence of commands or key strokes for later execution as a chain, with or without user intervention. There are too many new features to list them herein, but examples are: The ability to provide an audible signal, output through the cassette port. To flash or blink a one line message on the video display. A WAIT feature is included so that the machine can be put into a "sleep" state until such time as the system clock matches the time specified. And so on!

Hard disks in addition to single/double density, single/double sided, 8" and 5¼" floppies are supported although they may, of course, require hardware modifications. Utilities included in the package are:

BACKUP	COMMAND FILE	FORMAT	LCOMM
PATCH	RS232	KEY STROKE/MULTIPLIER	PRINTER FILTER

A Basic Renumbrer facility is included, as is a Basic Cross Reference function. Both are similar to the ones in Newdos+ and Newdos80. Most of the utilities are library commands which were existent in the previous DOS's, have been improved with the addition of new functions or facilities.

The prime development team of LDOS consisted of no less than 8 first rank programmers and they had the support and advice of six other well known programmers. They have done an excellent job to bring to the user what must be the best disk operating system so far produced for a microcomputer, which is destined to become the Standard DOS.

LDOS is totally upward compatible with TRSDOS, that is to say LDOS will be able to copy files and programs from TRSDOS disks onto LDOS formatted disks. As they are competitive disk operating systems, it is not surprising that the manual states that disks created under Newdos are not guaranteed to be compatible with LDOS, but we have not experienced any difficulty. We have done some work on investigating the compatibility of LDOS and the Video Genie and at the time of going to press we have found no incompatibilities. LDOS appears to run on the Video Genie without any problems at all. LDOS is compatible with either the Tandy or Electric Pencil lowercase modifications and Scripsit. LDOS is available for the Model I and Model III. A Model II version will be available shortly.

LDOS .....£85.00 plus VAT and £1.50 P&P.

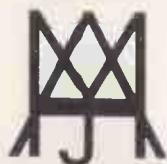

## MOLIMERX LTD

### A J HARDING (MOLIMERX)

1 BUCKHURST ROAD, TOWN HALL SQUARE, BEXHILL-ON-SEA, EAST SUSSEX.

TEL: [0424] 220391/223636

TELEX 86736 SOTEX G

TRS-80 & VIDEO GENIE SOFTWARE CATALOGUE £1.00 [refundable] plus 50p postage.



# Your chance to be



## ***Business opportunities for Dealers, OEM's and Software Houses that cannot be missed.***

LSI Computers Limited, one of Britains most progressive and successful computer manufacturers, have been marketing micro-computers in the end-user market for many years. Now, with an enviable track record behind us, things are expanding.

Through our OEM division we are looking to appoint dealers all over the U.K. for some very advanced microcomputer products.

### **System M-Three**

A high performance, low cost professional desk top micro-computer running CP/M\* with integral disk capacity from 350k to

10 Mbyte.....designed, developed and manufactured by LSI.  
**if 800**

Japanese innovation at it's best. As sole U.K. agents for this powerful CP/M\* multi-colour graphics and professional business micro-computer we are preparing a massive launch for this exceptional product.

### **SuperCalc**

As sole U.K. agents LSI is introducing what is undoubtedly the most comprehensive, versatile and simple to use Spreadsheet Simulator Software - available for almost every microcomputer equipped with CP/M\* operating system.

Our dealer programme offers attractive margins and a very substantial and exciting advertising and promotion campaign. With an ambitious stock programme, full back-up facilities already established

and good training schemes for your staff we are indeed predicting a massive success for ourselves and our dealers.

OEM business is very important to LSI and we are dedicated to offering our next generation computers through our dealer network. And, using our reputation and financial strength, we are implementing a vigorous programme to secure the very latest Technology and Machines for our Dealers.

Grasp this amazing opportunity to ensure a prosperous '82. Act now, ring Laurence Bright on 04862 23411 today to discuss this fantastic offer in more detail - you could be just one phone call away from a long and prosperous partnership.

\*CP/M is a registered trade mark of Digital Research

**EXCELLENT**  
Dealer Margins.

**LSI**

COMPUTERS

Putting Britain back in front.

Copse Road, St Johns,  
Woking, Surrey GU21 1SX  
Tel: (04862) 23411 Telex: 859592



an  dealer in '82



**BIG**  
advertising support.  
National Dealer Exhibitions.



**FULL**  
Engineering and  
Technical back-up.

Ring Laurence Bright on  
**04862 23411**

# nascom



- \* Housed in strong, stylish case with high quality QWERTY keyboard.
- \* 0.7Mbyte floppy disc system available in matching case.
- \* Full 8K RAM, expandable to 200K with page mode and RAM boards.
- \* Factory-built options plus additional range of Nascom-approved hardware and software.

Think of Nascom3 as an advanced personal computer, built to professional standards and offering the total systems-versatility needed by enthusiasts whose imaginations are already ahead of the toy computer field.

Think of Nascom3 as the powerful heart of a truly versatile educational or business computer system, with added peripherals and an extensive range of firmware and software options.

Or think of Nascom3 as a custom-structured industrial control unit, well capable of cutting production costs in many key areas.

Nascom3; reliable, expandable, affordable – and backed by one of Britain's best known engineering groups. Think about it.

## Lucas Logic

Nascom Microcomputers  
Division of Lucas Logic Limited,  
Warwick CV34 5PZ.



# authorized stockists



**semicomps**  
NORTHERN LIMITED

Semicomps Northern Ltd.,  
East Bowmont Street,  
Kelso, Roxburghshire. Tel: (0573) 24366

*Eley Electronics*

112, Groby Road, Glenfield, Leicester LE3 8GL  
Tel: (0533) 871522

## MID-SHIRE'S COMPUTER CENTRE

68 Nantwich Road, Crewe, Cheshire  
Tel: (0270) 211086

ELECTRICAL ELECTRONIC & MICROCOMPUTING  
RETAIL & REPAIR

18 Station Road Lower Parkstone  
Poole Dorset BH14 8UB  
Tel: Parkstone (0202) 746555

**PARKSTONE  
ELECTRICS**

**MicroComms**

Amateur radio C.B. radio  
Electronics Computers

372-374 George Street Aberdeen  
Telephone: 0224 633385

**JPS**

9 East Street, Colne,  
Nr. Huntingdon, Cambs.  
Tel: Ramsey (0487) 840710  
Contact Paul Jephcott



**SRS MICROSYSTEMS**

161 Bramley Road, Oakwood,  
London N14  
Telephone: 01-363 8060

58 Battersea Rise,  
Clapham Junction  
London SW11 1HH  
Tel: 01-674 1205  
01-675 4557

**OFF  
Records**

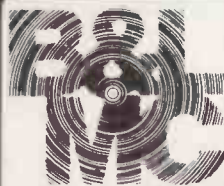

**In the heart  
of the Nascom  
country lies  
Business & Leisure**

**Business & Leisure  
Micro Computers**

We specialise in tailoring  
systems to your specific  
requirements.

16 The Square, Kenilworth, CV8 1EB.  
Tel: Kenilworth (0926) 512127



Stationstraat,  
6241 CL,  
Bunde (L),  
Netherlands.  
Tel: 043 641147

## OTHER NASCOM PRODUCTS

- \* Nascom 1 from £125 + VAT
- \* Nascom 2 from £225 + VAT
- \* Memory Extension Unit from £80 + VAT
- \* Disc systems from £375 + VAT
- \* Input/Output board from £37 + VAT

## NEW

- \* Advanced video controller from £155 + VAT
- \* Enhanced BASIC from £40 + VAT
- \* Pascal compiler from £45 + VAT
- \* Compiled BASIC from £150 + VAT

## SPECIAL OFFER

**Imp Printers**

**£199 + VAT**

including IMPPRINT

# COMBINED FORCES!

South East Computers PLUS Castle Electronics can now offer you Unequalled Service - at Supermarket Prices!



## VIC-20 COLOUR COMPUTER

- Graphics character set ●Plug-in programme/memory cartridges
- Colour ●Sound ●Programmable function keys ●5K memory expandable to 32K ●Standard PETBASIC ●Full-size typewriter keyboard
- Low-priced peripherals ●Joystick/paddles/lightpen
- Self teaching materials ●Cassette Deck now available £44.95

Only £189-95 INC. VAT

You won't find a Better Deal Anywhere in the South

BBC MICRO-COMPUTER NOW IN STOCK PLUS FULL RANGE OF ACCESSORIES



## Acorn Atom BRITISH DESIGNED PERSONAL COMPUTER

- |                             |         |                             |         |
|-----------------------------|---------|-----------------------------|---------|
| 8K ROM + 2K RAM kit .....   | £140.00 | 4K Floating Point ROM ..... | £ 23.00 |
| 8K ROM + 2K RAM Ass. ....   | £174.50 | Colour Encoder .....        | £ 21.85 |
| 12K ROM + 12K RAM kit ..... | £255.00 | Mains Power Supply .....    | £ 9.20  |
| 12K ROM + 12K RAM Ass. .... | £289.50 |                             |         |

## TANGERINE microtan

- |                              |        |
|------------------------------|--------|
| Microtan 65 Kit .....        | £79.35 |
| Microtan 65 Built .....      | £90.85 |
| Tanex Min. Config. Kit. .... | £49.45 |
| 20 way Keypad .....          | £11.50 |

### TANTEL PRESTEL ADAPTER - £199.00

We hold a complete stock of all the Tangerine equipment. Send SAE or Phone for details.



### COMPUTERS FOR PEOPLE

FROM £345.00 Plus All Accessories Available!

- |                       |         |
|-----------------------|---------|
| Model 400 16K .....   | £345.00 |
| Model 800 16K .....   | £645.00 |
| Cassette .....        | £ 50.00 |
| Disk Drive .....      | £345.00 |
| 80 Col. Printer ..... | £550.00 |



## COMMODORE PET

- |                         |         |
|-------------------------|---------|
| 8K PET .....            | £458.85 |
| 16K PET .....           | £550.00 |
| 32K PET .....           | £699.00 |
| Dual Disk Drive .....   | £799.00 |
| Printer .....           | £454.25 |
| External Cassette ..... | £ 44.95 |
- Complete range of PET equipment in Stock

CASSETTE SOFTWARE: Strathclyde Basic Course, Basic Basic Course, Invaders, Treasure Trove of Games 1 to 10 (10 Selections of games), Basic Maths, Algebra, Statistical Packs and lots more!

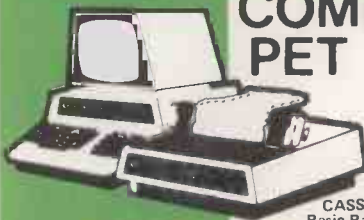

Special Offer! **sinclair ZX81 FOR IMMEDIATE DESPATCH £69.99**



### BUILT-IN SOUND-HIGH RES. GRAPHICS'

- |                               |         |
|-------------------------------|---------|
| Apple II Plus 48K .....       | £790.00 |
| Disk Drive + Controller ..... | £383.00 |
| D.D. without Cntrlr .....     | £303.00 |
| Pascal Card .....             | £264.00 |
| Eurocolour Card .....         | £73.00  |
| Hitachi 9" Monitor .....      | £146.00 |
- We Stock All the Goodies for Apple!



WE SPECIALISE IN COST EFFECTIVE SYSTEMS FOR SMALLER BUSINESSES

ALL PRICES INCLUDE VAT : ACCESS & BARCLAYCARD WELCOME ORDERS NORMALLY DESPATCHED DAY OF RECEIPT

## MicroComputers for Business

ASK FOR DETAILS OF OUR TOTAL SUPPORT OPTION

From Only £19 per week

### Package A

#### SILICON OFFICE SYSTEM

- 1 x CBM 8096 Computer
- 1 x CBM 8050 Dual Disk Drive
- 1 x CBM 8023 Matrix Printer

Connecting cables, plus Silicon Software

From Only £43 per week

### Package B

#### ALTOS MULTI-USER HARD DISK SYSTEM

- 1 x ALTOS 8000/10 Computer with 10 Mbyte Hard Disk
- 208Kbyte Memory (4 users)
- 500Kbyte Floppy Disk Drive
- 2 x TVI 912C VDU's
- 1 x OKI Microline 83A Printer

ALL PERSONAL COMPUTER ENQUIRIES:- Contact Paul Brown or Sam Wright on Hastings (0424) 437875 (Formerly Castle Electronics)

SEC BUSINESS SYSTEMS SUPPLY A WIDE RANGE OF EASY-TO-OPERATE SYSTEMS AND PROGRAMMES TO MEET ALL OF TODAY'S BUSINESS NEEDS + FULL RANGE OF COMPUTER RELATED PRODUCTS + LEASING AGREEMENTS + FULL AFTER SALES SERVICE



The Complete Computer Service!

FOR ALL BUSINESS SYSTEMS ENQUIRIES:- Phone Nick Rosenberg on Hastings (0424) 426844

15 CASTLE STREET, HASTINGS, EAST SUSSEX TN34 3DY DEPT. CW1



# THE TRANSTEC 1200 VIDEO MONITOR.



At last, a top quality green screen 12" video monitor at a really competitive price.

The Transtec 1200 has a composite video input, compatible with all micro computers and the screen gives a crisp read-out of a full 80 columns.

The unit is housed in a durable plastic cabinet with controls neatly concealed behind a hinged front-access panel.

Why pay more? Send the coupon today for full specification or better still, call us direct in Bristol.

**transtec**

13A Small Street, Bristol W.1.  
Tel. 0272-277462.

Lisburn Road, Belfast.  
Tel. 24009.

35 Pearse Street, Dublin 2.  
Tel. 713049.

**SEND  
£115 (VAT  
CARRIAGE  
INCL.) FOR  
IMMED.  
DELIVERY.**

I like the Transtec 1200 price — send me more data — fast.

Name \_\_\_\_\_  
Company \_\_\_\_\_  
Position \_\_\_\_\_

**JUST £99 COMPLETE.\***

\*Vat postage and packing not included

## APPLE OWNER!

### COLOUR FROM EUROAPPLE WITHOUT COLOURCARD

Now you can purchase the famous

## LUXOR 14" COLOUR MONITOR

for your APPLE Computer

*Just plugs into your APPLE does not require a Colourcard*



The Monitor that gives you the best resolution and the most magnificent colours will work on APPLE II EUROPLUS or APPLE U.S.A.

**ACT NOW AND SAVE!!**

**STILL AT 1980 PRICES**

**1 year Guarantee!!**

**ONLY £325.00 + VAT + P&P**

*We accept cheques, Visa & Access Card conversions*

Call Now:

**S.B.D. SOFTWARE**

15 Jocelyn Road,  
Richmond, Surrey, TW9 2TJ  
Tel: 01-948 0461 Telex: 22861

OR

**PORTATELL LTD.**

25 Sunbury Cross Centre, Stains Road West,  
Sunbury-on-Thames, Middlesex TW19 7BB  
Tel: (Sunbury) 88972

# No experience required to shop here!

We fully understand that to the uninitiated the first look at the Micro Computer world can be somewhat confusing, to say the least. But of course, to the experienced operator or programmer it's all plain—Kilobyte! Well, you don't have to be experienced to shop at SRS, we try to keep things as simple as possible and cater for everyone's needs. The businessman thinking about a small computer for the office or the advanced hobbyist requiring all the extra accessories for the micro system at home. We'll be pleased to give you all the help you need, advising you, in plain English, and plan the system that's just right for your needs—not one 32K RAM Module more! And at the end of the day, with our **LOW PRICES** and all the bits you were advised **NOT** to buy, we'll have almost certainly have saved you a great deal of money too! Call in and see us soon.



**LIMITED  
APPLE ///  
STOCKS!  
PLEASE PHONE  
FOR DETAILS**

## ATARI for the HOME & OFFICE

The advanced electronics of the ATARI 400 and 800 systems make them simple to use, even if you've never used a computer before. Yet, for the sophisticated user, they offer full user-programmability. In BASIC or Assembly Language. Connects to any TV. You simply attach them to any home television set, causing no interference to TV reception. And entertainment programs turn your television set into an entertainment centre for the whole family. Call in and find out more about these exciting new Micro Computers.

### Model 400

**16K  
RAM**



Cassette recorder... PLEASE  
Disc drive..... PHONE  
Thermal printer.... **FOR PRICE**

### Model 800

**16K  
RAM**

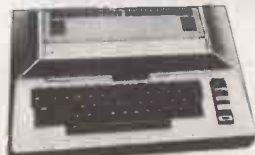

Plain paper printer... PLEASE  
Printer Interface..... PHONE  
16 Plug-in RAM..... **FOR PRICE**

**apple computer**  
Sales and Service

**APPLE II 48K; Disc Drive with controller;  
additional Disc Drive and Video  
Monitor  
Please phone for price.**

**SHARP SHARP**

**Model MZ80K  
MZ80B and  
PC3201**

Now in stock!  
Please phone for prices.

### NASCOM II

This excellent single board Micro Computer is supplied ready built and tested with keyboard but no memory

Power supply ..... PLEASE  
4 x 4118 Memory chips (4K)..... PHONE  
48K RAM Board..... **FOR PRICE**

### BUSINESSMEN!

We are now appointed dealers for  
**JARMAN SYSTEMS**

Demonstrations of these excellent business  
accounting systems given in our private show-  
room, anytime, by appointment.

Call in and see us for: Printers, video monitors, computing books, discs, tapes etc.

**ACCESS & BARCLAYCARD WELCOME – HIRE PURCHASE AVAILABLE  
FREE SECURICOR DELIVERY ON ORDER OVER £100**

All prices shown are excluding V.A.T. E. & O. E.



## SRS MICROSYSTEMS

161 Bramley Road,  
Oakwood, London N14 4XA

Telephone: 01-363 8060  
(Closed Monday)

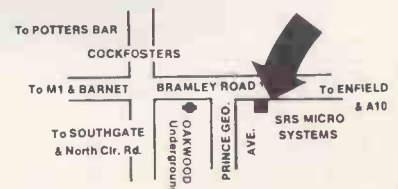



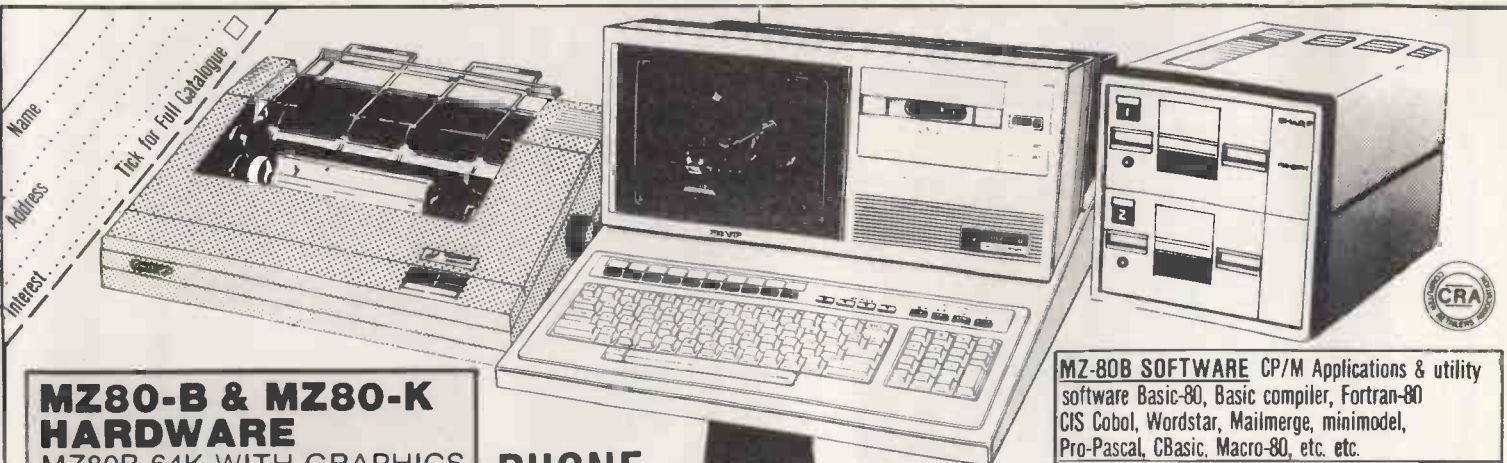

Name \_\_\_\_\_  
 Address \_\_\_\_\_  
 Interest \_\_\_\_\_ Tick for Full Catalogue



**MZ80-B & MZ80-K  
 HARDWARE**  
 MZ80B 64K WITH GRAPHICS  
 TWIN FLOPPY DISCS  
 P5 PRINTER  
 CPM  
 EXPANSION UNIT  
 UNIVERSAL I/O CARD

MZ80-K 48K COMPUTER  
 MZ80-K-FO DUAL DISC UNIT  
 MZ80-K-P3 PRINTER  
 MZ80-K 5 SLOT I/O BOX  
 BI-DIRECT V24/RS232 CARD  
 UNIVERSAL I/O CARD

**PHONE  
 NOW  
 FOR  
 LATEST  
 KUMA  
 PRICES**

**MZ-80B SOFTWARE** CP/M Applications & utility  
 software Basic-80, Basic compiler, Fortran-80  
 CIS Cobol, Wordstar, Mailmerge, minimodel,  
 Pro-Pascal, CBasic, Macro-80, etc. etc.  
**PHONE US FIRST FOR FULL CATALOGUE**

**UTILITY PACKAGES FOR MZ-80K**

APOLLO WORD PROCESSOR	£24.95
MEMORY TEST	£5.50
CASSETTE DATABASE	£29.50
BASIC EXTENSIONS	£13.00
ARDENSOFT TOOLKIT	£35.00
CP/M KIT	£150.00
ZEN EDITOR/ASSEMBLER	£19.50
SHARP EDITOR/ASSEMBLER	£45.00
ZEN-DOS DISSASSEMBLER	£37.50
SHARP MACHINE CODE TAPE & MANUAL	£22.50
CRYSTAL BASIC	£40.00
SUPER COPY	£10.50
PROGRAMME FILING INDEX	£5.50
MUSIC COMPOSER-EDITOR	£10.50
DOUBLE PRECISION BASIC FOR THE MZ80K DISC SYSTEM	£40.00
PASCAL (CASSETTE)	£50.00
MZ80-K CALC CII (FINANCIAL MODELLING)	£34.50

**MZ80-K MANUALS &  
 ACCESSORIES**

MZ80-K DUST COVER	£9.95
BASIC 5025 MANUAL	£7.00
<b>SERVICE MANUALS</b>	
MZ80-K	£7.50
MZ80-I/O	£5.00
MZ80-P3	£7.50
MZ80-FD	£10.00

**Software  
 authors  
 contact  
 us**

**GAMES FOR THE MZ-80K**

ANIMATE	£5.50	LUNAR LANDER	£5.50
BLOCKADE	£5.50	MAP OF ENGLAND	£5.50
BOMBER	£5.50	MASTERMIND	£5.50
BREAKOUT	£5.50	MIZ MAZE	£5.50
CAMELOT	£5.50	MONKEY CLIMB	£5.50
CAROLS	£5.50	MORTAR ATTACK	£5.50
CATCH 2000/INVADER	£5.50	PATIENCE	£5.50
CHESS	£10.50	POKER	£5.50
COMBAT	£5.50	PONTOON	£5.50
CONCENTRATION	£5.50	PRINCESS MAZE	£5.50
COSMIAD	£8.00	3D	£5.50
CRIBBAGE	£10.50	QUADRAX	£5.50
DONKEY DERBY	£5.50	RACING	£5.50
ELECTRONIC ORGAN	£5.50	RACETRACK	£5.50
ENIGMA	£5.50	RAIDER	£5.50
EVASION	£5.50	REACTOR	£5.50
EXECUTIVE	£8.00	ROAD HUNTER	£8.00
EXPLORING AFRICA	£5.50	RHYMES	£5.50
FALL OUT	£5.50	SHAPEMATCH	£5.50
FIREBALLS	£5.50	SHARP DEMO (GRAPHICS)	£5.50
4 IN A ROW	£5.50	SHOW JUMPING	£5.50
FRUIT MACHINE	£5.50	SNAKES & LADDERS	£5.50
GRAPHICS/ MUSIC PACK	£5.50	SPACE BATTLE	£5.50
TYCOON	£5.50	SPACE INVADERS	£5.50
GUESS WORD	£5.50	SPACE PURSUIT	£5.50
GUN	£5.50	STAR TREK	£5.50
HANGMAN	£5.50	STOMPER	£5.50
HEAD ON	£5.50	SUBMARINE	£5.50
HOME BUDGET	£5.50	SUPER FIRE	£5.50
HUNTER KILLER	£5.50	SUPER SIMON	£5.50
INTRUDER	£5.50	SWORDMAN	£8.00
J.S. LINE 4	£5.50	TANK WARP/WALL	£5.50
LARGE DISPY	£5.50	TEN PIN BOWLING	£5.50
LIFE	£8.00	TRADER SMITH	£8.00
LUNAR	£5.50	U.F.O.	£5.50

**EDUCATIONAL PACKAGES**

MUSIC COMPOSER EDITOR	£10.50
TIMETABLING AID	£19.50
CHILDRENS' MATHS	£5.50
ELECTRONS	£10.50
WAVES	£10.50
CESIL	£14.95
FRONT PANEL	£ t.b.a.
AS THE CROW FLIES	£ t.b.a.
BROWNIAN MOTION	£10.50

**AND MUCH MORE COMING!**

**Trade  
 enquires  
 welcome**

The  
 Point of  
 this Ad. is  
**SHARP**

**Kuma Computers**



Kuma computers: 11 York Road, Maidenhead Berks.  
 phone: Maidenhead (0628) 71778/9 Telex: 849462 TEL FAC.KUM

# GW Computers Ltd

## COMPUSTAR™



But the real beauty of the CompuStar is its 'shared logic' design concept. Each user station contains its own distinct microprocessor and RAM. The result is lightning fast program execution. Even when all 16 users are on-line. Even when all are performing different tasks! A special multiplexor circuit in the CompuStar ties all external users together to 'share' the system's disk resources so that no single user ever need wait on another. An incredibly existing concept!

A remarkable breakthrough in price/performance, the CompuStar boasts nearly 1 megabyte of on-line mini-disk storage (almost 2 megabytes on CompuStar II) and can be easily expanded to 20, 36 or 96 megabytes of hard-disk in just seconds. And since each user station can accommodate up to 64k of RAM, a total of over one million bytes can be incorporated into the system to tackle even your most difficult programming tasks.

CompuStar user stations can be configured in a countless number of ways. A series of three intelligent-type terminals are offered. Each is a perfect cosmetic and electrical match to the system. The CompuStar 10 — a 32k programmable RAM-based terminal (expandable to 64k) is just right if your requirement is a data entry or enquiry/response application. And, if your terminal needs are more sophisticated, select either our CompuStar 20 or CompuStar 40 as user stations. Both units offer dual disk storage in addition to the disk system in the CompuStar. The Model 20 features: 32k of RAM (expandable to 64k) and 350k of disk storage. The Model 40 comes equipped with 64k of RAM and over 700k of disk storage. But, most importantly, no matter what your investment in hardware, the possibility of obsolescence or incompatibility is completely eliminated since user stations can be configured in any fashion you like — whenever you want — at amazingly low cost!

## COMPUSTAR™



**Functional characteristics**  
The CompuStar 10 megabyte Disk Storage System (DSS) consists of read/write and control electronics, read/write heads, a track positioning mechanism, a spindle drive mechanism, dual disks, an air filtration system, and our exclusive 255 user controller — all packaged in a compact desktop enclosure. Although designed primarily to accommodate multiple CompuStar Video Processing Units (described at left), the unit can easily be connected to a single SuperBrain Video Computer System to facilitate additional disk storage. When used with CompuStar VDUs, however, the integral Z80 based controller will permit up to 255 users to 'share' the resources of the disk with minimal CPU response degradation.  
**Read/Write Heads and Disks**

The recording media consists of a lubricated thin magnetic oxide coating on a 200mm diameter aluminum substrate. This coating for mulation, together with the low load force/low mass Winchester type flying heads, permits reliable contact start/stop operation. Data on each disk surface is read by one read/write head, each of which accesses 256 tracks.

**G.W. COMPUTERS LTD. 01-636-8210. 01-631-8210. TELEX 892031 TW6G.**

### \*\*\*THE NEW DBMS (DATABASE)\*\*\*

DBMS2 is a record relational as well as a file relational database management tool that is capable of being at different times, many different things. The one core program can be set up to perform tasks normally associated with the following list.

Accounting	Budgeting	Cashflow
Stock control	Address mailing	Letter writing
Simulations	Time recording	Filing
Calc-type predictions	Hospital indexing	Profit analysis
Bureaux services	General analysis	Mathematics
Answer what-if's	Employees records	Tabulate values
Print reports	Sort files	Edit records

Within hours perform all the above in French or German.

The list is as endless as that which meets the requirements of your own imagination. Within the appropriate frame of reference you could ask questions like the following.  
Find someone whose name begins with W, who is either in London or Birmingham, and available for work at a salary of less than 10,000.00; and is under 40 years of age, not married, of credit worthiness grade 1, with a car, prepared to travel, and who likes horses, does not mind the hours he works, is congenial and has good references. When you find such persons produce a printed list of them showing their names, telephone numbers, and what their salaries are as well as their salary if increased

by 10% and show their availability for work. At the end of the list enumerate the total of such persons.

Find all stock items that are codes *micro-computers* that are either in warehouse 1 or warehouse 2, where the quantity on hand is more than 50 units, the cost is less than 1000.00, the selling price higher than 2000.00; that are not in cartons, bought from supplier 52, allocated more than 20, rated for tax at .15% and weigh less than 50 lbs. When you find such categories then print a report showing the description, cost price, quantity on hand, lead time for refills, what the selling price should be if raised by 12.3% as well as the profit in either per-cent or round figures of that projected selling price.  
Find all patients who suffered from cold, that are either girls or women younger than 23 years old, and who live in London at a socio-economic grade higher than 3; do not smoke; have more than 3 children, are currently at work and where treatment failed to effect a cure in under 6 days. When you find such persons then print a list showing their age, marital status, income, and frequency of illness in the past 2 years.  
Currently you can ask 5 types of questions 20 times for a single selection criterion, and then you can compute 10 mathematical relationships between the questions for the individual as well as for the total number of matches. In all some 60 bits of information relating to one record or a group of records on simply one permutation of the selection criterion, with a cross referencing facility as well.  
Every word in the system, as well as the file architectures, print masks, and field attributes, is capable of alteration by you without programming expertise (but with some thought).

ALL IN ONE PROGRAM FROM G. W. COMPUTERS. THE DBMS2!!

**24 HOUR ANSWER PHONE — LEAVE ADDRESS FOR STANDARD INFORMATION PACK**

### \*\*\*ALL YOU NEED FROM A COMPUTER SYSTEM\*\*\*

DATABASE MANAGEMENT+WORD-PROCESSING+MODELLING+DIY INTERPRETER+SERVICE

TWO TYPICAL PACKAGE DEALS ..... NORMALLY

01-SUPERBRAIN 64K RAM 320 K	1950.00
02-EPSON MX80 FT (OR SIMILAR)	475.00
03-CABLE	25.00
04-12 MONTH WARRANTY	235.00
05-DELIVERY IN U.K.	40.00
06-TRAINING SESSION	50.00
07-CPM HANDBOOK	8.75
08-50 BASIC EXERCISES	8.75
09-BOX PAPER (2000 SHEETS)	20.00
10-DBMS2 (DATABASE)	575.00
11-MAGIC WAND	190.00
12-MBASIC-80	150.00
13-SUPER CALC	150.00
14-40 MEMOREX DISKETTES	114.00
15-DOS+ AND DIAGNOSTICS	125.00
16-MSORT & DSORT	75.00
17-RECOVER+AUTOLOAD	25.00
18-INSTANT BASIC	9.00

NOT INC VAT) ..... 4225.50

OUR PRICE\*\*\*2995.00\*\*\*

(Note: Items 1 and 2 are more flexible)

EXTRA SPECIAL SUPERBRAIN PROGRAM MAIL ORDER OFFER OF THE 5 MAIN PROGRAMS DBMS2 + SORTS + MAGIC WAND+MBASIC 80+SUPER-CALC NORMALLY 1140 POUNDS

OUR PRICE\*\*\*\*\*595.00\*\*\*\*\*+ VAT

WARRANTY NOTE: WE HANDLE ALL REPAIRS OURSELVES.

WARRANTY COVERS FREE REPLACEMENT EQUIPMENT IF DEFECTIVE IN FIRST THREE WEEKS. THEREAFTER UP TO 12 MONTHS THE COVER PROVIDES INSURANCE ON ALL SPARE PARTS AND LABOUR COSTS (EXCLUDING CARRIAGE). CALL OUT MAINTENANCE IS ALSO AVAILABLE AT 25.00 MINIMUM (LONDON) 50.00 MINIMUM ELSEWHERE IN U.K. PLUS MILEAGE.

**CALL ONLY BY APPOINTMENT AT 55 BEDFORD COURT MANSIONS,  
BEDFORD AVENUE, LONDON W.C.1. TELEX 892031 TWC G.**



# GW Computers Ltd

## SUPERBRAIN™



SuperBrain users get exceptional performance for just a fraction of what they'd expect to pay. Standard SuperBrain features include: two double density mini-floppies with 350k bytes of disk storage, 32k of RAM memory (expandable to 64k) to handle even the most sophisticated programs, a CP/M® Disk Operating System with a high powered text editor, assembler, debugger and a disk formatter. And, with SuperBrain's S-100 bus adaptor, you can add all the programming power you will ever need... almost any type of S-100 compatible bus accessory.

SuperBrain's CP/M operating system boasts an overwhelming amount of available software in BASIC, FORTRAN, COBOL, and APL. Whatever your application... General Ledger, Accounts Receivable, Payroll, Inventory of Word Processing, SuperBrain is tops in its class. And the SuperBrain QD boasts the same powerful performance but also features a double-sided drive system to render more than 700k bytes of disk storage and a full 64k of RAM. All standard!

Whatever model you choose, you'll appreciate the careful attention given to every engineering detail. A full ASCII keyboard with numeric pad and user-programmable function keys. A non-glare, specially focused 12-inch CRT for sharp images everywhere on the screen. Twin Z-80 microprocessors to insure efficient data transfer to auxiliary peripheral devices. Dual universal RS-232C communications ports for serial data transmission. And, a single door design to make servicing a snap!

## ADVANTAGE



Integrated Desk Top Computer with 12 inch Bit-Mapped Graphics or Character Display, 64Kb RAM, 4 MHz Z80A, Two Quad Capacity Floppy Disk Drives, Selectric® Style 87 Key Keyboard, Business Graphics Software.

The North Star ADVANTAGE™ is an interactive integrated graphics computer supplying the single user with a balanced set of Business Data, Word, or Scientific-Data processing capabilities along with both character and graphics output. ADVANTAGE is fully supported by North Star's wide range of System and Application Software.

The ADVANTAGE contains a 4 MHz Z80A CPU with 64Kb of 200 nsec Dynamic RAM (with parity) for program storage, a separate 20Kb 200 nsec RAM to drive the bit-mapped display, a 2Kb bootstrap PROM and an auxiliary Intel 8035 microprocessor to control the keyboard and floppy disks. The display can be operated as a 1920 (24 lines by 80 characters) character display or as a bit-mapped display (240x640 pixels), where each pixel is controlled by one bit in the 20Kb display RAM. The two integrated 5 1/4 inch floppy disks are double-sided, double-density providing storage of 3600Kb per drive for a total of 720Kb. The 87-key rollover Selectric style keyboard contains 49 standard typewriter keys, 9 symbol or control keys, a 14 key numeric/cursor control pad and 15 user programmable function keys.

## G.W. COMPUTERS LTD. 01-636-8210, 01-631-8210, TELEX 892031 TW6G.

\*\*\* BUS \*\*\* WIDELY USED IN UK/France/USA AND ENGLISH SPEAKING COUNTRIES FOR ITS OVERALL FLEXIBILITY AS A COMPLETE BUSINESS PACKAGE.

Includes Inventory, Database, Management, Invoicing, Mailing Addresses, Statements, Sales/Purchase Ledger with or without Auto Stock Update and Double Entry Journals including Nominal Ledger; plus A/C Receivable and Payable making Auto Bank entries.

- |                       |                                |                                |                           |
|-----------------------|--------------------------------|--------------------------------|---------------------------|
| 01 = Address section  | 07 = Bank update               | 13 = Print customer statements | 18 = Change vocabulary    |
| 02 = Stock control    | 18 = User database area        | 14 = Print supplier statements | 19 = Nominal analysis     |
| 03 = A/C receivables  | 09 = Invoice creation          | 15 = Print agent statements    | 20 = Aged debtor analysis |
| 04 = Sales ledger     | 10 = Order files               | 16 = Print tax statements      | 21 = Disk directories     |
| 05 = A/C payables     | 11 = 30/60/90 day age analysis | 17 = Run separate programs     | 22 = File management      |
| 06 = Purchase ledgers | 12 = Arithmetic section        | 24 = Disk swap/exit system     | 23 = Sorts                |

\*\*\*\*\* SUPER - BUS \*\*\*\*\* A NEW HIGHER LEVEL OF THE ABOVE PACKAGE. . . HAS BEEN REDUCED IN SIZE BY 50 PER CENT TO A SINGLE 15K BASIC PROGRAM, MAKING ALL FILE RETRIEVALS A MATTER OF NANoseconds. WORKS UNDER M/PM AND COMPUSTAR FOR COMMON DATA RETRIEVAL LEVEL 10.00 . . . \*\*\*\*\* 1475.00 \*\*\*\*\*

DBMS (DATABASE) HAS 01=,02=,04=,06=,07=,08=,17=,18=,21=,24=. PRICE 475.00

DATABASE FEATURES ARE: . . . . . FOR ANY SIZE RECORD UP TO TWENTY FOUR FIELDS FILE ARCHITECTURES CAN BE DESIGNED WITH COMPLETE FREEDOM OVER THE LINGUISTIC CONVENTIONS ASSIGNED TO EACH FIELD. THE FILE THEN CAN STORE 32000 RECORDS WHICH CAN BE SEARCHED BY THE RANDOM ACCESS NUMBER (RETRIEVED IN LESS THAN ONE SECOND) OR 'KEY' RANDOM ACCESS ON SPECIFIED FIELD OR SEQUENTIALLY COMPARING FOR LEFT FIELD PARTS, FIELD-INKEYS, OR PARTS OF RECORD, AND THEN CHANGED, PRINTED, DELETED, SKIPPED.

GRAMA (WINTER) LTD/G.W. COMPUTERS LTD ARE THE PRODUCERS OF THIS PACKAGE WHICH IS UNEQUALLED FOR ITS LEVEL OF TOTAL INTEGRATION, LINGUISTIC FLEXIBILITY AND MAXIMISED DISK/MEMORY CONSERVATION. AUTHOR TONY WINTER (M.O., B.A. LIT., B.A. HON. PHIL. AND LECTURER)

## 24 HOUR ANSWER PHONE — LEAVE ADDRESS FOR STANDARD INFORMATION PACK

SuperBrain	CorvusDSK	North Star	CompuStar	Printer	Printer
64K + 320 K DISK	1950.00	64K MDL 10 VPU	1695.00	OKI MICRO-82A	575.00
64K + 700 K DISK	2395.00	64K MDL 15 PRNT	1595.00	OKI MICRO-B3	795.00
64K + 1.5 M DISK	2995.00	64K MDL 20 VPU	2495.00	OKI MICRO-83A	850.00
64K + 6.3 M DISK	4595.00	64K MDL 30 VPU	2795.00	EPSON MX80F/T	475.00
N*Star & Graphics	2395.00	64K MDL 40 VPU	4895.00	EPSON MX100	575.00
5.7 MG CORVUS DSK	2250.00	10 MEG INTERTEC	3250.00	TEXAS 810	1395.00
10 MEG CORVUS	3250.00	BUS VER 8.00	875.00	NEC 5510	1695.00
20 MEG Corvus DSK	4250.00	BUS MANUAL	25.00	NEC 5525	1895.00
Corvus Multiplex	395.00	DMBS2	575.00	QUME 9/45	1695.00
Corvus Mirror	395.00	N Star QD & CPM	2395.00	QUME 5/55	1950.00
Advantage N/Star	2395.00	OKI Micro 80	295.00	ORE 8830	1675.00
<b>SYSTEM 1</b>	<b>2395.00</b>	<b>System 2</b>	<b>4595.00</b>	<b>System 3</b>	<b>2950.00</b>
64K + 750 K DISK		64K + 5.6 MEGABYTE CORVUS		64K + 1.5 MEG	
CRT and Graphics CP/M		MICRO-WINCHESTER & CRT		CRT AND TWIN 5"	
IN 1 "N/Star" Unit		IN 1 SUPERBRAIN UNIT		IN COMPUSTAR UNIT	
MBASIC 80	150.00	FORTRAN-80	200.00	COBOL-80	320.00
CI\$ COBOL	420.00	PASCALUCSD	475.00	WORD-STAR	250.00
MAIL MERGE	55.00	SUPER SORT	120.00	CBASIC	75.00
DATA STAR	190.00	BASCOMPILER	190.00	MAGIC WAND	190.00
DBMS (DATABASE)	475.00	SUPER CALC (CPM)	155.00	T/MAKER	150.00
DBMS (EXTENDED)	575.00	BUS VER B.00	975.00	BUS VER 9.00	1075.00
MSORT & DSORT	75.00	LETTERIGHT	100.00	UTILITIES	75.00

OUR PRICE INCLUDES FREE TRAINING SESSION CABLES EXTENDED WARRANTY IF REQUIRED CPM HANDBOOK

10% ALLOWANCES AGAINST DELIVERY 6/12 MONTHS WARRANTY RIBBONS & THIMBLES BASIC MANUAL

ANY SOFTWARE ABOVE 5-50 DISKS \* \* \* \* \* 24/48 HOUR REPAIR MANUALS 2000 SHEETS PAPER

IF YOU WISH TO MAKE THE WARRANTY TO 1 YEAR THEN ADD 5% OF HARDWARE COST. OTHERWISE NO MAINTENANCE SCHEDULE. SIMPLY AD-HOC CHARGES AFTER WARRANTY EXPIRATION, SAME QUALITY SERVICE. (SITE MAINTENANCE ON APPLICATION).

Due to long term contractual commitments, we are only giving restricted demonstrations by appointment at one of our London offices. We export to all countries, and take Amexco, Barclaycard and Access. Contact Tony Winter on 01 636 8210 or 01 631 4818 and if unavailable then leave a call-back message (clearly stating your telephone number and name) on the 24 hour answer-phone, we call back anywhere in the world. Or simply leave your address and we'll mail you a standard information pack. Mail address: 55 Bedford Court Mansions, Bedford Avenue, London W.C.1.

**CALL ONLY BY APPOINTMENT AT 55 BEDFORD COURT MANSIONS, BEDFORD AVENUE, LONDON W.C.1. TELEX 892031 TWC G.**

# FOR FAST, LOW-COST LOCAL NETWORKS OMNINET PROVIDES THE CLEVER TWIST.

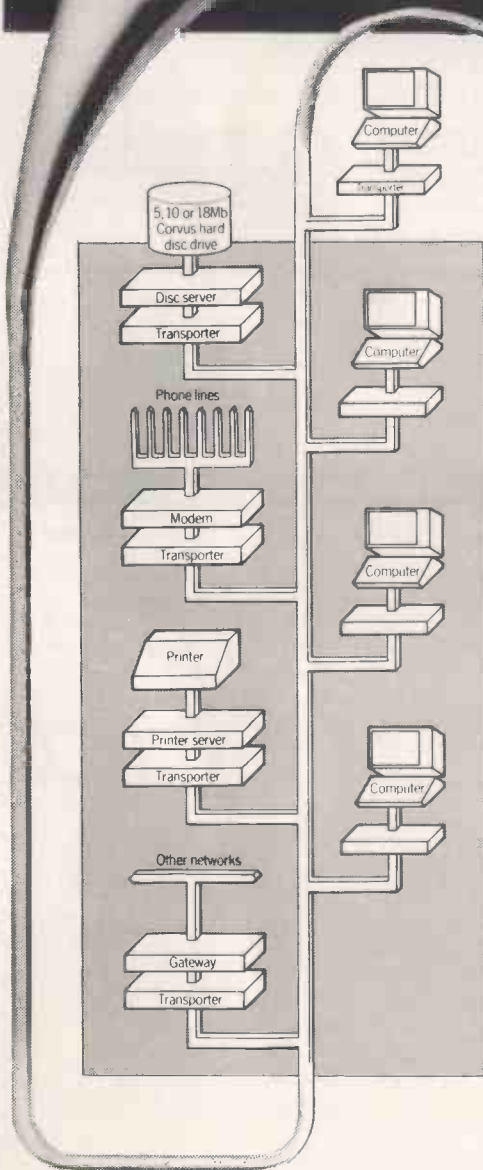

Omninet is the intelligent way of linking up to 64 different microcomputers or peripherals into a fast, low-cost local network. And the intelligence is in the microcomputer-based transporters. These manage the total network operation, without stealing processing power or requiring significant software support from the host – and will interface with a wide range of popular micros, including Apple, Onyx, DEC and IBM.

The rest is simple. Data is transmitted through twisted-pair wires at 1 million bits per second. Over 4,000 feet. Modems will link to the GPO telephone system and gateways to other networks will bring international communications to every office.

Other networks just can't match up to Omninet – on speed, price or ease of installation. Coaxial-linked systems are much more expensive. And jobs which have to be performed by the host computer in other networks – generating and receiving acknowledgements, retransmitting messages, and detecting duplicate messages – are all automatically performed by the Omninet transporter.

Sounds too good to be true? Check it out by phoning for more information today.

**Nottingham 0602 412777**

**London 01-236 5682/3/4 or write to  
Keen Computers, Marketing Dept.,  
5 Giltspur Street, London EC1A 9DE**

**Keen  
Computers**





# The model of good business.

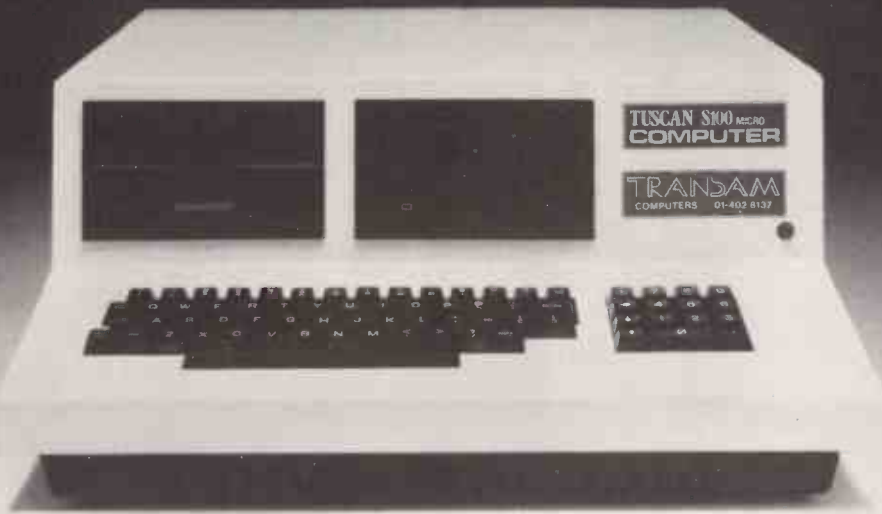

## Tuscan - the all-British microcomputer

With a proven record of steady development behind it, the Tuscan S100 now goes a step forward, solving the problem of effective backup storage.

The Tuscan S100, Britain's first S100 computer on a single board, is now available with designed-in mini-Winchester drive for better performance, shorter access time and higher transfer rate. All this from Britain's own home-grown micro manufacturer.

Systems with printer, screen and CP/M start at £2125 with twin floppies, and at £3625 with one floppy and one 5-meg. mini-Winchester.

**SOFTWARE.** Business accounts packages start at £800 when purchased with the Tuscan system. Word processing packages start at £315; Database packages start at £100.

**HARDWARE.** Flexibility is the key feature of all Tuscan systems. A choice of storage capacity, video format and graphics is available. The Tuscan S100 can read and write in sixteen different disk formats, with a choice of 5¼" or 8" drives.

**SUPPORT.** The Tuscan S100, designed and built in Britain, is backed by Transam's substantial experience in electronics plus a dedicated hardware and software team. National third party maintenance is available at ten per cent of hardware costs.

**BUSINESS SYSTEM DEALERS.** Business Equipment Centre, 10 Edge Lane, Liverpool. Tel: 263 5783. Contact: Rod Crofts.  
Purley Computers, 21 Bartholomew Street, Newbury, Berkshire. Tel: 41784. Contact: Ron Smith.

**FURTHER INFORMATION.** Two new catalogues covering "systems and peripherals" and "CP/M Software" are available, giving details of our systems and services. Call or write for yours.



# TRANSAM

TRANSAM COMPONENTS LIMITED  
59/61 THEOBALD'S ROAD, LONDON WC1  
Tel: 01-405 5240/2113. Telex: 24224 (Ref. 1422)

# EXPLORER 85

**For Maximum Flexibility**

**A thoroughly versatile S100 based computer  
Arrange your own microsystem with the  
following fully assembled and tested modules**



- MOTHER BOARD 8085 cpu—3.5MHz 2K Monitor, Cassette Interface, S100 bus connectors and circuitry, provision for ROM/EPROM . **£165.00**
- KEY BOARD TERMINAL Stand alone, cpu controlled 1K RAM, 64/32 x 16 format, 128 character upper & lower case, full cursor control. **£130.00**
- AP-1 POWER SUPPLY UNIT 5AMP power supply. . . . . **£35.00**
- 64K DYNAMIC S-100 RAM CARD . . . . . **£175.00**
- FLOPPY DISK CONTROL CARD controls 4 drives  
2 serial I/O ports 2716 PROM socket . . . . . **£165.00**
- 8" Control Data Corp Professional Drives. . . . . **£350.00**
- Cable set. . . . . **£19.00**
- Disk drive cabinet P.S.U. . . . **£79.00**
- CP/M2.2 . . . . . **£95.00**
- BK BASIC in ROM. . . . . **£65.00**

## VIDEO GENIE

**Amazing Value for a  
Complete Computer System**



16K User RAM  
12K Microsoft  
Basic in ROM  
Utilises Z80

**ONLY £279**

Full Range of Peripherals available

## ACORN ATOM

**Top Quality  
Unique Personal Computer**



6502 Microprocessor 2K RAM  
Audio Cassette Interface  
Full Size Keyboard

High Resolution  
Colour Graphics

**Complete £150 Ready to use**

## PRINTERS

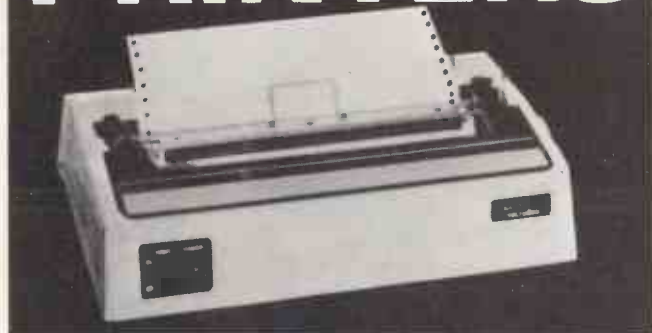

### EPSON

MX 80      £359  
MX 80 FT   £399  
MX 80 FT II   £440  
MX 82      £389  
MX 82 FT   £455  
MX 100     £575

Full Range of Epson Interfaces

### OKI MICROLINE

82A      £399  
83A      £650

### OLYMPIA

ESW 100 RO   £836  
ESW 100 KSR   £998

**MONITORS 12" GREEN SCREEN 18MHz. . . £99.00**

## FUJITSU 8

**NEW  
64K MICRO  
WITH  
BUBBLE  
MEMORY**

**MAIN  
LONDON  
DEALER**



**BASIC STARTING PRICE £895**

**LOOK AT THESE FEATURES**

CP/M and UTILITIES (Optional)	80 CHAR. x 25 LINE DISPLAY
30KB ROM BASIC	REALTIME + DATE CLOCK
640 x 200 DOT COLOUR GRAPHICS	CPU - TWIN 6809 plus Z80A
49 8 x 8 MATRIX BLOCK GRAPHICS	48K VIDEO MEMORY
REVOLUTIONARY EDITING FACILITIES	64K MAIN MEMORY
PRINTER SCREEN DUMPING (with Grey Scaling)	8 COLOURS
2 x 32KB BUBBLE MEMORY CASSETTES (Optional)	LOW COST
656KB OF MINI FLOPPY DISK STORAGE (Optional)	
STANDARD SERIAL, PARALLEL, BUSS, CASSETTE & ANALOG INTERFACES	



**NEWTRONICS**

255 ARCHWAY ROAD,  
LONDON, N.6 TEL: 01-348 3325

Please add VAT to all prices. P&P extra. Please make cheques and postal orders payable to NEWTRONICS or phone your order quoting BARCLAYCARD, ACCESS number.

We are open for demonstrations and Sales. Monday-Saturday 9.30 a.m.-6.30 p.m. Near Highgate Underground on main A1 into London.



# Prism— the new generation of pin matrix printers which leaves all your options open.

How would you like a matrix printer to meet your precise requirements now and in the future!

Teleprinter's new Prism does just that for you. As standard it has all the features you expect of a top-quality unit, without committing you to specialised functions you may never require.

If however you do need such facilities as letter quality printing, ultra-high speed printing, raster graphics and even full colour printing with up to 400 shades, any or all of these options are available to you either at time of purchase or as retro-fits in the field.

Keep all your options open – find out about the remarkable new Prism today.



Teleprinter Equipment Limited –  
*the peripheral people*

70-82 Akeman Street, Tring, Herts. HP23 6AJ. U.K.  
Tel. Tring (0442 82) 5551/9. & 4011/9 Telex: 82362 BATECO G.

Please send full details of the Prism printers

Name \_\_\_\_\_

Company \_\_\_\_\_

Address \_\_\_\_\_

Tel. \_\_\_\_\_ PCW 2/82

# Superior

## Easy to use CP/M\* Spreadsheet simulator from LSI

SuperCalc is the planning tool you need to make better use of your time and energy, having a direct positive effect on your business profits.

SuperCalc finally makes it possible for decision makers to manipulate data quickly, setting up exactly what is necessary for in-depth analysis and modelling. It all takes place on the SuperCalc simulator screen. You can examine and alter numbers and text within a grid that can cover 63 columns and 254 rows of data.

Accountants, planners, engineers, and business owners have found SuperCalc invaluable for day-to-day 'what if' questions, as well as 'now what?' for those times when the unexpected occurs. All it takes is a second to enter the new figure in the appropriate column, and SuperCalc automatically calculates the rest of the spreadsheet. And, you certainly don't need a programmer - SuperCalc really is easy to use. It's been designed to use the minimum number of commands to get the maximum power, and its' self-explanatory: just press the ? key if you need assistance.

Another feature that makes SuperCalc special is the error message display. Previous planning products 'beep' the user when a mistake is made, without telling the user what exactly the mistake is. SuperCalc images a

message on your screen informing you where the error has occurred so that you can immediately correct it and proceed with your analysis.

You can produce a report from your spreadsheet simply by activating the output command sequence. Other packages require a completely different programme to accomplish this. Furthermore you can combine portions of other previously created spreadsheets to build a completely new one. All of this happens in seconds; SuperCalc is as fast as it is workable.

SuperCalc's editing capabilities are more powerful than other packages: you can delete entire commands, not just one letter at a time. You can plug in a repeating formula simply by typing in a one letter command and telling SuperCalc which entries are to be affected. To prevent accidents or entry loss, all data can be protected from new manipulations. This way you can preserve one spreadsheet version whilst working on another.

Pencils, paper, and a calculator have been replaced. SuperCalc and your CP/M\* are now the tools of the successful decision maker and businessman.

Find out more about SuperCalc now by mailing the coupon or calling the number below.

\* CP/M is a registered trade mark of Digital Research

# £190

# + VAT

Post and Package Extra

#### DISTRIBUTORS

LSI Computers (Manchester), Genesis, Birchwood Science Park, Risley, WARRINGTON, Cheshire WA3 7BH. Tel: Padgate (0925) 824660.

LSI Computers (Croydon), Restmor Way, Hackbridge Road, HACKBRIDGE, Surrey SM6 7AG. Tel: 01-773 0917.

LSI Computers (South East), 4 Springfield Road, HORSHAM, West Sussex RH12 2PN. Tel: Horsham (0403) 64363.

LSI Computers (South West), West House, Stawell, BRIDGWATER, Somerset TA7 9AA. Tel: 0278 722073.

Encotel Systems Ltd., 530-539 Purley Way, CROYDON, Surrey. Tel: 01-686 9687.

Roundhill Computer Systems Ltd., Axholme, London Road, MARLBOROUGH, Wiltshire SN8 1LR. Tel: Marlborough (0672) 84675 Telex: 444453 Aware G.

KGB Micros Limited, 14 Windsor Road, SLOUGH, Berks SL1 1EL. Tel: Slough 38581/38310 Telex: 847777 Delray G Attn KMICRO



# SuperCalc™

# SuperCalc™

# SuperCalc™

# SuperCalc™

# SuperCalc™

# SuperCalc™

# SuperCalc™

# SuperCalc™

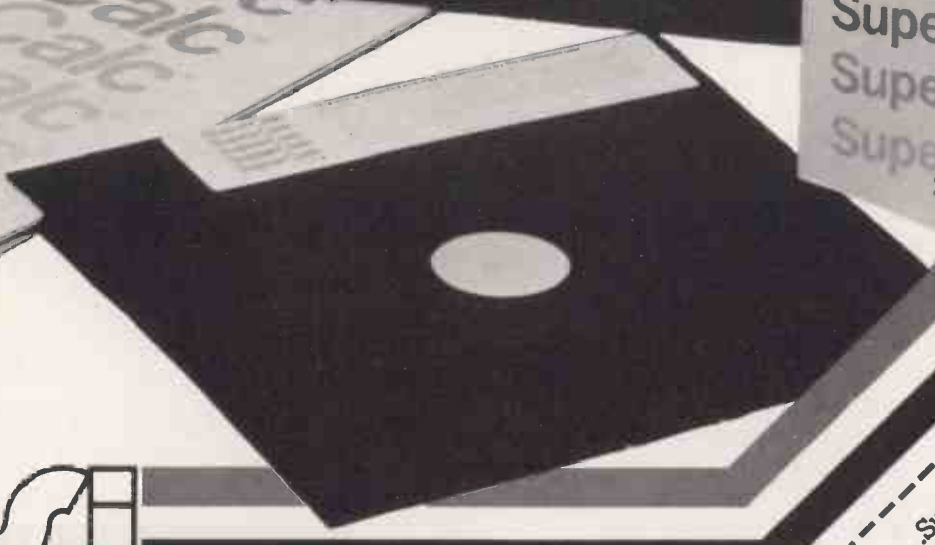
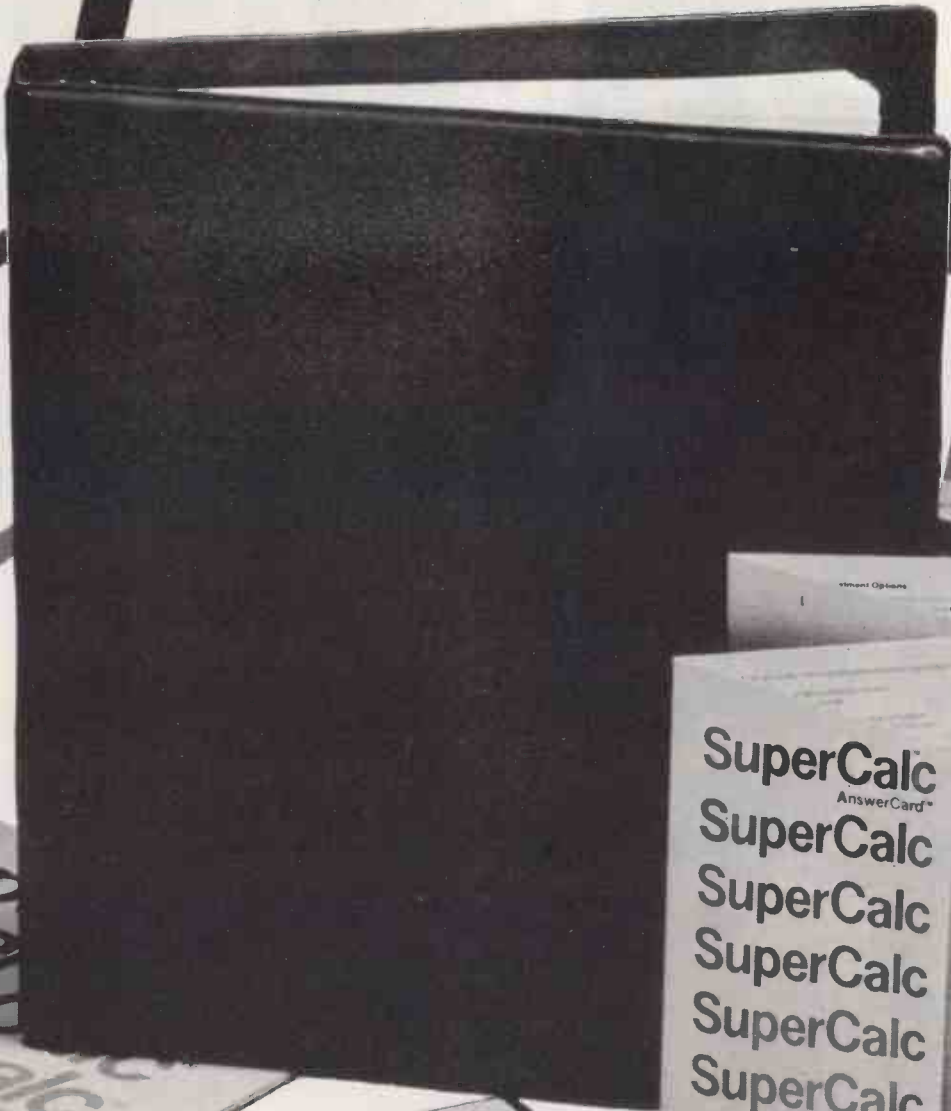

COMPUTERS  
Copse Road, St Johns,  
Woking, Surrey GU21 1SX  
Tel: (04862) 23411 Telex: 859592

-----  
\* I enclose my order for ..... SuperCalc Spreadsheet Simulator System(s) priced at  
£190.00 plus VAT. \* Contact me with full details of new Superior SuperCalc  
Name \_\_\_\_\_  
Address \_\_\_\_\_  
Tel \_\_\_\_\_  
System \_\_\_\_\_  
Company \_\_\_\_\_  
\* Delete which ever necessary.

# LIVERPOOL COMPUTER CENTRE



## Latest Computer Books

Don't (or How to Care for your Computer) (Zaks/Sybex) .	£9.60
50 Pascal Programs (Sybex) .....	£10.70
32 BASIC Programs for Apple II .....	£11.85
Beneath Apple's DOS .....	£12.95
The Book (of Apple Software) .....	£14.45
How to Get Started in CP/M .....	£10.95
Some Common BASIC Programs - Apple II .....	£10.95

and the latest ZX-81 books.

## Disks

Accutrack - per box of ten

5 1/4" SS/DD .....	£15.50
5 1/4" DS/DD .....	£26.50
8" SS/DD .....	£19.95
8" DS/DD .....	£28.95

**We also supply other formats plus a wide range of Computer Consumables.**

**Postage & Packing FREE on orders over £10. Orders under £10 add 75p.**

**Add VAT at 15% to all items except books.**

**14-16 MANCHESTER ST.  
LIVERPOOL L1 6ER**

**051-236 2000**

## U-MICROCOMPUTERS

U-Microcomputers  
are one of the  
UK's top Apple  
Dealers and one  
of the longest  
established.

Look at our system price  
offers - don't be confused by  
offers on the basic unit only:

### BUY:

Apple II 48K and one Drive  
and get *free* - U-RAM 16,  
U-Z80 or U-S232  
or  
U-TERM (80 col) and one of  
U-RAM 16, U-Z80 or U-S232.

**£1219.00**



## This months offers:

QUME SPRINT 5/45 RO	£1349.00
CORVUS 5MB Drive	£2100.00
VISICALC 3.2	£50.00
CENTRONIC 745 with interface (S)	£250.00
MICROHUSH 40 COL PRINTER (S) with interface	£49.00
MOUNTAIN EXPANSION CHASSIS	£375.00
SSI'S COMPUTER Bismark, Napoleonics or Conflict	£21.00
APPLE DOC	£25.00

**Wordstar Hardware Kit:**  
U-TERM (80 Col), U-Z80 with  
CP/M, U-RAM 16 and U-S232  
Our Price ONLY **£400.00**  
Elsewhere **£637.00**

**Wordstar Software**      **£200.00**

All offers mail order only, VAT and delivery  
extra. Payment with order. All offers subject  
to availability and expiring end of February  
1982.

(S) indicates used equipment.

## U-MICROCOMPUTERS

U-Microcomputers Ltd  
Winstanley Industrial Estate  
Long Lane, Warrington  
Cheshire WA2 8PR  
Tel: 0925 54117/8

'make it easy on yourself'



# MICROCOMPUTER PRODUCTS



INTERNATIONAL LTD.

ROOM PCW 8 CAMBRIDGE HOUSE, CAMBRIDGE ROAD, BARKING, ESSEX IG11 8NT, ENGLAND  
Telephone: 01-591 6511 Telex: 892395

SOFTWARE FOR CP/M COMPUTERS INCLUDING

CROMEMCO Z2D EXCIDY SORCERER SUPERBRAIN VECTOR MZ NORTH STAR HORIZON	COMART COMMUNICATOR COMART EDUCATOR RAIR BLACK BOX SD SYSTEMS NASCOM	RESEARCH MACHINES GEMINI TRANSMAN TUSCAN SHARP MX 9.6" IBM FORMAT	OTHER FORMATS AVAILABLE
--	--	---	-------------------------------

## BYROM SOFTWARE

	Software & Manual	Manual Only
BSTAM—Utility to link one microcomputer to another also using BSTAM	£95	£6
BSTMS—Utility to link a micro to a mini or mainframe	£95	£11

## COMPILER SYSTEMS

CBASIC v 2.08	£65	£15
---------------	-----	-----

## CP/M USER LIBRARY

51 Volumes—Price per volume		
8 disc (one volume per disc)	£4	
5 disc (one volume per 2 discs)	£8	
Index	£2	

## CREATIVE COMPUTING

CS-9001 BASIC Games 1	£14	
CS-9002 BASIC Games 2	£14	
CS-9003 ADVENTURE 1.0	£14	
CS-9004 BILINGUAL Original Adventure	£14	
CS-9005 BASIC Games 3	£14	
CS-9006 BASIC Games 4	£14	

## DIGITAL RESEARCH

MPM 1.1	£195	£20
MPM 2.0	£250	£30
CP/MB6	£160	£27
CP/M 2.2	£95	£20
CP/NET	£120	£14
SID	£50	£14
ZSID	£55	£14
MAC	£60	£14
TEX	£50	£14
DESPOOL	£33	£6
PL/1	£300	£27
BT-80	£140	£20

## INFORMATION UNLIMITED

WHATSIIT (Database Management System)	£80	
---------------------------------------	-----	--

## KLH SYSTEMS

Spooler for CPM systems v3.0	£70	£6
------------------------------	-----	----

## MPI LTD.

FORTH	£72	£20
PAYROLL	£500	£15
SALES LEDGER	£200	£15
PURCHASE LEDGER	£200	£15
NOMINAL LEDGER	£200	£15
INCOMPLETE RECORDS	£1200	£20

# WHAT A TEAM!



## MICAH INC.

	Software & Manual	Manual Only
CP/M for COOS Users: Program to Expand CP/M system to be compatible with Cromemco COOS software	£65	£6

## MICROFOCUS

CIS COBOL version 4.4	£400	£25
FORMS 2 v11	£100	£10

## MICROLOGY

FTNUMB (FORTRAN-80 RENUMBER & REFORMATTER)	£50	£5
--	-----	----

## MICROPRO INC.

WORD-MASTER 1.7A	£75	£22
TEX-WRITER 2.6	£37	£17
WORSTAR 3.0	£250	£38
MAIL MERGE 3.0 (requires Wordstar)	£75	£10
SPELLSTAR 1.0 (requires Wordstar)	£125	£10
WORDSTAR TRAINING MANUAL		£18
WORDSTAR CUSTOMIZATION NOTES	£50	
SUPER-SORT 1.6: Version 1	£125	£22
Version 2	£110	£22
DATASAR 1.101	£175	£25
CALCSTAR	£150	£25

## Books/Magazines/Order Information overleaf

## MICROSOFT INC.

BASIC-80 5.21	£185	
BASIC Compiler 5.3	£205	
FORTRAN-80 3.43	£260	
COBOL-80 4.01	£380	
M/SORT 1.01	£75	
EOIT-80 2.02	£65	
MACRO-80 3.43	£105	
MULISP 2.10	£105	
MUMATH 2.10	£130	

## MICROTECH EXPORTS

REFORMATTER		
CPM-IBM	£98	£17
CPM-DEC	£98	£17

## MT MICROSYSTEMS

PASCAL MT- 5.25	£150	£25
PASCAL MT- 5.25 with SPP	£265	£50
Library Sources	£110	
Speed Programming Pkge. (Solibus)	£125	£25

## NORTHSHARE

Multi-user system for Horizon Users 5.12	£44	£7
--	-----	----

## SPECIAL PRODUCT

### THE STAR QUALITY FEATURES OF CALCSTAR

With CalcStar you will be able to manipulate data, either text or numeric, on a visually orientated display. The numeric data may either be constant or be dependant on other data. CalcStar has facilities for editing, formatting, storing, calculating and printing all data. This is a true electronic worksheet, with 127 columns and 255 rows. Uses include:-

## OSBORNE & ASSOCIATES

	Software & Manual	Manual Only
ACCOUNTS PAYABLE & ACCOUNTS RECEIVABLE	£50	£15
GENERAL LEDGER	£50	£15

## PHOENIX SOFTWARE ASSOCIATES (For Z80 only)

PLINK—Disc to disc link loader	£72	£15
PASM—Macro Assembler	£72	£15
PEDIT—Line editor with Macros	£72	£15
BUG—Very powerful debug	£72	£15
PDEVELOP Package with all the above	£193	£33
PLINK—2 Overlay Link Loader	£185	£15

## STRUCTURED SYSTEMS (All converted to UK Standard)

SALES LEDGER	£350	£20
PURCHASE LEDGER	£350	£20
NOMINAL LEDGER	£350	£20
STOCK CONTROL	£350	£20
LETTERRIGHT	£95	£11
ANALYST (File management Reporting System)	£125	£11
NAD (Name and Address selection system)	£55	£11
QSORT	£55	£11

## SUPERSOFT INC.

DIAGNOSTICS 1	£45	£9
DIAGNOSTICS 2	£55	£9
TERM	£72	£7

## TDL SOFTWARE (Technical Design Labs)

BUSINESS BASIC	£80	
ZTEL (Text Editing Lang.)	£35	
LINKER	£35	

## TINY-C ASSOCIATES

Tiny-C language for 8080, 8085, Z80 systems	£55	£39
---	-----	-----

## New Products

MICROPRO INFOSTAR	TBA
FOX & GELLER QUICKSCREEN	TBA
MICRO AP SELECTOR V	TBA
DIGITAL RESEARCH CB-80	TBA

## BASF DISCS

The following formats are available from stock: 8" SSSD  
5" Soft Sectors, 5" 10 Sectors, 5" 16 Sectors

Quantity	Price Per Disc Ex VAT	
1 - 50	£2.40	Minimum order quantity 10 discs. Orders must be in multiples of 10. Postage, Package & Insurance 86p per 10 Discs up to 50 Discs thereafter 17p per 10. Other formats on request.
51 - 100	£2.00	
101 - 200	£1.80	
201 - 500	£1.70	
501 -	£1.50	

Balance Statements • Cash Flow Analysis and Forecasting • General Ledger • Inventory Records • Jobs Cost Estimates • Market Share Analysis and Planning • Patient Records • Profit Projections • Profit Statements • Profit Budgeting and Control • Salary Records • Sales Projects and Records • Tax Estimation etc.

Are you in business?  
Can you afford to be without CALCSTAR?  
Have a STAR Company. Use CALCSTAR!!!

## ORDER INFORMATION

**MAGAZINES:** Magazine back issues that are not currently in stock are often difficult to obtain. For unavailable back issues there is a photocopying service at £0.15 per page plus £0.25 p+p plus VAT.

**BOOKS:** Most books are published in the USA and stocked in Britain by Microcomputer Products International Ltd. We aim to keep all of these books in stock and as a result of this, most prepaid orders are despatched by return of post. Please add £1.00 towards postage for EACH book purchased. If purchasing more than 3 books at any one time, please add £0.25 for each extra title (over the 3).

**PAYMENT:** All payment must be in sterling and drawn against a UK Bank. Send cash cheques, postal orders, IMO, Access or Barclaycard No. to: Microcomputer Products International Ltd., Room PCW 8 Cambridge House, Cambridge Road, Barking Essex IG11 8NT. Telephone: 01-591 6511. Telex: 892395.

**SOFTWARE:** Software Prices reflect distribution on 8" Single Density Discs. When ordering, please specify the format you require. If not specified, all software will be despatched on an 8" Single Density Disc. Please add £3.00 for postage, packing and insurance plus VAT on EACH Software item purchased. For overseas, please add £6.50 per item. Prices based on £2.00 to the pound. Any deviation in this involves surcharge or discount, as appropriate. If required, DATAPOST (overnight) service is available in the U.K. for an extra charge of £8.50 per item plus VAT. Most Software on this list is available from stock and a 72 hour return service is therefore offered on most prepaid orders.

Retailer and OEM terms available

MAIL ORDER TELEPHONE CREDIT CARD ORDER

\* VISIT \*

Full descriptive Catalogue: available £1 - deductible from first purchase

Trade Enquiries Welcome

# How well does your computer understand you?

**You don't need to understand computers if your computer understands you.**

Together you and your computer can form a great team. Analysing your problems and formulating solutions—quickly, accurately and cost effectively.

Through Vector Graphic products the right system can be found for you and your company.

MEMORITE III, probably the best word processor on a computer system today: including mailing list merge, spelling, dictionary, phrase library, password system, help screens.

EXECUPLAN. The information system that replaces the calculator, pencil and paper. The system that adapts to you, never forgets, speeds up your workflow, and it's a perfect typist too!

MEMORITE and EXECUPLAN are just two of the packages helping business today, others include: solicitors packages, accounts, stock control, payroll, job costing, estimating, planning, printers job costing, manufacturing and a host of scientific and technical systems.

All Vector systems are based on the Industry Standard S-100 Bus Configuration and CP/M operating system. Call us today – we'll be pleased to arrange a demonstration. Then you can judge the benefits for yourself.



## Almarc

DATA SYSTEMS

Almarc Data Systems Limited, Great Freeman Street,  
Nottingham NG3 1FR. Tel: (0602) 52657.

Telex: 37407 Almarc/G.

Also at: Green Street, High Wycombe,  
Bucks. HP11 2RF. Tel: (0494) 23804.

#### APPROVED ALMARC DEALERS

BALDOCK	Modus Systems	(0462) 894848
BIRMINGHAM	Taylor Micro Systems Ltd.	(021) 358 2436
DONCASTER	Reed Computing	(0709) 67087
HIGH WYCOMBE	Common Sense Business Systems	(0494) 40116
HARROGATE	Business Microsystems	(0423) 68224
KETTERING	Shuttleworth Business Systems	(0536) 511357
LONDON	Micro Systems Consultants	(01) 979 4098
LOUTH	Computa-Crop	(0507) 604271/2
NOTTINGHAM	Bestmoor Limited	(0602) 415315
SWANSEA	Business Microsystems	(0792) 474082
TYNE & WEAR	H.P. Micros	(0632) 859923
YEovil	Dale Computers	(0935) 23097





# "— the most successful show we have ever attended"

This quote from Interactive Data Systems is typical of many made by exhibitors at the 1981 Micro Show. For instance, Systime achieved signed contracts in excess of £75,000 and appointed 15 new dealers. Ingersoll also reported fantastic sales.

The 1982 exhibition is specifically designed for a business audience seriously considering the installation of a micro system or personal computers for business use within their organisation.

Many of the larger display areas have already been allocated, so if your company has not yet reserved space,

please contact our Exhibition Department who will make you a provisional booking awaiting your written confirmation.

## THE 1982 MICRO SHOW

11-13 May 1982

Wembley Conference Centre  
London

### INTERACTIVE DATA SYSTEMS

Online Conferences Ltd  
Argyle House  
NORTHWOOD HILLS  
Middx  
HA6 1TS

Dear Jane

Our Ref: JS/PL

We have now had the opportunity to follow up the many leads we received at the 1981 Microcomputer Show, and are pleased to say that this show was, without doubt, the most successful show we have ever attended.

We have signed up several new dealers, including one in Eire, and in total the new business we found at the show could result in orders to the value of £1<sup>1</sup>/<sub>2</sub>m over the next twelve months.

We will be back in 1982!

Yours sincerely

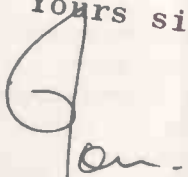
  
Jon Spencer  
Marketing Director



# OSBORNE

**"The answer to every would be computerist's prayer"  
(PCW Bench Test)**



The Computer Retailers Association is a voluntary organisation of leading microcomputer dealers and service organisations.

The purpose of the Association is to maintain and improve standards of trading and customer support within the industry, and to present the industry's case to the outside world. The Association also acts as a forum where members can discuss common problems.

Membership is open only to those reputable organisations within the industry who are willing to subscribe to the Association's Code of Practice, and who meet the Conditions of Membership.

See it at your nearest **CRA** dealer

**Xitan Systems Ltd.**  
23 Cumberland Place,  
Southampton,  
SO1 2BB  
Tel: 0703 38740

**Datron Micro Centre**  
2 Abbeydale Road,  
Sheffield S7 1FD  
Tel: 0742-585490/585400  
Telex: 547151

**Microcomputers at Laskys**  
10 stores within selected  
Laskys  
Phone 051-227 2535  
for details

**Crystal Electronics**  
40 Magdalene Road,  
Torquay, Devon.  
Tel: 0803 22699  
Telex: 42507 XTAL G

**Lion Micro Computers**  
Lion House,  
227 Tottenham Court Road,  
London W1  
Tel: 01-580 7383

**Byteshop  
Computerland**  
5 Shops Nationwide  
Phone 0480 215005  
for details

**Digitus Ltd.**  
10-14 Bedford Street,  
Covent Garden,  
London WC2  
Tel: 01-379 6968

**Adda Computers Ltd.**  
154, Victoria Road,  
Acton, London W3  
Tel: 01-992 9904

## COMPUTER RETAILERS ASSOCIATION



### Your Guarantee of Satisfaction



# New from Sams Six COMMODORE SUPERPET COMPUTERS Books Using Waterloo microSoftware

## Available this month

F. D. Boswell, T. R. Grove, K. I. McPhee, J. B. Schueler and J. W. Welch

### System Overview

This introduction to the Commodore SuperPET personal computing system provides an overview of the hardware and of the Waterloo microSoftware packages.

£4.15 672-21903-4

P. H. Dirksen and J. W. Welch

### Waterloo microFORTRAN

*Tutorial and Reference Manual*

Waterloo microFORTRAN is a dialect of FORTRAN designed for use in educational and research environments. This book introduces the many features of Waterloo microFORTRAN step by step, placing emphasis on the detection and diagnosis of errors.

£7.65 672-21904-2

F. D. Boswell, T. R. Grove and J. W. Welch

### Waterloo microPascal

*Tutorial and Reference Manual*

The Tutorial gives a quick introduction to Pascal while the Reference Manual provides a concise definition of the language. Waterloo microPascal is an interpretive implementation of Pascal. It is accompanied by Waterloo microEdit—a full-screen text editor.

£7.65 672-21905-0

## Future titles

J. Wesley Graham and K. I. McPhee

### Waterloo microBASIC

*Tutorial and Reference Manual*

£7.65 672-21906-9 March

D. D. Cowan and M. J. Shaw

### Waterloo 6809 Assembler

*Tutorial and Reference Manual*

£7.65 672-21908-5 March

J. C. Wilson and T. A. Wilkinson

### Waterloo MicroAPL

*Tutorial and Reference Manual*

£6.95 672-21907-7 April

Prices and publication dates are correct at the time of going to press but may be subject to change. All titles advertised are published as spiral-bound paperback books.

Dealer enquiries are welcome:

Please contact Roy Jones at the address below or telephone Hemel Hempstead (0442) 58531.

Prentice/Hall  International

66 Wood Lane End, Hemel Hempstead, Hertfordshire HP2 4RG, England  
Exclusive distributors of Howard W. Sams books in the UK and Europe.

#### Sams Books Stockists

Business and Electronic Machines  
7 Castle Street  
Edinburgh

Byteshop Computerland Ltd  
P.O. Box 2  
St Neots  
Huntingdon  
Cambridgeshire

Cambridge Computer Store  
1 Emmanuel Street  
Cambridge

Comprite Ltd  
Thorite House  
Laisterdyke  
Bradford

Datron Micro Centre  
Duckworth Square  
Derby

Datron Micro Centre  
2 Abbeydale Road  
Sheffield 7

Micro-C  
5-11 Martineau Way  
Union Street, Birmingham

Micro-C  
Unit 2, Channons Hill  
Industrial Estate  
Fishponds Bristol

Micro-C  
57-59 Albion Street  
Leeds

Micro-C  
127 Charles Street  
Leicester

Micro-C  
Units 91-93,  
Arndale Centre  
Luton, Bedfordshire

Micro-C  
19 Brown Street  
Manchester

Micro-C  
31-35 Blagdon Road  
New Malden, Surrey

Micro-C  
2 Wheeler Gate  
Nottingham

Micro-C  
10-11 Bargate  
Southampton  
Hampshire

Mid-Shires Computer Centre  
68 Nantwich Road  
Crewe, Cheshire

Newbear Computing Store  
40 Bartholomew Street  
Newbury  
Berkshire

Silicon Centre  
Pictaural Electronics Ltd  
21 Comely Bank Road  
Edinburgh 4

Software House  
Horseshoe Yard  
Brooke Street  
London W1

Tomorrow's World  
Grafton Arcade  
Grafton Street  
Dublin 2



# MAPLIN the people for Atari



## 3 Consoles available:

**Atari 400 with 16K RAM (AF36P) £345**

**Atari 400 with 32K RAM (AF37S) £395**

**Atari 800 with 16K RAM (AF02C) £645**

### Lots of other hardware:

Cassette Recorder	(AF28F)	£50.00
Disk Drive	(AF06G)	£345.00
Thermal Printer	(AF04E)	£265.00
Printer Interface for 400	(AF41U)	£49.95
Printer Interface for 800	(AF42V)	£49.95
Interface Module	(AF29G)	£135.00
Versawriter	(AF43W)	£169.00

16K RAM Module	(AF08J)	£64.00
32K RAM Module	(AF44X)	£125.35
32K Upgrade for 400	(AF45Y)	£75.00
Floppy Disk	(YX87U)	£2.75
Le Stick	(AC45Y)	£24.95
Joystick Controllers	(AC37S)	£13.95

For full details ask for our hardware leaflet (XH54J) SAE appreciated

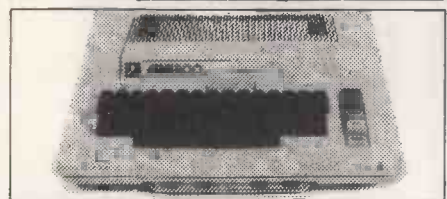

**NOW YOU CAN JOIN THE U.K. ATARI COMPUTER OWNER'S CLUB.** An independent user's group. Four issues of the club magazine for only £1.60! Address your subscription to Graham.

## THE CHOICEST GEMS OF ATARI SOFTWARE FROM MAPLIN

### Adventure Games

Star Warrior	-C- 32K - (B024B)	£28.95
Rescue At Rigel	-C- 32K - (B021X)	£22.45
Invasion Orion	-C- 32K - (B023A)	£18.95
Dalstones of Ryn	-C- 32K - (B022Y)	£14.95
Galactic Empire	-C- 24K - (B0140)	£14.95
Hi-Res Adventure #2	-D- 48K - (B025C)	£24.95
Analog Adventure	-D- 32K - (B033L)	£24.95
Adventure Land	-C- 24K - (B000A)	£14.95
Pirates Adventure	-C- 24K - (B001B)	£14.95
Mission Impossible	-C- 24K - (B002C)	£14.95
Voodoo Castle	-C- 24K - (B003D)	£14.95
The Count	-C- 24K - (B004E)	£14.95
Strange Odyssey	-C- 24K - (B005F)	£14.95
Mystery Fun House	-C- 24K - (B006G)	£14.95
Pyramid of Doom	-C- 24K - (B007H)	£14.95
Ghost Town	-C- 24K - (B008J)	£14.95
Savage Island I	-C- 24K - (B009K)	£14.95
Savage Island II	-C- 24K - (B010L)	£14.95
Golden Voyage	-C- 24K - (B011M)	£14.95
Energy Czar	-C- 16K - (YG53H)	£8.95
Kingdom	-C- 8K - (YG55K)	£8.95

### Teach-Yourself Programs

Conversational French	-5C- 16K - (YG44X)	£22.50
Conversational German	-5C- 16K - (YG45Y)	£32.50
Conversational Spanish	-5C- 16K - (YG46A)	£32.50
Conversational Italian	-5C- 16K - (YG47B)	£32.50
Touch Typing	-2C- 16K - (YG49D)	£14.95
States & Capitals	-C- 24K - (YG56L)	£8.95
European Countries & Capitals	-C- 16K - (YH57M)	£8.95

### Learn Programming

Invitation to Programming	-C- 8K - (YG43W)	£11.95
Basics of Animation	-C- 32K - (B057M)	£9.95
Basics of Animation	-D- 32K - (B058N)	£10.95
Player Missile Graphics	-C- 16K - (B059P)	£18.95
Player Missile Graphics	-D- 24K - (B060Q)	£19.95
Display Lists	-C- 16K - (B051F)	£9.95
Display Lists	-D- 24K - (B052G)	£10.95
Horiz/Vertical Scroll	-C- 16K - (B053H)	£9.95
Horiz/Vertical Scroll	-D- 24K - (B054J)	£10.95

Page Flipping	-C- 16K - (B055K)	£9.95
Page Flipping	-D- 24K - (B056L)	£10.95
Master Memory Map	-Walchart - (XH57M)	£4.00

### Business Programs

Visicalc	-D- 32K - (YL39N)	£119.95
Word Processor	-D- 32K - (YG42V)	£85.00
Calculator	-D- 24K - (YG50E)	£16.95
Graph—It	-C- 16K - (YG51F)	£11.95
Statistics	-C- 16K - (YG52G)	£11.95

### Arcade Games

Star Raiders	-E- 8K - (YG66W)	£29.95
Asteroids	-E- 8K - (YG60O)	£29.95
Space Invaders	-E- 8K - (YG70M)	£24.50
Missile Command	-E- 8K - (YG64U)	£29.95
Super Breakout	-E- 8K - (YG67X)	£29.95
Tari Trek	-C- 24K - (YL36P)	£8.95
Tari Trek	-D- 32K - (YL37S)	£11.95
Star Trek 3.5	-C- 32K - (B015R)	£14.95
Race In Space	-C- 16K - (B035O)	£14.95
Shooting Gallery	-C- 16K - (B036P)	£14.95
Mountain Shoot	-C- 16K - (B012N)	£10.95
Jawbreaker	-D- 48K - (B026D)	£22.95
Basketball	-E- 8K - (YG61R)	£29.95
Tank Trap	-C- 16K - (YL34M)	£8.95
Tank Trap	-D- 32K - (YL35O)	£11.95

### Home Game Programs

Scram	-C- 16/24K - (YH58N)	£12.95
Cypher Bowl	-C- 32K - (B020W)	£22.45
Thunder Island	-C- 16K - (B037S)	£10.95
Rotating Tilt	-C- 16K - (B048C)	£14.95
Lunar Lander	-C- 16K - (B016S)	£10.95
Jumbo Jet Lander	-C- 16K - (B046A)	£29.95
Submarine Commander	-C- 16K - (B047B)	£24.50
Sunday Golf	-C- 16K - (B013P)	£10.95
Darts	-C- 16K - (B042V)	£19.95
Tournament Pool	-C- 16K - (B045Y)	£19.95
Snooker & Billiards	-C- 16K - (B044X)	£19.95
Chess	-E- 8K - (YH63T)	£29.95
Microchess	-C- 16K - (YL40T)	£15.95
Checker King	-C- 16K - (YL41U)	£15.95
Cribbage & Dominoes	-C- 16K - (B043W)	£14.95

Poker Solitaire	-C- 16K - (B017T)	£10.95
Blackjack	-C- 8K - (YH62S)	£8.95
Fast Gammon	-C- 8K - (YL33L)	£9.95
Reversi (Othello-type)	-C- 16K - (B019V)	£14.95
Gomoko	-C- 16K - (B018U)	£14.95
Hangman	-C- 8K - (YH54J)	£8.95
Humpty Dumpty & Jack & Jill	-C- 16K - (B038R)	£19.95
Hickory Dickory Dock	-C- 16K - (B039N)	£19.95
British Heritage	-C- 16K - (B040T)	£19.95
Jig-Saw Puzzles	-C- 16K - (B049D)	£19.95
European Scene	-C- 16K - (B041U)	£19.95
Jig-Saw Puzzles	-C- 16K - (B049D)	£19.95
Atari Safari (25 Programs)	-C- 16K - (B050E)	£24.95
Atari Safari (25 Programs)	-D- 16K - (B050E)	£24.95
Mind Bogglers (3 Programs)	-C- 16K - (YL38R)	£8.95

### Music Programs

Music Composer	-E- 8K - (YH48C)	£32.50
Movie Themes (use with Music Composer)	-C- 16K - (B034M)	£9.95

### Computer Languages

Basic A +	-D- 48K - (B031J)	£52.50
Operating System A +	-D- 48K - (B030H)	£52.50
Basic A + &	-D- 48K - (B032K)	£99.50
Operating System A +	-D- 24K - (YL29G)	£44.90
QS Forth	-E&2C- 8K - (YH69A)	£49.50

### Utilities

3D-Super Graphics	-D- 48K - (B028F)	£29.95
3D-Super Graphics	-C- 48K - (B029G)	£29.95
Atari World (Graphics)	-D- 48K - (B027E)	£43.95
Assembler Editor	-E- 8K - (YH68Y)	£34.50
Assembler	-C- 16K - (YL32K)	£14.95
6502 Disassembler	-C- 8K - (YL30H)	£8.95
6502 Disassembler	-D- 8K - (YL31J)	£11.95
Character Generator	-C- 16K - (YL27E)	£9.97
Character Generator	-D- 16K - (YL28F)	£12.50
Telelink	-E- 8K - (YH59P)	£14.95

Key: C=Cassette, D=Disk, E=Cartridge, 2C=2 Cassettes etc. 8K: 16K etc. shows minimum memory requirement.

Send sae now for our new software leaflet with details of all the above programs. Order As XH52G — Issue 2.

Lots of exciting new software titles available soon. Keep in touch with Maplin!

Subscribe now to America's leading Atari-only magazine — Analog — 6 issues per year for just £9.00. Order as GG24B.

# MAPLIN

Maplin Electronic Supplies Ltd  
P.O. Box 3, Rayleigh, Essex.  
Tel: Southend (0702)  
552911/554155.

Demonstrations at our shops NOW  
See the amazing Atari's in action at  
159-161 King St., Hammersmith W6  
Tel: 01-748 0926  
or at 284 London Road,  
Westcliff-on-Sea, Essex.  
Tel: (0702) 554000

Note: Order codes shown in brackets. Prices firm until 15th May, 1982 and include VAT and Postage and Packing (Errors excluded).



APPLE SYSTEM SALES AND SERVICE  
IN BOTH LONDON AND LANCASHIRE

Competitive Quotes and Personal Service  
Ring Chris Gillard in London —  
Pete or Pam Fisher in Lancashire

Now over 500 items for APPLE in stock  
Full catalogue and description are available

- Apple Galaxian — Galaxy Wars — Head-On — Galactic Revolution — Galactic Trader — Galactic Empire — Mystery House — Bridge Partner — Checker King — Gammon Gambler — Roulette — Craps — Apple 21 — Puckman — Global War — Space Warrior — Apple Typhoon — Sneakers — Galactic Attack — Gorgon by Nasir **All at £12.95**
- Microsoft Adventure — ABM — Dog Fight — Phantoms Five — Orbitron — Pulsar — Microchess 2 — Odyssey — LA Land Monopoly — Morloc's Tower — Rescue at Rigel — Space Eggs — Trilogy of Games — The Prisoner — Buster Blaster — Autobahn — Space Raiders — Tawala's Last Redoubt — Gamma Goblins — Apple Panic — Cops and Robbers **All at £14.95**
- Computer Conflict — Computer Quarterback — Carets and Cutthroats — Space Album — Bill Bludge 3D Graphics Tutor — Cyber Strike — 3 Mile Island — Adventure 789 — HI Res Soccer — Temples of Apsbar — Hellfire Warrior — Zork — Computer Baseball — President Elect — The Battle of Shiloh — Tigers in the Snow — Warp Factor — Computer Conflict **All at £20.95**
- Computer Air Combat — Computer Ambush — Computer Bismark — Operation Apocalypse — Torpedo Fire — Shattered Alliance **All at £29.95**
- OLYMPIC DECATHLON from Microsoft**  
Superb HI-Res Graphics — Winner of this year's WCCF prize for creative programming **£12.95**
- FLIGHT SIMULATOR by Sub-Logic**  
So realistic — you might feel airsick! — be warned **Disk £19.95**  
**Cassette £14.95**
- DRAGON FIRE from Dakin Corp.** **£29.95**
- VERSA EXPANDER PORT**  
An expansion cable ZIP socket for the Apple game I/O socket allows zero insertion force of peripherals requiring connection to game socket **£12.95**
- SENSIBLE SOFTWARE UTILITIES**
- AppleSoft Programme Optimiser **£12.95**
  - Multi Disk III **£14.95**
  - Super Disk Copy III **£17.95**
  - DOS Plus **£17.95**
  - Disk Organizer II **£17.95**
  - Disk Recovery **£17.95**
  - AppleSoft Plus Structured Basic **£14.95**
- DAKIN 5 PROG AIDS 3.3** **£49.00**
- PASCAL TUTOR** **£79.00**  
If you want to learn Pascal this is the package to use — complete with two disks
- PASCAL PROGRAMMER** **£79.00**  
The Pascal programmer's dream — all the utilities you wanted to use but never had time to write
- RAMCARD** **£89.00**  
A 16k Expansion card for you Apple. It will provide additional memory for Visicalc load integer from a System Master and is fully compatible with Apple's Pascal System. The only board with Neon Read/Write indicators. The only card with data bus lines for faster data retrieval
- RAMEX 16** **£75.00**  
UK emulant to the expansion card market — does not need to be ribboned to the memory area
- MEMORY MANAGEMENT SYSTEM** **£29.00**  
A utility that moves DOS onto a 16K expansion card — freeing motherboard Ram space for larger programs
- Z80 SOFTCARD** **£195.00**  
A Z-80 microprocessor for Apple comes with CP/M operating system and Microsoft Basic 5
- COBOL 80** **£299.00**
- FORTRAN 80** **£109.95**
- BASIC COMPILER** **£199.00**
- ASSEMBLY LANGUAGE DEVELOPMENT (6502, 8080 and Z80)** **£79.00**
- Z TERM** **£59.00**  
Software that allows you to emulate the terminal of your choice whilst using Apple with a Z-80 Softcard
- 80 COLUMN BOARDS**
- SUP-R-TERMINAL** **£195.00**
  - VIDEX** **£185.00**
- NEC GREEN SCREEN MONITOR** **£169.00**
- WORDSTAR for APPLE** **£169.00**  
If you want the best in word processing for Apple then WORDSTAR is the answer. Very well documented and great to use. Requires the installation of a Z-80 Softcard
- MAILMERGE** **£69.00**  
Allows you to maintain name and address lists and merge fields into text to form letters etc
- SOFTKEY** **£74.00**  
(Basic or pascal versions available) A 15 key programmable keypad  
Patch for WORDSTAR and SOFTKEY to permit use of programmable pad with WORDSTAR
- ABT NUMERICAL KEYPAD** **£74.95**
- VISICALC 3.3** **Our Price £105.00**  
At last — Visicalc on 16 sector DOS 3.3 with 12 additional commands. Enhanced Manual is included
- VISIDEX** **£105.00**  
New from Personal Software — type in whatever key words, phase dates or numbers you want the info to be associated with and store away
- VISITERM** **£79.00**  
Allows your computer to communicate with larger computers or other personal computers. Link your personal computer with your company's mainframe
- VISIPILOT** **£85.00**  
Automatically creates high resolution graphs and charts. Visualise data in six different formats and 6 different colours. Data can be directly entered or data files loaded from VISICALC 3.3
- VISITREND** **£129.00**  
Allows you to perform sophisticated math operations on a time series data such as stock prices or production figures. Includes multi-line regress cumulative total percent change lead/lag moving averages, smoothing and various transformations which let you create new time series. This package also includes VISIPILOT
- VISIFILE** **£139.00**  
New data base from Personal Software
- DB MASTER** **£129.95**  
The data base with 100 fields operating on multi-diskette files for large capacity
- DB MASTER Utility Pack No. 1** **£60.00**  
Links DB Master with Apple text files and VISICALC 3.3 add delete or change existing DB Master fields and more
- DB MASTER for Corvus — available soon** **£295.00**
- INFORMATION MASTER — Data Base** **£79.00**  
A dream to use has advanced facilities such as global change and calculator mode of entering figures. A system that a novice can use with ease
- DATA MASTER** **£55.00**  
A utility for use with INFORMATION MASTER allows the splitting of a data base system selectively change of field types and transfer of print formats
- TRANSIT** **£29.00**  
A utility that enables you to link INFORMATION MASTER to many files including those created by VISICALC
- PASCAL JOB CONTROL SYSTEM — from High Technology** **£295.00**  
A fast sophisticated job control/costing system able to control costs on 400 jobs providing useful reports and maintaining 50 cost centres with 500 sub cost centres. Worth its weight in gold!

## UP TO 82K FOR VISICALC

Saturn System 32K Ram board and their software package.

Visicalc-Expand can give additional memory for Visicalc applications.

32K single board gives 47K.

16K card + one Saturn board gives 66K.

2 Saturn boards give 82K.

Board comes with DOS relocation, pseudo disk Applesoft integer utilities.

Single Board **£149.00**

Visicalc-Expand software **£55.00**

## APPLE OS9 STELLATION TWO'S MILL 6809

Is available with OS9 and BASIC O9 — NOW.

BASIC O9 allows simultaneous running of separate programs. It has to be seen to be believed — (OS9 is modelled along the lines of UNIX).

**£399.00 + VAT**

**REMOTE OPERATING SYSTEM — ROS** **£499.00**  
Provides multiple Apple II users with the capability of utilising the disk storage available from one control Apple. Up to 127 remote computers may be connected to one central Apple containing up to 8 floppy disk drives starter system (1 central + 2 remote boards) with software and cables. Single remote board **£124.00**

**64K RAM CARDS** **£449.00**  
Here at last! Can be used in pairs to emulate a disk drive. 2 cards and card emulating software. Single board **£225.00**

**TASC — THE APPLESOFT COMPILER** **£109.00**  
A two pass compiler from Microsoft — the Applesoft authors. Comes with extensive documentation and copyable disk. Compiles to disk so can compile any length of programme. From 2 to 20 times improvement in speed

**THE MILL — A 6809 plug-in board for Apple** **£249.95**  
Can run at full speed whilst the 6502 runs at 20%. Comes with either a Pascal speed-up kit to increase the speed of execution of Apple's U65D pascal or a 6809 assembler. Also available a debugging utility. COMING SOON — OS9 Operating system

**APPLE MUSIC THEORY** **£29.95**

**MOUNTAIN CPS — Multi-function Card** **£135.00**  
A bi-directional serial interface — parallel port and clock/calendar card — all on one board. Can be made to use phantom slots

**VISIWRITER** **£149.95**  
Superb graphics tablet from Versa Computing — you don't have to go to the expense of an Apple Graphics Tablet for graphics capability

**VERSA EXPANSION SOFTWARE** **£20.95**  
Auxiliary pack for the VISIWRITER includes the ability to draw in fine detail using magnification mode

**EPSON MX-80 F/T** **£398.00**  
9 x 9 matrix printer with friction and tractor feed

**EPSON MX-80 T** **£349.00**  
Tractor feed only

**INTERFACE AND CABLE** **£65.00**  
For the above (non-graphic)

**GRAPPLER from Orange Micro** **£99.00**  
An interface for the Epson MX-80 and 100 that obeys Apple protocols and has a graphics dump programme in ROM producing 2 sizes of picture and 360 degrees rotation with positive or negative image

**AIO INTERFACE from SSM** **£119.95**

**MACHINE COVERS — only the best material used**

- Apple only **£5.95**
- Single Disk **£2.95**
- 2 stacked disks **£4.45**
- Apple, 2 disks and 9" monitor or Apple and 12" monitor **£8.95**
- Apple and 2 disk **£7.95**
- Epson MX 70/80 **£5.45**
- Paper Tiger 445 — 460 **£5.45**
- BASF DISKS (for 10)** **£18.50**

### Authorised Apple Sales and Service

LONDON RETAIL, 98 Moysers Road, London SW16 6SH  
Tel: 01-677 2052/7341

MAIL ORDER AND DISTRIBUTION, Waingate Lodge, Waingate Chase  
Rossendale, Lancs. BB8 7SD  
Tel: Rossendale (0706) 227011



Prices do not include VAT. Please add 15% VAT to your remittance. Postage and packing FREE



# Xitan

## South Coast Leaders in Microcomputer Support Application and Service



### **Xitan – First for Business & Commercial Systems**

Xitan's specialised Administrative and Operational Microcomputer Systems provide cost effective computer support for wide ranging business organisations; from low entry level, stand alone systems for the smaller business, to integrated multiuser/multitasking systems to meet the more specific needs of the larger business enterprise.

### **Xitan – First In Science and Research**

Xitan support the more personalised requirements of the scientific and research users universities and colleges, and in government and independent research establishments with comprehensive practical experience embracing hardware, system, and applicational software.

### **Xitan – First in Industry**

Xitan's depth in microcomputer experience is playing an increasing role in the rapidly developing industrial applications for production and process control, and in product and production development operations.

### **Xitan – First for Service**

Xitan's local reputation is founded securely on Service- both in system development- software and hardware support, and service in the field.

# **XITAN**

**SYSTEMS**

Xitan Systems Ltd 23 Cumberland Place Southampton SO1 2BB Tel: 0703 38740

**Cromemco SHARP North Star Horizon comart**

# **The ITT 3030 Microcomputer System**

will be demonstrated  
for the first time  
in the U.K. at the  
Which Computer? Show

Visit the ITT Stand  
Nos. 1000 1001 1003  
and see the ITT 3030 in action

## **ITT**

World-wide Technology

ITT Consumer Products (UK) Ltd., Chester Hall Lane, Basildon, Essex. Telephone: Basildon 3040 Ext. 196 - 198



## MIDAS S100 SYSTEMS

**MIDAS 1: From £835**

**MIDAS 2: From £1,790**

**MIDAS 3: From £2,450**

**MIDAS 3HD: From £5,495**

**ITHACA-DPS 1: From £1,494**

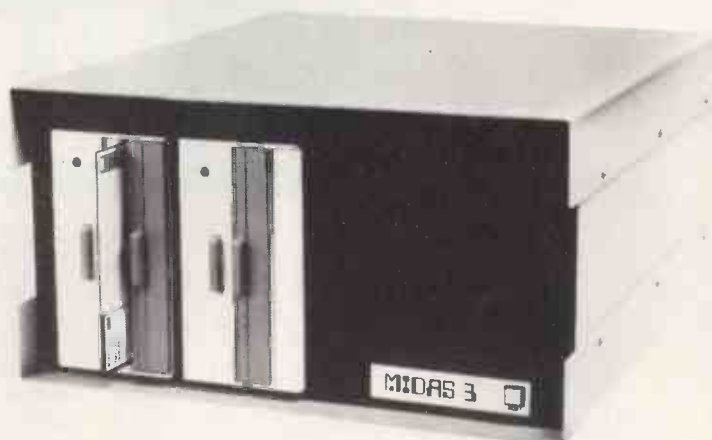

- Our versatile Z80 Microcomputers are available as standard units or custom configured to your exact specification from a comprehensive range of stocked S100 boards.
- Disc storage capacity of the MIDAS 3 can be 2M Bytes, expandable to over 80M Bytes with a Winchester Hard Disc Unit in our MIDAS 3HD range.
- MIDAS runs CP/M and MP/M. Other Software includes M-BASIC, C-BASIC, FORTRAN, COBOL, CIS-COBOL, PASCAL and Word Processing.
- A MIDAS 3D with 64K RAM and 2M Bytes storage on two 8" drives with two Serial I/O Ports and CP/M only **£2,965**.
- Printers, VDUs and other peripherals stocked to give complete package system at keen prices.

## BOARDS

We stock over 50 different S100 Boards all from quality manufacturers, such as Godbout, SSM, Micromation, Dual, Ithaca, Vector, S.D. Systems, Morrow, Pickles & Trout, etc.

### PROCESSOR

Z80 Starter Kit	£251
SBC 100	£215
8085/88 CPU	£190
Z80A CPU 4MHz (4 Types)	From £157
8086	(tba)

### EPROM

2716 EPROM (2 x 16K)	£95
2768/2716/2732 Programmer	From £143

### VIDEO BOARDS

24 x 80 I/O Drive	£240
24 x 80 Memory Mapped	£240

### DISK CONTROLLERS

Single Density 5" or 8"	From £150
Disc 1 D/D DMA	£282
Double D/D + Serial I/O	£336

### RAM

Static RAM 16-64K 24 Bit add.	From £175
Dynamic RAM 64K 8/16 Bit	£683
Memory Manager	£60

### I/O BOARDS

2s/2p or 4s/2p or 3p/1s etc	From £120
A/D & D/A 8 or 12 Bit	From £220
IEE 488 interface	£360

### MISCELLANEOUS

Real Time Clocks (2 Types)	From £120
Graphics 256 & 512 x 256	£280
Maths Board AMD 9511	£345
Extender Boards/Logic Probe	£45
Mother Boards 8-20 Way	From £32

### MAINFRAMES

We are the sole UK Distributor for Ingrand Mainframes and Disc Enclosures, available in nine models including Desk Top and Rack Mounting, with or without provision for Disc Drives. All units totally enclosed, painted on all external surfaces and complete with power supply etc.

### SOFTWARE

CP/M 1 & 2, MP/M, PL/1, C-BASIC 2, M-BASIC V5, XYBASIC, FORTRAN 80, COBOL 80, CIS-COBOL, PASCAL/Z, PASCAL M/T, Forth, MAC, ZSID, Disassembler, Wordstar, Datastar, Magic Wand, Wordmaster, Supersoft etc etc.

Prices exclusive of VAT

We are pleased to discuss your requirements and will advise you as to whether your needs can be met with one of our computers.

All of our systems are specials as they are configured to suit your specification, thus ensuring that you get what you want rather than what happens to be available.

Write or phone for a catalogue.

**Unit 14, 29 Willow Lane, Mitcham, Surrey**

**Telephone: 01-640 6931/2/3**

# Employment wanted

Small, versatile computer system seeks small and progressive business company with view to mutual growth and advancement.

Extremely versatile and readily adaptable to all that adds up to the efficient and profitable running of a company like yours.

Fluent in every aspect of Pay Roll procedure. Skilled in the preparation of sales, purchase and general ledgers. Fully conversant with estimating, word processing, filing and stock control.

Equally at home with cash flows,

posting procedures, accounts payable and accounts receivable. Willing to be programmed to meet practically every office or business requirement.

Placid disposition. Willing to work around the clock without remuneration or argument. All types of businesses considered. Can start immediately.

For further details, please phone one of the numbers below.

More and more it's the age of the computer. More and more, and no matter how small, your business is at a big disadvantage without one. Phone Metrotech to discover just how easily one can be yours. Remember: if you're thinking of a computer of your own, the best time is always now.



NEC



**BUY OF  
THE MONTH!**

EXCLUSIVE TO  
PERSONAL  
COMPUTER  
WORLD READERS!  
Bring this ad, to  
qualify for this  
fantastic offer!



Buy a  
NEC PC8000 series  
system valued at over £2,000 and get a  
Monochrome display 12" High Resolution  
Monitor (rec price £182) **ABSOLUTELY FREE!**

OFFER ENDS 18.2.82

**'GROW BIG WITH A SMALL COMPUTER'**

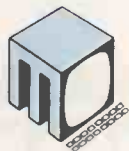

**METROTECH** AT **Ryman**

A MEMBER OF THE GRAND METROPOLITAN GROUP

6-10 Great Portland Street, London W1. 01-637 2181 Ex 39.

19-20 High Holborn, London WC1. 01-242 9819.

15 Lower Regent Street, London SW1. 01-839 4872.



# FOR PRICE PERFORMANCE THE BEST MICROCOMPUTER AVAILABLE



# BRITISH GENIUS

- \* Z80 MICROPROCESSOR AND CP/M
- \* BEAUTIFUL GREEN SCREEN
- \* SUPERB DETACHABLE KEYBOARD (buffered)
- \* RS232 SERIAL & CENTRONICS INTERFACES
- \* COMMUNICATIONS SOFTWARE AVAILABLE
- \* 64K RAM
- \* 24 x 80 VDU screen
- \* REVERSE VIDEO AND GRAPHICS CHARACTERS
- \* 61 PROGRAMMABLE FUNCTION KEYS
- \* PRINTERS – wide range available
- \* GPIB OPTION (gen. purpose i'face bus)
- \* MODELS 2 & 3 Two 5" floppy disc drives giving total capacity of 320K or 700K
- \* MODELS 4 & 4A Two 8" floppy disc drives giving total capacity of 1.2M or 2.4M
- \* MODEL 5 One 8" floppy and One integral Winchester hard disc – capacity 4.8M
- \* MODEL 6 One 8" floppy and One integral Winchester hard disc – capacity 9.0M

## MAINTENANCE AND SUPPORT

We have our own team of maintenance engineers. This enables us to provide an unparalleled support service. 24 hour response contracts are available or service on a time and materials basis. Telephone and onsite assistance is available for software queries.

## MICRO SOLUTION APPLICATIONS (British software written in CIS-COBOL)

- INTEGRATED ACCOUNTING SYSTEM . . . £1000
- BILL OF MATERIALS . . . . . £450
- STOCK CONTROL . . . . . £450
- PAYROLL . . . . . from £250

### The Accounting System includes:

- Full double-entry accounting
- Sales/Purchase/Nominal Ledgers + VAT
- Sales Invoicing
- Trial Balance/Profit & Loss

### Bill of Materials includes:

- Maintenance of Assembly structures
- Multi-level Parts Explosion
- Assembly Component cost calculation
- Requirement Breakdown by period

- Open Item or Balance Forward
- Up to the minute Enquiry facility
- Alphanumeric Account codes etc.

### Payroll System includes:

- Up to 15 Gross and Net pay fields
- Retention of Historical data
- Pension and Holiday pay calculation
- Special Stationery available
- Multi departments
- Up to 9999 employees

### Stock Control includes:

- Order processing
- Invoice/Delivery Note printing
- Reordering and Valuation reports

## WORD-PROCESSING

The British Genius is second to none as a word-processor. Using the 61 function keys and the proven WORDSTAR software it's a pleasure to do your paperwork!

## BESPOKE SOLUTIONS

Our team of experienced systems analysts and programmers are ready to provide your tailor-made software solutions. Ask us for a quotation.

Contact:



Park Farm House  
Heythrop  
Chipping Norton  
OXFORDSHIRE  
OX7 5TW

telephone  
CHIPPING NORTON (0608) 3256  
ask for: Bill Whaley  
or  
Bede Dunlop

# Which Computer?

Just a few tasks a microcomputer could be organising for your company, division or department:-

Businessmen and professional people alike can rid themselves of day-to-day problems and increased workload with a microcomputer.

- Accountants
- Estate Agents
- Retailers
- Insurance Brokers
- Doctors
- Dentists
- Solicitors
- Architects
- Engineers
- Chemists
- Farmers
- Bankers
- Teachers

to name  
but a few

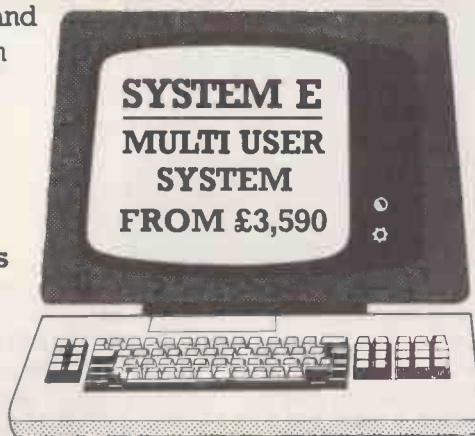

- Integrated Accounts
- Sales Ledger
- Purchase Ledger
- Nominal Ledger
- Sales Forecasting
- Stock Control
- Job Costing
- Estimating
- Payroll
- Word Processing

(automatic compilation, editing and production of repetitive letters and documents).

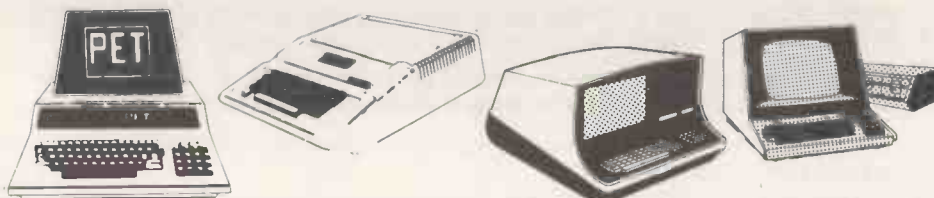

	PET	APPLE II	SUPERBRAIN	RAIR
<b>SYSTEM A</b> Basic computer including screen & keyboard	£399	£755	—	—
<b>SYSTEM B</b> As 'A', plus floppy disk drive(s) and matrix printer for small business user.	£1700	£1579	£2380	£2400
<b>SYSTEM C</b> As 'B', but quality printer for word processing instead.	£2150	£2050	£2830	£2850
<b>SYSTEM D</b> As 'B', plus hard disk for up to 5,000,000 bytes on line.	—	—	£4380	£4335

Prices exclude V.A.T. Rental, Leasing, and/or Maintenance Contracts plus System Software Consultancy available.

# Johnson

microcomputers

Johnson House, 75-79 Park Street,  
Camberley Surrey. Telephone 0276 20446

48 Gloucester Road, Bristol. Telephone 0272 422061

148 Cowley Road, Oxford. Telephone 0865 721461



# TRS 80 MODEL III DUAL DENSITY DISK DRIVES



## INTERNAL DRIVE PRICES

	PRICE	CAPACITY
1 x 40 TRACK DRIVE	£420	184K BYTES
2 x 40 TRACK DRIVES	£599	368K BYTES
1 x 80 TRACK DRIVE	£490	368K BYTES
2 x 80 TRACK DRIVES	£729	737K BYTES
2 x 80 TRACK DOUBLE SIDED DRIVES	£999	1474K BYTES

INTERNAL DRIVE PRICES INCLUDE DISK CONTROLLER BOARD, POWER SUPPLY UNIT AND ALL CABLES AND CONNECTORS REQUIRED FOR INSTALLATION.

## EXTERNAL DRIVE PRICES

1 x 40 TRACK DRIVE	£236
2 x 40 TRACK DRIVES	£440
1 x 80 TRACK DRIVE	£299
2 x 80 TRACK DRIVES	£569
EXTERNAL 2 DRIVE CABLE	15.50

EXTERNAL DRIVES ARE DIRECTLY COMPATIBLE WITH THE TRS 80 MODEL I AND VIDEO GENIE EXPANSION INTERFACES.

**Call your nearest dealer for a demonstration:**

**RADIO SHACK LTD.**,  
188, Broadhurst Gardens,  
London NW6  
Tel: 01-624-7174

**COMP SHOP LTD.**,  
14, Station Road,  
New Barnet, Herts.  
Tel: 01-441-2922

**COMP SHOP LTD.**,  
311, Edgware Road,  
London W2.  
Tel: 01-262-0387

**COMP SHOP LTD.**,  
19, Herbert Street,  
Dublin 2  
Tel: 604165

**LONDON COMPUTER CENTRE**, 43, Grafton Way, London W1.  
Tel: 01-388-5721

**N.I.C.**,  
61, Broad Lane,  
London N15.  
Tel: 01-808-0377

**CROYDON COMPUTER CENTRE**, 29a, Brigstock Road, Thornton Heath, Surrey.  
Tel: 01-689-1280

**P J EQUIPMENT LTD.**,  
3, Bridge Street,  
Guildford  
Tel: 0483-504801

**R.D.S. ELECTRICAL LTD.**, 157-161, Kingston Road, Portsmouth  
Tel: 0705-812478

**TANDY HASTINGS LTD.**, 48, Queens Road, Hastings.  
Tel: 0424-431849

**MICROWARE COMPUTING SERVICES**, 57, Queen Charlotte Street, Bristol  
Tel: 0272-279560

**BLANDFORD COMPUTERS**, Higher Shaftsbury Road, Blandford Forum  
Tel: 0258-53737

**TAPE SHOP**,  
32, Viaduct Road,  
Brighton.  
Tel: 0273-609099

**PARWEST LTD.**,  
18 St. Mary Street,  
Chippenham.  
Tel: 0249-2131

**COMPUTER SHACK**,  
14, Pittville Street,  
Cheltenham.  
Tel: 0242-584343

**ENSIGN**,  
13-19, Milford Street,  
Swindon, Wilts.  
Tel: 0793-42615

**TANDY GLOUCESTER**,  
13, Clarence Street,  
Gloucester  
Tel: 0452-31323

**COMSERVE**,  
98, Tavistock Street,  
Bedford.  
Tel: 0234-216749

**CLEARSTONE COMPUTERS**, Prince of Wales Ind. Estate, Abercarn, Gwent  
Tel: 0495-244555

**EMPRISE LTD.**,  
58, East Street,  
Colchester  
Tel: 0206-865926

**MAGNUS MICRO-COMPUTERS**,  
139 The Moors,  
Kidlington, Oxford.  
Tel: 08675-6703

**CAMBRIDGE COMPUTER STORE**,  
1, Emmanuel Street,  
Cambridge.  
Tel: 0223-65334

**I.C. ELECTRONICS**,  
Flagstones,  
Stede Quarter,  
Biddenden, Kent.  
Tel: 0508-291816

**MICRO CHIP SHOP**,  
190, Lord Street,  
Fleetwood, Lancs.  
Tel: 03917-79511

**HARDEN MICRO-SYSTEMS**, 28-30, Back Lord Street, Blackpool,  
Tel: 0253-27590

**AMBASSADOR BUSINESS COMPUTERS LTD.**,  
Ashley Lane Works,  
Shipley, W. Yorks  
Tel: 0274-695941

**Q-TEK SYSTEMS LTD.**,  
2 Daltry Close, Old Town, Stevenage, Herts  
Tel: 0438-65385

**COMPUTER & CHIPS**,  
Feddinch Mains House,  
St. Andrews, Fife,  
Scotland  
Tel: 0334-72569

**NORTH WEST COMPUTER CONSULTANTS LTD.**,  
214 Market Street,  
Hyde, Cheshire  
Tel: 061-366-8624

**HEWART MICRO-ELECTRONICS**,  
95, Blakelow Road,  
Macclesfield.  
Tel: 0625-22030

**KARADAWN LTD.**,  
2 Forest Way,  
Great Sankey,  
Warrington.  
Tel: 0925-572668

**PHOTO-ELECTRICS**,  
459 London Road,  
Sheffield.  
Tel: 0742-53865

**ARC ELECTRONICS**,  
54, Heron Drive, Sandal,  
Nr. Wakefield,  
W. Yorks WF2 6SL  
Tel: 0924-253145

**VICTOR MORRIS LTD.**, 340 Argyle Street, Glasgow, G2 8LY  
Tel: 041-221-8958

**THOMAS WRIGHT LTD.**,  
Thorite House,  
Laisterdyke,  
Bradford.  
Tel: 0274-663471

**GNOMIC LTD.**,  
46, Middle Street,  
Blackhall,  
Hartlepool.  
Tel: 0783-863871

**BRIERS COMPUTER SERVICES**, 1, King Edward Square, Middlesbrough, Cleveland.  
Tel: 0642-242017

**3 LINE COMPUTING**,  
36, Clough Road, Hull.  
Tel: 0482-445496

**H.C. COMPUTER SALES LTD.**, 182, Earlsway, Team Valley Trading Estate, Gateshead.  
Tel: 0632-874811

**EWL COMPUTERS LTD.**,  
8, Royal Crescent,  
Glasgow.  
Tel: 041-332-7642

**CUMANA LTD**

35 Walnut Tree Close, Guildford, Surrey, GU1 4UN.  
Telephone: (0483) 503121.

*Please add VAT to all prices.  
Delivery at cost will be advised  
at time of order.*

**TODAY'S  
BEST  
PRICE  
PERFORMANCE  
RATIO  
FROM A  
MICRO  
COMPUTER  
FROM  
£1875**

Standard Model 64K RAM/320K DISK



ALTERNATIVE MODEL:  
'QD' 700K DISK £2150

# SUPERBRAIN

## MASSIVE DATA STORAGE FROM HARD DISK

Massive storage capability is available with the 8in. Winchester Micropolis 7MB - 35B Hard Disk from £3500 including a controller to connect directly to your Superbrain. 12 month warranty included in price.



## WORDPROCESSING SYSTEMS

A complete wordprocessing system including 'Word Star' and 'Mailmerge', standard Superbrain, Diablo 630 printer, training and up to a day's installation for around £3850.

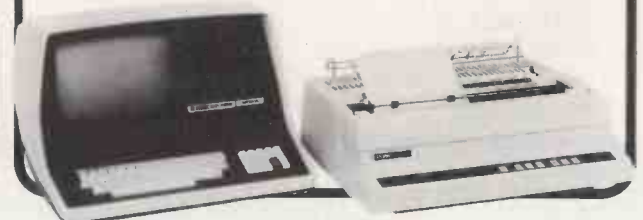

**Software Options:** we market a full supporting range of standard languages, including, BASIC @ £175, FORTRAN @ £225, PASCAL @ £225, and CIS COBOL @ £425. We have a growing and comprehensive library of software programmes available:

**Incomplete Records for Practising Accountants @ £750**

**Graphics - Hardware @ £435 with Software from £80**

**Integrated Accounting System - Stock Control @ £350, Order Entry and Invoicing @ £350, Sales Ledger @ £450, Purchase Ledger @ £450, General/Nominal @ £400, Name & Address @ £250, Complete Package so far @ £1650 plus Payroll @ £500.**

**Financial Modelling - T/Maker @ £155 and Micromodeller @ £645**

**Data Base Management - DMS @ £400 Word Processing - Wordstar @ £250 and Mailmerge @ £75.**

Also available - Form Creation, Debugging etc. Alternatively we will design and implement software packages to suit your specific needs

# KGB

**MICROS LIMITED**

**KGB Micros Ltd., 14 Windsor Road, Slough, Berks. SL1 2EJ Tel: Slough 38581**

Prices exclude V A T and are subject to fluctuation, please phone for an up-to-the-minute quote



# LONDON COMPUTER CENTRE

## PET! APPLE! TRS80! HORIZON! OWNERS!

Let LCC the BIG COMPUTER CENTRE put you a cable's length away from **Letter Quality Printing** with 6-Star Printers.

Olivetti ET 121. 20 CPS. Proportional Spacing. Doubles as Typewriter. **£795**  
 Tec 40. 40 CPS. 2K Buffer. Bi-Directional Printing, uses Diablo Daisywheels and ribbons. **£1235**  
 Daisywheel II. 60 CPS. Ricoh 1600 Daisywheel. **£995**  
 Flowriter RP1600. 60 CPS. The most intelligent Daisy. 8K Buffer. /Bi-Directional/Printing X On/Off. Repeat Built-in **£1500**  
 Qume Sprint 5. 45 CPS. **£1300**  
 NEC 55 CPS. **£1650**



DEMONSTRATIONS ON ALL MODELS

**New! 12" wide Automatic Sheet Feeder fits all above**

**£580**



**SUPERBRAIN WITH NEW EXTRA FEATURES FROM £1795\***



- \* 16% Greater Disc Capacity
  - \* Faster disc Access
  - \* Auto Repeat on all Keys
  - \* 18 Programmable Keys
- Now with multi-coloured dedicated keys for Magic Wand and Wordstar; the ultimate word processors.

### EPSON DUAL MODE PRINTERS

LETTER QUALITY & STANDARD DOT MATRIX IN ONE LOW COST UNIT

MX-80 F/T List £425 £ PHONE  
 LETTER LIKE PRINT QUALITY  
 3 WAY PAPER HANDLING  
 1. Letterheads or A4  
 2. Fanfold  
 3. Paper Rolls  
 LOW NOISE  
 132 COLUMNS PER LINE  
 JAPANESE RELIABILITY  
 MX-80 F/T2 List £440 £ PHONE  
 MX-100 F/T List £575 £ PHONE



## AUTHORISED TANDY DEALERS

### COMPLETE MODEL I 48K SYSTEM

SPECIAL OFFER: LIMITED PERIOD 48K System — 16K keyboard, 32K Expansion Interface, dual Disc Drives, Green VDU, complete with all cables. **£999**  
 16K keyboard with UHF Modulator **£375**  
 16K System with VDU & Cassette **£475**  
 32K Expansion Interface **£289**  
 Dual Disc Drives **£399**  
 Double Density Doubler **£75**



### MODEL II

from £1999 including CP/M

**We supply Model II with TRS DOS AND CPM at NO EXTRA CHARGE.**

### MODEL III

From £650

16K without disc drives **£650**  
 48K without disc drives **£695**  
 48K with disc drives **£1350**  
 With Epson MX-80 and Scripsit for Wordprocessing **£1799**

### CP/M SOFTWARE WORD PROCESSORS

WORDSTAR **£275**  
 WORDSTAR WITH DEDICATED KEYS **£340**  
 WORDSTAR MAIL-MERGE **£65**  
 MAGIC WAND **£185**  
 MAGIC WAND WITH DEDICATED KEYS **£250**  
 SPELLBINDER **£185**  
 SPELLBINDER WITH DEDICATED KEYS **£250**

### DATA BASE SYSTEMS

DBASE II RELATIONAL DATA BASE **£375**  
 CONDOR **£250**  
 TIM **£75**

### CRITICAL PATH ANALYSIS

MILESTONE **£250**  
 TASK **£250**

### TRS-80 MODEL I SOFTWARE

ELECTRIC PENCIL (DISC) **£60**  
 SCRIPSIT (DISC) **£61**  
 SCRIPSIT (CASSETTE) **£25**  
 MAIL-MERGE FOR PENCIL & SCRIPSIT **£45**  
 VAT AID PROGRAMME **£45**  
 CCA DATA MANAGEMENT SYSTEM **£125**  
**FINANCIAL PLANNER/ MODELLING**  
 T/MAKER **£155**  
 SUPERCALC **£250**  
 MINI-MODELLER **£350**

### THE SPECIAL LCC APPLE SYSTEM

48K Apple, Dual 40 Track Disc Drives & 12 Green Screen Monitor **£1395**  
 80 Column Card with Decenders **£135**  
 CP/M Softcard **£95**  
 16K RAM (Integer) Card **£65**  
 Centronics Parallel Card **£75**  
 Serial Printer/Communications Card **£75**

**ALL PRICES ARE EXCLUSIVE OF VAT AND DELIVERY DEALER ENQUIRIES INVITED ON ALL PRODUCTS**

43 GRAFTON WAY, LONDON W1P 5LA (Opposite Maples )  
 OPENING HOURS: 11-7 MON-FRI 12-4 SAT Tel: 388 6991/2  
 24 hour answer phone: 01-388 5721

MICROTEK INTRODUCE THE  
**'MICOM 81'**  
THE 'STATE OF THE ART' MICRO-COMPUTER SYSTEM.



- \* 4 MHZ Z80A CPU!
- \* 18 Slot S100 Mainframe!
- \* 32 MB or 96 MB CMD Hard Disk Storage!
- \* Up to 768K Dynamic or 384K Static RAM with Bank Switching!
- \* 2, 4 or 8 port Serial and Parallel I/O boards!
- \* 8" Double Density Floppy Disk Drives, (optional)!
- \* IBM Comtable Communications!
- \* Rugged and Reliable Rack Housing!

The 'MICOM 81' system will run CPM, (if you really must!) or

## 'MVT FAMOS'

The most powerful and versatile multi-tasking, multi-user 8-bit operating system currently available! You don't believe us? Well we have a large international bank using this system with 6 terminals and 2 printers in a 'Real Time' trading application!

Do you know of a UNIX, MPM, MBOS, OASIS or any other 8-bit 'multi-user' operating system, that you can get demonstrated doing the same? Well neither do we!

The 'MICOM 81' system is also currently being used in one of this country's leading universities, and in many other different types of industrial and commercial applications.

Prices start from as little as £7,000 and OEM enquiries are welcome.

For further details phone Orpington 26803/36228 or write to Microtek Computer Services, 50 Chislehurst Road, Orpington, Kent, BR5 0DJ.



# DATA LINK

## MICROCOMPUTER SYSTEMS (U.K.) LIMITED

Microcomputer hardware and software  
for business, educational, industrial and  
scientific application.

### COMPUTERS AND PERIPHERALS

Full APPLE range  
Full COMMODORE range  
Instant delivery carriage FREE (U.K.)  
for complete systems

### SOFTWARE MICROPLANNER

The definitive managerial planning and control  
tool that gives mainframe power and  
capability on a micro — (Ex. VAT)

**£695**

### DISKS

Finest quality made in Germany, BASF disks

5.25" Single Sided Soft Sector Single Density	£19.00 (box of 10)
5.25" Single Sided Hard Sector Single Density	£19.00 (box of 10)
5.25" Single Sided Soft Sector Double Density	£24.00 (box of 10)
5.25" Double Sided Soft Sector Double Density	£28.00 (box of 10)
Postage and Packing per box of 10	00.50
Also 8" from	£20.00 per box of 10

(all prices ex. VAT)

### COMPUTER FURNITURE

Locally made — 'Shipshape & Bristol Fashion' —  
superb quality — standard patterns and bespoke.  
eg. Wheeled desks from (Ex. VAT)

**£95**

# DATA LINK



MICROCOMPUTER SYSTEMS (U.K.) LIMITED  
10, Waring House, Redcliffe Hill,  
Bristol BS1 6TB.  
Tel: Bristol (0272) 213427

Authorised Dealer and Service Centre for



24hr answering service

To: DATA LINK MICROCOMPUTER SYSTEMS (U.K.) LIMITED

Please send:  Full Price List  
 Quotations for (please attach details)  
 Items listed (cheque enclosed)

Name .....

Address .....

Tel No. ....



in association with Kent Barlow Information Associates  
present

# Eagle Eye<sup>®</sup>



## The Database Management and Information Retrieval System For CP/M\* Microsystems

- Mainframe retrieval power at micro cost using internationally accepted EURONET Command Language.
- Sets new standards in clarity of instructions. Entire system is menu driven to make it really friendly to users, experienced or otherwise.
- Design and update your own database with over 50 searchable terms and relocate any record by any combination of terms.
- Each record can be up to 472 characters. Each database up to 8 megabytes. Typical retrieval time is 6 seconds using any term in 10,000 records.

Search results can be viewed, printed or filed for subsequent processing into any format which makes Eagle Eye ideal for custom built information systems, mailing lists, personnel records, cataloguing, market research, sales management, medical and veterinary records, correspondence filing, customer profiles, product lists, price lists, project research, insurance client records, legal research, enquiry services for libraries, museums, sales promotion, recruitment etc., etc., etc.

Eagle Eye is available from Leading Software Dealers or direct from

SOLE UK DISTRIBUTOR  
KATOTEK SYSTEMS DESIGN LTD  
21/25 GOLDHAWK RD LONDON W12

Recommended Retail Price **£310** (excluding VAT)  
Dealer enquiries welcome.

\* CP/M is a trademark of Digital Research. Telephones: (01) 580 7693/4 Telex: 264419





# COMPUTER WAREHOUSE

NOW OPEN  
MONDAY-SATURDAY  
9.30-5.30

## BULK BUY SPECIALS



### RAM SCOOP

4116 200 NS 8 for £12.95  
4164 200 NS £8.50 each  
2102-850 NS 8 for £5.50  
INC VAT

### 25 WAY "D" CONNECTORS

	50+	100+
25p	1.70	1.10
25S	1.90	1.20
	1.00	

ALL + VAT

### WIRE WRAP SKTS.

24 Pin Vero 28p  
14 Pin Gold 22p  
16 Pin Gold 24p  
100 PCS Min Ord.

### C10

DATA CASSETTES  
10 for £5.75  
Inc. VAT

### RF CONNECTORS

50Ω BNC PLG 50p  
75Ω BNC PLG 50p  
PL259 PLG 40p  
SQ239 SKT 35p  
100 PCS MIN ORD.

## TELETYPE ASR33 I/O TERMINALS

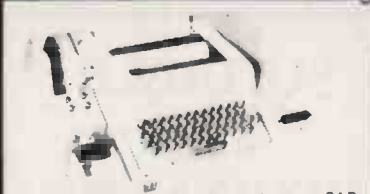

From £195 + CAR + VAT

Fully fledged industry standard ASR33 data terminal. Many features including: ASCII keyboard and printer for data I/O, auto data detect circuitry, RS232 serial interface, 110 baud, 8 bit paper tape punch and reader for off line data preparation and ridiculously cheap and reliable data storage. Supplied in good condition and in working order. Options: Floor stand £12.50 + VAT  
Sound proof enclosure £25.00 + VAT

## ICL TERMIPRINTER 300 BAUD TERMINALS

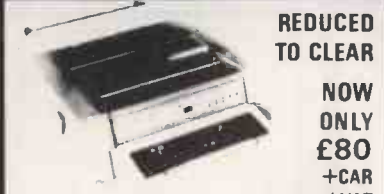

REDUCED TO CLEAR

NOW ONLY £80 +CAR +VAT

Made under licence from the world famous GE Co. The ICL Termiprinter is a small attractive unit with so many features it is impossible to list them in the space available! Brief spec. as follows: RS232 serial interface, switchable baud rates 110, 150, 300, (30 cps). upper and lower case correspondence type face, standard paper, almost silent running, form feed, electronic tab settings, suited for word processor applications plus many more features.  
Supplied complete, in as seen condition, no guarantee.

## MPU EXPERIMENTATORS +5v, 12v, 12v, 24v POWER SUPPLY

Once again we are very pleased to offer this superb Power Supply Unit and hope to satisfy most of our previous customers who were disappointed when we sold out due to demand last time they were advertised!!! These units may just have well been made for your lab., they consist of a semi-enclosed chassis measuring 160mm x 120mm x 350mm containing all silicon electronics to give the following fully regulated and short circuit proof outputs of:  
+5v @ 2 amps DC  
-12v @ 800 ma DC  
+12v @ 800 ma DC  
+24v @ 350 ma DC  
and if that's not enough a fully floating 5v output @ 50 ma DC which may be sensed to give a host of other voltages. All outputs are brought out to the front panel via miniature jack sockets and are also duplicated at the rear on short flying leads. Units accept standard 240v mains input. They are ex GPO and may have minor scratches on the front panels, they are sold untested but in good internal condition. £16.50 each + £2.50 p+p complete with circuit and component list. Transformer guaranteed. HURRY WHILE STOCKS LAST!!

## HIGH SPEED DATA MODEMS

A superb piece of engineering made by SE Labs Ltd. to "no cost spend" spec for the GPO, the Modem 12 is a synchronous Modem for use on DATEL 2412 services, on other data links. Many features include switchable V28 modulation, 2400 baud full duplex 800/1200 standby, auto answer, 4 wire or 2 wire operation. Self test, LED status indication, CMOS technology, modular construction, original cost over £700 each. Believed brand new, supplied complete with PSU etc.  
£185.00 + £9.50 carriage + VAT.  
\*Permission may be required for connection to PO lines.

## PERTEC

PERTEC TAPE DRIVES  
7 track 6840 — 75-25 £175.00 +VAT  
9 track 6840 — 9-25 £295.00 +VAT

Phone for more details

## DIABLO S30 DISK DRIVES

Another shipment allows us to offer you even greater savings on this superb 2.5 MB (formatted) hard disk drive. Two types are available both fully refurbished and electronically identical, the only difference is the convenience of changing the disk packs.  
S30 front loader, pack change via front door £550 + vat  
S30 fixed, pack change via removal of top cover £295 + vat  
+ & - 15v PSU for 2 drives £125 + vat  
SPECIAL OFFER new, 12 sector packs £20 + vat carriage & insurance on drives £15.00 + vat fully DEC RK05, NOVA, TEXAS compatible further info on controllers etc on request.

## NATIONAL MA1012 LED CLOCK MODULE

- ★ 12 HOUR
- ★ ALARM
- ★ 50/60 HZ

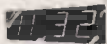

The same module as used in most ALARM/CLOCK radios today, the only difference is our price! All electronics are mounted on a PCB measuring only 3" x 1 1/2" and by addition of a few switches and 5/16 volts AC you have a multi function alarm clock at a fraction of cost. Other features include snooze timer, am pm, alarm set, power fail indicator, flashing seconds cursor, modulated alarm output etc. Supplied brand new with full data only  
Suitable transformer £1.75. £5.25

## MAINS FILTERS

Professional type mains filters as used by "Main Frame Manufacturers" ideal for curing those unnerving hang ups and data glitches, fit one now and cure your problems! Suppression Devices SD5 A10 5 amp £6.95  
Corcom Inc F1900 30 amp £13.95 + pp £1.00

## MUFFIN FANS

Keep your equipment Cool and Reliable with our tested ex-equipment "Muffin Fans" almost silent running and easily mounted. Available in two voltages. 110 V.A.C. £5.05 +pp 90p OR 240v A.C. £6.50+pp 90p. DIMENSIONS 4 3/4" x 4 3/4" x 1 1/2"

ELECTRONIC COMPONENTS & EQUIPMENT

66% DISCOUNT

Due to our massive bulk purchasing programme which enables us to bring you the best possible bargains, we have thousands of I.C.'s, Transistors, Relays, Cap's, P.C.B.'s, Sub-assemblies, Switches, etc. etc. surplus to our requirements. Because we don't have sufficient stocks of any one item to include in our ads., we are packing all these items into the "BARGAIN PARCEL OF A LIFETIME" Thousands of components at giveaway prices! Guaranteed to be worth at least 3 times what you pay plus we always include something from our ads. for unbeatable value!! Sold by weight

2.5kts £ 4.75 + pp £1.25      5kts £ 6.75 + pp £1.80  
10kts £11.75 + pp £2.25      20kts £19.99 + pp £4.75

## THE PRINTER SCOOP OF THE YEAR THE LOGABAX Z80 MICROPROCESSOR CONTROLLED LX180L MATRIX PRINTER



A massive bulk purchase enables us to offer you this superb professional printer at a fraction of its recent cost of over £2000. Utilising the very latest in microprocessor technology, it features a host of facilities with all electronics on one plug in P.C.B. Just study the specification and you will instantly realise it meets all the requirements of the most exacting professional or hobbyist user.  
STANDARD FUNCTIONS ★ Full ASCII character set ★ Standard ink ribbon ★ RS232/V24 serial interface - 7 xtal controlled baud rates up to 9600 ★ 194 characters per line ★ Parallel interface ★ Handshakes on serial and parallel ports ★ 4 Type fonts, italic script, double width, italic large, standard ★ Internal buffer ★ Internal self test ★ 170 CPS ★ Variable paper tractor up to 17.5" wide ★ Solid steel construction ★ All software in 2708 eeproms easily reconfigured for custom fonts etc.

All this and more, not refurbished but BRAND NEW At Only £525 +VAT  
Also available identical to above LESS Electronics Card £250 + VAT + Carriage and ins. £18.00 + VAT  
OPTIONAL EXTRAS ★ Lower case £25.00 ★ 16K buffer £30.00 ★ Second tractor for simultaneous dual forms £85.00 ★ Logabax maintenance, P.O.A.

## 8" FLOPPY DISK DRIVES

Yet again we've managed to secure a large shipment of tomorrow's technology at prices as yet unheard of!! And as with most of our purchases can pass these savings direct to you!! The DR 7100 & 7200 8" floppy disk drives have many inbuilt features to provide literally any BUS configuration with full daisy chain via internal jumpers 77 tracks on the single sided 7100 give upto 0.8 MB of data and 154 tracks on the 7200 double sided drive give a massive 1.6 MB of data. Many other features such as soft or hard sectoring, IBM or ANSI standards, only 240v AC, +24 & +5 v dc power requirements, and our unbelievable prices make these drives a snip.  
Supplied BRAND NEW and boxed complete with user manual:  
7100 single sided £225.00 + 8.50 ins. & carr. + vat.  
7200 double sided £295.00 + 8.50 ins. & carr. + vat.  
Full technical manual available £7.50 write or phone for more details.

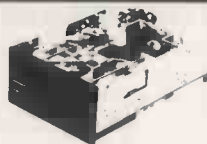

## LAMBDA

## DEC CORNER

DECTU60 TWIN CASSETTE DRIVE ... £375 +VAT  
PDP1105 MINI I/O MEMORY, CPU ETC. £450 +VAT  
LSI1132K BYTE MEMORY CARDS £295 +VAT  
RK05 MEMOREX DISK PACKS (12 sector) £20.00 +VAT  
LSI1102 PROCESSOR CARD £275.00 +VAT  
\* \* All types of DEC equipment purchased for cash \* \*



Dept. P.C., 64-66 Melfort Rd., Thornton Heath, Croydon, Surrey, Tel: 01-689 7702 or 01-689 6800  
MAIL ORDER INFORMATION  
Unless otherwise stated all prices inclusive of V.A.T. Cash with order. Minimum order value £2.00 Prices and Postage quoted for UK only. Where post and packing not indicated please add 60p per order. Bona Fide account orders minimum £20.00. Export and trade enquires welcome. Orders dispatched same day where possible. 3% surcharge on Access and Barclaycard orders.

## SOFTY 1 & 2

### EPROM BLOWER

Software development system invaluable tool for designers, hobbyists, etc. Enables open heart surgery on 2716, 2708 etc. Blows, copies, reads EPROMs or emulates EPROM/ROM/RAM in situ whilst displaying contents on domestic TV receiver. Many other features. £115 + carr. + VAT. Optional 2716, 2716 Function Card £40 + VAT. PSU £20 + £1.50 carr. + VAT.  
Softy 2 for 2716/2732 £169 +VAT  
Write of phone for more details.

## 9" VIDEO MONITORS

Ex-equipment 9" Motorola Video Monitors 75Ω composite input, tested but unguaranteed. £39.99 + £7.50 carriage + VAT. Complete with circuit.

## SEMICONDUCTOR "GRAB BAGS"

Mixed Sems amazing value contents include transistors, digital, linear, I.C.'s, triacs, diodes, bridge rects, etc. etc. All devices guaranteed brand new full spec with manufacturer's markings, fully guaranteed. 50p bag £2.95 100p bag £5.15 TTL 74 Series  
A gigantic purchase of an "across the board" range of 74 TTL series I.C.'s enables us to offer 100+ mixed "mostly TTL" grab bags at a price which two or three chips in the bag would normally cost to buy. Fully guaranteed at I.C.'s full spec. 100+ £6.90 200+ £12.30 300+ £19.50

## RCA FULLY CASED ASCII CODED KEYBOARDS

IDEAL - TANGERINE, OHIO, ETC.  
Straight from the U.S.A. made by the world famous R.C.A. Co., the VP600 Series of cased freestanding keyboards meet all requirements of the most exacting user, right down to the price! Utilising the latest in switch technology. Guaranteed in excess of 5 million operations. The keyboard has a host of other features including full ASCII 128 character set, user definable keys, upper/lower case, rollover protection, single 5V rail, keyboard impervious to liquids and dust, TTL or CMOS outputs, even an on-board tone generator for keypress feedback, and a 1 year full R.C.A. backed guarantee.  
VP601 7 bit fully coded output with delayed strobe, etc. £43.95  
VP611 Same as VP601 with numeric pad. £54.95  
VP606 Serial, RS232, 20MA and TTL output, with 6 selectable Baud Rates. £64.26  
VP616 Same as VP606, with numeric pad, Plug and cable for VP601, VP611 £2.25  
Plug for VP606, VP616 £2.10  
Post, Packing and Insurance. £1.95  
ORDER NOW OR SEND FOR DETAILS.

## 5v D.C. POWER SUPPLIES

Following the recent "SELL OUT" demand for our 5v 3 amp P.S.U. we have managed to secure a large quantity of ex-computer systems P.S.U.'s with the following spec.: 240 or 110v A.C. input. Outputs of 5v @ 3-4 amps, 7.2v @ 3 amps and 6.5v @ 1 amp. The 5v and 7.2v outputs are fully regulated and adjustable with variable current limiting on the 5v supply. Unit is self contained on a P.C.B. measuring only 12" x 5" x 3". The 7.2v output is ideal for feeding "on board" regulators or a further 3 amp LM323K regulator to give an effective 5v @ 7 amp supply. Supplied complete with circuit at only £10.95 + £1.75 pp. Believed working but untested, unguaranteed.

# NEC PC-8000!

- Z80A
- CP/M
- COLOUR

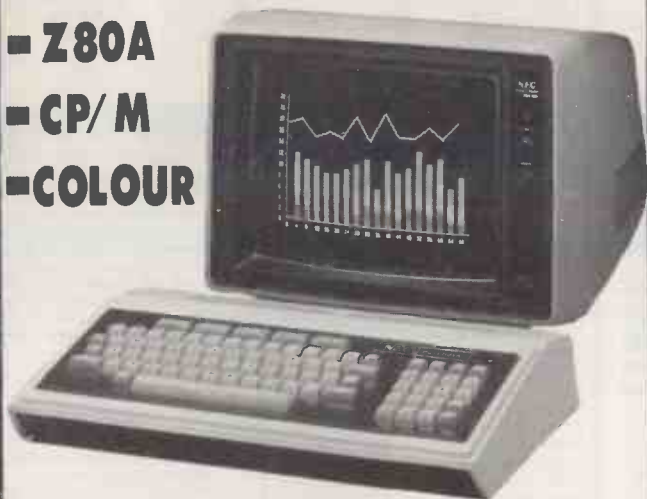

"Superb value for money" - PCW June 1981

## KEYBOARD UNIT: \* Z80A processor (4 Mhz).

- \* 32k RAM + 24k ROM MICROSOFT EXTENDED DISK BASIC. Screen editor, Monitor, 8k ROM slot.
- \* 83 key query keyboard with N-KEY ROLLOVER for fast typists. Auto repeat on all keys.
- \* 8 colours or 8 monochrome intensities.
- \* VECTOE, PLOT, and SCREEN ARRAY graphics.
- \* 36 to 80 character screen width, 20 or 25 lines. SCROLLING AREA control, function key display.
- \* SINGLE or DOUBLE PRECISION variables (16 significant figures), INTEGER, HEX. Maths character set.
- \* TERMINAL OPTION with built-in RS232 INTERFACE
- \* 15 character string FUNCTION KEYS, numeric keypad.
- \* 8 bit parallel output for CENTRONICS printer.
- \* RS232 up to 4800 baud. 600 baud cassette I/O.

## JAPANESE QUALITY AND RELIABILITY

£599 (+VAT)

## EXTRAS: \* Expansion to 64k, 96k, 128k, 192k RAM.

- \* CP/M 2.2—the universal disk operating system.
- \* Dual 5 inch floppy disks, HARD DISK shortly.
- \* Superb colour or green monochrome monitor screens.
- \* Expansion boxes for extra RAM, IEEE 488, multiple I/O, prototyping, sound, joysticks etc. \* Light pen.
- \* 100 cps bi-directional logic seeking matrix printer: 14 styles inc. proportional & graphics (£399).
- \* 35 cps SPINWRITER, also by NEC. £1322.

Complete 64k Business system with dual disks & printer: £1975 (+VAT) +software

# Brighton Computer Centre

130 LEWES ROAD  
BRIGHTON BN2 3LG  
(0273) 688946  
MON-SAT 10AM-6PM

## CAMBRIDGE LEARNING SELF-INSTRUCTION COURSES

# A PRACTICAL DIGITAL ELECTRONIC KIT FOR ★ LESS THAN £20 ★



## SUITABLE FOR BEGINNERS

Learn the wonders of digital electronics and see how quickly you are designing your own circuits. The kit contains: seven LS TTL integrated circuits, breadboard, LEDs, and all the

DIL switches, resistors, capacitors, and other components to build interesting digital circuits; plus a very clear and thoroughly tested instruction manual (also available separately). All this comes in a pocket size plastic wallet for only £19-90p inc VAT and p&p. This course is for true beginners:

- needs no soldering iron.
- asks plenty of questions, but never leaves you stuck and helpless.
- teaches you about fault-finding, improvisation, and subsystem checking.
- the only extra you need is a 4½V battery (Ever Ready 1289, or similar), or a stabilised 5V power supply.

Using the same breadboard you may construct literally millions of different circuits.

This course teaches boolean logic, gating, R-S and J-K flipflops, shift registers, ripple counters, and half-adders. Look out for our supplementary kits which will demonstrate advanced arithmetic circuits, opto-electronics, 7-segment displays etc.

Other self-instruction courses from Cambridge Learning Ltd include:

COMPUTER PROGRAMMING IN BASIC	£10.50
DIGITAL COMPUTER LOGIC AND ELECTRONICS	£ 8.50
DESIGN OF DIGITAL SYSTEMS	£14.00

Please send for full details (see coupon below).

**GUARANTEE** No risk to you. If you are not completely satisfied, your money will be refunded upon return of the item in good condition within 28 days of receipt.

CAMBRIDGE LEARNING LIMITED, UNIT 72 RIVERMILL SITE, FREEPOST, ST IVES, CAMBS, PE17 4BR, ENGLAND.  
TELEPHONE: ST IVES (0480) 67446. VAT No 313026022

All prices include worldwide postage (airmail is extra - please ask for prepayment invoice). Giro A/c No 2789159.

Please allow 28 days for delivery in UK

Please send me:

.....SUPERKIT(S) @ £19.90

.....Free details of your other self-instruction courses.

I enclose a \*cheque/PO payable to Cambridge Learning Ltd for £..... (\*delete where applicable)

Please charge my:

\*Access / American Express / Barclaycard / Diners Club  
Eurocard / Visa / Mastercard / Trustcard

Expiry Date..... Credit Card No .....

Signature.....

Telephone orders from card holders accepted on 0480 67446  
Overseas customers (including Eire) should send a bank draft in sterling drawn on a London bank, or quote credit card number.

Name.....

Address.....

Cambridge Learning Limited, Unit 72 Rivermill Site, FREEPOST, St Ives, Huntingdon, Cambs, PE17 4BR, England. (Registered in England No 1328762).



# THE ONE YOU'VE BEEN WAITING FOR!

**Personal Computer**  
World  
SPECIAL ISSUE

**MICROCOMPUTER  
BENCHTEST SPECIAL**  
BRITAIN'S LARGEST  
SELLING MICROCOMPUTING  
TITLE BRINGS YOU  
COMPREHENSIVE BENCHTESTS  
ON 25 LEADING MICROCOMPUTERS

**IN ONE COMPLETE VOLUME**

USE THE COUPON BELOW TO  
ORDER YOUR COPY OF PCW'S  
BENCHTEST SPECIAL

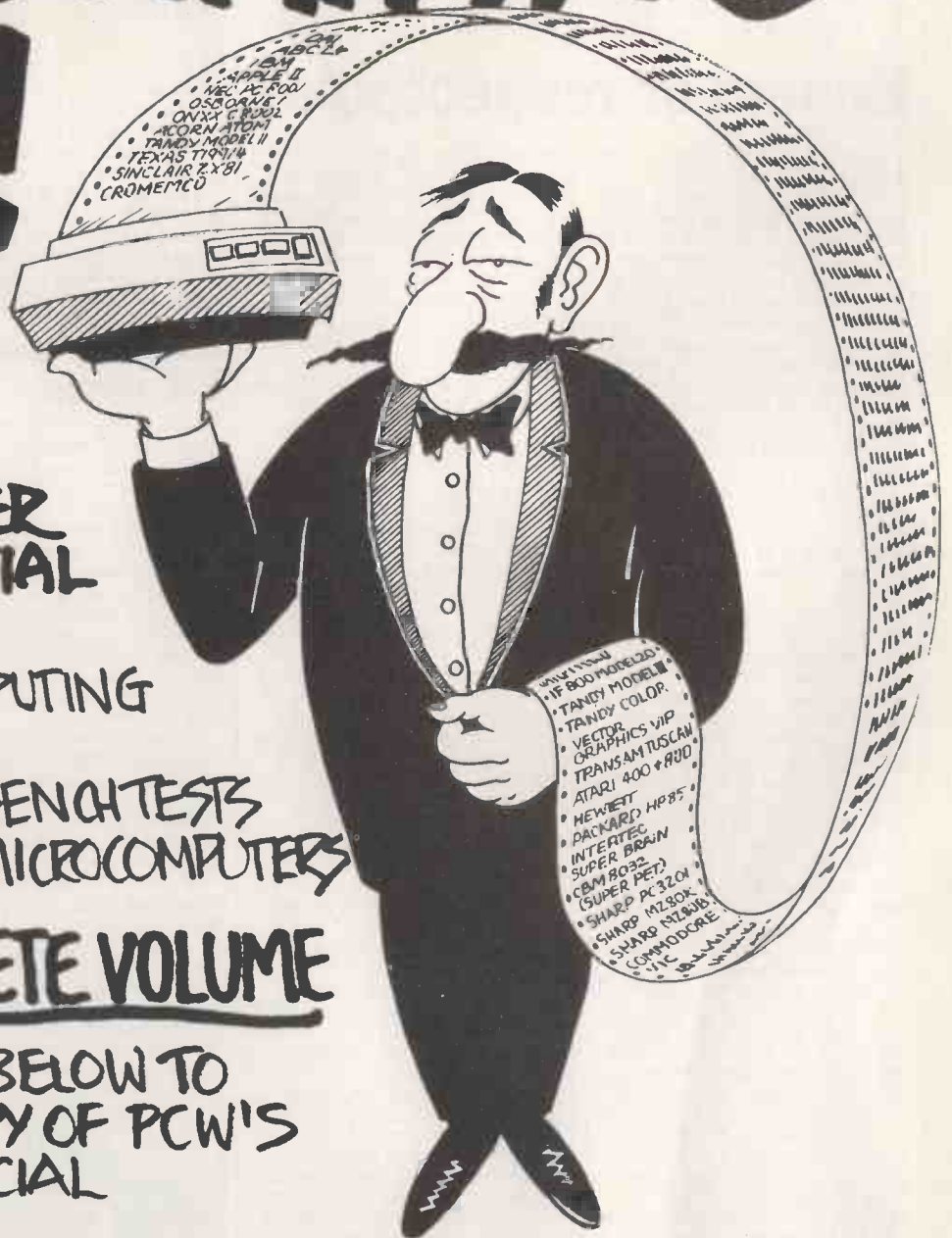

YES, I'VE BEEN WAITING FOR IT.  
PLEASE SEND ME \_\_\_\_\_ COPIES OF  
PCW'S BENCHTEST SPECIAL.  
I ENCLOSE £ 1.80 TO BENCHTEST  
SPECIAL OFFER, 14 RATHBONE PL.  
LONDON W1P 1DE. CHEQUES SHOULD  
BE MADE PAYABLE TO -  
'PERSONAL COMPUTER WORLD'

NAME \_\_\_\_\_  
ADDRESS \_\_\_\_\_  
\_\_\_\_\_  
\_\_\_\_\_

Compiled by Guy Kewney

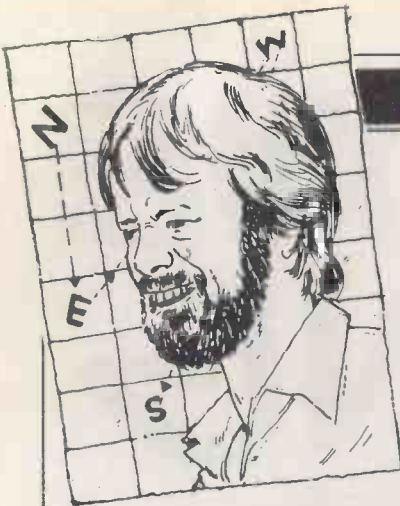

## Honest or respectable?

You are planning to buy from a respectable micro dealer. Good. But there is a warning that should go with that: respectable is not the same as honest. Respectable tradesmen in the micro business are not always eager to tell their customers the truth. Worse, if the truth occasionally slips out, they become very annoyed and try to get somebody else to contradict it. And worst of all, the truth does them no harm. It's completely daft.

The example I'm going to give was so embarrassing to the people involved that I feel obliged to disguise the events, personalities, and factors.

A computer called The Honk (it isn't) has an interesting language called Bleat (it doesn't) which is very useful for writing recipe scrambling programs. Got all that?

A supplier of recipe scramblers, called Yolk was very annoyed to find that Honk Supplier Ltd would not provide Bleat on the Superhonk, which was the ideal recipe scrambling machine with a direct interface to a gas cooker.

Now a small scrambler writer is not in any position to produce their own Bleat language and so they decided to put pressure on Honk Supplier, encouraging them to get their finger out of the pie and make Bleat work on the Superhonk.

The method they chose to put pressure on Honk was not the obvious one of raising Cain and forming pressure groups. It was the strange one of being as nice as pie to Honk, not offending them, and flattering them at every opportunity, with the eventual object of becoming so high on Honk favours that their request for a Bleat system would become a high priority in Honk strategy. You are free to make your own judgements about the likelihood of success this approach would bring and remembering phrases such as 'let sleeping dogs lie' and 'it's the squeaky wheel that gets the oil' might help you understand my own judgements.

Ingratiating, then, was the

name of the game. At this point, I arrived, writing an article on culinary processing. I asked the directors of Yolk for their opinion of Honk Suppliers. Their opinion, they said, was that Honk were the sweetest tempered, most thoughtful bunch of gentlefolk ever to involve themselves in trade, and had promptly supplied every want of the users, whenever the occasion had arisen. Furthermore, Honk had the best Bleat system on the market, available on the Superhonk.

This was just not true. In fact, it formed the basis of their biggest complaints against Honk, that there was just no Bleat on the Superhonk, as I related above. This minor fact didn't bother the Yolk directors. They knew, furthermore, that part of my article would be a feature on kitchen equipment and the importance of Bleat. Readers who based their judgement on my article would be encouraged to buy Superhonks, only to discover that the machine was absolutely useless at Bleating and that the direct connection to a gas cooker counted for nothing.

On this occasion, I am relieved to relate that professional scruples led me to question people other than the respectable directors of Yolk, and among these was one of the senior managers, in charge of products on the old Honk, which had a reasonable Bleat system. This man informed me, in no uncertain terms, that the Superhonk was a total waste of time, and couldn't under any circumstances be sold to anybody with culinary interests until Honk Suppliers got off their pie-crust and got Bleat working — and that there was no sign of this happening inside a year.

My article quoted this man generously as the source of this essential information and conveyed the warm recommendation to my readers that so honest a supplier was obviously to be trusted, and they would be in safe hands asking him for advice on Bleat problems.

I suppose I need hardly add that the creeps on his board took a very dim view

of his action. I expect to hear, any day now, that he has been asked to resign.

The really ironic thing about this is the fact that one effect of the article was that Honk Suppliers were sent a copy of it by the Bleat User Group, and for the first time, were put under real pressure to do something sensible instead of being mindlessly flattered.

## VIC recall

Not wanting to alarm anybody, Commodore has nonetheless issued orders to its dealers to recall the first batch of VIC computers it sent out in this country. By the time you read this, most of the offending ones will have been replaced, the company assures me, and in any event, no more than a couple of dozen had got further than the dealers before the fault was discovered.

The fault was a flaw in the power supply unit and while it may not have been serious enough for customers to worry about, it must have seemed like the last straw to many Commodore dealers.

Prior to this little hitch, there had been a long delay which annoyed the stuffing out of the retailers. Understandably, they decided to support the launch of the cheap Commodore micro with a co-ordinated advertising campaign. And when the customers arrived in the

shops, there were no VICs. Rage was reported to me from several quarters and no official statement has yet been issued explaining the delay, so I can only pass on a rumour, from a 'usually reliable' source.

This source reported that the little socket, on the side of the VIC, where the power comes in, was (quite by chance) identical to the shaver output socket found in German hotels, and that the German authorities decided this was an unacceptable match in a machine built in Germany.

Anyway, the picture shows the man in charge of marketing the VIC, John Baxter (with a nice smile, leaning on the Thorn colour TV), presiding over the awarding of a prize VIC to 15-year-old Mark Watson of Wimbledon, a student at St Paul's school in South London. The prize was the result of a competition held in Summer at the PET show. The man with the beard (and quite possible another nice smile?) is Cyril Grant, managing director of the local dealer, Microcomputer Centre of Sheen.

## New TABS prices

The price of business software from TABS (The Accounting Business System) for serious accounting work has gone up. It can't really be said that it is now expensive — from costing under



See Vic Recall



£100, the price is now just under £200.

The old price applies to each of the following: the Foundation, Fast Data Entry, Mail List, Word Processor, Invoice compiler, Sales Order Processing and Management Accounts. The new price applies to Sales Ledger, Purchase Ledger, Nominal Ledger, Stock Control, Job Costing and Payroll (each). Reason for the rise is not just that the company found it was having to do more helping work than planned for each new customer, but also that people are daft and reckoned that something costing £100 couldn't be any good. According to the industry, TABS packages are in fact up to a high standard. Details from Sopers House, Chantry Way, Andover, Hants SP10 1LU, tel: (0264) 58933.

## Hard time

I need some help in spotting hard and soft returns.

The difference between a soft return and a hard return in cricket is obvious, unless you are looking the other way when the ball is thrown at the stumps. It is less obvious in the text processing program called Wordstar but, nonetheless, I shall try to explain it.

A 'soft' return is the way Wordstar knows that it has reached the end of a line and that the next word must start a new line. It puts these in itself, which is very clever. When you are typing away and reach the end of the line (the right margin) instead of having to decide whether the next word will fit in, you just type on. If it fits, Wordstar leaves it there. If it doesn't fit, Wordstar takes the whole word to the beginning of the next line. Lovely, isn't it?

A 'hard' return is the end of a paragraph. You type it yourself, in exactly the same way you would on an electric typewriter, and Wordstar prints the next letter at the beginning of a line, even if the previous word was at the beginning of a line.

Anybody who has ever used Wordstar will know that you sit in front of your screen and type, using lines that are not spaced out. Then, when you want to print it, you re-format the text so that there is a space between each line, so that a reader can make notes between the lines.

When you do this, Wordstar refuses to space out the paragraphs. As far as this program is concerned, a hard return merely signifies the end of a paragraph and has no other purpose. If you like spaces between your paragraphs — tough.

Most people can live with this but I can't. I want to adapt Wordstar so that I can

find all 'hard' returns in the file and replace them with two 'hard' returns, or else I want to change the reformat command. Alternatively, I could do with another way of marking paragraph ends.

No, I realise this isn't the most crucial matter likely to affect the computer world in the next few years, but I thought I'd share the thoughts with you as an illustration, if nothing else, of the fact that there is no such thing as the perfect program. And, of course, somebody reading might have already solved the problem.

## The bear is buried

The announcement that Newbury Laboratories is going to make its own micro is not a startling turnaround from the sad decision to drop the NewBrain hand-held computer (now being made by Grundy).

The plan was announced as part of a package involving the full merger between Newbury, which makes video terminals, and Newbear, a subsidiary which sells micro-computers.

Newbear now becomes Newbury Micro Systems, a splendid change of name designed to make us all forget the excellent reputation Tim Moore has built up over the years he has been The Bear, and to substitute the image of the company which had the BBC micro contract and failed to produce a single computer in a year.

In the circumstances, Newbury's prediction that its new micro will be available in the third quarter of this year and will be a 128k byte, 8-bit micro using a dual Z80 board built into the company's new 8000 series moulded case video terminal cuts little ice with me.

It is nice, however, to see Moore get a little credit for having sold one or two systems — the company has actually published a list. It reads: more than 50 Apples sold to (and still supported at) the Atomic Energy Authority; multiple Sharp and Apple systems installed at 30 universities, 15 polytechnics, and in major organisations such as British Aerospace, Marconi, Plessey, Ferranti, Thorn EMI, Tektronics, the BBC, ITN, Texas Instruments (or Tube Investments, it isn't clear which because it is listed as TI), GEC, English Electric, Honeywell and the *Yorkshire Post*.

For my part, I'm still waiting for Newbury boss Rod Saar to return a series of calls I made in April last year. I suppose that means I'm not impressed by Newbury's micro performance so far.



The important thing to look for in this photograph of Mimi is the extra row of rather darker keys at the top of the keyboard, where there were no keys on the original Gemini 801 which John Marshal announced about this time last year. The machine remains one of the best-value CP/M systems, with a total of 700 k bytes of floppy storage, CP/M, screen interface and Mbasic, for around £1350 — if you can get one. British Micro is still sending the bulk of the production abroad, which is nice for the pound but not much use for the rest of us. Those extra buttons are Hewlett-Packard type, programmable function keys, which provide ways of letting a user give complex commands without having to spell them on the unfamiliar typewriter keyboard. Details of the new machine on Watford (0923) 48222.

## Show goes East

Our own show, the PCW Show, has happened in the Cunard Hotel in Hammersmith for two years now — and the time has come to give the other side of London a chance. Next year, on 9 — 12 September, it will be in the City at the Barbican Centre.

Those who have been before will know that the show is suitable for hobby users or business users, because it is divided into two sections. You can get into either section or both.

Unlike last year, the show runs for four days, not three. We hope this will mean shorter queues (ho ho).

Details from organisers Montbuild on 01-486 1951.

## Disk course

Winchester disks are very large capacity data storage items, with the clever feature of being airtight enclosures with absolutely no dust inside. This allows the magnetic data surfaces of the disks to be very close indeed to the recording and reading heads. The truly important thing about them is the fact that they can be built in exactly the same size boxes as ordinary floppy disk drives, which allows most of us to buy a computer with a small disk in it and then save up for a big disk later on. So, naturally, many of us are doing this.

Anybody who wants to go into this a bit further can attend a seminar on the subject. It is being given by Robin Bradbeer, editor of *Educational Computing* and of the monthly newsletter *Microprocessors At Work*, together with his co-editor

Jonah McLeod (who is also consultant to Strategic Inc, a market research company in California). Also speaking are Martin Whitaker of Sintrom, and Frank Burger of Frank Burger and Associates. The course is sponsored by the newsletter and organised by Oyez IBC Ltd. It runs for a day at the Royal Lancaster Hotel in London on 16 February, and the cost is £115 inc VAT and refreshments, lunch and some drinks — and documentation. Details on 01-242 2481 from Suzanne Mayhew.

## Will it catch on?

I am just about as nervous to see all these micros with Motorola 6809 chips in them as the motoring world must have been when the Wankel engine first appeared on the roads. Will it catch on? How can we tell? And is it really as good as the fans say?

The latest machine to appear with this chip inside is the Positron, a new company's design and aimed at the sophisticated viewdata users who want personal computing power.

The two founders of Positron are Peter Loftus and Peter Plinston. Both were IBM systems engineers before and both are unimpressed by the argument that a machine has to be able to run CP/M software: they both thought the 6809 was a better chip than the Z80 and backed their judgement.

'We realised the need for a general purpose, personal workstation device,' commented Loftus (marketing man). 'It has colour as we believe colour enhances the display of information, making it easier to understand. External communication we felt was important,

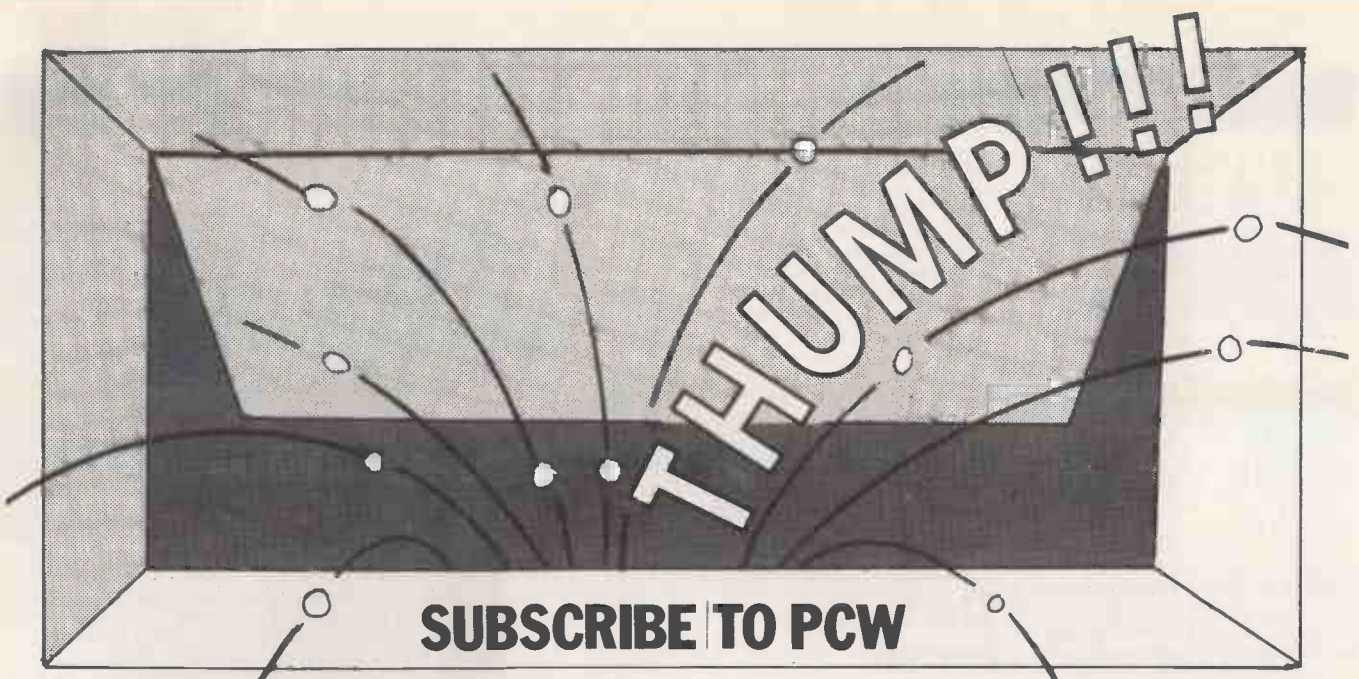

**“Personal Computer World is the most consistent, intelligent, informative and irreverent publication on the subject available. It’s a pleasure to hear it thump through my letterbox every month.”**

An authentic, unsolicited reader comment. Perhaps that’s why PCW is easily Britain’s largest selling microcomputing magazine. And why our subscriptions have risen to more than 8,000 copies per issue, doubling in the last year alone.

Why not ensure your copy of Personal Computer World every month. Use the coupon below or the subscription card you’ll find elsewhere in the magazine.

**And listen out for the ‘thump’!**



## SUBSCRIPTION ORDER FORM

I would like to subscribe to Personal Computer World for one year (12 issues).  
 Please start my subscription from the \_\_\_\_\_ issue.

This is a new subscription  This is a renewal  
 UK :£10.00  Rest of the world: £17.00.  
 I enclose my cheque, made payable to Personal Computer World, for £ \_\_\_\_\_  
 Please invoice my company (UK only).  
 Please debit by American Express/Access/Barclaycard (delete where not applicable)

Account Number \_\_\_\_\_

Signed. \_\_\_\_\_

Name	
Address	

Please use block capitals.

For Office use only  a  b  c  d  e

Please send this order form, with your remittance, to Personal Computer World,  
 Subscriptions Dept, Freepost 7, London W1E 4EZ. No stamp is required.



hence the viewdata capacity and, especially, it needed a lot of "horse-power" in terms of capacity and speed.'

The machine backs up South West Technology's contention (see 'Communications' a couple of months back) that the 6809 is neglected, but capable of doing things which normally are regarded as impossible on 8-bit micros — for example, running Unix (or Unix-like) operating systems. Positron has a multi-user timesharing operating system called OS-9, which it describes as 'using Unix type I/O facilities'. This is a Motorola software product.

The first model will handle up to 512 kbytes of internal RAM, and another 256 kbytes of ROM providing high-resolution colour graphics and multi-user facilities.

The company was provided with a £250,000 capital investment by Anglo-American Venture Fund (which has government sponsorship) last year.

Details on 061-228 3768.

## Acorn software

Getting its hand in before releasing software for the BBC Computer, Computer Concepts has launched a program for the machine's predecessor, the Acorn Atom.

The first CC program for the BBC Computer will be a word processor, which the company says will be available in a ROM chip early February (with luck). In the meantime, Softscreen aims to provide some of the display features of the BBC machine to Atom users — for example, the ability to mix high resolution graphics and text anywhere on the screen, or the ability to define your own character shapes, or to have 'windows' of text. The text is full upper and lower case (not just capitals as on the standard Atom). To run this program, Computer Concepts says, you must have the extra 6k bytes of graphics memory fitted. The 2.75k bytes of code are loaded from cassette, and fit in at memory locations 2900H to 3400H.

Cost is £11.40 including VAT, and details are available on (09277) 62955. Cheques to 16 Wayside, Chipperfield, Herts WD4 9JJ.

## Atom afloat

You have to admire Acorn's nerve: publicising the fact that an Atom performed happily on a ship and on the island of St Helena, even with the fluctuating power supplies found in both those places.

The feat was performed as part of a publicity generating trip (that wasn't how it was planned, but it certainly

turned out like that) by University College in London. The geography department used the machine in a field exhibition and the thing worked perfectly, say the academics.

I only hope that Atom isn't besieged by hundreds of people whose Invaders games went down in December's storms, all demanding a refund or replacement.

## Human aspects course

Human aspects of computer systems: a seminar on the subject is to be held from 21-26 March at Loughborough University of Technology. It covers such aspects as display terminal ergonomics (I do wish they wouldn't call them 'visual displays', as if there were such a thing as an olfactory display or audio display, or tactile display), dialogue design, and human aspects of the system design process. Details from Brian Pearce on Loughborough (0509) 63171. The course repeats in September.

## Turbo Apple

Putting the enormously powerful Motorola 68000 chip inside the Apple II microcomputer instead of its nice little old 6502 engine is a process described by Simon Laurence of Simon Computers as 'turbocharging'. It certainly is that, and more.

Most people now expect Apple to announce a special machine (Apple IV, maybe) at the end of this year (1982) with this giant micro inside it. Simon's idea could give professional systems builders who already have an Apple II a lead on this.

Simon's own blurb emphasises the benefits to the experienced assembler programmer: 'How often have you struggled on those Assembler programs which

become just too complex?' he asks. 'Or never quite managed to grasp the awkward knack of programming those 8-bit machines?'

True, assembler programming can be easier on the 68000, because it has instructions which perform functions that a programmer has to write in himself on the 68000's grandfather or the 6502 (its bastard brother).

But I rather suspect that the reason Simon emphasises the assembler benefits is simple: at the time of announcing, assembler is all he can offer. 'Many software products are planned, commencing with a native 68000 Assembler,' he notes. The assemblers supplied with the board rely on the 6502 chip for input and output.

For people who already have an Apple II, the cost of an Aristocard 68000 (the turbocharger) is £475. For people who want a complete evaluation system including a 64k byte Apple II, a disk drive and a monitor, with the Aristocard, the price is £1695.

Simon plans a system to plug the Aristocard into the bigger Apple III as well. That won't be available much before the summer, however. Details on 01-680 4646.

## Better Beta Basic

Long have I wanted to see a version of Microsoft Basic which was compatible with Microsoft's own product, but made life easier for the programmer, especially at the time of testing.

It has now been done. I have to confess, however, that my enthusiasm for Micromedia's Beta Basic is slightly tempered by the fact that the interpreter is written in a language called BCPL 'and can thus be run on any computer which supports BCPL, from a single-user microcomputer to an IBM 370' (a sort of giant mainframe with a brain in its tail)

'and beyond'.

The claimed improvements over Microsoft's editing facilities include what Clive Sinclair has already proved is a vital function that of checking what the programmer is typing in while the keyboard is still rattling, not only when the RUN command is given.

If you have a micro-computer that 'supports BCPL' then contact Micromedia on Newport 5927. I have to admit to a terrible ignorance — I don't know of any micro that does. Also, the interpreter costs £800-odd. It certainly won't do for my Genie, will it? But it might be handy for somebody developing Tandy Software on a big IBM machine.

## Decorous micro

'DECOR-conscious office managers' (it says on this here press release) 'will appreciate that the cabinet of the Model 30 can be ordered in Teak, or in a wide choice of real wood veneers,' according to Computability, the London agent. The machine costs less than the magic £2000 for an S100, CP/M system with only a single 160,000 character disk store, plus a screen and keyboard. Details on 01-380 0807.

## Terminals spreading

New Televideo computers are animals to take seriously, if only because the company's terminals are so confoundingly ubiquitous. The company launched the first processors in summer last year and has followed them up with two more in November, at the Las Vegas Comdex show.

As a guide to the power of Televideo in terminals, it would be worth asking a cross section of users of CP/M systems what are the few niggles they have about their systems, and then asking the manufacturers why those fea-

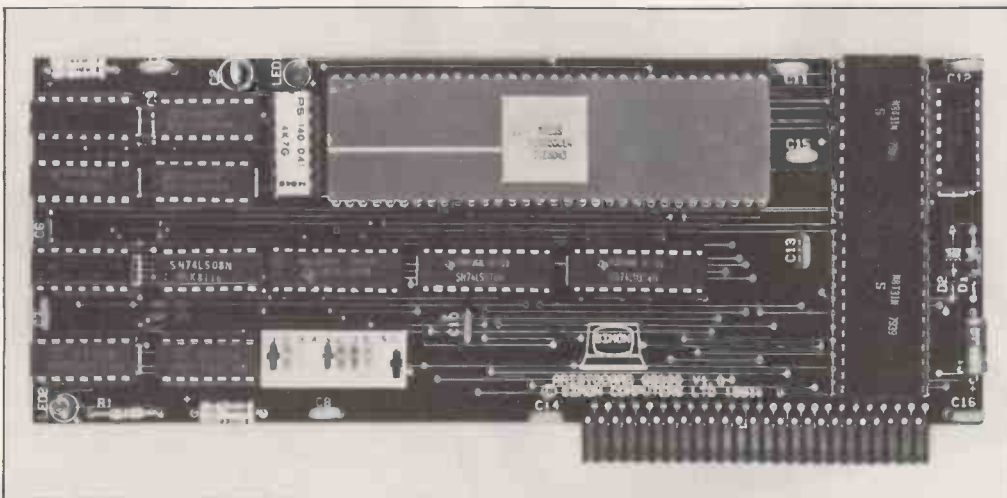

Apple Turbocharger from Simon Computers

# Sinclair Owners!

## We'll give you £50 trade-in when you trade-up!\*

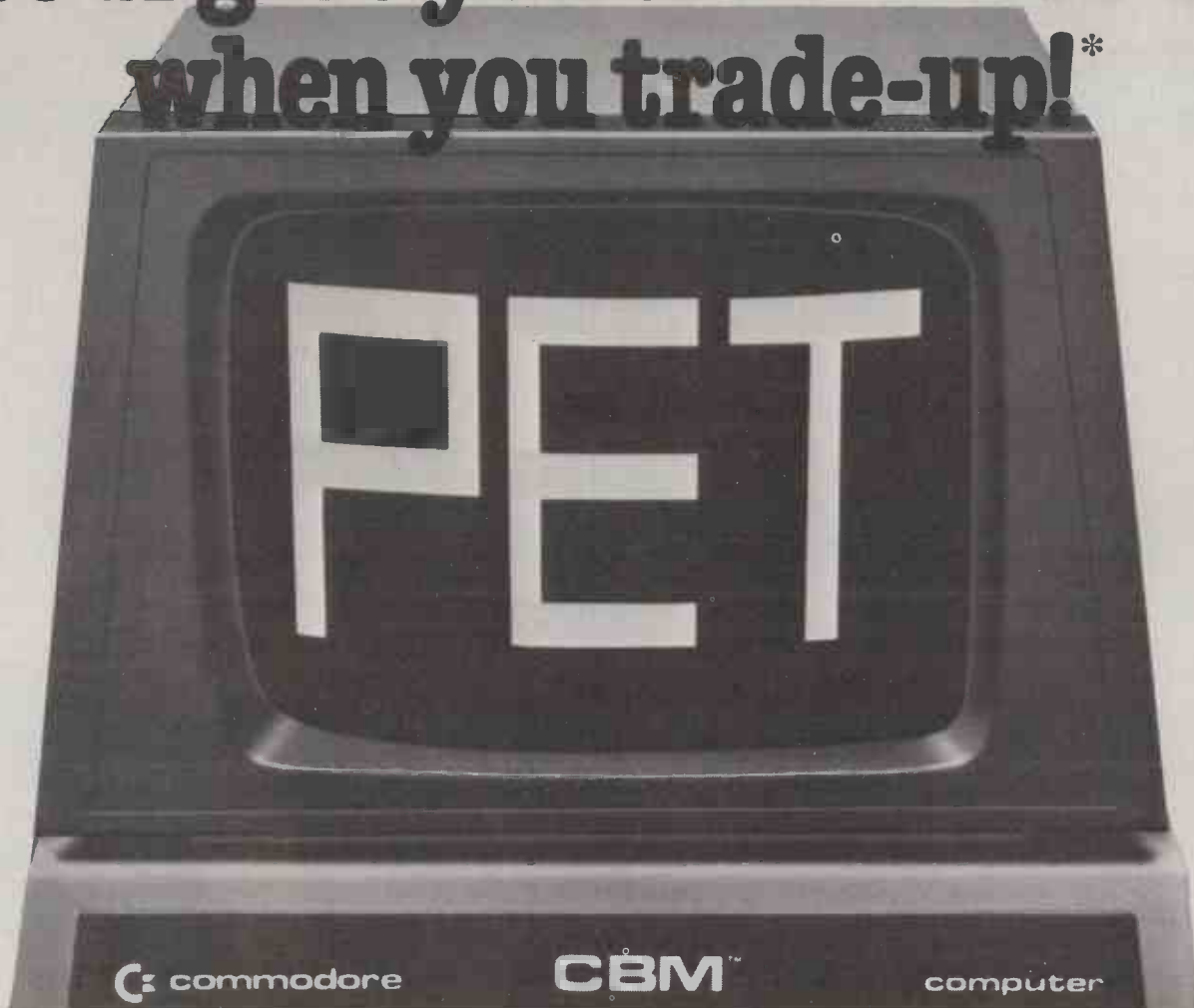

## commodore COMPUTER

Our offer will be of special interest to those who've found the popular Sinclair a fine introduction to computing. True, there's no better value at under £100. However, as your skills increase, you may find you need a microcomputer with greater memory, expansion capability and performance.

If so, PET, the Commodore microcomputer, is the natural choice. It has a range of memories from 16K to 96K, full size typewriter keyboard and integral display that gives upper and lower case plus graphics, with ease of connection to a full range of peripherals including printers and floppy disk drives. There is also an enormous library of software which includes everything from the sciences and education to business applications – as well as fun and games. All that you'd expect from a company that has been in electronics for over 20 years.

It's very simple to use and should you need any assistance or advice there's the reliable back-up of our nationwide dealer network. There's bound to be one near you so you can be confident that help will never be far away.

So, send back the coupon to take us up on our £50 trade-in. There's never been a better time to enjoy trading-up.

**sinclair**

Please tell me more about the £50 offer and the name and address of my nearest Commodore Dealer.

Name \_\_\_\_\_

Address \_\_\_\_\_

Tel \_\_\_\_\_ Postal Code \_\_\_\_\_

Offer closes 31st March 1982

Commodore Information Services,  
P.O. Box 109, Baker Street, High Wycombe,  
Bucks. Tel: Slough 79292

78PC2

\*Offer applies only to Sinclair ZX80 and ZX81



tures were installed.

You might be surprised how many times you get the answer from the factory: 'we didn't plan to do it, but we found we had to, in order to be compatible with Televideo terminals.'

We will have to see how the computers sell. The new ones are the TS802, with a megabyte or so of floppy disk storage capacity, costing \$3500 in the US; and the TS802 H which has a hard disk instead of one of the 5in floppies and costs \$7000.

Details from the Sunnyvale office: phone (408) 745 7760.

## Another biggie

A new machine, which can do several things at once, has been launched by Manchester distributor Fi-Cord. The machine costs under £3000, says Fi-Cord, and its only obvious 'defect' is the absence of CP/M as the operating system.

Theoretically, the machine should be able to run CP/M as well as its own operating system ('one of the most powerful and flexible operating systems to be available as standard on a latest generation microcomputer,' as the US builder, Monroe Corporation, a calculator supplier, puts it). It does have the necessary internal processor, a Z80A chip.

The Fi-Cord machine is code-numbered the OC 8820 for no apparent reason. I shall call it the Monroe, to avoid irritating people who don't recognise numbers. It has twice the normal amount of memory internally — 128 kbytes instead of 64k. This allows Monroe to give it a special operating system which can handle 'as many as 12 tasks at the same time,' says Fi-Cord. 'For instance, while permitting you to review random reports (on the bright, easy-to-read amber display), the Monroe could simultaneously be printing sales ledger statements.'



Monroe Micro

Disk storage provided gives 650k bytes on two minifloppies. Software available includes Basic and Pascal (supplied as 'standard', but I can't be sure if that's included in the price) supporting index sequential access method (Isam) file handling. Applications programs already available include Wordstar, Datastar, Infoster and Supercalc — but no information is available at press time on their prices. They have been adapted and upgraded by Monroe to run under the Monroe operating system, so obviously a Benchmark test of some complexity must be done before anybody knows how good these new versions are.

Details from Fi-Cord on 061-445 7716.

## IBM expansion

Memory for the new IBM micro is normally available on add-in boards which take up rather more space than they should, thinks Datamac Computer Systems of Sunnyvale, California. The company has produced a \$500 board with 64 kbytes and also has boards with two, three and four times the storage capacity, compared with IBM's own design with either 32k or 64k.

'IBM users will now be able to put together much larger systems,' claims Datamac sales manager Robert Lindgren, 'since fewer expansion slots will be needed for memory and more slots will thus be available for peripheral devices'. Details on (408) 735 0323.

## Two cats

Two catalogues of educational programs. One, for Apple, PET and Tandy computers, is available from New York software publisher K-12 Micro Media, for \$3.95. The catalogue contains information on over 300 programs from over 65 publishers, says the company, and the scope



*The reason we have this picture of a lady of the cloth is not because she is a nun (she's also a headmistress) but because Sister Mary Agnes is using the first UK installation of the Sharp MZ80B, at the Notre Dame Convent, Cobham, Surrey. As a first it comes as a surprise, because dealers have been saying how nice the B is for so long I hadn't realised they weren't installed before.*

is pretty wide. Details from Alan Zoldan at Box 17, Valley Cottage, NY10989, or phone (914) 358 2582.

The other is from UK firm Software Production Associates. The type of games and lessons is roughly the same in each case, as is the price level of around £10 per program on average. However, this company concentrates almost entirely on the Research Machines 380Z micro (it includes a £20 Adventure program) and I have no phone number. Address is PO Box 59, Royal Leamington Spa, Warwickshire W31 3QA.

## Xerox software

Obviously taking its new dynamic role seriously, software supplier Lifeboat is adding to the list of CP/M computers which can run its software, with the announcement of support for the Xerox 820. Details from Helen Smith on 01-836 9028 if you know where to find an 820.

## Prestel project

Meanwhile, back to Prestel, software is now being distributed for educational users of the Research Machines RML 380Z computer. The project is being organised by the Council for Educational Technology (CET) in the United Kingdom, and funded by CET and the Department of Industry.

A group of 25 schools, colleges, and other institutions, says CET, are being supported to take part in the initial trials, and 'a growing library of well-tried and tested programs is being built up.'

Now they want volunteers to join in with the project 'on an associate basis.'

You need not have a Research Machines machine to join in: 'A number of other manufacturers, including Acorn computers in relation to their work on the BBC micro-computer, are already working towards providing a similar facility on their machines,' says CET.

Details of the service and the programs themselves are stored on Prestel, on pages leased from CET's Prestel Umbrella Service for education and Training, #2114. Further info from Jill Coates on 01-580 7553.

## School Teletext

A serious study of Prestel as a tool for education has been carried out. It makes a bit of a change from all the opinionising which proponents and detractors have been able to indulge in so far and it shows that the remote information base was something of an incentive to class work.

The educational trial was done by CET, the Council for Educational Technology, for the United Kingdom. 'It helped to encourage advanced reading skills, skimming and scanning, and there were some indications that, in the case of slower readers, the motivation of using Prestel and the need to understand the options presented on a frame, were an incentive to, the development of reading,' says CET.

Criticisms: mainly, the lack of information relevant to subject areas other than economics, business studies, geography and social studies, which were the subject areas

**QUANTITY DISCOUNT  
AVAILABLE**

# BASIC-80 CP/M Z-80



## Turn your Apple into the world's most versatile personal computer.

**The SoftCard™ Solution.** Softcard turns your Apple into two computers. A Z-80 and a 6502. By adding a Z-80 microprocessor and CP/M to your Apple, SoftCard turns your Apple into a CP/M based machine. That means you can access the single largest body of microcomputer software in existence. Two computers in one. And, the advantages of both.

**Plug and go.** The SoftCard system starts with a Z-80 based circuit card. Just plug it into any slot (except 0) of your Apple. No modifications required. SoftCard supports most of your Apple peripherals, and, in 6502-mode, your Apple is still your Apple.

**CP/M for your Apple.** You get CP/M on disk with the SoftCard package. It's

a powerful and simple-to-use operating system. It supports more software than any other microcomputer operating system. And that's the key to the versatility of the SoftCard/Apple.

**BASIC included.** A powerful tool, BASIC-80 is included in the SoftCard package. Running under CP/M, ANSI Standard BASIC-80 is the most powerful microcomputer BASIC available. It includes extensive disk I/O statements, error trapping, integer variables, 16-digit precision, extensive EDIT commands and string functions, high and low-res Apple graphics, PRINT USING, CHAIN and COMMON, plus many additional commands. And, it's a BASIC you can compile with Microsoft's BASIC Compiler.

**More languages.** With SoftCard and CP/M, you can add Microsoft's ANSI Standard COBOL, and FORTRAN, or Basic Compiler and Assembly Language Development System. All, more powerful tools for your Apple.

**Demonstration.** See SoftCard at your local Apple dealer. Or we'll send it to you with a dealer list. You will find it simplicity itself to operate. Call or return the coupon to us.

SoftCard is a trademark of Microsoft. Apple II and Apple II Plus are registered trademarks of Apple Computer. Z-80 is a registered trademark of Zilog, Inc. CP/M is a registered trademark of Digital Research Inc.

Caxton Software Publishing Company, 10-14 Bedford Street, Covent Garden, London WC2. Telephone 01-379 6502

Please send me a SoftCard. I enclose a cheque for £225 (VAT & delivery included)

Please send me further information.  User  Dealer

Name \_\_\_\_\_ Position \_\_\_\_\_ Company \_\_\_\_\_

Address \_\_\_\_\_

Primary Interest \_\_\_\_\_



Distributor for



PCW 2/82



where teachers found Prestel useful. Costs were not a grumble, especially after the classes got used to Prestel — but lack of good indexing was.

A full report on the trial is available for £2.00 from CET — it was written by Vincent Thompson and details are available on 01-580 7553.

## Virgo puts a Dent in

There is at least one High Tory with a sense of humour. And anybody who has ever met the delightful Philip Virgo, who is trying to become the Party's authority on What Computers Really Mean to Conservatives, will not be at all surprised to find that he has smuggled the Hitch Hiker Round the Galaxy, Arthur Dent, into the latest Bow Group paper.

I can't honestly say that the paper has no value apart from the appearance of the Hiker, because it does deal with several interesting items about life in the future and the problems of training citizens to cope with it, and with micros. But the jewel in the paper is the arrival of the 'typical school leaver of the 1990s, John Dent, cousin of Arthur Dent, who has no academic interests'.

John Dent is not carried off into space by marauding Vogons: instead, he ends up a retired authority on the Welsh long-bow in use and in literature, in a ruined hill farm in Mid-Wales, converted to a holiday camp.

He starts off as a robot supervisor and part-time CAMRA activist, and gets retraining four times in his life... oh, it's a laugh a minute. And it costs a mere £2.00 from Bow publications, 240 High Holborn WC1V 7DT and is designed to be discussed. It may even provide the future Opposition with useful ammunition one day. — and it is called *Learning for Change*.

Share and Enjoy!

## Friend or foe?

I'd like to go on record as heartily endorsing the opinions of my colleague Martin Banks in his grouses about software that won't let you make mistakes. My comments are provoked by several brushes with a very interesting type of software tool, of which *The Last One* is the best known and *Nucleus* one of the latest — the program writing program.

*Nucleus*, like *The Last One*, is now permanently on show at the NCC's micro centre in London, where people can walk in and try

it out free. My own experience of it is so far limited to a demonstration at the official launch, where the demonstrators proved conclusively that they knew all the necessary mistakes involved in totally crashing the system on several different machines.

The point to make is not that the systems crash, but that if you are sold on the idea of using them, a quick trip to the Centre to see whether you can live with their current limitations is well worth the petrol; it may be true that you can crash these systems three times in an afternoon and still have a program developed in hours rather than in weeks in the normal, Basic-writing way — but if you have put a boot through the screen in sheer frustration in that afternoon, you aren't that much ahead of the field.

The NCC centre is virtually empty, most days, too.

## PET links

Up to 255 PETs can be linked together with a little board called Hydra, now available from Wordcraft Systems of Derby. The machines can communicate, load and or save programs, and interchange screen display, says Wordcraft Systems, passing messages at a rate of 250,000 baud down a four-way screened wire, up to a kilometer long.

Apparently the board plugs into the memory expansion port, and costs £125 for every PET in the system. It will work on model 3000, 4000 and 8000 PETs. Details on (0332) 760127.

## Torch set to shine

The question of what computer shops will find to be pleased about in the BBC micro project is (sort of) answered in a new announcement by a company called Torch computers, which is, in fact, a company with Acorn behind it.

Torch is a joint venture between Acorn and Climar Group, and it plans to release a machine called the Communicator — a name already used by another manufacturer. Similarities between this machine and the BBC micro are obvious. If one were to take the BBC machine and attach a Z80-based host at the other end of the Tube connection, thus turning the BBC machine into a terminal, it would end up very like the £2500 Torch.

The obvious addition is the provision of the communications facilities hinted at by the name. The Torch, say its makers, will be



Hydra links PETs

capable of handling telex, Prestel and Teletext facilities, because it can connect directly to a telephone line, with a built-in dual modem.

It also uses Acorn's local net system, Econet, to send messages from one Torch to another and a full word-processing system, integrated with the communications software, allows messages to be edited before transmission.

Languages include Microsoft Basic, BBC Basic, Pascal, Fortran, Cobol, Algol 68, C, Lisp and Forth, and the operating system is 'CP/M compatible.' Further data on 01-930 1612.

## Upmarket I/O

When a company asks for £400 for a board to handle message input and output on an ordinary micro there has to be more than the ordinary justification — that you may want to attach a printer.

Metrotech's input/output board is, in fact, a computer in its own right, with a Z80 micro. Its function, however, is to provide ultra-reliable control of communications between the central micro and its printers, terminals, and other remote 'peripheral' devices.

'Metaport uses the full interrupt capabilities of the Z80 and SIO/2 chips,' says Metrotech, 'to ensure no data loss in transmission or receipt of information — this means error-free communications even under multi-user operating systems such as MP/M'.

This isn't the sort of information which the average user can do much with, but for consultants, putting systems together for non-expert customers, it could be a way of creating a more reliable system. Metaport fits into an S100 socket, and provides four serial input/output ports capable of running synchronous, asynchronous, or SDLC protocols. Speed of data transmission and reception is

independent, and variable between 75 baud and 19,200 baud (which in this case means bits per second).

Details from Metrotech's Craig Ogilby on 0895 58111.

## Atom database

Ideal for storing a personal phone directory, says Acorn's Acornsoft, referring to a small program it has produced for the Atom and which it describes as a database.

The program takes up 5 k bytes, and will organise information on cassette or disk, sorting items into alphabetic order, selecting various items and listing selected batches. It will be available in July, however, so there isn't any need to get worked up just yet.

Details on 01-930 1612.

## Japanese software coming

Craftsmen can't compete with factory efficiency, because no matter how much we may admire their work, we can't afford to buy the stuff they make. For this reason, the Japanese will take over the software world, because they are steadily and determinedly building software factories, well stocked with software tools.

This warning was issued recently by the boss of Britain's National Computing Centre, David Fairbairn, just back, from a visit to Japan.

'British software vendors will have to discard the myth that the Japanese are good at producing computer hardware but out of their depth in the field of computer software,' he said. 'It is time for this misconception to follow into the dustbin the earlier myth that Japan has a genius for imitation but no capacity for innovation.'

Fairbairn's opinion is that there is clear evidence of a 'consistent national plan to

# "Every PET owner should read it"

**Chuck Peddle**, Inventor of the PET

"The PET Companion" is a fascinating collection of essential PET information from the pages of *Microcomputer Printout*. It contains all of the editorial from the 1979 & 1980 issues, including 105 PET programming hints and tips, 116 news reports, reviews of 54 peripherals ranging from light pens to printers and 27 major articles on PET programming. All of it written in straightforward English.

## Some of the topics covered:

### PROGRAMMING THE PET

Double Density Plotting  
Modular Programming  
Programming Style  
Graphics  
Subroutines  
Sorting Out Sorts  
Tokens  
The Game of LIFE  
Tommy's Tips  
ROM Addresses

### THE SOFTWARE

Business Software Survey  
Cosmic Invaders  
Superchip  
PETAID Do-It-Yourself Database  
What's Wrong with WORDPRO?  
Screen Display Aids  
Keyboard Tutor  
Photography Course  
Who Do You Want To Be?: Fantasy Games  
Commodore's Assembler Development System  
Programming Aids & Utilities Survey  
PET Games

### HARDWARE REPORTS

The New ROM Set  
CBM 8032 SuperPET  
CompuThink Disk Drives  
Hardware Repeat Key  
High Resolution Graphics  
The Commodore Printer  
How the Keyboard Works  
AIM161 A to D Converter  
Commodore's 3040 Disk Drive  
PET's Video Logic  
Colour for PET: The Chromadaptor

### THE SPECIAL REPORTS

PET in Education  
PET Show Report  
The Jim Butterfield Seminar  
Hanover Fair Report  
PET In Public Relations  
Local User Groups  
High Resolution Graphics  
Commodore's New Technology  
Future Shock: Forecasting The Future  
Speech Synthesis  
PET As Secret Agent  
A Visit to the Commodore

*plus news, letters, gossip and regular columns by leading PET experts.*



**To: Printout Publications, P.O. Box 48, Newbury RG16 0BD. Tel: 0635-201131**

Please rush me a copy of the PET Companion

I enclose cheque/postal order/money order

Please charge my Access/Eurocard/Mastercharge  
or Barclaycard/Visa No:.....

UK £9.50 plus 45p postage     USA \$25     Overseas £12  
(Credit card orders accepted by telephone on 0635-201131)

NAME: .....

ADDRESS: .....

.....

Postcode: .....

PCW 2/82





produce highly efficient software development tools' in Japan. Unlike the earlier plan to put Japan in front of America's silicon chip skills, this plan is kept under cover. 'The existence and context of the plan is not fully declared, but is evident in a consistent pattern of work undertaken in both the manufacturers and in independent sectors.'

It appears, says Fairbairn, that some six years ago, plans were laid for the development of new programming languages, code-named a, b, c, and so on, and these are now nearing fruition. 'The same dedicated logic is being applied there to the processes of software production, as enabled Nissan (in the field of cars) to achieve six times British Leyland's output with only half the work force. The merits or demerits of existing software products are of little consequence compared with the techniques that may be used to produce their successors,' he said.

## Hup, two, three, beep.....

American cinemas have been rendered unsafe by the arrival of the alarm watch. All over the country, romance is destroyed by the near-simultaneous sound of hundreds of beepers sounding out the hour every hour, followed by frantic rustlings as hands are removed from . . . well, as hands are rushed to the job of silencing the little beepers.

Now Casio tells us that it has found a new function for the wrist watch. It is a novel 'pacer mode' for joggers.

Parks and country roads, Casio plans, will be made into arenas of hideous beeping by joggers who have fed in the details about their length of stride (in feet and inches or in metres) and their preferred running rate. 'Provided a jogger keeps pace with the pips and holds the set stride length consistently, the J100 watch offers the wearer a series of meaningful data for display at the touch of the button, showing target speed, time elapsed from start, distance covered, or number of strides made.'

Any one of these factors may be progressively increased in future training sessions, the company adds.

At £22.95 per watch, it's an expensive joke, if silly rather than funny. I suppose company executives inside Casio will be encouraged to take the thing to bed with them . . .

## Heavy PET

The expanded Commodore, the 8096 with 96 K bytes

inside it, has had Visicalc loaded into its capacious store by Heronview. The company claims that this increases the capacity from 1200 items of information to 8000, which is three times the capacity of comparable Visicalc machines. Details on 01-734 3532.

## Give your Atom an arm

There's a lot more to building a robot than merely having a mechanical arm though this is a high priority and is normally very costly. So an arm for £430, designed for teaching purposes, is quite a breakthrough.

The arm in question is the Smart Arm model 4E (E for educational) from Systems Control. It has a micro in it — the original Acorn card which the company produced before it got round to building the Atom — and it is designed to be controlled by an Atom.

Smart Arms come in a range, from the small 4E with just four movements, a maximum reach of 200 mm and a 120 degree rotation span, only able to lift 50 grammes and exert 2 kg — to the industrial 61 model. That has six motions, can reach out a metre, turn through 300 degrees with much greater precision, and lift 1.5 kg with a grip of 10 kg. It costs £2560. Details on 01-930 1612.

## Sinclair-ICL tie-up

Now for the news of Sinclair's deal with big computer builder ICL — the announcement touched on in the other news item above, about educational software.

Surprisingly, the deal with ICL doesn't involve computers, but terminals. And, at last, it involves the use of Clive's clever flat-screen video tube, as both phone connection and computer connection inside big companies.

The tube was announced as a research project a year ago, with predictions of availability some time next year in a £50 pocket TV set. So it shouldn't be any surprise to find that this project isn't planned to bring fruit until next year (1983) too.

More impressive, to my mind, is the news that ICL has received an order from W H Smith for 100,000 software tapes — for the ZX81. Sinclair expressed surprise that nobody had heard about ICL's involvement so maybe everybody else knew all along that the training division of the computer giant had written

training software for the little computer and that Smiths were selling it as fast as they could record the tapes.

According to Smiths executives, the ICL tapes are far superior to other tapes, because they are enhanced to make loading more reliable than normal on the ZX81. In other words, the machine finds it easier to load these tapes than it does to load tapes it generates itself on tape recorders with the SAVE command.

The reason this impresses me is that it underlines an achievement of Sinclair which his competitors would like to ignore — that is, to get the first chain store in this country to really get into micros to take on his machine only. The fact of the matter is that no other product would stand up to being sold by non-expert staff like this.

## Logical choice

Long ago, people who called themselves electronic engineers were able to design logic. They could connect transistors together to form gates. Then, because the chip makers got clever, it became possible to design gates onto single chips and logic designers became people who could link gates together to produce logic circuits. Finally, logic circuits got so complex that nobody knew which circuits to design and they invented micros, to do everything.

It has now been definitely discovered that micros can't do everything, and that specially designed logic circuits are still needed — but you can't make a specially designed chip unless you plan to produce a few thousand, because that's how the business works.

So the chip makers are now producing all-purpose logic chips which the engineers can modify. They are logic arrays, either field-programmable, or uncommitted — and Sinclair used one very effectively in the ZX81, while the BBC microcomputer has two very powerful chips of this sort.

But logic design engineers still don't quite know how to use gate chips at first. So Texas Instruments is now running £500 courses on the subject. The courses last for a week each, and there is one a month from now till June. Full details from Mike Hughes, Logic Array Training, on (0234) 67466.

## Lie detector

You may possibly have imagined that you don't need a digital multimeter fitted to your personal computer (Atari, Tandy, PET or Apple). How wrong you were!

Without one, you could

not have tried any of the following: turned it into a lie detector by interpreting changes in skin resistance; programming your plant watering by measuring oil conductivity; monitoring or controlling pressures of gases or liquids using pressure transducer in lab analysis, process control, school projects; testing the effects of stress using strain gauges; monitoring and or controlling temperature-related functions in solar projects, water heating, greenhouse control; monitoring mains power by automatically monitoring the circuit and having the computer set off an alarm . . .

Details from Black Star, which sells the Sabtonics Model 2020 digital multimeter with interfaces to all the above micros. Price £165, details on (0480) 62440.

## Easier formatting

Because Basic is inherently clumsy (like most languages of its vintage) at allowing programmers to plan and to change the layout of forms on a terminal screen, people are always producing ways of improving its powers in formatting. Latest product is a piece of add-in software for CBasic, called Microscreens.

According to supplier Microbits, Microscreens 'provides professional form-style input to CBasic programs to interface with dumb terminals in page mode. Full control of protected fields and cursor controlled editing is provided and numeric fields are validated on input.'

This facility is probably more important on CBasic than other forms of the language, because of the fact that CBasic is not even as friendly as Microsoft Basic in detecting errors — you have to edit it using a text processor and then compile it, before noticing that you've screwed up the syntax as well as the logic.

Incidentally, if you edit your CBasic program on Wordstar, don't use the reformat command, because it puts all sorts of illegal characters into the program and they are all invisible. (Anybody who knows a way of going through a Wordstar-produced CBasic file and re-setting the high bits, let me know, and I'll certainly give you code a plug.) The company Microbits is in Wokingham on (0734) 792021 and the program costs £110.

## Intelligent decision?

Intel is the company which gave us the microprocessor and which has, up till now,

When it comes to looking at what the incredible VIC-20 has to offer, there's one cost-free add-on it will pay you to consider right

# The VIC centre

## It's the add-on to start with for your VIC-20

your knowledge grows, we can supply the software and peripherals which give the VIC-20 system its unrivalled

from the start. It's called The VIC Centre, and you'll find it at the Adda Home Computers shop in West London. Part of the successful Adda Computers group, The VIC Centre provides the kind of service you'll not find anywhere else in the country.

Our business is dedicated towards providing you with a "one-stop" source for the VIC-20, VIC-20 peripherals, and VIC-20 software. On the basis of a very simple philosophy: providing a friendly, fast and comprehensive service for the world's most user-friendly and helpful personal computer.

With its magnificent sound and colour capabilities, the VIC-20 makes it easy to learn all about computing. And as

versatility in applications ranging from home budgeting and video games to business records and statistics.

All our customers benefit from our telephone technical advisory service and in-store repair facilities.

So if you want to get to the heart of what the VIC-20 system is all about, go straight to the centre—The VIC Centre.

**154 Victoria Road, Acton, London W3 (near to North Acton tube station). Open Saturdays 10.00-17.00, Tuesdays to Fridays 10.00-18.00.**

For up-to-date information on the VIC-20 system join our information service. Just complete the details on the FREEPOST coupon below and post it today, or telephone us on 01-992 9904.

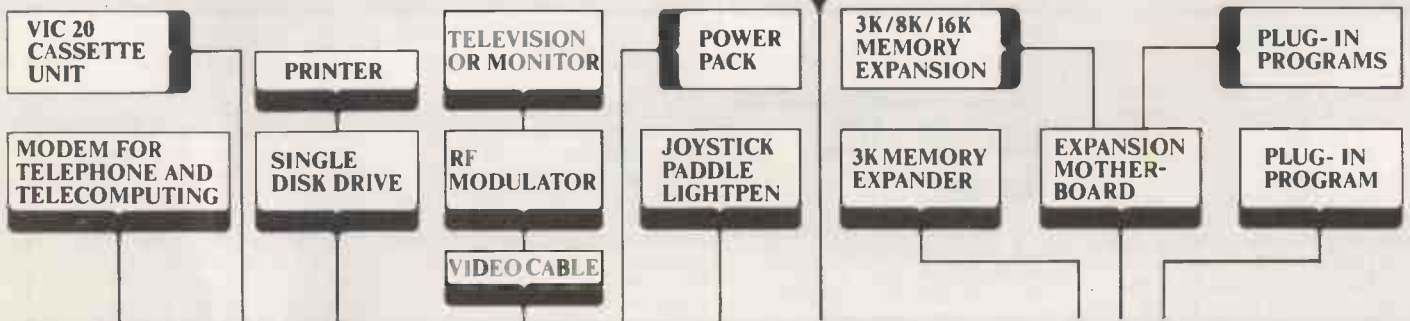

ite information

Please pull out on your mailing on the 1

Name \_\_\_\_\_

Address \_\_\_\_\_

The VIC Centre  
Adda Home Computers Ltd.  
FREEPOST  
London W3 9BR



steadfastly refused to give us a microcomputer. Instead, it has put its own chips inside a few highly crafted mini-computers and has (perhaps sensibly) steadfastly refused to compete with those of its customers who put them inside cheap micros.

There are now some signs that this is changing. The company recently announced a 16-bit minicomputer built round its 8086 chip, which is the processor that Future Technology uses and which IBM and Sirius are working towards. Intel's new machine is the 86/330 and it is half-way to providing the fashionable future-style operating system, Unix, because it has C language already. (Yes, I know Unix is ten years old, but most future things are ten years old.)

More interestingly, this seems to be the forerunner of more significant products. This 86/330 is one which Intel hopes will be used as a development system by other people who want to build and test 8086-based systems for a wider market. And there is starting to be some evidence that one of these people will be Intel itself. A genuine business system for some time this year is, say sources, really on the cards — and the people who have seen somewhat of the prototypes in California are coming back white-faced with shock at its sophistication and handcuffed by non-disclosure agreements.

Details are not available to any but the favoured few as yet. Whether sophistication is really what the market wants remains to be seen. But if a Rolls-Royce system is built, Intel can do it. And the 86/330 may be the straw showing the way the wind blows, or so I am told.

## IBM PC on sale in UK

The IBM Personal Computer has appeared in the UK, much to the surprise of everyone and, not least, the surprise of International Business Machines itself.

It was imported by a company calling itself Micro-computerland, which turned out to be a subsidiary of a well-known UK software houses, called Zeus-Hermes, which was buying the machines from Computerland in San Francisco, an authorised IBM micro dealer.

To use the machine in the UK takes a bit of thought, because it not only requires a different voltage from our 240 V, but wants it supplied at 60 Hz rather than the 50 Hz frequency of UK mains. So Microcomputerland was obliged to sell the machine with a voltage converter in this country. At Compec, the biggest UK computer show,

they sold 20 or so at about £2500 each with 64 k bytes of memory only and with only the Adventure game as demonstration software.

A couple of weeks later, Z-H director Nick Punter turned up at the Software Information Exhibition with Visicalc added to the software repertoire, and with the promise of CP/M-86 coming soon.

But even Punter had no idea when IBM planned to release the machine in a UK version.

## Hardware in software

Time was when computer designers virtually built programs into the hardware by the way they connected valves and wires together. Today, on a Tandy micro, they can build circuits into the software, with a program that Wayne Green calls Electronic Breadboard. It simulates the effects of adding or removing electronic components from a circuit, saving a lot of experimenting. Details in Peterborough, New Hampshire on (603) 924 7296.

## Scriptit for Model 1

There are so many Tandy users running a text processing package called Scriptit that the people who have an old Model I machine must feel jealous. One deduces this easily enough from an enhancement to the Model I, announced by RHA (Mini-systems) — an enhancement, which amongst other things, provides lower case letters that are compatible with Scriptit.

The product is a display enhancement, which also allows the user to invert the characters (black on white rather than the normal white on black) and provide a clearer display thereby.

## Sigh for Cifer

The name Series 1 normally applies to a rather old and somewhat strange IBM mini-computer, so Cifer will probably not really offend anybody by giving that designation to a new desk-top micro.

Starting at £2700, the machines are notable for the amount of diskette storage they offer, with the three-floppy model 1888 having 2.4 megabytes, rising to the 1887 with 12 megabytes on a winchester and 800 k bytes on one floppy.

The really beautiful machine from Cifer is a different one, however — and it isn't a computer itself. It is



The Commodore Vic is expandable. It has to be, because it comes with a measly three and a bit K bytes of memory. But by press time, Commodore still didn't have lots and lots of expansion memory or interface boxes available (or VICs, come to think of it). So Arfon Microelectronics was understandably pleased at getting this little box out.

It contains its own power supply, capable of powering the added boards and also the printer which Arfon expects to put on the market very shortly at £100 or less. Price of the expansion system is £98 including VAT and it will take seven cartridges at once.

Arfon has also put together its own add-in cartridges, and is convinced these will be generally available before the official Commodore ones. Its add-on memory is available to plug into this box now, at a cost of £65 for a 16 k byte cartridge. Details on (0286) 5005.

an add-in graphics board, with 1024 by 300 point resolution, high accuracy graphics at £650.

It may not be cheap enough for amateurs, but it is

pretty nifty looking, isn't it? It plugs into the 2680 and 2630 series machines, providing Tektronix emulation.



See Sigh for Cifer

# The Printer People

**NEC**

**3500**

## A NEW GENERATION OF NEC SPINWRITERS

**(A little less speed for  
a lot less money)**

*They've done it again! NEC Information Systems' new Series 3500 Spinwriter combines the reliability of past NEC products with an unbelievable low price.*

*The 3500 series is a new generation of Spinwriters capable of printing up to 35 characters per second at a saving of approximately 25% over past products. NEC has accomplished this tremendous price reduction while maintaining the same high quality printing and reliability found in all past NEC models. The new series has full functional compatibility with the 5500/7700 series printers, which means not a single line of code need be rewritten to take full advantage of this new product. Call today for more info.*



**BDT**

**ASF 160**

## Automatic sheet feeders



*Feeds up to 250 single sheets or letterheads automatically — no more hand feeding !*

*Universal unit with mountings for NEC, Tec, Qume, Ricoh, Diablo and others.*

*Easily attached or removed in seconds.*

*No modification to printer or software required.*

Trade, OEM and Educational Discounts available — area dealerships invited.



# 0372 62071/66398

Phone for your nearest stockist

*You've come this far to find a printer supplier - don't blow it now.*

Lots of people can sell you terminals. But no one can give you terminals that come with a guaranteed immediate delivery that ours come with!\*

So what's it to be? A terminal from a company that delivers what it promises.

Or a terminal from a company that just makes lots of promises?

\*subject to being in stock.



## EPSON

### MX80

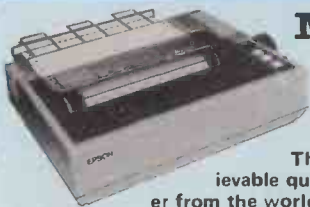

The unbelievable quality printer from the world's largest print head manufacturer. A whole stable of machines to suit a wide variety of applications: MX80, MX82, MX 80FT/1 & MX80 FT/New Type 2. MX100

## OKI

### 82A 83A



Small, light, quiet, dot matrix printer. 40, 80 or 132 columns, 6 or 8 lines per inch, 96 ASCII characters plus 64 graphics characters, Centronics int.

## TRANSTEC

### 1200



Green Screen

Computer data and graphic displays never look better, brighter, sharper. Low cost, high resolution, high performance.

## QUME

### SPRINT 9



The Daisywheel Printing Terminal series that sets a new standard for print quality, reliability and serviceability. Unbeatable performance at a realistic price.

## RICOH

### FLOWRITER



The 1600 is one of the most advanced daisy wheel printers on the world market today. With a unique combination of features.

## TEC



Daisy wheel printer for word processing, professional results. Diablo compatible, suitable for most micro and mini computers.

## TVI

### 910/920/925/950



Fully intelligent terminals with 24x80 display & dual intensity, blinking, reversed, underlining and protect fields, 96 ASCII chrs etc.

## HAZELTINE

### ESPRIT

Green Screen



The Hazeltime Esprit is a buffered terminal capable of displaying the complete 128 ASCII character set. Based on a 12" diagonal non-glare CRT, the video is crisp and clear with each character presented on a large matrix to reduce eye fatigue.

## NORTHAMBER LIMITED

3 & 4 DAWES COURT, ESHER, SURREY.

Tel: Esher (0372) 62071 or 66398 (from 01 nos. dial 78-62071 or 78-66398)

Importers, Distributors & Wholesalers of quality Computer products.

**If you want a Printer tomorrow - call us today**

# Banks' Statement

## HOW SMALL IS BEAUTIFUL?

**Martin Banks holds forth on politics, bureaucracy and stuff....**

So I said to 'Bumper', said I, 'what do you reckon, then?'

At the time we were sharing a quiet corner at this illustrious journal's autumn fete at the Cunard Hotel (the one where Mike Sterland employed all those cute little midshipmen). I had managed to corner one of the personal computer industry's most sagacious sages, 'Bumper' Harris, the man whose finger is really on the pulse of who is doing what, with what and unto whom. I felt it was time to ask him some serious questions.

So I said to 'Bumper', said I, 'what do you reckon, then?'

His answer was most revealing. 'Interesting,' he said, after a great deal of consideration. In fact, he gave the same answer to the two questions I had asked him. The first concerned the potential for government intervention in the business, and what the end result might conceivably be. The second concerned the ultimate question of life, the universe, and everything.

Bumper pondered the second question first and after a while thought the answer might lie somewhere in the high 30s. 'But maths was never my strong point,' he added, defensively.

Having thus cleared his mind of such trivia, he turned his attention to my first question. 'Now this is of far greater import,' he said importantly. 'The potential for government intervention is limitless within all normal bounds of reason,' he continued, 'and the scope for Government to make a complete and utter balls-up of it is directly proportional.'

These seemed harsh views indeed from one so close to the heart of the matter. It appeared that, maybe, they required just a little clarification. Being brave, I asked for it.

'Well, look at it this way,' he said, 'any government worth its salt is going to want to do the best it can for the people it governs.' At this point, it seemed Bumper's clarification needed clarification.

'I'll rephrase that,' he said. 'Any government purporting to be freely elected by the population will be keen

to be seen doing what the population can be convinced is the right thing for those people, so that the government will get re-elected next time around. Clear?' Certainly, it felt better the second time.

'So,' he continued, 'one significant option open to the government is in the economic area, the object being to keep as many as practicable of the population in jobs so that they can be convinced they are useful to society. In this way, lots of money keeps changing hands as wages are earned and spent and shareholders get rights issues aimed at them; and the government takes a slice of all the action in taxes.'

Okay so far, but what has this to do with government intervention in the microcomputer business, I asked.

'I'm coming to that,' he said. 'When a nation, or geographically definable governed area, gets to be rather old its opportunities for providing useful means of obtaining a tax take from the population - ie, keeping them working - is directly proportional to the intrinsic age of the indigenous industries. Old industries will tend to show signs of senile decay, usually quite rightly, and they should be allowed to die.' But that won't get many votes. It seemed a logical question, so I asked it.

'Right,' he said, 'so governments are left with two options. One: they can inject monkey glands into the old biddies in the hope that there will be a miraculous recovery. Two: they can do something completely different, and probably make a cock-up of it. On balance, the monkey gland treatment gets the vote by most governments because the cosmetic effects look good in the short-term, and the short-term is vote-catching. But as often happens with miracle cures, the patient only appears to get better. When it keels over and dies it is often rather sudden, and sometimes spectacularly messy.'

But governments are trying some new things, I suggested to him, especially in the microelectronics and general new technology area. What of these? I asked.

'Yes,' he said, 'many of them have cottoned on to the monkey gland syndrome at last, and are trying the second alternative. The trouble seems to be that, as with anything new, it is the nature of the political process not to understand a single thing about the subjects it has decided to support. For a start, the bureaucratic machinery takes over what is often a good theoretical idea and, slowly and inexorably, grinds it into dust.'

'Now, I can sense that you are going to ask why.'

I was.

'I will tell you,' he continued without stopping. 'The first Law of bureaucracy is to protect your own backside. The second Law is to build your own empire, thus enhancing the first Law. Any new development, such as a ministerial decision to support a new industry like microcomputer manufacture, poses a direct threat to the first Law as the vast majority of bureaucrats will not understand a single word that is uttered about the business. When this happens, the bureaucrats react quite naturally. It is they that are given the responsibility of implementing any support scheme, yet they do not understand what they should be doing, or how they should go about doing it. They therefore run an immense risk of breaking the first Law. They try to make it look as if they know what they are doing, to fool their political masters, while at the same time making those masters look good to the public. At the same time they actually only do some little bits that they can understand.'

I asked him if he could perhaps be more specific, perhaps point to one or two actual instances.

'That's easy,' he said, 'just look at the education announcement earlier this year. With full fanfare it is proclaimed that every school in the land is to be given a cut-price deal on obtaining a microcomputer. Now this is highly laudable. It is good for the schools and their pupils, it is good for the country's future as all the little children come out into the wide world brim full of computer literacy. It is even good for the politicians that displayed such far-sightedness.'

'As it is indigenous manufacturers that are to be supported, it even appears good for the industry as well. But is it? The bureaucrats fail to understand that there is already an enormous groundswell of microcomputing in education, where schools are using machines like PETs and Apples and all sorts. They fail to understand that software is probably more important than hardware and that schools without micros, that are in areas where there are schools already using them, can gain



more from being allowed to buy the same machines, even at full price, than from buying something different at an enormous discount.

'The worst sin in my view comes in the administration of the scheme; the fact that the administration is actually more important than achieving the purpose for which it was established.'

This I asked him to explain more fully, and he did.

'Look, they have settled on two systems from indigenous manufacturers. Just two. Now the two they have selected are both very fine machines. I have no criticism of them at all. But while it appears to provide a degree of choice, it is my own view that the real reason is to make the administration of the scheme as convenient as possible for the bureaucrats. With more than two types of machine involved, the bureaucratic mind would tend to haemorrhage.'

'But there are more than two indigenous manufacturers worthy of support. Some of them have machines available that, at face value at least, have a great deal to offer the educationalists and pupils. You end up

with a scheme that is supposed to partly provide overt support for local industry actually being counter-productive, actually penalising companies and effectively banning them from a good and long-term marketplace.'

This seemed to beg the question of what 'Bumper' Harris would propose as an alternative. I felt brave enough to ask him.

'I have a variety of alternatives,' he said, 'that range from taking the bureaucrats and politicians outside and shooting them, through to ideas that are more humane but probably less justifiable, certainly from their point of view. One alternative is for the micro business to carry on as it started - just ignore them. After all, the bureaucrats have done little to provide really constructive help so far. They might sulk for a while, but the business now seems to have picked up enough momentum to ignore them, if necessary.'

'Of course, it would be nice if they gave some real help - or, more specifically, money - with as few strings as possible. If the politicians feel that employment for the people is a major

vote-catcher - and I'm sure it is - then they should look to history. No company started life as a multi-national; they all started small. So what we need are lots and lots of small companies. They won't all succeed, of course; in fact, the majority will fail. But so what, some will make it. All you need to do is keep the money rolling for start-ups, and reap the benefits from the ones that make it.'

I ventured that this was not unakin to the venture capital approach; and 'Bumper' concurred.

'That's right,' he said, 'and it wouldn't take too much in the way of money either. Just ten per cent of what has been poured into operations like British Leyland could probably start up a thousand small companies. Each of those would actually employ people, and maybe ten per cent of them would survive and prosper, funding other start-ups.'

I asked if he felt it would work. 'God knows,' he replied, 'but it would be more fun than what we have at present.'

It all started when I saw an advertisement in a magazine which said 'Buy our new powerful fantastic computer and you can run your own power station, control your own home-built nuclear reactor, solve simultaneous equations, play Space Invaders, etc. . .'

*Play Space Invaders!!* Well, visions floated into mind of sitting down at the pub, waiting tenth in line to blast the invaders to bits. Oh boy! No more waiting. A Space Invaders machine to myself. Wow! I must have one, gimme gimme gimme. 'Please let me have one dear, drool, teach the kids, drool, gimme, Space Invaders all to myself, yes dear, future for the kids in computers, etc, etc.'

The waiting was awful, Doctor, truly, *awful!* Three weeks it was. Seemed more like three years. Then it came, Doctor. 'It's here! Ha ha ha ha, it's here! Put the kettle on, dear.' It was a big box, I remember. Everybody gathered round. Just like Christmas it was. I think it was then, just at that moment as I looked at the box that my condition started, Doctor. I mean you know what Russian dolls are like? You open one and there's another smaller one inside? Well, it was just like that. A big box to begin with and then a smaller box inside and then some packaging and another smaller box and so on until at last this plastic piece of rubbish, this totally useless piece of modern technology trash, this utterly utterly. . . Oh! It's okay Doctor. I'm okay now. Sorry, I'll continue now - well anyway, I got this piece of the equipment out onto the floor along with the other bits and bobs and had a look to see where everything fitted together.

A couple of hours later I managed to get a small square on the TV screen and started to look for the 'start Invaders' button. *It's all a con I tell you, Doc. It's evil the way they con innocent people Doc, it's evil, evil, evil, mmmmm m m mmmmm mmm m m mm.* You'll have to excuse me, Doctor, I'll be okay in a minute. Okay, I'm fine now. By the way, you don't happen to have a proper Space Invaders machine in your consulting rooms do you, Doctor? No?

## Well, Doctor...

*John Jackson goes several steps beyond microholism.*



Wendy Hoile

Oh well, never mind. Anyway, when my wife picked up the bits and pieces from the far side of the room, she suggested I read the book and see what it said. Maybe it could tell me what to do to make Space Invaders work. . . Well, to cut a long domestic crisis short, I had to send money to get a cassette with Space Invaders on it before I could start!

*Did they tell me that in the magazine ad? Oh no. Nothing about buying one shiny new fantastic powerful wonderful magic FBX92 machine for £35,000 and then send another £2000 for a cassette to play Space Invaders on it! Oh no, they don't tell you that, do they? Oh, sorry Doctor, I didn't know I was holding your neck so tight, sorry. . . Anyway where was I?*

Oh yes. I got their miserable cassette.

'Zap the Klingons before they tramp on you!' That's what it said, Doc. 'Blast the Zombies before their lasers blow you to smithereens' it said. Do you know what happened? No? Well, I'll tell you. I loaded this cassette, sat back and pressed the button ready for anything the Klingons could throw at me. What happened was that three small black squares appeared at the top of the screen and an 'X' at the bottom. 'Probably testing the screen before the fun starts,' I thought. Then a question mark appeared from the first black square and moved slowly down the screen and the 'X' disappeared. . . Then a message appeared: 'You are dead, earthling - Klingons rule - press newline for another try, another try. . .'. Where were the bug-eyed monsters, the moving saucers, the rockets, the lasers, the moon bases, the noise, the excitement? Nowhere to be seen, Doctor. Three black squares, an 'X' and a question mark and that was it. It had about as much similarity to the real Invaders as a doorbell has to a Brandenburg Concerto. Well, I was okay after my three weeks in the intensive care unit for a coronary, but it still affects me sometimes at night Doc. I sometimes wake up in a sweat thinking of all those games of the real Invaders I'd missed, spending all my money on three black squares, an 'X' and a question mark. . . I just get up and have a game on my very own real Invaders machine I now have in the corner. Admittedly it cost me an arm and a leg but now I'm a sane, healthy, normal person once more. I just feel the need to tell somebody about my experiences sometimes and I feel good for another couple of weeks.

Well thanks, Doc for talking to me. You can come out from under your desk now, Doc.

*A Doctor writes: At times like this, I find it useful to remember the words of the great Mongolian sage, Lao Tse Bhom: 'When in worry or in doubt, run in circles, scream and shout'. If that doesn't work, take two aspirins and get plenty of rest. Next please.*



# WE'RE LOOKING FOR THE BEST SOFTWARE IN BRITAIN SOFTWARE GOOD ENOUGH TO BEAR YOUR NAME....AND OURS



When customers buy software from Caxton, they not only get finely crafted programs, but also a tutorial manual outlining applications and a user manual so that the software can be turned to practical use quickly.

We are now looking for Software Writers who identify with our aims – providing 'electronic paper', as easy to use as paper and pencil but a lot faster; producing software in plain English, making computers as simple to access as a textbook, but a lot easier.

To help Software Writers produce and bring their products to an international market we have also written a booklet – 'Guidelines for Software Authors', containing tips on the market and what makes a program successful. The booklet sets out the requirements for quality products and gives the author a first feel of the real world view of his work.

Our authors come in a variety of guises. Some are software houses who want to get their work to a big market, thereby boosting their name and revenues, others are work-at-home professionals who steam over micros into the early hours. Members of universities, polytechnics, and colleges with clever ideas and programs are another valued source. And, of course, the micro has stimulated a new breed of imaginative user, specialists in particular disciplines who have produced new solutions to old problems.

We are looking for software which will cross international boundaries to the big markets in the USA, Japan and Europe. We do not want application packages peculiar to the UK. We do want Management and Productivity Aids and Systems Software.

The Management and Productivity Aid category includes everything that could be done on timesharing yesterday, and some new applications made practical by micros. Statistics, Modelling, Scheduling, Network Analysis, Queuing Procedures, Linear Programming and Information Retrieval are just a few examples. The Systems Software category includes: Utilities, Program Generators, System Generators and Communications Software.

Authors should not however be limited by these suggestions. Our doors are open to imaginative suggestions from writers and users. We have a preference for software written in industry standard languages for the most popular machines, but if you have solved a common problem using a less popular machine or language, then we will help with translation.

To find out more about software that is good enough to bear your name and ours, fill in the coupon. If you have written or are writing programs which you want to get to market, send us a description. Your synopsis should describe the product, the likely market, the benefits, and what makes your product better or unique.

Caxton Software Publishing Company 10-14 Bedford Street Covent Garden London WC2E 9HE Telephone (01) 379 6502

I am a Software Writer     Enclosed is a synopsis of my product     I enclose £2 for Caxton's Author Guidelines  
 We are Software Dealers     Please send us details on Caxton products     Add us to your mailing list

Name \_\_\_\_\_ Position \_\_\_\_\_ Company \_\_\_\_\_

Address \_\_\_\_\_





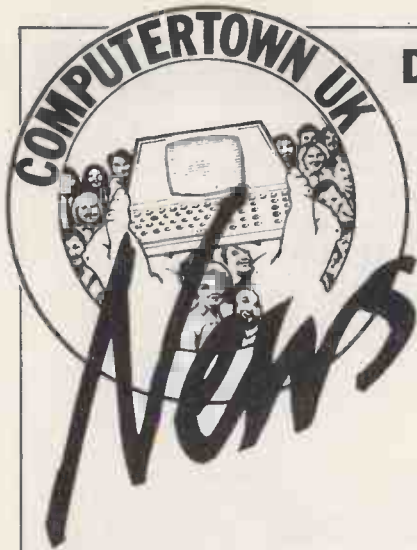

## David Tebbutt brings you the latest update.

Shock! Horror! No ComputerTowns have started this month. Oh well, it is December and who wants to start something new just before Christmas? I'm sure business will pick up again in the New Year.

Despite that somewhat gloomy start to the News, there are plenty of good things happening. We've had our first letter from CT Harrow which, at the time of writing, had run five ComputerTown evenings at the Civic Centre Reference Library. Susan Kelly started CT Harrow back in August with half a dozen machines — an Apple, a Nascom and some PETs. She has found that six is about the maximum number of machines that can be accommodated because, beyond this, the noise levels tend to rise. Sue noticed that if games are being played then the noise becomes intolerable for a library environment. Both Eastcote and Enfield had come to the same conclusions and put a ban on the 'Space Invader' type of game.

The Harrow ComputerTown runs on alternate Tuesday evenings between 6 and 8pm but will not run during periods of peak academic activity. The library also provides study facilities and text books for 124 students and there are times when ComputerTown would interfere. Accordingly, ComputerTown sessions will probably be run from early September to early December and mid-January to the end of March. Sue is in the process of preparing a book list which she will send me when it is complete. If appropriate, I'll publish it in this column.

Finally, I'll quote direct from her letter for the benefit of any other librarians reading this piece: 'ComputerTown evenings are good for the library's public relations. Usually, quite a crowd gathers to watch, and the ComputerTown area is full of interested (sometimes baffled!) and enthusiastic people.'

News now of a Town which is expected to start in Tonbridge. Brian Taylor writes from the county library at 4 High Street, Tonbridge, Kent to say that the Area Librarian has given permission for sessions to be run at the new library in Tonbridge starting in the middle of January. Brian plans to use the library from 5 to 7pm on either Tuesdays or Thursdays. Anyone who would like to pitch in and help Brian can contact him at work on Tonbridge 352754 or at home on 351994.

The regular sheaf of news has arrived

from Alan Waring of ComputerTown Enfield. Since they are about to install a ZX81 in the library permanently, they are designing a sort of computer 'driving test' so that people who have passed may use the machine out of ComputerTown hours. Alan's newsletter makes the following points: validation is on operating, *not* programming; operating instructions will be provided on a stand-up card by the side of the machine; instruction classes will be held in preparation for the test; the test would be on machine operation and what to do when things go wrong; and validated individuals would be given a card enabling them to use the machine outside ComputerTown meetings.

Among other things, Alan's newsletter also mentioned the ban on the Space Invader type of game.

ComputerTown USA wrote this month asking for details of our constitution for inclusion in a forthcoming 'ComputerTown Implementation' package they are preparing. I'll give you more information about what sounds like an interesting kit when it's ready.

Now for the serious enquiries. These are people who sound as if they'd be interested in starting a ComputerTown. If you'd like to help them then I know they'd be delighted to hear from you: Alan Hardy, 3/177 College Road, Moseley, Birmingham B13 9LJ; P Pullen, East Finchley Library, High Road, London N2; R L Hall, 9 Brackendale Avenue, Arnold, Nottingham NG5 8DQ; Mr R J Cheeseman, 66 Totterdown Lane, Oldmixon, Weston Super Mare, Avon BS24 9NJ; J N Buttler, 15 The Brow, Brecks, Rotherham, Rotherham S44 233 (home) or Sheffield 446333 (office); Jim Turner, 63 Millais Road, London E11 4HB, 01-558 3681. Jim has been on the microcomputer scene for a long time and has close links with the East London Amateur Computer Club. I suspect that we'll be hearing about at least one new Town from Jim in the near future.

Maggie Jefferies writes from The National Federation of City Farms. Maybe this is the start of ComputerFarm UK. Maggie can be contacted at 15 Wilkin Street, London, NW5 3NG. Telephone 01-267 9461.

Other enquiries this month came from Rochdale, National Westminster Bank's Computer Users Group in Birmingham, Northallerton, Leighton Buzzard, Folkestone, Harrow, Nottingham, Amersham, Isle of Dogs, Pinner, Staines, Ruislip, Gillingham, Finchley and Glasgow. Strangely, we've had four enquiries from Glasgow, all from the same place — Dowanhill. If you want to be put in touch with anyone from any town mentioned since PCW started running ComputerTown News then just send an SAE and I'll dig out the details from our database. Make sure that your covering letter makes your requirement clear.

Thanks to all those who have written this month. I look forward to hearing from lots of new ComputerTowns early in the new year.

ComputerTown UK! is an ever-growing network of computer literacy centres, where members of the public are given free access to microcomputers, courtesy of those willing to volunteer their time and equipment. ComputerTowns might be found anywhere: in a church hall, a library or maybe in a school after hours. The emphasis is on making computing enjoyable and non-threatening and, because ComputerTown is entirely non-commercial, overt axe-grinding of any sort is banned. Guidelines are available for those interested in setting up their own 'Towns: Write to CTUK!, 7 Collins Drive, Eastcote, Middlesex HA4 9EL and remember to enclose a large SAE (A4 would be fine) for your reply. Please don't try to telephone PCW for information because this project is entirely a spare-time activity.

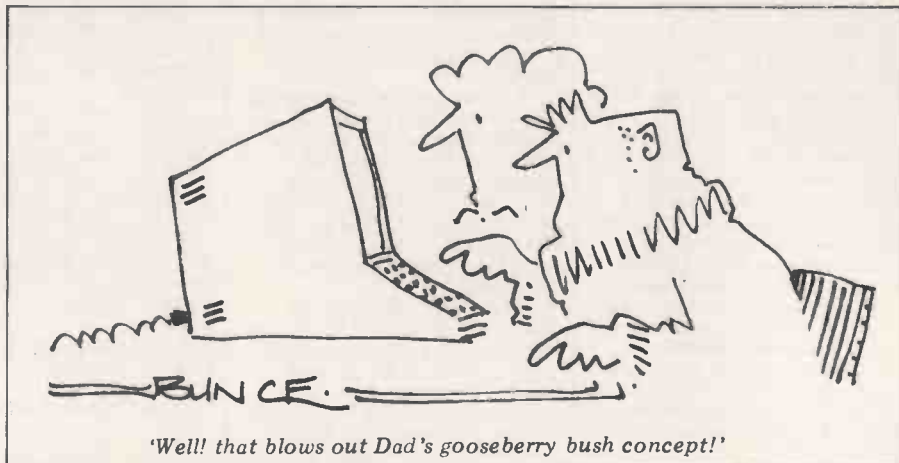

'Well! that blows out Dad's gooseberry bush concept!'

PCW welcomes correspondence from its readers but we must warn that it tends to be one way! Please be as brief as possible and add 'not for publication' if your letter is to be kept private. Please note that we are unable to give advice about the purchase of computers or other hardware/software these questions must be addressed to Sheridan Williams (see 'Computer Answers' page). Address letters to: 'Communications', Personal Computer World, 14 Rathbone Place, London W1P 1DE.

## Microsoft editing

Do I know something no-one else does? Your correspondent R Silson states that one can't duplicate program lines in Microsoft Basic using the EDIT function. I have been able to do this quite easily.

The technique I use is not mentioned in either the Basic manual which I used with a Vector Graphics System B or in the Apple softcard manual, but it always works. Perhaps Microsoft doesn't know what its own system is capable of.

The following sequence will duplicate a program line:

1. Call EDIT (line number);
2. Press RETURN — line is displayed in full;
3. Press control 'A' - exclamation mark appears with cursor on same line;
4. Press 'I' for INSERT and type new line number;
5. 'ESC' will end insert mode as normal — old line number is no longer there. Press return;
6. Old line still exists in program plus.

So no patching is needed.. With so many copies of Microsoft Basic about I'll be surprised if no-one else has come across this trick. If not, I'll be pleased to receive a 5p donation from everyone who finds this routine useful towards my new computer fund.

P H Elliott, Thundersley, Essex

## Paper plea

I am writing to appeal to your readers and advertisers for alternative sources of the special paper needed for the Tandy Quickprinter I used in conjunction with the TRS-80 Model I computer.

Although this printer was still on sale in late October, I have been informed by my local Tandy store that this paper has been 'discontinued' and that no more will be available once the existing (low) stocks are exhausted.

The paper in question is black, aluminium coated, and is 4¼in nominal width. It would be supplied in rolls of minimum internal diameter of 1in (2.54cm) and maximum external diameter of 2¼in (5.5cm).

I expect there will be other readers who would be glad of this information, if it could be obtained.

Martin A Kennelly, Derby

## Atari interpreter

I was very interested in the article 'Inside the interpreter' by A F T Winfield (PCW, January). I ran the same test programs on an Atari 800 and other readers may be interested in the results.

Test Program 1 (FOR A = 1 TO 1000 NEXT A) ran in 1.7 seconds compared to the Applesoft's 1.4 seconds. Test 2 (with LET B=1) ran in 3.1 seconds, the same as Applesoft. Test 3 (with LET B=1000 + (1000\*1000)) ran in 6.6 seconds, compared to Applesoft's 15.2 seconds.

Then I took three lines of the test and reran the program using one multiple statement line. I thought that would make execution quicker — it did, but not by very much: 0.15 seconds, in fact.

Deleting the LET from the original did not make the program run any faster at all. Changing the 1000 to a pre-defined variable ZZZZ gave a speed improvement of only 0.05 seconds — much less than the 50 percent improvement with Crystal Basic.

One of the great pains of computing is trying to read badly documented listings — which means virtually every one I've ever seen in the UK — so I added seven lines of REM statements to pad out the test. These took up 212 bytes and slowed the program execution time down by the fantastic amount of 0.33 seconds.

I think published programs should contain masses of REMs. They can always be removed by people with memory problems, but if they aren't there, the listing is almost unreadable for the 90 percent of your readers who don't own the specific machine.

My other complaint is about advertising. I think you should make all your advertisers include VAT in their prices. They don't, I know, because excluding VAT gives a false impression of how cheap things are. However,

probably 95 percent of your readers have to pay VAT, and the ones who don't are no doubt capable of subtracting it if they really need to.

Apart from that, keep up the good work on the magazine.

Jack Schofield, London

## Manuals belaboured

May I, through the columns of your excellent magazine, suggest a competition to be run through 1982 with the monthly winners going in for the annual award to be announced in January 1983?

The prize is for the worst handbook... and from what I have seen, the competition is fierce.

Why is it that most manual authors appear to think in machine code and have difficulty in converting their neat computing tricks into English so that others may share their skills?

I have been the owner of a Superbrain computer for some months; together with the computer I bought the Spellbinder word processing package and a database system called dBase II. Now, I have every reason to believe that when coupled to my Sanders 12/7 Media printer I have a potent system, but I'm damned if I can fathom the dBase II handbook. The Superbrain tome makes up in weight what it lacks in clarity and even Spellbinder, though by far the best of the trio, is far from clear.

I do not believe that it is difficult to write clear, logical handbooks to accompany software and hardware, but so far it seems to have defeated many manufacturers.

'See your dealer,' I hear some cry, but that is not the answer. There is no point in printing a manual if it is only understood by those in the industry. So, may I kick off the competition with my own nominations for the 'Duff Handbook Awards 1982'? First — 'dBase II' by Ashton Tate; second — 'Superbrain Users Manual' by Intertec; third — 'Spellbinder Manual' by Lexisoft.

Trevor Taylor, London W1

PCW has always been aware

of the rarity of good documentation; we even have a separate section for its evaluation in our Benchtests. Should Mr Taylor's awards ever be presented, however, I don't think his three nominations will even figure in the top (or is it bottom?) ten! — Ed

## Speak no eval

I was interested to read your reviewer's comments on the EVAL function built into the BBC Microcomputer. Is this operation all that unusual? I have used VAL A\$ on my Sinclair ZX81 to perform what seems to be essentially the same operation — eg, the program

```
10 LET A$ = 'X**2-3*X+6'
20 PRINT VAL A$
gives 4 if (previously) X has been assigned the value 2. I use this in a small program to turn my ZX81 into a calculator:
10 PRINT TAB 9; 'CALCULATOR'; TAB 41; '=====';
20 PRINT
30 INPUT A$
40 PRINT A$; ' = '; VAL A$
50 GOTO 20.
A$ is then input as the expression to be evaluated (which may contain any function, eg, SIN and indeed logic expressions such as AND).
```

G W Dorling, Wymondham, Norfolk

## Instrument flying

In answer to the question put by B M Neary, Coventry (PCW, November) regarding simulation instrument flying, I know of three programs: 'Air Flight Simulation' from Instant Software, Dept HC-2, Peterborough, NH 03458, USA, cassette \$9.95, for TRS-80 L1 and L2, Apple II 16k (Applesoft); 'Sublogic A2FS1 Flight Simulator' from Sublogic, Box V, Savoy, IL 61874, USA, disk \$33.50, for Apple II (write-up of this program in July/August issue Computers & Programming; 'Flight Simulation' from Elcomp, cassette \$17.95, for Atari 800 16k, Tandy Colour Computer 16k.

I have not used any of



these programs but a friend tells me that the Sublogic program is particularly good, so perhaps you could pass this information to Mr Neary or even publish it!

Thanks for a great column and a great magazine — I'm a regular reader.  
Rod Stewart, Singapore

## Worried

I have been puzzling since November over a problem which I have tried to program for my Apple. The crunch finally came in December, by which time neither I nor my Apple had come up with a solution.

The problem is how to fit 12 issues of PCW into a binder which is clearly designed for only ten.

My Apple did suggest that I stop buying PCW, but since I have only just taken out a subscription, I rejected this option.

Can you help?  
L E Upton, Bexley, Kent

*Since PCW is continually increasing in size, in a non-linear fashion, the problem is a version of the well known 'knapsack problem' which defies easy computer solution. The partial answer is that we've made the binders bigger — Smart-ass Ed.*

## Taxing application

In the 'heavy' newspapers and other business press there is a steady flow of news, editorial and correspondence about the use of computers in the Inland Revenue. At the moment, a major topic within this brouhaha is the proposal that a local income-tax should replace the rating system as a means of raising revenue for local authorities.

The Chairman of the Board of Inland Revenue (no less) has stated categorically that conversion of the PAYE system to computer is planned to take several years, and that the Inland Revenue should not be asked to handle local income-tax during the transitional period.

I have just completed my 1980/81 tax return (yes, I know it was late, but have good reason and the agreement of the IR!) The questions are not always simply phrased and the explanatory notes do not, but completion of the form itself is relatively simple. Having seen a

moderately bright 11 year old programming the ZX81 and a TRS80 with relatively complex mathematical tasks, I reckon a similar 12 year old should be able to write a Basic program:

1. To calculate the code number from the 'Claim for Allowances' section.
2. Work out the tax under/overpaid from last year's code and actual income.
3. Replace the tax tables used by the employer; essentially these apportion the tax allowances and tax-rate break-points over the weeks/months from the start of the year, and then apply tax at the appropriate rates to the residues.

I would guess that the whole lot would run comfortably on the 'GLS' version of most home micros, so perhaps one of your readers could have a crack at it and save the Inland Revenue six years hard work.

Inevitably, figures have to be checked before entry, but this is not in any case a job for the computer. Even so, a cross-check for inconsistency with previous years' returns could rapidly be programmed.  
M Campbell Jones, Dinas Powys, South Glamorgan

## Price Goof

As we at Terodec (not GDSS), especially Paul Joyce, are pleased that our new business system, PBM-1000 impressed Guy Kewney, we are a little upset that he didn't report the price correctly.

The PBM-1000 does in fact cost approximately £4000 and not £7000 as stated. The heading should have read: 'Faster and Cheaper'.  
Ellie Joyce, Terodec Ltd, Reading

## Help wanted

I am carrying out research into 'applications of micro-computers to small businesses' and I am particularly interested in the problems of first time users.

I would like to get in touch with anybody else researching in this field. I am particularly interested in talking to any small businesses who have used microcomputers, and any consultants involved in the field.

Frank Blewett, Principal

Lecturer in Computing,  
Polytechnic of North  
London, Holloway, London  
N7 8DB

## Fortran overlays again

With reference to recent correspondence on the subject of overlaying Fortran-80 programs I should point out that a simple and effective system was openly advertised in successive issues of PCW. Clearly Mr R D Redman, Mr P L McIlmoyle and Mr Steve Withers are unaware of this system — VERA, which is now in common use in several of the nationalized industries, local authorities and other offices. Mr Withers cites an article in what he calls the 'relatively obscure' Journal of the Operational Research Society. No doubt this article would help Mr Redman, but it may be easier to use existing software which is obtainable at low cost. Details are in the July and August 1981 issues of PCW.

E W Solomon, Engineering Computations, London

## Please don't poke

After reading about the BBC micro, and its excellent graphics specification, I wondered where the 'catch' was; a micro cannot, in my mind, be both excellent in all categories and yet relatively

inexpensive. After examining your articles, and a few from other magazines, I have found a major shortcoming the BBC Micro's Basic interpreter does not have PEEK or POKE in its command set. This surely limits its uses for advanced programming, and since it has 32k of memory only, an alternative RAM-based interpreter is pointless. The only alternative would be a machine code routine (on the line of the PET's toolkit) to provide these functions: this should not have been necessary, as the command should have been supplied. This lack makes such accolades as 'As a programmable machine, it will be by far the easiest thing to write useful code on' sound rather hollow. Nigel Cole, Cuffley, Herts

*The absence of PEEK and POKE most certainly does not hinder 'advanced programming' (whatever that might be!). In fact, the powerful BBC Basic has sufficient facilities to avoid the need for these commands. Far from being a 'major shortcoming', it makes programs just that bit more portable by removing some (but not all) of the machine-dependence — Ed.*



# FRESH OFF THE PRESS FROM SYBEX!

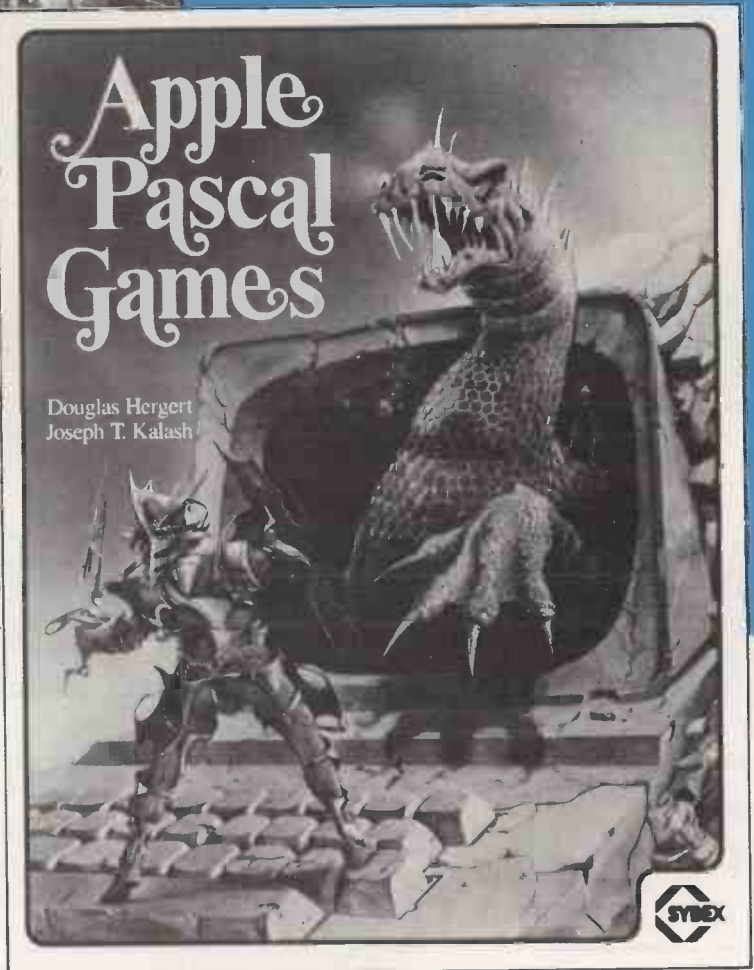
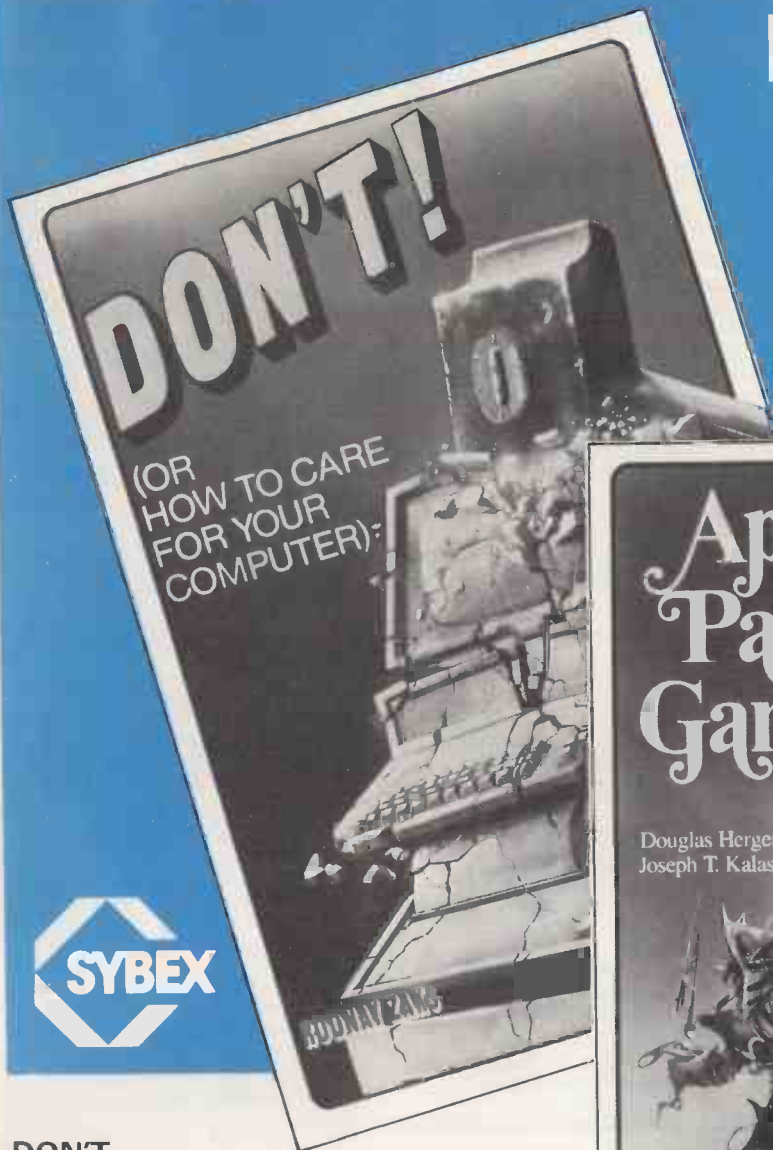

**DON'T**  
(Or how to care for your Computer)  
By Rodney Zaks  
200 Pages 100 Illustrations Only £9.65

**Apple Pascal Games**  
By Douglas Hergert  
& Joseph T. Kalash  
350 Pages 40 Illustrations Only £11.45

**DON'T (Or how to care for your Computer)**  
This is the first book exclusively dedicated to the care, preservation and correct operation of a small computer system: The computer itself, the CRT terminal, the printer, the magnetic disks and tapes — even the Computer room.  
In everyday language, this invaluable book gives all the do's and don't's of successful operation for each piece of computer hardware and software. An indispensable book for users or owners of a computer system.

**Apple Pascal Games**  
A collection of some of the most popular Computer Games, all written in UCSD Pascal. Includes Cribbage, Horserace, Keno, Overunder, Baccarat, Kismet, Black Box, Chuckaluck and many others. Each game includes a complete listing of the programme, a description of the rules, a sample run and an Illuminating Guide to understanding the structure of the programme itself.

Get these invaluable books from your local Bookshop or Micro Store — Now.

In case of difficulty, send S.A.E. and we'll let you have the name of your nearest stockist.

The Computer Bookshop is the exclusive distributor for all Sybex books in the UK.

Dept. PCW

**The Computer  
Bookshop**



30 Lincoln Road, Olton, Birmingham B27 6PA  
Tel: 021-707 7544



# WHEN IT COMES TO MICROCOMPUTER SOFTWARE WE WROTE THE BOOK

How do you stay up-to-the-minute with the rapidly changing world of microcomputer software? Get the Lifeboat Catalogue.

**The latest innovations** The new Lifeboat Catalogue is packed with the latest state-of-the-art software. And if we publish a new program after the latest catalogue has gone to press, we enclose a flash bulletin in your copy.

**The greatest selection** Because Lifeboat is the world's largest publisher of microcomputer software, our catalogue offers you the greatest selection of programs for business, professional and personal use. Our more than 200 programs range from the integrated accounting and professional practice systems to office tools for book-keepers and secretaries to sophisticated tools for programmers. Included are business systems, word processors, programming languages, database management systems, application tools and advanced system utilities.

We specialise in software that runs on most small business computers. Our more than 60 media formats, including floppy disks, data cartridges, magnetic tape and disk cartridges, support well over 100 different types of computer.

**Get full service** We give the crucial dimension of after-sales service and full support to everything we sell.

That includes:

- An update service for software and documentation.
- Telephone, telex and mail-order services in the London office and at overseas offices in the United States, France, Switzerland, West Germany and Japan.
- Subscriptions to Lifelines,<sup>TM</sup> the monthly magazine that offers comparative reviews, tips, techniques, identified bugs and updates that keep you abreast of change.

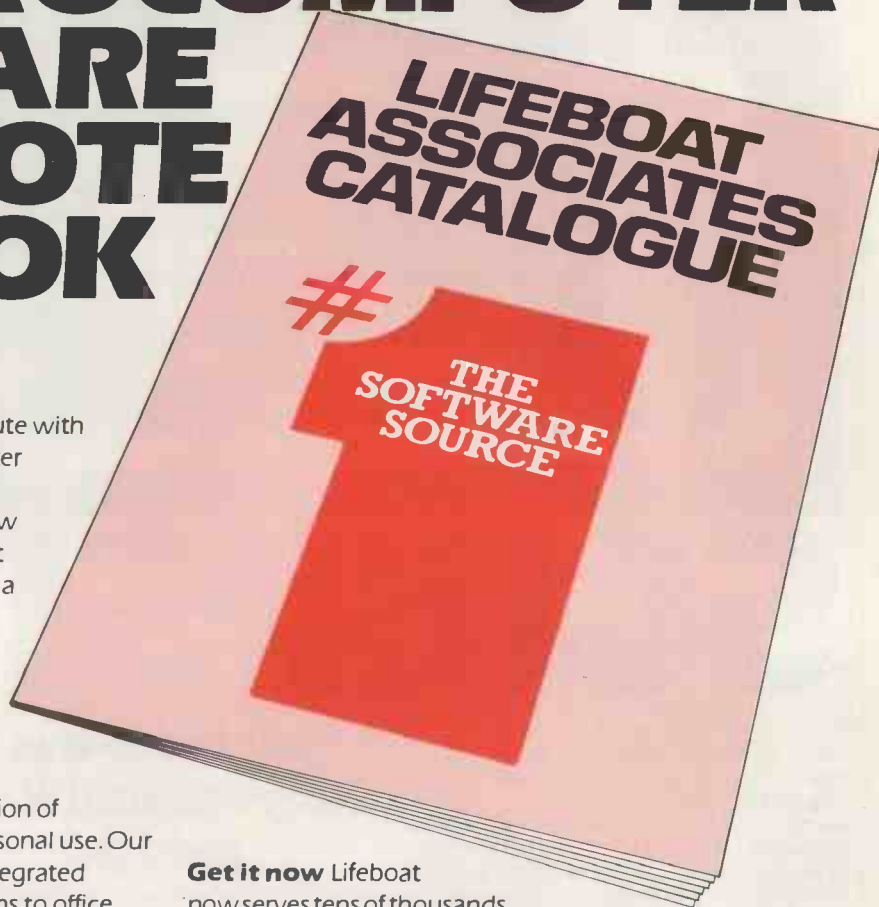

**Get it now** Lifeboat now serves tens of thousands of satisfied customers with our breadth of up-to-date, fully tested, fully supported and competitively priced software.

You may not need all we offer, but we offer just what you need. After all, we wrote the book.

**#1 Lifeboat Associates**  
World's foremost software source

**Mail coupon to: Lifeboat Associates**  
PO Box 125, London WC2H 9LU or call 01-836 9028

Please send me a free lifeboat catalogue.

Name \_\_\_\_\_

Title \_\_\_\_\_

Company \_\_\_\_\_

Address \_\_\_\_\_

Postcode \_\_\_\_\_

Copyright © 1981, by Lifeboat Associates.

**Lifeboat Worldwide** offers you the world's largest library of software. Contact your nearest dealer of Lifeboat.

**USA** Lifeboat Associates 1651 Third Ave. New York NY 10028 Tel (212) 860-0300 Telex 640693 (LBSOFT NYK) TWX 710 581-2524 **JAPAN** Lifeboat Inc. OK Bldg. 5F 1-2-8 Shiba-Daimon Minato-ku Tokyo 105 Japan Tel 03-437-3901 Telex 2423296 (LBJTYO) **ENGLAND** Lifeboat Associates Ltd PO Box 125 London WC2H 9LU England Tel 01-836 9028 Telex 893709 (LBSOFTG) **SWITZERLAND** Lifeboat Associates GmbH Hinterbergstrasse Postfach 251 6330 Cham Switzerland Tel 042-36-8686 Telex B65265 (MICO CH) **WEST GERMANY** Intersoft GmbH Schlossgartenweg 5 D-8045 Ismaning W. Germany Tel 089-966-444 Telex 5213643 (ISOFD) **FRANCE** Lifeboat Associates SARL 10 Grande Rue Charles de Gaulle 92600 Asnières France Tel 1-733-08-04 Telex 250303 (PUBLIC X PARIS)

# BENCHTEST

## WORD PROCESSOR



# SCRIPTSIT 2.0

Word processing is just one of many tasks we expect micros to perform now that they have become virtually universal. But word processing is special: this particular use of micros demands something more than the applications package or program generator. The word processing micro has to imitate the obsolete machine it is ousting — the typewriter — while still being an intelligent terminal or stand-alone computer.

Scriptsit 2.0 is the latest version of the standard word processing package for the Tandy TRS-80 and, as such, combines the benefit of powerful computing resources with the drawback of hardware designed also to be used by the programmer.

This test was done on a TRS-80 Model II which includes one 8in floppy disk drive, in addition to which I used a disk extension unit containing two more drives, although this is not essential to run Scriptsit. Scriptsit comes on its own disk, which also contains a copy of the operating system and space for creating documents.

On loading the Scriptsit disk and inputting the appropriate date and time, the Scriptsit directory is displayed. Pay due respect to the directory as it tells you a lot about the state of your disk and is very much the focal point of the system. It also appears on completing a utility or exiting from a document. The directory shows details of five documents at a time from the disk and you can scroll through to find the rest. The sort of details given include a brief description of content as entered by the user on each header, dates when the document was created and revised and the amount of space it occupies on the disk, with an 'efficiency figure' relating to how many times the document was

## Jane Bird reviews Tandy's standard W/P package.

revised. At the bottom of the screen is a list of your options for what to do next, each activated by a single letter command and pressing 'enter'. You can open one of the documents, copy one, print, delete or create a new document. (New documents are always listed at the beginning of the directory.) You can also jump straight to the directory for the next disk, or end the session.

To open a document you simply align the cursor against the appropriate name and press 'enter'. This brings you straight to the document's header, the 'open document' menu which has eight responses you have to go through.

The open document menu includes information identifying the document and specifying how many lines you want on a page. It displays updated figures on size and usage of the document. The 'create new document' menu also lets you state whether you want a vertical document with margins anywhere between columns 1 and 96, or a horizontal document with margins between columns 1 and 156. You tab through pressing 'enter' if you are changing the responses and 'escape' if you are not.

As soon as you've made it through the menu, a clean screen leaps into vision. At the bottom of the screen is the 'format line' and below that a status line which reminds you what page, row and column you are on. At this point, you can set up your special formats if you like, although at any stage within a document you can jump the cursor

into the format line and alter margins, paragraph indent or tab settings. One very useful feature when inputting text is the ability to go into 'full video' mode, press CTRL and V, and have all the document's internal format commands displayed on the screen. This lets you see precisely where you have pressed 'enter' for a forced end of line, or 'tab', or simply let the soft wrap-around take effect.

The wrap-around prevents division of words and puts the whole word onto the beginning of the next line, but it is not perfect. One problem arises if you reach a full stop at the last position on the line. The following two spaces are wrapped around to the beginning of the next line where they look very odd. Of course, they can be edited out later.

On the subject of wrap-around, however, I did have one inexplicable 'bug' where the system failed and left me with the last letter of the word on the next line. I was building up a column of information on the right-hand half of the page and had margins set at 35 and 70. On typing the word 'advertising' I got 'advertisin' at the end of the first line and 'g' at the beginning of the second. Perhaps the computer was trying to introduce a more vernacular style into my turgid prose, but experiments showed the same thing happened when other words were substituted.

One advantage of using the 'full video' mode when editing is that you can see when the existence of a forced end of line, for example, is preventing text from shuffling back into the shape left from a deletion. But the confusing thing about editing with these format codes in view is that, while ordinary characters can be overtyped on the screen, format commands have to be deleted and then re-entered. Familiarity



probably eliminates this problem, like others on the system.

Inserting and deleting can be done by pressing two keys to the far right of the keyboard marked F1 and F2 respectively, presumably so named on account of their function for the programmer since the abbreviation has no obvious reference for the average typist. If you want to delete volumes of text you can use the CTRL-D command which lets you define areas of text in words, sentences, paragraphs and larger blocks. Line centering is done by first entering the heading with a forced end of line and then pressing CTRL-L (mnemonic L for line-centering reflects the fact that the system only centres single lines). You can edit the text as you go along and have up to 22 lines of text in view, constantly inputting into the bottom line of the page.

## Formatting

There are a number of ways of specifying how you want the text to be printed, the most obvious being to input special print codes within the text as you type. To get an underline, for example, you input the underline code at the beginning and end of the text you wish to be affected and similarly for text to be printed in bold. One obliging code allows you to input notes to yourself which will appear on the screen but which will not be printed. However, a problem with these codes is that they involve two distinct operations, first pressing 'escape' to get out of the straightforward text input mode and then using the shift key in combination with another key to input the command. This can be very laborious if you are writing something which needs lots of words underlined or in bold, and a shortcut I used was the search string utility. This allows you to choose your own shorthand, 'XX' for example, and at the end of the piece change every occurrence of 'XX' to, say, 'campaign for user-friendly micros'. The search string facility gives you the option of stopping as each string is found and checking that you want it to be deleted or replaced.

An apparent inconsistency means that the system ignores a single underlined space at the beginning of a line, which might later have something filled in by hand. The printer will simply not print unless you take the precaution of using the 'required space' command (ESC pressed with space bar). The same goes for the end of a line when the text is being right justified.

A gaping hole in the print facilities, however, is the absence of the vertical line. In fact it's there on the printwheel and a sufficiently dedicated user could work out the routine for using it, but there is absolutely no reference in the manual to the vertical line. This seems to ignore any need to put text in columns or boxes and offers no easy-to-use facility to draw lines round things on the screen.

There are commands for a wide range of diacritic marks, superscripts and subscripts.

The second method of affecting the final printed copy is by use of the format line which, unlike the print codes, allows you to see on the screen the effect of your format commands.

Basically, the format line deals with tabs and margins but there are permutations of each. There is the 'outline' marker which determines the position to which the cursor will return after any forced end of line. The left margin can be to the right of the outline marker if you want the first line of each paragraph indented, and left of the left margin if you want paragraphs to start to the left of the rest of the text.

There are three different types of tab, a fact which seems unnecessary at first, but they do all perform discrete functions. Apart from the ordinary use of tab, you can also have aligning around a decimal point which is useful if you have columns of figures that run beyond the decimal point. By typing tab marker '@' you have the option of either function with the same tab marker.

## Printing

Whenever you try to print a document you will be presented with a print document menu. Apart from specifying precisely which pages you want to print, it also offers you another chance to affect the appearance of the text on the page. Options given include defining the column position for the left side of the

paper, by justifying in character or word increments, and specifying the maximum number of lines on a page. Again, however, there is no way of bypassing this menu if there is nothing you want to change and you have to tab down through it. If the layout still doesn't look right then you can repaginate or define forced ends of pages. The print monitor menu allows you to pause between printing each page, or to stop printing or to move into another document while continuing printing.

## Merging files

One valuable facility of Scripsit for the businessman is the ability to merge information from different files onto one sheet of paper. The classic application for this is the personalised letter with individual names and addresses attached to a standard text.

Merging files is done by creating two documents, one which contains the 'base document' where all variables are identified by names between brackets. You then build up a 'merge file document' which repeats the names of variables that you have used on the base document, followed by lists of what all these may be in individual cases. At the printing stage you can create standard

The TRS-80 Colour Computer represents a major departure from Radio Shack traditions. First, although the 'TRS-80' trademark is still used, the processor is the Motorola 6809 ('Another Leap Forward in 8-bit Processing Power', PCW Vol 1, no.11, page 36). Second, it can be used with plug-in ROM packs. Third, it offers high-resolution (256 by 192) colour graphics.

The cheapest Colour Computer comes with 4k of memory which can be increased to 16k. The only significant option is 'Extended Colour Basic' which provides additional functions, including access to the high resolution graphics, but requires extra RAM.

Before I go into any detail, I should stress that as yet there is no UK version of the Color Computer. A model with a PAL TV interface is under development, but the sample tested was supplied an American receiver. On top of this, various seals had been broken, suggesting cavalier treatment in the past. ■

----- (-----) -----  
 DEMO1 Pg:1 Cursor:18,032 Window:01 LS:1/1 Marg:010,070 Mode:0

```

.. SCRIPSIT DIRECTORY LIST as of Dec 17 1981 ..
-----
NAME          FMT  CREATED  REVISED  AUTH/OPR  PAGES  SIZE  EFF  ACT
-----
SCRIPSIT DEMO1  V    12/17/81 12/17/81  MB/MB     1      0%   99%  M
2
SCRIPSIT Service Contract V 12/12/81 12/17/81  A/A       1      1%   99%  M
3 Overview of service contract costs TRS-80 II
-----
SCRIPSIT QUOTE-BOSDARI  V    12/16/81 12/16/81  J/J       2      1%   99%  M
4 Bosdari quote on Mod III with VISICALC ENH
-----
SCRIPSIT SPELLING      V    12/14/81 12/12/81  J/J       1      0%   99%  M
5 SCRIPSIT SPELLING CHECK
-----
SCRIPSIT REFERRALS     V    12/14/81 12/16/81  J/J       1      1%   99%  M
6 Referral forms for store use
-----

```

DOCUMENT:  Open,  Copy,  Print,  Create,  Delete  
 NEXT:  Screen,  Disk CELL:  -  DISK:  Utilities  Time  End session

# ITT 2020

## 48 K Disk Based Computer System

WITH COLOUR GRAPHICS & T.V. MODULATOR FOR T.V. DISPLAY

■ DISK DRIVE WITH CONTROLLER INTERFACE

■ 48K + 12K FLOATING POINT BASIC

■ APPLEWRITER WORD PROCESSING SOFTWARE PROGRAMME

■ ALL NECESSARY LEADS AND MANUALS PROVIDED

■ 12 MONTH WARRANTY (IN HOUSE SERVICE)



**EXCLUSIVE LIMITED OFFER**  
FROM Lion Micro Computers

**£699** + VAT

SYSTEM SPECIFICATIONS: ITT 2020 Microcomputer: Standard ASCII Keyboard displaying 24 lines x 40 Characters in upper case: optional lower case display available. 6502 CPU, 48K Bytes RAM and 12K fast floating point Palsoft Basic in ROM. Both high resolution (360 x 192) and low resolution colour graphics, ports for up to seven peripherals and paddle ports as standard. Manufactured in Britain under licence from Apple – largely compatible with Apple hardware and software (contact Lion for advice – this is NOT an Apple). ITT Disk Drive. 116K Capacity, random or sequential file access, 35 Track soft sectored disks – Apple DOS 3.2 (contact Lion for advice on other operating systems). Field Maintenance contracts for all equipment are available.

**EXPANDABLE & VERSATILE PRICES EX. VAT.**

Second Disk Drive	£200.00
Lower-case screen (fitted)	£50.00
Visicalc 3.2	£75.00
Silentye printer	£207.00
Centronics 737	£425.00
Olympia RO Scripta	£836.00
12" Green Monitor	£119.00
Printer interface	£90.00
Database	£75.00
Vinyl Carrycase	£17.00
Cleaning Kit	£30.00
10 x Disks in case	£25.30
2000 sheets paper	£15.00
OTHER ACCESSORIES	POA
OTHER PERIPHERALS	POA
CP/M For 2020	£250.00

**OVER £1200 VALUE FOR**

**£699** + VAT



**Lion Micro Computers**

Lion House,  
227 Tottenham Court Road, London W1P 0HX  
Telephone: 01-580 7383 & 01-636 9613  
Telex: 28394 Lion G





# SCRIPTSIT 2.0

text with different 'variable' information in each case. Although this facility is most obviously useful to the small businessman who can generate much more effective mailshots by addressing them to named individuals, there are applications for the hobbyist. One example is the production of letters that you may write regularly: 'Dear Mr Shilling. . . please transfer X pounds from my deposit account to my current account. . .' where X might be any one of a number of predefined sums. You can also create a base document which contains wholly variable information, such as lists of names and addresses.

In this case, all the base document contains is a set of identifiers for each piece of information: name, number of house, road, town county, postcode. Printing commands as to where the address should appear on the envelope can also be stored. When the files are then merged you get individualised envelopes generated.

## Spelling and hyphenation

Dictionaries against which spellings can be checked are becoming a standard feature of word processing packages and are available from companies like IBM and ICL. They also include the facility for the user to include a list of specialist words that are likely to come up frequently in his own writing. This facility is provided on Scripsit which allows the user to add up to 2047 words of his own to the dictionary's 100,000 words. The dictionary facility is somewhat complicated to use since you are emphatically ordered first to make your own copy of the dictionary onto a backup disk. Then, as with the global search and replace facility, you have the option to stop and check over each correction that the dictionary wants to make. The capacity of the dictionary is huge; it can catch up to 1500 misspellings in one go which ought to be enough even for near-illiterates. It also deals with the hyphenation of words.

Given the considerable processing power of Scripsit it is disappointing that there is no simple arithmetic function. It is quite possible to list columns of numbers but there is no option to run the cursor down them and reach a total at the bottom. Given that this function is easily performed by the flimsiest of calculators these days, it seems an unnecessary omission from the all-singing, all-dancing word processor. Tools to perform simple mathematical functions have already proved to have great popular appeal. Scripsit already handles numbers dextrously with its facility for aligning columns of figures around the decimal point.

## Documentation

Since the version of Scripsit that I tested was still very new, there was no completed documentation available. However, my major criticism of the prototype training manual is that the order of introducing the new procedures manual is extraordinary. The method is to direct the reader to perform certain exercises which draw on lessons of the

ensuing chapter. It is easy enough to find out how to do the exercises by reading ahead but this tends to undermine one's faith in following the manual step-by-step. The reference manual deals with all the same procedures in a much more compact form but its index could prove unhelpful to the non-programmer. You have to be competent in computer jargon to know which words to look up for a solution to your problem. Words like merge, define, format and scroll.

The 'help' facility could be useful here although it is not particularly readable on the screen, amounting to a single line entry for all commands that can be entered under Scripsit, and appears as screens full of text. 'Help' could save you bothering with the manual over a simple command you have forgotten, but is not useful in explaining peculiar error messages on the screen or the apparent impossibility of entering a character where you want to put it.

## Good and bad points

The most obvious irritation with Scripsit is the flashing cursor. Although word processing shouldn't require the user to look at the screen much, apart from when editing, the flashing cursor is most unpleasant. However, the method of highlighting text to be deleted or moved elsewhere is very effective and puts all the text concerned very clearly into reverse display.

I also found it laborious that the keys didn't automatically repeat when held down, although this facility can be awkward if you're not used to it. Cursor movement up and down the screen requires holding down the 'repeat' key at the same time as the 'arrow' key or the use of 'hold' to move directly to the top, bottom or either side of the screen. An automatic repeat on arrows would be particularly useful.

There are also no arrows to move the cursor diagonally across the screen. Also, the end of the page isn't marked on the screen, so unless you keep a sharp eye out, your sentences and paragraphs will be split in odd places from one page to the next.

Another straightforward facility which would be useful is to be able to alter upper case to lower case with a single key and vice versa. This would avoid the need to re-type headlines which you subsequently decided should be in upper case, for example. The 'convert-case' key could also be an automatic repeat if held down.

Where pieces of text that you want to alter do not fit neatly into words, sentences, or paragraphs it would also be nice to have a facility to let you run the cursor through the particular phrase or one-and-a-half paragraphs you want deleted.

There are some characters which cannot be printed without special user intervention. The keyboard contains no '£' sign and, by default, the printer makes the numeral '1' and lower case 'l' the same character, a characteristic of old-fashioned typewriters.

## Attractive features of the system

You can make an individual document as big as you like up to the capacity of

the disk. The 8in high-density disks have a capacity of over half a megabyte (509,184 bytes, to be exact). Tandy claims that it would take a 70-words-per-minute typist 24 hours of typing at speed to fill an 8in disk.

Another plus is that you can work on one document and simultaneously print another without getting any significant degradation on the system. Of course there are some special functions, such as formatting a disk or merging or copying documents, which you cannot do in this mode.

The need to back up documents created every day is made easier by means of the 'back-up' utility which copies disks wholesale at the end of the day at ten minutes a time.

## Summary

Scripsit is a word processing package on the sort of micro that you would expect to find in a small business or educational environment. In both situations the user might be expected to be familiar with the rudiments of computing and, given that background, I would expect him to find Scripsit an exciting tool. For example, the dual function of the keyboard means it is often necessary to hold down two keys simultaneously to perform functions. Scripsit is very versatile but could be off-putting to the non-programmer.

Of the PCW 'standard users', I would expect the author/journalist to find this system a little over-complex. He/she wants a system that is relatively cheap and easy to use. He has no great need of sophisticated formatting facilities. However, he would benefit from the speed with which you can move around in the text and from the repaginate and page numbering facilities. And he/she might find the dictionary very useful for proof checking.

The technical/managerial report writer might bemoan the lack of simple maths functions but would appreciate the extensive facilities for formatting, printing and making global alterations. Such users could also employ the user-defined area of the dictionary for specialist words relating to their own subjects. However, they might regret the lack of a vertical line or graphics capability.

The manager might find that there is insufficient time to learn the wide range of functions that the system could perform.

The secretary, once familiar with the machine, should be able to make extensive use of it and find the dictionary useful.

### Benchmark timings

1	(na)
2	(na)
3	1.0
4	1.0
5	32.0
6	27.0

Printer (Tandy daisywheel): 37.4 cps  
All times in seconds.

For an explanation of the Benchmarks timings see PCW vol 4 no 4 April 1981.

# FRAMES OF REFERENCE



## Part 2: Understanding the microcomputer industry

The objective of this section is to provide pegs on which you can hang and relate information about microcomputing. The microchip has stimulated a bewildering array of new suppliers. When you visit an exhibition or pick up a magazine, it is not easy to determine where the various suppliers fit into the jigsaw that will eventually provide a solution to your problem. Even when you do begin to separate the systems from the chips, the golden rule of selection applies: choose the company you keep, choose a professional supplier.

The micro industry is a component industry. No one company dominates micros as does IBM in the field of mainframe computers. Even the arrival of the world's number one computer supplier to the micro scene will not destroy those already established, any more than IBM's entry into minis killed off DEC or Data General. New companies have emerged to exploit the technology and some older ones have incorporated micro elements in their products and systems. Without this dispersal of the costs of product development and distribution, micro technology in itself would not have produced such exponential growth in supply.

The complex array of component companies is as much a minefield to the unwary as it is a goldmine to the educated. The following are the main participants in a complex industry: semiconductor manufacturers; board manufacturers and assemblers; computer manufacturers; peripheral manufacturers; systems software manufacturers; application software manu-

facturers; software publishers; importers/distributors; dealers/shops; micro systems companies; and maintenance companies. There are two categories of component supplier, 'new' and 'old', specialist and generalist. For example, Dynabyte is a new specialist microcomputer manufacturer, whereas DEC is an old mini manufacturer that has its own LSI chip and microcomputer.

### Semiconductor manufacturers

The new specialist group noted for filling the huge demand for chips includes Intel, Zilog, National Semiconductor and Motorola. Existing computer manufacturers with their own chips include IBM, Data General, Texas Instruments and Hewlett Packard. In many cases the demand for chips has been beyond the capacity of the original manufacturers and the business of 'second-sourcing' has developed where one semiconductor manufacturer licences another to make its products.

Because of the investment needed to generate large-scale chip production and the need to guarantee supply in quantity, the business of second-sourcing is very important. OEM purchasers tend to shy away from new chip sets until second-sourcing has been arranged so that they can be sure of regular, competitively priced supplies. The big names in second-sourcing are, not surprisingly, the Japanese: Fujitsu, NEC, Mitsubishi (Intel 8086), Hitachi (68000); the Americans: Fairchild (NS16000), Harris (8086), Mostek (68000), Rockwell (68000), AMD (8086); and the Euro-

peans: Siemens (8086), Signetics (68000), Thomson CSF (68000), SGS-ATES (Z8000). Intel gained ground in the 16-bit market by early entry and by licensing such a strong line of second-source manufacturers. Motorola's more complex product took longer to bring to market and to set up second-sourcing. Zilog looks poorly supported compared to the other two.

The semiconductor manufacturers are the 'mining' companies of the industry, its suppliers of raw materials. Some specialise almost exclusively in raw material supply while a few have developed general purpose computers, eg, Zilog, Texas Instruments and, very recently, Intel.

### Board manufacturers/assemblers

Many of the chip and computer manufacturers contract out the assembly of boards. There are assembly shops all over the world. Additionally, a variety of specialist board makers have become established, whose boards re-appear under the labels of other manufacturers. Some of the recurring names in specialist boards include Ithaca, Morrow, Thinker Toys, Mountain Computer and Tarbell. Some board makers graduate to producing their own microcomputers, such as Morrow.

The practice of buying in boards or putting out to assembly has a strong influence on the size of many major microcomputer manufacturers, in relation to the number of machines sold. For example, Dynabyte employed 60 personnel at the beginning of 1981 and had an installed base of 3000 computers. New companies that have sprung up in Silicon Valley (just south of San Francisco) owe much of their growth to the ready availability and high quality of local 'board stuffers' — companies that put chips on boards. In two years, Convergent Technologies' production of MiniMicros has grown from zero to 80, through the use of such companies. Apple's quite phenomenal growth had a similar basis, though Apple itself has been known to set up a whole assembly factory in a month. The slowly emerging British industry is not so well served (except, perhaps, in Scotland) and suffers in consequence.

# A DP MANAGER'S GUIDE TO MICROS

by Alan Wood



# Computer manufacturers

Some mini manufacturers have produced cut-down micro versions of their products, but the lion's share of the market is taken up by specialist micro manufacturers. Lead time to supply is an important factor as microcomputers seldom want to wait more than ten-30 days, whereas mini suppliers are usually on three to six months' lead times.

There are four main levels of micro-computer:

Level 1. Home and educational devices, using cassette tape, price range £50-500, examples Acorn, Atari, Sharp, Sinclair; Level 2. Personal computers, supporting floppy disks, low volume data processing, maths and stats applications, price range £500-2500, examples: Apple, PET, Osborne, Tandy;

Level 3. Tiny business systems, one-to-four users, 500k-20M on-line store, price range £2500-15,000, examples: Altos, Dynabyte, Cromemco, Sirius, IMS; Level 4. Minicomputer replacement: multi-user machines, local area networks, 10-100M on-line store, price range £8000-30,000, examples: Alpha Micro, Micromation, Nestar, Zilog.

A mistake the novice makes is comparing Ford Escorts with Granadas, or not comparing Apples with apples. Some manufacturers span several levels: PET and Tandy span levels 1 and 2, Micromation and Zilog levels 3 and 4.

The mini manufacturers beginning to influence the market are Data General, DEC, Hewlett Packard and Texas Instruments. Affected by minicomputer pricing, their prices tend to be less competitive and their software base not so extensive as the specialist micro manufacturers. Hewlett Packard and Texas Instruments have both produced personal computers which are especially well suited to engineers and draw on much of the software library developed on programmable calculators.

Hewlett Packard has recently adopted Visicalc, a successful package originally developed for Apple. The trend of software manufacturers converting their products to other machines is developing to the benefit of computer manufacturers and users. DEC has one of the widest ranges of micros of all the mini vendors, starting with a single-user 8in floppy and rising to a multi-user hard disk machine. In October 1981, DEC joined the flood to CP/M, bringing out the VT1 8X, a printed circuit module that plugs directly into the VT100 VDU, converting it into a complete Z80 computer with two minifloppy drives.

The entry of IBM into the market has added several dimensions to micro-computing. Firstly, IBM involvement makes micros respectable, so that many users holding back will no longer do so, although that does not mean they will automatically buy IBM. Secondly, IBM customer base and sales strength is bound to ensure that micros become as commonplace as typewriters. Thirdly, the market for software has doubled overnight as users look for programs to play on their IBM hi-fi. And unlike Hewlett Packard and Texas Instruments, IBM has no base of programmable calculator software from which to stimulate programs, so it is encouraging independent authors, including its own staff, to produce programs. It has a long way

# Component members of the micro industry

The micro industry is a component industry. The principal members are the following:

- 1 Semiconductor Manufacturers
- 2 Board Manufacturers and Assemblers
- 3 Computer Manufacturers
- 4 Peripheral Manufacturers
- 5 Systems Software Manufacturers
- 6 Application Software Manufacturers
- 7 Software Publishers
- 8 Importers/Distributors
- 9 Computer Retailers
- 10 Microsystem Companies
- 11 Maintenance Companies

to go to catch up with Apple, PET and the CP/M vendors.

## Peripheral manufacturers

The old and the new grouping also applies here and some of the new manufacturers have produced good, low cost input and output devices. Traditional, established suppliers familiar to minicomputer users include CDC disks, Lear Siegler, Newbury, Hazeltine VDUs, Centronics, Texas, Diablo, DEC printers. New names include Trendcom, Epson and Anadex low-cost printers, Volker Craig and Televideo displays. Be wary of the very latest devices on the market which may not be backed up with maintenance or spare parts. In comparing peripherals, one should draw a clear distinction between heavy duty, all day use devices, and occasional use, lightweight ones.

The new peripheral manufacturers have caused a price collapse on the market and prices will continue to fall as volume demand for products, increase, notably for display screens, disks and daisywheel printers. As much as 50 percent was chopped off in 1980 as new micro-controlled devices penetrated. The Japanese effect is being felt in the peripheral market, especially with printers and disks, and it is significant that a number of US computers already contain Japanese disks and chips.

Winchester disks are presently the most important low-cost storage medium for microcomputers. The first in the market were the 8in variety with typically between ten and 20 megabyte capacities. These were followed by the 5in mini-winnie, five megabyte disks that take up the space of a 5¼in floppy disk drive but provide five to ten times the capacity. The Japanese and Americans are the big producers of winchester disks — Fujitsu and Seagate have a name for good quality products. Rodime is a new UK name in winchester disk supply.

## Some popular micros

There are several grades of micro, with popular suppliers in each grade.

Grade 1: Home and Educational Devices  
Acorn, Commodore, Sinclair, Tandy

Grade 2: Personal Computers  
Apple, Commodore, Intertec, Tandy

Grade 3: Business Systems  
Altos, Cromemco, Dynabyte, NIMS, North Star, Vector Graphic, Sirius

Grade 4: Minicomputer Replacement (16 bit and local area networks)  
Alpha-Micro, Nestar, Zilog

## Systems software manufacturers

Three companies have become dominant suppliers of systems software for microcomputers. Each supplier's product is sold worldwide and recognised in the major markets of the USA, UK, Japan and Europe. Each has produced what has become an industry standard or classic. Each has its product regularly endorsed by computer manufacturers around the world. The three companies are: Digital Research with CP/M, Microsoft with MBasic and Micro Focus with CIS Cobol.

Systems software manufacturers are one of the most important elements in the micro component industry. And the most significant of these is a Californian firm, Digital Research, the author of the *de facto* micro industry software standard for operating systems, CP/M.

CP/M, available for virtually all Z80/8080 micros, is at the heart of much excellent systems and application software. More recently, Digital has produced MP/M, a multi-user system which is being rapidly adopted. CP/M runs on both 8-bit and 16-bit micros. Like VHS in the video world, it may not be technically the best operating system but the access it provides to a growing range of programs ensures its ever-increasing popularity. Other operating systems suppliers have to supply hooks under which CP/M programs can be run. And faced with the alternatives, the buyers usually prefer CP/M.

MP/M has even more technical detractors than CP/M, although some criticisms have been answered by MP/M version II. However, a large recent investment in Digital Research should help it retain its leading position through the production of the more sophisticated versions compatible with 16-bit and even 32-bit machines.

Digital has also acquired the second most popular Basic, CBasic and developed PL/1 for micros. The IBM Displaywriter now has CP/M, as has the Wang-



# THE SHARP MZ-80K HAS GOT IT ALL



STOP PRESS... NOW AVAILABLE  
BASIC COMPILER  
PASCAL (CASSETTE BASED)  
DOUBLE PRECISION DISC BASIC

Since its introduction the Sharp MZ-80K has proved to be one of the most successful and versatile microcomputer systems around. Sharp now have a comprehensive range of products ready to make the powerful MZ-80K with its Printer and Disc Drives even more adaptable.

Products include: - Universal Interface Card, Machine Language and Z-80 Assembler packages, CP/M\* plus a comprehensive range of software.

\* Trade mark of Digital Research Ltd.

You'll find all the help and advice you need about the MZ-80K at your Specialist Sharp Dealer in the list below.

If there is no dealer in your area, or if you require any further information write to: - Computer Division, Sharp Electronics (UK) Ltd., Sharp House, Thorp Road, Newton Heath, Manchester M10 9BE.

## SHARP

*First, and foremost*

## GET IT ALL HERE ...

**AVON**  
BCC Computer Systems Ltd.,  
Bristol. Tel: 0272 425338  
Decimal Business M/Cs Ltd.,  
Bristol. Tel: 0272 294591  
**BERKSHIRE**  
Computer 100,  
Bray. Tel: 0628 35619  
Newbar Computing Store Ltd.,  
Newbury. Tel: 0635 30505  
**BIRMINGHAM**  
Camden Electronics,  
Small Heath. Tel: 021 773 8240  
Electronic Business Systems Ltd.,  
Birmingham. Tel: 021 384 2513  
Jax Rest Ltd.,  
Birmingham. Tel: 021 328 4555  
Newbar Computing Store Ltd.,  
Birmingham B26.  
Tel: 021 707 7170  
**BUCKINGHAMSHIRE**  
Cury's Microsystems,  
High Wycombe. Tel: 0494 40262  
Interface Components Ltd.,  
Amersham. Tel: 02403 22307  
**CAMBRIDGE**  
The Avery Computing Co Ltd.,  
Bar Hill. Tel: 0954 80991  
**CHESHIRE**  
Bellard Electronics Ltd.,  
Chester. Tel: 0244 380123  
Charlesworth of Crewe Ltd.,  
Crewe. Tel: 0270 56342  
Chandos Products,  
New Mills. Tel: New Mills 44344  
CR Technical Services,  
Chester. Tel: 0244 317549  
Fletcher Worthington Ltd.,  
Hale. Tel: 061 928 8928  
Newbar Computing Store Ltd.,  
Stockport. Tel: 061 491 2290

Ors Group Ltd.,  
Warrington. Tel: 0925 67411  
Sunlock Software,  
Warrington. Tel: 0925 574593  
**CLEVELAND**  
Hunting Computer Services Ltd.,  
Stockton-on-Tees. Tel: 0642 769709  
Intex Datalog Ltd.,  
Stockton-on-Tees. Tel: 0642 781193  
**DEVON**  
Plymouth Computers,  
Plymouth. Tel: 0752 23042  
**DURHAM**  
Neecons (DP) Ltd.,  
Darlington. Tel: 0325 69540  
**ESSEX**  
Prorole Ltd.,  
Westcliff-on-Sea. Tel: 0702 335298  
Wilding Office Equipment,  
Ilford. Tel: 01 514 1525  
**GLOUCESTERSHIRE**  
Gloucestershire Shop  
Equipment Ltd.,  
Gloucester. Tel: 0452 36012  
The Computer Shack,  
Cheltenham. Tel: 0242 584343  
**HAMPSHIRE**  
Advanced Business Concepts,  
New Milton. Tel: 0425 618181  
Xitan Systems Ltd.,  
Southampton. Tel: 0703 38740  
**HEREFORD**  
BMP,  
Little Dewchurch. Tel: 021 643 3832

**HUMBERSIDE**  
Commercial Systems Ltd.,  
Hull. Tel: 0482 20500  
Silicon Chip Centre,  
Grimsby. Tel: 0472 45353  
**KENT**  
Technolink Europa Ltd.,  
Tunbridge Wells. Tel: 0892 32116  
Video Services (Bromley) Ltd.,  
Bromley. Tel: 01 460 8833  
**LANCASHIRE**  
Nelson Computer Services,  
Rawtenstall. Tel: 0706 229125  
Sumita Electronics Ltd.,  
Preston. Tel: 0772 51696  
The Micro Chip Shop,  
Blackpool. Tel: 0253 403122  
**LEICESTERSHIRE**  
Gilbert Computers,  
Lubenham. Tel: 0858 65894  
G.W. Cowling Ltd.,  
Leicester. Tel: 0533 553232  
Leicester Computing Centre,  
Leicester. Tel: 0533 556268  
Mays Hi-Fi,  
Leicester. Tel: 0533 22212  
**LINCOLNSHIRE**  
Howes Elect & Autom. Servs.,  
Lincoln. Tel: 0522 32379  
Z.R. Business Consultants,  
Lincoln. Tel: 0522 31621  
**LONDON**  
Bridgewater Accounting,  
Whetstone. Tel: 01 446 0320  
Butel-Comco Ltd.,  
Hendon. Tel: 01 202 0262  
Central Calculators Ltd.,  
London EC2. Tel: 01 729 5588  
Deans,  
London W8. Tel: 01 937 7896

Digital Design and Development,  
London W1. Tel: 01 387 7388  
Euro-Calc Ltd.,  
London EC2. Tel: 01 729 4555  
Lion Computing Shops Ltd.,  
London W1. Tel: 01 637 1601  
Scope Ltd.,  
London EC2. Tel: 01 729 3035  
Sumlock Bondain Ltd.,  
London EC1. Tel: 01 253 2447  
**MANCHESTER**  
The Byte Shop,  
Manchester M1. Tel: 061 236 4737  
Sumlock Electronic Services Ltd.,  
Manchester M3. Tel: 061 834 4233  
**MERSEYSIDE**  
Microdigital Ltd.,  
Liverpool. Tel: 051 227 2535  
**NORFOLK**  
Sumlock Bondain (East Anglia)  
Norwich. Tel: 0603 26259  
**NORTHAMPTONSHIRE**  
Computer Supermarket,  
Corby. Tel: 05366 62571  
**NORTHERN IRELAND**  
Bromac (UK),  
Co. Antrim. Tel: 023831 3394  
**O & M Systems**,  
Belfast. Tel: 0232 49440  
**NOTTINGHAMSHIRE**  
Mansfield Business M/C Ltd.,  
Mansfield. Tel: 0623 26610  
**OXFORDSHIRE**  
Oxford Computer Centre,  
Oxford. Tel: 0865 45172  
**REPUBLIC OF IRELAND**  
O'Connor Computers Ltd.,  
Galway. Tel: 0009 61173  
Sharpnext,  
Dublin 2. Tel: 0001 764511  
Tomorrows World Ltd.,  
Dublin 2. Tel: 0001 776861

**SALOP**  
Computer Corner,  
Shrewsbury. Tel: 0743 59788  
**SCOTLAND**  
A & G Knight,  
Aberdeen. Tel: 0224 630526  
Business and Electronics M/Cs,  
Edinburgh. Tel: 031 226 5454  
Esco Computing Ltd.,  
Glasgow. Tel: 041 2041811  
Micro Centre,  
Edinburgh. Tel: 031 596 7354  
Micro Change,  
Glasgow. Tel: 041 554 1462  
Microforth,  
Dunfermline. Tel: 0383 34954  
Moray Instruments Ltd.,  
Elgin. Tel: 0343 3747  
Pointer Business Equipment Ltd.,  
Glasgow. Tel: 041 332 3621  
**SOMERSET**  
Norsset Office Supplies Ltd.,  
Cheddar. Tel: 0934 742184  
**STAFFORDSHIRE**  
W.B. Computer Services,  
Cannock. Tel: 0543 75555  
**SUFFOLK**  
C.J.R. Microtek Co. Ltd.,  
Ipswich. Tel: 0473 50152  
**SURREY**  
3D Computers,  
Surrey. Tel: 01 337 4317  
Microlines Ltd.,  
Kingston. Tel: 01 546 9944  
Petalec,  
Woking. Tel: 04862 69032  
R.M.B. Ltd.,  
Croydon. Tel: 01 684 1134  
Saradan Electronic Services,  
Wallington. Tel: 01 669 9483

**SUSSEX**  
Crown Business Centre,  
Eastbourne. Tel: 0323 639983  
Gamer,  
Brighton. Tel: 0273 698424  
M & H Office Equipment  
Brighton. Tel: 0273 697231  
**WALES**  
Limrose Electronics Ltd.,  
Wrexham. Tel: 097 883 5555  
Morrison Computer Centre,  
Swansea. Tel: 0792 795817  
Sigma Systems Ltd.,  
Cardiff. Tel: 0222 21515  
**WARWICKSHIRE**  
Business & Leisure  
Microcomputers,  
Kenilworth. Tel: 0926 512127  
**WILTSHIRE**  
Everyman Computers,  
Weyburn. Tel: 0373 823764  
**YORKSHIRE**  
Bits & P.C.'s  
Wetherby. Tel: 0937 63744  
Datron Micro-Centre Ltd.,  
Sheffield. Tel: 0742 585490  
Huddersfield Computer Centre,  
Huddersfield. Tel: 0484 20774  
Omega,  
Leeds. Tel: 0532 704499  
Ram Computer Services Ltd.,  
Bradford. Tel: 0274 391166  
Superior Systems Ltd.,  
Sheffield. Tel: 0742 755005

Also at selected Lasky's and Wildings Office Equipment Branches.



# An important announcement to all Superbrain users.

FIVE, TEN, TWENTY, TWENTY SIX Megabyte Hard Disc Drives are now available from CLENLO COMPUTING SYSTEMS.

The new CLENLO interface unit enables the Morrow Design Disc Drives to be linked to a Superbrain, giving a total of up to 100 megabytes of on-line storage.

Backed by Morrow's proven technology (1500 Drives installed worldwide), the new unit is the most cost effective way

of expanding the data storage capacity of your Superbrain or any S100 Microcomputer system.

For more details of this development, and our complete range of Microcomputer systems and business services, fill in the coupon or telephone John Nixon.

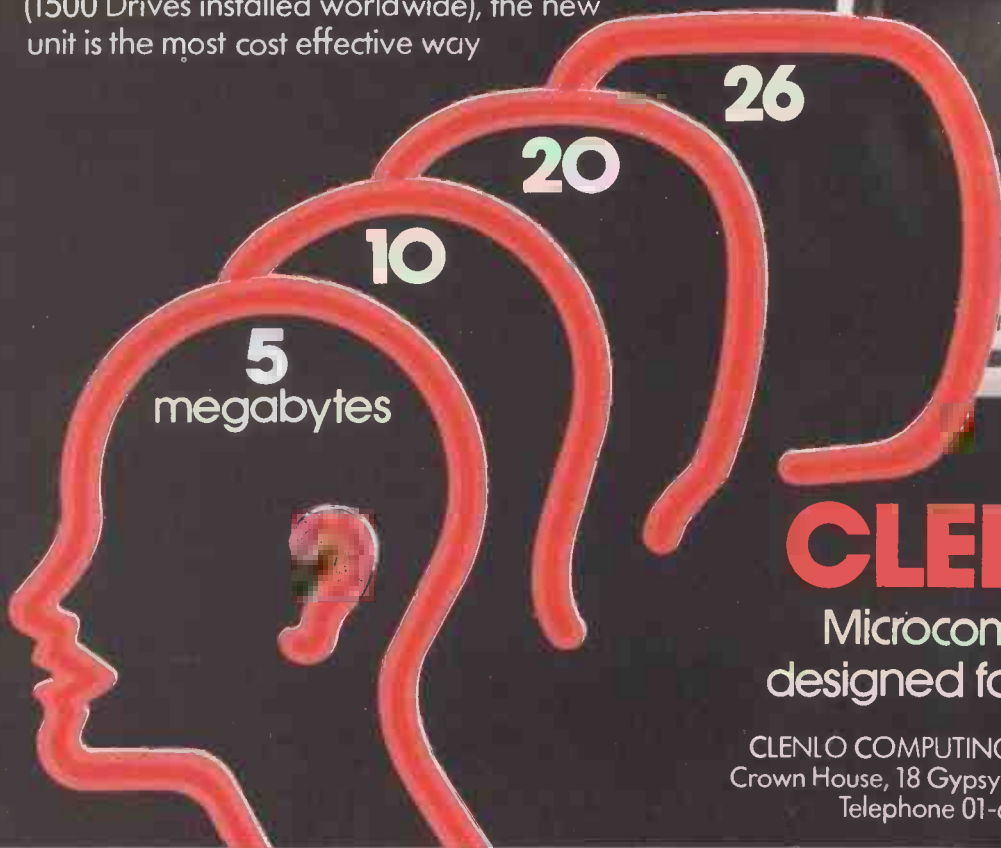

## CLENLO

Microcomputers  
designed for business

CLENLO COMPUTING SYSTEMS LIMITED,  
Crown House, 18 Gypsy Hill, London SE19 1NL.  
Telephone 01-670 4202/3.

To: CLENLO COMPUTING SYSTEMS LIMITED,  
Crown House, 18 Gypsy Hill, London SE19 1NL.  
Telephone 01-670 4202/3.

- Please send me details of your new hard disc interface unit.
- Please send me details of the complete CLENLO range.

Name \_\_\_\_\_

Position \_\_\_\_\_

Company \_\_\_\_\_

Address \_\_\_\_\_

Tel. \_\_\_\_\_

# COMPUTERS IN SCOTLAND

## CASIO FX 702

The World's Most Advanced Handheld Computer

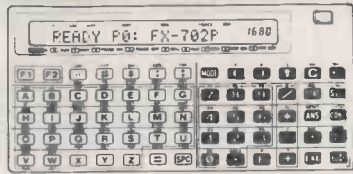

- \* More memory—up to 1,680 steps or 226 memories
- \* Program selection—programs may be written on labels PO-P9
- \* More powerful programming with 8 level nesting, string control (LEN & MID), 2 dimensional arrays. Tests include  $\neq$  and easy debugging in trace mode.
- \* More hardwired functions, including factorial, deviation regressions, hyperbolics and co-ordinate conversions, maximises programming space.

The FX 702 at a B.E.M. Price of only £103.48.

Peripherals FP2 Printer £43.43.

FA2 Tape Interface Unit £17.35.

## SHARP PC 1211

**NEW  
LOW  
PRICE**

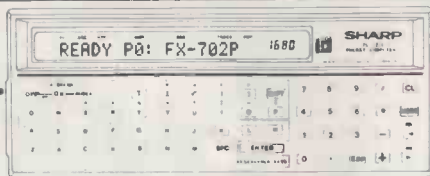

SHARP PC 1211 B.E.M. Low Price £69.52.

Peripherals CE 122 Printer and Tape Interface £56.48.

CE 121 Tape Interface £11.26

## SHARP MZ 80K RAM

NOW ONLY £346 + DISCOUNT  
VOUCHER WORTH £20



## VIC-20

Vic 20 CPU £165.00

Vic C2N Tape Drive £39.00

Texas 99/4A Computer £256.00

Cassette Cable £8.65

Thermal Printer £207

RS 232 Adaptor

£138.00 + Software.



Add 15% VAT. All Machines Guaranteed 12 months.

Tel. 031-226 5454 for prices, delivery and credit card mail order.  
or send remittance including 15% VAT. Carriage FREE over  
£100. Add £2.00 to orders under £100.



CARD HOLDERS 'PHONE YOUR ORDER  
-24 HOUR SERVICE.

**BEM BUSINESS & ELECTRONIC  
MACHINES**

7 Castle St, Edinburgh EH2 3BB Tel 031-226 5454

Credit Terms Available On Larger Items.

# Applesoftware from Leicester Computer Centre

## SUPER TRACE by I Trackman

Super Trace is a high-speed 6502 machine-code utility routine for use in debugging Applesoft programs. As each of your program statements is executed, it is displayed at the bottom of the screen, together with the values of any variable types or functions that you may have pre-selected.

- \* Programs can be written, loaded and edited without affecting Super Trace.
- \* Does not interfere with DOS
- \* Can be invoked and disconnected as often as required during program run-time.
- \* Simple to use. Run-time control by single keystrokes.
- \* Optional display of all statements or only statements containing selected variable types or functions.
- \* Variables highlighted in inverse display and their values displayed.
- \* Normal screen display not affected.
- \* 6 run-time speed settings plus instantaneous stop and single-step facilities, all available by keyboard control whilst program is running.
- \* Optional review of previous 10 program statements without destruction of screen display.
- \* Fully documented.

SYSTEM REQUIREMENTS: Apple, Apple Plus or ITT 2020. Applesoft/Palsoft in Rom 48K of memory. One disk drive. DOS 3.3.

£23.95 + VAT

## SYMDIS

Symdis is a symbolic disassembler for use by both competent 6502 assembly-language programmers and those less experienced.

Symdis will take a block of machine code from anywhere in ROM or RAM (except zero-page) and produce from it a disassembled source code with all relative branches and internal absolute address references converted to alphanumeric labels. Every affected operand will be replaced by an address-related symbol and all target addresses will be labelled with their correct symbols.

The experienced programmer will be able to have access to machine code programs in a useable form, whilst the newcomer to assembly language can take a working program and teach himself how it operates by studying a properly labelled source file.

SYSTEM REQUIREMENTS - 48k of memory. One disk drive, DOS 3.3. £23.95 + VAT

## Visicalc Utilities

Visicalc Utilities Apple computer program includes Visiprint - Re-format the printout of your worksheets with variable column widths, additional text headings, dates, page control and numbering. If you have a clock card the date & time are automatically included in your printout. Visiprint format files can be saved to disc for future use.

Visiform - Enabling you to list out on your printer or VDU all the worksheet formulae.

Also allows you to display or print those formulae too wide for the Visicalc display area.

Find routine allows you to trace calculation reference in worksheet. £34.95 + V.A.T.

**tridee** ©Robin L. Frost

An exciting new addition to your Pascal library - enables you to create 3D graphics, viewable from any angle and distance. As easy to use as Turtlegraphics.

Procedures include Ortho, Perspec, Rotate, View, Move to-3, View-from. Complete with comprehensive instructions. £49.95 + VAT

Apple /// Software

# 3-D BUSINESS GRAPHICS

Produces 'presentation graphics' from your files including Visicalc - Gives more impact to your presentation - Send for further details. (Apple II program available soon)

# LEICESTER computer centre limited

Dept. P1, 67 Regent Road, Leicester LE1 6YF.

Tel: 0533 556268



# FRAMES OF REFERENCE

writer and the Hewlett Packard 125. The Japanese have adopted CP/M in the shape of NEC, Sharp and others. Digital estimated copies sold by 1980 was 200,000, a figure likely to grow tenfold by the end of 1982.

In just under seven years, Microsoft has become the primary source of languages on micros. It was the originator of Basic on micros and supplied the Basic for the very first micro, the MITS Altair. MBasic, available both as an interpreter and compiler, is now in its fifth edition and version six may be issued as this is written. Arguably the main flaw in MBasic is the absence of an ISAM facility, which is to be corrected in version six (there are those who increasingly argue for keeping file management separate from the language, so some regard the absence of ISAM as a plus). MBasic is widely employed throughout the microcomputing world.

Microsoft is not a one-language company; it also has a powerful hold on the Fortran market with Fortran 80, as well as an interest in the Cobol market with Cobol 80 and the Pascal market with MS Pascal. More recently, it has made a thumping entry into the independent operating systems market by supplying MSDOS to IBM and by developing Xenix, its micro version of Unix.

Recently described in the trade press as the 'superstar' of Britain's micro industry, Micro Focus can fairly claim to dominate, if not quite own, the international market for Cobol on micros. Its product has great appeal to Cobol programming shops worldwide and is so structured that it is remarkably adaptable for new machines and operating systems. Micro Focus has penetrated the US, European and Japanese markets in strength. Its product is available on the industry-standard operating systems, CP/M, MP/M, Unix and a growing horde of manufacturers' operating systems. In the USA, Intel, Apple, Vector Graphics, QI and Convergent Technologies all have CIS Cobol. In Europe, Siemens, Tandberg, ICL and R2E have taken to CIS.

## Applications software manufacturers

There are now almost as many different accounting packages as there are microcomputers. Each week, a new ledger or

payroll package is announced, some very good, many strong in documentation, freedom from bugs and support. Additionally, packages for lines of business and specialist applications, eg, personnel systems, financial modelling and hotel management, are gradually appearing. Existing names include MicroProducts Software, Peachtree, MicroPro. New names will be added to the list and some will be subtracted, having failed to meet the standards of marketing, product quality and support which earn the survivors reputation and profit. MicroPro is an outstanding supplier of generic application software and development aids. Its word processing package, Wordstar, is the industry leader, as is its data management package, Datastar. The MicroPro utility program, Supersort, really does live up to its name. To these it has added Mail Merge mailing with Wordstar; CalcStar, a rows and columns electronic spreadsheet; and soon, Infostar, an information manager. These products are some of the very best in the micro industry and, used in conjunction, they are much cheaper than the old hand programming methods.

MicroProducts Software has one of the most extensive ranges of packages in the UK, which is available for over 25 microcomputers. It supplies standard accounting packages as well as information management and development tools AutoIndex and AutoClerk.

## Software publishers

Some of the best microcomputer software has been written by individuals and small groups who lack the know-how or resource to bring their products to an international market. As a result, a few software publishing firms have emerged to take, verify, publish, market and distribute software products. Examples include Lifeboat Associates for CP/M software and Personal Software with triumphant Visicalc. The emergence of the software publisher is important, since buyers are able to rely on such reputable names, the prices of whose products might otherwise deter speculative purchase. Closely related to software publishing and frequently overlapping it is the magazine publishing industry. There are approximately two dozen micro publications in the USA, the better known being *Byte*, *Interface Age*,

*Infoworld*, *Creative Computing* and *6502*. There are also nearly a dozen micro-related publications in the UK, including *Personal Computer World*, *Micro Decision*, *Office Systems*, *Business Information Technology* and *Microcomputer Printout*. Magazine and book publishers also publish programs, notably Osborne & Associates (now the software publishing arm of McGraw Hill) and Sybex, the Rodnay Zaks publishers.

## Importers/distributors

Most hardware — and some software — manufacturers do not supply direct to the end users. There is a two-tier distribution structure in the UK. It divides between the importer/wholesaler/distributor who buys in bulk, splits up and sells to dealers/OEMs/shops. Good distributors build up expertise in their products, employ hardware and software engineers and test their equipment before releasing it on the market. They are in the minority. Bad distributors have minimal knowledge of what they sell. They deliver, ex-airport, ex-box, and supply untested equipment. Buyers are faced with missing parts, loose boards still rattling inside cabinets, US plugs still intact and an engineer is often required to put it all together.

Recently, some of the bigger manufacturers are taking a direct interest in the UK by buying up their local distributor, as Apple has done. Commodore and Tandy are already represented here and it won't be long before the others follow suit. The newly arrived Osborne has bypassed the middleman distributor and gone straight to dealers, thus providing the end user with systems at prices similar to those on the American market with some allowance for carriage, duty and local promotion. We may not have to wait long for the arrival of other manufacturers in the UK, particularly if the US suppliers want to stay ahead of the Japanese.

## Computer shops

A new computer outlet is the computer shop, which sprung up because the low cost of micros will not support a large visiting salesforce. This comes as a shock to the man used to having the main-frame or mini representative at his beck and call. Computer shops largely sell off-the-shelf hardware and software. The better ones limit the range they cover and learn their products well. Poor ones attempt to cover too many products and then find they lack the cash and expertise needed to support them. The computer chain stores are a new development: in the USA, IBM is selling through Sears Roebuck, as well as the specialist Computerland chain. In the UK, several retail outlets are experimenting with micro sales including Currys, Micro C, Laskys, Microdigital, Xerox Stores, W H Smith and Ryman Metroplay. Laskys and Ryman have bought in computer skills to combine with their retailing ability. The necessary expertise is of a specialist nature and businessmen are obviously happier when discussing their needs with specialist salesmen. However, outlets like these will come to dominate in the retailing of low cost electronic consumables.

GOTO page 190

## Some popular software

### Operating systems

CP/M, MP/M

Unix derivatives

### Language

Microsoft: Basic, Cobol, Fortran, Pascal

Micro Focus: CIS Cobol,

UCSD Pascal

### Popular packages

MicroPro: Datastar, Wordstar, Mail Merge

Micro-AP: Selector IV

MicroProducts Software: AutoClerk, Autoindex, Ledgers

Personal Software: Visicalc

Intelligence UK: MicroModeller

Peachtree: Business Packages

# The Essential Software Company

47 Brunswick Centre, London WC1N 1AF

## ROBOT ATTACK

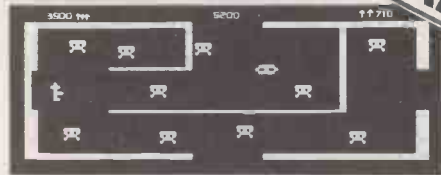

TRS 80 Levels I & II 16 K Tape  
Video Genie 16 K Tape

The Newest and Most Astounding Arcade Game that TALKS has just Reached Planet Earth. You can't help yourself. You have to stop them at all cost. Don't let up. Written especially for high quality graphics you'll simply be dazed and excited by the action.

## Attack Force

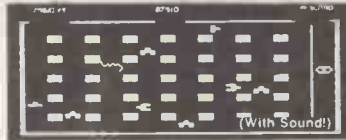

THE GAME THAT TALKS

TRS80  
VIDEO  
GENIE

Dodge the alien Ramships and fire missiles to destroy them before they get you. The alien Flagship uses his deadly laser bolt to transform a Ramship into another Flagship or into your ship's double. Look out! Destroy your double and you could destroy yourself.

TRS 80 Level I & II 16K Tape  
Video Genie EG3003 16K Tape



## Galaxy Invasion



The newest and most exciting invaders type game yet! Cruel and crafty aliens attack Earth. You are the sole defender. As you fire your laser at the aliens they swoop down and bomb you. Exciting use of graphics! Must be seen.

TRS 80 Level I & II 16K Tape  
Video Genie 16K Tape

# GOBBLE MAN



Your fighter appears below a convoy of Aliens! If you destroy them another set appears who seem to be slightly cleverer than before! Soon your space station nears but before you can dock the station comes under attack! Survival is up to you! The excitement is just beginning!!



Watch out behind you! As you hurry through the maze collecting modules you score points. But don't let the Gobblemen catch you. If you are crafty, sneak up behind them and neutralise them to gain extra points. Just keep a watch. When they attack you they come in fast. Just don't lose your nerve.

TRS 80 Levels I & II 16 K Tape  
Video Genie 16 K Tape

## Cosmic Fighter

TRS 80 Levels I & II 16K Tape  
Video Genie 16K Tape



3-D means that as you wander through the mazes and buildings, full screen graphic display constantly shows your position in a perspective format as though you were actually there! This "rat's eye" view adds an entirely new dimension to adventure.

English language commands can be entered at any time to manipulate your environment.

The command sets are extensive and sophisticated. Dozens of objects are scattered throughout the mazes and buildings. You can pick them up, burn them, throw them, etc. You may need the sword to fight off an ugly little man. Or a steel rod to hold apart crushing walls. Deathmaze 5000 and Labyrinth allow the traditional one and two word commands.

Asylum incorporates our Advanced Language Interpreter which allows full sentence input Deathmaze and Labyrinth over 550 locations! Asylum 1200

## SuperNOVA

Now the amazing ASTEROIDS arcade game for your TRS 80! Your ship is floating in the middle of an asteroid belt! Your only escape is to destroy them and the crafty alien spacecraft! Blast them with your laser, thrust, rotate or hit hyperspace to survive!



All Tapes £10 ea



ASYLUM Tape £12

THE ESSENTIAL SOFTWARE COMPANY  
(Viscounti Ltd.) 01-837 3154  
47 Brunswick Centre, London WC1N 1AF

I have a ..... microcomputer.  
 Please send me your software catalogue. I enclose a stamped self addressed envelope.  
 Please send me .....  
I enclose a cheque/postal order for £ .....  
(plus 50p post & packing)

Signature .....

Name .....

Address .....

Postcode .....

My ACCESS No is .....



# CHECKOUT

## WATANABE PERSONAL PLOTTER



**Peter Rodwell takes a close look at a versatile, upmarket plotter which can hook up to any micro**

One of the major applications of computers of all sizes is handling information — collecting it, storing it and regurgitating it in a selective or structured way. While the first two have been quite easy tasks to implement, the presentation of information in a form which humans can easily assimilate and use is more difficult, mainly because we humans aren't too good at taking in huge amounts of information.

Suppose, for example, we want to compare a company's sales figures for the first half of this year with those of the first half of last year. We could produce two columns of figures but this provides no instantly-visible comparison; we have to subtract one figure from another for each month to find out whether we're doing better or worse this year than last. If, on the other hand, we draw a bar chart of the figures, we have an immediate visual comparison of the two sets of figures — the visual representation is much easier to take in than the written.

Presenting information visually from a computer is a reasonably easy task these days. Most good business micros have at least some rudimentary graphics capabilities which allow bar charts and graphs to be drawn on the screen. Things get a little more complex when we want these reproduced on a piece of paper, though; photographing a screen isn't very satisfactory and although graphics printers are getting steadily cheaper, they still have limitations. For real versatility, you need a plotter, a device which can draw on paper with a pen under computer control.

Plotters have been around for a long time in the computer world and are used in all sorts of applications apart from presenting business information in a form the MD can understand.

Computer-aided design is one major application area in which plotters are having a major impact, in some cases replacing draughtsmen or at least relieving them of much tedious donkeywork.

Early plotters were relatively crude devices in which every single event had to be directly controlled by the host computer. Microprocessors have changed that by giving plotters their own 'intelligence', freeing the host CPU from much tedious work. This 'Checkout' is of one of these intelligent plotters, produced by the Japanese company Watanabe and aimed very much at the microcomputerist.

The Watanabe WX 4636 Personal Plotter is a weighty (18 kg) desk-top flat bed plotter which takes paper up to A3 size (297 mm x 420 mm). It's also available with a paper roll mechanism, which adds 10kg to the weight and £366 to the price. Both models can handle ten pens, which can be ball-point, ink or felt tip or a mixture of these.

Setting up the plotter and interfacing it to a computer are easy. The pens are held magnetically in a row of holders along the left-hand side — a sticker sensibly warns you to keep disks away from the holders as the magnets will corrupt data quite efficiently. There's an electrostatic paper-holding mechanism which grips the paper very tightly, keeping it not only in position but perfectly flat as well, although it isn't necessary with the roll mechanism.

The power switch is on a panel along the front edge of the plotter, together with the following controls: plotting speed (fast or medium, for use in local mode only), local or remote selector, enter key (of which more in a moment), chart hold and eight keys which, in local

mode, allow you to move the pen about: home returns the pen to the lower left corner, lower left and upper right move the pen to those positions but also function with the enter key to allow you to preset the size of the plotting area — you move the pen to where you want the lower left position to be and press 'enter' and 'lower left', for example. The plotter will then only plot within that area and a red LED flashes if you try to plot outside it. There's a key to raise and lower the pen, and four pen movement keys, similar to a computer's cursor control keys, which allow you to move the pen about in local mode.

Three interfaces are available — RS232, 8-bit parallel and GP-IB. The interfaces are on cards which slide in at the back of the plotter and come complete with the appropriate sockets (a plug is also provided with the machine). The RS232 interface contains a battery of switches to allow baud rate (75 to 9600) and framing selections.

The plotter has built-in self test and interface test facilities and the manual provides detailed instructions for setting up and troubleshooting.

### In use

Plotting is carried out by sending commands and data to the plotter, either as binary codes followed by two-byte data words, or entirely as ASCII strings. The plotter has a 1.6 kbyte internal buffer, so it's possible to pour in quite a complex string of commands, which aren't executed until a terminating character is sent; the computer can then get on with something else while the plotter does its thing.

For convenience, I used the ASCII format, programming in Basic. A typical format would be:

```
10 PRINT 'M 1000,2000';CHRS(3);
which would move the pen to the position 1000 units along the X (horizontal) axis and 2000 units along the Y (vertical) axis. The CHRS(3) is the terminator character which is by default the ASCII ETX code but which can be redefined at will.
```

The 'units' mentioned above are in fact 0.1 mm, the plotter's resolution. The full-size plotting area is 3810 units by 2540 units. This can lead to some clumsily large numbers, so there's a factor command which will automatically magnify the dimensions you send by a specified amount. The 0.1 mm resolution makes for very smooth curves — plotting speed is 400 mm/sec.

Some 42 commands can be executed, and they are divided into several categories: plotter control (home the pen, change pen colour, etc); plotting characters and symbols (selecting one of the 12 character fonts, size of characters, etc); straight line plotting (including selection of a variety of dotted and dashed lines); graph plotting (drawing axes and hatching); plotting circles and curves; reading pen co-ordinate values; and controlling the interface. The read commands cannot be executed with the 8-bit parallel interface.

Having such a range of commands available makes for good versatility. To draw a bar chart, for example, one can specify the length of the axes and the number and size of its divisions. The divisions can then be labelled using upper and lower case characters in a

**AT LAST!**

# THE COMPLETE SINCLAIR ZX 81 BASIC COURSE

At last, a comprehensive text for your Sinclair ZX 81! The complete BASIC Course is a manual which will immediately become an indispensable work of reference for all your ZX 81 programming.

Whether you have never done any programming or whether you are an experienced microcomputer user, the Complete BASIC Course will provide itself to you as an invaluable aid.

The Complete BASIC Course is designed to teach you to write and develop BASIC programs for the Sinclair ZX 81 - no other books or aids are necessary. All is revealed in our easy step-by-step guide with programs and "test yourself" exercises all the way through.

As you become more proficient with computing, the Complete BASIC Course will continue to be an essential guide, giving you finger tip references, numerous advanced programming techniques and memory saving devices specifically for the Sinclair ZX 81.

## HOW TO WRITE PROGRAMS:

Even if the idea of writing programs is completely mystifying to you, the Complete BASIC Course will show you just how easy it is. In no time you will be able to write and enjoy complex programs for whatever use you desire.

Using the proven "TOP-DOWN" approach, the Complete BASIC Course will show you systematic and simple ways to write programs. Even experienced programmers will benefit from this Course, making programs easier to write and less prone to error!

## NUMEROUS EXAMPLES:

Every concept, every function is fully described by simple programs that you can enter on your Sinclair ZX 81 in minutes.

The Complete BASIC Course contains over 100 programs and examples! These programs illustrate the use and possibilities of the Sinclair ZX 81:

- Home use
- Financial analysis and planning
- Educational applications
- Games
- Mathematical applications
- Displays of 'Artificial Intelligence'

## EVERY FUNCTION COVERED:

No matter what your application, what your confusion about any function, you will find it covered in the Complete BASIC Course.

A full and detailed discussion is included of even traditionally taboo topics such as **USR**, **PEEK** and **POKE**.

A handy alphabetical summary section lists all functions, and provides a short description and example programs of all topics.

## A PERMANENT WORK OF REFERENCE:

The Complete BASIC Course is an excellent reference work for experienced programmers (including tips on using special techniques) as well as a comprehensive step-by-step guide for complete beginners.

The Complete BASIC Course has over 240 pages filled with information in an attractive durable ring binder - this is a lay-flat work of reference that deserves a place next to every Sinclair ZX 81 microcomputer.

## OTHER TITLES AVAILABLE:

Melbourne House is the world's leading publisher of books and software for the Sinclair ZX 81.

The following titles are also available if you wish to expand your horizons:

### BASIC Course Programs on Cassette -

All major programs in the BASIC Course are available pre-recorded in this set of cassettes. This is a valuable adjunct to the Course, saving you time and effort.

### Not Only 30 Programs for the Sinclair ZX 81: 1K -

Not only over 30 programs, from arcade games to the final challenging Draughts playing program, which all fit into the unexpanded 1K Sinclair ZX 81 but also notes on how these programs were written and special tips! Great value!

### Machine Language Programming Made Simple for the Sinclair -

A complete beginner's guide to the computer's own language - Z80 machine language. Machine language programs enable you to save on memory and typically give you programs that run 10-30 times faster than BASIC programs.

### Understanding Your ZX 81 ROM -

A brilliant guide for more experienced programmers by Dr. Ian Logan, this book illustrates the Sinclair's own operating system and how you can use it. Includes special section on how to use machine code routines in your BASIC programs.



## Order Form:

Orders to Melbourne House Publishers  
131 Trafalgar Road, Greenwich London SE10

(Correspondence to  
Glebe Cottage, Station Road, Cheddington, Leighton  
Buzzard, BEDS LU7 7NA)

NAME: .....

ADDRESS: .....

.....

Postcode: .....

The Complete Sinclair ZX 81 BASIC Course	@ £17.50
Basic Course Programs on Cassette	@ £ 2.50
Not Only 30 Programs/Sinclair ZX 81:1K	@ £ 6.95
Machine Language Programming Made Simple	@ £ 8.95
Understanding Your ZX 81 ROM	@ £ 8.95

Postage and Packing £ 0.80

Remittance enclosed £



specified size and spacing, with, if desired, the labels on the Y-axis rotated through 90 degrees. The bars can then be drawn and hatched, with any angle and spacing of hatching required, with or without a line around it. The whole business can be made even more elaborate by changing type fonts or writing parts of the text in italics and, of course, to clarify the presentation of information, different pen colours can be selected for different bars!

When drawing graphs, it's possible to draw the axes and labels, etc, then feed in the points of the graph following a command to connect them up either with straight lines or with a curve. Circles can be drawn either around the centre's co-ordinates or from a point on the circumference. In both cases you must define the initial and final radii and the initial and final angles (in tenths of a degree). One can thus draw a curve of varying radius, such as a spiral or a figure-of-eight with quite simple command lines.

Character plotting is very versatile — or complex, depending upon your point of view. The 12-character fonts are tailored to the requirements of most European languages as well as the USA and ISO standard characters. Additionally, it's possible to print Japanese Kana and Greek characters. Having selected a font, it's then necessary to specify the height and spacing between letters; using this latter facility it would be possible, although tedious and of doubtful value, to produce proportionally-spaced text! Characters can be rotated in tenths-of-a-degree steps and italics —

either backwards- or forwards-sloping — can be produced, too. The default settings at power-on are for upright, horizontal (ie, parallel with the x-axis) standard characters 3mm high.

There is likewise a useful choice of line types which come in handy for producing small technical drawings. Lines can be solid (the default type), dashed in three styles, dotted and dashed, long and short dashed, double-dot dashed or even long-short-short-long dashed! The length of the cycle at which these dots and/or dashes are produced is also programmable, so you can produce just about any type of line you'd ever need. There are also a number of special characters, such as arrows, crosses and stars, which can be drawn at the current pen position.

Unless you're using the parallel interface, it's possible to read information from the plotter. Thus you can read in the current pen position and the lower left and upper right settings and check on various aspects of the plotter's status such as the amount of empty space in the buffer, whether the plotter is in remote or local mode and whether the chart hold switch is on or off.

## Documentation

The plotter comes with a 132-page manual which contains detailed instructions for setting up and testing the plotter and interfaces and for routine maintenance procedures. Each command is explained in careful detail with an example which includes a reproduction of the plotter's output in response to the command. There are

also extensive tables showing exactly what characters are produced in each of the 12 character fonts and there's a quick-reference summary of the commands and their formats at the end of the book.

Although the manual does explain every facility, it is rather terse and boringly laid out, with rather difficult-to-scan-through-in-a-hurry layouts and typefaces. But in comparison to many examples of Japanese documentation, it is well-translated and unambiguous.

## Conclusion

The Watanabe Personal Plotter is a very versatile, well-built and easy to use device which should prove useful to anyone wishing to present business and scientific information in graphic form. Coupled with a digitising pad, it would make a very useful tool for the draughtsman producing small technical diagrams from rough sketches. Its prices puts it well beyond the range of all but the richest hobbyists but it would appeal to a great many educational, scientific and business institutions.

## Prices

WX4636	£2430.00
WX4636R (with paper roll)	£2796.00
Parallel interface	£137.00
RS232 interface	£265.00
GB-IB interface	£302.00
Spare paper rolls	£3.98
Set of five felt tip pens	£2.80

Our thanks to Environmental Equipment Ltd (tel: 0270 625115) for the loan of the plotter for this review.  
All prices exclude VAT.

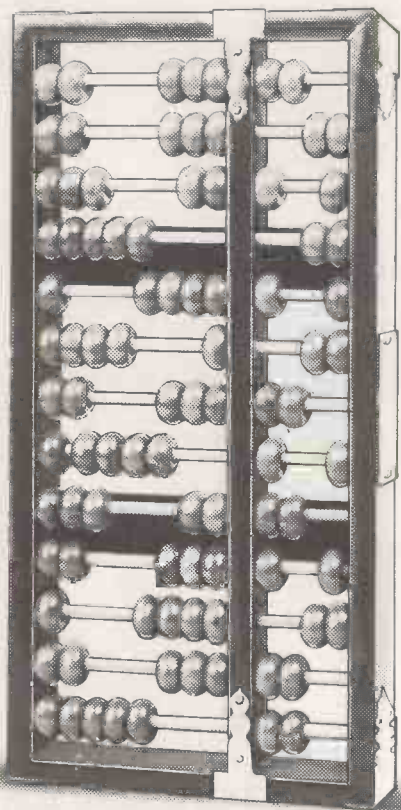

# *Low Cost* START COMPUTING IN CAMBRIDGE

For less than £100 you can launch yourself into the world of computing with your own system. At Cambridge Computer Store our "Budget Micro" department offers an exceptionally wide range of inexpensive machines, all generally on demonstration, available from stock and fully supported by our enthusiastic staff.

- Sinclair ZX81
- Acorn Atom
- Commodore VIC 20
- Tandy Colour Computer
- TRS-80 Model I
- Sharp/Casio Pocket Computer
- Low-cost peripherals

Make the right start! Visit us at:



## Cambridge Computer Store

1 Emmanuel Street, Cambridge CB1 1NE  
Telephone (0223) 65334/5

# THE SOFTWARE THAT EXTENDS YOUR HORIZONS

MicroTechnology Limited is the company who supply all the software you need to expand the potential of the remarkable Sharp MZ80B computer. The company who supply, exclusively, the CPM2.2 that makes the Sharp MZ80B so versatile. The company who supply the software that enables the businessman, the educationalist, the scientist, and the enthusiast to create a better, more efficient, more exciting lifestyle. Just look at the scope.

## MICROPRO WORDSTAR

Powerful word-processing package, made easy to use by full function key support on the MZ-80B £242

## MAILMERGE

Add on to WORDSTAR, provides mail-shot and conditional/parameterised text inclusion. £73

## SPELLSTAR

Add on to WORDSTAR, allows document spelling checks. Own technical term dictionary can be defined. £121

## DATASTAR

Screen orientated form definition and data entry tool. £171

## SUPERSORT I

Powerful disk based sort package. Stand alone program and MICROSOFT® compatible calling sequence relocatable routines. £122

## SUPERSORT II

As SUPERSORT I, but only the stand alone program. £97

## WORDMASTER

Superb screen based text editor, all functions driven off MZ-80B function keys. £73

## MICROSOFT PASCAL

ISO standard PASCAL compiler system £298  
CB80 full compiler for CBASIC Price TBA

## BASIC-80

Accepted standard Microprocessor based BASIC interpreter. £209

## BASIC COMPILER

BASIC-80 compatible compiler, makes BASIC programs run many times faster. £236

## FORTRAN-80

ANSI standard FORTRAN, except for COMPLEX numbers. £298

## COBOL-80

1974 ANSI standard COBOL, with large program chaining and screen DISPLAY/ACCEPT. £448

## M/SORT

Powerful sorting facility for use primarily with COBOL-80. £75

## Mu-MATH & MuSIMP

Symbolic math package, allows computation up to 611 arithmetic digits. Superb for scientific and engineering applications. £149

## Mu-LISP & Mu-STAR

Extended LISP 1.5. Includes screen based LISP environment editor. £119

## EDIT-80 & FILCOM

Line orientated random access text editor. Includes source and binary file compare program. £71

## MACRO-80

Most popular assembler supporting Z80® mnemonics. Includes linking loader, library manager and cross referencing tool. £119

## MICRO TECHNOLOGY EXPAND

Library routines for use with MICROSOFT® calling sequence products. Gives MZ-80B graphics, cassette and music handling. £65

## MICROFOCUS

CIS COBOL ANSI 74 standard COBOL to full level 1 standard. £425

## FORMS-2

For use with CIS COBOL, provides superb screen handling capability for CIS COBOL programs. £100

## COMPILER SYSTEMS

CBASIC Commercial BASIC, used extensively for business packages. £65

## DIGITAL RESEARCH

PL/1-80 ANSI standard subset G based PL/1 producing direct object code for fast execution. £298

## BT-80

Record retrieval system for use with PL/1-80, to give data base management facilities. £119

## MAC

Upward compatible assembler from ASM, provides MACROS and Z80® assembly support. £53

## ZSID

Super symbolic debugger, with full Z80® mnemonic support. Works well with MACRO-80. £59

## TEX

Text formatter ideal for producing manuals and similar documents. Note this is not screen based. £59

## DESPOOL

Allows listing of files at same time as other processing. £29

## PROSPERO SOFTWARE

PRO PASCAL Fastest Z80® based PASCAL that we know of. £190

## MICROEASE

EASVFLER Flexible data definition, data entry, data update and report generator. £275

\*\*\*\*\*NEW\*\*\*\*\*NEW\*\*\*\*\*NEW\*\*\*\*\*

## CALCSTAR

The new Micropro financial modelling system £144  
\*\*\*\*\*

\*\*\*\*\*

## GREAT NORTHERN

MINI MODEL Very powerful modelling package, with uses not just in business and financial applications, but in any situation where your model may be affected by external conditions. The buz-word is WHAT-IF? £399

\*\*\*\*\*

## MAGSAM

Indexed sequential access routines, available for use with BASIC-80 and CBASIC. Superb documentation. £110

## BASKAM

Basic keyed access routines for use with BASIC-80. £95

## DATAFLOW

Easy to use data file description and entry tool. Will output reports, labels or MICROPRO® MAILMERGE compatible files. £99

## COMPUT-A-CROP

\*\*\*\*\*NEW\*\*\*\*\*NEW\*\*\*\*\*NEW\*\*\*\*\*

## TARGET PLANNER

Business planning system with many features extra to VISICALC®. Easy to use, with big machine facilities. £125

\*\*\*\*\*NEW\*\*\*\*\*NEW\*\*\*\*\*NEW\*\*\*\*\*

## PADMED

Sales Ledger System £300

Purchase Ledger System £300

Sales Invoicing System £300

Nominal Ledger System £450

## SOFTWARE FOR SHARP PC3201

The majority of this software will be available for the PC3201 under CP/M from January 1982. Please contact us for full details of availability.

## WE TAKE ORDERS!

You can order any of the above items of software from us. Today. Personal callers and trade enquiries are welcomed. (All software can only be used in conjunction with the MZ80B including disk-based CPM2.2).

All systems are supplied on 5¼" floppy disks and come complete with comprehensive reference manual. All prices will be held for 30 days from the date of issue of this advertisement.

The quoted prices do not include postage, packing, insurance and VAT, so you should phone first for an exact total price. If you wish to pay by VISA or ACCESS card, you can, of course, phone your number through. If you wish to pay by cheque or postal order, make it payable to MicroTechnology Limited.

As most items are available ex-stock, we will normally be able to deliver to you within 72 hours.



The MZ80B Computer.

## Micro Technology LIMITED

Cheltenham House, 62 Mount Pleasant, Tunbridge Wells, Kent. Telephone: 0892 32116. Telex: 95441 Tecln.G.





# First time on Earth.



## SHARP MZ-80B

Sharp bring you the MZ80B. A machine that offers you functions previously only associated with more powerful, more expensive computers; that gives you versatility to handle a huge range of software and hardware applications in scientific, business and personal use.

The MZ80B opens up a new world of graphic display potential, more flexible data storage and retrieval, and ease of operation.

Here is the computer from the future. Available today.

### Stunning Graphic Display.

Seeing is believing. The large-screen, high-focus, green-face display incorporated in the MZ80B gives you high-resolution graphics of 320 x 200 dots.

An additional graphic RAM can be added which allows another 320 x 200 dot resolution pattern to be displayed.

This dual high-resolution graphic ability is especially useful for simulating and displaying a dynamic picture. It can display 40 characters x 25 lines or 80 characters x 25 lines via software switching.

In addition there are facilities for full, on-screen editing, reverse video, partial scrolling and a full range of graphic symbols.

### Character and Graphic Printer.

This fast, quiet printer will reproduce your graphic displays and, of course, print-out upper and lower case letters and symbols. A tractor/friction feed version is also available.

### Data Storage/retrieval.

The MZ80B has a remarkable memory. 64K of RAM. And that constitutes all the memory area, giving flexible storage of any computer language and its software. The cassette deck is electromagnetically-controlled, with a data transfer speed of 1800 bits/sec combined with a unique

programme search facility to make data storage and retrieval super-fast



A typewriter-style keyboard incorporates characters and symbols plus a numeric key-pad and ten user-definable keys for fast and simple operation.

BASIC is, of course, provided with Z-80 Assembler Packages, PASCAL and a BASIC compiler.

### Floppy Disk Drive.

A twin Floppy Disk Drive unit can be added which will give you 560 bytes of storage on double-sided, double-density disks.



### Comprehensive Documentation.

Each MZ80B comes complete with a full set of documentation including an owners' manual giving full circuit diagrams, a monitor reference manual and programming manuals.

PCW 2/82

### Interfaces

RS-232C and IEEE Interfaces are available from January 1982 allowing the MZ80B to communicate with scientific instruments and other peripherals.

### CP/M\*2.2

CP/M\* is also available making a wide range of packages immediately available including wordprocessing, financial modelling, data base management to mention but a few. CP/M\* also increases the disk capacity to 680K.

(CP/M\* is a Trade Mark of Digital Research Ltd).

# SHARP

*First, and foremost*

SHARP ELECTRONICS (UK) LTD., COMPUTER DIVISION,  
SHARP HOUSE, THORP RD., NEWTON HEATH,  
MANCHESTER M10 9BE. TELEPHONE: 061-205 2333.

**Why on Earth don't you find out more?**



Please send me full information on the Sharp MZ80B computer.

Name

Address

Tel:

To: Sharp Electronics (UK) Ltd., Computer Division,  
Sharp House, Thorp Road, Newton Heath,  
Manchester M10 9BE. Telephone 061-205 2333.

**Comart Approved Dealers**

**Aberdeen**  
MOM Offshore  
21 Bon Accord Street  
Tel: 0224 22863

**Belfast**  
O & M Systems  
95 Dublin Road  
Tel: 0232 49440

**Birmingham**  
Byteshop Computerland  
94/96 Hurst Street  
Tel: 021 622 7149

**Bristol**  
Senton  
27 Nicholas Street  
Tel: 0272 276132

**Cambridge**  
Toltec  
24 Thompson Lane  
Tel: 0223 312347

**Cheshire**  
Holdene  
82a Water Lane  
Wilmslow  
Tel: 0625 529486

**Dublin**  
Lendac Data Systems  
8 Dawson Street  
Tel: 000 1 372052

**Edinburgh**  
Holdene Micro Systems  
48 Great King Street  
Tel: 031 557 4060

**Glasgow**  
Byteshop Computerland  
61 Waterloo Street  
Tel: 041 221 7409

**Leeds**  
Holdene Micro Systems  
11/12 Rampart Road  
Tel: 0532 459459

**London**  
Byteshop Computerland  
324 Euston Road, W1  
Tel: 01-387 0505

**Digitus**  
9 Macklin Street, W/C2  
Tel: 01-405 6761

**Jarogate**  
67 Tulsemere Road, SE17  
Tel: 01-670 3674

**Manchester**  
Byteshop Computerland  
Piccadilly Station Approach  
Tel: 061 236 4737

**NSC Computers**  
29 Hanging Ditch  
Tel: 061 832 2269

**Newbury**  
Newbear Computing Store  
40 Bartholomew Street  
Tel: 0635 30505

**Nottingham**  
Byteshop Computerland  
92a Upper Parliament Street,  
NG1 6LF  
Tel: 0602 40576

**Sheffield**  
Hallam Computer Systems  
451 Eccleshall Road  
Tel: 0742 663125

**Southampton**  
Xitan Systems  
23 Cumberland Place  
Tel: 0703 38740

**Suffolk**  
Eurotec Consultants  
Little Waldingfield,  
Sudbury  
Tel: 0787 247959

**Surrey**  
Gemlines  
184 London Road, KT2 6QU  
Tel: 01-546 9944

**Warwicks**  
Business & Leisure  
Microcomputers  
Kenilworth  
Tel: 0926 512127

**Wattford**  
Lux Computer Services  
108 The Parade,  
WD11 2AW  
Tel: 0923 29513

**Worthing**  
Ace Computing Services  
1-11 Bridge Road  
Tel: 0903 35411

**Comart Ltd,**  
St. Neots, Cambs.  
Tel (0480) 215005  
Telex 32514 Comart G.

# New Slidemaster brings colour graphics with no application programming

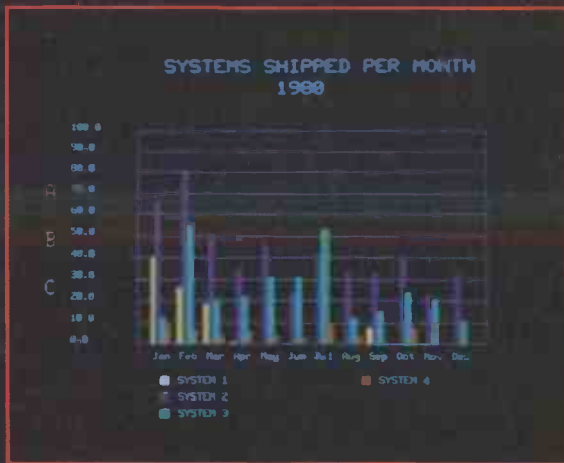

# The Colourful World of Cromemco



**C**romemco brought High Resolution, broadcast quality colour graphic systems onto a new price/specification level with the SDI System. They gave a wide colour palette, up to 4096 colours, and a wide variety of functional development; area infill, rotation, — a true professional graphics capability.

With the Slidemaster they have added a new dimension — User Convenience. Slidemaster is an optional expansion to the SDI System. It provides sophisticated colour graphics with no programming.

Slidemaster users still have full SDI 756 x 482 point High Resolution capability, and the facility to program in the high level languages of BASIC, and Fortran. Cromemco Colour Graphics is supported on the floppy disk based System 2 and System 3, and the hard disk Z-2H. Cromemco's analogue, digital, and optically isolated I/O Modules provide versatility for control applications.

Slidemaster is a fully self contained application package. It allows images to be developed, stored and manipulated interactively with speed and ease.



The image is developed from a digitising tablet, and reproduced directly on the colour Monitor.

Slidemaster offers a choice of up to 75 powerful design functions. A touch of the pen and the images can be erased, shaded, coloured, enlarged or reduced, or rotated. The menu provides for a variety of pen or brush selections, and the capability to generate circles, ellipses, lines or text, and to zoom and pan.

The images can be stored on diskette, and redisplayed "sideshow" style at the touch of a key. The user can have up to six images stored in RAM Memory for instant recall or merging, and hundreds more stored on disk in a highly compact and cost effective form.

Cromemco Colour Graphics users benefit from the in-depth support of Comart — Cromemco's longest standing, and leading European Distributor. Comart, its nationwide UK dealers, and supported OEM's provide local and specialist end user support at all levels. Comart's central technical, distribution and service facilities ensure ready availability and well qualified technical support in hardware, software and after sales service.

# comart

SPECIALIST IN MICROCOMPUTERS

A member of the Comart Group of Companies



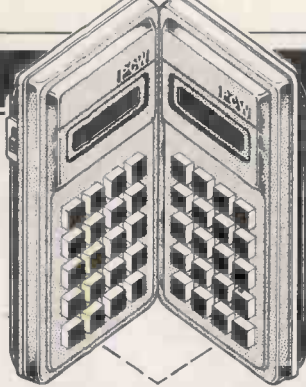

## CALCULATOR CORNER

*If there are still any people who consider programmable calculators to be poor substitutes for a micro they should have been awakened by the use of HP-41CV's by the Space Shuttle crews (despite the availability of no fewer than five computers). This article by M E Rankin, a BAC 1-11 pilot with Dan-Air, further drives home the point that a programmable can still be the most cost effective solution to computational problems under certain conditions.*

## I'M PROGRAMMABLE, FLY ME!

In early 1980 I bought a TI-59 programmable calculator with the intention of solving a quite simple problem in air navigation. The commonest form of navigation equipment in use throughout the world allows the measurement of very accurate distances and rather less accurate bearings from ground radio stations placed at suitable intervals along the airways. The display given to the pilot shows him distance to run and, by means of a deviation meter with a single needle, tells him whether he is on track, left, or right of it, in terms of angular displacement rather than distance. The maximum useful range of the groundstations is around 120 miles and they are usually less than 100 miles apart.

Airways are rarely straight, for a variety of reasons. For example, they may make considerable detours to avoid airspace allotted to the military for weapons training. The detours are often not permanent necessities and, at times of light traffic and when the armed forces are not using their bombing ranges, it is often possible to take short cuts. If such a direct routing begins at a point between navigation beacons and leads to a beacon well outside reception range, the equipment described above simply cannot cope. It is neither flying away from a radio station, nor (as far as it can tell) towards one. It cannot advise the pilot of the correct bearing to his destination. If he knows the correct bearing, the system cannot tell him whether he is on it. In short, if he wishes to take advantage of a direct routing offered to him, the pilot of such an aircraft must resort to guesstimation. This is frustrating for him because he is surrounded by navigation beacons, his ability to measure their bearings and distances is unimpaired and if he had appropriate charts and plotting facilities he could in time derive all the information he needs. A typical example of this situation is shown in the illustration. The crosses on the map are a selection of the navigation stations which are within useful range of some part of the dotted direct routing.



The solid line is a section of a common route along airways between, say, Malaga and Manchester or Cardiff, and from Bilbao leads via Nantes, Dinard and Berry Head near Dartmouth. If a route between Bilbao and Berry Head could be flown with complete accuracy in one long, straight line, 22 nautical miles would be saved — about three minutes' flying time in a BAC 1-11. An airliner of that size could cost anywhere between £25 and £75 a minute to operate, so the saving is obviously worth having. Part of this reduction in flight time would be achieved by guesstimation, unless the pilot was rather bad at it, so the amount of the saving which could be credited to any new system of navigating would be rather less than the three minutes of this example. How much less is a matter of opinion, since there is no way of measuring it. However, these figures suggest that the potential savings are not large enough to repay the cost of buying any of the very high cost equipment, such as Inertial Navigation Systems normally priced in six figures. Hence the TI 59.

Since I am no mathematician I bought the Texas Instruments Aviation Module with its ready-made programs for this form of navigation, known as Area Navigation. From the moment I opened the superb handbooks I was lost to everyday domestic life.

I found an adequate system of area navigation based on a straightforward constant-scale grid on which the locations of the navigation beacons can be plotted as pairs of X and Y coordinates. A Load module program provides for the calculation of the coordinates of the beacons, each of which is allotted a 'waypoint' number. The coordinates are stored in a pair of data registers whose addresses are a simple function of the waypoint number.

On entering a waypoint number and the bearing and distance from it, the area navigation program calculates, or 'fixes', the aircraft's position in terms of X and Y. On entering the destination waypoint number, a little Pythagoras provides the track and distance to that destination. Time of the fix and estimated speed are used to forecast the arrival time. Finally, when two or more fixes have been entered, and if the time between them is known, the actual speed achieved can be determined, and used to revise the estimated time of arrival.

The principles are simple enough, but I ran headlong into practical difficulties. To begin with, I simply couldn't key in

the data accurately enough. It came too thick and fast for me to enter directly into the calculator; and when I wrote it down, the meaning seemed to evaporate within seconds. (It is an axiom among pilots that the brain drops to about one third power as the wheels retract.) That problem disappeared when I designed a form on which to enter the data. This is a type of Log and turned out subsequently to have many other uses. In a much developed form it is now an essential component of the system.

Secondly, the recommended method of constructing the model of the area required that the bearings and distances between adjacent waypoints on the chart be fed into the Load Module. That didn't work with more than six or eight waypoints because the cumulative effects of errors in these figures built up to an unacceptable level. Accuracy was regained by the laborious use of a further program for the calculation of the bearings and distances. The reasons for the initial errors then became clear — the airways charts themselves contain significant errors.

During this process the amount of keypunching required, and the destructive effects of keying errors, made it clear that a printer was required, so a PC-100B was obtained. It then became possible to trap errors more or less as they occurred; and certainly before any real damage had been done. My first successful waypoint model took two full days of continuous work, but was very accurate. It was about 1000 nautical miles long; and over that distance had errors of 0.2° and 0.2 nautical miles. Not all have been as good as that, but errors of this order are considerably less than the errors of the information fed in and are completely irrelevant for practical purposes.

The system now began to show its paces. For the first time I was able to see where my over-the-horizon destination lay and whether I was maintaining an accurate track towards it. The initial determination by the calculator of the direct tracks between well-known locations demolished a few myths among my colleagues and the significance of the well-known inconstancy and inaccuracy of the bearing information available to the pilot began to sink in for the first time. It was becoming clear quite quickly that the guesstimation methods generally in use are not nearly as good as most pilots believe, and that major deviations from the correct route must be quite common. I had also begun to be aware of some of the other shortcomings of

GOTO page 188



A popular exercise in computer graphics is to take a design already represented in store and displayed on the screen, and to make a reverse copy of it alongside, making a pair of mirror images.

I set out to write a short note on how to do this, illustrating it with the particular code for my DAI computer, but along the route I was waylaid by an intriguing series of numbers which themselves give rise to some interesting patterns. It turns out that the central bit of processing necessary to reverse an image on a micro involves reversing the order of bits in a byte. This is because the screen map for graphics cannot afford the luxury of eight or even 16 bits for each cell on the screen that is possible on larger systems. Bits have to be packed into one or two bytes representing several cells on the screen. More of that later.

First I give four ways of reversing the bits in a byte, a kind of theme and variations in programming; then some patterns based on the values of reversed bytes, and lastly the problem that started all this, reversing an image on the screen.

## Reversing bits

The process of taking a byte and reversing the bits in it is a single valued function of one argument. Like SIN(X) and LOG(Z), it takes one value and returns one value.

The first thing to decide in programming a function like this is whether the value is to be computed each time one is called for, or whether it is possible to compute the values once for each value that the argument can take and then store the results in a table. This is not practicable for functions like SIN and LOG, as there are far too many possible values. However, for our function there are only the 256 possible values of a single byte 0 to 255. The advantage of using a table is increased speed when the function is used, since the only cost is a single reference to an array. The price is the computation of all the values at the start of the program and the store needed for the array of 256 elements. This is the method used for the following.

Now we come to the far less important but much more interesting question, from the point of view of computing efficiency, of just how the reversed values are to be calculated. You might think of doing it by hand and storing the 256 values explicitly in DATA statements. Here is part of the table to show how the values go, in both binary and decimal:

00000000	0	0	00000000
00000001	1	128	10000000
00000010	2	64	01000000
00000011	3	192	11000000
00000100	4	32	00100000
00000101	5	160	10100000
-----			
11111110	254	127	01111111
11111111	255	255	11111111

But that way is cowardly cheating — I have a computer to perform precisely this kind of task. So here is the brute force computer method. Each bit is extracted from the byte by ANDing it logically with the appropriate power of



## Alan Sutcliffe continues his thought-provoking series.

2 and then shifting it right or left the correct number of places, which is easily done by division or multiplication. For example, (I IAND 2)\*32 picks out the second lowest bit and moves it up to the second highest position in the byte. Program A shows the whole code. The calculation is split into two lines simply to avoid having too long a line. On the DAI, all eight expressions in one statement produced the error message LINE TOO COMPLEX, so you might have a similar problem on your machine.

## Second method

Now this program is correct and the fact that it is a bit slow hardly matters since it only takes a few seconds anyway, and it is only five lines. But I have this mean Yorkshire temperament that drives me to look for ways of saving a second here and there, no matter what the cost, plus a slight obsession with programming elegance.

The first method I thought of was a mixture of the two I have described so far, the manual and the brute force. It uses a table of the 16 reverse values for the 4-bit nibble or half-byte calculated by hand to set up the main table in a double FOR loop. This is Program B. You can easily confirm that the values in the DATA statements are correct by completing the following table for 4-bit reversals.

0000	0	0	0000
0001	1	8	1000
0010	2	4	0100
-----			
1111	15	15	1111

Statement 70 uses this table stored in array B to take the top nibble, reverse it and put it at the bottom and contrarily with the other half of the byte.

Although this takes more than twice as many statements it is very little longer in number of characters to be stored, and very much faster to run. A quick and rough way to compare two pieces of code like these for speed is to count the number of elementary operations in the inner loops. In each case this loop is obeyed 256 times. In program A there are, for example, four multiplications while in program B there are only two. A simple table shows the comparison, where ( ) is the number of references to an array element, an operation that may cost an addition and a multiplication.

	+	*	/	( )	=	IAND	Total
A	7	4	4	1	2	8	26
B	2	2	0	3	1	0	8

The total may be misleading if the differences are for very different kinds of operation: IAND is very much

quicker than an array reference. Since Basic is interpreted, the cost of this can be approximately compared by counting the number of characters, or more correctly the number of tokens, a variable name and a reserved word, each being a single token. Using these two measures Program B runs three or four times faster than program A. The overheads in program B for setting up the array B and for having two loops make hardly any difference. They have one sixteenth the effect they would have inside the inner loop.

## Algorithmic method

The table below shows the reversal values for each number of bits up to four.

0	0								
1	0	1							
2	0	2	1	3					
3	0	4	2	6	1	5	3	7	
4	0	8	4	12	2	10	6	14	1 9 ...

From this, a clear pattern of how the series for n bits can be obtained from that for n-1 bits may be seen. The first half of the series is doubled, and the second half is the first with 1 added to each item. If  $T_r$  is an item in the list for n bits, and  $S_r$  is an item for n-1 bits, the rule is:

$$T_r = 2 * S_r \quad \text{for } r=0 \text{ to } N-1$$

$$\text{and } T_r = 2 * S_{r-N} + 1 \quad \text{for } r=N \text{ to } 2*N-1$$

$$= T_{r-N} + 1$$

$$\text{where } N = 2^{n-1}.$$

Program C implements this algorithm recursively, so that the table for each number of bits up to eight is computed in turn. Notice that the rule even works going from zero bits to one bit, so that the only data that needs to be supplied is to set the first element of A to zero.

The attraction of this method is its elegance and its generality. Given an array big enough, Program C will compute the table for any number of bits: one more than the number given as the upper limit in the FOR loop, statement 40.

From the point of view of speed, however, there is a penalty. The inner loop is not executed 256 times as in the other programs, but  $1+2+4+8+\dots+256 = 511$  times — virtually twice the cost. It contains ten elementary operations to eight in Program B, but there are no multiplications so each time round the loop is probable faster.

Three very different looking programs. Interesting that they all produce the same result. Here is just one more — that uses another pattern in the construction of the series.

The first value is set to zero. Then the series for one bit is generated, but



this time in the positions it will occupy in the final table for eight bits: 0 is already in place, and the 1 goes in cell 128. Next the values that will make the series for two bits are added: 2 in cell 64 and 3 in cell 192. And so on.

Program D does all this. It is not obvious, perhaps, just looking at it how it works, but it is easy to obey the first few steps with pencil and paper — and its operation then becomes clear. It is more efficient than any of the others. The inner loop is obeyed 256 times and it contains five operations, with no multiplications.

It also makes a good test of program comprehension. Ask a friend who hasn't read the story so far to work out without a computer what this little program does and why. I would be very impressed by anyone who could figure this out without benefit of writing anything down.

But enough of numbers for a while and on to some graphics — graphics based on these numbers, that is. Program E is simply a histogram of the table for six bit reversals, made pretty with a little flower at the top of each stalk. Array A is already loaded with the values. Figure 1 shows the result, and maybe you can tell that I am doing this just before Christmas.

One or two small points about this program. I used the 6-bit table with 64 values rather than 128 or 256 values simply to get a more bold effect. The first and last values in the table, A(0) and A(63), are left out because the petals of the flowers, if that's what they are, would go off the screen for these two extreme values. It also makes for a more compact picture. It is necessary to plot the lines in descending value of I because otherwise the longer lines plotted later would obliterate petals on the shorter stems next to them. A pretty pattern, simple certainly, but effective I hope.

Program F uses the eight bit values to plot overlapping rectangles. Figure 2 shows the output, reminiscent of a design from the 1920s. The first FILL statement draws a rectangle and the second one draws another one row of cells smaller along each side, so the effect is of a rectangle with a border. That is unless the random function which is used to determine the colour in each case gives the same colour for both rectangles in a pair, when the border is invisible. Different effects can be obtained by using different values for the STEP in statement 520.

For both graphics I changed the colours to one more suitable for photographing once the design was on the screen. This is done by a single COLORG statement.

## Taking photos

A few words about my experiences in taking photographs from the screen. I am now using a monitor with RGB input, so that the pictures on the screen are crisp and clear. I have found it pays to take great care in positioning the monitor and camera. For the pictures shown here I used a Polaroid SX-70.

My tips are these. Make sure both the screen and camera lens are as near vertical as possible. Get the camera in line with the centre of the screen. Obvious stuff, but it is worth taking

```
10 DIM A(255)
20 FOR I=0 TO 255
30 B=(I IAND 10*128+(I IAND 2)*32+(I IAND 4)*8+(I IAND 8)*2
40 A(I)=B+(I IAND 16)/2+(I IAND 32)/8+(I IAND 64)/32(I IAND 128)/128
50 NEXT I
```

N.B. IAND is the instruction for a bitwise AND in DAI-Basic.

```
10 DIM A(255),B(15)
20 FOR I=0 TO 15
30 READ B(I)
40 NEXT I
50 FOR I=0 TO 15
60 FOR J=0 TO 15
70 A(16*I+J)=B(I)+16*B(J)
80 NEXT J
90 NEXT I
100 DATA 0,8,4,12,2,10,6,14
110 DATA 1,9,5,13,3,11,7,15
```

Program B

```
10 DIM A(255)
20 A(0)=0
30 M=1
40 N=128
50 FOR I=0 TO 7
60 FOR J=0 TO 255 STEP N+N
70 A(J+N)=A(J)+M
80 NEXT J
90 M=M+M
100 N=N/2
110 NEXT I
```

Program D

measurements to ensure this. Otherwise there will not only be more depth of field than need be and so more problems of uniform focus, but also verticals and horizontals at the edges of the screen will be curved. At little over a foot away from the screen there is still a problem with more light in the centre than at the edges, particularly obvious in Figure 2. Next month I hope to show some conventional 35mm slides for comparison. Another problem is that the colours are not reproduced at all faithfully, a fairly bright red coming out as almost brown.

## Reversing a picture

Now to use the byte reversing array A to give the mirror image of a graphic on the screen. It is necessary to say something about the screen map on the DAI,

```
10 DIM A(255)
20 A(0)=0
30 N=1
40 FOR I=0 TO 7
50 FOR J=0 TO N-1
60 B=A(J)
70 A(J)=B+B
80 A(J+N)=B+B+1
90 NEXT J
100 N=N+N
110 NEXT I
```

Program C

```
200 MODE 2
210 COLORG 0 1 2 3
220 FOR I=62 TO 1 STEP -1
230 B=A(I)
240 DRAW B,0 B,I 1
250 DOT B,I 2
260 DOT B-1,I 3
270 DOT B+1,I 3
280 DOT B,I-1 3
290 DOT B,I+1 3
300 NEXT I
```

Program E

```
500 MODE 6
510 COLORG 0 1 2 3
520 FOR I=0 TO 127 STEP 3
530 B=A(I)
540 C=A(255-I)
550 FILL I,B 255-I,C RND(4)
560 FILL I+1,B+1 254-I,C-1 RND(4)
570 NEXT I
```

Program F

# PATTERNS

which is shown in Figure 3. My example is for four colour mode in low resolution, that is MODE 2. The screen has 72 by 65 cells in this mode. Each line of cells is represented by 24 bytes made up of two control bytes, two bytes for a left margin which cannot be plotted, 18 bytes for the 72 cells, and two more bytes for the right margin. Moving left to right across the screen, these bytes are in descending order in store. The upper control byte for the top line is always at store location # BFEF, so the top left of the plottable screen is stored in #BFEB, the top right (71, 64) at #BFEF-17, and the bottom left (10, 0) at #BFEF-64\*24.

Each block of eight cells is represented by two bytes, two bits per cell. The top bit in each byte determine together the leftmost cell in the block, and so on down the two bytes. The value of the two bits together give which of the four possible colours is to be used — how these four colours are chosen from the total of 16 is set in the control bytes for the line.

Program G1 copies an area of 32 by 20 cells from the bottom left of the screen to the bottom right, and reverses it. SCRN reads the colour of the cell at the stated coordinates. This method is slow because each call to SCRN causes two bytes to be fetched from store and the appropriate bit unpacked from each of them, while DOT entails setting a bit in each of two bytes. It does not use the array A.

Program G2 using the reversing array A runs about four times faster. There is no packing and unpacking of bits to do. The bits in each byte are reversed and pairs of bytes along a line are reversed in order so that bytes a b c d e f g h become g h e f c d a b. Once again the price of speed is a more complicated program. This can easily be adapted to work in other modes — higher resolution and 16 colours. I have chosen the simple case where the edges of the areas to be copied to and from, line up with the blocks of eight cells corresponding to a pair of bytes. Clearly if the edges pass through the middle of a block of eight, there will have to be some packing and unpacking, but this will be once or twice for each byte rather than for every bit, and the program will still be two or three times faster than the method using SCRN and DOT.

Next month, if I keep to my plans, I shall show some patterns based on a simple program to generate octagons — and write about deciding in 3-D graphics which lines and planes are behind which others — the famous hidden surface problem.

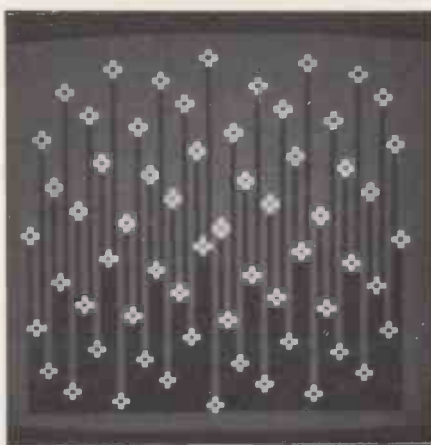

Fig 1

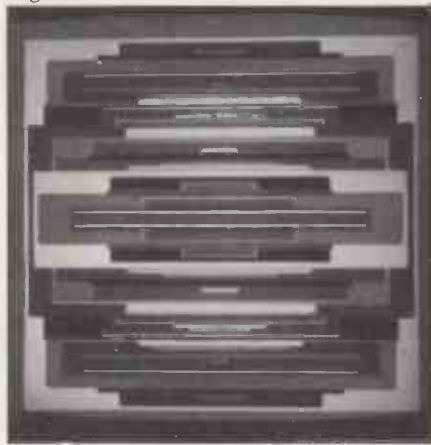

Fig 2

```

200 MODE 2
210 COLORG 0 1 2 3
220 FOR I=0 TO 19
230 FOR J=0 TO 31
240 DOT 71-J,I SCRN(J,I)
250 NEXT J
260 NEXT I
Program G1
    
```

```

200 MODE 2
210 COLORG 0 1 2 3
220 B= BFEF-64*24
230 FOR I=0 TO 19
240 FOR J=0 TO 7 STEP 2
250 POKE B+J-16,A(PEEK(B-J))
260 POKE B+J-17,A(PEEK(B-J-1))
270 NEXT J
280 B=B+24
290 NEXT I
Program G2
    
```

Control bytes	Margin	Main screen area (71,64)	Margin
BFEF BFEF-24 2 bytes	2 bytes	BFEF BFEF-24 18 bytes for 72 cells All repeated for 65 lines	BFEF-17 BFEF-41 2 bytes
BFEF-64*24		BFEF-64*24	BFEF-64*24-17

(0,0)

Figure 3 — DAI Screen Map for MODE 2.

# GUESTEL MAIL ORDER LIST

- Apple III System ..... 2545:00
  - Apple II ..... P.O.A.
  - Disk Drive with controller (DOS 3.3) ..... 349:00
  - Disk Drive ..... 289:00
  - BMC 12" Green Monitor ..... 149:00
  - NEC 12" Yellow monitor ... 170:00
  - OKI Microline 80 printer ... 275:00
  - Epson MX 80T printer ..... 349:00
  - Silentype Printer ..... 195:00
  - Centronics 737 ..... 325:00
  - Centronics Parallel Interface ..... 69:00
  - 16K RAM card ..... 89:00
  - Visicalc 3.3 ..... 105:00
  - Colour card (inc. modulator) ..... 92:00
  - Disks (10) ..... 21:00
  - DOS Tool Kit ..... 39:00
  - Apple World ..... 35:00
  - 40 Disk lockable tray ..... 20:00
  - Upgrade Kit ..... 39:00
  - Gorgon ..... 21:00
  - Olympic Decathlon ..... 15:50
  - Monopoly ..... 16:50
  - Pool ..... 19:00
  - Space Eggs ..... 15:50
  - GUESS WHO? Guestel Sweat Shirt ..... 5:00
- All prices exclusive of VAT.

## GUESTEL MAIL ORDER FORM

Goods required: \_\_\_\_\_

\_\_\_\_\_

\_\_\_\_\_

\_\_\_\_\_

Total cost £ \_\_\_\_\_

VAT at 15% £ \_\_\_\_\_

Add £1 P&P to orders under £10

Total £ \_\_\_\_\_

Payment must accompany order

Date: \_\_\_\_\_

Name: \_\_\_\_\_

Address: \_\_\_\_\_

\_\_\_\_\_

Telephone: \_\_\_\_\_

GUESTEL LIMITED  
MAIL ORDER DEPARTMENT  
15 GRAND PARADE BRIGHTON  
EAST SUSSEX BN2 2QB



# FOUR GOOD REASONS FOR CHOOSING GUESTEL

**1. The Systems** – Whatever your micro computer hardware or software requirements, Apple systems can meet them and we can supply them to rent or buy. Visit our showrooms in London, Brighton and Bristol or use our nationwide mail order service – one of the largest and most efficient in the country. Guestel provide sales, service and an in depth knowledge of Apple systems. We buy bigger so you can buy cheaper.



**2. The Consultancy** – Micro computer systems are simple to use once you know how. But how do you learn when so much of the so-called advice is in confusing computer jargon? Come to us. We talk plain English. Quite simply, we will help you to identify your particular needs for hardware, software and support services – then we'll match them with Apple systems.



**3. The Service** – Immediately you come to us with your needs you'll get a personal service. Whatever your requirements, we respond right away. And once your equipment is installed our reliable back up service ensures that help is always on hand



when you need it. We operate a two tier maintenance agreement, with a 24 hour call out service. We also have an in house engineering facility and a telephone enquiry service to cope with emergencies. Our fast, efficient mail order service will take care of your additional requirements and our offices are within easy reach.

**4. The Know How** – Some of Britain's leading companies have come to us for help in developing major custom built micro computer linked systems – your guarantee that we have the depth of technical knowledge and the experience to help with your needs, large or small.



**GUESTEL**

EXPANSION THROUGH EFFICIENCY

**APPLE III  
NOW AVAILABLE**

**MAIL ORDER – BRIGHTON**  
15 GRAND PARADE BRIGHTON  
EAST SUSSEX BN2 2QB  
TELEPHONE 0273 695264

**HEAD OFFICE – LONDON**  
8-12 NEW BRIDGE STREET  
LONDON EC4V 6AL  
TELEPHONE 01-583 2255

**OFFICES WORLDWIDE**  
DUSSELDORF  
SAN FRANCISCO

AUTHORISED APPLE DEALER AND LEVEL ONE SERVICE CENTRE



## BENCHTEST BUSINESS SYSTEM



# SIRIUS BUSINESS

**Peter Rodwell tests the  
ACT Sirius 1—16 bits for the price of eight**

Chuck Peddle is widely regarded as the man who started the personal computer industry. He designed the 6502 processor — now the second most widely-used microprocessor in the personal computer scene — and then designed the Commodore PET around it, thereby launching the first generation of true microcomputers.

Chuck has now left Commodore (and at the time of writing was involved in a complex, two-way lawsuit with CBM) and has started his own company, Sirius, the first product of which is the subject of this Benchtest.

The Sirius 1 is Chuck's idea of a 'third generation' microcomputer. The first generation, he says, comprised machines such as the PET and Apple; the second consists of the sort of machines now being offered to the business market — 64k, twin-disk micros with 8-bit processors. The third generation he defines as being based around 16-bit processors and plenty of memory and offering advanced features such as very high resolution graphics and good ergonomics; above all, he

says, they should be designed for the end user rather than for the programmer, and should be regarded by the user not so much as a computer but as a piece of business equipment.

The Sirius 1 reflects these criteria in that it has been designed for the end user rather than for programmers or computer freaks. In this country it is being sold through software house ACT and is known as the ACT Sirius 1; in the States a similar deal has been done with a distributor and the machine is known there as the Victor 9000. The basic Sirius comes with 128k of RAM, twin minifloppy disk drives, a VDU and keyboard and software which includes CP/M-86, Microsoft's Basic-86 and various utility packages.

### Hardware

Three modules make up the Sirius system: a main cabinet housing the processor, RAM, power supply and disk drives; a display unit which sits on top of the main cabinet on a turn-

table which allows you to rotate and tilt it and a low-profile keyboard unit.

Opening up the main cabinet immediately reveals one important aspect of the hardware design — it's easy to get at and service, which should reduce maintenance costs. The back panel is secured by two screws and, with this removed, the unit's lid simply unslots to allow easy access to the internals. At the back there's a heavily shielded power supply module, which can be removed simply by slackening half a dozen screws. At the front are the disk drives, under a PCB containing their control circuitry, all of which are similarly easy to remove.

The processor, 128k of RAM (Hitachi 64k chips) and all the other electronics are sited on one large PCB at the bottom of the cabinet; this slides out completely, allowing field maintenance staff to simply replace the entire board in the customer's office within minutes; faults can then be corrected back at the workshop while the client carries on computing. This is just as well, for only five chips in the whole system are socketted.

The CPU is an Intel 8088, running at 5 MHz. This is a 16-bit micro internally but looks like an 8-bit processor to the rest of the system, thus offering the power of a 16-bit micro with the lower system cost of an 8-bit engine. It's the same processor which IBM chose for its Personal Computer and which will be appearing in a number of new machines, including several from Japan, during the course of 1982. Cost-effectiveness apart, its big advantage is that it is code-compatible with the Intel 8086, a full 16-bit micro, and can thus run software developed for the '86, including, most importantly, the CP/M-86 operating system from Digital Research.

Four sockets are provided on the main board for add-in cards. Three of these will be used by people wanting to expand the system to its full half-megabyte internal RAM capacity, by adding 128k expansion cards. An external expansion unit will be available in the future to expand the memory to the full megabyte possible with the 8088. As can be seen from the memory map, things aren't quite as simple as with an 8-bit machine — various parts of the memory are reserved for system use (screen, interrupt vectors, character dot patterns, I/O ports, etc) and the expansion memory in fact slots into the middle of the map, with the operating system then being reconfigured to sit at the top of it.

Disk drives are usually pretty boring things but the twin 5¼in drives on the Sirius aren't — they each cram 600 kbytes onto *one side* of a disk. At the moment only single-sided drives are supplied, giving a total of 1.2 Mbytes of storage, but double-sided drives are on their way to give an incredible 2.4 Mbytes; I know of no other system which achieves this capacity on 5¼in drives. It's achieved by some pretty clever circuitry and software which, firstly, varies the number of sectors per track from 19 at the outer edge to 12 at the centre and then varies the speed at which the disk rotates according to which track the head is over, from 250rpm when it's at the outer edge to 350rpm when it's in the centre, in eight



steps. You can actually hear the drives changing speed, especially when copying a number of files from one disk to another; they hum at different pitches, sometimes in harmony — it can only be a matter of time before some bright spark writes a program to play tunes on them. The drives are actually quite noisy and when the heads are seeking back and forth across the disk's surface, the machine emits weird clucking noises not unlike a demented chicken. Quite what the effect on disk life will be as a result of being spun at 350rpm (normal speed is 300rpm) for some of the time, I'm not sure. Ordinary single-sided, double-density disks can be used.

The Sirius has three ports with which to communicate with the outside world. There's a parallel printer port which doubles as both Centronics standard and IEEE-488 and an asynchronous RS232 printer port with programmable baud rates from 75 to 9600 baud. A second serial port is provided for communication (ie, to other computers under a number of protocols) at baud rates between 1200 and 9600.

One very unusual feature is an on-board Codec speech digitiser which allows you to store speech on disk and play it back through a built-in loudspeaker! Unfortunately, the machine doesn't come with any means of inputting speech — there's no internal input amplifier, let alone a jack socket for a microphone. A small mic and amplifier will be available as an extra as it's thought that software houses rather than end users will be doing the speech input — adding verbal prompts and messages to programs, for example. The quality of the replayed speech is quite good — not hi-fi but much better than synthesised speech.

A surprising omission is a clock/calendar with Nicad battery back-up, but an add-in clock card should be available in the Spring.

Two areas of memory are reserved for the display, one of the machine's outstanding features. In normal mode, the display is 80 characters by 25 lines. The 12in green screen monitor gives a

clear, steady display, of which the only criticism I have is that the screen has a fairly long-persistence phosphor — the image takes a few seconds to die away, which is rather confusing when listing a long program or scrolling through text. I understand that the current green display will eventually be replaced with an amber-on-bronze screen when one can be found with sufficiently high resolution, and a full colour screen is also promised in the future.

Like just about everything else on the machine, the screen is under full software control. A 4k area high up in RAM holds the characters to be displayed while lower down there's another area containing the dot patterns which make up the characters. Characters on the 80 x 25 standard screen are built up on a 10 x 16 matrix, which makes for very clear, elegant text indeed. But because the dot patterns are there in RAM, you can access them and change them using a utility program called Edot, of which more later. Up to 2048 characters can be held in RAM at any one time and character sets can be stored on disk and called into memory under program control.

Naturally the Sirius has graphics capability, a bit-mapped 800 x 400 display, in fact, finer resolution than any other microcomputer of this price range. In the graphics mode it's possible not only to display some very spectacular graphics but also to display finer resolution text, up to 132 columns by 50 lines, all perfectly readable!

The display allows dual intensity, reverse video and proper underlining, either under program control or from the keyboard. And, of course, brightness and contrast are adjustable (through eight levels), again under software control or from the keyboard — there are no controls at all on the

monitor itself. The loudspeaker's volume is similarly controlled, by the way.

The monitor is mounted on a turntable which allows rotation 42 degrees in either direction and it can be tilted upwards up to 11 degrees from horizontal. It has an anti-reflective coating on the screen.

The keyboard is wider than the main unit and has a firm, pleasant feel; it's



The disk controller PCB

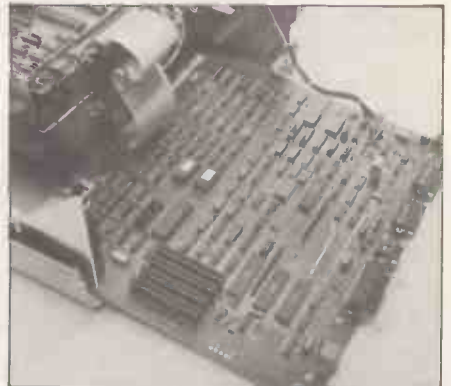

Main board contains 8088 and 128k RAM

Boot ROM	FFFFFH
Screen RAM	F0000H
Memory-mapped I/O	E0000H
Memory expansion area	20000H
CP/M-86 & BIOS	1A000H
User program area	2460H
Video dot RAM	460H
Boot vector table	40H
Interrupt vectors	0H

Fig 1 Memory map of basic 128k Sirius 1



Slimline remote keyboard is IBM Selectric format



# BENCHTEST

## BUSINESS SYSTEM

also relatively heavy (1.5kg) so it doesn't slide around on a desk top. There are a total of 95 keys, divided into several groups. The main group is, naturally, a full qwerty keyboard, laid out (according to Sirius documentation) in IBM Selectric format; IBM seems to have changed its layout recently, if our newly-acquired office typewriter is anything to go by, but the differences are minimal. At power-on the keyboard is in lower-case, but there's a shift lock key (with a funny padlock symbol on it), although no warning light to show when you're in upper case. Two unusual keys sit at the ends of the space bar, right where my fingers expect to find the shift key. One is labelled 'ALT' while the other is called 'CONT'. The ALT key is, in fact, the control key, while CONT, confusingly, isn't control but suspends whatever the computer's doing and resumes the operation at a second touch, useful for stopping fast-scrolling text or listings while you read them.

Across the top of the keyboard are seven large programmable function keys, only one of which was pre-programmed on the machine I used — it gave a directory command under CP/M-86. They are, of course, all user-programmable, although I would prefer to see more than just seven.

At the right-hand end of the keyboard is a numeric pad which includes percent, plus, minus, add and divide symbols but, strangely, no equals sign.

Between the numeric pad and the main block are two columns of keys controlling the cursor and, on the model I used, clearing the screen and deleting and inserting characters and lines. Pressing ALT with some of these keys gave control over screen brightness and contrast (eight levels) and loudspeaker volume. On the far left of the board is another column containing the escape and repeat keys and controls for the dual intensity display, reverse video and underlining.

The keyboard is fully debounced and has n-key rollover but it isn't encoded — it doesn't generate ASCII codes but 'logical key numbers' which system software converts to ASCII. This means that you can easily redefine any key to generate any character, a necessary feature when programming in Basic, as we'll see later.

Setting up the system is simplicity itself. All connectors are at the rear of the main cabinet (I would prefer the keyboard to plug in at the front) and all that's involved is for the video and keyboard plugs to be plugged in (they use different, keyed plugs, so it's impossible to get them mixed up or plug them in the wrong way up despite the lack of labels on any of the sockets, although there is a labelled drawing of them in the manual) and for the power to be turned on, again at the back of the main cabinet, where a reset button also lurks, sensibly out of harm's way. There is no power-on indicator, although the built-in fan makes so much noise that this

isn't really needed. It's a pity about the fan — it is noisy and it forms my only real complaint about the hardware design. The disks spring to life and inserting a system disk into the left-hand drive immediately causes the machine to boot up CP/M-86 without any further action required from the operator. All that's missing is an 'Insert disk . . . ' message on the screen, a la SuperBrain.

The review model came with CP/M-86 modified to run a voice program on boot-up—the operating system loaded, the disks clunked and chattered briefly and a sinister voiced announced: 'I am the ACT Sirius 1, the number one choice in business microcomputing'. I found this disconcerting the first time, mildly amusing the second time and very irritating thereafter; I cured it by simply erasing the voice program from the disk.

## CP/M-86

The first interface a user will have with the Sirius (or most other micros, come to that) is via its operating system. At the moment, the Sirius comes with CP/M-86, the 8086 version of the industry-standard CP/M operating system, written by Digital Research. This was my first encounter with CP/M-86 and, frankly, I was deeply disappointed. If you're familiar with CP/M, you'll know what I mean when I say that, to the user, CP/M-86 looks and behaves exactly like the old CP/M. You can now skip the next two paragraphs while I explain that remark to those who have never tried to use CP/M.

Back in the early days of microcomputers, a Californian called Gary Kildall wrote a basic (not Basic) program which would take care of all the boring nitpicking things a computer has to do, such as receiving character typed in at the keyboard, displaying it on a screen or printer and, especially, carrying out all the intricate work involved in using floppy disks. The idea was to make life easier for the programmer; all these 'housekeeping' routines were supplied so that the programmer could use them easily while writing his (assembler-language) programs, without having the trouble of re-inventing half a dozen wheels by writing them all himself. It had the added, and very considerable, advantage that it was so designed that a program written under CP/M on one machine would run perfectly well on another, completely different machine, providing that it, too, had CP/M on it. And CP/M could easily be configured to fit any machine which had an 8080, 8085 or Z80 processor and a minimum of 16k or RAM.

This ease of transferring programs from one computer to another did much to encourage the growth of the microcomputer industry, both hardware and software. An enormous number of machines are now available which run CP/M and there is a correspondingly massive and ever-growing amount of software available, especially language compilers and interpreters and some applications packages, particularly word processors.

The problem is that CP/M was designed to make life easy for the programmer — it does little to make things

easy for the user and in fact it's very unfriendly, with a nasty habit of displaying unintelligible error messages and stopping dead when something goes wrong.

In producing CP/M-86, Digital Research had the chance to make the system a lot friendlier and easier to use for the user but they didn't — they blew it. Various attempts have been made by other companies to produce CP/M-like operating systems which are more user-friendly; the one with which I am most familiar is Cromemco's CDOS, developed three or more years ago as an upwards-compatible version of the 8-bit CP/M (ie, you can run CP/M programs under CDOS, usually, but CDOS contains extra facilities which, if you use them, prevent your program from running under CP/M).

I'll give one example, comparing CP/M-86 with the older CDOS, to show what I mean about user-friendliness (and this doesn't mean that I regard CDOS as the ultimate in user-friendliness; it's just that it provides an indication of what can be done, quite easily, to make life a little easier for the user).

It's possible to write-protect a mini-floppy disk by placing a sticky label over a notch in its plastic envelope; this prevents the computer from altering the data on the disk or from adding new data to it. If you try to transfer a file from one disk to another which is write-protected, then CP/M-86 displays the following message: 'Drive=0, Track=7, Sector=0: Error =32 Bdos Err on A: Bad Sector' and stops dead. I defy any end user who isn't a programmer to make sense of that. CDOS, under the same circumstances, displays: 'Diskette in drive A is write-protected'.

There are those who would argue that a user shouldn't be trying to write to a write-protected disk; this is ridiculous, as it's one of those mistakes which everyone, even experienced users, make from time to time and an operating system should cater for it in a useful and helpful way, especially on a machine which is designed to be used by the rapidly-growing army of first-time end users.

In CP/M-86 and the Sirius, then, we have the curious combination of third-generation hardware running what is essentially still a first-generation operating system. Fortunately, when the machine goes into full production, it will be sold with Microsoft's operating system, MSDOS (which is virtually identical to the operating system that company produced for the IBM Personal Computer as well as CP/M-86).

From the programmer's point of

### BENCHMARK TIMINGS

BM1	2.0
NM2	7.4
BM3	17.0
BM4	17.5
BM5	19.8
BM6	35.4
BM7	55.9
BM8	42.5

All timings in seconds. For an explanation of the Benchmark tests, see PCW Vol 4 No 11, November 1981.



view, CP/M-86 is very similar to the 8-bit CP/M, but with added facilities; this, coupled with the XLT-86 package from Digital Research (which translates 8080 source code into optimised 8088/8086 source code) means that many software houses may initially be inclined to produce CP/M-86 packages for the Sirius rather than tackle the unknown MSDOS. This is a pity, because, although I have no first-hand experience of MSDOS, from all accounts it does sound far friendlier and easier to use than CP/M-86.

## Other software

Several packages were supplied with the review machine. Unfortunately, because they (and the machine) had only just arrived from the States, and because the machine itself was a pre-production model, not all of these were usable, mostly because of a lack of documentation.

The first package I looked at was Microsoft's Basic-86, an 8088/8086 implementation of that company's MBasic V5.0. It was pretty standard, with one or two minor alterations but when I ran the standard Benchmark tests I found it appallingly slow. Quite why it was so slow, neither I nor the ACT software experts could figure out, but it could be that this version was a straight translation from the original 8-bit Basic and took no advantage of the 8088's superior computing power. I did discover a curious omission from the Sirius's keyboard when trying to run Benchmark 8, though. This involves exponentiation, for which the symbol required by Microsoft Basic is '^', this symbol isn't on the Sirius keyboard, although it's in the standard character set. The problem was solved by re-programming a 'spare' key on the keyboard to produce it, a problem which won't bother most end users but which will prove irksome to Basic programmers.

The slowness of the Basic will be overcome, though, as an 'extended business Basic compiler' is on its way.

A bog-standard version of WordStar came with the review machine. This was a very early version which hadn't been fully tailored to the system and thus made no use at all of the programmable function keys, relying instead on those tedious and difficult-to-remember control sequences (from which you'll correctly gather that it's not my favourite word processing package!). A fully-configured version is on its way, though, and a Version 3 will be available in March or April which incorporates SpellStar, currently a separate package.

A particularly frustrating aspect of the review machine was that there was no easy way to access its more interesting facilities, such as the hi-res graphics or the ability to do fancy things on the screen such as define windows or calling in different character sets from Basic, or to use the voice digitiser. Several demonstration programs were supplied which did all these things from Basic, but relied on masses of assembler language routines. There was, for example, a program called GRAF on disk which could be called into memory from Basic and which contained a number of assembler language modules for using the hi-res graphics;

unfortunately there was no documentation at all to enable me to use it. (Once loaded, it requires a CALL statement from Basic to a specific routine's address, together with a number of parameters, but without documentation it's impossible to find out what the correct addresses are, let alone know what parameters are required and what they do.) Fortunately, there's a whole team back in California working on documentation and GRAF will be fully documented when the machine goes on sale, as will all the other utilities.

Additionally, a new Basic should be available in March, called GW Basic (it's rumoured that this stands for 'Gee-Whizz' Basic!). This will incorporate a full set of graphic commands, such as PLOT, DRAW, LINE and BAR. I was pleased to hear this as, although many end users will simply be running pre-written packages (according to Chuck Peddle's philosophy for third-generation micros), there will still be many users particularly in engineering, science and education, who will want to do their own programming in a high-level language without having to dive into assembler to do anything fancy. Making the machine's facilities available through high-level languages will also speed up software development times, and consequently, lower software costs, too.

Earlier I mentioned a package called Edot, which enables the user to define or alter character sets. This I found a fascinating program indeed. Figure 1 shows the screen when Edot is running; the character dot matrix is displayed, together with the full character set currently in memory — you can read in other sets from disk and write your own-developed set to disk. By using the numeric pad, you can manoeuvre a 'blob' (it's up in the top left-hand corner in Figure 1) to any pixel you want displayed and a keystroke then lights up the cell at the blob's position. Simultaneously, the character you are building is displayed in normal, underlined, dual-intensity and reversed modes and is updated as you build it up, as are any other occurrences of that character on the screen if you happen to be working on a character in the set currently in use by the system.

Using Edot, you can call in any character set from disk and use it as the system's 'normal' character set. The demonstration disk contained several sets, including a handwriting-style script set, which looked decidedly funny when used with WordStar.

Again there was no documentation for Edot, but a booklet is under preparation to deal with the whole subject of character sets.

Other packages which will be available for the Sirius — some immediately, others fairly soon — include an Assembler, Fortran, Cobol, Pascal and PL-I for the programmers and application packages such as ACT's Wordcraft, its Pulsar integrated accounts package and products from other companies including Micro Modeller, Decision Modeller, Supercalc and Micro Planner.

## Documentation

As you'll have gathered by now, the review machine's documentation was far from complete. By the time you read

this, the machines should be on sale with complete documentation and there'll even be a full technical manual available in the Spring.

The documentation I was supplied with was all preliminary, the usual typed-on-a-word-processor-and-photocopied sort with occasional handwritten corrections and additions. Most of the important areas of the machine were covered, although there were a few gaps, which were quickly filled by the people at ACT. The final documentation will, apparently, be properly typeset, which is welcome news and, given Chuck Peddle's obvious determination to win the hearts and cheques of the end user, I would expect it to be of a high standard.

The only 'proper' documentation which came with the machine were Microsoft's Basic manual with an updating leaflet describing the differences between MBasic and Basic-86, which was clear and readable as all Microsoft documentation seems to be; and Digital Research's CP/M86 manuals, one entitled 'System Guide', the other called 'Programmer's Guide'. In fact, both seemed to be aimed totally at the programmer and would give an end user an even bigger shock than CP/M-86 itself. Some of the Sirius documentation mentioned a 'User Guide' for CP/M-86; this wasn't supplied but I hope it's a lot better than previous attempts by Digital Research to communicate with end users.

## Users and potential

Chuck Peddle designed the Sirius as a business tool, primarily one which would sit on a desk and run applications packages. As such, with tailored software, it will be a big success, especially at its low cost (which, incidentally, is very slightly cheaper here than in the States!).

The machine is very pleasant to use, CP/M-86 and the noisy fan excepted; I feel that any business user, either manager or secretary, will feel at home with the Sirius as, once an application package is up and running and the operating system is left behind, it reveals itself as a machine with many attractive features and into which a lot of very careful thought — especially on the ergonomics side — has been put.

I think, too, that the Sirius will prove useful and popular among other users, especially engineers, scientists and teachers. For these people, a much easier interface to the machine's facilities is essential and will hopefully be provided by the enhanced high-level languages which have been promised. In particular, the very high resolution graphics will be extremely attractive — there's nothing available to compare with the Sirius in

GOTO page 185

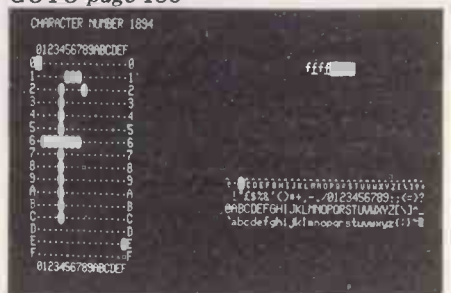

Fig 1 Edot in action

# THE NEW APPLE III

## MORE COMPUTER POWER ON YOUR DESK-TOP

Apple II has already captured the imagination of the world – and now we have introduced Apple III built to handle bigger problems – faster.

### MORE POWER

Apple III has a 128K processor (expandable to 256K), a built-in disk-drive with controller and an ergonomically-designed keyboard with sculptured keys and a separate numeric keypad. There's also a design-integrated monitor, Monitor III – with a full 80-column upper and lower case display.

But look closer and you'll find out why Apple III is unique, providing a total solution to business problems.

### MORE ABILITY

Apple III has a Sophisticated Operating System – the essential foundation for all software

developments. But the really big news is ProFile,<sup>SM</sup> the 5-megabyte hard-disk drive that's been developed for Apple III. Apple III and ProFile represent the ultimate in personal computer hardware.

Apple III can be programmed in Business BASIC or using Pascal III for a really powerful development environment.

### MORE CAPABILITIES

And, of course, there's a range of Apple Software for Apple III.

Apple Writer III – the complete word-processing package. VisiCalc III – the latest version of the most widely-used financial planning package – using the unique capabilities of Apple III. Mail List Manager – to allow you to create, sort and edit all kinds of mailing lists (and Mail List Manager interfaces to

Apple Writer III). Access III – a data communications package which allows Apple III to be connected to a larger computer or other Apples.

And already software developers have caught up with Apple III – creating software to handle ledger systems, database management, data communications and stock control – to cope with bigger business problems, faster.

### MORE INFORMATION?

Simply send back the coupon (no stamp required).

**Apple Computer (UK) Limited**  
Finway Road, Hemel Hempstead, Herts. HP2 7PS.  
Tel: Hemel Hempstead (0442) 48151  
\*Apple and ProFile are trade marks of Apple Computer Inc.

 **apple**  
**THE PERSONAL COMPUTER**



Please send me further details on the new Apple III and ProFile.  
I am interested in: –  Business Use.  Developing Software.  Dealership Details.  
Please complete this coupon and return it to: –

**Apple Computer (UK) Ltd,**  
Finway Road, Hemel Hempstead, Herts, HP2 4BR, FREEPOST.

Name \_\_\_\_\_ Position \_\_\_\_\_  
Address \_\_\_\_\_  
Telephone No. \_\_\_\_\_



## Malcolm Peltu looks at the latest micro literature

### Too much psychotech

#### FACE to FILE communication

A PSYCHOLOGICAL APPROACH TO  
INFORMATION SYSTEMS

Bruce Christie

I have believed for a long time that computing is too important to be left to computing people. After reading *Face to File Communication* by Bruce Christie, I am beginning to think that human beings are too important to be left to psychologists. This sour response represents my disappointment at a book which I had eagerly looked forward to reading. I was attracted mainly by its subtitle, 'A psychological approach to information systems'.

I expected to read something which accentuated the human element in computing and relegated technology to its rightful subsidiary role. Yet much of the book is littered with pseudo mathematical formula which are supposed to apply to human behaviour. As early as page 6, Christie says, 'The equation  $B = f(E, P)$  will be familiar to psychologists. It indicates that behaviour (B) — primary subject matter of psychology — is a function of the environment (E) and the person (P)'. It reminded me of an article written by Brian Smith of the Royal College of Art in the now defunct *Computer Age* in which he wrote of a student 'pursuing a Master's degree in advanced blindingly obvious things'.

Later on, Christie identifies personal computer users (like you, dear reader) as A ergs. Or even N ergs. (*But not nerds, I hope — Ed.*) It seems that people with assertive ergs (As ergs) are likely to be among those buying personal computers. People with high narcissism ergs (Na ergs) and Spouse Sentiment (Sw) support the introduction of systems allowing more work to be done at home. (An erg I gather hazily, is some psychological measure of motivation.)

But before I carry on with what psychologists will regard no doubt as a display of Ph ergs (Philistine ergs), I want to state clearly why I also like the book.

Firstly, and most importantly, the subject matter (human/psychological

aspects of information systems) is important but is rarely given the appropriate priority in books on computing. Christie treats the subject seriously. Many books treat human factors in computing superficially and as an add-on to the mainstream of computing. Christie stresses the key role of human factors in determining the ultimate effectiveness of a system.

There is a great deal of interesting material in the book, particularly in the two chapters on attitudes of managers and staff. Drawing on his own research as a consultant for Pactel, Christie explains how a group of managers were found to feel that the automated 'office of tomorrow' will be more 'impersonal, dehumanising, rigid, unyielding, fast, strong, colourless and boring'. And these negative attitudes remained even after the managers were told about the technical wizardry of the electronic office systems. Findings such as these are crucially important to systems designers, managers and others affected by information systems.

Now, back to psychologist bashing. It is because there is so much potential in the book that I was so disturbed by the pseudo-technical jargon used by Christie. Instead of opening up the subject to a wider audience, Christie builds up new, impenetrable barriers. At the start of the book Christie defines his target audiences as managers, psychologists, policy makers, trade unionists and equipment suppliers. Yet his academic style and over-liberal sprinkling of psychological jargon and conceptual psychological modelling is primarily appropriate to other psychologists.

My objection to the pseudo-maths in the book applies where Christie, in a particular psychological tradition, seems to treat people like elements in an equation. Of course, psychologists must use scientific and statistical analysis techniques in evaluating and analysing surveys. But this is different from trying to elevate psychological theories into apparently fixed and objective 'rules' through the use of mathematical notation and scientific waffle.

For example, he tries to define a First Law of Information Behaviour. He bases it on psychological 'laws' of intelligence and attitude. But giving it the name 'First Law' attempts to place it in the same category as the laws of thermodynamics, Newton or other scientific relationships. Christie's First Law of Information states: 'If any two items are selected from the universe of information behaviour items, and if the population observed is not selected artificially, then the population regressions between these two items will be monotone and with positive or zero sign.' I am afraid I do not understand what it means or why it was worth trying to define in the first place.

At the start of the book, Christie has a number of quotes ranging from Pontius Pilate to this one from the Rocky Horror Show which summarises my attitude to much of Christie's theorising:

'Crawling on the planet's face,  
Some insects, called the Human Race;  
Lost in time,

Lost in space —  
And lost in meaning?'

Of course, Christie could argue that I should take the effort to understand what he is writing about. Believe me Bruce, I tried, but I could not see that it would be worth the effort. If he is trying to broaden the subject to a wider audience, he should have avoided such obfuscation. And he should have taken more care to explain the statistical techniques used.

Christie spends a lot of time saying the obvious. For example, he more or less summarises the first hundred pages in one paragraph. What he is stating is that there are two levels in an information system. The superficial one is concerned with 'surface' activity — the machine used, the type of tasks done, etc. Beneath that is a deeper level relating to human interaction, motivation, attitude and other psychological behaviour.

I wanted him to start at this point, not to spend a third of the book leading up to it via various conceptual 'models' which I did not find particularly illuminating. I also find much of the evidence presented unconvincing and unworthy of the scientific aura he tries to create. Generally there appear to be rather flimsy, small-sample surveys trying to prop up woolly pseudo-scientific theories. Christie is aware of the hollow ground on which he stands. At one point he states that any item of Information (I) can be described in terms of its values on a set of Dimensions (D) as follows:

$$I = D_1 + D_2 + \dots + D_n$$

All this says is that there are many factors affecting information (such as content, relation to behaviour and organisational context, etc.) This is hardly worthy of an equation, particularly when he goes on to say that there could be an infinite number of dimensions. If there are an infinite number, it would be very difficult to come up with something meaningful. So he says they could be restricted to just four meaningful dimensions in any given context.

When he goes on to discuss specific evidence for theories he frequently adds disclaimers like: 'These judgements should be regarded as hypotheses rather than facts and should be interpreted with extreme caution'. As a 'lay' psychologist interested in human factors in information systems I found Christie's book valuable, precisely because of what I regard as its flaws. It gave me an insight into the type of work industrial psychologists are doing and to their limitations.

Psychologists seem to be losing sight of human beings, buried beneath a welter of statistics, theories and PhD theses. Stripped of the jargon and conceptualising, there is a kernel of important truth in Christie's book of importance to managers, users, systems designers and other 'ordinary' people. Perhaps if Christie tries to address this lay audience and forgets about his psychological peers, this kernel would be easier to find and would be of greater practical benefit.



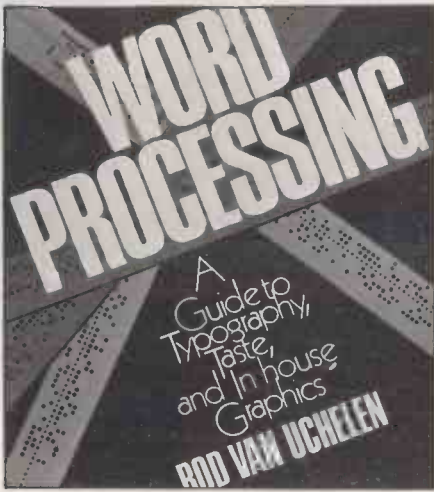

## Word pictures

'Understanding of the individual is more important than the function of the machine; it is the individual who fashions the product.' That is the credo of Rod Van Uchelen, who provides an interesting new angle on an increasingly well-worn theme in *Word Processing — A Guide to Typography, Taste and In-house Graphics*.

The title concisely summarises the contents. Van Uchelen began his career at Walt Disney Studios, has taught at the Hollywood Art Centre and has written a great deal about graphic design in publishing. He has now tried to relate his artistic perspective to electronic office and other new information technology. He is pretty weak on computer technology but very good on filling in the background to the development of typographic design and the aesthetic layout of printed (or word processed) pages.

His introduction to computing is confused and confusing. 'The computer itself consists of areas for input, processing, and output... the information must be on the ON or OFF current for input...' is a typical botched technical snippet. He gets his computing knickers into even more of a twist when trying to talk about how the 'Supervisor' software works. He is, 'however', much stronger on the systems aspects of electronic information technology. Although he overemphasises his own printing/graphic design background, he shows how traditional printing technology is converging into the same integrated information network as word processing and office automation.

An important issue raised by Van Uchelen is whether automation diminishes or enhances creativity. He points out that the power and flexibility of modern word processing and typesetting gives the designer a great deal of extra choice and flexibility from which to select the most appropriate form. Yet he also explains, 'The systematisation of required by the computer led to an increased use of formats. A new concept of typographic design began to emerge with automation and word processing. The discipline imposed by the system, for all its convenience, stereotyped design.'

The bulk of the book is a well written and well presented resume of the art

of typography, questions of selectivity and taste in graphic design and the role of the 'typographer' to straddle the traditional functions of typist and typographer. Van Uchelen believes that the spread of office automation will mean that more and more organisations have sufficient demand for automated printed output to warrant the employment of specially skilled staff to ensure that any typed or printed material is made more effective by being more aesthetically pleasing.

Although much of the book has little to do with word processing as such (it applies to graphic design using any printing method), Van Uchelen makes the important connection between art and automation. Despite its cockeyed technical intro and superficially positive tone about the impact of automation on creativity, I found it a stimulating and interesting book.

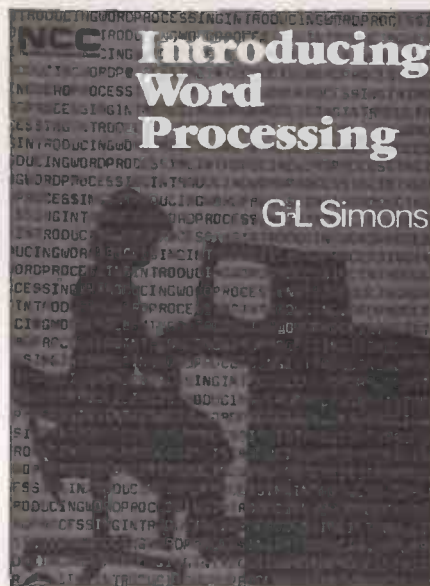

## Vanilla WP

*Introducing Word Processing* by G L Simons is a good plain-vanilla in guide to the subject. It is a straightforward, no-frills basic tour of word processing that does not try to extend its appeal into exotically tasty byways.

There are six main sections: background; components and capabilities; data processing and software; selection and implementation; the people aspect; and the future. A bibliography is associated with each to provide further, more detailed reading.

Simons places word processing into both historical and technical perspective — and he remembers to put people firmly into the word processing equation. He describes electronic typewriters, various types of word processors, and computer-based WP systems. Particular products mentioned include WordStar and Magic Wand, the Wang integrated word and data processing system and the Qyx and Olivetti electronic typewriters.

Simons draws together the research and writings of others to produce his own excellent objective evaluation of the current state-of-the-art understanding of word processing.

Although there are other books which provide a technical and product overview, there are few which give

as much weight as Simons to human aspects, such as the impact on employment, training, motivation, health, ergonomics and industrial relations. This human ingredient incorporated into the plain vanilla-flavoured base gives depth to this cool concise but comprehensive beginner's guide.

## YY UR YY UB, IC UR YY4 ME \*

From A for Accumulator to ZRTE for Zilog Real Time Emulator. Claude P Wrathall has made a comprehensive collection of items in his *Computer Acronyms, Abbreviations, Etc* (I like the inclusion of 'Etc' in the title of a book about abbreviations — according to Wrathall, ETC means EasyCoder to Cobol or Extended Text Composer).

Wrathall includes some company names and products (Apple and PET) as well as acronyms and abbreviations. He is pretty thorough (there are well over 120,000 entries). I could not think of an abbreviation or likely name that was not included, except the names of some British products.

Being American, there is naturally a heavy orientation towards Stateside usage but he does have a healthy sprinkling of British and other European terminology. He encompasses the mainframe, mini, micro and software industries and usefully includes definitions of various standards like the X. series of telecommunications specifications, of which X.25 is probably the most famous.

If anything, Wrathall is too meticulous. For example, he says that the

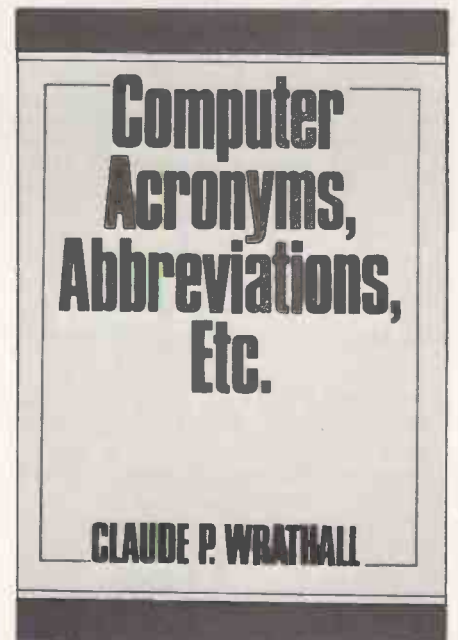

letter C could be an abbreviation for Capacitance, Capacitor, Carry, Celsius, Centi, Centigrade, Clear, Clock, Computer, Constant, Control, Controller, Counter or the name of the program language C. But in a dictionary like this, overkill is better than skimpy-ness. All all, an excellent reference book.

\*The meaning of the heading (not included by Wrathall) is: 'Too wise you are, too wise you be, I see you are too wise for me.' Geddit?

GOTO page 189





# ingenious!

... that's the only word to really describe the superb Genie microcomputer system, the home compatible with the TRS 80, and ideal for enthusiasts, especially the committed Genie has now been upgraded to Genie I, incorporating all of the original, excellent features, but with the addition of:

- Extended BASIC, including RENUMBER and SCREEN PRINT.
- Full upper and lower case, flashing cursor and auto-repeat on all keys.
- An internal SOUND UNIT to add a new dimension to your own programs.
- A MACHINE LANGUAGE MONITOR, with Display, modify, enter and execute (with break points) facilities.

Genie I has all of this, plus the built-in cassette deck, 16K RAM, 12k ROM with BASIC interpreter, full-size keyboard, an extremely wide range of new and updated peripherals, and literally 1000's of pre-recorded programmes available. Yet, almost unbelievably, the price of Genie I is even lower than that of the original Genie.

the superb Genie computer which is all micro-hobbyist.

## Ingenious for business



The Genie II is a major breakthrough for small business computers. Harnessing all the advantages of Genie I, including low price, Genie II adapts perfectly to commercial functions with the following features:

- Numeric keyboard
- Four usable, definable function keys.
- Extension to BASIC
- Basic business commands
- Fully expandable with the same peripherals

## New!...12" Monitor

Now, a choice of 2 monitors giving a clear easy to read image. The updated EG101 has a new green phosphor tube.



## New!...Expander

An updated Expansion Box (EG 3014) is a major feature of the new Genie I system, and unleashes all its possibilities, allowing for up to 4 disk drives with optional double density. It connects to a printer, or RS232 interface or S100 cards. There is 16K RAM fitted and it has a new low price!

## New!...Printer

The EG 602 printer can be connected to the Genie either through the expander or directly into the computer using the Parallel Printer Interface. It is a compact unit, with an 80 column, 5 x 7 matrix print-out, operating quietly and efficiently at 30 characters per second.



## Disk Drive

As well as the obvious advantage of mass storage, the addition of the disk system to the Genie means much faster access to other languages and full random access file handling. Up to 4 of these 40 track drives can be used on a system.



## SPECIAL TECHNICAL GENIE

### HOT - LINE ON 0629 4995

for all your technical advice and service back-up on any aspect of the Genie system direct from the experts!

For full details and demonstration of Genie I, Genie II or advice on any aspect of the system, either call in to your local dealer, or write directly to the sole importers at the address below.

# LOWE

## electronics

Chesterfield Road, Matlock, Derbyshire DE4 5LE.  
Telephone: 0629 4995. Telex: 377482 Lowlec G.

# Start talking business



## with your Apple

COBOL is the most effective business language.  
Apple II is the most friendly business computer.  
CIS COBOL with FORMS-2 brings together the best features of COBOL and Apple to enable you to deliver the most effective, user-friendly applications.

**Business Programmers:** Take the COBOL expertise you have acquired on big business mainframes, and use it on Apple II to create friendly applications that will talk directly to your users – where it suits them best, on their own desks.

CIS COBOL's dynamic module loading gives you big application capability and the FORMS-2 source generator lets you build and modify conversational programs from visual screen formats, creating much of the code automatically.

**Application vendors:** CIS COBOL with FORMS-2 steps up the pace for your development of the high quality professional application packages needed today. And creating them in COBOL makes them more maintainable.

Over half the Apple II's now being sold are going to business or professional users so demand for quality applications is growing fast, creating big business opportunities for you.

### **Stability proven by the US Government.**

CIS COBOL has been tested and approved for two consecutive years by the US General Services Administration as conforming to the ANSI '74 COBOL Standard. Apple II under CP/M is included in CIS COBOL's 1981 GSA Certificate of Validation (at Low-Intermediate Federal Standard plus Indexed I-O and Level 2 Inter-Program Communication).

**Get your hands on CIS COBOL at your Apple dealer.**

**Talk business with him now!**

Micro Focus Ltd., David Murray John Tower,  
Brunel Centre, Swindon, Wilts., SN1 1NB.  
Phone: (0793) 695891. Telex: 444418 MICROF G



## MICRO FOCUS

CIS COBOL with FORMS-2 for use on the Apple II with CP/M is an Apple Distributed Product.  
CIS COBOL and FORMS-2 are trademarks of Micro Focus. CP/M is a trademark of Digital Research. Apple II is a trademark of Apple Computer.



# WANTED - BETTER MONITORING



\*Measured at 3dB down.

SPECIFICATIONS: Input Signal: Composite Video, Negative SYNC.  $1.0 \pm 0.2V$  p-p, 75ohms. CRT Size: 31cm (12" diag). CRT Colour: P31 Green. Video Amp Bandwidth: 18MHz. Display Area: Hor. 21cm x Vert. 15cm. Display Format: 1920 Characters Max. Scanning Frequency: Horizontal 15.80kHz, Vertical 50Hz. Power Input: AC 230V, 50Hz. Power Consumption: 26W. Dimensions: 32 (W) x 27.9 (H) x 30.8 (D)cm. Weight: 7kg.

Sole UK Importer and Distributor:

## Micro Peripherals Ltd.

61 NEW MARKET SQUARE, BASINGSTOKE, HAMPSHIRE.  
Telephone: BASINGSTOKE (0256) 56468 (4 lines)

JAPANESE OFFICE: 101 Abe Bldg, 4F, 2-42 Kanda Jinbocho, Chiyado-ku. Tokyo, Japan.

WHOLESALE AND DISTRIBUTORS OF QUALITY JAPANESE MICRO PRODUCTS



**BMC** INTERNATIONAL

No. 27, 5-Chome, Tanimachi, Higashi-Ku,  
Osaka 540, Japan.

# NEC PC 8000 PERSONAL COMPUTER.

**"THE ELECTRONICS ARE EXCELLENT  
AND IT IS SUPERB VALUE FOR MONEY."**

**PERSONAL COMPUTER WORLD.**

Eight colour graphics, ten programmable function keys, a full qwerty keyboard with numeric key pad, alternative graphic and character sets, and superb editing facilities including definable scroll area.

Now at last you can have all the features you want in one expandable system with memory from 32K up to 190K for user application and prototyping facilities for industrial and scientific use.

As well as powerful N-Basic by Microsoft,\* full CPM compatibility gives access to a large library of software including Wordstar and compilers for Fortran, Pascal, Cobol and Basic 80 languages.

N-Basic packages are already available for sales, purchase and nominal ledgers, invoicing, stock control, payroll, information retrieval and word processing.

And when you consider the cost/performance ratio, NEC is even further ahead.

The NEC PC8000 Personal Computer is available through your local dealer now.

Complete the coupon or call the distributor IBR Microcomputers on Reading (0734) 664111 for the name of your nearest dealer.

\*Microsoft is a trade mark.



Please send me complete details on the NEC PC8000 series and the  
Name \_\_\_\_\_  
Company \_\_\_\_\_  
Address \_\_\_\_\_  
Tel. \_\_\_\_\_  
address of my local dealer.



**IBR  
MICROCOMPUTERS**

Suttons Industrial Park, London Road, Earley, Reading.  
Tel: 0734 664111. Telex: 848215.

A MEMBER OF THE IBR ELECTRONICS GROUP.



# FOILING ORIGAMI MERCHANTS!

Do your friends and colleagues drop by to 'borrow' back issues of **PERSONAL COMPUTER WORLD**? And 'forget' to return them?

Does your mother/father/sister/brother use 'those old magazines you left lying about your bedroom' to line the budgie's cage, the cat's litter or to practise the ancient art of origami?

Do people in your organisation filch issues of **PCW** from your office while you're absent and then write their own Department's name on them?

And do you ever find grinding your teeth back

yourself because our issues advertisement tells you an issue you urgently need to

consult is now 'out of stock'? And your original copy has long since vanished.

## THERE IS A SOLUTION

**PERSONAL COMPUTER WORLD Binders** will keep your copies of Britain's Largest Selling Micro Magazine in pristine condition. They are sturdily made, goldblocked front and spine and designed to hold a year's supply. (We recently enlarged their capacity to deal with the growth in pages of recent issues). And they not only make quick reference a reality at last, but look pretty impressive to boot.

The coupon is at the foot of the page. The price is only £3.25 each (and that price will almost certainly increase shortly) and includes all postage and handling.

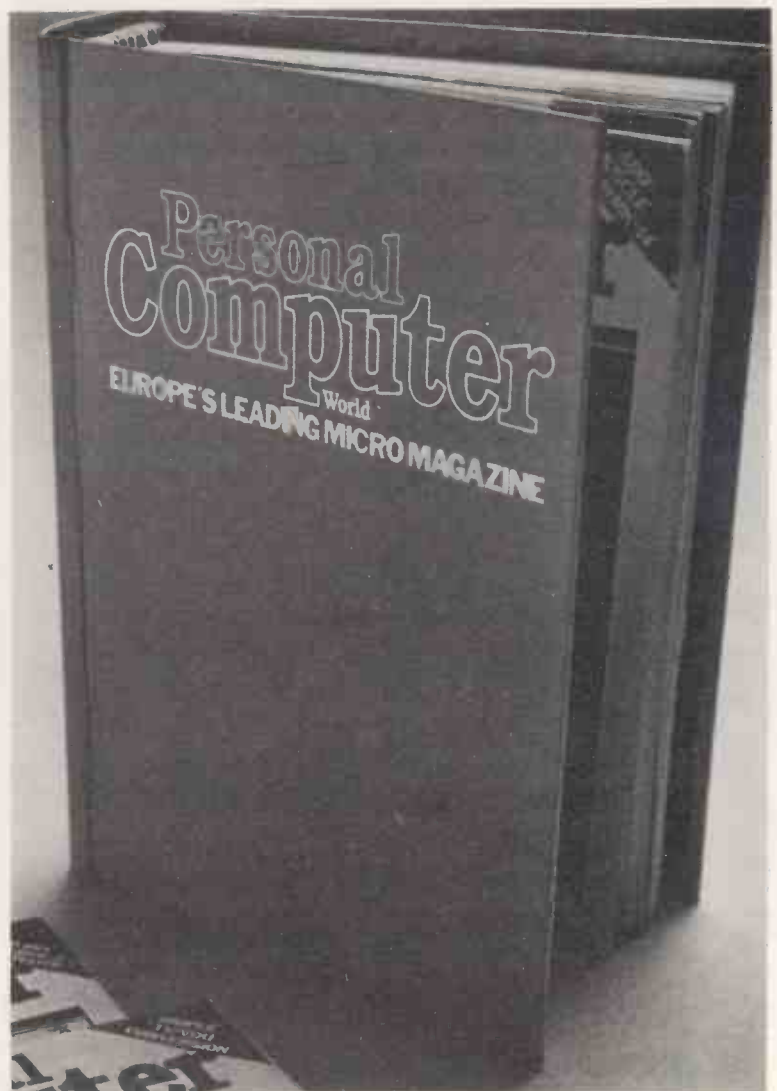
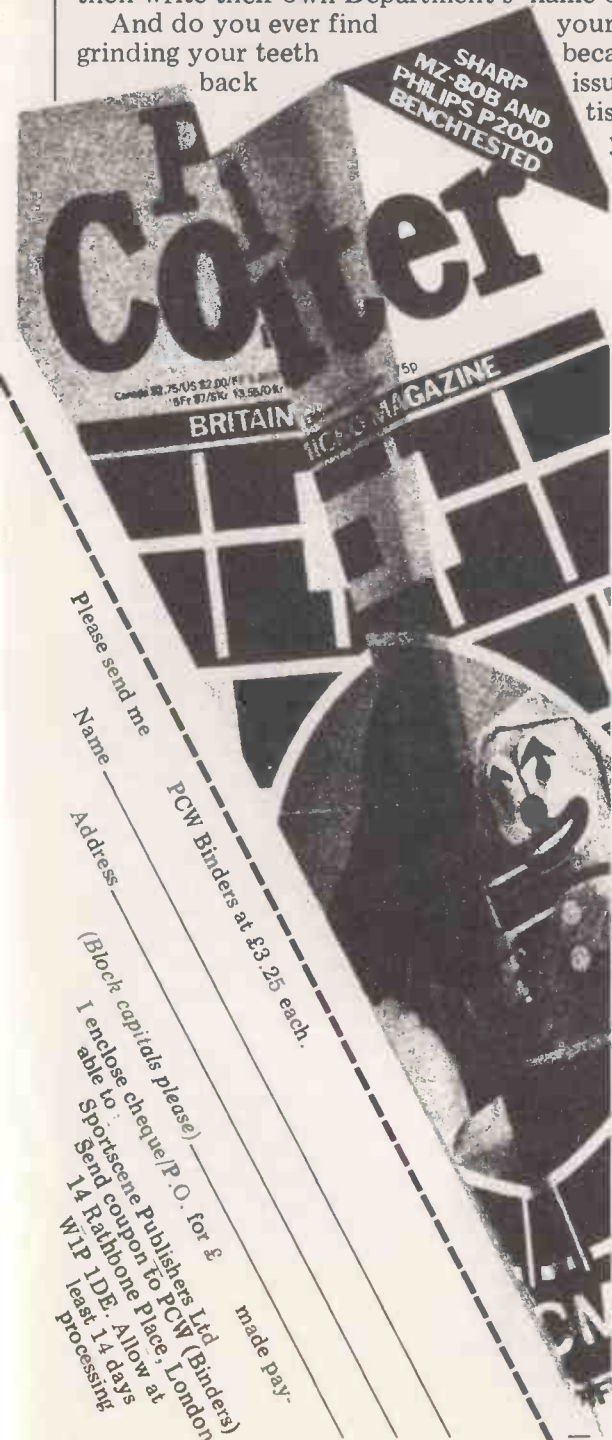

Please send me

Name \_\_\_\_\_

Address \_\_\_\_\_

PCW Binders at £3.25 each.

(Block capitals please)

I enclose cheque/P.O. for £ \_\_\_\_\_ made pay-  
able to Sportscene Publishers Ltd (Binders)  
Send coupon to PCW (Binders)  
14 Rathbone Place, London  
W1P 1DB. Allow at  
least 14 days  
processing.

**Comart Approved  
Dealers**

**Aberdeen**  
MOM Offshore  
21 Bon Accord Street  
Tel: 0224 22863

**Belfast**  
O & M Systems  
95 Dublin Road  
Tel: 0232 49440

**Birmingham**  
Byteshop Computerland  
94/96 Hurst Street  
Tel: 021 622 7149

**Bristol**  
Senton  
27 Nicholas Street  
Tel: 0272 276132

**Cambridge**  
Toltec  
24 Thompson Lane  
Tel: 0223 312347

**Cheshire**  
Holdene  
82a Water Lane  
Wilmslow  
Tel: 0625 529486

**Dublin**  
Lendac Data Systems  
8 Dawson Street  
Tel: 0001 372052

**Edinburgh**  
Holdene Micro Systems  
48 Great King Street  
Tel: 031 557 4060

**Glasgow**  
Byteshop Computerland  
61 Waterloo Street  
Tel: 041 221 7409

**Leeds**  
Holdene Micro Systems  
11/12 Rampart Road  
Tel: 0532 459459

**London**  
Byteshop Computerland  
324 Euston Road, W1  
Tel: 01-387 0505

Digitus  
9 Macklin Street, WC2  
Tel: 01-405 6761

Jarogate  
67 Tuisemere Road, SE17  
Tel: 01-670 3674

**Manchester**  
Byteshop Computerland  
Piccadilly Station Approach  
Tel: 061 236 4737

NSC Computers  
29 Hanging Ditch  
Tel: 061 832 2269

**Newbury**  
Newbear Computing Store  
40 Bartholomew Street  
Tel: 0635 30505

**Nottingham**  
Byteshop Computerland  
92a Upper Parliament Street,  
NG1 6LF  
Tel: 0602 40576

**Sheffield**  
Hallam Computer Systems  
451 Eccleshall Road  
Tel: 0742 663125

**Southampton**  
Xitan Systems  
23 Cumberland Place  
Tel: 0703 38740

**Suffolk**  
Eurotec Consultants  
Little Walsingham,  
Sudbury  
Tel: 0787 247959

**Surrey**  
Gemlines  
184 London Road, KT2 6QU  
Tel: 01-546 9944

**Warwicks**  
Business & Leisure  
Microcomputers  
Kenilworth  
Tel: 0926 512127

**Wattford**  
Lux Computer Services  
108 The Parade,  
WD11 2AW  
Tel: 0923 29513

**Worthing**  
Ace Computing Services  
1-11 Bridge Road  
Tel: 0903 35411

**Comart Ltd,  
St Neots, Cambs.**  
Tel (0480) 215005  
Telex 32514 Comart G.

# Trust Comart to turn a new ADVANTAGE

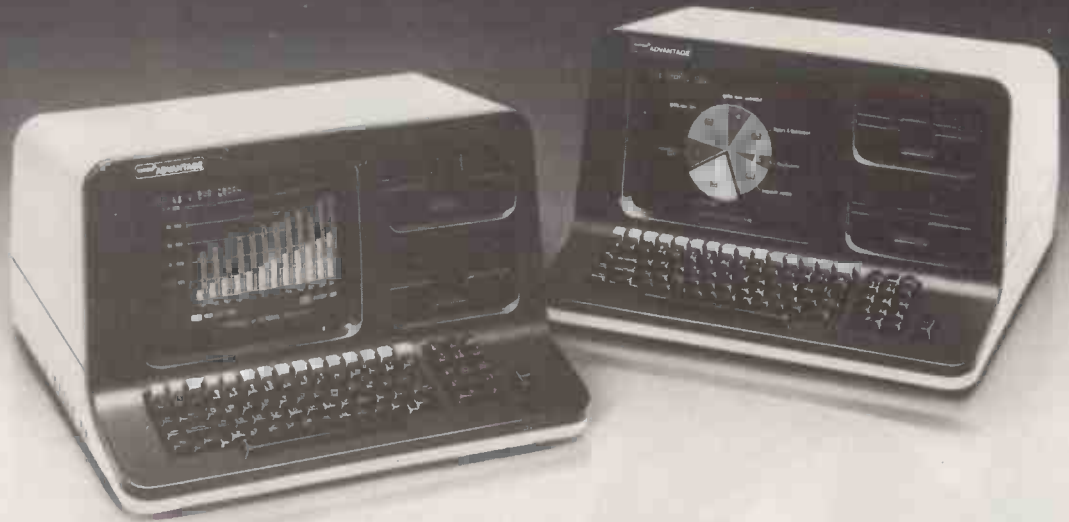

## into a major benefit.

ADVANTAGE is the exciting new, packaged high performance desk top computer with integral video screen. It brings the proven reliability, so long the hallmark of NORTH STAR products, into new and broader fields of application.

Add the established Comart technical, software, and service support and the ADVANTAGE becomes a major benefit to users looking for a low cost, yet versatile, dedicated system. NOW!

Just look at the benefits.

ADVANTAGE is economical: A complete integrated accounting system and word processing system will cost around £4500 depending on the printer and software used.

ADVANTAGE is versatile: You have the benefit of application software that is already available and proven on NORTH STAR Systems.

ADVANTAGE is new: It's Business Graphics can convert data into bar charts, pie charts, graphs, and 3D representations instantly. And, what you can see on the screen, you can print.

For the technically minded, Advantage is a 4MHz, Z80A based microcomputer with 64K dynamic RAM, a 20K Byte display dedicated RAM, plus 2K Boot PROM.

An auxiliary 8035 processor provides keyboard and disk control. It has a 12" green screen, and integrated twin quad capacity 5" disk drives providing 720K Bytes of data storage. It has a 87 key Selectric<sup>®</sup> style keyboard with 9 control keys, 14 key numeric/cursor control pad, 15 programmable function keys, and 49 conventional character keys.

ADVANTAGE comes complete with Business graphics, self diagnostic software and graphics demo software. Its G-Basic/G-DOS, and Graphics CP/M<sup>®</sup> are supersets of the industry standards. They enhance ADVANTAGE'S Graphic and Character Mode capabilities, and provide a consistent operating environment for development and application programs written in any other CP/M compatible language.

To see more of the benefits of the ADVANTAGE ask your Comart Dealer, or send now for further information.



# comart

SPECIALISTS IN MICROCOMPUTERS

A member of the Comart  Group of Companies.



# GEMINI MULTIBOARD

Neil Cryer reviews a versatile low-cost modular system.



Gemini Multiboard is an adaptable system of modules which can provide anything from a single board computer to a full CP/M disk system. The following modules are available: a Z80 CPU board, a 64K RAM board, an intelligent video board, a floppy disk controller board, a ROM board, an EPROM programmer, a keyboard and a power supply. The normal minimum configuration would probably consist of a CPU board, video board, RAM board, monitor, keyboard and power supply, with the boards plugged into a backplane for the bus that Gemini call 80-BUS, which is compatible with Nascom's Nasbus. All boards other than the EPROM programmer are 8in by 8in square and all but the CPU board can be used with a Nascom system.

With a RAM and video board and a software package called RP/M which is supplied with the CPU board, the system can run some CP/M programs from cassette tape rather than disk. This is an impressive achievement and makes for a remarkably low starting price for a CP/M system.

## CPU board

This board has a great deal of built-in flexibility. It can act either as a stand-alone controller or, with other boards, as a complete system, such as a software development system or a word processor, etc. The Z80A can be set to run at 2 or 4 MHz and there is a reset

jump facility to allow the system to start in a program stored on the board in ROM at any 4k address boundary. Four byte-wide sockets are provided to take RAM, ROM or EPROM in a wide variety of sizes. Wait states may be selected or not, depending on the speed of the memory.

All memory on the processor board can be switched in and out under software control. Thus a system could, for example, start from the RP/M monitor supplied with the CPU board, and then switch it out and perhaps run as an entirely RAM-based system.

A parallel input is provided for a keyboard and further input/output is via a Z80A PIO, giving two 8-bit ports. There is also a serial interface which includes programmable baud rates, full modem support signals for the RS232 interface and a 1200 baud Kansas City/CUTS tape interface. Switching between these is under software control.

The RP/M resident software on the CPU board is designed so that software written for CP/M may work without disks. Naturally, the cassette mimic of CP/M cannot substitute for all the disk facilities and can only cope with one single serial access file at a time. It will, however, allow loading of programs such as ZSID, the Digital Research dynamic debugging program, or Microsoft's disc MBasic. MBasic can then be used to write to, or read from, a file which is also on cassette tape.

RP/M supplies the usual series of

commands for examining and changing memory contents and ports, executing programs, shifting blocks of code and saving and loading tapes. Particularly useful is the screen editing. This is also available under CP/M (see under 'Video board' below).

## RAM board

Like all the boards, the RAM board is suitable for any system with the correct 80-BUS or Nasbus. It comes complete with 64k of dynamic RAM and uses 32 4116 dynamic RAM chips. It can be switched in and out of the memory map using a method which allows up to four memory boards on the bus at the same time. Which one is active is under software control.

## Video board

The video board is intelligent in that it has its own Z80 and 6845 video controller chip. All normal writing to the screen occurs during the line flyback time to give a continuous flicker-free display. There is also some spare memory which can hold the user's own programs irrespective of whether they are directly associated with the video display. The display is normally 25 lines of 80 characters, but there is an adjustable dot clock rate to run an alternative of 48 characters per line for a Nascom system. The normal character set is 128 in ROM with a further 128

# GEMINI MULTIBOARD

in RAM although the user could if he wished put it all in either ROM or RAM.

A keyboard socket is provided and Gemini recommends that it be used in preference to the one on the CPU board as then a buffer allows entering of further commands while still processing the current command. A light pen socket is provided.

The interface to the CPU board is via three I/O ports. The system requires a video monitor rather than a normal television to provide the necessary resolution for the 80 character line.

The documentation gives information and advice for users who wish to add their own programs to the VDU board and facilities are provided for programs to be downloaded from the main system to the CPU board where they may take part in the video processing or perform some completely independent task.

There are 51 separate control codes by which the main system can communicate with the video board. These provide a wide range of functions: the normal ones such as cursor positioning, insertion, deletion and scrolling, and many extras such as programmable characters, inverse video and a memory 'lock' (which allows only a definable portion of the screen to scroll).

I found only one (rather trivial) problem with this board which might be less noticeable on some monitors than others. The inverse video tended to show a slight drifting herringbone pattern across the screen. Nevertheless, I tended to use the inverse video because the black letters on white seemed easier to read on my small monitor.

The screen editing facility really comes into its own with CP/M programs, which are often frustrating through lack of editing facilities. The screen editing is initiated by merely touching the delete (DEL) key. The system acknowledges by changing the blinking cursor to a solid one. The cursor can be moved anywhere on the screen and any line can be edited — by overtyping, deletion and insertion — and re-entered as the new command line for CP/M. Although Gemini warns that there may be times when this facility gives unexpected results (due to CP/M programs not having been written with it in mind), it worked every time I tried it. I was very impressed.

## The disk controller board

This floppy disk controller board will control both 5.25in and 8in drives, although software is available for only 5.25in drives with a double-density, double-sided disk on drive A. Drive B can be double or single-density; Switching between densities is under software control. The board uses the 1979 chip and occupies five Z80 I/O ports. A phase-locked loop is used for data recovery and there is automatic motor turn off after ten seconds of no read/write activity.

## ROM board

The ROM board will hold EPROMs, which may be of more than one type,

and may be switched in and out of the memory map. This has been arranged so that data can be read from EPROM and written to RAM. In particular, the RP/M monitor provides a command whereby a program held in ROM can be copied to RAM at address 100H ready for execution like any normal CP/M program. An EPROM programmer is also available from Gemini. It does not plug into the system bus like all the other boards but is driven from a pair of ports.

## Other modules

Gemini supplies a keyboard for the Multiboard system, although any parallel output ASCII one should be suitable. Gemini also supplies Pertec disk drives and other ancillaries.

According to Gemini, the following ancillaries from other manufacturers are compatible with the Multiboard system: Arfon supplies a light pen and a speech board; the latter utilises the National Semiconductor Digitaltalker chip set which is somewhat similar to the speech board reviewed in the September 1981 PCW.

Quantum supplies an I/O board which offers three PIOs, a Z80 CTC and a battery-backed real-time clock. There is also a facility to accept a range of daughter boards, such as A/D and D/A, a serial interface and a fibre optic interface.

EV Computers supplies an IEEE 488 interface. This 80-BUS compatible IEEE-488 interface has much to offer in scientific and laboratory usage.

Both Vero and Winchester Technology produce a prototyping board.

## Software available

Many CP/M packages will run on Multiboard without any modification. According to Gemini, packages such as Wordstar will run if they are configured for a Lear-Siegler ADM 3A terminal. Also according to Gemini, the following software from other manufacturers is compatible and will run from cassette or disk. The GEM ZAP package combines a flexible editor with a fast assembler; — GEM PEN is a text editor and

formatter based on what is claimed to be a considerably enhanced version of NASPEN, a package presently available for Nascom systems. I regularly use NASPEN and am very happy with it but look forward to trying GEM PEN; — Pascal is being adapted for Multiboard by the author of the Blue Label Software recently adopted by Nascom as its standard;

— Comal 80 is a very topical language which has been receiving considerable press coverage recently. Borg Christensen, who was its originator, acted as consultant to Metanic, the producers of the Comal version being modified for Multiboard. The package offers extensive error messages in various languages. Gemini plans an attractive sales offer to purchasers of Multiboard.

## Documentation

There is a separate set of documentation for each module. The layout is clear and the information is sufficiently detailed for all normal purposes.

## Conclusions

The Multiboard system will appeal to owners of Nascoms 1 and 2 if they wish to expand to a disk system or to take advantage of the 80-column display and additional features of the video board.

The system will also appeal to many hobbyists who wish to start in a small way and expand with off-the-shelf modules. The CPU board, the video board, RAM board holding 64k memory, keyboard and power supply should be sufficient for starting purposes. Although a tape recorder would complete the system, it might be best to go for disks in the first instance.

For the more professional user, the CPU board could act as a stand-alone controller with space for plenty of RAM and ROM and one serial and one parallel port chip, the latter giving two 8-bit ports. Extra I/O may be provided by adding any number of I/O boards to allow as many ports, both serial and parallel, and counter timer chips as required. A daisy-chained interrupt system is implemented to allow rapid

GOTO page 187



A selection of the Gemini boards reviewed



**Cash price**  
 ONLY £595 + VAT  
 BEAT THAT FOR VALUE

# The DAI Personal Computer is

**\*High Performance\***

**\*High Value\***

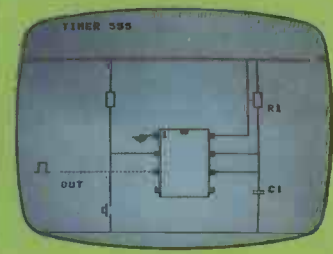
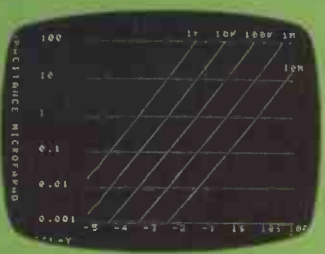
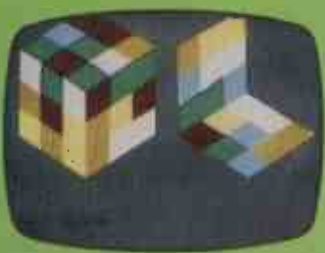

## Standard Features

- \* 24k Resident High-Speed Basic
- \* 16 Colour High-Resolution Graphics (255 × 335)
- \* Scrolling Screen Editor
- \* Sound Commands for Music Generation
- \* Very High Speed Hardware Maths Option
- \* Resident Monitor for Machine Language Programming
- \* 3 Programmable Parallel Ports
- \* Standard TV Interface via Aerial Socket
- \* RS232 Serial Port and Dual Cassette Interfaces

Manufactured by:

# DAI

THE  
 MICROCOMPUTER  
 ENGINEERING  
 COMPANY  
 Brussels, Belgium.

Available from:

## Data Applications (UK) Ltd.

Personal Computer Division  
 16b Dyer Street  
 Cirencester  
 Gloucestershire  
 GL7 2PF  
 Tel: Cirencester  
 (0285) 61902

For further information please complete and post to:  
 Data Applications (UK) Ltd, 16b Dyer Street, Cirencester, Glos GL7 2PF

NAME \_\_\_\_\_

ADDRESS \_\_\_\_\_

MY INTEREST IS: \_\_\_\_\_

# The *if* 800-Colour

## FEATURES

- Powerful Z-80A 4MHz Processor
- Memory 64K - 256K
- High Resolution Multi-Colour Graphics CRT
- CP/M\*
- Versatile, 'Easy-to-Use' BASIC
- Twin set of Programmable Function Keys
- Integral 80 cps Printer
- 400K x 2 Floppy disks

## OPTIONS

- 8 inch Floppy Disk Unit
- 10 mb Winchester Drive
- I/O Expander Unit
- 132 Column Printer
- Paper Tape Reader & Punch
- 5 inch Floppy Disk Unit
- XY Plotter
- Digitizer
- Light Pen
- ROM Cartridge

## INTERFACES

- RS-232C
- Centronics Parallel Interface
- IEEE-488 Instrumentation Interface
- Analogue-Digital and Digital-Analogue converters

## SOFTWARE

- Extensive range of business application software to meet all requirements.



**KGB Micros Ltd** 14 Windsor Road, Slough,  
Berks. SL1 1EL. Tel: Slough 38581/38310  
**Encotel Systems Ltd** 530-539 Purley Way,  
Croydon, Surrey. Tel: 01-686 9687



# in your Computing

The if 800 brings a new and colourful dimension to business and personal computing. Now you can enjoy and benefit from extensive multi-coloured graphics and a CP/M\* environment on the same compact system.

Built around a CPU using the high speed Z-80A processor, the if 800 combines

keyboard, hard-copy 5 x 7 dot 80 cps printer, twin 400K 5 inch floppy disk drives, high resolution colour display, and every type of interface into one complete unit.

Just look at some of the fantastic features, facilities, and options offered on the if 800 ....a truly versatile and fully integrated computer system

that more than meets the demands and varied applications in today's world of business information processing.

To discover the exciting new horizons of if 800 Multicolour Graphics computing, complete the coupon below or telephone us or our Distributors.

\* CP/M is a registered trade mark of Digital Research



COMPUTERS

Copse Road, St Johns,  
Woking, Surrey GU21 1SX

Tel: (04862) 23411 Telex: 859592

-----  
Please contact me with details of the if 800 today!  
Name \_\_\_\_\_  
Address \_\_\_\_\_  
Company \_\_\_\_\_  
Tel \_\_\_\_\_

# CASIO fx-9000p

Dick Pountain benchtests Casio's first fully fledged personal computer.

Casio emerged from the calculator wars of the 60s and 70s as the world's largest manufacturer of pocket calculators and has maintained this position by a policy of technological innovation combined with cheap pricing. Constant memory, LCD displays, 'credit card' size and various bells and whistles such as music,

clock and games facilities have been incorporated into its enormous model range with bewildering speed.

It is rather surprising, though, that Casio has been slow to enter the micro-computer market (especially as its full name is Casio Computer Co Ltd). Sharp beat it by a year to the first

pocket Basic computer (the PC-1211) and Europe has yet to see the subject of this review, Casio's fx-9000p desktop computer; in fact, this is something of a preview since no decision has yet been taken to import it to the UK, though it is already on sale in the USA. Whatever the reasons for Casio's reticence in the micro market, it is clear that it is determined to tread cautiously, by which I don't mean that it has followed fashion — far from it. Fashion would have dictated a 64k twin disk, CP/M-based business machine, similar to those now pouring from Japan. Casio has stuck with what it knows: the 9000 is a super-calculator, aimed at engineers and scientists and a niche which is currently occupied solely by the Hewlett-Packard HP-85. It is also quite unorthodox, from the quirky CA-Basic to the CMOS RAM storage.

## Hardware

The external packaging of the 9000 is compact, attractive and a shameless rip-off of the HP-85. The case is a high-quality plastic injection moulding in cream with a windowed hinged trapdoor covering the huge port next to the VDU screen into which fit four assorted memory modules. The VDU itself is a tiny 5in diagonal green screen job, which, despite its diminutive size, is eminently readable due to its fine resolution and a good (upper case only) character set. The display is 32x16 characters, or 255x127 dots in the point graphic mode, which means in practice that a fair bit of the tiny square screen goes unused. Brightness and contrast are adjustable by screwdriver at the rear of the cabinet.

The keyboard is of the calculator type, with keys like blown-up versions of those on the Casio 502. Although they are rebounded and have two-key rollover, the whole keyboard is too small and the gaps between keys too large for touch typing; this isn't a criticism since only a crazy person would want to word process on this machine. Instead, Casio has deliberately deviated from standard layout to facilitate two-fingered pecking by myopic scientists; commonly-used symbols like '!', '@', '#', '\$', '%', '&', '<', and '>' are all unshifted while all the numbers and arithmetic operators are on a separate keypad. 'Shift' doesn't give any lower case characters but single key entry of maths functions and Basic commands instead.

The numeric keypad has its own return key called 'COMP' which allows direct mode calculation without the need for 'PRINT'; a further nice touch is the 'ANS' key (imported from its

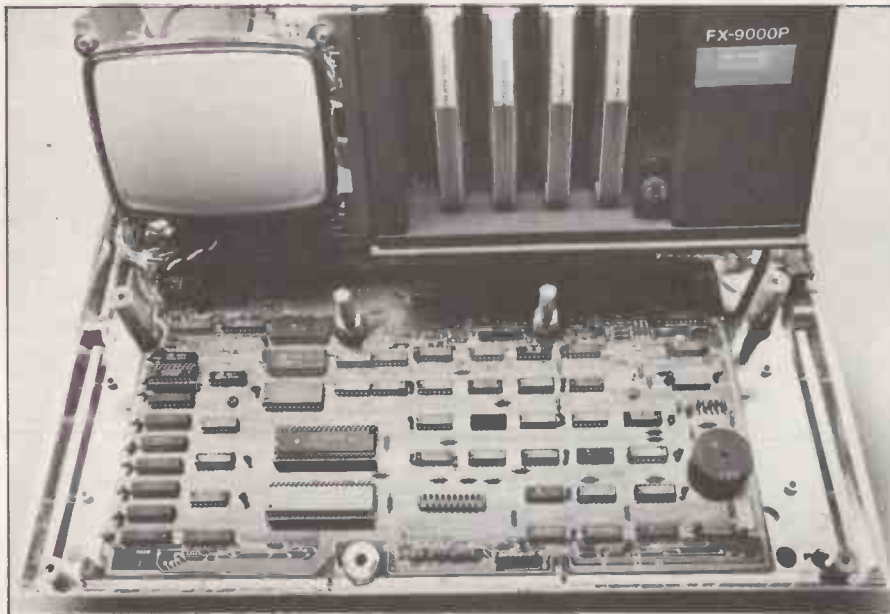

Main board, memory modules, power supply and dinky CRT.

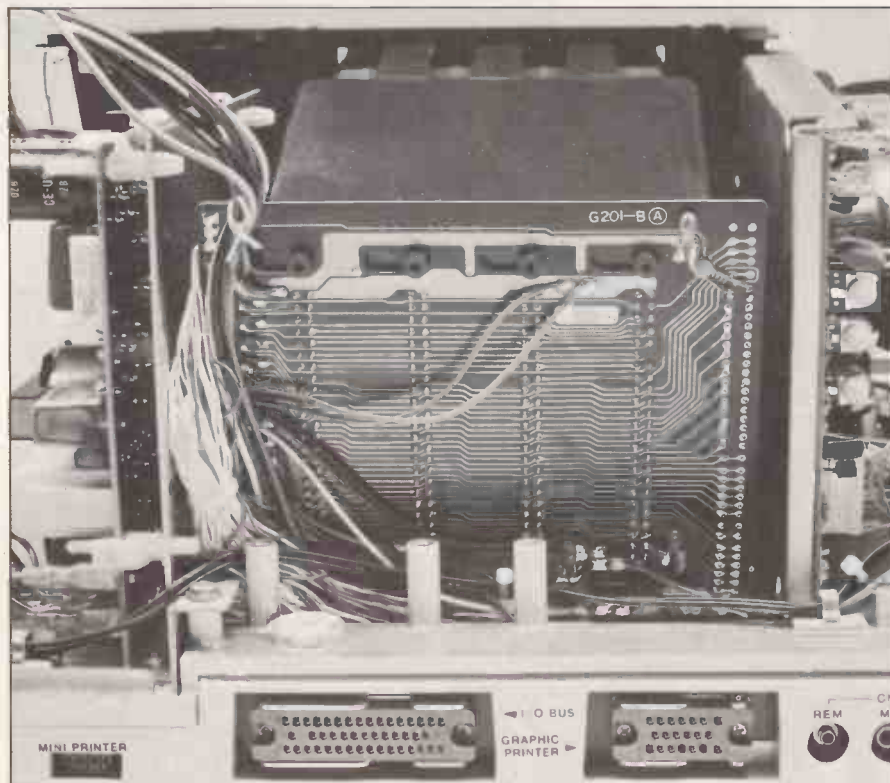

Expansion ports are on OP-1 adaptor; PCB is connector for memory modules.



latest calculators) which returns the result of the last calculation to the screen and is a godsend in long computations with ten-digit numbers. A 'STAT' key is provided for entering data to the comprehensive, built-in statistics routines.

Probably the most innovative and controversial aspect of the '9000 is its memory organisation. The machine comes with 4k of NMOS RAM and 12k of ROM, holding the CA-Basic, on board; the rest of the memory map is 28k of fresh air, divided into four slots and contained behind the hinged door. There are three options with which to displace this fresh air: 16k NMOS RAM, 4k CMOS RAM with battery protection, or 12k ROM modules. Only one 16k expansion may be added which must sit in slot one. Its contents evaporate on removal or power-off, of course. Similarly, only one ROM pack may be present which must sit in slot four. The one I have is an extended Matrix Handling Basic of which more later. Up to four CMOS modules may be added, using all the slots, which are removable with their contents held safe for up to three years by replaceable internal batteries. Although a cassette interface exists and Casio speaks of disks as a future option, they obviously see these modules as the principal bulk storage medium for programs, if not for data. Access to their contents is effectively instantaneous, faster even than hard disks. Nevertheless, I have reservations about the system, of which more is said below. A little mental arithmetic will soon

show that the maximum memory configuration is 32k (12k protected).

Physically, the modules are identical plastic boxes the size of a small paperback with a sturdy metal handle at the front and an edge connector at the rear, via which they plug into the slot. If less than four are fitted the slots must be filled from the left (1) in order to maintain contiguity of the memory map. You're probably wondering what they're going to cost; me too, and the viability of the system is crucially dependent on the answer.

When the case is removed, a single board of excellent layout and construction is revealed which contains all the chips, of which only the processor, its unidentifiable partner and, curiously, a single RAM are socketed. The processor is Casio's own 'Z80 compatible' (this is all the manual gives away) chip which runs at 2.75 MHz.

The internal construction shouts of cost-effective Japanese production engineering; not afraid of a custom connector where required nor too proud

for a strip of sticky tape where adequate. Ventilation of this small, tightly-filled space is simply via slots in the case top; when I accidentally left it running all night with a document half-covering these slots, it was barely warm in the morning (yes this is the sort of idiot you lend machines to, dealers!). The slots are covered on the inside with the fine nylon mesh to catch small objects — smart thinking. The built-in power supply is filtered and shielded, giving a rock-steady display on our alien occidental mains.

The underside of the case has a large shallow depression, the front edge of which has a slot through which an edge connector on the main board protrudes (BBC micro style). I was supplied with the optional OP-1 I/O adaptor which fits snugly into this depression and fixes by four screws. (It fits so snugly that one disingenuously wonders why it wasn't built in.) The rear edge, which is now the back panel of the computer, flaunts an I/O Bus connector (for disk and RS232C expansions), serial and parallel printer sockets (for Casio's own



# BENCHTEST

PERSONAL COMPUTER

miniprinter and the Epson MX-82 graphic printer) and three phono sockets for connection to cassette or reel-to-reel tape recorder, one of which is a remote control line. In addition, the OP-1 contains batteries and a real-time clock/calendar which is accessible from Basic and includes three independent alarms using the built-in bleeper.

## Software

The 9000 is programmable only in Casio's CA-Basic dialect, which sits in 12k of internal ROM. There is no mention in the manuals of machine-code operation and no obvious way into the monitor, nor any CALL or USR in the Basic.

CA-Basic is quite large with around 120 instructions, a large number of which have to do with graphics, maths and the handling of RAM files. The 'core' commands are Microsoft-like, particularly the control structures and string handling, but there are two glaring and curious omissions: there are no Boolean operators and no DEF FN statement. I suspect both will be sorely missed by the sort of scientific users the machine is aimed at. Less importantly, there are no AUTO, RENUMBER or TRACE commands for those used to the soft life.

The arithmetic is of 12-digit precision with 15 digits held internally and a dynamic range of 10+/-99, which is a

good deal better than most micros. Angular modes of degrees, radians and gradians are selected by the 'SET' command. The maths functions not found in 'ordinary' Basics include hyperbolics, factorial, permutation and combination, extensive statistics including standard deviation and linear regression, 'FRAC' as well as 'INT', and 'MODulus'. 'ROUND' rounds off numbers to a chosen number of significant figures. Additional output formatting is performed by PRINT##.## statements - no USING is required.

Another good feature carried over from Casio's calculators is the partitioning of memory into ten program areas assigned to keys P0 through P9 (the shifts of the numeric keys). Ten separate programs can be stored simultaneously and executed by a keystroke; the partition is dynamic and user-transparent. Full cursor editing is provided but, irritatingly, it must be summoned by the EDIT command which has the same syntax as LIST; you can't cursor up and edit a line you just entered, nor edit a LISTing, nor continue editing a line after hitting return unless you call EDIT again. The editor is exited automatically after the last line is reached. On the subject of LIST, it only takes one (optional) argument so you can only list from a named line to the end which is highly inconvenient when you wish to inspect ten lines in the middle of a program; this involves diving for the (shifted) Break key as the listing whizzes past the tiny screen. You can't slow the scrolling, either.

Variable names must be a single

upper case letter or letter plus one digit and the same goes for one and two dimensional arrays. String arrays and variables take the conventional '\$'. An interesting and useful (in its intended context) eccentricity of CA-Basic is that variables and arrays are not cleared by the RUN command but must be specifically erased by CLEAR DATA. A single named array may be cleared by ERASE (array name). By dimensioning and erasing arrays in a separate program (under a different key) matrix operations involving accumulation of data are easily done. Arrays may be dimensioned and redimensioned (by the REDIM statement) dynamically during run time; excess elements are lost or set to zero as appropriate.

These facilities are already ahead of most Basics but the Matrix Handling extensions in the ROM module widen the gap further. MAT READ (n,m) fills an n by m matrix with DATA 1,2,3... without the need for looping and MAT PRINT displays it in any chosen numeric format, though the small screen becomes embarrassing here; memory size is the other limit since in theory a 255x255 matrix can be defined. Functions are provided for matrix sum, difference, scalar and vector product, transpose and inverse and to create zero, unit and constant matrices and take the determinant. To give an idea of the speed, it takes 11 seconds to invert a 10x10 matrix and 130 secs to invert one 20x20.

On the subject of speed, inspection of the Benchmark timings will show that CA-Basic is far from fast and in particular is lamentably slow on trig

## FROM THE PUBLISHERS OF THE BEST SELLING BOOKS FOR THE SINCLAIR COMES:

**Not Only But Also...**  
PROGRAMS FOR THE SINCLAIR ZX81...IK

**Not Only**...does this book contain over 30 fully debugged and exciting programs, every one of which will fit into the basic 1K memory of your Sinclair ZX81 - including programs such as STAR WARS, LUNAR LANDER, BLACKJACK, MINI ADVENTURE, DRAUGHTS, BREAKOUT.

### But Also

- \* Detailed explanation of how these programs were written.
- \* Lots of hints on how you can write exciting programs for your ZX81.
- \* Numerous space saving techniques - obviously invaluable to the ZX81 owner.
- \* PEEKS and POKES and all the other 'complicated' functions are clearly explained.
- \* MUCH, MUCH MORE...

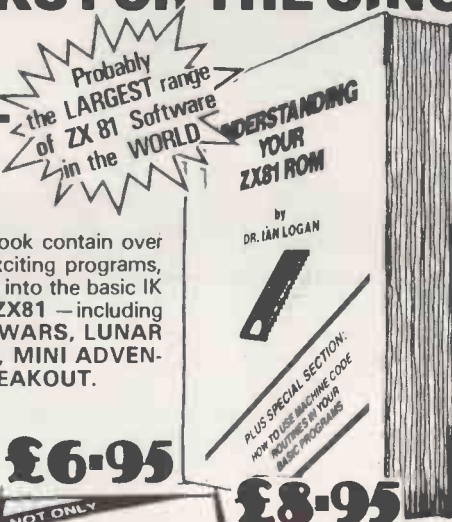

## Understanding Your ZX81 ROM

Plus special section: How to use machine code routines in your BASIC programs. by DR. I. LOGAN.

Dr Logan was the first person to disassemble the Sinclair ZX80 Monitor and was the co-author of the ZX80 COMPANION.

In UNDERSTANDING YOUR ZX81 ROM Dr. Logan illustrates all the facilities of the ZX81 Monitor, how it works and how you can use it in your own programs. A special section shows you how you can squeeze more power into your ZX81, by using machine language and machine language subroutines.

An essential book for those who really want to understand the full working of the SINCLAIR ZX81.

Published by MELBOURNE HOUSE PUBLISHERS LTD. Send Stamped, self-addressed envelope for FREE catalogue.

THE ESSENTIAL SOFTWARE COMPANY (Visconti Ltd)  
47 Brunswick Centre, London W1CN 1AF (01-837 3154)

- Please rush me NOT ONLY 30 PROGRAMS FOR THE SINCLAIR ZX81 1K: at £6.95 each
- Please also rush UNDERSTANDING YOUR ZX81 ROM by Dr. I. Logan at £8.95

I enclose a cheque/postal order for £..... +50p post and pack.

Name .....

Address .....



and logs (BM8) for one with scientific pretensions; to keep things in perspective, however, it's still 30 times faster than the fastest programmable calculator. I suspect that the Basic is slow because it uses neither tokens nor link-listing. Certainly when permitted abbreviations such as P. for PRINT are used they are not replaced by the full word when listed, and savings in both memory and execution time accrue when they are used.

The graphics on the 9000 are one of its most endearing features and are excellent for a machine of its size; in character mode it has a fully addressable cursor via the CSR(x,y) statement, in addition to TAB, and any character string may be displayed in reverse field by preceding it with REV which operates until cancelled by NORM. In the 'hi-res' mode the screen is dot addressable by DRAW(x,y) which cleverly doubles as a vector plot by taking multiple arguments; DRAW(a,b)-(c,d)-(e,f)-(a,b) draws a triangle between the named points. QUADx1, y1,x2,y2 is an even more compact form which draws a horizontal rectangle with the named bounds. CDRAW and CQUAD undrawn the corresponding figures. Both these commands may be modified, without having to change their arguments, in INIT(x,y),n,m which sets the origin at x,y and the axes of the axes to n and m.

If this still doesn't make graph plotting simple enough for you then the functions CHGX and CHGY convert co-ordinates from the current system (defined by INIT) to physical screen co-ordinates. Used in an IF statement they can trap off-screen errors and alter the co-ordinate system to fit a graph onto the screen. PLOT(x,y) is a flag which is true if dot x,y is illuminated.

Finally there are GIN\$ and GOUT, lovely words which have nothing at all to do with elderly military gentlemen, but enable 8x8 characters to be read from the screen or output to the screen in bit-image form GIN\$ reads a character as a string of eight characters whose ASCII values in binary define the bit-image; GOUT takes a similar string as its parameters and can be used in three modes 0,1, and 2 which respectively replace, overwrite or are logically ANDed with the previous screen content. GOUT is used in a PRINT statement and when used with GIN\$ enables characters or shapes to be moved about the screen without erasing the background. To summarise, these are powerful and well conceived graphics which make complex plots and charts a pleasure to program.

Finally, the file handling. Cassette files are created by perfectly orthodox SAVE, LOAD, OPEN, GET, PUT and CLOSE commands, the only icing on this cake being SAVE DISP and LOAD DISP which do just what they suggest to the screen contents; nice for fancy plots. A similar screen dump to the graphic printer is allowed. Password protection of program files is provided which prevents listing, editing, saving or loading unless the password is entered.

RAM filing is a different can of worms. Understanding its operation is really not much more difficult than say, Byzantine Theology but unfortunately, should you have trouble,

the requisite chapter of the manual appears to have been translated from Japanese to Maori to Urdu and finally into a sort of English.

As I understand it, up to 28k of RAM from the top down can be specified as the RAM File Area which is divided into seven RAM files and is protected from encroachment by the work area and from the effects of commands when so specified. Each RAM file is subdivided into two 2k blocks. The files are numbered from low memory up so that if you specify RFILE 6 you are only protecting the top 8k, the rest being still available as workspace until you specify a lower RFILE number (draw a picture, it helps). This is assuming a maximal 32k is present, in which case you will instantly see that files 1 to 4 are not in CMOS RAM, which is to say they are as much use as tits on a boar. If you have four CMOS packs present (20k total) then the first pack is reserved for workspace so that only files 1 to 3 are available (don't ask me why it isn't 2 to 4). On the review machine I have the 16k pack, two CMOS packs and the Matrix ROM which allows me to specify only files 4 and 5. I can, of course, save into a lower file but the contents will go up to heaven when I swith off (which they did until I sussed what was happening). I leave it as an exercise for the reader to work out what files are available with other combinations of packs (you are following this aren't you?). The point is that the software gives you no clue; when you RLIST you always get a list of seven files regardless of whether they're safe or not; they may not even exist since the RAM file is a purely logical entity.

Once you've found a safe file, RSAVE will put a program (from a single program area) into its first block. A second RSAVE puts another program into its second block. You may now remove this pack with your two programs safely stored in it; regardless of how short they are they are occupying 4k of (probably) expensive CMOS RAM. If a program is bigger than 2k it spills over into the next block unless this is already occupied, in which case the save is aborted without any message to that effect. If a program exceeds 4k it spills over into the first block of the next pack if present; if absent, you are prompted to 'SET NEXT BLOCK'. In no circumstances can you corrupt a previously stored program, which is a blessing. To retrieve your program, select a program area, clear it and RLOAD. Interestingly, this process does not automatically clear the loaded program area so, by cunning choice of line numbers, you can chain, overlay or even interleave programs. When no blocks are left you are prompted to 'SET NEW PACK'. With the configuration on the review machine I could only store four programs as I had no spare packs. All of the foregoing applies equally to data files which are created with ROPEN, RPUT RGET and RCLOSE and are sequential files. The net effect is as if you are working a strange floppy disk system where you have to decide which sectors to use instead of the operating system (and I doubt that floppies would have ever caught on if you had to)! The hardware works fine but the software

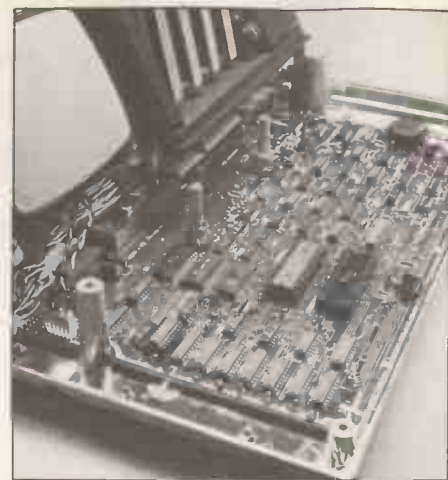

Black 'pillbox' is a beeper.

needs to provide better guidance and to be more transparent.

Even so, the system may find favour with sci/tech users when many smallish programs need to be quickly available, but whether or not it will prove cost-effective depends crucially on how much Casio decide to charge for RAM packs and when you consider what goes into them compared to a floppy disk, I'm not optimistic. In fact the US price suggests that they could be over £40 each.

## Documentation

Two manuals are supplied with the '9000, a thin flimsy Operation manual similar to those for the calculators, and a 180 page CA-Basic Reference Manual. The former is overly condensed though useful once you've made the initial strides. The latter is a fairly comprehensive account of the language and error messages though it makes few concessions to the novice programmer. It does, however, have programming problems at the end of each chapter with sample solutions at the back which are helpful. Both are marred by shaky English translations, the section on RAM files being only the most extreme case. Fortunately, the description of matrix operations is quite lucid.

## Expansion and potential

It's already quite clear what the potential use of the fx-9000p is. It's not designed for word or data processing and so is unsuitable for most business applications, though I could see possibilities as a desk-top machine in insurance, banking or broking. Whether it can cope as a management tool is doubtful since the small screen rules out Visicalc-type displays (unlike the Osborne it doesn't have sideways scrolling). It is not going to find favour with educationalists who are fighting to separate computers from mathematics and vice versa while hobbyists would want colour graphics or machine language depending on their bent. It is, in fact, aimed squarely at the laboratory, design office and study, as a superior number-crunching replacement for the programmable calculator. To arrive there, it has to compete with the HP-85; no direct comparison is possible because although

GOTO page 187

# The Systems

**RADER 1000 with Dual 5¼" drives**

**RADER 2000 with Dual 8" drives**

By combining the economy of using the most up-to-date techniques of microprocessor technology with the reliability of British design and engineering, these highly advanced systems of tomorrow are affordable and available to you today. Just look at what we're offering.

Start with the economically designed, free-standing keyboard, where your fingertips can glide easily over the 92 keys, which eagerly respond to your touch through innovative capacitive technology. It has its own intelligence, through its microprocessor control, enabling fast reliable response to your every instruction. A special feature is full diagonal cursor control for rapid cursor positioning (keyboard layout can be easily reconfigured for special applications).

Your eyes can rest comfortably on the 12" screen, with its clear, high resolution display, enabling quick decisions to be made from its clarity of output. The latest lowpower 5¼" or slimline 8" double-sided double-density precision drives provide accurate, fast retrieval of data from the highly efficient data store, which uses double-sided double-density floppy disk format.

The powerful heart of the system, its Z80 A microprocessor, pounds quietly and efficiently away at a rate of 4 MHz. It will obey your every instruction, and memorise every bit of information in its on-board 64K of dynamic RAM.

This highly flexible machine will communicate to the peripherals of your choice, through dual parallel or serial input/output ports. Future needs are well taken care of, as we've allowed sufficient room for 12 or more dual port expansion boards.

The whole system is reliably powered via its sophisticated multi-output switched-mode power supply.

To all this, we've added the ease and availability of running CP/M 2.2 software plus the entire CP/M users library and also the new Paxton.

## **RADER 1000 £1480 RADER 2000 £1980**

Features of these surprisingly low-priced systems include:-

- CPU - Z80 A 4 MHz
- ROM area expandable to - 16K x 8 bits
- RAM area - 64K bytes of RAM
- DMA capability - Powerful and versatile management of data transfer between ports. Memory to ports, port to Memory.
- Floppy Disc Control - Using the WD 1397 chip-set to provide full double-sided double-density storage in IBM 3740 format.
- Character Generator RAM - Arranged as 2K Bytes of memory-mapped storage enabling a wide range of character sets to be created.
- Memory-Mapped Video Display - 2K Bytes of memory-mapped storage provides fast, flexible display. Inverse Video. Video enhancement. Invert character. Dual Intensity. Multi-Level Expansion Connectors available.

## **Option Boards**

- ROM Expansion Board - For user Read Only Memory Expansion.
- RAM Expansion Board - Through P10 Controlled Boards, each with 3 pages of 64K Bytes.
- Serial Ports - 2 Serial I/O Ports utilising Z80 A SIO
- Parallel Ports - 2 Parallel I/O Ports utilising Z80 A PIO.
- Real Time Clock with battery back-up

## **Shortly Available**

- Cassette Interface
  - 8 bit A to D and D to A boards.
  - Hard Disk Interface
  - Programmable Video Controller
- Designed and Engineered in the United Kingdom and supported with a full year's Warranty.



# RADE

For further information contact your local dealer or 'phone or write to:  
**Rade Systems Ltd., 53/55, Ballards Lane, London N3 1XP.**  
**Telephone: 01-349 4711/4 Telex: 46523 SIMSYS G**



Come to one of our  
**Free**  
**Introductory**  
**Seminars**  
 at our Training  
 Centre in Andover



XEROX 820 ABC 26 N.E.C. PC8000

TABTIME 500

APPLE PET COMMODORE 8032 SUPERBRAIN

# The universal business system

TABS unique business software is a flexible package designed to maximise business efficiency and profitability.

TABS is **universal**. The modular system currently running on PET, Apple and Superbrain will shortly be available on most CPM microcomputers.

TABS is also **modular**. Each of 13 modules may be run individually or together. Modules include: Sales Ledger, Purchase Ledger, Sales Order Processing, Invoice Compiler, Fast Data Entry, Nominal Ledger, Management Accounts, Job Costing, Payroll, Bill of Materials, Stock Control, Word Processor, Mail List.

The system is **fully integrated** so that updated information on one module automatically updates information on a related module e.g. items entered on the Sales Ledger would deplete Stock Control.

Each module is **parameter driven** enabling end users to adapt each module to suit their unique accounting requirements.

The TABS system is **upgradeable**. It bridges the gap between micro and mini computers facilitating expansion from the single user system to the multi user system on SYSTIME and D.E.C.

We would, however, like to add a word of caution to the end user. Naturally a package as flexible as this is a sophisticated product and although simple to operate we strongly advise professional help either from your Dealer or from TABS during its installation.

For more details about TABS software and hardware, please tick box(es) and return coupon to us. We are pleased to offer credit card facilities to our customers.

**Dealer enquiry**

Please send me details of your Dealer Plan

**User enquiry**

Please send me details about TABS accounting systems

Please send me the TABS User Manual £20 inc p&p

I enclose cheque/postal order for £ \_\_\_\_\_

Signature \_\_\_\_\_

Name \_\_\_\_\_

Address \_\_\_\_\_

Tel. No. \_\_\_\_\_

TABS Ltd, Sopers House, Chantry Way, Andover, Hants. SP10 1LU  
 Telephone: Andover (0264) 58933

PCW H



Accounting  
 Business Systems

**TABS**

**SEEING IS BELIEVING**

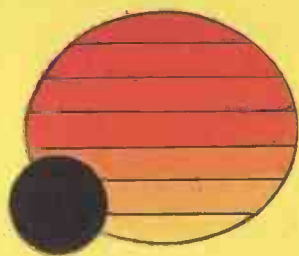
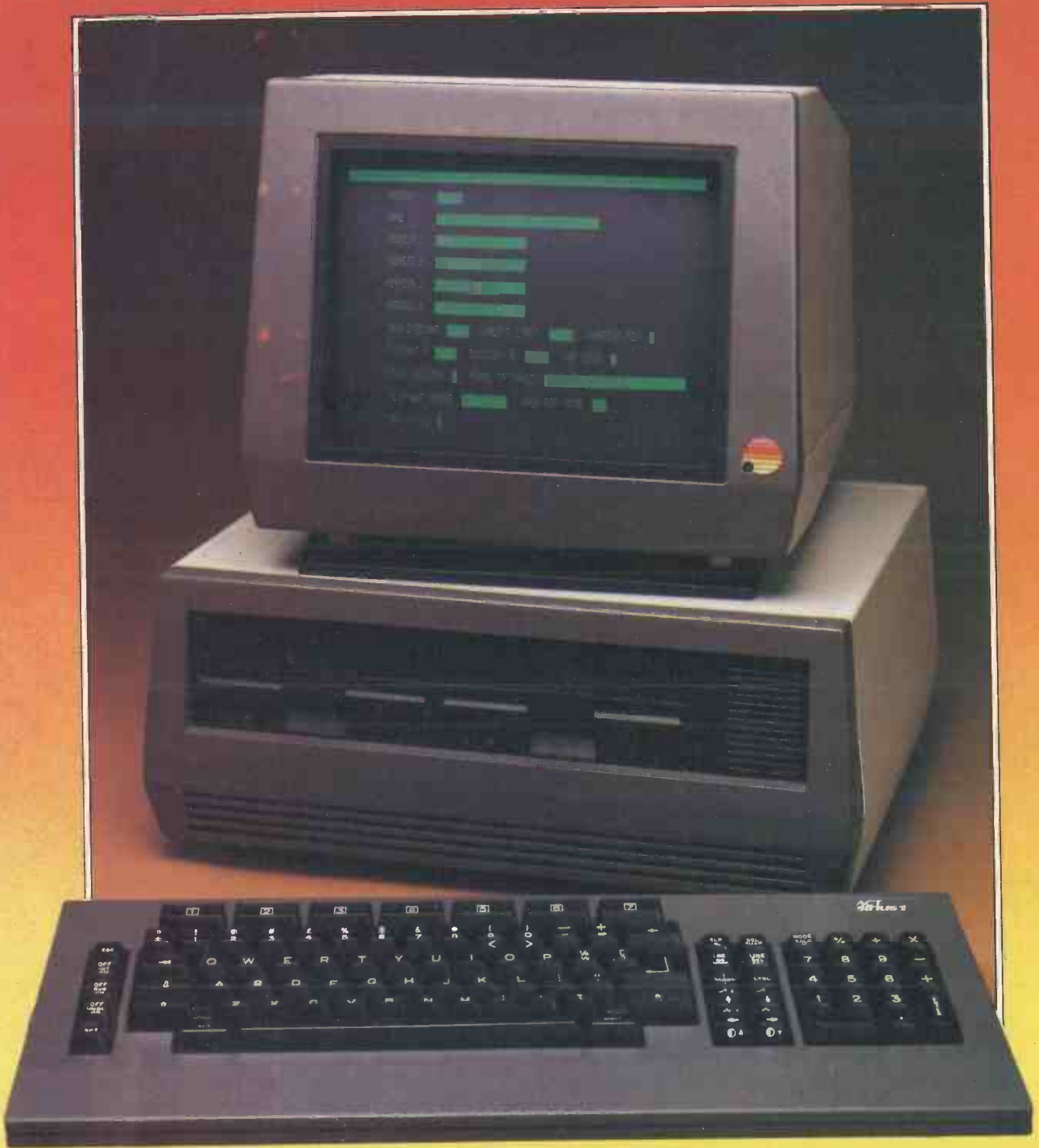

**ACT  
SIRIUS 1**



# NEW ACT SIRIUS 1

## Minicomputer Performance. Personal Computer Price

### 16 bit processor: £2,395

The best price/performance ratio you've ever seen on a personal computer.

	ACT Sirius 1	Typical Personal Computers	Typical Business Systems
Memory	128K-1024K	32K-64K	48K-256K
Disk Capacity	1.2Mb-10 Mb	140K-1Mb	1.2Mb-10 Mb
Processor	16 bit	8 bit	8 bit
Operating Systems Languages	CP/M-86, MSDOS Microsoft BASIC Compiled BASIC COBOL PASCAL FORTRAN	CP/M or Machine Specific Microsoft BASIC perhaps one or two others, eg PASCAL	Usually Machine Specific BASIC and perhaps one or two others
Price	£2395	£1800-£3000	£4500-£8500

ACT Sirius 1 is a new generation personal computer. Quite simply, it has no competition at the price.

It's the first personal computer developed from the outset for business and professional use.

It's launched with more software than anything before it.

It's supported and distributed solely by ACT — the biggest name in personal computer software.

And it's developed by Chuck Peddle, formerly of Commodore and generally regarded as the father of personal computing.

### SOFTWARE SPELLS SUCCESS

ACT Sirius 1 has more software than any other new personal computer:

A choice of two operating systems — CP/M-86 or MSDOS, from Microsoft.

### For Software Houses

The ACT Sirius 1 has a language for you. Microsoft BASIC 80, two BASIC Compilers, two COBOLS, PASCAL and FORTRAN.

### For Applications

Wordstar, Mailmerge, Pulsar, SuperCalc and MicroModeller — all the best sellers.

And the ACT Sirius 1 can run any software written for CP/M — that means hundreds of specialised packages.

### THE BODY IN QUESTION

Ergonomics play a vital part in the design of ACT's Sirius 1.

The screen tilts and swivels to suit the user and glare is eliminated.

The display is razor sharp; and the brilliance and contrast can be adjusted using keys on the low-profile detachable keyboard.

### STAYING OUT IN FRONT

The ACT Sirius 1 is designed to keep you out front. Winchester, networks, multi-user facilities and colour graphics are all scheduled during the next twelve months. And all at the same record-breaking price level of the ACT Sirius 1.

### SEEING IS BELIEVING

The ACT Sirius 1 goes through the most exhaustive quality control process of any microcomputer — including the much vaunted Japanese products.

ACT Sirius 1 has been successfully operating testing field trials for over 6 months already. And now it's at your nearest ACT Dealer — ready to revolutionise your ideas on personal computers.

Clip the coupon for literature. Better still, call David Low now on the hot line 021-454 8585, get the name of your nearest dealer and see a demonstration soon as you can — because seeing is believing.

To: ACT (Microsoft) Ltd, FREEPOST,  
Birmingham B16 8BR.

- Please send a brochure and name of my nearest dealer.
- I am interested in dealership — send the dealer's name and ask your sales director to contact me.

Name \_\_\_\_\_

Position \_\_\_\_\_

Company \_\_\_\_\_

Address \_\_\_\_\_

Telephone \_\_\_\_\_

**ACT No.1 in Total Computing.**

# HI·TECH ELECTRONICS

S100 Boards:

SID 1 High-definition 8-colour graphics board

The memory is 'off the bus' and addressed through three switch-selectable ports.

## Software

The SID 1 software consists of machine-code routines: initialization, set background, plot a point, draw a line, plot a character, print a character, print a character string, fill a rectangle. These may be used directly, or called from a high-level language.

Customized Basic is also available to provide these facilities on North Star, Communicator and other Z80 machines.

## Video interface

The SID 1 graphics board has a Hi-tech Electronics standard 20-way connector. The pin-outs provide:

- red, green, blue and sync outputs at TTL level
- red, green, blue and sync outputs at 0.75V into 75 ohm (CCIR)
- luminance, sync, 6 MHz dot clock and PRINT for standard screen-dump print.

The luminance output is the sum of the red, green and blue signals.

## Prices

SID 1 graphics board	£390
Colour monitor	£328
Graphics package (SID 1 + monitor)	£689
XBASIC	£195

HI·TECH ELECTRONICS

54 HIGH ROAD, SWAYTHLING, SOUTHAMPTON, SO2 2JF  
TEL 0703 581555 TELEX NO. 47388 HTEL

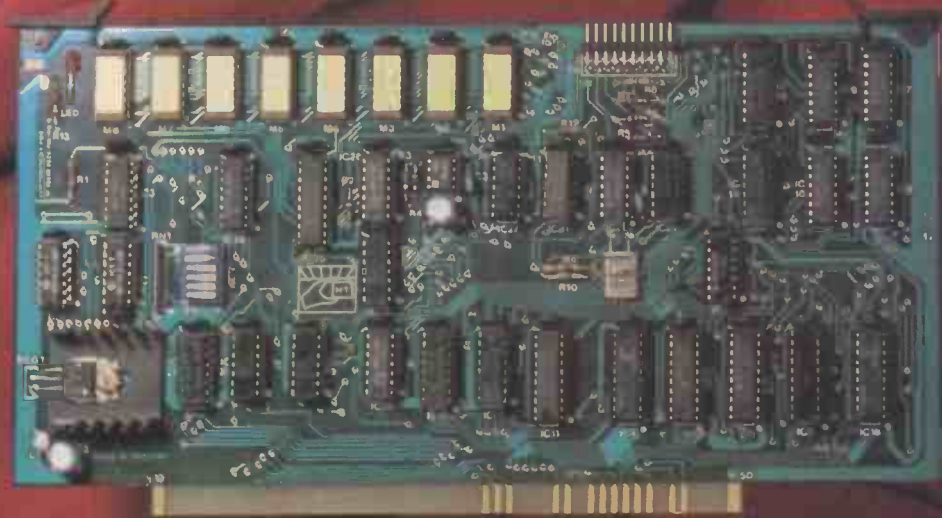
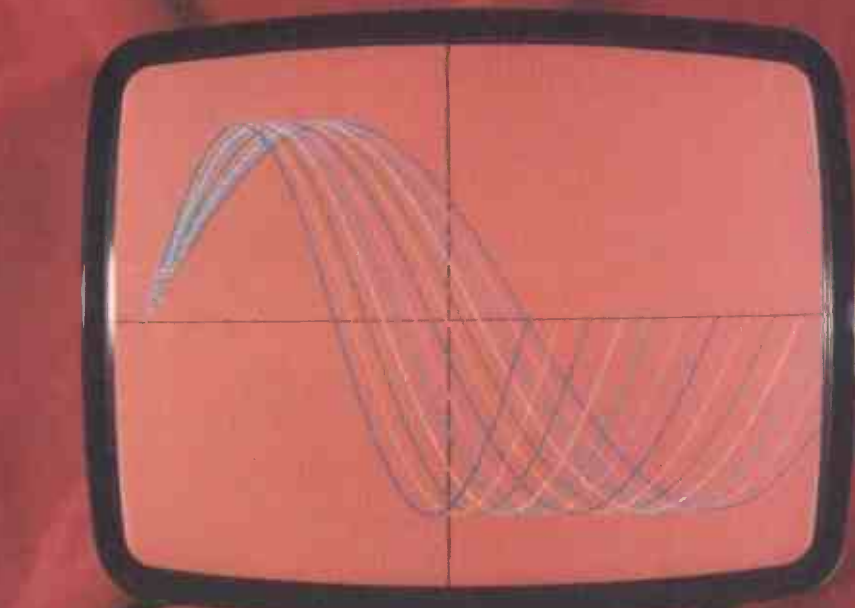

One of a new range of advanced S100 boards, SID 1 provides high-definition colour graphics with any S100 machine.

A classic bit-mapped display of 312 x 290 (90480) pixels, with three bits per pixel, defines each pixel individually as one of eight colours: red, green, blue, magenta, cyan, yellow, white or black.

The display fills the entire active screen area, and all colours can be used simultaneously while retaining full definition. Up to 28 rows of 52 alphanumeric characters can also be displayed. The TV frame, with a completely programmable TV waveform allowing for 625 and 525 line standards, is entirely generated by an on-board 64K byte memory.



# HIGH DENSITY VDU CARD

*B J Hawkins, in a two-part feature, tells how to produce a 80 x 26 display for your Z80/8080 system.*

This article explains the principles, design and construction of a high density VDU interface card suitable for a wide range of machines and systems. Next month I'll give the assembler language driver routines to enable the VDU card to be interfaced to an 8080/8085/Z80 — based system to give a professional quality, full cursor control display screen.

Many of the single board computer systems on the market today have for reasons of economy, and so that a

modulator/domestic TV may be used as the display screen, settled on a 64 character by 16 line display format. This is ideal for the apprentice programmer in terms of cost and performance but, once hooked, the serious programmer will soon outgrow this display and yearn for a professional 80 by 26 size screen. This project provides a low cost, flexible unit that, coupled with the driver routines in next month's article, will provide a professional quality display interface with the full range of standard functions but no expensive frills. My prototype was interfaced to an 8085-based system but the design is flexible enough to be used with other microprocessors, such as the 6800 or 6502. The driver routines of Part Two would, of course, require translating into the relevant machine code language.

## Hardware design

The basic philosophy behind the hardware was to design a unit that meets the following broad criteria: 80 character

by 26 line display format, of the memory mapped, non-interlaced raster scan type; standard composite 1V peak-to-peak video output to drive a professional monitor (approx 12 MHz bandwidth); standard low power Schottky TTL and industry standard memory devices to be used as opposed to exotic and expensive LSI chips; economy of hardware by making more complex software carry out functions such as cursor generation and control, screen scrolling and automatic carriage return and line feed; and a unit that uses standard bus signals and has non-critical timing requirements, allowing it to be coupled to a wide range of processors and systems.

A raster scan display is built up of a large number of horizontal lines traced out by the electron beam in a CRT. The scan lines start at the top right hand corner of the screen and trace out the whole area of the CRT face, ending at the bottom left-hand corner; the spot then flies back to the top right-hand corner and the process is repeated (see Figure 1). This sequence is called a field and is repeated every 1/50 second or at a repetition rate of 50 Hz. Because of the visual persistence of the phosphor of the CRT and that of the human eye, this creates the illusion of a steady picture.

To produce a video picture, therefore, certain information in the form of timing and picture data must be provided. The electron beam spot must be told when to start a horizontal scan line and when to 'flyback' to start the next scan line.

In the same way, each video field must be informed when to start and when to flyback to start the next field. And finally, of course, the electron beam intensity must be modulated along each scan line to produce picture information. These timing signals and video are combined together in set proportions to give a composite video signal (see Figure 2) and this is the signal that a CRT monitor will require to produce a steady synchronised display.

Figure 3 shows a block diagram of the main circuit areas of the high density VDU card. The video information to be displayed is held in a 4 kbyte video RAM memory. This is data in the form of ASCII character codes. The main timing generation logic in the

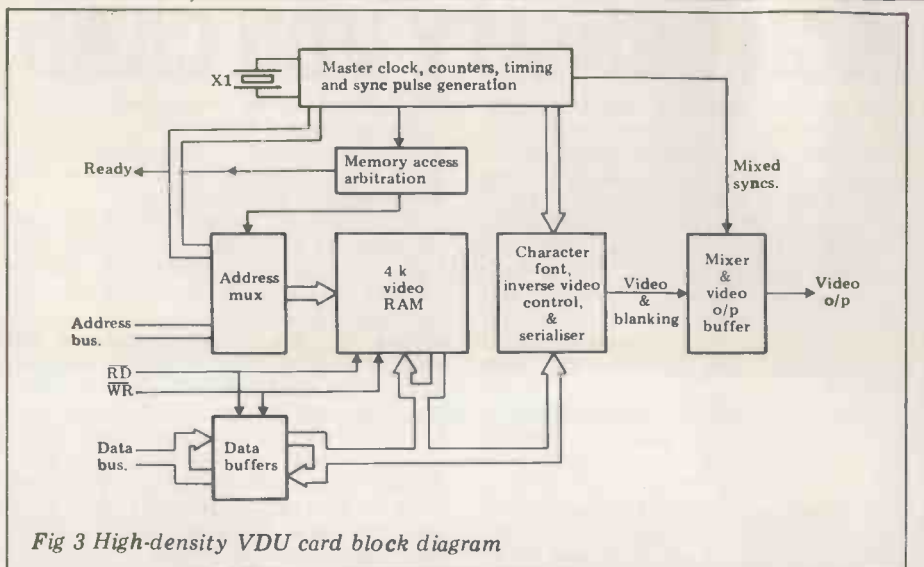

Fig 3 High-density VDU card block diagram

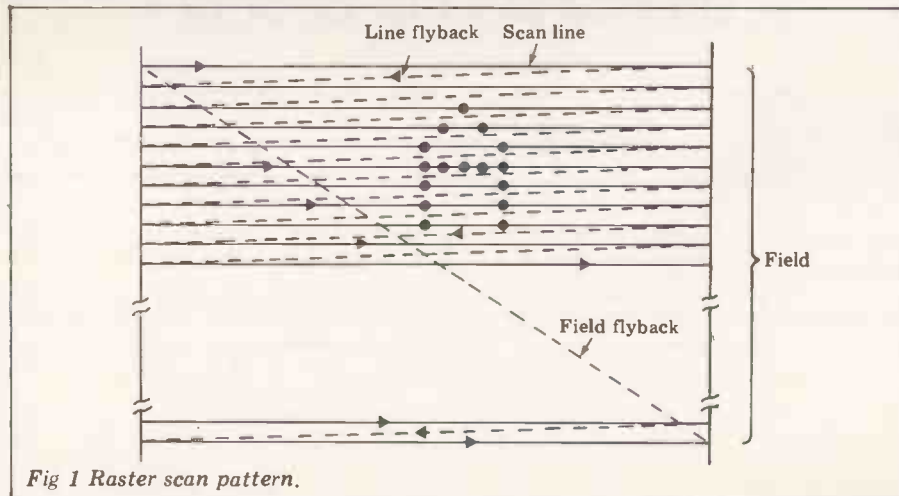

Fig 1 Raster scan pattern.

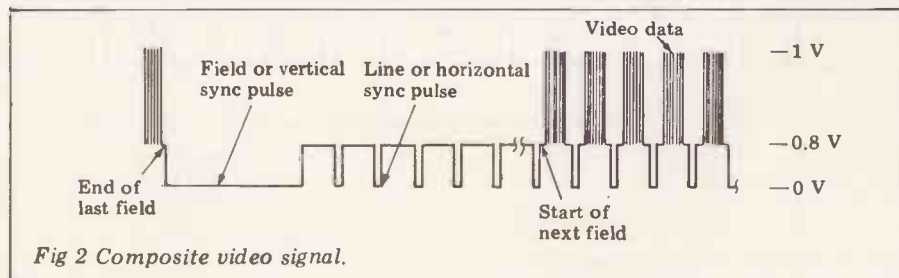

Fig 2 Composite video signal.

# HIGH DENSITY VDU CARD

block above scans the video memory and synchronised to the generation of horizontal and vertical synch pulses produces at the memory output a string of consecutive ASCII code bytes. These are used by the character font block to produce the serial pattern of dots on each line needed to form the required character on the screen. The mixer and video output buffer block mixes the video data and synch pulses to produce a composite video signal of the form Figure 2.

This is how ASCII characters held in the video RAM are 'mapped' to the display screen, but of course they must be first placed there by the host system. This is accomplished by the host system writing into the 'dual port video RAM'. This may occur at any time and if this were to be allowed, it would cause the display to look unsteady and 'noisy'. To prevent this happening, the circuit block called Memory Access Arbitration controls when the host system may have access to the shared memory space. This is done by detecting when in each video field the host system may have access without upsetting the video data, ie during horizontal and vertical flyback times. During these times the logic switches over the address multiplexers so that the video memory may be addressed by the host system and data may be written or read from the memory space. If the processor of the host system should attempt to access the memory at any other time it will be placed into a 'Wait' state until the next 'flyback' time occurs. Thus the video memory may only be accessed at safe times and appears to the processor as a block of normal memory, that sometimes has a long access time. (Please note that the processor is only 'slowed down' when accessing the VDU memory and its speed is not affected when it is talking to its own system memory.)

## Detailed operation

The master oscillator IC28, R1, R2, C1 and X1, uses a 12.598 MHz crystal to produce a pixel clock with a period of approximately 80 ns. Thus a pixel element, which is the smallest picture element that is displayed on the screen corresponds to 80 ns of a scan line. The basic pixel clock is divided by a factor of eight to produce a square wave character clock of 640 ns period,

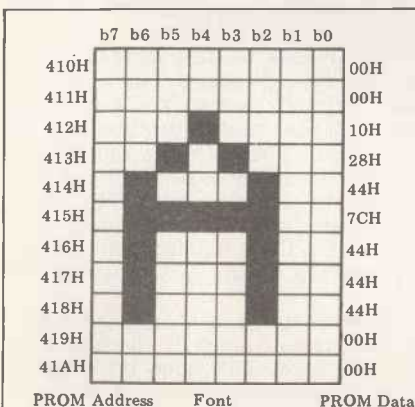

Fig 4 Example from character font PROM.

CHCLK, and a low going character load pulse of 80 ns every 640 ns, CHLD. Each character cell is thus composed of eight pixel elements on 11 consecutive scan lines (see Figures 4 and 5).

The character clock CHCLK is used to drive the character counter IC6 and IC8; this is a synchronous binary counter that counts from 00H to 63H (decimal 0 to 99) and is then parallel loaded by the decode produced by IC20,6 back to 00H. Thus this counter has a cycle of 64 microseconds, which is the basic line rate period required, and has seven counter output lines which give the character position on a text display line (MA0 to MA6). Flip-flop IC14 is used to produce the basic scan line rate signal HS (see Figure 6). This flip-flop is set by having a logic '1' clocked into it by a decode of the counter sequence (81 decimal) and is reset by a clear signal produced by a second decode of the counter sequence (01 decimal). (Gates IC7,8 IC20,12 IC20,6 IC11,12 IC9,3 IC4,2 and IC4,4.)

As can be seen from Figure 4, an individual cell is made up of eight pixels on 11 consecutive scan lines, hence the next step is to divide the scan line rate signal HS by 11 to produce a character line rate signal CLN. This is accomplished by counter IC10. This counter counts from zero to ten and is then parallel loaded by IC3,3 back to zero (see Figure 7). The counter output lines P0 - P3 are used to address the character look-up font to give each row of the character cell pattern.

The next step is to count the number of character text lines to give the line count addresses and the field rate signal VS. This is achieved by counter IC12 and flip-flop IC14. This is a 5-bit counter that counts from 00H to 1BH

(0 to 27 decimal) and hence has a sequence length of 19.7 ms, which gives the basic 50 Hz field rate. (Gates IC13,6 IC9,8 IC9,6 IC4,8 and IC4,6.) The counter outputs MA7 to MA11 give the character text line address, and the basic field rate signal (see Figure 8) is produced from a decode of the counter output lines (gates IC11,6 and IC9,11).

This completes the description of the block of circuitry labelled as the main timing generation logic; from it the basic system clock signals and synchronisation pulses and the raster scan bus MA0 - MA11, and P0 - P3 have been produced. Now let's look at the video RAM and its associated address multiplexers.

The video RAM consists of a 4k block of 8-bit memory composed of industry standard 2114 memory chips (IC21 - 24, IC34 - 37) and the two-to-four line decoder chip IC25. The address multiplexer consists of three quad two-to-one line multiplexers IC38, IC39 and IC40. If we assume that the signal X/I SEL is high (ie internal access selected), the raster scan bus MA0 to MA11 is selected by the address multiplexers to become the video address bus VA0 to VA11. In the internal access mode, the video memory R/W signal will always be high and the RAMs will carry out read cycles only. Hence the cycling addresses on the raster scan bus will cause the video memory to produce a string of data bytes onto the video data bus. As will be explained in greater detail in the second article of this project, the memory map is not continuous; this is to economise on the number of counters used to generate the raster scan bus. This also has the effect of allowing all the software pointers and variables needed for the driver programs to be stored in non-displayed RAM areas and gives 3/4k of extra continuous RAM for user programs.

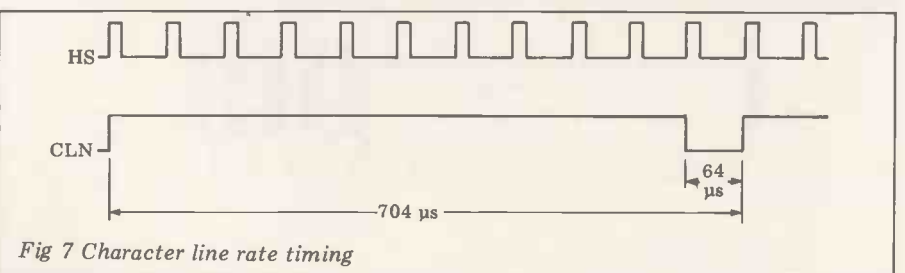
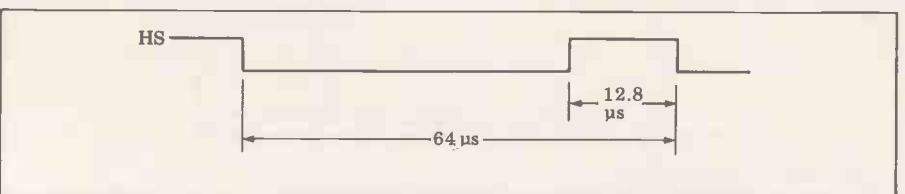
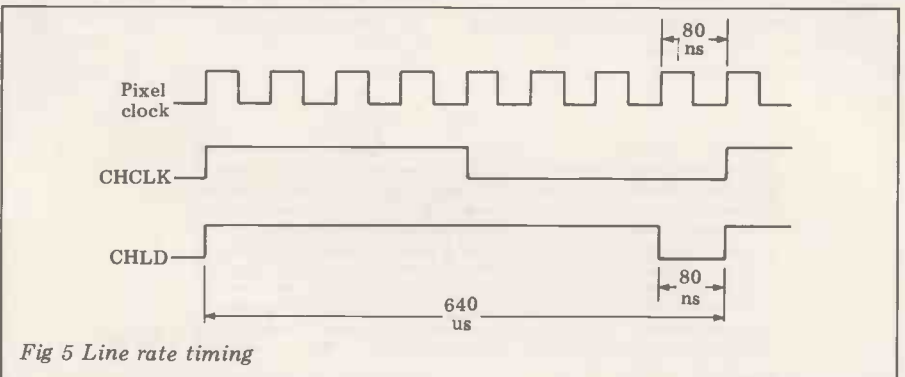



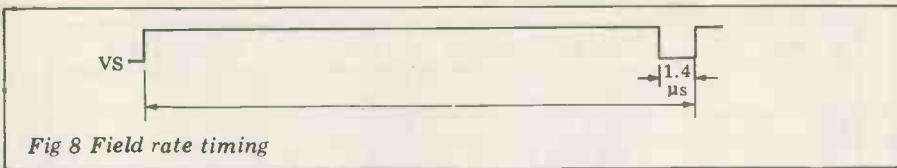

Fig 8 Field rate timing

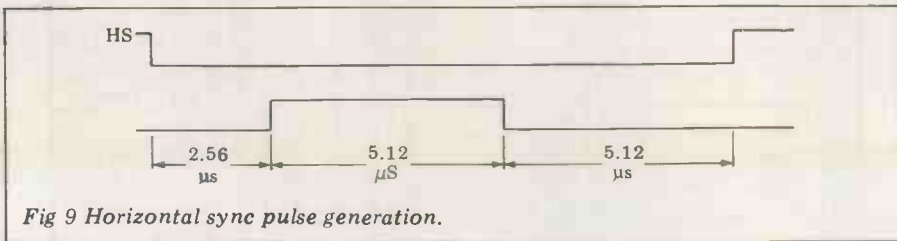

Fig 9 Horizontal sync pulse generation.

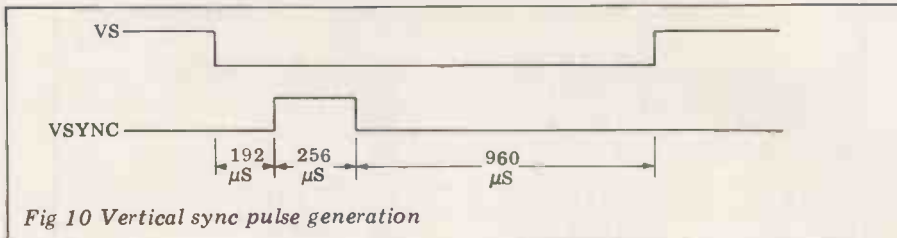

Fig 10 Vertical sync pulse generation

The string of data bytes produced by the video RAM onto the video data bus are presented in turn to the next section of circuitry that will be described, the character font and serial converter logic. ASCII data bytes on the video data bus, VID0 - VID7, are latched into the 8-bit latch IC33 by the character load pulse CHLD. The seven l.s. bits from IC33 are connected to the seven top address lines of the character font PROM IC32. This is an industry standard 2 kbyte 2716 EPROM. The character font PROM contains 128 character patterns (see Figure 4) which each consist of 16 bytes (five of which are unused); each character is selected by its 7-bit ASCII code on the top seven address bits and the required row of the pattern is selected by the scan line address bits P0 - P3. Details of the character font patterns will be given in the second article of this project. The font row data at the output of the character font PROM is latched into the parallel inputs of the serial converter shift register IC31, by the next character

load pulse CHLD. This shift register is clocked by the pixel clock and produces a serial data stream from its QH output.

The m.s. output bit of IC33 is connected to the D input of the inverse video flip-flop IC19. The function of this flip-flop is to allow characters to be individually placed into the reversed video mode, ie to appear as black characters on a white or green background. Flip-flop IC19 is used to control the exclusive or gate IC18; this gate acts as a programmable inverter on the serial data stream from IC31. Thus if the msb of a byte in memory is set, the ASCII character given by the other seven bits will appear in reverse video on the display screen.

During the field and line flyback times the character font and serial converter logic will produce unwanted data that is not required to be displayed. The video data stream from IC18 is gated by IC3,8 with a signal called mixed blanking. This is produced by ORing the HS and VS timing signals together after they have been resynchro-

nised to the character clock CHCLK (IC2 and IC30,3). Thus IC3, from its output, produces the complete video signal carrying the picture information for each scan line and blanking information during the line and field flyback times.

To produce a composite video signal (see Figure 2) we need to add line and field synchronisation pulses to the mixed video and blanking signals. To do this the signals HSYNC & VSYNC are generated (Figures 9 and 10). The horizontal sync pulse HSYNC is produced by the horizontal sync porch generator logic (IC15, IC3,6 IC4,11 and IC4,12). This circuitry produces a line sync pulse correctly framed within the line rate signal HS. The vertical sync pulse VSYNC is produced in a similar fashion by the vertical sync porch generator logic (IC16 and IC29,3). This logic produces vertical sync pulses correctly framed within the field rate signal VS. Finally the synchronisation pulses and the mixed video and blanking signals are mixed together in the correct ratio by using open collector gates and weighting resistor networks to produce a standard composite video signal (IC1,2 IC1,4 IC1,6 & R4 to R8)

The final sections of circuitry to be described are those responsible for placing display data into the video RAM at permissible times. The memory access arbitration logic produces a signal called X/ISEL; this signal determines who has access to the video RAM. When X/ISEL is high the internal raster scan bus is scanning the memory to obtain display data, when the signal is low the external system may if it is required have access to the video RAM to read or write data. X/ISEL is produced by NORing a line flyback access signal (IC19,9) and a field flyback access signal (IC17,4); these signals in each case go non-active before the 'deadline time' to allow my previously initiated external access time to be completed without the R or W cycle being 'clipped' short. The video RAM is thus available to the host system for approximately 25 per cent of the time. The other 75 per cent of the time it is being scanned by the internal logic to display data.

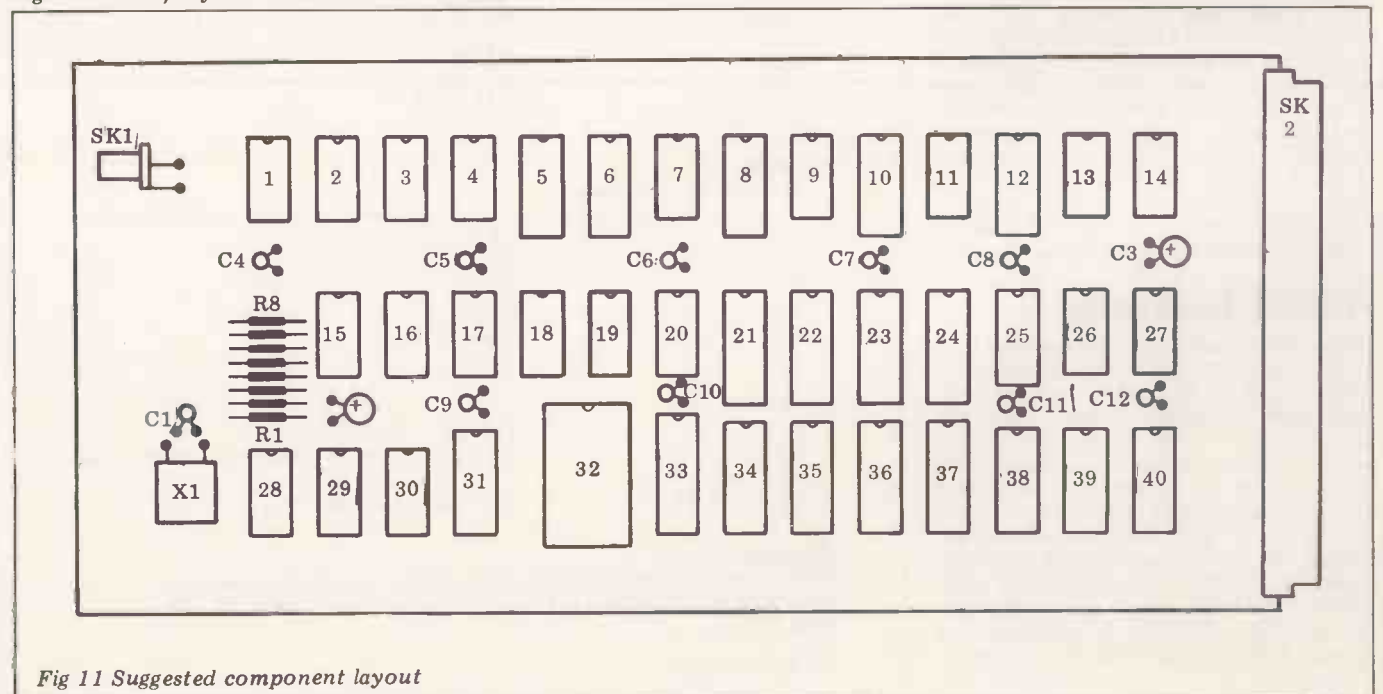

Fig 11 Suggested component layout

# HIGH DENSITY VDU CARD

The access control signal X/ISEL is used for a number of purposes: first, it controls the address multiplexer to determine who is addressing the video RAM. Secondly, it qualifies the generation of Ready/Wait signals and finally it qualifies the enabling of the memory and the control of the data bus buffers. The prototype unit was designed to fit into the host system's memory map from the address F000H to FFFFH; of course, if the necessary address changes are made to the driver routines any other 4k block could be used, and the decoding of the top four address lines A12 - A15 changed to suit. When the host system attempts to access the video RAM the decode signal FxxxH will go low (IC13,8).

If the signal X/ISEL is high (ie internal access selected), this will cause the Ready/Wait line to go low forcing the processor into a wait state. When the signal X/ISEL goes low (ie external access selected) the wait signal is removed and the accesses allowed to continue as required until X/ISEL goes high again. During a read or write cycle to the video RAM the active strobe is used to enable the memory in a read or write mode and to control the data buffers to correctly input or output onto the system data bus (Gates IC3,11 IC29,8 IC30,6 IC30,8 IC17,10 IC29,11 and data buffers IC26 and IC27).

This completes the description of the high density VDU card hardware operation.

## Construction

My prototype was constructed using wire wrap sockets and pins, but any suitable technique may be used as long as adequate power and ground bussing is provided. The circuitry uses a single +5V power rail at approx 1.1 amps. Figure 11 shows a suggested component layout for an extended Eurocard (220mmx100mm) matrix card, and Figure 12 gives a parts list for the project. The video output to the monitor should be kept as short as possible and a good quality monitor of at least 12 MHz bandwidth used. A modulator/TV combination will *not* have the bandwidth/resolution to give a good display.

## Added features

There are a couple of extra features that could be added to the hardware quite easily: a low frequency square wave generated by further dividers from the line counters could be gated with the output of the inverse video flip-flop to allow selected characters to alternate between normal and inverse video fields; the character font PROM could be replaced by a dual-port RAM memory operating in the same way as the main video RAM (this would allow the user to load any character or graphics font required down from the host system).

IC No.	Type Number	+5V	0V	Spare gates
3	74LS00	14	7	
17	74LS02	14	7	
4	74LS04	14	7	
28	74S04	14	7	3 Inverters
1	7406	14	7	2 o.c. Inverters
9,30	74LS08	14	7	1.2 l/p And.
11	74LS10	14	7	1.3 l/p Nand.
7,13	74LS20	14	7	
20	74LS27	14	7	1.3 l/p Nor.
29	74LS32	14	7	
2,14,19	74LS74	14	7	
18	74LS86	14	7	3. 2 l/p Exclusive Or.
25	74LS139	16	8	1. 2 to 4 Line decoder
38,39,40	74LS157	16	8	
6,8,10,12	74LS161	16	8	
31	74166	16	8	
5	74S168	16	8	
26,27	74LS243	14	7	
33	74LS273	20	10	
15,16	74LS393	14	7	
21,22,23,24				
34,35,36,37	2114	18	19	
32	2716	24	12	

Fig 12 IC power pins

### ICs

IC1	7406
IC2,14,19	74LS74
IC3	74LS00
IC4	74LS04
IC5	74S168
IC6,8,10,12	74LS161
IC7,13	74LS20
IC9,30	74LS08
IC11	74LS10
IC15,16	74LS393
IC17	74LS02
IC18	74LS86
IC20	74LS27
IC21,22,23,23 34,35,36,37	2114
IC25	74LS139
IC26,27	74LS243
IC28	74S04
IC29	74LS32
IC31	74166
IC32	2716
IC33	74LS273
IC38,39,40	74LS157

### Resistors

All ¼ W 5% tolerance.

A1,2,3	1kΩ
R4	22Ω
R5	180Ω
R6	120Ω
R7	33Ω
R8	330Ω

### Capacitors

C1	0.01 μF	Ceramic
C2,3	10 μF	16v tantalum bead electrolytic
C4,5,6,7,8 9,10,11,12	0.1 μF	Ceramic

### Miscellaneous

Matrix board, video connector SK1, System interface connector SK2, Wire wrap sockets for ICs, wire wrap pins, Crystal 12.598 MHz X1.

Fig 13 Parts List



# DO NOT ADJUST YOUR SET!

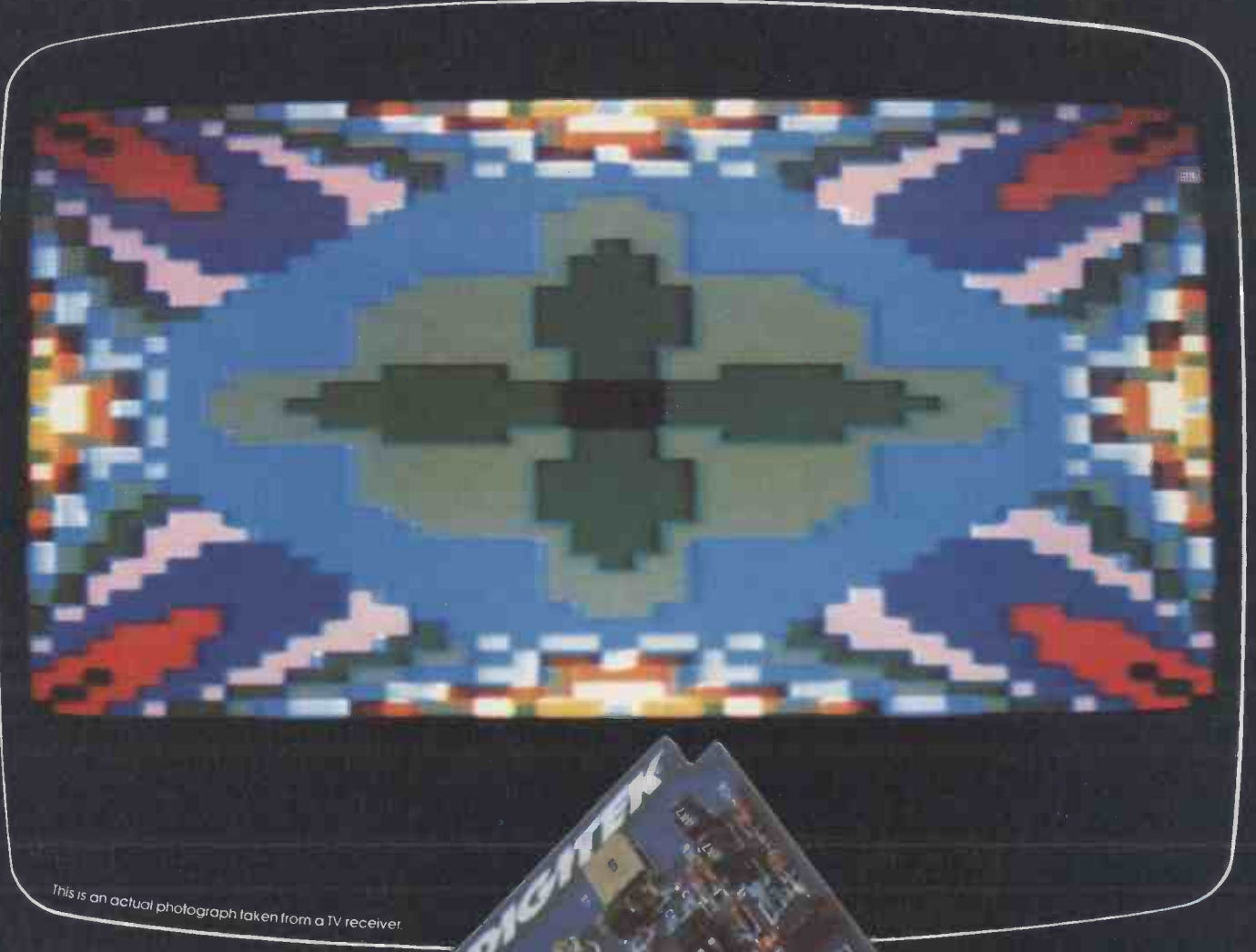

*This is an actual photograph taken from a TV receiver.*

## That's the colour of the Digitek PAL Encoder Card for APPLE II computers.

Featuring an on-board UHF modulator and the unique Digitek 'Safety Tab' for sure, easy handling.

This principal member of the Digitek range of Apple expander cards not only gives the best quality PAL version of the Apple's colour graphics capabilities, but is also simplicity itself to install.

One plug-in card is all it takes to transform your dull display into a techni-colour masterpiece.

Also in the Expander Range are a 16k Ramcard, Z80 Expansion card, High speed serial interface, and more!

Send in the coupon for details and your nearest stockist.



# DIGITEK

EXPANDER CARD SERIES

The people who are really into Apples.

Please send me further details on your range of Computer Expander Cards.

Name \_\_\_\_\_  
Address \_\_\_\_\_  
Post Code \_\_\_\_\_

Digitek International Ltd., Unit 14, Grafton Place, Dukes Park Industrial Estate, Chelmsford, Essex, Eng.

# HAVE YOUR INPUT NOW!





It's all in the first international Microcomputer Magazine for European traders. All you need to know about the international microcomputer market in Europe you'll find in Micro Digest. The new, distinguished magazine born out of four leading European computer magazines (Bit, Chip, Databus and Micro Systemes).

Now you can get the international and most important microprocessor news in just one monthly magazine. In your own language (English, French, German or Italian). A refreshing concept. Each issue will bring you the latest product information, topical events of international importance,

interviews, market research, editorial news... Exactly the input a trader needs.

Micro Digest is an initiative of the European Micro Publishers Association (EMPA), located in Zug, Switzerland. It brings you the most interesting articles and the latest news from Europe, especially selected by leading international editors. So don't stuff your head too much. Subscribe - next to your national magazine - also to Micro Digest. The magazine that gives you a better insight in your own profession.



## MICRO-digest

Monthly magazine for traders

MICRO DIGEST IS PUBLISHED BY THE EUROPEAN MICRO PUBLISHERS ASSOCIATION (EMPA)

Send to: Micro Digest  
Advertising:  
F. A. Smyth & Associates  
23 A Aylmer Parade  
London N2 0PQ  
tel. (01) 340 5058

Subscriptions:  
Pegasus Marketing Ltd  
65 Hookfield Surrey  
Epsom Surrey KT 19 8JQ  
tel. Epsom 24230  
**FREE**

Convince yourself. Get a copy of Micro Digest and see what this magazine means to you. Mail this coupon and we send you the first issue. Free of charge. Special offer. A one year (10 issues) subscription to Micro Digest is available at a special rate of £ 21.- post paid only. Subscribe now!

Name \_\_\_\_\_  
Address \_\_\_\_\_  
City \_\_\_\_\_  
Country \_\_\_\_\_

# FREQOUT!

## Dr David Ellis checks out a new music synthesiser package.

Up until about a year ago, anyone wanting to use his/her microcomputer for music-making was stuck with square wave renderings of 'your favourite tune'. Such buzzy inputs to the right hemisphere aren't exactly the greatest thing since sliced bread, and most of the sound board add-ons did a pretty efficient job of perpetuating the myth that such microcomputer music sounds like what the average person in the street expects computer music to sound like — some gross extension of Space Invaders sound effects — and, hardly surprisingly, found themselves consigned to the bottom drawer.

256-byte waveform table. Where the MusicSystem falls down somewhat, at least with regard to the ALF system, is in the ease of music entry, but that's another story.

Alongside the Mountain Computer approach to producing high quality synthesis, there's also the technique of totally software-driven synthesis using just one D/A converter for each channel of sound, and this is where the Micro-products Music II system steps into the picture.

likely to be part of the 20 percent of the 'normal' British population with a significant high frequency loss of hearing. For the rest of us, 15 kHz is more or less the top limit, and, incidentally, where FM radio also puts its foot down, so this is a pretty good figure to aim for in D/A conversion.

In practice, not many systems engaged in real-time synthesis (ie, using the processor to produce instantaneous music) achieve this, exceptions being



Most of these 'systems' use programmable sound generators, such as the General Instruments AY-3-8910 or Texas SN76489, and their great advantage is that they do the lion's share of the hard synthesis work for the computer. However, these chips aren't that brilliant at producing accurately pitched notes, owing to the limited resolution in counting down from a master oscillator, and the sounds themselves are still of an unremittingly square wave nature.

The ALF AMII system (using the old MC16 board) gets around the resolution problem by using an Intel 16-bit timer chip to count out the notes with rather greater accuracy, but, even though the system also includes a CHROMA routine for applying pulse-width modulation (a variable mark-space ratio of the square wave which produces a sweeping of harmonics) to one's musical deliberations, the basic synthetic capabilities are still limited by the hardware.

The arrival of the Mountain Computer MusicSystem on the scene made it quite apparent that the former hardware-directed approach was a bit of a lame duck, for, with some clever hardware (effectively, 16 D/A converters with the added benefit of being driven by DMA), a frequency response of 30 to 14,000 Hz is achieved, and that's of any waveform one cares to program into the respective pages of RAM as a

## Musical conversions

A D/A converter is essentially a programmable power supply that generates an output voltage in response to a numerical value received from a parallel output port of the computer. When a program changes the value sent to the converter, so the output voltage changes to a new value. Simple enough in theory, but problems start to arise as soon as D/A conversion is required to produce the very fast voltage changes required in synthesising music.

True hi-fi necessitates a flat frequency response from 20 to 20,000 Hz and most professional music synthesisers will also be aiming for this sort of range. Ironically, it's the rock musicians using this technology who are most

dedicated processor systems like the Fairlight CMI and Synclavier II or a microcomputer system like the Apple II-based MusicSystem. The reason for this lies in the Nyquist formula, a piece of invaluable home truth for the digital synthesist, which states that the sampling rate must be at least twice the highest frequency you wish to output to the analogue world.

Given that the programs needed to generate sounds of specified pitch and amplitude from RAM-stored waveform tables take an appreciable amount of time to run, the sampling rate can never be as high as musical desires dictate, at least with the current generation of 8-bit processors, and compromises tend to be the order of the day.

One of the most obvious compromises is to make every numerical value sent to the D/A converter the product of scanning a single waveform table. If

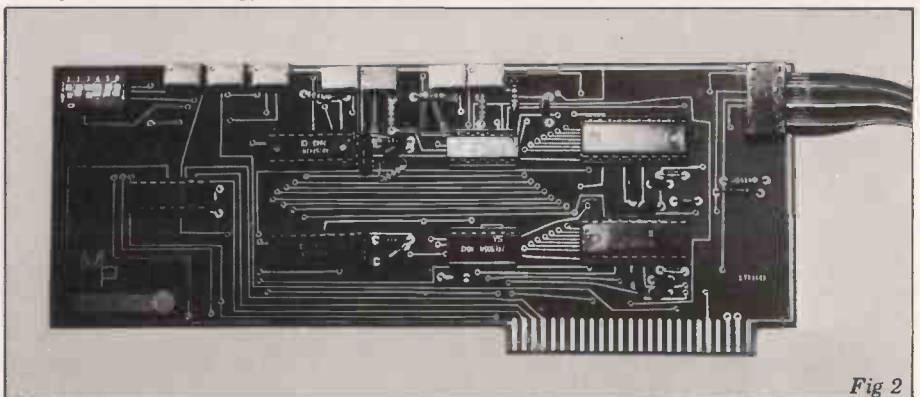

Fig 2



the 256 bytes in the table correspond to a sawtooth waveform, then the sound emerging from the converter will remain a sawtooth for as long as the same data is being directed to the output. The scanning is performed by storing exactly one cycle of the waveform in the table, conceptually bending the linear table into a circle, and then setting up a table pointer that points to the desired numerical value for output to the D/A converter. Coincident with every execution of the lookup and output program, the table pointer is incremented to a new pointer position, thereby achieving a continuous table scan. So, provided that one sticks to the same waveform over the period of a note's duration, the fast execution time for table lookup (approx 23  $\mu$ s in the case of the 1 MHz 6502) enables a basic high frequency waveform to be adequately synthesised, giving a Nyquist limit of about 21.6 kHz in this case.

Unfortunately, even though the composition of musicians and their instruments generally remain more or less static when they're playing, the notes emerging from vibrating air columns, strings or whatever, don't lead such a normalised existence. The average note produced by an average natural instrument consists of a whole range of harmonics in addition to the fundamental pitch or the note that one's actually reading from a score, fingering and then playing. If all the harmonics interacted with the surrounding air, wood or metal in the same way, then the resultant sound would appear rather flat and uninteresting. In practice, and in the hands of a good practitioner, the harmonics interact with the environment in a differential manner, giving rise to what is called a 'timbral envelope', where the harmonics of a note change dynamically from one moment to the next.

For the listener, this provides sounds that breathe with an internal animation; for the digital synthesist, it's something of a headache!

On an analogue synthesiser, various types of voltage-controlled filters can be used to sweep through the harmonic content of square or sawtooth waveforms when a note is triggered from the keyboard. The effect is dramatic but doesn't actually correspond to the behaviour of real instruments, hence the characteristic sound of synthesisers. In theory, digital filtering could be used to achieve the same sort of filter sweep on the waveform outputted from a particular lookup table, but, as luck would have it, the necessary multiplication and division required to do this takes too much computation to be practical in real-time music synthesis. The alternative is to extend the table lookup operation to a sequence of different waveform tables, each with a different harmonic composition. Using this approach, we actually kill two birds with one stone, as we also gain the necessary attack and decay characteristics of a note (the amplitude envelope) along with the all-important timbral envelope. To set up a typical waveform-sequencing routine, it's necessary to use an additional 256-byte table containing numbers corresponding to the page addresses of particular waveform tables. By moving another pointer rapidly through a waveform-sequence table that contains repeat waveform table

addresses for portions of a note where amplitude and timbre remain constant, or one-off entries when sounds are on the move, it's possible to synthesise natural-sounding instruments.

All this is straightforward enough in theory but problematic to implement without making a whacking great compromise in terms of the frequency response of the output. The waveform-scanning routine developed by Frank Covitz and Cliff Ashcraft and used in the Micro-Technology Instrument Synthesis package (reviewed in the March 1981 issue of *PCW*) takes 128  $\mu$ s to run. This reduces the sampling rate down to 7.81 kHz, giving a Nyquist limit of about 3.9 kHz — a long way from our original 15 kHz aim in D/A conversion!

The Microproducts Music II doesn't achieve this figure either, but it does provide waveform-table sequencing (though not quite to the extent of the Micro-Technology software) and a very fair maximum output frequency of 8 kHz.

## Microproducts hardware

Supposedly, there's a great woman behind every great man; and the sexist cliché also applies in a somewhat obtuse way to D/A conversion, because, no matter how elegant the software is, the eventual sound quality relies upon the converter doing a good job. The Microproducts Data Acquisition and Data Distribution System card contains two A/D converters (Analog Devices 7574s) and two D/A converters (Signetics 5018s). The AD7574 is an 8-bit converter using the successive-approximation technique to provide a fast conversion time of 15  $\mu$ s and is used in the ROM interface mode in order to simplify programming. Microproducts provide a 'quick and dirty' operational and capability test that converts an off-tape music signal to digital information and then back to analogue signals.

This operation clearly demonstrated

the accuracy of the bidirectional conversion offered by the board but also showed up a couple of drawbacks. Firstly, the required input voltage levels to the A/D converter are either -10 V to +10 V or 0 V to +10 V. These are high level inputs and necessitate adding an additional amplifier to boost line level or microphone inputs. Secondly, the output from the D/A converter doesn't have the benefit of being smoothed by a low-pass filter from its raw converted state into something more fit for human consumption. One of the main problems with raw signals from a D/A converter is the presence of distortion components arising from 'aliasing'. Mathematically, this component is generated from the difference ( $F_s - F_w$ ) between the sample rate ( $F_s$ ) and waveform frequency ( $F_w$ ). So, if we aim to synthesise a waveform of frequency 7 kHz at the sampling rate Music II uses (16 kHz), then an alias at 9 kHz will also be generated. This isn't exactly desirable, so a low-pass filter is employed to block-out any signals above the Nyquist limit, ie, half the sampling rate. In theory, if the filter was perfect, it should be possible to separate an aliasing component of just greater than 8 kHz from an output waveform of just less than 8 kHz. Because no filter is this ideal, a compromise is made by trading-off some of the theoretical top end of the output for a more secure blocking of the alias signals. The type of filter customarily used is a multi-section one with a sharp cut-off. This latter characteristic gives the filter its other important function in this situation, namely that of filling in the gaps between the voltage steps emerging from the converter and thereby smoothing the output waveform.

So, the first step on from the basic operational test with the Microproduction board is to add a couple of low-pass filters. I chose 7 kHz as a suitable cut-off point and made up some fourth-order Butterworth filters as in Figure 3. The bi-polar power supply for these op-amps is no problem as the board usefully provides  $\pm 12$  V on the input/

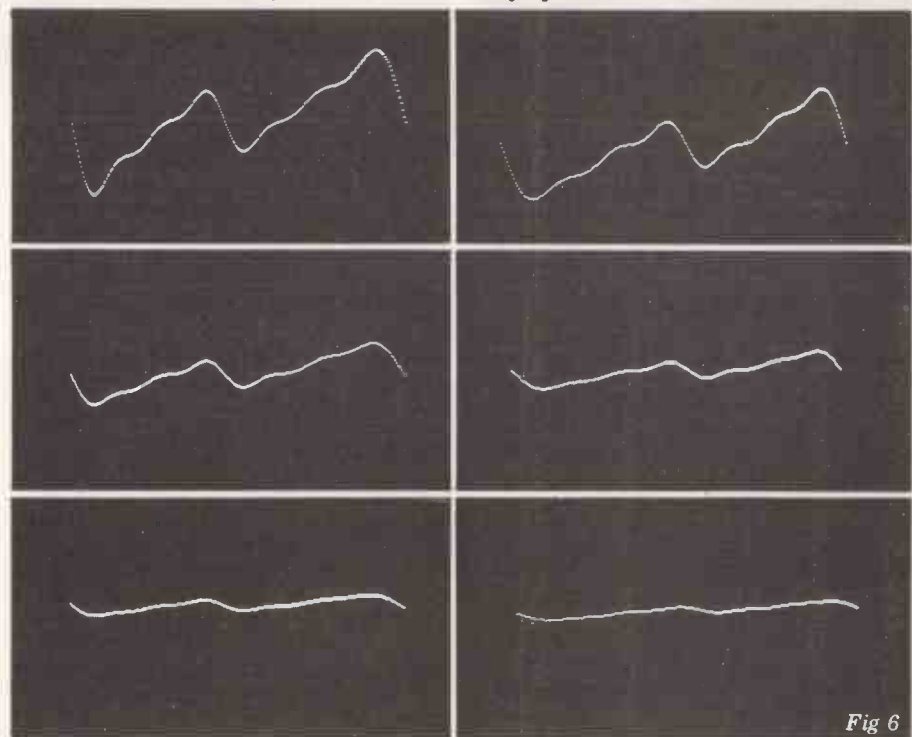

Fig 6





what the Compiler thought of 'Boogie': some beats out of place but no errors as such. This is because the two messages encountered in putting Boogie to bed — 'Too few beats' and 'Too many beats' — are treated as warnings rather than errors, while the other 11 are unambiguous spanners in the works. I think this Compiler is quite splendid — especially in comparison to the brusque and unhelpful Compiler in the Mountain Computer MusicSystem.

PLAY SCORE loads the compiled machine code score with appropriate sets of waveform tables and a player program, SCORE. After specifying the slot in which the Microproducts card is located, the score is then played through the two D/A converters, parts 1 and 2 by the first and parts 3 and 4 by the second.

So far, so good, but how does the final output quality compare with comparable systems like the Micro-Technology Instrument Synthesis software? Well, if asked that question when I first received the system for review, I'd have had to make some fairly disparaging comments. Of the two demo scores included on the Music II disk, only 'Fanfare for the Uncommon Apple' (yuck) would load successfully, and turned out to be an extremely uninspired version of Aaron Copeland's 'Fanfare for the Common Man' complete with lots of noise, glitches and clicks between events while the processor was doing its job. However, once I'd entered my own score, made up some more imaginative waveform sets than those given, and added the aforementioned low-pass filters, the sound quality improved fairly dramatically. Consequently, I'd certainly recommend Music II in preference to the Micro-Technology software, and you gain double the frequency range to boot.

## Fishing for sounds

An area of digital synthesis which extracts the maximum amount of interest from rock musicians, the public and the media, centres around sampling 'real' sounds via an A/D converter and the subsequent use of this data as a set of waveform tables with which to play music. The main problem with this lies in the vast amount of memory needed to capture in real time any appreciable length of analogue sound. Using a 16 kHz sampling rate (and therefore a Nyquist limit of 8 kHz), just one second of sound can be frozen for eternity (or until the plug gets pulled out) in 16k of free RAM. Apart from the inimitable Fairlight CMI, which collects samples at rates from 2 to 30 kHz, and then loads the data directly into 16k voice banks of dedicated RAM, two computer drum machines, the MCS Percussion Computer and the Linn Drum Computer, have got in on the act by burning-in real drum/percussion sounds into EPROMs.

All this produces jolly sounds like choirs of cats, chords of kisses, and so on, but none of this is the product of true digital synthesis. What's much more interesting is if you can take the sampled sound and then chop it up and reconstitute it with harmonic analysis/synthesis. To do this, we need to apply some Fourier analysis techniques, which is what Microproducts's Freqout program is all about.

## Freqout



Fig 9

This program is a package of routines that utilizes one of the A/D converters on the Microproducts card to turn the Apple II into a signal analysis tool. The four principal routines are: acquisition of data from disk files or via A/D converter; examination of data in HIRES 'oscilloscope' mode; Fourier transformation of the data to the frequency domain; and display of harmonic envelopes.

Data is sampled at a rate selected from 1 to 16,384 Hz and turned into a binary file of single byte samples, 00H being most negative and FFH being most positive. The sample length can be any size up to 8192 bytes and acquisition is started either manually (by pressing any key) or automatically (when the input level exceeds a preset value). HIRES graphics can then be used to display the sampled waveforms (Figure 10) with the text beneath the graphics informing you of where you are in the sample set. The combination of right arrow, space bar and CR enable you to advance through the data point by point or with a continuous series of sweeps from beginning to end. In theory, these sample sets should provide 32 256-byte waveform tables if 8192 bytes of RAM have been loaded with sample data. Life's not that simple, though, because the real trick to successful sampling is to get exactly one cycle of the waveform into each sample set. Remember also that Music II defines instruments on the basis of only

eight waveform tables, so it's necessary to scan through the sets of sample data and choose those that make the most sense to your current musical pursuits.

So far, we've only been considering the resurrection of sample data in an abbreviated format suitable for instrument definitions. The other two Freqout routines apply Fast Fourier Transform (FFT) analysis to the sampled data. Transform Data converts the sampled waveforms into a display (Figure 11) showing graphical representations of individual harmonic components, the set number, duration of each set, and the amplitude and frequency of each component as it appears on the screen. Frequency Analysis can then be used to plot the amplitude envelope of any chosen frequency (harmonic) component drawn from all the sets of frequency domain data.

Taken as a whole, the set of Freqout routines provides one of the best musically applicable Fourier analysis programs I've come across. I had a lot of fun sampling sounds and turning this data into instruments for use by Music II. Admittedly, not all of these were equally effective, which isn't surprising considering the tricky nature of sampling and FFT techniques when applied to such demanding sources as real (and, therefore, identifiable) sounds.

I'm grateful to Wildport Ltd (7 Willow Rise, Kirkbymoorside, York, tel: 0751 32308), the sole UK/European agents of Microproducts systems, for lending me the dual D/A and A/D hardware/Music II software (£187.50) and Freqout software (£37.50). The obvious drawback to the Music II package is the price — especially when you consider that the Mountain Computer combined A/D and D/A board sells for around the same price, but with 16 channels in both directions and a 9 us conversion time. The addition of Freqout to the system makes it much more attractive, but a serious user may well find the limited documentation and absence of any explanation of software implementation rather frustrating — I certainly did!

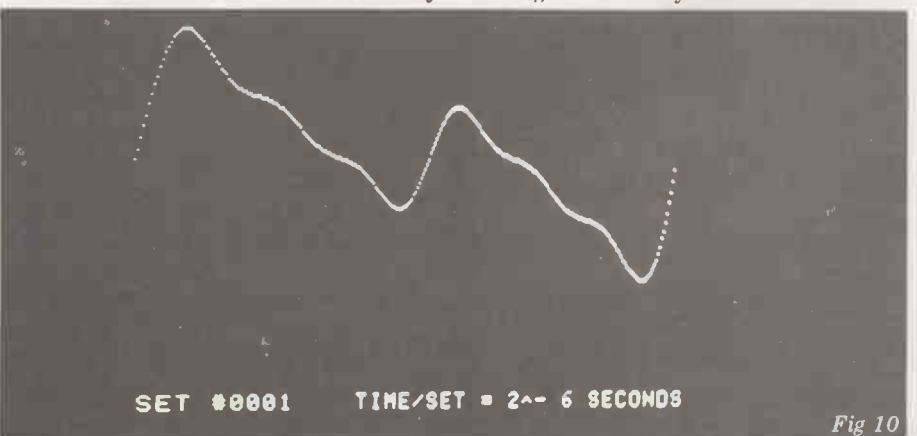

Fig 10

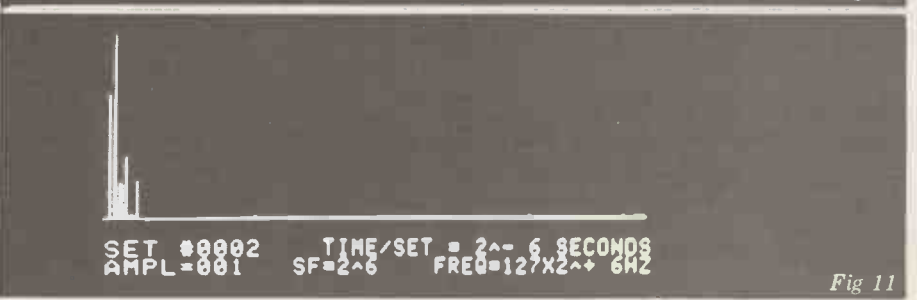

Fig 11

# ANS BASIC:

## Mike Parr outlines the unexpected features of American National Standard Basic.

Basic is unusual in that, unlike Fortran, Cobol or Pascal, there has been no realistic standard — the nearest we get is the 'de facto' standard of Microsoft, because it is implemented on many micros. A new standard though, will soon make an appearance; American National Standard Basic, which defines a language of greater power than Microsoft (in the following, I'll use ANS, or simply Basic to stand for the new language).

When I first heard of a new standard, I expected some hat-tipping to Microsoft, ie, a tight definition of Microsoft with additional 'structuring' statements, but this is not the case — the ANS designers have gone for a new language that bears little relationship to Microsoft.

This article will examine the new standard, concentrating on new or different features from what we have come to know as Basic. As the standard is some 200 pages long, you'll be pleased to know that many points are omitted but I trust that the main ideas will come across.

Firstly, the standard is written as a set of modules, not all of which need be present in every implementation. You will always have certain 'core' modules, but may not have those dealing with graphics, enhanced file I/O, or real-time. In practice, though it seems likely that any manufacturer wishing to sell an ANS implementation will (at least) need to implement graphics and enhanced file modules.

### The language

ANS includes much that can be found in traditional Basic. Perhaps a quick way of describing this is to say that it will accept most Microsoft programs that don't use string variables or multi-statement lines. On top of this, variable names can be up to 31 characters long (all significant). Lower-case characters can be used, and variables can be local to sections of a program. The use of numeric variables is conventional in that they aren't declared and are all floating-point. Lines are numbered and may only contain one statement, though a comment may be added at the end of a statement by prefixing it with an exclamation-mark:  
30K=K+1 ! INCREMENT COUNTER

### Control structures

There are two main functions performed by control structures: repetition and selection. For repetition, we have a conventional FOR — NEXT, but also a DO — UNTIL, eg,  
80 DO UNTIL X>N

```
90 X=X+1
100 PRINT X,N
110 LOOP
```

Every structure is delimited by DO and LOOP but we can ring the changes by:

- using WHILE instead of UNTIL
- placing the terminating condition after LOOP
- breaking out of the loop by an EXIT IF statement.

Here's a couple of examples:

```
120 DO
130 X=X+1
140 LOOP WHILE X<N
```

```
150 DO UNTIL K>10
160 EXIT IF A(K)=0
170 K=K+1
180 LOOP
```

For selection, we have traditional single-line IF statements, but also multi-line IF...END IF and SELECT (case)

```
190 IF X>=0 THEN
200 Y=SQR(X)
210 PRINT Y
220 ELSE
230 PRINT "NO SQUARE ROOT"
240 END IF
250 SELECT AGE
260 CASE<16
270 PRINT "NOT WORKING"
280 CASE 16TO 65
290 PRINT "WORKING"
300 CASE ELSE
310 PRINT "RETIRED"
320 END CASE
```

If you like to design programs with a pseudo-code approach, these control structures should fit the bill.

### Strings

The implementation of strings is radically different from that in Microsoft. Firstly, the maximum string length is implementation-dependent, but must be a minimum of 72. Secondly, the familiar LEFT\$ and RIGHT\$ are replaced by a 'substring qualifier', as in:

```
10 A$="ABCDEFGH"
20 B$=A$(2:5)
```

Here, the bracketed qualifier specifies characters 2 through 5; thus B\$ becomes 'BCDE'. Qualifiers may also appear to the left of an assignment, eg,

```
30 A$(2:3)=A$(4:6)
would set positions 2 and 3 of A$ to 'DEF', resulting in the value 'ADEFDEFG'. To save you the trouble of writing the Microsoft equivalent, it is:
```

```
30 A$=LEFT$(A$,1) + (MID$(A$,4,3) + RIGHT$(A$,4))
```

ANS also has a concatenation operation '&', together with string functions, the main ones being:

CHR\$(N)	] character/internal code conversion
ORD\$(X\$)	
LWRC\$(X\$)	] lower/upper case conversion
UPRC\$(X\$)	
STR\$(N)	] character/number conversion
VAL(X\$)	
LEN(X\$)	length of a string
POS(X\$, Y\$)	substring search (the Microsoft INSTR)

### Arrays

Surprisingly, only a maximum of two subscripts are allowed, but a number of very useful features exist:

- several matrix functions, eg,  
40 MAT A=INV(B)
- the ability to pass an array of any size to a function, eg,  
50 X=FINDMAX(A())
- a SIZE function to find the maximum allowed subscript, eg,  
60 N=SIZE(A,2)  
sets N to the largest possible value for the second subscript of array A.
- character string arrays exist as in Microsoft, but ANS allows their use in MAT statements, eg,  
70 MAT A\$=A\$ & ""  
would put '.' at the end of every string element of array A\$.

# IS IT THE ANSWER?



# sinclair ZX81 PERSONAL COMPUTER

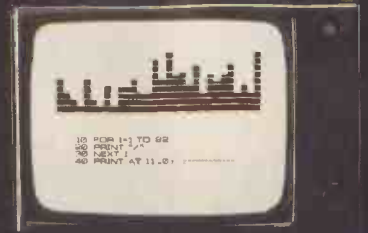

# Sinclair ZX81 Personal Computer the heart of a system that grows with you.

1980 saw a genuine breakthrough – the Sinclair ZX80, world's first complete personal computer for under £100. Not surprisingly, over 50,000 were sold.

In March 1981, the Sinclair lead increased dramatically. For just £69.95 the Sinclair ZX81 offers even more advanced facilities at an even lower price. Initially, even we were surprised by the demand – over 50,000 in the first 3 months!

Today, the Sinclair ZX81 is the heart of a computer system. You can add 16-times more memory with the ZX RAM pack. The ZX Printer offers an unbeatable combination of performance and price. And the ZX Software library is growing every day.

## Lower price: higher capability

With the ZX81, it's still very simple to teach yourself computing, but the ZX81 packs even greater working capability than the ZX80.

It uses the same micro-processor, but incorporates a new, more powerful 8K BASIC ROM – the 'trained intelligence' of the computer. This chip works in decimals, handles logs and trig, allows you to plot graphs, and builds up animated displays.

And the ZX81 incorporates other operation refinements – the facility to load and save named programs on cassette, for example, and to drive the new ZX Printer.



New BASIC manual

Every ZX81 comes with a comprehensive, specially-written manual – a complete course in BASIC programming, from first principles to complex programs.

## Kit: £49.<sup>95</sup>

### Higher specification, lower price – how's it done?

Quite simply, by design. The ZX80 reduced the chips in a working computer from 40 or so, to 21. The ZX81 reduces the 21 to 4!

The secret lies in a totally new master chip. Designed by Sinclair and custom-built in Britain, this unique chip replaces 18 chips from the ZX80!

### New, improved specification

- Z80A micro-processor – new faster version of the famous Z80 chip, widely recognised as the best ever made.
- Unique 'one-touch' key word entry: the ZX81 eliminates a great deal of tiresome typing. Key words (RUN, LIST, PRINT, etc.) have their own single-key entry.
- Unique syntax-check and report codes identify programming errors immediately.
- Full range of mathematical and scientific functions accurate to eight decimal places.
- Graph-drawing and animated-display facilities.
- Multi-dimensional string and numerical arrays.
- Up to 26 FOR/NEXT loops.
- Randomise function – useful for games as well as serious applications.
- Cassette LOAD and SAVE with named programs.
- 1K-byte RAM expandable to 16K bytes with Sinclair RAM pack.
- Able to drive the new Sinclair printer.
- Advanced 4-chip design: micro-processor, ROM, RAM, plus master chip – unique, custom-built chip replacing 18 ZX80 chips.



## Built: £69.<sup>95</sup>

### Kit or built – it's up to you!

You'll be surprised how easy the ZX81 kit is to build: just four chips to assemble (plus, of course the other discrete components) – a few hours' work with a fine-tipped soldering iron. And you may already have a suitable mains adaptor – 600 mA at 9 V DC nominal unregulated (supplied with built version).

Kit and built versions come complete with all leads to connect to your TV (colour or black and white) and cassette recorder.

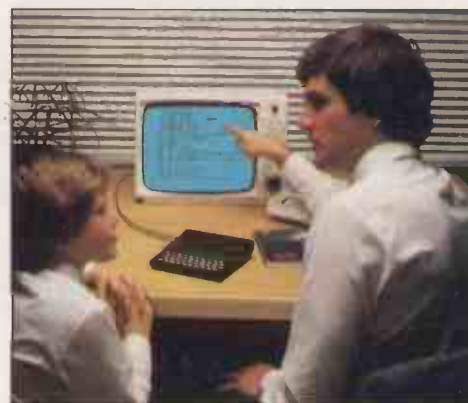



ter-



## Available now- the ZX Printer for only £49.<sup>95</sup>

Designed exclusively for use with the ZX81 (and ZX80 with 8K BASIC ROM), the printer offers full alpha- numerics and highly sophisticated graphics.

A special feature is COPY, which prints out exactly what is on the whole TV screen without the need for further instructions.

At last you can have a hard copy of your program listings – particularly useful when writing or editing programs.

And of course you can print out your results for permanent records or sending to a friend.

Printing speed is 50 characters per second, with 32 characters per line and 9 lines per vertical inch.

The ZX Printer connects to the rear of your computer – using a stackable connector so you can plug in a RAM pack as well. A roll of paper (65 ft long x 4 in wide) is supplied, along with full instructions.

## 16K-byte RAM pack for massive add-on memory.

Designed as a complete module to fit your Sinclair ZX80 or ZX81, the RAM pack simply plugs into the existing expansion port at the rear of the computer to multiply your data/program storage by 16!

Use it for long and complex programs or as a personal database. Yet it costs as little as half the price of competitive additional memory.

With the RAM pack, you can also run some of the more sophisticated ZX Software – the Business & Household management systems for example.

### How to order your ZX81

BY PHONE – Access, Barclaycard or Trustcard holders can call

01-200 0200 for personal attention 24 hours a day, every day.

BY FREEPOST – use the no-stamp-needed coupon below. You can pay

by cheque, postal order, Access, Barclaycard or Trustcard.

EITHER WAY – please allow up to 28 days for delivery. And there's a 14-day money-back option. We want you to be satisfied beyond doubt – and we have no doubt that you will be.

To: Sinclair Research, FREEPOST, Camberley, Surrey, GU15 3BR.				Order	
Qty	Item	Code	Item price £	Total £	
	Sinclair ZX81 Personal Computer kit(s). Price includes ZX81 BASIC manual, excludes mains adaptor.	12	49.95		
	Ready-assembled Sinclair ZX81 Personal Computer(s). Price includes ZX81 BASIC manual and mains adaptor.	11	69.95		
	Mains Adaptor(s) (600 mA at 9 V DC nominal unregulated).	10	8.95		
	16K-BYTE RAM pack.	18	49.95		
	Sinclair ZX Printer.	27	49.95		
	8K BASIC ROM to fit ZX80.	17	19.95		
	Post and Packing.			2.95	

Please tick if you require a VAT receipt

\*I enclose a cheque/postal order payable to Sinclair Research Ltd, for £ \_\_\_\_\_

\*Please charge to my Access/Barclaycard/Trustcard account no. \_\_\_\_\_

\*Please delete/complete as applicable. \_\_\_\_\_ Please print.

Name: Mr/Mrs/Miss \_\_\_\_\_

Address: \_\_\_\_\_

\_\_\_\_\_

\_\_\_\_\_

**FREEPOST – no stamp needed.**

PCW 02

**sinclair**  
**ZX81**

6 Kings Parade, Cambridge, Cambs., CB2 1SN.  
Tel: (0276) 66104 & 21282.

# How the ZX81 compares with other personal computers

SYSTEM IDENTIFICATION		ZX81	ZX80	ACORN ATOM	APPLE II PLUS	PET 2001	TRS 80 LEVEL I	TRS 80 LEVEL II
ROM		8K	4K	8K	8K	14K	4K	12K
GUIDE PRICE	Basic unit - inc. VAT	£70	£100	£175	£630	£435	£290	£375
	Unit plus 16K RAM (*12K RAM)	£120	£150	£285*	£630	£530	£360	£375
COMMANDS	LIST, LOAD, NEW, RUN, SAVE	●	●	●	●	●	●	●
STATEMENTS	PRINT, INPUT, LET, GOTO, GOSUB/RETURN, FOR/NEXT IF/THEN	●	●	●	●	●	●	●
	STEP	●		●	●	●	●	●
	TAB	●			●	●	●	●
ARITHMETIC	ABS, RND	●	●	●	●	●	●	●
FUNCTIONS	INT	●			●	●	●	●
	ATN, COS, EXP, LOG, SGN, SIN, SQR, TAN	●			●	●		●
	ARCSIN, ARCOS	●						
STRING FUNCTIONS	CHR\$	●	●		●	●		●
	LEN	●		●	●	●		●
NUMBERS	ASC(CODE), STR\$, VAL, INKEY\$	●			●	●		●
	FLOATING PT ±10 <sup>±38</sup>	●			●	●	●	●
NUMERIC VARIABLES	INTEGERS		●	●	●	●		●
	A-Z			●			●	
STRING VARIABLES	AA-ZØ				●	●		●
	An-Zn, n= any alphanumeric string	●	●					
NUMERIC ARRAYS	A\$ & B\$						●	
	A\$ to Z\$	●	●	●				
DISPLAY	An\$ to Zn\$, n= any alphanumeric character				●	●		●
	SINGLE DIMENSIONAL		●	●			●	
SPECIAL FEATURES	MULTI DIMENSIONAL	●			●	●		●
	ROWS	24	24	16	24	25	16	16
SPECIAL FEATURES	COLUMNS	32	32	32	40	40	64	64
	LOW RES GRAPHICS (<7000 pixels)	●	●	●	●	●	●	●
	HI RES GRAPHICS (>40000 pixels)			●	●			
SPECIAL FEATURES	USR (CALL, LINK)	●	●	●	●	●		●
	PEEK, POKE (OR EQUIV)	●	●	●	●	●		●

## Sinclair software on cassette.



The unprecedented popularity of the ZX Series of Sinclair Personal Computers has generated a large volume of programs written by users.

Sinclair has undertaken to publish the most elegant of these on pre-recorded cassettes. Each program is carefully vetted for interest and quality, and then grouped with others to form single-subject cassettes.

Software currently available includes games, junior education, and business/household management systems. You'll receive a Sinclair ZX Software catalogue with your ZX81 - or see our separate advertisement in this magazine.

## The ultimate course in ZX81 BASIC programming.



Some people prefer to learn their programming from books. For them, the ZX81 BASIC manual is ideal.

But many have expressed a preference to learn on the machine, *through* the machine. Hence the new cassette-based ZX81 Learning Lab.

The package comprises a 160-page manual and 8 cassettes. 20 programs, each demonstrating a particular aspect of ZX81 programming, are spread over 6 of the cassettes. The other two are blank practice cassettes.

Full details with your Sinclair ZX81.

## If you own a Sinclair ZX80...



The new 8K BASIC ROM used in the Sinclair ZX81 is available to ZX80 owners as a drop-in replacement chip. (Complete with new keyboard template and operating manual.)

With the exception of animated graphics, all the advanced features of the ZX81 are now available on your ZX80 - including the ability to drive the Sinclair ZX Printer.

# sinclair

## ZX81

6 Kings Parade, Cambridge, Cambs., CB2 1SN.  
Tel: (0276) 66104 & 21282.



# ANS BASIC

## Segmentation

Together with GOSUB/RETURN, ANS provides three other methods of splitting programs into modules. Firstly, there's a CHAIN statement, which can load and run complete programs — many existing Basic systems have this facility. Secondly, as well as the familiar single-line function definition, we have a multi-line version, as illustrated by:

```
350 DEF BIGGEST (A, B)
360 IF A>=B
370 THEN DEFEXIT BIGGEST=A
380 ELSE DEFEXIT BIGGEST=B
390 END IF
400 END DEF
```

Note DEFEXIT, which returns control to the calling program, with a result assigned to the function name.

We could use such a function by:

```
35 X=BIGGEST (G, SIN(Y))
45 PRINT BIGGEST (K+3, T)
```

Thirdly we have a subprogram, similar in concept to a Pascal procedure, eg,

```
410 DEF SWAP (A, B)
420 TEMP=A
430 A=B
440 B=TEMP
450 END SUB
```

and we could make use of this (to interchange the values of two variables) by:

```
55 CALL SWAP (G, N)
```

Functions and subprograms have facilities for string and array parameters, together with the allocation of local variables each time a module is entered. Among other things, this simplifies the business of writing recursive routines.

At first sight, it may seem that functions and subprograms are very similar, but the crucial difference is in the way parameters are passed: in a function, a copy of the value of a parameter is made available, but in a subprogram a reference (similar to an address) is provided. What this means in practical terms is that given only the copy of a value, a function can't change the original value. However, if a subprogram has a reference to an item (be it an array or simple variable), then its value can be altered.

## Input - output

'Core' ANS Basic has sequential files only, but an interesting feature is the ASK statement, by which a program can make enquiries about a file, eg,

```
500 ASK #3: ACCESS A$
```

This set A\$ to either 'INPUT' or 'OUTPUT', depending on how the file was opened. If you are lucky enough to have Basic with 'enhanced' file facilities, you also get random and indexed-sequential files.

## Graphics

Most languages don't have built-in graphics, hence the incomprehensible use of PEEK/POKE on many Microsoft systems. Let's examine some features of the ANS graphics module.

Assume that we want to plot in a square at the top right of the screen:

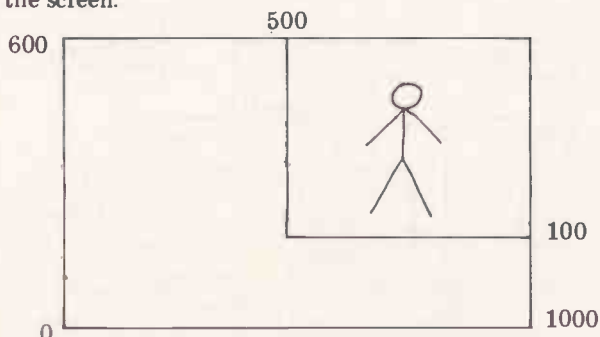

In other words, the physical screen ranges from 0 to 600 vertically, and 0 to 1000 horizontally, and we need to select a certain area. In Basic, we do this by —

```
600 SET VIEWPORT 500, 1000, 100, 600
```

in which the order of the values is: left, right, lower, upper. Unfortunately, the coordinates of our square are likely to be unsuitable for our problem so Basic allows us to define a mapping, eg,

```
610 SET WINDOW -100, 100, -100, 100
```

which gives us an origin at the centre, and 100 units in each direction. Once the plotting area is set up, we can use the PLOT statement, eg,

```
620 PLOT X,Y
```

Here, the beam is moved to the position specified by the values of X and Y, and then switched off. To leave the beam on, a semicolon is used, eg,

```
630 PLOT A,B;
```

In one PLOT, we may use several points, so to draw a square:

```
640 PLOT 0,0; 0,1; 1,1; 1,0; 0,0
```

Progressing to more advanced features, we can define routines which draw objects (called pictures) and transform them with rotation, scaling and positioning:

```
700 PICTURE SQUARE
```

```
710 PLOT 0,0; 0,1; 1,1; 1,0; 0,0
```

```
720 END PICTURE
```

So, to plot the square we can use:

```
65 PLOT SQUARE
```

and to plot it half-scale and rotated by 45 degrees:

```
75 PLOT SQUARE WITH SCALE(0.5) * ROTATE(45)
```

Finally, in a similar manner to file enquiries, we may ask about facilities:

```
730 ASK VIEWPORT A,B,C, D
```

## Real time

In a real-time system (eg, control of a chemical plant) the computer may have to perform tasks such as:

- examine a thermocouple every second;
- ring a bell every eight hours;
- detect when an alarm button is pressed;
- write some information to disk.

But, at any instant, several such activities may be partially completed: they proceed in parallel and such activities may be defined:

```
800 PARACT WORKSHIFT
```

```
810 WAIT DELAY 8*60*60 ! 8 HOURS
```

```
820 PRINT "SHIFT COMPLETED"
```

```
830 PAREND
```

This activity may be initiated by:

```
85 START WORKSHIFT
```

The result of this WAIT is that execution may proceed to other parts of the program, control only returning to line 820 after the specified delay.

However, there's more to real-time systems than this and Basic also provides for the suspension of activities until events occur, and for passing messages between parallel activities.

## The future

After this quick look at the language, would you want to use it? More precisely, how does it compare with (say) Pascal, Comal, and other Basics?

ANS Basic has very good control structures — better than Pascal — but is weak in the data-structuring area, eg, no records or user-defined types. Also it's insecure compared to Pascal; mis-spelled identifiers may not be detected.

The graphics and real-time modules are attractive and relatively easy to use but ANS will have to stand against competition from existing languages supplemented by systems software (eg, graphics packages, real-time operating systems), or in the future, competition from Ada.

Perhaps it is doomed to be treated as just another Basic dialect, and users will stick to the devil they know — if manufacturers take this attitude, will it ever be implemented?

# TJ's WORKSHOP

Our monthly pot-pourri of hardware and software tips for the popular micros. If you have a favourite tip to pass on, send it to: 'TJ's Workshop', PCW, 14 Rathbone Place, London W1P 1DE. Please keep your contributions as concise as possible. We will pay £10 for any tips we publish (think how much solder and/or Elastoplast that would buy).

## TESTING MACHINE CODE

It may sometimes be found necessary to write machine code routines to be incorporated in Basic programs (using **USR** command). This program was developed to facilitate the entry and testing of machine code for a Video Genie, although it could be used for other machines. After loading the Basic program, machine code can be input to any locations above those occupied by the Basic program. I use 4A38H as a start point since this happens to be easily remembered as 19000 decimal. Using this address will allow machine code in excess of 1 kbytes even a 4k machine, sufficient for any machine code likely to be required to be incorporated in a Basic program.

The program shown in Figure 1 will only accept hex digits (O-F) as input. The first input required is the start address in hex; 4 digits must be input and these are converted to a decimal start address which is then displayed, and the program waits for a pair of hex digits to be in-

put. These are poked into the address and the address incremented by 1 — when all the necessary instructions have been input, the break key will return to command level.

A specimen routine is shown in Figure 2, and this was prepared by writing assembler instructions then hand-assembling to arrive at the machine code required. The routine shown will fill a screen with asterisks, go into a waiting loop, then change three lines from asterisks to percentage signs, not a great breakthrough but sufficient to demonstrate a principle.

After loading the Basic program, enter **RUN** and insert the machine code instructions, when all instructions have been entered press **BREAK** to return to command level. Type in **SYSTEM** to enter system level and enter /19000 in reply to the \*? prompt. The routine described in the previous paragraph will be executed and the processor will go into a waiting loop which

can be cleared by pressing **RESET**. If the last instruction is omitted then control will automatically be returned to command level.

Various modifications would be possible to the program described; for example, it may be thought desirable to print decimal equivalents of hex code as input, or it would be possible to **PEEK**

the machine locations and display data when the machine code routine has been verified. When you are satisfied with the machine code routine, it can be implemented in a Basic program after incorporating the necessary linkage as described in your user manual.

R.M. Degg

## COMPUKIT 600 BAUD MODIFICATION

The following describes how to convert a CompuKit cassette interface to operate at 600 baud as well as 300.

On page 5 of the CompuKit manual, a method is described for increasing the baud rate of the cassette. This modification will not, in fact, work since as well as speeding the baud rate of the machine by a factor of two, four or eight, it also increases the '1' and '0' tones by similar factors, bringing the frequencies out of range of

most tape recorders. Therefore unless the operator uses a video recorder, the speed increase is not much use.

The method I have used is to connect the clock inputs of the ACIA to the other side of the divide by two systems formed by IC63. This doubles the baud rate, while not affecting the tone of the transmissions.

To effect the change it is simply necessary to cut one track on the PCB and connect a single pole changeover switch in its place (see diagram).

A D Love

Figure 1: Basic Program

```

10 DIM L$(15)
20 DATA "0", "1", "2", "3", "4", "5", "6", "7",
  "8", "9", "A", "B", "C", "D", "E", "F",
30 FOR I = 0 TO 15
40 READ L$(I)
50 NEXT
60 PRINT @ 130, "ENTER START ADDRESS"
70 GOSUB 310
80 A=X*4096
90 PRINT @ 150, A$
100 GOSUB 310
110 A=A+X*256
120 PRINT @ ISI, A$
130 GOSUB 310
140 A=A+X*16
150 PRINT @ 152, A$
160 GOSUB 310
170 A=A+X
180 PRINT @ 153, A$
190 PRINT @ 258, "ADDRESS", A;
200 PRINT @ 290, "DATA"
210 GOSUB 310
220 D=X*16
230 PRINT @ 295, A$
240 GOSUB 310
250 D=D+X
260 PRINT @ 296, A$
265 FOR I = 1 TO 150: NEXT
270 POKE A,D
280 PRINT @ 275, " "
290 A = A+1
300 GOTO 190
310 A$ = INKEY$(9)
320 FOR I = 0 TO 15
330 IF L$(I) = A$ GOTO 360
340 NEXT
350 GOTO 310
360 X=X-I
370 RETURN
  
```

Figure 2: Machine code example

	ORG	4A38H	Address (Hex)	Machine Code (Hex)
	LD	HL,3C00H	4A38	21003C
	LD	BC,1024	4A3B	010004
	LD	D,2AH	4A3E	162A
LOOP1	LD	(HL),D	4A40	72
	INC	HL	4A41	23
	DEC	BC	4A42	0B
	LD	A,B	4A43	78
	OR	C	4A44	B1
	JP	NZ,LOOP1	4A45	C2404A
	LD	BC,0	4A48	010000
LOOP2	INC	BC	4A4B	03
	LD	A,B	4A4C	78
	OR	C	4A4D	B1
	JP	NZ,LOOP2	4A4E	C24B4A
	LD	HL,3C00H+384	4A51	21803D
	LD	B,192	4A54	06C0
	LD	D,25H	4A56	1625
LOOP3	LD	(HL),D	4A58	72
	INC	HL	4A59	23
	DEC	B	4A5A	05
	JP	NZ,LOOP3	4A5B	C2584A
STOP	JP	STOP	4A5E	C35E4A

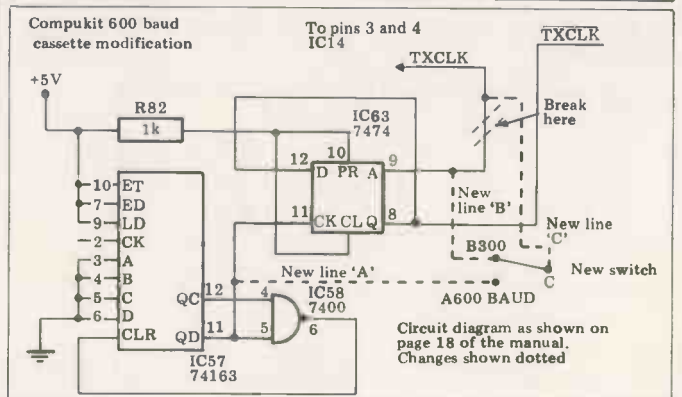
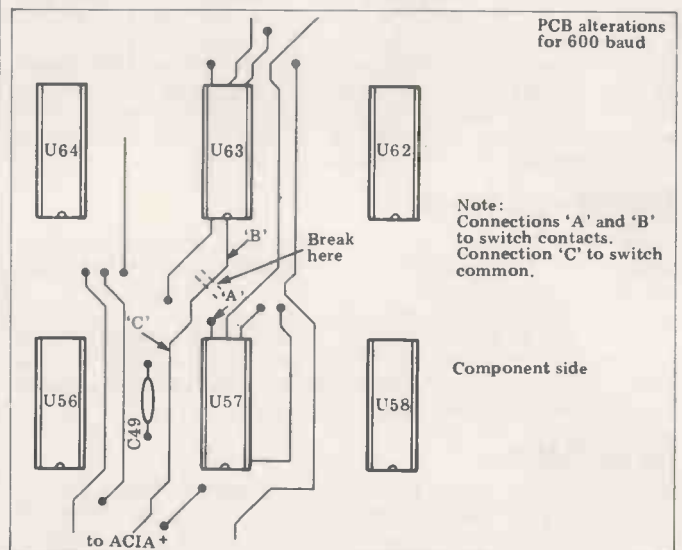



## ZX81 TIPS 1

Machine code users might like to know that you can reset RAMTOP without clearing the memory (useful if you suddenly remember you haven't reserved enough space). Method is as follows: POKE desired value for RAMTOP into 16388 and 9; PRINT USR 1040. It's as simple as that. Any Basic program remains unaffected, though variables are cleared.

Replace bulky IF statements used to control printing with one line as follows:

```
10 IF X=1 THEN PRINT 'YES'
20 IF X=0 THEN PRINT 'NO'
30 IF Y=D THEN PRINT 'FALSE'
40 IF S<>F THEN PRINT 'TRUE'
```

becomes:

```
10 PRINT 'YES' AND (X=1);
'NO' AND (X=0), 'FALSE' AND
(Y=D), 'TRUE' AND (S<>F)
```

Unfortunately, even if the third condition is not fulfilled the two commas are still acted upon, so you have to

watch line spacing. This can be a terrific memory saving.

Why not structured Basic on a ZX81? Simply identify program areas with REM statements (you do anyway, don't you?), giving each area a name. Declare that name as a variable at the beginning of the program with a value equal to the line number following the REM statement in which it occurs. Then, in your GOTOS, specify the variable name. This also makes simple renumbering routines which cannot cope with GOTOS more useful. After renumbering the lines you have only to check the REM statements to see what new values have to be assigned to the variables; no need to keep a record of where lines specified by GOTOS have been moved to. An end to incomprehensible GOTOS?

David Lawrence

## ZX81 TIPS 2

I have noticed a few useful features of the ZX81 logical operator set. In addition to the standard functions (AND, OR, NOT), relational operators are valid boolean operators. This is because the logical result of a comparison is one or zero, instead of true and false, ie, PRINT A=B is a valid expression. This has useful implications when modelling combinational logic systems.

ZX logic is defined in Figure 1. Care must be taken when mixing arithmetic operators (+, \*) with standard logical

operators (AND, OR, NOT) as the latter have much lower priority when the expression is evaluated, so application of brackets is essential. In fact, the only use for AND and OR as standard functions is the mixed type expression, ie, A&AND B will return string A& if A is true. Full truth tables for a switching function can easily be generated thus as in Figure 2. (note I=one):

Try expression  
A <> (B <> (C <> D)) — 4-bit parity generation!  
David Davies

Figure 1

ZX notation	Boolean expression	
A<B	$\bar{A}.B$	(NOT A) AND B
A>B	$A.\bar{B}$	(A AND (NOT B))
A<=B	$\bar{A}+B$	(NOT A) OR B
A>=B	$A+\bar{B}$	A OR (NOT B)
A<>B	$A\oplus B$	A EXOR B
A=B	$A\odot B$	A EXNOR B
A*B	A.B	A AND B
A+B	A+B	A OR B

Arithmetic operators work too!

Figure 2

```
100 FOR A=0 TO 1
110 FOR B=0 TO 1
120 FOR C=0 TO 1
" " "
260 FOR Z=0 TO 1
270 PRINT A;B;C;...Z;";"; (SOME EXPRESSION.)
280 NEXT Z
290 NEXT Y
" " "
530 NEXT A
```

## EPROM PROGRAMMER FOR PET

An EPROM programmer is out of my price range, especially when I only want an occasional 2716 programmed; also as a hobbyist felt I should do as much as possible myself, even if it took a long time — that's part of the enjoyment.

The current 'standard' EPROM is the 2716; it costs around £5, but will doubtless cost half that by the time this article is published. It holds 2048 bytes of memory. It has 11 address pins, eight data pins and five others:

Vcc : 5 volts  
Ground : 0 volts  
Vpp : 26 volts when programming, 0 or 5 volts when reading  
OE : needs Vcc when programming, 0 volts when reading  
CE/PGM : requires a 50 millisecond pulse of Vcc when programming and 0 volts enables the 2716 when reading.

To program the first address of the EPROM we do the following:

- 1 apply 25 volts to pin 21 (Vpp);
- 2 apply 5 volts to pin 20(OE);
- 3 apply the address to the address pins (1-8, 22-23 & 19);
- 4 apply the data required to the data pins (9-11 and 13-16);
- 5 apply a 50 millisecond TTL high-level pulse to pin 18. (CE/PGM).

To program the next memory we now increment the address in 3 above, change the data, and then send another program pulse.

When all 2048 bytes of data have been programmed, we switch off the 5 volts to pin 18 and then the 25 volts to pin 21. It is important to do the switching in this order. Vpp should only be switched

when CE is at ground potential. It is also important that the program pulse be fairly accurate. If it exceeds 55 milliseconds damage will almost certainly be done to the EPROM.

Of the PET's output ports the Parallel User Port (PUP) is the most useful. It has the data bus available — for both input and output — and the CB2 output for control. I wanted two other outputs so I spent some time studying the IEEE port. In the past I have treated this with great suspicion, but after some experimentation (not to mention several frustrating crashes) I obtained two outputs that could be programmed fairly easily. These were from pins 6 and 8 (DAV and NDAC), which can be addressed in machine code within \$E821 and \$E823.

The provision of addresses for the 2716 is straightforward. Three SN749s will give 12 addresses — one more than needed — with only two inputs to think about: one to zero the counters and another to increment them one at a time.

Basic is too slow and unreliable for times as short as 50 milliseconds so the programming and checking of the EPROM is done entirely with machine code. The Basic program (shown in Figure 1) which leads to it is merely a print-out program which slows me down, forcing a 'Y E S' from me when I have done various things in the right order. The machine-code program is shown in Figure 2.

During the programming of the 2716 there is a need for four states. A SN7474 is used to latch these states according to the following truth table:

Figure 1

```
LIST
100 PRINT "2716 EPROMMER"
110 PRINT "-----"
120 PRINT "MEMORY FOR ROM MUST BE PLACED BETWEEN"
130 PRINT "80C00 AND 813FF BEFORE RUNNING THIS"
140 PRINT "PROGRAM ANY FURTHER. IF THIS IS OK"
150 PRINT "PLEASE WRITE";CHR$(34);"Y E S";CHR$(34);":":GOSUB 2000
160 PRINT "PIN 20 (OE) SHOULD NOW BE AT 0 VOLTS"
170 PRINT "AGREE? (Y E S)":GOSUB 2000
180 PRINT "PLEASE APPLY 25 VOLTS TO PIN 21(VPP)"
190 PRINT "DONE? (YES)":GOSUB 2000
200 PRINT "PLEASE APPLY 5 VOLTS TO PIN 20(OE)"
210 PRINT "DONE? (YES)":GOSUB 2000
220 PRINT "FINAL CHECK. IS EVERYTHING NOW READY?"
230 PRINT "FOR PROGRAMMING?":GOSUB 2000
240 PRINT "THE EPROM IS NOW BEING PROGRAMMED.":SYS 2688:REM 2688=0DA0
250 PRINT "PLEASE APPLY 0 VOLTS TO PIN 20(OE)"
260 PRINT "DONE? (YES)":GOSUB 2000
270 PRINT "IF OE IS NOW AT ZERO PLEASE APPLY 0"
280 PRINT "VOLTS TO PIN 21(VPP)":PRINT "DONE? (YES)":GOSUB 2000
290 E=0:PRINT "EPROM IS NOW BEING CHECKED.":SYS 2883:REM 2883=0B25
300 IF PEEK(2880)=0 AND PEEK(2881)=20 THEN 360:REM 2880=0B40
310 F=PEEK(2924)+PEEK(2881)*256:G=255-PEEK(59471):REM 2924=0B6C
320 PRINT "ERROR!":F;" SHOULD BE";PEEK(F);" BUT IS";G
330 E=E+1
340 SYS 2920:REM 2920=80B8A
350 GOTO 300
360 PRINT "THE EPROM HAS NOW BEEN CHECKED. THERE WERE";E;" ERRORS."
370 END

2000 INPUT#1:IFA$<>"YES"THEN 2000
2010 RETURN
```





# ANNOUNCING THE NEW SORCERER



1.2 Megabyte

**ONLY £2,680**

**or £16 per week rental**  
(exclusive of VAT)

**The VIDEO DISK UNIT**  
can be linked with any  
printer and comes with  
a **FULL YEAR'S**  
guarantee from **EMG**

Dealers invited

Educational discounts

For Wordprocessing  
and Accountancy

**DISTRIBUTED BY EMG AT EMG MICRO CENTRES**

The **LONDON**  
MICRO CENTRE

47 Lower Belgrave Street  
LONDON SW1

Telephone: 01-730 8791

The **SOUTH LONDON**  
MICRO CENTRE

30 Heathfield Road  
CROYDON

Telephone: 01-688 0088

*Contact us today for further information*

**An EMG Company**

# THE NEW MICRO

## SYSTEM M-THREE

LSI, Britain's leading micro-computer manufacturer, is pleased to present the long awaited low cost, high performance, **SYSTEM M-THREE**.

From the early days of the large commercial computers, it became obvious that the need would arise for a compact micro-computer for use by smaller businesses, professional people, scientists and in many other areas. With the development of the micro-chip, other manufacturers, mostly overseas, soon flooded the market with their unverified versions of personal or small business computers.

At LSI we approached the matter more thoughtfully. With the success of highly acclaimed **SYSTEM M-ONE** and **M-TWO** machines, we were able to put together a large and experienced research and development team. They were given the task of producing a system that would adapt itself to the varying requirements of a single professional person, for example an accountant, or a medium sized commercial business, needing the full range of sophisticated facilities now available to the commercial user.

With assistance from the Department of Industry, no effort or expense was spared in producing a machine that is way ahead of it's class. The end result... a system that caters for all needs, from stock control to word processing; a system which in price, performance, reliability and looks, really has put **BRITAIN BACK IN FRONT**.

## Salient features.

**M-THREE** is designed in a modular form allowing many versions to be manufactured with the advantages of economics of scale. Common to all basic configurations are:

- Single board computer comprising Zilog Z80 processor with 64K RAM, 2K bootstrap loader prom, optional 2K monitor/diagnostic prom, parallel printer port, RS 232 serial port and optional General Purpose Interface Bus (GPB/IEEE488/IEC625-1).
- **VDU**: Integral display monitor, green phosphor, bonded faceplate, 80 characters x 24 lines, upper and lower case character set plus graphics characters, reverse video, blinking or non-blinking cursor.

- **DETACHABLE KEYBOARD**: A total of 109 keys including QWERTY, editing, cursor control and 24 programmable function keys; far more than the majority of competitive systems.



- **INTERFACES AND COMMUNICATIONS**: The parallel, serial port and General Purpose interface Bus allow a wide selection of printers and other peripheral devices to be interfaced, plus the capability for communications.

## ...PUTTING BRITAIN

**LSI**  
COMPUTERS

LSI Computers Limited Head Office: Copse Road, St Johns, Woking



# RO FROM LSI



Available to the customer as part of the basic system are a wide range of floppy and Winchester disk options:

- **5.25" MINI-FLOPPY DISK DRIVES:** two single sided double density drives totalling 350Kb OR two double sided double density drives totalling 700Kb.
- **8" FLOPPY DISK DRIVES:** two single sided double density drives, totalling 1.2Mb OR two double sided double density drives totalling 2.4Mb.
- **FLOPPY/WINCHESTER COMBINATION:** one 8" floppy disk and one 8" Winchester fixed disk of 5Mb or 10Mb capacity.
- **A SYSTEM HIGHLIGHT:** For larger users the keycap colours and engravings can be customised.
- **HOUSING:** The System, including disk drives, is contained in an extremely attractive foam moulded case ergonomically designed for the professional user; once again, special colours can be provided for large orders.

Call into your nearest dealer now, or clip the coupon for further information.

**LSI Computers Woking**  
Cope Road, St Johns, Woking, Surrey  
GU21 1SX  
Telephone: Woking (04862) 23411

**LSI Computers South East**  
4 Springfield Road, Horsham,  
West Sussex RH12 2PN  
Telephone: Horsham (0403) 64363

**LSI Computers South West**  
West House, Stawell, Bridgwater,  
Somerset TA7 9AA  
Telephone: Bridgwater (0278) 722073

**Bonsai Limited**  
112-116 New Oxford Street  
London WC1A 1HJ  
Telephone: 01-580-0902

**Welsh Business Systems Limited**  
1 Windsor Chambers, Windsor Arcade,  
Penarth, South Glamorgan  
Telephone: Penarth (0222) 700059/  
700021

**KGB Micros Limited**  
14 Windsor Road, Slough,  
Berkshire SL1 2EJ  
Telephone: Slough (0753) 38310 or  
38581  
Telex: 847777 DELRAY G attn: KMICRO

**The Micro Solution**  
Park Farm House, Hythrop,  
Chipping Norton, Oxfordshire OX7 5TW  
Telephone: Chipping Norton (0608)  
3256

**LSI Computers Manchester**  
Genesis, Birchwood Science Park,  
Risley, Warrington, Cheshire  
Telephone: Warrington (0925) 824585

**LSI Computers Croydon**  
Restmor Way, Hackbridge Road,  
Hackbridge, Surrey SM6 7AG  
Telephone: 01-773-0917

Dealer enquiries  
welcome; please  
apply to head office.



## N BACK IN FRONT.

Do not think that once you have bought your M-THREE that it ends there. LSI as always, will continue to develop new applications and enhancements to the existing system, all of which are available to you, the user.

It is an important part of the Company philosophy to fully protect existing users by ensuring easy upgrading to new ranges through maximum possible compatibility of software and hardware.

Surrey GU21 1SX. Telephone: Woking (04862) 23411. Telex: 859592

Please send me full details of System M-Three, today!

Name .....

Position .....

Company .....

Address .....

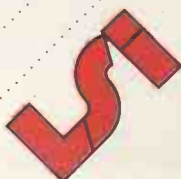

# you'll never beat the system



the low cost word processing/business system which matches quality with performance that you'll find hard to beat

The **SIG/NET 211-6** microcomputer is an advanced and innovative British designed computer manufactured in the U.K. by Shelton Instruments Ltd. The 211 series offer unrivalled expansion, very high performance and unbeatable value for money. The SIG/NET 211-6 includes 6 megabyte capacity (enough for approx. 1800 A4 pages!) integral mini winchester disk drive together with high speed double-sided mini-floppy drive, 64K of fast dynamic RAM, Z80A processor, dual programmable serial ports, CP/M operating system and hard disk utility software.

The **VDT-6 WordStar VDU** offers, at a unique price, a customised WordStar display terminal with numerous features normally found on significantly more expensive equipment. The VDT-6 VDU incorporates the latest WordStar implementation (Version 3.0). Display features are: 12" direct etched enhanced contrast screen, green P31 phosphor, 80 character by 24 line with true descenders, detachable keyboard, numeric keypad, 30 customised WordStar function keys, printer port, baud rates to 19,200 baud, full cursor addressing, full erase and editing functions, graphic line drawing mode, pound sign, full video attributes (underline, blinking, inverse, half intensity) etc.

The **RICOH 1600S** is a high quality daisy wheel printer. The 1600S is reliable, fast (60 cps) and incorporate a Z80 microprocessor to control auto-bidirectional printing and look-ahead logic for increased speed and efficiency. Other capabilities include proportional spacing, graph plotting and word processing enhancements (bold face etc.). The 1600S can optionally be fitted with forms tractors or a single sheet feeder. An internal buffer option is also available to increase throughput further still. A double daisy wheel provides a standard ASCII character set plus 30 additional characters.

We are distributors of **WordStar** and other MicroPro products

WRITE OR PHONE FOR DETAILS OF THESE AND FURTHER PRODUCTS AVAILABLE

TRADE ENQUIRIES WELCOME

SIG/NET is a trademark of Shelton Instruments Ltd

VDT-6 is a trademark of Insight Terminals Ltd

CP/M is a trademark of Digital Research Corp

**Interam Computer Systems Ltd.**  
46 Balham High Road, London, SW12 9AQ  
Telephone: 01-675 5325/6/7  
Telex: 925859

**INTERAM**



# THE MAN BEHIND THE WEST COAST FAIRE

An insight by David Tebbut and Judy Lower into WCF  
organiser Jim Warren

The day following the 1981 West Coast Computer Faire I found myself interviewing the show's organiser, Jim Warren, at his office-cum-home on a Californian mountain top. To my astonishment, halfway through the evening Jim suggested that we take our clothes off and finish the interview in the hot tub! Since note-taking was nigh on impossible under these circumstances, Judy Lower kindly offered to go back and complete the job.

This is a story about a man with dreams and, in these times of almost exclusively bad news, I feel that it's a story worth telling just to prove that dreams can come true, especially in the rapidly expanding microcomputer business.

Like so many people in the personal computer industry, Jim Warren was a bit of a drifter, fooling around with things that interested him rather than the things that other people thought he ought to be doing. He had no plans to become 'something big in micros' because, until just a few years ago, the darned things hadn't been invented! Now, every spring in San Francisco, Jim runs the biggest and best micro show in the world.

Jim's success has enabled him to buy 40 acres of prime Californian mountain top on the ridge that divides what he calls Silicon Gulch from the Pacific. Typically, Jim decided to design his own home/office for himself and his staff where they could all enjoy themselves while getting on with the serious business of organising the West Coast Computer Faires. The house is built on three storeys, with Jim's circular office/bedroom occupying the top level. The bedroom half overlooks 50 miles of Pacific coastline, including San Francisco, while the office/library half faces magnificent redwoods. The middle floor contains his computer with its seven terminals (three or four more are planned) and his staff, when they're not taking advantage of his fridge, hot tub, sun deck, visiting masseur or swimming pool. Fortunately (?), all the 'phones are on very long leads so that his staff can deal with calls wherever they happen to be.

Since California gets more than its fair share of earthquakes, the house is built almost entirely of wood. The theory is that wood flexes well when a tremor hits and everything returns to its original position after the 'quake. Jim very proudly showed off constructional details when we went into his equivalent of a basement and while we were down there he also showed me a large pit which was being cut out of



the mountainside. This will contain rocks which will be used as a form of heat storage. Jim plans to have solar panels and windmills scattered around his plot of land in order to become self-sufficient in heat and electricity. In fact, by plugging into the national network, he expects to become a net producer of electricity and receive negative power bills! Space heating is provided by a wood-burning fire in Jim's bedroom. All sorts of tubes carry the heat away to other parts of the building. It all seems to work very well in California. Sadly, it would probably be less successful in chilly Britain.

## The Faire staff

During the day, this beautiful retreat is populated by an unusual crew of 14 who operate together more like a family than a business. Even the carpenter, who has done such an amazing job on the house, seems to have joined the family. Whenever Jim needs someone new he just puts the word out in the computing community or through his existing staff and, lo and behold, the staff 'just magically appears'. Jim readily admits that he hasn't got an optimal mix of personalities or talents but he finds that from 'an overall living standpoint' it is pretty near optimal. Everyone gets along well together and, I suspect, if they don't then they probably drift away of their own accord. Jim feels that loyalty is very important and he abhors the sort of businesses that thrive on ego games and politics. He also believes in giving his employees the

maximum amount of freedom. If someone doesn't feel like working one day then fine, perhaps tomorrow they'll produce twice as much. Jim feels that nobody should have to do anything they don't want to do and he also lets them switch between jobs if that's what they want. Obviously, if someone refuses all jobs offered then they'd have to go, but this sort of thing doesn't seem to happen.

Since this all sounded jolly good coming from Jim, we thought we'd ask the staff how they saw things working out. Sarah Candelario is rapidly becoming Jim's 'right hand woman' and she had this to say: 'We're free to use whatever we want around the house — raid the refrigerator, whatever. No-one takes advantage, though. This environment is the best.' Sarah lives with her husband, Rick, just down the road from Jim in a little wooden cabin deep in the forest. She continued: 'Working in this area has made my whole world smaller because you only see a few people. On the whole I like it, but once in a while I have to go out of the area and see other people, otherwise I get cabin fever.'

Bruce, the man in charge of construction, planning and landscaping, had this to say about Jim: 'I've worked on and off with Jim for about five years. I think he's a pretty outrageously fine person. The more I know him the more I like him. He's conscientious, very sure of himself.'

Another, anonymous, friend had plenty to say about Jim. Things like: 'Jim's substantially ahead of his time ... He's casual about formal organisation, has no patience with society's organisation ... He's a bit of an anarchist, a one man band.' And, finally, perhaps giving a little insight on the remoteness of his home: 'His great love is his house, he wants people to come to him.'

## Early years

Jim was born in Oakland, California and when he was three or four he was taken to live in Texas. He doesn't know what Texas is like now, but he says in those days it was a 'major social disease'.

We're told that during his childhood Jim was 'bright, introverted and rejected by his peers'. Following school he spent two and a half years at college but before his course was complete he left to begin teaching at a Texas high school. He felt obliged to finish his own schooling during summer holidays. He describes the earning of the subsequent degree as 'obligatory bullshit'.

Somehow he found himself involved with the South Texas Math Council and,



typically, he wound up chairing it. He expanded and revitalised the organisation and ended up with a few National Science Foundation grants — two for the council and one for himself to get a master's degree. He finally ended up with three master's degrees — in Mathematics, Medical Information Systems and Computer Engineering. In case that seems to contradict what he said earlier, this is what Jim had to say about his life in general: 'I see my life as accidental. I sort of meander along and if something tweaks my interest I wander over and sniff that rose for a while. Not only is my life not planned, I don't mind it not being planned!' Luckily for Jim he finds most of the things that catch his interest are things which other people want to pay for.

## California

Jim came to California with no job, no savings and no plans. He wanted to live in the (San Francisco) Bay Area because he wanted to be where a lot of things were happening — innovation, frontiersmanship and people doing things that hadn't been done before, simply because they were considered to be worth doing. He was also attracted by the fact that people in the area live life the way they want to and not in the way which others say they should. Jim found himself teaching at a Catholic girl's school, a job which would see him through the next ten years.

At some time during this period he had fallen into the then popular habit of experimenting with alternative lifestyles, trying to find a better way to live. One of his discoveries was that of hosting nude parties for 'large groups of people with desirable goals, wishes and interests'. At the parties 'there were no rules and guests were encouraged to act themselves' — Jim figures that it is very hard to maintain a facade without a stitch on. These parties gained a certain amount of notoriety. First, good old Auntie BBC filmed one of his parties for a 'Now Generation' documentary, then both *Time* and *Playboy* magazines jumped on the bandwagon. Once the Catholic girl's school heard about this publicity, they invited Jim to move on.

He then got involved with the Free University, a Stanford-based alternative school founded by left-wing political activists. Jim found it exciting and interesting so he gave a hand with the administration. At the next election of officers all the left-wingers were ousted and the hippie counter-culture types, Jim Warren included, found themselves in power. Jim started a newsletter called *The Free You*. I think the nude parties petered out soon afterwards.

While working with the Free University, Jim needed some sort of part-time job. A friend suggested that he work at Stanford Medical Center. There he learned a lot about computers in process control and data acquisition work. Although these were fairly specialised applications, there was an immense demand for his services among the Bay Area electronics companies, so he became a successful consultant. The more he went along the more he realised that he had great peaks of expertise surrounded by chasms of ignorance. He had zero interest in research mathematics but a profound interest in the

practical applications of computing. The path he was about to follow would lead him to become one of the most knowledgeable people in the microcomputer business.

## Dr Dobbs and the Computer Faire

Jim migrated from consultancy into the editorship of *Dr Dobb's Journal*. He was its first editor and, according to many, it still bears the impression of his personality. At the time that Jim got involved with *Dr Dobb's* he was on the point of completing his PhD dissertation. It seems that he was enjoying the magazine so much that the doctorate was never completed. In 1976 a large computer festival was held in Atlantic City, New Jersey and Jim decided that something like it should be happening on what he considers to be the 'right' coast. The Computer Faire idea was born.

The Faire with an 'e' was named after the Renaissance Faire, a medieval-themed festival held each year in the area. The fun, excitement and festive air was just the flavour he was looking for. In those days the industry was so small that verbal agreements were honoured and Jim was easily bootstrapped into business. With more than a little help from friends, the Faire was on its way. In Jim's words, 'being the egomaniac I am there was a whole lot of information I wanted to put out about the Computer Faire. A leaflet was inadequate, but I knew a newspaper format was inexpensive so that's how I dreamed up the *Silicon Gulch Gazette*.' The *Gazette* has become quite a feature of the run-up to the Computer Faire. Everyone on Jim's massive mailing list gets each issue as it comes out. It contains news of what's going to be at the Faire, extracts from papers submitted for the conference section, as well as ramblings from the mountain-top muse himself.

The Atlantic City show had attracted 3000 people — a huge number in those days. Jim figured that, since he was in the centre of the industry, he could expect 7000 to come to San Francisco. In fact, the first Faire drew 13,000! For eight months Jim spent something like 60 hours a week working on the schedule that would cripple most people, Jim would claim that he plays 'almost constantly'. He explains: 'If work is performing activities that generate income then I work all the time. If it's something that's unpleasant that you have to do when you'd rather be doing something else, then I haven't worked since high school.'

Since those days the Faire has grown substantially and in 1981 it attracted 32,000 visitors. As if this wasn't achievement for one man, Jim decided that what the industry really needed was a fast-turn-round newspaper so, just a couple of years after starting the Faires, he launched a paper called *Journal of Intelligent Machines (JIM!)*. Even Mr Warren got tired of the mnemonic and renamed it the *Intelligent Machines Journal*. Tom Williams had been editing *Dr Dobb's* since Jim left, so Jim invited him to take over the editorship of *IMJ*. Jim, in his turn, got tired of running the paper and sold it to

Pat McGovern, the owner of *Computer-World*. John Craig was seduced away from the editorship of *Creative Computing* to become *IMJ's* publisher, the paper was renamed *Infoworld*, and it is now an immensely popular source of fast intelligence about the microcomputer industry.

## The man himself

Jim finds close friends and companions very hard to come by. He longs for a close companionship and is not too worried whether this involves marriage or not. He is easily turned off by people who are significantly constrained by conformity and tradition. Jim is very aware that he has put on a lot of weight and will readily admit to being 'slothful and opinionated'. Despite these things he is a compellingly attractive man. His weight gives the appearance of solidity and strength and he certainly appears larger than life when belting around the West Coast Faire on roller skates, as is his custom. Judy and I both find Jim an intriguing person.

He feels very secure about his professional future because, although the work brings problems, the approaches are usually pretty evident and achievable too. In his personal life things aren't so easy and this is probably why it is becoming so much more important, to Jim that he works something out with someone who can relate to him at the right level.

## Present and future

The Computer Faire and Conference is the main source of income at present. Jim plans a whole series of one-day topic-oriented mini-faires. Themes will include small business computing, educational computing, word processing, etc. The format would be a three-hour seminar by independent consultants, followed by an exhibition of products and rounded off with more seminars in the evening. Jim again: 'The seminars will be independent of the vendors to offer straight dope to the Faire participants.' There is also the possibility of running regional swap-meets.

Jim is also considering the possibility of two more good-sized Computer Faires — one in Southern California and the other in the Pacific North-West. These are expected to be smaller, regional shows as opposed to the major San Francisco Faire. A new feature of future Faires will be seminars by carefully chosen independent paid lecturers for fee-paying attendees. In the past the talks have been given by a variety of people, unpaid and talking about whatever they want. Jim says: 'Sometimes the speakers are worth a damn, and sometimes they're not.'

Three publications will be standard for future Faires — the *Silicon Gulch Gazette* already mentioned; the *Faire Word*, which gives even more news about the show; and *Inexpensive Computing for Business*, which will concentrate on promoting Faire activities to businessmen.

Jim has also been working on his Datacast project. Originally conceived as an airwave information provision system, it is at present being developed

GOTO page 189



# PCW SUBSET

More usefull assembler code subroutines from Alan Toothill

## Random numbers

What I particularly like about doing this series is getting one of those letters that connects up ideas from several different sources. Such a letter is just to hand from Andrew Bain of Welwyn Garden City on the subject of random numbers.

It began in the July 1981 issue with Gavin Evans' 16-bit pseudo random number generator using the formula:

New Random Number = 'a' times Previous Random Number plus C mod M, with 'a' = 257, C = 41 and M = 2\*\*16 (ie, 65536). Gavin gave some better values of 'a': 765; 889, 989 and 2009.

In October, Brian Steel pointed out that the value of 'a' in a good random number routine must, when a modulus of 65536 is used, be between 655 and 64480 and be such that 'potency' is 5 or more, potency being the power to which (a-1) must be raised before it is directly divisible by the modulus 65536.

Andrew now gives us first a simple means of calculating potency when M = 65546: (a-1) is divided

by 2 until the answer is an odd number. The number of divisions that have had to be made to produce this result is then divided into 16 and the answer, ignoring any remainder, is the potency. Thus, when 257 is used for 'a', (a-1) or 256 has to be divided by 2 eight times before the first odd number (one) results and 8 divided into 16 gives 2; too low a potency for a good random number routine. When 765 or 989 is used for 'a', (a-1) has to be divided by 2 only twice before an odd number results and 2 divided into 16 gives a potency of 8. Both these 'a's' satisfy Brian Steel's criteria.

Andrew offers a routine, Datasheet RANDM, based on the formula:

$$X_{i+1} = 1021 X_i + 41 \text{ mod } 65536.$$

Again 'a' satisfies Brian Steel's requirements, giving a potency of 8 and being >655 and <64880. Is RANDM then a particularly good pseudo random number generator or would it be better with an 'a' of 765, 989 or something else?

You might see how this could be tested if you read Alan Sutcliff's 'Patterns' in the November 81 issue of PCW.

## Ramm check

Here's an odd idea from Edmund Ramm of Kaltenkirchen, West Germany. Most small memory test programs have the disadvantage of not being able to test the locations they occupy themselves.

Edmund gives the code in Listing 1, for his Sharp MZ-80K, to test all RAM. It does this because it is stored and executed from the video RAM, which doesn't need testing by program, as faults there are apparent from faulty display.

```
RAMCHK:REL D000H
RAMSTA: EQU 1000H
RAMSIZ: EQU C000H
INIT: XOR A ; clear A. AF
LOOP1: LD HL, RAMSTA ; pointer. 21 00 10
LD BC, RAMSIZ ; counter. 01 00 C0
LOOP2: LD (HL),A ; write data. 77
CP (HL) ; check OK. BE
JR Z,OK ; 28 06
FOUND: LD (ADRSTO),HL ; "display" 22 22 D1
OK: JP MLOOP ; faulty addr. C3 82 00
EX AF,AF' ; save A. 08
KOR A ; clear A'. AF
DEC BC ; counter -1. 0B
CP B ; checked all RAM? B8
JR NZ, NEXT ; no. 20 07
CP C ; no. B9
JR NZ, NEXT ; no. 20 04
EX AF,AF' ; yes-restore data 08
INC A ; add 1 and 3C
JR LOOP1 ; try again. 18 E3
NEXT: INC HL ; next location. 23
EX AF,AF' ; restore data 08
JR LOOP2 ; try next locn. 18 E5
DUMMY: DEFS 100H ; make screen room
ADRSTO: DEFS 2 ; display addr.
END
```

Listing 1

Edmund advises that the Sharp 'ASCII' has little — and the display code nothing — in common with standard ASCII code, so the displayed address of a faulty location would be represented by a character according to the Sharp display code table. Sharp users, apparently, are accustomed to this code mixing and will make light of translating the address.

'Snow' on the screen during execution is caused by the repeated access to the memory chip. To get out of the program, one must actuate the hardware reset.

You can try this on an unexpanded Nascom 1. I did, storing the program from address 0A8AH and checking the RAM from address 0C80H for 0380H bytes. The amount of 'snow' generated is quite spectacular. The address of a faulty memory location can not always

be shown correctly from the Nascom by a LD (ADRSTO), HL instruction, since the most significant bit of a byte is not used in standard ASCII and such bits in the address will be ignored in generating the characters displayed. To simulate a faulty memory location by testing into EPROM, increase the memory size to 0381H bytes.

Strange things happen on my Nascom when a HALT (76) instruction is executed from a video RAM instead of the JP MLOOP into the monitor. The HALT superimposed a matrix of 16 x 24 dots over the screen or, sometimes, a less regular pattern, when a different address for ADRSTO was used. Does this happen on your Nascom and can you explain why? A HALT executed from other RAM works correctly.

## Datasheet

```
:=RANDM — 16-bit pseudo random number generator
;CLASS: 1
;/TIME CRITICAL ? : No
;/DESCRIPTION: Generates a 16-bit random number from the series
; Xi+1 = Xi*1021 41 mod 65536
;/ACTION: See program comments
;/SUBDEPENDENCE: None
;/INTERFACES: None
;/INPUT: HL contains the previous random number or,
; at the first call, a seeded number
;/OUTPUT: HL contains the new random number
; which must be saved for the next call
;/REGs USED: HL
;/STACK USE: 6
;/LENGTH: 18
;/TIME STATES: 144
;/PROCESSOR: Z80
```

```
RANDM: PUSH AF ; save F5
PUSH BC ; registers. C5
PUSH HL ; save original (HL). E5
LD H,L ; 65
LD L,+10 ; HL ← 256*(HL) + 10. 2E 0A
POP BC ; BC ← original (HL). C1
OR A ; clear carry. B7
SBC HL,BC ; HL ← 255*(HL) + 10. ED 42
ADD HL,HL ; HL ← 510*(HL) + 20. 29
ADD HL,HL ; HL ← 1220*(HL) + 40. 29
SCF ; add 1. 37
POP BC ; restore ED 4A
POP AF ; registers. F1
RET ; C9
```

## Find FOWIA

FOWIA (see PCW April and June 1981) is the two-byte Z80 routine to give the current instruction address in HL. Roger Hargraves points out that the two bytes (E1 and E9) are in locations 000BH and 000CH of the TRS-80 (and Video Genie) level II. Microsoft Basic

ROM. Let us know of anywhere else you find it.

## Improve and correct

Background correspondence has led to some clarification of the use of September's DIVNM for the M6809. Richard Crane uses DIVNM in a signed number environ-

# PCW SUBSET

ment where a previous routine handles the signs and formatting of the numbers. Hence only positive values are passed to DIVNM. The

## 6502 32-bit arithmetic

Dennis May of London SE1 has sent in the 6502 equivalents of SNEG4, SBAD4, SADB4, SMUL4 and SDIV4, Z80 32-bit arithmetic routines printed in last June's Sub Set. This gives us another chance to compare two processors working at the same task.

Remember that 'Sub Set' standards for 6502 code allow for 16 bytes, designated MO to MF, reserved in zero

first line of DIVNM's description should therefore be replaced by 'Divides one positive integer by another'. My mistake in December's Datasheet CVBA omitted the machine code displacement F9 at the DJNZ CVB1 instruction. The routine length is 16 bytes and the last five bytes are 10 F9 C1 F1 C9.

page memory and note that Dennis's routines depend in many cases on some of these locations being contiguous. This month we are printing Datasheets SNEG46 and SBAD46. The rest will follow later.

The Class 2 SNEG46, saving no registers, does in 20 bytes and 92 T states what the Class 1 Z80 version does in 23 bytes and 255 T states.

## Datasheet

```

SNEG46 -- Negate 4 bytes
CLASS: 2
TIME CRITICAL?: No
DESCRIPTION: Negates (2's complement) 4 bytes in zero page
              with the Cy copying the sign of the result
              Byte count ← 4
ACTION:      Byte pointer ← 0
              Cy ← 1
              Loop until byte count zero
              Byte ← 0 - byte - Cy
              Byte pointer ← byte pointer + 1
              Byte counter ← byte counter - 1
              Loop end
              Cy ← sign of result
SUBr DEPENDENCE: None
INTERFACES: None
INPUT:      Locations M1 - M4 contain a signed 32-bit number with
              the most significant byte in M4 and the least
              significant in M1
OUTPUT:     Locations M1 - M4 are negated and the carry is set
              to the resultant sign
REGs USED: A, X, P, M1 to M4 and ME
STACK USE: None
LENGTH: 20
T STATES: 92
PROCESSOR: 6502
    
```

```

SNEG46:  LDA  £4      ; byte count      A9  04
          STA  ME     ; to memory.      85  ZZ
          LDX  £0     ; RAM point.     A2  00
          SEC          ; set carry initially. 38
SNG1:    LDA  £0     ; subtract byte   A9  00
          SBC  M1,X   ; from zero and   F5  ZZ
          STA  M1,X   ; store back to RAM. 96  ZZ
          INX          ; point to next byte. E8
          DEC  ME     ; all done?      C6  ZZ
          BNE  SNG1   ; jump if not.    D0  F5
          ASL  A      ; cy = sign.     0A
          RTS         ;                60
    
```

The Class 2 SBAD46, again saving no registers, does in 73 bytes and a maximum 13,007 T states what the class 1 Z80 version does in 66 bytes and a maximum 25,244 T states. Being without a 6502 processor, between returning a borrowed

VIC-20 and not receiving delivery of my own BBC Micro, SBAD46 has been checked out by Mark Langham in North London. Mark also recovered an instruction that had slipped from Dennis's typewriter.

## Datasheet

```

SBAD46 -- 32-bit binary to ASCII-Decimal conversion
CLASS: 2
TIME CRITICAL?: No
DESCRIPTION: Converts a signed 32-bit binary number to an
              ASCII-Decimal string.
ACTION:      Make value absolute.
              If negative put "-" to RAM.
              Divide number by ten
              put remainder onto stack
              increment number of digits
              repeat until number = 0.
              Pop digit off stack
              convert to ASCII and load into RAM.
              Decrement number of entries
              repeat until number of entries = 0.
              Put ASCII CR into RAM for terminator.
SUBr DEPENDENCE: SNEG46
INTERFACES: None
    
```

```

INPUT:      M1-M4 contains the signed 32-bit number for conversion
              with the least significant byte at M1 and the most
              significant at M4.
              MA, MB contain the RAM start address of the result.
              MA, MB are unchanged.
              The ASCII string equivalent is in RAM starting at
              the address given in MA, MB.
REGs USED:  A, X, Y, P, M0 to M4, MA and MB.
STACK USE:  10 maximum.
LENGTH: 73
T STATES: 13,007 maximum
PROCESSOR: 6502
    
```

```

SBAD46:  LDY  £0      ; RAM point.      A0  00
          BIT  M4     ; test sign.      24  ZZ
          BPL  SBD1   ; skip if positive  10  08
          LDA  £32D   ; else put "-"    A9  2D
          STA  (MA),Y ; to RAM,      91  ZZ
          JSR  SNEG46 ; point to next RAM  C8
          STY  M0     ; and negate number  20  XX  XX
          LDY  £0     ; save RAM point.   84  ZZ
          LDX  £32   ; number of digits = 0. A0  00
          LDA  £0     ; bit count = 32.   A2  20
          SBD3:      LDA  £0     ; zeroise accumulator  A9  00
          ASL  M1     ; shift            06  ZZ
          ROL  M2     ; number           26  ZZ
          ROL  M3     ; left             26  ZZ
          ROL  M4     ; into            26  ZZ
          ROL  A      ; accumulator      2A
          CMP  £10    ; is acc less than 10 ? C9  0A
          BCC  SBD4   ; skip if so, else  90  04
          SBC  £10    ; subtract ten     E9  0A
          INC  M1     ; and set a result bit. E6  ZZ
          SBD4:      DEX          ; repeat      CA
          BNE  SBD3   ; 32 times.       D0  EC
          PHA        ; save digit.       48
          INY        ; increment no of digits. C8
          LDA  M4     ; check            A5  ZZ
          ORA  M3     ; if number        05  ZZ
          ORA  M2     ; is zero         05  ZZ
          ORA  M1     ; and             05  ZZ
          BNE  SBD2   ; repeat if not.   D0  DC
          TYA        ; transfer          98
          TAX        ; Y to X.          AA
          LDY        ; restore RAM point. A4  ZZ
          PLA        ; pop digit off stack, 68
          CLC        ; convert it       18
          ADC  £30    ; to ASCII        69  30
          STA  (MA),Y ; and put into RAM. 61  ZZ
          INY        ; increment RAM point. C8
          DEX        ; get next       CA
          BNE  SBD5   ; digit, else     D0
          LDA  £13    ; load ASCII CR   A9  0D
          STA  (MA),Y ; and put it to RAM. 91  ZZ
          RTS         ;                60
    
```

## BEFORE YOU JUMP IN AT THE DEEP END

Deep end tactics are alright for those who want to learn fast but not when massive capital investments are involved.

DIGICO enable you to find out exactly what computer facility you need before you get into the deep end. Step by step you can invest and see results from your investment at every stage.

How?

Well start with the Prince micro-computer system.

Add to it accounting packages as you wish, such as payroll, purchase ledger, word processing, sales ledger, order processing, stock control and so on

if you need more facilities then add more

printers, disc storage, graphics etc., at each stage learning exactly what you need.

And if you still want to grow, then add another micro-computer at the same price, or link your existing investment to a mini-computer as an on-line terminal. Then add lots more terminals, all accessing the same information base.

And you still have years more growth potential with you plus a guaranteed maintenance plan for seven years.

At no stage is there massive capital investment involved.

Send today for details on our mini micro network and no longer will the inevitability of computing loom fearfully on your horizon.



DIGICO LIMITED, Arena House, 46 Broadway, Letchworth, Herts. Tel: 78172 Leeds 486688



# Make the most of your Sinclair ZX Computer... Sinclair ZX software on cassette.

## £3.<sup>95</sup> per cassette.

The unprecedented popularity of the ZX Series of Sinclair Personal Computers has generated a large volume of programs written by users.

Sinclair has undertaken to publish the most elegant of these on pre-recorded cassettes. Each program is carefully vetted for interest and quality, and then grouped with other programs to form a single-subject cassette.

Each cassette costs £3.95 (including VAT and p&p) and comes complete with full instructions.

Although primarily designed for the Sinclair ZX81, many of the cassettes are suitable for running on a Sinclair ZX80 - if fitted with a replacement 8K BASIC ROM.

Some of the more elaborate programs can be run only on a Sinclair ZX Personal Computer augmented by a 16K-byte add-on RAM pack.

This RAM pack and the replacement ROM are described below. And the description of each cassette makes it clear what hardware is required.

### 8K BASIC ROM

The 8K BASIC ROM used in the ZX81 is available to ZX80 owners as a drop-in replacement chip. With the exception of animated graphics, all the advanced features of the ZX81 are now available on a ZX80 - including the ability to run much of the Sinclair ZX Software.

The ROM chip comes with a new keyboard template, which can be overlaid on the existing keyboard in minutes, and a new operating manual.

### 16K-BYTE RAM pack

The 16K-byte RAM pack provides 16-times more memory in one complete module. Compatible with the ZX81 and the ZX80, it can be used for program storage or as a database.

The RAM pack simply plugs into the existing expansion port on the rear of a Sinclair ZX Personal Computer.



### Cassette 1 - Games

For ZX81 (and ZX80 with 8K BASIC ROM)

**ORBIT** - your space craft's mission is to pick up a very valuable cargo that's in orbit around a star.

**SNIPER** - you're surrounded by 40 of the enemy. How quickly can you spot and shoot them when they appear?

**METEORS** - your starship is cruising through space when you meet a meteor storm. How long can you dodge the deadly danger?

**LIFE** - J. H. Conway's 'Game of Life' has achieved tremendous popularity in the computing world. Study the life, death and evolution patterns of cells.

**WOLFPACK** - your naval destroyer is on a submarine hunt. The depth charges are armed, but must be fired with precision.

**GOLF** - what's your handicap? It's a tricky course but you control the strength of your shots.

### Cassette 2 - Junior Education: 7-11-year-olds

For ZX81 with 16K RAM pack

**CRASH** - simple addition - with the added attraction of a car crash if you get it wrong.

**MULTIPLY** - long multiplication with five levels of difficulty. If the answer's wrong - the solution is explained.

**TRAIN** - multiplication tests against the computer. The winner's train reaches the station first.

**FRACTIONS** - fractions explained at three levels of difficulty. A ten-question test completes the program.

**ADDSUB** - addition and subtraction with three levels of difficulty. Again, wrong answers are followed by an explanation.

**DIVISION** - with five levels of difficulty. Mistakes are explained graphically, and a running score is displayed.

**SPELLING** - up to 500 words over five levels of difficulty. You can even change the words yourself.

### Cassette 3 - Business and Household

For ZX81 (and ZX80 with 8K BASIC ROM) with 16K RAM pack

**TELEPHONE** - set up your own computerised telephone directory and address book. Changes, additions and deletions of up to 50 entries are easy.

**NOTE PAD** - a powerful, easy-to-run system for storing and



retrieving everyday information. Use it as a diary, a catalogue, a reminder system, or a directory.

**BANK ACCOUNT** - a sophisticated financial recording system with comprehensive documentation. Use it at home to keep track of 'where the money goes,' and at work for expenses, departmental budgets, etc.

### Cassette 4 - Games

For ZX81 (and ZX80 with 8K BASIC ROM) and 16K RAM pack

**LUNAR LANDING** - bring the lunar module down from orbit to a soft landing. You control attitude and orbital direction - but watch the fuel gauge! The screen displays your flight status - digitally and graphically.

**TWENTYONE** - a dice version of Blackjack.

**COMBAT** - you're on a suicide space mission. You have only 12 missiles but the aliens have unlimited strength. Can you take 12 of them with you?

**SUBSTRIKE** - on patrol, your frigate detects a pack of 10 enemy subs. Can you depth-charge them before they torpedo you?

**CODEBREAKER** - the computer thinks of a 4-digit number which you have to guess in up to 10 tries. The logical approach is best!

**MAYDAY** - in answer to a distress call, you've narrowed down the search area to 343 cubic kilometers of deep space. Can you find the astronaut before his life-support system fails in 10 hours time?

### Cassette 5 - Junior

**Education: 9-11-year-olds**  
For ZX81 (and ZX80 with 8K BASIC ROM)

**MATHS** - tests arithmetic with three levels of difficulty, and gives your score out of 10.

**BALANCE** - tests understanding of levers/fulcrum theory with a series of graphic examples.

**VOLUMES** - 'yes' or 'no' answers from the computer to a series of cube volume calculations.

**AVERAGES** - what's the average height of your class? The average shoe size of your family? The average pocket money of your friends? The computer plots a bar chart, and distinguishes MEAN from MEDIAN.

**BASES** - convert from decimal (base 10) to other bases of your choice in the range 2 to 9.

**TEMP** - Volumes, temperatures - and their combinations.

### How to order

Simply use the order form below, and either enclose a cheque or give us the number of your Access, Barclaycard or Trustcard account. Please allow 28 days for delivery. 14-day money-back option.

## sinclair ZX SOFTWARE

Sinclair Research Ltd,  
6 Kings Parade, Cambridge,  
Cams., CB2 1SN. Tel: 0276 66104.

To: Sinclair Research, FREEPOST, Camberley, Surrey, GU15 3BR. Please print  
Please send me the items I have indicated below.

Qty	Code	Item	Item price	Total
	21	Cassette 1 - Games	£3.95	
	22	Cassette 2 - Junior Education	£3.95	
	23	Cassette 3 - Business and Household	£3.95	
	24	Cassette 4 - Games	£3.95	
	25	Cassette 5 - Junior Education	£3.95	
	17	*8K BASIC ROM for ZX80	£19.95	
	18	*16K RAM pack for ZX81 and ZX80	£49.95	
		*Post and packing (if applicable)	£2.95	
			Total £	

\*Please add £2.95 to total order value only if ordering ROM and/or RAM.

I enclose a cheque/PO to Sinclair Research Ltd for £

Please charge my Access\*/Barclaycard/Trustcard no.

\*Please delete as applicable.

Name: Mr/Mrs/Miss

Address:

PCW 02

# THOUGHT PROCESS

Commodore

Apple

Data General

Future Technology Systems



COMMODORE



APPLE



DATA GENERAL



FUTURE  
TECHNOLOGY SYSTEMS

Gate Microsystems have thought it out for you first.

A range of small computers to cover every conceivable practical application.

Star names that are all star performers:

COMMODORE, the popular multi-function professional.

APPLE, the most versatile of micro-computers.

Superb interactive single and multi-terminal business data processing systems from DATA GENERAL.

The powerful Series 88 from FUTURE

TECHNOLOGY SYSTEMS, combining high performance with advanced distributed processor architecture.

From this comprehensive armoury our experts can cover your every hardware and software requirement, off the shelf or tailor-made, with full training facilities and a prompt, caring after-sales service. Word processing to payroll, stock control to statistics, invoicing to information analysis... in a host of different contexts—we've given ourselves the complete range of options first.

Now we present them all to you.



## GATE MICROSYSTEMS LTD

The Nethergate Centre, 35 Yeaman Shore, DUNDEE DD1 4BU. Tel: 0382 28194.

Abbey House, Bothwell Street, GLASGOW. Tel: 041-221 9372.



# MICROCOMPUTERS AT LASKYS

## 10 Shops Nationwide Birmingham

19/21 Corporation Street, Birmingham, B2 4LP.  
Tel: 021-632 6303.  
Manager: Peter Stallard. 300 yards from Bullring Centre.

## Bristol

16/20 Penn Street, Bristol, BS1 3AN. Tel: 0272 20421.  
Between Holiday Inn and C & A.

## Chester

The Forum, Northgate Street, Chester, CH1 2BZ.  
Tel: 0244 317667.  
Manager: Jeremy Ashcroft. Next to the Town Hall.

## Edinburgh

4 St. James Centre, Edinburgh, EH1 3SR. Tel: 031-556 6217.  
Manager: Colin Draper.  
East end of Princes Street, St. James Centre.

## Preston

1/4 Guildhall Arcade, Preston, PR1 1HR.  
Tel: 0772 59264.  
Manager: Jim Comisky. Directly under Guild Hall.

## Manchester

12/14 St. Mary's Gate, Market Street, Manchester, M1 1PX.  
Tel: 061-832 6087.  
Manager: Lesly Jacobs. Corner of Deansgate.

## Glasgow

22/24 West Nile Street, Glasgow, G7 2PF. Tel: 041-226 3349.  
Manager: David Livingstone.  
Between Buchanan Street and Central Station.

## Sheffield

58 Leopold Street, Sheffield, S1 2GZ. Tel: 0742 750971.  
Manager: Justin Rowles. Top of the Moor, opposite Town Hall.

## Liverpool

33 Dale Street, Liverpool, L2 2HF. Tel: 051-236 2828.  
Manager: Mark Butler.  
Between the Town Hall and Magistrates Courts.

## London

42 Tottenham Court Road, London, W1 9RD.  
Tel: 01-636 0845. Manager: Vass Demosthenis.

**Official Orders** over £50 are welcome with normal 30 days credit extended to bona-fide commercial and government organisations.

Laskys, the retail division of  
the Ladbroke Group of Companies

# MICROCOMPUTERS AT LASKYS

# WORLD BEATING MICRO'S

**NEW**  
Now in stock  
the powerful  
Apple III and the  
exciting new  
Osborne I



### Apple II

The worlds best selling micro offers unmatched flexibility. At our special prices.

Apple II + 48K  
Nett: 675.00 Vat: 101.25 Total: 776.25  
Disk Drive Plus Controller (3.3)  
Nett: 375.00 Vat: 56.25 Total: 431.25  
Disk Drive  
Nett: 295.00 Vat: 44.25 Total: 339.25

### MZ 80K

Deservedly popular the MZ 80K comes with 48K of RAM, built in screen and cassette. - superb value.

MZ 80K Computer 48K  
Nett: 347.00 Vat: 52.00 Total: 399.00

### Atari 400

Ideal for the home with excellent games and education packages. This computer features colour and sound and is built tough to last.

400 16K Computer  
Nett: 300.00 Vat: 45.00 Total: 345.00  
410 Tape Recorder  
Nett: 43.48 Vat: 6.52 Total: 50.00

### Atari 800

The big brother of the 400 shares all the star features and has much more as well.

800 16K Computer  
Nett: 560.87 Vat: 84.13 Total: 645.00  
810 Disk Drive  
Nett: 300.00 Vat: 45.00 Total: 345.00  
822 Thermal Printer  
Nett: 230.43 Vat: 34.57 Total: 265.00

### Hewlett Packard HP 85

Scientific and technical professionals favour the HP 85, they are being joined by increasing numbers of business professionals.

HP 85 Computer  
Nett: 2146.95 Vat: 322.04 Total: 2468.99  
16K Memory Module  
Nett: 194.88 Vat: 29.23 Total: 224.11  
ROM Drawer  
Nett: 29.73 Vat: 4.46 Total: 34.19



# COMPUTER ANSWERS

Send your queries to: Sheridan Williams, 35 St Julian's Road, St Albans, Herts.  
Please note that Sheridan can no longer answer questions on an individual basis, so please don't send an SAE with your query.

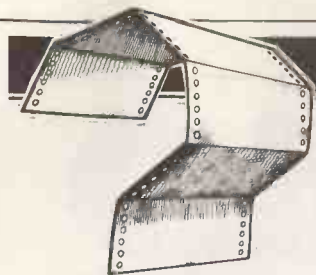

## Cruncher Wanted

I own a ZX80, and now want a bigger and better system. I require it to perform scientific calculations and be capable of differentiating and integrating with numbers up to  $10^{30}$ . I want it to be able to plot figures obtained, probably in high resolution graphics. It would be useful if it could handle statistical data, and be capable of storage and retrieval on tape. I also want to be able to play games and flash images on the screen for millisecond periods. I would dearly like an Apple or Sorcerer but wouldn't like the price.  
*A Hewitt, Northwich, Cheshire*

I think I'd better clarify one point: your ZX80 is capable of performing scientific calculations, differentiating and integrating; it has the same micro-processor as the North Star Horizon and other quite sophisticated systems. What you mean is you need built-in routines to perform what you require. There are three aspects that are important to you: 1. Ability to handle floating point arithmetic; 2. The range and accuracy of the arithmetic; 3. Speed of calculations — there is not a huge amount of difference between machines in this range as they are all slow, especially in Basic. The Apple and Sorcerer are not outstanding in this field and much cheaper systems such as the Video Genie are perfectly suitable. You would probably be best to look at a system that allows 'double precision' arithmetic, or, at a bare minimum, one that uses five bytes rather than four to store numeric variables. I know of no system that has built-in calculus facilities, although sub-routines exist for Simpson's method of integration and Runge-Kutta for differentiation. There are plenty of numerical analysis books available to help you.

As for statistics, there is no need to waste your money on an Apple when all you require are good file handling facilities built-in to Basic. This rules out the Video Genie and TRS-80, and

Apple. The PET/VIC range has good file handling and uses five bytes per numeric variable. Hopefully the BBC micro will also offer all that you require — and high resolution graphics too.

Finally your question about subliminal flashing. No system that I know of can do that. Most phosphors on a TV screen have a persistence ten times longer than the times you want. Why do you want to flash 1000 images per second onto the screen? A microcomputer could not generate images that quickly anyway.  
SW

## BBC I

Could you answer the following questions about the BBC Micro and BBC Basic? Is the computer programmable in assembler and, if so, can assembler routines be included in a Basic program as on the Atom? What are the differences between models A and B? When will they be on sale? How much will additional RAM cost and what is the maximum addressable RAM? When will Pascal (and the second processor) be available? Is the colour facility provided as standard and, if not, how much will it be?

*J Dickie, Morecambe, Lancs*

I passed this letter and the one from Colin Grant directly to Acorn where I received a prompt answer from its manager of educational services John Coll. (Now where on Earth have I seen that name before?) Here are the replies:

1. The computer is fully programmable in 6502 assembler language; and this can be freely mixed with the Basic as in the Atom; however there is improved labelling in that labels can now consist of a string of alphanumeric characters.  
2. You should send off to BBC Microcomputer System, PO Box 7, London W3 6XJ for their 'little red book', which describes the differences fully. Briefly, though, the B system is a very worthwhile starting point if you can afford the extra cost. It has an extra 16k RAM, serial (RS423) interface, Centronics-type parallel port, 8-bit I/O port, four 12-bit analogue input channels, Teletext expansion, RGB sync for colour, plus sockets for all interfaces. All the eight graphics modes are available, too.

3. Delivery started in early December 1981.

4. Maximum addressable RAM is 32k, but it is possible to expand externally up to about 8Mb of RAM. It is not possible to purchase a RAM expansion without upgrading to model B.

5. Pascal will be available about the middle of 1982, and there is likely to be more than one version.

6. Colour is provided as standard.

SW

## BBC 2

Could you answer the following questions for me and many other Acorn Atom owners about the new BBC Basic?

1. When will the new Basic be available? 2. How much will it cost? 3. Will it require the removal of the existing ROMs or will it be on a separate board? 4. Will the standard Atom PSU be okay? 5. Will it still be possible to use Atom Basic with the BBC Basic fitted? 6. Can the full graphics potential of the BBC machine be realised on the Atom? 7. Will the fact that the BBC machine runs at 2 MHz whereas the Atom runs at 1 MHz make a difference to program execution speed? 8. Does the BBC machine support the '?' and '!' (PEEK and POKE) as does the Atom? 9. Will the shorthand representation of keywords be present on the BBC system? 10. Will BBC Basic use labels? 11. The BBC machine has 10 user definable keys. Will it be possible to simulate these on the Atom? 12. Can we add the Teletext receiver and/or the second processor to the Atom? 13. Will the present Atom colour board support all the colour modes of the BBC system? 14. Will the additional ROM socket still be available for use? 15. I cannot get my Seikoshia GP80 printer to produce graphics, can you help?

*Colin Grant, Dumfries*

As in the previous question, John Coll, Acorn's Manager of Educational Services, has provided all the answers:

1. New Basic for the Atom should be available in February 1982, rather ahead of the original schedule. 2. About £35. 3. It will require the removal of the existing ROM and will be on a separate board which will plug into one of the existing ROM sockets. 4. Standard PSU is sufficient. 5. It isn't possible to use Atom and BBC Basic together. 6. It

will not be possible to use all the graphics for the BBC machine on the Atom since the Atom cannot support more than 256 horizontal points. 7. The Basic will run more slowly in the Atom because of the slower clock rate. 8. BBC Basic does support '?' and '!'. 9. Shorthand representation of keywords is maintained on the BBC system. 10. BBC Basic does not permit labels for subroutines, but does permit labels in the assembler. However, procedures and functions can be called by name and this is considerably more flexible than the use of named GOSUBs. 11. User-defined keys on the BBC machine can hold a string of characters. The maximum number of characters held is 255. It is therefore not possible to simulate these keys, even using a control key. 12. I doubt if it will be possible to add the second processor to the Atom, though it might be possible to add the Teletext receiver. This isn't certain at this stage. 13. The Atom will not be able to support the wide range of colour graphics facilities, but some of these facilities will be available. 14. The new BBC Basic and operating system will completely fill the memory space, so it will not be possible to usefully fill the additional ROM socket. 15. Routines to drive the Seikoshia printer were published in 'TJ's Workshop' last November and are available from Acornsoft as a single printed sheet.  
SW

## Club System

Can you advise me on which systems to buy? We have a bowling club with 3000 members, each member bowling in a different league and we want to maintain averages and pick players for matches based on those averages. What size memory would I need and do I need tapes or disks? Would an Acorn Atom, Video Genie or something larger like a PET be suitable?  
*M Pyke, London SE18*

The first thing you should do is read all the back issues of PCW that contain the series 'Secrets of Systems Analysis' (now also available as a book, *Desk Top Computing*, for £2.25 — see page 197). From that you will see that I haven't got enough information to specify a system. Some of the details



# COMPUTER ANSWERS

I would need are: your budget; speed of response to an enquiry; what data on members you need to keep; do you need printouts?; precise method for selecting match players; league procedures/structures; are members subscriptions to be managed, etc?

It appears that your master file will be around 240k in size, but your requirements for main store will only be about 16k on top of Basic (if indeed you are to use Basic). So a minimum system would probably be, say, 16k PET, 4000 series disks and a printer. Total hardware costs — about £1700. Software is of course, another matter and you should investigate this before looking at hardware.

SW

## Open question

The 'Open Question' (October *PCW*) was: could you suggest a method for obtaining a convincing RND product on MBasic 5.03? MBasic has been altered so that a 'seed' input is now required. My kids know the result of various seeds and the fun is spoilt as a result.

Mr Reason was the sole judge, as it was he who posed the question. He replies as follows:

'There were several replies in 'PET' Basic showing a solution using the GET statement. Unfortunately my MBasic doesn't have this function, just an INKEY\$ function which works only when a key is pressed. I also received some machine code routines but really wanted one that would work in MBasic.'

The winner is Frank Woodcock of Redditch Worcs, whose reply is reproduced below. I have the same problem with my Microtan 65, using Microsoft Basic. However I discovered that the keyboard has two entry points in memory. Location 1 stores the ASCII value of the last key typed, while location 49039 is floating between 0 and 255 until a key is pressed, and holds the ASCII value only when a key is held down. The following exploits this characteristic:

```
10 FOR A=0 TO PEEK(49039)
20 X=RND(1)
30 NEXT A
Another solution is to use part of the input statements to provide a seed, eg, LEN(A$) will return the number of characters in a string. This combined with string handling using MID$ in a FOR loop will set the RND between RND(32) and RND(96), each RND returning a number between 0 and 1. For example:
10 FOR A=0 TO LEN(A$)
```

```
20 X=RND(ASC(MID$(A$,A))):NEXT A
or
10 FOR A=0 TO LEN(A$):
X=RND(1):NEXT A
or
10 FOR A=0 TO ASC(MID$(A$,RND(1)*LEN(A$)+1))
20 X=RND(1):NEXT A
So long as the string A$ is not fixed then the above will give various levels of security.
```

Well done Mr Woodcock. By the way, my solution would be:

```
10 PRINT"Please press any key"
20 A=INP(3):A=INT((A-4*INT(A/4))/2)
30 X=RND(1):IF A=0 THEN 20
40 rest of the program.
SW
```

## Port problem

We were very interested in the article in October's *PCW* entitled 'Control your own Substation' describing the uses of the 80/81 port and we'd like to use it in conjunction with an electronic counter totalling up to 99.

Is it possible to program the ZX81 and port, and use one counter to refer to the ZX81 internal clock and provide totals per half, one, five seconds, five hours etc? Would any counts be lost while the ZX81 was doing calculations?  
*J Hopkins, Director, Hydrovac (Development) Ltd, Bournemouth*

Yes, it is a relatively easy matter to achieve what you ask. Some of the eight input channels of the 80/81 port (see October and November *PCW*) can be connected directly to the registers of a counter which the ZX81 may read periodically without losing counts

or losing track of time.

I have given a circuit using a couple of 74LS93 counter ICs connected to the input port. The ICs are powered by the port itself, so the only external connection required is to the input of the counter. In the circuit I have shown, this is connected to a switch so that the number of times the switch is opened and closed will be registered on the pair of counters (counting up to 255 before returning to zero). If your counting input is TTL-compatible rather than a switch, then simply remove the switch and the 1k resistor. As the counts are made they are recorded in the counting registers of the two ICs, and these registers may be read by the ZX81 through the input port. Simply executing PRINT PEEK 11000 will cause the count to be printed to the screen.

If you require a total number of counts per second or per half-second to be printed continuously this is easily achieved by software. Suppose that you require a screen printout every second, and the input count rate is less than 255 counts per second; the following program will achieve this:

```
30 SLOW
40 LET Z=0
50 LET X=PEEK 11000
60 FOR I=1 TO 200
70 NEXT I
80 LET Y=PEEK 11000
90 LET W=Y-X
100 IF W<0 THEN W=W+256
110 LET Z=Z+W
120 LET X=Y
130 PRINT Z
140 GOTO 60
```

You will need to adjust the length of the loop in line 60 to give the exact timing required, but once you have done this, the arrangement will give accurate readings of input count, though a

problem may be caused by the ZX81's irritating habit of executing PRINT PEEK X much faster when the result is zero than when it is another value. If you have a count rate much faster than 255 per second you will need to incorporate an updating routine for the count within the loop. This would check the value of the counter against the last value read in and, if it was less, then 256 would be added to the variable being used to keep track of the total count.

One further sophistication you may wish to add would be auto zeroing. If you disconnect both pins 2 of the counter ICs from ground, and connect them both to the W0 pin (pin 1) of the output port, you can use this to reset the counter. With this connection made, the counter will only function when W0 is low (this may be achieved by POKING either zero or any even number to the output port at 11000). To reset the counter to zero, simply bring W0 high, and then low again. Thus the following simple program would set the counter to zero, then print the count after a given time delay, reset it to zero and repeat the exercise. Here, of course though, you could lose a count during the resetting procedure.

```
20 POKE 11000,1
30 POKE 11000,0
40 FOR I=1 TO 400
50 NEXT I
60 PRINT PEEK 11000
70 GOTO 20
```

In both this and the other counting routine you could obviously make good use of the PRINT AT command in ZX81 Basic to achieve a digital counter effect anywhere on the screen, rather than have a scrolled printout with the programs as they stand.

D E Graham

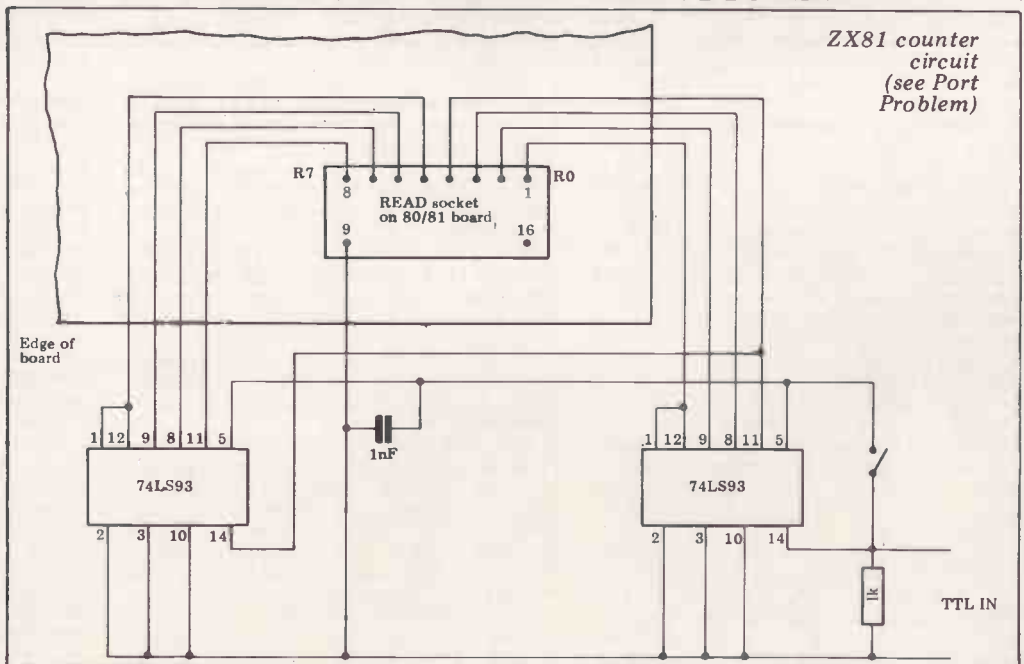

# NEWCOMERS START HERE

*This is our unique quick-reference guide, reprinted every month to help our readers pick their way through the most important pieces of (necessary) jargon found in PCW. While it's in no way totally comprehensive, we trust you'll find it a useful introduction. Happy microcomputing!*

Welcome to the confusing world of the microcomputer. First of all, don't be fooled; there's nothing complicated about this business, it's just that we're surrounded by an immense amount of necessary jargon. Imagine if we had to continually say 'numbering system with a radix of 16 in which the letters A to F represent the values ten to 15' when instead we can simply say 'hex'. No doubt soon many of the words and phrases we are about to explain will eventually fall into common English usage. Until that time, **PCW** will be publishing this guide — every month.

We'll start by considering a microcomputer's functions and then examine the physical components necessary to implement these functions.

The microcomputer is capable of receiving information, processing it, storing the results or sending them somewhere else. All this information is called **data** and it comprises numbers, letters and special symbols which can be read by humans. Although the data is accepted and output by the computer in 'human' form, inside it's a different story — it must be held in the form of an electronic code. This code is called **binary** — a system of numbering which uses only 0s and 1s. Thus in most micros each character, number or symbol is represented by eight binary digits or **bits** as they are called, ranging from 00000000 to 11111111.

To simplify communication between computers, several standard coding systems exist, the most common being **ASCII** (American Standard Code for Information Interchange). As an example of this standard, the number five is represented as 00110101 — complicated for humans, but easy for the computer! This collection of eight bits is called a **byte** and computer freaks who spend a lot of time messing around with bits and bytes use a half-way human representation called **hex**. The hex equivalent of a byte is obtained by giving each half a single character code (0—9, A—F): 0=0000, 1=0001, 2=0010, 3=0011, 4=0100, 5=0101 . . . . E=1110 and F=1111. Our example of 5 is therefore 35 in hex. This makes it easier for humans to handle complicated collections of 0s and 1s. The machine detects these 0s and 1s by recognising different voltage levels.

The computer processes data by reshuffling, performing arithmetic on, or by comparing it with other data. It's the latter function that gives a computer its apparent 'intelligence' — the ability to make decisions and to act upon them. It has to be given a set of rules in order to

do this and, once again, these rules are stored in **memory** as bytes. The rules are called **programs** and while they can be input in binary or hex (**machine code** programming), the usual method is to have a special program which translates English or near-English into machine code. This speeds programming considerably; the nearer the programming language is to English, the faster the programming time. On the other hand, program execution speed tends to be slower.

The most common microcomputer language is **Basic**. Program instructions are typed in at the keyboard, to be coded and stored in the computer's memory. To run such a program the computer uses an **interpreter** which picks up each English-type instruction, translates it into machine code and then feeds it into the **processor** for execution. It has to do this each time the same instruction has to be executed.

Two strange words you will hear in connection with Basic are **PEEK** and **POKE**. They give the programmer access to the memory of the machine. It's possible to read (PEEK) the contents of a byte in the computer and to modify a byte (POKE).

Moving on to **hardware**, this means the physical components of a computer system as opposed to **software** — the programs needed to make the system work.

At the heart of a microcomputer system is the central processing unit (**CPU**), a single microprocessor chip with supporting devices such as **buffers**, which 'amplify' the CPU's signals for use by other components in the system. The packaged chips are either soldered directly to a printed circuit board (**PCB**) or are mounted in sockets.

In some microcomputers, the entire system is mounted on a single, large, PCB; in others a **bus system** is used, comprising a long PCB holding a number of interconnected sockets. Plugged into these are several smaller PCBs, each with a specific function — for instance, one card would hold the CPU and its support chips. The most widely-used bus system is called the **S100**.

The CPU needs memory in which to keep programs and data. Microcomputers generally have two types of memory, **RAM** (Random Access Memory) and **ROM** (Read Only Memory). The CPU can read information stored in RAM — and also put information into RAM. Two types of RAM exist — **static** and **dynamic**; all you really need know is that dynamic RAM uses less power and is less expensive than static, but it requires additional, complex, circuitry to make it work. Both types

of RAM lose their contents when power is switched off, whereas ROM retains its contents permanently. Not surprisingly, manufacturers often store interpreters and the like in ROM. The CPU can only read the ROM's contents and cannot alter them in any way. You can buy special ROMs called **PROMs** (Programmable ROMs) and **EPROMs** (Erasable PROMs) which can be programmed using a special device; EPROMs can be erased using ultra-violet light.

Because RAM loses its contents when power is switched off, **cassettes** and **floppy disks** are used to save programs and data for later use. Audio-type tape recorders are often used by converting data to a series of audio tones and recording them; later the computer can listen to these same tones and re-convert them into data. Various methods are used for this, so a cassette recorded by one make of computer won't necessarily work on another make. It takes a long time to record and play back information and it's difficult to locate one specific item among a whole mass of information on a cassette; therefore, to overcome these problems, **floppy disks** are used on more sophisticated systems.

A floppy disk is made of thin plastic, coated with a magnetic recording surface rather like that used on tape. The disk, in its protective envelope, is placed in a disk drive which rotates it and moves a **read/write head** across the disk's surface. The disk is divided into concentric rings called **tracks**, each of which is in turn subdivided into **sectors**. Using a program called a **disk operating system**, the computer keeps track of exactly where information is on the disk and it can get to any item of data by moving the head to the appropriate track and then waiting for the right sector to come round. Two methods are used to tell the computer where on a track each sector starts: **soft sectoring** where special signals are recorded on the surface and **hard sectoring** where holes are punched through the disk around the central hole, one per sector.

Half-way between cassettes and disks is the **stringy floppy** — a miniature continuous loop tape cartridge, faster than a cassette but cheaper than a disk system. **Hard disk** systems are also available for micro-computers; they store more information than floppy disks, are more reliable and information can be transferred to and from them much more quickly.

You, the user, must be able to communicate with the computer and the generally accepted minimum for this is the visual display unit (**VDU**), which looks like a TV screen with a typewriter-style keyboard; sometimes these are built into the system, sometimes they're separate. If you want a written record (**hard copy**) of the computer's output, you'll need a **printer**.

The computer can send out and receive information in two forms — **parallel** and **serial**. **Parallel input/output (I/O)** requires a series of wires to connect the computer to another device, such as a printer, and it sends out data a byte at a time, with a separate wire carrying each bit. **Serial I/O** involves sending data one bit at a time along a single piece of wire, with extra bits added to tell the receiving device when a byte is about to start and when it has finished. The speed that data is transmitted is referred to as the **baud rate** and, very roughly, the baud rate divided by ten equals the number of bytes being sent per second.

To ensure that both receiver and transmitter link up without any electrical horrors, standards exist for serial interfaces; the most common is **RS232** (or **V24**) while, for parallel interfaces to printers, the **Centronics** standard is popular.

Finally, a **modem** connects a computer, via a serial interface, to the telephone system allowing two computers with modems to exchange information. A modem must be wired into the telephone system and you need British Telecom's permission; instead you could use an **acoustic coupler**, which has two obscene-looking rubber cups into which the handset fits, and which has no electrical connection with the phone system — British Telecom isn't so uppity about the use of these.



The star of the show this month is the ACT Sirius 1-a 16 bit machine with 128k RAM and 1.2 Mb floppy disk storage running CP/M 86 for just £2300! Acorn have recently announced a Prestel adaptor for the Atom which will cost you around £120 for the full kit. Please send any updates or additions to Dick Olney, 'INSTORE', PCW, 14 Rathbone Place, London W1P 1DE.

Machine (Price from)	Main Distributor/s (No. of Dealers)	Hardware	Software	Miscellaneous (Documentation)
ABC 24 (£3195)	A1 09237-77139	64k RAM: Z80A: dual 5 1/4" F/D (640k): 12", 24 x 80 VDU: 2 x S/P: 2 x P/P	CP/M: <i>Basic: Cobol: Fortran: Pascal.</i>	BT 4/81 (S)
ABC 80 (£738)	Datormark Ltd: 97 44896	16-40k RAM: Z80A: C: 12", 16 x 40 b&w VDU: 4680 bus: IEE 488: RS232 port.	DOS Basic (16k ROM): <i>Fortran: Pascal: A: Multi user Basic.</i>	Colour video graphics with UHF output. Viewdata compatible. Loudspeaker. Numeric keypad. Options: dual 5 1/4" F/D (320k) £895: dual 8" F/D (2 Mb). BT 1/80. (1)
ACT Series 800 (£3495)	ACT: 021-501 2284 (50)	48k RAM: 6502: dual 5 1/4" F/D (800k): 12", 30 x 64 VDU: 1 S/P: 1 P/P: Multi-screen int. Option: 10-20 Mb H/D	MDOS: <i>Basic: A: CBasic: PL/M: Forth: Fifth: Cesil: Pilot: Fortran.</i>	IBM compatible K/B High resolution graphics. Available with dual 8" F/D (2.4 Mb) £4950 — 4.8 Mb maximum. BT 2/80(E).
ACT Sirius 1 (£2349)	As above	128-512k RAM: 8088: dual 5 1/4" F/D (1.2M): 12", 25 x 80 VDU: 2 x RS232 ports: 2 x P/P	CP/M 86: <i>U: Basic: Cobol: Fortran: Pascal</i>	High res graphics. Options: 10 Mb H/D: dual 5 1/4" F/D (2.4 M). (S)
Adler Alphatronic (£1600)	Adler 01-250 1717	48k RAM: 8085 A single 5 1/4" F/D (160k): 12", 24 x 80 VDU: S/P: P/P	CP/M: <i>Basic: CBasic: Fortran: Cobol</i>	With 80 cps printer and dual F/D £2345 (inc CP/M). (S)
Alpha Micro (£5650)	Alpha Micro (UK) Ltd: 01-250 1616 (TBA)	64k — 1 Mb RAM: 16 bit: dual 8" F/D 2.4 Mb): 6 S/P.	Multi-user OS: <i>Basic: M/A: Pascal: U. Fortran: Cobol</i>	Modular. Expands to 1200 Mb, 24 terminals or multiprocessor system. (E)
Altos ACS 800-2 (£2995)	logitek: 02572 66803 (33)	64k RAM; Z80A; dual 8" F/D (1 Mb): 2 x RS232 ports: 2 P/P.	CP/M: <i>Basic: CBasic: Cobol.</i>	Single user. Options: DMA. Floating point processor. Phototyping board.
Altos ACS 8000-10 (£6675)	As above.	280k RAM: Z80A: single 8" F/D (500k): 10 Mb H/D: 6 x RS232 ports: P/P: network RS422 port: DMA	CP/M: <i>MP/M: Basic: Cobol: Fortran: APL: Pascal.</i>	Multi-user/multi tasking. Up to 4 users. Options: 10 Mb: mag tape backup (S + H).
APL Signet (£1750 or £130pm)	Micro APL: 01-834 2687	64k RAM: Z80A: dual 5 1/4" F/D (380k): 2 x RS232 ports.	CP/M: <i>APL: Basic: U: Fortran: Cobol: Algol: Forth</i>	Desktop APL computer with self teaching course. (S)
Apple II (£695)	Microsense: 0442 41191 (190)	16-48k, RAM: 6502: 8 I/O slots.	OS: <i>Basic: Pascal: Fortran: Cobol: Pilot</i>	280 x 192 high resolution graphics: Option: single 5 1/4" F/D (116k) £349.
Atari 400 (£345-16k)	Ingersoll: 01-226 1200 (40)	16k RAM: 6502: C int: cartridge slot: 12 x 20 TV int: RS232C port: touchpad k/b: Opt: C £40	OS (10k ROM): <i>Basic (8k ROM): Pilot: Forth.</i>	High resolution colour graphics. 4-channel sound. Four games controller/light pen sockets. BT 10/80. (1/B).
Atari 800 (£645-16k)	As above.	16-48k RAM: 6502: C int: 4 x cartridge slots: 12 x 20 TV int: RS232C port. Opt: single 5 1/4" F/D (90k) £345: 16k RAM £65.	As above.	As above. Software & RAM on cartridge modules. Up to 4 disk drives. BT 10/80. (1/B).
Athena 8285 (£5694)	Butel-Comco Ltd: 0703 39890 or 01-202 0262 (TBA)	64k RAM: 8085A: dual 5 1/4" F/D (644k): 12" 25 x 80 VDU: 150 cps printer: RS232 port.	AMOS: <i>T/E: Basic: Cobol: Fortran: Pascal: APL: M/A.</i>	Extended ASCII K/B with numeric pad: graphics. Options: dual 8" F/D (2 Mb): up to 1200 Mb H/D.
Atom (£120)	Acorn: 0223 312772 (35)	2-12k RAM: 8-16k ROM 6502: Full K/B: C int: TV int: 20 I/O lines: 1 P/P. Options: 80 col printer £199, Prestel adaptor £120.	Basic in 8k ROM: <i>A Cass O/S.</i>	High resolution graphics on bigger model: colour monitor O/P. Loudspeaker. Note also, systems based on Acorn SBC. BT 7/80(B).
Attache 201 (£8000)	COLT 01-572 3784 (10)	64k RAM: Z80: dual 8" F/D (2.4 Mb): 12" 24 x 80 VDU: 180 cps printer.	Basic: <i>Fortran: Cobol.</i>	Upgradable to multiuser system with 18 Mb H/D. Full range of business packages included software dealers TBA. (S)
BASF 7120 (£3600)	BASF: 01-388 4200 (12)	64k RAM: Z80A: 3 x 5 1/4" F/D (480k): 12", 24 x 80 VDU: RS232 port: P/P	DOS: (OASIS) <i>Ex Basic: Cobol U. A: CP/M</i>	H/D available soon. Also 7125 with 930k F/D £4280 and 7130 with single F/D (430k) & 5Mb H/D £4950. Disk controller has own Z80A. BT 9/80
Billings BC-12 FD: (£3995)	Mitech: 04862 23131 (TBA)	64k RAM: Z80A: dual 5 1/4" F/D (640k): 12", 24 x 80 b&w (or b&g) VDU.	DOS: <i>Basic: Fortran: Cobol: A</i>	With dual 8" F/D (2 Mb) £5995. Additional dual 8" F/D £300 option: 50Mb H/D. (S).
C/09 (£3500)	SWTP Ltd: 01-491 7507 7507 (16)	64k RAM: 6809: dual 5 1/4" F/D (700k) 9", 24 x 80 VDU: 2 S/P: 1 P/P.	TSC FLEX: <i>Basic: Fortran Pascal: A: Dis A: T/E: U.</i>	Expandable to S/09 UniFLEX 32 user system. (H)
Canon BX-3 (£4250)	Canon 01-680-7700.	32k RAM: 6809: dual 5 1/4" F/D (640k): 28 char display: 80 cps printer: 3 x RS232 port: P/P.	OS: <i>Basic: A. Cobol: Pascal</i>	Fully integral unit. Extensive applications support offered on all Cannon Machines. Options: dual dual 5 1/4" F/D (640k) £1500.

#### List of Abbreviations

A Assembler	G/C Graphics card	M/A Macro assembler	S Software
BT Bench Tested	H Hardware	N/A Not available	S/P Serial port
C Cassette	H/D Hard disk	N/P Numeric pad	T/E Text editor
E Extensive	I Introductory	O/S Operating system	TBA To be announced
F/D Floppy disk	Int Interface	P/P Parallel port	U Utility

Please note: Software items listed in *italics* are not included in the basic price of the equipment. All prices are *exclusive* of VAT.

Machine (Price from)	Main Distributor/s (No. of Dealers)	Hardware	Software	Miscellaneous (Documentation)
Canon CX-1 (£6000)	As above.	128k RAM: 6809: dual 5¼" F/D (640k): 12", 24 x 80 VDU: 180 cps printer: 3 x V24 ports: P/P: light pen.	OS: Basic: A: <i>Cobol: Pascal.</i>	Price includes installation & training. Extensive application support offered. Options: dual 8" F/D (1Mb) £3300. (S)
Canon TX-25 (£1600)	As above.	16-32k RAM: 6809: C: 20 char display: 26 col, 2.4 lps printer. Option: 2 x RS232 port.	Basic: A	Fully integral unit. Cassette is Canon's own design (8k). Can be used with communications. (S).
Challenger IP & C4P (£220 & £395)	CTS: 0706 79332 Millbank Computing: 01-549 7262. Mutek: 0225 743289. U-Microcomputers: 0925 54117 Watford Elec: Watford 40588 (18)	4.32k RAM: 6502: C int: RS232 port. Options: dual 5¼" F/D (160k) £550: for C4P dual 8" F/D (1.15 Mb) and 20MB H/D	O/S: Basic (8k ROM) <i>Ex Basic: A.</i>	D/A conv: colour capability. Runs OSI business software on 8" F/D Plato educational software avail soon. BT 4/80. (S).
Challenger 2 (£150)	As above	48k RAM: 6502: dual 8" F/D (0.5 Mb): RS232 port.	OS65U: Ex Basic: A.	Designed as low cost business system (S).
Challenger C3 (£2334)	As above	32-56k RAM: 6502: 6800: Z80: dual 8" F/D (1.15 Mb): 2-16 S/P.	OS65U: Basic: <i>CP/M: Fortran: Cobol</i>	Expandable to multi-user (8) system. Options: C3B & C3C H/D units, 74 Mb for about £8500. (S&H).
Clenlo Conqueror (£2475)	Clenlo Computing Systems Ltd: 01-670 4202 (TBA)	64k RAM: Z80: dual 8" F/D (1 Mb): 3 S/P: 2 P/P.	CP/M: CBasic-2: Pearl 1: <i>U Fortran: Cobol: Pascal</i>	With 2.4Mb F/D £2950. Also H/D systems with 10 Mb H/D & tape drive £5430.
Comart Communicator (£1995)	Comart 0480 215005 (25)	64k RAM: Z80A: dual 5¼" F/D (780k): 2 S/P: P/P.	CP/M: <i>Basic: Cobol: Fortran: Pascal</i>	With 1.5 Mb F/D £2295. With 4.8 Mb H/D & 790k F/D £3795. Option: 18 Mb H/D. £3395 (S).
Compucolor II (£1175)	Dyad Developments: 08446 729 (TBA)	16-32k RAM: 8080: 13" 32x64 8-colour VDU: single 5¼" F/D (51k): RS232 port.	DOS (ROM): Ex-Basic (ROM): A. <i>M/A: T/E: Fortran: U</i>	32k version £1295. High resolution graphics. 6-month subscription to user magazine inclusive BT 9/79. (S).
Compucorp 625 (£6000)	Compucorp: 01-952 7860 (17)	48-60k RAM: Z80: dual 5¼" F/D (630k): 9". 16x80 VDU: 40 col printer: RS232 port, P/P.	Basic: A: <i>Fortran: Pascal: U</i>	IEEE-488 Controller and S100 int. Many applications packages avail. (E).
Compucorp 655/665/675/685 (from £5050)	As above	60k RAM: Z80: Up to 4x5¼" F/D (160k-2.4 Mb): 9", 20x80 or 12" 20x80 or 20" 60x80 VDU: 40-col printer: RS232 port.	As above	Prices incl installation and training. Opt: 10-20 Mb H/D
Computermart 2000 DS (£1500)	Computermart: 0603 615089	32-256k RAM: 8085: dual 8" F/D (1-2 Mb): S/P: P/P.	CP/M: <i>Cis Cobol: Basic: Fortran</i>	Expandable to multi-user, multi-tasking,, multi-processor 96 Mb H/D system (around £15000).
Cromemco System Zero/DDF, System 2, System 3, System Z2H. (£2627/£2873/£4893/£6118).	Datron: 0742 585490. Comart: 0480 215005 MicroCentre: 031-556 7354 (18)	64k RAM: Z80: dual 5¼" F/D (346k) on System Zero, System 2 & Z2H: dual 8" F/D (1.2 Mb) on Sys 3: 10 Mb H/D on Z2H: S/P: P/P.	CDOS: <i>Basic: Cobol: Fortran: RPG II: Lisp: A: W/P: Multi-user Basic. Cromix.</i>	System 2 & 3 expandable to Multi-user (max 7) £8373 System 2: £10252 System 3. Options: dual 8" F/D (996k): 11.2Mb H/D. BT 10/79 (E).
DAI (£998-48k)	Data Applications (UK): 0285 2588 (7)	48k RAM: 8080: C int: 24x60 VDU int: RS232 port: over 20 industrial ints.	Basic (ROM): U	Colour graphics up to 255 x 335: 3 notes & noise generator: PAL O/P to TV: Paddle int: H maths option. (1). BT 10/80.
Diablo 3000 (£6950) (TBA)	Business Computers Ltd: 01-207 3344	32k RAM: 8085: dual 8" F/D (1.3 Mb): 12", 24x80 b&w VDU: 45 cps printer.	DOS: Basic: <i>DACL: A: U.</i>	Selection of business packages included (S).
Digital Micro-systems DSC-3 (£3530)	Modata: 0892 41555 (14)	64k RAM: Z80A: dual 8" F/D (1.14Mb): 4xRS232 ports: EIA port.	CP/M: CBasic: <i>Cobol: Fortran: Pascal: PL/I</i>	Expandable to multi-user system with 10-28 Mb H/D. Extensive software avail. (S).
Digital Micro-systems DSC-4 (£4395)	As above	128k RAM: Z80A: single 8" F/D (500k): 11 Mb H/D: 4x RS232 ports: 2 P/P.	CP/M: Basic-E: CBasic: <i>Cobol: Fortran: Pascal.</i>	Also DSC-3 with 64k RAM. Options: 128k RAM £1295: up to 4 Mb F/D and 20 Mb. H/D. (H).
Durango F-85 (£4995)	Comp Ancillaries: 0784 36455 (12)	64k RAM: 8085: dual 5¼" F/D (1 Mb): 9", 16x64 green VDU: 132 col 165 cps printer: N/P.	O/S: D Basic: <i>CP/M: CBasic: Micro Cobol.</i>	Up to 5 work stations: fully integrated system. Options: additional dual 5¼" F/D (1 Mb): 12-24 Mb H/D. (S).
Dynabyte 5200 5900 (£2600)	Metrotech 0895 57780(15)	64k RAM: Z80: S100 bus: 2 ser ports: 1 par port: any com of 5¼" F/D (630k), dual 8" F/D (1Mb), 9/27/45 Mb H/D, 32/64/96 Mb Cart Module Disk.	CP/M: MP/M: CP/Net, CBasic, MBasic Cobol, Fortran, Pascal, PL/1-80	All systems expandable to multi-user and net working: CP/M inc in base price for F/D system, MP/M for H/D systems.
Equinox 200 (£7500)	Equinox: 01-739 2387 (N/A)	64-512k RAM: Z80: 10 Mb-1200 Mb H/D: 6xS/P: 1 P/P.	CP/M: CBasic: <i>Cobol: Fortran.</i>	Multi-user MVT/FAMOS available in place of CP/M. 16-bit version (Equinox 300) £10,000. (S&H).
Exidy Sorcerer (£695)	Liveport Data Products: 0736 798157 (27)	48k RAM: Z80: RS232 port: 1 P/P: S100 connector: 30x64 VDU int. N/P.	O/S: Basic (ROM): <i>T/E: A: CP/M: Algol: Fortran: Basic: 80. Pascal: W/P.</i>	High-resolution graphics capability: user programmable character set, Option: single 5¼" F/D (316k) £600
Gemini 801 (£1075)	Gemini: 02403 22307 (7).	64k RAM: Z80A: Single 5¼" F/D (315k): 25x80 VDU int: RS232 port. P/P.	CP/M Basic: <i>Cobol: Fortran: Pascal: A: T/E.</i>	Up to two integral & two external F/D. Graphics. With no F/D and C int. £750. (S).

**List of Abbreviations**

A Assembler	G/C Graphics card	M/A Macro assembler	S Software
BT Bench Tested	H Hardware	N/A Not available	S/P Serial port
C Cassette	H/D Hard disk	N/P Numeric pad	T/E Text editor
E Extensive	I Introductory	O/S Operating system	TBA To be announced
F/D Floppy disk	Int Interface	P/P Parallel port	U Utility

Please note: Software items listed in *italic* are not included in the basic price of the equipment. All prices are *exclusive* of VAT.



# IN STORE

**DIRECT  
ACCESS**

Machine (Price from)	Main Distributor/s (No. of Dealers)	Hardware	Software	Miscellaneous (Documentation)
Gimix System 68 (£2000)	SEED: 05433 78151: Windrush 0692 505189	16-64k RAM: 6800/6809: dual 5¼" F/D (500k): 2xRS232 ports.	OS-9: Flex Basic: Pascal: A: Dis A: T/E:U	With dual 8" F/D (2 Mb) £2900. Designed as development system for industrial control. (H).
Haywood 3000 (£1925)	Haywood: 01-428 0111. (TBA)	32-64k RAM: Z80A: dual 5¼" F/D (800k): RS232 port: P/P. Opt: 15" 28x80 VDU £799.	CP/M: Basic: Cobol: Fortran: Pascal: W/P.	Also system 7000 with 48-65k RAM and 8" F/D (2.5 Mb) £2999. (S).
HP 85 (£1830)	Hewlett Packard Ltd: 0734 784774 (16)	16-32k RAM: C.P.U.: 5", 16x32 VDU: C(200k): 64 cps printer: 4 P/P. Options: dual 5¼" F/D (540k) £1408: fusi 8" F/D (2.4 Mb) £3744.	Basic (ROM)	Full dot matrix graphics. Complete range of interfaces, peripherals and application packages avail. 16k RAM £222. (S).
IMS 5000 (£1500)	Equinox: 01-739 2387 (20)	16-56k RAM: Z80: dual 5¼" F/D (320k): 2xS/P: 1 P/P:	CP/M: C/Basic: Cobol, Fortran.	3 drives option: (S&H).
IMS 8000 (£2500)	As above	64-256k RAM: Z80: dual 8" F/D (1 Mb): 2xS/P: 1 P/P	CP/M: CBasic: Cobol: Fortran: MicroCobol.	Multi-user MVT/FAMOS available in place of CP/M. (S&H).
Intecolor 8000 (£2999)	Dyad Developments: 08446 729 (TBA)	8-32k RAM: 8080: 19", 80x48 colour VDU: single 5¼" F/D (90k): Option: up to 26 Mb H/D.	DOS(ROM): Ex-Basic: A:M/A:T/E: Fortran: U	High res graphics avail: Many options including size of F/D and VDU. (S).
ITT 2020 (£867)	ITT: 0268 3040 (15)	16-48k RAM: 6502	Monitor: A: ExBasic: Dis A.	360x192 high res graphics. Ex-Basic in 6k ROM: Options: single 5¼" F/D (116k): £425: 16k RAM, £110: RS232 port, £96: 32k system, £931: 48k system £995: (B).
Ithaca DPS1 (£3995)	Ithaca: 01-341 2447 (10).	64k RAM: Z80: dual 8" F/D (1 Mb): 2xRS232 ports: 4xP/P. Opt: H/D.	CP/M: Basic: Cobol: Fortran: Pascal: A: U.	Z8000 16-bit processor board avail. IEEE/S100 (8 or 16 bit) compatible. (E).
LX-500 (£3500)	Logabax Ltd: 01-965 0061 (13)	32k RAM: Z80: dual 5¼" F/D (180k): 12" 25x80 b&w VDU: 100 cps printer.	DOS: Basic: A.	Other printers available. (S).
LSI M-One (£4200)	LSI Computers: 04862 23411 (20)	8-16k RAM: 8080: dual 8" F/D (1.2 Mb): 12", 24x80 b&w VDU	FMOS: A	Choice of standard business packages included in price. (S).
LSI M-Two (£7900)	As above	64-128k RAM: 8085A: dual 8" F/D (1.2 Mb): 12", 24x80 VDU: 60 cps printer	Elsie: CP/M: Basic: Cobol Fortran: Pascal: A: U	Max 8 VDUs and 4 printers. Many applications packages available. Option: 10 Mb H/D £2600. (S).
Macro I (£3950 or £294 pm).	Micro APL Ltd. 01-834 2687 (TBA)	64k RAM: Z80A: dual 8" F/D (1 Mb): 4xRS232 ports.	CP/M: APL: U: Basic: Fortain: Cobol: Word- 2star Algo: Pascal: Forth.	Designed as timesharing replacement. Macro 2 with 2 Mb F/D £4750 or £334 pm.
Megamicro (£6080)	Bytronix: 0252 726814(5)	56k RAM: Z80: dual 8" F/D (500k): 12", 20x80 green VDU: 180 cps printer: 2 S/P: 2 P/P.	CP/M: U: Basic: A: M/A.	Range of bus. packages now avail. from Ludhouse of Streatham. (H&B).
Micro Trainer 1 (£650)	Hewart: 0625 22030 (N/A)	16-32k RAM: 6800/6809: 10" 16x24 VDU: 2xC int: Opt: dual 5¼" F/D (160k) £595: 8k RAM £17.	Basic: A: Pascal: PL/M: W/P	SS50-based system. Graphics avail. Int card with real time clock £17. (1).
Microstar 45 Plus (£4800)	Data Efficiency Ltd: 0442 63561 (30)	64k RAM: 8085: dual 8" F/D (1.2 Mb): 3 S/P, RS232 port.	Stardos: CP/M: Basic: Cobol: Fortran	(E)
Microtan 65 (£69)	Tangerine: 0353 3633(6)	2k RAM: 6502: T Mint: Exp up to 277k RAM.	2k TANBUG monitor: 2k A, disassembler, cassette firm ware: 10k Microsoft Ex. Basic.	Options: bulk I/O modules, hi-def graphics, CP/M, system racking, ASCII keyboard. Prestel adaptor (S&H).
Millbank Sys 10 (£2995)	Millbank: 01-788 1083(6).	65k RAM: Z80: dual 5¼" F/D (700k): 12", 24x80 VDU: 2x RS232 ports: RS4449 port: P/P.	CP/M: Basic: Cobol: Fortran: Pascal: PLI: W/P.	One high level lang. included. 12-month warranty. Main-frame comm. package. H/D avail. soon. (S&H)
MS5001 (£7450)	BMG Ltd: 0793 37813 (N/A)	64k RAM: 8085: dual 8" F/D (1 Mb): 12", 80x24 VDU: 80 cps printer: RS232.	CP/M: Basic: Cobol: Fortran: MP/M.	Price includes desk mounting and one computer. Hardware & software support. Leasing arrangements available. (E).
MSI 6816 (£1200)	Strumech: 05433 4321 (5)	16-56k RAM: 6800: dual 9" 16x64 b&w VDU: C int: 1 S/P: 1 P/P.	Basic: A.	Graphics & PROM programmer available. (S&H).
MSI System 12 (£8000)	As above	56-184k RAM: 6800: 10 Mb H/D: single 8" F/D (500k) 24x80 VDU: 1 S/P: 1 P/P.	SDOS: Basic: CBasic: U.	As above. Business packages avail. Up to four terminals. (H&S).
NEC PC 8001 (£450)	NEC (UK)	32k RAM: Z80A: RS232 port: P/P Option: dual 5¼" F/D (574k) £675	CP/M: Basic N: Fortran Cobol: Pascal	Colour monitor £250 (low res) or £480 (high res) both 12", 25x80(E) BT 6/81
Newbrain MB (£199)	Grundy: 0223 350355 (TBA)	32k-2 Mb RAM: Z80A: Nat 420: 2xC int: TV int: 2xV24 ports.	CBasic (16k ROM): A.	Graphics. Battery or mains. Options: ½ Mb RAM £450 16 char display £30.(E).
North Star Horizon (£2230)	Comart: (7) 0480 215005. Comma: 0277 811131. Equinox: 01-739 2387(20)	48-56k RAM: Z80A: dual 5¼" F/D (360k): 15", 24x80 VDU: 150 cps printer: 2 S/P: 1 P/P.	DOS: Basic: CP/M: Cobol: Fortran: Pascal.	Options: 18 Mb H/D.

### List of Abbreviations

A Assembler	G/C Graphics card	M/A Macro assembler	S Software
BT Bench Tested	H Hardware	N/A Not available	S/P Serial port
C Cassette	H/D Hard disk	N/P Numeric pad	T/E Text editor
E Extensive	I Introductory	O/S Operating system	TBA To be announced
F/D Floppy disk	Int Interface	P/P Parallel port	U Utility

Please note: Software items listed in *italics* are not included in the basic price of the equipment. All prices are exclusive of VAT.

# COMPUTER 100

## LIMITED

# SHARP

## 11Z-80K SPECIAL OFFER!

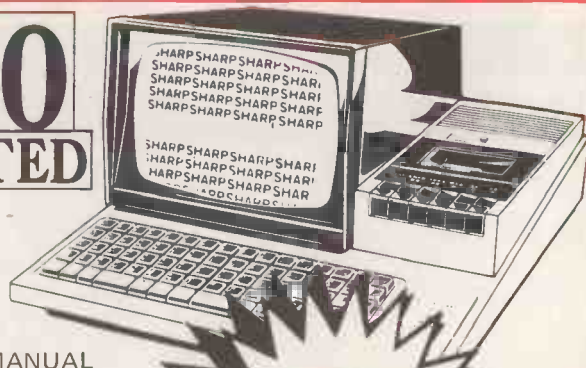

INCLUDING BASIC TAPE AND PROGRAMMING MANUAL

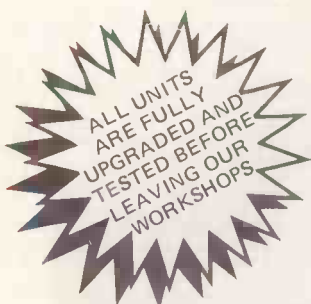

A proper full size microcomputer for less than the real cost of a toy microcomputer. The Sharp comes with 48k of RAM and the screen and cassette are built in, instead of being expensive extras.



### COMPUTER 100 LTD

7 Southcote Parade  
Southcote Farm Lane  
Southcote  
Reading, RG3 3D7  
Reading (0734) 584545

Full range of all Sharp peripherals stocked at highly competitive prices  
Ring for further details

Price is inclusive of VAT at current rate of 15%  
Add £7.50 carriage/insurance to Mail Orders

### COMPUTER 100 LIMITED Mail Order Form

Name: \_\_\_\_\_  
Address: \_\_\_\_\_  
\_\_\_\_\_ Post Code: \_\_\_\_\_  
Tel: \_\_\_\_\_  
Card No: \_\_\_\_\_

Mail to: Computer 100 Limited  
7 Southcote Parade, Southcote  
Reading, Berks, RG3 3D7

PCW/1/82



**DEMODISK**  
... now includes a free comprehensive BASIC language tutorial on the reverse side.

# STOP!

## MICROSYSTEMS LIMITED

SUMMERFIELD HOUSE, VALE,  
GUERNSEY, EUROPE-G.B.

Telephone: 0481 47377

Telex: 4191130 (DYNMIC G)

\*C.O.R.P. is a registered trademark of the MAROMATY & SCOTTO SOFTWARE CORP.

\*APPLE is a registered trademark of APPLE COMPUTER INC.

STOP BUYING THOSE "CANNED" DATABASE PROGRAMS THAT TURN OUT TO BE COSTLY, INEFFECTIVE AND INCOMPLETE. NOW THERE IS ONE SYSTEM WITH THE POWER, THE VERSATILITY YOU NEED TO MAKE PROGRAMMING FASTER, SIMPLER AND ERROR FREE. C.O.R.P. IS A PROGRAM GENERATOR THAT WRITES SOFTWARE. COMPLETE APPLESOFT PROGRAMS THAT EXECUTE INDEPENDENTLY AND MAY BE MODIFIED BY THE USER, BASED ON INFORMATION SUPPLIED IN THE USER'S OWN EVERYDAY LANGUAGE. WHAT'S MORE, COMPLETE PROGRAM GENERATION TAKES ONLY A FEW MINUTES.

# C.O.R.P.

PROGRAM GENERATOR

... the program that writes programs

C.O.R.P. CONSISTS OF 6 MAJOR SUBSYSTEMS: A DATA ENTRY PROGRAM GENERATOR, A SORT SUBSYSTEM, AN UPDATE SUBSYSTEM, A PRINT GENERATOR AND A COMPLETE UTILITIES & DIAGNOSTIC PACKAGE. TOGETHER THE 6 SUBSYSTEMS MAKE C.O.R.P. THE MOST ADVANCED, COMPLETE AND USEFUL TOOL AVAILABLE FOR YOUR APPLE II\*. ALL FOR THE INCREDIBLY LOW PRICE OF £235.00. NO OTHER PROGRAM GENERATOR OFFERS SO MUCH VERSATILITY FOR SUCH A PRICE. TO PURCHASE C.O.R.P. BRING THIS AD. TO YOUR LOCAL DEALER OR ORDER FROM US DIRECTLY.



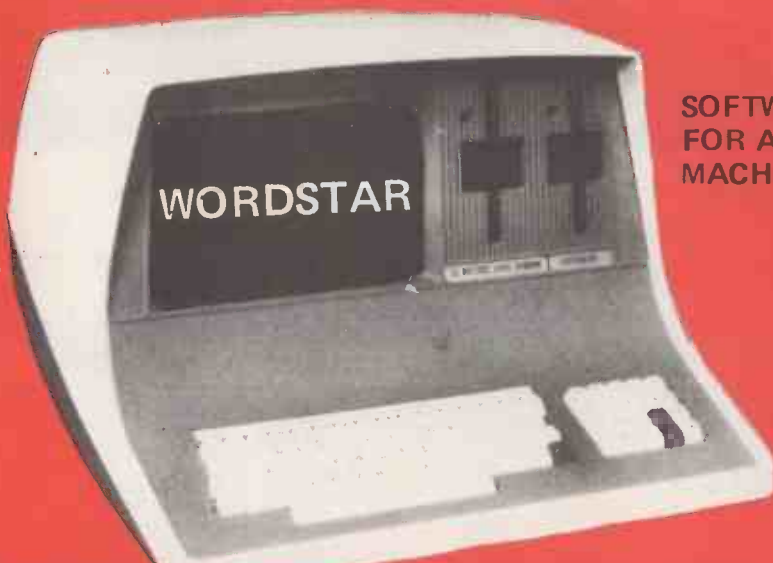

SOFTWARE  
FOR ALL  
MACHINES

SEE US ON  
STAND 83 AT

MICROSYSTEMS 82  
LONDON FEB 24-26

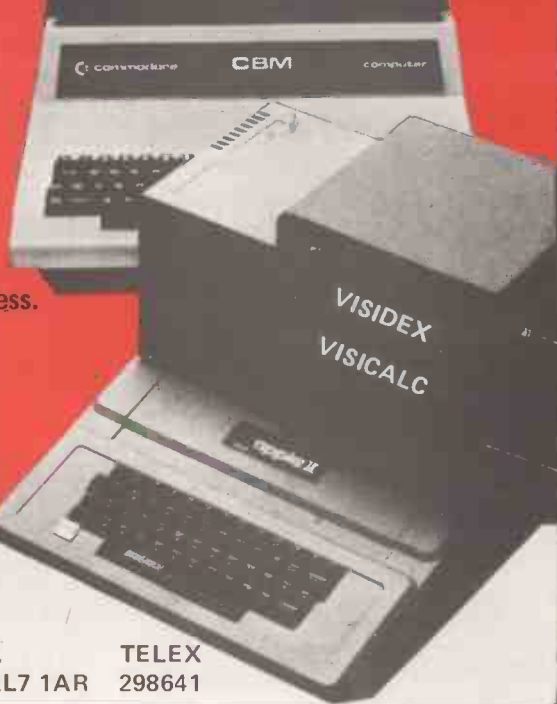

**SUPERBRAIN** AUTHORISED DEALERS — accept no less.

We also supply printers, plotters, monitors, media,  
hardware, software, computer workstations and more.

WORD PROCESSING SPECIAL OFFERS — RING NOW!

# MASS MICROS

07073 — 31436

WELLSON HOUSE, BROWNFIELDS,  
WELWYN GARDEN CITY, HERTS AL7 1AR

TELEX  
298641

## COMMODORE PETS



- 8032 Computer
- 8050 Floppy Disk
- 8024 Matrix Printer
- 8026 Daisy Printer Keyboard
- 8027 Daisy Printer Read Only
- 4032 Computer
- 4040 Floppy Disk
- 4022 Matrix Printer.

\*Phone for latest prices\*

**\*\*8095 COMPUTER AND SILICON OFFICE\*\***  
VIC'S NOW IN

Second Hand Equipment Brought & Sold. Call now.

Other printers we supply are: Qume, Ricoh, Epson,  
Centronics.

We also supply software: Visicalc, Wordcraft, Incomplete Records, Payroll, Stock Control, Invoicing,  
Sales & Purchase, Time Recording, Ozz.

All accessories are available from us and our other  
services include installation & training and maintenance contracts.

Please phone for a quotation of our typing, work-  
processing and personalised mail shot services.



DAVINCI COMPUTER SHOP  
65 High Street  
Edgware Middx.  
Mon-Fri. 9.00-4.30 Sat 9.30-5.00  
or send for details.  
Tel: 01-952 0526



## io systems Ltd.

### A/D BOARD FOR NASCOM

- ★ 8 Bit resolution
- ★ 8 Input channels
- ★ 30 microsecond conversion
- ★ Prototyping area
- ★ Sample and hold
- ★ Overvoltage protection
- ★ Full flag/interrupt control
- ★ Built and tested

Price £135

+ 15% VAT (post free)

### EPROM PROGRAMMER

- ★ Programs 3 rail: 2708/2716
- single rail: 2508/2758, 2516/2716, 2532/2732
- ★ Zero insertion force socket
- ★ Built and tested

Price £63

+ 15% VAT (post free)

### GRAPHICS BOARD FOR NASCOM

- ★ 384 (H) x 256 (V) very high resolution graphics display
- ★ Fully bit-mapped
- ★ Full software control
- ★ Graphics software supplied
- ★ Mixed text and graphics
- ★ NASCOM 2 or 4mhz NASCOM 1
- ★ Built and tested

Price £55

+ 15% VAT (post free)

### GRAPHICS BOARD SOFTWARE

- ★ Lunar lander: £6 + VAT (post free)
- ★ Graphdraw: £8 + VAT (post free)

### DUNCAN

- ★ Fast real time interpreter/control language for NASCOM 1 or 2 (please specify machine)

Price £12

+ 15% VAT (post free)

### MONITORS

- ★ BMC 12" green phosphor
- ★ 18 mhz bandwidth

Price £175

+ 15% VAT (carriage extra)

### MEMORIES

- ★ 4116 - 150ns 95 pence each + VAT (min order 8)
- ★ 64K - 200ns £10 each + VAT

SEND SAE FOR FUTHER INFORMATION

6 LALEHAM AVE, MILL HILL, LONDON NW7 3HL

TEL: 01-959 0106



Machine (Price from)	Main Distributor/s (No. of Dealers)	Hardware	Software	Miscellaneous (Documentation)
Oki if 800 (£400)	Encotel.	64k RAM: Z80A: 2k ROM: dual 5 1/4" F/D (560k): 12", 24x80 VDU: 80 col printer: loudspeaker: RS232 port: 20k ROM cartridge.	Basic: A: <i>CP/M</i> <i>Cobol: Fortran:</i>	Fully integral unit. Graphics. Options: dual 5 1/4" F/D (560k): RS232 port: PP. (1). BT 10/81
Onyx C8000 (£6875)	Onyx Dist Ltd: 0734 664343 Colt 01-577 2150. (TBA)	64k RAM: Z80: 12 Mb Cartridge: 10 Mb H/D: 4 S/P: P/P	CP/M: <i>MP/M Oasis:</i> <i>Unix: Fortran: Pascal:</i> <i>W/P</i>	C8001 with 128k RAM £8220. Multi-user version avail. using Oasis.(E) BT 3/81.
Oscar (£2560)	IDS Ltd: 0908 313997(30)	64k RAM: Z80: dual 5 1/4 F/D (800k): 12", 25x80 VDU: RS232 port: 1 P/P	CP/M: <i>Basic: Pascal</i> <i>Fortran: Cobol: W/P:A</i>	Also avail. with dual 5" F/D(1.6Mb) £2905 and 8" F/D(2 Mb) £3380. Advanced video board. S&H).
Panasonic JD 800U, JD840U (£4275, £4950)	Panasonic Business Equipment: 0753 75841 (10 regional dist)	56k RAM: 8085A: 12-4k PROM: dual 8" F/D JD800U (500k): JD840U (2 Mb): 12", 24x80 green VDU: 3xRS232 ports.	CP/M: Basic: <i>Micro-Cobol.</i>	Also available with 5 1/4" F/D: JD740U (570k) £4095. H/D avail soon. BT 3/80 (S).
Pascal Microengine (£2295)	Pronto Electronic Systems Ltd: 01-554 6222	64k RAM: MCP 1600: 2x RS232 ports: 2 P/P.	Pascal.	CPU instruction set is P-code: no interpreter needed. Available with dual 8" F/D (2 Mb) £3900.
Pasca 640 (£3700)	Westrex Ltd: 01-578 0957 (TBA)	64k RAM: Z80A: dual 8" F/D (512k): 12", 24x80 VDU: RS232 port: P/P	CP/M: <i>Basic: Cobol:</i> <i>Fortran: Pascal: A: W/P:</i> <i>U</i>	Maintenance contracts avail. 10 Mb H/D avail. soon. (S) BT 5/18
Periflex 630z564 (from £2250)	Sintrom: 0734 85464(5)	64k RAM: Z80: dual 5 1/4" F/D(1.2 Mb): 2xRS232 ports. 1 P/P.	CP/M: <i>Basic: Fortran:</i> <i>Cobol:A</i>	One-day installation training on site included in price. Option: dual 5 1/4" F/D(630k) £464, dual 8 1/4" F/D(1 Mb) £1025. 35 Mb H/D. BT 6/80 (S&H).
Periflex 1024/64 (from £2750)	As above	64k RAM: Z80: dual 8" F/D (1.2 Mb): 2xRS232 ports: 1 P/P.	As above	As above
PET 16k, & 32k (£550, £695)	Commodore: 0753 79292 (150)	16-32k RAM: 6502: C: 9" 25x40 VDU: IEEE-488 port: Options: dual 5 1/4" F/D (353k) £695: same but (950k) £895	O/S: Basic (in 8k ROM): <i>Forth: Pilot:</i> <i>Pascal: Comal: Lisp: A</i>	8032 with 80-col screen (32k) BT 12/80. £895 Field service avail. (1).
Philips P2000 (£2444)	Philips Data	16-48k RAM: Z80: dual 5 1/4" F/D (140k): 12", 24x80 VDU: RS232 port.	PDOS: UCSD p-system: <i>Pascal: Basic Fortran:A.</i>	With 48k RAM, Pascal and Basic £3300: BT 12/81.(S).
Powerhouse 2 (£1125)	Powerhouse Micros: 0422 48422 (TBA)	32-64k RAM: Z80A: 5" 29x96 VDU: RS232 port: external bus.	4k Monitor: <i>FDOS:</i> <i>Basic: ExBasic (14k EPROM)</i>	VDU has flexible screen logic. Options: <i>FDOS &amp; Basic</i> £210: graphics card £200. (H).
Powerhouse 3 (£2600)	As above	32-64k RAM: Z80A: dual 5 1/4" F/D (350k): 5", 29x96 VDU: RS232 port: external bus.	As above	VDU as above. With 1.2 Mb F/D £3500. <i>ExBasic &amp; FDOS</i> in 14k EPOMs £300. (H).
Prince (£3045)	Digico: 04626 78172 (TBA)	48-64k RAM: 2xZ80: dual 5 1/4" F/D (800k): 2xRS232 port: 12", 24x80 VDU	CP/M: <i>Basic: Pascal:</i> <i>Fortran: Cobol: W/P:A:</i> <i>T/E:U</i>	High res graphics. Options: single 5 1/4" F/D (400k) £600: dual 8" F/D(2 Mb) £2000. Rentals avail. (S).
Raannd SP1 (£4500)	Raannd: 0506 33372 (TBA)	64k RAM: MCP 1600: dual 8" F/D (2 Mb): 12", 24x80 VDU: RS232 port: P/P	Pascal <i>ADA: Basic</i>	Based on Microengine (with integrated P-code). Up to 4 F/D drives. 64k RAM expansion avail. BT 12/80. (S).
Rair Black Box 3/30 (£3750)	Rair: 01-836 6921 (N/A)	64-512k RAM: 8085: dual 5 1/4" F/D (260k): 10 Mb H/D: 2xRS232 ports.	CP/M: Basic: <i>Cobol:</i> <i>Fortran: M/A</i>	64k RAM expansion £500. 256k RAM £1250. Up to 16 RS232 ports.
Research Machines 380Z (£895)	Research Machines: 0865 49791 (N/A)	16-56k RAM: Z80A: 2xC: RS232 port. P/P.	<i>ExBasic: A: T/E: U:</i> <i>CP/M: Fortran:</i> <i>Cobol: Algol: Cesil: Pascal.</i>	High res colour graphics. Many possible systems. With 48k RAM & dual 8" 'FD (1 Mb) £3394.
S/09 (£7000)	SWTP Ltd: 01-491 7507(16)	128k RAM: 6809: dual 8" F/D (2 Mb): 12", 24x80 VDU: 2xS/P: 1 P/P.	UniFLEX: <i>Basic:</i> <i>Pascal: Fortran: A: Dis A:</i> <i>T/E:U.</i>	Expands to 32 users, 768k RAM, 90 Mb H/D, UNIX 'look alike'. (S&H).
Saracen (£1925)	Bytronix 0252 726814 (TBA)	32-64k RAM: Z80: dual 5 1/4" F/D (800k): 2xRS232 ports.	CP/M: <i>Basic: Cobol:</i> <i>Fortran: Pascal: A:</i>	Applications packages & maint. contracts avail. With dual 8" F/D (2 Mb) and 64k RAM, £2676. (E).
SBS 8000 (£1449)	Manhattan Skyline Ltd: 0801 3442: C Itoh 01-353 6090 (TBAz7)	64k, RAM: Z80A: 12", 16 x 64 VDU: 1 P/P: RS232 port (extra £133)	<i>ExBasic (24k ROM):</i> <i>DOS</i>	Options disk control card £237: dual 5 1/4" F/D (368k) £795: dual 8" F/D (2 Mb) £1400. BT 11/80. (S)
SEED System 1 (£2000)	Strumech: 05433 4321 (5)	32-56k RAM: 6800: various disk options: 12", 24 x 80 VDU: RS232 port: P/P	DOS: Basic U: <i>Fortran:</i> <i>A: Pilot: Strubal: T/E</i>	Graphics. PROM programmer Also system 19 multi-user (£3000). (E)
Sharp MZ-80K (£460-34k)	Sharp Electronics (UK) Ltd: 061-205 2333 (22)	6-48k RAM: Z80: C: 10" 24 x 40 VDU: Option: dual 5 1/4" F/D (289k) £695	Basic, A. <i>CP/M: Pascal: Fortran:</i> <i>Forth</i>	Graphics: loudspeaker. BT 10/79 (B)
Sharp MZ-80B (£1095)	As above	64k RAM: Z80A: C: 9", 25 x 80 VDU: RS232 port: P/P.	Basic: <i>A: Pascal: FDOS</i>	High res graphics. Options: dual 5 1/4" F/D (560k) £800: 80 cps printer £415. (S)
Sharp PC3201 (£2995)	As above <i>CP/M: Cobol</i>	64k RAM: Z80A: dual 5 1/4" F/D (500k): C int: 12", 25 x 80 VDU: 70 lpm printer.	DOS: U: Basic: <i>CP/M: Cobol.</i>	Various expansion cards avail. BT 7/81 (1&B)

**List of Abbreviations**

A Assembler	G/C Graphics card	M/A Macro assembler	S Software
BT Bench Tested	H Hardware	N/A Not available	S/P Serial port
C Cassette	H/D Hard disk	N/P Numeric pad	T/E Text editor
E Extensive	I Introductory	O/S Operating system	TBA To be announced
F/D Floppy disk	Int Interface	P/P Parallel port	U Utility

Please note: Software items listed in *italic* are not included in the basic price of the equipment. All prices are *exclusive* of VAT.



Machine (Price from)	Main Distributor/s (No. of Dealers)	Hardware	Software	Miscellaneous (Documentation)
Sinclair ZX81 (£50-kit, £70-built- prices inc VAT).	Sinclair: 0276 66140	1-16k RAM: Z80A: C int: TV inb: full K/B: 44-pin expansion port.	Basic (8k ROM).	Advanced 4-chip design. Printer now avail. BT 6/81
Signet 202 (£2145)	Interram 01-675-5325(N/A)	64k RAM: Z80A: dual 5 1/4" F/D (400k): 12", 24 x 80 VDU: 2 x RS232 ports: 80 col printer.	CP/M: <i>Basic: Fortran</i>	Options: dual 5 1/4" F/D (800k): dual dual 8" F/D (2M). (S)
Smoke Signal Chieftan (£1800)	Windrush 0692 405189: Seed 05433 78151 (TBA)	32-64k RAM: 6800/6809: dual 5 1/4" F/D (500k): 2 x RS232 port.	DOS: <i>68/FLEX: Basic: Fortran: Cobol: A: Disc A: Pascal: U.</i>	With dual 8" F/D (2 Mb) £2600. Designed as development system for industrial control. (H)
Solitaire WP & BS200 (£6750 & £8200)	Solitaire KPG: 01- 995 3573 (TBA)	64k RAM: 8085: 14" VDU (with own CPU): 45 cps printer: CPU port: dual 5 1/4" F/D (700k) 8" F/D (1.02 Mb) with BS200.	DOS: Basic	All solitaire systems are compatible: anmd can be upgraded to multi-user H/D system. (S)
Sord M100 ACE (£2339)	Midas Computer Services Ltd: 0903 814523 Exleigh Bus. Mach. 0735-66577.(10)	48k RAM: Z80: 8k ROM dual 5 1/4" F/D (245k): 24 x 64 green VDU: RS232 port: N/P	O/S: <i>Basic: A: Fortran: Pascal.</i>	Up to 3 drives possible. Colour graphics avail. Option S100 bus. (I)
Sord M223 Mk 11-V1 (£4078)	As above	64k RAM: Z80: 8k ROM: dual 5" F/D (700k): 12", 24 x 80 green VDU: RS232 ports: S100 bus: N/P	O/S: <i>Ex Basic: CBasic: Multi-User Basic: Fortran: Cobol</i>	Expandable to 4 Mb F/D. 32 Mb, H/D, 5 screens, 2 printers. M243 with 192k RAM & 1.4 Mb F/D £5087.
SPC/1 (£3770) (TBA)	Digital Data: 01- 573 8854	64-1024k RAM: 8085 A-2: dual 5 1/4" F/D (90k): 12", 24 x 80 VDU: 2 x RS232 ports: Option: single 8" F/D (1 Mb) £1090:	Mikados, Comal: Pascal: A.	With 32k RAM and single F/D (Comal only) £1995. Expandable to multi-user system (8 users). BT 7/80 (S).
Superbrain (£1950)	Icarus: 01-485 5574 (45)	64k RAM: 2 x Z80: dual 5 1/4" F/D (320k): 12" 25 x 80 VDU: 2 x RS232 port.	CP/M: <i>A: Basic: Cobol: Fortran: APL: Pascal</i>	Limited graphis, Mainframe int avail. Full range of application packages avail. Also avail with 700k & 1.5 Mb F/D. BT 8/80. (S&H)
System 10 (£2995)	Millbank 01-788 1083 (TBA)	64k RAM: Z80: dual 5 1/4" F/D (700k): 12", 24 x 80 VDU: 2 x RS232 port: P/P	CP/M: <i>Basic: Fortran: Pascal: Cobol: PL/I: W/P</i>	12 month warranty. Maint. contracts. Applications packages avail. Choice of high level language in price. (E)
System 20 (£3500)	Extel: 01-739 2041 (TBA)	64-512k RAM: Z80A: dual 8" F/D (1 Mb): 12", 24 x 80 VDU: 3 x V2	CP/M: <i>E Basic: M Basic: Pascal: Cobol: Fortran</i>	Maintenance contracts avail (132 field service engineers). Expands to multi- user system. Options 13.7 Mb H/D £5799: 27.4 Mb H/D £6674. (S)
System 80 (£1355-48k)	Nascom: 02405 75155 (32)	16-48k RAM: Z80A: dual 5 1/4" F/D (560k): TV int: RS232 port.	CP/M: Basic (8k ROM)	EPROM firmware avail. Colour graphics card £165. Many config- urations possible. (S&H)
Tandberg EC10 (£4000)	Tandberg: 0532 774844 (N/A)	64k RAM: 8080 A: single 8" F/D (250k): 12" 25 x 80 VDU: 7 x RS232 ports: printer int.	CP/M: <i>Ex Basic (24k) Multi-user Basic: Pascal: Cobol: A: U:</i>	Up to 7 terminals. Includes V28 comms port. (S&H)
Tandberg TG 8450 (£2200)	As above	64k RAM: 8085: single 5 1/4" F/D (77k): C int: 12", 24 x 80 VDU: RS232 port: P/P	TDOS: <i>Basic: Cobol: Fortran: Pascal.</i>	TDOS is CP/M compatible. Opt: single 5 1/4" F/D (77k) £250 (up to four): dual 8" F/D (2 Mb) £1800. (S&H)
Tandy TRS-80 Model I (£289)	Tandy: 0922 648181 (200)	4-48k RAM: Z80: C: 12", 16 x 64 VDU: RS232: P/P	Basic (4k ROM): A.	Fully expandable. Option: single 5 1/4" F/D (175k) £339 (up to 4). Many extras available. (I)
Tandy TRS-80 Model II (£2499)	As above	64k RAM: Z80: single 8" F/D (500k) 12" 24 x 80 VDU: 2 x RS232 port: P/P	Basic <i>M/A Fortran: Cobol</i>	Option: single 8" F/D (500k) £899 (subsequent £450, up to 4). 32k RAM £344.
Tandy TRS 80 Model 3 (£500-£1700)	As above	See Model I Levels 1 and II		Fully integral unit. Up to 2 integral and 2 external 5 1/4" F/D. BT 8/81
Tandy TRS-80 Colour (£349)	As above	4-16k RAM: 6809: 8-16k ROM: C: 16 x 32 TV int: RS232 port.	Colour Basic.	With 16k RAM, 16k ROM & Extended Colour Basic £449 (I). BT 9/81.
TECS (£1200)	Technalogs Computing Ltd: 061-793 5293 B&B Computers & (TBA) Ltd: 0204 26644 (TBA)	4-56k RAM: 8k PROM: 6800/ 6809: 2xC: TV int: 2xRS232 ports: internal viewdata modem & printer port.	FLEX: <i>Basic: Pascal: TDOS: A: T/E: Pilot: Fortran: Cobol.</i>	Fully viewdata compatible. Options — dual 5 1/4" F/D (320k) £850: dual 8" F/D £120 £1200. (S&H).
Terodec CPC-100 0 (£4095)	Terodec: 0734 664343 (8)	80k RAM: Z80A: single 5 1/4" F/D (819k): 2 S/P: 3 P/P	CP/M <i>CBasic: Fortran: Pascal: Cobol</i>	System with Okidata 80 printer: TV1 910 VDU: W/P and various application packages £5995 (S&H)
Terodec DPS 64/2M (£3598)	As above	64k RAM: Z80A: dual 8" F/D (2 Mb): 2 S/P: 3 P/P. Options: 10 Mb H/D: Tape.	CP/M: <i>MP/M: CP/Net: CBasic: Fortran: Pascal: Cobol: Basic.</i>	2 user system with 10 Mb H/D £7400 4 user system with 34 Mb H/D & tape back up £11981. (S&H)
TI 99/4 (£299)	TI: 0234 67466 (TBA)	16k RAM: 26k ROM: 9900: 2 x C int: 24 x 32, 16 colour TV int: 3 tones & noise: P/P.	OS: Basic.	12 month guarantee. Options 32k RAM: 2 x RS232: 3 x 5 1/4" F/D (92k each): Speech Synthesiser.
Tuscan CP/M Starter (£999)	Transam: 01-405 5240 (N/A)	24k RAM: Z80: single 5 1/4" F/D (190k): C int: TV int: RS232 port: P/P: N/P.	CP/M: <i>Basic: Fortran: Pascal: Cobol:</i>	Options: single 5 1/4" F/D (190k) £155: single 5 1/4" F/D (370k) £285: 8k RAM £50. (S&H)
Tuscan Starter Kit (£299)	As above	8k RAM: Z80: C int: 56-key K/B Options: Case £110: 5 x S100 sockets £20: TV int £3.50	8k Basic	Fully assembled version £499 BT 1/81 (H&S)
UDS 3000 (£2300)	Kemitron: 0244 21817. (TBA)	64k RAM: Z80A: dual 8" F/D 2 Mb: 2 x RS232 ports. Option: 10 Mb H/D	CP/M: <i>Basic: Cobol: Fortran: Pascal.</i>	Full range of industrial support cards, and applications software. (E)

#### List of Abbreviations

A Assembler	G/C Graphics card	M/A Macro assembler	S Software
BT Bench Tested	H Hardware	N/A Not available	S/P Serial port
C Cassette	H/D Hard disk	N/P Numeric pad	T/E Text editor
E Extensive	I Introductory	O/S Operating system	TBA To be announced
F/D Floppy disk	Int Interface	P/P Parallel port	U Utility

Please note: Software items listed in *italic* are not included in the basic price of the equipment. All prices are *exclusive* of VAT.

Machine (Price from)	Main Distributor/s (No. of Dealers)	Hardware	Software	Miscellaneous (Documentation)
Vector MZ (£2650)	Almarc: 0602 52657 (3)	56k RAM: Z80A: dual 5 1/4" F/D (630k): 3 S/P: 2 P/P.	CP/M: Basic: <i>Algol: Cobol: Pascal: Fortran: Cobol: A.</i>	High resolution graphics. Also system B with video board & terminal £3450. (E)
Vector System 2800 (£4600)	As above	56k RAM: Z80A: dual 8" F/D (2.4 Mb): 3 S/P: 2 P/P	As above	High-res graphics. Many Options. Fully expandable to 5005 multi-user system (max 5) £5400.
Vic 20 (£200)	Commodore: 0753 70292 (150)	5-32k RAM: 6502: Cint: 22 x 23 TV int: S/P: P/P: Games int.	Basic	Graphics 3 tone sound generator. Will interface to PET. Option: single 5 1/4" F/D (170k). BT 9/81(S).
VIP (£2650)	Almarc 0602 52657 (3)	64k RAM: 3k ROM: Z80B: single 5 1/4" F/D (630k): 12", 24 x 80 VDU: RS232 port, 3 x P/P	CP/M: <i>Basic: fortran: Cobol: Pascal: A.</i>	Up to 3 additional F/D drives. Options: dual 8" F/D (2 Mb) £1063, 32 Mb H/D (TBA). (H&S). BT2/81
Video Genie EG3003 (£300)	Lowe Electronics: 0629 4995 (N/A)	16k RAM: Z80: 500bps C: 16 x 64 TV int: extra C int: 1 P/P	Basic (12k ROM): <i>Pascal: A M/A: Fortran</i>	Graphics available with ex-Basic (13.5k) £3.50.
WH8 (£352)	Heath 0452 29451 (N/A).	16-64k RAM: 808A (or Z80): 4 S/P. Option: single 5 1/4" F/D (102k) £241.	OS: HDOS: CP/M: <i>Fortran: Pascal: Basic</i>	Kit. 3 drives max. Colour graphics avail. (S&H) BT 2/80.
Zentec (£4838)	Zygal Dynamics: 02405 75681 (TBA)	32-64k RAM: 2 x 8080: dual 5 1/4" F/D (256k): 15", 25 x 80 VDU: RS232 port.	OS/: A: U: <i>Basic: Cis Cobol</i>	User programmable character set. Option: dual 8" F/D (1 Mb). (S)
Zenith WH-11A (£2673)	Heath Ltd: 0452 29451 & 01-636 7349 (N/A)	LSI 11: 16-32k RAM: 25 x 80 VDU: S/P: P/P.	O/S: <i>Basic, Fortran: A: U.</i>	PDP 11-compat. Option: 2 x 8" F/D (1 Mb). £1717 (S&H).
Zenith Z89 £1570-£1710	As above	16-48k RAM: Z80: single 5 1/4" F/D (102k): 12" 24 x 80 b&g vdu: RS232.	<i>Basic: A: HDOS: CP/M: MBasic: CBasic: Fortran.</i>	3 x 5 1/4" F/D possible. Options: dual 8" F/D (1 Mb) £1717, 20 Mb H/D.
Zilog MCZ 1/05 (portable): MCZ 1/20A (£3250)	Memec: 084421 5471 (N/A)	64k RAM: Z80: dual 8" F/D (600k): RS232 port: MCZ1/20A only 1 P/P: Option: 10 Mb H/D £7100	RIO: O/S: <i>Cobol: Basic: Fortran: Pascal: M/A: U.</i>	Available desk top or rack mounted. Debug in 3k PROM. 1/20A runs multi-user Cobol, up to 5 terminals with 40 Mb H/D. (S&H).
Z-Plus (from £400)	Rostronics Ltd: 01-870 4805 (16)	64k RAM: Z80A: dual 8" F/D (0.5/1Mb): 12" 24 x 80 VDU: 4 S/P: 1 P/P	CP/M: MP/M: A: U: <i>Basic: Cobol: Fortran: Pascal: APL: PL/I: Algol.</i>	Complete with furniture. Various business packages avail. Option: 20 Mb H/D £4000. BT 12/79 (S&H)

**SINGLE BOARDS**

Machine (Price from)	Main Distributor/s (No. of Dealers)	Hardware	Software	Miscellaneous (Documentation)
Acorn System 1-5 (£65-£1600)	Acorn: 0223 312772 (35)	11/8k RAM: 6502: EPROM socket: Hex K/B: C int: 8-digit LED display: up to 16 ports. Options: Eurocard 64-way connector: VDU card: full K/B card.	1/2k monitor: <i>Basic. Pascal: Forth: DOS.</i>	Kit. Programmable address linking. On-board 5 V regulator. On-board 5 V regulator. Can be expanded to disk-based system. (S&H)
AEX-09 (£750)	Micro Design 0908 663655	8k RAM: 32k PROM: 6809: 16 I/O lines: RS232 port: RS422 port.	OS-9: ( <i>Basic: Pascal: Fortran avail soon</i> )	Full A/D & D/A conversion facilities. 4 x 8 but outputs. (H)
Aim 65C (£259)	Pelco: 0273 722155(7)	1-4k RAM: Full K/B 2 x C: 20 char LED: 20 char thermal printer: RS232 port.	A. Disc A: T/E: 8k monitor: <i>Basic (8k ROM): PL65. Forth</i>	Expandable using RM65 models to full disk systems. (E)
Bigboard (£450)	Maclin-Zand 01-837 1165 (N/A)	64k RAM: Z80, F/D controller: 24 x 80 VDU controller	2k monitor: <i>CP/M: Basic: Fortran: Cobol: Pascal: A.</i>	Many options. Will support up to four 8" F/D drives. BT 3/81. (E)
Biproc (£119)	B L Micros: 0494 44307. (TBA)	1k RAM: Z80: TV int: RS232 port. Opt: 4k RAM £8: K/B £30.	2k Monitor: A.	With 9980 instead of Z80 £155 as well as Z80 £180. Kit. (H)
Cromeco SC (£355)	Comart: 0480 215005 (25) Datron. 0742 585490.	1k RAM: Z80A: 8k EPROM sockets: RS232 port: 3 P/P. Option: S100 bus.	Monitor: <i>Basic.</i>	5 program interval timers. Can put own Basic program in EPROM. (E)
Elf II (£50)	Newtronics: 01-348 3325 (N/A)	1/4-64k RAM: RCA 1802: Hex K/B: 2-digit LED: TV int: C int: RS232. Options: Full K/B: VDU card.	1k monitor: A: Dis A: T/E: Elf-bug <i>Tiny Basic: Basic,</i>	TTY N-line decoders. Low resolution graphics (high res avail). Kits or built. Full range of peripherals. (H)
Explorer (£82)	As above	4-64k RAM: 8085: Full K/B. RS232 port: 6 x S100 bus: C int: 1k video RAM.	2k monitor: <i>Basic (8k) CP/M: Basic Fortran: Cobol.</i>	Supplied in kit or built. Full range of peripherals including F/D. (H)
Hewart 6800S (£299)	Hewart: 0625 22030 (N/A)	16k RAM: 6800: full K/B VDU int: 2 x C int: 1 S/P: 2 P/P: Option: 16k RAM £90	1k monitor: A: T/E.	Can be upgraded with 6809. (H)
Hewart 6800 Mk 111 (£152)	As above	1k RAM: 6800: VDU board	1k monitor.	Options: single 5 1/4" F/D (75k) £350: PROM programmer £32. (H)
Microaxis 1 (£250)	Micro Design 0908 663655 (N/A)	1k RAM: 1-8k PROM: 6809: 8 channel A-D system: 12 optically isolated I/O lines.	1k monitor	Designed for industrial control. Can be expanded to F/D system. (H)
MPC 09 (£750)	As above	17k RAM: 48k PROM: 6089: RS232 port: 50 I/O lines: 4 timers: 1 W audio amplifier.	1k monitor: <i>Multi-tasking OS</i>	As above. New 64k version avail.
Microtan 65 (£69)	Tangerine: 0353 3633 (6)	2k RAM: 6502: 16 x 32 TV int: Options: 64 Pixel graphics £6.50	2k monitor, <i>Basic</i>	TANEX expansion kit with 7k RAM: 4k EPROM sockets: 14k Basic: 4 S/P: 32 P/P £145. (E)

**List of Abbreviations**

A Assembler	G/C Graphics card	M/A Macro assembler	S Software
BT Bench Tested	H Hardware	N/A Not available	S/P Serial port
C Cassette	H/D Hard disk	N/P Numeric pad	T/E Text editor
E Extensive	I Introductory	O/S Operating system	TBA To be announced
F/D Floppy disk	Int Interface	P/P Parallel port	U Utility

Please note: Software items listed in *italic* are not included in the basic price of the equipment. All prices are exclusive of VAT.



# SINGLE BOARDS

Machine (Price from)	Main Distributor/s (No. of Dealers)	Hardware	Software	Miscellaneous (Documentation)
Nascom 1 (£125)	Nascom: 02405 75155 (20)	4k RAM: Z80: Full K/B: TV int: 2 P/P: 1 S/P. Options: 16k RAM £140: single 5 1/4" F/D (250k) £240 (4 disk controller £127).	2k monitor: <i>B Basic:</i> <i>Tiny Basic: A: T/E: U.</i>	Kit. Built version £140. Also Nascom 2 with 8k Microsoft Basic in ROM £225 (no RAM). (S&H)
77/68 (£90)	Newbear: 0635 30505 (N/A)	4k RAM: 6800: LED: C int: VDU int.	1k monitor: <i>Basic</i>	Expandable to 64k RAM with F/D. (B)
79/09 (£65)	As above	1k RAM: 6809: P/P: S/P	2k Monitor.	Designed to upgrade 77/68. (H).
SBC 100 (£135)	Airamco: 0294 57755 (TBA)	1k RAM: Z80: 8k ROM: S100: 1 S/P: 1 P/P.	<i>1k monitor: DOS in ROM</i>	Kit. Available assembled £196. (E)
Superboard (£188)	(as Challenger)	4-8k RAM: 6502: 10k ROM: full K/B: VDU int: C int.	Basic (8k ROM)	Options: RS232 port: single 5 1/4" F/D (100k) £316: 8k RAM £188. (S&H)
Smoke Signal SCB 68 (£181)	Windrush 0692 405189 (TBA)	1k RAM: 6800/6809: 8k EPROM: 1 S/P.	2k monitor	Fully expandable to 64k RAM with F/D. (H)
SYM-1 (£160)	Newbear: 0635 30505 (N/A)	1-4k RAM: 6502: C int: VDU int: 2 x 6522 ports. Option: TV int.	4k monitor: <i>Basic A.</i>	Expandable to 64k RAM with F/D. (B).
Tuscan (£299)	Transam 01-405 5240 (N/A)	8k RAM: 8k ROM: Z80A: 5 x S100 slots: RS232 port: TV int: C int: 1 P/P.	<i>2k monitor: 8k Basic:</i> <i>CP/M: Pascal</i>	High res graphics available. Can be expanded to F/D system. BT 1.81. (S&H)
UK101 (£149)	Comp Shop: 01-441 2922 (4)	4k RAM: 6502: full K/B: 16 x 48 VDU or TV int: C int: RS232 port, Options: 4k RAM £16	2k monitor: 8k Basic: <i>Dis A: U.</i>	Graphics. Expansion & colour avail. Kit or fully assembled. (S&H)
Windrush 6801 (£175)	Windrush: 0692 405189	2k RAM: 6801/3/5: 12k EPROM: S/P: 3 P/P	2k Monitor	Designed for industrial control & dedicated small systems. (H)
ZCB (£260)	Almarc: 0602 625035 (3)	1k RAM: Z80A: 3 PROM sockets: RS232 port: 3 P/P	<i>Will take any 2708/ 16 = 32 software.</i>	S100 bus compatible. Expandable to full system. (E)

## TRANSACTION FILE

We charge a flat fee of £1 for 1 insertion of up to 30 words. Ads for this section are accepted only from non-commercial readers. Please type or write clearly. Unfortunately, owing to a large backlog, we cannot repeat an ad, nor can we guarantee to put an ad in a particular issue. Send your ads plus cheque or PO for £1, made payable to SportsScene Publishers (PCW) Ltd. to: Transaction File (PCW) 14, Rathbone Place, London W1P 1DE.

Casio FX502P programmable calculator in wallet, as new, with overlay, instructions and program library. £50. ono. Tel: 0323-896790.

Tangerine ... Microtan, 8k Tanex, Xbug, Basic, Lower-case, graphics, RS232C, ASCII keyboard, P.S.U., cases, ddocumentation, £200. Casio FX502P and FAI adaptor, £60. All excellent condition. Telephone Blythe Bridge 8423.

Teleng/Rowtron home television entertainment centre, four cartridges, vigin 118

cartridges, giving 118 games, good condition and working order. A home programmer cartridge is available from manufacturers. £85 phone Bradford 832782.

Half price Smugart 8" 2 drives, S.S.S.P. Fully aligned and tested. Can be seen working Post or collect. £180 each. Phone 076-727 427. Ev. Wknds.

Pet 3022 Tractor Printer, IEEE connector, dust cover, as new. £295. Tel. Heathfield (04352) 2499 day.

Video Genie ... 48K sound + keyboard mods. with manuals and software. Good condition £280. Ring Hartlepool 70755 or write. S Sharpe, 18, Gulliver Road, Hartlepool, Cleveland.

TRS-80 16k L2. With cables power supply and cassette recorder, plus over 60 computer mags, 4 books and some programs. £280 Tel. Geoff Wilkins Hornchurch 47809 after 6.

ZX80 ... complete with 8k Rom upgrade plus PSU, leads, manuals and three books £55. Telephone South Benfleet (03745) 54240.

Sharp PC-1211 ... Perfect condition everything included; manuals, overlays etc. £90 if new, first offer of £70 or around accepted. Tel. after 4.30 pm. Peter Galbavy. 01-723 9947.

TRS-80 ... 16k, Level II with lower case mod., cass, green VDU, many books and manuals, only 3 months old. £450 or offers. Tel. 02214 2638.

ZX81 ... Sinc. built as new. Leads, P.S.U. + Manual + "not only 30 pgrams for your ZX81". All for £55. Phone Tony, Byfleet (09323) 45615 after 6pm.

UK 101, 8k Ram, cased, fan and sockets fitted, Ferguson Courier Batt/mains TV/monitor sits on case, Panasonic recorder, all leads, many games inc' space invaders, 3D noughts and crosses, etc. All perfect condition £300. Tel. Kelshall (Herts) 378.

TRS 80 16K L2 with numeric keypad + CTR 80A, Tandy modulator & £35 of Tandy Software. 2 months old. Not enough time to use. £295. Knutsford 3946. After 6pm.

Acorn Atom 12k + 12k inc. floating point. Little used, good cond. £200. Tel. Dave/Bry L/Spa. 38751.

Superboard II, cased modulator 8K Ram, 8K Rom, external P.S.U. excellent condition. Complete with manuals, leads, etc. games on tape including invaders £200 ono. Tel. Whitworth 2260 evenings.

Pet 32k new rom. Cassette Deck, speech output (infinite), Superchip, toolkit, picchip, reset switch. 3040 disks (Dos 2.1), disk safety device, 30 + disks, hundreds of progs. Games & utilities, only £1300. Tel. 0442 49762.

TRS-80 ... Level II 16k with VDU, cassette, editor/assembler, T. bug, tiny pascal, microchess. Plus lots more software. Also technical handbook, assembly language book only £350. Phone Padigham (0282) 74487.

For sale 80/80V mains power units small switch mode type S/C current limit and crowbar trip £15. Mr Adamson, Woodend, Victoria Road, Wingsdown, Deal, Kent. Tel. Deal (03045) 3788.

TRS80 Level II 16k — £339, level I 4k — £229. Both with power supply and modulators. Original packing and unused. 2 St Martins Street, Millfield, Peterborough (0733) 45731 or 222588.

"Wanted" microchess for 8k Pet. PCW vol. 3 no: 1-2-7 and 8. Write to: Arne Karlgaard, Hovedstasjonen NSB, N-7000 Trondheim, Norway.

ZX81 ... Factory built complete with leads etc and under guarantee plus compatible recorder, "ZX81 companion" and Sinclair cassette. £85 for the lot, ono, or will split. Winchester 51965.

Nascom II 48k ... 3A PSU, 5 1/4 SDD Drive (200K), CPM, Nassys3, Zeap, CBASIC II, Sound board (AY-3-8910), manuals, grotty box, £800. will separate. Unused I/O Hi-res Graphics board £55. Tel. (0403) 60734.

Acorn Atom, 12k Ram, 8k Rom. Acorn built and tested, as new. All leads and manuals. Needs external regulated PSU. Bargain £150. Write: Ian Paton 39 Yates Street, Liverpool L86RD.

ZX81 16k ... Manual, getting acquainted and mastering machine code. Sinclair Software and others including 'invaders' and 'defender'. Custom plug-in games controller. Leads, power unit. As new £95. Telephone Gloucester 423439.

Pet 8k ... Old Rom, Integral cassette deck, Small keyboard, with games and tutorial programs £325. Tel. Danbury (Essex) (02451) 4158 Evenings & weekends.

Video genie 32k, colour, control keys, sound; as new, with printer interface. Software including; other languages (Pascal, assembler, forth) and most popular games. Books. £375 ono. Tel. 021-440 4721.

Swap — complete Nikon camera kit. FM Body, standard and zoom lenses, computer flash, intervalometer, motor-drive, cases, metal case etc. Worth £300+, for pet, Mz-80 similar value. Reading (0734) 411333.

ZX81 + 16k Ram. Sinclair built including power supply, manual, all leads & much software. Very good condition and in perfect working order. £100 ono. Tel. Edinburgh (031) 449 2582.

ZX80 ... Sinclair built, complete with 3k additional RAM, PSU, manual, Leads, Magazines and games tape cost £130 will accept £69 ono. Tel (0827) 62714.

Video Genie 16k current model. Sound, extra shift key, controls at front. Leads, manuals, software incl. games, Editor-assembler (microsoft) & books. Value £380: accept £325 ono. Chambers 01-828 9811 x 2440 (day).

ZX80 ... Sinclair built, boxed complete with manual, PSU, leads. Little used £35. Tel: Paul 01-841 4268.

Sharp PC1211 ... with manuals, overlays, cassette interface, all in good condition will accept £65. Tel. Kiddeminster 67802 after 5.

Atari 800 32k. Cassette player, 1 cassette game, 2 cartridge games, 'Le Stick' joystick £775 and ZX80 1k. Sinclair built leads adaptor etc. £45 and 12" portable b/w TV. £40. Tel. 731 5512 after 8.30 pm.

Prinztronic Chess traveller ... battery operated but supplied with mains adaptor. Hardly used, ideal Xmas present. Costs £55 new £35 wanted. No offers. Tel: Langley Mill 62635 after 6pm.

Heathkit HM800 Manual set. New unused. Comprising assembly, operation, schematics for H8, H9, H10, H8-1, H8-2, H8-5. As Heath sells for £59. All for £15. Prath. Computing Oct. 78 — July '81. £10. Tel (0553) 86618.

TRS-80 ... 48K (model 1) one disc, lower case mod. Will add approx. 100 programmers eg. N.D.80, vlsicalc profile etc. £1000. Tel: 0733 270477.

ZX80 with 4K and 8K Roms, all factory replacements, used twice. 16k RAM pack, one year's INTERFACE, sync magazines; program listings, articles. £95. Tel: Bury St. Edmunds, Suffolk (0284) 61864.

Exchange DAI colour graphics computer 48K for VT100 or other dec equipment or best offer over £500. Phone Hythe (0303) 66963.



**PET** — 8K old Rom. Small keyboard, integral cassette. Programmers toolkit and 'Pet Revealed'. Several games including Star Trek. £230 ono. 01-897 9998.

**Personal Home Computer for Sale** — 32K New Rom Commodore Pet with sound box and 3600 BAUD cassette rom with repeat key and Commodore cassette. £425 o.n.o. Appley Bridge 3428 after 5.30 pm.

**Business Genie System** ... 48K, 2 disk drives, expansion box, special green monitor, cables, leads, manuals, dos, one month old, cost £1,390. Any offers? Phone 05432-55022 (Graham). May split. Printer available.

**Acorn Atom** ... 12K Ram, 8K Rom, Acorn Built, recently serviced, Basic and Assembler, PSU, 192 x 256 resolution graphics: Invaders tape, manuals. £235. Tel. Wolverhampton 780659, after 5pm.

**Sinclair ZX81** with leads and manual. Brand new, still in box. A real bargain at only £50. Phone 0382 74559 after 6.30 pm.

**Superboard II** ... good condition, with Cegmon monitor, and 5 user group newsletters. (Home Made Case, P.S.U. and modulator) expanded to 8K RAM. Working. Tel. 051-480 1979 after 6. S. Macnaughton, offer around £140 o.n.o.

**ZX81 + 16K RAM** ... sinc built, all leads, mains adaptor, 2 game cassettes, and 2 Hartnell books. Ideal Christmas gift. A snip at £80 + postage. Yeovil: 0935-22724 (after 5pm)

**For sale Apple Integer card** £50. Apple/ITT Communications (RS232) card. Apple Dos 3.3 card & manual £50. Brand new: 01-249 9895.

**Video Genie EG3003** ... 16K RAM, latest keyboard and VU meter. In perfect condition, complete in original parking. Extra manuals. Good reason for sale. £285. Tel: 01-680 2775 (Croydon).

**ZX81 16K, Sinc built**, fullsize keyboard, perfect working order, leads, manuals, adaptor, £125. Tel: 01-393 1313 (Robin).

**UK101 20K, Cegmon, TWD power supplies**. Smart 2, P.E. interfacing boards with PIA/PSG DA/Etc. Exmon, Toolkit, in Eprom SW cass baud 300/600/1200 uprated basic's 1,3 and 4 cooling fan cased manus £315. Wokingham 784897.

**ZX81. Factory built, 16K Ram, PSU, manual, 16K games tape, compatible cassette recorder, magazines etc.** £120 ono. Ring Worcester (0905) 357208 after 6 pm.

**Acorn Atom** ... 12K Ram, 8 Krom, PSU, Leads, lots of software, 2 books, 11 months old, £165. Tel: Portsmouth (0705) 372828 (after 6pm).

**Pet 4000 32K. Toolkit TK4.0.** Dual disk drive 4040, Pet revealed, Pet subroutines, memory maps, user manuals, dust cover, as new trials welcome. £110 o.n.o. Phone Binbrook 378.

**ZX81. factory built, 16K Ram, 2 sinc cassettes + programmes (breakout and Invaders).** Mains adaptor, leads and manuals. £110. Tel. Ilkley (0943) 608091.

**Sinclair ZX81 + 16K Ram Sinclair** built 2 books & 2 Sinclair cassettes 6 months old all original packing £100. Phone Princes Risborough (08444) 3182 Bucks.

**VIDEO GENIE 16K** ... 6 months old perfect condition, with leads & manuals. Many games inc. Space Invaders: £300. Tel. Dursley 3883 after 4pm.

**ZX81** ... Factory built, 16K ram pack, leads & books, lots of software. Altogether worth £140. Quick sale required, hence £99. Tel. Biggin Hill 72263 and ask for Alan.

**Acorn Atom** perfect condition, fully expanded; 12K + 12K. PSU leads, manusl. Acornsoft packs 1, 5, Startrek, Magic Book, £190. Tel. Edinburgh (031) 5564406 eve, (delivery within 15 miles).

**Superboard 2. 8K Ram, Intamon** monitor, case and P.S.U. — £125. Also, ASR 33 type teleprinter with punch/reader — £30. Tel. 061-338 4167.

**ZX81 sinc. built, inc. leads,** manual, adaptor, 5 months old. Complete with £12 software inc. Invaders, etc. for the 1K machine. All boxed. £67. Tel. Arun 0632-731204.

**ZX80 8K ROM and Video** upgradekit (Compshop) (allows use of fast and slow mode) 4K Ram. 5 books (software and programming) interface magazines. Bargain at £80. Phone Swindon (0793) 36829.

**2 5K ZX81's for sale** perfect working order sinclair built plus software £69 each phone David Kingswinford 292407 after 4pm.

**Nascom II** ... 32K Ram. Graphics, 3 amp PSU. Runs at 4 MM2 without wait. £300 o.n.o. Tel. Nottm. 841831.

**Acorn Atom 12K + 12K £250** o.n.o. Includes leads, PSU, printer interface, software, Acornsoft word-processor package. Also Monitor £40. Ring 01-934 5217 (day) or 0525-372141 (evenings).

**Apple Hardware** with documentation. Eurocolor card £60. Parallel Printer card £65. Hi. Speed serial card £65. Communications card £65. Programmers Aid No. 1 £20. Auto. start Rom £25. Tel. 0223 (Cambridge) 833772.

**Apple Pascal Language System** complete and never used. Yours for only £200. A Ram card costs £110 and no Dos 3.3 Roms or Pascal. Tel. 0223 (Cambridge) 833772.

**Software for Apple** ... as new with documentation. Visicalc £50, Visilist £10, Desktop plan £40, CCA Data Management £40, Hi. Tech. Dbms. £35, Appleplot £25. Tel. 0223 (Cambridge) 833772.

**Software for Apple** ... as new with documentation. Easywriter (40 col.) £30, Trendisk/1 database £20, Act Database £25, Whatsit (48k) £50, Stats Pack (Chas. Mann) £25. Tel. 0223 (Cambridge) 833772.

**TI-59 programmable, mag. cards,** charger, case, manuals, original box, mint £79; Motorola MEK-6800-D2 kit, complete, unused £69; Intel 8086 Chip set, memory & bus chips £50; Reading 697886 pm/W/ends.

**Wanted Computer, Disks, Tapes,** Printer, etc working or not (anything considered phone Leads (0532) 792163 after 6.00 pm or daytime. J. Spence 631478.

**Acorn Atom. 8K Rom + 11K** Ram. Acorn built, manuals. P.S. U. + leads £170. tel. Lulsgate 2802 (Bristol) after 4pm.

**Pet 2001 — 8K. Manuals old** Roms. + Games including micro chess £290. Tel. Lulsgate 2802 (Bristol) after 4 pm.

**ZX81 Sinclair built, with 16K** memory, leads, manual, program book, 2 Sinclair tapes. £100. N. Cook, 37, Queens Road, Windsor, Berks.

**Something different...** Neat Motorola 'Exorciser' system. CPU, 16k RAM, 16k Basic/Assembler/Editor EPROM, VDU controller, 5" monitor, keyboard, cassette interface, PSU. Cost £700 — gift at £300 o.n.o. Hunt, 21 Green St. Milton Malsor, Northampton.

**Atom 21K Ram + 12K Rom** manu. built, colour board + 6522 + progs, books + 5V5A boxed PSU £320 words £420 + 18" colour TV £100 all fully op. as seen. Lorne. Windsor 69884 9-10 pm.

**6809** ... Single board S100 processor, 2K Rom, 1K Ram £140. 64x16 VBI S100 video board £60. PBI S100 Errom programmer & 4K/8K Eprom board £70. Full documentation ring 01-959 4851.

**ZX81** ... Perfect working order, power supply, leads and manual. Still in box, many games on cassette including Sinclair games Pack 1. Ideal Xmas gift. — £65. Phone Southend (0702) 47211.

**Centronics microprinter P1** + spare rolls paper. As new £100 o.n.o. Sharp MZ80K interface unit — absolutely brand new — £80.00. Sharp PC1211 + cass int — £80.00 o.n.o. Sinclair ZX81 P.S.U. £6.00. Brighton 423021.

**ZX80 + 8K Rom** ... 3K Ram, cassette recorder & interface, saves/loads first time, all on a board, £100 o.n.o., tel: Winsford (06065) 53885.

**For sale Acetronic T.V. Game** ... 10 cartridges including space invaders, soccer, blackjack, tank/plane battle, etc. cost £250, would accept £150 o.n.o., tel: Winsford (06065) 53885.

**Nascom 2** ... 16K memory board, 3A PSU, graphics, assembler, cased, £325 for quick sale, ring Esher 62597.

**Cromemco** ... PR1 S100 printer interface card & manual, Centronics par + ?daisywheel ints, £90 ono. Tel. Peter 01-631 1433 10 am — 6 pm, weekdays.

**Sharp MZ-80** ... 48 K, Basic plus Knight Commander, manual, etc, good condition, 12 mths faultless working, owner upgrading, £400 ono. Will deliver up to 25 miles. 01-642 8019 (eves).

**Acorn Atom** ... 12K + 12K, PSU, manuals, leads, Prof. built. Printer int (Via), Progs. Asteroids, Star trek etc. £199. Tel: Kings Langley 62306 eves.

**ZX 81...** with 16K Ram plus manual and all leads, 20 tapes (some with programmes), 3 programme books, Interface magazines, no waiting for delivery. £120.00 ono. Phone 01-337 5302.

**Microtan 65** ... Tanex, 8K Ram, X-Bug, ASCII keyboard, 8-bit DAC, Manuals and PSU. Many programs including asteroids, invaders and DAC waveform generator. Worth £350, accept £215 Tel. Ascot 21210.

**Nascom 1** ... cased, working, with 3 amp, psu and Nas-Sys 2k monit monitor plus documentation and Z80 manuals, £140 ono. Phone Maidenhead (0628) 23930, (evenings & we).

**ZX 81** ... Sinc built, as new + Not only 30 progs, £60. Tel. Woking 73891.

**Pet 32k** ... New ROM, with Tensai cassette deck, manuals, dustcover and large quantity software, £500. Computhink 400k disk drive, almost new, £500. Commodore 3022/Tractor Drive Printer, £325. C.J. Blunt, Ashted (03722) 74909.

**Seikoshi** ... GP 80 printer as new, complete with handbook, cost £230 new, selling for £195. Genuine reason for sale. Tel: 0242 76994 (6-7 pm).

**Pet 32k** ... Basic 4 with cassette, many games tapes, inc Cosmiads, Petchess, Hich-Hikers guide etc, as new with Green screen, dust cover and Soundbox. £625 ono. Tel Alec, Preston 54821 ext 2289 day.

**ITT 2020** ... 48 k, disk drive, DOS 3.3, DOS tool kit, paddles, software, colour, new last Xmas, games, assembler, editor etc. etc. Orig. doc. and packing, as new, cost £1250, sell £795. Tel: (0432) 58127 evngs or weekends.

**Casio FX502P** ... prog. calc. and Fax cassette interface including manuals, program library and tape of programs — £50 ono. Ring Northallertow (0609) 2147 after 5.30 pm.

**ZX80** — As sent. Built by Sinclair — £35. Including power supply. Phone Woking (04862) 20818.

**ZX81** ... factory built with 16k RAM, leads, mains adaptor, manual, and book of games, £110.00 ono. Tel: Paul Sharp at Burgh Heath 61142.

**Pet 8K** ... built-in cassette, new ROM, + manuals. 75 programs (inc. Space Invaders). £380. Phone Hartlepool (0429) 60498 after 4pm.

**Atari Video Computer** — complete system plus following cartridges:- Combat, Invaders, Chess, Bowling Excellent condition, 11 mths old. Worth £180, only £110. Tel. Codsall (09074) 6560 after 6pm.

**Casio fx502p** ... as new in perfect order with orig. box, wallet, overlay, manual and program library. £50 ono. Tel: Lymm 3131 eves.

**ZX 81 Sinc.** built 4 months old perfect working order with manual, accessories, games, cassette, boxed, as new. £55. Tel. Leyland (07744) 32104. Eve.

**ZX81** ... Sinc. built inc. all leads, manual, power supply and 8 month Sinclair guarantee, V.g.c. only £60 ono. Phone 01-894 9747 after 4 pm.

**Free** ... Astrological computer worth £29.95, if you buy my Voice Chess Challenger (worth £245) for £119.50, incl. Black Attache case, lock, all leads, P.S.U., Transformer, Magnetic Hand Carved wooden pieces, Board overlay, Rules. Also Videoscree Colour TV game only £19.50. 01-446 3798 after 6 pm.

**Acorn Atom** ... 24k, PSU, manual, leads, colour board, exc. cond. and value. £200 ono. Tel. 01-561 4176 weekends only.

**Superboard II** ... 16k with 610 extension board, Cegmon and numeric keypad, PSU and modulator, cased, leads, manual, games. £260 ono. For quick sale. Tel. Pontefract (0977) 704418.

**ZX80** ... 1k, factory built, PSU, all leads, manual, nothing missing. Very good condition. Perfect for expert or beginner. £55 ono. Tel. 051-924 9042 (after 5, weekends)

**FREE!** ... Casio fx 502p prog calc, in wallet, with manuals when you buy my OSI built Superboard II, with manuals, all leads PSU, modulator, 8K ram, 48x32 display + Cegmon (prof fitted), some tapes, VGC, at £270. Tel. Paul Marning 01-778 6402 (after 6).

**Video Genie EG3003** used for less than 50 hours. Some books, software and all accessories worth £50 sell all for £285, or exchange with 80 column printer. Tel. 01-947 6673.

**Printer?...** Cheap reliable ASR33 Teletype gives you Printer, RS232 Terminal, plus ridiculously cheap off-line storage on paper tape. Good working order. Only £99.00. Tel. 0494 25938.

**Trendcom printer** (similar to Microhush) complete with Apple interface card and large supply of thermal paper. Original cost £300. Will accept £150. Telephone Liphook 722960.

**Sharp PC1211 pocket computer,** complete with cassette interface. Original cost £120, will accept £60. Telephone Liphook 722960.

**Sorcerer 56k** £550, disk unit £500, macro assembler £40, Algol £50, WP pac £80, B/W monitor £75, ICL Printer £200, Teletype 33 £100, Alan Knifton, 0629 83 4426 after 5 pm.

**Sharp MZ80k** ... 36k Ram basic plus Toolkit. Over 100 programs plus literature, pet program conversion details etc. Dust cover included £395. Tel: Peter Howard Stratford/Avon 298187 or Wrexham 263123.



Hewlett-Packard HP-67 card programmable with case, charger, user handbook, standard pac and manual plus 10 spare cards in wallet. £130. (0908) 640053 evenings/weekends.

MZ80 ... 36k with disks + i/o unit £995 (inc. stock control program) Epson printer MX80 FT/1 £375. Interface for above £85. All 6 months old. Tel. 07677 503.

ZX81 + 16 RAM, PSU, Manual, Leads, Sinc. cassettes 4 and 5. Sinc built, perfect, £100 the lot. 01-870 5753.

ZX81 ... Sinclair built. Complete with 16K Ram pack, PSU, leads and manual. As new. £100. Tel: Maidenhead 27854.

Superboard 2 ... 16k RAM, 48x32 character display, Cegmon monitor prog. sound generator, PIA, metal cased, fan cooled, with 10A fan cooled PSU, various software. £270. Tel. Cambridge 311028.

ZX81 ... plus 16k RAM, all Sinclair programs. Many books. £110. For the lot ring 01-852 5935.

ZX80 ... 1k sinc. Built exc. cond. with all leads, PSU, manual and Hartnell's "Making the most of", + book of 30 progs also cassette including Flicker free games. £70. Tel. (0334) 53434.

Seiko world timer alarm watch. Tough a button and a map of the world is shown. Immaculate still under guarantee. Boxed. £35. Tel. Earlswood 2143 after 6pm.

Pet 32k computer ... as new, full manuals plus many extras. UK delivery possible. £495. Telephone 0403 (Horsham) 731650.

Acorn Atom ... 12k Ram, 12k Rom, 6522 Printer interface, inc. manual, mains adaptor, tapes (Invaders, Asteroids, soft V.D.U. etc), Magic book, User Group News Letters £235. Tel: (0242) 510525 (Cheltenham).

Nascom 2. 32k. Graphics, basic screenplus, fully cased, port status indicator. Tapes: programmers and, Pascal, Assembler, games. Full documentation on above. Cost £650, accept around £450. (07816) 6028 eve).

## ACC NEWS

*News from the Amateur Computer Club, the national club for all amateur and personal computer users.*

This month has been pretty busy, particularly in London. Before I tell you what has been happening there, can I remind the rest of you to write to me with your club news for inclusion in this spot; if you don't, the London bias will continue!

Once again, our friends in the North London Hobby Computer Club make the news. At their recent AGM, they re-elected Robin Bradbeer as chairman and decided to become a BBC referral point. Also at that meeting, they decided to become the ACC's first fully affiliated club by adopting the ACC Block Membership Scheme. The exact details haven't been finalised, but the gist is that they will pay the ACC a per capita fee, somewhat less than the normal ACC membership, and that all their members will become affiliate members of the ACC. The North London Club will handle distribution of *ACCumulator* (the ACC's newsletter) to their members, possibly inserting their own flysheet giving local news and times of meetings; any articles will be submitted to *ACCumulator* and published by the ACC. If necessary, *ACCumulator* will be expanded to cater for the increased contributions.

The ACC is very pleased that the scheme (which in October was merely a twinkle in my eye) was adopted by North London without opposition on 25 November 1981, and that this extension to the ACC's services was kicked off by the affiliation of such a large group (approx 250 members). Please get in touch with me to discuss terms if your Club or User Group is interested in full affiliation.

Speaking more generally, the ACC is improving the communications with local clubs and user groups. We are offering a £2 subscription to *ACCumulator* for a single person (the chairman or his

nominee) from each club or group; we hope that many clubs will take up this offer so as to improve communication between clubs and the ACC. It is hoped that the communications will be two way as we want information from the clubs, as well as sending out *ACCumulator* to them. Write to: Vernon Gifford, 111 Selhurst Road, London SE25 6LH, for the details of this offer. We hope that you will take this up, and that the copies of *ACCumulator* will be useful if you consider full affiliation for your club.

The ACC database now contains well over 200 clubs and user groups, *Please* make sure that your club or group is on it, and that your entry is correct. We give out club information to many people at the exhibitions that we attend (eg, *PCW*, Breadboard) and we'd hate to miss you out or tell lies about you. Write to: Derek Fordred, 72 Mill Road, Hawley, Dartford, Kent, with full details and he'll put you online. We are hoping to have the database out on Prestel early this year, possibly with some telesoftware (ie, software that you can load into your machine from the telephone line). As soon as we know the page number, it will be published in 'ACC News'.

Further to Busby's computing interests, two other items have cropped up this month. Firstly, there will be a conference at Easter this year, organised jointly by the ACC and ALCC (Association of London Computer Clubs), on the subject 'Computers and your Telephone'. This will include discussions of networks, telesoftware, bulletin boards, etc. It will not be about £999,999.99 phone bills. Please write to me if you are interested. Secondly, British Telecom is offering a £1000 prize to the inventor of the best system for downloading telesoftware into a

Sinclair ZX81. Further details are available from the Prestel department of British Telecom.

On 28 November, the ACC held its first National Conference. This was held at Imperial College, London and over 60 delegates came to discuss 'Practical Micro-Robotics'. The evening was a great success; the delegates included university lecturers, computing professionals, robotics specialists, electrical engineers and students. There was a great kindred spirit of people looking to learn about micro mice, small robots and intelligent machines. The morning session was devoted to micro-mouse, while the afternoon concentrated on more general aspects.

The conference was opened by Vernon Gifford of the ACC, who chaired the morning session. He introduced the first speaker, David Woodfield from GKN, David had won the 1981 micro-mouse competition with his machine 'Thumper', which talked as it went. He was joined on the platform by Andrew Keatley of Alan Martin Electronics and they gave a brief introduction to the principles behind mice. Next to speak was Eddy George, of the ICI Amateur Computer Club. He stressed the importance of the low level hardware, such as sensors, and pointed out that a little hardware can sometimes be easier (and much quicker) than a whole lot of software. He demonstrated a 'brainless mouse' that worked without a computer at all.

Nick Smith, the winner of 1980 Micromouse with 'Stirling Mouse', then discussed the various types of maze and how they could be solved, including how to get out of Hampton Court. He stressed the difference between mice and men: some human solutions aren't suitably applied to a micro mouse, while some techniques used by micro

mice will lose humans (even those with good memories). Finally, he considered the ideas used in the maze designs and the kinds of trap put in them.

The last speaker of the morning was John Billingsley of Portsmouth Polytechnic, who is responsible for designing mazes for micro mice to solve. He showed some video recordings of micro mouse contests and made some suggestions as to the kind of problem a micro maze-solver will have to face.

After lunch, Mr Beresford-Hartwell took the Chair, and the conference turned its attention to more general robots. The discussion was kicked off by Douglas Urquhart of ICL Bracknell, who talked about Cuthbot, an early mobile robot. This was followed up by Peter Mathews of Colne Robotics, who discussed 'Armdroid', a simple robot arm which sells for under £200 in kit form. He felt that the opportunities were wide open in this area and that Britain was the world leader in the field of personal robotics. Tim Orr, of Powertran Cybernetics, then demonstrated a more powerful robot arm, 'Genesis', which was hydraulically operated and optimised for easy computer interfacing. Alan Dibley wound up by giving a discussion on building economical robots (ie, how to get started in robotics without seeing your bank manager).

Because of the enormous interest shown by the delegates at the conference, the ACC has agreed to set up a micro-robotics study group to encourage and further hobbyist interest, holding meetings and providing information. Vernon Gifford has the details of this.

*Rupert Steele*

Details of the ACC can be obtained from Rupert Steele, Membership Secretary, ACC, St John's College, Oxford OX1 3JP

# NETWORK NEWS

Here is a list of all British (and one Dutch) personal computer networks. As more networks appear — and as more facilities are added to existing ones — we'll report them in this section, which appears monthly.

**Forum-80 Hull.** . . Operator: Frederick Brown, tel 0482 856169. Facilities: electronic mail, software up/down loading, Forum-80 Users' Group, PET users' section, shopping list. Hours: 7 days/week, midnight-0800, Tues & Thurs 1900-2200, Sat & Sun 1300-2200.

**Forum-80 London.** . . Operator: Leon Jay, tel 01-286 6207. Facilities: electronic mail, program downloading. Hours: Tues, Fri, Sat & Sun 1900-2300.

**80-NET** . . . Operators: Leon Heller & Brian Pain, National TRS-80 Users' Group, tel 0908

566660. Facilities: electronic mail, software for downloading, newsletter, TRS-80 information. Hours: 7 days/week, 1900-2200.

**CBBS London.** . . Operator: Peter Goldman, tel 01-399 2136. Facilities: electronic mail, program downloading. Hours: Wed 0700-0930 & 1900-2200, Fri

1900-2200, Sun 1600-2200.  
**Forum-80 Holland.** . . Operator: Nico Karssemeyer, tel 010 313 512 533. Facilities: electronic mail, program up/downloading, shopping list. Hours: Tues-Sat 1800-0700 nightly, continuous from 1800 Sat — 0700 Tues.

## CTUK! CENTRES

Here's an updated list of people organising Computer Towns. Don't forget to enclose an SAE if you write to your nearest 'Town for details.

**Lyn Antill,**  
1 Defoe House,  
Barbican,  
London

**Peter J Kiff,**  
52 Stone Road,  
Broadstairs,  
Kent CT10 1DZ

**Patrick Colley,**  
52 Queensway,  
Caversham Park Village,  
Reading,  
Berks RG4 0SJ

**Pete Shaw,**  
15 St Vincent Road,  
Clacton-on-Sea,  
Essex CO15 1NA

**Steven Christian,**  
51 Burnstones,  
West Denton,  
Newcastle-on-Tyne NE5 2DF

**Derek Moody,**  
2 Victoria Terrace,  
Dorchester,  
Dorset DT1 1LS

**David Tebbutt,**  
7 Collins Drive,  
Eastcote,  
Middx HA4 9EL

**Vernon Gifford,**  
111 Selhurst Road,  
Croydon,  
London SE25 6LH

**John Stephen Bone,**  
2 Claremont Place,  
Gateshead,  
Tyne & Wear NE8 1TL

**Mike Baker,**  
5 Edinburgh Road,  
Hanwell,  
London W7 3JY

**Vernon Quaintance,**  
50 Beatrice Avenue,  
Norbury,  
London SW16 4UN

**R L Saunders,**  
14 St Nicholas Mount,  
Hemel Hempstead,  
Herts.

**Pete Rowan,**  
10 Lambton Road,  
Jesmond,  
Newcastle-on-Tyne NE2 4RX

**Steve Haynes,**  
5 Guinea Street,  
Kingsholm,  
Gloucester GL1 3BL

**Ted Broadhead,**  
27 Cardinal Road,  
Leeds LS11 8EY

**Andrew Holyer,**  
10 Masons Field,  
Mannings Heath,  
Horsham, Sussex RH13 6JP

**Brigitte Gorton,**  
18 Purbright Crescent,  
New Addington,  
Croydon CR0 0RT.

**Susan Kelly,**  
Head of Reference Services,  
PO Box 4,  
Civic Centre,  
Harrow,  
Middlesex.

**Bill Gibbings,**  
3 Longholme Road,  
Retford,  
Notts DN22 6TU

**Philip Joy,**  
130 Rush Green Road,  
Romford,  
Essex.

**Richard Powell,**  
22 Downham Court,  
South Shields,  
Tyne & Wear

**Derrick Daines,**  
18 Cuttings Avenue,  
Sutton in Ashfield,  
Notts

**Keith Taylor,**  
Carter Hydraulic Works,  
Thornbury,  
Bradford BD3 8HG

**Roger Shears,**  
18 Woodmill Lane,  
Bitterne Park,  
Southampton SO2 4PY

**Alan S Waring,**  
50 Drayton Gardens,  
Winchmore Hill,  
London N21 2NS

**Alan Northcott,**  
Rushmoor,  
464 Reading Road,  
Winnesh,  
Wokingham,  
Berks RG11 5ET

**Alan Sutcliffe,**  
4 Binfield Road,  
Wokingham,  
Berks RG11 1SL

**Tony Cartmell,**  
54 Foregate Street,  
Worcester WR1 1DX

**Tom Graves,**  
19a West End,  
Street,  
Somerset BA16 0LQ

## USER GROUPS INDEX

**INTERNATIONAL**  
Pascal Z User Group (Europe)  
Affiliated with Pascal Z USA.  
12 user disks available plus  
newsletter. Contact: George  
Brooke, Sebastian Bauerstrasse  
20c, 8000 Munich 83, West  
Germany.

**REGIONAL**  
Scottish Amateur Computer  
Society. Meetings 1st Weds  
monthly, Claremont Hotel,  
Claremont Crescent, Edinburgh  
from 7.30 onwards. Meetings  
include talks and demonstra-  
tions. Contact: P Lindsay

(Top right flat), 1 Lower  
Gilmore Place, Edinburgh.  
Tel 031-229 6841

**COUNTY**  
Mid Kent TRS-80 User Club.  
Users and potential users of  
TRS-80 and Video Genie wel-  
come. Meetings fortnightly at  
Kent Micro Services, 53 High  
Street, Maidstone, Kent. Contact  
Mike Marriott also John Rayfield,  
22 Beaconsfield Rd,  
Sittingbourne, Kent.

North Lancs User Group,  
meets monthly in Blackpool.

Contact: John Robinson,  
0253 67091 or Mick Fordham,  
0253 891769.

**TOWNS**  
Dalton-In-Furness Computer  
Club. Recently formed.  
Contact: A H Gay, 24 Rusland  
Crescent, Ulverston, Cumbria,  
LA12 9LX. Tel: 0229 52854.

Folkestone needs a computer  
club. I'm willing to start one but  
I need some help. Please write  
or call any evening. Ray Milton,  
94 Linden Crescent, Folkestone,  
Kent.

Glasgow area ZX80/81 User  
Group, presently being formed.  
Main aim is to promote  
computer literacy. Will eventu-  
ally include BBC Micro. Write  
or phone: Ian Watt, 107 Green-  
wood Road, Clarkston, Glasgow,  
G76 7LW tel: 041 638 1241.

Glossop (Derbyshire) — is any-  
one interested in forming a  
computer club in this area? If  
so, please contact Neil  
Jenkinson on Glossop 66027.

## DIARY DATA

Readers are strongly advised to check details with exhibition organisers before making travel arrangements to avoid wasted journeys due to cancellations, printer's errors, etc.

Tokyo, Japan	Data & Telecommunications Exbn. Contact: Cashners Exposition Group, Guildford 38085.	20-23 Jan
San Diego, CA, USA	Pacific Computer Expo. Contact: Judco Enterprises (Arizona), (602) 990 1715	21-23 Jan
Eindhoven, Holland	Int Microelectronic Subsystems Trade Fair	27-29 Jan
Cheltenham	(Queens Hotel) Computer Open Day Exbn. Contact: Couchmead Communications Ltd, 01-653 1101	27 Jan
London	(Barbican) Information Technology & Management Exbn & Conf. Contact: BED Exbns Ltd, 01-647 1001	9-12 Feb
Harrogate	(Majestic Hotel) Computer Open Day Exbn. Contact: Couchmead Communications Ltd, 01-653 1101	10 Feb
Dublin, Eire	Int Computing Exbn. Contact: SDL Exbns Ltd, Dublin 763871	16-19 Feb
London	(West Centre Hotel) Microsystems Exbn. Contact: IPC Exbns Ltd, 01-643 8040	24-26 Feb
Swansea	(Dragon Hotel) Computer Open Day Exbn. Contact: Couchmead Communications 01-653 1101	24 Feb



## LEISURE LINES

by J J Clessa

Perhaps the November Puzzle was more difficult than usual, since the response was less than I would have thought. However, almost 60 readers sent in answers, of which more than 50 gave the correct answer — the sheep is in pen C.

The winning entry was from a young (?) lady (?) (I'm guessing from the handwriting), Sandra Manby of Southampton. Congratulations, Sandra — your prize will be on its way shortly.

Meanwhile, may I re-emphasise that only entries on postcards will be accepted — no letters. If you don't have a postcard, then write on the back of a sealed empty envelope and send that.

### Quickie

A snail climbs up a greasy flagpole 20 feet high. He climbs three feet each day

but slips back two feet each night. He starts at daybreak on 1 February. When does he reach the top?

### Prize puzzle

This month's prize puzzle should be within the compass of those readers with micros or programmable calculators: if you divide 2519 by 10, there is a remainder of 9; if you divide 2519 by 9, there is a remainder of 8; if you divide 2519 by 8, there is a remainder of 7; and so on. Can you find two other numbers with the same property?

Answers on postcards, please, to: February Prize Puzzle, PCW, 14 Rathbone Place, London W1P 1DE to arrive no later than 28 February.

## PROGRAMS

We are interested in Basic or Pascal programs for any of the popular micros — please specify which one you wrote your program on and how much memory it uses up. Assembler language subroutines are covered in 'Sub Set'. We'd also prefer more 'serious' software: games are all very absorbing, but the programs section of PCW does seem rather one-sided. Make sure programs submitted are fully debugged before they're sent in, preferably on cassette with a clear listing enclosed. A short explanation of your program's function would also be desirable. If you want it returned, enclose an SAE and write your name and address on each piece of paper you send. Don't worry if you don't hear anything for a month or two — programs take a long time to evaluate. And we pay for all programs we print. Send contributions to Maggie Burton, PCW Programs, 14 Rathbone Place, London W1P 1DE.

In PCW's November and December issues the unforgivable sin of printing incorrect listings was committed. Appropriate grovelling apologies to all our readers who tried and failed to run TRS-80 Sheepdog Trial and ZX81 Battleships and Cruisers. Atonement is as follows:

Battleships and Cruisers contained several typing errors: line 181 should have been 818 and if line 702 is numbered 700 that solves the mystery of all those GOTO 700s in the listing. Line 780 should read:

```
PRINT AT 13-Y, X+ (K*16) - 14; "*"
```

Line 800 should read:

```
IF N(K,Z) <> 0 THEN GOTO 850
```

TRS-80 Sheepdog Trial seems to

have several line endings missing. I have recently run the program from cassette and it works. Once the problem of the missing characters is solved the program should work from the listing as printed. Here are the offending lines:

```
Line 50: OF=0: FOR N=L TO U:
```

```
IF PEEK (DP+N)>32 AND PEEK
```

```
(DP+N) <> 128 OF=1
```

```
Line 220: B$=" ": B1$=" ":
```

```
S$=CHR$(131)+CHR$(175)+CHR$(
```

```
143)+CHR$(175)
```

```
Line 230: D$=CHR$(131)+CHR$(
```

```
173)+CHR$(140)+CHR$(156)+
```

```
CHR$(129): P=15360: K=0
```

```
Line 600: FOR N=0 TO 2: IF
```

```
SX(N)>34 AND SX(N)<46
```

### PET UPGRADE

We can upgrade your large keyboard PET at a fraction of the 'New Price' difference.

8K to 16K ..... £44.00

16K to 32K ..... from £56.00

8K to 32K ..... £69.00

NO EXTRA CHARGE

If expansion area drilled with quarter inch holes . . .

All new RAMs fitted with sockets  
Fast 2 hours while you wait service.

Tel: Mick Bignell

01-953 8385.



ON THE MOVE WITH ZX SOFTWARE

PROGRAMS FOR THE ZX 80/81 INCLUDING:

ZX CHESS: Machine Code Program £10.00

ADVENTURES: From £7.00 To £9.00

ZX BUG: Machine Code Debugging £7.00

EDUCATIONAL GAMES For Children.

AND MANY OTHERS

FOR A CATALOGUE GIVING DETAILS OF

ALL PROGRAMS PLEASE SEND A SAE TO:

ARTIC COMPUTING,

396, JAMES RECKITT AVENUE,

HULL, HU80JA.

## MICROMART

### Great products from Mutek

## Tiny PILOT

Mutek's Tiny PILOT (MTP) is a small-scale yet comprehensive implementation of the PILOT text-oriented programming language for OSI and UK101 computers.

Commands are: R: remark; T: type text (or graphics character); ? : accept name; A: accept answer (numeric or alphanumeric); M: match (full range of comparisons); J: jump to label; U: use subroutine at label;

E: end subroutine; C: compute (26 single-character variables); I: input numeric value to variable; P: produce random number; S: stop (end program)

Numeric functions are performed in 16-bit unsigned form, giving a range 0-65535. A full line-editor is included in the package.

Note: MTP uses CEGMON facilities extensively and will not operate with non-standard monitors such as WEMON or MONUK02. MTP is available as a package with the relevant version of CEGMON at a special reduced price. This gives you the special facilities of CEGMON as well as the best use of MTP.

The EPROM package is available ex-stock, and comes complete with fitting instructions, manual and reference card.

PILOT package £17.50+VAT  
PILOT/CEGMON  
package £29.50+VAT

## StarLink

Communications package

A complete comms. package for OSI systems, including:

'Smart terminal' mode for link to external mainframe, mini or micro; half-duplex/full-duplex operation; transmit/receive prepared text or files (on-line/off-line preparation); direct upload/download of programs; 'indirect file' handling for transfer of programs/data between external computer, disk or ROM BASIC; full editing; and many other features

Available in EPROM in two versions: StarLink I for disk or ROM BASIC systems, and StarLink II for non-disk operation of Superboard Series II. Specify type required when ordering!

Starlink (either version) £17.50+VAT

### Coming shortly

Modem (acoustic coupler) for use with StarLink — c.£50 or less  
High res (256 x 256) graphics for Superboard/C1 — bare board + instructions, software c.£35, ready-built c.£110

FigFORTH (full Forth Interest Group implementation) in ROM — c.£50, source listing c.£15

MUTEK Quarry Hill, Box, Wilts  
Tel: Bath (0225) 743289

# BENCHTEST

PERSONAL COMPUTER

the HP-85 does more, it also costs an arm, a leg and several back teeth. If, as rumoured Casio, gets the '9000 out at less than £500 it could give HP a hard time in these days of dwindling research budgets.

As to expansion, little is revealed beyond hints in the manual of disk drives, a cheap electrostatic miniprinter, an RS232 interface and the existing Epson graphic printer. For its intended market, one would also want IEEE 488 for instrument control and a plotter, which are not mentioned. If I were in Casio's design team I'd rip out the RAM ports and whack in two Sony micro-floppy drives, so there!

At present the only ROM software available is the Matrix pack, though I expect more sci/tech packages will emerge in due course.

## Conclusions

Although I may appear to have been harsh in my criticism of the RAM file system, I still found the '9000 a likeable machine. In the weeks during which it sat on my office desk it found constant use as a calculator and for trying small programs and it took up so little room that one forgot it was there. For the biochemist it could gobble up statistics or for the engineer take the agony out of eigenfunctions. If Casio does decide to introduce it here it is likely to be considerably cheaper than any comparable device, but I think that many professional users will want disks rather than RAM packs.

### Benchmark timings

BM1	2.5
BM2	9.0
BM3	24.0
BM4	24.0
BM5	26.0
BM6	42.0
BM7	60.0
BM8	36.5
All timings in seconds	

### SPECIFICATIONS

Processor:	Z80-compatible, 2.75 MHz
Memory:	4k RAM expandable to 32k (up to 16k non-volatile CMOS). 12k ROM expandable to 24k.
Display:	5.5in green CRT, 32x16 characters, 255x127 dots for graphics
Cassette:	User's own cassette or reel-to-reel with remote control, requires OP-1 expansion unit.
Keyboard:	Calculator-style, 67 keys inc numeric pad and four cursor controls, upper case only and single-stroke Basic words.
Ports:	OP-1 expansion has parallel and serial printer ports plus phono cassette. OP-2 (not tested) adds RS232.
Language:	CA-Basic in ROM, Extended Matrix Basic in ROM.

## GEMINI MULTIBOARD

and ordered access to machine code routines. The CPU board requires only a power supply to operate in this form.

The user who would like to drive the system from a terminal via the RS232 port is at present only partly catered for as the RS232 port must start at 300 baud and is initially configured for input to the CPU board only. The software to run a terminal could easily be written, but Gemini does not provide it.

In conclusion, I was most impressed with the behaviour of the Multiboard system; and the costs, board by board,

compare very favourably with the equivalents for the S100 bus.

### Prices

CPU board	£125.00
RAM board	£140.00
Video board	£140.00
Disk controller	£140.00
ROM board	£65.00
EPROM programmer	£29.50
Keyboard	£57.50
Pertec twin disk drives, cased	£550.00
Veroframe box	£32.50
Kenilworth case	£49.50

The multiboard system as reviewed is also available as a complete, cased unit for £1450

All prices exclude VAT.

- MZ80K • PET
- VIDEO GENIE
- ZX81

### FOOTBALL POOLS PLANS

COMPUTERISED CHECKING CHARTS.

- Superb new programmes now available
- Write for details - (mention your make of machine) - soon you could be checking your favourite plan fast!

## POOLSOFT

Tel. 0323-890604 © 17 Blatchington Rd, Seaford, East Sussex, BN25 2AB.

### EPSON MX80 PRINTER RIBBONS REINKED

A new Epson ribbon costs around £10. We will re-ink your present ribbon for £5 incl. p&p and VAT.

Epson make printers under other names. If you have an MX80 based printer, we can re-ink your ribbon too.

Cash with order. Cheques made payable to, Douglas Recordings.

Send your ribbon in its cartridge to—

Douglas Recordings, 2 Glebe Park, DUMBARTON G82 3HF. Telephone (0389) 64384.

# MICROMART

## ZX81

### CASSETTE ONE

"I had your Invaders/React cassette... I was delighted with this first cassette" - P. Rubython, London NW10

"Thanks for your Cassette One you sent me - some excellent games at a very cheap price!" - P. Rushton, Leeds

"I have been intending to write to you for some days to say how much I enjoy the games on 'Cassette One' which you supplied me with earlier this month. Please let me into the secret of your first time load every time!" - E. H., London SW4

### CASSETTE ONE SIDE ONE 1K MACHINE CODE PROGRAMS

React, Invaders, Phantom aliens, Maze of death, Planet lander, Bug splat, Bouncing letters

### CASSETTE ONE SIDE ONE 1K BASIC PROGRAMS

I Ching, Mastermind, Basic hangman, Robots  
**CASSETTE ONE SIDE TWO** has large screen versions of Invaders and Maze of Death, ready for when you get 16k. Previous customers who did not get the large screen versions can get free upgrade instructions by sending me an sae.

**CASSETTE ONE** costs £3.80 from Michael Orwin, 26 Brownlow Rd., Willesden, London NW10 9QL

## PET and VIC Southampton

HIRE Commodore equipment by the week, all including manuals, cassette deck, media etc.  
 16K £20, 32K £25, Disk or Printer £25 VIC 20 £9

Ex hire equipment with guarantee usually available; 32K from £425. Part exchange your old 8K PET.

### NOW LOWEST EVER PRICES FOR NEW PRODUCTS

4016N	12" screen	£455.00
4032N	12" screen	£555.00
8032N	80 columns	£795.00
4040	Dual Disk	£625.00
2031	Single Disk	£355.00
4022	Printer	£355.00
C2N	Cassette Deck	£ 44.95 (inc VAT)
VIC20	Colour Computer	£189.95 (inc VAT)

Large range of software, books etc stocked

TOOLKIT BASIC 4 £30.00  
 6550 RAMS £12.00

All prices are cash-and-carry and exclude VAT

OFFICIAL COMMODORE DEALER

## SUPER-VISION

13 St James Road, Shirley, Southampton  
 Telephone (0703) 774023  
 After hours (0703) 554488

## ZX81 SOFTWARE

Cassette 1: DATABASE For serious users. Menu driven program to create, update, search and delete your own personal database. Full documentation and demonstration cassette. £10

Cassette 2: BANK ACCOUNT Record all your income/expenditure and use for home or office budgeting.  
 TELEPHONE DIRECTORY Set up your own personal directory of names addresses and telephone numbers, including extension numbers.

Cassette 3: OTHELLO/MASTERCODE

Cassette 4: BREAKOUT

Cassettes 2-4 all £4 each.

Send SAE for full details of these and other programs.

J PURVES 12 Stobhill Road  
 Gorebridge Midlothian EH23 4PL



# PROGRAMS

```

390 @ " 4 A semi", "5 Terraced", "6 A bungalow"
400 @ " 7 A flat", "8 A cottage", "9 A cave" : @
410 INPUT "What's your choice? ", A$
460 A1=VAL(A$) : IF A1=0 OR A1<1 OR A1>9 THEN 410
490 @ : @ "Now tell me which price range this place is in:"
500 @ : @ " 1 Under 10,000 pounds"
510 @ " 2 10,000 to 20,000"
520 @ " 3 20,000 to 30,000"
530 @ " 4 Over 30,000"
540 @ : INPUT "Enter the appropriate number: ", A$
550 A2=VAL(A$) : IF A2<1 OR A2>4 THEN 540
560 @CHR$(12);
600 IF A1=7 THEN 690
610 @ "Now think of the garden and give me:" : @
620 INPUT "The number of large trees there: ", A$
630 A3=VAL(A$) : IF A3=0 THEN 620
635 INPUT "Now tell me how many small trees there are: ", A$
640 A4=VAL(A$) : IF A4=0 THEN 635
645 INPUT "And how many bushes are there? ", A$
650 A5=VAL(A$) : IF A5=0 THEN 645
670 IF A1<3 AND A2>3 AND A3>100 OR A1=9 AND A2<>1 AND A3>50 THEN 2300
680 @CHR$(12);
690 @ "OK, now I'd like you to envisage a cup. Is it:"
700 @ : @ " 1 Decorative" : @ " 2 Plain"
710 @ " 3 Squarish" : @
720 INPUT "Well? ", A$
730 A6=VAL(A$) : IF A6<1 OR A6>3 THEN 720
740 @ : @ "Is there a saucer with the cup? "
750 INPUT "Type 'Y' for YES, 'N' for NO: ", A$
760 IF A3<>"Y" AND A3<>"N" THEN 750
770 @ : @ "As you look at the cup, is the handle on the right,"
780 @ "left or centre?"
790 INPUT "Type 'R', 'L' or 'C': ", A$
800 IF A1<>"R" AND A1<>"L" AND A1<>"C" THEN 790
805 @CHR$(12);
810 @ : @ "Is the cup:"
820 @ " 1 Empty" : @ " 2 Half full" : @ " 3 Full"
830 @ : INPUT "Well? ", A$ : A8=VAL(A$) : IF A8<1 OR A8>3 THEN 830
1010 @CHR$(12);
1020 @ "Now, think of a stream. Is it:"
1030 @ : @ " 1 Deep and murky"
1040 @ " 2 Shallow and clear"
1050 @ : INPUT "Well? ", A$ : A9=VAL(A$) : IF A9<1 OR A9>2 THEN 1050
1060 @ : @ "Are there any bridges and/or stepping-stones across"
1070 @ "the stream?"
1080 INPUT "Type 'Y' for YES, 'N' for NO: ", A$
1090 IF A2<>"Y" AND A2<>"N" THEN 1080
1170 @CHR$(12);
1180 @ "Now imagine a 14ft high wall. How would you get to"
1190 @ "the other side of it?" : @ " 1 Walk"
1200 @ " 2 Climb" : @ " 3 Use a rope"
1210 @ " 4 Use a ladder" : @ " 5 Stand on a box"
1220 @ " 6 Jump over" : @ " 7 Smash through"
1230 @ " 8 Fly over" : @
1240 INPUT "Type the appropriate number: ", A$
1250 A0=VAL(A$) : IF A0<1 OR A0>8 THEN 1240
1260 @CHR$(12); @ "Having reached the other side of the wall,"
1270 @ "you find yourself face to face with a large and"
1280 @ "very angry bear. Would you:" : @
1290 @ " 1 Stay put and let it kill you quickly"
1300 @ " 2 Try to run away from it"
1310 @ " 3 Try to fight the bear"
1320 @
1330 INPUT "Type the appropriate number: ", A$
1340 B1=VAL(A$) : IF B1<1 OR B1>3 THEN 1330
1350 ON ERROR GOTO 1400
1360 SET 5,80 : @CHR$(12); @ "Thank you - that was most interesting!"
1370 @ "Just a moment while I think about this."
1380 INPUT " ", A$
1385 SET 5,0
1400 @CHR$(12);
1510 REM CUP
1520 F=A6+11
1530 GOSUB 2240
1540 @ "You are ";G$;" person."
1550 REM SAUCER
1560 IF A3$="Y" THEN F=15
1570 IF A3$="N" THEN F=16
1580 GOSUB 2240

```

## HULLFORTH

A new Forth compiler for NASCOM I/II or any Z80-based micro. HULLFORTH is a structured high level language which runs over 10 times faster than BASIC.

- Runs in under 16K
- Supplied on cassette with full documentation
- Nascom users please quote NAS-SYS or NASBUG

Price - £25

Send SAE for further information to:

Mr A.F.T. Winfield,  
148 Goddard Avenue,  
Hull, HU5 2BP

## NASCOM BASIC

- A breakdown of how it works
- How and where GOSUB, FOR/NEXT, variable and string information is stored.
  - Description of floating point maths.
  - Data areas in the ROM listed.
  - Workspace, each byte is explained.
  - The ROM is broken down into over 200 parts with notes on each part. PRICE £5
- BASIC TOOLKIT**
- Uses spare RAM 0080-1000.
  - Nine functions featuring string array SAVE/LOAD and intelligent re-number. On tape for NAS 1 or 2, with demo. program and instructions. State monitor and tape format. PRICE £6.
- A.S. WATKINS 7, WARWICK CLOSE,  
MAIDENHEAD BERKSHIRE.  
Tel. (0628) 30494.

# MICROMART

## SYSTEM SCIENCE

### CP/M SOFTWARE

- Microstat Interactive Statistics Package. Parametric & non-parametric tests. Requires MBasic and 48k RAM £195.00
- Lynx friendly overlay/linking loader for those BIG programs. For .REL files £215.00
- Reformatter disc transfer routines
- CP/M DEC £125.00
- CP/M IBM £125.00
- Spell fast, easy to use spelling error detection program. Effective dictionary of up to 50,000 words. 48k RAM £45.50
- Z80 Forth Development System £35.50
- Ratfor pre-processor for Fortran-80. Many "Software Tools" programs inc. £35.50
- C Compiler - Fast macro assembler and useful programs inc. Requires 40k £35.50
- LISP/80 Interpreter - for AI with examples. Requires 48k £35.50

All software on 8in CP/M disc. Enquire for other formats. Add £2.00 post and packing.

## SYSTEM SCIENCE

54 Enfield Cloisters  
Fanshaw St, London N1

## MEMORY PRICES - are Tumbling!!

It makes no sense to buy more than your current needs for your ZX81. Now you no longer need to!

# ZX81

- The Incremental 1.1 by East London Robotics is a unique memory expansion system for ZX81 for minimum outlay but giving you maximum flexibility.
- Fits inside ZX81 case leaving expansion port free.
- Child's play to fit - no soldering. Plugs into existing micro-processor socket and bolts to existing holes in ZX81 board for high rigidity/reliability.
- Expandable up to 16k in increments of 2k simply by plugging in memory chips.
- Does not stop there! On board start address selection (plug and socket) allows configuration alongside other memory systems (eg with Sinclair RAM pack giving from 18 to 32k contiguous RAM) thus placing absolutely no limits on your future memory expansion requirements.
- Ultra low power - Incremental 1.1 with full complement of memory (16k) typically takes less power than existing 1k Sinclair RAM (about 40ma).
- Starts you off at a price you can afford:  
Incremental 1.1 socketed for max of 8k £8.50  
Incremental 1.1 socketed for max of 16k £9.50  
Hitachi 6116 CMOS 2k byte memory chips £5.89 each as at 6/12/81

s.a.e. for details or phone 01-471 3308  
EAST LONDON ROBOTICS (Electronics),  
'Finlandia House'  
14, Darwell Close,  
East Ham, LONDON E6 4BT

## THE

# BUFFER

MICRO SHOP

374A, STREATHAM HIGH RD,  
LONDON SW16.

(NEXT TO STREATHAM STATION)

NEW RETAIL SHOP FOR

# ★ ZX81 ★

"ADD-ONS", GAMES, SOFTWARE  
THE BEST OF THE MAIL ORDER  
ITEMS ADVERTISED IN THIS  
MAG. AVAILABLE OVER THE  
COUNTER.

NOW OPEN

★ RING 01-274 6674 FOR ★  
CATALOGUE AND OPENING DATE

# MICROMART

## BUSINESS & COMPUTER SERVICES

292 Caledonian Rd, London N1 1BA  
Tgl: 01-607 0157 (24-hour Answering Service)

We are  
**Micro-computer Consultants & Programmers**

— and specialise in industrial & commercial programs written to clients' specifications.

VAT & Post incl.

Cash Analyser £20.00  
Vehicle Cost Analyser £25.00  
Book Keeping (min 48k & 2 drives) £150.00

Please ask us for fuller details of the above. All are disk based for the TRS-80 Model I or III. Please state your DOS when ordering. Apple II versions soon.

# MONOPOLY

The computer will challenge you or the whole family at the worlds most successful board game, Monopoly. No need to enter your skill rating at the beginning, the program features an unique system whereby the computer detects who is the best player and adjust itself accordingly. The better you play so will the computer. Another feature for those long exciting marathons of the game but not the time to finish them, is that the game can be saved" on tape to be continued at another time.

COMPUTICS 1 BELL LANE  
MICROSOFT WHEATLEY  
OXFORD OX9 1XY

## SHARP MZ-80K software

- £5 — FOOTBALL MANAGER. Brilliantly original, complex football management simulation. Provided with a mediocre third division side, your objective is clear. Just gain promotion and eventually a place in Europe! How is up to you. Obviously you will buy and sell individual players and decide the tactics every game. However, you will also have to cope with injuries, low gates, the Bank manager and the Directors! How will you make out? Can you even survive in the riskiest profession of all? (14K available RAM)
  - £5 — DUST COVERS for MZ-80K computer or MZ-30P3 printer. Black, waterproof.
  - £5 — MOONLANDER. Complex real time lander. Superlative graphics/sound (10K RAM)
  - £5 — HEAD ON. Basic/Machine code arcade game, "gobble" up dots but avoid suicidal robot cars intent on your destruction. Very Very fast.
  - £5 — COMPOSER. Play tunes via the keyboard. Replay your compositions. Print music strings for future use.
  - £5 — COMBAT. Superb 2 person tank battle. Move and fire on opponent's tank and guns.
  - £4 each — BIORHYTHMS, MASTERMIND, ADDRESS BOOK, BANK ACCOUNT.
  - £5 each — CHASE, MANIAC.
  - COMPUTER ASSISTED LEARNING. Superb suite of programs for 3 — 7 year olds. £5 each — WORD MATCH, COUNT & ADD, PICTURE COUNT, CHAPES. £4 each — CHARACTER MATCH. All 22K RAM.
- Write or phone for full catalogue. Cash with order, or ACCESS. All prices fully inclusive. Orders despatched by return.  
FREE machine code SPACE INVADERS with orders of £15 +

## HIGHLIGHT SOFTWARE

3 Nether Court Halstead Essex CO9 2HE  
Telephone (0787) 475714

## MICROCOMPUTERS

Short intensive part time day and evening courses.

01-359 2465  
Angel Islington Centre,  
69 Upper St.  
London N1

# PROGRAMS

```

1590 @ "There is ";G$;" person in your life."
1600 REM CUF FULL
1610 IF A3$="N" THEN 1690
1620 IF A8>1 THEN 1650
1630 @ "You do not love this person."
1640 GOTO 1690
1650 IF A8=3 THEN 1680
1660 @ "You do not love this person very much."
1670 GOTO 1690
1680 @ "You love this person."
1690 REM HANDLE
1700 IF A1$<>"R" THEN 1740
1710 F=18
1720 J$="You are probably "
1730 GOTO 1770
1740 IF A1$="L" THEN F=19
1750 IF A1$="C" THEN F=20
1760 J$="You may be "
1770 GOSUB 2240
1780 @J$;G$;"."
1790 REM BRIDGES
1800 IF A2$="N" THEN 1830
1810 @ "You may have - or have had - a problem such as"
1820 @ " serious illness in your life."
1830 REM HOUSE & PRICE
1840 T=0
1850 IF A1<3 OR A1>8 THEN F=A1
1860 IF A1>2 AND A1<9 THEN F=(A2+2)
1870 T=T+1
1880 GOSUB 2240
1890 @ "You are ";G$;"."
1900 IF T=2 OR A1>8 OR A1<7 THEN 1930
1910 F=A1
1920 GOTO 1870
1930 REM GARDEN
1940 IF A1=7 THEN 2070
1950 IF A3<=10 THEN F=10
1960 IF A3>10 THEN F=11
1970 GOSUB 2240
1980 @ "You have ";G$;" close friends."
1990 IF A4<=10 THEN F=10
2000 IF A4>10 THEN F=11
2010 GOSUB 2240
2020 @ "You have ";G$;" friends."
2030 IF A5<=10 THEN F=10
2040 IF A5>10 THEN F=11
2050 GOSUB 2240
2060 @ "You have ";G$;" acquaintances."
2070 REM STREAM
2080 F=A9+20
2090 GOSUB 2240
2100 @ "You find it ";G$;" to see through your problems."
2110 REM BEAR
2120 IF B1=1 THEN F=27
2130 IF B1>1 THEN F=28
2140 GOSUB 2240
2150 @ "You tend ";G$;" give in easily."
2160 REM WALL
2170 IF A0=1 THEN F=23
2180 IF A0>1 AND A0<6 THEN F=24
2190 IF A0>5 AND A0<8 THEN F=25
2200 IF A0=8 THEN F=26
2210 GOSUB 2240
2220 @G$;"."
2230 @ : INPUT "Press RETURN when you've read this. ";A$
2235 @CHR$(12); : GOTO 2500
2240 FOR I=1 TO F
2250 READ K$
2260 NEXT I
2270 G$=K$
2280 RESTORE
2290 RETURN
2300 @CHR$(12);
2310 @ "Look, you don't appear to be taking this very seriously."
2320 @ "Do you want to continue?" : @
2330 INPUT "Type 'Y' for YES or 'N' for NO: ";B$
2340 IF B$<>"Y" AND B$<>"N" THEN 2330
2350 IF B$="N" THEN 2500
2360 GOTO 680
2500 @ : END
    
```

## ADD LOWER CASE AND INVERTED VIDEO CHARACTERS TO YOUR TRS 80 MODEL I FOR £26.45.

- \* TANDY COMPATIBILITY mode (default) gives lower case without the need for switches.
  - \* FULL MODE gives the FULL CHARACTER SET in POSITIVE and INVERTED VIDEO and all graphics characters.
  - \* WHOLE SCREEN INVERSION including borders is independently controllable. Double width capability is not affected. Mode selection by port FE. Fits inside the keyboard case.
- Technical manual with software patches £6  
Assembled and tested PCB, 2102 chip £23  
Parts and manual ordered together £26.45  
The above prices include worldwide postage and United Kingdom VAT. Dealer discounts. Installation available, please enquire.

RHA (MINISYSTEMS) LTD., 83 GIDLEY WAY, HORSPTH, OXFORD OX9 1TQ.  
Tel. 08677-3625

## S.WALES MICRO CENTRE

COMMODORE PETS

+  
APLES

+  
SHARP

+  
COMPUTER BOOKS



VIC-20 — ORDER NOW!!  
SEND £35 DEPOSIT.

## SIGMA SYSTEMS

54 PARK PLACE CARDIFF 21515/34869





## NASCOM SOFTWARE

We offer the following quality software for NASCOM systems:

**NASPAS** - a 12K PASCAL compiler which produces Z80 code directly, i.e. no P-code. The compiler offers floating point and integer arithmetic, arrays, sets, strings and all major Pascal statements together with fully recursive functions and procedures with value and variable parameters. The object program runs very quickly. Price: £35.00.

**NASMON** - A new monitor for NASCOMs. Occupies 4K and includes a sophisticated screen editor, a 'front panel' mode, blocked and buffered tape routines and powerful debugging commands. Price £30.00 in EPROM.

**BASI12K** - a 12K BASIC interpreter offering 11 digit precision arithmetic, PRINT USING, IF...THEN...ELSE and other advanced features. Price: £25.00

**NASGEN** - a fast 3K assembler generating a full symbol table and with many assembler directives and commands. Price: £15.00 on tape. £25.00 in EPROM.

**NASMEM** - a 2½K disassembler which interfaces to NASCOM's front panel to produce single step disassembly. Optionally it produces labels and o/p may be directed to a text buffer suitable for NASGEN. Price: £10.00 on tape. £15.00 in EPROM.

All the above software runs under NASMON except NASPAS which can run under NASMON or NAS-SYS. All prices are fully inclusive.

**FREE:** a free CHESS program with every order of NASMON.

**GEMINI DISK OWNERS:** HISOFT offer a Z80 development package to run under CP/M 1.4 on the Gemini Floppy Disk System. Included in the package are:

- a powerful screen editor.
- a fast Z80 assembler with conditional assembly.
- a debugger based on the Front Panel on NASMON together with a labelling Z80 disassembler. All this for the inclusive price of: £50! Send for details NOW. Full details may be obtained from:

HISOFT 60 HALLAM MOOR  
LIDEN, SWINDON, WILTSHIRE

## COMPLETE NESTAR SYSTEM

8" Controller with 1.26 KB Clusterbus system. Power supplies, cooling and system software. Clusterbus communication cards.

**NEAREST OFFER TO RETAIL PRICE SECURES**

Inventory Controller  
**Personal Computers Limited**  
Masters of Personal Computer Technology  
194/200 Bishopsgate London EC2M 4NR Tel: 01-626 8121

## FOR SALE

**FLOURISHING WEST MIDLANDS MICRO-BUSINESS**

**ESTABLISHED CUSTOMER BASE**

**OFFERS BASED ON -:**

**£15000 + S.A.V.**

**REPLIES TO BOX**

**NO. 80**

```

960 A=VAL(LEFT$(Q$,1)):B=VAL(RIGHT$(Q$,1))
970 IF RIGHT$(P$(A),1)<>RIGHT$(P$(B),1) THEN 1010
980 PRINT"[CD]STERILE MATCH: TRY AGAIN!"
990 FOR XX=1 TO 500: NEXT
1000 GOSUB 1450: GOTO 900
1010 IF B<5 THEN PRINT"HIGHLY IRREGULAR, BUT...":FORXX=1 TO 500: NEXT
1020 GOSUB 1450 CLEAR LOWER SCREEN
1030 REM
1040 REM PRINTS EXTENDED FAMILY TREE
1050 REM
1060 PRINT
1070 PRINTTAB(15);A;TAB(2);B
1080 PRINT TAB(15);P$(A);"[C][C][C][C]";P$(B)
1090 PRINT TAB(19)"[T]"
1100 PRINT TAB(13);"[C][C][C][C][C][C][C][C][C][C][C][C]"
1110 PRINT TAB(13);"[T] [T] [T] [T]"
1120 IF LEFT$(P$(A),2)<>[RUS]X" THEN GOSUB 1320: GOTO 1180
1130 REM (AVOIDS N-PARENTS > H-CHILDREN)
1140 GOSUB 1520 H-CHILDREN
1150 REM
1160 REM THIRD GENERATION
1170 REM
1180 FOR K=S TO F
1190 PRINT TAB(12);C$(K);" ";
1200 NEXT K
1210 PRINT
1220 PRINT"[CD][CD][CD]PRESS 'M' FOR ANOTHER MATING."
1230 PRINT"OR 'R' FOR NEW CHILDREN"
1240 GET A$: IF A$="" THEN 1240
1250 IF A$="R" THEN 500
1260 IF A$="M" THEN GOSUB 1450
1270 IF A$<"R" AND A$<"M" THEN 1240
1280 GOTO 900
1290 STOP
1300 REM SUBROUTINES
1310 REM
1320 REM NORMAL OFFSPRING
1330 REM 50/50 CHANCE BOY/GIRL * LAST HALF OF C$( ) STORES 4 N-CHILDREN
1340 REM
1350 S=5:F=8
1360 FOR K=5 TO 8
1370 IF RND(1)>.5 THEN Z=2:GOTO 1390
1380 Z=1
1390 C$(K)=S$(Z)
1400 NEXT K
1410 RETURN
1420 REM
1430 REM CLEAR LOWER SCREEN
1440 REM
1450 PRINT"[HOME][CD][CD][CD][CD][CD][CD][CD][CD][CD][CD]"
1460 FOR Y=1 TO 12
1470 PRINT" "
1480 NEXT
1490 PRINT"[HOME][CD][CD][CD][CD][CD][CD][CD][CD][CD][CD]"
1500 RETURN
1510 REM
1520 REM BLEEDERS/CARRIERS
1530 REM 4 CHILDREN (1/4 CHANCE OF H-CHILD) STORED IN 1ST HALF OF C$( )
1540 REM
1550 S=1:F=4
1560 FOR K=1 TO 4
1570 R=INT(RND(1)*4)+1
1580 IF R=3 AND P$(A)=S$(R) AND P$(B)<>S$(4) THEN 1570
1590 REM AVOIDS H-FATHER+H-MOTHER > H-SON (IMPOSSIBLE)
1600 C$(K)=S$(R)
1610 NEXT
1620 RETURN
1630 REM
1640 REM METAPRINTING ROUTINE
1650 REM
1660 PRINT"[CLS]":POKE 59468,14
1670 READ L$
1680 IF L$="END" THEN 1790
1690 P$=L$
1700 GOSUB 1720
1710 GOTO 1670
1720 LX=LEN(P$)
1730 IF LX/2<>INT(LX/2) THEN P$=P$+CHR$(32):LX=LX+1
1740 FOR IX=1 TO LX/2
1750 PRINTTAB(20-IX)MID$(P$,LX/2+1-IX,1)CHR$(145)
1760 PRINTTAB(19+IX)MID$(P$,LX/2+IX,1)CHR$(145)
1770 NEXT IX
1780 PRINT
1790 RETURN
    
```

### TRS-80 MODEL 1 - L11

**CONFLICT**, a new startrek format TACTICAL war game. Fight the Aliens across 180 quadrants each spanning 2 x 1.5y, using 18 primary ship handling commands and 12 ship systems. Long or short conflicts with 10 skill levels, perform gamesave in only 15 seconds, multiple replay feature. 16K program with 3.3K word manual, only £14.00

**SYSTORE**, A m/c code facility to copy system tapes, write RAM to tape and copy basic programs with variables intact. Includes programs to test all RAM. Presented in 6 modules for 4K, 11 modules for 16K. Complete with manual, only £14.00

All items double recorded on data cassette and carry quality guarantee. Send cheques/P.O. to J. Gosden, 13 Ashted Common, Ashted, Surrey KT21 2ED.

Experienced Programmer  
Required immediately to work  
on PETS and C.P./M. leading  
software house in Guildford.

Please telephone Guildford on  
(0483) 505918



# PROGRAMS

## TRS-80 Extra

By Francis Butters

```

10 TAB
20
30 CLEAR500
40 GOSUB110
50 FORX=1TO55:LPRINTCHR*(138):NEXT
60 GOSUB110
70 FORX=1TO7:LPRINTCHR*(138):NEXT:END
80
90 PRINTING GOSUB
100
110 A=10:LPRINTSTRING*(3,32):IFORX=1TO7:LPRINTSTRING*(2,32)*5*STRING*(3,32)A:=A+10:NEXT:LPRINTCHR*(13)
120 FORX=1TO8:LPRINT"*"STRING*(9,"."):NEXT
130 RETURN
    
```

## PC1211 Exam Questions

By J Chaplin

```

1:PRINT "NOT A VALID":
PRINT "ANSWER-TRY AGAIN"
:GOSUB 4
2:GOSUB 4:
INPUT B:IF (B>3)+(B<1)
GOTO 1
3:PRINT "YOUR ANSWER-":B:
GOSUB 4:
RETURN
4:FOR F=1TO 3:
PRINT " ":
NEXT F:
RETURN
5:PRINT A:"WHAT IS LETTER":
RETURN
6:"A"=0:PRINT "AFTER EACH REPLYPRESS / ENTER.":
PRINT "SIGN YOUR NAME HERE":GOSUB 4
7:PRINT "AND ENTER YOUR NUMBER-":
INPUT L:
PRINT L:
PRINT "ANSWER EACH QUESTION BY":
8:PRINT "TYPING 1,2 OR 3":
PRINT "UNLESS A WORD IS ASKED FOR":
:GOSUB 4
10:FOR A=1TO 7:
G=10*(A+1):H=G+1:GOSUB G:
GOSUB H:IF B=CLET F=1:
GOTO 14
12:P=0
14:A*(17+A)=P:
NEXT A:GOTO 250
20:C=2:RETURN
21:PRINT A:"HE IS CALLING AND DISTRESS CHANNEL IS":PRINT "(1) 12":PRINT "(2) 16":
PRINT "(3) 28"
22:GOSUB 2:
RETURN
30:C=3:RETURN
31:PRINT A:"THE COASTGUARD CHANNEL IS":
PRINT "(1) 8":PRINT "(2) 27":PRINT "(3) 67":
GOSUB 2:
RETURN
40:C=1:RETURN
41:PRINT A:"CHINEL 4 IS (1) PUBLIC CORRESPONDENCE (2)SHIP TO SHORE (3)SHIP TO SHIP":
GOSUB 2:
RETURN
50:C=1:RETURN
51:PRINT "IN THE INTERNATIONAL HONETIC ALPHABET":GOSUB 5:
PRINT "D":
GOSUB 4
52:INPUT O$:B=0:
PRINT "YOUR ANSWER":O$:IF O$="DELTA"
LET B=1:
GOSUB 4:
RETURN
60:C=1:RETURN
61:GOSUB 5:
PRINT "R":
GOSUB 4:B=0:
INPUT O$:
PRINT "YOUR ANSWER":O$:IF O$="ROME"
LET B=1:
GOSUB 4:
RETURN
70:C=3:RETURN
71:PRINT A:"WHAT IS THE FREQUENCY(MHZ) OF CH.16?":PRINT "(1) 156.25":
PRINT "(2) 1
    
```

# MICROMART

## £'S CALL

ACORN ATOM in Yorkshire

Kits or Built from £120

ATOM SOFTWARE

Play against the computer

ATOMIC CHESS £10.99

(plays different levels)

ATOMIC DRAUGHTS £4.99

(Both feature excellent graphics and play as a real opponent would) Both £14.99

SUPERBOARD/UK101 ADD-ONS

(require soldering ability)

High Speed Cassette Interface Kit £14.99

300/2400/4800 Sweetable to suit recorder

Enhanced Video Display 48 x 32 display £14.99

Kit + 48 x 32 CEGMON £36.99

Kit + 48 x 32 NEWMON £27.99

Software for all Superboard/UK101 screen formats.

Chess 1.9, £9.99 Draughts £4.99 Both £13.99

N.B. All board games are fully interactive with complete instructions and excellent graphics

## NORTHERN MICRO

29 Moorcroft Park, New Mill, Huddersfield

Tel: Holmfirth (0484) 892062

Add 50p P + P and 15% VAT

Callers welcome by appointment.

## SPORTING FORECASTS

Professor Frank George's well-known Football Pools Forecasting program is now available on the

SINCLAIR ZX81 16K

as well as:

APPLE II 32K

PET 32K

SHARP MZ80K 36K

Versions coming soon for:

Video Genie, BBC-micro, T1 99/4

A Horse-Race Forecast Program in preparation.

Write to: Professor F. H. George  
Bureau of Information Science  
Commerce House, High Street,  
Chalfont St. Giles, Bucks.

**TO ADVERTISE  
IN MICROMART,  
PLEASE RING  
01-6311433**

## SUPERCIPS!

Once upon a time those PET owners brave enough to look inside their machines wondered why Commodore had provided spare Rom sockets. Nowadays there are so many chips available that it can be quite difficult deciding which to fit

TOOLKIT is probably the most popular chip, but then it's been around the longest. Facilities such as AUTO, TRACE, RENUMBER, DELETE, FIND, DUMP, and APPEND make it easier to write and debug Basic programs. The 2001/3000 version fits in UF5 and costs £29; the 4000/8000 version fits in UD4/11 and costs £34.

COMMAND-O is an interesting alternative for Basic 4 machines which fits in the UD3 or UD12 socket. Apart from the Toolkit facilities it offers PRINT USING, BEEP, SET, EAT, and on 4000 machines AUTO-REPEAT. The SCROLL command enables Basic programs to be listed forwards or backwards with single keystrokes, and on 8000 machines allows the advanced screen functions to be called up from the keyboard. COMMAND-O is designed with disk owners in mind - several commands including INITIALIZE, EXECUTE, MERGE and SEND are disk-orientated - and another welcome feature is that RENUMBER can be used to renumber part of a program. Naturally COMMAND-O is a little more expensive than Toolkit, but then a Rolls-Royce costs more than a Mini-Metro. The 4000 and 8000 versions each cost £59.95, but we'll offer a £20 reduction if you trade in your Toolkit and manual before 31st March 1982.

PAGEWRITER is a machine-code word processor in a chip that will print out text exactly as you see it on the screen. You might think that this would limit you to 40 column lines - but in fact by scrolling up and down, left or right, PAGEWRITER allows you to type onto an electronic page which (subject to memory size) can be up to 240 characters wide and 191 lines long! Blocks of text can be inserted, deleted, or moved, and if you own a 3022 or 4022 Printer PAGEWRITER gives you access to 26 user-definable characters. Whether you use tape or disk PAGEWRITER is superb value at just £39 (please state model and required socket when ordering).

POST FREE IN U.K. - ADD 15% VAT to PRICES

## SUPERSOFT

Dept. P3, 10-14 Canning Road,  
Wealdstone, Harrow, Middlesex,  
Tel: 01-861 1166



## SOFTWARE

WE WRITE PROGRAMS TO FIT YOUR REQUIREMENTS  
E.G. SCHOOL RECORDS



ARBAM LTD  
KILN LANE  
LEIGH  
TONBRIDGE  
KENT TN11 8RT

HILDENBOROUGH 832130

ACORN ATOM

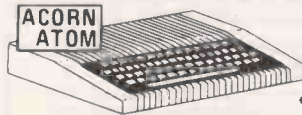

From

£120\*

Ex-stock

\*Plus 15% VAT

ACORN PRODUCTS-ACCESSORIES-SOFTWARE  
REPAIR SERVICE AND SPARES  
ECONET COMMUNICATIONS INTERFACE

Please call or write for more information, lists, order forms etc.

2114L R.A.M. £1.25 each

D.A. Computers Ltd, 184 London Road

# LEICESTER

# MICROMART

## TWIN 8" DISK DRIVES

### for NASCOM 2

OR OTHER COMPUTERS WITH SHUGART COMPATIBLE INTERFACE

## £985.00

PLUS CARRIAGE & VAT

DEALER ENQUIRIES WELCOME



HOLTAIN ELECTRONICS LIMITED

CROSSWELL CRYMYCH DYFED

TEL: 023979656

## VETS FOR PETS

Anita Electronic Services (London) Ltd. are specialists in the repair and service of Commodore Pets.

We offer a fast on-site service, or alternatively repairs can be carried out at our workshops should you wish to bring in your Pet.

Pet maintenance contracts are available at very competitive prices. Trade inquiries welcomed.

For further information, tel or write to:

John Meade

Anita Electronic Services

15 Clerkenwell Close, London EC1

01-253 2444

We also specialise in the repair of all makes of office equipment.

## ZX81 THE INCREDIBLE GULP (16K)

**GUMP** Smash hit game for all ages as seen at the ZX fairs. £6

**SHOPWINDOW** exciting new display system using 'window' language. £7

**DATABASE** business system for mailing lists, many other uses — already the standard work for ZX81. £10

All use machine code to make them hum, and are delivered on tape with full documentation. SAE for catalogue.

CAMPBELL SYSTEMS Dept PCW  
15 Rous Rd, Buckhurst Hill, Essex IG9 6BL

## MICROTYPE STAK-PAK

CASSETTE STORAGE SYSTEM FOR EASY PROGRAM FILING.



- Each drawer section takes 2 cassettes.
- Drawers lock together vertically.
- Each twin pack comes with 2 C12 digital cassettes.
- Each 'pak' is complete with index cards, cassette and drawer labels.

FIVE TWIN PAKS (10 CASSETTES)  
FOR £6.80 INC. VAT & P&P.

Send cheques or Postal Orders to:

MICROTYPE, PO Box 104,  
HEMEL HEMPSTEAD,  
HERTS HP2 7QZ.

## PROGRAMS

# PET Cheese

by Paul Bradshaw

A game to run on 'new ROM' or 'Basic 4.0' PETs in 8k.

Instructions are in the game.

```

120 A=RND(0)
130 Z$="000000":HS$="00000"
140 GOSUB1180:REM * INSTRUCTIONS *
150 GOSUB640:REM * READ MOVEMENT DATA *
160 PRINT"J"
170 GOSUB1390:REM * INSTAL MACHINE CODE *
180 CC=18:REM * CHEESE COUNTER *
190 GOSUB480:REM * INITIAL DISPLAY *
200 POKE59464,0:POKE59467,16:POKE59466,15:REM * INIT. SOUND BOX *
210 REM *** INITIAL CAT POSITION ***
220 C=32768+INT(RND(1)*1000):IFPEEK(C)>32THENC20
230 POKE16,INT(C/256):POKE15,C-256#PEEK(16):POKEC,81
240 POKE177,2:REM * 2-CAT SPEED-CAN BE ALTERED *
250 SYS826:REM * INIT. MACHINE CODE FOR CAT MOVEMENT *
260 MC=0:SC=0
270 FORDL=1TO1000:NEXT
280 GOSUB740:MD=0:F=0:Z=M:M=M*(D)
290 REM *** INITIAL WARNING ***
300 MC=MC+1:FORJ=1TO50:POKEZ,160:POKEZ,96:POKE59464,200-J#2:NEXT
310 POKE59464,0
320 REM *** MOVE MOUSE ***
330 Z=M*(M+M*(D)):MD=MD+1
340 IFPEEK(M+1)=32ANDRND(1)>.98THENM=M+1
350 IFPEEK(M+1)=160ANDPEEK(M)>160THENM=M+1
360 IFPEEK(M-1)=160ANDPEEK(M)>160THENM=M-1
370 IFPEEK(M)=32THENM440
380 IFPEEK(M)=81THENPOKEZ,32:GOSUB790:GOTO270
390 IFPEEK(M)>160THENM430
400 POKEZ,32:POKEM,32:CC=CC-1:GOSUB910
410 IFCC=0THEN1030
420 GOTO270
430 IFPEEK(M)=255THENGOSUB980:M=Z:GOTO330:REM * REBOUND *
440 IFF=1THENPOKEZ,32:REM * DELETE OLD MOUSE *
450 F=1
460 POKEM,46:REM * INSERT NEW MOUSE *
470 GOTO330
480 REM *** INITIAL DISPLAY ***
490 PRINT"J"
500 FORJ=32768TO32807
510 POKEJ,255:POKEJ+40,255:POKEJ+920,255:POKEJ+960,255
520 NEXT
530 FORJ=32768TO33728STEP40
540 FORK=0TO2
550 POKEJ+K,255:POKEJ+39-K,255
560 NEXT
570 NEXT
580 PRINT"SCORE:00000 HIGH:HS$";
590 FORJ=1TO3
600 PRINTTAB(17)"J"
610 NEXT
620 PRINT"TAB(6)"SCORE:00000 HIGH:HS$
630 RETURN
640 REM *** READ MOVEMENT DATA ***
650 FORJ=1TO4:READM(J):NEXT
660 DATA39,41,-39,-41
670 REM *** READ SOUND EFFECTS DATA ***
680 FORJ=1TO4:READS(J):NEXT
690 DATA254,200,170,127
700 REM *** REBOUND DATA ***
710 R(1)=2:R(2)=1:R(3)=4:R(4)=3
720 Q(1)=4:Q(2)=3:Q(3)=2:Q(4)=1
730 RETURN
740 REM *** RANDOM MOUSE STARTING POSITION AND DIRECTION ***
750 IFRND(1)>.5THENM=32851+INT(RND(9)*34)-800*(RND(1)>.5):GOTO770
760 M=32851+INT(RND(1)*2)*40-33*(RND(1)>.5)
770 D=INT(RND(1)*4+1):IFPEEK(M+M*(D))>32THEN770
780 RETURN
790 REM *** MOUSE EATEN ***
800 FORJ=1TO4
810 POKE59464,S(J)
820 FORK=1TO50:NEXT
830 NEXT
840 POKE59464,0
850 S1=INT((SC+450-MD*5)/10)*10
860 IF S1>SCTHENSC=S1
870 S#="ID#STR$(SC),2)
880 L=LEN(S#):IFL<5THENL#="LEFT$(Z$,5-L)+S#"
890 PRINT"TAB(6)"SCORE:"S#"HIGH:"HS#"
900 RETURN
910 REM *** CHEESE EATEN ***
920 FORJ=0TO200STEP20
930 POKE59464,J
940 FORK=1TO10:NEXT
950 NEXT
960 POKE59464,0
970 RETURN
980 REM *** REBOUND ***
990 POKE59464,128
    
```

## NASCOM 1 & 2

— the magazine devoted to NASCOM  
ISSUES 1, 2 and 3 NOW AVAILABLE  
ISSUE 4 AVAILABLE END OF DECEMBER  
ORDER NOW TO SECURE YOUR COPIES

— ONLY 95p each (incl. P&P.)

£3.80 will cover all four — SAVE TIME and postage!

EVERY ISSUE contains:

- Featured articles:
  - Series articles — "HANDS ON"
  - NAS-SYS Monitors revealed.
- Regular features
  - News from clubs & schools.
  - Letters to Editor.
  - Questions & answers.

PROGRAM POWER  
5 Wensley Road, Leeds LS7 2LX  
Tel: (0532) 683186

## TRS80 — VIDEO GENIE SOFTWARE

**BREAKOUT:** Fast action machine language program; first break through a double and then a triple wall, but beware of speed increasing at each new level; with skill control the angle of bounce or even swerve the ball as it approaches the wall; only £3.85 or send an s.a.e. for our full lists of software at unusually low prices.

J. T. WILSON

9 Cotswold Terrace, Chipping Norton, Oxon.



```

1000 IF (M-32850)/40=INT((M-32850)/40)OR (M-32885)/40=INT((M-32885)/40) THEN 1020
1010 D=Q(D):POKE59464,0:RETURN
1020 D=R(D):POKE59464,0:RETURN
1030 REM *** GAME OVER ***
1040 POKE59467,0:REM * DEACTIVATE SOUNDBOX *
1050 SVS849:REM * DISABLE CAT *
1060 FOR DL=1 TO 2500:NEXT
1070 PRINT "TAB(12)*** GAME OVER ***"
1080 PRINT "TAB(5)"ALL THE CHEESE HAS BEEN EATEN!"
1090 PRINT "TAB(12)"YOUR SCORE:"SC
1100 IF SC>=HIGHSCORE:SC=SC
1110 HS=MID$(STR$(HS),2)
1120 IF LEN(HS)<5 THEN HS=LEFT$(Z$,5-LEN(HS))+HS
1130 PRINT "TAB(12)"HIGH SCORE:"HS
1140 PRINT "TAB(6)"PRESS ANY KEY TO PLAY AGAIN.
1150 POKE158,0
1160 GETH$:IFH$="" THEN 1160
1170 GOTO 1010
1180 REM *** INSTRUCTIONS ROUTINE ***
1190 PRINT "TAB(17)"CHEESE:"PRINTTAB(17)"
1200 PRINT "THE OBJECT OF THE GAME IS TO PREVENT
1210 PRINT "THE NICE (< >) REACHING THE CHEESE.
1220 PRINT "YOU CONTROL A CAT (< >) AND MAY MOVE IT
1230 PRINT "WITH THE KEYS 8 (UP), 2 (DOWN), 4 (LEFT)
1240 PRINT "AND 6 (RIGHT). TO CATCH A MOUSE YOU MUST
1250 PRINT "INTERCEPT IT, IN WHICH CASE IT WILL RUN
1260 PRINT "INTO YOUR JAWS.
1270 PRINT "PRESS SPACE TO CONTINUE..."
1280 GETH$:IFH$<>" THEN 1280
1290 PRINT "THE GAME ENDS WHEN ALL THE CHEESE HAS
1300 PRINT "BEEN EATEN. YOUR SCORE POINTS FOR EACH
1310 PRINT "MOUSE YOU EAT: THE QUICKER YOU EAT A
1320 PRINT "MOUSE, THE MORE YOU SCORE FOR IT.
1330 PRINT "PLUG IN A SOUNDBOX IF YOU HAVE ONE!
1340 PRINT "PRESS 'R' TO READ THE INSTRUCTIONS AGAIN
1350 PRINT "OR SPACE TO BEGIN THE GAME..."
1360 GETH$:IFH$<>" ANDH$<>"R" THEN 1360
1370 IFH$="R" THEN 1180
1380 RETURN
1390 REM *** INSTAL MACHINE CODE ***
1400 REM (USED FOR CAT MOVEMENT)
1410 S=0:FOR J=826 TO 1002
1420 READX:POKEJ,X:S=S+X:NEXT
1430 IF SC>20252 THEN PRINT "TYPING ERROR: RECHECK LAST 23 LINES." END
1440 RETURN
1450 REM *** MACHINE CODE ***
1460 DATA 165,177,133,0,120,165,144,133
1470 DATA 192,165,145,133,193,169,226,133
1480 DATA 144,169,3,133,145,88,96,120
1490 DATA 165,192,133,144,165,193,133,145
1500 DATA 88,96,173,18,232,201,239,208
1510 DATA 16,169,0,141,75,232,165,132
1520 DATA 133,144,165,193,133,145,108,132
1530 DATA 0,198,0,208,249,165,177,133
1540 DATA 0,165,15,133,1,165,16,133
1550 DATA 2,165,151,201,18,240,15,201
1560 DATA 2,240,25,201,41,240,34,201
1570 DATA 50,240,39,108,192,0,165,1
1580 DATA 24,105,40,133,1,144,2,230
1590 DATA 2,76,199,3,198,1,165,1
1600 DATA 201,255,208,2,198,2,76,199
1610 DATA 3,230,1,208,2,230,2,76
1620 DATA 199,3,165,1,56,233,40,133
1630 DATA 1,176,2,198,2,160,0,177
1640 DATA 1,201,32,208,16,169,32,145
1650 DATA 15,165,1,133,15,165,2,133
1660 DATA 16,169,81,145,15,108,192,0
1670 DATA 160,0,169,81,145,15,76,92
1680 DATA 3
READY.

```

# MICROMART

## SPECIAL LIMITED OFFER

for just one month only  
**THE EPSON MX100 for just £499**

Yes, this popular 15 inch carriage 80 cps bi-directional printer which is ideal for APPLE, PET, SHARP, SUPERBRAIN, TANDY etc. is offered at this special price for 1 month only. Interfaces extra. Specify which micro on order. FULL 12 MONTH GUARANTEE

To claim your special offer send this advert together with your cash/cheque or bankers draft to:

ANDERLEE COMPUTING SERVICES  
 17 ADELPHI CRES., HAYES PARK, MIDDX.  
 PHONE: 01-841 1507

Offer is subject to product availability and will end on 30 November 1981.

**TO ADVERTISE  
 IN MICROMART,  
 PLEASE RING  
 01-631 1433**

## SIDELINES SOFTWARE TRS 80 LEVEL II 16K

\*HORSE RACING. Marshals the data available in most newspapers, evaluates it and makes a betting suggestion. On last seasons hurdles, over 126 races, we ended 84.89 units up! £7.50

FOOTBALL POOLS FORECASTER. Performs Sifts through the League tables, applying your weighting factors, to recommend your pools entry. Entry of weekly results updates the data. £7.50

PORTFOLIO. Keeps up to date record of your investments - gains, losses, yields and dividends by stock and portfolio total. £7.50

NEW CASH FLOW. Shows your future cash status for any month and during any year. £4.95

ROULETTE. Exactly like the real thing! Practise friends. £4.95

LEADERLESS C12 Cassettes; specially made for us. @ 45p including library case. £1 postage on blank cassettes regardless of quantity. \*Available for ZX81 16K

SIDELINES, 19 Lovelace Road, Oxford.

## ZX81 OWNERS ACCESS TO THE OUTSIDE WORLD



Using our programmable INPUT/OUTPUT controller based on the Z80APIO you can use upto 16 programmable input/output lines, all T.T.L. compatible. Control of port is carried out from within programmes giving a whole new dimension of uses for your ZX81 computer. The port can be used WITH or WITHOUT the 16K TRAM PACK & PRINTER. Available in kit form or assembled, & comes complete with instructions, a pack of software notes and circuit ideas. £10.99 IN KIT FORM or £12.99 assembled (add 15% VAT & 50p post & packing)

Snap on Analogue card and relay board available shortly. Send S.A.E. for details.



THURNALL (ELECTRONICS) ENG.  
 DEPT P, 95 LIVERPOOL RD.,  
 CADISHEAD, MANCHESTER.  
 M30 5BG TEL: 061-775 4461 (24hrs)

## ACT Sirius 1

Continued from page 109

this price range and indeed, given that the Sirius will have communications packages available to facilitate links to other computers, it would make a very cost-effective alternative to an ordinary graphics terminal.

Programmers will love the Sirius, too, as there's so much which is directly under software control and so many interesting features to live up to otherwise rather boring applications packages. I sincerely hope that programmers will make the effort to produce packages for MSDOS, if it's as good as it's said to be, instead of taking the easy way out and converting 8-bit CP/M packages to run under CP/M-86. And I'll give a free year's

subscription to PCW to the first person to write a program which plays a recognisable tune of more than 20 seconds' duration on the disk drives!

## Future expansion

As I've already mentioned, users will be able to expand the RAM up to half a megabyte internally by plugging in 128k RAM cards and an external expansion unit will be available later in the year to take this up to the full megabyte. If you want more than that you'll have to wait for an 8086 machine but most people should find the basic 128k machine enough for many applications.

Double-sided floppy drives will be offered as an option, but many will probably prefer to wait until a promised 10 Mbyte winchester drive becomes available - this will directly replace one of the floppy drives and sit inside the

# PASSAGE

4K ROM  
**PET ASSEMBLER PACKAGE**  
 2/3/4000 SERIES

THE EASY ROUTE TO ASSEMBLY LANGUAGE PROGRAMMING FEATURES:  
 ASSEMBLER/DISASSEMBLER/AUTO/RNUM/  
 DELETE/COPY/REPEAT KEY COMMANDS,  
 SOURCE CODE SYNTAX CHECKING ON ENTRY,  
 VERY FAST ASSEMBLY SPEEDS PLUS  
 MUCH MORE. FULL DOCUMENTATION.

ONLY £30 INCLUSIVE  
 PHONE OR SEND SAE FOR FURTHER DETAILS  
**GEMINI ELECTRONICS**  
 1 RADFORD AVE, KIDDERMINSTER  
 WORCS. TELE. KIDD 64484

## RING ME LAST Ring ROGER MAY

on 0342 832244

before you make the final decision ring me and check the price. You'll find I am the cheapest for your computer equipment.

or save time ring now  
 for best possible prices



# MICROMART

## TRS80 Models I+III and VIDEO GENIE

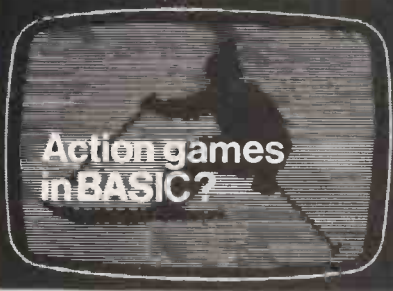

Not likely! It's too slow. You've tried writing in BASIC and you know the results are rarely realistic or enjoyable.

### You need a compiler

ACCEL or ACCEL2 will convert your BASIC programs to machine code. Spectacular speed-ups are possible - 20 or 30 times for games constrained by display or logic. Write for details

ACCEL Level 2 BASIC only £19.95  
ACCEL2 Full DISK BASIC £39.95

southern  
software

PO Box 39, Eastleigh, Hants, SO5 5WQ

## \* BIG EARS \* STOP GO! LEFT RIGHT!

SPEECH  
INPUT  
FOR ANY  
COMPUTER



Hugely successful Speech Recognition System, complete with microphone, software and full instructions

BUILT TESTED & GUARANTEED ONLY £49  
PLEASE STATE COMPUTER: UK101, SUPERBOARD, NASCOM2, ZX80/81, PET, TRS80, MZ80K, APPLE II

## ZX80 ZX81

MUSIC SYNTHESISER  
+ 16 LINE CONTROL PORT

Play 3 part music, sound effects, drums etc. Full control of attack, decay and frequency. Input/Output lines provide control and monitor facility for Home Security, Robot Control, Model Railway, etc. etc. Works with or without 16K RAM.

Add keyboard to make a live performance polyphonic synthesiser! Full instructions/software included.

AMAZING VALUE AT ONLY £19.50 (KIT)  
£25.00 (BUILT)

COLOUR MODULATOR KIT £12  
RGB In, PAL/UHF out BUILT £18

UK101/NASCOM COLOUR GRAPHICS KIT £45  
Inc. Modulator. Still the best selling system! BUILT £60

Please add VAT at 15% to all prices  
Barclay/Access orders accepted by telephone

WILLIAM STUART SYSTEMS Ltd  
Dower House, Billericay Road, Herongate, Brentwood, Essex CM13 3SD  
Telephone: Brentwood (0277) 810244

## DISKS DISKS DISKS

LOWEST PRICES FOR THE BEST  
BOXES OF 10 MINI DISKS (5.25")

MEMOREX  
S/S - S/DENSITY S/SECTOR £14.00  
D/S - D/DENSITY S/SECTOR 19.70

VERBATIM DATALIFE  
Single or Double Density  
S/S - S/SECTOR (40 TR CERT) 14.30  
D/S - S/SECTOR (40 TR CERT) 21.30  
S/S - S/SECTPR (70 TR CERT) 27.30

BASF  
S/S - S/DENSITY S/SECTOR 17.15  
S/S - D/DENSITY S/SECTOR 20.65  
D/S - D/DENSITY S/SECTOR 25.41

### Pinner Wordpro

34 CANNONBURY AVENUE, PINNER,  
MIDDXX.. HAS 1TS.  
TELEPHONE 01-868 9548 ANYTIME

main cabinet. A tape streamer for backing up the hard disk is also mentioned in the preliminary Sirius documentation.

Two add-ons are already in the pipeline: a clock card, due to be announced at this Spring's Hanover Trade Fair, and a thing called a Mouse, apparently a little box which you push around on a table top to move the cursor around the screen; this should also be on show at Hanover. A graphics tablet will also be developed and should be available in the second half of this year.

Other hardware add-ons mentioned in the Sirius documentation but as yet unscheduled include a modem card, a colour display and a network interface card, although at the time of writing no decision had been taken as to which network will be used.

On the software side, all the major language and applications packages should be available by March this year, including MSDOS, a single-user, multi-tasking version of MP/M-86, a package to read CP/M-86 files from MSDOS and a package to allow the transfer of files, by direct hook-up, between the Sirius and the IBM Personal Computer - the Sirius is 'upwards compatible' from the IBM, says Chuck. Various communications packages, including TTY and Telex emulation and assorted big machine protocols (all right, IBM 3276 and 307B) are also on their way.

## Summary

Chuck Peddle set out to design an office tool which would be easy to use, ergonomically satisfactory and provide 16-bit computing power at a low cost. He has succeeded; the Sirius is one of the few micros which has been designed completely with the user in mind and its astonishingly low cost (achieved by mass production) makes it about the best value for money on the micro market today.

Chuck perceives its market slot as *All prices exclude VAT*

slightly above the IBM Personal Computer, which, in the States, is being aimed at the very top end of the home market and the middle-to-low end of the business area. In Britain the IBM still isn't officially on sale; it is available from one enterprising importer at £2,700 for less memory (64k), smaller capacity disk drives and lower resolution graphics. It's likely that the machines which will really feel the pinch as a result of the Sirius are those such as the Apple III and the Super-Brain-type configurations, most of which are either more expensive or less powerful or offer fewer facilities, or all three.

As some computer manufacturers have found out the hard way, software sells hardware. The fact that ACT is importing the Sirius and selling it through its dealer network means that there should be a useful range of software available pretty quickly.

In summary, the Sirius is a neat, well-made machine with considerable potential and great appeal, especially in view of its very competitive price. If I were looking for a general purpose business micro, I'd be hard put to find an excuse for not putting this machine at the top of the list.

## Prices

ACT Sirius 1 with 128k RAM, 1.2 Mbyte disk, CP/M-86, MSDOS, Basic-86, utilities, documentation £2395  
As above but with 256k RAM £2890  
With 512k RAM £3890  
125 cps, 132 col dot matrix printer £695

40 cps TEC daisywheel printer £1295  
Sales/purchase/analysis package £495  
ACT Pulsar package £295  
Supercalc £125  
Micromodeller £495  
WordStar £295  
Maintenance contract £495/annum

## Technical specifications

CPU: 8088, 5 MHz  
Memory: 128k (64k dynamic RAM chips) internally expandable to 512 kbytes; external module to expand to 1 Mbyte  
Keyboard: 95 keys inc 7 prog function keys, numeric pad, cursor control, editing, screen & loudspeaker control, all software re-definable.  
Screen: 80 char x 25 lines; hi-res graphics, 800 x 400 bit-mapped, user-definable character sets.  
Disk drives: 2 x 5 1/4in single-sided, high density, 600 kbytes per unit.  
Ports: 1 Centronics/IEEE-488 printer port, 1 RS232 printer port, 1 RS232 communications port.  
System Software: CP/M-86 and MSDOS  
Languages: Basic 86; Graphics & character set packages. Assembler, Fortran, Cobol, Pascal, PL-I, Extended business Basic compiler, various applications software.

Teaching CP/M? Learning CP/M? A frustrating business even for the professional, let alone the poor user.

NOW for the FIRST time a truly self teaching course designed for the first time user.

The CP/M TUTOR is available on floppy disc for the SuperBrain at only £256 (inc VAT and manual).

SYNTAX SOFTWARE LTD  
16 LEYLAND AVENUE  
ENFIELD, MIDDLESEX  
Tel: 01-804 5817

MEMORY UPGRADES FOR:-  
PET, APPLE, 2020, SHARP,  
NASCOM ETC.

USING 4116 DYNAMIC RAM.  
16K (8 I.C.'S) ..... £7.50  
32K (16 I.C.'S) ..... £14.00  
INCLUDING INSERTION TOOL.  
FULL SPECIFICATION. FULLY  
GUARANTEED DEVICES.

PRICES ARE FULLY INCLUSIVE  
ACCESS AND BARCLAYCARD (+6%)

Ground Control

Alfreda Avenue, Hullbridge  
Essex S55 6LT.  
Tel: Southend (0702) 230324.



## TEST THIS PROGRAM BEFORE BUYING !!!!

"Midas" is the name of a successful inflation beating investment program, written for a 32 K (New Rom) PET

To show how profitable it is, we are making copies of this user friendly program available for examination; for a test fee of only £2.99, you can confirm that this £55 program really can pay for itself many times over.

All we ask is that, within 21 days, you either pay the balance of £52, or simply return the original cassette and owe nothing more.

Amron, 21, Grosvenor Road, Birkdale, Southport. PR8 2JG  
I wish to satisfy myself that MIDAS & PET together make MONEY.

Name \_\_\_\_\_

Address \_\_\_\_\_

Test Fee £2.99

PCW

### ZX81owners

## Protos

Keyboard is here!

At last! A real, full size keyboard in a top quality case for your ZX 81.

Simply unscrew your ZX 81 printed circuit board from its black Sinclair case and plug into Protos.

**FULLY BUILT £64.95 inc. VAT.**

- More accurate, faster typing with bigger and real keys.
- 40 colour coded key-tops for easy reading
- Robust, 'big' computer construction
- PCB prepared for more add-ons to come
- New edge connector provided for Sinclair and other manufacturers' peripherals
- Key legends can be changed for future new ROM functions
- Sinclair PCB fully enclosed - and room for much more

If you feel you've outgrown your ZX 81 don't sell it for peanuts and move to another system. Add it to Protos and make your ZX 81 grow.

For details, large SAE, please. For orders add £2.50 post and packing. Cheques to 'Frome Computing'.

### Protos Computer Systems

Frome Computing, 20 Ashtree Road, Frome, Somerset, BA11 2SF.

## ADVENTURE GAMES

MACHINE CODE PROGRAMS FOR THE UK101 OR SUPERBOARD WITH ANY MONITOR

1. NEW YORK SUBWAY/TROLL'S TUNNEL (£5.50)  
Overcome the trolls, stone giant, and marry other monsters to escape from an underground prison.
2. ZOMBIE FOREST/VAMPIRE CASTLE (£5.50)  
Survive the servants of the Evil One, and rid the forest of its dark curse.
3. KY, TEMPLE OF THE DRAGONKING (£5.50)  
With strong shield and pulsating sword, slay the dragon and liberate your people.

EACH ABOVE PACK HAS TWO 8K PROGRAMS

4. ALIEN ADVENTURE 16K (£6.00)  
Your spacercraft is stranded on an asteroid in deep space. Escape is possible, but not easy.

TWO OR MORE PACKS - LESS 20%

From Mr M Perkins, 290 Station Road, Stechford, Birmingham B33 8QR

## PROGRAMS

and SY(N)=576 AND S(N)=0  
S(N)=1

Hopefully that should rectify any problems encountered with these. If you do discover a bug in a PCW program, please write to me - do not phone - explaining what the error is.

Now onto this month's offering. Basic Personality Test by Roy Peters would, I think, be perfect for breaking the ice at parties! The computer asks you some questions similar to those a psychiatrist would ask (nb, I'm not speaking from personal experience) and then gives you a personality analysis from your answers. It's written in Cromemco 16k Basic which is pretty standard apart from the following: it uses the @ sign for PRINT; PRINT CHR\$(12) clears the screen; Cromemco Basic allows you to impose a time limit when awaiting an input: this is used in lines 1360-1380 to cause a delay of about ten seconds, giving the impression that the computer is thinking. This can be replaced by a FOR...NEXT loop; Strings have to be DIMENSIONED in Cromemco Basic - see lines 15 and 16 - which isn't necessary in many other Basics.

Recently I have had a fair number of requests for listings on programmable calculators. PC1211 Exam Questions by J Chaplin should fulfil some, at least, of those requests. It sets the user a number of questions and them marks them. Answers may be either numeric

or alpha and a facility is included for the 'candidate' to correct (alter?) any answer. Shift 'A' starts the program and shift 'B' prints out the results and lists any incorrect answers. These particular questions relate to Marine VHF radio but they could be changed to suit any other subject. Seven questions of this particular length fill the available memory.

PET Haemophilia Simulation by B Thorpe is not a game for the sick-minded but is a demonstration of how the disease Haemophilia is passed from generation to generation. Full instructions are included in the program. It was written on a 'new ROM' PET but the POKE instructions are simply for shifting between upper and lower case on the screen. These can be omitted for 'old ROM' PETs. The listing was done on a printer that cannot cope with PET graphics, so [CU] = cursor up; [CD]= cursor down; [CR]=right; [CL]=left. A single number of letters in square brackets simply means the shifted version of that character.

Finally, a small program for TRS-80 users by Francis Butters. This one is for Tandy's Printer II (80 columns) but could easily be adapted for other machines - it's the thought that counts! It gives a numbered scale at the top and bottom of a specimen sheet of paper which means you can plan your tables and printouts and fitting in the tabs becomes simplicity itself.

## Basic Personality Test

By Roy Peters

```

15 SET 5,0 : DIM G$(30),K$(30)
16 DIM J$(20)
20 DATA"extremely ambitious"
30 DATA"very ambitious"
40 DATA"unambitious"
50 DATA"semi-ambitious"
60 DATA"ambitious"
70 DATA"very ambitious"
80 DATA"a solitary person with few or no friends"
90 DATA"a contented person"
100 DATA"a contented, unambitious person"
110 DATA"few","many","an artistic","a practical"
120 DATA"a very logical","another","no other"
130 DATA"an illogical","heterosexual","homosexual"
140 DATA"bisexual","difficult","easy","You are lazy"
150 DATA"You do things the difficult way"
160 DATA"You are impractical"
170 DATA"You fantasize","to","not to"
300 @CHR$(12);
310 @TAB(16);"****PERSONALITY ANALYSIS****"
320 @ : @ : @
330 @"This personality is not a game - it should be used"
340 @"seriously. However, please note that it does not"
350 @"claim to analyse you with perfect accuracy."
360 @ : INPUT"Press RETURN when you're ready...";A$
370 @CHR$(12); : @"First, I want you to envisage a house. Is it:"
380 @ : @ 1 A castle","2 A mansion","3 Detached"
    
```

## ZX81 INHERITANCE 16K

A 2 part game (each 16K) of HIGH FINANCE, INVESTMENT DECISIONS and BUSINESS ACUMEN coupled with RISKY GAMBLING and Skulduggery.

PART 1. Gt. Uncle Arbuthnot is dead. His estate could be yours, but you will need your wits about you to get it!

PART 2. LOADED only on the successful completion of PART 1. Now enter the world of BIG BUSINESS. (FIND THE SECRET FORMULA FOR PARADISE COLA, MARKET IT, MAKE A MILLION AND WIN THE GAME)

SIMON W. HESSEL, £4.25  
15, Lytham Court, Cardwell Cresc., on cassette  
Sunninghill, Berkshire. + documentation

## ZX80/ZX81 USERS CLUB

(Formed February 1980)

Offers technical support to beginners and more experienced users. Enquiries from schools welcomed.

Membership £6 UK. £10 Overseas  
Also newsletter and low cost software.

Sample newsletter £1.00

10 ZX80/ZX81 program listings £4.00  
For further details send stamped addressed

envelope to:  
David Blagden

ZX80/ZX81 Users Club  
PO Box 159

Kingston Upon Thames, Surrey  
KT2 5UQ

## SIMPLY WRITE!



Super Word Processor at a silly price!

All you'd expect for ten times the price, PLUS re-define keyboard, graphics printing, tape or disk files, old or new ROMs, PET or ASCII printers, AND 40 or 80 column (same tape or disk). We didn't believe it either! £37 tape (can save to disk), £40 disk (sample files etc). Manual £1 refundable. Specify drive. and now...

'SIMPLY-FILE' database manager to match. Robust, versatile, self-calculating. £65 + VAT. Disk only. Specify drive.

LIGHT PEN + SOFTWARE plugs in. £22 PROGRAMMER'S TOOLKIT - 16/32K new ROM: makes programming less like work! £28 (£30 4.0).

ADVENTURE 1 & 2: authentic Scott Adams 24K classic games. Each £7 (both £13).

NEW! ASTEROIDS-81 Fast action £6

Add VAT to all prices please, but post/insurance included. Unconditional instant Refund Guarantee on hardware, also software if not up to description. Write for more details, more items, newsletter.

SIMPLE SOFTWARE LTD.  
15 HAVELOCK ROAD  
BRIGHTON SUSSEX BN1 6GL  
(0273) 504879



MAINTENANCE PROBLEMS? Then call for our 01-250 1481 for first class service on PET, APPLE and other micros.

AD100: A single board 4-channel A/D converter with on-board power supply. Works on any PET or computer with a parallel port. Comes complete with instruction manual. Price: £55.00

AD50: A 1-channel single-board AD/DA converter which is designed to work on any computer with a parallel port. 50,000 samples/sec. Requires power supply. Comes as a kit. No software included. Price: £27.50

PET TV INTERFACE: This well-built unit connects to either your domestic TV or monitor. Nothing to adjust. Connects to the PET user port and a second cassette port. For 40 to 80 column PETs. Price: £35.00

RL100: A 6-channel relay switching unit with on-board supply. Relay rating is 1A at 30V DC/100V AC. Price: £50.00 We also supply higher ratings and solid state switches. Phone or send s.a.e. for details.

CB-2 Soundbox: Ideal soundbox for your PET. Comes complete with programming instructions and demo tape. Plugs into PET user port and cassette port. Price: £17.50

VC100: This is a random-access video controller. VC100 enables your computer to keep an index of the recordings you have on your video recorder. You can then under software control rewind or fast forward to any position on your video tape. Send s.a.e. for details.

THE DR. WATSON BOOK OF ASSEMBLY LANGUAGE PROGRAMMING: This is a NEW teach-yourself guide to machine language programming for 2-3-4-8000 PETs. Price: £10.00

APPLE	
APPLE ROM Expansion Card	£50.00
Dual DOS in ROM	£45.00
APPLESOFT UTILITY IN ROM	£35.00
APPLESOFT Renumber & Merge	£35.00
APPLE Copy Disk in ROM	£35.00
APPLESOFT Edit ROM	£35.00
APPLE BRAIN SURGEON	£30.00

We also supply a selection of VIC computer games and hardware. Please send s.a.e. for details. Carr. £1.50 P&P per item. Dealer enquiries welcome.

**PCS** PEDRO COMPUTER SERVICES  
4 Cowcross Street  
London EC1  
01-250 1481

# CALCULATOR CORNER

Continued from page 99

the system I was using.

The area navigation programs had an irritating lack of order about them. Though the most urgently required output is the required track to destination, it was always necessary to calculate and display the distance first. A great deal of unnecessary accuracy had been built into the XY pairs specifying waypoint locations, which were calculated to ten significant figures. Other minor improvements suggested themselves, too, but of course the module programs cannot be altered. The area navigation program most commonly used was downloaded for study, and listed. Among the more interesting alterations made to it were the complete excision of 26 unnecessary steps and thanks to an idea suggested by N Harwood's article 'More Miles per Texan Stetson's' (PCW November 1980), the XY pairs were data-packed to reduce data register requirements from 88 to 44. It slowed things down a little but the improvements made it well worthwhile.

As an aside, if any pilot is thinking of using Polar to Rectangular conversion for navigation purposes, a neat trap has been prepared for you. By mathematical convention, angles are measured anti-clockwise from the 12 o'clock position. To fool your calculator into giving you the right answer, change the sign of the bearing or angle and add 90 to it before starting. It will save you two-and-a-half days of frustration if precedent can be taken as a guide.

The system worked very well once I was used to it. While I could never prove quantitatively the value of the system, it was subjectively an obvious improvement. This was emphasised for me when an unexpected headwind left me too short of fuel to continue legally to my destination. An en-route refuelling stop was necessitated by the fuel shortage, but a last minute direct routing brought the destination just within lawful reach again. I would not have felt it prudent to guesstimate that last leg for stakes like that, but the confidence given me by the area navigation system made the decision to continue easy and well-justified. That day the TI-59 paid for

itself and the printer several times over.

So, I was convinced, and I had found that there were several other obvious uses for it. By the end of the year I had written programs for the calculation of aircraft trim, for pre-flight fuel calculation and for a different kind of area navigation. But I had also found some fairly severe limitations of the system.

The TI-59 display is quite invisible in strong light — such as one commonly finds at 33,000ft. Its rechargeable battery is good for about three hours and my flights sometimes lasted four hours — one way. Card reading and writing was uncertain and often required several current-consuming attempts. Battery retaining clips broke off twice because they are not robust enough to take repeated use of the print cradle. Two or three identical digits would sometimes appear no matter how staccato I tried to make my data entry, due to the lack of keyboard debouncing.

The Aviation Module, too, has some limitations, partly in the programs themselves and partly in the concepts used in designing the whole package. Having once recovered from one's initial admiration at the range and number of the programs presented, it was possible to wonder why some of them had been written at all. There is a strong bias toward American-owned light twin-piston-engined aircraft, but it is apparently neither aimed exclusively at them, nor wholly satisfactory for any other category. The Aztec owner will be supremely uninterested in his newfound ability to calculate Mach number and any jet pilot will be frustrated by the trim calculations which allow him to calculate the effect of varying fuel load only if he uses petrol.

Sorriest of all, however, is the unnecessary clash of flags and data register allocations. With any type of navigation and any type of aircraft, the calculation of True Airspeed will sooner or later be required. If the Aviation Module is used for this purpose while area navigating, one flag and three data registers are overwritten, possibly ruining the area model. The humblime track and distance program

## 'Second Hand Stock Clearout'



264 Newmarket Road,  
Cambridge. CB5 8JR.  
Tel. 0223 — 314855

Texas 810 Printer	£650
Dolphin BD 80P Printer	£150
Southwest Technical Products 6809 inc 56K	£900
Southwest Technical Products 6800 inc 40K	£550
SWTPC DMF-1A 8" Dual Disc Drive (Ex. case)	£350

## LIGHTNING SOFTWARE ZX81 16K PROGRAMS

### MACHINE CODE ROUTINES

**X-REF & STRING SEARCH.** X-REF lists all variables with the lines on which they appear. **SEARCH** lists all lines on which any specified string appears. These routines are invaluable when de-bugging. Both can drive ZX printer. £2.50

**SCREEN HANDLING.** Comprehensive and extremely useful package. Adds 6 new commands to ZX81 BASIC:—

**PSCROLL:** Scrolls the display leaving top and bottom lines unaffected. **INV:** Inverts the entire display. **SINV:** Inverts all non-space characters on display. **STORE:** Saves the screen into a string. **RESTORE:** Brings back screen from string. **POINT:** Tests a PLOT point, whether on or off. £2.50

**FULL RENUMBER.** Inc. GOTOs and GOSUBs. £2.50

Lightning Software, Laurel Ho., High St., Hinderwell, Saltburn, Cleveland. TS13 5ES.

## 9900

## FORTH

16-BIT SINGLE BOARD COMPUTER  
TMS-9900 + 32k EPROM + 8k RAM +  
2 serial/2 parallel ports + BASIC  
Interpreter or monitor £385  
FORTH in EPROM for above £50

9900/9995 DEVELOPMENT SYSTEMS  
from £4990  
incl BASIC/PASCAL/word processor etc

FIG-FORTH installation manual and listings for 1802, 8080, 6800, 6809, 9900 each £9  
Manual and one listing £17

MICROPROCESSOR ENGINEERING LTD  
97 Wilton Cres, Southampton S01 2QG  
Tel: 0703 775482 9am — 10pm



## CALCULATOR CORNER

(which is used to find the way between two positions spelled out in latitude and longitude) is even worse because it quite gratuitously wipes out all of the data registers and thus the all-important route model. These related functions ought to be capable of operating without mutual interference.

It was with these thoughts that I recommended to my company that the programmable calculator looked promising for the area navigation task. I had read Dick Pountain's description of the HP-41C (PCW April 1980) and discovered its larger brother the HP-41CV in the shops. This calculator had so many characteristics which

improved on my TI-59 that I asked the airline to let me carry out a trial on it. The idea was to quickly translate a few of my existing programs into HPese, test them and try them out with some of my colleagues. After some very hard talking and an unusually successful demonstration flight I was given the money to buy two HP-41CVs, two card readers and a printer, with appropriate supporting stationery. With an astonished gasp or two, a colleague and I began work in June 1981, formally equipped and formally tasked (on an unpaid basis) to write a report by the end of October.

## JIM WARREN

Continued from page 156

as a series of printed publications. The broadcast system will work by transmitting digital information to the programmable receivers which can be instructed to search for words and phrases of interest. In this way articles can be plucked out of the air to meet your specific needs. Data will be transmitted at 960cps — that's about 2500 newspaper pages per 24-hour day. This is more than all the daily information from AP, UPI and Reuters.

Jim is also quite passionate about the development of alcohol fuels as an alternative to petroleum. At the moment it's on the back burner (so to speak). He feels that there's no great profit in it but, since it has already been proved viable for personal transportation, we might one day be seeing private stills in people's back yards.

Inevitably, I suppose, Jim is wondering whether to hold an alternative fuels fair. Why should Jim give away this idea? In his words: 'I want to see this occur. I don't care that much whether I do it or somebody else does, as long as it gets done. It's a potential service to the entire society and it needs to be done.'

So that's the story. Jim Warren has played a key part in a number of microcomputer industry developments — *Dr Dobb's Journal*, *Infoworld* and the West Coast Computer Faire. With signs that he will maintain his high profile in areas like data broadcasting and alternative fuel fairs, I'm sure we'll be seeing a lot more innovation from this incredible man.

The 1982 West Coast Faire will be held in San Francisco on 19, 20 and 21 March. Serious enquiries to: 333 Swett Road, Woodside, CA 94062. Telephone (415) 851 7075.

## BOOKFARE

Continued from page 110

### Wiley And Hayden

In October and December 1981 Book-fares I referred to three books published by the Hayden Book Company of New Jersey. If you had trouble finding them, it may be because I should have said they were distributed by John Wiley & Sons. Sorry, John.

The books were: *Problem Solving Principles for Basic Programmers* by William C. Lewis, *The Joy of Minis and Micros* by Philip Stain and Howard Shapiro, and *Beat the Odds* by Hans Sagan.

Please note, however, that there is a Heyden & Son publishing books in the UK, Germany and the US, such as one reviewed this month (note the different spelling of Heyden).

### Buyer's Guide

About 75 per cent of the 300+ pages of *Webster's Microcomputer Buyer's Guide* is devoted to descriptions of specific American and Japanese microcomputer hardware and software. The rest of the book is a highly condensed, hardware-oriented introduction to microcomputing and microprocessing theory and applications.

## ACORN ATOM

120 Basic ATOM [kit]  
150 Basic ATOM [built]  
**NEW** 299 DISC DRIVE  
199 Printer

50% royalties for good programs. All programs, accessories, tapes, discs, and books.

Credit cards accepted.  
Prices exclude VAT.

DATX MICRO  
193 TARRING ROAD  
WORTHING, SUSSEX  
0903 39290



PET KNOCK-OUT WHIST

8K 16K or 32K

Tape, listing and full instructions.

Challenge the Pet — £7 including p&p.

Please state type of Pet

Cheques/PO's payable to:  
E.B. Pepperall  
Wick House, Wick St. Lawrence,  
Weston-super-Mare. BS22 0YJ.  
Tel: 0934 515811

## MICROMART

### SEARCHING FOR 'BEST PRICE' FOUND 'BEST PRICE' GOTO

PET	RRP	OUR PRICE
4016 16K	£550	£467
4032 32K	£695	£590
8032 32K	£895	£760
DISK DRIVE		
4040 343K	£695	£590
8050 950K	£895	£760
PRINTERS		
4022 80COL	£395	£335
8023 132COL	£895	£760
8026 DAISY	£995	£845

VAT TO BE ADDED @ 15%  
CARRIAGE — £5 PER ITEM

IF YOU KNOW WHAT YOU WANT WHY WAIT?

THESE ARE THE PRICES YOU NEED.

ORCHARD COMPUTER SERVICES

21 ST MARTINS STREET,

WALLINGFORD, OXON.

OPEN 6 DAYS PER WEEK

Telephone — Wallingford 0491-35529



### SHARP MZ80K HARDWARE

ADC 8 BIT, 16 CHANNEL ADD JOYSTICKS, MONITOR TEMPERATURES ETC.	X11	£85.00
EPROM PROGRAMMER 2716/2732/2764 READ, COPY, VERIFY	X10	£89.00
I/O 8 RELAY O/P BA 240C + 12 OPTO I/P 2.50V 2.50AC/DC	X08	£98.00
BI-DIRECTIONAL SERIAL I/O RS 232 OR TTL WITH "DUMB TERMINAL" S/WARE	X05	£99.00
EXTENDER BOARD CONVERTS TO 0.1 INCH FOR YOUR BREADBOARDS	X02	£19.00
AVAILABLE SOON:— DAC 8 BIT, 8 CHANNEL	X15	
MEMORY STORAGE BOARD 32K KEEP PROGRAMS IN EPROM, SAVE LOADING FROM TAPE	X04	

ALL BOARD PLUG DIRECTLY INTO MZ80 I/O UNIT, AND ARE SUPPLIED FULLY ASSEMBLED AND TESTED, WITH SOFTWARE

POST & PACKING FREE. PLEASE ADD 15% VAT  
S.A.E. FOR DETAILS  
PETERSON ELECTRONICS LTD., ACADEMY STREET, FORFAR,  
ANGUS DD8 2HA. PHONE 0307 62591



PO Box 12  
Bentham  
Lancaster

Tel: Bentham (0468) 61848

ANALYSED CASHBOOK	£75 + VAT
INVOICE	£25 + VAT
LEDGER/STATEMENT	£25 + VAT

Each is available for CBM 'PET' 32K or 16K with CBM or Computhink Disk System and CBM Tractor Printer or other printers.  
All combined together with SALES JOURNAL and PERSONAL LEDGER into:  
AUTO-ACCOUNTS £225 + VAT  
to relieve the drudgery of book-keeping.

An inexpensive word processor for PET:  
EASYWORDS £15 + VAT

A data handling utility for PET:  
DATASTAX £15 + VAT

Each available on CBM disk or tape.

## GAMER

SHARP MZ80K (48K)	£347 + V.A.T.
SHARP MZ80B	P.O.A.
ATARI 400 (16K)	£285 + VAT
ATARI 800 (16K)	£525 + VAT
TEXAS TI99/4	£250 + VAT
VIDEO GENIE I (16K)	£289 + VAT
ATOM (assembled)	£150 + VAT
+ software, books, chess computers	
+ Intellivision + Ace TV games	
+ SF, Fantasy & Wargames	

BRIGHTON 24, GLOUCESTER RD  
TEL 0273 698424

# MICROMART

SS ENTERPRISES Announce their

## UK101 SUPER TOOLKIT

Add 19 NEW COMMANDS TO BASIC  
+ AUTOQUIT on error.  
Package Comprises

### GRAPHICS:

Ease of coordinates  
(0, 0 is bottom left corner)  
Speed of machine code.

Automatic out-of-range checking.

You can now:

- PLOT any character
- BLANK any Pixel
- TEST any pixel
- CLEAR SCREEN
- DISPLAY STRING OR VARIABLE AT X, Y

And

- \*DRAW LINES - ANY DIRECTION, ANY C CHAR
- \*CREATE A BLOCK - ANY CHAR, ANY SIZE, AT X, Y.

### UTILITIES:

To let you:

- RECOVER NEWED PROGRAMS
- BLOCK DELETE code.
- KILL REMS
- AUTO LINE NUMBER

Also Includes:

- FINDER: Locates a specified string and lists its WHOLE LINE. Does NOT have to line 0.
- = specify START and END lines

### TRACE ON/OFF

- Traces LINE NUMBER and SELECTED VARIABLES.

### OTHER FACILITIES:

- \*RESTORE to a line number
- \*GOTO or GOSUM using a variable as the destination
- \*CALL a m/c routine

ALL THIS IN UNDER 1.25K

SPECIAL INTRODUCTORY PRICE  
ONLY £14.95 incl.

### \*TAPE ONLY

\*SPECIFY MONITOR AND SCREEN SIZE

### \*TAPE ONLY

\*SPECIFY MONITOR AND SCREEN SIZE

Please make cheques/PO's payable to:

SS ENTERPRISES  
12/6 CRAIG AVENUE  
ALEXANDRIA, DUNBARTONSHIRE

## ZX81 MINI INVADERS

ALL THE THRILLS OF ITS BIG BROTHER ON A 24x16 DISPLAY ALL IN 1K RAM. £4 for M/C CODE CASSETTE 16K CASSETTES

Games 1. ZX81 Invaders (M/C)  
Games 2. Galaxy Wars/Tawil Battle/Yahtzee

Games 3. Life/Dodgems/Othello  
Sent by return on C12 computer cassette £3.95 each. SAE for Details.

EDMONDS, 29 Chestnut Ave. Grays, Essex

## SILVERSOFT

16K ZX81 SOFTWARE

"STARTREK"

"SUPER-WUMPUS"

"GOLF"

"HOME-ACCOUNTS"

"GAMES PACK 1"

"GAMES PACK 2"

Prices £4.95 first cassette any two £8.95 inclusive

Send S.A.E. for details.

To SILVERSOFT (Dept PCW)  
40 EMPRESS AV  
ILFORD, ESSEX

## WEBSTER'S MICROCOMPUTER BUYER'S GUIDE

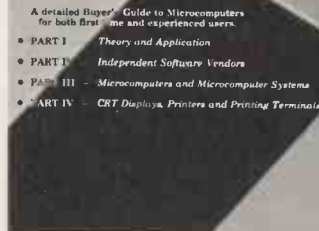

The exclusion of British suppliers immediately reduces its value to UK readers. As the 1981 guide was published in the UK in November 1981, there are also inevitable omissions and out-of-date information. While the book provides a useful round up of the specs of many systems, it cannot be relied on to be comprehensive, accurate and up-to-date.

I recommend the Direct Access section of *Personal Computer World* for more relevant and more contemporary information on what's available. It may be more abbreviated than Webster's specs but it is cheaper and of more immediate use.

In this month's Bookfare were:

*Face to File Communication - A psychological approach to information systems* by Bruce Christie (John Wiley & Sons, £14.50)

*Word Processing - A guide to typography, tests and in-house graphics* by Rod Van Uchelen (Van Nostrand Rheinhold, £6.75 paperback, £12.70 hard)

*Introducing Word Processing* by G L Simons (National Computing Centre, £8.50)

*Computer Acronyms, Abbreviations, ETC* by Claude P Wrathall (Petrocelli/Van Nostrand Rheinhold, £8.45 paperback, £14.90 hard)

*Webster's Microcomputer Buyer's Guide* by Tony Webster (Hayden Book Company/John Wiley & Sons, £19.50)

## FRAMES OF REFERENCE

Continued from page 91

### Micro systems companies

Some of the older software houses have set up micro divisions and some new specialist microsystems companies have emerged to market off-the-shelf equipment and packages, supply turnkey systems and develop special software and hardware. Because they take turnkey responsibility, microsystems companies are generally more alert to the frailties of equipment and software than distributors or shops. They frequently advise large companies' DP departments on selection and standards, as well as designing multiple micro and network systems. Microsystems companies order equipment to meet particular requirements, test systems on their own premises, install on the customer site, interface hardware and configure software, train and hand-hold users during the early days of micro computing. They are constantly evaluating new hardware and software and do not invest in bad products.

### Maintenance companies

Maintenance companies are the last, vital link in the chain of micro supply. The best microcomputers are reliable but even these break down occasionally, while peripherals in heavy use break, invariably at inconvenient moments. Several maintenance companies cover microcomputers, including Computer Field Maintenance and DDT. Because engineers' time and travel is no cheaper than when maintaining bigger machines, the percentage costs can be higher - around 12-20 per cent per annum. Equipment is generally replaced while repair is effected. Return to depot with a 24-hour turnaround at lower percentage cost is growing in popularity where micros are not on time-critical applications. It is sensible to have a single maintenance contract on peripherals and processors to avoid the 'it's not my processor, it's your peripheral' conflict.

### Component supply problems

Some benefits associated with the component makeup of the industry are:

## ZX80 & ZX81 16K RAM & I.O. BOARD

Gives 16K of RAM and 3 x 8 bit programmable I.O. ports, complete.

Uncased ..... £53.00  
4116-4 ..... £ 0.85  
23+23 edge conn ..... £ 3.20

S.A.E. with enquiries

And also suitable for Nascom

All including P&P  
Access & Barclaycard (+6%)

Ground Control  
Alfreda Ave, Hullbridge,  
Essex SS5 6LT  
Telephone Southend  
(0702) 230 324

## NATIONAL TRS-80 USERS GROUP

\*MONTHLY NEWSLETTER  
(All back issues available)

\*SOFTWARE LIBRARY  
(Free to members)

\*REGIONAL SUB-GROUPS

\*SPECIALIST SUB-GROUPS  
(Medical and Educational)

\*INDEPENDENT ADVICE

\*ONE-DAY AND WEEK-END WORKSHOPS  
(London, Birmingham, Manchester, Glasgow, etc.)

Membership is by subscription to the Newsletter - 6.00 for six monthly issues.

Contact: Brian Pain,  
40A High Street,  
Stony Stratford,  
Milton Keynes  
Tel: (0908) 566660/564271



low cost, diversity of supply, variety of products, choice of suppliers. Problems include poor quality control, interfacing difficulties (hardware), configuring difficulties (software), confused and changing supply channels. Because of the exponential growth of the industry and the remoteness of manufacturers from their end users, a number of fly-by-night companies have grown up. But there are those who provide a quality of service almost disproportionate to the one-off value of the goods they are selling. Quality control is a serious problem at every level, especially when a new component is introduced.

It can take two years for the bugs in a new piece of hardware or software to be ironed out. A thorough hardware checkout procedure will isolate equipment which is, a) dead on arrival, b) fails after two hours running, or c) fails or intermittently fails after 48 hours' running. A micro systems company will isolate the third level during systems development. Once the system gets through 48 hours' running, micros record an average of two failures per annum. Warranties are all return to depot, normally 90 days, frequently parts only, but commercial pressures are gradually improving these provisions. Sharp introduced its personal computer system with a 12-month warranty and its example was quickly followed by Apple. Day one maintenance is recommended as an insurance against problems and the inconvenience of return to depot. As for interfacing and configuring, unless you have time and the hardware and software expertise, you should ask your supplier and be prepared to pay extra to configure a hardware and software system.

## Future supply

Over the next few years, a number of suppliers will become established leaders in hardware. For example, Apple Computer recently had a spectacular success with its public quotation. At the same time, a few existing suppliers will successfully get to grips with the market, eg, IBM, DEC and HP. Serious, high quality software producers will grow on a vast market. And the '80s will see the establishment of micro-systems houses, similar in structure to the major software houses established in the '70s but very different in operation as software products come to largely replace tailored programs.

## The second commandment of microcomputing

The second commandment of micro-computing is: *Thou shalt choose the company thou keepeth.* Choose the supplier not the supplies. A good supplier will look after you. A bad supplier will mess up even good products and is never available when things go bang in the night. Educated buyers should be prepared to spend a few pounds more up front for good hardware, software and, especially, services rather than get caught in the bargain basements of shoddy suppliers. On this subject you will have to take up the cudgels with your purchasing department, who may be inclined to look at price only and are not concerned with the aggravation you may have after they have negotiated service out of the contract.

# MICROMART

## HINTS & TIPS FOR THE ZX81 by Andrew Hewson £4.25

HINTS & TIPS FOR THE ZX81  
by Andrew Hewson £4.25

"Good value and quite fascinating... a very inexpensive way of acquiring months of programming experience" - YOUR COMPUTER

- \*80 pages explaining clearly how to squeeze a computing quart into a Sinclair pint pot.
- \*Saving Space - vital reading for all ZX81 users.
- \*Understanding the Display File - using the display file as memory, clearing a part of the display etc.
- \*Converting ZX80 programs - explaining how to convert the hundreds of published ZX80 programs.
- \*Chaining programs - revealing techniques for passing data between programs, calling routines from cassette and establishing data files.
- \*Machine Code Programs - explaining how to get started, how to write, load, edit and save machine code routines, including full details of Z80 machine language.
- \*Routines and programs in Basic and machine code are scattered throughout the text and the final chapter lists twelve useful, interesting and entertaining programs such as LINE RENUMBER, BOUNCFER, LIFE, SHOOT, STATISTICS and they all run in 1K.

16 RAM PACK £37.50  
A top quality add-on 16K memory specially designed for the ZX81. Fully enclosed, it fits snugly at the rear of the machine. Just like the Sinclair version - but cheaper!

48K RAM PACK WITH POWER SUPPLY £148.35  
Sit your ZX81 on a custom built case containing a full 48K RAM. Fully buffered control-data-address bus with PCB 40 way header plug. Also available in kit form price £125.35

SPACE INTRUDERS (16K) £4.95  
Fight the marauding alien as you battle to save the Earth. All the dynamic parts of this program are written in machine code for super fast fun.  
\*All action display. \*40 alien ships per squadron  
\*Automatic option - the machine plays itself  
\*Three laser guns. \*Full score display  
\*Two copies per cassette. \*Full instructions included

PROGRAMMERS TOOLKIT (16K) £6.50  
Line Renumber including GOSUBs and GOTOs, full facility hexadecimal Loader/Copier/Printer, FIND Basic program sections, EDIT blocks of lines and REPLACE all occurrences of a given string.

Send SAE for full catalogue. Cheques with order or quote  
Access number to Hewson Consultants (PCW) 7 Grahame Close  
Blewbury Oxon (0235) 850075

## BLUDNERS

First, last month's BBC Computer Benchtest was attacked by gremlins who neatly removed an entire line from the top of the second column on page 112. It should have read: '... copy of the cassette, we passed straight...'

And no, omitting the phone number of the BBC Computer supplier wasn't a mistake: they cannot handle phone calls so please don't ring us to ask for the number!

Finally, a couple of bugs crept into

the Cubic Spline Curve program on page 132 of December's issue. Line 6050 has a (visually) ambiguous character which is in fact a W. The line reads:  
6050 W(0)=C(0) : FOR I=1 TO N :  
W(I)= C(I)- D(I) \* W(I-1)/V(I-1)) :  
NEXT

Also, line 45080 should be modified for FOR I=0 TO 49 if 50 data points are required and the array F in line 10 needs dimensioning accordingly.

## CP/M SOLUTIONS!

**xForth**  
Our superb implementation of the FORTH-79 standard, with virtual memory, screen editor, resident assembler and many other facilities. Fully integrated with CP/M.  
Special offer £40  
We have other Forth products including Cassidy's metacompiler. Write and ask.

**Amethyst**  
Write and find out why this is the best word processing system available! Price, including the BDS C-compiler so you can personalise the system if you like, is £200.

Add £3 p&p to all orders. Add £5 for formats other than North Star.

Send S.A.E. for more details on these and other products.  
A.I.M. Research (PCW), 20 Montague Road, Cambridge CB4 1BX.

## SPECIAL PCW READERS OFFER

THE NEW LOOK GREEN  
SCREEN SHARP MZ 80K  
48K MEMORY

£399.00 (VAT INCLUDED)

Sumlock Manchester  
Royal London House  
198 Deansgate  
Manchester M3 3WE  
Tel: 061 834 4233

To Advertise in  
MICROMART  
Please Ring  
01-631-1433

## PET HI-RES

- The new HR-40 board offers -
- 8k of its own RAM
  - 64,000 individually addressable points
  - 320 by 200 resolution
  - machine code utility software in EPROM
  - existing PET features unaffected
  - easily fitted, no soldering necessary
  - low price of £149 plus VAT.

There's no limit to what you can do when you have the HR-40 board fitted to your PET. The single dot resolution allows you to draw smooth curves, accurate diagrams and much more. If you've got one of the new 4000 machines with a 12 inch screen then you'll need the HR-40B, but it won't cost a penny more.

The HR-80 board for the 8032 should be available soon - phone for details.

SUPERSOFT are PET/CBM software specialists. Other top quality products include MIKRO, the assembler in a chip (£50) and SUPERCHIP, the biggest selling British chip (£45).

Our catalogue is available free to PET owners.

**SUPERSOFT**  
Dept. P3, 10-14 Canning Road,  
Wealdstone, Harrow, Middlesex.  
Tel: 01-861 1166





# BACK ISSUES SERVICE

Here is a complete guide to all available back issues of *PCW*. A quick guide to their contents is shown below. Check the coupon overleaf for the issues you require.

ABC 24: Vol 4 No 4



Mouse, PET Rebound, MZ-80K Alligator Swamp, PET Connect, UK101 Minefield, PET Simon



**Volume 4 No 1**  
**January 1981**  
**Benchmark:** Transam Tuscan/Real-time control using trains — part 1/  
**Recover from a data tape disaster/PET Music/Multi-user systems — part 1/Programs:** TRS80 Four in a row, TRS80 Target Practice, PET Convoy, PET Wire, PET Maze Chase, PET Android Attack, PET Anagram



**Volume 4 No 3**  
**March 1981**  
**Benchmark:** Onyx C8002/  
**Benchmark:** Bigboard/Micro music software package/ALC circuit/Commons report/HP 34C/Programs: TRS80 Show Jumping, PET Grand Prix, PET Aircraft landing, PET Bouncy.



**Volume 4 No 5**  
**May 1981**  
**Benchmark:** Pasca 640/  
**WP Benchmark:** Magic Wand/PET colour/Low-cost digital tape system/  
**Using calculator printers on micros/Apples music-making/Multi-user Benchmark:** MVT-Famos/Programs: PET Grand Prix, PET Aircraft Landing, PET Bouncy.



**Volume 4 No 6**  
**June 1981**  
**Benchmark:** NEC PC-8001/  
**Multi-user Benchmark:** MP/M/Benchmark: Sinclair ZX81/West Coast Faire report/Radio Teletype/WP Benchmark: Wordpro 4 Plus/Budget tape interface/Further Casio quirks/  
**Programs:** UK101 Zor, PET Chords.

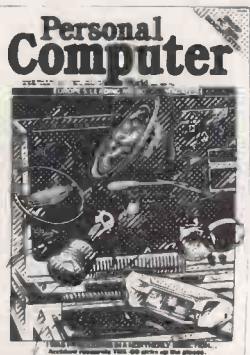

**Volume 4 No 7**  
**July 1981**  
**Benchmark:** Sharp PC-3201/  
**Multi-user Benchmark:** Acorn Econet/ Case study: Accident investigation on TRS-80/Zilog Z8 family/  
**WP Benchmark:** Format-80/  
**Pascal Benchmarks:** readers' letters/Quicker Casio computations/Programs: ZX80 Sliding Letters, UK101 Car Rally, TRS-80 Calendar, UK101 m/c code to Basic converter, PET Exam Questions, MZ-80K Designer, ZX81 Sketch Pad.



**Volume 4 No 8**  
**August 1981**  
**Benchmark:** Tandy Model III/Viewdata update/WP Benchmark: Spellbinder/Printer survey/Micro-holism/Programs: ZX80 Othello; Easter Sunday; Apple Mondrian; MZ-80K Duck Shoot; PET Gomoku; MZ-80K Football.

## PHOTO COPIES

are now available on benchmarks, articles and programs. Please state which issue the article was featured in. £1.00 per article includes P&P.

**Volume 1 No 1, 1978**  
 The 77-68/Practical hints on kit building/Nascom 1/Charity case study/Flowcharting/Pontoon flowchart

**Volume 1 No 2, 1978**  
 Kit building/Basic — first steps/Case study — a software house/PET 2001/Research machines 380Z/School computing/E78 — Europa Bus.

**Volume 1 No 3, 1978**  
 More efficient programs/Cosmac 1802/The PDP11 Part 1/Small business computing — an approach/The Z80/EPRON programmer construction.

**Volume 1 No 6**  
 October 1978  
 Pilot/Assembly code programming/Small business case study/PET preening/Time tabling for schools.

**Volume 1 No 8**  
 December 1978  
 Microcomputer architecture/System design/Colossus/Medical interviewing machine/Hints for the business beginner/Cromemco Z2D/School computing/3rd Noughts & crosses/Low cost/High speed cassette interface

**Volume 1 No 11**  
 March 1979  
 SYM-1/Mk14/IEEE-488 Bus/Motorola 6809/Small computer networks/TMS-9900 homebrew.

**Volume 2 No 1**  
 May 1979  
 Chess programming/Using a small business computer Part 1/Smart 1/In defence of PET/3D Noughts & crosses.

**Volume 2 No 2**  
 June 1979  
 Different computer lan-

guages/(MSI) 6800/Using a small business computer Part II/Demonstrations using the Apple II Part I.

**Volume 2 No 3**  
 July 1979  
 Basic or Pascal?/The Sorcerer/Z8000/Chess programming/Graphics for the TRS-80/Apple-Viewision — part II/

**Volume 2 No 4**  
 Apple medical application/North Star Horizon/Word processing/High speed cassette interface/Sorting/Buying a computer for a small business

**Volume 2 No 5**  
 September 1979  
**Benchmark:** Compucolor II/Checkout: Heuristics Speech Lab/Testing Precognition/Pascal series — Part I/Programs: 6800 Time response, Apple memory test, Fx 201p spaceship, PET Orbit sim, PET digital clock, Acronyms.

**Volume 3 No 6**  
 June 1980  
**Benchmark:** Tandy TRS-80 Model II/Benchmark: Sintrom Periflex 630/48/  
**Staff case study/Checkout:** Softy Intelligent EPROM Programmer/Checkout: Exatron Stringy Floppy/Practical examples of the IEEE-488 bus use/  
**Programs:** Naming Nascom files, 380Z Pictures, Fuel tank calculations — PET, PET large numeral generator, PET tank battle, Basic string handling routines/Pascal: Final instalment.

**Volume 3 No 12**  
 December 1980  
**Benchmark:** Microwriter/Printerfacing: Series — Part 1/Sharp PC-1211 speed-up/Programs: TRS-80 Tarot, PET Cat &





## Personal Computer



Vol 4 No 9  
September 1981  
Benchtests: Tandy Color Computer, Commodore VIC/Checkouts: Hi Tech Speakeasy, Tantel/ Multi-user Benchtest: HMSOS/WP Benchtest: Memorie III/Word proc program for PET/Apple dealership run by spastics/Printer-facing extra/Calc Corner: Casio fx602p review/Programs: PET Arithmetic test, ZX80 Eldorado, 380Z Memory test.

## Personal Computer



Volume 4 No 10  
October 1981  
Benchtest: OKI if-800/Checkouts: Heuristics speech link, Softy 2/Calc Corner: Texas TI51-III/ Jeff Taylor on computer literacy projects/Introducing TJ's Workshop/Control Your Own Substation pt 1/Programs: TRS-80 Sailing

## Personal Computer



Vol 4 no 11  
November 1981  
Benchtests: Osborne 01, IBM Personal Computer, Checkout: Sharp IQ3100 Microtranslator, Calc Corner: Casio fx702p, PCW Show report, Benchmark Summary, Euro Micro Chess Championship report, Programs: TRS-80 Sheepdog trial, ZX81 Sun and Planets.

## Personal Computer



Vol 4 No 12  
December 1981  
Benchtests: Sharp MZ-80B Philips P2000/School network/ BBC Micro inside story/ 'Turtle' Graphics for Apple/ Forth language/ Curve fitting/ Calc corner: HP14C review/ Programs: PET Fantasy, ZX81 Battleships and cruisers.

## Personal Computer



Vol 5 No 1 January 1982  
Benchtests: BBC Micro, Xerox 820/Frames of Reference (new series)/ ZX81 Printer Checkout/ Digital Drummer for PET/ Calc Corner: Benchmarks/ Programs: MZ-80K Fortune, TRS-80 Reaction Timing, ZX80 Laybrinth, Apple Letters.

# BACK ISSUES CENTRE

We have a complete selection of all available PCW back numbers in our flashy new Back Issues Centre in the West End of London, just half a minute's walk from Oxford Street (close to Tottenham Court Road tube station). Of course, you could order them from our excellent mail order service using the coupon below, but by visiting in person you save on postage costs. The Back Issues Centre also often has back numbers of PCW on sale which we cannot offer through the mail order service because of shortage of stock. And any new issue is usually on sale in the Back Issues Centre several days before it reaches your local newsagent. Our receptionists will also be happy to sell you a set of binders or take your subscription. And there's a range of interesting computer books on sale as well. Drop by next time you're in the West End. We're open Monday to Friday, 10am to 6pm. The address is 14 Rathbone Place, London W1.

## COME UP AND SEE US..



# DESK TOP COMPUTING

A COMPREHENSIVE GUIDE TO SUCCESSFUL BUSINESS AND PROFESSIONAL MICROCOMPUTING

Send £2.25 to Desk Top Computing Offer, 14 Rathbone Place, London W1P 1DE. Cheques should be made payable to *Personal Computer World*.

## PCW BINDERS

Strong, durable, attractive yellow PCW binders — £3.25 each, including postage and packing. See coupon below.

**NOW OPEN SATURDAY!!**  
11.00AM-5.00PM /  
**MON-FRI**  
10.00AM-6.00PM



Any one issue £1.25; Any two issues £2.25; Any three issues £3.00; Any four issues £3.75. All additional issues @ 75p each. Binders @ £3.25. All prices include post and packing. Cheque or P.O. payable to (PCW) SportsScene Publishers Ltd., 14 Rathbone Place, London W1P 1DE. Please allow up

to 3 weeks for delivery and don't forget to state clearly your name and full address with your order. Please send me the following copies of PCW. I enclose a cheque/P.O. for £ Please tick appropriate boxes.

Volume 1	Volume 2	Volume 3	Volume 4
1 <input type="checkbox"/> 2 <input type="checkbox"/> 3 <input type="checkbox"/> 6 <input type="checkbox"/>	1 <input type="checkbox"/> 2 <input type="checkbox"/> 3 <input type="checkbox"/> 4 <input type="checkbox"/> 5 <input type="checkbox"/>	6 <input type="checkbox"/>	1 <input type="checkbox"/> 3 <input type="checkbox"/> 5 <input type="checkbox"/> 6 <input type="checkbox"/>
8 <input type="checkbox"/> '11 <input type="checkbox"/>	Binder <input type="checkbox"/> DTC <input type="checkbox"/>	12 <input type="checkbox"/>	7 <input type="checkbox"/> 8 <input type="checkbox"/> 9 <input type="checkbox"/> 10 <input type="checkbox"/> 11 <input type="checkbox"/> 12 <input type="checkbox"/>

Name \_\_\_\_\_ Address \_\_\_\_\_

# **MBC**

## **UK Limited**

  
tele data  
01-200 0200

### **Micro/Minicomputer supply ; Maintenance & Media supply ;**

**MBC UK are not only North West Londons' main Sorcerer dealer but are also using teledata to give computer users the exclusive benefits of a continuous personal 24 hour media ordering service PLUS FREE DELIVERY anywhere in the U.K.! PLUS ;**

**Maintenance Agreements**

**S100 Subsystems**

**TTL, MOS, etc.**

**Professional CBM Software**

**GUARANTEED 2ND USER MICROS**

**THE NEW SORCERER . . . . .**

**\* EXCEPTIONAL RANGE OF BUSINESS SOFTWARE.**

**\* FULL 12 MONTH GUARANTEE.**

**\* FINANCE ARRANGED.**

**\* BOOK YOUR DEMONSTRATION NOW - 01 458 8437.**

**dealer and export enquiries welcomed.**

**Ring Now For FREE Catalogue**

  
tele data  
01-200 0200



**FREE**

LIBRARY BOX with every  
TEN-PACK

**\*\*PLUS\*\***

NEW DISK DIRECTORY & DISK-  
WRITER when ordering two packs  
or more

**\*\*PLUS\*\***

BRUSHED CHROME PAPERMATE  
PEN when ordering 5-9  
TEN-PACKS

**\*\*PLUS\*\***

GOLD PLATED PAPERMATE PEN  
when ordering 10+ TEN-PACKS

# DISKING

## FOR THE FINEST MINIDISKS & ACCESSORIES

*All disks are factory fresh and individually  
certified 100% error-free.*

DISKING INTERNATIONAL FREEPOST LIPHOOK HANTS GU30 7BR U.K. TEL (0428)722563

### 5 1/4 MINI DISKS

**Datalife** **minidisks**



**Verbatim**

VERBATIM The World's favourite media 'Datalife' are all double density with hub ring reinforcement

EXC VAT

MD525 S/Sided 40 track . . .	£18.95
MD550 D/Sided 40 track . . .	£24.95
MD577 S/Sided 77 track . . .	£26.95
MD557 D/Sided 77 track . . .	£34.95

10 & 16 Hard Sector at same prices

**MEMOREX** Mini Flexible Discs



MEMOREX The Ultimate in Memory Excellence based on many years of experience with recording media.

EXC VAT

MEMX 1 S/S S/Density . . .	£18.45
MEMX 1D S/S D/Density . . .	£21.45
MEMX 2D D/S D/Density . . .	£23.95

10 & 16 Hard Sector at same prices

**BASF FlexyDisk®**



BASF cross-linked Oxide coating for long media life and special lubricants minimize head wear.

EXC VAT

BASF 1 S/S S/Density . . .	£17.95
BASF 1D S/S D/Density . . .	£21.45
BASF 2D D/S D/Density . . .	£25.95

10 & 16 Hard Sector at same prices

**DISKING SUPERLUXE DISK LIBRARY**



Manufactured exclusively for us to our own design, the SDL keeps your valuable disks flat & dust free, while at the same time allowing you instant visual selection of any single disk. The standard SDL holds 20 disks, while the SDLX holds 28 disks. The SDL may be uprated to an SDLX retrospectively.

SDL only . . . . .	£8.65
SDLX only . . . . .	£10.39

**DISKING DISKMAILERS**

This product also exclusively ours, is a strong plastic envelope for making one, two or three disks, in safety and comes complete with warning labels & address labels.

DM only . . . . .	50p
-------------------	-----

**DISK DRIVE HEAD CLEANING KITS**



Prevent head crashes and ensure efficient error-free operation. Enough for 26 bi-monthly cleans & a lot cheaper than a service call!

CK5 only . . . . . £16.50

**ALL PRICES ARE EXCLUSIVE OF VAT, PLEASE ADD 15%**

**SUPERBRAIN SOFTWARE**

'DATAKING' coming soon: will mathematically massage any Datarstar or Wordstar data file, and columnate with report writer. Instant Sales, Nominal or Purchase ledger or Comprehensive Sales/Purchase Reporting for Datarstar users.

DATAKING only . . . . .	£49.00
DATAKING User Manual . . . . .	£2.50

**PLASTIC LIBRARY BOXES**

The genuine Egly Box that stores and protects your disks in tens - Unbeatable - (FREE with every ten disks ordered)

LB only . . . . .	£1.90
-------------------	-------

**ATTENTION THE TRADE**

Please write to us on your letter headed paper, and ask for our special trade prices and offers. Give your software and ultimate in presentation. We can make the SDL and SDLX in your colour PVC, with your Logo. Sample plastics swatch available free by request.

<b>U.K. P&amp;P RATES</b>	<b>EXC VAT</b>	<b>NORMAL ORDERS</b>
Disks (1-5 packs) each pack	@ 95p	We accept Armed Forces and all Ministry of Defence Establishments orders over £50,000 in value. All other customers cheques with order please payable to DISKING. If you are a large establishment, and can not raise cheques without an invoice please post or telephone us your order, and we will send a pro-forma invoice by return, for your accounts department to pay against.
Disks (6+ packs) each pack	@ 65p	
SDL or SDLX	@ 95p	
DM, each @ 25p		
Tens @ 80p		
LB @ 45p		
CK5 @ 75p		
DATAKING SOFTWARE	post free	
DATAKING USER MANUAL	post free	

**URGENT ORDERS**

Disks (1-5 packs) each pack	@ 95p
Disks (6+ packs) each pack	@ 65p
SDL or SDLX	@ 95p
DM (each @ 25p) Tens	@ 80p
LB	@ 45p
CK5	@ 75p
DATAKING SOFTWARE	post free
DATAKING USER MANUAL	post free.

We accept Barclaycard and Access card, and make a small surcharge of 6% on the total order value. You may write your c/card No. on your order or telephone the order day or night, 365 days a year. You may speak for as long as you like, and don't forget to give full details of what you wish to purchase, your credit card number, credit card holder's name & address, and delivery or invoice address if different.

**TO DISKING, FREEPOST, Liphook, Hants. GU30 7BR. England.**

QTY	DESCRIPTION	PRICE EXC. VAT

TOTAL GOODS VALUE EXC. VAT £ \_\_\_\_\_  
 TOTAL DELIVERY AND INSURANCE £ \_\_\_\_\_  
 SUB TOTAL EXC. VAT £ \_\_\_\_\_  
 VAT £ \_\_\_\_\_  
 VALUE OF CHEQUE PAYABLE TO DISKING £ \_\_\_\_\_

Name: \_\_\_\_\_  
 Address: \_\_\_\_\_  
 PCW 2/82 \_\_\_\_\_ Tel No: \_\_\_\_\_  
 My Access/Barclaycard\* Number is: \_\_\_\_\_

*\*Please delete that which is not applicable.*

RETAIL SALES & DEMONSTRATION 404 EDGWARE RD. LONDON, W2 1ED TEL: 01-402 6822

**TANGERINE • TANGERINE • TANGERINE • TANGERINE • TANGERINE**

## MICROTAN 65

Microtan 65 is the most advanced, powerful, expandable micro-computer available - it also happens to be the most cost effective!

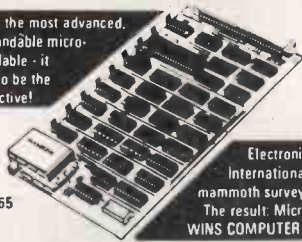

Electronic Today International held a mammoth survey of kits. The result: Microtan 65 WINS COMPUTER CLASS!

MICROTAN 65 CONTENTS

High quality, plated thru hole printed circuit board, solder resist and silk screened component identification. 6502 microprocessor 1K monitor TANBUG Now with 'V Bug' 1K RAM for user program, stack and display memory VDU alphanumeric display of 16 rows by 32 characters. MICROTAN 65 system file binder 136 page, bound, users hardware/software manual with constructional details and sample programmes. Logic and discrete components to fully expand MICROTAN 65.

The MICROTAN 65 kit has won widespread acclaim for its superb presentation. We pay attention to detail!

KIT FORM **£69.00** + £10.35 V.A.T., total £79.35.

MICROTAN 65 assembled and tested. Specification as above, but assembled and fully bench tested by ourselves **£79.00** + £11.85 V.A.T., total £90.85

TANBUG V2.3 KIT (separately) **£21.95 incl.**

## MICROTAN 65 OPTIONS

**LOWER CASE PACK**  
Two integrated circuits which connect into locations on MICROTAN allowing 128 displayable characters **£9.48** + £1.42, total £10.90

**GRAPHICS PACK**  
Five integrated circuits which connect into locations on MICROTAN allowing the display of chunky graphics (64 x 64 pixels). What are chunky graphics? Well, imagine a piece of graph paper with 64 squares vertically and 64 squares horizontally, a total of 4096. Each square can be made black on white. **£6.52** + V.A.T. 98p, total £7.50.

**20 WAY KEYPAD**  
Inexpensive means of getting up and running. Uses 'Schoeller' key-switches, and connects to MICROTAN through a 16 pin D.I.L. plug on ribbon cable. Black anodised escutcheon, with TANGERINE legends. Finishes off what must be the best value for money keypad available. Available assembled and tested. **£10.00** + V.A.T. £1.50, total £11.50

\*Space Invaders game (for use with keypad only) **£15.22** + V.A.T. £2.28 total £17.50

## POWER SUPPLIES

MPS 1: Input 120 or 240V AC. Output 5 Volts at 3 Amps Regulated. MPS 1 will power both MICROTAN and TANEX fully expanded. Built on the same size printed circuit board as MICROTAN etc. Available as a fully built and tested unit. **£23.00** - V.A.T. £3.45, total £26.45  
X MPS2 +5V 6A, +12V, -5 and -12V switch mode system PSU **£69.13** + V.A.T.

## MINI-SYSTEM RACK

We have produced a mini-system rack which accepts MICROTAN 65, TANEX and our mini-mother board. It has an integral power supply, just plug it into the mains and away you go! Finished in TANGERINE/BLACK, it gives your system the professional finish. Front panel access for I/O cables. AVAILABLE AS AN ASSEMBLED UNIT. **£56.35 INCL.**

## FULL SYSTEM RACK

For the man that has everything! 19 inch wide system rack which accepts MICROTAN 65, TANEX, TANRAM, SEVEN FURTHER EXPANSION BOARDS, TANDOS and THE SYSTEM POWER SUPPLY. Available in many formats, e.g. individual front panels, full width hinged front panel, back panel with or without connectors. **£49.00** + V.A.T. £7.35, total £56.35.

## NEW PRODUCTS (all inc. VAT)

System Motherboard (4 connector)	44.85	Parallel I/O Board Min (16 Lines)	54.63	Controller Card Full	138.00
System Motherboard (12 connector)	72.85	Parallel I/O Board Max (128 Lines)	99.48	Controller Card Min	69.00
Extra Edge connectors	3.50	32K Ramcard 16K Version	87.40	Cbus, Combined Tanbug & Xbug	T.B.A.
System Rack Front Panel	15.64	32K Ramcard 32K Version	115.00	2 Port Serial I/O Kit	T.B.A.
Serial I/O Board Min (2 Ports)	66.70	32K Romboard (Excl. Rom)	54.55	High Resolution Graphics	90.85
Serial I/O Board Max (8 Ports)	135.70	Alm/Kim Buffer	54.64	Aim TV Interface	79.35

## MICRON COMPUTER

FULLY BUILT, TESTED, and housed

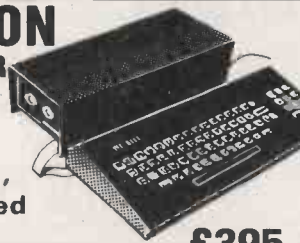

**£395**  
inc V.A.T. P&P

System Rack Micron **£550.00 incl.**

6502 based microcomputer VDU alpha numeric display Powerful monitor TANBUG 8K RAM 32 parallel I/O lines 2 TTL serial I/O lines Four 16 bit counter timers. Cassette interface. Data bus buffering Memory mapping control. 71 key ASCII Keyboard, including numeric keypad. Includes power supply. Also includes the first '10K MICROSOFT BASIC' available in the U.K. All the usual BASIC commands.

Full manuals, Microtan, Tanex, Basic, X Bug All **£5.00** each.

## TANRAM

AVAILABLE NOW TANRAM - 40K Bytes on one board! Single board of bulk memory offering 7K Static RAM (2114), and 32K Dynamic RAM (4116). Onboard refresh is totally transparent to CPU operation and is unaffected by normal DMA's. TANRAM fully expands the available address space of the 6502 microprocessor. MICROTAN, TANEX and TANRAM together provide 16K RAM, 48K RAM, and 1K I/O - that's a lot of memory and a lot of I/O! Built and tested TANRAM ASSEMBLED.

**40K RAM CARD with 16K DYNAMIC RAM £76 - VAT**  
CONTENTS: High quality plated thru hole printed circuit board, solder resist and silk screened component identification. Full complement of IC sockets for maximum expansion. 64 way D.I.N. edge connector 1K RAM (2114). Data bus buffering. TANRAM users manual.  
EXTRA RAM:  
1K STATIC (2114) £2.95 each 16K DYNAMIC (4116) £1.50 each

**MEMORIES EXPAND YOUR SYSTEM WITH OUR TANGERINE APPROVED CHIPS.**  
Discounts 10% for 4, 15% for 8, 20% for 16  
2102 1K x 1 Static RAM 80p IM 6402 UART £4.50  
2708 £3.50 2114 1K x 4 Static RAM £2.95  
2716 £6.50  
MK 4116 16K x 1 Dynamic RAM £1.50 All plus VAT 4118 1K x 8 Static RAM £7.50

**MONITORS (PROFESSIONAL)**  
RECONDITIONED AND NEW - FROM **£35.00** to **£129.95**

## CENTRONICS Ideal for Tangerine PRINTERS

SHEIKOSHA **£199** + V.A.T.  
Model 730 **£350** + V.A.T.  
Model 737 **£395** + V.A.T.



## NEW MICROTANTEL POST OFFICE APPROVED PRESTEL - VIEWDATA

• FULL COLOUR GRAPHICS •  
• CAN STORE PRESTEL • CAN BE USED AS AN EDITING TERMINAL • CAN BE INTERFACED WITH PET, APPLE etc.  
**£170** + V.A.T.  
Just connect to the aerial socket of any colour or black and white domestic T.V. receiver and to your Post Office installed jack socket and you are into the exciting world of PRESTEL. Via simple push button use you are able to view 170,000 pages of up to the minute information on many services, order goods from companies - all this without leaving your armchair!



## TANEX £43.00

Minimum Config Kit  
+ V.A.T. £6.45, total £49.45  
CONTENTS  
High quality plated thru hole printed circuit board, solder resist and silk screened component identification. IC sockets for maximum expansion. 64 Way D.I.N. edge connector 1K RAM, cassette interface, 16 parallel I/O lines, a TTL serial I/O port, two 16 bit counter timers, data bus buffering, memory mapping, logic and discrete components for maximum expansion. TANEX users manual.  
TANEX (Minimum configuration) Assembled **£53.00** + V.A.T. £7.95, total £60.95



## TANEX EXPANSION

Expanded TANEX offers 7K RAM, locations for 4K EPROM (2716), locations for 10K extended MICROSOFT BASIC, 32 parallel I/O lines, two TTL serial I/O ports, a third serial I/O port with RS232C/20mA loop, full modem control and 16 programmable baud rates, four 16 bit counter timers, cassette interface, data bus buffering, and memory mapping.

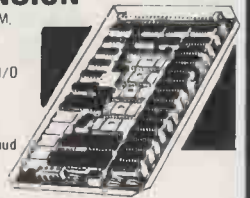

EXPANDED TANEX KIT (Excludes ROM, XBUG and BASIC) **£89.70** + V.A.T. £13.46, total £103.16

EXPANDED TANEX ASSEMBLED **£99.70** + V.A.T. £14.96, total £114.66

OPTIONS TO FULLY EXPANDED TANEX  
10K Extended MICROSOFT BASIC in EPROM (with manual) **£49.00** + V.A.T. £7.35, total £56.35

Extra RAM 1K (2 x 2114) **£5.20** + V.A.T. 78p, total £5.98

SERIAL I/O KIT **£17.25**  
6522 VIA **£8.00** + V.A.T. £1.20, total £9.20  
XBUG **£17.35** + V.A.T. £2.60, total £19.95  
± 12V KIT **£9.20** incl.

AS YOU CAN SEE THE PRICES OF OUR EXPANSION COMPONENTS ARE VERY, VERY COMPETITIVE!

## TANGERINE DISC SYSTEM

Z80 CONTROLLER CARD **£150.00** + V.A.T.  
DOUBLE SIDED DOUBLE DENSITY DRIVE **£215.00** - V.A.T.  
CP/M DISK OPERATING SYSTEM **£80** - V.A.T.  
Z80 AVAILABLE JANUARY  
DEC 81



## 71 KEY ASCII KEYBOARD £69.95 incl.

NO EXTRAS NEEDED  
Uses gold crosspoint keys. Includes numeric keypad and ribbon cable. Available as fully assembled and tested.  
SUPER METAL CABINET IN TANGERINE/BLACK  
**£20.00** + V.A.T. £3.00, total £23.00



## PROFESSIONAL ASCII KEYBOARDS Ideal for Tangerine

**£29.95** - V.A.T.  
• 52 key 7 bit ASCII coded  
• Positive strobe +5V-12V  
• Full ASCII characters  
• Parallel output with strobe  
• Power light on control  
• Chip by General Instrument (G.I.) TTL output  
• Superbly made  
• Size 13 x 5.5 x 1.5 ins  
• Black keys with white ledgers  
• Escape shift return & reset keys  
• Control repeat & bell  
• Complete with DATA



## ADD-ON KEYPAD

A compact 12 button keypad suitable for use with above keyboard to extend its functions plus four extra keys. Supplied brand new with data. A 4 x 4 non-encoded single mode keyboard.



LIST PRICE **£22.00**  
OUR PRICE **£7.95** - V.A.T.

PLUS MANY NEW EXCITING PRODUCTS IN DEVELOPMENT AUTOMATICALLY AVAILABLE FROM US WHEN RELEASED BY TANGERINE LTD.

All products are available  
FULLY GUARANTEED BUY WITH CONFIDENCE  
BRITISH DESIGN & MANUFACTURE AND ON DEMONSTRATION IN OUR COMPUTER DEPT.

**TANGERINE • TANGERINE • TANGERINE • TANGERINE • TANGERINE • TANGERINE • TANGERINE • TANGERINE • TANGERINE**  
Stockist Enquiries on headed notepaper to:  
COMPUTER KIT LTD. (Principal Distributors in U.K.)  
11/12 Paddington Green, London, W2. Tele: 01-723 5095  
Telex: 262284 Ref. 1400 TRANSONICS  
All orders pre-paid and official advertised here to be forwarded DIRECTLY to  
COMPUTER DEPT., 11/12 PADDINGTON GREEN, LONDON W2

SEND FOR  
FREE BROCHURE



# THREE PET TITLES

## from

# Nick Hampshire

### LIBRARY OF PET SUBROUTINES

A book which will save the software designer considerable time by providing 55 proven subroutines to integrate with his own programmes.

Each subroutine is preceded by a page of general information describing its purpose and implementation and possible problems that may arise. Basic machine language and a combination of both, are used throughout this publication.

"... We like this book very much and thoroughly recommend it."

*Printout*

"... well prepared, fun to use, and will help in better program development."

*Compute*

### THE PET REVEALED

A reference book which details everything you need to know about the workings of the PET. Containing information helpful to writing more elaborate programmes, which in turn create more interesting functions.

"... Should be congratulated. Supplies some much needed, useful and correct documentation."

*Compute*

"... 'PET Revealed' will save you an awful lot of time. I rate this book as good value for money."

*Printout*



All 3 publications are widely used by Commodore Business Machines.

### PET GRAPHICS

This book has two objectives. One, to provide the reader with an introduction to the programming techniques used to generate graphic displays.

Two, providing the programmer with a complete package of machine code routines giving a wide range of normally unavailable graphic functions. The book contains many comprehensively analysed routines and photographs to illustrate the effects created.

"... an invaluable guide to graphics on the PET."

*Micro Forecast*

#### Please send me:

..... copy/ies of Library of PET Subroutines @ 10.00 each  
 ..... copy/ies of The PET Revealed @ £10.00 each  
 ..... copy/ies of PET Graphics @ £10.00 each

I enclose a cheque for £ ..... payable to Computabits Ltd., P.O. Box 13, Yeovil, Somerset.

Name .....  
 Address .....  
 .....  
 Postcode .....



# DESK TOP COMPUTING

**ACOMPREHENSIVE GUIDE TO SUCCESSFUL BUSINESS AND PROFESSIONAL MICROCOMPUTING**

We live in an age of cheap computing power. For the first time the cost of a computer is within the reach of the small businessman, the professional person or the private citizen. And in the present economic climate the pressure is on to increase productivity and efficiency using these electronic aids.

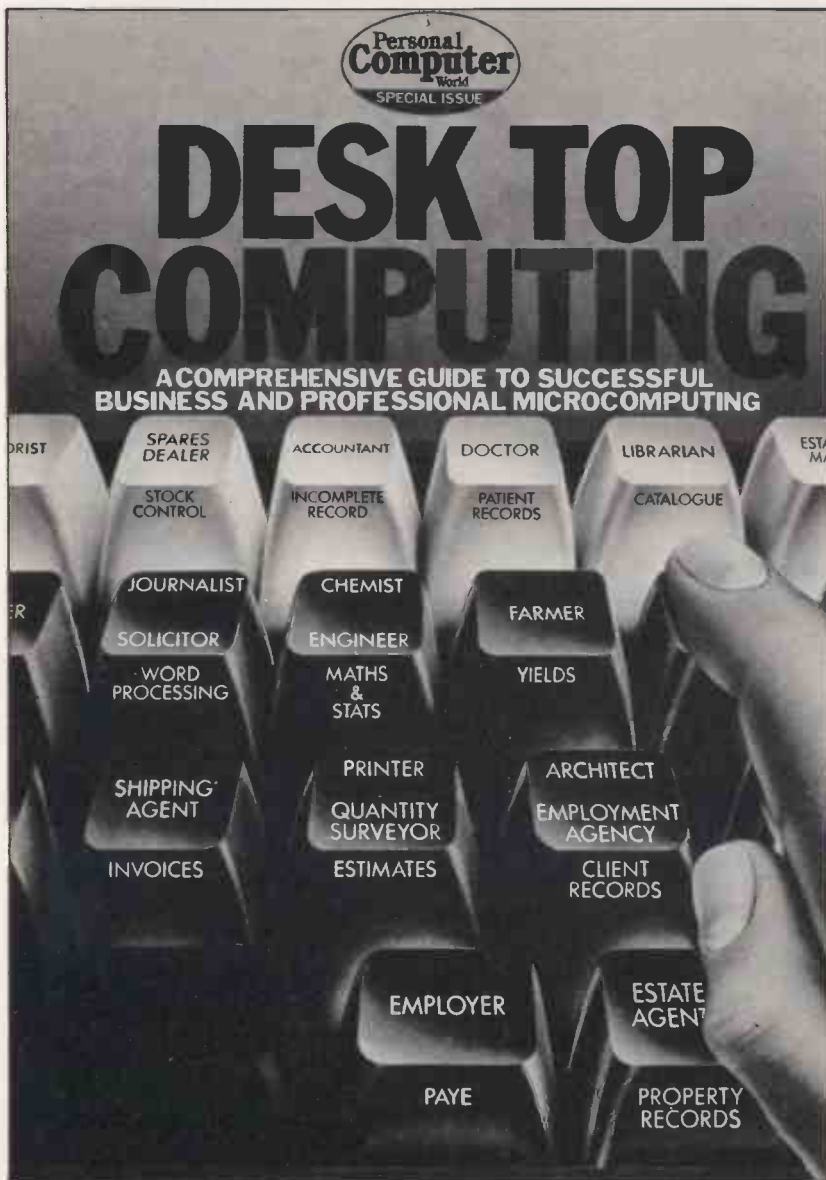

Also included are several case studies covering the installation of desk top computers in small businesses and for professional use together with a comprehensive listing of virtually every hardware and software system currently available in the UK.

But will your desk top computer be a boon or a curse? Will it increase your profits or disrupt your workplace? Will you be misled by salesmen's patter, baffled by programmers' jargon and find yourself the unhappy owner of a totally unsuitable system?

Success in computer installation depends on taking a logical approach to your task — the *Systems Approach*; the side of the microcomputing revolution they didn't tell you about. This book, from the publishers of PERSONAL COMPUTER WORLD, Britain's largest-selling micro magazine, tells you.

Lyn Antill explains, in language plain enough for the most non-technical user, the secrets of Systems Analysis, the key to obtaining the computer system you need. Step by step, this book tells you how to:-

- Define exactly what tasks you wish your computer to undertake.
- Interpret those tasks in a way the computer can handle.
- Choose the right machine for present and future needs.
- Buy off-the-peg software.
- Hire and supervise a programmer when necessary.
- Write program specifications tailored to *your* staff and working methods.
- Test programs and introduce them into your business smoothly with minimal disruption.
- Maintain and modify programs.

**AVAILABLE NOW PRICE £1.95 FROM YOUR PCW NEWSAGENTS,  
THE PCW BACK ISSUES CENTRE OR BY MAIL ORDER. SEE COUPON ON PAGE 193.**





# CHROMASONIC electronics

48 JUNCTION ROAD, ARCHWAY, LONDON N19 5RD 100 yds from Archway Station & 9 bus routes  
TELEPHONE 01-263 9493 01-263 9495

## YOUR SOUNDEST CONNECTION IN THE WORLD OF COMPUTERS

### VIC 20

- \*24 Colours, 8 for Characters, 8 for Border, 16 for screen mixed as you wish.
  - \*3 tone Generator for sound.
  - \*Uses Pet Basic \*Plugs into T.V.
  - \*Memory expandable to 32K
  - \*VIC complete with T.V. Modulator and Power Supply
- ONLY £165.00**

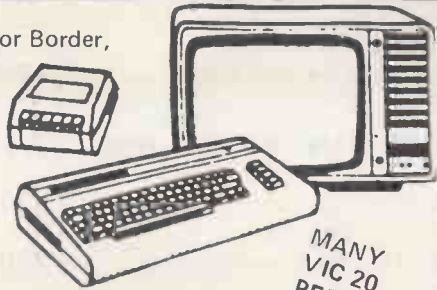

VIC Cassette Deck  
**ONLY £38.00**

Available soon  
VIC Dot Matrix Printer  
80 Column, 30 CPS,  
Tractor Feed  
**ONLY £199.95**



MANY  
VIC 20  
PERIPHERALS  
AVAILABLE  
SEND FOR  
LIST

### UK 101

- UK101 Kit inc 8K memory £125
- Ready Built inc 8K memory £175
- Complete in case £199
- 4K Expansion 8x2114 £10
- Parallel Printer Interface £24.50
- Cases £19.95
- Chromasonics Sound Kit £24.50
- Colour Kit £69.95

**NEW NEW NEW**

- 32K Dynamic Memory Board only £89.95
- P.I.O. and Eprom Programmer Kit only £24.50

DOWN  
IN PRICE

### APPLE II PLUS

AUTOSTART "EUROPLUS"

48K Apple Computer Disc Drive with Controller **649.00**

Disc Drive without Controller **349.00**

- Colour Card 299.00
- Silentype Printer 69.00
- Graphic Tablet 199.00
- TV Modulator 425.00
- TV Modulator 14.00

A range of Apple Accessories and Software are available

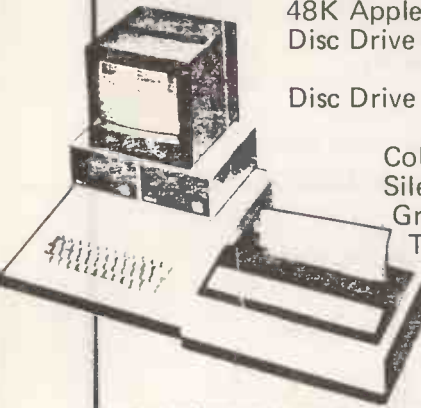

### PET

- 4016 16K RAM 445.00
- 4032 32K RAM 569.00
- 8032 32K RAM 755.00
- 8096 96K RAM 960.00
- 4040 Disk Drive 585.00
- 8050 Disk Drive 755.00
- 4022 Printer 80 Col 357.00
- 8024 Printer 132 Col 975.00
- 8026 Printer/Typewriter 835.00
- 8027 Daisy Wheel 735.00

A range of PET Accessories and Software are available



### PRINTERS

INTERFACES AND CABLES FOR APPLE II, PET, TRS80, RS232, UK101, SHARP SUPERBOARD ALL AVAILABLE

**EPSON MX80 £359**  
Dot-matrix printer with Pet graphics interface. Centronics parallel and serial. Pet and Apple compatible. True bidirectional, 80 cps.

**EP80 MX82 £389**  
As MX80 plus high Resolution Graphics.

JUST PHONE FOR FURTHER DETAILS

**EPSON MX80 FT/1£399**  
Dual single sheet friction and tractor feed, 9 wire head, true descenders.

**EPSON-MX FT/2 £440**  
An FT/1 with high An FT/1 with high resolution graphics.

**SEIKOSHA GP80A£199**  
Dot matrix 5 x 7, 80 columns, 30 cups graphics, double width characters.



### VIDEO GENIE

£279 EG3003

Utilises Z80, 12 K level II Basic, Integral Cassette Deck, UHFO/P, 16K RAM, all TRS80 features. Simply plugs into monitor or UHF TV, With V.U. Meter.

- PARALLEL PRINTER INTERFACE INC CABLE. . . . . 33.00
- CHROMASONICS PROGRAMABLE SOUND KIT. . . . . 24.95
- SOUND KIT (FITTING EXTRA). . . . . 7.00
- LOWER CASE KIT (FITTING EXTRA). . . . . 27.50
- COLOUR KIT (FIT) . . . . . 34.95
- EXPANSION BOX WITH/WITHOUT RS232 . . . . . 215/185
- 16K/32K RAM CARD . . . . . 94/129

### MONITORS

HITACHI PROFESSIONAL

- |                      |         |     |         |
|----------------------|---------|-----|---------|
| 9" Green Screen      | £99.00  | 9"  | £99.95  |
| 12" Green Screen     | £125.00 | 12" | £149.00 |
| 12" BMC Green Screen | £159.00 |     |         |

### TANTEL

## PRESTEL BY TANTEL

COMMUNICATION AT YOUR FINGER TIPS FOR BUSINESS & HOME. UP TO DATE INFO

180,000 pages of information on Travel, News, Investment, Holidays, Hotels Etc., Etc.,

£170

TANTEL IS POST OFFICE APPROVED. SEND FOR DETAILS. DEMONSTRATION AVAILABLE AT OUR SHOWROOM

BARCLAYCARD

VISA

Please add VAT 15% to all prices. Postage on computers, printers and cassette decks charged at cost, all other items, P&P 30p. Place your order using your Access or Barclaycard (Min. tel order, £5). Trade and export enquiries welcome. Official orders welcome.



# RAM EXPANSION 16K, 32K, 64K, 128K, 256K,

## MEMORY UPGRADE

## 6502 BASED (all are internal modules)

## Z80 BASED (External Ram Packs and internal modules available)

e.g. ATOM, PET, UK 101, O.S., AIM

e.g. VIDEO GENIE, ZX 81

16K	£45 (Kit)	Prices incl. of PSU components	£33 (Kit)	Prices incl. of PSU components
32K	£52 (Kit)		£40 (Kit)	
Ready built charge:	£10		£7	

## LARGER EXPANSIONS

64K	£80 (Kit)		£70 (Kit)	
128K	£120 (Kit)	PSU not necessary	£110 (Kit)	PSU not necessary
256K	£200 (Kit)		Not yet available	
Ready built charge:	£10		£7	

All prices are inclusive of postage and packing, but please add 15% VAT to all totals.

Discs are fast, but in some cases, not fast enough. You may have a customer waiting for details on the 'phone — and he can quickly become impatient. In such situations, when your computer has got to look through up to a few hundred files, our memory expansion systems really can help.

The memory is divided into 'Random Access Sectors' of 256 bytes each. For example, there will be 1024 sectors in a 256K bytes expansion.

We supply free the basic subroutines necessary. Each is roughly 180 bytes long and capable of handling one of the following functions:

1. READ/WRITE program
2. READ/WRITE screen
3. READ/WRITE string and files
4. READ/WRITE numerical array

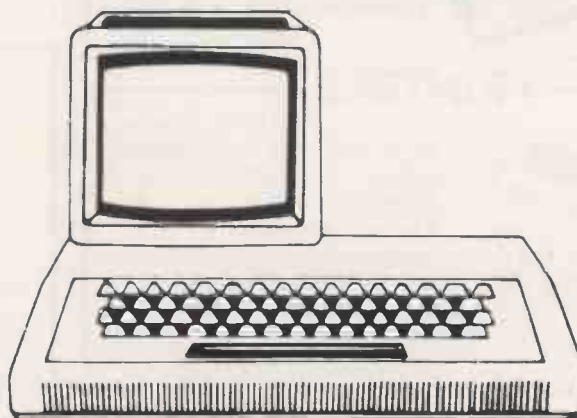

Take as an example the READ/WRITE screen function for a PET. This literally treats the screen as a piece of paper on which you can draw or write whatever you like. When you have finished, SYS 940 will store the result in one of the 256 screen pages in just 18 milliseconds (the blink of an eye!) Another example: the READ/WRITE string and files function opens to your Micro as many as 1000 files at any one time! If you want the file 100, write string AS with the contents of file 100 — it will take only 8 milliseconds.

Another advantage of memory sectors is that any program can READ or WRITE into the memory so that several programs can share the same data base.

**FOR FURTHER DETAILS (WE CAN SEND YOU FREE LITERATURE), PLEASE RING US ON SOUTHEND (0702) 613081, OR IF OUR LINE IS BUSY, WRITE TO:  
AUDIO COMPUTERS, 87 BOURNEMOUTH PARK ROAD, SOUTHEND-ON-SEA, ESSEX**



# IBM PERSONAL COMPUTER



**£2800+VAT**

**MICRO-COMPUTERLAND**  
**TEL: 01-637 4071**

# ZX81 SOFTWARE FROM VIDEO SOFTWARE LTD 1K & 16K

## 16K SOFTWARE

**VIDEO-PLAN** (ZX81 only). Performs the functions of an analysis book. Arithmetic functions include addition, subtraction, multiplication. Printer optional.

**VIDEO-AD.** Rotating display of 16 pages of advertising material. Set-up your own pages and change them as and when required.

**VIDEO-GRAPH.** Planning and design aid. Create pictures/charts/graphs and store within the program. Save on cassette. Combine pictures like an 'identikit'.

**VIDEO-VIEW.** Do it yourself teletext. Create pages of data. Store them within the program. Save on cassette. View on demand.

**VIDEO-MAP.** (ZX81 only). Educational game based on maps. Navigate your plane to its destination. Bomb the target and return to base.

**FORCE-FIELD.** (ZX81 only). Animated bombardment game. You control the force-field which protects your city against hostile UFOs.

**SPACE-RACE.** (ZX81 only). Party game for eight players. Rockets race to build stations in space. Winners gradually take over losers until only one winner remains.

**FOOTBALL-LEAGUE.** Realistic simulation of an entire season. Every match played and results shown with progressive league table. You give teams ratings for skill, effort, etc.

**TEST-MATCH.** Realistic simulation of a test match series. Dynamic scoreboard. Give each player your own ratings for skills, technique, etc.

**STOCK-MARKET.** (ZX81 only). An exciting game of skill and judgement. Buy and sell stocks and shares as prices change in response to world events.

**PACK 1** — VIDEO-PLAN + VIDEO-AD.

**PACK 2** — VIDEO-VIEW + VIDEO-GRAPH.

**GAMESET** — VIDEO-MAP + 5 GAMES.

## 1K PARTY TRICKS (ZX81 only) NEW! NEW!

If you don't have a 16K RAM this set of programs is for you. Ten separate programs — some games, some more serious. All completely original, all ten programs included in the price.

- SHOOT** Take the penalty and watch the goalie try to save.
- SKETCH** Draw an almost full screen picture and save on cassette.
- NAME THE DAY** Give the date, the ZX81 names the day of the week.
- TRAIN** For the very young who would like to drive a train.
- ONGER-WONGER** Watch the ZX81 draw its own pictures and yours.
- WEATHER** An endless variety of completely inaccurate weather forecasts.
- UFO** Shoot down the UFO before he gets you.
- WHO SHOT JR** An intriguing test of your powers of detection.
- FIELD-GUN** Can you hit the target.
- FOLLOW THAT** Follow the path traced by the ZX81.
- NOTE: These programs are not suitable for ZX80.

## NEW THIS MONTH

**VIDEO-SKETCH** (ZX81 16K only).

Move the cursor to any part of the screen. Draw or rub-out as you move it. Mix in text or graphics. Save picture in memory. Save picture sequence on cassette.

Std. @ £7.95.

De-luxe @ £9.95.

## NEWS FOR USERS

Those of you who have already voted with your cheque books may be interested in our 'top ten'. These are the best sellers so far:

- |                |                    |
|----------------|--------------------|
| 1. VIDEO-VIEW  | 6. FOOTBALL-LEAGUE |
| 2. VIDEO-GRAPH | 7. STOCK-MARKET    |
| 3. FORCE-FIELD | 8. TEST-MATCH      |
| 4. VIDEO-MAP   | 9. SPACE-RACE      |
| 5. VIDEO-PLAN  | 10. VIDEO-AD       |

Surprisingly some of the programs which we rate most highly are well down the list.

We expect our 1K programs to top this list soon. They are worth buying even if you have 16K.

## PRICE LIST

ORDER CODE	Manual	Std.	Lux
SKETCH 81	—	7.95	9.95
PLAN 81	—	7.95	9.95
AD 81	—	7.95	9.95
GRAPH 81	—	5.95	7.95
VIEW 81	—	5.95	7.95
MAP 81	—	5.95	7.95
FORCE	—	3.95	5.95
SPACE	—	3.95	5.95
FOOT	—	3.95	5.95
TEST	—	3.95	5.95
STOCK	—	3.95	5.95
PARTY 1	1.95	4.95	6.95
PACK 1	—	—	17.95
PACK 2	—	—	13.95
GAMESET	—	—	19.95

Prices include VAT.

Mail order customers add £1.00 per order. (50p for manual only). Allow 28 days for delivery.

Std = cassette & manual. Lux = de luxe boxed sets.

## VISIT US AT THE ZX MICROFAIR



STONE LANE,  
KINVER,  
STOURBRIDGE,  
WEST MIDLANDS,  
DY7 6EQ,  
ENGLAND.

Tel: KINVER 2462.  
Std. 030-483-2462

**VIDEO**  
SOFTWARE LIMITED

Directors: P. Smith, B.A., D. J. Smith (Director and Secretary).

Registered Number: 1085219 England

V.A.T. Reg. No. 278 0607 51

Personal callers welcome during office hours.  
Send s.a.e. for further details.

Code	M/S/L	Qty.	Price	Total

P. & P.

## ORDER FORM

See above  
for codes

Your cheque no. ....

NAME.....  
ADDRESS.....

PCW 2/82



# 'CFACC'

"THE BEST ACCOUNTS PROGRAMME ON THE MARKET\*" – £900

(FULLY TAILORED TO YOUR OWN REQUIREMENTS – £1200 IF YOU BUY THE HARDWARE FROM US, OTHERWISE £1500)

## MAIN MENU

- |                          |                                   |
|--------------------------|-----------------------------------|
| 1. ADDRESS PROGRAMME     | 16. BANK RECONCILIATION           |
| 2. SALES INVOICES        | 17. PURCHASE LEDGER               |
| 3. PURCHASE INVOICES     | 18. SALES LEDGER                  |
| 4. STOCK CONTROL         | 19. END OF MONTH PROCEDURE        |
| 5. ORDER CONTROL         | 20. VAT STATEMENTS                |
| 6. PAYROLL               | 21. ACCORDING TO VERSION          |
| 7. PAYMENTS MADE         | 22. PROFIT & LOSS ACCOUNT         |
| 8. PAYMENTS RECEIVED     | 23. BALANCE SHEET                 |
| 9. CREDITORS             | 24. CAPITAL ASSETS                |
| 10. DEBTORS              | 25. (JOB COST ANALYSIS)           |
| 11. SUPPLIER STATEMENTS  | 26. DISK DIRECTORIES              |
| 12. CUSTOMER STATEMENTS  | 27. ALTER IN CORRECT FILE ENTRIES |
| 13. AGENTS STATEMENTS    | 28. PRINT LEDGER CODES            |
| 14. PRINT CUSTOMER INDEX | 29. PRINT STOCK LIST              |
| 15. PRINT SUPPLIER INDEX | 30. FINISH USING 'CFACC'          |

PLEASE ENTER SELECTION NUMBER

## 'CFACC' ACCOUNTS PROGRAMME – COPYRIGHT COMPUTERS FOR ALL LTD

1. The Programme resides totally "in core" leaving BOTH DISKS FREE for files and enabling disks to be changed during use.
2. Every Programme issued is "PERSONALISED" with your Company's details. Our "After Sales Service" is positive, giving you constant access to the Author of "CFACC". We arrange Nationwide hardware support.
3. You need only enter invoices and other payments in and out and "CFACC" will produce all the DATA for the MENU Programmes (it will ask the user for any other information it needs).
4. All relevant information is stored for CUSTOMERS, SUPPLIERS, EMPLOYEES and Others.
5. Automatic VAT Calculations.
6. Automatic calculations of WAGES and SALARIES.
7. INVOICES can be produced automatically using Customers' names and addresses from file and Stock Items from file – all calculations are automatic.
8. INVOICES are automatically printed on plain paper or on your own stationery. Invoices entered are retained for automatic printing at the end of the day, lunchtime etc.
9. STOCK FILE is automatically UPDATED whenever a Purchase or Sales Invoice is entered and the User's attention is drawn to any item which has reached RE-ORDER LEVEL.
10. Customer and Supplier Statements printed on demand showing Current, 1 Month, 2 Months, and 3 Months and over figures. These are automatically updated as payments are entered. The User's attention is automatically drawn to any Customer exceeding his CREDIT LIMIT. REMITTANCE NOTES are produced of invoices selected for payment – CHEQUE PRINTING optional.
11. "Open Item" ledgers retain all invoices until they are paid (Purchase & Sales).
12. Outstanding Orders are retained on file until invoiced (Purchase & Sales).
13. Automatically calculates COMMISSION due to Agents and Salesmen.
14. DEBTOR and CREDITOR lists available on demand.
15. PROFIT & LOSS ACCOUNT, BALANCE SHEET and TRIAL BALANCE printouts on demand.
16. MANAGEMENT FINANCIAL REPORTS include:
  - i) GROSS PROFIT RATIO
  - ii) RATE OF STOCK TURNOVER
  - iii) NET PROFIT as a PERCENTAGE OF SALES
  - iv) INCOME STATEMENTS.
  - v) AGE OF DEPT ANALYSIS
17. CAPITAL ASSETS STATEMENT on demand.
18. INCOMES & EXPENDITURE is analysed into 70 ledger classifications and the amounts in any one of these can be called at any time.
19. ENVELOPES or ADDRESS labels can be printed from Address Files.
20. Full Random Access to any record in any file – No Limit on Record Lengths.
21. Ledgers are automatically updated after every transaction.
22. All sections of the Programme and files are fully integrated.
23. Some Programmes on the market claim to be easy to use with no need for a manual (BUT TO THE LAYMAN THEY SIMPLY ARE NOT). "CFACC" really is USER ORIENTATED – WE ARE PREPARED TO LET YOU PROVE THIS FOR YOURSELF. MONEY REFUNDED IN FULL IF YOU CAN SHOW US A BETTER MICROCOMPUTER ACCOUNTS PROGRAMME WITHIN 7 DAYS OF USE.
24. The PRICE makes "CFACC" the best VALUE FOR MONEY on the Market.
25. Fully tested and debugged. You will receive Free of Charge any Improvements or Modifications we make in the future.
26. All equipment is fully tested by us prior to installation – Normal Guarantees on all Equipment and we only recommend the most able. Service Contracts available. Finance and Leasing a speciality.
27. DELIVERY and INSTALLATION FREE of Complete Packages within the UK.
28. We have examples of other Accounts Programmes on the market which you are welcome to try and to compare them with 'CFACC'.
29. PETS, APPLES and TANDYS taken in PART EXCHANGE against Complete Packages.

64K 'SUPERBRAIN' (350K DISK STORAGE) – DAISYWHEEL PRINTER – "CFACC" ACCOUNTS –

"WORDSTAR" Word Processing.

\*\* ALL FOR £3,986.00 \*\*

Computers For All Ltd. Stratford on Avon (0789) 840064

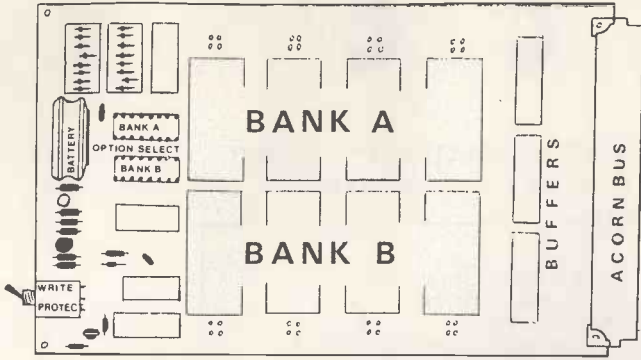

## CU-MEM — UNIVERSAL MEMORY

Up to 64K of byte-wide standard memory  
**NMOS RAM, battery-backed CMOS RAM,  
 ROM, EPROM, EEPROM**

CU-MEM has eight sockets arranged in two independent banks, each of which can be filled with 24 or 28 pin industry standard memory devices in 1K, 2K, 4K or 8K bytes sizes.

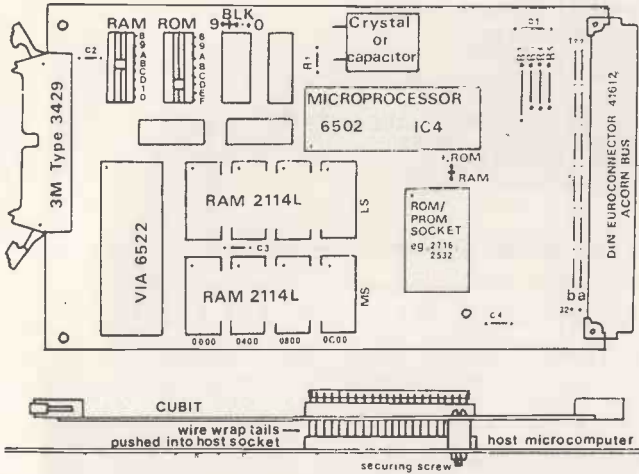

## CUBIT — VERSATILITY PLUS

This Eurocard carries 4K RAM, 4K ROM/EPROM, a VIA 6522 i/o chip and a DIN connector to the Acorn Euro-bus. It can be used:-

- ★ as a 6502-based single board microcomputer
- ★ as an extension to AIM 65 and similar computers
- ★ as a peripheral to a CUBIT or other computer

CUBIT and CU-MEM are fully compatible with the Acorn range of Eurocards (eg. VDU, disk, analog)

Control Universal supply CUBIT, CU-MEM, and all Acorn and Rockwell products.

**Control Universal Ltd, 11/15 Bush House,  
 Bush Fair, Harlow, Essex.  
 Tel: 0279 31604/412043.**

# SUPERBRAIN<sup>®</sup> SOFTWARE

**LINTEX PRODUCTS**  
 present

## LINDATA<sup>™</sup>

This flexible program is vocabulary based. It was designed with ordinary business people in mind and uses YOUR names for file areas and YOUR file architectures. Using prompts in plain English, Lindata<sup>™</sup> allows you to:

- ★ Sort a file numerically or alphabetically
- ★ Create file entries
- ★ Print out files in a number of formats
- ★ Alter or use field arithmetics
- ★ Edit a file on a constant keyed input

**£75** + VAT including disk, comprehensive manual, packing & UK postage.  
 Other CP/M<sup>™</sup> machines by arrangement

### LINTEX PRODUCTS LIMITED

16 Suffolk Road, Potters Bar, Herts, EN6 3EZ Telephone Potters Bar (0707) 52834  
 Regular demonstrations but ONLY by appointment



Now PSION COMPUTERS brings you a utility ROM for the ACORN ATOM

1) PROGRAM TEXT EDITOR, DEBUGGING AIDS, DISASSEMBLER with 57 commands which allow you efficiently to edit, debug, append, insert, replace, renumber, extract etc. etc. . . . Basic and Assembler Programs. *Features include:* local and global string search and replace commands; automatic numbering and renumbering, multiple commands; handles more than one text space; transfers sections of text from one space to another; memory dump and modify; register display on break.

**£18.95**  
 inclusive of VAT and postage

2) GRAPHIC SCREEN COPY for the ATOM ON CASSETTE for the Seikosha GPRQ and Epson MX80 printers. Supplied in both assembler and machine code (takes 256 bytes only) used from BASIC with the command \*COPY

**£3.95**  
 inclusive of VAT and postage



To: Psion Computers  
 20 Clifton Court  
 Maida Vale  
 London NW8 8HT  
 Tel: 01-286 4608

Tick  £18.95  
 Atom Utility ROM - program editor debugging aid and booklet  
 Tick  £3.95  
 Atom Graphic Screen copy on cassette

I enclose cheque postal order for £

Name .....

Address .....





At last! Watford now has a computer shop offering a wide range of personal computers PLUS a variety of related products and services.

## The COMPUTERS.

- Acorn Atom
- Commodore VIC, 4000 & 8000
- Sharp PC1211, PC3201, MZ-80B, MZ-80K (special price!)
- Texas TI-99/4

## The PLUS.

- peripherals
- software and supplies
- business systems
- books and magazines
- computer chess and games

and, above all, friendly advice and service from people who know about computers. Give us a call - or, better still, come in and have a chat or a browse. We're opposite Trewins in the Queen's Road - close to the car parks.

# COMPUTER PLUS

47, QUEEN'S ROAD, WATFORD, HERTS. WD1 2LW

TEL. WATFORD (0923) 33927

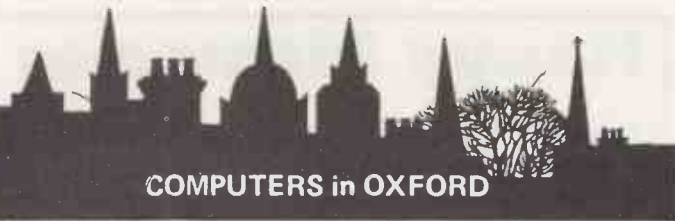

## COMPUTERS in OXFORD

### HARDWARE

**VIDEO GENIE MICRO** only £299 with 12 month warranty. We supply the full Genie System, including single disc drive: -£215; Twin 40 track:-£395; Twin 80 track:-£545. 12" Monitor £65.00. (Free with every Genie, 120 page Software Catalogue).

### PRINTERS

Epson MX80 FT £399 (High Quality Bi-Directional)  
Centronics 737 £349 (with proportional spacing)  
Seikosha GP80A £210 (Economical Matrix Printer)  
Microline 80 £229 (quiet and reliable).

### SUPERBRAIN-STATE OF THE ART BUSINESS

**MICRO** Tremendous Price/Performance Ratio. CP/M Based, Masses of Software. Lease a Superbrain from around £12 per week! or a complete Business system, including Software and 136 Column Printer from only .£29 per week.

**TANTEL** We can now demonstrate the Tantal Adapter, giving access to over 180,000 pages of Data with any Television, only £169.00

### SOFTWARE (ask for full list)

#### FOR GENIE/TRS 80

Visicalc £65.00  
Newdos 80 £69.00  
L.Dos £85.00

#### SUPERBRAIN

Wordstar £215.00  
Mailmerge £ 65.00  
Datatar £170.00

Complete Integrated Business systems, from under £1000,  
Ask for details.

**GOOD RANGE OF ACCESSORIES AND COMPUTER BOOKS FINANCE LEASING AVAILABLE**

Open 9.00 - 5.30 Monday - Friday

9.30 - 1.00 Saturday.

All prices VAT extra.

**MICRO BUSINESS SYSTEMS**

**C.T. MADDISON LTD**

**EAGLE INDUSTRIAL ESTATE THE CROFTS**

**WITNEY OXFORD TEL: WITNEY (0993) 73145**



and now for  
ZX81 with  
16K Ram



## SCI-FI FANTASY GAMES

Psion Computers introduces you to the new craze of computer Sci-Fi role-playing adventure-style games. The computer describes your situation (often hopeless) and prompts you with questions to which you reply using plain English words. Using your ingenuity you may escape your present predicament only to be confronted by the next horrifying threat.

Side A **PERILOUS SWAMP** - your position is displayed on the map of the perilous swamp. Can you thwart the monsters, rescue the princess from the evil wizard and escape alive?

**£3.85**

including VAT and postage in U.K.

Side B **SORCERER'S ISLAND** - even more difficult and not for the uninitiated.



To: Psion Computers  
20 Clifton Court  
Maida Vale  
London NW8 8HT

Tel: 01-286 4608

I enclose a postal order, cheque in

payment for



FANTASY GAMES

Name .....

Address .....



# THE SEED SYSTEM 19



## 6809 BASED SYSTEM

Mini-Floppy/Floppy Disk Drives  
Single or Double Headed Drives  
Single or Double Density Recording

### CHOICE OF TWO POWERFUL DISK OPERATING SYSTEMS

MICROWARES OS-9  
Multi-Tasking Multi-User  
BASIC09 Interpreter/  
Compiler  
PASCAL  
STYLOGRAPH WORD  
PROCESSOR

SSBs DOS69  
Single User  
  
BASIC  
DOS69 Equivalent  
TEXT  
PROCESSOR

WIDE RANGE OF TERMINALS & PRINTERS  
NATIONWIDE FIELD MAINTENANCE  
PERSONEL TRAINING

32K BYTES (MIN) 1MEGABYTE (MAX)  
CDC HAWK 10 MEGABYTE HARD DISK DRIVE  
supported by OS-9

RING NOW FOR FURTHER DETAILS

# SEED

## STRUMECH

PORTLAND HOUSE, COPPICE SIDE,  
BROWNHILLS, WALSALL, W. MIDLANDS.  
TEL 054 33 78151 TELEX 335243 SELG

microcomputer products

# TEMPLEMAN SOFTWARE LIMITED

*Would like to apologise to all those of you  
who could not get on to our stand at the I.B.S.*

To make amends we invite you to our offices at 25 Greenhill Street, Stratford on Avon, for a personal demonstration by appointment on 0789 66237, of our new hardware range. It can be used as a single work station in your sales or accounts office or as part of a multi-terminal chain throughout every part of your office or factory.



## Happy Memories

Part type	1 off	25-99	100 up
4116 200ns	.95	.85	.65
4116 250ns	.90	.80	.60
2114 200ns Low Power	1.25	1.15	.95
2114 450ns Low Power	1.20	1.10	.90
4118 250ns	3.45	3.15	2.65
6116 150ns CMOS	6.95	6.45	5.65
2708 450ns	1.95	1.85	1.65
2716 450ns 5 volts	2.25	2.15	1.95
2716 450ns three rail	6.40	6.00	4.95
2732 450ns Intel type	4.25	3.95	3.35
2532 450ns Texas type	4.95	4.70	4.20

Z80A-CPU £4.75    Z80A-P10 £4.25    Z80A-CTC £4.25

Low profile IC sockets:

Pins 8 14 16 18 20 22 24 28 40  
Pence 9 10 11 14 15 18 19 25 33

Soft-sectored floppy discs per 10 in plastic library case:  
5 inch SSDD £17.00    5 inch DSDD £21.00  
8 inch SSSD £21.00    8 inch SSDD £26.65  
8 inch DSDD £31.75

74LS series TTL, large stocks at low prices with  
DIY discounts starting at a mix of just 25  
pieces. Write or 'phone for list.

Please add 30p post & packing to orders under £15 and VAT @ 15%.  
Access & Barclaycard accepted.    24hr service on (054 422) 618.  
Government & Educational orders welcome, £15 minimum. Trade  
accounts operated, phone or write for details.  
Prices are still tending to drop, 'phone for a quote before you buy.



Happy Memories (PCW),  
Gladestry, Kington, Herefordshire,  
HR5 3NY  
Tel: (054 422) 618 or 628



# Knights T.V. & COMPUTERS

108 Rosemount Place,  
Aberdeen AB2 4YW  
Telephone: 0224 630526  
Telex: 739169 "KNIGHTS TV"

## ROCK BOTTOM PRICES FROM SHARP'S BIG DEALER

DEAL A	SHARP MZ-80K with full 48K memory, BASIC AND PASCAL AND PASCAL + 10 PROGRAMS	£345
DEAL B	48K MZ-80K, BASIC, PASCAL, AND FORTH + 10 programs AND FORTH + 15 PROGRAMS	£359
DEAL C	" " BASIC, PASCAL, FORTH, FORTH, AND FORTRAN + 16 PROGRAMS	£379
DEAL D	everything in DEAL C AND MACHINE CODE	£395
DEAL E	48K SHARP, BASIC, PASCAL, FORTH, FORTRAN, MACHINE CODE, 16 programs and the KNIGHT COMMANDER	£410
DEAL F	everything included in DEAL E plus our famous library of 100 PROGRAMS	£425
DEAL G	MZ-80P3 printer complete with interface card	£339
DEAL H	MZ-8010 interface box (takes up to five cards)	£ 87
DEAL J	MZ-80FD dual disk floppy drive, K interface card, all cables	£575
DEAL K	MZ-80P3 printer, PASCAL, FORTH, FORTRAN and KNIGHT COMMANDER	£389
DEAL L	EVERYTHING IN DEAL K, INTERFACE BOX+ 100 programs	£499
DEAL M	EVERYTHING IN DEAL J, plus our new DISK COMMANDER	£599
DEAL N	MZ-80FD dual floppy, DISK COMMANDER, FORTH, FORTRAN, + PASCAL	£625
DEAL P	48K SHARP MZ-80K, PRINTER, DUAL FLOPPY, INTERFACE BOX all connecting cables and manuals	£1345

### MZ-80K PROGRAMS

1	SNAKE ISLAND, 10 PIN BOWLING, POKER	£5
2	COSMIC INVASION, SPA CE FIGHTER, PAPER	£5
3	CASINO CHIPS, OWARI SPACE INVADERS	£5
4	SURVIVAL, STAMP OUT, OTHELLO	£5
5	SKI SLOPE, STARTREK, JUMPS	£5
6	HYPNO, 3D MAZE, OTHELLO	£5
7	TEACH MAJOR SCALES' ORGAN KEYS	£5
8	EXPLODING ATOMS, STARTREK, 3D MAZE	£5
9	CO-ORDINWARS, STAMP OUT, SPACEFIGHTER	£5
10	LION TAMER, 10 PIN BOWLING, OTHELLO	£5
11	DISASSEMBLER, MEMORY DUMPER, BYTE SEARCHER	£8
12	TEACH TABLES, and 6 programs	£5
13	DIRECTED NUMBERS, DIVISION, MORSE TUTOR	£5
14	SP5025 RENUMBER	£10
15	INFLATION FORECASTING ACCOUNTS	£25
16	CRIBBAGE, BACKGAMMON, POKER	£8
17	WIZARDS CASTLE - role playing adventure game plus TOWERS and GATOR EATER	£5
18	ARCADE ROAD RACE, LION TAMER, KAMIKAZE PILOT	£5
19	KNIGHT COMMANDER takes no more memory than SP5025 but adds: RENUMBER, PRINT AT, PRINT SCREEN, TRACE, APPEND, single step etc	£25
26	CURVE FITTING calculates, intercept, slope, co-efficient, draws regression curves	£40
28	MAIL LIST and LABEL GENERATOR fast search facility, 1500 names per disk	£100
39	EIGHT MODE DISASSEMBLER Including an output to tape compatible with Sharp assembler	£25
54	MONACO GRAND PRIX - very fast	£5
48	UFO everone says it is too fast, we refuse to slow it down	£8
57	SNAPPER - CRASH - HEAD ON	£5
63	KISS THE TEACHER biology was never like this	£5
64	ALIEN MINE LAYER	£5
70	MISSILE COMMAND great graphics	£5
94	NUMERICAL INTEGRATION by Simpsons Rule, GAUSSIAN LEGENDRE/LAGUERRE. Needs Pascal on the B or K. Supplied with 20 pages of instructions - draws great curves	£20
109	KNIGHT DISK COMMANDER adds new commands to SP6015 Basic without taking extra memory. AUTO,BLOCK DELETE,DUMP,DEFINE KEYS, TRACE,REPEAT ON ALL KEYS, NUMERIC PAD,REUMBER,SINGLE STEP ETC.	£65

ALL FOUR Wee Pascal, Forth, Fourtran & Machine Code £85

KNIGHTS WEE PASCAL COMMANDS INCLUDE: append, insert line, delete, limit, find/replace string, VAR,BEGIN,PROC,FUNC,IF 'THEM. ELSE, PUT, INP, OUT, OR, XOR,NOT, AND, REMAINDER, INCREMENT/DECREMENT VARIABLES etc. Ideal for beginners to Pascal. Supplied with four programs. £20

KNIGHTS FORTH Arithmetical operators include +,-,\*,/,OR, XOR,AND, Stack operators include STK,CLR,DUP,OVER,SWAP, ROT,DROP,MV. Graphics: SET,RESG,LINE,CORDV etc. Supplied with very fast programs rotating cubes, drawing circles, etc and a FORTH DIS-COMPILER. £25

KNIGHTS FORTRAN takes 16K and is supplied with a 32K source program Monaco Grand Prix. Commands include: EDIT, COMPILE, EXEC,ADD TEXT,DIM,CALL,PAUSE, etc. Compiled programs are saved as machine code. £30

AGE for K or B. £45

KNIGHTS MACHINE CODE for experienced programmers. Can be run with Basic. Includes memory dump and modify, FIND, DISPLAY/MODIFY REGISTERS, CHARACTER LISTING £25

SHARP PASCAL takes 16K and is supplied with demos. comprehensive package with full screen editing, case statements etc. Supplied with either Knights Wee Pascal which we recommend first if you are a beginner or with our NUMERICAL INTEGRATION PACK-

### Dear Microfans,

If you buy your Sharp MZ-80K or MZ-80B from Knights you know that your order receives the personal attention of not just a retailer but an enthusiast. We use the Sharp In our own business for Stock Control, Invoicing and even for repairing TV sets. We use it for our amateur radio and music hobbies. We write articles on Sharp in Electronics and Music Maker and publish our own Sharp User Group Newsletter all to keep you up to date on the very latest about Sharp micros. The Newsletter is sent to you free when you buy your micro from us - it'll cost £3 if you bought it elsewhere.

The latest newsletter details my recent visit to Sharp in Japan, describes the new Double Precision Basic, the new Compiler, the PASCAL,FORTH AND FORTRAN languages, and our new super-speed 4MHz CPU board for the MZ-80K.

If you have any queries about Sharp microcomputers simply ring or write for our latest newsletters and price lists. We now have 300 programs for the Sharp MZ-80K and MZ-80B - everything from games to business.

As the largest Sharp micro retailer outside Japan we guarantee to give you the best possible price, programs and after sales service.

Happy Computing,

Graham Knight GM8FFX.

PS. All our prices are exclusive of Maggie's VAT but include delivery by British Rail Red Star.

# LEEDS COMPUTER CENTRE

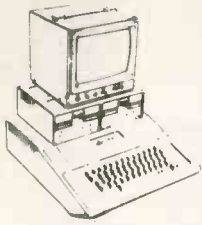

**apple II EUROPLUS**

**VIC 20**

**£175**

'INCLUDING VAT'  
P/P £3—

48K ..... £695 + VAT  
 Disk with controller ..... £360 + VAT  
 Disk without controller ..... £275 + VAT  
 Monitors b/w or green.  
 Full range of Peripherals, Epsom and Paper  
 Tiger printers all discounted, Post & Packing  
 £4.

Price includes fully tested unit with  
 fitted plug.  
 Complete range of Vic-Peripherals.

Sharp MZ80K  
 48K Model  
 £395 inc VAT



**COMMODORE PET**

**4000SR. WITH LARGE 12" GREEN SCREEN**

32K MODEL  
 P-P- £5.00 **£595 including VAT**

Access  
 and  
 Barclaycard  
 accepted

COMPLETE RANGE OF COMMODORE EQUIPMENT EX-STOCK

Official orders welcome: goods dispatched 24hr delivery. Please phone for our lowest prices.

SALES

SERVICE

SATISFACTION

**ADVANCED COMPUTER EQUIPMENT (LEEDS) LTD**

95 MEADOW LANE, LEEDS 11

PHONE: 0532 446960

TELEX: 335909

# SUPERBRAIN SOFTWARE AND HARDWARE +

DP/WP Consumables

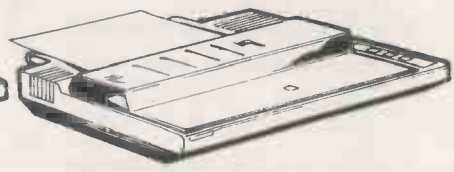
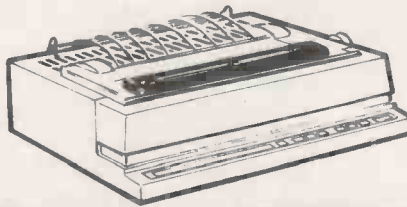
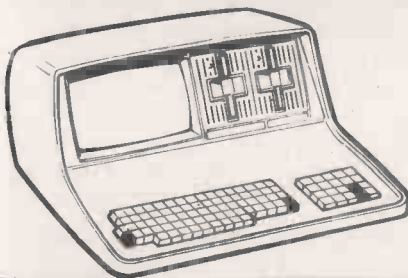

**Languages**  
 CIS COBOL ..... £425  
 FORMS-2 ..... £100  
 M-BASIC Interpreter ..... £175  
 M-BASIC Compiler ..... £195  
 CBASIC-2 ..... £75  
 FORTRAN-80 ..... £220  
 COBOL-80 ..... £345

**Communications**  
 TTY—Terminal Emulation/File  
 Transfer Link to mini  
 or mainframe (IBM, ICL,  
 DEC, Prime, etc) ..... £180

**Word Processing**  
 WordStar (version 3.0) ..... £260  
 Mailmerge (requires W'Star) ..... £80  
 SpellStar (requires W'Star) ..... £125  
 WordStar Upgrade (to 3.0) ..... £55

**Data Management**  
 DMS (Compsort) ..... £400  
 DataStar (input/update) ..... £195  
 SuperSort (sort/merge) ..... £125

**Financial Planning**  
 T/Maker (tables/reports) ..... £165  
 SuperCalc (Visicalc on CP/M) ..... £185

Call for latest prices of Superbrain, Diablo, NEC, TEC and Epson equipment.  
 Payment with order. Please add VAT and £2.00 postage & packing per item.

**Inchico Systems, 13 City Rd., Winchester, Hants SO23 8SD**

Tel. No. Winchester (0962) 51930



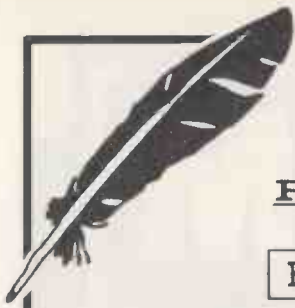

# WORDSWORTH

## Professional Word Processing

<\*> for the TRS-80 Models I and III <\*>

FROM PROSOFT, HOLLYWOOD, CALIFORNIA

Powerful editing and formatting features formerly available only on large IBM Time Sharing computers. Full Screen Editing, Typeahead, Headings, Pagination, Text Centring, Global Search and Change, Table of Contents and Indexing.

PLUS: underlining, <sub>sub</sub>scripts, <sup>super</sup>scripts and

**double-width.**

Proportional font right-margin justification on 737, 739, LP IV, DW II, all 12 MX-80 fonts + underlining, italics on the GRAFTRAX-80, and supports Diablo, Microline and Anadex printers. If your printer is capable, Newsprint can help you!

160 pages of CLEAR documentation will help you to get the best from your printer, whether you use TRSDOS, NEWDOS, NEWDOS/80, LDOS or DOSPLUS. Requires 48K TRS-80 with one disk drive. Specify Model I or III.

NEWSSCRIPT only £65.00 inc. p&p.

NEWSSCRIPT with MAILING LABELS £75.00 inc. p&p.

FASTER (analyses Basic programs to improve execution times)

£12.00. Model I and III on tape.

QUICK COMPRESS (removes blanks and REM's from software)

£9.00, Model I and III on tape.

FASTER and QUICK together £19.00.

We accept cheques or Access.

6 Grant Road Banchory, Kincardineshire, AB3 3UR. Tel. Banchory (033202) 4168.

# CITY MICROSYSTEMS LIMITED

65 LONDON WALL, LONDON EC2M 5TU

01-588 7272

## SUPERBRAIN®



320K, 680K and 1.5MB Diskdrives.  
Full graphics available.  
Wide range of standard packages.

## TELEVIDEO



Multi-user, Multi-task, Multi-processor  
Televideo reliability with  
complete expandability  
one to sixteen users

## VIDEO GENIE with VISICALC



Complete system £1275 inc Computer, Monitor  
Expander 1 Disk Drive & Software  
Vast library of standard software

COMPLETE BUSINESS ACCOUNTING SYSTEMS FROM £2000 WORD PROCESSORS FROM £1420

## ADVICE, TRAINING AND MAINTENANCE

ALL YOUR COMPUTER REQUIREMENT READILY AVAILABLE

IN THE CENTRE OF THE CITY-LONDON EC2

VISITORS TO OUR OFFICES MOST WELCOME 10.30am - 4.30pm

# TWICKENHAM

COMPUTER CENTRE LTD

With the best microcomputers available



commodore



ANADIX - EPSON - RICOH - ACCESSORIES - SOFTWARE - TANTEL

Special Christmas Offer

## NO VAT TO PAY

Yes! We will pay your V.A.T. on all cash sales from most of our range.

01 - 892 7896  
01 - 891 1612

TWICKENHAM COMPUTER  
CENTRE LIMITED

72, Heath Road Twickenham Middlesex TW1 4BW



## WHY YOU NEED THE INSPECTOR.

If you're serious about programming, you need to set all your utilities together in one place — *inside* your Apple. The Inspector comes on an Eprom that simply plugs into the D8 socket, or on a disk ready to merge with Integer Basic for automatic loading on boot. Either way, it stays at your fingertips, ready to call without disturbing your current program.

The Inspector puts you in total control of both memory and disks. You can search forward and backwards, edit, read nibbles, map disk space, dump the screen to a printer, examine every secret of your Apple. Use The Inspector to repair blown disks, undelete files, input "illegal" commands,

read and alter files, locate strings in memory or on disk. The uses are endless. The manual, alone, is an education. And it's always *there* when you need it.

You need the most powerful disk and memory utility available for your Apple. You need the Inspector.

See your local dealer, or order direct for just £45.00. Access or Visa accepted. Add £1.50 P & P. VAT excluded.



DDP RESEARCH & MARKETING

17 NOBEL SQ., BASILDON  
ESSEX SS13 1LP.  
TEL: (0268) 728484

Apple is a registered trademark of Apple Computer, Inc.



# I.A. SMALL ARM ROBOT



Runs PET, APPLE and other microcomputers.

**ROBOT** £349 + VAT  
**CONTROLLER** £148 + VAT

Microcomputers and Microsystems

Cambridge Road,  
Orwell, nr. Royston, Herts.  
Tel: Cambridge (0223) 207689

**INTELLIGENT ARTEFACTS LTD**

A wholly owned subsidiary of Sands Whiteley Research and Development Ltd.



I.A. SYSTEMS LTD.

Cambridgeshires  
Computer  
Specialist



- ★ OFF THE SHELF TURNKEY SYSTEMS BASED ON THE NORTH STAR HORIZON.
- ★ OVER 200 APPLICATIONS SOFTWARE TITLES INCLUDING WORD PROCESSING, ACCOUNTS, STOCK CONTROL, PAYE, DATALOGGING ETC.
- ★ DEVELOPMENT SYSTEMS WITH FULLY DOCUMENTED HARDWARE.
- ★ NORTH STAR DOS, CPM 2.2 AND FORTH READY CONFIGURED.
- ★ TRAINING AVAILABLE.
- ★ TOP QUALITY TERMINALS, DAISY WHEEL OR LETTER QUALITY DOT MATRIX PRINTERS.
- ★ RELIABLE PROVEN HARDWARE AND SOFTWARE GUARANTEED AND SUPPORTED FOR ONE YEAR.
- ★ MAINTENANCE CONTRACTS CAN BE ARRANGED.

CONTACT:

I.A.S., CAMBRIDGE ROAD, ORWELL, ROYSTON, HERTS.  
TEL: 0223 207689.

A SUBSIDIARY OF SANDS WHITELEY RESEARCH AND DEVELOPMENT.

SPOCK: "Computer! Calculate the value of Pi to ten thousand decimal places".  
COMPUTER: "Working..."

## CAN YOUR COMPUTER SPEAK?

The **WIDEBAND SPEAKEASY** speech synthesiser adds voice response to any computer with a parallel port including PET, APPLE, expanded ATOM, HORIZON etc.

for Only **£69 + VAT**

- \* UNLIMITED VOCABULARY
- \* EASY TO PROGRAM
- \* LOW MEMORY OVERHEAD
- \* COMPLETE MANUAL WITH DICTIONARY, SAMPLE SOFTWARE AND TUTORIAL ON SPEECH PRODUCTION.



Also includes high flux speaker and power supply, all housed in high quality wood cabinet, with volume control and rear pitch control.

Programmed with simple phonetic codes. Apart from the obvious applications of voice response in manufacturing, testing, blind terminals etc., this product also teaches a great deal about linguistics and speech production.

Software is available in BASIC and Z-80 and 6502 assembly for direct input in PHONETIC SPELLING closely related to the ARPABET international phonetic alphabet.

For your nearest dealer contact:

**WIDEBAND** PRODUCTS, CAMBRIDGE RD.,  
ORWELL, ROYSTON, HERTS. TEL: 0223 208017

A subsidiary of Sands-Whiteley Research and Development

**INTELLIGENT ARTEFACTS LTD**

JOIN THE FORTH REVOLUTION.

INTELLIGENT ARTEFACTS ARE THE UK SPECIALISTS  
IN FORTH SYSTEMS

Forth available for:

COMMODORE PET	£56 + VAT
TRS 80 (MMS FORTH)	£95 + VAT
NORTH STAR HORIZON (compact, fast, romable code)	£95 + VAT
NORTH STAR ADVANTAGE	£95 + VAT
CPM BASED MACHINES from	£95 + VAT
FORTH EVALUATION SYSTEM COMPRISING PET 4016 + 2031 DISK DRIVE + FIGFORTH — Bargain (Limited number available)	£699 complete + VAT

Books

USING FORTH	£25
STARTING FORTH	£16
FIG FORTH INSTALLATION MANUAL	£15
6809 FIG FORTH SOURCE LISTING	£15
BYTE — AUGUST 1980 FORTH SPECIAL ISSUE	£5

GIVE YOUR PET 300K OF VIRTUAL MEMORY AND SPEED UP PROCESSING  
BY A FACTOR OF 10, Z80 MACHINES BY A FACTOR OF 40.

INTELLIGENT ARTEFACTS LTD.  
Cambridge Road,  
Orwell, nr. Royston, Herts.

Tel: Cambridge (0223) 207689

# Environmental Equipments (Northern) Limited

- tel. 0270-626132

Environ House, 64 Welsh Row, Nantwich, Cheshire CW5 5ES.

## Seen any good plots lately??

The season of good will has just passed, but at E.E. (N).LTD it is still Christmas so give us a ring for the price, because you still have a surprise left

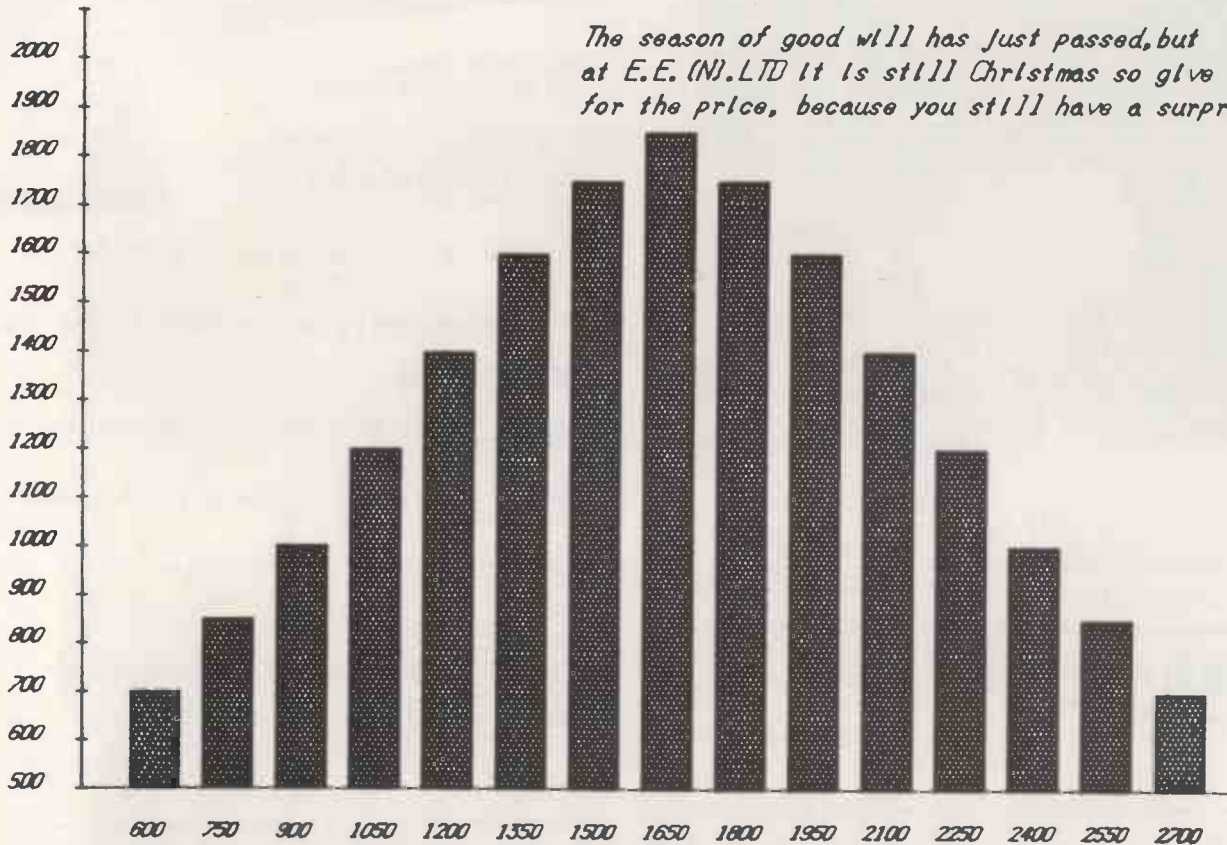

Good plotting begins with the right equipment—and the new range of Intelligent plotters, from Environmental Equipments Limited gives you the best against any other plotter on the market. You may already have one of our plotters DIGI-PLOT/MI PLOT so you will know that our prices are the most competitive. This new range of plotters are the big brothers to the digi-plot family, the size starts at A3 and goes up to A0, the number of pens begins at one and goes up to ten, but most important of all the new range has over forty commands i.e. CIRCLES, CURVES, HATCHING, DIGITIZING, ALPHA SCALE, etc. For more information on this new range of Intelligent plotters PLEASE GIVE US A CALL ON 0270 626132 /625115

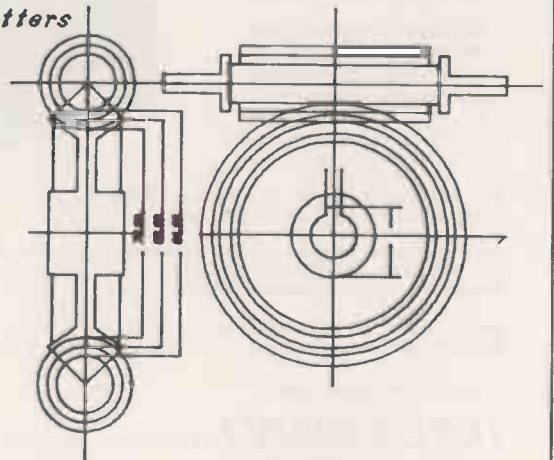

PS this complete advertisement was drawn on one of the new plotters (WX4636)

Drawn by K.D.F. CHARNLEY

WATANABE XY plotter WX4636 400/mm sec



# WOULD YOU LIKE TO START YOUR OWN SOFTWARE COMPANY?

At Superior Systems in Sheffield we have over 4000 sq ft of office space available in our building and would like to offer space at a fraction of normal costs. We are looking for up to 10 individuals interested in starting a software bureau associated with the hardware we sell (Apple, Sharp, Adler, BBC, Acorn, Video Genie, VIC). This will give obvious benefits to everyone involved.

Interested parties please contact,  
**MIKE MAHONY**  
 at  
 Superior Systems Ltd,  
 178 West Street, SHEFFIELD, S1 4ET

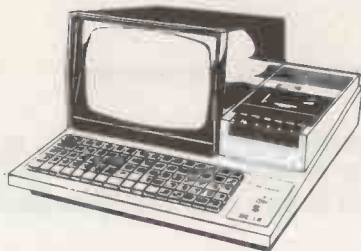

## Fighting your way through the silicon jungle?

We carry a comprehensive selection of microcomputer software, hardware and peripherals

Apple ][  
 Apple ///  
 Sharp 3201, MZ80B  
 Superbrain  
 Altos  
 Millbank System 10

Accounting  
 Stock Control  
 Database Management  
 Production Control  
 Graph Plotting  
 Word Processing

We are to you as Jane was to Tarzan!

Well, perhaps not quite, but please 'phone us for a brochure which explains exactly how we can help

**THE AVERY**  
**COMPUTER COMPANY**  
 13, The Mall  
 Bar Hill  
 CAMBRIDGE  
 Tel. Crafts Hill 80991 (24 hours)

# HOW TO GET SERIOUS ABOUT ZX GRAPHICS FOR ONLY £3.50

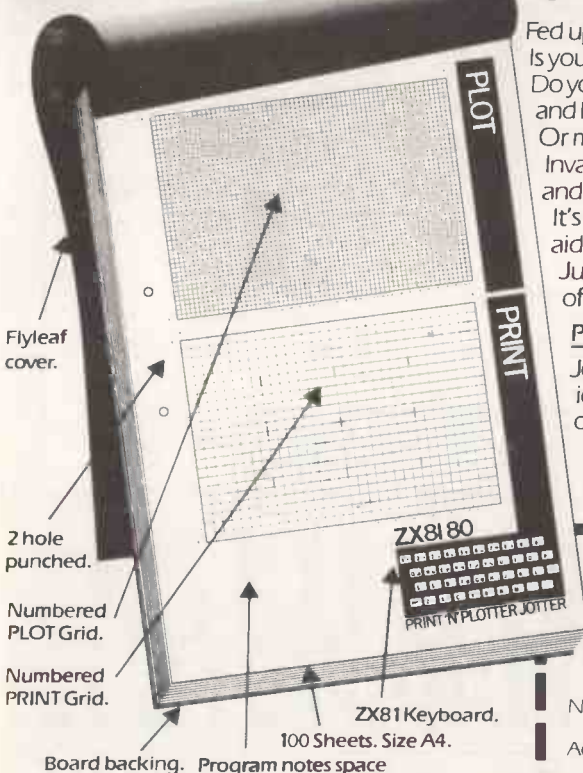

Fed up with listings that ignore the graphic approach? Is your PRINTING and PLOTTING still guesswork? Do you want to write data programs with graphic PRINT AT and PLOT and professional looking 'windows' and 'scrolls'? Or maybe you're still trying to find the successor to Space Invaders! All you need is ingenuity... and the **PRINT'N'PLOTTER JOTTER**.

It's the professionally-produced ZX Graphics-aid designed by enthusiasts... for enthusiasts. Just take a look at the specification - then think of the possibilities for **real** graphic graphics!

### PRINT'N'PLOTTER FILM TOO - FOR ONLY £2.25!

Jotter 'FILM' is a matt Polyester film version of the 'JOTTER' Grids identical in size so you can co-ordinate **precisely** PRINT and PLOT or you can copy photographs, drawings, maps, charts! The surface of the film is ideal for drawing (with pencil) and erasure.

With both JOTTER and FILM the graphics possibilities are enormous - despite low resolution. Isn't it time you got serious about ZX Graphics?



Post to Butler, Currie & Hook, 19 Borough High Street, London SE1 9SE.

Please send me \_\_\_\_\_ "Jotters" @ £3.50 (inc VAT, P&P)

Please send me \_\_\_\_\_ "Films" @ £2.25 (inc VAT, P&P)

Please send me your illustrated leaflet - I enclose a stamp.

Name \_\_\_\_\_

Address \_\_\_\_\_

Post Code \_\_\_\_\_

All goods are despatched within 48 hours of receipt.  
 If you require 1st Class return post please add 50p to "Jotter" price.

How to turn your ZX 81 into a powerful picture machine!



Also available 'over the counter' at  
 Denny's Booksellers, 2 Carthusian St., London EC1.  
 Buffer Micro Shop 374a Streatam High Rd. London SW16.

# This memory is made for your Atom

OR OTHER 1MHz 6502/6800/6809 SYSTEM

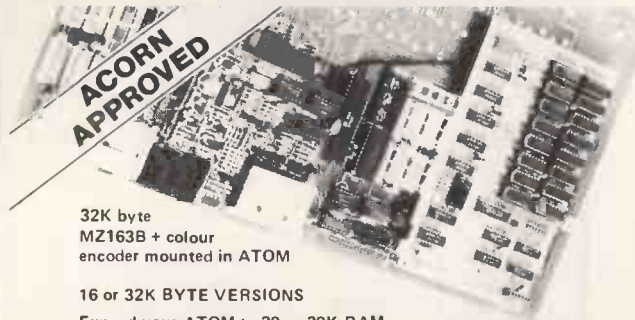

32K byte  
MZ163B + colour  
encoder mounted in ATOM

16 or 32K BYTE VERSIONS

Expand your ATOM to 28 or 38K RAM

Ideal for Word Processing, Chess programs and Business Software.

Fully Compatible with other Acorn ATOM software and hardware

Versions available to fit inside the ATOM while still leaving room for other extensions such as the Acorn ATOM colour encoder board. Eurocard rack mounting types also available

PRICES: INCLUDING U.K. P&P & 15% VAT

MZ163A 16K Built & tested to fit inside ATOM'S case	£59.50
MZ163B 32K " " " "	£74.00
MZ163C 16K Built & tested, Eurocard rack mounting	£62.00
MZ163D 32K " " " "	£76.50
MZ163E Bare PCB to build any of above with data	£23.00
MP100 DC/DC converter; powers any MZ163 board from unregulated 8V supply such as the ATOM mains adaptor	£8.50

S.A.E. for further details.



ALL PRICES INCLUDE U.K.P&P +15% VAT WHERE APPLICABLE. PAYMENT WITH ORDER PLEASE.

TIMEDATA LTD 57 Swallowdale, Basildon, Essex, SS16 5JG Tel; (0268) 411125 (MON-FRI)

# Books and bits for ZX, Atom

## The Explorer's Guide to the ZX81

IF YOU'VE GOT A ZX81 THEN YOU NEED THIS BOOK!

Programs for 1K RAM, and programs for 16K RAM. Games, Business and Engineering Applications. RAM & I/O Circuits. Useful ROM Routines. Hints and Tips. And Much Much More, for only

£4.95

**NEW!**

## The ZX80 Magic Book

\*With 8K ROM/ZX81 Supplement\*

Games programs, computer music, converting programs written in other BASICS, improving the picture RAM & I/O circuits, and much more.

£4.75

## Getting Acquainted with your ZX81

75 + programs including Draughts; by Tim Hartnell

£4.95

## Mastering Machine Code on your ZX80/80

180 pages of immense value to beginner and expert alike.

£5.95

## The Atom Magic Book

A wealth of games and other programs: storing speech in your ATOM, converting programs written in other BASICS tape recoding hints, and many more useful hardware tips.

£5.50

## Getting Acquainted with your Acorn Atom

By Tim Hartnell and Trevor Sharples. 80 programs including Draughts!

£7.95

## ZX & Atom IC's & Connectors

S.a.e. for list.

# TIMEDATA



## Metal cased 9" CROFTON MONITOR

10 MHZ Bandwidth  
P4 Standard  
£72.50 + VAT (£83.37)  
plus carriage £3.00  
For P31 (green) high  
resolution tube add £12.50 + VAT (£14.38)

## NEW Plastic cased 12" PRINCE MONITOR



High resolution  
24 MHZ Bandwidth  
P31 (green) Standard  
for only  
£110.00 + VAT  
(£126.50) plus  
carriage £3.00



ALL MAJOR CREDIT CARDS ACCEPTED - Small surcharge



CROFTON ELECTRONICS LTD

35 Grosvenor Road, Twickenham, Middx TW1 4AD  
01-891 1923/1513

# 6809 is HERE!

## HARDWARE

SWPTC and APPLE Distributors. '77-68'

A single board 6800 or 6809 system, that can be expanded into a full business system. Sold as bare printed circuit boards, with constructional notes.

'6800'	CPU	12.00
MON 1	Soft Monitor	12.00
MON 2	ROM Monitor	12.00
'6809'	CPU	12.00
CASSETTE	High Speed Interface	6.00
4K RAM	Static Memory	12.00
DYNAMAR	32K Dynamic Memory	12.00
VDU	Memory Mapped Screen	12.00
PIO	Parallel Interface	12.00
ROM A	8K-16K EPROM Memory	12.00
PROM PROG	EPROM Programmer	12.00
DISC CTRL	Disc Controller	12.00

## SOFTWARE

FLEX 9 for 6809 Systems, 5 1/4 or 8 inch Disks.

SORT/MERGE PACKAGE	69.00
DEBUG PACKAGE	69.00
UTILITIES	55.00
TEXT PROCESSOR	69.00
BASIC	62.00
EXTENDED BASIC	90.00
XBASIC PRECOMPILER	48.00
FLEX DIAGNOSTICS	62.00
GENERAL FLEX, Incl EDITOR and ASSEMBLER	120.00
CASSETTE SOFTWARE for 6800.	
SWTPC 4K BASIC	15.00
SWTPC 8K BASIC	20.00
TSC TEXT EDITOR	25.00
TSC ASSEMBLER	25.00
TSC TEXT PROCESSOR	30.00
TSC RELOCATOR	20.00

## BUSINESS SOFTWARE

'Visicalc' for the APPLE II. Price £125.00. 'TABULA RASA' for '6809'. Price £139.00.

Call or send for detailed information sheet and price list. Design Notes £1.00 each.

- Come in and try out any of these systems, or use our Mail Order service.
- All prices correct at time of going to press and include VAT at the current rate.
- Send for our latest catalogue and price list. Access and Visa accepted.
- Store Opening Hours, Monday to Saturday, 9.30 to 5.30.
- The '6809' Hardware and Software Specialist Store.

# STILLING MICROSYSTEMS

241 Baker Street, London NW1 6XE. Telephone: 01-486 7671.



# Software for CP/M™

## MICRO PRO

	LIST
Wordstar™ 3-X	£250
Mail Merge	£ 60
Data Star	£170
Supersort I	£120
Spellstar (USA dictionary)	£120
Calcstar	£150
<b>NEW</b> Compiler Systems CB 80	£280

(True Compiler)

## MICRO SOFT

	LIST
Basic-80 Interpreter	£150
Basic Compiler	£190
Fortran-80	£210
Cobol-80	£310

## MISC

		LIST
Compiler Systems	CBasic-2	£ 65
Sorcim	Pascal/M	£120
Sorcim	Supercalc	£170
Ashton Tate	d Base II	£380
<b>NEW</b> Ecosoft MicroStat		£150
Organic	Milestone	£160

(critical path)

CP/M is TM of Digital Research. WORDSTAR is TM of Micro Pro  
Other Products constantly being added to our range.  
Send large s.a.e. for latest list

### TRADE ENQUIRIES WELCOME

Ordering Instructions:  
Cash with order. Specify disk format.  
Add £3.00 per item P&P. Add 15% VAT

the  
**soft**  
option

PO BOX 11 CRANBROOK KENT  
TN17 2DF Tel: (058 080) 310

S.B.D. Software is proud to announce their distribution agreement with the most up to date APPLE-only magazine in America.

## CALL A.P.P.L.E. MAGAZINE

In today's fast changing world of the APPLE you just can't afford to stay behind, so don't settle for anything less than the best APPLE-only magazine in America.

Now you can purchase this outstanding magazine for the low price of £1.75 per issue.

Your subscription for 12 or 24 magazines may start from any month in 1981.

Single back issues are available at £2.25 per issue including postage and packing.

A bound volume of the issues in 1980, 1979, 1978 are available for £20.00, £15.00 and £10.00 respectively, including postage and packaging.

(Please note that in 1980 & 1981 there were only 9 issues published but in 1982 there will be 12 issues.)

CALL A.P.P.L.E. is ahead of any other APPLE publication for its technical information and evaluation of all hardware and software for the Apple.

For example:-

In the June 1981 issue CALL A.P.P.L.E. had already reviewed the new APPLE III.

In the July/August 1981 issue one of the topics in CALL A.P.P.L.E. was loading DOS 3.3 onto the Language Card.

In the September 1981 issue Word-Processing reviews have begun, they will continue reviewing 5 different word-processors until they run out of software to evaluate.

12 issues @ £21.00

24 issues @ £40.00

Europe Air Mail postage, add £6 per 12 issues

NAME .....

ADDRESS .....

TOWN .....

POSTCODE .....

Please start my subscription .....

Month Year

Barclaycard/Access Number Expiry Date

Please make cheques payable to CALL APPLE (UK)

Send to:- CALL APPLE (UK), c/o SBD Software,  
FREEPOST, RICHMOND,  
SURREY TW9 1BR  
(No postage stamp required)  
Telephone: 01-940 5194

The Famous Book

### "ALL ABOUT APPLESOFT"

Now available @ £9.50 incl. P. & P.

# MAKE 1982 THE YEAR YOU MASTER MACHINE LANGUAGE!

And do it easily with

## 'GETTING STARTED'

Mike Chalk's simple to understand first-steps instruction — with actual examples — into machine language programming.

## EDITOR, ASSEMBLER AND DEBUGGER

The renowned full-feature Editor Assembler and combined Debugger which gives you everything you need to program in machine language and completely debug. And unlike the others, it works on the Genie! £19.50

## SYSTEM MASTER MONITOR

Mike's own creation, far surpassing its American counterparts, allowing the disassembly of any system tape to be then loaded into the Editor Assembler to do with what you will! This is the program which allows complete relocation of any machine language program. £17

SAVE £7 ON THE COMPLETE PACKAGE AT £29.50



Programs for the Video Genie and TRS-80 straight from the publishers (we do not retail other people's programs). All programs thus in stock for our famed same-day first class post despatch — whether cheque or credit card — and fully guaranteed. Free catalogue upon request.

# Kansas

Kansas City Systems, Unit 3, Sutton Springs Wood, Chesterfield, S44 5XF. Tel. 0246 850357

## FREE SOUND WITH VIDEO GENIE

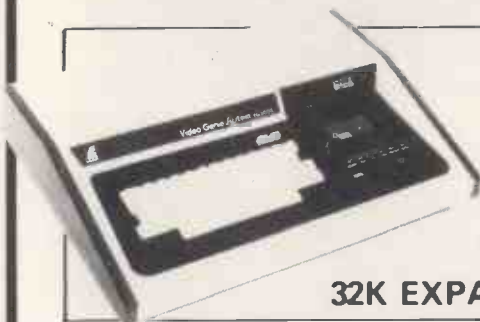

**NEW 32K GENIE I  
WITH UPPER/LOWER  
CASE AND SOUND!  
ONLY £299**

**32K EXPANSION BOX ONLY £189**

Centronics 737  
Proportional Spacing  
Dot Matrix Printer  
**ONLY £339**

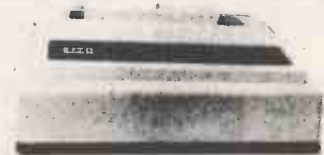

### MEMORY CHIP

4116 16k BIT DYNAMIC £0.79  
2114 4k BIT STATIC £0.89  
2114L 4k BIT STATIC £1.19  
PRICES EXCLUDE V.A.T.

### EPSON PRINTERS

MX80T — £329  
MX80F/T — £379

**DISC DRIVES FOR  
VIDEO GENIE  
(40 TRACK)  
SINGLE — £195  
DUAL — £380**

12 inch green screen metal monitors  
made by  
Bergquist & Hobberstad  
Copenhagen  
**ONLY £89**

**SEIKOSHA  
PRINTER  
NOW ONLY £179**  
PRICES EXCLUDE V.A.T.

**KRAM ELECTRONICS,  
VICTORIA HOUSE,  
17 HIGHCROSS ST.,  
LEICESTER.  
TEL. LEICESTER 27556**





# L&J COMPUTERS

192 HONEYPOT LANE, QUEENSBURY, STANMORE, MIDDX HA7 1EE. 01-204 7525



## THE "PET" SPECIALISTS

### GET THE BEST OF BOTH WORLDS!

WE CAN SUPPLY ALL YOUR 'PET' NEEDS AT CASH & CARRY PRICES

4032	40 Col. PET.	£585.00*	8050	IM Byte Disk	£755.00*
8032	80 Col. PET	£755.00*	4022	Printer	£357.00*
4040	347K Disk	£585.00*	8024	Printer	£975.00*

OR WE CAN SUPPLY, INSTALL AND TRAIN YOUR STAFF AT THE NORMAL PRICE WITHOUT ANY EXTRAS!!



**TRY US!  
YOU WILL NOT BE  
DISAPPOINTED**

### EXT CASSETTE DECKS (INC COUNTER & SOUNDBOX) £65 £55\*

<b>Printers</b>	<b>Disk Drives</b>	<b>Sundries</b>	
CBM 4022 & 8024	CBM 8050	Interfaces:	C12 Cassettes
Centronic 779	CBM 4040	Disks:	Library Cases
Centronic 737	CBM 3040	Paper:	(roll & tractor feed)
Spinwriter 5510		Labels:	Dust covers
CBM 8026 & 8027			

TOOL KITS (BASIC 2 & 4), SUPERCHIPS,  
.....AND ALL SORTS OF OTHER CHIPS.....  
UPGRADE YOUR PET EVEN MORE!!

THE "MUPETS" ARE HERE!  
3 TO 8 PETs ONLY NEED 1 DISK DRIVE...  
Daily demonstrations: Ring for details.

\* PRICES DO NOT INCLUDE VAT

### SOFTWARE

As well as a full range of Petsoft and Commodore Software, we have some highly reliable "Home-Brewed" programs available.

<b>STOCK CONTROL &amp; INVOICING</b>	<b>£60</b>
(Handles up to 500 items — 32K) (180 on 16K). Stock depleted on invoicing, search etc. Cassette, disk (& print option).	
<b>3000 item; 4040/8050</b>	<b>£125</b>
<b>CASH BOOK</b>	<b>£90</b>
Enter daily/weekly amounts — printout and totals, weekly/monthly analysis, totals and balances.	
<b>4032 &amp; 8032 versions</b>	<b>£110 &amp; £120</b>
<b>STOCK TAKING</b> for the licensing trade	<b>£240</b>
<b>OUTSIDE SERVICES</b> (For Mini-Cabs etc.)	<b>£220</b>

Sae for free software booklet

<b>VISICALC "OZZ"</b>	Commodore Business Programs
<b>COMPSOFT DMSV</b>	Bristol Trader, Item & Monitor
<b>ANAGRAM LEDGERS</b>	Superpay Word Processing.

COME AND SEE THE NEW **VIC-20** at £189 (inc VAT)

FULLY WORKING AND OPERATIONAL  
ASK US ABOUT ALL THE ADD-ON-GOODIES  
THAT GO WITH THE VIC ...!

PERSONAL SHOPPERS WELCOME  
Phone & Mail Orders accepted.

ALL GOODS SENT SAME DAY WHEREVER POSSIBLE  
LARGE S.A.E. FOR LISTS ETC.

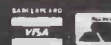

### NEW CASIO FP-10 MINI PRINTER

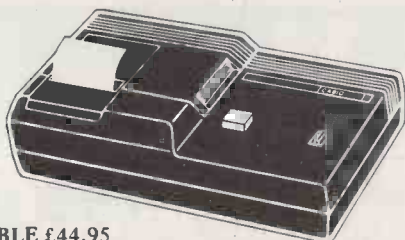

(RRP £49.95)  
AN INCREDIBLE £44.95

Compatible with the FX-501P, FX-502P, FX-601P, FX-602P and FX-702P Manual and program results printout. Memory and program listing.

FP-10 electric discharge mini printer. A remarkably clear 5x7 dot matrix printout of 20 characters per line. Up to 30 characters store/printout over 1½ lines, with overload symbol. Fast 2 lines/second print speed. Aluminised paper rolls are approx 2,500 lines/30 feet long. Connects directly to the calculator, or via FA-2 cassette interface. Four AA batteries will print approx 6,000-9,600 lines. Rechargeable pack NP-4M, 13,000 lines. (£6.90) AC adaptor AD-4140 will recharge NP-4M, in situ. (£5). Printer rolls £2.50 per pack of five. Dims: 43.5H x 156.5W x 82.5D (1¾" x 6¼" x 3¼") weight 372g (13.1 oz)

FX-602P. 512 program steps. With FREE MICROL PPP (£9.95) £74.95 FX-702P. Basic pocket computer. 1680 to 80 program steps, 26 to 226 memories, all non-volatile. FREE MICROL PPP. £119.95 MICROL PROCOS. Professional Programming solutions on tape £24.95.

DISCOUNTS ON SOFTWARE WHEN YOU BUY YOUR HARDWARE FROM US.

Catalogue of Casio calculators, keyboards and watches and further information on the 602P or 702P and PROCOS on request. (14p stamp).

Price includes VAT, P&P. Delivery normally by return. Send cheques, P.O. or phone your Access or Barclaycard number to:—

Dept PCW, 38 Burleigh Street,  
Cambridge. CB1 1DG.  
Tel: 0223 312866

# TEMPUS

**FREE**

**9" BLACK & WHITE  
MONITOR  
+  
32K ADD-ON RAM**

with every purchase of latest model of



Note: This is NOT a cheap U.S. import, but the genuine article backed up by the full one year warranty

You get:—

- Apple II europlus 16K (incl one year warranty)
- 32K Add-on memory \*\* FREE \*\*
- 9" Black & White monitor & cable \*\* FREE \*\*
- 3.3 DOS Disc drive & controller
- 2nd 3.3 Disc drive

(SYSTEM VALUE £1,684 + VAT + P&P = TOTAL PRICE £1,953)

for **£1412** + VAT + P.P. = TOTAL PRICE **£1640**



All prices correct at going to press. Allow 28 days delivery. CALLERS WELCOME. Send cheques, money order, bankers draft, cash with order to:

**CARLTON COMPUTERS LIMITED**

4 Swanstone Road Great Yarmouth Norfolk NR30 3NQ Tel: 01 Yarmouth (0493) 56906

**ATTENTION**

# NASCOM USERS

**ATTENTION**

Ikon Computer Products pioneers in product development have broken the £100 barrier in data storage systems.

The HOBBIT CASSETTE system is available at only £99 plus VAT. This ready built, but unboxed, data storage system is based on a Phillips Mini Cassette with drive unit, interface board, firmware (in 2 2708's), manual, cassette with 100K storage, transfer speed of 750 bytes/sec. The Hobbit is compatible with all Nascom Computers and Monitors.

**£99**

**IKON – Sophistication at a realistic price**

**£99**

£113.85 (incl. VAT) for the Hobbit Unit available from:

**IKON Computer Products**

**Kiln Lake**

**Laugharne**

**Carmarthen**

**DYFED**

**Tel: (099 421) 515**

## The RX 8000 Printer

**A HOST OF OUTSTANDING FEATURES  
AT A GREAT FINANCIAL SAVING!**



- Features ● Low Cost ● Excellent Printing Quality
  - Logic Seeking Carriage Control for Faster Output
  - 96 ASCII Character Set plus block graphics characters
  - Long Life Print Head 100 million characters minimum
  - Variety of Interfaces ● Paper Roll Carrier Optional
  - Tractor Feed Version includes friction feed facility
  - Centronics Version available now ● RS 232C Version available in February
- Order Code Friction Feed Version RX 8000 FF-CENT **£219**  
Tractor Feed Version RX 8000 TF-CENT **£238** VAT & CARRIAGE EXTRA

## Data Display Monitor

- Reliable Quality
  - High Revolution picture tube shows 1920 characters (18 x 24)
  - Lightweight and compact with controls
  - Easy operating for user
- 12 inch or 9 inch monitor  
**£125 + VAT** and carriage  
Quantity discount available

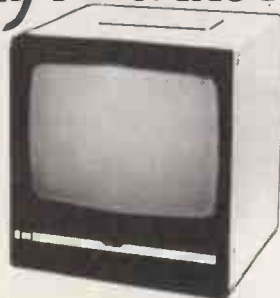

**STOTRON LIMITED**

Member of the Roxburgh Group of Companies.  
STOTRON LTD., 4A, Shilton Industrial Estate, Bulkington Road, Shilton, Coventry CV7 9JY  
Tel: 0203 613521  
STOTRON LTD., 72 Blackheath Road, Greenwich, London, SE10 80A Tel: 01691 2031  
STOTRON (HAYWARDS HEATH) LTD., 12 Bridge Road, Haywards Heath, West Sussex, RH16 1VA Tel: 0444 52550

For complete Specifications or demonstrations, Write or call today.

NAME \_\_\_\_\_

ADDRESS \_\_\_\_\_

\_\_\_\_\_

\_\_\_\_\_

\_\_\_\_\_

\_\_\_\_\_

PCW 2/82



## MICROS MEMORIES TTLs AND INTERFACE DEVICES

Z80	£3.70	6800	£3.70	6502	£4.50
Z80A	£4.50	6802	£4.25	6502A	£6.00
8085A		6809	£10.00	2650A	£12.00
Z80CTC	£3.00	8205	£2.20	6522	£5.00
Z80ACTC	£3.50	8212	£1.60	6532	£8.00
Z80DMA	£10.00	8216	£1.60	6821	£1.60
Z80ADMA	£12.00	8224	£2.50	6845	£7.75
Z80 ADART	£8.00	8228	£2.50	6850	£1.60
Z80 PIO	£3.00	8251	£3.50	6852	£2.50
Z80A PIO	£3.50	8255	£3.50	6875	£6.00
Z80 SIO-1	£20.00	8279	£9.50		

Large range of PERIPHERAL devices available.

### SPECIAL OFFERS

	1-24	25-99	100
2114Low Power - 450ns	£1.00	£0.90	£0.85
2114Low Power - 200ns	£1.10	£1.00	£0.90
2716 (+5v)	£2.25	£2.10	£2.00
2732 (+5v)	£4.80	£4.50	£4.00
2532 (+5v)	£4.50	£4.00	£3.75
4116 - 200ns	£0.75	£0.70	£0.65
6116/3 - 150ns	£6.50	£6.00	£5.80

## MICRO TRAINER NANOCOMP

(as described in W.W. 17 January 81)

Based on 6502 processor & 8 ICs, this micro computer provided up to 4K EPROM, 1K RAM, PIA & 6 digit display & 8 monitor commands. Although designed as a trainer kit, it can be used as a desktop computer or a software development tool. Spare EPROM space allows applications for dedicated control.

Kit c/w 2K Programmed EPROM monitor, all other ICs & skts, pcbs for cassette interface & PSU & case £72.00 + £1.50 p&p 6502 Prog. Ref Manual £5.50 + 0.80p p&p (no vat)

## ACORN ATOM

A personal computer supplied with full size QWERTY keyboard and a UHF modulator for connection to a domestic TV. Basic unit is 2K RAM & 8K ROM expandable to 12K + 12K.

Basic kit £120 Built & Tested £150 Fully expanded £198 p&p £2.50 Power supply 5v 1.8A £10.20 5v 3A £22 + £1.20 p&p 4K Floating Point ROM 1K RAM (2 x 2114 low power) £2.00 6522 VIA £5.00

64K Dynamic RAM Card (fits into Atom case) 200mA at 5v Kit £87.50 Ready Built & Tested £95.00

### ATOM SOFTWARE

Games Pack 1-10, SOFT VDU, Maths Pack 1, Data Base, Desk Diary, Chess, Word Tutor, Adventures £10 ea.

ATOM FORTH with manual £16 Word Pack ROM £26

Invaders £7.00, Fr. m/c, Breakout, UFO Bomber, Disassembler £3.50 ea.

### ATOM CONNECTORS:

2 x 32 Way Plug £3.00 Skt £4.00 26 Way Plug £2.00 Skt £2.00

## ADD SOUND TO YOUR ZX80/81 ZX80/81 USER PORT

(Described in PCW Oct/Nov 81)

Port module plugs directly into 2 x 80 or ZX81 to provide 8 input and 8 output lines. These allow input of data from switches, photocells, sensors, joysticks etc. VARIABLE TONE AUDIO OUTPUT can produce YOUR OWN SOUND EFFECTS, additionally output can be used for control of up to 8 relays, 7 segment displays or LEDs. Port access is by simple PEEK & POKE commands.

READY BUILT & TESTED UNIT £14.95 + 70p for P&P

Reprints of PCW articles £1 + large SAE For ZX81 users, extender card for mounting RAM PACK provided F.O.C.

## UK101: INTERFACING COMPUKIT

### A TWO BOARD HARDWARE INTERFACE

DECODING MODULE: plugs into UK101/OH1011 socket to provide 16 bit user port plus a wide variety of decoding lines for interfaces (incl. full decoding for AY3-8910/12 PSG) and a 40 pin skt for further expansion. Kit Price £27.50

ANALOGUE BOARD: interfaces with Decoding Module to provide D/A Converter, 8 channel multiplexed A/D converter. AY3-8910 PSG plus 6522 via allow complex timing & complex timing functions plus 16 bit port. Kit Price £39.95

Reprint of PE articles £1.50 + large SAE.

## MEMORY EXPANSION PCB

A low price versatile compact memory expansion PCB suitable for 6502 based computers like ATOM, UK101 & SUPERBOARD. PCB layout fully buffered & decoded. Expansion capability of 8k RAM + 4, 8 or 16k ROM or 16k RAM. (for ATOM 5k RAM + up to 16k ROM or 13k RAM). PCB: £11.50

PLEASE ADD P & P 40p AND VAT AT 15% SEND SAE FOR DETAILED PRICE LIST.

# TECHNOMATIC LIMITED

Colleges, Govt etc. orders welcome.

Barclaycard & Access orders accepted.

### SHOPS:

15 Burnley Road, London NW10  
305 Edgware Road, London W2.  
Tel. 01-723 0233

### MAIL ORDERS:

17 Burnley Road, London NW10  
Tel. 01-452 1500/  
450 6597  
TLX 922800

## S.B.D. SOFTWARE

15, Jocelyn Road, Richmond TW9 2TJ.  
Tel: 01-948 0461. Telex: 22861

### PURCHASE YOUR COMPLETE APPLE II COMPUTER SYSTEM FOR THE LOWEST PRICE IN THE U.K.

- 1 APPLE II EURO PLUS 48K
- 1 DISK DRIVE WITH CONTROLLER
- 1 DISK DRIVE WITHOUT CONTROLLER
- 1 HITACHI 10" MONITOR
- 1 EPSON MX-80FT PRINTER + INTERFACE
- 1 MAGIC WINDOW WORD PROCESSOR
- 1 BASIC MAILER
- 1 VISICALC 3.3
- 1 DAN PAYMAR LOWER CASE ADAPTOR
- 1 BOX OF DISKETTES

ALL ITEMS GUARANTEED 1 YEAR  
ALL MANUALS INCLUDED  
LIMITED QUANTITIES AVAILABLE! HURRY!  
ALL FOR ONLY £1,975.00  
CREDIT CARD SALES ADD 3%

## BUSINESS SOFTWARE

MAGIC WINDOW, BASIC MAILER, DAN PAYMAR - All 3 for £145.00.

MAGIC WINDOW will instantly convert your Apple system into a word-processor, no modification or fancy gadgets to buy. Magic Window's 4-way scrolling allows you to type up to 80 CHARACTERS per line, will show you exactly how your letter will be printed. Inserting, deleting, centering, you can see it all on the screen. £79.95

BASIC MAILER is a mailing list merge system design to take MAGIC WINDOW documents, files and replace names, addresses or any other sections of the document with individual data, creating customised letters, invoices, etc. £49.95

DAN PAYMAR lower case adaptor. £39.95

VISICALC 3.3 THE UPGRADED VERSION £99.00

VISIDEX A most useful cross-reference of information. £99.00

VISILOT Plot your data onto high-res. graphs. £75.00

BRAIN SURGEON Thoroughly test your Apple II. £30.00

D.B. MASTER Computed fields, Statistical Analysis £130.00

## UTILITIES

EXPEDITER II At last you can compile your Applesoft programs into machine code and watch it run 2-20 times faster. £75.00

CRAE Co-Resident Applesoft Editor. Anyone writing software on the apple needs this editor. £19.95

CRAE & MCAT £29.95

SUPER DISK COPY III The most versatile copy program on the market. Initialize a diskette with or without DOS sectors. Copy files one by one or the entire disk. View the catalog and then see a display of the diskettes free and used sectors. Copy DOS 3.2 to 3.3 and visa-versa, many other commands. £24.95

APPLEGUARD Protect against bit copiers, protect your software. £200.00

AOPT - APPLESOFT OPTIMIZER, remove REM's. Pack as many instructions as possible per line. £19.95

APLUS - STRUCTURED BASIC. Write programs in a structured manner with your new additional commands and then compile into a regular APPLESOFT program. £19.95

DOS PLUS. Three new DOS Commands built-in 5 commands are user-definable. You can now FLIP easily between DOS 3.3/3.2 from within the program. Also DOS Command Editor. Edit the names of the DOS commands and initialize disks with your own DOS. £19.95

DISK RECOVERY Scan your disks and mark faulty tracks so they are not used. Also able to REDO VTOC which may re-cover your messed-up disk. £24.94

BACK-IT-UP Bit copier to back-up your protected software. £50.00

## ARCADE GAMES

Space Warrior	£12.95	Star Mines	£14.95
Alien Rain	£12.95	Apple Panic	£14.95
Snoggle	£12.95	Sneakers	£17.95
Demon Derby	£12.95	Raster Blaster	£17.95
Galaxy Wars	£12.95	Star Thief	£17.95
Gobbler	£12.95	Space Quarkes	£17.95
Star Cruiser	£12.95	Missile Defence	£17.95
Allen Typhoon	£13.95	Pegasus II	£17.95
Space Eggs	£14.95	Threshold	£19.95
Autobahn	£14.95	Epoch	£19.95

## ADVENTURE GAMES

Mission Asteroid	£9.95	Ulysses & the golden fleece	£17.95
Mystery House	£12.95	Oldorf's Revenge	£11.95
The Wizard & The Princess	£17.95	Tarturian	£14.95
Cranston Manor	£17.95	Creature Venture	£14.95
Soft Porn Adventure	£17.95	Wizardry	£25.00

## CARD & SPORT GAMES

German Whist	£9.95	Cribbage	£12.95
International Grand-Prix	£16.95	Pool 1.5	£18.95
Draw Poker	£14.95	Hi-Res Soccer	£22.95

## STRATEGY GAMES

Galactic Empire	£12.95	Tawala's Last Redoubt	£14.95
Galactic Trader	£12.95	Golden Mountain	£9.95
Galactic Revolution	£12.95	Kubic	£9.95

Add 15% VAT. Postage and Packing Free.  
Dealer enquiries welcome.

Write or phone for full catalogue of available software.

# SHARP

# MZ80K

Personal Computer

## BETTER THAN EVER VALUE

48K RAM with  
BASIC (cassette)

### £335

Many extras can be added such as discs, printer, CP/M operating system, PASCAL, FORTH, games and business software, etc.

Phone or S.A.E. for current list.

PC1211 POCKET COMPUTER

### £74

CE122 PRINTER for PC1211

### £60

ORDER NOW

Add V.A.T.

01-643 4290

at 15%



Delivery extra.

## Croydon Mikros

202 Stanley Park Road, Carshalton, Surrey SM5 3JP

## A NEW MICRO TIME MODULE

A REAL TIME BATTERY SUPPORTED CALENDAR  
CLOCK MODULE FOR YOUR TANDY OR  
VIDEO GENIE MICROCOMPUTER AT A

### REALISTIC PRICE

### £69.25

includes delivery and VAT

Place your order now or contact for further information



JOHN BIRKWOOD ASSOCIATES  
WYVERN HOUSE, 49 STATION ROAD, BILLINGSHURST,  
W. SUSSEX. TELEPHONE (040381) 3813

Imperial College of Science  
and Technology  
University of London

## Microcomputers in Chemical Instrumentation

The second and third of these intensive five day courses will be held from Monday to Friday March 29th - April 2nd 1982 and September 20th - 24th 1982. The course is designed for those concerned with data acquisition and the control of instruments in the laboratory who need to gain first hand experience of the revolutionary impact of microcomputers on laboratory practice. No previous experience of computing is required.

The course includes 12 lectures and seminars, but most of the time is spent gaining 'hands-on' experience in the micro-computing laboratory. All instruction is in basic. After a review of the use and economics of microcomputers the subjects covered include interfacing, choice of programming languages, word processing and the choice of peripherals.

The course fee is £300 including lunches, tea and coffee and the course notes (250 pages). For details and an application form write or phone Dr N. Goddard, Chemistry Microprocessor Unit, Department of Chemistry, Imperial College, London SW7 2AY. Phone 01-589 5111 Ext. 1269 or 1200.

## A PROMISE AND A GUARANTEE!

To the personal and business computer user.

The most professional service, guidance and

help. Plus the keenest prices in the business!

Ring us last for the best quote of all!

## ELFTON LTD

MICROSYSTEMS

(0429) 61770



## INGENIOUS Genie I

All the features of the EG3003 system plus: \* Machine Language Monitor  
\* Fitted Sound \* Renumber Command  
\* Full Lower Case \* Screen Print

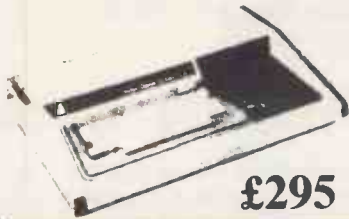

16K

£295 + VAT

The most compact 80 column  
impact graphic-dot  
printer available

at a very compact price

## seikoha GP80 printer

£195 + VAT

## Genie II

The MacroComputer

Offering all the advantages of the Genie I system, with the benefit of advanced design for the professional user.

- \* 4 Defineable Function Keys
- \* Full Upper & Lower Case
- \* Terminal Routines
- \* Facility to upload & Download
- \* Screen Print
- \* Includes T.V. Modulator

£299 + VAT

## Acorn Atom

Special features include

- \* FULL SIZED KEYBOARD
- \* ASSEMBLER AND BASIC
- \* HIGH RESOLUTION COLOUR GRAPHICS

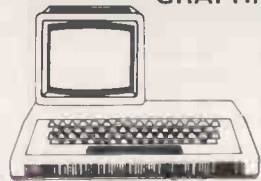

from:

£120

+ VAT

The Second Generation  
Personal Computer  
**Highest performance**

- \* 48K
- \* 16 Colours
- \* Multiple Resolution Graphics
- \* Split screen modes

**lowest price**

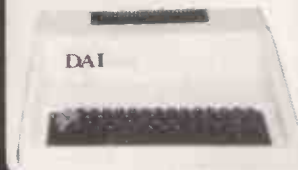

**DAI**

£595

+ VAT

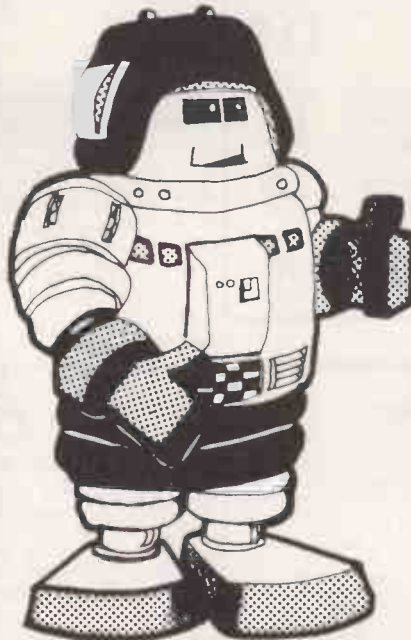

## TANTEL

'PRESTEL'  
adaptor

Converts any black  
and white or  
colour T.V.  
for 'PRESTEL'  
reception.

£170 + VAT

## Printers

EPSON MX80  
EPSON MX100  
ANADEX  
PAPER TIGER  
T.E.C.  
SCRIPTA  
MICROLINE 80

## EG3023

Special adaptor to  
allow connection of  
TRS 80 to GENIE  
peripherals

## EG3014

GENIE low cost 16K  
expander

FOR

PAPER

DISK-  
ETTES

BITS

RIBBONS  
for most  
printers

BOOKS

LABELS

SOFT-  
WARE

LATEST  
SECOND  
- HAND  
PRICES  
Ring: 0225-  
334659

MONITORS

all this and  
much much  
more . . . .

# MicroStyle

29 Belvedere, Lansdown Road, Bath.  
Telephone: (0225) 334659.





## CRAB SOFTWARE

(for the TRS-80;  
Level II)

### CRAB ALGOL INTERPRETER

Based on ALGOL W (developed by Niklaus Wirth) CRAB ALGOL offers the best features of block structured, high level languages and as an interpreted language, CRAB ALGOL is an ideal tool for developing powerful programs. Included amongst the features of this extensive language are:

- Data modes; Integers (2-100 bytes length), logical, strings, ref (pointer), records (any number of fields), dynamic arrays.
- Functions and procedures; recursive definitions, any number of parameters (value, result & value-result)
- Statements; IF, REPEAT, WHILE, FOR, CASE etc.

-all fully implemented

- m/c link & memory access; CALL, GET, PUT
- Standard functions; SIGN, ASC, RND, STR, INKEY etc.
- Full tape I/O; user definable I/O; multi-speed scrolling; repeating keyboard; definable cursor etc.

Send S.A.E. for further details £75.00

### CRAB MACHINE CODE DEVELOPMENT SOFTWARE: CRAB ASSEMBLER

Features all the usual assembler functions, but with compressed storage can assemble programs 40% longer than with EDTASM. Includes complete documentation for Z80 instruction set. £10.00

### CRAB DIS-ASSEMBLER

Fully comprehensive dis-assembler producing source tapes compatible with the CRAB ASSEMBLER. £6.00

Both above programs £14.00

All three programs above will run on the MODEL III

Make cheques/postal orders payable to: CRAB SOFTWARE. Orders, by post only, to: CRAB SOFTWARE

Prices are completely inclusive. 10% discount on orders over £15. 2, PONDWICK RD.

Send S.A.E. for full software list HARPENDEN HERTS AL5 2HG



# MACRONICS

## ZX81

26 Spiers Close  
Knowle, Solihull  
West Midlands  
B93 9ES England

## ZX80



**1K Space Intruders £5.00**  
**3K Super Version £6.00**

Written in machine code to give fast moving 'Flicker Free' graphics. A superb achievement.

Supplied on cassette with listing



**16K High Resolution £4.00**  
**(192 x 184) graphic pictures**

Never before achieved on the ZX. Create your own artwork.

Supplied on cassette with listing and demonstration picture

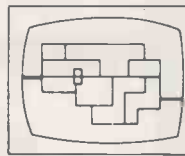

**9K Nightmare Park £3.75**

The park of DEATH - can you get through this nightmare. No human has yet succeeded. Confronted by all sorts of 'Happenings' you'll be taken to your wits end.

Supplied on cassette only

Specify 4K, 8K ROM or ZX81 when ordering.

### NEW INTERACTIVE GRAPHICS for the 16k ZX81

**DRAGON MAZE** ... are you cunning enough to evade the dragon? you are impeded by darkness; the walls are only displayed when you make a bad move, this gives the dragon an advantage. You have to play by the rules - the dragon breaks them when he gets angry. Fun for all ages!

Cassette and listing ..... £5.00 (for ZX81 only)

### SINCLAIR ZX81

ZX81 built + mains adaptor £60.83 (Post £2.95 extra).

### PRINTERS

Buy any of the below and get a free interface kit and word processor program for UK101 or Superboard. Seikosha GP80A £199. Centronics 737 £335. OKI Microline 80 £295. OKI Microline 82A £399. Epson MX70T £259. Epson MX80T £359. Epson MX80F/T1 £399. Epson MX80F/T2 £449.



### UK101 AND SUPERBOARD

UK101 with 1K and free power supply and modulator built £149. The below accessories suit both the UK101 and Superboard:— Extra ram £2.70 per K. 16K memory expansion complete kit £50, built £58. 32K memory expansion kit £74, built £82. Case £27. Cassette recorder £19. Cesmon £22.50. Wemon £19.95.

Assembler/Editor tape £25. Word processor program £10. Centronics interface kit £10. 610 expansion board £179. Cased minifloppy disc drive with DOS £275. Cassette recorder £19. The below suit only Superboard:— Colour adaptor board built £45. Guard band kit £10. Series 1 only 30 lines x 50 characters display expansion kit £14. UK101 display expansion kit £14.

### ACORN ATOM

Kit £120, built £150.

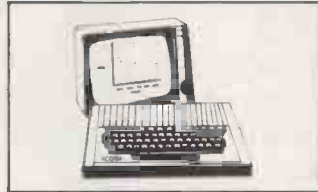

### SHARP COMPUTERS

MZ80K 20K £380, 36K £394, 48K £408. PC1211 £82. 46 sample programs for £15. We can supply any Epson printer to run direct from the MZ80K without i/o box for £39 plus printer price.

### VIC 20 COMPUTER

£165 with free cables to suit a normal cassette recorder, free high definition graphics and free machine code monitor. 3K ram £26.04. 8K ram £39.09. 16K ram £65.17. Expander + high res 1211M £30.39. Vic printer £199.



### 5V POWER KITS

Fully stabilized 5V computer and TTL power kits. Short circuit and over-voltage protection 1.5A £7.83, 3A £12.17, 6A £20.

### SWANLEY ELECTRONICS

Dept PCW, 32 Goldsel Rd, Swanley,  
Kent BR8 8EZ.  
Tel Swanley (0322) 64851

### VIDEO GENIE £279

EG3014 Expansion box with 16K/32K ram £189/£197. Disk drive £205. Colour board £34.95. Parallel printer interface £32. Monitors: EG100 white £69. OVM9PGR green £95. Sound kit £8. Lower case kit £26.

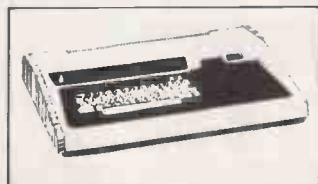

Postage £3.50 on computers, £4.50 on printers and 45p on other orders. Lists 27p post free. Please add VAT to all prices. Official credit orders welcome.

AT LAST!

## YOUR OWN COMPUTER PAPER

1000 single part forms up to 11" x 9 1/2" for £86+VAT!

Until now you could only buy huge quantities, paid the earth for it and waited, seemingly, for ever. Now we can offer you your own bespoke business forms (invoices, pay-slips, letterheads etc.) in really low quantities at economical prices, delivered in three weeks if necessary.

### PRICE LIST

No job is too big or too small (format or run) or too complicated, but the following list should help. The rates include artwork and proofs.

1000 single part forms, printed black on white paper, sizes up to 11" x 9 1/2"	£86.00
Per thousand extra copies	£19.50
1000 two part NCR forms, printed black on white/pink paper, sizes up to 11" x 9 1/2"	£119.50
Per thousand extra sets	£46.00

Prices include delivery but not VAT

60gm <sup>2</sup> Plain listing paper, size up to and including 11" x 9 1/2"	
250 copies	£2.35
500 copies	£4.36
1000 copies	£8.06
2000 copies	£14.78

Delivery is £1.95 for each 2000 sheets or under. Prices exclude VAT

### HOW TO ORDER

It's very simple. All you do is take a print-out from your computer to show the position of text, and write on it the printing you require, attaching a black print of your company logos or symbols etc. Send it to us with your remittance. We will send you a proof within one working week, and then upon receipt of your authorisation, we can print your forms within two weeks.

If you need any further information, please send us a SAE, or contact Simon Bedford-Roberts on Cambridge (0223) 69665

Call Printers (St. Ives) Ltd.  
8a The Pavement, St. Ives, Huntingdon, Cambs PE17 4AD





# MICRO-PRINT LTD

**59, CHURCH STREET, STOKE ON TRENT, ST4 1DQ  
TELEPHONE (0782) 48348**

## FOR THE BEST SELECTION OF **COMPUTER BOOKS**

**NORMALLY OVER 150 TITLES IN STOCK.**

**FAST SERVICE  
MAIL ORDER 80p post per book  
24 hour Telephone ordering  
Send Large S.A.E. for List.**

## Does your microcomputer suffer from hiccups?

If so, quite often the cause of irregular performance or breakdown is very simple.

It's probably a high voltage spike in the electricity supply, called a transient, affecting the performance. Heavy electrical loads in the vicinity of your microcomputer (from domestic electrical appliances to office photo-copiers) can often cause voltage transients, which in turn, play havoc with both hardware and software.

The Reguvolt 'P' Model Constant Voltage Transformer provides the answer to a very simple yet aggravating problem, offering the following benefits to safeguard your supply sensitive computer and equipment.

- Transient suppression — gives software and hardware protection.
- Brownout protection — prevents micro interruptions and system crashes.
- Isolated secondary circuitry — gives complete electrical isolation between mains and computer.
- Fast voltage stabilisation — prevents VDU screen drift and complete system failure.



- Automatic overload current limited — protects equipment against damage during a fault condition.
- Low frequency mains harmonics removed, preventing VDU flicker and circuit overload.

The complete range of Reguvolt 'P' models, from 1/2 to 2 amp ratings (ie. 120VA to 500VA) are available from stock.

Should you require further details, please fill in the coupon, or, if you prefer, give us a call.



**Cetronic Limited**

Hoddesdon Road, Stanstead Abbots,  
Ware, Herts SG12 8EJ, England

Tel: Ware (0920) 871077 Telex: 817293

Please send me further information on your range of Reguvolt 'P' Model Constant Voltage Transformers.

Name .....

Company .....

Address .....

Telephone .....

PCW

# Micropro Software at less cost than Micropro Software!

## CALCSTAR™

FOR BUDGET PLANS, SALES FORECASTS, CASH FLOW ANALYSIS, AND FOR EVALUATING THE POTENTIAL EFFECT OF FINANCIAL DECISIONS.



## INFOSTAR™

THE POWERFUL REPORT GENERATOR, TO TAKE THE PLACE OF CONVENTIONAL PROGRAMMING LANGUAGE IN BUSINESS APPLICATIONS IN AREAS ONLY PREVIOUSLY ACCESSIBLE THROUGH MINIS AND MAINFRAMES.



## DATASTAR™

THE POWERFUL COMPREHENSIVE DATA ENTRY RETRIEVAL AND UPDATE SYSTEM FOR MICRO SYSTEMS.



## SPELLSTAR™

"PROOFREADER" ON A DISK - A SPELLING CHECKER PROGRAM THAT WORKS WITH WORDSTAR™ TO IDENTIFY SPELLING ERROR IN CONTEXT.



## WORDSTAR™

THE SCREEN ORIENTATED INTEGRATED WORD PROCESSING SYSTEM SPECIFICALLY DESIGNED FOR NON-TECHNICAL PERSONNEL.



## SUPERSORT™

SUPERIOR SORTING, MERGING AND SELECTING POWER WITH UNMATCHED SPEED AND CONVENIENCE.



## MAILMERGE™

THE POWERFUL FILE MERGING TOOL



This discount offer is available for a limited period only-Please tick appropriate box and send the correct remittance to the address below before March 31st 1982.



GRAHAM DORIAN SOFTWARE SYSTEMS LTD. Unit 58, Suttons Park Avenue, Earley, Reading, Berks. RG6 1XZ. 0734-664343/6

### CP/M PRICES

### APPLE PRICES

	REC. RETAIL PRICE	GDSS DISCOUNT PRICE	MANUAL	REC. RETAIL PRICE	GDSS DISCOUNT PRICE	MANUAL
<input type="checkbox"/> WORDSTAR	£285.00	£195.00	£25.00	£215.00	£145.00	£25.00
<input type="checkbox"/> MAILMERGE	£ 85.00	£ 55.00	£15.00	£ 70.00	£ 50.00	£15.00
<input type="checkbox"/> SPELLSTAR	£145.00	£105.00	£15.00	£115.00	£ 75.00	£15.00
<input type="checkbox"/> DATASTAR	£200.00	£150.00	£25.00	-----	-----	-----
<input type="checkbox"/> SUPERSORT I	£145.00	£105.00	£20.00	£115.00	£ 80.00	£20.00
<input type="checkbox"/> SUPERSORT II	£115.00	£ 80.00	£20.00	-----	-----	-----
<input type="checkbox"/> INFOSTAR	NOT	YET	RELEASED	-----	-----	-----
<input type="checkbox"/> CALCSTAR	£170.00	£120.00	£20.00	£140.00	£ 75.00	£20.00
<input type="checkbox"/> WORDMASTER	£ 85.00	£ 60.00	£20.00	N.A.	N.A.	N.A.

●Price of software includes manual. If manual purchased initially, 100% credit if software purchased subsequently ● Calcstar, Datastar, Wordstar, Mailmerge, Supersort, Spellstar, Infostar and Wordmaster are all Trademarks of MicroPro International Corp. ● Prices do not include VAT and are subject to change without notice.



# THE STYLIST

a high quality daisy wheel printer



**£695**  
+VAT

- V24/RS232 interface
- Proportional spacing
- Bidirectional / logic seeking
- Wide range of type styles and international languages

Trade/OEM Discounts available

Write or call for further information:  
Butel-Comco Limited, Garrick Industrial Centre, Garrick Road, London NW9 6AQ. Telephone: 01-202 0262.

**BUTEL**  
Technology for business

**STCS**  
S T Commercial Systems Ltd

## Brain Specialists

**Simplify all your accounting  
Sales, Purchases, Invoicing,  
Payroll, Stock control  
VAT Reports  
Even Trial balances and  
P & L Accounts**

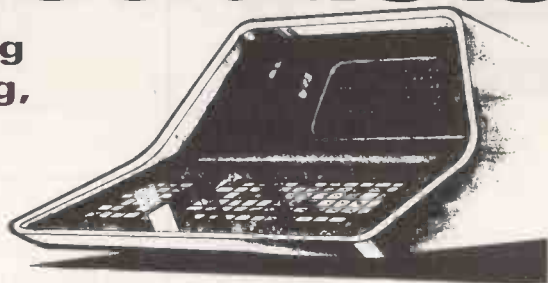

**SuperBrain can work as a word processor  
Provide All Tektronix type graphics  
and even emulate a Tektronix terminal.**

- Communications to most mainframes and MINIS
- Runs IBM "BISYNC" protocol emulating 3270s or 2780s.
- Programming languages include PASCAL FORTRAN BASIC COBOL!
- Disk capacities from 360K to 10M bytes ● Prices from **£1695** plus VAT
- Full range of C.P/M. software and peripherals
- NEC spinwriters. EPSON printer MICROPRO software
- **DEALERS BEST DISCOUNTS**
- We also sell CROMEMCO and North Star Hardware.

26 New Broadway, Ealing, London W5  
Telephone: 01-840 1926



SELLING YOUR COMPUTER.  
UPGRADING – PART EXCHANGE YOUR SYSTEM.  
LOOKING FOR A NEW OR USED COMPUTER.  
SEARCHING FOR A SUITABLE SUPPLIER.



COMPUTE A COMPUTER WITH

# KELLYS COMPUTER MARKET

## 01-659-7997

New APPLE 48k £595  
Refurbished ITT2020  
Used 5¼ floppies

New ACORN ATOM – Ring for details  
Used Computers – printers – Peripherals etc.  
Software for all. Bespoke + off the shelf.

### NEW

ELECTRONIC TILL. Everything for the small BUSINESS. INSTANT STOCK UPDATE, Invoice printer, daybook, VAT Calculations, Posting, Accounts, Low Stock Warning, Reorder printing, Visual verification of Inputs, Transactions analysis, Remote keypad + VDU. INCLUDING PRINTER from £2700.

All prices exclude VAT and Carriage

PARAGON HOUSE, 46 KENT HOUSE LANE, Beckenham, KENT

### APPLE II AUTOSTART EUROPLUS AT REDUCED PRICES



48K  
£599.95  
+ VAT

12 MONTHS WARRANTY

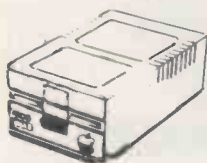

Apple  
Disk II  
3.3 DOS  
Disc with  
controller  
£339 + VAT

ADDITIONAL DISK DRIVE £279 + VAT

## SHARP MZ-80K

There's a lot to consider when you want a computer – For you and your wife? Are you sure it'll suit her? We'll match you up with the best of machines... Like Sharp and the Apple. The best is at Dean's

When you're spending money it really is nice To get first-rate service and good sound advice. For business or finance or just playing games DEAN'S, Sharp and Apple-three very good names.

Our special this month, Sharp's MZ-80K They've expanded the memory to 48K And for your peace of mind, a two-year guarantee. Just £395 (that includes VAT!)

So remember the place where you should go first To figure out that new program you've cursed. Software and books (there's Hi-fi here too) It's DEAN'S for computers – and computers for you.



2 YEARS Parts + Labour Guarantee on MZ-80K Supplied BY DEANS

£395.00 inc VAT



SHARP  
PC1211  
£69.95  
+ VAT

CE122 INTERFACE PRINTER £59.95  
CE121 CASSETTE INTERFACE £10.95

CASIO VL TONE £30.40  
+ VAT



MUSICAL INSTRUMENT  
A computerised synthesiser that helps you create, play and arrange composition.

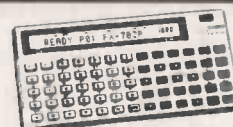

CASIO  
FX-702P  
£114.95

High speed computer  
Using Basic language - Input can be varied from 1680 program steps, with 26 independent memories

CREDIT FACILITIES AVAILABLE  
SAE FOR FURTHER INFORMATION

WE HOLD LARGEST STOCK  
OF COMPUTER BOOKS  
CARRIAGE AT COST SURCHARGE  
ON CREDIT CARD



NEW

TANTEL  
ONLY  
£159 + VAT

PRESTEL SHOWROOM  
Demonstration available  
180,000 pages of up to date information at your fingers, tips for business and home.

DEANS of Kensington

Bring this voucher to qualify for the discount

WEST END SHOWROOM AND MAIL ORDER (Open 24 hours 7 days a week)

191 KENSINGTON HIGH STREET, LONDON W8  
Telephone: 01-937 7896 ext 5





# KAI



Apple is a trade mark of Apple Computer Inc. Cupertino C.A. USA

When you have decided that **Apple** means business for you, what next?

We believe most businessmen would ask 3 key questions . . .

1 Where can I get the best service and back up?  
**KAI**

2 Where can I get the best deal?  
**KAI**

3 Who will deliver promptly?  
**KAI**

Computation Automation Information is a NEW breed of Business Microcomputer Store dedicated to meeting the needs of today's **Micro Managers**. Our professional standards and willingness to serve ensures that our clients receive the very best attention.

We are specialists in:

- ★ Financial Planning & Modelling
- ★ Accounting, Invoicing & Stock Control
- ★ Project Control & Costing
- ★ Word Processing & Mailing
- ★ Database & Bespoke Programming

At **KAI** we have an excellent choice of **Apple** accessories and package software to meet most business requirements. In addition we stock a comprehensive range of printers, disks, print wheels, ribbons and other micro supplies.

Equipment rental, service and repair. Consultancy, training and on going support — all available under one roof.

**KAI** offers you the choice between our **Full Service** or our **Over-the-Counter** package.

The **Full Service** package is designed for first time micro users who can benefit from having the system installed and tested, staff trained and operational support in the early stages.

Very competitive discounts are available for **Over-the-Counter** sales. For example:

#### **KAI Business Pack**

Apple II Europlus 48K, Disk Drive with Controller (DOS 3.3), Disk Drive, 12" Green Screen Monitor, Epson MX80FT with Interface, Visicalc (3.3), Desktop Plan II, Appleplot, Applewriter and Hi Tech Information Master-Database.

£1999.00 + VAT

Offer subject to availability, sale terms and conditions.

#### **FIND OUT MORE**

Telephone, write or leave a message today

**KOMPUTATION AUTOMATION INFORMATION LTD**  
203A Belsize Road, London NW6  
Telephone  
01 328 7038 01 328 3968  
24 hour personal answering service 01 486 4808

# TOMORROW TODAY

## at Birmingham Computer Centre

Commodore official distributors



12 months warranty



All models now with new large screens

4008-16-32 PETs  
-8032 -8050 -8096

The reliable value for money system with after sales support, instruction and training facilities and a wide range of programmes.



12 months warranty



48K Disk drive with controller  
£1075 + VAT

Apple authorised distributors  
The sophisticated quality system with a reputation for advanced design and innovation.



12 months warranty



The incredible computer system.  
Now available ex-stock including the new dual drive double sided floppy disk.



64K FROM £1650

DEALER ENQUIRIES WELCOME

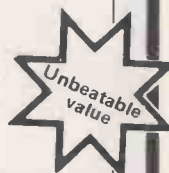

Camden Electronics Ltd.  
462 Coventry Road, Small Heath,  
Birmingham B10 0UG.  
Telephone 021 773 8240  
Telex 335909 (Camden G)  
Open Mon.-Sat. 9.30-6.00 p.m.



A MEMBER OF THE COMPUTER RETAILERS ASSOCIATION



# COMPUTECH for Apple

## Authorised dealer, service centre and system consultancy

### SUCCESS BREEDS SUCCESS!

As authorised dealer and service centre for Apple computers we have acquired extensive experience of users' needs and the most cost effective means of satisfying them from the considerable resources of this popular and reliable machine. Over 1,000 of our financial accounting packages have been installed. In the process we have detected areas of special need and opportunities for enhancing these resources. Our own manufactured hardware and system software have been produced to meet these requirements. As a result we have compatible products for all configurations of Apple II and ITT 2020 installations - and the new Apple /// !

<b>Apple /// now on demonstration - systems from</b>	<b>£1,645</b>
<b>Pro-File 5 MB mass storage for Apple ///</b>	<b>£2,256</b>
<b>Computech mass storage for Apple II and Apple ///, up to 12 MB, from</b>	<b>£1,950</b>

### COMPUTECH SOFTWARE AND HARDWARE INCLUDES:

**Payroll** for 350 employees, 100 departments, all pay periods, printed payslips, approved year end documents, very quick and easy to use, **£375**. **Sales, Purchases and General Ledgers** **£295** each, detailed statements. **Job Costing and Group Consolidation** are amongst many and various applications of the **General Ledger** package, which supports values to totals of one thousand million accurate to a penny! Our **Utilities Disk** available like other packages in 13 sector or 16 sector format, is widely used for reliable, error checking, copying, including single drive, and the renowned **DPATCH** program beloved of programmers for **£20**. We have developed a **Terminal Utilities** package which enables Apple to Apple and Apple to mainframe communications with local processing and storage as well as Apple to host communications from the amazingly low price of **£130**. Our **Graphics Utilities** program for use with the **Microline** and **Epson** families of printers enable the plain paper production on low cost printers of high resolution screen pictures, graphs etc. - free with **Microlines** or **£30** separately. **Keyboard Driver** enables the use of our **Lower Case** adaptor with BASIC programs and **Applewriter Patches** supplied **FREE** with our character generator package (total cost **£50**) is separately available on disk with documents for **£10**. At the same price **CAI** (convert Apple pictures for ITT) makes binary high resolution picture files display properly on the ITT 2020. We sell the famous **Visicalc** for **£111** and have delivered systems using it to do amazing things like production control, shipping accounts and stocks and shares valuations! The versatile **Applewriter** word-processing package at only **£39**, especially employed with our **Lower Case Character Generator** is widely used by people who cannot type to produce word-perfect copy! Experience with Apple systems has led to the design and manufacture of compatible products with enhanced features at very favourable prices to satisfy users' needs. These include the **Diplomat Serial Interface** which has handshaking capability and switchable options (**£80**), the **Diplomat Parallel Interface** which enables the direct use of text and graphics with the **Microline** and **Epson** printers and is a complete 'plug in and go' item with gold-plated edge-connector at **£80** and has optional direct connection for **Centronics 730/737** printers. Our new **Diplomat Communications Card** at **£95** is a sophisticated peripheral especially suitable for Apple to mainframe communications at high speeds in full duplex mode with switch selectable bit rates and other options. The **Lower Case** adaptor is available for Apples (revision 7 and earlier) as well as ITT 2020, complete with diskette software for **£50**. It offers true descenders on screen and the £ sign. We also have an **Optional Character Generator** for the ever popular **Microline M80** at **£15**. This provides £ sign and improved digits and lower case characters with USASCII special symbols. Our price for the **Microline M80**, with graphics, 40, 80 and 132 characters per line, friction, sprocket and teleprinter feed, is only **£295**, amazing for this small, quiet reliable 'look alike' printer. Tractor option is **£40** and **Serial Adaptor** **£80**. The **Microline M82**, bidirectional printer with both parallel and serial input is only **£345**, it can have an optional 2K buffer, while the **Microline M83** full width adjustable tractor 120 cps printer with similar specification is only **£595**. Then for all computer users there is the unique **Micromux** which from **£800** provides up to 16 ports for simultaneous independent serial asynchronous communications! Telephone for data sheets or to arrange a demonstration or for the address of our nearest dealer. Please hurry - the demand for our products has been such that some have been temporarily out of stock. We offer the effective low cost solutions you need. **Prices exclude V.A.T., carriage and packing.**

## COMPUTECH SYSTEMS

168, Finchley Road, London NW3 6HP. Tel: 01-794 0202

AGENTS THROUGHOUT THE UK AND OVERSEAS

**NEW**

# Business Disk

The versatile program that will help every small businessman.  
**THE PROGRAM YOU LEAVE IN YOUR PET COMPUTER ALL DAY.**

BUSINESS DISK combines an easy-to-use wordprocessor with a filing system, electronic jotters, desk diary, and much more. Very powerful searching/editing functions. Wordprocessor can use information from any of your files. Print totals of conditional searches. **TOTALLY FLEXIBLE** and easy to set up to suit your exact requirements. Change your mind later? Easy to alter/create sub-files/etc. You can be halfway through editing a letter; go to your product file to look up some prices; print out an invoice for someone who wants to pay cash; and then continue editing your letter! Free leaflet gives full details of this advanced program which will run on the 8032 PET. Extensive User Handbook available separately for £15 (refundable).

Costs £350+ VAT

OBM Dealer enquiries welcome. This is the program all your 8032 customers will want; and you'll find many uses for it yourself. Demonstration pack available soon for £30.

How have we managed to get what is virtually a small S<sup>1</sup> c<sup>n</sup> Off<sup>c</sup> into a 32K PET? By writing all the commonly used subroutines in very efficient machine code and putting these in ROM. These are also available separately and you can write simply BASIC programs to use these superb subroutines. The ROM is called the **Business ROM** and costs £120 plus VAT. Full details on request.

**ROM Pager:** A small board that fits neatly inside PET and allows up to 8 different ROMs to be fitted at once. Fitted in seconds, software controlled; price £45 plus VAT.

**EPROM PROGRAMMER:** Very many facilities including disassembler; programs ALL common EPROMS £250 plus VAT. (2532 EPROMs from £5.50.....10 off)

**Assemblers:** Complete easy-to-use packages for ALL PET's, including 80 column. Disk or cassette. From £25 plus VAT.

**Accessories:** Floppy Disks; Paper; USA Software (eg VISICALC £99); and other PET products. All software is post free. Send for free catalogues. Demonstrations any time.

We also sell VIC and have some exciting software on the way!

**JCL SOFTWARE**  
47 London Road, Southborough,  
Tunbridge Wells, Kent.  
Tel: (0892) 27454

**REPRODESIGN**  
131 Market Street, Chorley,  
Lancashire  
Tel (02572) 78376

## Fuller FD System for ZX80/81

The Fuller FD System is not a ZX80 81 'add on' but uses the micro board at the heart of a more powerful system, allowing the user to expand with the system or stop with a standard keyboard & case and using existing Sinclair 16K RAM pack etc. either way you only need a screwdriver to assemble the built items, the FD Keyboard simply plugs into the ZX81 which is screwed in position in the FD case, ZX80 installation requires soldering to the keyboard, we will carry out this work at a fixed charge of £10. SAE will bring you details of our products. Have your ZX81 Kit built by us FREE when you buy The FD Keyboard, Case and Power Supply at £42.95 + £2.25 p & p

- FD Keyboard Kit £18.95
- FD Keyboard Built £24.95
- FD 16K RAM Board £39.95
- Above items + 80p p & p
- FD Keyboard / Motherboard add £15.95 to Keyboard price
- FD Case £11.75 + £1.25 p & p

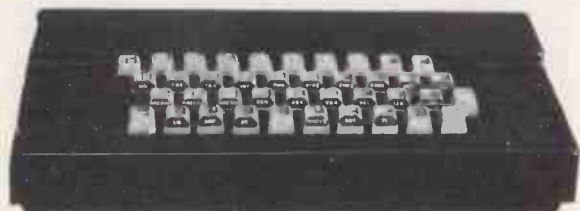

To Fuller Micro Systems  
The ZX Computer Centre  
Sweeting Street  
Liverpool, 2  
Phone (051) 236 6109  
tick ZX 80  81

Please send me  
I enclose a cheque / po for  
Name  
Address



# NASCOM USERS

Take a look at the NASCOM APPROVED HS-IN STORAGE SYSTEM. Where else can you get features like these . . .

- \* **A full on screen instant display of the catalogue.**
- \* **Auto verification of each file as it is written.**
- \* **CRC error checking.**
- \* **Link selectable 2Mhz or 4Mhz option.**
- \* **Fast data transfer rate of 6000 bps.**
- \* **Powered from NASBUS.**
- \* **8" sq NASBUS compatible PCB.**
- \* **Far more reliable than any floppy disk system.**
- \* **112K on-line storage with 2 drive system.**

The HS-IN has a Command Set which makes it a floppy-disk "look-alike". It can load an 8K program in under 11 seconds and can store up to 56K (28 files) on each side of tape. Why spend £700 on a floppy disk system when the less expensive HS-IN system has a command set like this . . .

- B— Write a Basic file**
- C— Instant display of catalogue.**
- D— Delete file.**
- J— Jump to Basic.**
- N— Jump to NAS-SYS.**
- Q— Warm start to NASPEN text editor.**
- R— Read a file.**
- T— Transfer file to another drive.**
- W— Write a file.**

**X— Exit and rewind cassettes.**

**Z— Warm start to Basic.**

This Mini-Cassette Storage System is technologically far ahead of anything like it on the market and is extremely reliable into the bargain. AND THE COST? Because we have been successful in quantity component purchases we have been able to lower the price until January 31st 1982 (the old price is in brackets).

Single Drive System built and tested **£199 (€230)**  
 Double Drive System built and tested **£279 (€299)**

Carriage **£3.50.**

We are Scotland's foremost NASCOM Dealers and keep in stock the full range of NASCOM products as described in the Lucas Logic Advert in this magazine. For the Christmas period and up to January 31st 1982 we are offering a **FREE Statistical Calculator** (without battery) with every NASCOM product worth more than £100 or each series of NASCOM products with a value totalling £100 or more in the same order. AND if you don't want the calculator . . . just 'phone and see if we have something else you need FREE – a book perhaps!

We now have the new NASCOM CASE in stock as well as many more new NASCOM related products.

## COMPONENTS AT THE BEST PRICES IN BRITAIN

MICRO-SPARES now have a vast selection of Logic I.C.'s including 74; 74LS and CMOS full range. There are Z80's and support chips as well as resistors, capacitors etc. etc. . . . far too many to list on this page. But to give you an idea of the prices just compare these . . .

	<b>1-199</b>	<b>200 +</b>	
<b>2114's (all speeds) Low</b>	<b>93p</b>	<b>POA</b>	
<b>4116's (all speeds) power</b>	<b>62p</b>	<b>POA</b>	

<b>2708's</b>	<b>1.73p</b>	<b>POA</b>
<b>2716's Single + 5v</b>	<b>2.12p</b>	<b>POA</b>
<b>4118's</b>	<b>3.80p</b>	<b>POA</b>

All components are fully guaranteed and are in stock as at 15th December 1981. Orders under £30 please add 50p p. & p. VAT not included. Send SAE for current price list. Official orders from all establishments welcome.

**All components in stock sent same day.**

## NEW

Very shortly now MICRO-SPARES will be selling the all computer RS232C version of the HS-IN. The Mini-Cassette System is just as fast and files can be any length. The machine can be connected to computers, V.D.U.'s, Printers and

and other RS232C device. They will take the place of paper tape in loading engineer test programs for instance. Other communication modes are 20mA current loop, IEEE and Z80 bus.

## SECOND HAND COMPUTERS

MICRO-SPARES keep a register of users that are buying or selling a computer. Stocks of second-hand machines – all in working order – are

available from the very small to the very large at extremely keen prices.



# Micro-Spares

19 Roseburn Terrace, Edinburgh EH12 5NG.  
Tel: 031-337 5611.



# Compare & Save

**apple**  
europlus



£ call + VAT

Complete 48K with Games  
Paddles — 12 Months Warranty  
Disc Drive with 3.3 Controller £ call  
Disc Drive without Controller £ call

## EPSON MX-80F/T

£359+ VAT

80 CHARACTERS / SECOND  
3-WAY PAPER HANDLING  
CORRESPONDENCE QUALITY PRINTING  
VERSATILE INTERFACE OPTION  
FULL 96 ASCII WITH DESCENDERS

Epson MX80F/T2 Hi-Res £399  
Epson MX100 Hi-Res Printer £517

## 12" GREEN MONITORS



## UNBEATABLE VALUE AT £95

- Green display
- Stable display — Low Distortion
- Video Response — over 11MHz
- Instant action — fast warm-up
- Complete with video cable + 13 amp plug

VisiCalc II (Dos 3.3)	£99
VisiPlot	£89
VisiDex	£99
VisiFile **NEW**	£130
DB Master Data Base	£109
Data Plot	£49
SuperText II Word Processor	£125
Address Book Mailing List	£40
Form Letter Module (S/Text+Add Bk)	£80

CIS-COBOL with Forms-2	£450
Apple Pascal Language System	£225
Apple FORTRAN	£99

U-RAM 16k-RAM Card	£86
U-Z80 Processor Card	£86
Microsoft Z80 Softcard/Disks etc	£175
Games Socket Extender	£9

GAMES	
Anti Ballistic Missiles	£17
Global War	£17
Three Mile Island	£25
Galactic Wars	£16
Apple Adventure	£18

Send for list of games for Apple II  
Disks (Wabash/BASF) per 10 £17.50

PLEASE REMEMBER TO ADD 15% VAT



FREEPOST, 68 ALMA RD,  
BRISTOL BS8 2YY  
TEL: 0272 - 737555

## TEC STARWRITER

£1188 (40 CPS) \* 40 or 55 Chrs/sec  
£1549 (55 CPS) Bidirectional

- \* 2K BUFFER STANDARD
- \* AUTOMATIC PROPORTIONAL SPACING
- \* LOGIC SEEKING AND SPACE SKIPPING
- \* DOUBLE PRINT, BOLD PRINT, AUTOMATIC UNDERLINING
- \* HORIZONTAL TABULATION, REVERSE PLATEN FEED, GRAPHICS
- \* STANDARD 96 CHARACTER SET, DIABLO OR GORE PRINT WHEELS
- \* SERIAL RS232C or 8 BIT PARALLEL ICENTRONICS!

## MICROSAVE

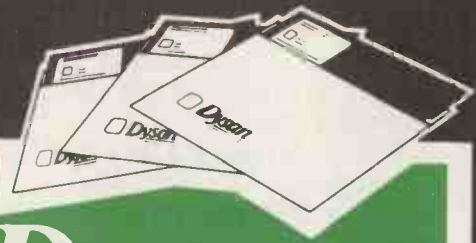

# Dysan

## The better diskette for your system

## - Ask Anyone

TELEPHONE  
Farnborough (0252) 517171  
FOR FURTHER INFORMATION

## HAL COMPUTERS LIMITED

# Personal Computer Palace



£367



£299

INC. CARRIAGE, FREE SOUND  
AND DUST COVER

## Video Genie

The Video Genie is the modern answer to programming problems. Powerful BASIC compatible with TRS-80.

INC.  
V.A.T.

## PRICE BREAKERS

... C12 cassettes £3.50/ten  
+ £1.40 p&p ... quality Verbatim disks (Apple, Pet, Genie &c.) £17.00/ten + £1.00 p&p ... 2000 sheets printer paper 11"x9.5" £14.00 + £2.00 p&p ... 'egly' box for ten disks £1.80 + 40p p&p ...

EPSON  
MX80F/T  
printer  
£440

Many other great offers are available from the friendly computer shop with unbeatable service. Phone or write for more information/order form.

Super Space Invader II  
2 player hand-held  
game of skill and  
dexterity.

£35  
£22

PRICES LAST DURING JANUARY ONLY

All our equipment is guaranteed for one year, parts and labour, by the Personal Computer Palace Servicing Scheme.

Goods are despatched same day as order received, where possible.

6 Castle Street  
Reading, Berkshire  
Tel: (0734) 589249



2nd Edition  
**The BASIC Handbook**  
Encyclopedia of the BASIC Computer Language  
by David A. Lien

Makes Program Conversion From One Computer to another - EASY!

only  
£13.95

Program Conversion for :-  
ACORN ATOM · SINCLAIR · APPLE · TRS-80 · ATARI  
IBM · PET · ABC-80 · SHARP · NEC · HEATH  
HEWLETT-PACKARD · SYSTEM 80 · DEC · APF  
NORTHSTAR · MAXBASIC · T.I. · WANG · VARIAN  
ANSI · OHIO

The computer industry has experienced tremendous change over the last three years. Hundreds of new computers have been introduced since the worldwide top-selling BASIC Handbook was first released.

But the Second Edition meets the challenge head on. Documenting every significant BASIC word used by practically every BASIC-speaking computer. So if you don't have the BASIC Handbook: You need it.

Get it from your local bookshop or micro-store now! Or, alternatively, write to the address below and we'll send you the name of your nearest stockist.

Dept.PCW,

## The Computer Bookshop

30 Lincoln Road, Olton,  
Birmingham B27 6PA Tel:021-707 7544



The Computer Bookshop is the exclusive U.K. Distributor for "The Basic Handbook"

RETAILERS - WE OFFER FAST DELIVERY EX-STOCK



# Hard Disks for the PET

The Small Systems **HARDBOX** acts as an intelligent controller for up to 4 Corvus Winchester drives or one SSE Mini Winchester drive unit.

- PET DOS 1 and 2 compatibility
- Multi user capability on Corvus Drives
- 16 Megabyte max file size
- 65535 max records per relative file
- Over 2000 files on 5 MB drive

## CORVUS DRIVES

Well proven systems with nationwide support and maintenance.

- 5, 10, 20MB capacity
- Up to 4 drives can be daisy chained
- Backup onto standard video cassette using the Mirror unit
- Up to 64 users with the Constellation multiplexer unit.

5MB Corvus drive	£2295
10MB	£3595
20MB	£4495
Mirror back up unit	£495
Constellation	£495

## SSE MINI WINCHESTER

Drive and Hardbox or Softbox housed in one small desktop unit. Single user.

Prices inc. Integral Hardbox

3MB	£2300
6MB	£2500
12MB	£2800

Add £120 for Integral Softbox

## SOFTBOX and CP/M SOFTWARE

**SOFTBOX** allows the PET to run the worlds most popular operating system for micros. Operates with PET floppies and/or a Hard disk system.

Comprehensive range of CP/M software available - ask for our Catalogue

Softbox	£550
RS232 Option	£45
Corvus Option	£65

## IEEE-488 INTERFACES

Comprehensive range for PET and HP-85 e.g. B300 RS232 Bi-directional 40 char buffer, full hand shake

£186

## RICOH DAISY WHEEL PRINTERS

Letter quality, 60CPS with integral IEEE, RS232 or Centronics interfaces.

RP1600	£1450
Flowriter	£1795
Large Buffer. Qume/Diablo compatible Bidirectional printing	

## S100-CP/M SOFTWARE DEVELOPMENT TOOLS FOR INDUSTRY

8048 famly in circuit emulator	£150
8748 programmer	£395
Prom emulator	£295
Range of cross assemblers for most popular micros	£95
8048 BASIC compiler	£195

## COMPLETE PET and HP-85 SYSTEMS

Telex 264538

**small  
systems  
engineering  
limited**

2-4 Canfield Place - London-NW6 3BT  
Telephone 01-328 7145/6 Telex 264538

# THE SIGN OF HADRIN A HUNT FOR REAL TREASURE

Hadrin was a magician who lived in the time of Merlin.

Lost in history and long forgotten, his trail was picked up by a fighter pilot during the first world war.

Following it is not easy. It will mean decoding messages, consulting books, looking up references and tracing long forgotten documents.

There is also some witchcraft involved!

★ ★ ★

You can only start part two with a chance, if you have successfully completed part one.

As there is real treasure involved, we intend to send the first disk out on receipt of your order, whilst we shall send out the second disks in batches at the same date in the near future, so that everybody has the same chances of discovering Hadrin's tomb and take possession of the (VERY REAL!) treasure.

**A new concept in games with real treasure at the end.**



Runs on Apple 48K

£29.50 Remittance to:  
**HOLDCO LTD**  
14, Britton Street,  
London EC1M 5NQ  
01-253 9060

**SCOOP  
ONLY  
£29.95  
+VAT.**

- BRITISH MADE
- 52 KEY 7 BIT ASCII CODED
- POSITIVE STROBE +5V - 12V
- ASCII CHARACTERS
- PARALLEL OUTPUT WITH STROBE
- POWER LIGHT ON CONTROL
- CHIP BY GENERAL INSTRUMENT (G I)
- TTL OUTPUT
- SUPERBLY MADE SIZE 13 x 5.5 x 1.5 ins
- BLACK KEYS WITH WHITE LEDGNS



The 'CHERRY' Computer Keyboard

Ideal for use with TANGERINE, TRITON, TUSCAN, APPLE and most computers. Ex-Stock from HENRY'S  
This is definitely the BEST BUY FULLY GUARANTEED. Supplied BRAND NEW in manufacturers original packing. Just post remittance total £35.95 (incl. VAT & Post)

## The 'Apple' Power Supply

A PROFESSIONAL BUILT & TESTED, CASED & VENTILATED POWER UNIT WITH BUILT IN OVERLOAD & CUT OUT PROTECTION CIRCUITS

**SPECIFICATIONS**  
Input voltage 210-250v  
Supply voltages +5.0, +11.8, -12.0, -5.2  
Power consumption 60 watts max (full load)  
Full load power output +5v 2.5 amp, -5v 250ma, -12v 1.5 amp, -12v 250ma  
Size 10" x 3 3/4" x 2 1/2"  
Weight (Approx) 3 lbs

Complete with full data & information -  
Supplied brand new

The Apple Power Supply is a high-voltage "switching" power supply. While most other power supplies use a large transformer with many windings to convert the input voltage into many lesser voltages and then rectify and regulate these lesser voltages, the Apple Power Supply first converts the AC line voltage into a DC voltage, and then uses this DC voltage to drive a high-frequency oscillator. The output of this oscillator is fed into a small transformer with many windings. The voltages on the secondary windings are then regulated.  
**PREVENTS DAMAGE & RETURNS UNIT TO NORMAL WORKING CONDITIONS**

Suitable for use with most computers



LIST PRICE £60  
**OUR PRICE £32.50 + VAT**  
Just post remittance £39.50 (includes VAT post & packing) for delivery by return

## TANGERINE APPROVED CHIPS

2102 450 n/s.....	£1.00
2114 300 n/s.....	£1.75
4116 200 n/s.....	£1.50
2732 450 n/s.....	£7.50

incl VAT  
Discounts - any one type 10% for 4, 15% for 8 20% for 16

## D.I.L. MINIATURE SWITCHES

Gold-plated contacts. Sealed base. Ideal for programming. 6-position at less than half manufacturer's price. ONLY 75p  
ON/OFF  
Will fit into 14-pin diil socket. Ten at 65p ea., per 100 55p ea.



## 'CHERRY' ADD-ON KEYPAD

A compact 12 button keypad suitable for use with Cherry keyboard to extend its functions plus four extra keys. Supplied brand new with data A 3 x 4 non-encoded single mode keyboard in sloped form! **£7.50 inc. VAT**

**HENRY'S**

COMPERKIT DIVISION  
404 Edgware Road, London, W2 England  
Telephone: 01-402 6822  
Telex: 262284 Mono Transonics 1400



# Master Your Micro FAST with...

Little Genius floppy diskette based courses will teach you, how to use your system and how to realise the full potential of the "Mighty Micro". These interactive computer courses are a guide to help you gain confidence in your microcomputer system.

# NOW PASCAL



Courses now available :-

- Applesoft BASIC
- Advanced
- Applesoft BASIC
- Using your Apple
- PET BASIC
- Advanced PET BASIC
- Using your PET
- Palsoft BASIC
- Advanced Palsoft BASIC
- Using your 2020
- 380Z BASIC
- Advanced 380Z BASIC
- Using your 380Z

## Little Genius

Each course, comprising a floppy diskette, and starting instructions, costs only £40.00 plus VAT

SPECIAL "3 in one" OFFER for 3 courses covering the same system only £99.00 plus VAT.

Little Genius courses are available from most computer retail outlets or direct mail from :

### LITTLE GENIUS

Suite 504, Albany House, 324 Regent Street, London W1R 5AA.  
Telephone: 01-580 6361

## Acom Atom

**PROGRAMMER'S TOOL-BOX**

A packed 4K EPROM (fits Utility Socket) containing:-

1200 BAUD CASSETTE OPERATING SYSTEM

Visible Load and SAVE Routine

**PLUS \*TRACE(X)** — controlled execution, line no. display

**\*STEP** — single step execution

**FIND** — any string of chars. in program

**VAR** — list variables

**LVAR** — print variables

**AUTO X,Y** — automatic line numbering (any start, any step)

**RENUMBER X,Y** — any start, any step

**DELETE X to Y** — any range to line nos.

(\* VIA chip required)

**HEX** — HEX and ASCII dump

**1 HEX** — HEX dump in instruction format

**PLUS Additional BASIC statements**

**READ,DATA & RESTORE**

**KEY X** — scans keyboard-input to variable

**INKEY \$X** — scans keyboard-input to string variable

**IF... THEN... ELSE**

**WHILE... ENDWHILE**

**CURSOR X,Y** — position cursor as required

**ON ERROR**

**BEEP X,Y** — sound a note-any duration, any pitch

**ZERO** — zeroes all basic variables

**POP** — close out sub-routine

**STOP** — useful debugging instructions

**RAM card.**

**Microsoft 16K RAM Expansion card.**

**Missile Defense** — Hi-res animation and sound arcade game.

**Mission: Asteroid** — Hi-res adventure in 21 colours. Save The World!

**MultiBoot Upgrade** — Upgrade 3.2 disks to book under 3.2 or 3.2.

**Mystery House** — Hi-res adventure using over 100 pictures.

**Norad** — A hi-res simulation of an I.C.B.M. attack.

**Olympic Decathlon** — Long jump, high jump, hurdles plus much more.

**Online** — A new concept in dial-up software for the Apple II.

**Orbitron** — Fight off enemy forces and avoid meteor showers.

**Pascal Graphics Editor** — The professional graphics editing package in Pascal.

**Pegasus II** — The latest in pub games now available for the Apple II.

**Phantoms Five** — A fighter-bomber mission simulation in real time 3-D graphics.

**Pool 1.5** — Hi-res colour graphics pool table simulation. 4 games.

**Pulsar II** — 2 superb hi-res games on one disk.

**Raster Blaster** A very realistic full-colour pinball simulation.

**Sabotage** — Shoot down helicopters and bombers in hi-res.

**Shooting Gallery** — A shooting gallery simulation in hi-res.

**Shuffleboard** — Real time hi-res simulation by the authors of Pool 1.5.

**Snakers** — Waves of little creatures attack you in hi-res.

**Snoggle (Puckman)** — Hi-res maze of ghosts. Great fun.

**Softporn Adventure** — An adventure for adults only.

**Space Eggs** — Hi-res super-fast arcade style game.

**Space Quarks** — Shoot down the quarks before they get you.

**Space Warrior** — Protect your shields from the dreaded drone ram ships.

**Star Avenger** — A fast paced game of guerilla warfare in space.

**Star Cruiser** — Save yourself from the swooping aliens.

**SuperGraphics** — A 3-D game development system in colour.

**SuperKRAM** — As KRAM but with multi-key and multi-index.

**SUPERSCRIBE** — WORD PROCESSOR. TRUE UPPER/LOWER CASE ON SCREEN.

**Tarturian (Wizard)** — Another hi-res adventure with 160 rooms.

**TASC** — An optimising Applesoft compiler from Microsoft.

**The Prisoner** — A game based on the famous TV series.

**The Wizard and the Princess** — Hi-res adventure in 21 colours.

**Threshold** — Yet another fast action arcade style game.

**Time Zone** — The largest adventure ever implemented. Hi-res colour graphics.

**Ulysses & the Golden Fleece** — Another superb hi-res adventure.

**Visicalc 3.3** — The 16 sector version with enhanced manual.

**Visidex** — Store and retrieve information by key words.

**Visille** — A database from the same stable as Visicalc.

**Visiplot** — A hi-res graphics graph plotting package.

**VisiTerm** — Use your Apple as an on-line terminal.

**Visitrend** — Performs maths operations on time series data.

**Wizardry** — 3-D adventure. The best we have seen yet.

**Z-Term** — A full feature terminal package for the CP/M Apple.

A: Requires Applesoft in ROM. M: Will run on any Apple.

Suitable for any memory size. Greatly enhances the Atom's existing facilities.  
Real Value at £24.50 + VAT & 25p P&P

5, Wensley Road, Leeds LS7 2LX  
Tel. (0532) 683186

Send S.A.E. for details & full catalogue.  
(State Atom)

# SPIDER SOFTWARE

## APPLE SOFTWARE

- A.C.E. — A program line editor with macro facilities £19.95 A48K
- Alien Rain (Galaxian) — Colour + hi-res version of pub game. £13.95 M48K
- Alien Typhoon — A much more difficult version of Alien Rain. £13.95 M48K
- Akalabeth — An advanced fantasy role playing game. £22.95 M48K
- Apple-Doc — Cross reference utility + Variable replacement. £22.95 A48K
- Apple Panic — Chase little apples up and down ladders. £16.95 M48K
- AppleWorld — Allows you to produce 3-D animated graphics. £38.95 M48K
- Asci Express II — A complete intelligent terminal package. £42.95 A48K
- Asteron — The ultimate Asteroids replica game. £19.95 M48K
- Autobahn — Road race game with sound and hi-res graphics. £14.95 M48K
- Beneath Apple DOS — The definitive guide to the Apple DOS. £11.95 Book
- Both Barrels — 2 hi-res action games on one disk. £12.95 A48K
- Castle Wolfenstein — An action adventure game in hi-res graphics with sound. £18.95 M48K
- Copts & Robbers — An adventure game in the tombs of ancient Egypt. £19.95 M48K
- CPS Multifunction Card — Serial, Parallel and Clock on one card. £183.95 Card
- Cranston Manor — A new hi-res adventure like Wizard & the Princess. £19.95 Disk
- Cross-Ref — Cross reference Applesoft programmers utility. £14.95 A32K
- Cyber Strike — 3-D hi-res action arcade game in space. £19.95 M48K
- DDATABASE — Ultra-fast, user friendly database using DDA. £39.95 A48K
- DDA FILES CONTROLLER — Sort, copy & restructure DDA files. £39.95 A48K
- DDA PROGRAMMERS UTILITIES — Direct Disk Access for programmers. £199.95 A48K
- Dogfight — Hi-res jet combat game for 1 or 2 players. £18.95 M32K
- Epoch — Hi-res action game fighting the aliens. £19.95 M48K
- E-Z Draw 3.3 — This is the poor man's graphics tablet. Very easy to use. £28.95 M48K
- EXPEDITOR II — THE APPLESOFT COMPILER AT A LOW LOW PRICE. £56.95 A48K
- Falcons — The best Invaders style game available for the Apple. £18.95 M48K
- Fender Bender — Super car game in hi-res colour graphics. £14.95 M48K
- Galaxy Wars — Colour graphics + Sound effects + Hi-res arcade game. £13.95 M32K
- Galactic Attack — A hi-res Star Trek type game. £19.95 M48K
- Gamma Goblins — Yet another superb hi-res action game. £16.95 M48K
- Genetic Drift — A departure from the normal arcade style game. £16.95 M48K
- Higher Graphics — Hi-res picture drawing utility. £23.95 M48K
- Hi-res Cribbage — The title describes it. Even hear the pegs move. £14.95 M48K
- Hi-Res Soccer — English football for 1 or 2 players in hi-res. £16.95 M48K
- Jawbreaker (Gobbler) — Eat up the dots but watch out for the Gobblers. £16.95 M48K
- KRAM — Fast and powerful Keyed Random Access Method for quick disk access. £58.95 M32K
- Linker — A linking loader/editor for assembly software development. £28.95 M32K
- LISA — The assembly language development system for professionals. £45.95 M48K
- List Master — An excellent companion product to Apple-Doc. £22.95 A48K
- Memory Management System — Enables you to put DOS on a RAM card. £29.95 M64K
- Microsoft 16K RAM Expansion card. £114.95 Card
- Missile Defense — Hi-res animation and sound arcade game. £16.95 M48K
- Mission: Asteroid — Hi-res adventure in 21 colours. Save The World! £10.95 M32K
- MultiBoot Upgrade — Upgrade 3.2 disks to book under 3.2 or 3.2. £23.95 M48K
- Mystery House — Hi-res adventure using over 100 pictures. £12.95 M48K
- Norad — A hi-res simulation of an I.C.B.M. attack. £19.95 M48K
- Olympic Decathlon — Long jump, high jump, hurdles plus much more. £17.95 M48K
- Online — A new concept in dial-up software for the Apple II. £59.95 A48K
- Orbitron — Fight off enemy forces and avoid meteor showers. £14.95 M48K
- Pascal Graphics Editor — The professional graphics editing package in Pascal. P.O.A.
- Pegasus II — The latest in pub games now available for the Apple II. £16.95 M48K
- Phantoms Five — A fighter-bomber mission simulation in real time 3-D graphics. £18.95 M48K
- Pool 1.5 — Hi-res colour graphics pool table simulation. 4 games. £19.95 M48K
- Pulsar II — 2 superb hi-res games on one disk. £14.95 M48K
- Raster Blaster. A very realistic full-colour pinball simulation. £15.95 M48K
- Sabotage — Shoot down helicopters and bombers in hi-res. £13.95 M48K
- Shooting Gallery — A shooting gallery simulation in hi-res. £15.95 M48K
- Shuffleboard — Real time hi-res simulation by the authors of Pool 1.5. £19.95 M48K
- Snakers — Waves of little creatures attack you in hi-res. £16.95 M48K
- Snoggle (Puckman) — Hi-res maze of ghosts. Great fun. £13.95 M48K
- Softporn Adventure — An adventure for adults only. £16.95 M48K
- Space Eggs — Hi-res super-fast arcade style game. £14.95 M48K
- Space Quarks — Shoot down the quarks before they get you. £16.95 M48K
- Space Warrior — Protect your shields from the dreaded drone ram ships. £13.95 M48K
- Star Avenger — A fast paced game of guerilla warfare in space. £19.95 M48K
- Star Cruiser — Save yourself from the swooping aliens. £18.95 M48K
- SuperGraphics — A 3-D game development system in colour. £23.95 M48K
- SuperKRAM — As KRAM but with multi-key and multi-index. £99.95 M32K
- SUPERSCRIBE — WORD PROCESSOR. TRUE UPPER/LOWER CASE ON SCREEN. £73.95 M48K
- Tarturian (Wizard) — Another hi-res adventure with 160 rooms. £14.95 A48K
- TASC — An optimising Applesoft compiler from Microsoft. £129.95 M48K
- The Prisoner — A game based on the famous TV series. £21.95 A48K
- The Wizard and the Princess — Hi-res adventure in 21 colours. £18.95 M48K
- Threshold — Yet another fast action arcade style game. £16.95 M48K
- Time Zone — The largest adventure ever implemented. Hi-res colour graphics. CP.O.A. M48K
- Ulysses & the Golden Fleece — Another superb hi-res adventure. £19.95 M48K
- Visicalc 3.3 — The 16 sector version with enhanced manual. £119.95 M48K
- Visidex — Store and retrieve information by key words. £19.95 M48K
- Visille — A database from the same stable as Visicalc. £149.95 M48K
- Visiplot — A hi-res graphics graph plotting package. £94.95 M48K
- VisiTerm — Use your Apple as an on-line terminal. £89.95 M48K
- Visitrend — Performs maths operations on time series data. £149.95 M48K
- Wizardry — 3-D adventure. The best we have seen yet. £28.95 M48K
- Z-Term — A full feature terminal package for the CP/M Apple. £65.95 M48K

Please specify which DOS you require when ordering. If you don't see what you are looking for please give us a call. We ALSO OFFER A BESPOKE SOFTWARE SERVICE WHICH IS SECOND-TO-NONE.

PRICES INCLUDE VAT AT 15% Add 50p P+P for orders under £30 totally.  
Please write or telephone for your free copy of our up-to-date software list.

DEALER INQUIRIES INVITED.  
PERSONAL CALLERS BY APPOINTMENT ONLY PLEASE.

## SPIDER SOFTWARE

98 AVONDALE ROAD,  
SOUTH CROYDON,  
SURREY.

Tel: 01-680 0267 (24 hours a day — 7 days a week)

234 PCW



# SOFTWARE FOR CP/M®

HIGH QUALITY SOFTWARE - WITH HIGH QUALITY SERVICE



**NEW!** The Formula: £300. Application builder and reporter. SUPERCALC: £165. Spread sheet financial planning. SPELLSTAR: £125. Option for Wordstar.

<b>WORDSTAR</b> - Professional word processing software. On-screen formatting, wordwrap, pagination, line and character count on view. Micro-justification on daisy-wheel printer. Search and replace. Block/paragraph manipulation. External file read/write. Background printing during editing etc.	£250	<b>MICROSOFT FORTRAN COMPILER</b>	£205
<b>MAIL-MERGE</b> - Powerful Wordstar enhancement for file merging and document personalisation.	£65	<b>MICROSOFT COBOL</b>	£310
<b>DATASTAR</b> Screen orientated system for Data Entry, Retrieval and Updating.	£175	<b>MAGSAM</b> - Versatile easy to use Keyed File Management System for Microsoft Basic or CBASIC.	£130
<b>SUPERSORT</b> - Sort, merge and selection program.	£125	<b>CIS - COBOL</b> - ANSI' 74 implementation to full level 1 standard. Supports random, indexed and sequential files, features for conversational working, screen control, interactive debugging, program segmentation etc.	£425
<b>CONFIGURABLE BUSINESS SYSTEM (CBS)</b> - Unique information management system with user definable files, powerful report generator, menu-driven for ease of use. No programming experience necessary!	£225	<b>FORMS-2</b> - Automatic COBOL code generator for screen formats.	£100
<b>ACCOUNTING PACKAGES</b> by Median - Tec: PAYROLL, SALES, PURCHASE, NOMINAL Specially developed by UK software house to exacting specifications. Written in Microsoft Basic each package may be customised by end user, all are widely used. Ledgers are open item. Payroll caters for weekly and monthly pay.	£500 each	<b>PASCAL-Z</b>	£235
<b>PROJECT COST CONTROL/JOB ACCOUNTING</b> - A comprehensive set of programs to monitor budgets, account for expenditure and project completion etc. Ideally suited for contractors. Written in CBASIC-2.	£150	<b>STRUCTURED BASIC</b> - Relocatable compiler	£160
<b>STATISTICS PACKAGE</b> - Over 25 routines including Regression & ANOVA	£100	<b>CBASIC-2</b> - Extended Disk Basic pseudo compiler and run-time interpreter.	£75
<b>MATHS PACKAGE</b> - Over 40 easily used routines.	£100	<b>SELECTOR III - C2</b> - Information management system written in CBASIC-2	£185
<b>IBM - CP/M COMPATIBILITY</b> - Powerful utility to transfer data to/from IBM machines in standard disk format.	£110	<b>SELECTOR IV</b> - Upward compatible version of III with enhanced reporting.	£300
<b>MICROSOFT BASIC INTERPRETER</b>	£155	<b>BSTAM</b> - Telecomms facility for exchanging files between CP/M computers.	£75
<b>MICROSOFT BASIC COMPILER</b>	£195	<b>ASCAM</b> - Facility for communicating with other computers.	£95
		<b>TRANSFER</b> - CP/M to CP/M file exchange - telecomms source code	£125
		<b>MACRO 80</b> - Macro Assembler	£99
		<b>CP/M 2.2</b> - Standard Version 8" Single Density.	£99

Please contact us for availability of other products  
All orders must be PREPAID. Add £1 per item P & P (Minimum £2.00) and VAT  
CP/M is trade mark of Digital Research



## TELESYSTEMS LTD

P.O. Box 12, GREAT MISSENDEN, BUCKS, HP16 9DD

Telephone (02406) 5314

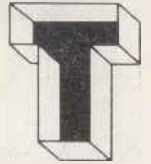

## "COPY-WRITE" A most complete bit copier for Apple programmes

"COPY-WRITE" disk backup system copies virtually all Apple programmes. SPREEBOND believes "COPY-WRITE" is the most sophisticated disk backup system available. Do not be misled by our advertised competitors. Their programmes may not copy all the latest protection formats employed by manufacturers to frustrate the software buyer from making needed backup copies of his vital business, accounting, data base, and modelling programmes.

### FEATURES OF "COPY-WRITE"

- **AUTOMATICALLY COPIES HALF TRACKS.** Apple disks only use 35 tracks, or every other one of the 70 available on a 5 1/4 inch disk. Many protection techniques place some data on the alternate or half-tracks which normal copy programmes cannot read or copy.  
"COPY-WRITE" automatically searches and reads both full tracks and half-tracks and then writes the data found to the destination disk.
- **COPIES SYNCHRONIZED TRACKS.** Some disks align all tracks in the same pattern as on track 00. "COPY-WRITE" writes these sectors in the same pattern as found on the original disk. Most other copy programmes cannot.
- **PROVIDES "STATUS FIELD DISPLAY".** "COPY-WRITE" supplies the operator with a track by track progress report as the programme reads, aligns, verifies, and writes each track.
- **PERMITS PARAMETER CHANGES.** "COPY-WRITE" not only recognizes the usual DOS 3.2, 3.3, Pascal, CP/M, etc. formats, it will also change parameters to adjust to abnormal or

foreign DOS techniques designed to frustrate making of backup copies.

These parameter changes can be made with "COPY-WRITE's" special and unique state-of-the-art utility called MDSS (Memory Dumper/Disk Searcher). MDSS enables the user to look at each track in ASCII or HEX and determine whether the usual FF sync-bytes have changed to some abnormal permutation.

- **FILE PROGRAMMES.** Once unusual parameters have been identified by MDSS, "COPY-WRITE" allows the user to save to disk each set of parameters for future use with similarly encoded disk formats.
- **FLEXIBLE.** "COPY-WRITE" is the only bit copier with flexible parameters and filer programmes that enable it to respond to new encoding techniques developed by manufacturers. SPREEBOND'S subscription maintenance service will provide parameters that update the programme to match new encoding techniques. No other copy programme is as versatile.
- **TUTORIAL MANUAL.** "COPY-WRITE's" 21 page tutorial manual provides instructions for use of the programme.

### HOW TO GET "COPY-WRITE"

- "COPY-WRITE" is available for £50 + VAT.

Orders may be placed by mail or by telephone. Personal cheques are accepted, as are VISA and ACCESS cards.

**Spreebond Limited**

Telephone: (0622) 683-866  
Dealer enquiries welcome

Unit 7, Haslemere,  
Parkwood Estate,  
Sutton Road,  
Maidstone,  
Kent. ME15 9NE.

**MICROLINK  
MICROLINK  
MICROLINK**

**The  
MICROLINK  
Interface for  
your Commodore or  
Hewlett Packard  
Computer.**



The MICROLINK interface has been designed for use in laboratory environments where acquisition and processing of data from a variety of sources is required. MICROLINK is a modular system consisting of a mainframe incorporating the IEEE-488 interface and a power supply, and a cabinet holding upto 17 modules—this means that the interface can be configured for your precise requirements.

**Modules for signal acquisition:**

- AN-1, AN-1D single-ended and differential analogue voltage conditioning modules.
- A-8D, A-10D 8 and 10 bit analogue to digital converters.
- HSC, HSM high speed clock and multiplexer where rapid sampling is required (up to 10 kbytes/sec).

**Modules for experimental control:**

- RR-8, HDR-4 reed and heavy duty relay outputs.
- CC-8 8 contact closure or logic level inputs.
- UDC up/down counter (for counting logic pulses).

**Modules for data collection from instruments:**

- BCD-8 8 decade BCD input.

**Modules for signal generation or displays:**

- 8D-A 8 bit digital to analogue converter.
- SCOPE 2 channels + trigger for oscilloscope displays.
- 8D-XY 2 channels + pen lift relay for analogue XY plotter.

**Modules for specialist applications:**

- TIM millisecond timing.
- HR heart rate monitoring.
- NHI neural pulse histogram data collection.



Write or telephone with details of your application and we will be pleased to quote for the appropriate configuration.

6 Lower Ormond St.  
Manchester M1 5QF. U.K.  
Telephone:  
061-236 1283

**MICROLINK  
MICROLINK  
MICROLINK**

**dBASE II DELIVERS...**

dBASE II is a relational database management system for CP/M micros — an information handler, not a mere file handler.

dBASE II harnesses the most sophisticated techniques to organise *your* data, the way *you* want it.

dBASE II is not an appendage to a programming language, it is a programming language, one that is in use, completely standalone, to support many applications, such as invoicing, stock control and maintenance scheduling.

*Look at these features:*

- ★ Fully interactive with easy X-Y cursor control and protected fields
- ★ Commands entered directly or stored as programs
- ★ Database structure easily modified and data copied to new structure in single command
- ★ Any number of indexes for each database
- ★ Full range of arithmetic, logical and string operators (e.g. single command to search for character string *anywhere* in particular field)
- ★ Powerful report formatting features.

**WHAT A PERFECT COMBINATION...**

An HD Superbrain with 12 megabytes of hard disc capacity *built-in*, dBASE II and a printer costs around £5,200 (depending on which printer selected). dBASE II alone costs £385.

**For further details call: 01-950 0303**



**BOYD MICROSYSTEMS**  
59 High Road, Bushey Heath, Herts WD2 1EE

**YOUR LOCAL  
FRUIT & NUT SHOP**

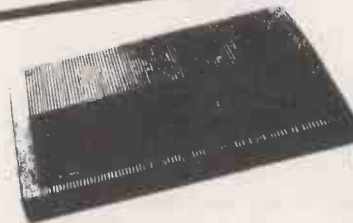

DISCS - PAPER - RIBBONS ETC. FOR ALL MICROS

**CARDIFF MICRO COMPUTERS**

46 CHARLES STREET, CARDIFF, SOUTH GLAMORGAN. CF1 4EE.

Tel. (0222) 373072



# THE ZX81 COMPANION

by Bob Maunder.

ISBN 0 907211 01 1

If you have a Sinclair ZX81 and want to use it to its full potential then, as the experts have all agreed, this is the book for you. It contains detailed guidelines and documented programs in the areas of gaming, information retrieval and education, as well as a unique listing of the 8K ROM for machine code applications.

'Far and away the best . . . once again Linsac has produced the book for the serious end of the market'. — *Your Computer, November 1981.*

'The ZX81 Companion is a most professional product . . . with many good illustrative programs, tips and warnings'. — *Education Equipment, October 1981.*

'Bob Maunder's attempt to show meaningful uses of the machine is brilliantly successful . . . thoughtfully written, detailed and illustrated with meaningful programs . . . To conclude — the book is definitely an outstandingly useful second step for the ZX81 user'. — *Educational ZX80/81 Users' Group Newsletter, September 1981.*

Send cheque for **£7.95** to:

**LINSAC** (PCW) 68 Barker Road, Linthorpe,  
Middlesbrough, Co. Cleveland TS5 5ES

# VIC GAMES

FROM HI-TECH

Now available these super value, fun games, exclusively for the VIC 20 Computer.

SUPER-BREAKOUT	— A brilliant version of the 'Arcade' game	— 7.50
DEFLECTION	— Deflect a fast moving ball to hit a target	— 7.50
CAR-RACE	— Control the steering & speed of a grand prix car in a race with other drivers	— 7.50
U.F.O. SHOOTING	— Shoot down a moving U.F.O.	— 7.50
ALIEN ATTACK	— Aim your laser at the attacker and fire — sounds real	— 7.50
LUNAR LANDER	— Try to land your craft onto a base	— 7.50
RUGBY GAME	— Beat the defenders and score	— 7.50
SUPER SNAKE	— First action game — snake eats the dots — beware of the 'walls'	— 7.50
ASTEROID BELT (U)	— Hit the alien craft through the asteroids, watch out if fires back	— 7.50
CARE DRIVE	— Drive your car through a forest track	— 7.50
3-D MAZE (U)	— Walk through a maze in 3-D & try to find the exit	— 7.50
INVADER FALL (U)	— Destroy the invaders before they destroy you	— 7.50
DRAGON MAZE (U)	— Can the dragon eat you before you get out of the maze	— 7.50
ALIEN MAZE (U)	— Build your force field against the 3 aliens after you	— 7.50
MISSILE COMMANDER (U)	— Fire your A.B.M. at I.C.B.M. coming in to destroy your cities	— 8.50
3K RAM PACKS	— are required for (U) Games. We are giving a FREE GAME with every purchase —	29.50

**\*BUY 5 GAMES AND GET 1 FREE**

**\*No extra costs — the price includes VAT, post and packing.**

Barclaycard/Visa Access welcome. Order now while stocks last!

7 Queensway, Hemel Hempstead  
Herts. Tel: (0442) 50450

**HI-TECH**  
COMPUTERS LTD.

# SIMPLICALC

FOR EVEN 8K PETS.....FROM CRONITE

**NEW!**

For the first time, you can have a visual electronic calculator on even the smallest Commodore Pet, with no need for a disk drive.

You can move your screen around on your electronic worksheet, adding and deleting and recalculating . . . and if you think that sounds familiar, you're right. Simplicalc was written to provide the main facilities of programs like VisiCalc™ on machines which do not have the 32K and disk drive required for VisiCalc™. Now the real power of your micro can be harnessed at a quarter of the cost of larger programs.

- ★ Runs even in 8K
- ★ Writes figures or alphabetic characters on your sheet
- ★ Allows easy change or deletion
- ★ Can save your sheet for future use
- ★ Lets you print out your sheet on PET printers
- ★ Uses cassette or disk
- ★ Allows formulae to be set up for rapid recalculation
- ★ Shows you your sheet on the screen all the time
- ★ Allows replication of columns and rows

What can you use it for? It's limited only by your imagination; any tabular computation, especially where you want to adjust and recalculate, is ideal. The Cronite Group uses it for costing, modelling, consolidation and capital investment appraisals. Try these:

- ★ Education — business studies and economics
- ★ Investment analysis
- ★ Household budgeting
- ★ Financial modelling and cash flow
- ★ Costing
- ★ Tax computations — personal or business

To obtain your copy of this versatile numeric tool, with comprehensive manual, send cheque with order, specifying whether your CBM is ★ 2001/3000/early 4000 (PEEK (144) = 46) ★ late 4000 series ★ 8032 and whether you want cassette £29.90 Inc. VAT or disk £36.80 Inc. VAT (specify drive) to:

SIMPLICALC — The Cronite Group Limited, Montgomery Street, Birmingham B11 1DT.

Further versions for other popular micros e.g. VIC 20 are planned; enquiries welcome.

Further details from Mark Turner on 021-773 8281 — telex 338247

VisiCalc is a trade mark of Personal Software Inc.

# WATFORD ELECTRONICS

33/35, CARDIFF ROAD, WATFORD, HERTS, ENGLAND

Tel Watford (0923) 40588. Telex: 8956095

MAIL ORDER CALLERS WELCOME

ALL DEVICES FULL SPEC. AND FULLY GUARANTEED. TERMS OF BUSINESS: CASH/CHEQUE/P.O.S. (OR ACCESS) WITH ORDER. GOVERNMENT AND EDUCATIONAL INSTITUTIONS OFFICIAL ORDERS ACCEPTED. TRADE AND EXPORT INQUIRIES WELCOME. (P&P ad 50p on all orders under £10.00).

**VAT** ALL PRICES ARE EXCLUSIVE OF VAT. PLEASE ADD 15% TO THE TOTAL COST INCLUDING P & P.

SHOP HOURS: 9.00am - 6.00pm MONDAY TO SATURDAY. AMPLE FREE CAR PARKING SPACE AVAILABLE.

COMPUTER IC's	280A CTC	7491	45
1702	400	7492	30
2012CP	999	7493	30
2101-2	125	7494	34
2112B	423	7495	50
2114-450	726	7496	45
2114L-300n	725	7497	120
2114L-200n	190	74100	85
2118-3	130	74104	54
2118-4	250	74105	55
2147-3	195	74106	84
2532-450n	350	74107	32
2708	325	74109	35
2716-5V	625	74110	40
2732-450n	478	74111	55
4027	200	74112	170
4116-150n	200	74118	80
4116-200n	775	74119	80
4118-250	138	74119	90
4164-200	240	74120	75
4334-3	210	74121	30
(CMOS 2114)	100	74122	45
4864-3 64K	130	74123	50
5101	270	74125	42
6116-3 16K	325	74126	40
CMOS RAM	85	74128	42
6502 CPU	85	74132	48
6503	450	74135	80
6504-250	295	74136	35
6505	295	74141	70
6502 PIA	310	74142	190
6522 VIA	375	74143	250
6530RRIOT	1350	74144	250
6532 RIOT	750	74145	250
6545 CRTA	1450	74147	90
6551 ACIA	785	74148	75
6592 PC	626	74150	80
6800	500	74151	45
6803	1360	74152	45
6804	160	74153	45
6805	670	74154	125
6808	520	74155	75
6809	175	74156	75
6810	175	74157	45
6820	175	74158	115
6821	150	74159	99
6840	470	74160	60
6843	1450	74161	60
6845	975	74162	62
6847	850	74163	64
6850	175	74164	64
6852	255	74165	62
6875	550	74166	65
8039	350	74167	65
8080A	350	74168	185
8085A	650	74172	290
8155	00	74173	65
81LS95	115	74174	72
81LS96	115	74175	72
81LS97	115	74176	75
8166	00	74177	75
8123	125	74178	95
8202	625	74179	68
8212	170	74180	65
8214	625	74181	140
8216	170	74182	75
8224	250	74183	84
8226	250	74184	99
8228	250	74188	290
8243	375	74190	70
8251	370	74191	70
8253	790	74192	62
8255	375	74193	65
8257	800	74194	75
8279	90	74195	65
8T26A	90	74196	65
8T27	150	74197	65
8T28A	135	74198	99
8T31	350	74199	99
8T95N	135	74200	150
8T97N	135	74201	150
8364AP	550	74202	150
AM26LS31C	125	74203	22
AM26LS32A	125	74204	22
AY-3-1015	350	74205	18
AY-3-8910	625	74206	28
AY-3-8912	625	74207	28
AY-5-1013	350	74208	28
AY-5-2376	700	74209	28
FD1771	118	74210	16
IM6402	380	74211	20
MC1488	62	74212	20
MC1489	62	74213	22
MC14411	695	74214	32
MC14412	800	74215	32
MM5280D	895	74216	25
RO-3-2513L	700	74217	25
RO-3-2513U	700	74218	16
SFF86364E	800	74219	16
SFC71301	825	74220	16
TMS2716-3V	870	74221	80
TMS6011	365	74222	22
ULN2003	85	74223	22
ULN2004	150	74224	22
280CPU 2.5	800	74225	22
280ACPU4M	445	74226	28
280 P10	350	74227	28
280A P10	400	74228	28
280 CTC	350	74229	28

IC's	7491	45
LS295	215	4071
LS298	130	4072
LS299	420	4073
LS300	157	4075
LS301	175	4076
LS302	270	4077
LS303	270	4078
LS304	200	4079
LS305	200	4081
LS306	200	4082
LS307	200	4083
LS308	200	4084
LS309	200	4085
LS310	200	4086
LS311	200	4087
LS312	200	4088
LS313	200	4089
LS314	200	4090
LS315	200	4091
LS316	200	4092
LS317	200	4093
LS318	200	4094
LS319	200	4095
LS320	200	4096
LS321	200	4097
LS322	200	4098
LS323	200	4099
LS324	200	4100
LS325	200	4101
LS326	200	4102
LS327	200	4103
LS328	200	4104
LS329	200	4105
LS330	200	4106
LS331	200	4107
LS332	200	4108
LS333	200	4109
LS334	200	4110
LS335	200	4111
LS336	200	4112
LS337	200	4113
LS338	200	4114
LS339	200	4115
LS340	200	4116
LS341	200	4117
LS342	200	4118
LS343	200	4119
LS344	200	4120
LS345	200	4121
LS346	200	4122
LS347	200	4123
LS348	200	4124
LS349	200	4125
LS350	200	4126
LS351	200	4127
LS352	200	4128
LS353	200	4129
LS354	200	4130
LS355	200	4131
LS356	200	4132
LS357	200	4133
LS358	200	4134
LS359	200	4135
LS360	200	4136
LS361	200	4137
LS362	200	4138
LS363	200	4139
LS364	200	4140
LS365	200	4141
LS366	200	4142
LS367	200	4143
LS368	200	4144
LS369	200	4145
LS370	200	4146
LS371	200	4147
LS372	200	4148
LS373	200	4149
LS374	200	4150
LS375	200	4151
LS376	200	4152
LS377	200	4153
LS378	200	4154
LS379	200	4155
LS380	200	4156
LS381	200	4157
LS382	200	4158
LS383	200	4159
LS384	200	4160
LS385	200	4161
LS386	200	4162
LS387	200	4163
LS388	200	4164
LS389	200	4165
LS390	200	4166
LS391	200	4167
LS392	200	4168
LS393	200	4169
LS394	200	4170
LS395	200	4171
LS396	200	4172
LS397	200	4173
LS398	200	4174
LS399	200	4175
LS400	200	4176
LS401	200	4177
LS402	200	4178
LS403	200	4179
LS404	200	4180
LS405	200	4181
LS406	200	4182
LS407	200	4183
LS408	200	4184
LS409	200	4185
LS410	200	4186
LS411	200	4187
LS412	200	4188
LS413	200	4189
LS414	200	4190
LS415	200	4191
LS416	200	4192
LS417	200	4193
LS418	200	4194
LS419	200	4195
LS420	200	4196
LS421	200	4197
LS422	200	4198
LS423	200	4199
LS424	200	4200
LS425	200	4201
LS426	200	4202
LS427	200	4203
LS428	200	4204
LS429	200	4205
LS430	200	4206
LS431	200	4207
LS432	200	4208
LS433	200	4209
LS434	200	4210
LS435	200	4211
LS436	200	4212
LS437	200	4213
LS438	200	4214
LS439	200	4215
LS440	200	4216
LS441	200	4217
LS442	200	4218
LS443	200	4219
LS444	200	4220
LS445	200	4221
LS446	200	4222
LS447	200	4223
LS448	200	4224
LS449	200	4225
LS450	200	4226
LS451	200	4227
LS452	200	4228
LS453	200	4229
LS454	200	4230
LS455	200	4231
LS456	200	4232
LS457	200	4233
LS458	200	4234
LS459	200	4235
LS460	200	4236
LS461	200	4237
LS462	200	4238
LS463	200	4239
LS464	200	4240
LS465	200	4241
LS466	200	4242
LS467	200	4243
LS468	200	4244
LS469	200	4245
LS470	200	4246
LS471	200	4247
LS472	200	4248
LS473	200	4249
LS474	200	4250
LS475	200	4251
LS476	200	4252
LS477	200	4253
LS478	200	4254
LS479	200	4255
LS480	200	4256
LS481	200	4257
LS482	200	4258
LS483	200	4259
LS484	200	4260
LS485	200	4261
LS486	200	4262
LS487	200	4263
LS488	200	4264
LS489	200	4265
LS490	200	4266
LS491	200	4267
LS492	200	4268
LS493	200	4269
LS494	200	4270
LS495	200	4271
LS496	200	4272
LS497	200	4273
LS498	200	4274
LS499	200	4275
LS500	200	4276

IC's	7491	45
LS295	215	4071
LS298	130	4072
LS299	420	4073
LS300	157	4075
LS301	175	4076
LS302	270	4077
LS303	270	4078
LS304	200	4079
LS305	200	4081
LS306	200	4082
LS307	200	4083
LS308	200	4084
LS309	200	4085
LS310	200	4086
LS311	200	4087
LS312	200	4088
LS313	200	4089
LS314	200	4090
LS315	200	4091
LS316	200	4092
LS317	200	4093
LS318	200	4094
LS319	200	4095
LS320	200	4096
LS321	200	4097
LS322	200	4098
LS323	200	4099
LS324	200	4100
LS325	200	4101
LS326	200	4102
LS327	200	41



# ZX81 owners

have you seen

*The Cambridge Collection*

A book of

## 30 PROGRAMS

For Only **£4.95**

### NO MEMORY EXPANSION NEEDED

Each program has been designed to fit into 1K of RAM

### TEACH YOURSELF PROGRAMMING

Comprehensive explanations of each listing will teach you many techniques of ZX81 programming.

### HOURS OF AMUSEMENT

With titles such as FORTRESS, BALLOON, and ODD MAN OUT, you could easily become a ZX81 addict. Plus, entirely new implementations of well-known favourites; LUNAR LANDING, MASTER CODE, ORBITAL INVADERS, and many others.

### CASSETTE AVAILABLE TOO!

If you order the book you can also buy the programs on a quality cassette for only **£4.95 extra.**

Please send me:

copies of the book at **£4.95** each

copies of the book and cassette at **£9.90** pair

Please send your orders with cheques/PO's to:

Richard Francis, Dept PCW  
22 Foxhollow, Barhill,  
Cambridge, CB3 8EP.

**ATARI**  
MICROCOMPUTERS



**ATARI** PERSONAL COMPUTER SYSTEMS  
**400 & 800**

## IN MANCHESTER

★ SOFTWARE ★ PERIPHERALS  
★ COMPUTER CHESS GAMES



**Commodore VIC due**

**GEMINI ELECTRONICS**

Dept. PCW 50 Newton St., Off Piccadilly,  
Manchester M1 2EA. Tel: 061-236 3083.

WE ARE AT THE CORNER NEWTON ST./ HILTON ST.

# WE TURN ELECTRONIC TYPEWRITERS INTO COMPUTER PRINTERS

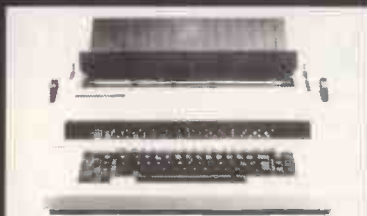

SILVER REED



OLYMPIA



OLIVETTI

If you have one of these, your local typewriter/computer dealer can arrange for the upgrade. The discom upgrade enables most popular electronic typewriters to communicate with any micro computer. Interfaces fitted as standard on each machine are: RS 232, Centronics IEEE.

\* Interfaced machines are available from your local dealer.

**discom**

Old Manor Farm, Ashton under Hill  
Worcestershire  
Telephone (0386) 881962

Please send me more details

Name \_\_\_\_\_

Address \_\_\_\_\_

Telephone \_\_\_\_\_

# FLOPPY DISK DRIVES FOR TRS 80 AND VIDEO GENIE

## DUAL DISK UNITS

2 x 40 TRACK DRIVES

£440

2 x 80 TRACK DRIVES

£569

## SINGLE DISK UNITS

1 x 40 TRACK DRIVE

£236

1 x 80 TRACK DRIVE

£299

## DISK DRIVE CABLES

2 DRIVE CABLE

£15.50

4 DRIVE CABLE

£26.00

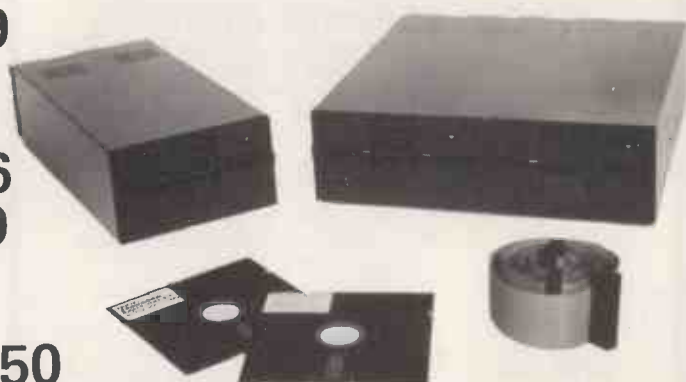

## PERCOM DATA SEPARATORS

£20

Plugs into the TRS 80 expansion interface and corrects 'READ/VERIFY' and 'CRC ERROR! TRACK LOCKED OUT!' problems on the inside tracks of any floppy disk system. Comes with full installation instructions – NO SOLDERING, NO CUTTING, JUST PLUGS INTO THE EXPANSION INTERFACE.

**Call your nearest dealer for a demonstration:**

**RADIO SHACK LTD.**,  
188, Broadhurst Gardens,  
London NW6  
Tel: 01-624-7174

**COMPSHOP LTD.**,  
14, Station Road,  
New Barnet, Herts.  
Tel: 01-441-2922

**COMPSHOP LTD.**,  
311, Edgware Road,  
London W2.  
Tel: 01-262-0387

**COMPSHOP LTD.**,  
19, Herbert Street,  
Dublin 2  
Tel: 604165

**LONDON COMPUTER  
CENTRE**, 43, Grafton  
Way, London W1  
Tel: 01-388-5721

**N.I.C.**,  
61, Broad Lane,  
London N15.  
Tel: 01-808-0377

**CROYDON COMPUTER  
CENTRE**, 29a, Brigstock  
Road, Thornton Heath,  
Surrey.  
Tel: 01-689-1280

**P J EQUIPMENT LTD.**,  
3, Bridge Street,  
Guildford  
Tel: 0483-504801

**R.D.S. ELECTRICAL  
LTD.**, 157-161, Kingston  
Road, Portsmouth  
Tel: 0705-812478

**TANDY HASTINGS  
LTD.**, 48, Queens Road,  
Hastings.  
Tel: 0424-431849

**MICROWARE  
COMPUTING  
SERVICES**, 57, Queen  
Charlotte Street, Bristol  
Tel: 0272-279560

**BLANDFORD  
COMPUTERS**, Higher  
Shaftsbury Road,  
Blandford Forum  
Tel: 0258-53737

**TAPE SHOP**  
321 Viaduct Road,  
Brighton.  
Tel: 0273-609099

**PARWEST LTD.**,  
18 St. Mary Street,  
Chippenham.  
Tel: 0249-2131

**COMPUTER SHACK**  
14, Pittville Street,  
Cheltenham.  
Tel: 0242-584343

**ENSIGN**,  
13-19, Milford Street,  
Swindon, Wilts.  
Tel: 0793-42615

**TANDY  
GLOUCESTER**,  
13, Clarence Street,  
Gloucester  
Tel: 0452-31323

**COMSERVE**,  
98, Tavistock Street,  
Bedford.  
Tel: 0234-216749

**CLEARSTONE  
COMPUTERS**, Prince of  
Wales Ind. Estate,  
Abercarn, Gwent  
Tel: 0495-244555

**EMPRISE LTD.**,  
58, East Street,  
Colchester.  
Tel: 0206-865926

**MAGNUS MICRO-  
COMPUTERS**,  
139 The Moors,  
Kidlington, Oxford.  
Tel: 08675-6703

**CAMBRIDGE  
COMPUTER STORE**,  
1, Emmanuel Street,  
Cambridge.  
Tel: 0223-65334

**I.C. ELECTRONICS**,  
Flagstones,  
Stede Quarter,  
Biddenden, Kent.  
Tel: 0508-291816

**MICRO CHIP SHOP**,  
190, Lord Street,  
Fleetwood, Lancs.  
Tel: 03917-79511

**HARDEN MICRO-  
SYSTEMS**, 28-30, Back  
Lord Street, Blackpool,  
Tel: 0253-27590

**AMBASSADOR  
BUSINESS COM-  
PUTERS LTD.**,  
Ashley Lane Works,  
Shipley, W. Yorks.  
Tel: 0274-595941

**Q-TEK SYSTEMS LTD.**,  
2 Daltry Close, Old  
Town, Stevenage, Herts  
Tel: 0438-65385

**COMPUTER & CHIPS**  
Feddinch Mains House,  
St. Andrews, Fife,  
Scotland  
Tel: 0334-72569

**NORTH WEST  
COMPUTER  
CONSULTANTS LTD.**,  
214 Market Street,  
Hyde, Cheshire  
Tel: 061-366-8624

**HEWART MICRO-  
ELECTRONICS**,  
95, Blakelow Road,  
Macclesfield.  
Tel: 0625-22030

**KARADAWN LTD.**,  
2 Forest Way,  
Great Sankey,  
Warrington.  
Tel: 0925-572668

**PHOTO-ELECTRICS**,  
459 London Road,  
Sheffield.  
Tel: 0742-53865

**ARC ELECTRONICS**,  
54, Heron Drive, Sandal,  
Nr. Wakefield,  
W. Yorks WF2 6SL  
Tel: 0924-253145

**VICTOR MORRIS  
LTD.**, 340 Argyle  
Street, Glasgow,  
G2 8LY  
Tel: 041-221-8958

**THOMAS WRIGHT LTD.**,  
Thorite House,  
Laisterdyke,  
Bradford.  
Tel: 0274-663471

**GNOMIC LTD.**,  
46, Middle Street,  
Blackhall,  
Hartlepool.  
Tel: 0783-863871

**BRIERS COMPUTER  
SERVICES**, 1, King  
Edward Square,  
Middlesbrough,  
Cleveland.  
Tel: 0642-242017

**3 LINE COMPUTING**,  
36, Clough Road, Hull.  
Tel: 0482-445496

**H.C. COMPUTER  
SALES LTD.**, 182,  
Earlsway, Team Valley  
Trading Estate,  
Gateshead  
Tel: 0632-874811

**EWL COMPUTERS LTD.**,  
8, Royal Crescent,  
Glasgow.  
Tel: 041-332-7642

**CUMANA LTD**

35 Walnut Tree Close, Guildford, Surrey, GU1 4UN.  
Telephone: (0483) 503121.

*Please add VAT to all prices.  
Delivery at cost will be advised  
at time of order.*



Micromail

## MAIL ORDER ITEMS

	Including VAT Net & carriage	
Apple 48k	650.00	760.00
Apple Disk + Controller	340.00	400.00
Apple Disk without Controller	265.00	315.00
Micro-Sci A40 Disk + Controller	295.00	350.00
Micro-Sci A40 Disk without Controller	235.00	280.00
Micro-Sci A70 Disk with Controller	415.00	485.00
Micro-Sci A70 Disk without Controller	355.00	418.00
NEC 12" Green Screen Monitor	160.00	194.00
Visicalc 3.3	99.00	116.00
Visiterm	75.00	89.00
Visiplot	80.00	94.00
Visidex	99.00	116.00
Visitrend/Visiplot	125.00	146.00
Visifile	125.00	146.00
Micromodeller	360.00	420.00
DOS 3.3 Toolkit	35.00	42.00
Desktop Plan	99.00	116.00
Bit 3 Full View 80 Column Card	175.00	210.00
Executive Secretary (Apple Word Processor)	160.00	186.00
Apple Writer (Apple Word Processor)	35.00	42.00
CCS Asynchronous Serial Interface	85.00	100.00
16k RAM Card	75.00	88.00
Tasc Compiler	100.00	118.00
Wordstar	160.00	186.00
Mailmerge	60.00	71.00
Supersort	95.00	110.00
CPS-Multifunction Card	125.00	146.00
40 Track DD Verbatim 5 1/4" Disks	17.00	21.00
77 Track DD Verbatim 5 1/4" Disks	30.00	36.00
Illustrating Basic	3.00	3.50
Some Common Basic Programs	10.95	11.50
Basic Computer Games	5.90	6.50
More Basic Computer Games	5.90	6.50
6800 Assembly Language Programming	11.95	12.50
Z80 Assembly Language Programming	11.95	12.50
6502 Applications	10.20	11.00
Programming the 6502	10.20	11.00

Micromail Micromail Micromail Micromail Mic

\*Cash with Order  
MICROMAIL, PO Box 34 (Dept PCW),  
Leighton Buzzard LU7 8SJ  
Telephone: (0525) 376600.  
Barclaycard/Access accepted

Petchberry Ltd. Trading as Micromail

## SHARP MZ80K

THE BEST VALUE IN HOME  
& BUSINESS COMPUTERS

WITH DISCS & PRINTER £1399



48K  
£339

## MZ80B

THE ADVANCED MICRO WITH BIG  
FEATURES  
64K HIGH RES GRAPHICS

£2250 WITH DISCS, PRINTER, CP/M & WORDSTAR

## THE QUALITY BUSINESS MICRO

### PC3201

SUPERB SHARP ENGINEERING  
ELEGANT STYLING. UP TO 128K  
BIG CLEAR SCREEN FOR ACCOUNTS  
WORK & WORD PROCESSING  
MANY EXCELLENT PACKAGES AVAILABLE OR  
WE CAN DEVELOP SYSTEMS FOR YOU.

## THE AMAZING POCKET MICRO

MANUAL CONTAINS UP TO 150  
ENGINEERING, SCIENTIFIC & OTHER PROGRAMS.

PC1211

£69.00

CASSETTE I/F 9.95 PRINTER £55

SOME MZ80K ACCESSORIES	CP/M S/W	COMPUTER AIDED INSTRUCTION FOR MZ80K, B & PET £48
DUST COVER 4.37	RING FOR FULL UST	
10 CASSETTES 5.00	WORDSTAR 269	
10 GAMES 5.00	MAILMERGE 82	
PASCAL 39.00	SPELLSTAR 136	
	CIS-COBOL 425	
	FINANCIAL PLANNING	

WE AIM TO OFFER YOU THE BEST DEAL,  
AND IF OUR PRICES AREN'T THE LOWEST  
CALL US FOR OUR LATEST OFFERS.

PLEASE  
ADD VAT  
TO ALL  
PRICES



THE COMPUTER COMPANY  
78 LOWER ADDISCOMBE RD.  
CROYDON Tel: 656-7715 & 654-4147

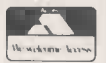

## CREAM

HAVE

# E-X-P-A-N-D-E-D

Cream, with its large modern shop centrally situated in Harrow (5 minutes from Harrow on the Hill Tube) has long been recognised as THE Computer Shop in North-West London to see and buy the latest in Apple and Commodore PET computer systems.

— NOW WE HAVE EXPANDED —

More professional demonstrators and consultants and  
AN EVEN GREATER PRODUCT RANGE!

## PROFESSIONAL SERVICES

- \* The best demonstrators in town.
- \* First class consultants to help identify your specific business needs.
- \* Programming expertise second to none for special software and tailoring.
- \* Full after sales service and training of your staff.

## PRODUCT RANGE

- \* THE Fullest range of Apple and Commodore Pet computers and the latest peripherals.
- \* MORE printers to choose from — Qumes, Okis, Epsoms, etc.
- \* Excellent business software.
- \* THE NEW VIC 20 personal computer with colour and sound — plugs straight into your TV — Just £189.95 inc VAT.
- \* Disks Tapes Books, Paper Ribbons.

FOR KEEN PRICES PROMPT DELIVERY AND THE BEST SERVICE IN TOWN —

## CREAM COMPUTER SHOP

380 STATION ROAD, HARROW, MIDDLESEX HA1 2DE.

Open Tuesday — Friday 10am — 5.30pm — Saturday 10am — 5.00pm Tel: 01-863 0833/4

ACCESS BARCLAYCARD and MAIL ORDERS WELCOMED.

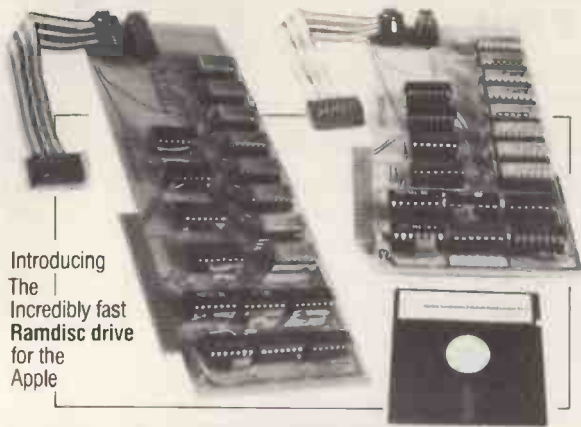

Introducing  
The  
Incredibly fast  
Ramdisc drive  
for the  
Apple

- Uses two 64K RAMCARDS and RAMDISC software to simulate a disc drive.
- Appears exactly like a real disc drive with a slot number given by the slot into which the lower 64K RAMCARD is plugged.
- Allows use of any DOS 3.3 command.
- Provides up to two thousand per cent (2000%) increase in speed during disc intensive computing.
- Compatible with all existing software which uses DOS 3.3
- No controller required.
- Saves on disc head and drive wear.
- One single real disc drive only is required for saving finished files.
- Up to four 64K RAMCARDS may be plugged into any one Apple giving 2 RAMDISC drives.
- The 64K RAMCARDS may be used directly as banked memory in other applications.

The RAMDISC package of two 64K RAMCARDS and RAMDISC software costs £345.  
Dealer enquiries invited.  
Please add 15% VAT.

 Merton Electronics 8 Rutlish Road London SW19 Telephone 01-543 3533

**MICROCOMPUTER COMPONENTS**  
LOWEST PRICES - FASTEST DELIVERY

## SPECIAL OFFERS MEMORIES

2114L	200 ns	0.99
2708	450 ns	1.48
2716	450 ns	2.10
2532	450 ns	3.99
2732	450 ns	3.20
4116	150 ns	0.75
4116	200 ns	0.67
6116	200 ns	6.50
5516	200 ns	11.95
4118	200 ns	3.85

\* OFFER VALID FROM DEC 1st - JAN 1st.  
SUBJECT TO AVAILABILITY

OFFICIAL ORDERS WELCOME CREDIT CARD ORDERS WELCOME QUANTITY DISCOUNTS AVAILABLE  
All prices exclude post and packing on orders under £10 (50p) and VAT (15%).  
ALL ORDERS DESPATCHED ON DAY OF RECEIPT WITH FULL REFUND FOR OUT OF STOCK ITEMS IF REQUESTED.  
24-hour Telephone Credit Card Orders

**MIDWICH COMPUTER CO. LTD.**  
(Dept CW/2)

HEWITT HOUSE, NORTHGATE STREET,  
BURY ST. EDMUNDS, SUFFOLK IP33 1HQ  
TELEPHONE: (0284) 701321 TELEX: 817670



# ZX81 VIC ATOM



Make the most of your microcomputer with our popular range of proven books:

- GETTING ACQUAINTED WITH YOUR VIC 20, by Tim Hartnell, with over 60 programs to get your VIC up and running from day one.....£5.95
- GETTING ACQUAINTED WITH YOUR ACORN ATOM, by Trevor Sharples and Tim Hartnell. 184 pages, 80 programs, including draughts.....£7.95
- GETTING ACQUAINTED WITH YOUR ZX81, by Tim Hartnell. Eighty plus programs in this 120-page book, including draughts.....£4.95
- MASTERING MACHINE CODE ON YOUR ZX81 OR ZX80, by Tony Baker. 180 pages, teaches machine code from first principles.....£5.95
- THE GATEWAY GUIDE TO THE ZX81 AND ZX80, by Mark Charlton. Over 60 programs and routines, ZX BASIC explained in detail.....£5.95
- 30 AMAZING GAMES FOR THE 1K ZX81, by Alistair Gourlay.....£3.95
- 50 RIP-ROARING GAMES FOR THE ZX80 and ZX81, edited by Jeff Weinrich.....£4.95
- INTERFACE, the monthly magazine published by the National ZX80 and ZX81 Users' Club, in conjunction with the Independent Atom Users' Group, is just £8.50 for 12 issues. Sample copy, with many programs for each machine, book, software and hardware reviews, education, contact addresses, just £1.

Please send me the items marked. I enclose £.....

Name .....

Address .....

Please make cheques payable to INTERFACE, and send the above form, or a copy, to:

**INTERFACE, Dept. pcw, 44-46 Earls Court Road, London W8 6EJ**



We are exclusive distributors for UK of SERENDIPITY SYSTEMS packages for Apple & CP/M; of MAGSAM index sequential access routines for CBASIC and IFO-Information File Organiser - the best data base package available for use with Apple.

If you are puzzled by the lack of good application software for CP/M micros; then puzzle no longer. - Ask about

our **GANG OF FOUR**  
**BASKAM**      **MINIMODEL**      **DATAFLOW**      **BILLFLOW**

**BASKAM**  
 BASic Keyed Access Method routines are merged into your MBASIC programs to provide simple but efficient INDEX-SEQUENTIAL file handling : Multiple indexes : re-organisation : speeds processing : cuts desk use : cuts programming time by 60%. R.R.P. £95

**MINIMODEL**  
 Financial Modelling system for CP/M : Very easy to use : Flexible report layouts : consolidation : can handle large models simply and practically. Designed by business consultants for use by real businessmen. R.P.P. £399.00

**DATAFLOW**  
 The easy-to-use, fast and flexible Database management and information retrieval package for CP/M systems. If you can file it manually; then you can file it faster and better with DATAFLOW. R.P.P. £99.95

**BILLFLOW**  
 Client Billing for "Professional" business - Accountant, Consultant, Engineer, Surveyor : Invoicing, Sales Ledger, Work-in-progress, Analysis Contribution by Fee- earner : With Nominal Ledger forms complete system from Time Sheet to Balance Sheet. R.R.P. £375.00

Also ask about; Inter-Stat, Advanced Maths and Video Message packages for Apple Ask for leaflet on; Serendipity Ledgers and Stock Control for CP/M All CP/M packages NOW AVAILABLE for **APPLE II** and SHARP MZ80B

**GREAT NORTHERN** Computer Services Limited

116 Low Lane, Horsforth, Leeds LS18 5PX. Telephone (0532) 589980



**S.W. WINTER & Co. Ltd**

**A TEACHER FOR THE APPLE**

**WE CAN HELP YOU!!**

Before you buy a micro-computer let us show you how the Apple ] [ can help you. We can advise you on systems and software. You can come in and try a system in our showroom and we will train an operator for you free of charge on purchase.

Remember: buying a computer system is easy, but living with the wrong system can be expensive.

**WE OFFER BACKUP**

We have fully trained Apple Technicians and all our installations can be covered by service contracts at rates to be negotiated. After all we have been in Office Machine servicing since 1925.

**WE WRITE SOFTWARE**

If the system that you need is not readily available we will write it for you. We already have a number of packages available off the shelf.

**WINTERSOFT PACKAGES:**

Sales Order Processing:  
 An Integrated system designed for the Importer/Wholesaler with provision for Supplier, Delivery and Invoicing Address Files, Agent Reference, Order Number, Order Entry, Delivery Note Printing, Invoicing, Credit Notes, Re-order Levels, Order size dependant Structured Pricing and Stock Control. £395.00

Stock Control with Order and Delivery Processing:  
 Items with Alpha/Numeric stock referencing. Detailed Finished Item Component Recipe Files. Entry of Stock Orders with Alpha/Numeric Order Numbers. Entry of Deliveries, and Part Deliveries referenced by Order Numbers. Full PRINTED REPORT on all DATED Movements, and printouts of stockfile. Deliveries Movements, and Suppliers. £375.00

Employment Agency:  
 A Data Based System written for agencies catering for both Full and Part-time Staff. Provision is made for creating new data disks, as well as for editing the contents of old ones. The system can be supplied with or without the facilities for paying staff and debiting clients. £350.00

**WE OFFER THE BEST VALUE WORDPROCESSOR**

Our Apple based wordprocessor is the best package on the market. For £2950.00 + VAT we offer:

- 48K Apple ] [
- 2 5 1/4" Disk drives with controller
- 80 column card
- 12" Green Screen
- Olympia Scripta ES100KSR
- Format 80 Wordprocessing Package with Mailer

**APPLE II EUROPLUS COMPUTER**

- Apple 48K Video Output £595
- Disk Drive with Controller £370
- Disk Drive without " £295
- Cuma Double Disk Drive with Controller £645

**INTERFACE CARDS**

- CCs Serial Card £113
- Apple Parallel Card £92
- Apple High Speed Serial £102
- Integer Basic Card £102
- RS232 Communications Card £130
- DV80 80 Column Display Card £188

**VIDEO MONITORS**

- 12" BMS Green Screen £164.00
- 14" Colour Monitor £355.00

**PRINTERS**

- Olympia ES 100 KSR £998
- Olympia ES 100 RO £834
- Paper Tiger 560 £859
- Paper Tiger 445 £598

TRADE ENQUIRIES WELCOME ON ALL ITEMS

S. W. WINTER & CO. LTD., 101 WESTMINSTER BRIDGE ROAD, LONDON, SE1 7HR

TELEPHONE 01-633-9611 & 01-928-4700/5945

## PHONETIC VOICE SYNTHESIZER

F..A..N..C..Y  
S..H..O..W..I..N..G O..F..F



Make your Micro talk –  
with the help of our baby, EC-01

Our baby is the well trained, sophisticated baby in the Micro market, yet easy to handle.

LOOK & COMPARE THE FEATURES BEFORE YOU BUY

- |                           |                        |
|---------------------------|------------------------|
| *UNLIMITED VOCABULARY     | *CONTINUOUS SPEECH     |
| *A ONE WATT AUDIO AMP     | *SPEAKER/AUX OUTPUT    |
| *ON BOARD BUFFER          | *BUILT IN POWER SUPPLY |
| *ASCII CODE ECHO          | *RS232 INTERFACE       |
| *ABOVE ALL TYPE 'N' VOICE | *MANY OTHERS           |

PRICE £149.95 + VAT + P&P & INSURANCE

ORDER NOW FOR XMAS

IEEE INTERFACE AVAILABLE AT EXTRA COST  
FOR FURTHER INFORMATION PLEASE SEND S.A.E.  
OR PHONE

EASICOMP SOUND GENERATORS FOR PET, OSI,  
UK101, NASCOM, ETC, STILL AVAILABLE. ONLY  
£43.00 + VAT. FOR FURTHER PRODUCTS PLEASE  
SEND S.A.E. CREDIT CARD FACILITIES READILY  
AVAILABLE.

## MULTI-FUNCTION EPROM PROGRAMMER/COPIER

This is another Easicomp product which is technically superior to anything in the market on this price range.

### FEATURES

- |                         |                      |
|-------------------------|----------------------|
| *EDITS PROGRAMS         | *READS PROGRAMS      |
| *COPIES PROGRAMS        | *VERIFIES PROGRAMS   |
| *CHECKS PROGRAMS        | *CHECKS EMPTY        |
| *PROTECTION FROM MISHAP | *UNIVERSAL INTERFACE |
| *LOW COST HIGH QUALITY  | *ONE YEAR WARRANTY   |
- DEVICE CAPABILITY 2508, 2758, 2516 2716, 2532, 2732

### EXAMPLE EDITING FUNCTION

1. DATA AREA – BYTE 'BLOCK' WHOLE DEVICE TRANSFERS.
2. LOCATION – IN HOST RAM FOR UPLOADING/DOWNLOADING.
3. DISPLAY FORMAT – ASCII, HEX.

### FUNCTION MONITORS

- |                          |                          |
|--------------------------|--------------------------|
| *SELF TEST FAILURE       | *SOCKETS EMPTY           |
| *VCC OVERLOAD            | *VPP OVERLOAD            |
| *SHORT CIRCUIT DETECTION | *CHECK PASS/FAIL         |
| *VERIFY PASS/FAIL        | *PROGRAMMING IN PROGRESS |
| *FUNCTION COMPLETE       | *MANY OTHERS             |

\*PRICE ONLY £99.95 + VAT + P&P & INSURANCE

**Easicomp 57 PARANA COURT, SPROWSTON, NORWICH NR7 8BH TEL. 0603 416352**

### LOW COST ZX81 MEMORY EXPANSION S4 MEMORY PACK

£16 INC. VAT.



INCREASE YOUR ZX81'S MEMORY TO 4K. RUNS MOST PROGRAMMES DESIGNED FOR 16K EXPANSION AT A FRACTION OF THE PRICE.

SEND CHEQUE OR POSTAL ORDER TO:-

**CEEDATA LTD.**  
GLEBE HOUSE, ARMFIELD CLOSE,  
WEST MOLESEY TRADING ESTATE,  
SURREY. KT8 0UP.



## Diskwise Ltd

25 Fore Street, Callington  
Cornwall, PL17 7AD.  
Tel: 05793 3780

## Devon & Cornwall

Computer enthusiasts look no further

WE STOCK THE FOLLOWING PRODUCTS:

APPLE II PLUS 48K .....	£776
ADLER ALPHATRONIC System from .....	£1,825
VIDEO GENIE .....	£305
COMMODORE VIC .....	£165
EPSON MX80 F/T .....	£399
Plus extra for I/F to Pet, TRS80, etc.	
MICRO LINE 80 .....	£325
OLYMPIA SCRIPTA	
DAISYWHEEL quality printers from .....	£838
TANTEL PRESTEL ADAPTER .....	£170

.. AND LOTS MORE ..

Above prices plus VAT

Paper, Discs, Books, Games and the largest range  
of APPLE BUSINESS SOFTWARE in the South West

**Plymouth Shop Now Open at:**

DEPTFORD PLACE,  
NORTH HILL, PLYMOUTH  
TEL: 267000





# WHY ARE 45 MULTINATIONALS C/WP CUSTOMERS?

C/WP is a long established service company based in Rochester Row, London SW1.

C/WP Computers is an Apple authorised level 1 service centre.

C/WP now offers Personal Computer World readers the chance to buy at its special prices.

Contact C/WP if you are interested in:

Financial forecasting  
Communications  
CP/M on Apple



## Apple/Visicalc offer

Apple 48K Europlus	£ 579
Disc drive with controller	£ 310
12" green monitor	£ 110
Silentype printer	£ 180
Visicalc 3.3	£ 100
	<hr/>
	£1279

VAT and installation extra  
12 months guarantee

# C/WP

C/WP Computers  
01-828 3127  
108 Rochester Row  
London SW1P 1JP

# ZX81 16k SOFTWARE

All our software comes with full instructions and is **SAVED** and ready to **RUN**, no need to spend hours laboriously typing in from books.

**PACK 16/1** includes all of:  
**AIR TRAFFIC CONTROL:** Animated radar screen of busy airport shown, you must bring planes into land;  
**INVADERS SELF PLAY;** **PHONEBOOK** — keep friends' and relatives' numbers on cassette; **DATE '81** — computer dating program. Who will it pick for you?  
**ALL ONLY £4.95**

**PACK 16/2** includes all of:  
**ADVENTURE ATLANTIC:** You may become very rich or you may be marooned forever; **BREAKOUT: SQUASH PRACTICE;** **LANGUAGE TRANSLATOR** translates any European language to any other; **COMPUTAPRINT** — use this program to predict results of horse races, football pools, etc.  
**ALL ONLY £4.95**

**PACK 16/3** includes all of:  
**INDI 500;** video roadracer; **DRAUGHTS;** Computer Chequers; **BATTLESHIPS** — nautical warfare on your own computer.  
**MASTERMIND** — Brain Teaser, see if you can beat a microelectronic mind.  
**ALL ONLY £4.95**

The breakthrough you've waited for:  
**PROGRAM THE ZX81 IN ENGLISH!!!**  
 With **GAMAL 81** you can now write adventure programs in hours not weeks and with **GAMAL 81** you'll have every adventure you'll ever want for the price of one. Comes on cassette with instruction book, **£7.95**

**CONTROL TECHNOLOGY —  
 PERSONAL  
 COMPUTER SCIENCE**

## Cassette 1½

A super value cassette of 16K and 1K software written in Machine Code and Basic.  
 Includes:  
 React, Invaders, Phantom Aliens, Maze of Death, Planetlander, I Ching, Hangman, Invaders, Laser Base, rectangle plus more.  
**ALL ONLY £4.95**

## Tapebook 50, Version 3

50 programs for the IKRAM ZX81.  
 Latest version includes:  
 SQUASH, BREAKOUT, COLUMBIA, SPLAT, INTEGRATION, CREDIT CARD CALCULATOR, BANK A/C, VATCHECK, TANK BATTLE, TORPEDO, HEXLOADER, BINARY CONVERTER, AND LOTS, LOTS MORE.  
 Still amazing value at **£8.95** the lot.

# ZX ~ 81

**PACK 16/1 + 16/2 + 16/3**  
 (any two only **£5.95**)  
**ALL THREE ONLY**  
**£6.95**

**TAPEBOOK 50.3 + CASSETTE 1½**  
**BOTH ONLY**  
**£9.95**

**BOTH OFFERS ARE ONLY £13.95**  
**SPECIAL OFFER**  
**TO ALL ZX81 OWNERS**

All prices include VAT and postage and packing

**CONTROL TECHNOLOGY,**  
**39 Gloucester Road, Gee Cross,**  
**Hyde, Cheshire SK14 5JG**  
**061-368 7558**

## PROTECT YOUR SOFTWARE INVESTMENT

# APPLE® COPY II PLUS — the newest and fastest bit-copier version 3.0

Apple Copy II Plus gives you the power to make back-up copies of nearly all the "protected" software packages currently available. Several thousand Apple users have already recouped their investment many times over with Copy II Plus.

### RELAX

With the Apple Copy II Plus in your top drawer you can stop worrying about accidental damage to your valuable diskettes. The Copy II Plus allows you to make back-up copies for normal use, so you can keep your originals safely locked away — away from the dangers of spills or stray magnetic fields, or just the wear and tear of everyday usage.

### EXTREMELY VERSATILE

Version 3.0 of Copy II Plus is an advanced bit-copier which can defeat nearly every protection system now in use. It will copy most DOS 3.2 and 3.3 diskettes including: Visicale 3.3, Desk Top Plan, Magic Window, DB Master (2.4) Dataplan, the Apple Special Delivery Software range and many, many more.

### UNIQUE

- Copy II Plus is the *only* bit-copier that allows you to make back-up copies of itself — for complete peace of mind.
- Copy II Plus is the fastest bit-copier by far. It copies 5 tracks at a time and makes a complete disk copy in only 35 seconds, while ordinary bit copiers take 5–7 minutes!

### FEATURES

- easy to use menu.
- comprehensive instructions.
- copy with 1 or 2 drives.
- track-by-track copy program report.
- copies half-track and irregular track spacing.
- variable search parameters — for non-standard sync or header nibbles.
- "display" option shows data being copied.
- "examine buffer" option helps identification of protection system used.

### HOW TO GET YOUR COPY II PLUS

Copy II Plus needs 48K DOS 3.3, and at least one disk drive.

Send **£45.00 + VAT** to:

Apple Orchard Ltd  
 7a Church Lane  
 Loughton

Milton Keynes MK8 0AS

or: Phone 0908 53595 and quote your Access or Diners Club card to our 24-hour answerphone.

Please allow 7–14 days for delivery — or tell us to rush if that's too long.



Apple is a registered trademark of Apple Computer Inc. Desk Top Plan and Visicale are registered trademarks of Personal Software Computer Systems. Dataplan is a registered trademark of Ferguson Ltd. Magic Window is a registered trademark of Data Ltd. D.B. Master is a registered trademark of Stonegate Micro Computer Products Ltd. Copyright Apple Orchard Ltd 1981.



# MICRO GEN

## ZX81 CHESS

- \* GRAPHIC DISPLAY
- \* SEPARATE DISPLAY OF YOUR MOVE AND THE COMPUTERS
- \* SUPERFAST MACHINE CODE
- \* SIX LEVELS OF PLAY
- \* ALLOWS ALL LEGAL MOVES INCLUDING CASTLING AND EN PASSANT
- \* IF AN ILLEGAL MOVE IS ENTERED WILL REPLY "ILLEGAL MOVE"
- \* BOARD CAN BE SET UP TO ANY CONFIGURATION
- \* ABILITY TO CHANGE SIDES IN MID GAME
- \* SUPERB POWER IN A 10K PROGRAMME

## + CHESS CLOCK

- \* SINGLE KEY ENTRY
- \* INCREMENTS TIME FOR EACH PLAYERS MOVE
- RESERVABLE FUNCTION

## ZX NEW YORK

Can you bomb and blow up your targets before your plane loses altitude and crashes?  
 Superb Graphics, Superfast Machine Codes, Score continuously incremented, Simulated bombs and rockets  
 Runs In 2K of Memory

## + ZX REFLEX

Are you as fast as thought?  
 Find out with this game!

ZX81 CHESS + CHESS CLOCK ONLY £9.50 + 40p p&p  
 ZX NEW YORK + ZX REFLEX ONLY £4.50 + 40p p&p

## MICRO GEN

24, AGAR CRES, BRACKNELL, BERKS

## MICROAGE ELECTRONICS

- \* Personal Computers \* TV Games
- \* VCR's \* Printers \* Monitors \* Software



**ATOM's and DAI's  
 ALWAYS IN STOCK**

Complete range of Atari games.  
 Open Mon - Sat. 9am till late.  
 Credit cards welcome.

**NEW THIS MONTH**

You could collect

**£10 OFF**

£5 voucher on goods over £100  
 £5 voucher when you introduce a new customer

The Seikosta 96 ASCII character printer only £199 inc. VAT.  
 Paper and cable free.

Send for price list and mail order details.  
 135 HALE LANE EDGWARE MIDDLESEX HA8 9QP  
 TEL: 01-959 7119 TELEX 881 3241

## SHARP PC3201 PAYROLL

Up to 500 employees All Tax and NHI codes Monthly and weekly paid with full coin analysis, full end of year printout. Complex Bonus calculations, voluntary deductions 3 overtime rates.  
 All output, payslips etc on PLAIN PAPER Full support and updates available. Personalisation undertaken  
 ..... £275.00

## CP/M REVIVE

Ever erased a file by mistake? Revive enables you to recover all erased files on a disc! You must have REVIVE if you use CP/M, fully menu driven

**ONLY £20**

**PC3201** now with choice of **PRINTERS**

The Latest **MZ80B** on display.

Phone Chris Robinson on (0473) 50152

**MICROTEK** IPSWICH

15 Lower Brook St Ipswich Suffolk



# SALES - LEASE

and other services

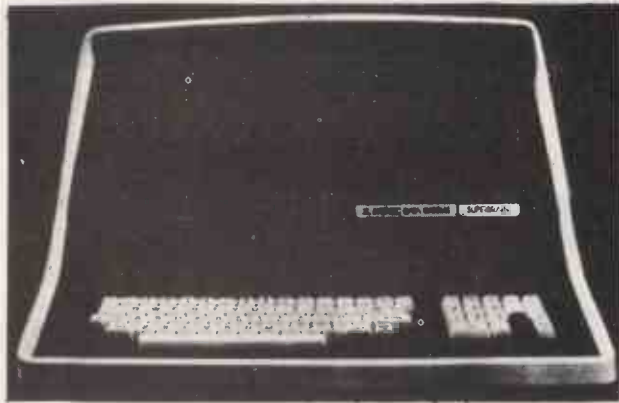

64K

SUPERBRAIN

APPLE  
CPM  
Z80



**SUPERBRAIN 64K**  
£1680 SUPERBRAIN STANDARD MODEL  
(350KB DOUBLE DENSITY DISK DRIVE)  
£2070 SUPERBRAIN QUAD MODEL  
(700KB QUAD DENSITY DISK DRIVE)

**APPLE 48K £590**  
£320 DISK DRIVE  
WITH 3.3  
CONTROLLER

£ SOFTWARE  
95 APPLE DESK-TOP PLAN  
60 CCA DATA MANAGEMENT SYSTEM  
10 DISC UTILITY PACK  
300 APPLE BUSINESS CONTROLLER PROGRAM  
25 APPLE POST PROGRAM  
35 3.3 DISK OPERATING SYSTEM  
100 APPLE FORTRAN PACKAGE  
100 VISIPLLOT VISI-TREND  
70 VISITERM  
110 DB MASTER  
100 VISICAL DISK & BOOK COMPLETE 3.3  
50 MICROBASE MAILING LSIT  
100 MICROCHASE STOCK CONTROL  
20 3D SUPER GRAPHICS  
8 CIRCUIT ANALYSIS

CARDS & ACCESSORIES  
120 ALF MUSIC SYNTHESIZER CARD  
10 TIMING MODE INPUT BOARD  
7 ALF MUSIC ALBUM 1  
7 ALF MUSIC ALBUM 2  
7 ALF MUSIC ALBUM 0 (CHRISTMAS)  
180 ANALOG OUTPUT BOARD 4 CHANNEL  
280 ANALOG OUTPUT BOARD 8 CHANNEL  
200 A1-02 DATA ACQUISITION CARD  
200 AD-DA 16 CH 12 BITS  
11 PROTOTYPE/HOBBY CARD  
40 PARALLEL PRINTER INTERFACE CARD  
100 COMMUNICATIONS CARD  
80 HIGH SPEED SERIAL INTERFACE CARD  
90 LANGUAGE CARD  
50 CENTRONICS CARD  
80 RAM CARD 16K  
150 280 CARD CRM OP  
75 EUROCOLOUR CARD  
120 SPEECH LAB  
120 GRAPHICS TABLET  
90 CONTROLLER CARD  
APPLETEL SYSTEM  
160 80-COL DISPLAY CARD FOR BASICS  
10 DISC TO CONVERT DV80 TO PASCAL  
180 APPLE JUICE POWER SUPPLY  
5 APPLE BLACK & WHITE MODULATOR  
58 HEURISTICS CONTROLLER 70  
168 HEURISTICS SPEECHLINK 200  
219 IEEE INTERFACE  
160 CLOCK/CALENDAR CARD  
180 SUPERTALKER  
110 ROM-PLUS CARD  
100 ROMWRITER  
30 COPYPLUS ROM  
300 MUSIC SYSTEM COMPLETE  
220 PASCAL LANG SYST.  
PRINTERS  
SILENTYPE 80-COL GRAPHICS PRINTER  
25 10 ROLLS THERMAL PAPER FOR  
A2M0034  
9 DUST COVER FOR SILENTYPE  
PRINTER  
CENTRONICS 737 PRINTER  
C/W ADAPTOR  
20 11x9.5" PAPER FOR CENT. 737  
32 IJ ZIPPACK RIBBONS FOR CENT. 737  
9 DUST COVER FOR CENT. 737 PRINTER  
8 SERIAL CABLE FOR TIGER PRINTER  
18 GRAPHICS SOFTWARE FOR TIGER/G  
18 2000 SHEETS 11x9.5 PAPER 1 PART  
RE-INKING RIBBON & ROLLER SET  
1395 QUME 5/45 RX  
110 QUME FORM TRACTOR  
400 CENTRONIC 739  
460 PAPER TIGER 445  
560 PAPER TIGER 460  
650 PAPER 560  
750 ANADEX DP9000  
780 ANADEX DP9500  
810 ANADEX DP9001  
845 ANADEX DP9501

LANGUAGES  
PASCAL  
FORTRAN  
CIS-COBOL  
COBOL 80  
FORTRAN 80  
MBASIC  
CBASIC  
APL  
MPM  
PLI

STANDARD  
WORDSTAR  
MAGIC WAND  
SPELLBINDER  
MAILMERGE  
DATASTAR  
SUPERSORT 1  
IBM 3780 EMU  
STATIONERIES

ACCOUNTANCY  
INCOMPLETE RECORDS  
INTEGR. ACCOUNTS  
SALES LEDGER  
PURCHASE LEDGER  
NOMINAL LEDGER  
INVOICING  
PAYROLL  
STOCK CONTROL  
DBMS

ADVENTURE GAMES  
14 ODDESSY  
16 ZORK  
16 SANDS OF MARS  
8 STELLAR INVADERS  
17 TEMPLES OF ARSHAI  
10 MISSION ASTEROID  
12 MYSTERY HOUSE  
15 WIZARD AND THE PRINCESS

BOARD GAMES  
18 SARGON II  
12 FAST GAMMON  
12 BRIDGE PARTNER  
12 CHECKER KING  
10 WINDFALL  
6 TANK COMMAND  
12 FRACAS

**EPSON** Unbelievable quality from  
the world's largest print head manufacturer.



Qume  
£1395



MX80F/T<sub>1</sub> = £340  
MX80F/T<sub>2</sub> = £380 MX100 - £525

DOCUMENTATION  
12 FORTRAN  
9 APPLE II REFERENCE MANUAL  
10 6602 HARDWARE MANUAL  
8 6502 SOFTWARE MANUAL  
3 APPLE II BASIC PROGRAM MANUAL  
4 APPLESOFT II REFERENCE MANUAL  
4 DOS 3.2 MANUAL 3.3  
4 APPLE II BASIC TUTORIAL MANUAL  
4 AUTOSTART ROM MANUAL  
11 PASCAL MANUALS  
14 BENEATH APPLE DOS

WAR GAMES  
17 WARP FACTOR  
10 LORDS OF KARMA  
25 BISMARCK  
25 AMBUSH  
16 CONFLICT  
25 AIR COMBAT  
25 NAPOLEONICS  
17 BASEBALL

VIDEO MONITORS  
100 9" HIGH RESOLUTION B/W MONITOR  
100 9" BLACK & WHITE VIDEO MONITOR  
165 12" BLACK & WHITE VIDEO MONITOR  
CABLE FOR VIDEO MONITOR  
120 12" VIDEO MONITOR GREEN DISPLAY  
MONITOR CABLE FOR VM12G  
250 12" COLOR MONITOR

HARDWARE  
590 APPLE 48K VIDEO OUTPUT ONLY  
260 DISC DRIVE WITHOUT CONTROLLER  
320 DISC DRIVE WITH CONTROLLER  
25 16K ADD ON  
150 280 SOFTCARD/CPM/MANL

MAIL ORDER TO CENTRAL OFFICE  
SEND FOR FURTHER DETAILS ON REST OF OUR EXCELLENT RANGE OF SOFTWARE HARDWARE

\*All prices ex. V.A.T. \*Our own low cost maintenance 24 hrs. service \*Please ask for other brands of software and hardware

## MICROCOMPUTER HIRE SERVICE

A TRIAL PERIOD FOR YOUR COMPUTERISATION  
A COMPREHENSIVE SERVICE FOR RENTALS

Superbrain with application packages · Apple System · PET Tandy Sorcerer Horizon Printers

CENTRAL OFFICE: Microcomputer Spacedrome, 3 Westholm, London NW11. 01-458 5845  
Promglow Ltd., 12 Dene Road, New Southgate.



# Give Your Apple<sup>®</sup> Mainframe Capability.

By adding our software to your PASCAL system.

## LinkVideo<sup>™</sup>

REDUCE SCREEN I/O PROGRAMMING 90%

- create terminal independent programs
- safeguard programs from user error
- validate, filter and prompt input
- give programs a professional look
- simplify screen handling
- source and P-code included... R.R.P. £44.95

## LinkDisk<sup>™</sup>

GET FOUR FUNCTION DISK CONTROL

- convert Dos 3.3 text/binary to Pascal
- guarantee correct readable copies
- examine and change any byte on disk with easy-to-use screen editor
- print text files selectively ..... R.R.P. £54.95

## Learn Pascal the active way with LinkSampler 1<sup>™</sup>

- Pascal techniques illustrated
- 21 teaching programs
- 68-page easy reading manual
- games and personal finance .. R.R.P. £49.95

Link software is Corvus compatible. Ask us about Pascal software for Apple III<sup>™</sup> and CP/M<sup>™</sup> systems.

## DataLink<sup>™</sup>

ERROR-FREE MAINFRAME COMMUNICATIONS

- transmit/receive up to 4800 baud
- control entire session with 1 key stroke
- dial and retry automatically
- send concurrently to screen, printer & disk
- complete error-checking
- also supports Apple-Cat II<sup>™</sup> at 1200 baud  
... R.R.P. £99.95

## LinkIndex<sup>™</sup>

USE THE FASTEST KEY RETRIEVAL SYSTEM

- sophisticated B-tree indexing method
- 1 record from 25,000 in less than a second
- maintains sorted order
- supports duplicate keys
- easy to use Pascal unit ..... R.R.P. £134.95

# LINK SYSTEMS

UK DISTRIBUTOR

ADVANCED QUALITY SOFTWARE

88 ST. BENEDICTS STREET  
NORWICH NR2 4AB

TEL: (0603) 21117

Please send more info

Name: \_\_\_\_\_

Company: \_\_\_\_\_

Address: \_\_\_\_\_

City: \_\_\_\_\_

County: \_\_\_\_\_ Code: \_\_\_\_\_

Signature: \_\_\_\_\_

Payment enclosed for the following. Add £1.50 for p&p and

LinkVideo

DataLink

15% for VAT

LinkDisk

LinkIndex

LinkSampler 1

Post to: ADVANCED QUALITY SOFTWARE

88 ST BENEDICTS STREET

NORWICH

NR2 4AB

ENGLAND

TELEPHONE  
0603-21117

Apple trademark of Apple Computers Inc. CP/M trademark of Digital Research Inc. Apple-Cat II trademark of Novation Inc.

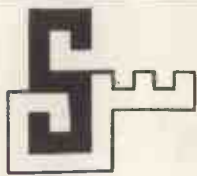

# STEMMOS LTD

## SOFTWARE WITH SUPERBRAIN MICRO

344 Kensington High Street,  
LONDON W14.  
Telephone: 01-602 6242 (3 lines)  
Telex: 893003

### REASONS FOR CONTACTING STEMMOS

LOWEST MICRO PRICES	
Superbrain 360KB	£1995
Superbrain QD 720KB	£2195
Compustar	£2710

PRINTERS	
Oki Microline 82	£390
Anadex DP 9501	£980
NEC-Spinwriter	£1900
+ others	

LOW COST	
Tailoring	
Software support	
Computer accessories	

HARDWARE MAINTENANCE	
1 - On contract basis	
2 - On call basis	
We specialise in Intertec technology	

### WIDE RANGE OF RELIABLE AND WELL-TESTED SOFTWARE

STEMMOS AND OTHERS	
Programmers Superscreen	£300
Estimation/Civil eng	£2000
Microsoft range	-
Graphics	-
Data base information	£300
Job costing	£300

STEMMOS - ENGINEERING	
SuperFrame 3D	£2000
Demo-kit	£150
Shells of Revolution	
Analysis	£2000
SuperPipe	£2500
Non-linear Circuit	
Analysis	£1200

MICROBUREAU	
Stock control	£350
Purchase ledger	£350
Sales ledger	£350
Nominal ledger	£450
Payroll	£350
Job costing	£450
Full integrated pkg	£1700

Wordstar	£240
With Merge	£290
Mail Merge	£70
Data Star	£150
Wordmaster	£150
Supersort	£150

GOOD DISCOUNT FOR EDUCATIONAL INSTITUTIONS

DEALERS AND SALES AGENT - GOOD DISCOUNT AND COMMISSION

**SPECIAL OFFER**

FLOPPY DISCS 5¼" (SOFT SECTORED)	
SS/SD	£1.50
SS/DD	£2.00
DS/DD	£2.35

COMPUTER LISTING PAPER	
11"x9½" PLAIN WHITE	£8.00 PER BOX
11"x9½" MUSIC RULED (GREEN)	
12"x9¾" PLAIN WHITE	£9.50 PER BOX
	£8.00 PER BOX (2,000 SHEETS)

MAILLINE LABELS (SELF ADHESIVE - 2 ACROSS)	
3½"x1½"	PRICE PER 1,000 £3.20
4"x1½"	PRICE PER 1,000 £3.50

FOR DETAILS OF OTHER BARGAINS CALL 01-670 4411 OR CUT OUT SLIP AND SEND TO:

CONSUP, 62 TRITTON RD, LONDON, S.E.21.  
NAME .....

ADDRESS .....

PHONE NO. ....



## CRYSTAL ELECTRONICS CC ELECTRONICS

### FOR YOUR SHARP MZ80K CP/M 2.21 (XTAL)

BASIC CP/M FACILITIES INCLUDE:

- Dynamic file management
- Fast assembler
- General purpose editor
- Advanced debugging utility

YOUR SHARPCP/M 2.21 (XTAL) PACKAGE INCLUDES:  
• Hardware modification (if fitted by a SHARP dealer does NOT break the guarantee) • SHARP CP/M 2.21 (latest version) on disc • XTAL Monitor and Operating system • 7 Digital Research manuals • 12 months guarantee and up-dates (on all our products)

**CP/M 2.21 (XTAL) FROM £150 + VAT**

Ask your SHARP dealer for further details or contact CRYSTAL ELECTRONICS

CP/M SOFTWARE HOUSES - XTAL CAN HELP YOU ESTABLISH YOUR SOFTWARE ON THE SHARP.

### XTAL BASIC (SHARP)

Takes 5K less memory, has all the features of SHARP BASIC PLUS Multi dim strings, error trapping, logical operators, machine code monitor, more flexible peripheral handling, improved screen control, increased list control, auto run, if..then..else - and it doesn't stop there - it grows. You can extend the commands and functions at will - 10K, 12K, 16K, BASIC?. SHARP to XTAL BASIC conversion program is included. £40 plus VAT.

Bi-directional serial board for your SHARP RS232 compatible 150 Baud to 2400 Baud adjustable < 5,6,7,8 Bit words, plugs into MZ80I/O £99.50 plus VAT. Includes software for bi-directional use in XTAL BASIC, software for using SHARP BASIC with serial printer and self-diagnostic software for testing Baud rate etc.

Members of Computer Retailers Association & Apple Dealers Association

Shop open 0930 - 1730 except Saturday & Sunday

40 Magdalene Road, Torquay, Devon, England. Tel: 0803 22699

Access and Barclaycard welcome





# IMPROVE YOUR PETTING TECHNIQUE!

## PROGRAMMING THE PET/CBM by RAETO WEST

Contents include this and very much more:-

- 1 Introduction and overview: Plan of the book, sources of information and help, features and chronology of CBM hardware
  - 2 BASIC and how it works: Storage of BASIC and variables; pointers, syntax; modifying, running, and optimising BASIC
  - 3 Program and system design: What the equipment can do; charts, structured design, algorithms; estimating size, timing
  - 4 Effective programming in BASIC: Subroutines, DATA, date handling, crashproof INPUT, packing, rounding, searching, etc.
  - 5 Alphabetic reference to BASIC: Full descriptions, examples, notes for all keywords, plus DEL, OLD, POP, SORT, VARPTR, etc.
  - 6 Disk drives: Descriptions; six file types and uses; CBM disk handling, direct access, machine-code; Compu/think; reliability, bugs
  - 7 Alphabetic reference to disk BASIC: BASIC 4 disk commands with syntax, examples, and notes; earlier equivalents
  - 8 Other peripherals and hardware: Cassettes; tape timing, storage, ROM routines; printers; keyboard programming; reset switches
  - 9 Graphics and sound: Tables of characters, graphics; CRT chip; 6502 animation, bar plots, 80 by 50 etc.; square-wave & 8-bit sound
  - 10 Transition to machine-code: 8-bits and 16-bits; BASIC and 6502; use of monitors; Supermon listings; demonstrations
  - 11 More 6502 machine-code: 6502 addressing, flags, PC, SP, etc.; how to compare, negate, add, subtract, multiply, divide, increment etc.
  - 12 Alphabetic reference to 6502 opcodes: Examples, notes, full details on all opcodes from ADC to TYA
  - 13 Using ROM routines: IRQ, NMI, RESET; BASIC, the kernel; modifications-LIST, PRINT USING, TRACE; writing relocating loaders
  - 14 Effective 6502 programming: BASIC, CHRGET and wedges; assemblers; examples; PIAs, VIA, IEEE; common mistakes
  - 15 Index to BASIC ROMS and RAM: Memory map; the first four pages; comparisons and detailed explanations of BASICs 1, 2, and 4
  - 16 Mathematical Programming: Accuracy; equations; statistics; simulation; finance; trigonometry; matrices; how ROM routines work
  - 17 Business and education: Examples, applications, cautions; menus, users, input; packages; documentation; educational needs
- Appendices: 6502 reference charts, tables, pseudo-opcodes, ASCII, glossary

Many programs, diagrams, and charts. Paperback (suitable for ring binding), approx. 500 pages 19 cm x 26 cm. ISBN 0 9507650 0 7.

LEVEL LIMITED (PCW), P.O. BOX 438, HAMPSTEAD, LONDON NW3 1BH  
U.K. Price £14.90 (includes postage, packing) — Please allow 6 days for delivery

## Micro General

### MATRIX PRINTERS...

Please contact us for advice on printer selection

#### MICROLINE 80

Popular, robust printer with block graphics. Models 82A & 83A available, 120 cps. Serial/Parallel Interfaces switch selectable. Call for details.

**£275** +VAT



#### EPSON MX-SERIES

Remarkably versatile printers for many applications. Graphics models and full range of Interfaces available.

FROM **£359** +VAT  
(FOR MX-80T)

#### CENTRONICS 737-2

Correspondence quality. Forward and reverse paper motion. Superscript and subscript etc. Nascom 2 driver routine supplied.

**£345** +VAT



FREE DELIVERY to UK Mainland.

Listing paper £17.00 +VAT per 2,000 sheets.

FREE INSTALLATION within 30 miles of Reading.

DAY or EVENING appointments welcome.

MICRO GENERAL, 6 The Birchwoods, Tilehurst,

Reading, Berks RG3 5UH. Tel: 0734 25226.



## ZX81 Workstation...



... is a stylish and ergonomic plinth for the ZX81. It raises and tilts the TV to avoid eyestrain, holds the 16KRAM in place and hides the wiring and power supply. This very professional unit costs £15, a built-in power switch is £3, plus postage at £1.50, inc. VAT. Peter Furlong Products, 125 Catford Hill, London SE6 4PR. Callers by appointment, please. Tel 01690 7799. Visa, Access.

**The Sinclair ZX80 is innovative and powerful.  
Now there's a magazine to help you get  
the most out of it.**

# Get in sync



SYNC magazine is different from other personal computing magazines. Not just different because it is about a unique computer, the Sinclair ZX80 (and kit version, the MicroAce). But different because of the creative and innovative philosophy of the editors.

## A Fascinating Computer

The ZX80 doesn't have memory mapped video. Thus the screen goes blank when a key is pressed. To some reviewers this is a disadvantage. To our editors this is a challenge. One suggested that games could be written to take advantage of the screen blanking. For example, how about a game where characters and graphic symbols move around the screen while it is blanked? The object would be to crack the secret code governing the movements. Voila! A new game like Mastermind or Black Box uniquely for the ZX80.

We made some interesting discoveries soon after setting up the machine. For instance, the CHR\$ function is not limited to a value between 0 and 255, but cycles repeatedly through the code. CHR\$(9) and CHR\$(265) will produce identical values. In other words, CHR\$ operates in a MOD 256 fashion. We found that the "=" sign can be used several times on a single line, allowing the logical evaluation of variables. In the Sinclair, LET X=Y=Z=W is a valid expression.

Or consider the TL\$ function which strips a string of its initial character. At first, we wondered what practical value it had. Then someone suggested it would be perfect for removing the dollar sign from numerical inputs.

Breakthroughs? Hardly. But indicative of the hints and kinds you'll find in every issue of SYNC. We intend to take the Sinclair to its limits and then push beyond, finding new tricks and tips, new applications, new ways to do what couldn't be done before. SYNC functions

on many levels, with tutorials for the beginner and concepts that will keep the pros coming back for more. We'll show you how to duplicate commands available in other Basics. And, perhaps, how to do things that can't be done on other machines.

Many computer applications require that data be sorted. But did you realize there are over ten fundamentally different sorting algorithms? Many people settle for a simple bubble sort perhaps because it's described in so many programming manuals or because they've seen it in another program. However, sort routines such as heapsort or Shell-Metzner are over 100 times as fast as a bubble sort and may actually use less memory. Sure, 1K of memory isn't a lot to work with, but it can be stretched much further by using innovative, clever coding. You'll find this type of help in SYNC.

## Lots of Games and Applications

Applications and software are the meat of SYNC. We recognize that along with useful, pragmatic applications, like financial analysis and graphing, you'll want games that are fun and challenging. In the charter issue of SYNC you'll find several games. Acey Ducey is a card game in which the dealer (the computer) deals two cards face up. You then have an option to bet depending upon whether you feel the next card dealt will have a value between the first two.

In Hurkle, another game in the charter issue, you have to find a happy little Hurkle who is hiding on a 10 X 10 grid. In response to your guesses, the Hurkle sends our a clue telling you in which direction to look next.

One of the most ancient forms of arithmetical puzzle is called a "boomerang." The oldest recorded example is that set down by Nicomachus in his *Arithmetica* around 100 A.D. You'll find a computer version of this puzzle in SYNC.

## Hard-Hitting, Objective Evaluations

By selecting the ZX80 or MicroAce as your personal computer you've shown that you are an astute buyer looking for good performance, an innovative design and economical price. However, selecting software will not be easy. That's where SYNC comes in. SYNC evaluates software packages and other peripherals and doesn't just publish manufacturer descriptions. We put each package through its paces and give you an in-depth, objective report of its strengths and weaknesses.

SYNC is a Creative Computing publication. Creative Computing is the number 1 magazine of software and applications with nearly 100,000 circulation. The two most popular computer games books in the world, *Basic Computer Games* and *More Basic Computer Games* (combined sales over 500,000) are published by Creative Computing. Creative Computing Software manufactures over 150 software packages for six different personal computers.

Creative Computing, founded in 1974 by David Ahl, is a well-established firm committed to the future of personal computing. We expect the Sinclair ZX80 to be a highly successful computer and correspondingly, SYNC to be a respected and successful magazine.

## Order SYNC Today

Right now we need all the help we can get. First of all, we'd like you to subscribe to SYNC. Subscriptions are posted by air directly from America and cost just £10 for one year (6 issues), £18 for two years (12 issues) or, if you really want to beat inflation, £25 for three years (18 issues). SYNC is available only by subscription; it is not on newsstands. We guarantee your satisfaction or we will refund the unfulfilled portion of your subscription.

Needless to say, we can't fill up all the pages without your help. So send in your programs, articles, hints and tips. Remember, illustrations and screen photos make a piece much more interesting. Send in your reviews of peripherals and software too—but be warned: reviews must be in-depth and objective. We want you to respect what you read on the pages of SYNC so be honest and forthright in the material you send us. Of course we pay for contributions—just don't expect to retire on it.

The exploration has begun. Join us.

The magazine for Sinclair ZX80 users

# SYNC

27 Andrew Close  
Stoke Golding  
Nuneaton CV13 6EL, England



**★ NEW BROOM FOR EPROMS ★**  
**TEX ERASER SWEEPS CLEAN!**

**EPROMPT is Prompt Enough!**



Eproms need careful treatment to survive their expected lifetime. Rushing it could burn their brains out. So cop-out of this helter-skelter world; take it easy the TEX way and give your chips a well-earned break. Cool, gentle and affordable; EPROMPT does it properly.

- ★ 16-chip basic economy EPROMPT EB: £32 nett; £39 c.w.o. ★
- ★ 32-chip interlocked de-luxe EPROMPT GT: £40 nett; £49 c.w.o. ★

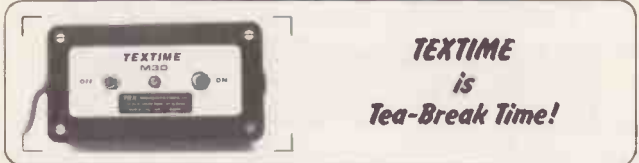

**TEXTIME**  
**is**  
**Tea-Break Time!**

Our EPROMPT needs just half-an-hour to finish its job; this is the proper erase time for all Eproms. While it's busy you may as well take a break yourself, but don't take too long without a timer on the job; over-erasing can shorten data storage time. So our TEXTIME will remember to turn out the light and your chips will forget nothing new.

- ★ 30-minute solid-state TEXTIME M30: £15 nett; £19 c.w.o. ★
- ★★★ Special Offer EB + M30: £45 nett; £55 c.w.o. ★★★
- ★★★ Special Offer GT + M30: £53 nett; £66 c.w.o. ★★★

TEX: Reliable quality at affordable prices. We manufacture in the U.K. and sell direct. All items ex-stock from St. Albans or Watford Electronics. C.W.O. Prices include Carriage & VAT. Write post-free: **BOX 11;**

**TEX MICROSYSTEMS LTD. FREEPOST**  
 ST. ALBANS, HERTS. AL1 1BR ST. ALBANS 64077/TRING 4797 ANYTIME

**IBM SELECTRIC GOLFBALL PRINTERS  
 AND INPUT, OUTPUT 735  
 TYPEWRITERS**

PRINTERS FROM	£195.00
735 TYPEWRITERS FROM	£245.00
WIRING AND COMMISSION	
TO SUIT ACULAB INTERFACE	£48.00
ACULAB INTERFACES EX STOCK	£155.00

**ALSO AVAILABLE**  
 IBM 71, 72, 82 typewriters.  
 Full workshop facilities for rebuilds and servicing.  
 Keyboard ASCII-ASCII, 10-12 pitch, language conversions undertaken.  
 11", 13", 15" platen lengths, split platens pin feed platens. Operational keylever repeats fitted on request.  
 Full IBM range of 10-12\* pitch heads including language, symbol and metric.  
 Language keybuttons blue or grey

**WE BUY SELL OR EXCHANGE ALL IBM  
 SELECTRIC TYPEWRITER MODELS**

For further details phone Stuart Kirby or  
 Louis Baker Prices excl VAT @ 15% carriage &  
 packing, callers by appt only please

KEYTRONICS

Unit 3A, Eastington Trading Estate,  
 near Stonehouse, Gloucester  
 045 382 4004

# a must for your ZX81

Authors: Ian Stewart & Robin Jones

The reader-friendly guide to getting started with the Sinclair ZX81. Includes an introduction to looping and branching, graphics, subroutines, and debugging techniques, with over 50 programs designed to run on the standard 1K memory.

Approx. 130 pages Paperback £4.95  
 Publication: 4 January 1982  
 ISBN 0 906812 17 8

Published by: Shiva Publishing Ltd., 4 Church Lane,  
 Nantwich, Cheshire CW5 5RQ Telephone: (0270) 628272



Please supply me with \_\_\_\_\_ copy/copies of: PEEK, POKE, BYTE & RAM

Price. £4.95 per copy. Cheques should be made payable to Shiva Publishing Ltd.

NAME (Capitals please) \_\_\_\_\_

Full postal address \_\_\_\_\_

For payment by Access/American Express:

Card No. \_\_\_\_\_

Signature \_\_\_\_\_

Order from your Bookseller, or fill in the coupon.

PROFESSIONAL PASCAL

Pascal/Z

NEW

4.0

SYMBOLIC DEBUGGER

This fourth generation version of our reliable, Z-80 native code compiler adds the two features professionals ask for:

- ◆ SWAT™—an interactive symbolic Pascal debugger that allows easy error detection.
- ◆ Overlays—that allow larger programs to run in limited memory.

A compiler for Professional programmers

Pascal/Z is a true Pascal. It closely follows the Jensen and Wirth standard with a minimum of extensions designed to aid the serious program developer in producing extremely compact, bug-free code that runs FAST.

Pascal/Z generates Z-80 native code that is ROMable and Re-entrant. Permits separate compilation, direct file access, external routines and includes a relocating macro assembler and Microsoft compatible linker. And code written for Pascal/Z is fully compatible with I-PAS 8000, our new native code Pascal compiler for Z-8000, to guarantee graceful migration to 16 bit operation.

Get "The FACTS about Pascal"

Confused about which Pascal to buy? Pseudo-code... Native code... M, MT or Z? Compare the unbiased benchmarks in our new booklet. Don't buy a Pascal compiler until you've read it.



Call us for a free copy: AVAILABLE IN SEVERAL FORMATS INCLUDING SHARP MZ80 B SUPERBRAIN IBM 8" DOUBLE PRECISION INTEGERS FOR BUSINESS ALSO AVAILABLE

ITHACA InterSystems (UK) Ltd.

"MAKING MICROCOMPUTERS FOR THE '80s"

Ithaca Intersystems (U.K.) Ltd. Coleridge Road London N8 8ED Phone: 01-341 2447 Telex: 299568

SHARP MZ-80B



WORLD BEATING VERSATILITY

Take a look at the MZ 80B, it is an incredibly good machine. Probably the best graphics of any microcomputer. Very fast operation - 4 Megahertz Z80. Double sided, double density disk drives (optional) - 560K of store. User friendly - pleasant and easy to use. Superb build quality - if anything it is over engineered. 3 available disk operating systems - Sharp DOS, FDOS & CP/M. Plenty of languages - BASIC, Double Precision BASIC, BASIC Compiler, PASCAL Interpreter. Single unit - screen, keyboard, fast cassette interface (1800 bits/sec). See the MZ 80B at your nearest Microcomputers at Laskys.

MZ 80B Computer 64K

Nett: 1095.00 Vat: 164.25 Total: 1259.25

10 Shops Nationwide

Birmingham

19/21 Corporation Street, Birmingham, B2 4LP. Tel: 021-632 6303. Manager: Peter Stallard. 300 yards from Bullring Centre.

Bristol

16/20 Pann Street, Bristol, BS1 3AN Tel: 0272 20421. Between Holiday Inn and C & A.

Chester

The Forum, Northgate Street, Chester, CH1 2BZ. Tel: 0244 317667. Manager: Jeremy Ashcraft. Next to the Town Hall.

Edinburgh

4 St. James Centre, Edinburgh, EH1 3SR. Tel: 031-556 6217. Manager: Colin Draper. East end of Prices Street, St. James Centre.

Preston

1/4 Guildhall Arcade, Preston, PR1 1HR. Tel: 0772 59264. Manager: Jim Camisky. Directly under Guild Hall.

Manchester

12/14 St. Mary's Gate, Market Street, Manchester, M1 1PX Tel: 061-832 6087. Manager: Lesly Jacobs. Corner of Deansgate.

Glasgow

22/24 West Nile Street, Glasgow, G7 2PF. Tel: 041-226 3349. Manager: David Livingstone. Between Buchanan Street and Central Station.

Sheffield

58 Leopold Street, Sheffield, S1 2GZ. Tel: 0742 750971. Manager: Justin Rowles. Top of the Moor, opposite Town Hall.

Liverpool

33 Dale Street, Liverpool, L2 2HF. Tel: 051-236 2828. Manager: Mark Butler. Between the Town Hall and Magistrates Courts.

London

42 Tottenham Court Road, London, W1 9RD. Tel: 01-636 0845. Manager: Vass Demosthenis.

Laskys, the retail division of the Ladbroke Group of Companies





# ADVERTISERS INDEX

ACT	128,129	DDP	210	Katotek	56	Newtronics	32
Adda	70	Data Applications	119	Keen	30	Northamber	72,73
Almarc	38	Datalink	55	Kellys	226	Oasis Software	227
Altwasser	239	DaVinci	169	Keytronics	253	On-Line	40
Anglia Computers	249	Deans	226	Knights	207	Osborne	41
Anglian Comp Eng		Digico	158	Kram	216	Personal Computers	OBC
Apple (UK)	108	Digitek	135	Kuma	27	Personal Computer Palace	232
Audio Computers	200	Digitus	1	L&J Computers	217	Pete & Pam	44
Avery	213	Discom	239	LP Enterprises	37	Prentice Hall	42
BEM	90	Disking	195	LSI 20,21,34,35,120,121,152,153	90	Printout	68
John Birkwood Associates	220	Diskwise	244	Leicester Comp Centre	90	Program Power	234
Biodata	236	Display	57	Level	251	Psion	204,205
Blythe	17	EMG	151	Lifeboat	81	Rade Systems	126
Boyd	236	EMPA	136,137	Linsac	237	Research Machines	39
Brighton Comp Centre	58	Easicomp	244	Lintex	205	Riva Terminals	14
Butel	225	Elfton	220	Lion House	84	SBD Software	25,215,219
Butler, Currie & Hook	213	Environmental Equipment	212	Little Genius	234	SEC	24
C/WP	245	Essential Software	92,124	Liverpool Comp Centre	36	SRS Microsystems	26
Calisto	227	Flintdata	246	London Comp Centre	53	ST Commercial	225
Call Printers	222	Fuller Designs	230	Lowe Electronics	111	Sharp	88,97
Cambridge Comp Store	95	Furlong Products	251	Lucas Logic	22,23	Shiva	253
Cambridge Learning	58	GW Computers	28,29	MBC	194	Sinclair Research	143-146,159
Camden	208,228	Gate Microsystems	160	Macronics	222	Sirtou	47
Cardiff	236	Gemini	239	Maddison	204	Small Systems	233
Carlton	217	Graham Dorian	224	Maplin	43	Spider Software	234
Caxton	66,76	Great Northern	243	Mass Micros	169	Spreebond	235
Ceedata	244	Guestel	102,103	Melbourne House	94	Stemmos	250
Cetronics	223	Hal	232	Merton	242	Stirling	214
City Microsystems	209	Happy Memories	206	Metrotech	48	Strotron	218
Chromasonic	199	Harding	18,19	Microage	247	Strumech	206
Clenlo	89	Henry's	196,233	Microcentre	IFC	Superior Systems	213
Comart	98,116	Hewlett Packard	4,5	Microcomputers at Laskys	7-10,	Swanley	222
Commodore	64	Hi-Tech Computers	237	Microcomputerland	15,161,254	Tabs	127
Comp Shop	256,IBC	Hi-Tech Electronics	130	Microcomputer Spacedrome	201	Technomatic	219
Computech	229	Holdco	233	Microfocus	248	Teletype Equipment	33
Computerbits	197	IBR	114	Microgen	112	Telesystems	235
Computer Bookshop	80,232	IO Systems	169	Micro Gen	247	Teletone	25
Computer Company	241	ITT	46	Micro General	251	Templeman	206
Computers For All	203	Icarus	215	Micro Mail	241	Tempus	217
Computer 100	168	Ikon	218	Micro Peripherals	113	Tex	253
Computer Plus	205	Imperial College	220	Microprint	223	Timedata	214
Consup	250	Inchico Systems	208	Microsave	231	Transam	31
Control Technology	246	Intelligent Artefacts	211	Microspares	232	Twickenham	210
Control Universal	204	Interam	16,154	Microsolution	49	U-Microcomputers	36
Crab Software	222	Interface	242	Microstyle	221	Video Software	202
Cream	241	Ithaca	230	Microsystems	168	Watford Electronics	238
Creative Computing	252	JCL	227	Microtechnology	97	SW Winters	243
Crofton	237	JRS	50	Microtek (Ipswich)	247	Wordsworth	209
Cronite	220	Johnson Micros	228	Microtek (Orpington)	54	Xitan	45
Croydon Micros	220	Kai	52	Microvalue	12,13		
Crystal	250	KGB	216	Midwich	242		
Cumana	51,240	Kansas		NSC Comp Shops	11		



Hot on the heels of the ACT Sirius 1 comes news of a British rival — from British Micros and due out this Summer. It, too, is 8088-based, has 128k of RAM, a built-in clock/calendar and twin 350k of disks. Projected selling price is £2000, or £3000 if you'd like a 5 Mbyte hard disk. . . Stateside PET punters have been spared the awesome sight of CBM's global marketing supremo Kit Spencer staring at them from that company's ads. The latest ad feature Captain James T Kirk — sorry, actor William Shatner of 'Star Trek' fame, now looking much older — extolling the virtues of Commodore computers. Strange. One would have thought that after the hi-tech hardware aboard the Enterprise (direct voice input, planet scanning interfaces, auto Klingon alert, lots of lovely flashing lights), the CBM products would seem

boringly mundane. . . Editor Rodwell thought he'd discovered a rival to the hated Rubik's Cube — putting a ZX Printer back together. After spending several weeks trying to cram all the bits back into the case, he was most annoyed to see nubile Programs Editor Maggie Burton establish the world record by re-assembling it in three minutes flat. And it worked perfectly. . . Reports of 'overwhelming success' reach us from the BBC after the 'Tomorrow's World' experimental software broadcast. Hundreds of viewers reported receiving and running the programs successfully, the youngest being a six-year-old, the most extravagant being the man who ran the program though his computer to a phototypesetting machine, and the most dedicated being the BBC TV engineer who built a TV sound-only receiver

especially for the purpose. The reason why the Apple in the studio failed to receive the program was simple: in the tension of a live broadcast, presenter Sue Ingle pressed the wrong key and crashed it. . . Talking as we were earlier of British Micros, co-boss of that outfit, the unspellable Manas Heghoyan, set a record of sorts by being the first person from the entire British microcomputer industry to win money in Las Vegas during a recent trip there. On hearing the news, Editor Rodwell promptly packed his bags and jetted off to spend Christmas trying to do better than Manas's \$100 win. He was last heard of sitting on the pavement outside the Golden Nuggett frightening passers-by with a tuneless rendering of 'Buddy Can You Spare a Dime'. . . Meanwhile PCW's publisher, Felix Denis, has been reaping the reward of a misspent

adulthood. While holidaying on the QEII (alright for some . . .) he won an Asteroids tournament against 11-16 year old opponents. First prize: an Atari 800! To them that hath, mumble, bitch, gripe. . . Finally, please, please will everyone stop ringing us for the phone number of the BBC Computer sales office — there is no phone number. You have to write to: BBC Microcomputer Systems, 14 Station Road, Kettering, Northants NN15 7HE. The BBC Computer is only available by mail order and, when we last heard (just before Christmas) there was a backlog of some 9000 orders, although hopefully this will have diminished by the time you read this. We're sorry if this sounds unhelpful but we just can't handle dozens of phone calls a day — we have a magazine to produce.



NOBODY CAN GET NEAR OUR PRICES EXCEPT OUR CUSTOMERS

**NOW IN STOCK**

**THE NEW & EXCITING TRS80 MODEL III**



48K £619 + VAT

The Radio Shack TRS-80™ Model III is a ROM-based computer system consisting of:

- A 12-inch screen to display results and other information
- A 65-key console keyboard for inputting programs and data to the Computer
- A Z-80 Microprocessor, the "brains" of the system
- A Real-Time Clock
- Read Only Memory (ROM) containing the Model III BASIC Language (fully compatible with most Model I BASIC programs)
- Random Access Memory (RAM) for storage of programs and data while the Computer is on (amount is expandable from "16K" to "48K", optional extra)
- A Cassette Interface for long-term storage of programs and data (requires a separate cassette recorder, optional/extra)
- A Printer Interface for hard-copy output of programs and data (requires a separate line printer, optional/extra)
- Expansion area for upgrading to a disk-based system (optional/extra)
- Expansion area for an RS-232-C serial communications interface (optional/extra)

All these components are contained in a single moulded case, and all are powered via one power cord.

- Disc Drives Kit with 2x40 Track Drives — £599 + VAT
- Disc Drives Kit with 2x80 Track Drives — £729 + VAT
- Add £25 for installation

EXTENDED GUARANTEE BY COMPLACARE

**WE ARE NOW STOCKING THE APPLE II AT REDUCED PRICES**



**AUTOSTART EURO PLUS**  
48K  
£649.00 + VAT

Getting Started APPLE II is faster, smaller, and more powerful than its predecessors. And it's more fun to use too because of built-in features like:

- BASIC — The Language that Makes Programming Fun.
- High-Resolution Graphics (in a 54,000-Point Array) for Finely-Detailed Displays.
- Sound Capability that Brings Programs to Life.
- Hand Controls for Games and Other Human-Input Applications.
- Internal Memory Capacity of 48K Bytes of RAM, 12K Bytes of ROM; for Big-System Performance in a Small Package.
- Eight Accessory Expansion Slots to let the System Grow With Your Needs.

You don't need to be an expert to enjoy APPLE II. It is a complete, ready-to-run computer. Just connect it to a video display and start using programs (or writing your own) the first day. You'll find that its tutorial manuals help you make it your own personal problem solver.

EXTENDED GUARANTEE BY COMPLACARE

**APPLE DISC II 3.3 Dos**

Disc with Controller  
£349 + VAT  
Additional Drives  
£299 + VAT



- Powerful Disk Operating Software Supports up to 6 drives
- Name Access to Files for Ease of Use
- BASIC Program Chaining to Link Software Together
- Random or Sequential File Access to Simplify Programming
- Dynamic Disk Space Allocation for Efficient Storage
- Individual File Write-Protection Eliminates Accidental File Alterations
- Loads an 8K Byte Binary Image in 6.5 sec. (1.2 sec. in Pascal)
- Storage Capacity of 116 Kilobytes (143K Bytes with Pascal) on Standard 5¼" Diskettes
- Powered Directly From the APPLE (Up to 6 Drives) for Convenience and High Reliability
- Packaged in Heavy-Duty, Colour-Coordinated Steel Cabinet

Colour Monitors for Apple — £295 + VAT

**NEW The PEDIGREE PETS**

RRP £795 for 32K



32K  
ONLY £569 + VAT

Very popular for home & business use. 8K Microsoft Basic in ROM. 32K with new improved keyboard. 12" screen. Cassette Deck £55 extra

EXTENDED GUARANTEE BY COMPLACARE

**GET YOURSELF A NEW MX80 PRINTER AND SAVE A FORTUNE**

only £349 + VAT



- 80 Column, • Upper & lower case
- Centronics Parallel • Uni-directional.
- MX80 — from £349 + VAT MX80FT £399 + VAT

EXTENDED GUARANTEE BY COMPLACARE

EX-STOCK

**NEW**

**ACORN ATOM**  
UNIQUE IN CONCEPT — THE HOME COMPUTER THAT GROWS AS YOU DO

Fully Assembled £149 + VAT



EXTENDED GUARANTEE BY COMPLACARE

- Special features include
- Full Sized Keyboard
- Assembler and Basic
- Top Quality Moulded Case
- High Resolution Colour Graphics
- 6502 Microprocessor

**CASIO VL TONE**

NEW £29.95 + VAT



It's a new kind of musical instrument. A computer controlled synthesiser that helps you create, play and arrange compositions that normally take years of musical training.

EXTENDED GUARANTEE BY COMPLACARE

EXTENDED GUARANTEE BY COMPLACARE

**8032 80 COLUMN PET**

ONLY £825 + VAT



The reliable value for money system with after sales support, instruction and training facilities and a wide range of programmes.

**SALE MEMORY UPGRADES**

16K (8 x 4116) £12.90 + VAT  
4K CompuKit (8 x 2114) £12.90 + VAT

**COMMODORE VIC-20**

ONLY £159 + VAT



- 16 foreground colours
- 8 background colours
- Real typewriter keyboard with full graphics
- Music in three voices and three octaves
- Language and sound effects

EXTENDED GUARANTEE BY COMPLACARE

**TV GAME BREAK OUT**

Has got to be one of the world's greatest TV games. You really get hooked. As featured in ETI. Has also 4 other pinball games and lots of options. Good kit for up-grading old amusement games.



MINI KIT — PCB, sound & vision modulator, memory chip and de-code chip. Very simple to construct. £14.90 + VAT  
OR PCB £2.90 MAIN LSI £8.50 Both plus VAT

EXTENDED GUARANTEE BY COMPLACARE

**NEW**

**TANTEL**

ONLY £169 + VAT



Demonstration available at our showroom

**PRESTEL BY TANTEL** The greatest thing since television & telephones. Communications at your fingertips for business & home. 180,000 pages of up-to-date information on travel, news, investment, holidays, hotels etc etc. Ask Prestel a question and you have your answer in seconds in full colour on your own TV. Only requires a telephone jack socket available from the PD.

**HITACHI PROFESSIONAL MONITORS**

9" — £129 £99.95  
12" — £199 £149



EXTENDED GUARANTEE BY COMPLACARE

- Reliability Solid state circuitry using an IC and silicon transistors ensures high reliability.
- 500 lines horizontal resolution Horizontal resolution in excess of 500 lines is achieved in picture center.
- Stable picture Even played back pictures of VTR can be displayed without jittering.
- Looping video Input Video input can be looped through with built-in termination switch.
- External sync operation (available as option for U and C types)
- Compact construction Two monitors are mountable side by side in a standard 19-inch rack.

EXTENDED GUARANTEE BY COMPLACARE

**CENTRONICS 737 DOT MATRIX PRINTER**

only £369 + VAT including cables

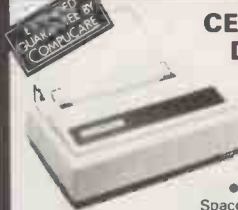

- Standard Features
- 80 CPS — Proportional Spaced Mode
- 50 CPS — Monospaced Mode
- Proportional Spacing (Plus 10 CP1 and 16.7 CP1
- N x 9 (Proportional) or 7 x 8 (Monospaced)
- Dot Matrix • 7 x 8 Dot Matrix • 3 Way Paper Handling System
- 96 Character ASC11 plus 6 European character sets
- Microprocessor Electronics
- Expanded Print
- Right Margin Justification
- Print Underlining
- 9-Wire Free Flight Print Head
- Bidirectional Stepper Motor Paper Drive
- Full One Line Buffer
- 21 LPM With 80 Columns Printed
- 58 LPM With 20 Columns Printed
- 6 Lines Per inch Vertical Spacing
- Paper Tear Bar
- Centronic Colours and Logo

EXTENDED GUARANTEE BY COMPLACARE

Microline 83 & 82 NOW IN STOCK

**MICROLINE 80** £299 + VAT

- 80 cps Uni-directional • Small size: 342 (W) x 254 (D) x 108 (H) mm.
- 160 Characters, 96 ASCII and 64 graphics • 3 Character sizes: 40, 80 or 132 chars/line • Friction and Pin Feed
- Low noise: 65 dB • Low weight: 6.5 kg

**MICROLINE 82** £449 + VAT

- 80 cps bi-directional logic seeking
- Small size: 360 (W) x 328 (D) x 130 (H) mm.
- 160 characters, 96 ASCII and 64 graphics with 10 National character-set Variants.
- 4 Character sizes: 40, 66, 80 or 132 chars/line.
- Built-in parallel and serial interfaces.
- Friction and Pin Feed
- Low noise: 65dB • Low weight: 8kg

**MICROLINE 83** £779 + VAT

- 120 cps bi-directional logic seeking
- 136 column printing on up to 15in forms
- Small size: 512 (W) x 328 (D) x 130 (H) mm.
- 160 characters, 96 ASCII and 64 graphics with 10 National character-set variants
- 3 Character spacings: 5, 10 and 16.5 Char/in.
- Built-in parallel and serial Interfaces
- Friction and Pin Feed
- Low noise 65dB • Low weight: 13 kg

**THE VIDEO GENIE SYSTEM**

Ideal for small businesses, schools, colleges, homes, etc. Suitable for the experienced, inexperienced, hobbyist, teacher, etc.

**EG3000 Series**



16K £279 + VAT

WITH NEW EXTRA KEYS!

- 16K user RAM plus extended 12K Microsoft BASIC in ROM
- Fully TRS-80 Level II software compatible
- Huge range of software already available
- Self contained, PSU, UHF modulator, and cassette
- Simply plugs into video monitor or UHF TV
- Full expansion to disks and printer
- Absolutely complete — just fit into mains plug.
- The Video Genie is a complete computer system, requiring only connection to a domestic 625 line TV set to be fully operational; or if required a video monitor can be connected to provide the best quality display.
- 51 key typewriter style keyboard, which features a 10 key rollover. Supplied with the following accessories:
  - BASIC demonstration tape;
  - Video lead;
  - Second cassette lead;
  - Users manual;
  - BASIC manual;
  - Beginners programming manual.
 Write useful programs in the BASIC computer language yourself.

**VIDEO GENIE EXPANSION BOX**

Complete with RS232 interface and floppy disc controller. 0 memory. £225 + VAT.

Memory expansion card (S100) 16K £110 32K £159 + VAT

EXTENDED GUARANTEE BY COMPLACARE



IF IT WASN'T FOR THE LOWEST PRICES, THE BIGGEST CHOICE AND THE BEST AFTER SALES SERVICE, WE JUST WOULDN'T BE COMP SHOP

## YOUR ZX80 IS NOW NO LONGER REDUNDANT

Upgrade your ZX80 to the full animated graphics of the ZX81. (No screen flicker).

FOR ONLY **£12.95 + VAT** IN KIT FORM

Works only in conjunction with **NEW 8K ROM** from Sinclair (Not Included).

ZX81 part-exchanges accepted - **GOOD PRICES OFFERED**

## UP GRADE YOUR SINCLAIR TO A 16K RAM PLUS EXPANSION BOARD WITH 3 SLOTS

This Expansion Board is designed for more than just memory - that's why it costs more than others!

**16K £69 + VAT      4K £49 + VAT**

## ATARI CARTRIDGES IN STOCK

Phone for availability

## COMP PRO MIXER

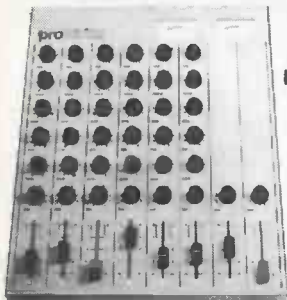

**Professional audio mixer that you can build yourself and save over £100.**

Only **£99.90**

plus VAT for complete kit. Plus **FREE** power supply valued at **£25.00**

## WORD PRO II SALE FOR PET

**£35 + VAT**

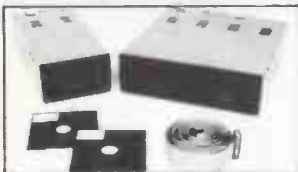

## TEAC DISK DRIVES

- TEAC FD-50A has 40 tracks giving 125K Bytes unformatted single density capacity.
- The FD-50A can be used in double density recording mode.
- The FD-50A is Shugart SA400 interface compatible.
- Directly compatible with Tandy TRS80 expansion interface.
- Also interfaces with Video Genie, SWTP, TRS80, North Star Horizon, Superbrain, Nascom, etc, etc.
- Address selection for Daisy chaining up to 4 Disks.
- Disks plus power supply housed in an attractive grey case.

**40 TRACK**  
Single Disk Drive **£225 + VAT**      Double Disk Drive **£389 + VAT**

**77 TRACK**  
Single Disk Drive **£299 + VAT**      Double Disk Drive **£499 + VAT**

**STOCKTAKE SALE NEVER TO BE REPEATED AT THIS PRICE UNTIL STOCKS LAST**

\*6502 based system — best value for money on the market. \*Powerful 8K Basic — Fastest around \*Full Qwerty Keyboard \*1K RAM Expandable to 8K on board. \*Power supply and RF Modulator on board. \*No Extras needed — Plug-in and go \*Kansas City Tape Interface on board. \*Free Sampler Tape including powerful Disassembler and Monitor with each Kit. \*If you want to learn about Micros, but didn't know which machine to buy then this is the machine for you.

Build, Understand and Program your own Computer for only a small outlay.

## EUROPE'S FASTEST SELLING ONE BOARD COMPUTER

# COMPUKIT UK101



**COMPUKIT WITH ALL THE FEATURES THAT MADE IT THE MOST PROFESSIONAL COMPUTER KIT ON THE MARKET. NOW WITH FREE NEW MONITOR (a saving), which includes Flashing Cursor, Screen Editing, & Save Data on Tape.**

KIT ONLY **£99.95 + VAT**

Fully Assembled — **£149 + VAT**

**NEW MONITOR IN ROM** — available separately at **£7.90 + VAT**.

Improved Basic function — revised GARBAGE routine. Allows correct use of STRING ARRAYS **£4.90**  
This chip can be sold separately to existing CompuKit and Super board users. **+ VAT**

**4K Upgrade Kit £12.95 + VAT**

**FOR THE COMPUKIT** — Assembler Editor **£14.90**

**GAME PACKS** — 1). Four Games **£5.00**    2). Four Games **£5.00**    3). Three Games 8K only **£5.00**  
Super Space Invaders (8K) **£6.50**    Chequers **£3.00**    Realtime Clock **£3.00**

Case for CompuKit **£29.50**

40 pin Expansion Jumper Cable **£8.50**

All Prices exclusive VAT

## TTL SALE

Minimum Order — **£5**

74LS00	£0.10	74LS86	£0.30	Z80	£4.90
74LS04	£0.10	74LS93	£0.50	6502	£1.90
74LS05	£0.15	74LS157	£0.60	ACIA 6850	£1.90
74LS10	£0.15	74LS165	£0.90	OP-AMP	£0.45
74LS32	£0.20	74LS365	£0.40	CA3130	£0.45
74LS74	£0.25	74LS373	£1.20	REG.	£0.75
				7805 5V	£0.75

### Low Profile Sockets

14 PIN	£0.05	18 PIN	£0.10	24 PIN	£0.20
16 PIN	£0.06	20 PIN	£0.15	40 PIN	£0.27

## OUR NEW SUPER LOCATION IN IRELAND

**19 Herbert Street, Dublin 2.**  
**Telephone: Dublin 604165**

**HEAR OUR ADS ON RADIO NOVA 88.1 VHF Stereo**

## NEC SPINWRITER

only **£1490 + VAT**



NEC's high quality printer uses a print "thimble" that has less diameter and inertia than a daisy wheel, giving a quieter, faster, more reliable printer that can cope with plotting and printing (128 ASCII characters) with up to five copies, friction or tractor fed. The ribbon and thimble can be changed in seconds. 55 characters per second bidirectional printing — with red/black, bold, subscript, superscript, proportional spacing, tabbing, and much, much more.

8MHz Super Quality Modulators	<b>£4.90</b>
6MHz Standard Modulators	<b>£2.90</b>
C12 Computer Grade Cassettes	10 for <b>£4.00</b>
Anadex Printer Paper — 2000 sheets	<b>£15.00</b>
Floppy Discs 5 1/4" Hard and Soft Sector	<b>£2.90</b>
Floppy Disc Library Case 5 1/4"	<b>£3.50</b>
Ribbons DP8000	<b>£3.50</b>
DP9500/9501	<b>£12.50</b>

All Prices exclusive VAT

## THE ANADIX DP9500 and DP9501 A PROFESSIONAL PRINTER



- Bi-directional printing
- Up to 220 chars/line with 4 print densities
- 500 char buffer
- RS232C and Centronics Parallel interface built in
- Full software control of matrix needles allowing graphics capability
- 200 chars/sec • Adjustable width tractor feed.

DP9500 — ONLY **£845 + VAT**

DP9501 — ONLY **£895 + VAT**

## LUXOR COLOUR MONITOR FOR THE APPLE

**£295 + VAT**

**WE HAVE ONE OF THE LARGEST COLLECTIONS OF COMPUTER BOOKS UNDER ONE ROOF, ALONG WITH RACKS OF SOFTWARE FOR THE GENIE AND TRS80.**



## SHARP PC1211

**£79.90 + VAT**

- COMPUTER POWER THAT ONCE FILLED A ROOM CAN NOW BE CARRIED IN YOUR POCKET!**
- Programs in BASIC • "QWERTY" Alphabetic Keyboard • 1.9K Random Access Memory • Long Battery Life.

We give a full one year's guarantee on all our products, which normally only carry 3 months guarantee.

**A SELECTION OF APPLE INTERFACES ARE NOW AVAILABLE AT OUR EDGWARE ROAD SHOWROOM**

Delivery is added at cost. Please make cheques and postal orders payable to **COMP SHOP LTD.**, or phone your order quoting **BARCLAYCARD, ACCESS, DINERS CLUB** or **AMERICAN EXPRESS** number.

### MAIL ORDER AND SHOP:

14 Station Road, New Barnet, Hertfordshire, EN5 1QW (Close to New Barnet BR Station — Moorgate Line). Telephone: 01-441 2922 (Sales) 01-449 6596 Telex: 298755 TELCOM G

**OPEN (BARNET) — 10am - 7pm — Monday to Saturday**

### NEW WEST END SHOWROOM:

311 Edgware Road, London W2. Telephone: 01-262 0387  
**OPEN (LONDON) — 10am - 6pm — Monday to Saturday**

- IRELAND: 19 Herbert Street, Dublin 2. Telephone: Dublin 604155
- COMP SHOP USA, 1348 East Edinger, Santa Ana, California, Zip Code 92705. Telephone: 0101 714 5472526

**CREDIT FACILITIES ARRANGED** — send S.A.E. for application form.

**TELEPHONE SALES**  
**OPEN 24 hrs. 7 days a week**  
**01-449 6596**



# COMP SHOP

"Europe's Largest Discount Personal Computer Stores"

# BUYING THE HARDWARE IS ONLY HALF THE STORY...

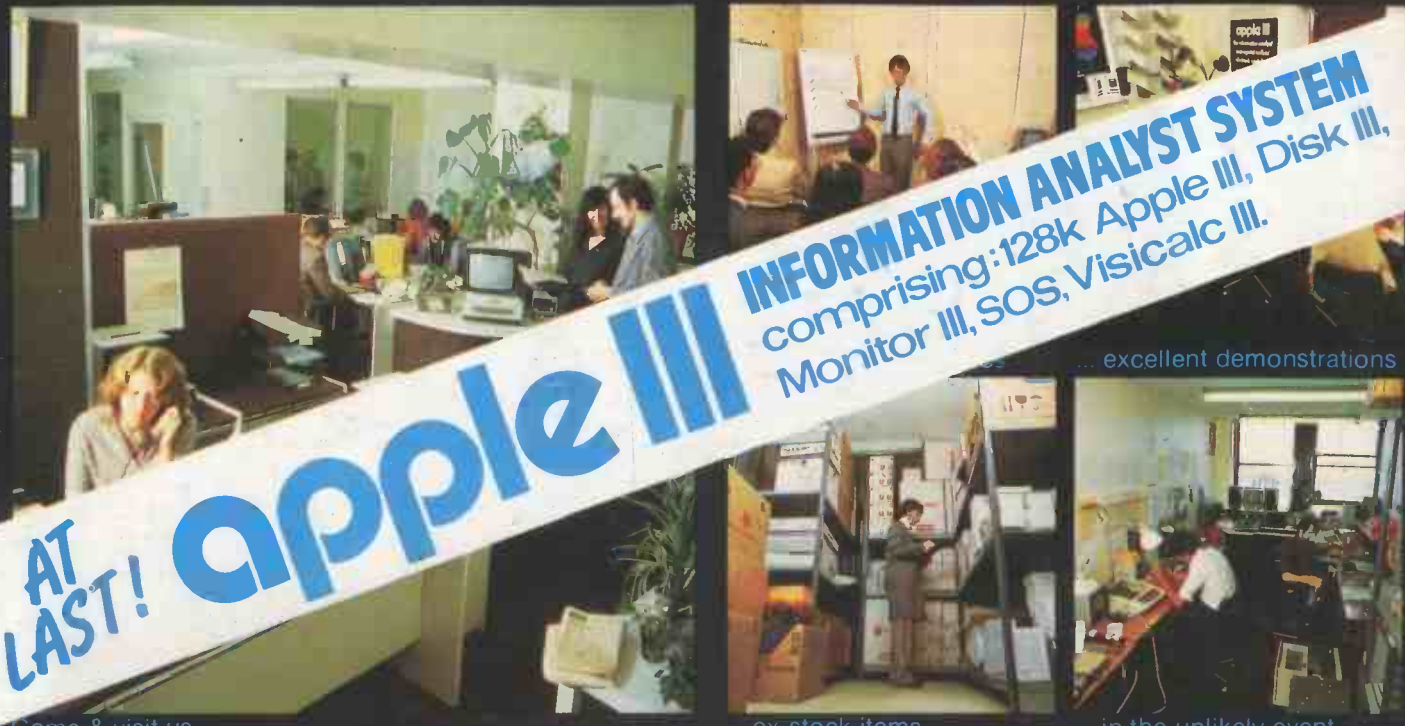

## ... At Personal Computers we'll give it a happy ending.

Personal Computers Limited have been in the personal computing business right from the start — so we've got our values sorted out.

It's important for you to choose the right hardware and vital to select the right software.

To help you make the right choice we offer our highly-trained staff.

They know what makes computers whirr, and they know how to give you the right kind of support and maintenance.

### THE BEST AVAILABLE

We stock the best available hardware and software packages in the market.

Such as Apple and Sharp units, with the latest additions like 16K RAM card.

We have I.E.E.E. Interface, low cost serial, parallel interfaces, Doublevision 80 character card, numeric keypads, personal computer plotters, Paper Tiger printers and much more besides.

Whatever you need in computing, we will satisfy your requirements.

### FROM PERSONAL COMPUTERS

- **Small Business/Accounting.** We provide low-cost invoicing, purchase, sales and general ledger systems.
- **Financial Planning.** Micromodeller or Visicalc for ad hoc or regular financial reporting.

- **Dow Jones & Prestel** (including I.P. Terminal) services to the city, plus access to city commodities data base.
- **Word Processing.** Our Format 80 system is recognised as the best of its kind.
- **Databases.** State-of-the-art products like Personal Filing Systems and Data Factory.
- **Graphics.** Pad to plotter software and low-cost plotter.
- **Technical Support.** Our knowledge of computer languages and application requirements is unrivalled. And we can supply either on-site or in-house maintenance.

*Once again ... Personal Computers Limited give the story a happy ending.*

*Computers are only as good as the people who use them ... and sell them. Think about that! Then give us a call.*

Personal Computers Limited  
Masters of Personal Computer Technology  
194/200 Bishopsgate London EC2M 4NR Tel: 01-626 8121