

PE12

The Post Office Electrical Engineers' Journal

VOL 64 PART 3/OCTOBER 1971



THE POST OFFICE ELECTRICAL ENGINEERS' JOURNAL

VOL 64 PART 3 OCTOBER 1971

Contents

	<i>page</i>
Editorial	137
Manpower Productivity in Telecommunications—G. E. Turner	138
Aluminium Conductor Cables in the Telephone Distribution Network— E. E. L. Winterborn	146
The Application of the Electro-optic Effect to Telecommunications—Sheila Ayers	154
The Manufacture of Waveguide Components by Electroforming—E. J. J. Goodman	160
Telecommunications Power Supplies—The Next Decade—Part 3— A Modular D.C. Plant—S. F. Humphries	164
Concorde over Goonhilly—P. J. Duffy	172
Micro-Architecture or Chemical Tailoring—M. M. Faktor and P. Heckingbottom	177
International Automatic Transit Switching at Faraday I.T.S.C. —R. L. Williams and R. Rimmer	184
Synchronization of an Integrated Digital Transmission and Switching Network— D. Thomson	190
Notes and Comments	195
Regional Notes	197
Associate Section Notes	200
Institution of Post Office Electrical Engineers	202
Press Notices	204
Book Reviews	159, 163, 189

Published in April, July, October and January by the *Post Office Electrical Engineers' Journal*,
2-12 Gresham Street, London EC2V 7AG

Price 21p 31p (Including Postage and Packaging). Orders by post only.

Annual Subscription (post paid): Home and Overseas £1.24. (Canada and U.S.A., 3 dollars)

**ever
wanted**

to match your
load bearing capacity to
your own rate of growth?

**with GEC
multiplex
you can!**

GEC Multiplex equipment is easily built up from a few circuits to the maximum capacity you require. Groups, supergroups, and hypergroups can be assembled economically in line with CCITT, North American, or other requirements. The equipment construction is compact but flexible, with plug-in units mounted in standard 'CASE' rack frameworks easily adaptable in height to meet individual requirements. These features of design *and* construction enable you to match the development of GEC Multiplex equipment to your own developing requirements, large or small.

GEC MULTIPLEX TYPE 4M EQUIPMENT



Takes telecommunications into tomorrow

GEC-AEI TELECOMMUNICATIONS LTD, OF COVENTRY, ENGLAND.

A Management Company of The General Electric Co. Ltd. of England.

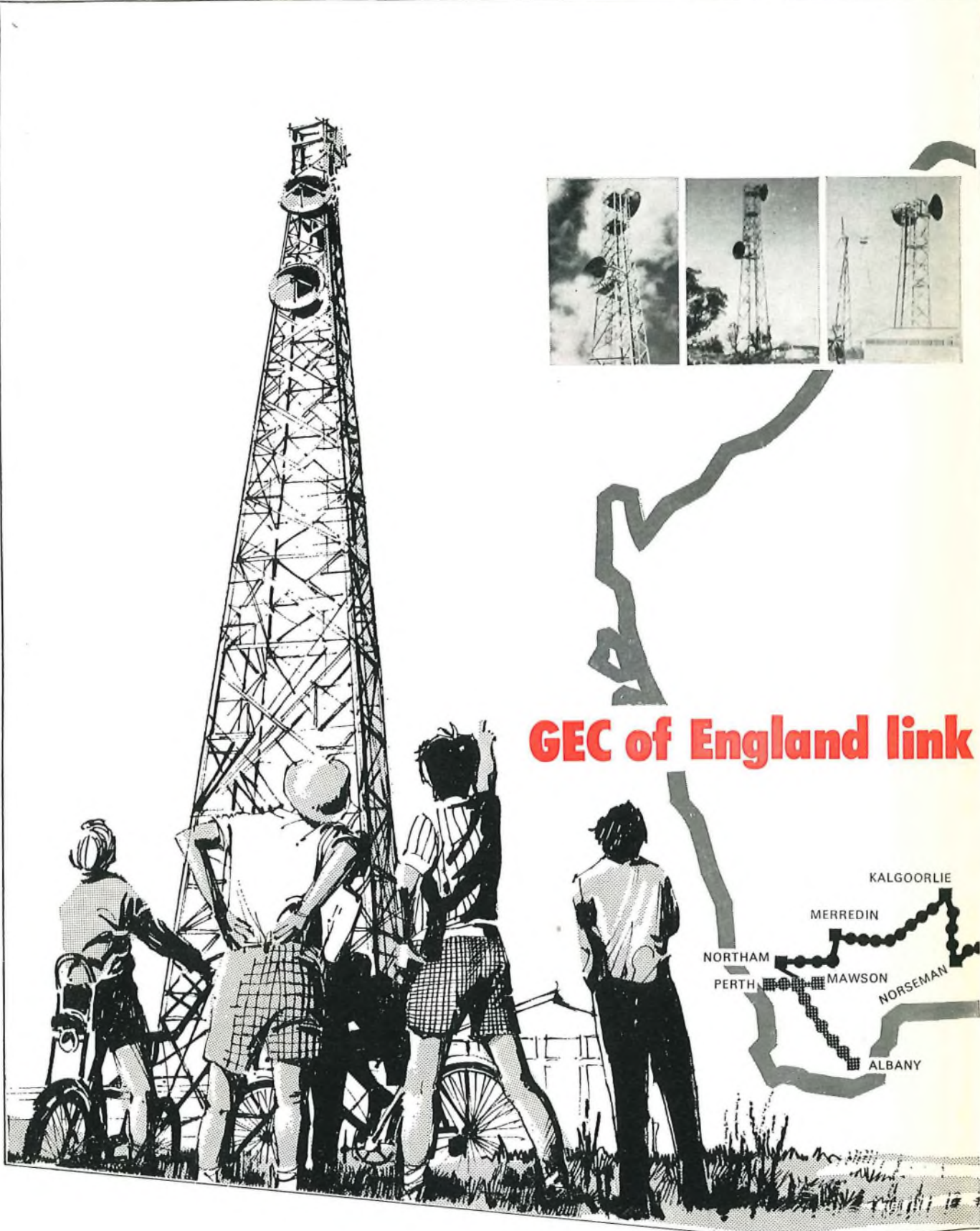

GEC of England link



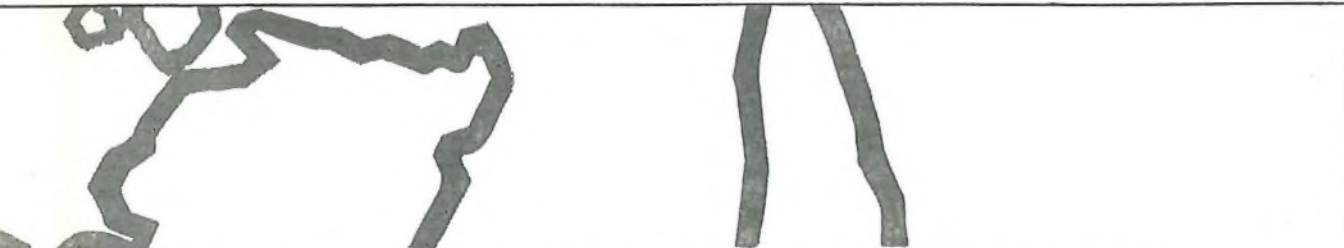

GEC of England is proud to have acted as main contractor for the East-West 2GHz microwave radio system now in service, which brings Western Australia into the national broadband trunk telephone and television relay network. The largest single telecommunications project carried out in Australia, and one of the longest systems in the world, it carries trunk telephone calls, at the present rate of 1.3 million per year, over 1500 miles between Western Australia and the Eastern States, and provides circuits to all centres en route. Working in close collaboration with the Australian Post Office, GEC was responsible for the engineering, manufacture, installation and commissioning of the radio equipment, and the design parameters for antennas and feeders, power plant equipment shelters and towers, and overall project management—an A\$8,000,000 responsibility.

The 2GHz system is part of the GEC total systems capability which includes 2GHz, 4GHz, 6GHz and 6.8 GHz systems for speech or colour television on long-haul main routes, and 7.5 GHz for speech on medium-haul and spur routes, all in accord with CCIR requirements, together with associated equipments including frequency division Multiplex, for up to 1800 circuits, supervisory alarm indication and remote control systems, I.F. and baseband switching, narrowband auxiliary radio for serviceband and antenna systems.

East and West with one of the longest civil microwave systems in the world!

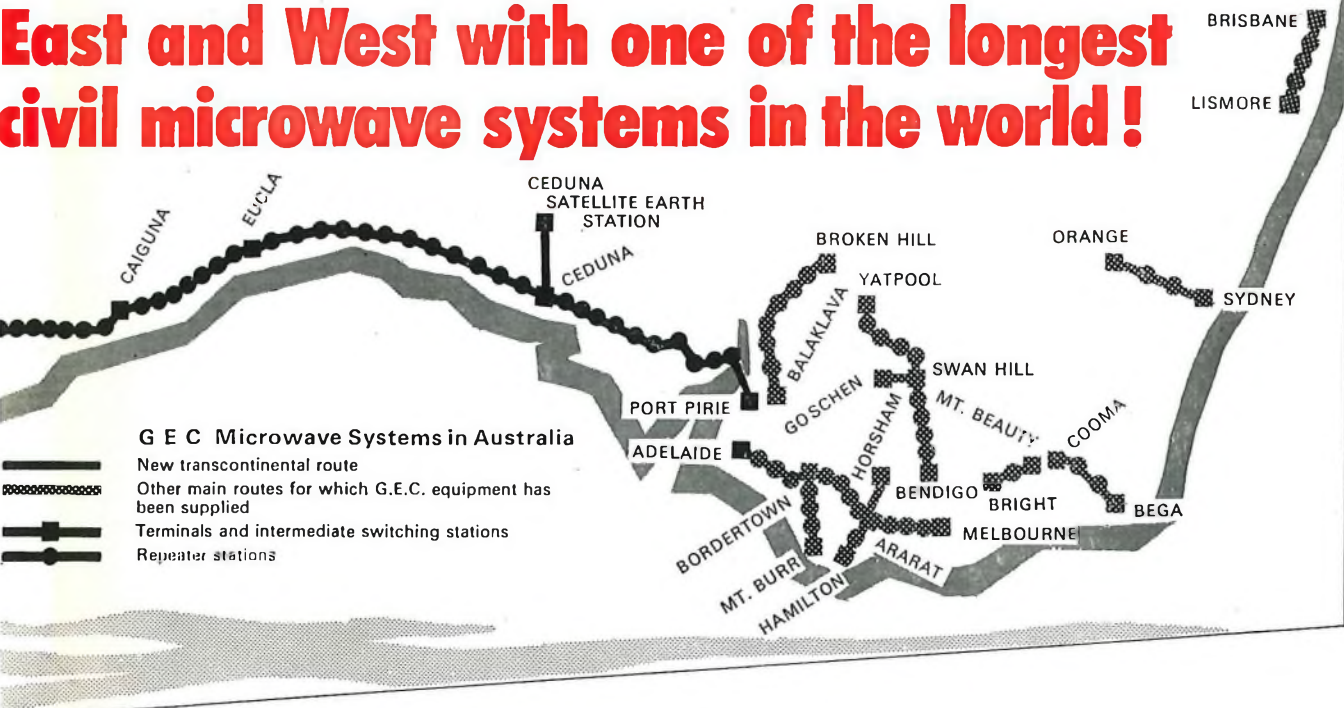

Takes telecommunications into tomorrow

GEC-AEI TELECOMMUNICATIONS LIMITED OF COVENTRY, ENGLAND
 A management Company of The General Electric Co. Ltd. of England

ever wanted

to improve your
capacity for
conversation?

with the GEC small-diameter co-axial cable system 4K9B you can!

- * 960 telephone circuits.
- * 4.4 mm. (0.174 in.) or 9.5 mm. (0.375 in.) coaxial-cables.
- * Power-fed repeaters at a maximum spacing of 4010 m. (4,400 yd.) for 4.4 mm. cable and 9250 m. (10120 yd.) for 9.5 mm. cable.
- * Performance to CCITT recommendations.
- * Proven in operation with over 230 systems covering 6000 route miles being supplied in the U.K. alone.
- * Underground repeater boxes to house up to six systems.



S.E.C.

Takes telecommunications into tomorrow

GEC-AEI TELECOMMUNICATIONS LTD, OF COVENTRY, ENGLAND.

A Management Company of The General Electric Co. Ltd. of England.



Matching your growth rate.

STC Frequency Division Multiplex — today's equipment for tomorrow's system. Matching your growth rate channel by channel, group by group, and supergroup by supergroup.

With 50 years experience, STC leads in the design and manufacture of multiplex equipment and is well able to meet your increasing demand.

STC also specialise in Coaxial Cable and Pulse

Code Modulation Systems, offering installation, commissioning, training and maintenance services. STC is backed by the global resources and experience of ITT.

For more information write to: Standard Telephones and Cables Limited, Transmission Division, Basildon, Essex, England.
Telex: 99101 (STC Basildon).

an associate of
ITT

world-wide telecommunications and electronics

STC



Listen.

STC headsets are light as a feather. And beautifully comfortable to wear. Hardwearing to the point of being indestructible.

Yet inexpensive.

So it's not surprising that PTT's the world over are using them. When you want headsets, use ours. You'll be glad you listened to us. STC Subscriber Apparatus and Acoustic Division, Standard Telephones and Cables Ltd, Oakleigh Road, New Southgate, London N.11. Tel. No: 01-368 1234. Telex: 21917

an associate of
ITT

STC

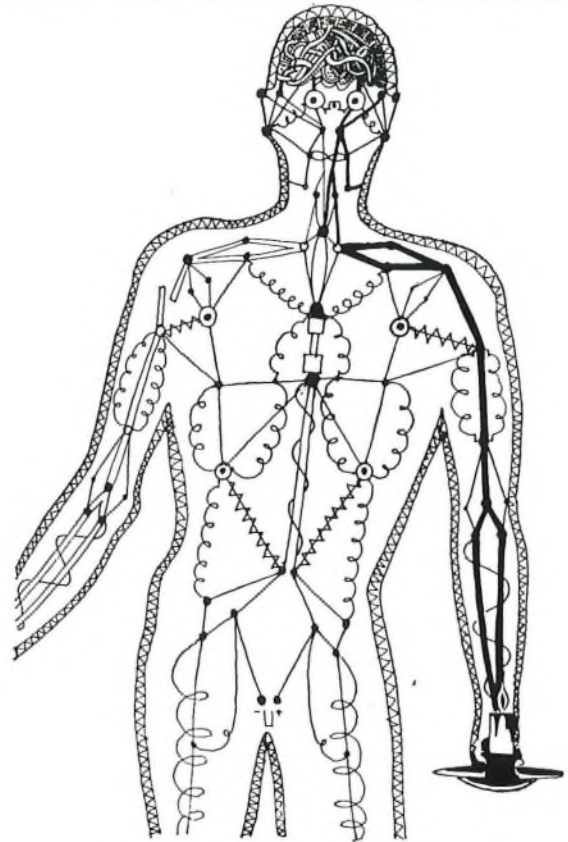

Where would we be without internal communication?

We take the intricate workings of our nervous systems very much for granted. Can't imagine them to be anything but reliable and smooth running.

The same goes for our INTERPHONE office communication—and think what a big hang-up life would be without that. STC, one of the largest manufacturers of cable for PABX and PBX installations, think so too.

STC cables are of the highest quality and have tinned copper wire conductors, insulated with PVC. Cables are sheathed overall with PVC and can be supplied in various conductor sizes and pairages, either as armoured or unarmoured cable.

These cables are designed primarily for use indoors. They are also satisfactory for outdoor use (but installation should not be attempted at temperatures below 0°C.)

They are part of a comprehensive range of STC cables and wires. Designed and manufactured for every application in the telecommunications and electronics field—with cables for particular applications made specially to order.

You only have to pick up the phone for more details.



STC Plastic Telephone Cable Division, Corporation Rd., Newport, Monmouthshire. Telephone: Newport 72281 Telex: 49368

an associate of

ITT

Communications Cables

STC

Last year the Post Office told us exactly where to put our switching systems.



Into their new transit switching network. To make more 'phones available all over the country and give an even faster more efficient telephone service.

The British Post Office knows STC produces all three kinds of telephone exchanges: step-by-step, crossbar and electronic. All available for director, non-director or transit switching. And as we're one of their major suppliers all our systems are designed to integrate with the

British network. We have a specialised installation team to supply complete working exchanges, too.

So it's hardly surprising that people keep telling us where to put our systems.

For further information contact:
Standard Telephones and Cables Limited,
Telephone Switching Group,
Oakleigh Road, New Southgate,
London N.11.
Telephone: 01-368-1234.

an associate of
ITT

worldwide telecommunications and electronics

STC



Our phone is your fortune.

Every Deltaphone your subscribers rent means more profit for you. And Deltaphone has a modern shape and comes in colours to blend with any colour-scheme.

That's why so many people want one.

There is no extra outside plant investment and maintenance is easy.

Let us help you make your fortune.

STC Subscriber Apparatus & Acoustic Division,
Standard Telephones and Cables Limited,
Oakleigh Road, New Southgate, London, N.11.
Tel No: 01-368 1234. Telex: 21917

an associate of
ITT

world wide communications & electronics

STC

STC are the best in submarine telecommunications because they offer the most.

The most experience

20 years' experience in repeater technology.
Over 100 years in submarine cables.
34 countries interconnected with our direct,
excellent quality communications.
Over 53,000 miles of all types of submarine
cable installed.
Some 2,500 repeaters in commission, 500
solid state.
Over 4½ million circuit miles of systems
currently on order.
Over 87 million repeater hours in service.

The most advanced systems technology

In systems design.
In product development and manufacture.
In installation.
And we have the world's highest production
capacity for cables, repeaters and
associated equipment.

The highest circuit capacity

Up to 23 supergroups for 1840 circuits.
First with 2, 8 and 23 supergroup systems.

The most comprehensive service

From initial survey and design through planning
and civil engineering requirements to fully
commissioned systems.
And our submerged plant is designed to give a
trouble-free lifespan of 25 years.

Demands for submarine systems are still
increasing. As the leader in this technology,
STC Submarine Systems Group today is the best
equipped organisation to supply and install
systems anywhere throughout the world on time.

Standard Telephones and Cables Limited,
Submarine Systems Marketing and
Projects Division,
North Woolwich, London E.16.

an associate of
ITT

Submarine Systems Group

STC



TELECOMMUNICATION EQUIPMENT AND INSTALLATIONS

- MULTIPLEX TELEPHONE SYSTEMS
- RADIO RELAY SYSTEMS
- DATA TRANSMISSION SYSTEMS
- TRAFFIC CONTROL SYSTEMS

Telettra S.p.A.

LABORATORI DI TELEFONIA ELETTRONICA E RADIO - Milano - Vercate - Roma - Trieste - Rieti

The Post Office Electrical Engineers' Journal

BOARD OF EDITORS

N. C. C. de JONG, B.Sc.(Eng.), C.Eng., M.I.C.E., F.I.Mech.E.,
F.I.E.E., Chairman

E. W. AYERS, B.Sc.(Eng.), C.Eng., F.I.E.E.

D. R. BEARHAM, B.Sc.(Eng.), C.Eng., M.I.E.E.

S. H. SHEPPARD

A. J. BARNARD, C.Eng., M.I.E.E.

A. C. CROISDALE, M.B.E., B.Sc.(Eng.), M.I.E.E.

J. MARTIN, B.Sc.(Eng.), C.Eng., M.I.E.E.

Managing Editor

N. J. H. NINNUM, M.Sc., B.Eng.

Deputy Managing Editor

D. MILLINGTON, C.Eng., M.I.E.E.

Assistant Editors

P. G. STEELE, M.Sc., B.Sc.(Eng.)

T. R. K. RAITT

N. G. CRUMP, A.M.I.T.E.

Secretary-Treasurer

B. FARR, A.B.I.

Advertisement Manager

R. G. ROTHERY

EDITORIAL

This quarter the Journal contains articles on widely-varying topics including a look at the future in two articles by authors from the British Post Office Research Department. Exploitation of the electro-optic effect described could revolutionize our ideas about bandwidth availability, and the concepts put forward in the article on chemical-tailoring give an insight to the efforts being made to fabricate materials with properties suitable for use in advanced telecommunications systems.

This issue, however, begins with a more down-to-earth topic which has attracted much attention in recent years. Improvements in manpower productivity have undoubtedly brought important benefits to the telecommunications business in the United Kingdom and we are pleased to have the opportunity of publishing an authoritative article on this subject of widespread interest to readers at home and abroad.

Many readers may not be aware that the Journal is widely read in a large number of countries throughout the world; in fact, ten per cent of the 38,000 or so copies printed each quarter are sold to readers in more than fifty different countries. It seems timely to remind our overseas readers that the correspondence column is open to them as much as to those at home. Letters, or short articles on topics of special or unusual interest to postal and telecommunications engineers would be very welcome and would give some idea of the widely varying conditions which under we work.

Manpower Productivity in Telecommunications

G. E. TURNER, C.ENG., M.I.E.E.†

U.D.C. 621.39:658.3.007:338

Manpower productivity has many facets affecting financial prospects, organizational structure and the working environment of people. The method of measuring productivity of the British Post Office regional engineering field force is described, and details given of the new productivity indices introduced in 1971. The improvement in engineering productivity in the 1960s is discussed against the background of the improvement in the business as a whole, and the influence on pay and productivity negotiation.

INTRODUCTION

Any discussion of productivity or efficiency quickly centres on how it is measured and whether the method used is correct and fair. Care has to be taken, therefore, in choosing a method of measurement, and the choice is influenced by the way in which the measurement is used. Productivity may be simply defined as the ratio of output of a particular economy, industry, plant or machine with respect to one or more inputs (labour, raw materials, capital). In most instances, there are multiple inputs and outputs but only specific items are usually considered; it is necessary, therefore, when comparing productivity measurements over a period of time, to examine to what extent the product mix of inputs or outputs has changed.

The majority of productivity studies have concentrated on the productivity of labour and involve comparisons between similar sections of industry or national economies. The international comparison of the crude oil refined per man-day and the investment per man which has been made by the Esso American parent company, is a case in point and has led to the productivity agreements at Fawley. Productivity measurement is, therefore, a useful managerial tool in forecasting manpower, questioning the way in which work is organized, and seeing in what way it can be improved by making comparisons with more efficient undertakings.

In a single-commodity industry, it would be possible to relate output to inputs of manpower, materials or investment. In the case of the coal industry, which is the nearest to a single commodity industry, it is possible to measure coal output per man-shift, and the target of the Coal Board at one time was to reach 47 cwt per man-shift; by using simple measurements like this it has been possible to show that productivity increased 9 per cent in 1968/69. In a similar way, the ratio of electricity supplied per member of staff employed on distribution has increased from 1,000 MWh to 1,840 MWh between 1960 and 1968, an average improvement of 7.8 per cent per annum.¹

In the telecommunications industry, productivity could be measured by the simple statistic of the number of telephones per member of staff employed; this measurement was 28 telephones per man in 1915 and by 1970 had risen to 68. This, however, is a very broad measurement and does not take into account the two separate components of the business, one dealing with its operation and maintenance, and the other, capital investment for growth.

INTERNATIONAL COMPARISONS

International comparisons have shown that there is a correlation between telephone penetration (measured in terms of telephones per 100 head of population) and the standard

of living.² A similar correlation can be seen between telephone penetration and productivity measured in telephones per member of staff.

This is illustrated in Fig. 1, which shows that although productivity measured in this way is low in the U.K. compared with Sweden and the U.S.A., when account is taken of the different telephone penetration the disparity is no longer

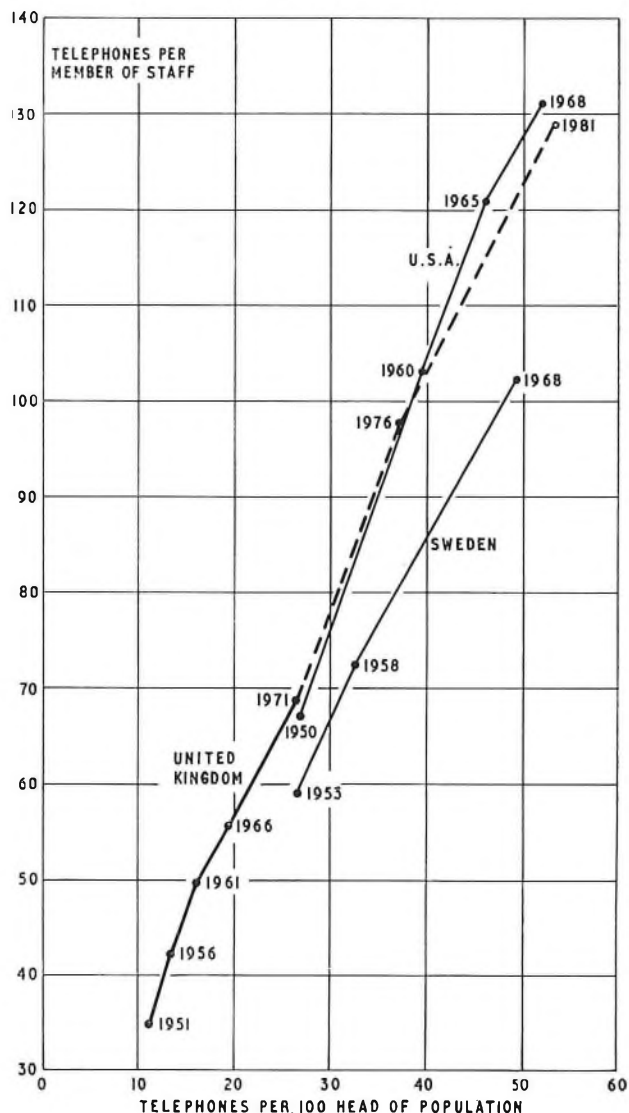

FIG. 1—Telephone productivity and penetration

† Productivity Improvement Division, Telecommunications Headquarters.

apparent. Based on current forecasts, the telephone penetration in this country should reach 38 per 100 head of population by 1975, i.e. the same penetration as that in the U.S.A. in 1959, and if total manpower remains substantially constant over this period—as forecast—productivity would rise to 100 telephones per man. This is similar to that achieved in the U.S.A. ten years ago at the same telephone penetration; comparisons like this are very broad, and to be fully comparative would have to take account of the different organizational structures, responsibilities, and service standards. They do, however, illustrate the broad correlation between manpower productivity and telephone penetration.

In simple terms, our objective in manpower productivity terms could perhaps be said to achieve the highest level of telephone penetration without increasing the number of staff employed in the business (currently 0.8 per cent of the working population). Here again, however, in the national context of manpower utilization, account must be taken of all factors of production, and the current large increase in capital investment means an increase in manpower in the manufacturing industry which must also be quantified when considering overall manpower productivity in the national economy.

OVERALL BUSINESS PRODUCTIVITY

When dealing with a multi-commodity industry it is necessary to quantify all inputs and all outputs. The simplest measurement which takes into account all resources is to compare the increase in revenue with the increase in expenditure at constant tariffs and prices year by year. This then quantifies the value of all services rendered and the costs incurred in providing these services. Costs in this context would include stores and labour charges for the maintenance and operation of the business in addition to the interest and depreciation charges resulting from the capital investment in plant. Between 1958/59 and 1963/64 this ratio of revenue to expenditure increased 2.6 per cent per annum and further improved 3.6 per cent per annum in the following five-year period. This increase in overall productivity of nearly 4 per cent per annum over the period 1963/64 to 1968/69 was similar to the increase in prices of stores and other charges,

TABLE 1
Percentage Change per Annum

	Outputs	1958-9 to 1963-4	1963-4 to 1968-9	1969-70
1	Revenue (at constant tariff)	8.4	10.3	9.6
2	Total stations	4.6	6.6	8.1
3	Total connexions	4.0	7.0	8.7
4	Local calls	6.6	7.8	11.6
5	Trunk calls	12.6	14.0	11.4
6	Engineering work	5.2	8.8	8.3
Inputs				
7	Expenditure (at constant prices)	5.6	6.4	6.7
8	Telecommunications manpower	2.6	3.6	0.8
9	Engineering manpower	4.0	2.0	1.4
Productivity				
1 ÷ 7	Overall (revenue/expenditure)	2.6	3.6	2.7
1 ÷ 8	Telecommunications manpower	5.7	7.8	10.0
6 ÷ 9	Engineering manpower	1.1	6.2	6.7

and, although wages increased around 6 per cent per annum, the effect of the improvement in the overall business productivity has been to give tariff stability. The result is that the telephone has become cheaper, relative to other commodities, with the consequent stimulus to the demand for telephone service.

Table 1 shows the annual increases in outputs, i.e. services provided (trunk and local calls, etc.) in 1969/70 with the corresponding increases in the two previous five-year periods. The figures for the increase in engineering work has been based on the growth of telephones and the increase in cable provision and telephone supply weighted in proportion of the productivity groups detailed in Table 2.

Inputs have been considered under three headings, firstly, current-account expenditure at constant prices, secondly, total manpower in the telecommunications business (pay at constant wages), and finally total engineering manhours. Productivity improvement has then been estimated by dividing the annual improvement in output by input as follows:

- (a) overall productivity (in financial terms of income and expenditure at constant tariffs and prices),
- (b) total manpower productivity (by comparison of income at constant tariffs (i.e. services rendered), and total manpower costs employed in providing these services),
- (c) engineering productivity.

The relative improvement indicated by these three methods of measuring productivity is shown in Fig. 2.

Since the drive to improve productivity in 1963, the increase in engineering manpower productivity has exceeded 6 per cent per annum and the increase in total telecommunications manpower productivity has similarly been very high (between 8 per cent and 10 per cent per annum). When account is taken of the influence of other charges (e.g. interest, depreciation, and capital investment), overall productivity improvement is reduced to between 3 per cent and 4 per cent per annum over the past decade and it is a cause for concern that productivity

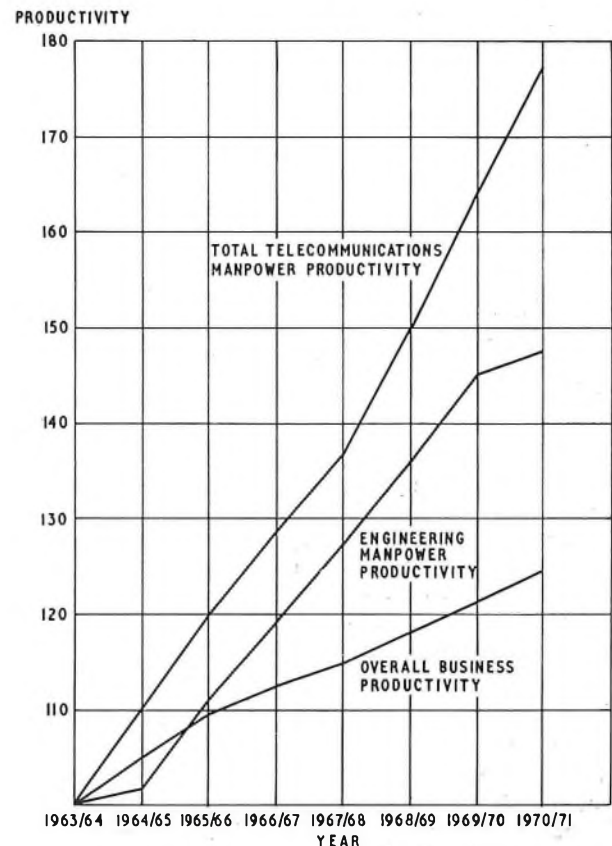

FIG. 2—Productivity improvement. (base 100 at 1963/64)

TABLE 2
Engineering Manpower Productivity Indices (In use from 1963 to 1970)

Productivity Group	Index	Principal Manhour Components	Index Value 1970/71
Maintenance (F1A)	Total stations per kmh*	All telephone and telegraph, i.e. exchange and repeater stations, subscribers' apparatus and line, trunk and junction cables, telegraphs	283
Installation (CS)	Real stations supplied per kmh	All subscribers' services	69.0
Local line construction (CL)	Added main pairs per kmh	Local cable and duct, main and local	70.0
Other maintenance and works (OMW)	Total stations per kmh	Accommodation maintenance and construction, exchange, repeater, telegraph and miscellaneous construction, miscellaneous maintenance, repayment, storm	278
Indirect (G)	Total stations per kmh	Stores, leave, driving, substitution, tool and mechanical-aid maintenance	332
Overall	Total stations per kmh	All manhours	75.8

* kmh = kilomanhour = 1,000 manhours.

measured in this way has been declining over the past few years. Only by maintaining an overall business productivity improvement similar to the rise in pay and prices, can the tariff stability of the 1960s be maintained.

IMPROVING MANPOWER PRODUCTIVITY

Improvements in manpower utilization and productivity arise from changes in practice which can be grouped in four main categories,

- (a) increases in scale of operation,
- (b) technological development,
- (c) mechanization of operations,
- (d) application of work-study methods.

The improvement in productivity arising from increases in scale of operation can be very significant in industry, but the scope in a monopolistic industry is limited. The greatest advances in manpower productivity arise from technological development, and this has been evident in the telephone industry over the past decade. The mechanization of the telephone system by the replacement of manual exchanges and the introduction of s.t.d. have made the greatest contribution to productivity in this period. In addition, the introduction of polythene has radically changed construction techniques in both the internal and external fields, and the transistor has enabled transmission maintenance manpower to be held constant although trunk calls have been rising around 13 per cent per annum. The last five years have seen a large increase in work-study effort which has had a radical effect on the working methods in the clerical, operating and engineering fields. The combined effect of these changes has enabled the overall productivity to be improved more than the national average and manpower productivity has improved at a rate which has been equalled by very few other industries.

PERFORMANCE AND PRODUCTIVITY

The study of manpower utilization over the past decade has shown the need for two methods of measuring efficiency. The first method relates to a system of measurement which compares manpower effort in manhours against a standard based on work study. Under the Unit Construction Cost (U.C.C.) system, standard times are laid down for the majority of the work operations, and all items of work completed are claimed by the staff; this is used to derive an efficiency ratio or performance rating. The introduction of the present external planning and works procedure in 1968 reduced the number of rated items to the major work operations and produced a performance rating which exceeds 100, as no allowance is given for travelling and waiting time. This system, together with the Installation (CS) Labour Cost Control and Unit Maintenance Cost (U.M.C.) systems and

the recently introduced Internal Work Control procedure are the management tools for labour control within telephone areas in the short term.

The second method of measuring manpower utilization relates manpower effort (in manhours) to the prime output of a particular field of work (e.g. pairs provided or telephones supplied) on an annual basis. As the work pattern of a particular telephone area does not normally vary widely from one year to another, a manpower ratio or productivity index of this nature takes account of the work performance (job efficiency) and work content of the telephone area. A study of the changes in performance and productivity measured in this way indicates the extent to which the work content is changing year-by-year relative to the major output of a particular work activity. For example, for installation services, performance and productivity indices could be compared as follows:

$$\frac{\text{telephones supplied}}{\text{total CS man hours}} = \frac{\text{telephones supplied}}{\text{total standard man hours}} \times \frac{\text{total standard hours}}{\text{total CS man hours}}$$

i.e., productivity = work content × efficiency.

Work content on installation is currently around 10 standard hours per telephone supplied, and efficiency is given by the performance rating. The productivity index can thus be increased by greater efficiency in work execution (i.e. a better performance rating) or by reducing the work content of the work by the application of work-study techniques.

ENGINEERING PRODUCTIVITY INDICES

Work measurement systems have been used in the engineering field since the 1930s but in National Productivity Year (1963) it was decided in the Organization and Completions Branch of the British Post Office Engineering Department, to introduce a simple system of measuring productivity which related the input of engineering effort in manhours to suitable prime outputs of the business. Productivity indices were introduced in the 1963 financial review for installation, maintenance, local lines and overall. Subsequently, in 1965, two further indices were introduced in order to cover the whole of the minor engineering manpower effort. The classes of work included under the various indices and the method of measurement are shown in Table 2.

Originally, only regional indices were produced, but in 1966/67 these were extended to cover all telephone areas and the indices were calculated quarterly on a rolling 12-monthly basis. These indices have been an integral part of the financial review forecasts including the 5-year investment reviews which provided long-term engineering manpower forecasts. Fig. 3 shows the improvement in the individual

TABLE 3
Engineering Manpower Productivity Indices (Introduced 1971/72)

Code	Productivity Group	Index	Principal Manhour Components	Index Value 1970/71
ME	Equipment maintenance	Total stations per kmh*	Exchange, transmission, telegraphs	801
MF	Field maintenance	Total stations per kmh	Control, subscribers' apparatus and line, trunk and junction cables	438
MA	Accommodation maintenance	Total stations per kmh	—	2,351
MO	Other maintenance	Total stations per kmh	Outside broadcast, watching other undertakers, repayment, radio-interference investigation, storm damage	3,095
IND	Indirect	Total stations per kmh	Driving, stores	1,401
CS	Installation construction	Engineering stations supplied per kmh	Subscribers' services	69.0
CLX	Local-exchange construction	Net mean added capacity per kmh	—	85.6
COI	Other internal construction	Total stations per kmh	Main exchange, telegraphs internal planning	947
CL	Local-line construction	Added main and distribution pairs per kmh	Main and local subscribers cables	137
COE	Other external construction	Total stations per kmh	Trunk and junction, renewals, repayment, external planning	952
TRG	Training "on cost"	Per cent of basic hours	All training except apprentices (TTA)	4.0
LS	Leave and substitution "on cost"	Per cent of basic hours	—	15.7
O	Overall	Total stations per kmh	All manhours	75.8

* kmh = kilomanhour = 1,000 manhours.

productivity indices since 1964/65. The drive to improve productivity since 1963 has been accompanied by a large increase in work study effort in Telecommunications Headquarters and regions. The introduction of new procedures, mechanical aids, simplified construction practices and the reorganization of working parties enabled productivity to be increased substantially, particularly in the installation and external fields of operation. The extent of this improvement has been such that engineering manhours increased only 1.6 per cent between 1964/65 and 1969/70, although the size of the telephone system increased 40 per cent. The percentage improvement in the individual productivity indices per annum over this five-year period has been as follows:

Maintenance (FIA)	4.5
Installation (CS)	12.9
Local Lines (CL)	18.8
Other maintenance and works (OMW)	3.6
Indirects (IND)	4.6
Overall	6.3

In considering the improvement in these indices, account must be taken of the influence of the constituent parts of each of the productivity groups. For instance, on maintenance over the past two years the improvement in the index has been due, in the main, to the savings on field maintenance by the *Subscribers Apparatus and Line Agreement*. Similarly, on local lines, the large increase in the CL index over the past five years has been influenced by the introduction of long-length cabling, simplified construction practices, mechanization and large growth in main-cable pair provision relative to the increase in cable provision in the distribution part of the network.

Although the indices described above provided adequate measurement in the initial drive to improve productivity, there has been a need to improve the measurement of the works contained in the OMW and Indirect productivity categories. New productivity groups have been introduced, therefore, from the financial year 1971/72 and are detailed in Table 3; the choice of productivity groups has been based on organization of the area staff. In addition, it will be possible to link the productivity groups with work performance systems so that trends in the change of work content can be established to assist in forward forecasting. The productivity groups are broadly in line with the budget account groups

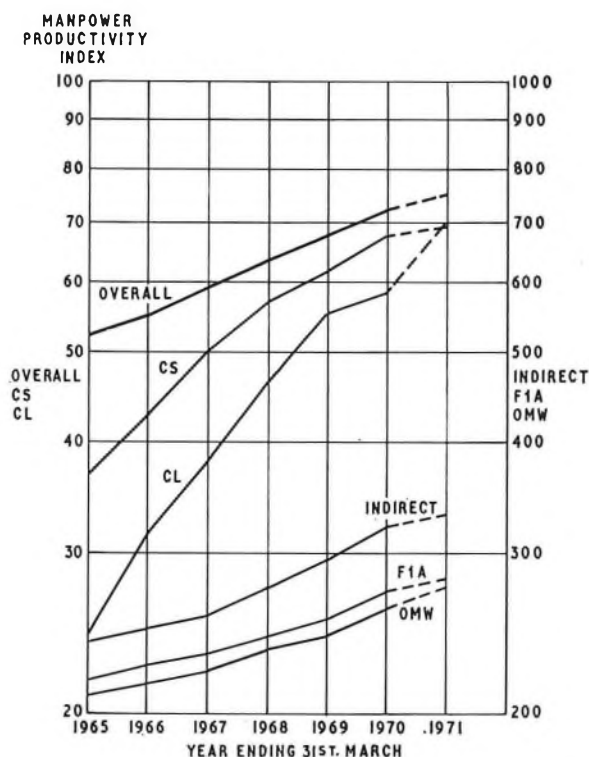

FIG. 3—Engineering manpower productivity indices (U.K.)

used in the operational plan. This examines the main activities of the business in terms of cost ratios which are the equivalent of manpower productivity indices except that they are in money terms and include all costs incurred on a particular activity.

APPLICATION TO TYPES OF WORK

Subscriber Services

The reorganization of the work force and the simplified construction methods and work procedures have been particularly successful in reducing manpower on the installation of subscribers' services, whilst at the same time increasing work output. The mechanization of pole erection and the introduction of cable drop-wire provided the opportunity to

reduce the 3-man and 4-man gangs to 2-man parties and singleton installers. This, together with the reorganization of the fitting force with a working foreman, and a new grade of senior technician in the installation controls and for the more difficult fitting work, provided the opportunity to match the staff to the needs of the work and thereby improve productivity. This reorganization of the work force was assisted by the simplified advice note procedure and the *advice note stop-start* procedure which avoided the wasteful recovery and re-provision of telephones in residential premises. This latter procedure is perhaps the best illustration of productivity improvement by providing service at minimum cost to the business; takeovers are equal to one-quarter of the supply of new exchange connexions. The effect of this reorganization on the installation external staff is illustrated in Fig. 4; there was an initial increase in 2-man parties, then the numbers reduced on the introduction of installers. The increase in productivity and work levels from 1966 to 1970 are shown in Table 4.

External Construction

The application of work study has had a marked effect on the efficiency of the external work force during the last decade. This has been achieved by the introduction of specialist parties equipped with mechanized vehicles to provide cable more efficiently on poles, in duct and direct in the ground. Simplified construction methods have enabled 2-man parties to erect aerial cable and poles and construct jointing chambers. The use of polythene for cable sheaths and insulants is perhaps the most significant technological development to affect productivity in the external field by facilitating long-length cabling and reducing the high labour cost of conductor jointing. The reduction in the number of jointers' mates also helped to improve the efficiency of the jointing force. These radical changes in working methods, together with simplified planning methods, enabled the external work force to be

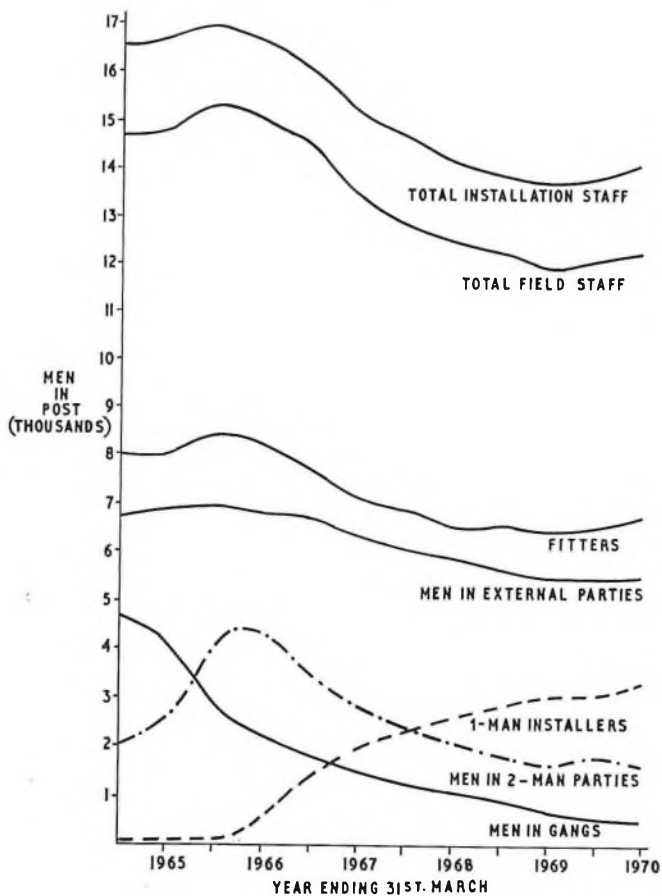

FIG. 4—Installation staff

TABLE 4
Increase in Productivity and Work Levels—Subscriber Services

Year	Output		Input in kmh × 10 ³	Performance (actual/standard hours)	Productivity (stations supplied per kmh)
	Supply of Stations × 10 ³	Work Level Standard Hours × 10 ³			
1966	1,636	16,612	34,943	125.5	46.8
1970	2,117	21,531	30,857	81.2	69.0
Percentage Change	30	30	-10	-35	47

reduced from 15,839 to 13,569 between 1966 and 1970 with a considerable increase in the works program (the pair provision to cabinets and pillars increased from 747,000 to 1,080,000).

Although work performance ratings have improved only about 4 per cent per annum in this period, productivity improvement has been considerably higher due to the large reduction in work content that has been achieved. The pressurization of local and trunk and junction cables similarly has reduced the work content of cable maintenance and renewal.

The significant difference between the performance and productivity improvements can be seen from Tables 5 and 6.

Maintenance

Although the productivity improvement on maintenance has not been so dramatic as for the capital construction classes of work, the improvement since 1965 has continued the trend over the past 20 years. The changes of practice which have been particularly effective include gas pressurization of cables, the introduction of solo maintenance jointers and the reorganization of field staff under the *Subscribers Apparatus and Line Agreement*. The increasing use of automatic testing equipment and maintenance aids has also improved the efficiency of exchange maintenance whilst, at the same time, improving the quality of service.

TABLE 5
External Construction—Work Performance Rating

System	Year	Performance	Average Improvement p.a. (per cent)
Old Unit Cost Construction System	1965/66	70.0	3.2
	1968/69	63.5	
New Major Works Procedure	1968/69	202.0	4.6
	1970/71	184.0	

TABLE 6
External Construction—Local Line Productivity

Index	Year	Productivity	Average Improvement p.a. (per cent)
Old Index (main pairs/kmh)	1965/66	31.6	17
	1970/71	70.0	
Main and Distribution Pairs (pairs/kmh)	1966/67	82.2	11
	1970/71	136.9	

In the five-year period ending 1969/70, productivity improvement (measured in stations/kmh) averaged 4.5 per cent p.a., and a slightly higher improvement is evident in efficiency measured in manhours per work unit. Although work units were abandoned a few years ago for external plant, it is possible to estimate the improvement in manhours per work unit in order to examine the contribution made by each of the main maintenance work (FIA) sub-divisions to the overall improvement in maintenance productivity as shown in Table 7.

TABLE 7
Maintenance Productivity

Activity	Man Hours per Work Unit		Average Improvement p.a. (per cent)
	1964/65	1969/70	
Director (DE)	7.3	5.4	5.8
Non-Director (AE)	6.0	4.1	7.3
Manual (ME)	6.5	4.5	7.1
Transmission (IV)	5.0	3.3	7.8
Total Equipment Maintenance	6.3	4.4	7.0
Testing (TR)	6.8	5.4	4.5
Subscriber (SU)	8.5	6.6	4.9
Overhead (O)	6.3	3.8	9.6
Junction Cable (UJ)	11.4	19.8	-11.6
Main Cable (UM)	8.2	9.9	-3.8
Local Cable (UL)	9.4	8.1	2.9
Total Field Maintenance	7.9	6.4	4.2
Grand Total	7.2	5.5	5.3
Maintenance Productivity (stations/kmh)	221.0	275.0	4.5

Although the telephone system increased 40 per cent in this period, the work content on maintenance (measured in work units) increased over 50 per cent with the growth in work units for non-director equipment at 75 per cent doubling that in director exchanges. This large increase in work units arose from the manual exchange conversion program, provision of s.t.d. and large growth of trunk switching. The growth rate of work units is expected to follow more closely the growth in exchange connexions and thus increase at a lower rate than that of telephone stations in the future.

On field maintenance the work units have increased *pro-rata* to telephone stations with the lower improvement in performance reflecting the additional effort for gas pressurization of the underground cables; consequent manpower savings are evident, however, on cable-renewal costs whilst, at the same time, service standards have been improved, particularly on the trunk and junction network. As two thirds of the maintenance effort is incurred on field maintenance, the reduction of labour costs by improved cable construction methods and higher reliability of subscribers' apparatus is a prime objective to improving maintenance productivity.

ROLE OF STAFF ASSOCIATIONS

As new technologies and work-study techniques affect working conditions, staff associations have an important role to play in improving productivity. In 1963 the Experimental Changes of Practices Committee (E.C.O.P.C.) was reorganized to consider productivity measures, and since 1965 has considered over fifty major changes of practice giving staff savings of over 17,000 men. Three committees now keep a watching brief on field trials and productivity statistics, as well as considering the safety aspects of existing and proposed

working methods. Engineering Productivity Committees (E.P.C.) were introduced in telephone areas in 1968 to consider and advise on matters directed toward improving productivity in the engineering and allied fields with particular reference to area progress and the effect of changes in procedures from national agreements.

Although substantial economies in manpower utilization can be realized by work-study techniques, there is ample scope for local initiative by ensuring that existing procedures are fully effective and national agreements are adapted to meet local conditions. It is in this field that local productivity committees can contribute to improve productivity overall.

Co-operation by staff associations is a prime factor in obtaining productivity improvement, and the improvement in the engineering field is due in a large part to work of the E.C.O.P.C. committees and the very stable industrial relations which have existed in the Post Office.

EFFECT OF CHANGE ON PEOPLE

Changes in working practices to improve productivity invariably disturb individual and group relationships, and care has to be taken to ensure that the need for change is understood and accepted. The satisfactory introduction of changes of practice is dependent upon adequate detailed work study, full discussion with staff associations and, finally, careful planning of implementation with the co-operation of the staff concerned and line management.

Studies of the effect of change on people have shown that change is more acceptable when the range of skills of a particular individual is enlarged, and there is an inevitable conflict between this approach and the economic benefits that arise from specialization. The mechanization of poling work set up a few specialist parties in telephone areas with a limited range of skills; this, however, enabled the installation gangs to be reduced to one-man installers with a wider range of skills and responsibility, and at the same time yielded substantial economies in manpower and vehicles. Although specialization can give rise to monotony, careful choice of working methods to give a maximum range of skill should be one of the prime objectives of work study. The mechanization of aerial cabling using the *Telsta* machine is a particular example where the skill of the two-man party has been harnessed to the full, and the sophistication of the machine and power tools has given a high sense of job satisfaction. The computerization of office methods tends to reduce job variety leading to lack of interest and an increase in absenteeism and wastage. Without a greater accent on job satisfaction, manpower savings are reduced, and the full potential of the staff is not made available.

Reorganization of staff invariably affects career prospects, and this factor has to be taken into account when negotiating changes. The effect of the major reorganization of the installation and external work force on the numbers of staff and grades is illustrated in Table 8. Although the numbers of staff have been reduced, the career structure has been improved, though at the same time the responsibilities and status of some of the grades have been changed. This applies in particular to the T1 foreman grade due to the reduction in supervision responsibilities.

PAY AND PRODUCTIVITY

The importance of productivity in the determination of pay was finally established in the 1965 White Paper on Prices and Incomes (Cmnd 2639) which accepted rises above the norm "... where the employees concerned, for example by accepting more exacting work or a major change in working practices, make a direct contribution towards increasing productivity in a particular firm or industry. Even in such cases some of the benefit should accrue to the community as a whole in the form of lower prices".

TABLE 8
Grade Analysis of Area Staff
(Number and Percentage Distribution)

	Installation Staff			
	1966		1970	
		per cent		per cent
Senior Technician (ST)	1,561	(9.4)	1,984	(14.1)
Technician 1 (T1)	2,603	(15.7)	2,723	(19.3)
Technician 2A (T2A)	10,973	(66.1)	8,759	(62.0)
Technician 2B (T2B)	1,470	(8.8)	647	(4.6)
Total	16,607	(100.0)	14,113	(100.0)
	External Works Staff			
	1966		1970	
		per cent		per cent
Technical Officer (TO)	970	(6.1)	1,263	(9.3)
Senior Technician (ST)	604	(3.8)	722	(5.3)
Technician (T1)	3,380	(21.3)	3,320	(24.5)
Technician 2A (T2A)	5,538	(35.0)	6,566	(48.4)
Others	5,347	(33.8)	1,698	(12.5)
Total	15,839	(100.0)	13,569	(100.0)

In considering improvements in productivity, it is essential to consider the continuous nature of productivity changes, and it is not always possible to consider one year in isolation. The link between pay and productivity in the engineering field has been recognized for some years. Table 9 illustrates the way in which gross manpower savings are calculated for the year 1969/70. Manpower savings in the region of 6,000 men per annum have been typical over the past five years, although the saving in 1970/71 of only 4,200 men was very disappointing. This low productivity improvement arose from the high recruitment and overtime at the beginning of the year which was not reflected in work levels of telephone supply or growth.

Although productivity improvement normally averages over 6.0 per cent p.a., offsetting costs of work study, mechanical aids and savings from technical development and scale usually reduce the saving to around 5.0 per cent p.a. net. After taking into account that some benefit should accrue to the customer, the productivity element in pay agreements has varied between 1.5 per cent and 3 per cent. Although this may appear small in the present climate of price inflation, the cumulative benefit of increases above the norm for a period of years has been a significant factor in pay movements for engineering minor staff. The importance of identifying the element in a pay increase which reflects improvements in

TABLE 9
Productivity Savings 1969/70. (Kilomanhours $\times 10^3$)

Productivity Group	Forecast Requirement with No Productivity Improvement*	Forecast Expenditure	Outturn Expenditure
FIA	54.1	50.4	50.8
CS	32.5	28.3	29.5
CL	16.0	16.5	15.3
OMW	56.3	52.3	52.8
IND	47.3	42.4	44.7
Overall	206.2	189.9	193.1
Kmh Saving		16,300	13,100
Percentage Saving		7.9%	6.4%
Gross Manpower Saving		7,075	5,597

* At 1968/69 Productivity Index.

productivity is one way of maintaining co-operation, and thus ensuring further improvement in the profitability of the business. Although there have been benefits for the staff, the customer has also benefited equally from the improvement in productivity of the business as a whole as illustrated by the small increase in tariffs in the 1960s which averaged only 1.3 per cent p.a. compared with an increase of 3.9 per cent p.a. in the retail price index.

MANPOWER PLANNING

The last decade has seen an increasing awareness of the need for manpower planning at company, industry and national level, and this applies particularly in the British Post Office which employs 0.8 per cent of the working population on telecommunications. The importance of conserving and utilizing to the full the manpower resources is all the more important when viewed against the forecast that the working population is likely to decrease in the next few years by about 3,000 p.a. as a result of the low birth rate in the 1950s, and the increase in population after this period is only likely to be around 0.5 per cent p.a.

The preparation of a manpower plan is the basis of many aspects of planning, and the ability to achieve the Corporation objectives is dependent on the way it is possible to optimize the latent talents and energies of the personnel who comprise the British Post Office. The creation of a manpower plan for the telecommunications business requires co-ordination between many departments in order to ensure that objectives are compatible. This is not to say that, once formulated, a plan is not subject to change, in fact the converse is true; manpower planning is a never-ending process of adaptation and modification to ensure that changes in demand for services and new developments are taken into account. An apt description of manpower planning is: a continuous reconstruction of expectations and intentions by a coalition having various unstable goals in an uncertain environment.

Although there is a certain measure of uncertainty in all forecasts, the very process of preparing a manpower plan highlights the areas of uncertainty and the implication of the assumptions made, it also indicates the need for further study to reduce the degree of uncertainty. A high degree of accuracy is rarely necessary in the long term, particularly in a capital intensive industry such as telecommunications. A manpower plan is, however, the basis of forecasts of training and accommodation requirements, recruitment and career development plans; it is also an essential component of productivity bargaining in wage negotiation. Although future forecasts may indicate an increase in the level of skills required, this may be still within the capabilities of the existing work force. A manpower plan should thus be not only concerned with quantity but also quality, and should equate need with availability. It has also to take account of the interaction of its own needs with those of its environment.

BUSINESS OBJECTIVES

A manpower plan evolves from the stated objectives of the Corporation in respect of forecasts of the growth of the individual services provided to customers, the expectations from improvements in technical development, the increase in efficiency from work-study effort and the savings from the increase in scale of operation. The continuous feedback from manpower planning ensures that objectives are realistic and capable of achievement. The forecast of a 45 per cent increase in telephones over the next five years with substantially the same number of staff appears possible with the present rate of technological development and improvement in efficiency. In view of the overall limitations of the total working population in this period, the Post Office's contribution to the total G.N.P. could be said to be to increase the number of telephones by the maximum amount within the existing manpower resources. Failure to make the best use of existing

manpower resources would increase costs, and if profits are to be maintained to allow for capital investment, the consequent increase in tariffs reduces demand; the growth rate is therefore partly determined by the ability to improve manpower productivity. In discussing the interrelationship between manpower productivity and the policy objectives only one parameter—namely growth of telephones—has been considered; the needs of the other objectives have also to be taken into account, e.g. to decrease plant failures and improve the speed of provision of services in respect of quality objectives, and meet the expansion of other services (telex, data) as regards growth objectives. Quality and quantity are normally in conflict, particularly where relatively large groups of staff are employed separately on the provision and maintenance of services; the success of any organization, however, lies in the ability to improve communications and devise procedures and intergroup relationships so that the objective of one group is not jeopardized by another.

FUTURE PROSPECTS

The telephone system is forecast to grow by over 45 per cent in the next five years with only a 2 per cent increase in staff for the inland service. The completion of the manual conversion program with full s.t.d. access and the application of further productivity measures will enable the operating force to be reduced by between 1 per cent and 2 per cent per annum over the period. The provision of cordless switchboard positions from 1974 onwards will assist in the improvement in productivity towards the end of the 1970s. The manpower savings from the further computerization of office methods and the application of work study to clerical procedures through the Telecommunications Office Productivity Program (TOPP) are forecast to offset the increase in work levels in clerical staff in area offices and stabilize total staff numbers. The engineering force in regions is only expected to increase marginally over the next five years and productivity improvement is forecast to average about 6.5 per cent per annum. Although this period will see the completion of full automatic switching and an increase in local and trunk calls of around 11 per cent per annum, maintenance staffs are only expected to increase 10 per cent overall with a slightly higher growth of the internal maintenance staff. By the middle of the 1970s, crossbar and electronic switching systems will account for around 15 per cent of the equipment, and with an increasing proportion beyond this date, new systems will start to make a substantial contribution to productivity improvements in the installation and maintenance of switching plant.

Although there will be an increase in maintenance staff,

this will be offset by the continuing reduction in the external works force. This is due to the decline in the local line requirements in the mid 1970s and the manpower savings from further cable mechanization, the introduction of jointing machines and other productivity measures. The overall effect of changes in practice and technical development is expected to improve productivity for the main engineering staff groups as shown in Table 10.

TABLE 10
Anticipated Productivity Improvement

Activity	Average improvement in productivity p.a. (per cent)
Maintenance	6.0
Installation	5.5
Internal works	4.0*
External works	5.0†
Total staff	6.5

* Based on ratio of capital investment/manhours.

† Based on local lines (CL) index.

Overall manpower productivity in the business is forecast to improve between 9 and 10 per cent per annum up to 1976/77 continuing the trend over the past few years. This large improvement reflects the manpower savings from the completion of local and trunk mechanization program. The importance of this productivity improvement can be judged from the fact the cost of a loss of productivity of 1 per cent per annum in all fields of activity over six years is equivalent to the level of profits in 1969/70.

CONCLUSION

Productivity improvement is the end result of the activities of people in all parts of the business, management and staff. The degree of improvement is dependent on the extent to which these activities can be optimized to the benefit of the staff as well as the customer.

References

- ¹ BOLTON, K. G. W. Electricity Supply Distribution—Trimming for Efficiency. *I.E.E. Journal Electronics and Power*, Vol. 16, p. 124, April 1970.
- ² WHITE, J. S. Telecommunications in the Next Thirty Years. *P.O.E.E.J.*, Vol. 62, p. 137, Oct. 1969.

Aluminium-Conductor Cables in the Telephone Distribution Network

E. E. L. WINTERBORN†

U.D.C. 621.395.74:621.315.212.4:669.71

Copper is the traditional material for use as a telephone-cable conductor. Unfortunately, the world distribution of copper is such that it is prey to political and economic influences leading to wide variations in price, at times maintained at an artificially high figure. This article deals with the development of aluminium as an alternative conductor material and its introduction into the British Post Office network. The possibility of a change to some suitable aluminium alloy is forecast.

INTRODUCTION

The first practical telecommunications cable was provided in the United Kingdom in 1837 between Euston and Camden Town and consisted of five separate copper wires embedded in grooves cut in lengths of timber. Since then, copper has been used as the conductor material in both telecommunications and power cables and until comparatively recently went unchallenged. Copper possesses the following apparently unassailable advantages.

(a) It is not a rare element, ore being found in the U.S.A., Chile, Canada, Zambia and Australia, although deposits in the last-named territory have not yet been exploited.

(b) It can be extracted from the ore at a reasonable cost.

(c) Its ductile properties in the annealed condition are such that it can be drawn into wire of any diameter down to 0.025 mm.

(d) It has a high conductivity, inferior only to that of silver.

(e) Its tensile strength, at 38,500 lb/in² in the fully-annealed condition, is more than adequate for high-speed processing of conductors of gauges much finer than those commonly used in telecommunications cables.

It may, therefore, be asked why so much effort has been expended in promoting aluminium as an alternative to copper. The copper producers, conscious of the apparent indispensability of their product, agreed the level of world production and established world prices. However, the producers overreached themselves in their attempts to maintain prices, and thus forced users to look for alternatives.¹

ALUMINIUM AS A CONDUCTOR MATERIAL

Aluminium is the obvious alternative to copper where electrical properties are important since, apart from gold, it is next in order of conductivity. It is in plentiful supply and has a relatively stable price since there are worldwide deposits of bauxite, the ore from which it is obtained. Consequently, it is free from the strategic and political influences which affect the supply of copper.

Table 1 compares the properties of aluminium and copper. The specific resistance of aluminium is 2.76, and that of copper is 1.72, so that for equivalent resistance, aluminium wire must be 1.27 times the diameter of the copper wire it is to replace. However, the specific gravity of aluminium is only 2.7 compared with 8.89 for copper. Thus, for equivalent resistance, the weight of an aluminium wire is about half that of the copper it replaces. Table 2 compares gauge, diameter and resistance for different copper and aluminium Electrical Conductivity (E.C.) grade conductors.

Fig. 1 shows the London Metal Market prices for aluminium and copper for the period 1954–71. Taking inflationary trends into account, aluminium is probably cheaper now than

TABLE 1
Comparison of Physical Properties of Copper and Aluminium

Property	Aluminium	Copper
Specific Gravity	2.70	8.89
Weight ratio for equal volume	0.30	1.00
Conductivity	62.00	100.00
Specific Resistance	2.76	1.72
Area ratio for equal conductance	1.64	1.00
Diameter ratio for equal conductance	1.27	1.00
Weight ratio for equal conductance	0.49	1.00

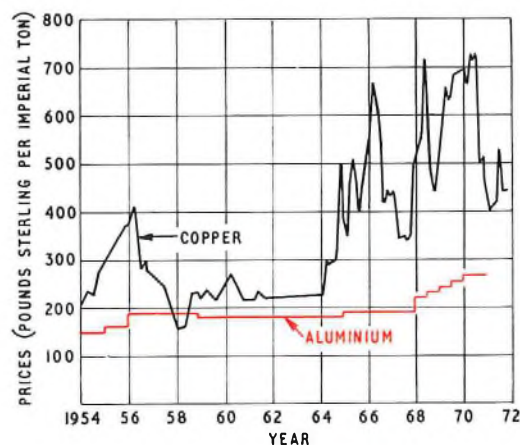

FIG. 1—Average prices of copper-wire bar and aluminium rod

it was 18 years ago when the British Post Office installed its first aluminium-conductor telephone cables. The graph effectively demonstrates the economic attractiveness of aluminium as a cable-conductor material and indicates that substantial economic savings are now possible after absorbing additional processing and incidental costs.

EARLY EXPERIMENTS

The shortage of copper during the 1939–45 war led both Germany and Japan to an extensive use of aluminium as conductor material for telephone cables. The problems which they encountered resulted in a reversion to copper at the earliest practicable opportunity.

Table 3 gives details of the aluminium-conductor cables installed by the British Post Office between 1953 and 1960. These required more than 30,000 conductor joints to be

† Telecommunications Development Department, Telecommunications Headquarters.

TABLE 2
Comparison of Conductor Gauges

Designation				Diameter	Resistance			
U.K. and Commonwealth lb/mile (with equivalent in mm)	Continental and Others mm	U.K. S.W.G.	U.S.A. A.W.G.	Inches	Copper		Aluminium	
					ohms/mile nominal at 20°C	ohms/km nominal at 20°C	ohms/mile nominal at 20°C	ohms/km nominal at 20°C
2½ (0·32)	0·3	30	28	0·0118	393·0	244·2	644·0	400·2
				0·0124	356·0	221·2		
				0·0126	345·0	214·4	566·0	351·7
4 (0·404)	0·4	27	26	0·0157	222·0	137·9	363·0	225·6
				0·0159	217·0	134·8		
				0·0164	204·0	126·8		
6½ (0·508)	0·5	25	24	0·0197	141·0	87·6	232·0	144·2
				0·020	137·0	85·1		
				0·0201	136·0	84·5		
9¼ (0·610) 10 (0·635)	0·6	23	22	0·0236	98·3	61·1	161·0	100·0
				0·0240	95·1	59·1		
				0·0250	87·6	54·4		
				0·0253	85·6	53·1		
	0·7			0·0276	72·1	44·8	118·0	73·3
	0·8	21		0·0315	55·2	34·3	90·5	56·2
			0·0320	53·5	33·2			
20 (0·902)	0·9	20	19	0·0354	43·7	27·2	71·5	44·2
				0·0355	43·5	27·0		
				0·0359	42·5	26·4		
				0·0360	42·3	26·3		
25 (1·016)	1·0	19	18	0·0394	35·3	21·9	57·9	36·0
				0·040	34·2	21·3		
				0·0403	33·7	20·9		
37 (1·219) 40 (1·270)	1·2	18	16	0·0472	24·6	15·3	38·1	23·7
				0·0480	23·8	14·8		
				0·0500	21·9	13·6		
	1·3			0·0508	21·2	13·1		
				0·0512	20·9	13·0	34·3	21·3
70 (1·684)	1·6	16	14	0·0630	13·8	8·6	22·6	14·0
				0·0640	13·4	8·3		
				0·0641	13·3	8·3		
	1·7			0·0663	12·5	7·8		
				0·0669	12·2	7·6	20·0	12·4

made by the conventional crank-handle method but, because of the rapid formation of oxide on aluminium exposed to air, the joints could not be left dry, as with copper. The aluminium-aluminium joints were, therefore, tip-welded and aluminium-copper joints were soldered with a zinc-rich solder using an iron or an ultrasonic soldering bath.

The initial schemes broadly indicated that, for directly-buried cables, mechanical damage was the main cause of failure which is the same as with copper-conductor cables. In wet conditions, aluminium corrodes much more rapidly than copper and the tests showed that a more reliable method of excluding water from cables and joints should be devised.

The Dover-Deal experiment has been adequately covered in earlier articles² and the remaining cables listed in Table 3 have given satisfactory service.

A technical costs exercise carried out in 1958 showed that, theoretically, only £90 worth of aluminium was required to provide the electrical counterpart of £200 worth of copper. Actual cost comparisons, obtained from the experimental installations of the 1953-60 era, showed that most of the apparent advantage had been absorbed in the higher cost of drawing aluminium wire and in the increased costs of insulating and sheathing the larger conductors needed in

aluminium-conductor cables. This explains why the use of aluminium was not pressed at that time.

Compared with an approximate total annual local-cable provision of one million loop-miles, the quantity of cable provided on the initial experimental scheme was insignificant. It did, however, establish that the cable industry in the U.K. possessed the capability of producing aluminium-conductor cables in both the paper- and polythene-insulated types used in the local network, and that the British Post Office could install and use them should the need arise. The fact that 90 per cent of the loop-mileage was paper-insulated indicates that this form of construction should not be lightly dismissed when considering the economics of aluminium-conductor telephone-cable construction.

Two major problems, those of jointing and terminating the aluminium conductors, were not resolved by the early trials. The cost and unreliability of tip welding and ultrasonic soldering could not be tolerated on large-scale provision and although the sealing of block-terminal connexions was satisfactory, it was known from past experience with copper conductors in similar blocks, that the reliability obtained under the close supervision associated with field-trial work would be difficult to maintain on normal provision.

TABLE 3
Aluminium-Conductor Cables Installed 1953-60

Size	Manu- facturer	Length	Date	Metal Condition	Insulant	Location
51/0·020 in 54/0·044 in 15/0·026 in	Siemens U.T.C. (S) B.I.C.C.	685 yards 5 miles 2 miles	1953 1954 1957	VEN/1 32·37 Semi-annealed $\frac{3}{4}$ Hard 99·5 per cent pure	Paper Paper Polythene	Borden-Guildford Area. Dover-Deal. St. Helens-Liverpool Area. Starcross-Exeter Area. Waddington-Lincoln Area. Maidstone-Canterbury Area.
400/0·026 in 400/0·026 in	U.T.C. (S) B.I.C.C.	1 mile 1 mile	1957 1957	$\frac{3}{4}$ Hard 99·5 per cent pure $\frac{3}{4}$ Hard 99·5 per cent pure	Paper Paper	Elgar Exchange-L.T.R. Herne Bay-Canterbury Area. Four Oaks Exchange-Birmingham Area. Rhose-on-Sea-Chester Area.
50/0·044 in 1/0·044 in	U.T.C. (S) U.T.C. (S)	2 miles 10 miles	1959 1959	$\frac{3}{4}$ Hard 99·5 per cent pure $\frac{3}{4}$ Hard 99·5 per cent pure	Polythene Polythene	Randlestown and Annaghmore-Northern Ireland. Aberdeen Area.

U.S.A. EXPERIENCE

At about the same time, a far more extensive trial of aluminium-conductor telephone cables was under way in the U.S.A. Starting in 1951, the Western Electric Company produced aluminium-conductor cables in 24, 22, 20 and 17 A.W.G.³ By 1953, they had produced 5-billion conductor-feet giving about 1,700 sheath-miles of cable. This represents about 6-months' U.K. usage in the distribution network. To quote from the Bell Laboratories' own report, "The experiment was not a success. The cable contained pulp-insulated conductors, which corroded catastrophically when they became wet, hundreds of them corroding open in a short time."⁴ That the cause of failure was an inadequate sheath-closure technique did little to lessen the inhibiting effect of the disaster. It served only to highlight the vulnerability of aluminium. Within the last few years, there have been further developments in the U.S.A., but only with polythene insulation and production has been concerned mainly with 17 and 20 A.W.G. conductors. Considerable expansion of the production capacity is now taking place and this extends to the use of 24 A.W.G.

ALUMINIUM-WIRE QUALITY

The manufacturers of power cables started using aluminium for cable conductors about twenty years ago. They were faced with problems in conductor jointing and terminating but, having relatively large masses of metal to deal with, these were readily overcome. This use of aluminium wire led to the issue of British Standard Specification 2627 in 1955 and established three grades of wire, namely, fully annealed (O), three-quarter hard ($\frac{3}{4}$ H) and hard (H).

As can be seen from Table 3, apart from the first two schemes which pre-dated the standard, it was the $\frac{3}{4}$ H material, having a tensile strength in the range 18,000-24,000 lb/in², which was adopted for the early manufacture of telephone cables. It is thought that the VEN/1 32·37 material was probably very similar to the $\frac{3}{4}$ H and it is known that the Dover-Deal cable was made with material described as semi-annealed.

The correct range of properties in an aluminium wire which make it suitable for cable manufacture and subsequent installation are not necessarily compatible. Copper wire is normally used in the fully-annealed condition, a process achieved by heat soaking in an inert atmosphere after wire drawing. The time required for complete anneal is temperature dependent and, the lower the temperature, the longer is the time. Although it could be effected at 180°C, it is usually done at 300-350°C and since a terminal condition is the aim, it is necessary to ensure that the entire mass of wire on the reel is completely heat treated. Fully-annealed aluminium wire is too soft to handle and in the as-drawn condition lacks ductility and is very prone to fracture when bent. It is, therefore, necessary to achieve a partially-annealed condition in the wire to leave it with adequate tensile strength for processing and, at the same time, retaining sufficient ductility to

permit twisting and bending without risk of fracture during jointing operations. Complete drawdown to cable-conductor diameter, resulting in hard wire which is then subjected to controlled anneal to leave it in the required optimum condition, is not considered practicable as a production operation, since the degree of anneal is a function of temperature and time and it is impossible to ensure that every part of a closely-wound reel of wire receives identical treatment.

The method normally adopted is that of inter-anneal in which the aluminium wire is drawn to a suitable intermediate size, say 2·0-2·5 mm diameter, and given a full anneal. The work hardening resulting from the further drawdown to cable conductor size, of, say, 0·5 mm diameter, then produces the required tensile strength in the end product. There is a bonus associated with this method since it is convenient to provide wire-drawing and insulating facilities as tandem operations, the relatively large diameter wire fed into the line being easier to handle and joint than the smaller conductor wires. Fig. 2 shows a typical tandem-line layout for production of aluminium wires.

LARGE SCALE EVALUATION

The rising price of copper in 1964, followed by the unilateral declaration of independence by Rhodesia in the Autumn of 1965, and the threatened cutting off of the Zambian copper supplies at a time when there were protracted strikes in the Chilean copper fields, prompted the British Post Office to look again at aluminium as a telephone-cable conductor. The exercise was undertaken as a matter of contingency planning, although it became clear before very long that there was a chance of considerable economic saving.

It was assumed that the aluminium cables should have conductor resistances comparable with those of the copper cables they replaced. Therefore, the best place to use such cables was in the secondary part of the local network where much of the duct space is not used or where cables are buried directly in the ground. Since all the cables in this section were polythene insulated, the basic design of the new cables was predetermined. As, officially, metrication had already been viewed with favour, it was decided that the new aluminium conductor cables should have metric size conductors, 0·8 mm and 0·6 mm being chosen; the former is virtually a direct replacement for 10 lb copper, and the latter is between the 4 lb and 6½ lb copper in respect of resistance. If successful, the change would, in addition to the main objective of saving copper, achieve a degree of rationalization by reducing the number of types of cables supplied by one third. Although a 1·0 mm aluminium conductor was included in the earlier cable specifications as a replacement for 20 lb copper conductor, this size was not used owing to problems with the jointing sleeves and crimping tools eventually adopted.

Before beginning trials of aluminium-conductor cables, it was decided to re-appraise the grade of aluminium to be used and a range of wires having different tempers was obtained for

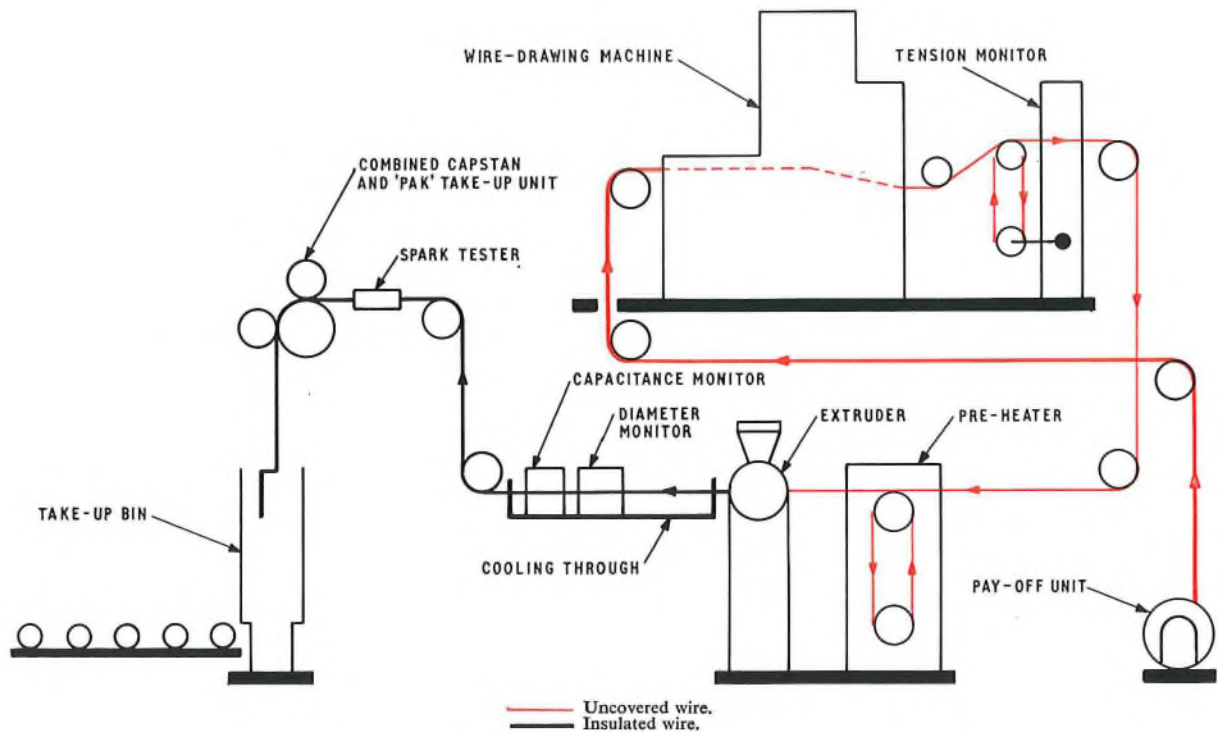

FIG. 2—Typical tandem-line layout for production of insulated aluminium conductors

evaluation. These wires were polythene-insulated and subjected to stringent physical testing using the crank-handle twist joint technique as a means of assessment, it being assumed that this would be the jointing method used in the field. Each manufacturer co-operated by supplying insulated wire for test, and many thousands of twist joints were produced in the evaluating process. The standard for acceptance was set at no breakages in 100 crank-handle twisted joints, a second 100 joints being required without breakage in the event of a single break in the first 100. The re-appraisal confirmed the findings of the 1957–59 trials that wire having a tensile strength in the range of 18,000–24,000 lb/in² was the most suitable. This investigation delayed the production of aluminium-conductor cables, but the confirmation of the earlier conclusions which it provided gave valuable reassurance.

PHASE I TRIALS

Phase I of the new program involved the ordering of 60 sheath-miles of cable in sizes up to 100 pairs using 0.6 mm and 0.8 mm aluminium conductors. Although not ordered to specification B.S.2627, since the Post Office requirement demanded compliance with bend and wrap tests to ensure adequate ductility, the wire was of $\frac{3}{4}$ H, E.C. grade material. Owing to unfamiliarity with the wire and breakages due to imperfections in the surface finish, the cable manufacturers found that, on average, they achieved only about three-quarters of the insulation speed which could be obtained with copper conductors. Measurements of the characteristics of the wire at various stages of manufacture showed that these were unaltered by the cable-manufacturing processes.

By the end of April 1966, 38 sheath-miles (1,500 loop-miles) had been installed for field trials, the cable being substituted for copper-conductor cable in development schemes already planned. About 100 lengths of cable were involved, these being drawn into ducts, mole ploughed or otherwise buried in the ground. Many of the lengths handled exceeded half a mile in length. In general, the cable behaved satisfactorily and pulling tensions were less than for electrically-equivalent copper cables. Breakages of the complete cable were thought to be more frequent than would have been the case for

copper-conductor cables, but no information was available for copper under similar conditions of installation, particularly as it appeared that the telephone areas rarely attempted to install copper cables in lengths comparable to those used in the trials.

Eleven complete cable breaks were investigated. These all occurred at the leading-end close to the cable grip and, in this respect, were similar to copper-cable failures. Seven of the failures occurred on one scheme and were the result of repeated attempts to pull excess cable through the duct to obtain material for jointers' training and qualification testing. It was concluded that the breaks were due to failure to maintain correct control of the rope of the winch capstan, with consequent high snatch loads on the cable. Sixteen wire breaks occurred of which twelve were in two cables, both known to have been subjected to high tensions during installation. The remaining four were thought to be due to manufacturing difficulties associated with wire quality.

All joints on this phase were crank-handle twisted, welded for aluminium-aluminium and soldered for the aluminium-copper. The production of the twists was slowed because it was necessary for jointers to use wire strippers to avoid damage to the conductor by nicking its surface. Aluminium is particularly notch sensitive and tends to break when bent at a point where the surface has been scored. Jointers do not normally use a separate stripping tool when jointing polythene- or paper-insulated copper conductors. Welding was found to be slower than the conventional soldering of copper-copper twists and the use of zinc-rich solder for the aluminium-copper joints was generally more difficult than normal soldering. A well-heated iron, free from all traces of lead/tin solder, was found to be essential, and even then, it was difficult to avoid blobs and spikes. About 9,000 joints were made during this phase of the trial with an overall failure rate of 1.2 per cent which was considered to be unsatisfactory when compared with a failure rate of 0.36 per cent on some 6,500 laboratory-made conductor joints.

INTRODUCTION OF FULLY-FILLED CABLES

For many years, it had been mistakenly thought that polythene-insulated and polythene-sheathed cables were sub-

mersible and immune to failure if waterlogged, whether as a result of sheath damage or by water-vapour permeation of the sheath followed by condensation. It was assumed that the polythene insulation would form a continuous coating over the conductors in the same manner that gutta-percha had provided insulation for submarine cables. Unfortunately, there is no comparison between the thickness used for gutta-percha and polythene, and no matter how carefully polythene is extruded, or how often it is tested and defects repaired, it continues to contain pin holes and small cuts when laid up into cable strand. Consequently, water gaining access to a polythene-insulated and sheathed cable results in some loss of circuits. Furthermore, the interstices between the insulated conductors provide a ready path for water to travel rapidly along the cable so that, not only does it enter joints, but more than one length of cable can be affected by a single case of sheath damage. Manufacturers were, therefore, asked to incorporate some means of preventing the flow of water inside distribution cables (up to 100 pairs) by filling the interstices between the insulated conductors with some suitable mastic or pliable material at 20-yard intervals.

Various compounds were used, such as two-part rubber mixes having a long curing time triggered off by the heat of sheath extrusion, gasket sealing compounds, and a mastic consisting in the main of asbestos and castor oil. Water flow was certainly prevented but physical discontinuities and distortion of the cables resulted and there were problems for the jointers when it was found that the jointing point coincided with one of the blocks. The Phase I cables were of this type.

British Insulated Callenders Cables Ltd.⁶ conceived the idea of extending the well-established practice of fully-filling power cables to the field of telephone cables by using petroleum jelly as a filler in place of oil. In order to maintain the specified capacitance of the cables without increasing cable diameter, cellular polythene insulation was used. This is obtained by incorporating a blowing agent in the polythene granules which gasifies on passing through the heated extrusion die, forming a sponge-like polythene covering on the conductor. This construction became the standard for copper-conductor distribution cables in 1967.

PHASE II TRIALS

The trials so far had shown that aluminium-conductor cables could be manufactured and installed, but indicated that further information was required before the overall economics of use could be assessed. It was, therefore, decided to order additional cable for a Phase II trial. There were a number of objectives; on the manufacturing side, it was hoped to enable the industry to resolve outstanding manufacturing problems and to determine more realistic selling prices while the British Post Office needed the opportunity of exploring more effective and less costly methods of jointing.

Orders for 600 sheath-miles of cable, 3,200 loop-miles, in 0.6 mm and 0.8 mm conductors were placed in mid 1966. Ten per cent of this cable was of the cellular-insulated, fully-filled type. Observed trials were confined to four regions, namely, Midland, Home Counties, South Western and London. The B-wire Connector⁷ was currently under investigation as an alternative means to tip welding and soldering and this new technique was used for jointing in the Midland and Home Counties Regions, the earlier methods being used in the other two Regions.

The B-wire Connector

The B-wire connector was developed by the Bell Telephone Laboratories.⁸ As shown in Fig. 3, it consists of three parts, the inside being a strip of galvanized phosphor-bronze pierced



Fig. 3—The B-wire connector

to produce a pattern of tangs, something like an inside-out nutmeg grater. The intermediate portion is a folded notched piece of brass which, when compressed, holds the phosphor-bronze. The outside consists of a cup-ended polyvinyl-chloride (p.v.c.) sleeve to insulate the whole.

Two telephone pairs are jointed together by giving all four wires a single twist to hold the wires in physical proximity, the A-legs forming one pair and the B-legs a second. All four wires are cut to the same length, about 1 in from the twist, and connectors slipped over each pair of wires. A crimping tool is then applied to each connector, in turn. Once operated, the pliers cannot be released until sufficient pressure has been applied to make a satisfactory joint. The crimping action forces the tangs on the inside of the connector through the conductor insulation into the conductor metal. The brass sheath deforms and maintains a steady pressure on the conductors so that a reliable joint is maintained. In practice, it is found best to lay up a number of pairs, cut them all to the desired length and fit the connectors, the crimping being done as a subsequent operation on the prepared pairs.

Findings of Trial

There were no real problems in the manufacture of cable for Phase II, the production speed achieved by manufacturers varying between $\frac{2}{3}$ and $\frac{7}{8}$ of the speed for cable with electrically-equivalent copper conductors. The aluminium wire complied with the specification having a tensile range of 19,000–23,000 lb/in². As a cross check, 2,500 laboratory crank-handle twist joints were made and only one failure was reported.

A few difficulties were caused by duct-space limitation, but it was always possible to install the cable. Owing to their lighter weight, aluminium-conductor cables were found to be better than copper for long-length cabling. Three cable breakages were reported. In none was the tension higher than the breaking weight of the cable, and it was, therefore, concluded that the use of small roller guides was the cause. There were also three causes of failure of the cable grip, all on the petroleum-jelly-filled cables and no different from similar failures on copper-conductor cables. Only one conductor failure was reported in 1,200 loop-miles installed and this was attributed to a defective factory joint.

JOINTING

As three methods of jointing were used on Phase II, it was possible to obtain an accurate assessment of the merits of each. Table 4 gives details of the numbers of each type of joint made and the number of faults observed.

Welded Joints

For welded joints, the conventional crank-handle twist was applied to the conductors, the end of each twist then being tip-welded. To do this, the jointer applied a carbon electrode to the twisted wire ends, a 24-volt battery having been connected between the electrode and the base of the twist. This operation required considerable dexterity such that some jointers found it impossible to acquire the knack and only succeeded in completely destroying the twist by melting. An improved technique could have been developed utilizing the discharge from a capacitor as the welding current, but this would not have been justified in view of the disadvantages which became apparent. These were that:

(a) the time taken was much longer than for standard copper-twist jointing,

(b) each jointer had to be equipped with a 24-volt battery and associated generator to maintain battery voltage,

(c) it was unsuitable for fully-filled cable as the petroleum jelly contaminated the weld and caused a high rate of failure, and

(d) it was unsuitable for copper-aluminium joints.

TABLE 4
Cable Installed, Wire-to-Wire Joints Made and Joint Faults

Conductor Size (mm)	Cable Installed (loop miles)	Wire-to-Wire Joints Aluminium-Aluminium						Wire-to-Wire Joints Aluminium-Copper					
		B-wire connectors			Welded			B-wire connectors			Soldered		
		Total	Failures	Per-centage	Total	Failures	Per-centage	Total	Failures	Per-centage	Total	Failures	Per-centage
0·6	375	5,720	9	0·17	1,470	5	0·34	410	0	0	1,630	0	0
0·8	862	4,696	4	0·09	74	0	0	1,210	2	0·17	202	0	0
Total	1,237	10,416	13	0·12	1,544	5	0·33	1,620	2	0·12	1,832	0	0

Notes. 1. Total B-wire connector joints Aluminium-Aluminium and Aluminium-Copper—12,036 with 15 failures (0·12 per cent).
2. Phase I gave a total of welded joints of 15,496 with 132 failures (0·85 per cent).

Soldered Joints

Soldering used on the aluminium-copper joints, had little more to recommend it as:

(a) the temperature of the soldering iron was found to be critical and only two or three connexions could be made before reheating of the iron became necessary,

(b) the face of the iron deteriorated rapidly and frequent re-tinning was required, and

(c) it was found difficult to avoid leaving spikes of solder and careful visual inspection of each joint was needed.

Crimped Joints

The crimping technique using the B-wire Connector was found to be the most satisfactory. The time taken for making the joint is no longer than that for a conventional dry twist and the result is electrically superior. Although designed for copper conductors, it is equally suitable for the making of aluminium-aluminium and aluminium-copper wire joints in fully-filled cables.

Precautions against Corrosion

Laboratory experiments completed in mid-1967⁹ showed that a small amount of silica-gel included in the joint of an aluminium-conductor cable ensures freedom from corrosion of the conductor in the connectors for the life of the cable, that is, up to 50 years. It was also realized that fully-filling was an essential factor in establishing complete confidence in the use of aluminium-conductor cable to avoid problems arising from water-vapour penetration of the sheath.

FURTHER TRIALS

Although the Phase II trials were incomplete, it was decided in mid-1967 that the outlook was sufficiently encouraging to justify the placing of further orders to establish the true cost of manufacture on purpose-built plant and to resolve any outstanding problems in producing fully-filled aluminium-conductor cable. A contract was, therefore, placed for 34,000 loop-miles at a cable price equivalent to copper at about £400 per ton, the current copper price then being £500 per ton. This meant that 6 per cent of the production of distribution network cable was already committed to aluminium for a 9-month period commencing in September 1967.

By the end of November 1967, another 3,000 loop-miles of cable, involving some 43,000 wire-to-wire joints, had been installed under regional control. The results confirmed the findings of the headquarters-controlled trials. Consequently, it was concluded that aluminium-conductor cables were suitable for use in the local distribution network and that only a marginal increase in installation costs compared with copper-conductor cables was involved. Thus, the economics

of the use of aluminium conductors depended primarily on the relative manufacturing costs of copper and aluminium cables which, as a result of the 1967 tendering, favoured the aluminium. At the end of 1967, the U.K. cable industry was informed that it was the intention of the British Post Office to equip and train its installation staff for the new techniques required for aluminium-conductor cable and that it was estimated that from June 1969, or at the latest December 1969, all orders for distribution cable would be in aluminium.

In the event, the controlling factor in the change-over was the rate of supply of wire connectors and crimping pliers. The annual consumption of the former was estimated to be 30 million and a stock of 10 million was considered necessary before aluminium-conductor cables could be issued to the field. Twenty-thousand crimping pliers were required to equip all jointers and to provide a reserve for maintenance.

By the middle of 1970, about 80 per cent of distribution cable was ordered with 0·5 mm or 0·8 mm aluminium conductors, the remainder being in copper to cover requirements for terminating and for aerial and wire-armoured cables, the design for which had not been changed. The situation altered significantly in 1971 and the current purchase of aluminium-conductor cable represents only about 40 per cent of the total distribution cable bought.

ECONOMIC CONSIDERATIONS

Fig. 4 shows the relative prices paid for 100-pair distribution cables from August 1968 to date, taking into account copper cost variation, the price of 100/0·5 mm copper at £500 per ton being taken as 100 per cent. For the period August 1968 to January 1970, see Fig. 4(a), the main planning consideration was the resistance constant, a situation in which 0·8 mm aluminium was the replacement for 0·63 mm copper, with 0·6 mm aluminium a convenient intermediate replacement for 0·4 mm and 0·5 mm copper. With the advent of optimum design,¹⁰ however, and working to 1,000-ohm loop resistance, the attenuation coefficient became more significant, so that 0·8 mm aluminium had to compete with 0·5 mm copper and 0·5 mm aluminium with 0·4 mm copper, see Fig. 4(b).

Fig. 5 shows the estimated prices for 100-pair copper- and aluminium-conductor cables based on 1971 costs for materials, labour and overheads at various price levels for copper wire bar and aluminium rod, using the cost variation factors for these metals normally applied to British Post Office contracts. The figures are again related to the 100/0·5 mm copper-conductor cable of 1968 with copper at £500 per ton. From the figure it can be seen that aluminium would have to fall well below £100 per ton for a 100/0·8 mm cable to be at a comparable price level to a 100/0·5 mm copper-conductor cable with copper at £450 per ton, the rate pertaining for the first half

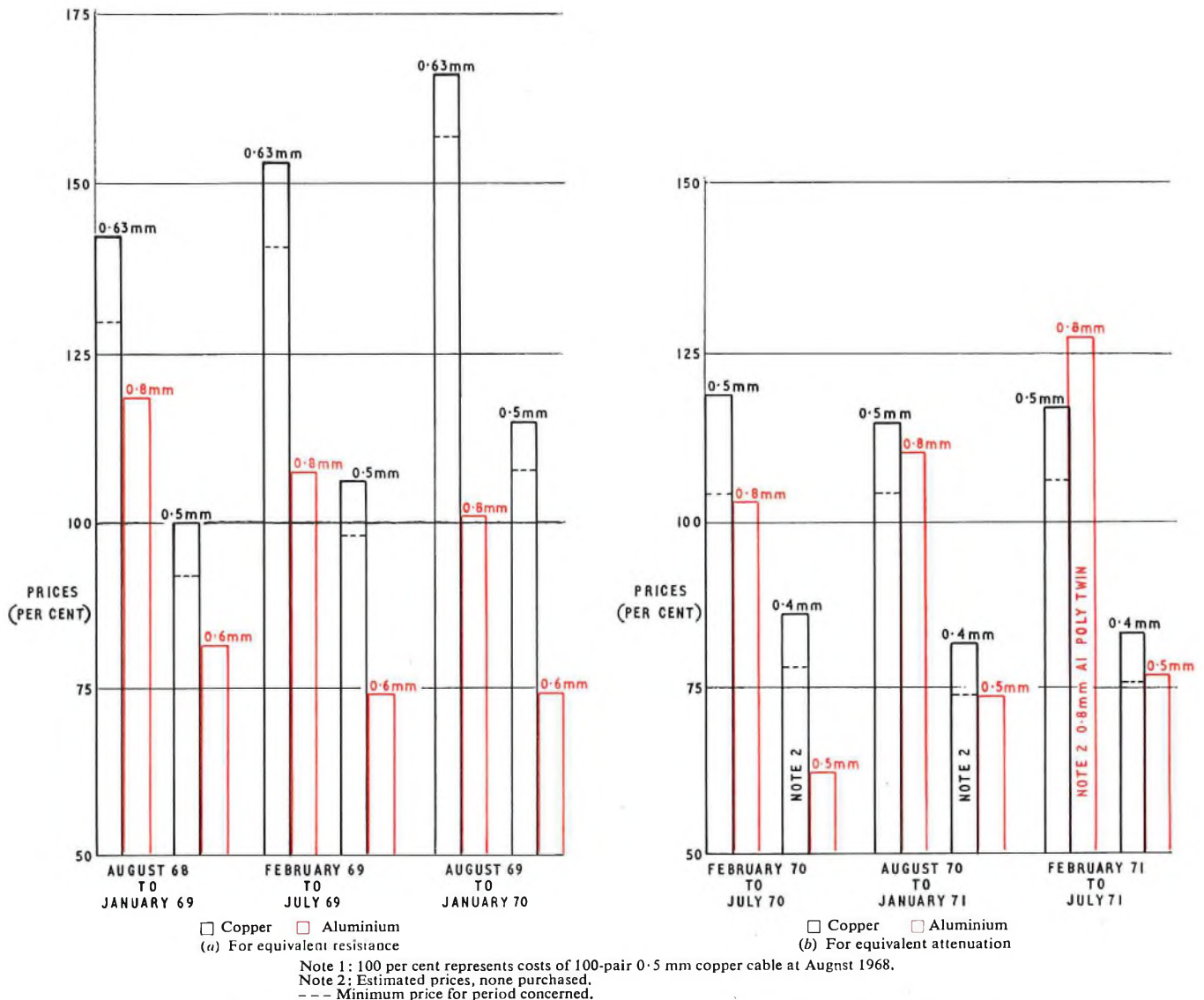

FIG. 4—Relative prices paid for 100-pair copper and aluminium distribution cables, August 1968 to date

of 1971. This explains the decision early in 1971 to discontinue the purchase of 0.8 mm aluminium-conductor cables. The figure also shows that aluminium would have to rise to £300 per ton before the cost of a 100/0.5 mm aluminium-conductor cable exceeded that of 100/0.4 mm copper, again with copper at £450 per ton.

UNIT-TYPE FULLY-FILLED CABLES

During 1969, consideration was given to the extension of the aluminium-conductor fully-filled concept to the cables between telephone exchanges and cabinets. The basic specification for unit-construction polythene-insulated and -sheathed cables was used for colour code and make-up, but the conductors were 0.5 mm and 0.8 mm aluminium insulated with cellular polythene in accordance with the distribution-cable specification. Manufacturers were also asked to completely fill these cables with petroleum jelly.

The first installation at Shelford in the Cambridge Area took place early in 1970. One 800-pair and one 600-pair cable were terminated on the main distribution frame (m.d.f.) using the wrapped-joint technique. It was not found possible to strip, crop and wrap in the standard fashion as with copper conductors but with pre-strip, satisfactory terminations were made. There were 5,200 conductor joints in the system all being made with B-wire connectors. Cabinet tails of copper-conductor cables were provided. Only one serious problem was encountered, that of handling the petroleum-jelly-filled cable in the exchange.

The extension has now been brought into use.

The second scheme at Camberley in the Guildford Area was a little more ambitious. It had originally been intended to terminate 2,000 aluminium-conductor pairs (1,600 + 400) on the m.d.f., but owing to a manufacturing mishap, the final length of the 1,600-pair cable was too short. Since some experimental 400-pair fully-filled copper-conductor cable was available it was decided to use five lengths of this for frame termination. Cable forms were accommodated in p.v.c. trunking fitted to the m.d.f. and the sheathing was removed to a point just below the m.d.f. The 400-pair cable cores were divided into ten 40-pair skinners in the normal way. A complication in preparing the cable forms was the incompatibility of the 25-pair units of the cable and the 40-pair fuse mountings.

Despite considerable efforts to prevent the spread of jelly over the floor by the use of disposable polythene sheets, the entire operation proved to be extremely unpleasant and there was considerable contamination of the m.d.f. ironwork and fuse mountings requiring a tedious clean-up operation afterwards. The presence of the jelly occasioned considerable embarrassment to the staff carrying out the work because of contamination of protective clothing. Although copper-conductor cables were involved, the difficulties are relevant since this development is aimed at establishing the practicability of extending the use of aluminium conductors and fully-filled construction including the termination of such

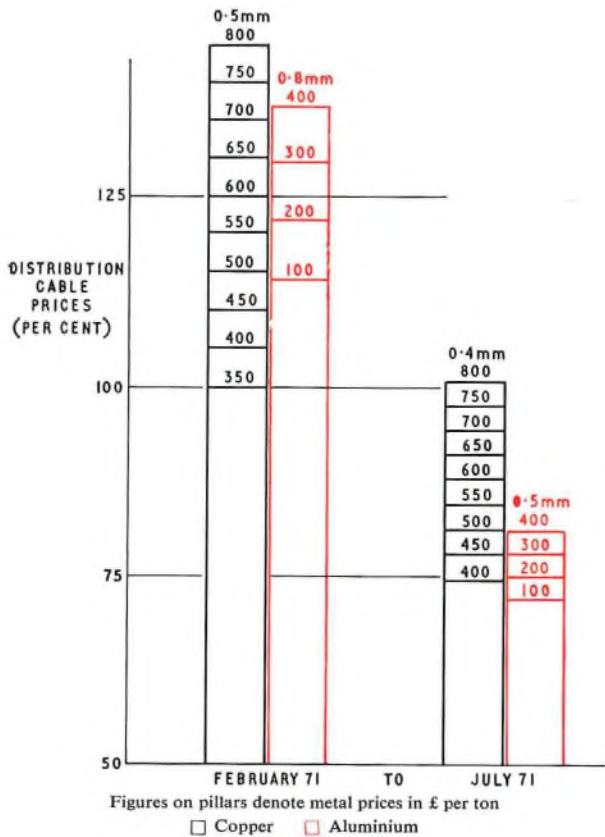

FIG. 5—Relative prices for copper- and aluminium-conductor cables for various copper and aluminium prices

cables on m.d.f.s. The provision of 50-pair fuse mountings is receiving consideration as one means of ameliorating the problem although a complete solution of the difficulty has yet to be produced.

The introduction of larger fully-filled cables provides a new concept for the main part of the exchange area network. The present system of pressurization is not completely effective in safeguarding against penetration of cables by water in the event of defective sheath closures or mechanical damage. Because of the number of branch cables and multiple joints, pressurization can be maintained only on a flow basis which renders detection of leaks at points of defect much more difficult. Furthermore, if work is carried out on a cable, the lengths on the side remote from the exchange lose pressure and can themselves be subjected to ingress of water if the pressurization had previously been effective at a point of minor damage.

There are no problems with new installations of fully-filled cable provided the most vulnerable part then remaining, the joint, is given adequate protection. A first-line protection could be the use of grease-filled connectors, but a better technique is to completely fill the joints with the same compound that is used in the cable. This is, in fact, the most likely line of future development.

There remains the problem of re-arrangements of the existing cable systems or the insertion of maintenance lengths where pressurization is the present form of protection. Consideration is, therefore, being given to the embodiment of an air pipe in fully-filled cables which will readily transmit pressure through the cable, but which can be easily sealed if not required. It has not been overlooked that air pressure might continue to be the safeguard at jointing points if the fully-filling of joints presents difficulty.

Since the largest size of 0.5 mm aluminium-conductor cable which can be accommodated in a standard Post Office duct is one of 1,600 pairs, there is a necessity to continue with 0.32 mm copper-conductor cables where higher pair densities are required, that is, up to 4,800 pairs. Since such cables are

needed only in localities where the telephone penetration is high and the duct lines are, therefore, probably deep and well protected by footways, it is possible that reliance can continue to be placed on pressurization.

A number of additional experimental schemes using fully-filled aluminium-conductor unit-type cables have been planned, since only by increasing experience in this way can firm conclusions be reached on what should be the pattern of future installations.

ALLOYS

There is no doubt that aluminium-conductor cables need more careful handling than copper due mainly to the reduced elongation capability of the drawn wire. A further problem is the tendency for the wire to break at any point subjected to a sharp bend. This could be associated with discontinuities in surface finish and investigations into ready means of testing for and eliminating this feature are in hand.

Consideration is, therefore, being given to the use of aluminium alloys, the ideal condition for the wire being that which most closely relates the properties to those of copper. This could incur some further loss of conductivity and some increase in conductor costs. In the meantime, E.C. grade aluminium-conductor cables will continue to be used in the secondary network to achieve an annual capital investment saving of £0.5 million with copper at £450 per ton. This figure represents the difference between 0.5 mm copper and 0.5 mm aluminium-conductor cables, it having been decided because of mechanical requirements that conductors smaller than 0.5 mm diameter should not be used in the secondary network.

CONCLUSION

The introduction of aluminium-conductor telephone cables in the United Kingdom has far outstripped any similar development elsewhere in the world, although there is now considerable activity in the U.S.A. and Japan along similar lines. It is not claimed that this has been achieved without problems, some of which have not yet been entirely overcome. The introduction of the fully-filled cable construction in the primary part of the exchange area network raises questions on the future of pressurization. Is it to be phased out or should advantage be taken of its availability for the protection of joints? A need is foreseen for a conductor having properties more akin to those of copper and a change from $\frac{3}{4}$ hard aluminium to a suitable alloy is virtually a certainty in the near future.

References

- ¹ *Management Today*, September 1966. The Great Copper Killing.
- ² HAYES, H. C. S. The Dover-Deal Experimental Cable. *P.O.E.E.J.*, Vol. 48, p. 224, Jan. 1956.
- ³ KREISHER, C. Aluminium Conductors in Telephone Cable. *Bell Laboratories Record*, Dec. 1953.
- ⁴ HORN, F. W., and BLEINBERGER, W. E. Aluminium Conductor Cable an Alternative to Copper. *Bell Laboratories Record*, Nov. 1967.
- ⁵ KINCAID, K. I., and SMITH, D. K. Aluminum Conductors for Polyethylene-Insulated Telephone Cables. *Electrical Communication*, Vol. 46, No. 1, 1971.
- ⁶ DEAN, N. S. The Development of Fully-Filled Cables for the Telephone Distribution Network. 17th International Wire and Cable Symposium, Atlantic City, N.J., Dec. 1968.
- ⁷ ARTAS, S. C. The B-wire connector for Cable Splicing. *Bell Laboratories Record*, Sept. 1962.
- ⁸ GRAFF, H. J., PEACOCK, J. M., and ZALMANS, J. J. Development of Solderless Wire Connector for Splicing Multi-pair Cable. *Bell System Technical Journal*, Jan. 1963.
- ⁹ HARRISON, J. C. The Metal-Foil Polythene Sheath and its use in the Post Office, I.P.O.E.E. Printed Paper No. 229.
- ¹⁰ SPENCER, H. J. C. Optimum Design of Local Twin Telephone Cables with Aluminium Conductors. *Proceedings IEE*. Vol. 116, No. 4, pp. 481-498, April 1969.
- ¹¹ SPENCER, H. J. C. Some Principles of Local Telephone Cable Design. *P.O.E.E.J.*, Vol. 63, p. 164, Oct. 1970.
- ¹² SPENCER, H. J. C. A New Method of Local Transmission Planning. *P.O.E.E.J.*, Vol. 63, p. 84, July 1970.
- ¹³ MILDNER, R. C., and THORNE, B. F. Aluminium in Telecommunications Cables. *P.O.E.E.J.*, Vol. 51, p. 16, April 1958.

The Application of the Electro-optic Effect to Telecommunications

SHEILA AYERS†

U.D.C. 537.533.3:621.39

The electro-optic effect is one of a group of phenomena described under the general title of opto-electronics. This article discusses the basic effect and describes the progress being made with its application to light beam modulation and deflexion for telecommunication purposes.

INTRODUCTION

In recent years interest has grown in the new technology of opto-electronics—a marriage of electronics and optics. Applications of this new art cover a wide range, from visual displays to the use of light beams for communication and switching. The *electro-optic* effect, which forms the subject of this article, provides one of the ways in which light can be controlled by electronic means. The effect can be used to modulate the phase, polarization, amplitude or direction of a light beam at frequencies up to the gigahertz range and the article describes the basic phenomena and the application of the effect to both light-beam modulation and light-beam deflexion. A simplified mathematical analysis of the processes is given in the Appendix.

Light is an electro-magnetic wave of the same nature as radio waves but of much shorter wavelength. Like them it is a *transverse* wave, i.e. the electric and magnetic field components are at right angles to one another, and to the direction of propagation. Such a wave is said to be *linearly polarized* if the electric field components are confined to one plane only, instead of being distributed at random over all planes perpendicular to the direction of propagation, as happens, for example, in ordinary daylight.

Devices can be constructed (e.g. Polaroid materials) which will pass only those components of light which are polarized in a specific direction and these can, therefore, be used to

create a linearly-polarized beam from a source of ordinary light. Such devices can also be used as *analyzers* to select a beam polarized in a particular direction or to determine the direction of a given polarized beam.

BIREFRINGENCE

In some crystals, light splits into two rays which are polarized at right angles to one another, and which travel through the crystal at different velocities. Crystals in which this occurs are described as birefringent, and the two rays are known as the *ordinary* and *extraordinary* rays.

In Fig. 1(a), the analyzer is set with its axis at right angles to the direction of polarization of the incident linearly-polarized light beam, and, in the absence of the birefringent crystal, would block its passage. Let us consider the effect of interposing the crystal. The incident beam may be regarded as the sum of two components polarized at $+45^\circ$ and -45° to the direction in which the whole beam is, in fact, polarized. If it is arranged that these two components (which are, of course, at right angles to one another) are aligned with the principal polarization directions, i.e. the planes of polarization of the ordinary and extraordinary rays in the crystal, for this particular beam direction, they will travel with different velocities and emerge from the crystal with a time phase difference. In practice the rays will also suffer slightly different angles of deflexion but this has been ignored in order to simplify the diagram. The result of recombining two rays polarized at right angles to one another and differing in time

† Research Department, Telecommunication Headquarters.

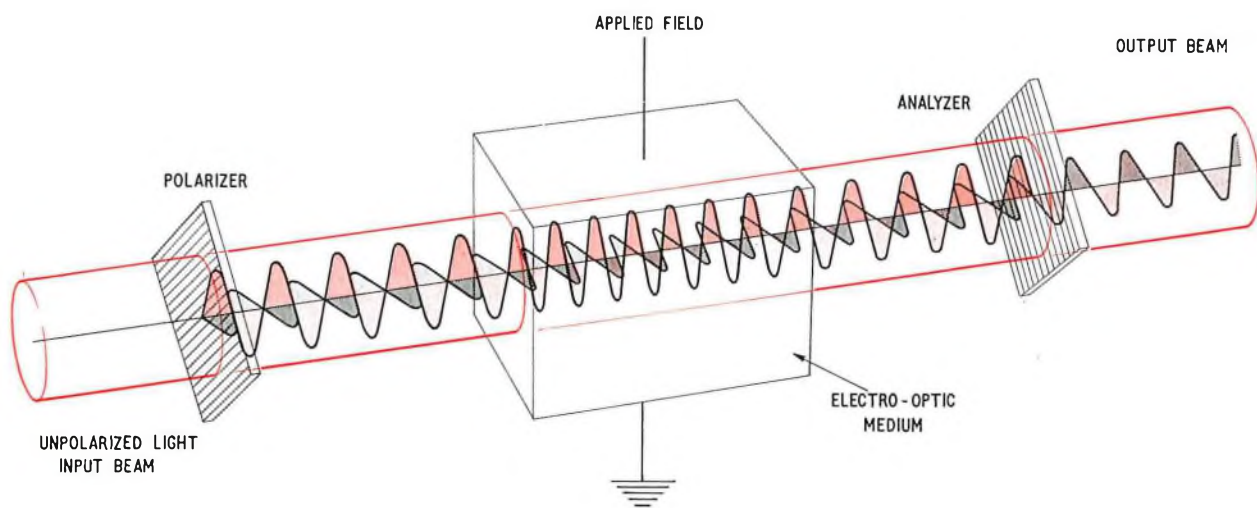

FIG. 1(a)—Electro-optic effect

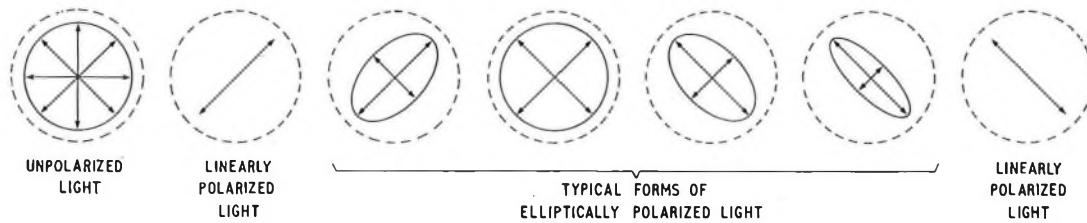

FIG. 1(b)—Elliptical polarization

phase is an *elliptically-polarized* ray. The magnitude of the time phase difference determines the eccentricity of the ellipse, which can vary over the whole range from a straight line to a circle, as shown by Fig. 1(b). In general, the elliptically polarized beam will contain a component perpendicular to the polarization of the incident beam and hence, some light will now be passed by the analyzer (the amount depends on the eccentricity).

ELECTRO-OPTIC EFFECT

In some crystals, birefringence can be induced or modified by an electric field. If a field is applied to a suitable crystal in the arrangement shown in Fig. 1(a), the time phase between the emerging 45° components will alter in sympathy. The proportion of light passed by the analyzer is related to this time phase as described above and thus can be varied from zero to maximum by the application of the appropriate electric field. 100 per cent transmission results when the time delay between the two components in their passage through the crystal amounts to a half-period of the optical frequency and the elliptical polarization degenerates to linear polarization perpendicular to that of the incident beam. The linear electro-optic effect is usually specified in terms of $V_{\lambda/2}$, the voltage required to reach this condition on a unit cube crystal.

In principle, provided an appropriate electro-optic coefficient exists, the field can be applied in any direction, but commonly-used conditions are with the field and light either perpendicular to one another (the transverse effect) or in the same direction (the longitudinal effect). The transverse effect has the advantage that, for a given voltage, the phase shift is proportional to the length while the field is inversely proportional to the thickness. A half-wavelength phase shift can thus be obtained for quite a low voltage, $V = V_{\lambda/2}(t/l)$, by making the crystal long and thin. No such advantage exists for the longitudinal effect.

At present, the design of devices is severely hampered by the lack of suitable crystals. There are many materials with high electro-optic activity, but only lithium tantalate, lithium niobate and members of the A.D.P. (ammonium dihydrogen phosphate) family have been grown to suitable size and optical quality for practical applications. The voltages

required to operate lithium tantalate and lithium niobate elements are compatible with transistor drive, and these crystals are commonly used when only small bars are needed. When large crystal plates are required, as in digital beam deflectors, members of the A.D.P. family (which require high operating voltages: $V_{\lambda/2} = 3$ to 7 kV) have to be used.

ELECTRO-OPTIC MODULATORS

Most practical modulators use amplitude modulation and two examples are described. The first uses lithium tantalate, and the second A.D.P. At frequencies above 1 to 10 GHz the transit time of light through the crystal becomes comparable with the period of the modulating signal, and the response falls off. Larger bandwidth modulators are attainable by using the travelling-wave principle, in which the electrical and optical waves are propagated through the crystal with matched velocities.¹⁻⁴ Polarization modulation is rarely used, but one example⁵ of such a device is mentioned later.

Demodulation is effected by an analyzer and photodetector.

Lithium Tantalate Wide-band Modulator

The modulator⁶ shown in Fig. 2 was developed by Bell Telephone Laboratories to impress the 224 Mbits/s digital output of a time-multiplexed p.c.m. system on to the beam of a helium-neon laser. The operating wavelength is $0.63 \mu\text{m}$, and the $0.25 \times 0.25 \times 10$ mm crystal is used in the transverse mode. Lithium tantalate is naturally birefringent so that, even with no field applied, there is some phase displacement between the two emerging rays. This is built up to a quarter wavelength by a quartz wedge. As shown in the Appendix, use of a static phase shift in this way makes the detector responsive to the polarity of the modulation. The natural birefringence of the crystal also causes angular displacement of the extraordinary ray relative to the ordinary ray, so a lens is used to converge them on to the detector. Temperature control to $\pm 0.04^\circ \text{C}$ is essential to avoid drift.

By arranging for the light beam to traverse the crystal twice (by putting a mirror-coating on the far end of the crystal) the effective path is doubled (round-trip mode) while the capacitance is unchanged. This halves the voltage required for a

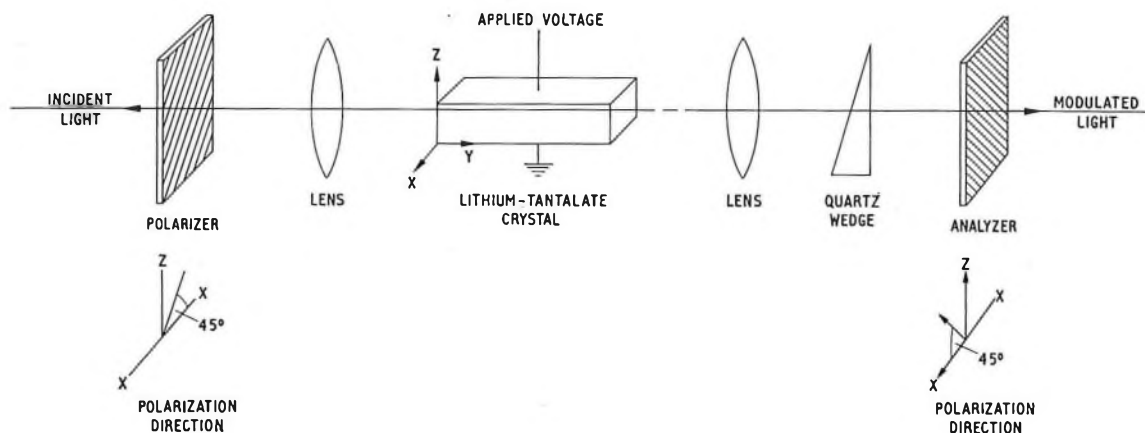

FIG. 2—Lithium tantalate modular—single transit mode

given depth of modulation and reduces the capacitive loading of the drive amplifier by a factor of four. In fact, a transistor amplifier delivering 6 volts r.m.s. across the 5 pF load suffices to drive the crystal from d.c. to 220 MHz with approximately 80 per cent modulation. The maximum output of the drive amplifier is 200 mW, and it is the amplifier, not the crystal, that limits the bandwidth. The modulator itself should be usable up to 1 GHz, since at this frequency the time required for light to traverse the crystal is less than a tenth of the period.

A.D.P. Video-Frequency Modulator

A transverse modulator shown by Mullard at the 1970 Exhibition of the Institute of Physics and Physical Society is typical of many using the A.D.P. family. It was made for a specific purpose and does not set out to show the ultimate performance of crystals of this type. In it, the natural birefringence and the changes in the refractive indices with temperature are compensated by using a pair of crystals. They are separated by a half-wave plate, which is a slice of birefringent material of such thickness that its ordinary and extraordinary rays suffer a constant relative delay of one half of a wavelength. As shown in Fig. 3, for normal incidence the

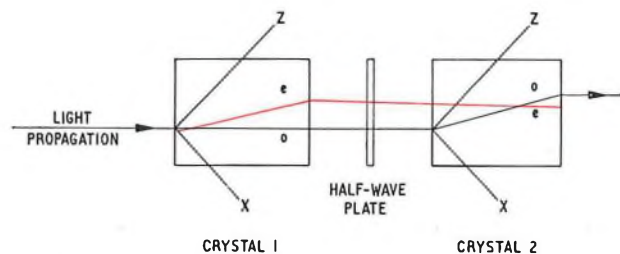

FIG. 3—A.D.P. two crystal birefringence compensation

ordinary ray travels undeflected through the first crystal, while the extraordinary ray is refracted through a small angle. The half-wave plate is set with its principal directions at 45° to the incident polarizations. Its effect is then to rotate the plane of polarization of each ray through 90° so that the ordinary ray in the first crystal becomes the extraordinary ray in the second, and vice versa. Thus, on emerging, the two rays will always be coincident. The overall dimensions of the complete modulator are $10 \times 11.5 \times 63$ mm and A.D.P. is transparent for light of wavelengths from 0.2 to $1.3 \mu\text{m}$, i.e. from the near ultraviolet, through the entire visible spectrum, to the near infrared. With red light at $0.63 \mu\text{m}$ propagated along the length of the device, 43 volts is needed to achieve 50 per cent depth of modulation. The average drive power required at 1 MHz is 0.25 watts and is almost wholly reactive. With a 100 ohm source impedance, the modulator will operate from d.c. to 36 MHz.

Polarization Modulator and Demodulator

In the amplitude modulators described above, there is a 50 per cent loss in system efficiency at the receiver because the polarization components perpendicular to the axis of the analyzer are not used. A polarization modulator described by Niblack and Wolf⁵ avoids this loss. Other claimed advantages are that interference due to linearly-polarized background light is negligible and the transmitter and receiver need only be aligned axially to initiate transmission. A block diagram is given in Fig. 4. The modulating voltage across the electro-optic crystal converts the incident linearly-polarized light alternately to right- and left-circularly polarized light. At the receiver the circularly-polarized light is focussed on a quarter-wave plate which splits it into two orthogonal components linearly polarized at 45° to the axes of the plate. The Wollaston prism is a device fabricated from birefringent material and is

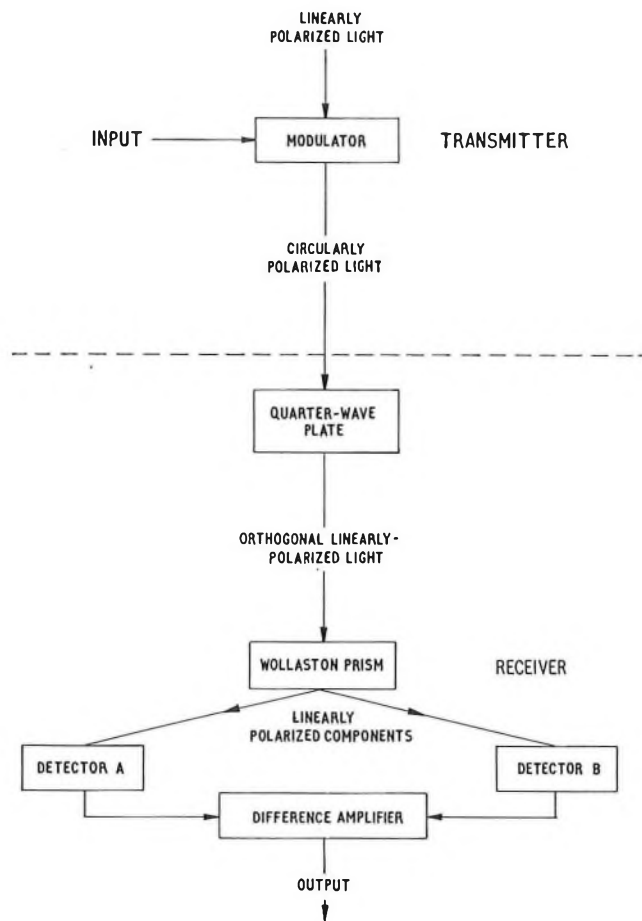

FIG. 4—Polarization modulation—demodulation transmission system

oriented so that its extraordinary and ordinary rays correspond to the vibration directions of these components. Its particular property is that it spatially separates the two components so that they impinge on the photocells in the detectors A and B. The two individual currents from the detectors are subtracted in a difference amplifier to yield the original modulating signal.

LIGHT BEAM DEFLECTORS

Light beam deflectors using electro-mechanical devices are very limited in frequency response due to mechanical inertia. The high operating speeds possible with electro-optic deflectors open up a wide range of new applications such as high-density optical memories, display devices and a non-blocking telephone switch. Line scanning applications embrace television, Viewphone and optical recording (including, for example, computer print-out and facsimile systems). Electro-optic light-beam deflectors can be divided into two types:

- (a) those where the electro-optic crystals are used only as binary polarization switches and the deflexion is achieved with passive birefringent crystals, and
- (b) those where the electro-optic crystals are, themselves, used to deflect the beam.

The first type is the most commonly used but is suitable only for digital operation while the second type can be used for continuous scanning over limited angles.

Digital Light Deflectors

A digital light deflector as shown in Fig. 5 consists of a series of binary stages, each comprising an electro-optic crystal E and a birefringent crystal B. Each additional stage doubles the number of choices, i.e. if there are n stages, there

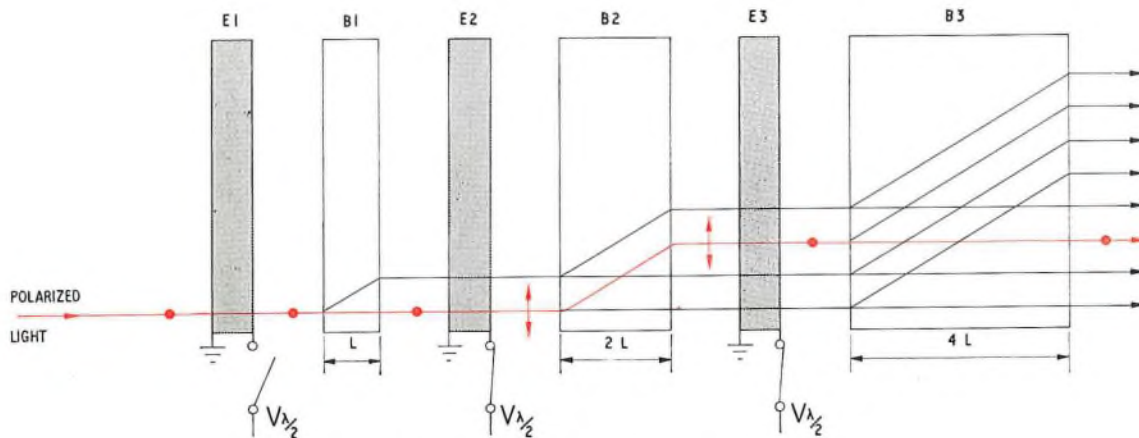
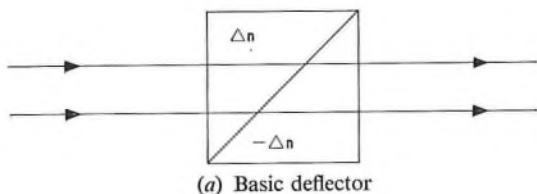

FIG. 5—Eight-position parallel-beam deflector

are 2^n possible output beam positions. The eight beam paths possible with the three-stage deflector shown in the figure are selected by switching the polarizations of the beams incident on the birefringent crystals B between the ordinary and extraordinary directions. The switching is effected by driving the electro-optic crystals E between zero volts and $V_{\lambda/2}$ as described above. With collimated (parallel) light, as shown in the figure, large crystals are needed for the late stages. Making the light incident on the device convergent eases this problem. Reference (7) describes a two-dimensional convergent-beam deflector with 1,024 (32×32) positions for a 10^7 -bit permanent memory claimed to be competitive with core stores. A 10^4 -bit hologram in each beam position is read by a photo-diode array. The deflector uses KD*P (potassium di-deuterium phosphate) crystals, transistor-driven at ± 2 kV, and needing 30 watts per stage. The random access speed of 500,000 positions per second is limited by power dissipation. Better materials would help, and some new organic crystals⁸ investigated in Research Department offer great promise.

Deflectors using Electro-optic Deflection

Refractive beam deflexion can occur either smoothly when a beam passes through a medium with a refractive index gradient, or discontinuously when it crosses a boundary between two regions of different refractive index. Although the former effect has been discussed theoretically,⁹ it has not been exploited in any device of practical interest. A small experimental index-gradient deflector has been reported¹⁰ but it requires a peak-to-peak signal of 20 kvolt to resolve eight positions. The latter effect is of greater interest and has been used in a number of devices. If a light beam passes through a prism it is deflected twice and a multiple deflector can be designed by combining prisms. A basic deflector unit comprises two 45° - 90° - 45° prisms forming a cube, arranged so that the change in refractive index is positive in one while negative in the other (Fig. 6(a)). The effect can be doubled by silvering the end face of the cube and further doubled (Fig. 6(b)) by adding two external mirrors. Incoming and outgoing beams are separated by inclining the input beam at a slight angle to the plane of deflexion. Several other arrangements of prisms can be used.¹¹ An attractive 300×300 position deflector, scanning 10^6 positions per second, has been proposed.¹² The design requires a pair of K.T.N. (lithium tantalate niobate) prisms as shown in Fig. 6(a) for the horizontal deflector and a similar pair for the vertical deflector. From experimental measurements it has been calculated that satisfactory operation would require a d.c. bias of 925 volts and a peak-to-peak sine-wave of 1,850 volts, the voltages on the two prisms in each deflector element being of opposite polarity. Unfortunately this remains a paper study as at present it is not possible to grow K.T.N. crystals of suitable size and optical quality.



(a) Basic deflector

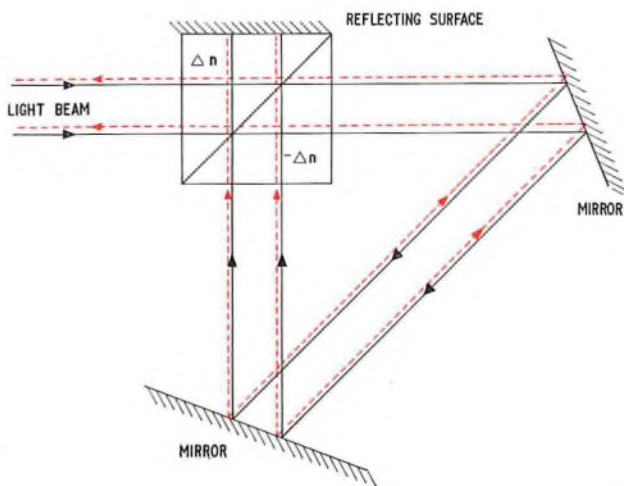

(b) Quadruple deflexion element

FIG. 6

Deflectors Inside a Laser Cavity

A number of deflectors have been designed where the electro-optic deflecting device is built inside a laser cavity. Two examples will be described briefly. The layout of a *scanlaser* reported in 1968¹³ is sketched in Fig. 7. The optics comprise a flat-field conjugate cavity and a quartz plate introduces a uniform birefringence across the cavity just stopping the laser oscillating for all modes. An electron beam can be focussed on a discrete area of the K.D.P. slice, providing a localized electric field. Due to the longitudinal electro-optic effect, this field causes additional birefringence in the cavity in the selected area which can be arranged to compensate for the initial birefringence thus allowing lasing action. Controlling the position of the electron beam selects the laser mode excited, resulting in the emerging light beam adopting one of 200 possible positions.

Another digital *scanlaser*¹⁴ is sketched in Fig. 8. It uses a crossed array of discrete lithium niobate electro-optic switches

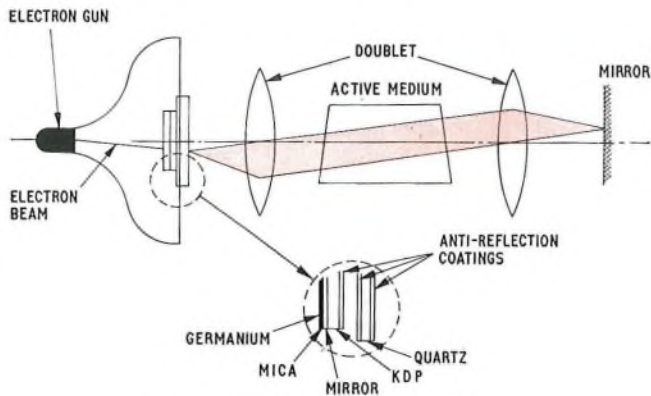

FIG. 7—Fast electron-beam scanlaser

excited in the transverse mode by applying voltages to a matrix of electrodes. It is suggested that an optimized digital scanlaser should be capable of emitting output pulses with amplitudes of 1 watt into any of 7.3×10^3 resolvable spots and be switched with less than 100 volts at more than 10^6 positions per second. Possible applications are in holographic stores and non-impact printing systems.

CONCLUSIONS

A variety of modulators and deflectors have been described but their design and range of application are severely restricted by the limited number of crystals available of suitable size and quality. In spite of the large number of electro-optic crystals reported, the only materials currently produced for practical use are members of the A.D.P. family, lithium niobate and lithium tantalate. Many of the interesting applications such as high-density memories, display devices, non-blocking telephone switches and optical recording of facsimile systems are unlikely to become practicable propositions until improved crystals are available.

However, preliminary work on a family of organic crystals, originated in Research Department, gives hope that new crystals may be developed which will combine easy growth with low operating voltages.

References

- KAMINOW, I. P., and LIU, J. Propagation Characteristics of Partially-Loaded Two-conductor Transmission Line for Broadband Light Modulators. *Proc. I.E.E.E.*, Vol. 51, No. 1, pp. 132-136, Jan. 1963.
- RIGROD, W. W., and KAMINOW, I. P. Wideband Microwave Light Modulation. *Proc. I.E.E.E.*, Vol. 51, No. 1, pp. 137-140, Jan. 1963.
- DI DOMENICO, M., JR., and ANDERSON, L. K. Broadband Electro-Optic Travelling-Wave Light Modulators. *Bell Syst. Tech. J.*, Vol. 42, pp. 2621-2677, Nov. 1963.
- PETERS, C. J. Gigacycle Bandwidth Coherent Light Travelling-Wave Phase Modulator. *Proc. I.E.E.E.*, Vol. 53, pp. 147-153, Jan. 1963.
- PETERS, C. J. Gigacycle Bandwidth Coherent Light Travelling-Wave Amplitude Modulator. *Proc. I.E.E.E.*, Vol. 53, pp. 455-460, May 1965.
- NIBLACK, W., and WOLF, E. Polarisation Modulation and Demodulation of Light. *App. Optics*, Vol. 3, No. 2, pp. 277-279, Feb. 1964.
- DENTON, R. T., et al. Lithium Tantalate Light Modulators. *J. App. Phys.*, Vol. 38, No. 4, pp. 1611-1617, Mar. 1967.
- REID, D. C. J., et al. An Optical Data Store. *Proc. of I.E.R.E. Conference on Lasers and Opto-electronics*, Mar. 1969 and private communication.
- Patent Application No. 58864.
- LOTSPEICH, J. F. Electro-optic Light-Beam Deflection. *I.E.E.E. Spectrum*, Vol. 5, No. 2, pp. 45-52, Feb. 1968.
- FOWLER, V. J., BUHRER, C. F., and BLOOM, L. R. Electro-optic Light Beam Deflector. *Proc. I.E.E.E.*, Vol. 52, pp. 193-194, Feb. 1964.
- LEE, T. C., and ZOOK, J. D. Light Beam Deflection with Electro-Optic Prisms. *I.E.E.E. J. of Quantum Electronics*, Vol. QE4, No. 7, pp. 442-453, July 1968.
- CHEN, F. S., et al. Light Modulation and Beam Deflection with Potassium Tantalate-Niobate Crystals. *J. App. Phys.*, Vol. 37, No. 1, pp. 388-398, Jan. 1966.

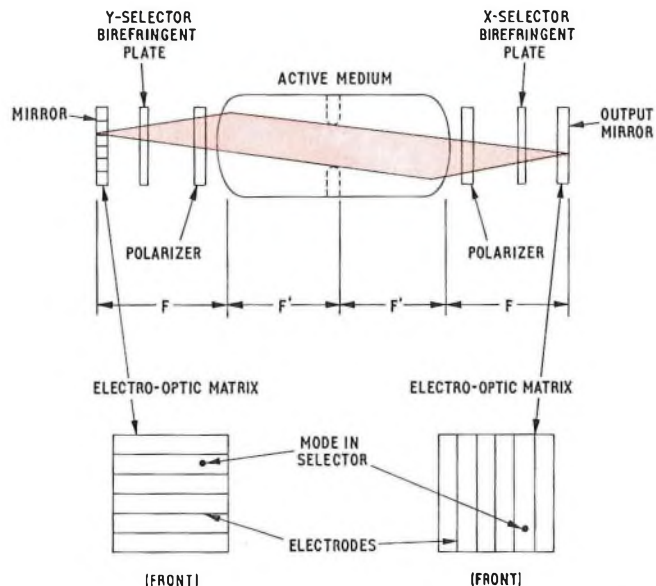

FIG. 8—Digital scanlaser with typical transverse mode illustrated

- MYERS, R. A. Fast Electron Beam Scanlaser. *I.E.E.E. J. Quantum Electronics*, Vol. QE4, No. 6, pp. 408-411, June 1968.
- DAKSS, M. L., and POWELL, C. G. A Fast Digitalised Scanlaser. *I.E.E.E. J. Quantum Electronics*, Vol. QE4, No. 10, pp. 648-654, Oct. 1968.

APPENDIX

Electro-Optic Modulation

Consider the general case of a birefringent crystal with a light beam, linearly polarized in an arbitrary direction, incident normally on the crystal face. Let the electromagnetic field of the light beam at the entrance face of the crystal be represented by $A \sin \omega t$. Then the two orthogonal components along the principal polarization directions are $A_1 \sin \omega t$ and $A_2 \sin \omega t$, where $A_1^2 + A_2^2 = A^2$ and the relative magnitudes of A_1 and A_2 depend on the direction of the initial polarization relative to the principal polarization directions. At the exit face of the crystal the two components polarized perpendicular to each other will be

$$A_1 \sin \left[\omega t + \frac{2\pi n_1 l}{\lambda_0} \right] \text{ and } A_2 \sin \left[\omega t + \frac{2\pi n_2 l}{\lambda_0} \right] \dots \dots (1)$$

where l is the length of the crystal in the direction of light propagation, n_1, n_2 are the respective refractive indices and λ_0 is the wavelength of light in free space.

If an electric field is applied to the crystal in an appropriate direction changes, Δn_1 and Δn_2 , are induced in the refractive indices and the two emerging orthogonally-polarized components become

$$A_1 \sin \left[\omega t + \frac{2\pi(n_1 + \Delta n_1)l}{\lambda_0} \right] \text{ and } A_2 \sin \left[\omega t + \frac{2\pi(n_2 + \Delta n_2)l}{\lambda_0} \right] \dots \dots (2)$$

These two components combine to form an elliptically-polarized beam whose ellipticity varies with the applied field. This effect forms the basis for the various types of modulation described below.

Phase Modulation

From expression (2) it can be seen that applying an electric field causes phase-shifts of $(2\pi\Delta n_1/\lambda_0)$ and $(2\pi\Delta n_2/\lambda_0)$, respectively, in each of the two orthogonal components. For a phase modulator it is necessary to use the output of only one component. Thus, for maximum light transmission, the direction of polarization of the incident beam should be aligned with one of the principal polarization directions, giving $A_1 = A, A_2 = 0$. All the light emerging from the crystal will then be linearly polarized in the same direction as the incident beam and the phase-shift of the output will be proportional to the applied field. No analyzer is required between the crystal and the detector.

Polarization Modulation

As previously described, the light emerging from a birefringent crystal is elliptically polarized and its ellipticity varies with applied field. No practical use has been made of this general property but the specific conditions to produce linearly-polarized and circularly-polarized light are utilized in a number of devices. If there is no birefringence, light emerges from the crystal polarized in the

same direction as the incident light. When an electric field is applied, sufficient to cause a half-wavelength shift between the two components, the emerging light has linear polarization perpendicular to that of the incident light. An example of a device which exploits switching between these two conditions is the digital beam deflector described in the article. Alternatively, the emergent light can be switched between right- and left-handed circular polarizations.

Amplitude Modulation

For amplitude modulation, maximum sensitivity is achieved when the incident polarization is at 45° to the two principal polarization directions of the crystal. The components of the incident beam along these two orthogonal directions have equal amplitudes of $A/\sqrt{2}$.

In general, at the exit face of the crystal, the light is elliptically polarized and represented by two orthogonally polarized components:

$$\frac{A}{\sqrt{2}} \sin \left[\omega t + \frac{2\pi n_1 l}{\lambda_0} \right] \text{ and } \frac{A}{\sqrt{2}} \sin \left[\omega t + \frac{2\pi n_2 l}{\lambda_0} \right]. \dots\dots(3)$$

An analyzer, set at 90° to the polarizer as shown in Fig. 1, will only accept components of the light polarized along its axis. Thus the light emerges from the analyzer with linear polarization perpendicular to the polarization of the incident beam. The output is given by:

$$\begin{aligned} & \frac{A}{2} \sin \left[\omega t + \frac{2\pi n_2 l}{\lambda_0} \right] - \frac{A}{2} \sin \left[\omega t + \frac{2\pi n_1 l}{\lambda_0} \right] \\ & = A \sin \frac{\pi(n_2 - n_1)l}{\lambda_0} \cos \left[\omega t + \frac{\pi(n_2 + n_1)l}{\lambda_0} \right]. \dots\dots(4) \end{aligned}$$

On applying an electric field, the output becomes:

$$A \sin \frac{\pi(n_2 - n_1 + \Delta n_2 - \Delta n_1)l}{\lambda_0} \cos \left[\omega t + \frac{\pi(n_2 + n_1 + \Delta n_2 + \Delta n_1)l}{\lambda_0} \right], \dots\dots(5)$$

where, $A \sin \frac{\pi(n_2 - n_1 + \Delta n_2 - \Delta n_1)l}{\lambda_0}$,

represents the amplitude of the input signal and is proportional to the applied field. To achieve a maximum change in amplitude for the minimum applied voltage the length of the crystal should be such that $(n_2 - n_1)l$ is equal to $n\lambda_0/4$, where n is an odd integer. A maximum change will then occur on switching from $+\frac{1}{2}V_{\lambda/2}$ to $-\frac{1}{2}V_{\lambda/2}$. (If the crystal is not birefringent a static shift of $\lambda_0/4$ can be applied by a quarter-wave plate.) Any unintentional change, for example with temperature, in the term $(n_2 - n_1)l$ must be very small compared with $\lambda_0/4$. Unless the desired electro-optic effect is obtainable from an optically isotropic material or with light directed along the optic axis of a birefringent crystal, so that $(n_2 - n_1)$ vanishes, close temperature control is likely to be needed.

Book Reviews

“Mathematics for Electrical and Telecommunications Technicians” J. L. Smithson. McGraw-Hill Publishing Co., Ltd. Vol. 1: 212 pp. 135 ill., Vol. 2: 251 pp. 189 ill., Vol. 3: 244 pp. 111 ill., Vol. 1, £1·20., Vol. 2, £1·25, Vol. 3, £1·40.

These volumes cover the mathematics syllabus of the City and Guilds Telecommunications Technicians course the Electrical Technicians course and the recently introduced Electrical Installation Technicians course.

SI Units are used throughout, although in his preface the author points out that the decision to do so was taken at a late stage in the preparation of the books. The necessary changes have undoubtedly resulted in some wrong answers in the worked examples and the set questions.

Starting with the basic processes of mathematics, Volume 1 develops the elementary concepts of algebra, geometry and trigonometry to cover the Practical Mathematics syllabus of the CGLI Telecommunications Technicians course.

Volume 2 covers the Mathematics A syllabus and Volume 3 both Mathematics B and C.

The books are well produced, with clear diagrams and a good layout, whilst steps in the calculations are for the most part clearly explained. Each topic is developed assuming little previous knowledge. Many worked examples are included in the text and the set problems are arranged in order of increasing difficulty so that the student may gain confidence before proceeding to more difficult questions.

It is a pity that the decimal coinage system has not been introduced where problems involve money, and it certainly should be possible to find the force in newtons due to grams weight without going via pounds and poundforce as Volume 2, page 203 suggests.

In spite of these minor criticisms and the inevitable misprint the books can be recommended to Telecommunications Technician students.

J.O.W.

“Fundamentals of Integrated Circuits.” Lothar Stern. Sir Isaac Pitman and Sons Ltd., x + 198 pp. 158 ill. £2·50.

A book of 200 or so pages which covers microcircuits from crystal structure to large-scale integration, taking in semiconductor and transistor theory, monolithic silicon technology, hybrid circuits, thin films, monolithic circuit design and layout, and packaging, cannot be expected to treat each topic in more than minimal depth. When most of the material has already appeared in textbooks elsewhere, it must be doubted that such a volume can find a significant readership. However, the book is well-written and generously illustrated and could be quite useful to newcomers to microcircuits. A young graduate, for example, anxious to get an early feel for the scope of his intended career could find it attractive as an “off duty” book, as could an older engineer resolved to move out of his traditional environment. Marketing personnel would find it similarly useful, assuming a modest technical background.

As might be expected, the approach is almost wholly non-mathematical, although some of the simplest transistor equations are introduced and the operation and performance of the various types of integrated circuit are described quantitatively.

The coverage ranges from RTL logic to wide-band amplifiers, treated rather as in useful application notes so often supplied by manufacturers to stimulate the use of their products. The identity of the author’s firm (Motorola) tends to emerge in this chapter (the longest), but not in an obtrusive way. Interestingly, the discussion of monolithic circuit design which outlines some of the topological rules for preparing the photoengraving masks for bipolar circuits, seems to accept that this task is a practical one for the equipment manufacturer.

Although the book inevitably has omissions, some cannot be excused if it is to be regarded as a completely up-to-date work. The most notable is the complete absence of any reference to MOS integrated circuits.

F. H. R.

The Manufacture of Waveguide Components by Electroforming

E. T. J. GOODMAN, C.ENG., M.I.MECH.E.†

U.D.C. 621.372.8-772 : 621.357.6

This article describes an electroforming process used in the Research Department of the British Post Office for the production of waveguide components. Typical electroformed waveguide elements are shown and some of the problems experienced are highlighted.

INTRODUCTION

Electroforming is a process whereby articles are formed by electro-deposition. It has been known for over one hundred years but it is only recently that industry has recognized its true value as a manufacturing medium. The process is one which produces bores or recesses of high accuracy and which faithfully reproduces the surface texture of the master on to which the article has been deposited. For certain applications, the process can compete successfully with conventional methods of manufacture, and can often do jobs which cannot otherwise be done. An example of one such job is shown in Fig. 1 in which the master can also be seen assembled ready for further electroforming.

The shape of many waveguide components is very complex, being generally of rectangular or circular cross-sections, or a combination of both. Frequently, they may be tapered, branched into clusters, or twisted in a spiral-like way. The inside of a waveguide tube needs accurate and uniform dimensions and form and surface finish are critical parameters. Electroforming is, therefore, a very suitable process for the manufacture of waveguides.



FIG. 1—Electroformed magic-tee and master

In order to meet the growing demand for the supply of both simple and complex waveguide components, especially for the millimetre band, an electroforming process was set up in the Post Office Research Department.

THE PROCESS

It is possible to electroform with various metals—nickel, silver, copper, iron and chromium—but for waveguides, copper is the metal which is used most.

Basically, the process is one in which metal (copper) is electro-deposited to a uniform thickness on to a master. The master, which is a precise and accurately finished male geometric form of the required bore or recess, is then separated (extracted) from the electro-deposit by mechanical or chemical means. To obtain high-conductivity copper electroforms, an acid copper bath, free from brightening or wetting agents, is used.

A millimetric waveguide system requires many small, precise elements which quite often have very complex shapes. The waveguide elements must be produced with as little machining as possible since, even when carried out with extreme care, distortion to the interior form can result.

The process and technique adopted by the Post Office Research Department, which satisfied the above condition, was evolved by the Royal Radar Establishment.¹ It is a controlled electroforming process giving a uniform wall thickness and a product having a precise finish. Subsequent work has enabled very small electroforms to be produced using multi-vat equipment. These electroforms are among the smallest being produced in this country.

EQUIPMENT

The equipment shown in Fig. 2 was manufactured in the Post Office Research Department and is, but for a few refinements, a copy of that developed by the Royal Radar Establishment. The equipment, which is capable of producing electroforms 1 m long, consists of a reservoir of electrolyte which is continuously circulated and filtered, copper anodes, a shaped cathode (master) and a power supply to control the current density. The cathode is generally rotated within the electrolyte, the speed and direction of rotation being variable. It is necessary periodically to reverse the direction of rotation of the cathode in order to avoid preferential deposition caused by the turbulent flow of the electrolyte over the master surface.

The multi-vat equipment, shown in Fig. 3, is basically the same as the equipment described above, except that it uses a number of smaller vats. These share a main reservoir of

† Research Department, Telecommunications Headquarters.

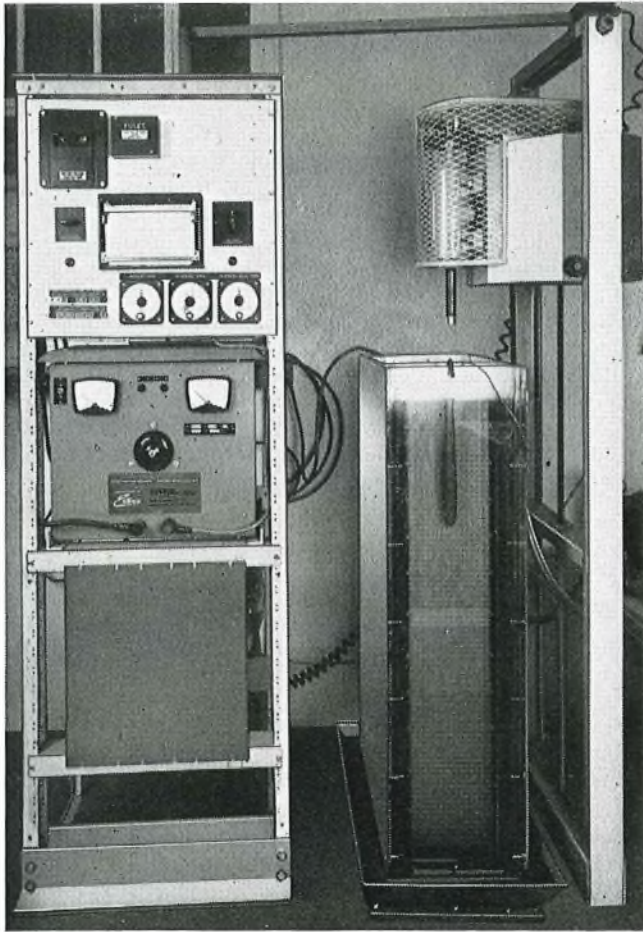

FIG. 2—Single unit electroforming equipment

electrolyte and a common filtering system, which can be seen at the rear of the figure, but have their own individual power supply and control to the anode and cathode.

Electrolyte

The formulation of the electrolyte used in the acid copper bath is 200 g of copper sulphate to 35–40 g of sulphuric acid per litre of distilled water. This gives high-conductivity copper deposits, close-grain structure, relatively high deposition rates and medium throwing power, that is, the ability to deposit into blind corners and cavities. In addition, the bath is designed such that complicated operations are least likely to go wrong and the electroforms may be removed for inspection and re-immersed without lamination of deposits taking place.

The electrolyte is contained in a perspex vat which allows the growth of the electroform to be observed without stopping the process. Any obvious impurities within the vat can be removed and bubbles, which may form immediately after immersion of the cathode, can be dislodged with a soft brush.

Filtration

Constant circulation of the electrolyte through a 1–3 micron polypropylene filter is necessary to deposit fine-grain copper, free from treeing and nodular growths. The filter is cleaned regularly to ensure good circulation.

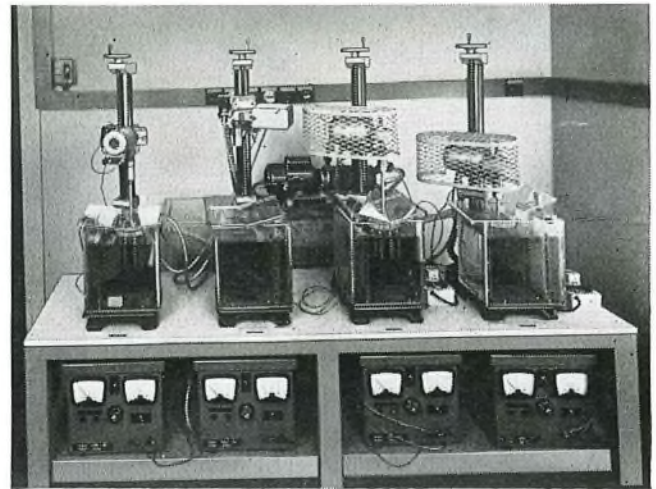

FIG. 3—Multi-vat electroforming equipment

POWER SUPPLY

The deposition rate is controlled by a d.c. supply which can be varied from 0–5 amp. The normal current density is 172 amp/m² of cathode which gives a deposition rate per wall thickness of 0.03 mm/h. Higher current densities enable faster growth rates to be achieved, but the resultant structure suffers from excessive nodular growth and is inclined to be porous. Faster rotation of the cathode enables the use of a higher current density, but if cavitation occurs within the electrolyte, uneven wall thickness results.

Several timers are included in the control circuit, these are:

- (a) an overall process timer (0–144 h),
- (b) a cathode (master) reversing timer (0–12 h), and
- (c) a cathode reversing delay timer (0–18 s).

Fail-safe circuits have been designed into the unit to ensure automatic shut-down of the process in the event of a malfunction, which could be caused by any of the following:

- (a) mains failure,
- (b) pump pressure rising owing to a blocked filter,
- (c) a blown fuse, and
- (d) removal of fuse cover during process cycle.

Automatic shut-down also occurs at the end of the process cycle. On shut-down, the electrolyte syphons from the electroforming vat back to the reservoir, leaving the electroform in free air.

The process can be left unattended for many hours and a pen recorder is included in the circuits to record the anode current during the forming cycle.

ANODES

Oxygen-free, 99.9 per cent pure copper is used for the anodes. Generally, a single anode is mounted at the side of the tank, suitably shielded with filter material to prevent sludge, formed by anodic etching, from contaminating the electrolyte. Where, however, the shape of the electroform is such that there is a tendency for preferential deposition to occur, additional anodes are used to improve the rate of deposition to particular areas.

The higher current densities present at corners and projecting points of some electroforms make these points prone to preferential deposition. This deposition can, however, be influenced to a considerable degree by the use of shields consisting of an insulating material placed in the path of the ion flow. The ion-flow path is then modified and the deposition pattern changed accordingly. An example of the use of shields is illustrated in Fig. 4, which shows an electroformed horn together with its master (cathode) and perspex shield.

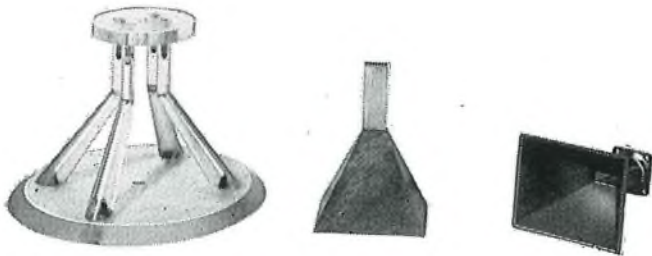

FIG. 4—Electroformed horn with master and perspex shield

The walls and bottom of the vat act as current reflectors causing variations in current densities. Thus, the size of the vat influences different electroforming applications to varying degrees, but in general, a small vat is preferred.

To offset the effects of higher current densities at the lower end of the cathode, caused by concentrated current flowing from the tips and corners of the anode, the side anode is normally kept shorter than the cathode.

MASTERS (CATHODE)

The accuracy of the finished electroform is a direct function of its master, since the shape, dimensional accuracy and surface texture of the master are faithfully reproduced. By far the greatest cost element in the electroforming process is the cost of manufacturing the master which may require the machining of a complex shape to a high degree of accuracy. This is particularly so in the case of millimetric waveguide elements. Masters may be manufactured from metals or non-metals and in the Post Office Research Department, stainless steel, perspex and aluminium alloy have all been used.

Stainless Steel

Stainless steel is used when the shape of the electroform is such as to allow mechanical withdrawal of the master. Its advantages are that,

- (a) it forms its own parting medium through oxidation by the atmosphere,
- (b) it can be readily and accurately machined to a good surface finish,
- (c) it is dimensionally stable and resistant to acid attack, and,
- (d) it is re-usable.

Disposable Masters

Where the shape of the electroform is such that the master is trapped within the electroform, it becomes necessary to destroy it. This may be achieved by melting, when heat has to be applied, or by chemical dissolution. Masters of this type are termed disposable.

Aluminium alloy

Aluminium alloy has good machining properties and can be eroded away easily with a hot solution of caustic soda. It is, therefore, a suitable material from which to manufacture disposable masters.

A serious limitation to the use of aluminium alloy, however, is the unreliability of the resultant internal surface finish of the electroform, which can have a minute hammered appearance. This is believed to be due to a chemical reaction between the electrolyte and the aluminium alloy. Three types of aluminium alloy have been used for the manufacture of masters and with one of these, fewer failures occur owing to the hammer finish.

Consistently good surface finishes can be produced by zincating the aluminium alloy master and then electroforming in a cyanide copper bath. However, the copper

deposited by the cyanide method is less pure and hence, has a higher resistivity, making it generally undesirable for waveguide applications.

Perspex

The first disposable masters manufactured in the Post Office Research Department were made from perspex. This material machines easily, but dimensional accuracy is difficult to maintain, particularly where thin sections are involved. It is resistant to acid attack and does not degrade during normal storage but is brittle and easily damaged. In order to initiate electro-deposition on to non-metallic masters, they must be made conductive and this is done by chemically silvering them.

Boiling alcohol is used to dissolve the perspex master from the completed electroform. This can be a long and tedious process, particularly with very small electroforms, because of the difficulty of introducing the solvent to the perspex master in sufficient quantity for rapid dissolution.

Fusible alloys

Masters may be removed by melting them but in order to avoid the adverse effects of heating, such as distortion and discoloration, low-melting-point alloys are used. Masters of this type have not been used in the Post Office Research Department.

INSERTS

It is possible to bond pre-machined inserts into the body of the electroform during the electroforming process. These inserts can be assembled with the master, using disposable devices where required, to very precise spacings and relative configuration. Thus, it is possible to produce very intricate components having internal machined elements. Fig. 5 shows

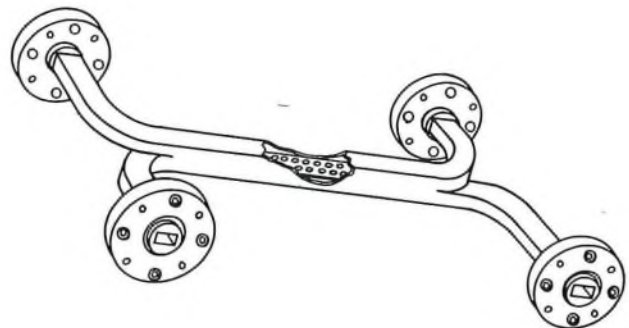

FIG. 5—Wideband coupler sectioned to show pre-drilled insert

an electroformed wide-band coupler which is an example of one such component. A section has been cut away to allow the pre-drilled insert to be seen.

The master design and fabrication for this bonding technique can be very complicated and costly to produce.

CONCLUSIONS

The electroforming process has enabled many valuable waveguide components to be produced, and some of these are shown in Fig. 6. There is, however, a need for further development work on master production in order to achieve a more economic method of manufacturing masters for batch quantities of electroforms, this being of particular importance for disposable masters. To this end, experiments are being conducted using moulding techniques and various plastic materials to determine whether it is possible to obtain the very precise dimensional accuracy and stability required for waveguide components. If these experiments are successful, economic savings will be achieved, and perhaps more impor-

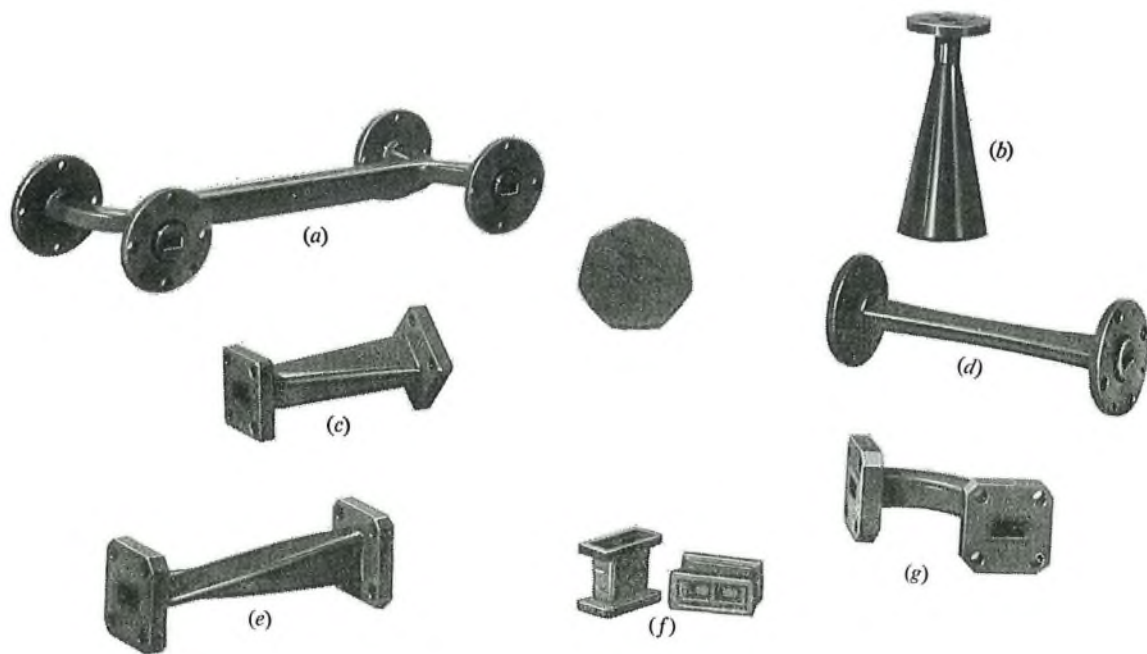

- (a) Wideband coupler
- (b) Horn
- (c) 45 degree twist
- (d) High-pass filter
- (e) 90 degree twist
- (f) Narrow-band couplers
- (g) 90-degree N-plane bend

FIG. 6—Selection of waveguide electroforms

tantly for a waveguide system, absolute repeatability of form and dimensional accuracy of similar waveguide components will be possible.

ACKNOWLEDGEMENTS

The author wishes to thank Messrs. T. Chalklen and L. Auchterlonie and other colleagues for help given in the preparation of this article.

Reference

- ¹ FYNN, G. W., and POWELL, W. J. A. Controlled Electrodeposition of High-Conductivity Copper. *Engineer*, p. 834, Dec 22, 1967.

Book Review

"Semiconductor Circuit Design." J. Watson, B.Sc., S.M., Ph.D., M.I.E.E. Adam Hilger Ltd., xi + 428 pp. 334 ill. £8.00.

It is important to notice the postscript to the title: "for a.f. and d.c. amplification and switching", since the book does not deal with high-frequency operation or with logic circuits. By restricting himself in this way the author is able to give a more thorough treatment of the subject than is common in many such text-books. After a brief discussion of the scope of semiconductor devices and their physical principles, the author deals with small-signal parameters and equivalent circuits. Two chapters are devoted to bipolar transistor amplifiers, though some may find it surprising that class A and class B operation are described under the heading "Special Purpose Amplifiers". A complete chapter is devoted to the bipolar transistor as a switch, and similar space is given to the characteristics and operation of field-

effect devices. A shorter chapter deals with semiconductor light transducers. Integrated-circuit amplifiers have adequate coverage, whilst the chapter on power supplies serves as an excellent introduction to a subject often neglected by such books. A number of other semiconductor devices are given a brief treatment, including the unijunction transistor and the thyristor.

The text follows a logical sequence and is written in a pleasing style. Frequent reference to modern devices and their data sheets gives the reader an impression that the book deals with reality, and not simply with theoretical concepts. Some of the more basic theory is covered in two appendices, whilst a third contains design problems. The index could usefully be expanded, but a helpful list of references is given at the end of each chapter. The book is appropriate to both student and practising designer, though they may be discouraged by the cost.

W. G. T. J.

Telecommunications Power Supplies— The Next Decade

Part 3—A Universal Modular D.C. Power Plant

S. F. HUMPHREYS, C.ENG., M.I.E.E., M.I.E.R.E.†

U.D.C. 621.39:621.3.031:621.311

A d.c. power plant has to satisfy many conflicting requirements and a successful compromise has to be found if a standard plant, suitable for universal application, is required. The design described is that arrived at to meet the modular concept outlined in earlier parts of this article. The principal design features and the circuit operation under various conditions are described.

INTRODUCTION

A new modular—50-volt d.c. power plant, designated Power Plant No. 233, has been developed to be the heart of the modular power system described in Part 1 of this article. The new plant is intended to be the standard for telecommunications equipment in the British Post Office.

The design of this plant is a compromise satisfying, as far as possible, a wide range of conflicting requirements. The result is a simple, fully-automatic plant designed to meet high targets of reliability. It is flexible in its application and, as it requires no routine battery charging, the maintenance costs are expected to be minimal.

Development of the plant has been completed to the full-scale prototype stage. Laboratory tests have been successfully completed and field trials are in preparation.

GENERAL DESCRIPTION

The Power Plant No. 233 gives an output regulated to within -46 to -52 volts with a normal output voltage of -51.5 volts. A complete installation comprises one stand-by rectifier, a smoothing battery and from one to four modules. Each module consists of a load battery of 25 lead-acid cells and a rectifier cubicle. The load battery is divided into a 23-cell section and a two-cell section. A typical 200-amp module rectifier cubicle contains the following main components:

(a) a statically-controlled 200-amp silicon-diode load rectifier regulated at -51.5 volts ± 1 per cent with a constant-power overload characteristic down to -42 volts,

(b) a statically-controlled 50-amp auxiliary rectifier, regulated at -5 volts ± 1 per cent with a constant-current overload characteristic down to zero volts,

(c) a silicon load diode,

(d) a d.c. contactor.

A prototype installation of four 200-amp load modules and one 200-amp stand-by rectifier is shown in Fig. 14. A view of the interior of a 200-amp load module is shown in Fig. 15.

A normal installation will anticipate a growth to four modules over a 20-year period, but a fifth or sixth module may be added if the 20-year forecast load is exceeded. The number of modules installed at any one time will meet the prevailing load without excessive overprovision. The electrical configuration is such that the modules need not be concentrated at any one location, but may be distributed throughout a building.

The equipment will be produced in ten module sizes in the range 30–2,000 amp, catering for plant capacities of 30 to 8,000 amp. The rectifiers will be available for operation from single or 3-phase a.c. supplies, according to size.

OPERATION

Normal Operation

Normally, the stand-by rectifier and all modules are connected to the a.c. supply, as shown in Fig. 16, with the output of the -51.5 -volt rectifiers sharing the prevailing load. The stand-by rectifier capacity is always surplus to the station load requirement, and is available should any of the load rectifiers fail.

The battery of 25 cells of each module is held at -56.5 volts by its load rectifier and auxiliary rectifier acting in series-aiding. At this voltage, the battery is maintained fully charged, in a float trickle-charge condition, at 2.26 volts per cell. The 23-cell section of the battery is at -52 volts which is 0.5 volt higher than the output of the load rectifier. With this p.d. of 0.5 volts across it, the load diode has a negligible forward current and, for practical purposes, can be considered as non-conducting.

Mains Failure

If the public a.c. mains supply should fail, the load and stand-by rectifiers cease to provide output and the 23-cell sections of the load batteries discharge via the load diodes. The 23-cell battery sections cannot supply the station on full load for more than a few seconds before the distribution voltage falls to the lowest permissible level of -46 volts. At this level, the voltage of the 23-cell battery sections will have dropped from -52 volts to approximately -47 volts (2.04 volts per cell); a full-load drop of one volt exists across the load diodes.

A solid-state voltage monitor, contained within the stand-by rectifier, continuously senses the distribution voltage. When the distribution voltage has fallen to -46 volts, a signal is passed to all modules to close the d.c. contactors. This causes the two-cell batteries in each module to be connected in series-aiding with the 23-cell batteries and the resultant 25-cell batteries are connected to the distribution. The output of the plant then rises from -46 volts to approximately -51.52 volts (-47 volts of the 23-cell section plus -4.52 volts of the two-cell section). The 25-cell batteries are of equal capacity, and will maintain the station on full load for at least one hour before discharging from -51.52 volts to -46 volts.

† Telecommunications Development Department, Telecommunications Headquarters.

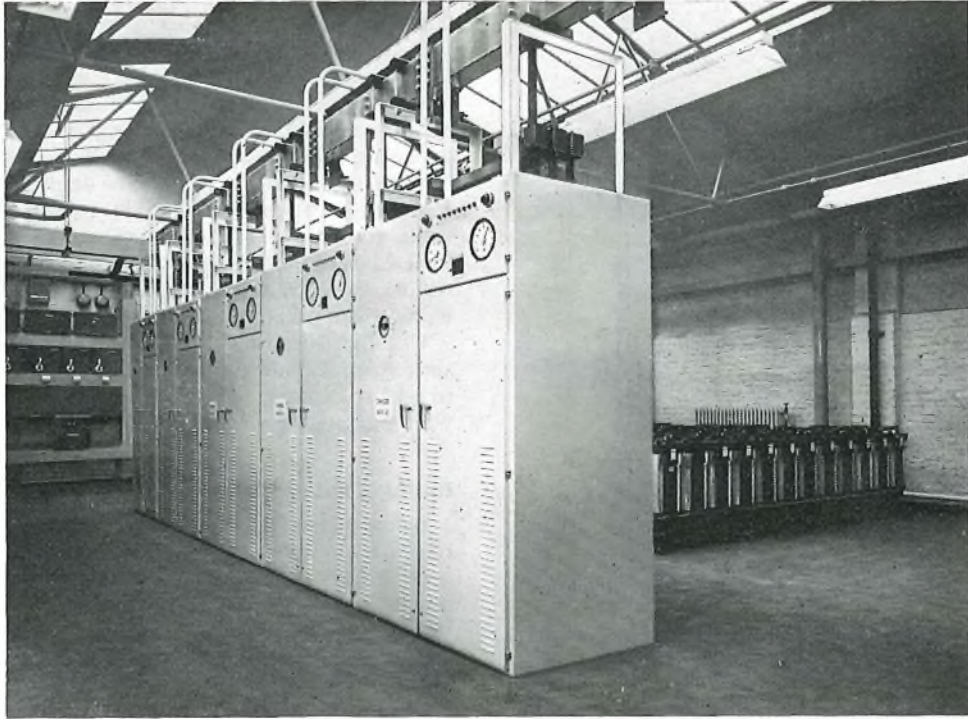

FIG. 14—Prototype installation of four 200-amp load modules and one 200-amp stand-by rectifier

Mains Restoration

When the public a.c. mains supply is restored, the d.c. contactors are held closed whilst the rectifiers take over the station load and also charge the 25-cell batteries until their voltage is -51.8 volts (2.08 volts per cell). In this condition, the load and stand-by rectifiers are biased to raise the voltage output by a minimum of one volt above the normal to ensure that the upper monitor setting is reached with a rectifier output at the lower limit of voltage tolerance. The auxiliary rectifiers are delivering full limited output current into the short circuits provided by the d.c. contactors.

At -51.8 volts, the static monitor causes the bias to be removed from the rectifiers and the d.c. contactors to be released, in that order. This sequence allows the charging current of the 25-cell battery to fall to a value below the current rating of the auxiliary rectifier before being broken by the d.c. contactor. It can be seen from Fig. 16 that the current broken by the d.c. contactor is zero when the battery-charging current through the contactor equals and opposes the current from the auxiliary rectifier. In practice, the d.c. contactors disconnect a current less than the auxiliary rectifier rating. With the d.c. contactors open, the auxiliary rectifiers, acting in series-aiding with the load rectifiers and with the stand-by rectifiers in parallel, re-charge the individual 25-cell batteries at constant current until they each rise to -56.5 volts. At this voltage, each battery has been restored to about 90 per cent of its full capacity and the remaining 10 per cent is restored gradually over the following two to three days under normal float trickle-charge conditions.

Although the auxiliary rectifier of a 200-amp module is capable of re-charging a battery at 50 amps, this current may not be available from its own load rectifier (acting in series), since the full 200 amps of the load rectifier is designated to supply a station load of 200 amps. However, 200 amps is available from the stand-by rectifier. This rectifier is in parallel with the load rectifiers of all modules and thus a maximum of four auxiliary rectifiers can be supplied with 50 amps each. In practice, the installed stand-by and load rectifiers will collectively share the station load plus the battery re-charging load. Block diagrams of the load module and stand-by rectifier are shown in Figs. 17 and 18 respectively.

Operation with Stand-by A.C. Supplies

The Power Plant No. 233 has a battery reserve sufficient to supply a station on full load for at least one hour, and is provided with a.c. stand-by supplies derived from associated engine/alternator sets. When one engine/alternator set is installed, the a.c. supplies to the rectifier cubicles are connected as shown in Fig. 19(a). Under normal conditions, all cubicles are connected to the public mains supply and the

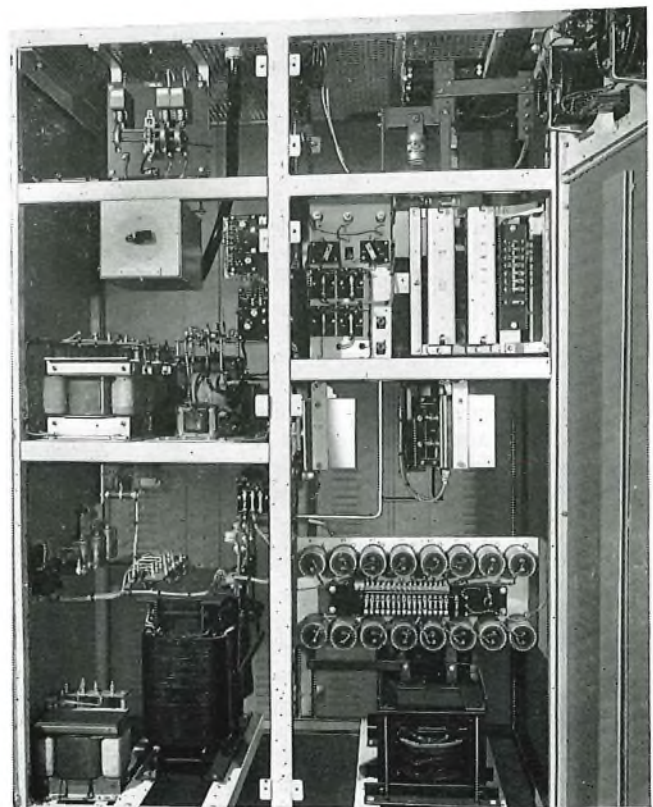

FIG. 15—Interior of a 200-amp load module

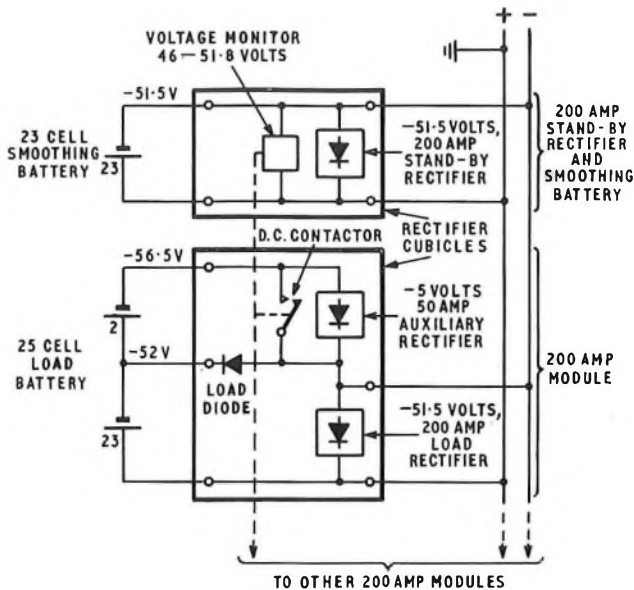

FIG. 16—Block diagram of Power Plant No. 233

d.c. load is shared by all rectifiers. If the public a.c. supply fails, the engine/alternator set starts up and the stand-by supply takes over the load of the module rectifiers but not that of the stand-by rectifier.

The cost of providing an a.c. stand-by plant capable of supplying the stand-by rectifier, in addition to the module rectifiers, is unjustified, since the probability of a module failure during a public supply failure is considered acceptably low. However, should a module fail at any time, the stand-by rectifier can be manually switched to the a.c. stand-by capacity thus thrown spare. This is achieved by the operation of a.c. input switches on the rectifier cubicles. Electrical interlocks prevent too many rectifiers from being connected to, and thus overloading, the a.c. stand-by supply. If the number of installed modules is such that the a.c. stand-by supply is not loaded with its ultimate complement of modules, the stand-by rectifier may be left switched to that supply without possible over-load.

Where two engine/alternator sets are provided, the a.c. supplies are connected as shown in Fig. 19(b). This arrangement differs from that for a single engine/alternator in that the capacity on stand-by supply No. 2, made spare by a module switched from that supply, can be utilized by a module normally connected to the stand-by supply No. 1. In turn, the stand-by rectifier can then utilize the capacity on stand-by supply No. 1 made spare by the module switched to the stand-by supply No. 2. The same electrical interlocks are provided as with a single engine/alternator to prevent a possible over-load of any a.c. stand-by supply.

A switching-error alarm is actuated by each rectifier associated with an attempt to overload any a.c. stand-by supply. The alarm is removed when one or more rectifiers are switched from the potentially overloaded supply.

High-Voltage Condition

A high-voltage monitor is connected to each rectifier, and arranged to release the a.c. input contactor should the distribution voltage exceed -52.5 volts for more than two seconds. The monitor is also arranged to re-operate the a.c. contactor when the distribution falls to -45.5 volts. The circuit operation is as follows.

If the output rises above the upper limit of -52 volts, the first rectifier to sense -52.5 volts releases its contactor. If the high-volts condition persists, other rectifiers will become de-energized in a similar manner. Dependent upon the load

conditions and the number of rectifiers fitted, all rectifiers may become de-energized or some may remain energized but in a current-limit condition. In either case, the output will fall to below -52 volts. If there is insufficient rectifier capacity to supply the prevailing load, the d.c. contactors connect the 25-cell batteries to load to make up the deficit.

When the batteries have become discharged to -45.5 volts, sufficient rectifiers are restored to raise the output to a value above -45.5 volts. Since one rectifier can supply at least 25 per cent of the prevailing load, the last rectifier to restore should raise the output voltage to a value close to or within the normal regulation limits of -51 to -52 volts.

Usually, at least one rectifier will not restore automatically, since there will always be one rectifier not normally required to take the station load. This rectifier is restored manually with a RESTORE key provided on the cubicle.

Initial Battery Charging

Before a 25-cell battery can be put into service, it is necessary to give it an initial charge to bring its voltage to approximately -66.5 volts or 2.66 volts per cell. This is achieved simply on site by the operation of links which modify the auxiliary rectifier output to give -15 volts ± 1 per cent with a constant current overload characteristic down to zero volts. If the 23-cell battery connexion is removed, the auxiliary rectifier, acting in series-aiding with the -51.5 volt load rectifier, can charge the 25-cell battery at constant current from -51.5 volts (the open-circuit battery voltage) to a fully-charged condition at -66.5 volts.

DESIGN CONSIDERATIONS

Smoothing Battery

The load batteries of existing designs of d.c. power plant are usually connected directly to the output. The low impedance presented by a battery to alternating currents reduces to low levels the a.c. noise voltages on a distribution system. This is important when one takes into account that, to conform with the C.C.I.T.T.* recommendation, the permitted level of noise is only 2 mV r.m.s. psophometrically weighted.

The load batteries of a Power Plant No. 233 are not electrically connected to the output distribution under normal conditions, since the load diode is in a non-conducting state. In order that the noise generated by the exchange equipment and the power-plant rectifier can be contained to the same extent as with existing types of plant installation, a separate smoothing battery of lead-acid cells is connected to the output distribution.

A battery of 23 cells has been chosen since, at the nominal rectifier output of -51.5 volts, the cells can be maintained in a float trickle-charge condition of 2.24 volts per cell. This voltage is slightly lower than is usually found for float trickle-charge operation but can be tolerated in this case since the battery is never discharged below -46 volts or 2.0 volts per cell.

Because the smoothing battery is not required to supply a station load, it can be of relatively small capacity. In the prototype plant, a battery of 60 Ah was used. For batteries of lower capacity, the battery resistance increases and begins to affect the total bus-bar plus battery loop impedance.

Load Batteries

The size of load battery in the plant was chosen to optimize cost and efficiency. To reduce the cost of a battery for a particular duty, it is necessary to use the largest number of cells in series which can give the required performance, e.g. a battery of 24 cells can be discharged to 1.92 volts per cell,

* C.C.I.T.T.—International Telephone and Telegraph Consultative Committee.

whereas a battery of 25 cells may be discharged to 1.84 volts per cell, before the terminal voltage falls to -46 volts. Also, the nominal voltage at which a battery should be float trickle-charged is approximately 2.25 volts per cell. Above this value, the confidence of recharging fully a discharged battery increases until, at approximately 2.3 volts per cell, gassing of the battery can occur dependent upon the temperature, electrolyte density, and other electro-chemical factors. Above 2.35 volts per cell, the degree of gassing may be such as to limit the life of the battery.

Below 2.25 volts per cell, the confidence of re-charging fully a discharged battery to this value falls, and the lowest float voltage level must be judged by the possible degree of discharge and the time taken to reach that state of discharge. Cells re-charged to 2.2 volts per cell could replace only small degrees of discharge with any confidence.

In the Power Plant No. 233, the nominal voltages of the load and auxiliary rectifiers are -51.5 volts and -5 volts, respectively. A load battery of 23 + 2 cells is, therefore, float trickle charged to -56.5 volts or 2.26 volts per cell. The circuit configuration is such that the 23-cell sections are maintained at -52 volts (load diode non-conducting). 24 cells could not be used in place of the 23 cells since, at -52 volts, only 2.17 volts per cell would be available. The 24 cells could not be fully re-charged automatically to this potential after an extended discharge. Thus, 23 cells is the maximum number of cells that can be employed in the main section of the battery.

Next, the number of end cells may be considered. The output limits of the power plant are -52 volts and -46 volts and the maximum voltage change is therefore limited to 6 volts. Thus, a maximum of two cells can be switched when floated at any voltage above 2.0 volts.

It follows that the maximum number of cells which can be provided for the total battery is limited to 25. This is the same as the number of cells used on existing -50 volt double-battery float plants having a one-hour battery reserve. If it were not for the fact that the load diode is virtually non-conducting at 0.5 volt, the main section of the battery would be limited to 22 cells and the total battery limited to 24 cells. The cost of a battery of 24 cells is approximately 40 per cent higher than that of a battery of 25 cells for the same one-hour discharge rating. This is a significant factor in an annual battery budget of around £¼m.

It would be possible to have a second stage of switching, using 26 or 27 cells, which would allow a discharge to 1.77 volts or 1.70 volts per cell, respectively. However, it will be shown later that the batteries may be required to discharge over a period of at least five hours. Batteries discharged in this manner could not be re-charged to 2.26 volts per cell with any reasonable degree of confidence.

The batteries used on this plant are the standard Post Office high-performance Planté-type. Enclosed-cells are used for plants not exceeding 3,200 amps in output; above this rating, open-type cells are used. It is confidently expected that the average life, when float trickle-charged at 2.26 volts per cell, will be better than 20 years.

As stated, the battery capacities are selected to maintain the station on full load for at least one hour before falling to -46 volts. At some stations, the current demand may increase as the battery voltage falls. This condition could exist where a large proportion of the installed equipment is fed via d.c./d.c. converters at the equipment racks. In order to cater for this condition, the battery capacities are chosen to supply a constant-power load.

At a station where two stand-by engine/alternator sets are provided, the probability of simultaneous failure of both stand-by supplies is very low. However, should one of the stand-by supplies fail during a mains failure when the d.c. plant is fully loaded, one half of the station load will be supplied by the load batteries. In this condition, the batteries could supply a constant power load for approximately 3.8

hours before falling to -46 volts. If, however, the load is not at constant power but is at constant current, the assisted batteries will be able to maintain the station above -46 volts for at least five hours. It is expected that most engine/alternator set faults could be corrected by the local maintenance staff within five hours, and in any case the probability of the mains supply being restored within this period is high.

RECTIFIERS

Choice of Rectifier Type

In the design of a d.c. power plant, two basic types of rectifier are available. These are generally referred to as the motorized-regulator type and the statically-controlled type.

The motorized-regulator type senses the output d.c. voltage and, when out of pre-set limits, sends a signal to a reversible motor. This motor alters the tapping position on the input transformer and compensates for the change in output. The speed of response is comparatively slow and, where rectifiers are connected in parallel, some form of common control is necessary to prevent hunting between rectifiers.

Any form of rectifier common control would be quite unacceptable for the new plant since the overall reliability of the plant would be determined by the fault rate of the common-control equipment.

The statically-controlled rectifier normally employs transducer or thyristor devices to correct for changes in output. An advantage of this type of rectifier is that the correction is proportional to the output error, is continuously applied, and is fast acting. The transducer can be regarded as an inductive choke whose a.c. impedance is varied by the degree of magnetic saturation produced by direct current in an auxiliary winding. Thyristor control is achieved by variation in the firing angle of the a.c. waveform.

The electrical efficiency of the static rectifier is slightly lower than that of an equivalent motorized-regulator type but the additional running costs can be offset by the savings in maintenance. The static rectifier is not subject to wear since there are no moving parts. Fortunately, statically-controlled rectifiers of similar design can work in parallel without common control and without hunting. For this reason, they are used on the Power Plant No. 233.

Normal Regulation Limits

The load and stand-by rectifiers are required to give an output voltage regulated to 51.5 volts \pm 1 per cent (51 to 52 volts), and the auxiliary rectifiers to give an output voltage regulated to 5 volts \pm 1 per cent (4.95 to 5.05 volts). These limits ensure that, under normal conditions, each load battery of 25 cells is kept at a voltage within the limits of -55.95 to -57.05 volts or 2.24 to 2.28 volts per cell.

Load-Rectifier Overload Characteristic

It has been shown previously that batteries, provided on the basis of supplying the full-load demand for only one hour, will maintain the station on full load for five hours when one half of the installed rectifiers only are available to assist the battery discharge. The degree of assistance provided by the rectifiers is augmented by a constant power-overload characteristic. A typical load-rectifier output characteristic is given in Fig. 20(a). The same characteristic applies to the stand-by rectifier. It is interesting to note that, because the overload is at constant power, the additional current, at the lower voltages, is made available with no increase in the a.c. stand-by power requirement.

Auxiliary-Rectifier Output Characteristic

The stand-by rectifier is required to supply up to four auxiliary rectifiers with current sufficient to re-charge the 25-cell batteries to -56.5 volts. The output of each auxiliary

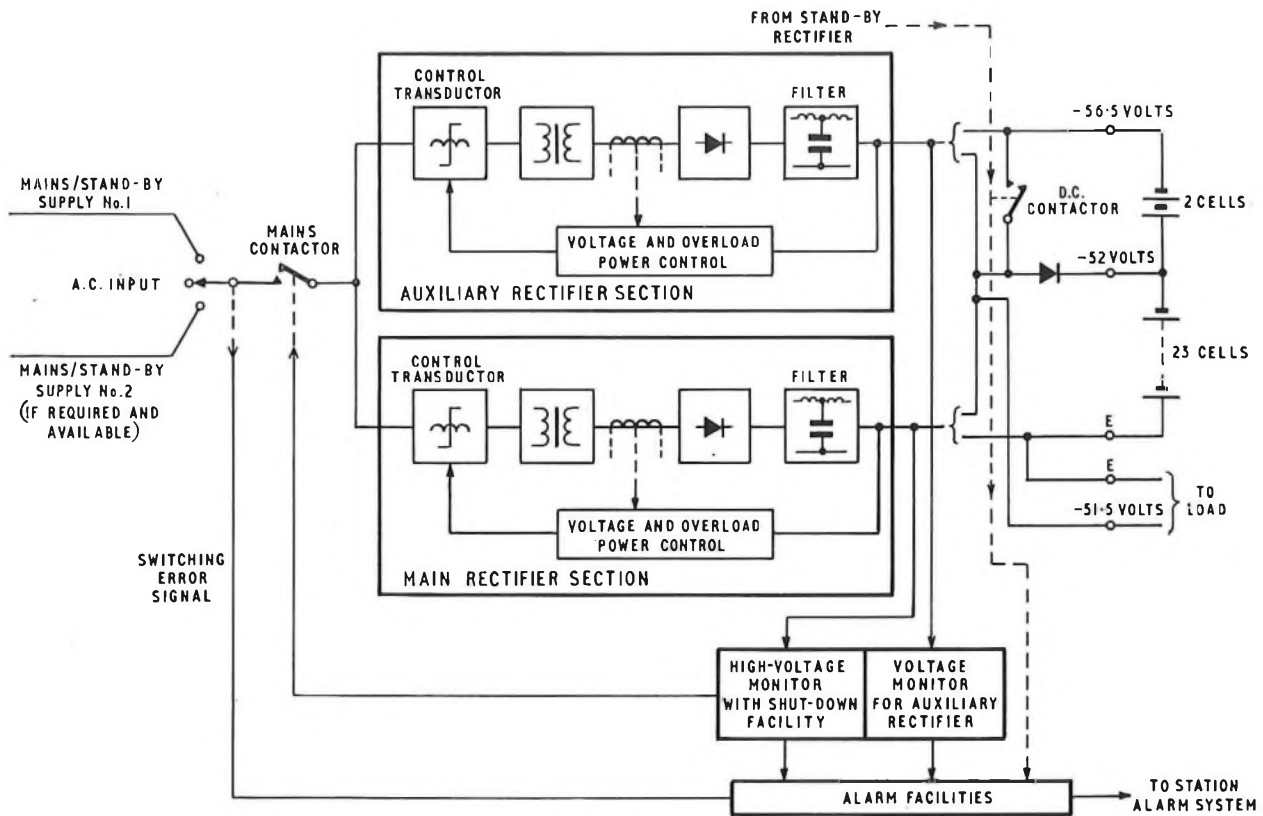

FIG. 17—Block diagram of load module

rectifier must, therefore, be current limited to 25 per cent of the stand-by rectifier current rating. For a 200-amp module installation, each module battery, having supplied a 200-amp load for one hour, can be re-charged at 50 amps in about four hours. The re-charge rate is approximately the same for all module sizes and is approximately 7–10 per cent of the battery capacity.

It has been shown that each auxiliary rectifier is short-circuited by a d.c. contactor during a period of a.c. supply failure. When the a.c. supply is restored to the rectifiers, the short-circuit current must be limited to the current rating of the auxiliary rectifier. If this were not so, when the d.c. contactor opened, the demand on the stand-by rectifier (acting in series) could be greater than its normal capacity. If the plant were supplying a full station load, the load and stand-by rectifiers would go into an overload condition.

It will be appreciated that, as the d.c. contactor opens at -51.5 volts, the auxiliary rectifier will be held on overload at a voltage determined by the difference between the load-

rectifier output voltage and the 25-cell battery potential. This will be, initially, zero, but will gradually rise to -5 volts as the battery becomes charged and its voltage rises to -56.5 volts. Hence, it is specified that the auxiliary rectifier current shall be limited to the full-load current rating from 5 volts down to zero volts.

When the auxiliary rectifier is adjusted to give an output of -15 volts for initial battery charging, its full output current must also be limited from -15 volts down to zero volts. This is because the open-circuit potential of a 25-cell battery is roughly the same as the output voltage of a load rectifier, i.e. -51.5 volts. The auxiliary-rectifier output voltage will always adjust to the difference between the battery voltage and the load-rectifier output voltage. This will be approximately zero when charging commences, and will rise to -15 volts as the battery becomes charged to -66.5 volts or 2.66 volts per cell.

A typical auxiliary-rectifier output characteristic is given in Fig. 20(b).

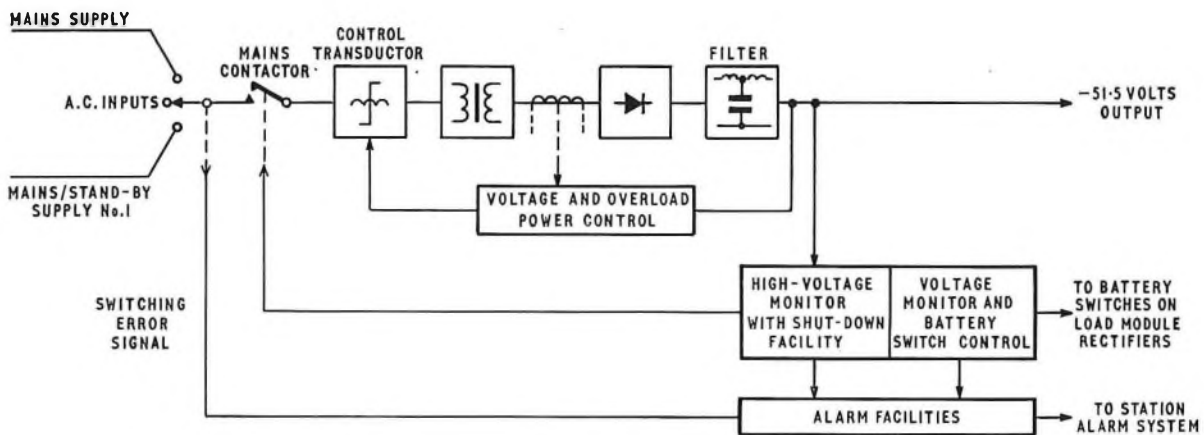
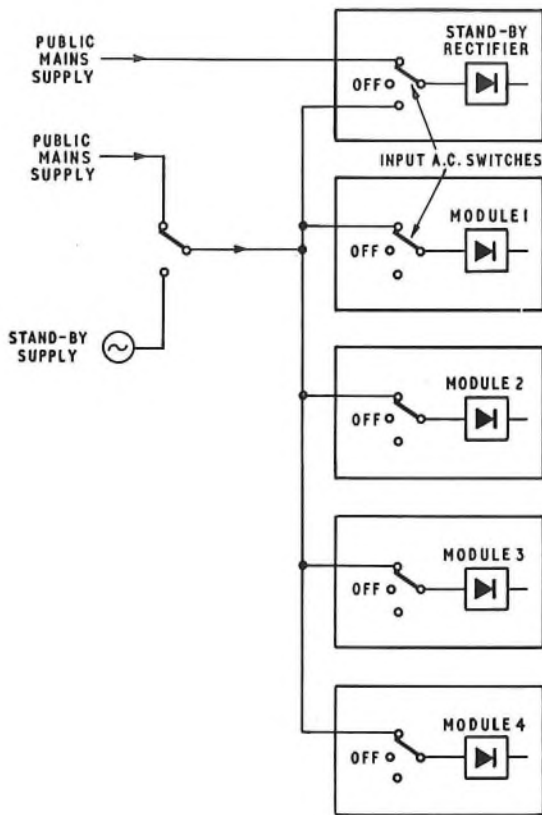
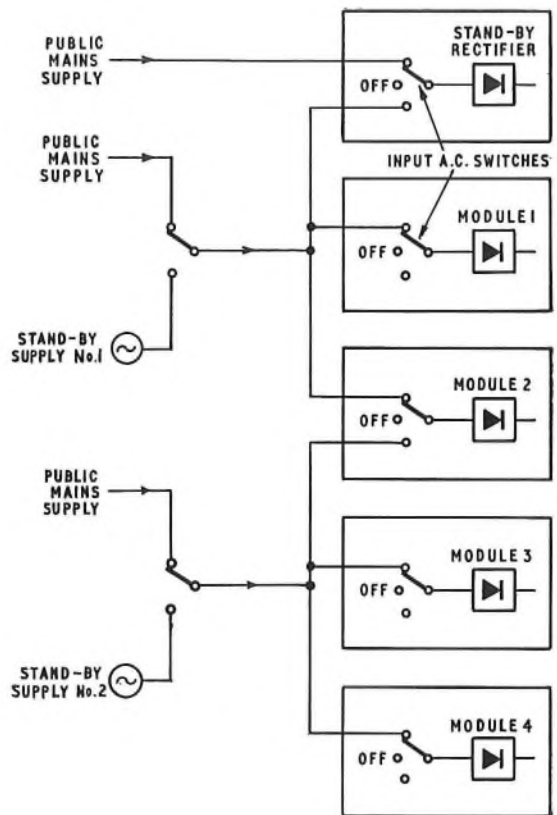

FIG. 18—Block diagram of stand-by rectifier



(a) One stand-by supply provided



(b) Two stand-by supplies provided

FIG. 19—Switching arrangements for a.c. stand-by supplies

The only time the d.c. contactor is required to close is when the load diode is carrying current to the station load. In this condition, the output of the auxiliary rectifier “sees” a voltage greater than 5 volts because of the increase in diode voltage-drop. Should the rectifier be energized, as would occur on an assisted-discharge condition, the auxiliary rectifier would be in a high-impedance condition. It follows that the surge current, when short-circuited by the d.c. contactor, will be limited to reasonable proportions until the control circuit acts to take up the new load condition.

VOLTAGE MONITOR

The voltage monitor used to operate and release the d.c. contactors is housed in the stand-by rectifier, since both equipments are common to any installation. The monitor is similar to the high-voltage monitor and is made up of solid-state components designed to give a very high degree of reliability. The monitor is a two-state device, giving a toggle action to a single relay output. Its thermal stability over a temperature range to -10°C to $+50^{\circ}\text{C}$ is within ± 0.1 volts. This applies to the operate and release levels of -46 and -51.8 volts. The thermal drift of the 5.8 volt differential is significantly better than ± 0.1 volts over the same temperature range.

To appreciate the reason for selecting the -46 and -51.8 voltage levels, the battery-switching sequence must be examined in some detail. After an a.c. failure, when the 23-cell batteries take the load, the lowest level to which the distribution voltage can be allowed to fall is -46 volts. Now, if the maximum load-diode volt-drop is specified at one volt and the difference between volt drops in the connections to the 23-cell and 25-cell batteries is, say, a maximum of 0.04 volt and the maximum end cell voltage is $2 \times 2.28 = 4.56$ volts, then the maximum additional voltage sensed at

the output when the d.c. contactor operates will be $1.0 + 0.04 + 4.56 = 5.6$ volts. That is to say, the output can rise from -46 volts to -51.6 volts. The d.c. contactors must not release at this level, or a hunting condition could exist causing the contactor to release and re-operate continually. The releasing voltage level must, therefore, be higher than -51.6 volts but not be higher than the plant upper voltage limit of -52 volts.

By setting the monitor at -51.8 volts, a thermal and adjustment error of up to 0.2 volt can be tolerated.

LOAD DIODE

In order to determine the current rating of the load diode, it is necessary to assess the maximum normal load it will be required to carry and the maximum current carried under fault conditions.

Take the normal condition first. When there is an a.c. failure, all 23-cell batteries will discharge through the load diodes to a common load. The degree of load-current sharing will be in proportion to the internal conductance of each battery supply and thus, each diode must be capable of carrying a current greater than an equal share.

For the second condition, the possibility of a diode becoming open-circuit must be allowed for. The worst effect of this will be when the installation consists of two modules, since one diode would then be required to carry twice its normal current for the period required to operate the d.c. contactors. In a two-module installation with 200-amp modules, the current required to supply a constant-power load at -46 volts would be $2 \times 226 = 452$ amps. But, at this rate of discharge, the 23-cell battery voltage would fall rapidly to operate the d.c. contactors in about two seconds. The thermal rating of a typical silicon diode is such that a diode continuously rated at 300 amps will comfortably carry

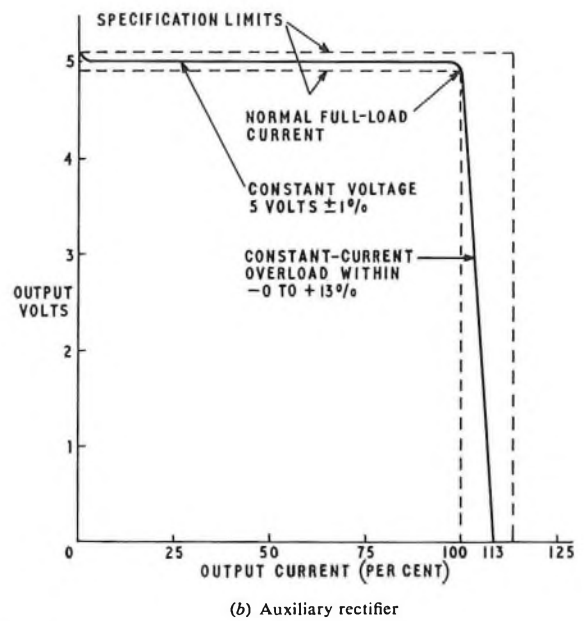
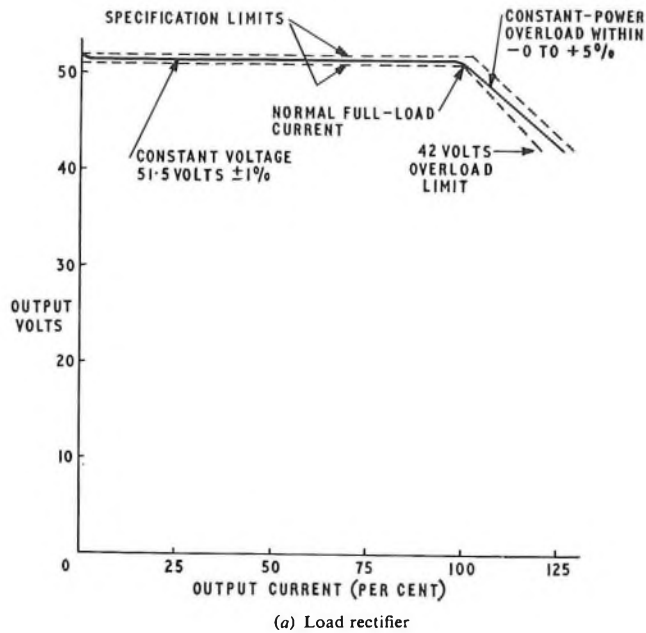

FIG. 20—Rectifier output characteristics

452 amps for this period of time. Also, no single battery will normally supply a load in excess of 300 amps where its specified average duty in a system of parallel batteries does not exceed 226 amps. By rating the load diodes at 150 per cent of the module current rating, the load can be carried until the d.c. contactors operate normally or for the period necessary to operate the contactors in the case of an open-circuit diode.

It is not usually practical to use one silicon diode element for the current required. A minimum of three elements in parallel are specified, with each parallel path fused. With three parallel paths, sufficient fuse discrimination is provided between the diode fuses and the battery fuse. If a battery fuse is not provided, e.g. on the larger sizes where fuses of adequate ratings are not available or are not practical, the diode fuses protect the two end cells from a possible short-circuit caused by a faulty diode via an operated d.c. contactor.

The maximum forward volt-drop under normal full-load conditions is specified as 1 volt. This limit is imposed by the operating level of the d.c. contactor voltage monitor and has already been mentioned in the section dealing with the voltage monitor. Silicon diode elements are specified, since this type of element has a negligible forward current at 0.5 volt and thus allows the 23-cell batteries to be maintained at half a volt higher than the load rectifier output voltage.

THE D.C. CONTACTOR

In normal service, the d.c. contactor is required to operate most infrequently. Also, when the contactor is required to operate, the closing potential across the main contacts does not exceed 5.6 volts. In order to achieve a high order of reliability, the contactor must comply with the following outline specification:

High Pressure Wipe-Action Load Contacts

The main contacts of the contactor must be capable of breaking through a contact potential barrier at only 5.6 volts. This barrier can be presented by dust, dirt or other airborne contaminants. A high-pressure contact can increase the chance of penetrating a barrier layer but, followed by a wipe action, the confidence of a successful *make* becomes very high.

Double-Break Bridging Load Contacts

Single-break contactors require a flexible braid to carry the load current. Such braids are normally terminated by a welded

joint or by nuts and bolts. With a double-break action, flexible braids are not required and the risk of faulty welds and loose nuts and bolts is eliminated.

Solenoid Operation with no Economy Coil

Contactors with economy coils require auxiliary contacts to insert the economy coil when the contactor is operated. If the auxiliary contacts fail in service, the main coil can become excessively hot and possibly burn out.

Coil Operating Voltage Range 47–57 Volts

The operating-coil voltage is supplied by the 25-cell load battery. For distribution voltages between -42 and -52 volts, the 25-cell battery voltage will range between -47 and -57 volts.

Make, Carry Continuously and Break 113 per cent of Rated Current

For a constant-power load, the current demand at -46 volts will be 13 per cent higher than at -52 volts. The demand on any battery of a multiple module installation may, initially, be higher than 113 per cent because of the differences which could exist between the internal conductances of the load batteries but, after a few minutes of discharge, paralleled batteries tend to share the load more evenly as the uneven discharges equalize the state of individual battery capacities.

Make and Carry for 200 ms, Six Times the Rated Current

Due to the inherent differences in the speed of operation, one contactor, on a multiple-module installation, will close slightly earlier than the others. The first contactor to close takes the full station load until the others operate to take their shares. The maximum number of modules will normally be four but it is intended that, exceptionally, the number can be increased to six. Each contactor must, therefore, be capable of switching six times its normal rated current for a period equal to the maximum difference in contactor operating times. This does not exceed 200 ms.

Make and Carry for 15 Minutes, 226 per cent of the Rated Current

Should one contactor on a multiple-module installation fail to operate, the contactors which do operate will be required to share the duty of the contactor which has failed.

The worst case will be on a two-module installation where the one operated contactor may be required to carry 226 per cent of the module rating. The 25-cell load battery associated with this contactor will discharge to -46 volts in about 15 minutes at this rate of discharge. (Normally, the a.c. supplies will have been restored by the stand-by generator long before this condition is reached.)

Physical design of contactor

The contactors developed for this plant have been rationalized to four sizes, i.e. 125, 300, 800 and 2,000 amps. The overall dimensions of the 2,000 amp contactor (which can carry 4,520 amp for 15 minutes) are 7.75 in long, 6.25 in wide and 7.375 in high. The operating-coil current of all sizes is less than 0.75 amperes. Each contactor is contained in a dust-proof cover and should require no maintenance whatever. When installed, it is impossible to operate the contactor manually. The design allows the contactor to be mounted on the cubicle ironwork or supported by its bus bars. The vibration and noise generated on operation and release is minimal. A photograph of the 300-amp contactor is reproduced in Fig. 21.

PLANT DEVELOPMENT

During the early investigations, it became obvious that some form of end-cell switching would be required. Fortunately, the existing power plant No. 227, used in very small unattended automatic exchanges, employs this principle and was readily available. The early proposals were tried, on a small scale, using suitably modified power plants No. 227. When sufficient confidence had been established in the modular principle as described, a full scale six-module prototype plant with 200-amp modules was built for detailed laboratory evaluation.

To date, no major difficulty has been found in the laboratory but a further test will come when field trials are carried out at suitable working exchanges. A 400-amp plant, using

two 200-amp modules, has just been installed at Chessington telephone exchange. By early 1972, a similar plant will be installed at Redhill group switching centre. Each plant will use battery and rectifier equipment from the laboratory prototype. Chessington is an existing Strowger local exchange. The load, therefore, varies throughout the day in response to traffic demand and the electrical noise fed back into the d.c. distribution is typical of any Strowger exchange.

At Redhill, in addition to the crossbar exchange equipment, the plant will supply transmission equipment designed to the -50 volt standard. From this installation, it will be possible to determine the practicability of supplying f.d.m. transmission equipment and electro-mechanical exchange equipment from a common power-plant incorporating end-cell switching.

CONCLUSIONS

It has been shown how the new modular plant design can satisfy those requirements specified in Part 1 of this article. The plant should meet the standards of reliability required, involve the minimum of capital and running costs, and produce significant savings in maintenance. The plant is simple in operation, is fully automatic, and flexible in provision and installation.

Part 1 of this article showed the need for a secure extendible power system requiring minimal maintenance. The designers task has been to develop a d.c. plant to fulfil these requirements.

The modular approach has produced the building blocks necessary for simple plant extension, and the same approach has provided the degree of rectifier redundancy necessary for high system reliability. Reliability has been further enhanced by the use of proven modern techniques of rectifier design, without common rectifier voltage and current control, and by simple design with the minimum number of components.

The result is a plant which can be used with confidence as the basis for modular power with its inherent service productivity and cost-advantages.

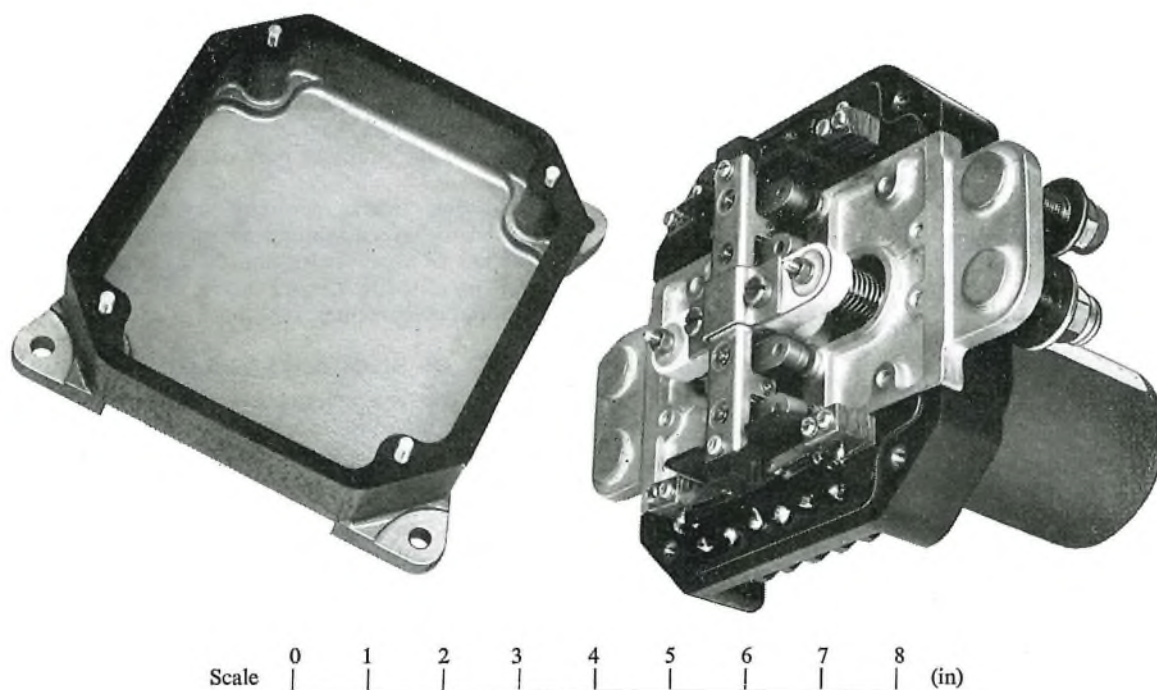

FIG. 21—300-amp d.c. contactor

Concorde over Goonhilly

P. S. J. DUFFY, C.ENG., M.I.E.E. and J. D. HATTON†

U.D.C. 536.011.5: 534.83: 621.396.677

The alarm generated by the proposed supersonic flights by Concorde, together with conflicting opinions about the likelihood of structural damage being caused, led to a study of the effects of sonic booms on satellite-communication earth-station aerials, followed by experiments to determine the validity of theoretical findings. Measurements of simulated and actual sonic booms were made. The results show that the aerial structures were well able to withstand the shock loads and that satellite-communication services were unaffected.

INTRODUCTION

Following the announcement of plans for Concorde to fly near to the satellite-communication earth-station at Goonhilly Downs, Cornwall, at supersonic speeds, an investigation was carried out into the probable effects of the pressure waves on the large steerable aerials to determine if any interruption or degradation of service was likely to be caused. In particular, the possibility was considered that pressure waves might be focused by the paraboloidal reflectors and cause excessive structural deflections, vibrations or damage. Theoretical studies were made by the British Post Office (B.P.O.) in conjunction with experts from the Royal Aircraft Establishment (R.A.E.), Farnborough, Husband & Co., the designers of the two Goonhilly aerials and the Marconi Co. Ltd., builders of the No. 2 aerial. These showed that there was little likelihood of trouble occurring. Nevertheless, it was decided that the theoretical studies ought to be confirmed by practical tests. At the suggestion of the R.A.E. it was agreed to simulate sonic booms by firing explosives near to an aerial. Test shock-wave pressures could then be created ranging from low values up to the maximum likely to be experienced from a sonic boom. The tests could be stopped at any stage if it was found that damage was being caused. Moreover, such tests would enable the probable effects of actual supersonic flights to be predicted. Subsequently, measurements were made of actual sonic booms from Concorde.

SHOCK WAVE GENERATION AND PROPAGATION

An aircraft flying at a subsonic speed generates pressure waves from its nose and stern. These pressure waves propagate outwards from the aircraft at the velocity of sound in a manner analogous to the spreading of ripples in water.

At supersonic speeds the aircraft travels faster than the pressure waves, which then accumulate at the nose and stern, forming strong waves of compression that travel with the aircraft and radiate from it. The pressure waves take the form of a solid cone with the aircraft at its apex. Thus, as the aircraft moves, it produces a circular corridor within which the pressure waves exert their influence. The maximum effects are experienced directly beneath the flight path, and these diminish with increase of distance away from the flight path. At long distances from the aircraft, the nose and stern pressure waves produce a waveform which has a nominal *N*-shape. It is this pressure wave which is heard as a sonic boom. The difference between the actual pressure and ambient atmospheric pressure at any instant is called the overpressure. The

actual shape of the pressure wave is determined by the shape, size, weight, speed and altitude of the aircraft together with the prevailing weather conditions in the lower atmosphere.

The four basic waveforms generally encountered are shown in Fig. 1. The *nominal N-wave* is the theoretical waveform, and the *pseudo-nominal* is similar to it except that there is a slight rounding of the waveform at the maximum and minimum levels. The *rounded* waveform has more pronounced rounding at the maximum and minimum levels and the maximum overpressure is less than that of the *nominal N-wave*. The *spiky* waveform has a fast initial transient rise to a maximum overpressure of 2–3 times that of the *nominal N-wave* followed by a fast fall to the normal value, then a slower rate of fall followed by a sharp fall to well below the normal minimum. On each waveform the main slopes can be projected to give the approximate value of the maximum overpressure on the equivalent *nominal N-wave*.

The magnitude of the energy in the shock wave, Fig. 2, is only significant at frequencies up to about 100 Hz. Maximum energy occurs at around 3 Hz. Between these frequencies the energy content of the shock wave decreases at a rate of 6 dB per octave. Structures having low resonant frequencies would not respond differently to the various waveforms, whereas structures having high resonant frequencies may respond to the transient peak overpressure of a *spiky* shock wave.

The sonic booms generated by Concorde flights were expected to have maximum overpressures of 1.5–2.5 lb/ft², rise times of about 10 ms and durations of 200–250 ms. On the advice of the R.A.E. the theoretical studies were based on maximum overpressures of 3 lb/ft².

EFFECT OF SHOCK WAVES ON STRUCTURES

Structures have components with natural frequencies of vibration within the frequency range of the sonic boom, but if a structure is in good condition it is unlikely to suffer damage. In a few instances minor damage such as breaking or cracking of windows and cracking of plaster has occurred. It is believed to have resulted from the sonic-boom excitation of structural components having abnormal stress concentrations owing to faulty design, construction or maintenance. More rarely, the damage has been serious but has often been shown to be caused by other sources of excitation acting in conjunction with the sonic boom. Exceptionally, the sonic boom has been shown to be the sole cause of damage to poor-quality structures.

It is possible to calculate the probable effects of a sonic boom on a structure if its size, mass, stiffness and damping are known. If the structure is complex, the calculations will also be complex and difficult. Excitation of the foundations

† Telecommunications Development Department, Telecommunications Headquarters.

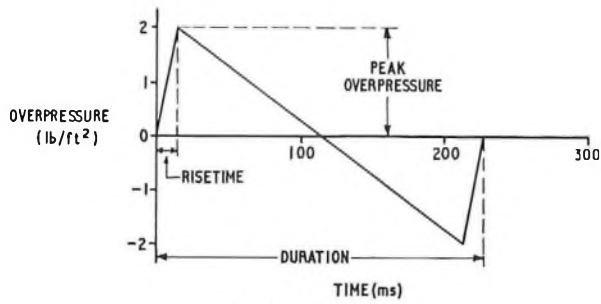

(a) Nominal N-wave

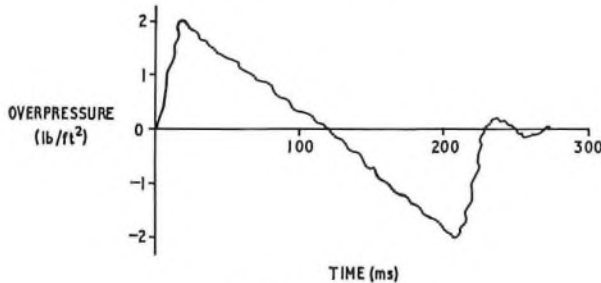

(b) Pseudo-nominal waveform

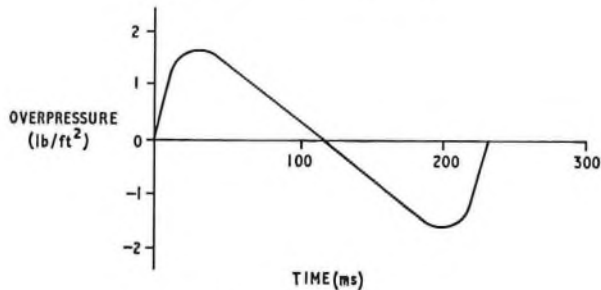

(c) Rounded waveform

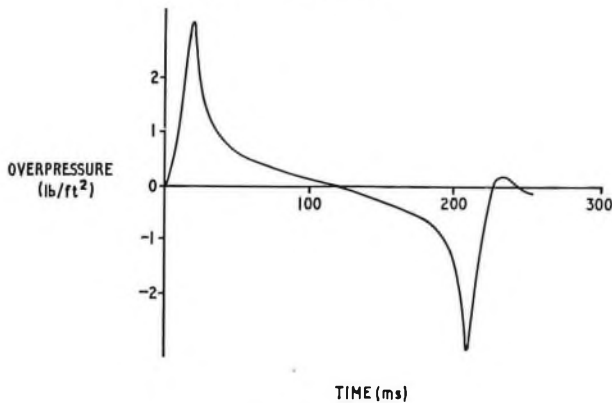

(d) Spiky waveform

FIG. 1—Basic overpressure waveforms

of a structure can be caused by the sonic boom through the production of seismic waves. A sonic boom produces a dynamic load that can produce structural deflection up to 2.5 times that which a static load of the same amount would produce. To cater for variations of the shock-wave waveform and the response of the various resonant-frequency components of the structure, the R.A.E. advised that for calculations the nominal maximum overpressure should be multiplied by a dynamic gain factor of 2.5. This would be equivalent to a maximum shock-wave overpressure of 7.5 lb/ft².

It was concluded that the short-duration loadings likely to be imposed on the aerial structures would be relatively insignificant, and that apart from a quartz waveguide window and a quartz vane polarizer in an aerial feed, the aerial and associated equipment were unlikely to be harmed by sonic

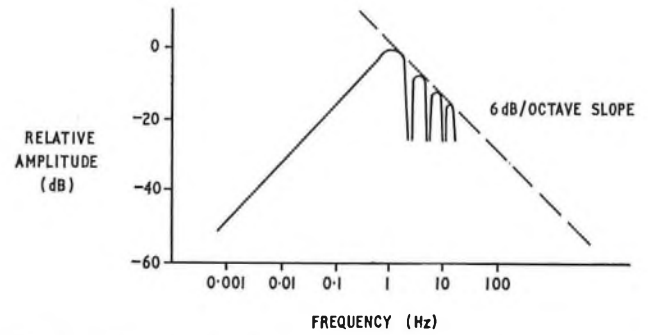

FIG. 2—Frequency distribution of energy for a typical Concorde sonic boom

booms. Subsequent tests carried out on the waveguide window and vane polarizer indicated that these items also were unlikely to be damaged. These conclusions were based on theory, supported to a limited extent by practical work carried out by the R.A.E. on different types of structures. The B.P.O. and their consultants accepted the suggestion of the R.A.E. that simulated sonic booms should be generated by the strictly-controlled firing of explosive charges at Goonhilly prior to the actual sonic booms. A program of tests was then drawn up.

Focusing of Sound Waves

By analogy with the transmission of electromagnetic waves where, if the wavelength of the signal is small compared to the reflector diameter, the gain is given by:

$$G = \left[\frac{\pi D f}{v} \right]^2,$$

where G is the gain,

D is the reflector diameter in feet,

f is the frequency in hertz, and

v is the velocity of propagation of the wave in feet/second.

Thus, for a given reflector, the pressure gain increases with frequency at a rate of 6 dB per octave. For a sonic-boom duration of 0.25 s, and a velocity of sound of 1,100 ft/s, the fundamental frequency is given by:

$$f = \frac{1}{0.25} \text{ Hz},$$

$$\begin{aligned} \text{and the corresponding wavelength} &= \frac{v}{f}, \\ &= 1,100 \times 0.25, \\ &= 275 \text{ ft.} \end{aligned}$$

This wavelength is large compared to the reflector diameter, and it is therefore unlikely that the pressure gain through focusing will be as large as that calculated. Also, the increase of pressure gain at 6 dB per octave will be offset by the reduction of energy at the same rate, and there will not be any apparent focusing effect.

Reflection of the incident pressure wave affects the overpressure. With a focal length of 30 ft it takes 0.055 s for the pressure wave to travel from the focus to the reflector and back to the focus. This is about one-fifth of the duration of the pressure wave and, consequently, the reflected pressure wave merges with the still incoming pressure wave and affects the pressure at the focus. In this time interval the incoming wave pressure is still greater than the ambient pressure and the reflected wave can add to it, thus raising the overpressure. The arrival of the reflected wave at the focus is too late to coincide with the peak overpressure, but it will arrive during the fall of overpressure period and produce another peak the value of which depends on the incident wave-shape.

Equivalent Wind Loading

Large steerable aerials are designed to withstand wind loadings which take into account the effects of wind gusts having frequency components at or near the frequencies of structural resonance. Hence, it is convenient to consider the shock wave in terms of the equivalent wind loadings. If the reflector is considered as a flat plate normal to the shock wave, then for each 1 lb/ft^2 of pressure loading, an 85 ft diameter reflector will experience a total shock load of 2.53 tons, while that for a 90 ft diameter reflector will be 2.84 tons.

The 90 ft diameter No. 2 aerial is designed to withstand wind gusts of 130 miles/h which give short-duration loads of about 120 tons. At Goonhilly, it is expected that wind gusts greater than 108 miles/h will only occur once in 50 years, and that gusts of 80 miles/h or more will occur for 0.01 per cent of each year, i.e. for 52 minutes. In fact, during the 10 years of its existence, the Goonhilly earth station has only once experienced wind gusts of about 80 miles/h. Hence, taking a wind of 80 miles/h as the upper practical limit, adding to its loading the sonic boom overpressure gives the effect of an 80 miles/h wind gusting to 87.2 miles/h, to produce a wind-load increase of 3 lb/ft^2 , and to 96.8 miles/h, to give a 7.5 lb/ft^2 increase. These wind-gust velocities are within the wind-loading design values of the structure for survival without damage. Moreover, a wind gust normally has a duration of about 3 s and, because the shock-wave duration is only about a twelfth of this, its effect will therefore be less.

SIMULATION OF SONIC BOOMS

There are two basic charge arrangements which can be used to simulate sonic booms. The first is called a *crackerjack* and consists of two spaced charges suspended from a horizontal wire. These charges are fired in sequence with a predetermined time delay between firings. A pressure wave of the form shown in Fig. 3 is produced, which although not

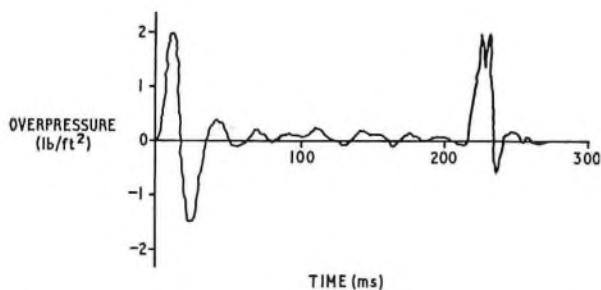

Fig. 3—Overpressure waveform generated by a *crackerjack* charge

an *N-wave*, simulates the major shock components. There is little or no energy at 3 Hz, most of it being at frequencies higher than 30 Hz, with a peak at 60 Hz. The second arrangement is called a *line charge*. This consists of bundles of charges arranged to form a 100–300 ft line which explodes progressively along its length such that an *N-wave* is produced within a solid cone centred on the longitudinal axis of the line. A shock wave of much larger amplitude is produced in the broadside direction and great care has to be taken in siting the charge. The energy in the shock wave is mostly at frequencies below 30 Hz, with a peak at about 5 Hz.

The R.A.E. have carried out many tests on a wide variety of structures and structural components using simulated shock waves. By the use of well-tried routine procedures they are able to ensure that tests are safely carried out. The initial simulated pressure waves are designed to have low overpressure values, e.g. 1 lb/ft^2 , and these are increased in stages until the structures show signs of stress or the maximum test overpressures are reached. For a particular charge arrangement the amount of charge is kept constant and is situated

progressively nearer the structure under test to produce higher pressures.

INSTRUMENTATION

It was decided that measurements should be made on the No. 1 aerial of the incident and focused pressure waves, structural vibrations at selected points on the aerial structure and associated equipment, and levels of signals passing through the aerial system.

Measurement of Pressure Waves

A special capacitor-type microphone was connected to a tuned circuit, the resonant frequency of which was influenced by the microphone capacitance. The tuned circuit, which had a nominal resonant frequency of 10 MHz, was connected to a 10 MHz crystal-controlled oscillator so that small changes in microphone capacitance, caused by sound pressure on the diaphragm, frequency modulated the oscillator output. The resultant signal was fed to a frequency-modulation detector and then to a preamplifier. The oscillator, frequency-modulation detector and preamplifier were contained in the microphone head which was connected by long cables to a unit which contained the power supplies, and an amplifier with an output peak-indicating meter. The output was also fed to an oscilloscope fitted with a camera.

A microphone was attached near the foot of the tripod leg and another near the focus to enable the incident and focused pressure waves to be measured. A third microphone was placed about 60 ft nearer the explosions or planned flight path to provide a signal to trigger the oscilloscope time-base. A few minutes before the explosive charge was fired, or sonic boom expected, the camera shutter was manually opened. After receipt of the sonic boom the oscilloscope graticule illumination was turned on for a few seconds and the camera shutter then closed. Each microphone system was set up and calibrated by the use of a *pistonphone* which is a precise sound source of $124 \pm 0.2 \text{ dB}$ (0.662 lb/in^2) relative to $0.0002 \mu \text{ bar}$.

Measurement of Mechanical Vibrations

Vibrations of the reflector rim and azimuth damper fin were measured with strain-gauge transducers and accelerometers.

The strain-gauge transducers consisted of cantilevers, with an effective length of 6 in, clamped to the reflector backing structure at strong points near the elevation bearings. Each cantilever had a strain-gauge bridge mounted on it. The free ends of the cantilevers were connected by tensioned steel wire to the reflector rim. Movement of the rim relative to the elevation bearing produced small changes in the bending of the cantilevers and thus changed the resistances of the strain gauges. The resultant variations in the output of the bridge were calibrated to show the extent of the cantilever deflections. The outputs of the strain-gauge transducers were fed to ultra-violet galvanometer recorders. Two of these systems were installed to enable the rim vibrations at the top and left-hand side of the reflector to be measured.

Three piezo-electric accelerometers were used. They were fixed to the bottom and right-hand side of the reflector backing structure, and to the azimuth damper fin. Their outputs were fed to double integrators which gave outputs proportional to the structure displacements. The integrator outputs were fed to a multibeam oscilloscope fitted with a camera.

During some of the explosive tests, vibration measurements were also made with a seismometer mounted on the aerial turntable.

Goonhilly No. 1 aerial is front fed, and vernier tracking of the satellite is provided by small azimuth and elevation tilting of the feed mechanism. Potentiometers fitted to the

azimuth and elevation gimbals and wired to displays on the control console in the main building indicate the respective displacements. Pen recorders were wired in parallel with these displays to record whether the explosion or sonic-boom tests caused movement of the feed mechanism.

In service, tracking of the satellite is facilitated by spinning the feed aperture, which is slightly offset from the main axis of the feed. This results in modulation of the received satellite beacon signal which is fed to the tracking receiver. This receiver gives outputs proportional to the azimuth and elevation offsets of the aerial axis from the direction of the satellite. Samples of these signals were fed via d.c. matching amplifiers to a tape recorder. Comparison of the beam offset and tracking error enabled movement of the feed due to satellite movement to be distinguished from movement caused by sonic-boom waves.

Measurement of Signal Levels

The composite received signal in the band 3,700–4,200 MHz is fed by waveguide from the aerial feed to a low-noise amplifier and then to a travelling-wave-tube amplifier. Individual carriers are then separated in a dividing network, converted to an intermediate frequency (i.f.) of 70 MHz, amplified and demodulated to baseband. During the tests, the 3,825 MHz carrier level was monitored by measurement of the automatic gain control voltage of the appropriate i.f. amplifier, together with the level of the satellite beacon at 3,934 MHz. An in-station pilot is injected into the aerial system by means of a horn feed fitted at the reflector vertex. The pilot thus follows the whole of the station receive path but is completely independent of the satellite. By comparison of the received signals and the pilot it was possible to determine if any variations of the received signals were due to changes in the aerial system or in the satellite and propagation path.

Measurements of out-of-band noise levels were obtained by filtering a 4 kHz slot of the baseband derived from the 607 kHz telephony carrier, and feeding this to noise-measuring equipment. This was connected to a teleprinter which gave a print-out of the number of noise bursts in each minute which exceeded -40 dBm0, and the total duration of these noise bursts.

SIMULATED SONIC-BOOM TESTS

Tests using *line* and *crackerjack* charges were carried out on the No. 1 aerial. Both types of charge were detonated in turn at distances of 600, 400 and 245 ft in front of the aerial to produce calculated pressures of 1, 2 and 6 lb/ft², respectively, at the aerial. Measurements were provisionally analysed after each explosion to determine if it was safe to proceed to the next higher pressure. Some tests were duplicated to demonstrate the repeatability of results.

Examples of the overpressure waveforms produced by the simulated sonic booms are shown in Fig. 4. The upper traces represent the overpressures at the aerial focus and the lower traces those at the foot of the tripod leg. On the upper traces the first peak on the left-hand side is the incident wave and the second is the reflected wave plus the incident wave. The average ratio of the second peak to the first is 1.02. Thus, after allowing for the low-level incident wave, there is no evidence of focusing of the pressure wave by the reflector. The pressure microphone near the foot of the tripod leg was 5 ft from the reflector surface. Consequently the recorded pressure wave has incident and reflected components.

Examination of the recordings of accelerometer and strain-gauge outputs show that all the vibration levels are very small. The maximum reflector displacement was 0.007 in in a direction normal to the reflector surface. Such displacements will not produce any significant variation in aerial gain. The frequencies of vibration are between 10 and 70 Hz with the main response at 25 Hz. These are well above the natural

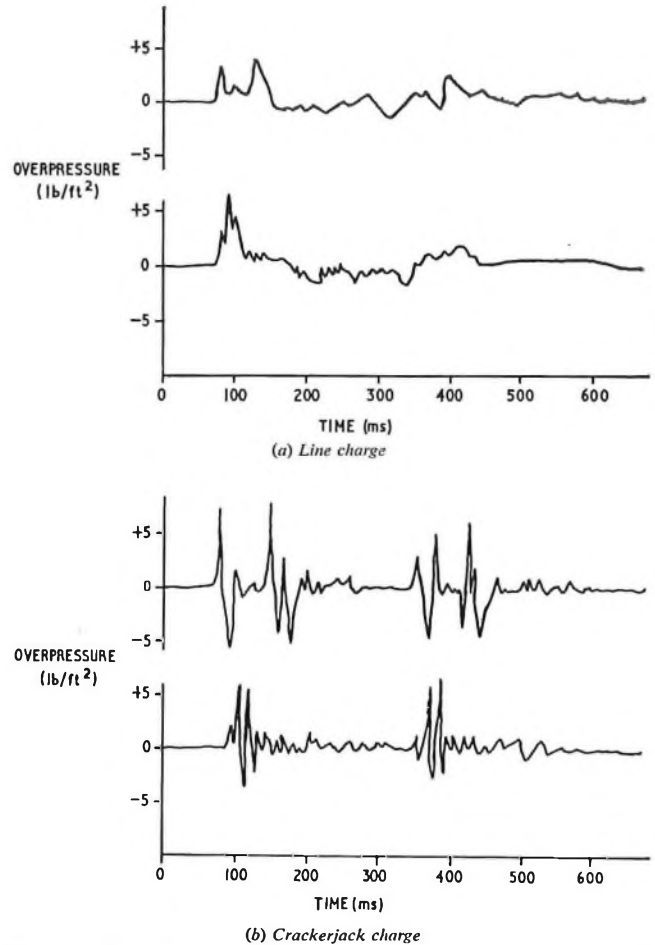

FIG. 4—Overpressure waveforms produced by simulated sonic booms

frequencies of vibration of the structure and are not likely to cause structural resonance.

The recordings of received carrier levels and feed displacement show no disturbances of the telecommunication or aerial tracking systems during the tests.

The results of the simulated sonic boom tests were analysed, and although it was realized that further information could be gained, and that the pressure waveforms produced were not fully representative of sonic booms, the tests indicated that an actual sonic boom was unlikely to affect the Goonhilly aeriels and telecommunication services.

Some measurements were also made whilst explosive charges were detonated in a nearby quarry, but no firm conclusions could be reached about the equivalence of quarry blasts and sonic booms.

MEASUREMENTS DURING CONCORDE SUPERSONIC FLIGHTS

For measurements during Concorde supersonic flights the accelerometers and strain-gauge transducers were removed because it was believed that there would be no significant structural vibrations caused by the sonic booms.

The flights were expected to take a North-South path a few miles to the East of Goonhilly, the direction which the No. 1 aerial faced. However, due to changes in the flight plans, the first five supersonic flights passed 5–13 miles to the West of Goonhilly with Concorde flying at heights between 44,000 and 47,000 ft, and at speeds between Mach 1.42 and Mach 1.7. This resulted in the sonic-boom pressure-wave being incident on the rear of the reflector.

Recordings made of four of the sonic-boom overpressure waveforms have maximum overpressures of 0.7, 0.6, 0.9

and 0.9 lb/ft^2 . A sample waveform is shown in Fig. 5. The upper trace represents the overpressure at the aerial focus and the lower trace that at the foot of the tripod leg. The ratios of reflected wave plus incident wave to the first incident peak at the focus are 0.63 , 1.6 , 0.65 and 1.1 , with an average of 1.0 , and the time interval between the first two peaks is about 60 ms . It is interesting to note that the recording taken near the foot of the tripod leg shows two peaks spaced by about 40 ms , whereas the period for a sound wave to travel from the pressure microphone to the reflector and back again is about 10 ms . This indicates that the second peak may have been caused by a pressure wave reflected from the ground.

The results obtained do not provide conclusive evidence of focusing, and though the beamwidth of the aerial at acoustic frequencies is so large that the aerial would not have to point directly toward the flight path to show any focusing effects, more definite conclusions could have been drawn if the aerial had pointed directly toward the flight path.

No effects were recorded on the monitored signal levels.

CONCLUSIONS

The tests have confirmed the results of the theoretical studies, and have not produced any evidence that pressure waves from supersonic Concorde flights are focused by the large paraboloidal aerial reflectors, or that they cause harmful structural resonances and deflections. None of the valuable international telecommunication services were affected, and it seems likely that they will be unaffected by flights directly over Goonhilly.

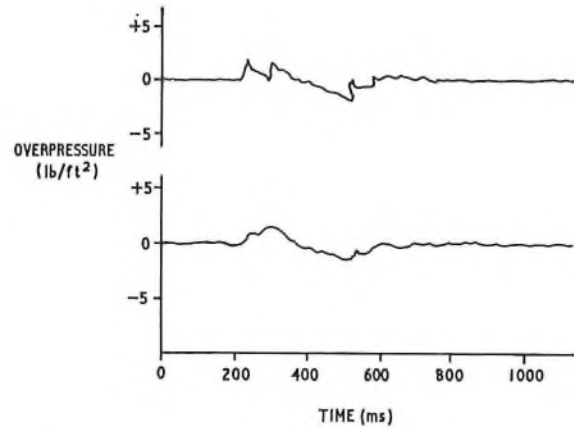

FIG. 5—Overpressure waveforms produced by Concorde

ACKNOWLEDGEMENTS

The advice, assistance and loan of equipment by The Royal Aircraft Establishment, the participation of Husband and Co., consultants to the Post Office and Marconi Communication Systems Ltd and the assistance given by colleagues in the Post Office is gratefully acknowledged.

References

¹ TAYLOR, F. J. D. Equipment and Testing facilities at the Experimental Satellite Ground Station, Goonhilly Downs, Cornwall. *P.O.E.E.J.*, Vol. 55, p. 105, July 1962.

Micro-Architecture or Chemical Tailoring

M. M. FAKTOR, B.SC., PH.D., and R. HECKINGBOTTOM, M.A., D.PHIL.†

U.D.C. 539.2: 539.194: 620.1

Information about the properties of a material can often be obtained from models of its atomic and molecular shapes, sizes and symmetry. In the same way, materials for specific purposes can be designed at the molecular level. This article gives an outline of how this is done with particular reference to materials of interest to the British Post Office.

INTRODUCTION

The effect on materials of heat, and electric and magnetic fields can be described using well-known classical theories. Parameters such as resistivity or dielectric constant, which describe the material and can be measured experimentally, are obtained in this way. These theories, however, tell us nothing about the microscopic "building blocks," i.e. atoms and molecules, and would apply even if matter was a continuum.

The laws of thermodynamics illustrate well the strengths and limitations of the classical approach. Thus, ice melts at 0°C and water boils at 100°C, at 1 atmosphere pressure, yet no amount of information of this kind will explain why these particular temperatures are appropriate. Furthermore, classical thermodynamics tells us that all metals (except some of the noble ones) ought really to exist as oxides—which disposes of metallurgy as a long-term subject! Again, all organic matter, i.e. plastics, sugars and living organisms, should be oxidized to carbon dioxide and water. The, albeit transitory, existence of the readers and writers of this article is due to the process being slowed down by kinetic barriers. The actual rates of such changes and the half-lives of chemical reactions can be measured, under closely-controlled conditions, and meaningful results can be obtained, usually from statistical averages of the measurements, but here, again, nothing is said about the mechanisms which are operating on a molecular or atomic scale.

Data about the properties of materials can be obtained by measurement. If enough data is available, there is no problem in selecting materials for specific purposes, to yield new or improved products. This approach suffers from the crippling weakness that sufficient data is simply not available. The estimated number of chemical compounds prepared to date is $\sim 10^9$ and this does not exhaust the imagination of the preparative chemist (or, perhaps better, the imagination of nature). If we require some ten basic parameters for each compound, this entails 10^{10} empirical investigations. Perhaps less than 10^6 have been carried out. Clearly, this is a laborious and inefficient way of finding new materials for particular purposes. A better way would be to determine how to synthesize a material with the required properties.

The driving force behind the effort for synthesizing new compounds can take one of two forms. Firstly, one may make shots in the dark hoping to hit something interesting—an approach sometimes described, not altogether unfairly, as "stamp collecting." Secondly, one can try to predict the properties of materials, whether previously synthesized or not, from existing theories. This second approach is well known to chemists and it forms the basis of the present article.

HISTORY

At the beginning of the nineteenth century, the atomic theory of matter was beginning to be recognized. In addition, there arose the concept of elements—substances that can neither be changed from one to the other, nor subdivided into simpler substances. Measurement of the properties of elements invited classification of the elements into groups and the earliest attempts at classification aimed only at orderliness. In the next stage of development, at about the middle of the nineteenth century, two scientists, Lothar Meyer and Mendeléeff, noted independently that if the elements were arranged in order of increasing atomic weight, a marked periodicity in chemical and physical properties became apparent. From this work, Mendeléeff constructed his famous periodic table (Table 1). As can be seen, by comparison with Table 2, this early table is remarkably like today's version.

Mendeléeff's greatness lay not in his ability to construct the table—his attempt was not unique, only the best—but in the way he recognized and applied the predictive potential of the observed periodicities. Thus, he was able to identify errors in both measured atomic weights and chemical properties and, moreover, to make accurate estimates of the correct values. Perhaps even more remarkable was his prediction, not only of the existence of undiscovered elements, but also of their properties and those of their compounds. One of his examples, eka-silicon (later called germanium), is illustrated in Table 3.

The extension of these ideas has provided the main backbone to the study of chemistry and the synthesis of transuranic* elements from 1945 onwards, has tended to confirm the properties predicted for them, as opposed to providing a radically new field for chemists. With the advent of wave mechanics, Mendeléeff's ideas have been given a sound theoretical basis.

TYPES OF MATERIAL

The atom is the primary building-block from which all matter is composed. For present purposes, an atom may be considered as a positive core surrounded by inner (non-bonding) electrons and outer (valence) electrons, the net charge on the atom being zero. The interaction of the valence electrons, between like and unlike atoms, leads to the formation of either discrete molecules or extended structures. Throughout, the electron orbitals adopt only a limited number of shapes and sizes per atom, with only minor perturbations. These perturbations are the subject of detailed chemistry and will not be entered into here.

One aspect to be considered in more detail is that of the bonding between atoms. The treatment will have to remain

† Research Department, Telecommunications Headquarters.

* See Appendix for an explanation of this and other specialist terms.

TABLE 1
Mendeléeff's Periodic Table, 1872

Group	I	II	III	IV	V	VI	VII	VIII
	H = 1 Li = 7 Na = 23 K = 39 (Cu = 63) Rb = 85 (Ag = 108) Cs = 133 (Au = 199)	Be = 9.4 Mg = 24 Ca = 40 Zn = 65 Sr = 87 Cd = 112 Ba = 137 Hg = 200	B = 11 Al = 27.5 ? = 44 ? = 68 ?Yt = 88 In = 113 ?Di = 138 ?Er = 178 Tl = 204	C = 12 Si = 28 Ti = 48 ? = 72 Zr = 90 Sn = 118 Ce = 140 La = 180 Pb = 207 Th = 231	N = 14 P = 31 V = 51 As = 75 Nb = 94 Sb = 122 Ta = 182 Bi = 208	O = 16 S = 32 Cr = 52 Se = 78 Mo = 96 Te = 125 W = 184 U = 240	F = 19 Cl = 35.5 Mn = 55 Br = 80 ? = 100 I = 127	Fe = 56 Co = 59 Ni = 59 Cu = 63 Ru = 104 Rh = 104 Pd = 106 Ag = 108 Os = 195 Ir = 197 Pt = 198 Au = 199

Numbers denote atomic weights.
Question marks denote then undiscovered elements.

TABLE 2
Present-Day Periodic Table in Order of Atomic Number

Group	Ia	IIa	IIIa	IVa	Va	VIa	VIIa	VIII			Ib	IIb	IIIb	IVb	Vb	VIb	VIIb	0
	1 H																1 H	2 He
	3 Li	4 Be										5 B	6 C	7 N	8 O	9 F	10 Ne	
	11 Na	12 Mg										13 Al	14 Si	15 P	16 S	17 Cl	18 Ar	
	19 K	20 Ca	21 Sc	22 Ti	23 V	24 Cr	25 Mn	26 Fe	27 Co	28 Ni	29 Cu	30 Zn	31 Ga	32 Ge	33 As	34 Se	35 Br	36 Kr
	37 Rb	38 Sr	39 Y	40 Zr	41 Nb	42 Mo	43 Tc	44 Ru	45 Rh	46 Pd	47 Ag	48 Ag	49 In	50 Sn	51 Sb	52 Te	53 I	54 Xe
	55 Cs	56 Ba	57* La	72 Hf	73 Ta	74 W	75 Re	76 Os	77 Ir	78 Pt	79 Au	80 Hg	81 Tl	82 Pb	83 Bi	84 Po	85 At	86 Rn
	87 Fr	88 Ra	89** Ac	** Actinide Series 5f			90 Th	91 Pa	92 U	93 Np	94 Pu	95 Am	96 Cm	97 Bk	98 Cf			
	* Lanthanide Series 4f			58 Ce	59 Pr	60 Nd	61 Pm	62 Sm	63 Eu	64 Gd	65 Tb	66 Dy	67 Ho	68 Er	69 Tm	70 Yb	71 Lu	

TABLE 3
Comparison between Predicted and Observed Values for Germanium

Predicted for Eka-silicon (Es) (1871)	Property	Found for Germanium (Ge) (1886)
72 5.5 13 c.c. Dirty grey 0.073 White EsO ₂ Slight EsO ₂ with Na K ₂ EsF ₆ with Na Refractory, sp. gr. 4.7, mol. vol. 22 c.c. B.p. 100°C, sp. gr. 1.9, mol. vol. 113 c.c. B.p. 160°C, sp. gr. 0.96	Atomic weight Specific gravity Atomic volume Colour Specific heat Effect of heating in air Action of acids Method of preparation " " Dioxide Tetrachloride Tetraethyl derivative	72.32 5.47 (20°C) 13.22 c.c. Greyish white 0.076 White GeO ₂ None by HCl GeO ₂ with C K ₂ GeF ₆ with Na Refractory, sp. gr. 4.703, mol. vol. 22.16 c.c. B.p. 86°C, sp. gr. 1.887, mol. vol. 113.35 c.c. B.p. 160°C, sp. gr. < 1.00

general but it is hoped that it will be sufficient to provide a framework within which individual examples can be discussed. Bonds between atoms can be conveniently divided into four main categories:

- ionic bonds,
- covalent bonds,
- inter-molecular bonds, and
- metallic bonds.

In many materials there is more than one kind of bond: there is one kind of bond between atoms in a group and a different kind of bond between groups. These groups of atoms are called molecules and it is often most convenient to consider these as the basic building blocks in a material. In order to convey the main characteristics of the different bonds, materials in which one type of bond predominates will be considered first.

Ionic Materials

Ionic materials always contain at least two kinds of atom. Electron transfer occurs, from atoms of one type to those of the other, to form charged ions, e.g. $\text{Na}^+ + \text{Cl}^-$ in sodium chloride (common salt), see Fig. 1. The ions are held together

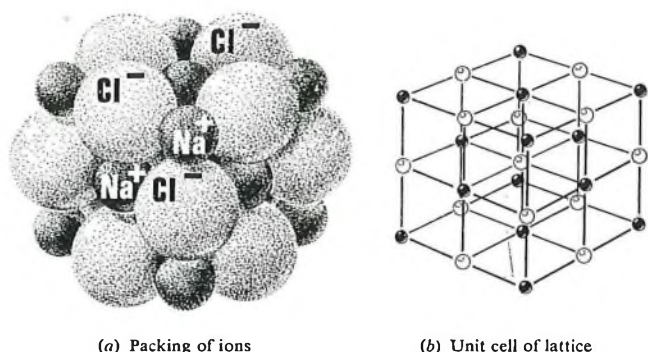

FIG. 1—Ionic structure of sodium chloride

by electrostatic attraction and are prevented from coalescing by short-range repulsive forces. The situation may be summarized mathematically by the relationship

$$U(r) = N \left(\frac{-e^2 A}{r} + \frac{B}{r^n} \right),$$

where U is the lattice energy for an assembly of N ion pairs, e is the electronic charge, r is the closest interionic distance and A , B and n are constants; singly-charged ions are assumed. As n is usually large (8 to 10), the ions approximate closely to hard spheres of radii r^+ and r^- where $r^+ + r^- = r$. These ionic radii are approximately constant, for a given ion, from compound to compound. It is, thus, extremely useful to have a table of the radii of the more commonly-occurring ions (Table 4). Initially, these radii were obtained by measuring r , using x-ray diffraction, and deducing the values of the component radii r^+ and r^- from a variety of other experimental data.

Ionic material consists of these charged spheres, packed as efficiently as possible. Obviously, an ion of one charge would like to be in contact with as many ions of the opposite charge as possible. Depending on the relative sizes (radius ratio) of the two types of ion, there are distinct limits to the number of larger ions that can be in contact with a smaller ion. The situation is illustrated in Fig. 2. As the lower limit on radius ratio, for a given co-ordination number*, is reached, the ions of like charge come into contact with one another instead of with the smaller ion.

From a knowledge of ionic radii, one can, thus, predict the structures of ionic materials. Furthermore, the model described above allows two main guide-lines to be drawn when considering the properties of ionic materials. Firstly, other properties as well as size can be described in ionic

TABLE 4
The radii of the building blocks frequently adopted by common elements

Element	Van der Waals (intermolecular)	Covalent (atomic)	Metallic	Ionic
H	1.2	0.37	—	(1+) vanishingly small (1-) 2.08
Li	—	1.22	1.51	(1+) 0.70
Cs	—	2.35	2.62	(1+) 1.70
Ba	—	1.98	2.17	(2+) 1.38
C	—	0.77	—	(4+) 0.20 (4-) 2.60
Si	—	1.17	—	(4+) 0.40 (4-) 1.98
N	1.5	0.74	—	(3+) 0.16 (5+) 0.15 (3-) 1.71
P	1.9	1.10	—	(3+) 0.44 (5+) 0.35 (3-) 2.12
O	1.4	0.74	—	(6+) 0.09 (2-) 1.40
S	1.85	1.04	—	(4+) 0.37 (6+) 0.30 (2-) 1.84
F	1.35	0.72	—	(7+) 0.07 (1-) 1.33
Cl	1.8	0.99	—	(7+) 0.26 (5+) 0.34 (1-) 1.81
Ne	1.59	—	—	—
Xe	2.2	—	—	—

Radii in Ångströms (1 Ångström = 10^{-10} metre)

Radius ratio span	Co-ordination number	Shape of unit	
		(Diagrammatic)	(Realistic size)
0.155-0.255	3	 triangular	
0.255-0.414	4	 tetrahedral	
0.414-0.732	3	 octahedral	
0.732-1.00	8	 cubic	
1.00	12	densest packed (metallic)	

FIG. 2—Variation in the packing of ions with their radius ratio

terms, e.g. polarizabilities (leading to refractive indices). Secondly, for a given interatomic separation, the more nearly equal the two types of ion are in size, the greater the packing efficiency, with comparable trends in several important properties, e.g. for ions of the same charge it leads to higher melting points.

With the identification of the ion as the correct building block, the prediction of many properties becomes possible. With the electrons localized on the ion cores, ionic compounds are insulators when solid. In the melt or in solution, where the ions can move, they show ionic conductivity. As expected from the electrostatic attraction between the ions, these compounds are soluble in solvents (such as water) with a high dielectric constant.

Atomic Materials

Atomic materials, like ionic materials, form extended lattices, but that is almost the only similarity between them. As best typified by certain elements, e.g. silicon and germanium, the valence electrons are shared between adjacent atoms, not transferred from one to the other. A second notable feature is that even in homopolar* lattices where the radius ratio of adjacent atoms is unity, the co-ordination number is low, e.g. four in silicon, see Fig. 3. Clearly, the lattice cannot be regarded as geometrically-packed spheres and chemists have long realized that directional bonds must be involved. This feature distinguishes atomic materials from metals as well as from ionic materials. In terms of modern atomic theory, the directional bonds result from the overlap of shaped electron orbitals on the atoms. The bond lengths can, again, usefully be regarded as the sums of atomic radii (see Table 4), the latter being obtained from homopolar bonds. Occasionally, bond lengths are observed which differ significantly from those suggested by Table 4, carbon providing some of the best-known examples. This reflects the fact that there is sometimes more than one arrangement of overlapping orbitals of comparable stability, resulting in multiple bonds as well as the normal single bonds.

Atomic materials form insulating solids and liquids. This follows from the fact that the electrons are localized in the directional bonds in the solid, and on melting, the solid breaks down into neutral atoms. Following from the existence of the coherent extended network of bonds, however, a limited amount of electronic conduction can sometimes occur; these materials are known as semiconductors. This extended overlap also leads to a highly polarizable lattice with a correspondingly high refractive index.

As with ionic materials, several properties of atomic materials can be predicted from the underlying model. Thus the extended lattice of strong bonds leads to high or very high melting points. The directional nature of the bonds leads to poor space filling and, thus, low-density materials, e.g. germanium is less than two-thirds as dense as metals of similar atomic number like copper and cobalt. Also, following the poor space filling, many of these lattices contain open cages or channels, a feature which can be exploited as will be described later.

Molecular Materials

Strictly speaking, molecular bonding appears only as the bonding in elemental solids such as solid argon. As implied by the title of the section, however, the most well-known examples are provided by the residual attraction between small molecular units containing either atomic or partially-ionic bonds. Typical examples are provided by oxygen (O_2), carbon dioxide (CO_2) and octane (C_8H_{18}). This bonding is weak when compared with the other three classes under consideration. It is due to what have long been termed Van der Waals forces, now known to originate in correlated oscillations of the electron clouds about the nuclear framework.

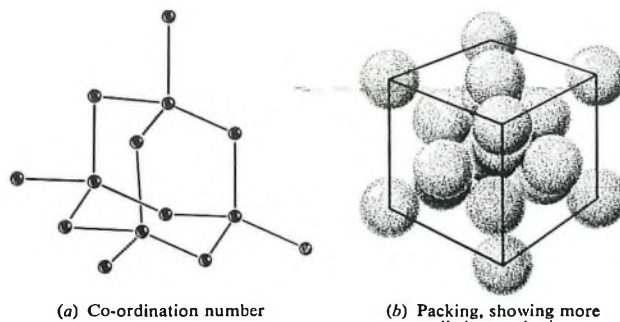

FIG. 3—Atomic lattice of diamond, silicon and germanium

The properties of molecular materials are mostly clearly seen where the molecular units are small. Then, the materials are soft and compressible, of low refractive index, low melting point and high vapour pressure. They are also electrical insulators. The packing is a function of the shape of the molecules but is, generally, of low efficiency leading to materials of low density. A second factor leading to low density is that Van der Waals radii are long when compared with the other radii previously mentioned. (See Table 4 and Fig. 4.)

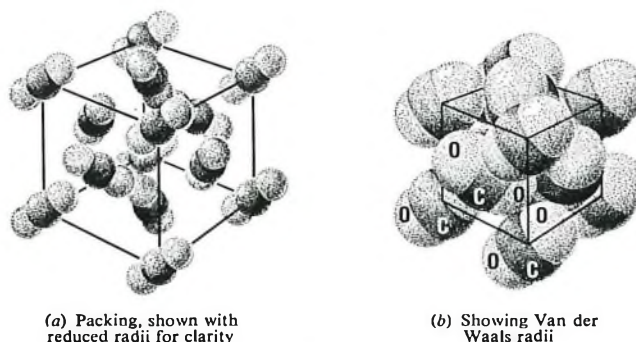

FIG. 4—Solid carbon dioxide

Although more complex, some of the most interesting materials owe their properties to a more intimate combination of ionic, atomic and molecular bonds. Thus, in a simple polymer, the atomic bonds form long linear chains. Such polymers are strengthened and their melting points raised if cross-linking can be introduced, i.e. if one can find a way of forming atomic bonds between chains as well as within chains. Graphite provides a good example where the atomic bonds form extended two-dimensional structures (layers) which are then joined by inter-molecular bonds (see Fig. 5). Such layer

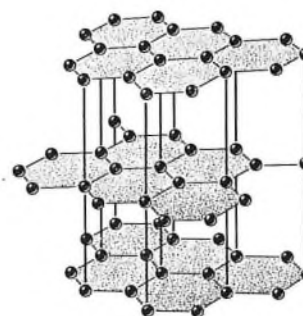

FIG. 5—Lattice of graphite showing atomic bonding within shaded planes and Van der Waals distances between planes

structures show a marked anisotropy* in properties, which can often be put to good use.

Metals and Alloys

Very little will be said here about metals and alloys and the comments will be limited to placing the metallic bond in the context of the other bonds described. Metallic bonds show the greatest resemblance to atomic bonds. The main difference is that so many sets of electron orbitals overlap that directionality is lost. The spheres representing the inner electron orbitals are, accordingly, closely packed. The valence electrons occupy extended orbitals whose characteristics are determined by the periodic potential presented by the atomic cores. The strength of the metallic bond is, thus, comparable with that of the atomic bond. With a few notable exceptions, the melting points are high or very high. The existence of extended electron orbitals, both occupied and unoccupied, with similar energy, leads to very high electrical conductivity and a dielectric constant so high that in simple models it is regarded as being infinite.

RECAPITULATION

The intention of the foregoing section was to establish a framework of thinking about matter and physical processes in molecular and atomic terms. To recapitulate what has been covered so far: atoms and molecules have shapes and sizes; these shapes and sizes are functions of bonding; in the same material diverse bonding is possible. Much of this information was obtained from the following sources:

- x-ray and other related techniques,
- Mendelevian ideas of periodicity,
- modern quantum mechanics,
- semi-classical theoretical and empirical approaches.

It is these last approaches that will now be examined a little more closely. If molecular and atomic properties like size and shape can be established from macro-properties* of materials, then, using the principles outlined in (a) to (c) above, the process can be put into reverse and materials designed with the required macro-properties.

APPLICATIONS OF CHEMICAL TAILORING

The interrelationship of macro-properties is an important aspect of physics and it would be both lengthy and inappropriate to enter into a general discussion of these interrelationships here. It is useful, however, to note that certain properties of materials can be derived precisely from knowledge of other related properties. For example, dielectric constant is closely related to refractive index. The dielectric constant is a measure of the response of a medium to the application of an electric field while the refractive index is a measure of the interaction of the medium with electro-magnetic radiation.

As a first example we shall consider the refractive index of a material.

Refractive Index

In the absence of an applied electric field, the centres of gravity of positive and negative charges in an atom coincide, as shown in Fig. 6(a). In Fig. 6(b), a field is applied and the centres of gravity of positive and negative charge no longer coincide. If the elementary charge has magnitude e and the charge separation distance is d , a dipole ed is formed.

To a first approximation, but more about this later, it can be written that the displacement p , is proportional to the applied field f .

$p = \alpha f$ where α is a proportionality constant, and is termed the polarizability. α can be related to the refractive index (n) and density (ρ) of a material by the following expression:

$$\alpha = \frac{3}{4\pi N} \frac{n^2 - 1}{n^2 + 2} \frac{M}{\rho}$$

where N is Avogadro's number (the number of molecules in a gram mole* of material) and M is the molecular weight

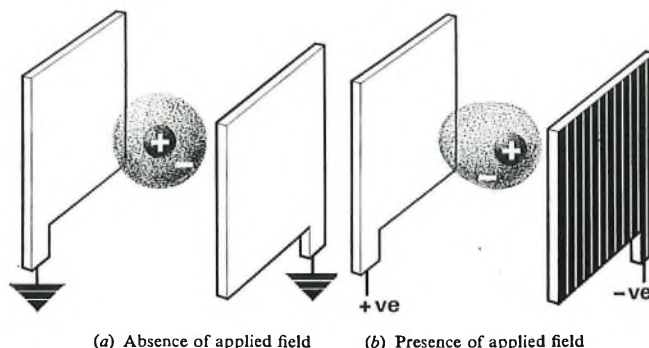

FIG. 6—Diagrammatic representation of an atom in a dielectric

of the material (the ratio of the weight of a molecule of the material to the weight of an atom of hydrogen).

The dimensions of polarizability α are those of volume. The value of α can be derived both empirically and theoretically, and there is good agreement between the two, which yields the size of the building blocks. Thus, it can be seen that the refractive index of a material is an indirect measure of the size of the building blocks. The refractive index is a pseudo-scalar* quantity in isotropic crystals, liquids and gases. In general, however, it is a vector quantity in anisotropic* materials and a useful tool when studying anisotropy.

If, on the other hand, materials of high birefringence* are required for some optical function, the aim should be to prepare layer lattices like naphthalene (a flat organic molecule) or cadmium iodide (CdI_2) (where non-directional ionic bonding is just broken with). Or chain lattices might be investigated, where there will be one very high refractive index along the direction of atomic or ionic bonding. Crystalline selenium and many organic materials are of this type. Giant molecules like diamond or the various forms of silica will show largish refractive indices but little birefringence. Also, almost-spherical organic molecules will show little birefringence.

This line of thinking is helpful if what is required is, say, a material of high birefringence combined with isotropic hardness. This particular combination is unattainable, but other combinations of physical properties, which are less interdependent, are more readily achieved.

Finally, in this section, to return to a statement made earlier, the electrical displacement is proportional to the applied field. This is an electrical analogue of Hooke's law in elasticity, and like Hooke's law, it will have a limited range of application. For large applied fields, α and n cease to be independent of the field and n can then be represented by the expression

$$n_E = n_0 + aE + bE^2 + cE^3 \dots$$

where n_E is the refractive index at applied field E , n_0 is the refractive index at zero applied field and a, b, c are coefficients; all quantities are direction-dependent. In general terms, increasing powers of E represent corrections of decreasing importance, with one notable exception. For the large class of centro-symmetric* crystals, all the terms involving odd powers of E become zero (contributions from different parts of the unit cell cancel). For these crystals, the dominant correction term involves E^2 but the effect remains small compared with the cancelling components of the terms in E . This is called the Kerr effect or, sometimes, the quadratic electro-optic effect. Thus, large changes in refractive index with changes in applied field can only be expected in non-centro-symmetric crystals. The change then shows, to a first approximation, a linear dependence on field and is called the Pockels effect. The Pockels effect can be used for fast optical switches and to modulate or deflect light beams; devices based on these capabilities will have a place in optical communications.

A family of new materials showing the Pockels effect have

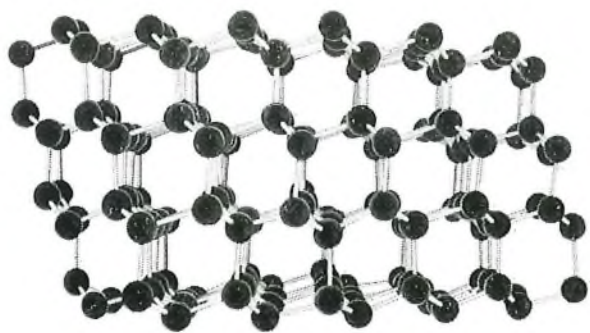

(a) Viewed along the major channelling direction

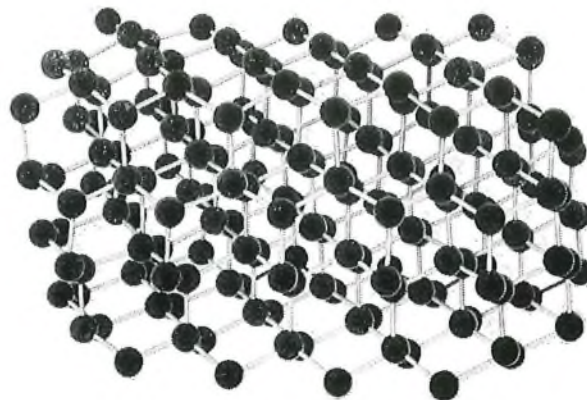

(b) Viewed along a random direction

FIG. 7—Model of the diamond-type lattice

been selected, on the basis of the above ideas, for investigation by Research Department at Dollis Hill. It has already been shown that they have important advantages over the conventional choice of materials in terms of ease and cheapness of manufacture and markedly-reduced power consumption.

Semiconductor Materials

The approach outlined in this article is proving useful in the application of a new development in semiconductor technology. Semiconductor devices, such as diodes and transistors, require modification of the basic material (e.g. germanium or silicon) in specified regions (e.g. base, emitter or collector) by the addition of small amounts of foreign ions to confer the property that electrical conduction is mainly by electrons (*n*-type) or by holes (*p*-type).¹ Ion implantation provides a new way of introducing dopant ions into semiconductor lattices.

Basically, a beam of dopant ions is given sufficient energy (typically, 100 keV)[†] to penetrate some way (typically, a few tenths of a micron) into the semiconductor. Penetration is accompanied by lattice damage, but, with annealing at temperatures significantly below those required for diffusion, many implanted ions move on to normal lattice sites and become electrically active.

One of the potential advantages of the technique over the conventional methods of doping is the added control it gives over the shape and concentration profile of the implanted region. Just what might be possible depends on the fact that silicon and gallium arsenide are typical atomic materials. In particular, they have an open structure. The open regions are arranged in channels along well-defined crystallographic directions. Incident ions of a given energy penetrate much further into the lattice if the beam is aligned along a major channel axis than if it is in a random, non-channelling direction. That this should be so is not surprising as Fig. 7(a) and 7(b) well illustrate.

There is a further refinement to be considered where the control of the range of implanted ions is concerned. At the typical energies referred to above, ions in a non-channelling direction lose energy, and hence come to a stop, by close (nuclear) collisions with host atoms resulting in physical displacement of the atoms. The effectiveness of ions in this process is proportional to their mass, hence for a given energy, the range of heavy ions is less than that of light ions. When the ion beam is in a channelling direction, the situation changes significantly. Direct nuclear collisions account for only a small fraction of the energy loss; the main energy loss mechanism is by electronic stopping, i.e. it is due to energy exchange between the outer orbitals on the ion and the lattice atoms. The range of channelled ions is, thus, primarily

determined by the size, not the mass, of the ions. As will be recalled, the size and shape of outer electron orbitals shows a periodic variation with increasing atomic mass. Thus, in order to use channelled ions to produce a controlled doping profile, a knowledge of this periodicity is needed.

In many semiconductor devices, an abrupt boundary to a region of given doping is required. In early experiments, only implants in non-channelling directions produced such abrupt boundaries and, in consequence, channelled implants have not been considered seriously as a useful option. It now appears that large ions, showing strong electronic stopping, do form an implanted region with an abrupt boundary, thus, in this instance, channelling may also lead to profiles useful for device purposes. The possibility is now being studied by Research Department as implanting in a channelling direction always has two distinct advantages over non-channelling; for a given energy, channelled ions may penetrate up to ten times as far as non-channelled ions, and for a given ion dose, channelled ions create much less damage.

Chemical considerations may also prove to be the most useful guide in optimizing the choice of dopant, now that ion implantation has been added to the methods of introducing dopants. This is a topic with a wide range of possibilities so it will merely be illustrated with a single example. Zinc is a popular choice for doping gallium arsenide and was chosen on elementary chemical grounds in the first place. It is particularly attractive for diffusion because, although its electrical activity is due to occupation of normal lattice sites, it can diffuse rapidly at usefully-low temperatures via interstitial* sites. At the same time, this tendency to occupy interstitial sites presents a possible degradation mechanism during subsequent device operation. Cadmium satisfies the same basic chemical criterion as zinc as a dopant in gallium arsenide and its ions are slightly larger. It should, therefore, be less likely to occupy interstitial sites and should reduce any tendency for device degradation by this mechanism. If ion implantation is used to introduce the dopant, the low-temperature diffusion mechanism is no longer required and, thus, implanted cadmium may prove a better choice than diffused zinc in some circumstances. This possibility is also being studied by Research Department at Dollis Hill along with a much wider range of potential dopants.

CONCLUSION

A very elementary account of material selection for particular applications has been given, on the basis of existing chemical theories of the solid state. The treatment is capable of greater erudition which was avoided out of respect for the non-specialist reader. It is hoped that, even at the elementary level adopted, the usefulness of the approach is self-evident.

[†] keV—kilo-electron volts.

References

¹ Henderson, J. C., and Wilson, Sylvia J. Transistor technology, *P.O.E.E.J.*, Vol. 56, p. 239, Jan. 1964.

Bibliography

1. MOELLER, T. Inorganic Chemistry (Chapman and Hall, London, 1954).
2. ZHDANOV, G. S. Crystal Physics (Oliver and Boyd, Edinburgh and London, 1965).
3. NARAY-SZABO, I. Inorganic Crystal Chemistry (Akademiai Kiado, Budapest, 1969).
4. VON HIPPEL, A. R. Molecular Science and Molecular Engineering (John Wiley and Sons, Inc., London, 1959).
5. MAYER, Y. W., ERIKSSON, L., and DAVIES, Y. A. Ion Implantation in Semiconductors (Academic Press, New York and London, 1970).
6. BUNN, C. W. Chemical Crystallography (The Clarendon Press, Oxford, 1945).

APPENDIX

Glossary of specialist terms

Birefringence—In an anisotropic crystal, the refractive index is direction-dependent. The birefringence is defined as the difference between the extreme values of the refractive index.

Centro-symmetric—crystals possessing a centre of symmetry. Any feature in such a structure has its inverse at the corresponding distance through the centre of symmetry.

Co-ordination number—the number of nearest neighbours around an atom in a crystal lattice.

Gram mole—the molecular weight in grams.

Homopolar—applied to a lattice or a bond. Literally, the atoms in the lattice, or forming the bond, have the same polarity. For this to be exactly so the atoms have to be identical, i.e. of the same element. Bonds between atoms of different elements are termed heteropolar.

Interstitial-substitutional—When a foreign atom is introduced into a crystal lattice, it can either replace a normal atom on a normal site or it may occupy what is normally an interatomic space in the lattice. The former gives rise to a substitutional dopant atom and the latter to an interstitial one. Clearly, there are several types of interstitial sites in some lattices but, in practice, only one or two types are large enough to accommodate a foreign atom.

Isotropic-anisotropic—In an isotropic material, the value of a property is not direction-dependent; in an anisotropic material, properties are direction dependent.

Macroscopic—macroscopic properties are those relating to amounts of a substance which are large compared with atomic dimensions (10^{-10} metres) or even microscopic dimensions (10^{-6} – 10^{-4} metres).

Scalar-vector—If a property is a scalar, it is characterized only by its magnitude. If it is a vector, it is characterized by direction as well as magnitude.

Transuranic elements—elements with an atomic number (the number of positive charges on the nucleus of the atom) higher than that of uranium.

Book Reviews

“Jahrbuch des Elektrischen Fernmeldewesens 1971 (Telecommunications Yearbook.)” Prof. Dr. Ing. Hans Pausch. Verlag für Wissenschaft und Leben. DM 66.40.

As in previous editions, the yearbook is devoted mainly to one or two themes. This year a full description is given of the EWSO1 system—a program-controlled local-exchange switching system with remote-control capability and which uses a new type of sealed-reed relay. Mention is also made of a companion system now being developed for the trunk service—the EWSF1. A shorter section of the book is concerned with EDS—an electronic data-switching system giving enhanced facilities for the super telex network. This again is program-controlled, but uses time-division multiplexing for the main interconnexions and sealed-reed relays for the concentration stages. A final article describes the international operations of the telecommunications industry and includes some commercial summaries of the largest firms.

The book is useful not only for its descriptions of the particular exchange types but also for the general way in which it explains how such new systems could be introduced into existing networks, could be used to evolve the capability of the whole system, could be programmed to give the many new facilities required, and finally could be maintained. The diagrams are clear enough to be understood without too much translation, although unfortunately the illustrations of the existing network refer mainly to the EMD system (motor-driven selectors).

H. B.

“The Post.” Alan James. B. T. Batsford Ltd., 94pp. 63 ill. £1.00.

“The Post” is one of a uniform series of volumes, published by Batsford & Co., each of which is designed ostensibly to provide secondary school readers with a broad survey of the

historical development of some particular aspect of British social and economic history.

Mr. James's subject is the development of postal communication from the first attempts in the late Middle Ages to institute national services by various monarchs, solely for their own use, to the elaborate institution that today, with 400,000 employees, handles 40 million letters daily, provides a wide variety of additional communication facilities for the community at large, runs a banking business and acts as distributing agent for pensions and licences.

Before Sir Rowland Hill's celebrated reforms in 1840, postal services suffered from numerous defects, principally high charges. These were based upon the distances letters were carried and the number of sheets per letter, and had to be paid for by the recipients, if they could afford to do so (many could not). By offering a cheap, uniform pre-paid postage, Sir Rowland effected a social revolution and laid the foundations of a successful State business.

Mr. James has written an informative and entertaining introduction to a complex subject, which should do much to encourage his intended readers, and many others, to pursue more detailed studies, with the aid of the books thoughtfully listed for further reading, at the end of each chapter. The book should also prove particularly interesting to new members of the Post Office Staff.

One would have appreciated a greater degree of clarity in some of the numerous illustrations, particularly where these are likely to be of interest to philatelists. The names on the map of Thomas Withering's mail routes (Fig. 6) are also difficult to decipher with the unaided eye.

It should perhaps be pointed out that the Post Office took over the inland telegraph services in 1870, not 1868 as stated, although the Bill enabling it to do so was laid before Parliament in the latter year. Another important Post Office service that possibly deserves a mention in 1971 is the provision of a wide range of data-transmission facilities.

D. A. J.

International Automatic Transit Switching at Faraday International Telephone Services Centre

R. L. WILLIAMS and R. RIMMER†

U.D.C. 621.395.346

With the continuing growth of international telephone traffic, and the increasing automation of both national and international networks, it has become necessary to provide automatic international transit switching and accounting facilities at Faraday International Telephone Services Centre. This article describes how the equipment providing these facilities was integrated with the existing international complex, and briefly outlines the progress of typical transit calls.

INTRODUCTION

The facilities provided by the London Faraday international telephone services centre (i.t.s.c.) have grown in refinement and complexity since the introduction of semi-automatic operation of certain international circuits in 1959.¹ The final phase in development of the centre was reached in December 1969 with the introduction of facilities for automatically switching international transit calls, i.e. the through connexion of calls originating and terminating outside the United Kingdom. At that stage, the Faraday i.t.s.c. achieved Centre-du-Transit I (c.t.i.) status in the international telephone network and provided facilities for connecting both originating and terminal international traffic as well as new international transit facilities. The use of the automatic transit switching facility gives an overall higher circuit utilization and permits the use of alternative or overflow routings giving increased security in the case of route failure. An additional advantage is that the facilities afforded by the transit centre can attract additional usage, and thus revenue, which may not normally be received.

The new equipment provides for the use of circuits utilizing one or other of the two major international signalling systems at present in use (Signalling Systems C.C.I.T.T.* No. 4¹ and C.C.I.T.T. No. 5^{2,3}). Interconnexion between circuits using any combination of these signalling systems is possible, conversion of signals from one system to the other taking place where necessary.

In establishing the design requirements for the new equipment, it was also necessary to take into account changes to the C.C.I.T.T. No. 4 Signalling System brought about by the introduction of a full world numbering plan,⁴ the fact that some countries would need more than one gateway exchange, and the introduction of the C.C.I.T.T. No. 5 Signalling System.

Within the international telephone service, it is necessary for the revenue derived from a call to be apportioned between the various administrations involved in the connexion, and facilities for collecting the relevant information have been included in the new design. For accounting purposes it is necessary to record, for each valid combination of incoming international route, outgoing international route and ultimate destination, the cumulative total chargeable-time in respect of all effective transit calls. Since the volume of traffic envisaged is low and the immediate availability of accounting informa-

tion is not required, a punched paper-tape system was developed.

To provide the new facilities, six new circuits were required together with major modifications to four existing circuits in the Faraday i.t.s.c. Prototypes of the new and modified equipments were successfully laboratory tested during 1967 and a limited service commenced in December 1969.

BASIC TRUNKING ARRANGEMENTS

The basic trunking arrangements for the incoming routes are shown in Fig. 1 and Fig. 2. These unusual trunking arrangements were used for the following reasons:

(a) The need to limit modification of working equipment at Faraday i.t.s.c. meant that access to both the required outgoing route, and to the accounting equipment, had to be given within the existing design of line relay-sets which already incorporated transit access arrangements (transit hunters). These hunters are 25-point uniselectors on the incoming routes using the C.C.I.T.T. No. 4 Signalling System and 50-point motor uniselectors on the incoming routes using the C.C.I.T.T. No. 5 Signalling System.

(b) The switching system existing at Faraday i.t.s.c.⁵ is a register-marker-controlled link system in which each link consists of two 100-outlet motor uniselectors. The system has a maximum capacity of 1,500 incoming and 1,500 outgoing circuits, and there are, therefore, 15 discrete incoming and 15 discrete outgoing link circuit sections.

(c) There was a need to provide transit accounting facilities.

Trunking for Routes Using the C.C.I.T.T. No. 4 Signalling System

This trunking (Fig. 1) can be divided into two main sections, that required for the purposes of call switching and routing and that required for call accounting.

An incoming call is switched via the transit hunter, the transit register-access relay-set hunter, the transit register-access relay-set and the international link-circuit to the required outgoing-line relay-set under control of the transit register, translator and the marker. Call accounting information is connected via the accounting-equipment access relay-set, which is held for the duration of the call, and the accounting common-control equipment, which consists of the accounting-equipment register and the tape-punch unit with its two associated tape punches. The accounting equipment is connected in such a way that progress of the call is unimpeded by any accounting considerations.

† Telecommunications Development Department, Telecommunications Headquarters.

* C.C.I.T.T.—International Telegraph and Telephone Consultative Committee.

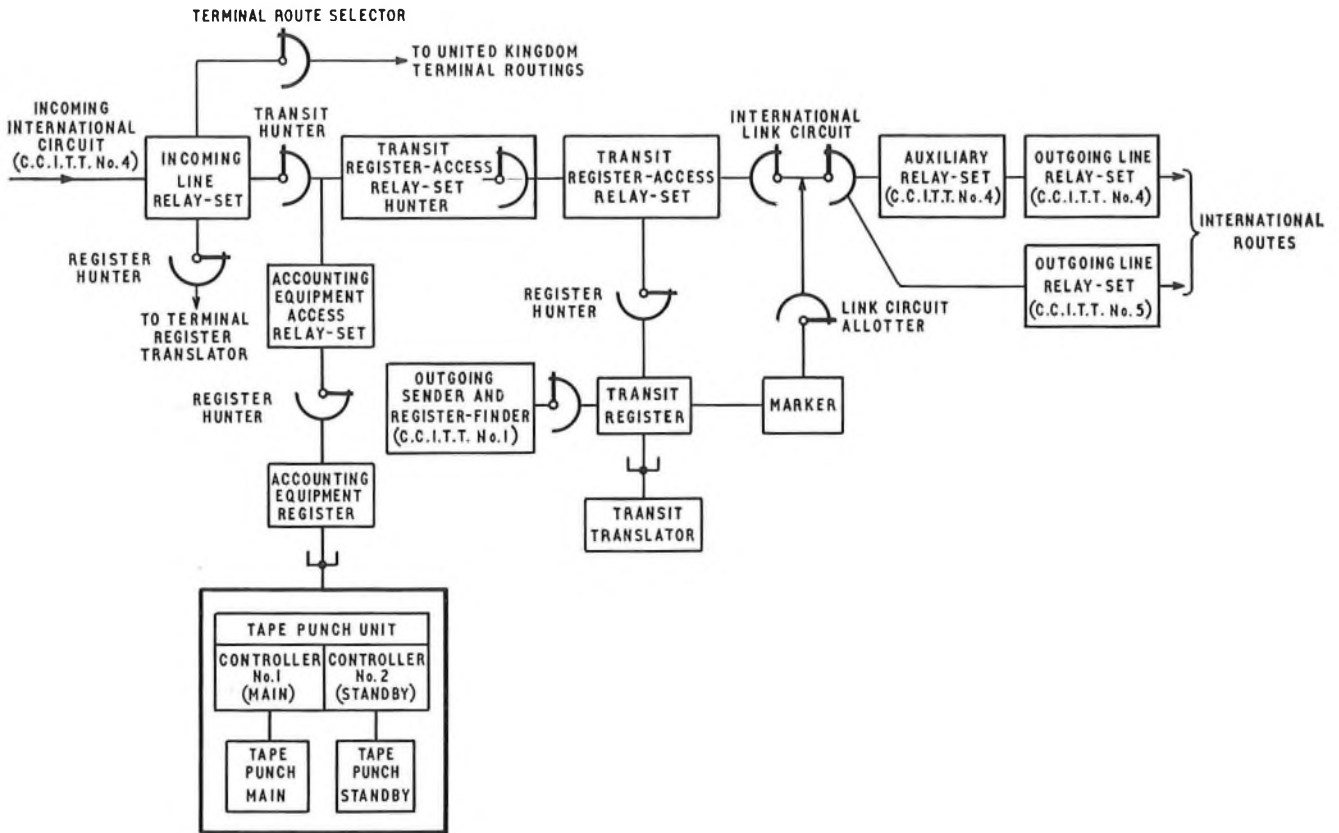

FIG. 1—Basic trunking for incoming routes using the C.C.I.T.T. No. 4 Signalling System

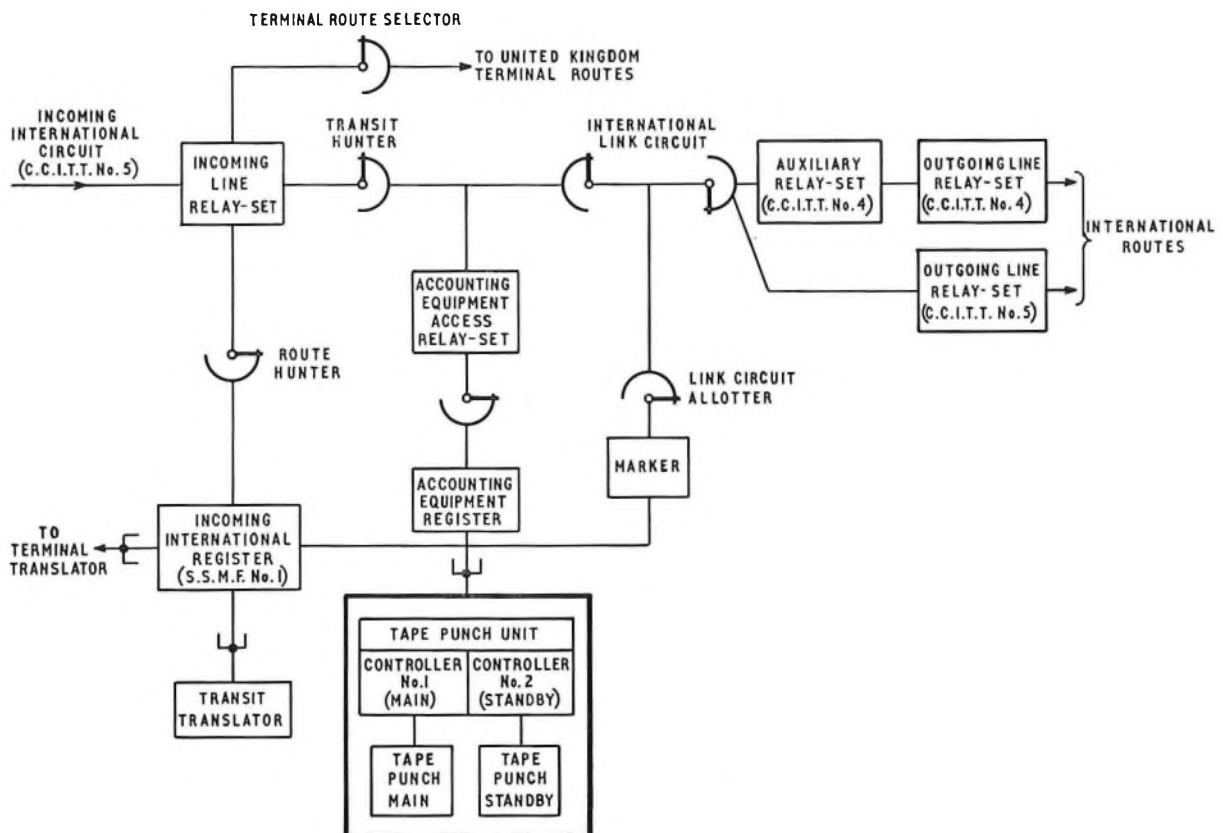

FIG. 2—Basic trunking for incoming routes using the C.C.I.T.T. No. 5 Signalling System

Trunking for Routes Using the C.C.I.T.T. No. 5 Signalling System

The trunking for incoming routes using the C.C.I.T.T. No. 5 Signalling System (Fig. 2) differs slightly from the trunking for incoming routes using the C.C.I.T.T. No. 4 Signalling System. This is dictated by the designs of the incoming C.C.I.T.T. No. 5 line relay-set and incoming international register, which already has transit switching and routing capabilities.

The trunking can be divided in a manner similar to that already described for incoming routes using the C.C.I.T.T. No. 4 Signalling System. The incoming call is switched to the required outgoing relay-set via the transit hunter and the international link-circuit, under control of the incoming international register, translator and the marker.

Call accounting information is collected in a manner similar to that described for Fig. 1.

PROGRESS OF AN INCOMING TRANSIT CALL USING THE C.C.I.T.T. No. 4 SIGNALLING SYSTEM

This signalling system utilizes two acknowledgement signals x and y . Changes have been made to the meanings of the two acknowledgement signals x and y . Previously the acknowledgement signal x was sent from a terminal centre in response to each digit received, and the acknowledgement signal y was sent from a transit centre in response to each digit received.

To enable the signalling system C.C.I.T.T. No. 4 to interwork with the signalling system C.C.I.T.T. No. 5 it was agreed that the following meanings would be given to the x and y acknowledgement signals.

The acknowledgement signal x is now used to indicate:

(a) after a terminal *proceed-to-send* signal has been received by the outgoing register: digit received, send next digit,

(b) after a terminal *proceed-to-send* signal but, before a terminal *proceed-to-send* signal has been received by the outgoing register: digit received, stop sending digits and prepare to receive a further *proceed-to-send* signal (either terminal or transit).

The acknowledgement signal y has one meaning only, after a transit *proceed-to-send* signal has been received by the outgoing register: digit received, send next digit.

Call Description

Following recognition of an incoming seizure signal, the incoming line relay-set seizes, via its transit hunter, a transit register and an accounting equipment access relay-set. (See Fig. 1.)

The transit register initiates the sending of the transit *proceed-to-send* signal, and the first digit is received in response to this signal. The incoming digits, which are stored in 2-out-of-6 code, are received on a send and acknowledge basis, y acknowledgement signals being returned to the distant international switching centre (i.s.c.) until the country-code digits are received. The country-code digits are examined within the register to determine the number of digits in the country code and thus, the position of the language digit. The register also determines the expected outgoing routing (C.C.I.T.T. No. 4 or C.C.I.T.T. No. 5 route) i.e. the primary route.

Calls on which the Primary Outgoing Route uses the C.C.I.T.T. No. 4 Signalling System

If the primary route is determined as an outgoing route using the C.C.I.T.T. No. 4 Signalling System, the register withholds the acknowledgement signal to the last digit received, and sends a signal to seize a free transit translator. The register forwards to the translator the country-code digits and a routing demand.

After examination of the received information, the trans-

lator provides the following routing information to the register:

- (a) the marking information for the outgoing route (two discrete signals),
- (b) the type of seizure signal to be sent (terminal or transit),
- (c) the choice of route (one of five),
- (d) the charging zone (one of five),
- (e) the signalling system used on the outgoing route,
- (f) number length information (this is not required on outgoing routes using the C.C.I.T.T. No. 4 Signalling System).

If the translator confirms that the outgoing route uses the C.C.I.T.T. No. 4 Signalling System, the register signals the release of the translator, sends an x acknowledgement signal to the distant i.s.c. and proceeds to establish a connexion between the transit register-access relay-set and a free outgoing C.C.I.T.T. No. 4 Signalling System line relay-set on the selected route, via the international link-circuit. When this connexion is established, the register forwards a signal to the outgoing C.C.I.T.T. No. 4 Signalling System line relay-set causing it to send the indicated seizure signal. The transmission path is switched through at this stage to permit end-to-end signalling.

An auxiliary C.C.I.T.T. No. 4 Signalling System relay-set is used to convert the phantom signalling system used via the link, to the separate wire system used in the outgoing C.C.I.T.T. No. 4 Signalling System relay-set. Following its seizure, the accounting-equipment access relay-set associates a transit accounting-equipment register and forwards to it a SEIZE EVENT indication and its three-digit identification code for the particular call (see below for transit-accounting arrangements). The register stores this information, disconnects itself from the access relay-set and signals seizure of a tape-punch controller. The information stored in the register is then sequentially transferred to the tape-punch controller, where it is converted into seven-digit computer code and fed to the tape punch. Each digit is transferred on a send-and-acknowledge basis, and following transfer of the stored information, the tape-punch controller causes three time marks, derived by its inbuilt clock from the six-second pulse supply, to be punched onto the paper tape. These record in tens of minutes, minutes and tenths of minutes past the hour, the time that the event information was punched. Finally, an end-of-information signal (block end) is punched. When this is acknowledged, all accounting common equipment is released.

The route destination information is derived within the transit register-translator equipment. When this is available, a signal is given to the accounting-equipment access relay-set which seizes an accounting register, passing to it the three-digit call-identification code and a *route-destination* signal. Subsequently, the route-destination information (four digits at 14 pulses per second) is transferred to the accounting-equipment register. The route-destination information comprises the first two digits of the country code, the charging zone signal and the choice of route.

If the country code concerned is of three digits, the third digit replaces the charging-zone information. For a country with a single-digit code, the digit one is sent as the second digit.

If congestion conditions have been encountered, the digit "8" is sent as the choice-of-route signal. When storage is complete, the information is punched onto the paper tape in a manner similar to that described above. No time marks are, however, provided in this instance.

The transit register releases after sending the accounting information, subject to the recognition that a *proceed-to-send* signal has been sent from the distant i.s.c. in response to the outgoing seizure signal. If the translator does not confirm that the call is to be routed via an outgoing circuit using the C.C.I.T.T. No. 4 Signalling System, the translator information stores are reset, and the register continues sending y acknowledgement signals until end-of-pulsing conditions are detected

in a manner similar to that described for a primary route using the C.C.I.T.T. No. 5 Signalling System. At this stage, the register makes a further routing demand to the translator.

Calls on which the Primary Outgoing Route uses the C.C.I.T.T. No. 5 Signalling System

Since all digital information for a call on a route using the C.C.I.T.T. No. 5 Signalling System is sent en-bloc (the C.C.I.T.T. No. 5 system uses link-by-link techniques), it is necessary for the register-translator equipment to determine the number length of the called party. This is required on subscriber-originated calls only, which are identified by inspection of the received language digit which, for such calls, always is zero.

The register continues sending y acknowledgement signals until it has received the first five digits of the international number. The acknowledgement signal to the fifth digit is withheld and the register sends a signal to seize a transit translator and forwards to it a number-length information demand and the received digits of the international number. Information received from the translator in response to this demand comprises the maximum number of digits in the international number, whether the national number is of fixed or variable length, and the signalling system used on the outgoing route.

If the translator indicates that the call is to be via an outgoing route using the C.C.I.T.T. No. 4 Signalling System, the register sends an x acknowledgement signal, and makes an immediate routing demand to the translator. The call is then set up as previously described. If the translator confirms the outgoing route uses the C.C.I.T.T. No. 5 Signalling System, the register sends a y acknowledgement signal and continues sending y acknowledgement signals in response to each digit

received. Eventually a *number-received* signal is returned to the originating i.s.c. when either the maximum number of digits have been received for a call to a country with a fixed number of digits in its international number, or, after expiry of a five-second time-out for a country with a variable international number length. For operator-dialled calls, the *number-received* signal is sent after recognition that the *end-of-pulsing* signal has been received.

A routing demand is now made to the transit translator and, on receipt of the translator information, the register sets up the connexion via the international link-circuit as described for an outgoing route using the C.C.I.T.T. No. 4 Signalling System. During this process, the register sends a signal to seize a free Signalling System Multi-frequency No. 1 sender and following receipt of a *proceed-to-send* signal from the distant i.s.c., signalling proceeds in the C.C.I.T.T. No. 5 mode. When sending is complete, the register, subject to completion of sending the accounting information, releases and the call is switched through.

If conflicting outgoing circuit signalling information is given to the register, on two successive demands to the transit translator, a *congestion* signal is sent to the originating i.s.c. and the call is abandoned.

Answering and clearing signals are detected by the line relay-sets and this information is transferred by the accounting-equipment access relay-set to the accounting common equipment in a manner similar to that described for a seize event. Following punching of the clear event information, all the accounting equipment is released.

PROGRESS OF AN INCOMING TRANSIT CALL USING THE C.C.I.T.T. No. 5 SIGNALLING SYSTEM

Following recognition of an incoming seizure signal, the incoming line relay-set seizes a free incoming register (see Fig.

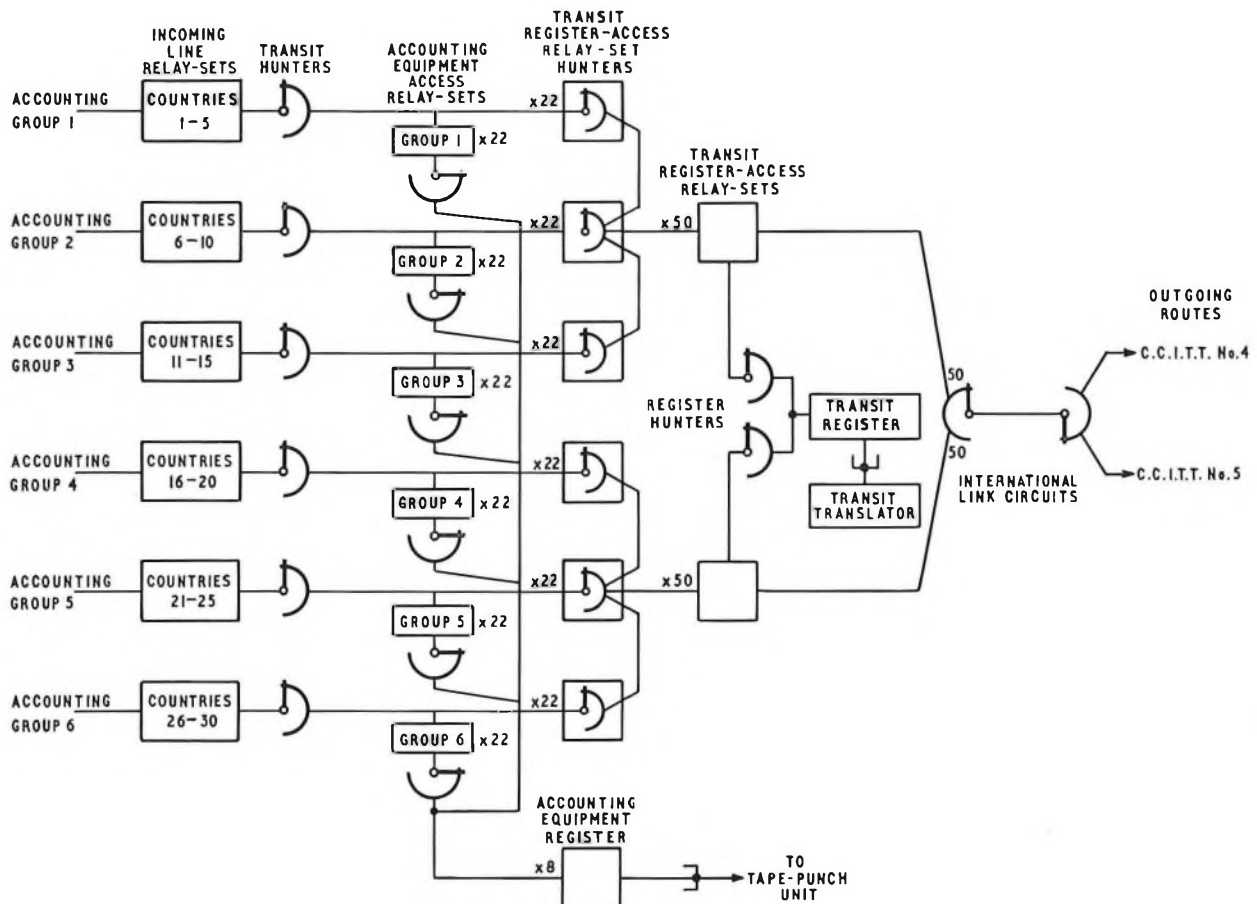

FIG. 3—Grouping of equipment for accounting purposes: incoming routes using the C.C.I.T.T. No. 4 Signalling System

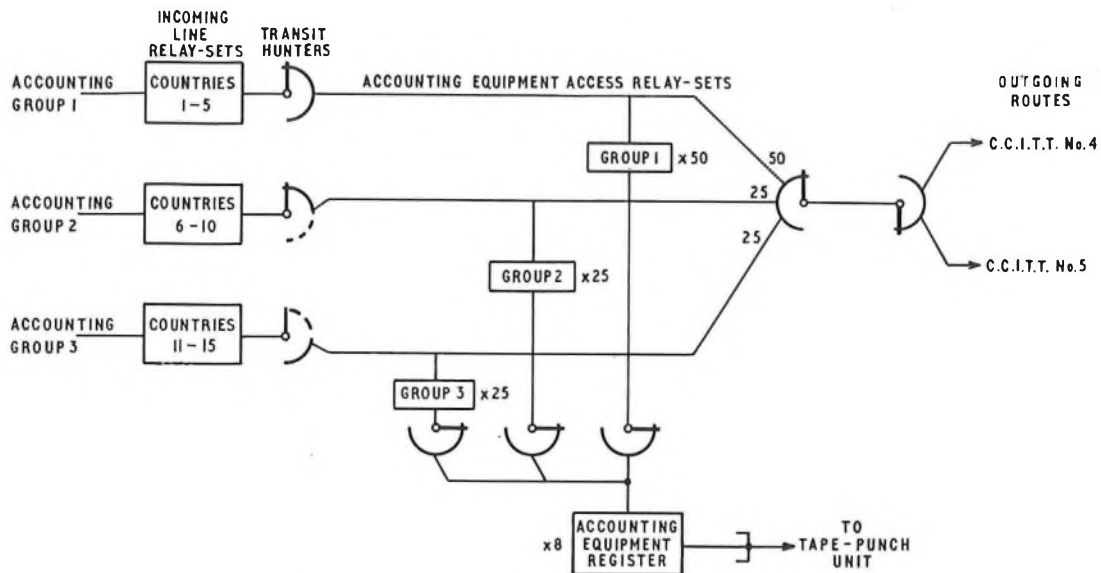

FIG. 4—Grouping of equipment for accounting purposes: incoming routes using the C.C.I.T.T. No. 5 Signalling System

2) and sends a *proceed-to-send* signal to the originating i.s.c. All digits are received, en-bloc, and following recognition of the *stop* signal, the register seizes a free translator, forwarding to it a routing demand indication and the first six digits of the international number.

On receipt of the routing information, the register proceeds to set up the call via the international link-circuit to the required outgoing circuit in a manner similar to that described for an incoming transit call using the C.C.I.T.T. No. 4 Signalling System. An accounting-equipment access relay-set is associated at this time, and seize-event information is stored by the accounting equipment as previously described.

Following receipt of a *proceed-to-send* signal, the required digital information is sent to the distant i.s.c. using the signalling system indicated by the transit translator. Route destination information is transferred to the accounting equipment for subsequent punching in a manner similar to that already described.

The register releases when all information has been sent and the transmission path is established. Answering and clearing signals are detected by the incoming line relay-set and passed to the accounting equipment for storage.

TRANSIT ACCOUNTING ARRANGEMENTS

In order to correctly determine international accounts it is necessary to derive the following information for each effective transit call:

- (a) identity of the incoming route,
- (b) time of seizure of the transit equipment,
- (c) outgoing route destination information, which comprises:
 - (i) the outgoing route taken from the transit centre,
 - (ii) the country-code digits of the destination country,
 - (iii) if applicable, the charging zone in the destination country,
- (d) the time of answer of the called subscriber,
- (e) the time the incoming circuit is cleared at the transit centre.

Since it is possible for any incoming circuit to be connected to any outgoing circuit, it is necessary for each call to be separately identified. This is achieved by identification of the accounting-equipment access relay-set which is provided according to the traffic carried and is held for the duration of the call. This is a more economic arrangement than identifying each incoming line relay-set. On some routes, the amount of transit traffic is small and it is economic to provide the accounting-equipment access relay-sets in groups with a

number of incoming routes (countries) having access to them. Each accounting-equipment access relay-set can be shared by five incoming countries and, therefore, has five separate identities. Determination of the incoming country is by path of entry. A three-digit code is used to identify each of the five entry paths. This identification code prefixes all information forwarded to the transit-accounting common-control equipment during the progress of the call.

For a normal call, the accounting-equipment register is seized four times, i.e. in order that information concerning time of seizure, route destination, time of answer and time that the incoming circuit is cleared may be stored. This results in four blocks of information being recorded onto paper tape. An ineffective call results in less than four blocks being recorded, this fact being used by the computer to distinguish between an effective and an ineffective call.

Grouping of Equipment for Accounting purposes

Incoming Circuits using the C.C.I.T.T. No. 4 Signalling System

Each accounting-equipment access relay-set has five separate identities, and the incoming line relay-sets are arranged in groups serving five incoming countries. This is known as an accounting group, the maximum arrangement for one international link-circuit section is shown in Fig. 3.

To prevent uneconomic traffic loading, concentration is required between the 25-point transit hunters and the 100 outlets of the link system. This is provided by the 50-outlet transit-register access relay-set hunter. Three accounting groups each having access to a maximum of 22 accounting-equipment access relay-sets are concentrated via this hunter to one half of an incoming section of the link-circuit. A similar arrangement is provided for the other half and thus, traffic from a maximum of 30 countries (six accounting groups of maximum five identities) can be switched via one complete link-circuit section. A maximum of eight transit accounting registers and one tape-punch unit with its two associated tape-punch controllers (main and standby) can be provided per link section to receive and store the necessary accounting information.

Incoming Circuits using the C.C.I.T.T. No. 5 Signalling System

The differences which occur in the trunking between circuits using the two line signalling systems (see Fig. 4) are brought about by the design of the line relay-sets, but the same basic principles apply. For incoming routes using the C.C.I.T.T. No. 5 Signalling System, no concentration is required between the 50-outlet transit hunters and one half of an International link-circuit section.

The incoming circuit groups for countries using the C.C.I.T.T. No. 5 Signalling System are expected to be larger than those using the C.C.I.T.T. No. 4 Signalling System, more traffic being presented from fewer incoming routes.

One accounting group of five countries will have access to 50 accounting-equipment access relay-sets, and to one half of a link-circuit section. Two such groups will connect traffic from 10 incoming countries via one complete link-circuit section.

For small incoming routes the bank multiple of the transit hunter can be split into two 25-outlet groups, as shown in Fig. 4. This allows a maximum of 10 countries from two accounting groups to connect traffic via one half of a link-circuit section. Common equipment provision is the same as for the incoming routes using the C.C.I.T.T. No. 4 Signalling System. It is also possible to share one link section between incoming circuits using the C.C.I.T.T. No. 4 Signalling System and incoming circuits using the C.C.I.T.T. No. 5 Signalling System; an accounting group of 15 incoming routes using the C.C.I.T.T. No. 5 Signalling System having access to one half of the link and an accounting group of five or 10 incoming routes using the C.C.I.T.T. No. 5 Signalling System having access to the other half.

APPLICATION OF THE TRANSIT SERVICE AT FARADAY I.T.S.C.

It has been estimated that initially a total transit traffic of 88 Erlangs will be switched automatically by the new

equipment at Faraday i.t.s.c. This traffic will originate from 28 countries. Thirteen countries using the C.C.I.T.T. No. 5 Signalling System will share one 5-country and one 10-country accounting group and will be connected to one international link-circuit section.

Twenty-five countries using the C.C.I.T.T. No. 4 Signalling System will also be connected to one international link-circuit section. They will share six 5-country groups.

This arrangement will permit an eventual total traffic of some 140 Erlangs derived from a maximum of 45 incoming countries to be connected via the new transit switching equipment.

References

- 1 TURNBULL, M. G. Introduction of Semi-Automatic Operation of Continental Telephone Services. *P.O.E.E.J.*, Vol. 52, p. 89, July 1963.
- 2 WELCH, S. Line and Register Signalling System for Dialling over Transatlantic Telephone Cables, *P.O.E.E.J.*, Vol. 56, p. 111, July 1963.
- 3 WELCH, S. Signalling Arrangements for Dialling over Transatlantic Telephone Cables. *P.O.E.E.J.*, Vol. 53, p. 201, Jan. 1964.
- 4 MUNDAY, S., and FRY, R. A. The New International Telephone Switching and Transmission Plan. *P.O.E.E.J.*, Vol. 61, p. 199, Oct. 1968.
- 5 HEPTINSTALL, D. L., and JONES, P. F. Switching Arrangements for Semi-automatic Operation of Trans-oceanic Telephone Cable Circuits. *P.O.E.E.J.*, Vol. 56, p. 105, July 1963.

Book Reviews

"Television Engineering Vol. 2 (Principles and Practice)." S. W. Amos, D. C. Birkinshaw and K. H. Green. The Butterworth Group. 298pp. 162 ill. £3.50.

First published in 1956 and revised in 1958, a second edition of Volume 2 on video-frequency amplification has now been issued. Although this book discusses the intricacies of the practical design of video amplifiers, backed up by a theoretical treatment of the subject, 16 of the 20 chapters are valve-oriented and based on the practices of the 1950s. Thus the greater part of the book is devoted to solving problems that are largely different from those met in modern transistor designs, and which may not have quite the same relevance to modern valves either.

Some of the terms defined or implied in the book are misleading, e.g. in section 1.4.3, Undershoot, and some of the methods described do not necessarily correspond to good practice nowadays, e.g. in section 11.1, LF compensation by choice of the decoupling components.

A short chapter has been included on the subject of transistor video amplifiers, which gives scant and not wholly accurate information. The extra requirements for colour transmissions are hardly mentioned. In its present form this book falls sadly short in relevance to the modern situation and, if it is to retain its place as volume 2 of a 4-volume work it should be revised accordingly.

Not recommended for general use.

G. C.

"Dauermagnete, Werkstoffe und Anwendungen." K. Schüler and K. Brinkmann. Springer-Verlag. 628 pp. 660 ill. DM 168.

A very good English work, "Permanent Magnets and Magnetism" (edited by Hadfield), appeared in 1962, and this new German book can well be compared with it. It covers much the same ground as the English one; it is very thorough and somewhat more mathematical (but not overwhelmingly so); it has more numerical data, and more references (many of them to papers in English). It deals more fully with the magnetic circuit and magnetic leakage, and covers many more applications, and on these subjects it is well worth consulting. It has the advantage of covering the new materials of the last 8 years, although, as it happens, the only one of much interest is cobalt-samarium.

On the other hand, Hadfield's book is the more readable—and this is not just a preference for one's native language. The English book can be read with interest, but the German one is to be thought of rather as a first-rate work of reference, to be consulted as the need arises, especially on the topics indicated above.

The diagrams, photographs, and indexes are up to the usual Springer standards.

A. C. L.

Synchronization of an Integrated Digital Transmission and Switching Network

D. THOMSON, C.ENG., M.I.E.E. †

U.D.C. 621.395.74:621.395.345:621.395.49

One of the requirements of some methods of operating an integrated digital transmission and switching network using time division multiplex (t.d.m.) techniques is the need to synchronize the clocks which control the timing of the switching and multiplexing functions at the switching centres so that they remain effectively in phase. The feasibility of applying this principle to a network such as the United Kingdom national network has been established and this article describes a control system which has been designed and developed by the British Post Office Research Department. Equipment has been built and tested in the laboratory with satisfactory results and a field trial involving five centres is now being undertaken in the London Telecommunications Region.

INTRODUCTION

The use of digital time division multiplex (t.d.m.) techniques for transmission in the national junction network is now well established and may be expected to spread in the near future to the trunk network, the present multichannel p.c.m. systems being augmented by higher-order multiplex systems for this purpose. The possibilities of using digital t.d.m. techniques for switching centres have been amply demonstrated¹ and integration of these compatible techniques into the network is an attractive economic proposition.

In such a network, all the timing and switching functions at the switching centres are controlled by the exchange clock which has a nominal rate (frequency) equal to, or simply related to, the basic digit rate of the t.d.m. system.

Differences in clock rates are troublesome and the accuracy and long-term frequency stability of the clocks are of importance. There are two main ways of operating such a network, each having a large number of possible variants:

- (a) asynchronous operation, in which each centre has an independent clock and the problem of keeping them in digit alignment is ignored, and
- (b) synchronous operation, in which control is applied to the clocks to ensure that the mean digit-rate of all clocks is the same.

The asynchronous solution involves inevitable loss of information which has to be kept within tolerable bounds and this can lead to the need for clocks of atomic-standard quality (and price) and for large amounts of variable storage per transmission link. On the other hand, synchronous operation involves no loss of information, requires little variable storage, and can use simple, inexpensive clocks. Control of the clocks can be made sufficiently cheap and reliable to lead to a preference for this scheme.

The application of clock control in a multi-mesh network such as the United Kingdom national network raises problems, notably those concerning stability (in the Nyquist sense). However, the feasibility of designing such a system has been established elsewhere.² A large number of synchronization methods have been proposed and studied, abroad as well as in this country, and these differ in principle, technique and complexity. Work in the British Post Office Research Department has led to the design of a preferred system and to the construction of sufficient equipment to permit a field trial involving the synchronization of five centres situated in and around London and interconnected by standard p.c.m. links,

in order to demonstrate the physical realisability of a sufficiently cheap and reliable system. The possible extension of synchronization internationally has been borne in mind. This article describes this system and the way in which it could be applied to the national network.

PRINCIPLE OF CLOCK CONTROL

The effectiveness of the control system depends on the frequency stability and security of the clocks used. The clock at each centre consists of a set of three oscillators followed by a system of majority-decision logic which controls combinations of their outputs in such a way as to ensure security and continuity of supply on failure of one oscillator. This demands a close phase-lock of the three oscillators to avoid a phase disturbance on failure of one and this, in turn, demands a degree of long-term stability. Simple, inexpensive crystal oscillators in small ovens have been used for this purpose and have been demonstrated to be satisfactory.¹ These have a long-term stability of the order of 2 parts in 10^8 per month. The digit rate is 1.536 Mbit/s (2.048 Mbit/s when 32-time-slot p.c.m. is introduced). Clocks of this quality can give rise to frequency differences throughout the network of about 5 Hz over a period of 10 years without any maintenance adjustments. The control system, therefore, must be able to control such clocks to make their mean frequencies equal, without permitting large phase differences to be established between them.

Fig. 1 shows the secure clock provided for the Empress digital tandem exchange and Fig. 2 shows one of the oscillators contained in it.

A digital method of control has been used because it is considered to be easier to implement and maintain and because control can be achieved without reducing the inherently good long-term stability of the oscillators.

To illustrate the method of control which is used, consider two clocks the frequencies of which differ by 1 Hz. They may be regarded as devices the relative phase of which changes by 360° per second continuously in the same direction. If the frequency of the faster is periodically stepped by 30 Hz downwards for, say, 1 ms and returned to its natural value for the next 29 ms, then the mean frequency has been reduced to that of the slower (Fig. 3). Furthermore, the relative phase difference between the clocks has been limited to a few degrees (i.e. a small fraction of a digit). In practice, the control would be shared between the two clocks and the final system frequency would be the mean of the two original frequencies. Stepping of the clock frequency is effected physically by connecting into the oscillator circuit small reactances when control is needed.

† Research Department, Telecommunications Headquarters.

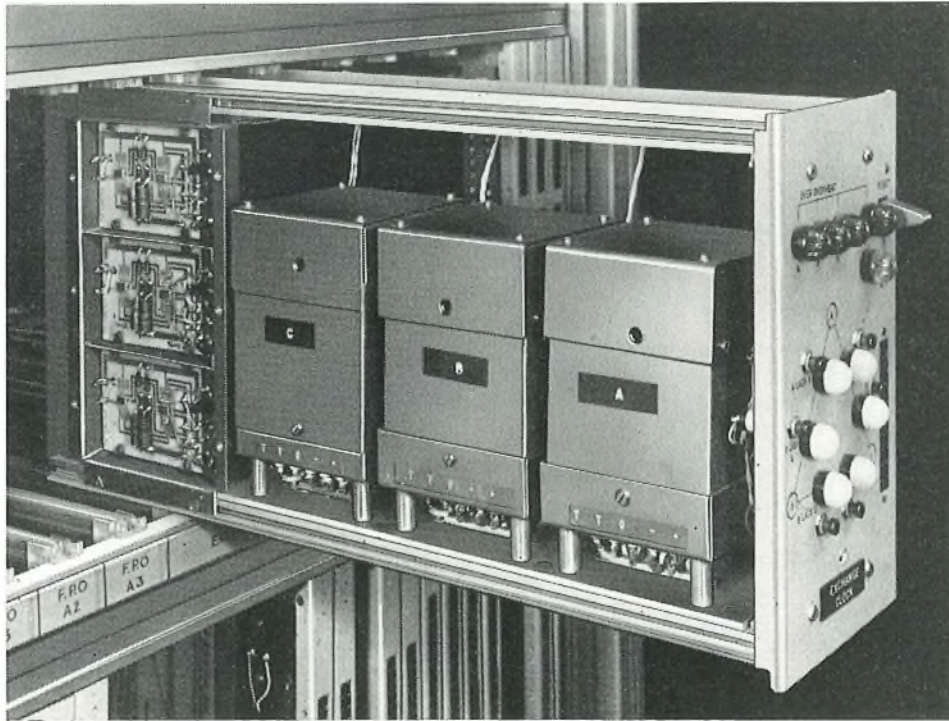

FIG. 1—Exchange clock showing oscillators and majority-decision logic circuits

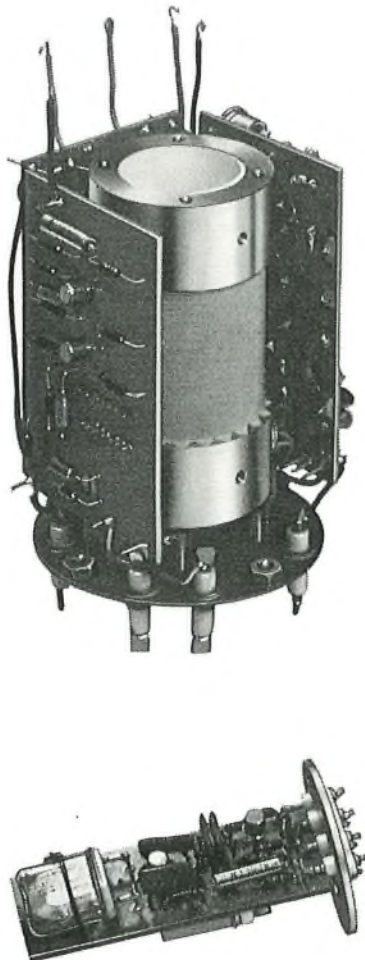

FIG. 2—Oscillator with oven and control circuits

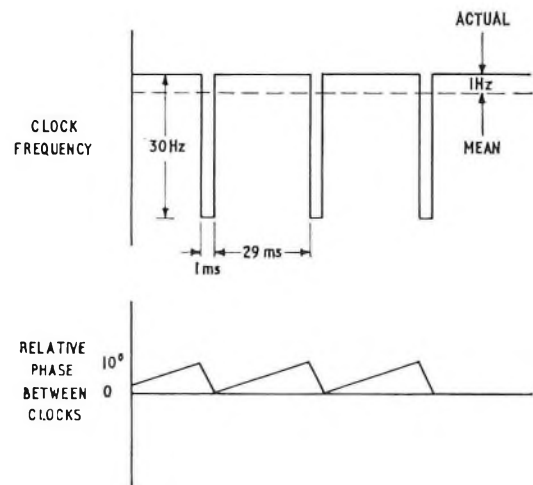

FIG. 3—Principle of clock control

DERIVATION OF CONTROL INFORMATION

The loop transmission delay on any link interconnecting two switching centres must be equal to, or an integral multiple of, the duration of a frame of the multiplex signal. For a 24-channel p.c.m. system operating at 1.536 Mbit/s the frame time is 125 μ s (the sampling interval), each frame containing 192 digits. Building-out delays are generally required and because the line delays are subject to variation due to annual cyclic temperature variation, part of the building-out delay needs to be variable. This takes the form of a small amount of buffer storage in which information is written at line time and read at exchange time. Typically, the delay change due to temperature on a 48 km p.c.m. link provided on deloaded symmetrical-pair audio cable amounts to about 2 digits, so that the variable storage required is small and an 8-bit store is used in this scheme.

A typical digital link and switching centre arrangement is shown in Fig. 4. For simplicity it is assumed that each

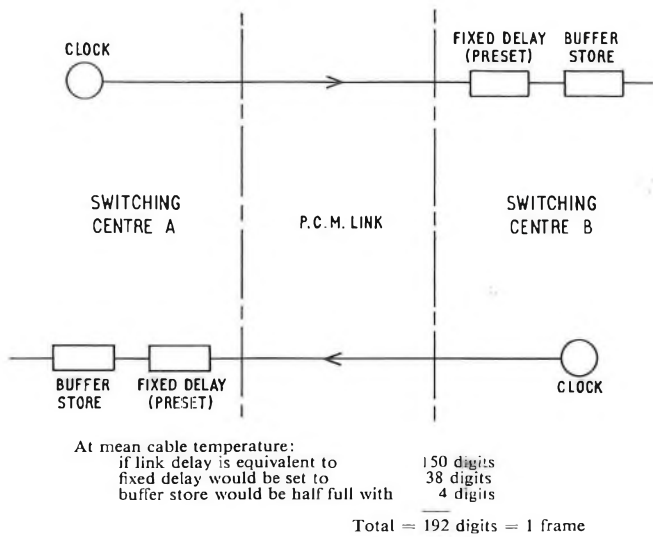

FIG. 4—Maintenance of frame delay between centres

direction of transmission is built out so that the delay is equal to one frame (192 digits) and at mid-cable temperature each buffer store is half full (i.e. contains 4 digits). If the clocks remain in phase, a change of temperature will cause the buffer stores to fill (or empty) together. On the other hand, if the temperature remains constant, one clock having a higher frequency than the other will cause one buffer store to fill and the other to empty. Information regarding the relative phases of the clocks is therefore obtainable, even in the face of cable temperature changes, by subtracting the fills of the buffer stores at the two ends of a link. The presence of line jitter, produced by the signal regenerators on the link, can cause uncertainty in the fills of the buffer stores and this is reduced by averaging the fill reading over a short period, typically 8 ms.

THE BASIC CONTROL SYSTEM

Fig. 5 shows in block form the control system at one end of a link. The system is symmetrical so that the same diagram refers to either end of any link.

The buffer-store fill is read (averaged over an 8 ms period) to the nearest quarter digit, so that the reading can have any one of 32 values at any time. This value is coded into a 5-bit binary pattern, passed to the local subtractor and also to the distant end on the outgoing multiplex path. This outgoing information may change as often as once every 8 ms. The subtractor subtracts the local fill and the coded distant fill received on the incoming multiplex path. If the difference exceeds a predetermined threshold value, advance (A) or retard (R) signals are generated depending on the sense of the difference. These signals are used locally and are also sent, in reversed sense, to the distant end (a single bit is required for each).

Because of the limited amount of buffer storage provided, the control system operates in its *normal* mode when the relative phases of the clocks differ by a few digits. As will be explained later, a coarser method of control is applied to get within the normal range. An additional control signal is transmitted between the two ends of the link to indicate that the system is within its normal control range, and is known as the *in limit* signal. A small amount of multiplex capacity is required for transmission of these signals. In the existing 24-circuit p.c.m. system, spare capacity is available in the 4th frame and a total of 8 bits per 4th frame is used. Different but similar arrangements will be required when a 32-time slot system is introduced; for example, the spare capacity of channel 0 could be used.

The locally-generated A or R signals and the confirmatory signals from the distant end are fed to the central signal-

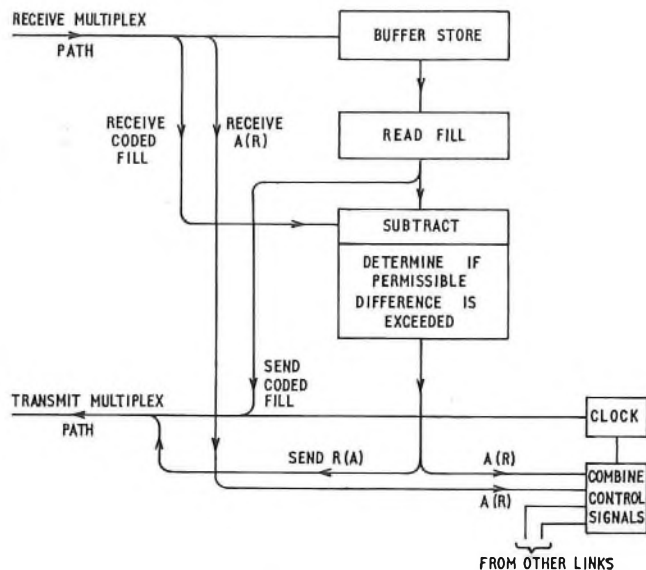

FIG. 5—Basic control system

combining unit where they are combined with control signals from other switching centres. There are many ways in which these signals could be combined and in the system being described the simplest possible method has been adopted.

The method chosen uses the following logic rules:

- if all signals being received are of the same sense, control is applied in the appropriate direction,
- if signals are of mixed sense, nothing is done.

Control of the clock is permitted only at fixed 16 ms intervals, signals being received from various links at various times during these intervals being stored, confirmed by signals from the distant ends and combined in accordance with the rules.

A demand for control, resulting from the combining function, causes the clock frequency to be stepped by ± 15 Hz for a small pre-set time (typically 4 ms). Since control will usually take place in opposite senses at the two ends of a link, the periodic phase correction being applied in the case quoted above amounts to 0.12 digit (43°). Such corrections are applied as often as they are needed, the difference in the buffer-store fill being driven back towards, or beyond, the threshold value. For example, if the frequency difference existing between two clocks is 3 Hz, control signals will be generated at a mean rate of 25 per second.

THE POSSIBILITY OF BLOCKING AND RECOVERY OF NORMAL CONTROL

Normal control can only take place when the frame-start signals from adjacent clocks are within a few digits of one another, the precise phase difference being dependent on the amount of variable buffer storage provided. It is possible to visualise a situation (e.g. on first connecting the network, or after a catastrophic failure covering an area) in which no normal control is possible and a blocked condition exists. For example, Fig. 6 shows a set of three switching centres the clocks of which have the phase relationship shown. None of the links carry *in limit* signals and normal control cannot take place. Although natural drift due to clock ageing could clear the blocking, this could take a very long time and could not be relied on. The absence of *in limit* signals and the presence of both A and R signals on all the links indicates the blocking at each centre and this is used to initiate the coarse control referred to earlier which leads to fast recovery from the blocked state. The switching centres are given seniority

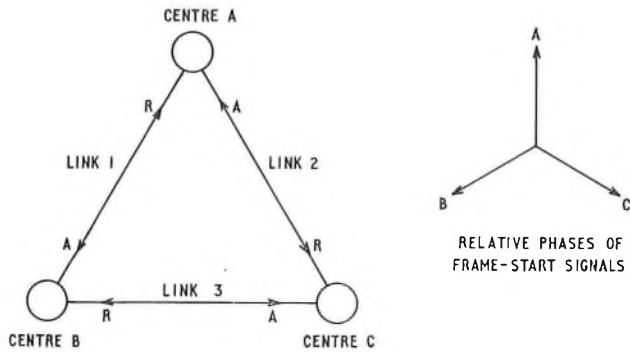

Fig. 6—Illustration of blocking in a ring of three switching centres

numbers and logic is included at each centre which, on recognition of blocking, inhibits normal control from both ends of each link from the least senior upwards until the A and R condition is removed. In Fig. 6 this means that normal control is inhibited on links 2 and 3. On link 1 accelerated control is applied by using continuous A and R signals until the link is within normal range, whereupon normal control is resumed. Accelerated control is then applied to link 2. This sequence is continued until all links are being controlled normally. In this way recovery from serious faults and system stoppages can take place within a few seconds. It is believed that such stoppages will be extremely rare but it is felt that the ability of the system to automatically organize itself from the dead state is a worthwhile property.

APPLICATION OF THE SYSTEM TO THE NATIONAL NETWORK

The system could control a network of digital switching centres covering the whole country. A tiered system is proposed which would parallel the hierarchal nature of the main, district and group switching centres (m.s.c., d.s.c. and g.s.c.) of the national network as shown in Fig. 7.

The m.s.c.s are fully interconnected and mutual synchronization between them is possible. They are at the head of the hierarchy and the control system on the interconnecting links

operates with a large permissible fill-difference threshold (say 4 digits). The fill-difference threshold used in lower ranks of the hierarchy diminishes according to rank as shown. The values chosen satisfy the requirement that when a frequency difference exists between two switching centres such as M1 and M2 of Fig. 7, control will take place via the direct link between them rather than via an indirect path (e.g. M1-D1 D2-M2 or M1-M3-M2) because the permissible fill difference on the direct link will be reached before the total permissible fill difference on any indirect path is reached (i.e. 6 digits and 8 digits in the example quoted). This prevents the closure of control-path feedback loops which might otherwise contribute to instability.

At the lower end of the hierarchy the local exchanges (l.e.) are locked directly from the parent g.s.c., buffer stores being required only at the incoming ends of the links from l.e.s at the g.s.c.s. Direct links between l.e.s dependent on the same or neighbouring g.s.c.s are equipped with buffer stores and simple control equipment which generates A and R signals when the local buffer store approaches full or empty, without reference to the distant buffer store. The capacity of these stores is such that the emergency control does not come into effect unless the g.s.c. or the link between the l.e. and its parent g.s.c. is out of action, when the control takes over from the normal control to keep the l.e. synchronized.

It is to be noted that links such as those shown dotted in Fig. 7, which may be required for traffic purposes, have buffer stores but no control equipment.

The magnitude of the correction made by the control system is also arranged to fit the hierarchal structure. This is achieved by using a common value of step change in frequency (15 Hz) at all centres, but arranging that it is applied for a short fixed period at m.s.c.s (2 ms), and correspondingly longer periods at d.s.c.s (4 ms) and g.s.c.s (8 ms). This ensures that the effects of disturbances propagate outwards from the centre of the network to the periphery faster than in the opposite direction and prevents the "tail trying to wag the dog". It is also in line with the network stability criteria in that higher control-loop gains are used near the periphery of the network where the length of links, and thus delays, tend to be smaller.

In the network shown, many of the traffic routes between switching centres will be large and will consist of many p.c.m.

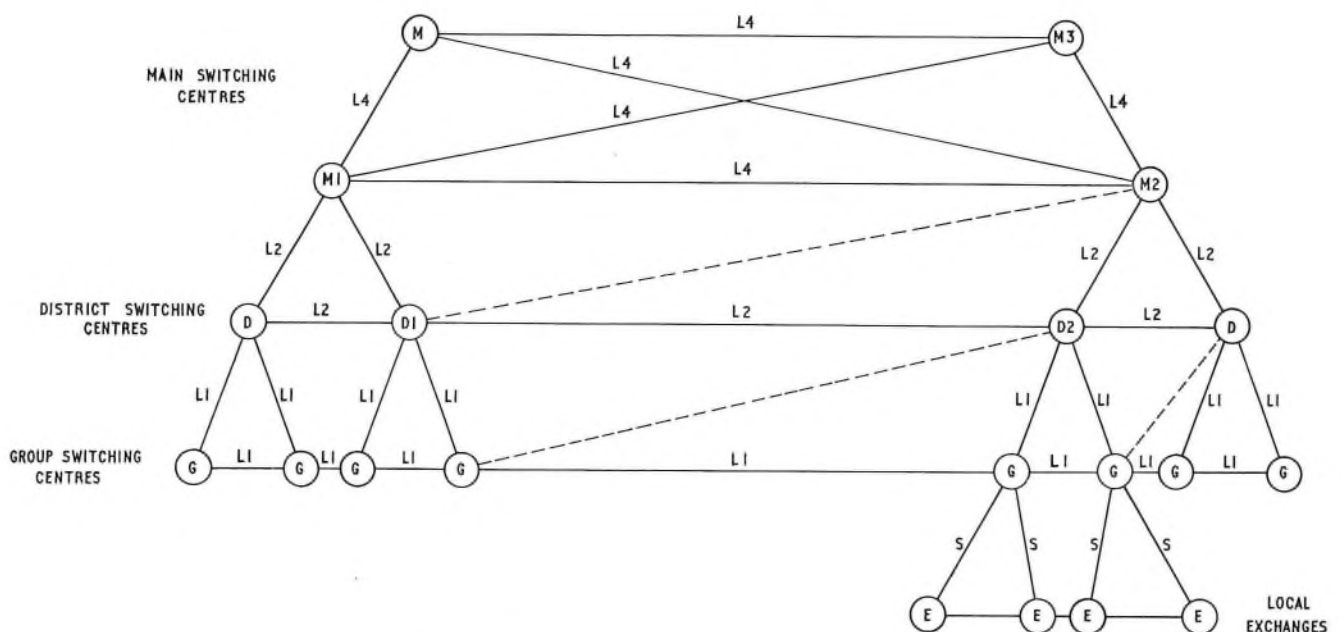

Fill-difference threshold of links L4 = 4 digits, L2 = 2 digits and L1 = 1 digit
Links S form a synchronous star arrangement. The local exchanges are slaved to the parent group switching centre

Fig. 7—Synchronization network configuration

links. Although buffer storage will be needed, only one or two links per route will participate in control functions, the majority of the links requiring no control equipment.

SYSTEM SECURITY

The system covers a wide area and security is very important. Faults occurring in one part of the network must be prevented from spreading their effects to the remainder. Each exchange clock consists of a set of three oven-controlled crystal oscillators directly locked in phase and these provide three outputs which are majority decided to give a number of outputs which are secure against failure of any one input. Also the relative phases are compared in pairs and an alarm is given when a phase difference of $\pm 10^\circ$ is detected. Thus, failure of one oscillator, or a shift in its natural frequency to a point outside the direct locking range, cannot produce a failure in the secure output (Fig. 8).

The control-signal combining function is also triplicated and majority decided to produce three secure outputs each of which controls one element of the clock. Comparators provide alarms to indicate failure of any one (Fig. 9).

If frame alignment is lost, or if the local and distant A or R signals fail to agree, or are not both present after a persistence check, the ability of that link to participate in the control of the clocks at its ends is inhibited. The loss of control on a link is not catastrophic because of the inherent redundancy in the multi-mesh structure: control information has an indirect alternative path between clocks on failure of the direct link. Although only one link in any route is needed for control purposes, two could be equipped with control equipment to give additional security.

INTERNATIONAL ASPECTS

In future, it may be necessary to consider the problem of synchronizing several national integrated networks and this could lead to a need to define the system frequency accurately. It is possible to do this by inserting somewhere in the network a reference clock of atomic-frequency standard. This could take the place of the normal clock at a particular switching centre, perhaps the international gateway exchange. This centre would send control signals outwards but would receive no control signals and so would dictate the absolute system frequency. Loss of this centre would not be catastrophic to the national network since this would assume a frequency equal to the mean of all the clocks participating in the control process.

It is feasible to consider integrating, over long periods, the demands for A or R control signals at each centre in the network. A preponderance of A over R signals at a centre could be taken as an indication that the natural frequency of the clock at that centre was lower than the reference and steps could then be taken to make a small manual adjustment. In this way the spread in frequency amongst the clocks could be kept within narrow limits. Thus, the system frequency need never be far from the reference frequency.

A network consisting of the national reference clocks could

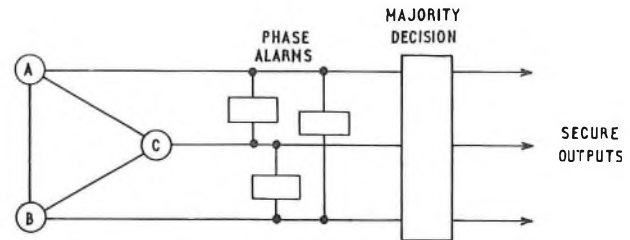

FIG. 8—Secure clock with phase alarms

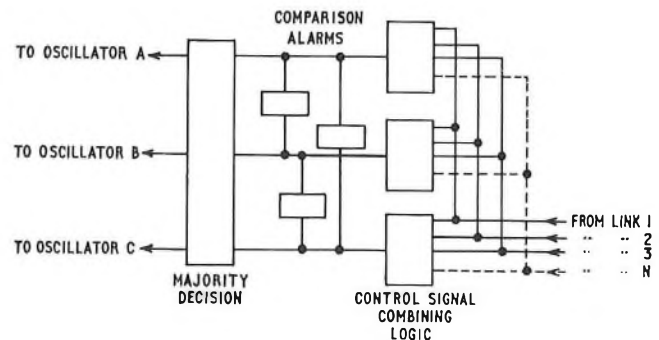

FIG. 9—Triplcation of control signal combining logic

also be synchronized, at least over some types of international digital links, and the control of the frequency of atomic reference clocks by digital means is quite possible.

CONCLUSION

A control system has been described which achieves synchronization of the switching centre clocks in a large multi-mesh network without danger of instability. In the absence of an atomic-standard reference clock, it produces a system operating frequency which is equal to the mean frequency of all the clocks and this frequency is independent of link delay variations. It is completely digital in character and is thus cheap to provide and easy to maintain and it is secure against failures in discrete parts of the network. Five switching centre clocks have been successfully synchronized in the laboratory and a field trial in the London Telecommunications Region is being undertaken. It is believed that the system is sufficiently cheap and adequately secure and provides an economic solution to the problem of operating a large integrated digital network.

References

- 1 CHAPMAN, K. J., and HUGHES, C. J. A Field Trial of an Experimental Pulse-Code Modulation Tandem Exchange. *P.O.E.E.J.*, Vol. 61, p. 186, Oct. 1968.
- 2 MILLER, M. R. Feasibility Studies of Synchronized-Oscillator Systems for P.C.M. Telephone Networks. *Proc. I.E.E.*, Vol. 116 p. 1,135, July 1969.

Notes and Comments

E. Croft, C.Eng, M.I.E.E.

The promotion of Ted Croft to Staff Engineer of MS4 was not unexpected, Ted having served in ED/OE and OWS branches since 1963 and in M.S.D. since reorganization. He entered the Post Office as a Probationary Inspector in 1937 via the open competition and after initial training at Dollis Hill, then also used as a training school, returned to his native North-East where he worked in Newcastle and Middlesbrough Areas before joining the Royal Corps of Signals in 1940. In 1946 he returned to Middlesbrough on internal maintenance duties and was successful in the E.E. Limited Competition in 1948. Posted to L.T.R. North Area as E.E. on maintenance he later moved to external planning and in 1957 was promoted Area Engineer on external planning and works.



In 1962 he moved to Cn branch as S.E.E. under Gerry Alston to set up the Work Study Group. Moving to OE branch in 1963 he was able to use his area background to even greater advantage particularly in the customer installation field. I always think of him as the customers' installation expert.

Ted's promotion will enlarge his scope considerably to cover all facets of area engineering efficiency—there is no doubt he will be busy but all his friends wish him well in his new appointment.

A. C. C.

D. Holmes, B.Sc. (Eng), M.I.E.E.

Congratulations are extended to Don Holmes on his recent appointment as Controller, Works, L.T.R. Don's new job is a formidable one, but he is the kind of person who will tackle



it with the enthusiasm and determination to make a success of it.

He joined the Post Office as a Youth-in-Training in 1940 at Bradford. Five years later he moved to Training Branch as a lecturer on automatic exchange systems at Dollis Hill and Stone. In 1951 he passed the Limited Competition for E.E. and the following year was appointed in that grade in Newcastle Area with responsibilities for external planning followed by spells on external works and internal planning. Promotion to S.E.E. in 1962 saw him in M.T.R. on duties involving exchange systems—long term planning. Four years later he was appointed to the Personnel Dept. as A.S.E. on engineering training. He will perhaps be best remembered there for his work on the organization and setting-up of Horwood House residential College and the Job Conference Course.

He transferred to M.S.D. (Engineering Efficiency) in 1969. Although not a specialist in work-study techniques, his extensive field experience combined with his natural directness and logical mind made him eminently suited to these duties.

Don brings to his new job a quiet efficiency and a realistic yet human approach. His many friends wish him every success.

J. D. S.

Correction

It is regretted that the following errors occurred in the July 1971 issue of the *Journal*: Figure 3, p. 100, should be turned through 90° clockwise, Figure 11, p. 104, should be turned through 90° anticlockwise and the aggregating stacker mentioned in the text as being shown in Figure 12 also on p. 104 is missing.

Publication of Correspondence

The Board of Editors would like to publish correspondence on engineering, technical or other aspects of articles published in the *Journal*.

Letters of sufficient interest will be published under "Notes and Comments". Correspondents should note that, as it is necessary to send copy to the printer well before publication date, it will only be possible to consider letters for publication in the January issue if they are received before 15 November 1971.

Letters intended for publication should be sent to the Managing Editor, *P.O.E.E. Journal*, Post Office Factories Headquarters, Bovay Place, London, N7 6PX.

Notes for Authors

Authors are reminded that some notes are available to help them prepare the manuscripts of the *Journal* articles in a way that will assist in securing uniformity of presentation, simplify the work of the *Journal's* printer and draughtsmen, and help ensure that authors' wishes are easily interpreted. Any author preparing an article for the *Journal* who is not already in possession of the notes is asked to write to the Managing Editor to obtain a copy.

It is emphasized that all contributions to the *Journal*, including those for Regional Notes and Associate Section Notes, must be typed, with double spacing between lines, on one side only of each sheet of paper.

Each circuit diagram or sketch should be drawn on a separate sheet of paper; neat sketches are all that are required. Photographs should be clear and sharply focused. Prints should preferably be glossy and should be unmounted, any notes or captions being written on a separate sheet of paper. Negatives or plates are not needed and should not be supplied.

Model Answer Books

Books of model answers to certain of the City and Guilds of London Institute examinations in telecommunications are published by the Board of Editors. Details of the books available are always given at the end of the Supplement to the *Journal*. The Board of Editors has reduced the price of Line Plant Practice A to 37½p (42½p post paid).

The Telecommunication Principles B Answer Book is out of print at the moment but a revised issue is in preparation and an announcement will be made in the *Journal* when it becomes available.

Articles on Current Topics

The Board of Editors would like to publish more short articles dealing with topical subjects. Authors who have contributions of this nature are invited to contact the Managing Editor.

Supplement

Students studying for City and Guilds of London Institute examinations in telecommunications are reminded that the Supplement to the *Journal* includes model answers to examination questions set in all the subjects of the Telecommunication Technicians' Course. Back numbers of the *Journal* are available in limited quantities only, and students are urged to place a regular order to ensure that they keep informed of current developments in telecommunications and receive all copies of the Supplement.

Syllabuses and Copies of Question Papers for the Telecommunication Technicians' Course

The syllabuses and copies of question papers set for examinations of the Telecommunication Technicians' Course of the City and Guilds of London Institute are not sold by *The Post Office Electrical Engineers' Journal*. They should be purchased from the Department of Technology, City and Guilds of London Institute, 76 Portland Place, London, WIN 4AA.

Letters to the Editor

Dear Sir,

This is to express my appreciation for the excellent survey "Developments in Data Communications" by M. B. Williams published in the July issue of the P.O.E.E. Journal.

The survey is especially valuable to people in Research Department for the comprehensive and forward-looking picture it gives of this important field. Research studies in the data transmission and allied fields tend to be highly specialized and to concentrate on achieving depth rather than general coverage. The survey enables research staff to see more clearly how their contributions fit into the general pattern and, perhaps more importantly, to see the areas of difficulty needing further attack.

I am sure that the Editorial Board of the *Journal* will find considerable support for its policy in publishing such surveys if they are as well written and to the point as this one.

W. J. BRAY

Director of Research
Post Office Research Station,
Dollis Hill,
London, NW2 7DT.

Dear Sir,

The letter from Mr. D. P. Simmons in your last issue emphasizes admirably a viewpoint which I am sure is held by the majority of your readers. But it raises an important issue other than the subject under discussion by its unwitting implication that the Institution consists of and provides for only telecommunication engineers. I hope that in considering the future constitution and role of the I.P.O.E.E. in the Post Office Corporation the Council will relate the Institution's title more clearly to the engineering spectrum of its members. They are no longer (if they ever were) wholly "electrical", nor (yet) replaced by "telecommunications". I would have thought that the recent contributions to the *Journal* from postal engineers and their participation in the affairs of the Institution at all levels, should have come within sight of even the most blinkered telecommunication eyes. To assure this in the future and, of more consequence, to encompass without ambiguity the major contributions to telecommunications and posts by civil and mechanical engineers in the Post Office, I suggest the only appropriate title is "Institution of Post Office Engineers".

Yours faithfully

J. PIGGOTT

Mechanization and Buildings Department,
Postal Headquarters,
Empire House,
St. Martin's-Le-Grand,
London EC1A 4AE

Dear Sir,

The point of view of Mr. D. P. Simmons on the question of broadening the scope of the *Journal* is, as I am sure he will readily admit, no more than a statement of the present position.

He puts his finger on the difficulty with which Mr. Endersby and your humble contributor, amongst many others, are trying to deal when he urges that another forum be chosen to proclaim the "message".

There's the rub! What forum would he suggest? Where does one, for instance, discuss the impact of technological change on the people affected?

People do still matter as Mr. Simmons says. The work does not get done without them and the current spate of new management techniques (and some not so new) testifies to the general acceptance of this fact. Where does one exchange ideas on such a topic as this?

Is there not a whole range of subjects legitimately claiming the attention of P.O. engineers besides technical improvements and developments in the hardware of the business?

What more appropriate place than the *Journal* could there be for, for example, attempting to bring into the management field the same scientific methods of thought so amply demonstrated in the technical field? There is a vast field of enquiry here as there is in many other directions.

Technical advance is fine and the *Journal* does a superlative job of reporting on it. But technology, unrelated to all the problems its development throws up can be a monster. What those who would like to expand the interests of the *Journal* are after is that the philosophies behind our engineering efforts shall get as adequate an airing as the efforts themselves. The *Journal* is the proper place for this.

Yours sincerely

E. A. HAWKINS

Colchester Telephone Area,
Ipswich T.E.C.,
247 Woodbridge Road,
Ipswich

Regional Notes

Eastern Region

Post-Hole Borer Experiments

Some alternative mechanical aid to the existing two pole erection units (p.e.u.) was necessary if the Norwich area was to meet its poling program of approximately 1,900 poles per year. With 82 per cent of the area total normally erected by the p.e.u.s, the loss of a unit for even a short period can produce very adverse effects on the program, and on productivity targets.

To help overcome these difficulties a Lister post-hole borer was purchased at a cost of £150, and delivered to the area in late September 1970. This borer, which is basically a very simplified edition of the now obsolete Post Office pole-hole borer (Horn-Draulic type), consists of a 12 in diameter auger which is capable of drilling to a depth of 5 ft, this being the longest auger available from the manufacturers. The auger is driven from the power take-off point at the rear of a tractor, and a universal fitting allows the borer to be mounted on most types of tractor (see Fig.).

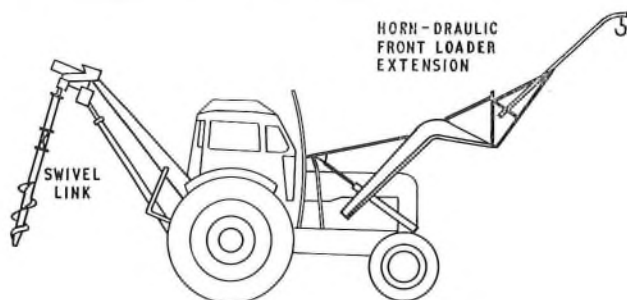

Lister post-hole borer type P.B.5

During the trial period in Norwich, the borer has been mounted on a Fordson Major tractor, the winch having been removed. The tractor is also equipped with a Horn-Draulic front-loader. The auger length was increased, as the flights on the auger shaft did not clear the bottom 6 in of the hole, and it did not have sufficient ground clearance in its travelling position. Both these difficulties were overcome by making and fitting an extension, which incorporated a swivel linkage, in the auger shaft. This modification gave an increase of 6 in in the auger length and also allowed the auger to be swung up towards the tractor when travelling, giving ample ground clearance. A track locator No. 1A is used to locate the position of other undertakers plant prior to drilling operations.

Transportation of the tractor varies according to the location of the work. The tractor can travel to site under its own power or can be transported on a low-loader, which can be towed behind the stores vehicle carrying the poles.

One of the advantages of the post-hole borer is that a tractor can gain access to pole positions which would be quite impossible for a p.e.u. such as fields and narrow country lanes. It can also be moved very easily, since it has no stabilizers to retract. Arrangements are being made for the external planning groups to indicate on operational surveys whether the post hole-borer would be suitable in conditions where the p.e.u. is not. This will allow the borer to be used in positions where manual poling would otherwise be necessary.

A small auxiliary dog clutch allows the auger to be disconnected from the engine drive when the Horn-Draulic front loader is in use.

The trial is now continuing with the tractor unit carrying out the complete poling operation. The Horn-Draulic front loader, fitted with an extension, allows poles up to 5 cwt to be erected, and as a 32 ft medium pole weighs approximately 4.5 cwt this will cater for the vast majority of poles used. The Horn-Draulic front loader can be used for provision and recovery work, light poles can be recovered with a direct lift after shaking the pole to loosen surrounding soil. This method of recovery takes only a few minutes to complete, lifting during provision and recovery operations being carried out by using a wire-rope sling.

The post-hole borer has proved a very useful mechanical aid and its simplicity makes field maintenance relatively easy. By using the auger and Horn-Draulic front lift, much heavy manual work associated with manual poling can be avoided.

The local branch of the Post Office Engineering Union, together with the safety committee, are giving every assistance with the trials and we hope that this borer will be a useful addition to our mechanical aids for our field staff.

F. D. W. EMBLING

London Postal Region

New Single-Position Letter-Sorting Machines at Eastern Central District Office

Five Thrissell multi-selection, single-position letter sorting machines have recently been installed at King Edward Building, London E.C.1, for use on outward foreign letter-mail.

Hoverpallets are being used successfully to transport the machines over low load-bearing floors.

These machines are at present unique, being the first to be used for foreign mail and also the first to incorporate a solid-state box director memory system instead of a mechanical pin-wheel.

Under international agreement outward foreign mail must not be marked with phosphor code-dots. In order to direct the mail to the selection box a single operator keys a code appropriate to the address and the stored information routes the letter accordingly.

R. F. POULTER

Mount Pleasant—Increase of Power Capacity

For many years, the extensive letter and parcel sorting offices and the Post Office railway station at Mount Pleasant have been supplied at 6.6 kvolts from the bulk supply sub-station at King Edward Building.

At an early stage in planning the redevelopment of the Mount Pleasant complex, it became apparent that the transformers then existing would not be adequate to meet the anticipated load and that it would no longer be possible to take the supply from King Edward Building. On completion of the whole project a total capacity of 6-7 MVA would be necessary. Furthermore, no space existed for a new conventional sub-station or for an extension. The problems have been overcome by the use of packaged sub-stations to provide medium voltage (m.v.) a.c. supplies. Further space can be made by replacing two mercury-arc rectifier sets by solid-state (silicon) devices.

An agreement was reached with the London Electricity Board (L.E.B.) for a dual 11-kvolt supply to be brought into Mount Pleasant from the Back Hill sub-station. The existing high-voltage board was enlarged and modernized, and the finished board (Fig. 1) now has 13 panels—two panels for



FIG. 1—Thirteen-panel high-voltage board in Mount Pleasant sub-station

the L.E.B. feeders, one panel for the bus-bar coupler, two panels for meters and the remaining eight panels are 11-kvolt oil circuit-breakers (Fig. 2). The existing 500 kVA transformers and medium-voltage board were replaced by three 1 MVA packaged sub-stations (Fig. 3). These are fed from three of the 11 kvolt oil circuit-breakers and are now on load and feeding the inland section at 415 volts.

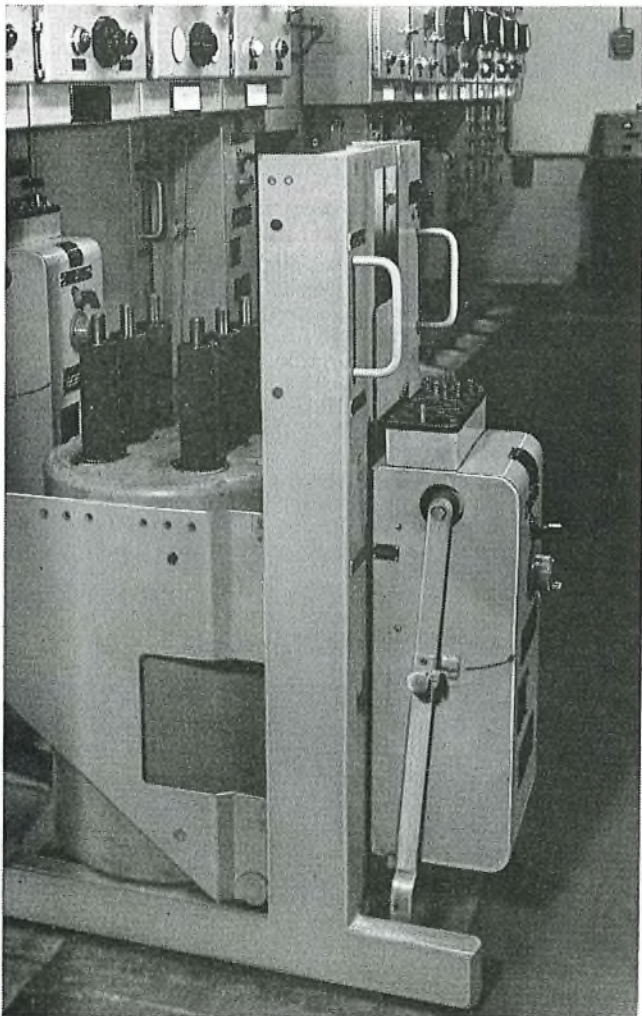

FIG. 2—An 11-kvolt oil circuit-breaker. Vertical-isolation and horizontal-withdrawal type

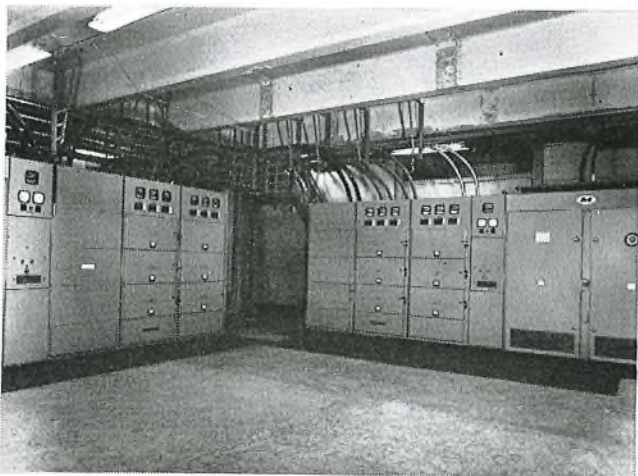

FIG. 3—Two of the 1-Mvolt-amp packaged sub-stations shown in position and on load

In September 1971 the Post Office railway sub-station at Mount Pleasant was cut off from the 6.6 kvolt supply from King Edward Building and replaced by an 11-kvolt feeder from the new Mount Pleasant sub-station high-voltage board.

At this stage the main high-voltage board had four oil circuit-breakers left for future expansion. This expansion may include, for example, two 11-kvolt supplies to a possible new building on the parcel section site, one 11-kvolt supply to a possible new building on the Phoenix Place site and one spare which is at present being utilized for a temporary 1 MVA transformer which in turn feeds a temporary megavolt board.

This transformer has enabled the progressive change-over from old to new equipment to be carried out smoothly with minimal interruption of the services to the parcel and letter offices which have continued to operate normally throughout.

It is also available for backing up the supplies whilst the present parcel block remains and for the future expansion already mentioned.

J. A. Cook

Northern Ireland Directorate

Eurovision Song Contest 1971

On the 3 April 1971, Radio Telefis Eireann (R.T.E.), under the patronage of the European Broadcasting Union, were organizers of the 16th Eurovision Song Contest. The Contest was broadcast live and in colour by R.T.E. from the Gaiety Theatre in Dublin.

Under normal circumstances this would have been treated as a straightforward outside broadcast, but, owing to terrorist activity prevailing in Northern Ireland, special security arrangements were made. The broadcast was being taken by a total of 29 countries, including, for the first time, South America, and with estimated viewing figures of several hundred million, any break in sound or vision owing to terrorist sabotage would have resulted in massive world-wide publicity.

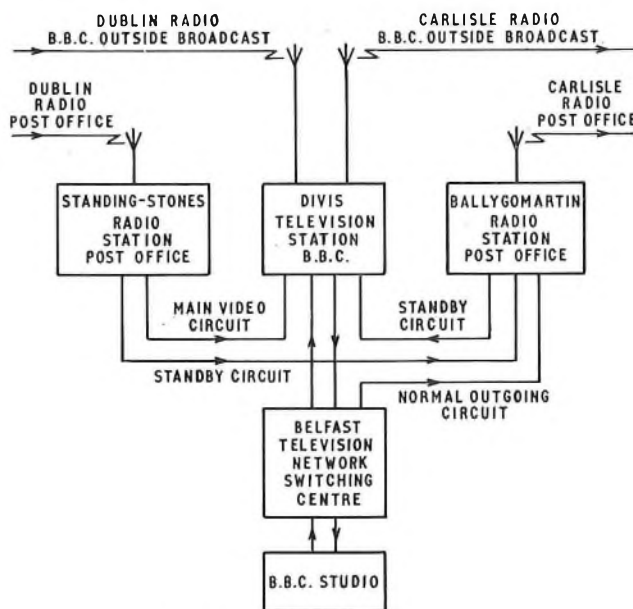

NOTE: All circuits to 625 line colour standards

Eurovision Song Content vision circuits in Northern Ireland

The Irish Republic-Northern Ireland vision feeds from the Gaiety Theatre followed two physically separate routes. The first route consisted of microwave radio-link equipment provided by R.T.E. (Irish Republic side) and the British Broadcasting Corporation (B.B.C.) (Northern Ireland side), a circuit normally used for news items. The second route was via the protection channel of the established microwave radio-system in service with the British Post Office between Dublin and Standing Stones, a radio station on the outskirts of Belfast. From Standing Stones the Post Office provided a main video circuit to the B.B.C. circuit control at Divis Mountain, by diverting two coaxial cable pairs into the site and providing the necessary equalization. A further standby

video-circuit was provided from Standing Stones direct to Ballygomartin radio station to bypass Divis and give injection into the Belfast–Carlisle radio link, in any emergency.

Multiple music feeds were provided from Dublin via Belfast using audio (physical) circuits and music in-band equipment on the radio route. Sound was also multiplexed into the R.T.E.–B.B.C. vision link from Dublin to Belfast.

To provide sound for the different languages involved in the contest, 28 commentary-lines and 30 control-lines were routed via groups in the Dublin–Belfast–London systems.

At the B.B.C. Divis control, switching was provided to select either of the two vision inputs from Dublin, and connect it to two separate outputs, one via a Post Office protection channel to Carlisle, the other via B.B.C. outside broadcast equipment to Riddings Hill radio station for injection into the Post Office Carlisle link. From Carlisle the vision circuit followed normal (though separate) routing via the London international control room arriving eventually at the Brussels Eurovision control for final distribution.

In Northern Ireland all the Post Office and B.B.C. stations handling the broadcast were staffed during the broadcast and armed guards were provided by units of the British Army, following threats of disruption from the terrorists.

The broadcast finally took place without any trouble from equipment or terrorists, viewed, no doubt, with great pleasure everywhere except in the Northern Ireland Post Office radio stations where the staff were quite relieved to see the final curtain to mark the end of the 1971 Eurovision Song Contest.

E. G. AUGHEY

Accuracy of Underground Records

Psychologically, it is difficult to get some people to carry out any follow-up operation once the immediate objective is achieved. This problem arises with underground records. The objective is to make some change in the line plant, and once this is done, the follow-up operation of completing the records is often neglected.

There are several ways of tackling this problem:

(a) *Exhortation.* The offenders are too forgetful for this to be effective, although Telecommunication Headquarters are trying this with underground records.

(b) *Retribution.* Unfortunately with underground records the error is usually discovered far too late for the offender to be identified.

(c) *Automatic.* An automatic underground record correcting machine has yet to be evolved.

(d) *Integration.* Where the follow-up operation is moved forward to become an integral part of meeting the objective.

This final approach is being used by the Belfast Telephone Area Engineering Productivity Committee in a local field trial. No trouble is experienced with men failing to close up cabinets; it is obvious that they include this operation in their objective. We are, therefore, arranging that the recording is done before cabinets are closed up again, in the following manner.

An omnibus exchange line is provided via one pair to each cabinet. Anyone making any change is instructed to ring a certain number to which is connected a recording machine. The routing-and-records officer extracts the information from the recording machine daily, amends his own records and advises the repair centre.

As stated earlier, because of the time lag in error detection, it is difficult to determine the number of errors which have crept into the system before and after the field trial was started. This makes it difficult to evaluate. However, what is known is that the routing and records officer now makes nearly twice as many record changes as he did before the trial started six months ago and on this basis the records must be considerably more up to date now than previously. It is proposed to extend the trial to a second large installation control territory in the Belfast Telephone Area.

R. BEGGS

South Eastern Region

Services Bridge Spanning the River Medway

A scheme to improve the flow of traffic on the A2 between Strood and Rochester, over the River Medway, was instigated in 1964, and involved the reconstruction of a disused railway bridge.

Since the bridge was administered by a Court of Wardens and not by a road authority, the normal Public Utility Streets Works Act did not apply and reconstruction of the bridge, therefore, required a Parliamentary Bill.

The design of the reconstructed bridge was not suitable for the provision of plant for future expansion of all public services, in particular the Post Office required twelve 4 in diameter ducts and a bridge solely for the use of public services was constructed.

The cost of the main structure was £70,000 and was shared on a percentage basis of the weight of ducts or pipes provided by each service. The contributions of each service was as follows:

Rochester Corporation Sewer 32.2 per cent, Post Office 18.8 per cent, Area Electricity Board 15.9 per cent, Gas Board 15.1 per cent, Central Electricity Generating Board 12.0 per cent and Water Company 6.0 per cent.

Annual charges are born by the services on the same percentage basis as the initial charges, these charges include painting every five years and renewal of main structure after 75 years if necessary.

The services bridge is situated between the existing and new carriageway bridges, giving greater security to all plant (Fig. 1).

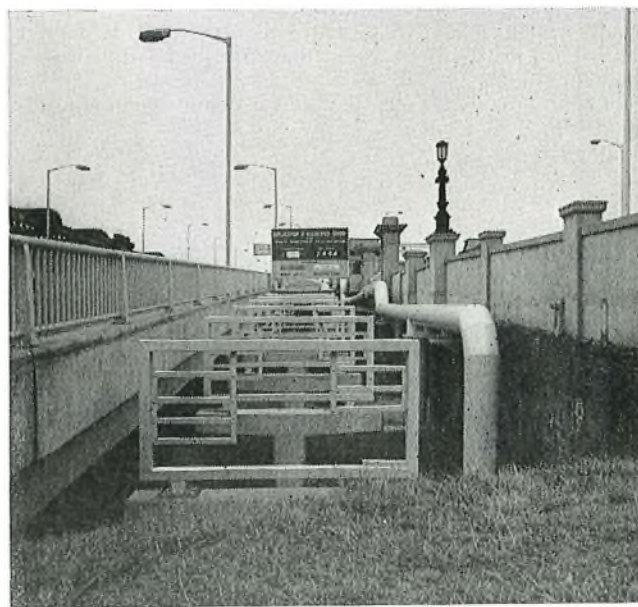

FIG. 1—The new services bridge

The bridge has four spans and is approximately 200 metres in length, 2.25 metres high, 2.55 metres wide, is covered by a continuous fibre-glass roof and incorporates a central timber-floor 0.9 metres wide, giving access to plant for inspection and maintenance (Fig. 2). Centrally situated over the timber floor is a manually-propelled travelling chain-block, enabling plant to be transported along the inside of the bridge.

All supporting iron work within the bridge is welded and end-support sections are mounted on concrete pillars which decrease in height to allow ducts to enter the river bank at a reasonable depth. The steel ducts have an external coating of polyvinyl-chloride (p.v.c.) and are sleeve jointed in the usual manner. Joints are then bound with a similar p.v.c. tape to ensure complete sealing of the external p.v.c. coating.

The ducts are supported in the iron framework sections by

wood formers (see Fig. 2) and both were manufactured to Telecommunications Headquarters specification.

Construction of the interception manhole at the Strood end

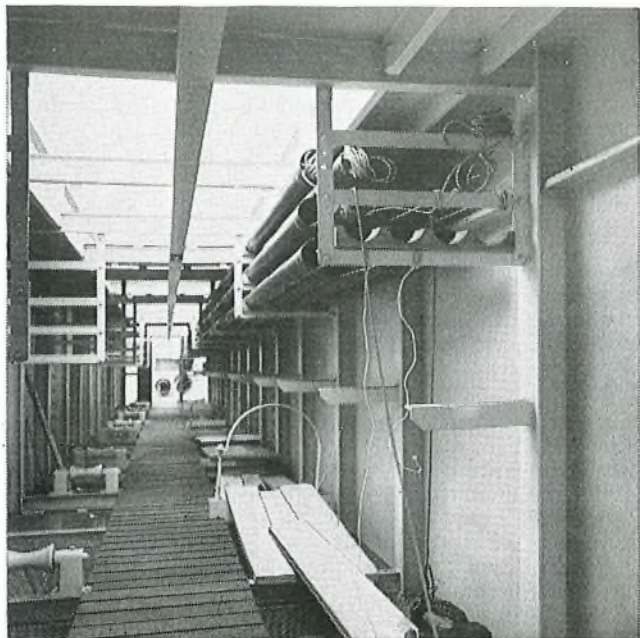

FIG. 2—An inside view of the services bridge

of the bridge was prolonged owing to the discovery of 18 in. square wooden piers, which had supported part of the old South Eastern Railway station, the wood being still in very good condition.

Duct and manhole construction was completed in November, 1970.

J. SIMPSON

A. C. BANHAM

South Western Telecommunications Region

Water Power

At 2200 hours on 9 April 1971, a 250-pair cable serving an industrial site in the Alphington area of Exeter went faulty. The fault was proved into a length of cable where the duct track was adjacent to extensive road and demolition works being carried out in connexion with the provision of a new bridge across the river Exe. The situation was not

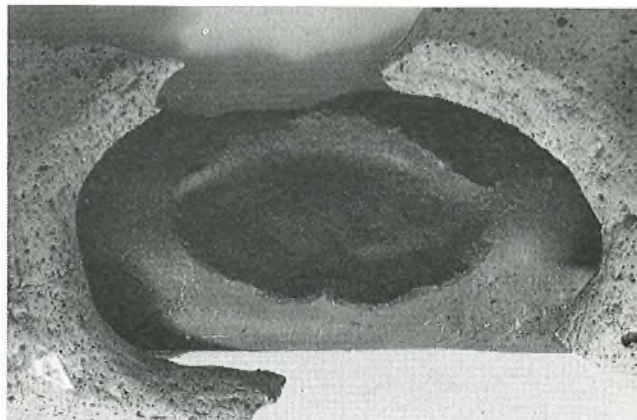

Eroded duct and lead cable

improved by heavy traffic and the fact that it was the start of the Easter holiday.

It was decided to locate the fault by a Murray test, renewal of the length was impossible whilst the traffic conditions were bad, but an *in-situ* repair was possible if the fault proved to be clear of the road. The fault was measured to a point under the concrete forecourt of a garage, just clear of the road, and digging down on the fault commenced. Almost immediately water started to appear in some quantity, but by using a pump to clear it, the excavation was continued, finally a 3-in water main was uncovered. It was fractured around its circumference and water was jetting from the pipe in two places. The main force of the water was directed on the Post Office duct situated at about 14 in from the water pipe. The other jet had displaced the caulking of a joint in an adjacent gas main, and so we had a gas leak to contend with; it had also started to wear a depression in an asbestos duct belonging to the electricity board.

The photograph clearly shows the effect of the water on the Post Office duct and cable. The glazing of the duct had been worn away by the abrasive action of the soil and water, and the continued pressure of the jet of water had bored a hole through the duct and then compressed the lead sheath of the cable until it finally fractured. The core of the cable was saturated and an *in-situ* repair was not possible.

Service, by means of an interruption cable, was finally restored at 1930 hours on 11 April 1971 after the Gas Company and the Water Board had finished their repairs.

How long the water main had been fractured is not known, it only supplied water to the garage under whose forecourt the fault occurred.

C. F. W. CONDER

Associate Section Notes

Aberdeen Centre

On the morning of Wednesday 28 April a party of 10 visited the Fraserburgh works of Consolidated Pneumatic Tool Co. Ltd. where they spent a very interesting three hours touring the plant which manufactures pneumatic tools and industrial hand tools.

After lunch the coach took the party to Buckie for a visit to Thorn Electrical where they make a wide variety of lamps including Post Office Lamps No. 2.

This year the annual general meeting was held on 4 July in the Caledonian Hotel and the following office bearers were elected.

President: Mr. J. H. W. Sharp; *Vice-President:* Mr. D. S. C. Buchan; *Chairman:* Mr. J. Davidson; *Secretary and Treasurer:* Mr. J. H. McDonald; *Assistant Secretary:* Mr. R. Mathewson; *Librarian:* Mr. W. Williamson.

The gratitude of the centre for past services was expressed, at this meeting, to Mr. R. T. Ross who resigned as chairman after holding this office for 18 years.

J. H. McDONALD

Ayr Centre

The March meeting was a talk entitled "Railway Signalling and Telecommunications" and was given by Mr. R. Dean of Britain Railways. Many aspects of signalling, telecommunications and electrification of the British Railway system were discussed and a very interesting meeting resulted.

The undoubted highlight of the 1970-71 session was a visit to Grant's Distillery Girvan, in May. On a very fine evening our party went by bus to Girvan where the various processes connected with whisky production were carefully explained to us by knowledgeable guides.

The session ended in June with the annual general meeting at which some changes in committee were made and we now look forward to next session.

A. BAGNALL

Colchester Centre

At the annual general meeting held on Wednesday, 14 April, the following officers were elected. *Chairman:* Mr. L. A.

Farrow; *Vice-Chairman*: Mr. J. Fisher; *Secretary*: Mr. R. L. E. Durrant; *Assistant Secretary*: Mr. G. Humm; *Treasurer*: Mr. K. J. Bridges; *Committee*: Messrs. K. Pilgrim, T. Shanks and K. Marshall.

The evening was completed by a talk on modern racing car development by Mr. Maskery and Mr. Hayward of Merlin Racing Cars.

With the winter program completed, the summer program got off to a flying start, so to speak, with a visit by helicopter to a gas rig, situated somewhere in the North Sea. Those of us who were fortunate enough to attend were well satisfied with the visit.

My thanks to the retiring secretary for completing the final details of the rig visit, after his term of office, in the absence of the assistant secretary.

Other visits which took place during the summer were: Shell Mex refinery, a nuclear power station, B.B.C. studios, Hawker Siddeley aircraft, Vauxhall Motors, and Booths Distillery.
R. L. E. DURRANT

Edinburgh Centre

The annual general meeting and dinner of the Centre was held in the Iona Hotel on 7 April 1971.

The following office bearers were elected for 1971-72 Session. *Chairman*: Mr. J. A. Coghill; *Secretary*: Mr. M. K. Finland; *Assistant Secretary*: Mr. T. A. Woolard; *Treasurer*: Mr. R. W. Elder; *Librarian*: Mr. M. I. Collins; *Committee*: Messrs. J. Samson, I. D. Hoseason, J. Sharp, S. Barr, J. Edwardson, R. R. Thomson, R. S. Elder and R. Cunningham. *Auditors*: Messrs. A. R. Clachers and G. Scott.

M. K. FINLAND

Medway Centre

On Tuesday 26 January the Centre welcomed Professor J. H. H. Merriman, C.B., O.B.E., as its guest speaker.

Professor Merriman, who is board member for Technology spoke on "The Post Office and its Technology".

Over 100 members gave the Professor an enthusiastic welcome and in his talk he spoke of some of the advancements that would be made during the next 10 years. Under-ground systems would be improved with increased use of pulse code modulation and electronic exchanges would be commissioned in ever-increasing numbers. Crossbar exchanges would also increase but not to the same extent and the Strowger system, which has done sterling work over the years, would slowly disappear.

Professor Merriman used slides to illustrate his talk. Expenditure was also considered and vast sums of money will be required if the envisaged expansion is to take place.

L. PASCOE

Middlesbrough Centre

At the annual general meeting on the 19 May 1971 the Chairman reported another full year of activities but still a shortage of members at meetings. He reported that despite initial teething troubles, our week-end trip to Amsterdam had been a huge success and it was hoped we would make these visits abroad an annual event.

The Secretary gave an account of the season's activities which had consisted of four talks and four visits in addition to the holiday week-end.

The officers elected for the coming season are: *Chairman*: Mr. R. G. Inns; *Vice-Chairman*: Mr. W. Outhwaite; *Secretary*: Mr. K. Whalley; *Assistant Secretary*: Mr. R. D. Purvis; *Treasurer*: Mr. P. K. Harrison; *Librarian*: Mr. T. Becket; *Auditors*: Messrs. K. Roe and R. Oliver; *Committee*: Messrs. C. Carr, I. Tyreman, T. Becket and W. K. Brown.

A variety of suggestions were put forward for our next year's program which, when arranged, will be published at a later date.

K. WHALLEY

Southampton Centre

Postal mechanization and the British Broadcasting Corporation (B.B.C.) were our closing features this year. Mr. R. Toogood of the Southampton postal engineering section was our guide to the mechanized sorting office. He gave a thorough description of the electrical and mechanical functions used in handling letters and parcels.

A week later we were pleased to welcome Mr. G. P. Copping from the Design and Development Branch of Postal Headquarters. His enlightening lecture, which was illustrated with slides, gave us the theory behind the mechanized system,

its initial conception, its growing pains and its future expectations.

The visit to the B.B.C. at the White City complex was most informative. We were shown into the studios and the technical rooms, watched a producer and staff at work and saw scenery being made. During this quite speedy visit to a very large centre we were treated to a marvellous dialogue linking all that we saw to producing, staffing and financing a program.

Our year finished with the annual general meeting in late April supported by technical and other films. The Centre wishes to thank Mr. Collins, the President, Mr. Wiltshire and Mr. Luff, Vice-Presidents, for their support in the past year and are glad that they have all accepted our invitation to stand next year.

The Centre's committee for the following year is: *Chairman*: Mr. R. G. Genge; *Vice-Chairman*: Mr. A. A. Hutchings; *Secretary*: Mr. M. C. Short; *Assistant Secretary*: Mr. G. A. Holyoake; *Treasurer*: Mr. E. J. Green; *Librarian*: Mr. K. J. Mann; *Committee*: Messrs. K. W. Hammerton, S. R. Parker, B. G. Roberts and D. Stephenson.

To enable our library to perform an increasing service to members it is hoped to stock a comprehensive set of journals and answers to City and Guilds questions, correspondence courses and other up-to-date information. Those members who have copies of journals, etc., which they no longer require, please contact the librarian.

The program arranged so far for this session has included a mystery tour and social evening in August, visits to International Business Machines, Hursley, and B.B.C. London in September and an introduction to a subscriber trunk dialling in October.

M. C. SHORT

Stirling Centre

The following office bearers were elected for the 1971-72 session at our annual general meeting held in Falkirk on Tuesday, 20 May. *President*: Mr. E. Taunton; *Chairman*: Mr. T. S. Young; *Vice-Chairman*: Mr. J. Smith; *Secretary*: Mr. J. Hannah; *Treasurer*: Mr. R. Henderson; *Committee*: Messrs. G. Derby, W. McGregor and J. McLaren.

Our 1971-72 program has not been fully compiled, but we hope more members will avail themselves of joining in visits and talks. In fact an improvement on the average of 18 members per monthly meeting in 1970-71 is hoped for in this our second full session.

J. HANNAH

Chester

The annual general meeting of the section was held at the Black Lion Hotel on Tuesday 11 May 1971, and was followed by a film show. In his report the Chairman, Mr. C. Smith, mentioned the visits to British Celanese and Firestone Tyres at Wrexham, and the Chester Chronicle offices at Chester. While these visits were reasonably well supported numerically, it did seem that it was always the same nucleus of members on each one and we would welcome some new faces. There were also two interesting talks during the session, one by a fellow member, Mr. H. Finnigan, who gave an interesting talk on stamp collecting, supported by an excellent display of some of his collection. The other talk was our annual event, presented this year by the Rank Organization, on fibre optics. The 150 people present were treated to a first class lecture on the subject, supported by many visual aids.

There was also a joint meeting of the Colwyn Bay, Bangor, and Chester centres at Llandudno at which our hosts, the Colwyn Bay Centre, presented a talk by one of their members on mountain rescue, supported by a film on the ascent of Everest.

The following officers were elected for the coming session: *Chairman*: Mr. C. Smith; *Vice Chairman*: Mr. B. T. Childe; *Secretary*: Mr. T. Parsonage; *Treasurer*: Mr. D. B. Hickie; *Committee*: Messrs. J. Park, G. Darwin, T. G. Clapshaw, W. A. Davies, W. A. Davies, W. J. Crewe, E. A. Bates, J. R. Ingman, L. T. Davies, A. Davies, J. Doyle, J. A. Edwards, P. Salamon.

Mr. F. V. Gallagher, who did not wish to be re-elected, and Mr. H. W. Jones who had recently been promoted, were both thanked for their services to the section.

We look forward to an interesting year in which we hope to visit an Aircraft Factory, Planetarium, Brewery, Motor Race, and a Steelworks.

T. PARSONAGE

Institution of Post Office Electrical Engineers

Essay Competition 1971-72

To further interest in the performance of engineering duties and to encourage the expression of thought given to day-to-day departmental activities, the Council of the Institution of Post Office Electrical Engineers offers prizes totalling £40 for the five most meritorious essays submitted by Post Office engineering staff below the rank of Inspector. In addition to the five prizes, the Council awards five certificates of merit. Awards of prizes and certificates made by the Institution are recorded on the staff docketts of the recipients.

An essay submitted for consideration of an award in the essay competition and also submitted in connexion with the Associate Section I.P.O.E.E. prizes will not be eligible to receive both awards.

In judging the merits of an essay, consideration will be given to clearness of expression, correct use of words, neatness and arrangement, and although technical accuracy is essential, a high technical standard is not absolutely necessary to qualify for an award. The Council hopes that this assurance will encourage a larger number to enter. Marks will be awarded for originality of essays submitted.

Copies of previous prize-winning essays have been bound and placed in the Institution Central Library. Members of the Associate Section can borrow these copies from the Librarian I.P.O.E.E., 2-12 Gresham Street, London, EC2V 7AG.

Competitors may choose any subject relevant to engineering activities in the Post Office. A4 paper should be used, and the essay should be between 2,000 and 5,000 words. An inch margin should be left on each page. A certificate is required to be given by each competitor, at the end of the essay, in the following terms:

"In forwarding the foregoing essay of . . . words, I certify that the work is my own unaided effort both in regard to composition and drawing"

Name (in Block Capitals)

Signature

Official Address

The essays must reach:

The Secretary,
The Institution of Post Office Electrical Engineers,
2-12 Gresham Street,
London, EC2V 7AG

by 15 January, 1972

The Council reserves the right to refrain from awarding the full number of prizes and certificates if in its opinion the essays submitted do not attain a sufficiently high standard.

Institution Field Medal Awards—1969-70 Session

Details of the medals awarded for the best papers read at meetings of the Institution in field subjects primarily of regional interest were published in the July 1971 issue of the *Journal*.

The Council of the Institution is indebted to Mr. H. T. McGrath, Chairman of the Papers Selection Committee of Council, for the following précis of the medal winning papers:

"The Innovators—Efficiency Engineers in Regional Planning and Works Execution", by A. G. J. Fagg and D. A. Gray

This paper describes the development of efficiency engineering in the Post Office and demonstrates the contribution of the regional efficiency organization in achieving improvements in the planning and major works fields.

Having stressed the need for continual improvement in efficiency in order that the published aims of the Post Office can be achieved, the authors provide a short description of business efficiency principles; explaining that specialist

engineers, divorced from day-to-day operations, can contribute towards substantial economies by the systematic development of new working methods.

After tracing a short history of efficiency engineering in the Post Office, the quantifiable measurements of efficiency are defined in terms of profitability, productivity and performance together with an explanation of the relationships between the terms. The indices used by the Post Office in the main engineering fields are mentioned.

The paper then describes how a major project, usually labour intensive, is selected at Telecommunications Headquarters (T.H.Q.) (Management Services Division) for investigation, cleared with staff associations via the Experimental Changes of Practice Committee, and then implemented in the field after suitable field trials. Net savings achieved by the change of working practice form the basis for assessing pay agreements and Area Telephone Improvements Plans (TIPs). Although major productivity schemes usually originate in T.H.Q., the authors stress that useful ideas for local or national development can materialize via line management, area engineering productivity committees and the Post Office awards scheme.

The role of the regional efficiency organization in the planning division of a typical region is then discussed in some detail, the authors explaining that in addition to monitoring major schemes originating in T.H.Q. they provide advisory services for the planning controller on manpower and productivity issues. Other facets of their role include the maintenance of a monitoring function on various area performance statistics and an advisory service to area management when required. It is emphasized that an efficiency engineer must also be something of a psychologist and a diplomat, since any proposed project is doomed to failure without the whole-hearted support of staff and local management.

The principles described in previous paragraphs are then illustrated by accounts of some recent case studies, notable examples being:

- (i) the external and internal planning and works control schemes,
- (ii) reorganization of rodding and cabling staffs,
- (iii) utilization of pole erection units,
- (iv) jointing procedures, and
- (v) vehicle utilization.

As regards the future, the authors consider that the Post Office is moving from a decade where the emphasis has been on productivity and automation, towards a period when profitability in all aspects of innovation will be the main criteria in judging the effectiveness of efficiency improvement. Introduction of the new cost results system will ensure even tighter control over all resources of the business and critical examination of all planning and control procedures.

The paper concludes that with efficiency engineering undergoing considerable change as nationally agreed projects are systematically introduced, the regional efficiency engineer is providing an essential service in introducing and monitoring the projects in the field; as the title of the paper suggests, they are becoming innovators!

The paper is adequately illustrated by drawings and diagrams supporting the main arguments in the text and providing additional detailed information on appropriate subjects.

"Network Co-ordination", by J. D. Thomas

The paper provides a commentary on procedures adopted in the recently established network co-ordination centres (n.c.c.s) at Telecommunication Headquarters (T.H.Q.) and regional levels, and discusses their effectiveness based on experience gained in the North Eastern Telecommunications Region (N.E.T.R.).

The dramatic rise in the level of automatically-dialled calls as subscriber trunk dialling penetration increased in the

1960's together with the progressive introduction of refined high-frequency techniques, demanded an organization which could report major failures on the main network within minutes to all parts of the United Kingdom. Co-ordination centres were initiated at T.H.Q. (n.n.c.c.s) and regions (r.n.c.c.s) during 1968 following the preliminary introduction of pilot schemes in three Regions.

The author describes how n.c.c.s were established indicating staffing and communication arrangements. Difficulties encountered in compiling high-frequency network records in the N.E.T.R. and how they were overcome are mentioned. The need for close co-operation between r.n.n.c and the regional circuit provision control is stressed.

The main functions and objectives of n.c.c.s are then defined, the priority task being to report major network failures to other Regions and T.H.Q. in a minimum of time. Other functions are to highlight weaknesses in serviceability and performance by maintaining surveillance on circuit and plant outage times; a study of trends in breakdown and restoration of systems often indicating necessary remedial action. The n.c.c. also provides an essential service in co-ordinating and controlling planned withdrawal of plant and circuits on A60 procedure. Monitoring circuit restoration times and system availability contributes towards the main objective of the n.c.c. organization, "the improvement in serviceability of all public and private circuits".

The procedure when reporting a major network failure via the n.c.c. organization is then described in some detail, the author emphasizing the essential differences in approach when dealing with failures on co-axial, radio link and television systems. The incidence of exchange isolation is also discussed. The r.n.c.c. in the N.E.T.R. shows that the number of failures attributable to human activity (both Post Office and non Post Office) is disturbingly large, and "faults not found" on transmission plant are also regrettably high. Remedial action in the region is being directed towards improvement in these classes of failure.

The author considers that n.c.c.s have been generally effective in reporting and investigating major failures, and prompt notification to appropriate operational groups has achieved positive results in preventing recurrence of many faults.

Efforts to improve trunk circuit serviceability inevitably revolve around re-routing possibilities, and the author considers that the *ad hoc* arrangements made on available spare plant, both nationally and in the N.E.T.R., although effective in specific cases, are not entirely satisfactory. The problem will not be resolved until the new planned 4 MHz and 12 MHz service protection network (s.p.n.) is commissioned; whilst planning on line plant aspects is well advanced, final arrangements for switching at terminal repeater stations have not yet been decided. The provision of the s.p.n. will facilitate preparation of permanent re-route plans, with the possibility of automatic control and switching by computer in the future. An interesting example of how a major breakdown occurred in the N.E.T.R. is outlined, indicating how radio-protection links and the s.p.n. can be utilized in maintaining communication channels.

The author concludes with descriptions of some locally introduced r.n.c.c. activities, all of which contribute towards improvement in serviceability.

The text of the paper is lavishly supported by illustrations, diagrams and graphs where appropriate; the clarity with which the statistics of performance, network failure and serviceability are represented being particularly notable.

Election of Members of Council 1971-72

The results of the recent elections of members of Council are as shown below, the names being shown in order of votes counted.

Grade Representation

Senior Executive Engineers and Regional Motor Transport Officers of the Provincial Regions. Factory Senior Executive Engineers and Assistant Factory Managers of the Factories Division (Provinces).

Mr. M. W. BAYLEY (Cardiff) (returned unopposed).

Inspectors of the Post Office Headquarters Departments and of the London Regions.

Mr. M. COCKERELL (Croydon) (returned unopposed).

Inspectors of the Provincial Regions.

Mr. M. RICHARDS (Pontypool) (returned unopposed).

Draughtsmen and above and Illustrators and above of the Post Office Headquarters Departments and the London Regions.

Mr. C. F. GOLDSMITH (Croydon) (returned unopposed).

Draughtsmen and above of the provincial regions and of the Factories Division (provinces).

Mr. K. CHINNER (Wolverhampton)

Mr. J. STANLEY (Middlesbrough)

Mr. D. LORIMER (Edinburgh)

Mr. J. C. CLARKE (Northampton)

Mr. H. E. WESTON (Bedford)

Mr. J. R. PEARSON (Taunton)

Mr. D. JENKINS (Swansea)

The constitution of the council for the year 1971-72 will, therefore, be as follows:

Mr. N. C. C. DE JONG—Chairman.

Mr. D. WRAY—Vice-Chairman.

Mr. H. T. MCGRATH—Honorary Treasurer.

Mr. M. MITCHELL, M.B.E., E.R.D.—Representing the Staff Engineers, Chief Motor Transport Officers, Submarine Superintendent, Senior Principal Scientific Officers, Assistant Staff Engineers, Motor Transport Officers Class 1, Deputy Submarine Superintendent, Principal Scientific Officers, Chief Experimental Officers, Commanders (Cable Ships), Chief Factories Engineer and Principal Technical Costs Officers of the Post Office Headquarters Departments and Regional Engineers of the London Regions.

Mr. S. H. SHEPPARD—Regional Engineers of the Provincial Regions.

Mr. A. H. ELKINS—Senior Executive Engineers, Motor Transport Officers Class II, Senior Experimental Officers, Senior Scientific Officers, Chief Officers, Chief Engineers and Senior Technical Costs Officers of the Post Office Headquarters Departments and Assistant Factory Managers of the Factories Division (London).

Mr. F. K. MARSHALL—Senior Executive Engineers and Regional Motor Transport Officers of the London Regions.

Mr. M. W. BAYLEY—Senior Executive Engineers and Regional Motor Transport Officers of the Provincial Regions. Factory Senior Executive Engineers and Assistant Factory Managers of the Factories Division (Provinces).

Mr. J. F. WALLINGFORD—Executive Engineers, Motor Transport Officers Class III, Experimental Officers, Scientific Officers, Second Officers, Second Engineers and Technical Costs Officers of the Post Office Headquarters Departments and Factory Overseers of the Factories Division (London).

Mr. F. W. G. REDMAN—Executive Engineers, and Assistant Regional Motor Transport Officers of the London Regions.

Mr. J. FARRAND—Executive Engineers, Assistant Regional Motor Transport Officers, Experimental Officers and Scientific Officers of the Provincial Regions, Factory Executive Engineers and Factory Overseers of the Factories Division (Provinces).

Mr. J. M. MACKIRDY—Assistant Executive Engineers, Technical Assistants, Senior Scientific Assistants, Assistant Experimental Officers, Third Officers, Fourth Officers, Third Engineers, Fourth Engineers, Electrical Engineers and Assistant Technical Costs Officers of the Post Office Headquarters Departments and Factory Foremen and Assistant Factory Foremen of the Factories Division (London).

Mr. G. F. MORLEY—Assistant Executive Engineers and Technical Assistants of the London Regions.

Mr. R. C. MALTBY—Assistant Executive Engineers, Technical Assistants, Senior Scientific Assistants and Assistant Experimental Officers of the Provincial Regions. Factory Foremen and Assistant Factory Foremen of the Factories Division (Provinces).

Mr. M. COCKERELL—Inspectors of the Post Office Headquarters Departments and of the London Regions.

Mr. M. RICHARDS—Inspectors of the Provincial Regions.

Mr. C. F. GOLDSMITH—Draughtsmen and above and Illustrators and above of the Post Office Headquarters Departments and of the London Regions.

Mr. K. CHINNER—Draughtsmen and above of the Provincial Regions and of the Factories Division (Provinces).

Mr. D. R. BEARHAM—Corporate Members holding non-engineering posts in the Post Office (Rule 11(a)).

Mr. L. A. WHITE—Affiliated Members of the Post Office Headquarters Departments and of the London Regions.

A. B. WHERRY
General Secretary

Press Notices

Electronic Telephone Exchanges Number more than a Hundred

More than 100 of Britain's telephone exchanges are now operated electronically. The total has been achieved within four years of the start of the present program of installing TXE 2 electronic exchanges, following the opening of the first TXE 2 exchange at Ambergate, Derbyshire, in December 1966. The Ambergate exchange was the first production electronic exchange in Europe, and the first small to medium-size production electronic exchange in the world.

Electronic telephone exchanges are now coming into service at a rate of more than two a week. The 100th was recently opened at Bawtry, near Doncaster. By the end of July the total in service was more than 130.

Commenting on the progress of these installations, Mr. Edward Fennessy, Managing Director Post Office Telecommunications, said, "These exchanges are helping to meet the needs of today and the future. Over the next four years the Post Office will be bringing them into service at a rate of three a week, so that in 1975 we shall have more than 700 in operation."

The size range of this type of exchange—meeting the needs of up to 2,000 lines initially, and with two in harness capable of growing to around 8,000 lines—covers about two-thirds of exchanges and about one quarter of subscribers.

Electronic exchanges, although rather more expensive initially, have undoubted advantages over electro-mechanical exchanges. Their components are not subject to mechanical wear, do not require mechanical adjustment and so require much less maintenance; they have lower running costs and greater reliability; installations and extensions are easier and, because they are compact, they need less space.

New Development to Streamline Telephone Switchboard Operation

The Post Office is to develop an entirely new type of operator switchboard to serve telephone exchanges through the last quarter of this century.

Based on solid-state electronics and using stored-program control the switchboard system is aimed at reducing operating time for a call; and it will enable switchboards to be placed many miles away from the exchange control equipment and in areas where staff can be recruited most readily.

A contract worth about £750,000 has been placed by the Post Office with Marconi Communications Systems Ltd to develop the system to Post Office specification and to provide two prototype switchboards with their associated control equipment. Following successful completion of stringent laboratory tests, the Post Office will place an order for 50 switchboards for a pilot exchange installation.

Large-scale orders for the new switchboard to be used in national and international exchanges could stem from experience gained with this pilot exchange.

At the switchboards, operators will push buttons to connect calls. Information required for billing will be recorded automatically and full details of the call will appear on a video display unit to aid the operator.

To ensure that telephonists will work with minimum

fatigue the switchboard and key layout have been designed in conjunction with the Post Office human factors research laboratory and with specialist assistance in the fields of ergonomics and applied psychology from the Medical Research Council.

Staff associations representing telephonists and their supervisors have co-operated with the Post Office in formulating requirements to meet the primary objectives of providing the best possible operating facilities with the minimum operator effort.

The new switchboard—to be known as C.S.S. No. 2—will be Britain's second generation of cordless switchboards. The first cordless switchboards were introduced by the Post Office at Thanet exchange, Kent, in 1956. By the middle of the present decade there will be about 4,000 of these switchboards in use in Britain, while similar switchboards have been exported to Australia and South Africa.

Post Office's Major Part in Global Plans

The British Post Office is playing a major part in meeting the challenge of future world telecommunications. It is actively preparing for vast increases in the volume—25 per cent a year—of international telephone and telex calls and transmitted computer data over the next decade. This involves providing many more cable, satellite and microwave radio circuits.

In 1970 more than 18 million international telephone calls were made from the United Kingdom, of which 58 per cent were dialled direct by customers. The volume is expected to be five times greater by 1980 and dialled calls will account for 85 per cent of the total.

There were 25 million international telex calls made from the U.K. in 1970—93 per cent of them dialled by the customer. The Post Office expects that by 1980 there will be nearly seven times as many and that customers will dial 99 per cent of them direct.

International data transmission from the U.K. started in 1965 when Datel 600 service was introduced to three European countries and the U.S.A. Since then Datel 100, 200 and 600 services have been introduced to a number of other European countries and to Australia and Canada. During the first half of the present decade, trials will begin on a separate high-speed inland data network based on telephone circuits. This follows studies of the need for a separate international data network offering an extended range of data transmission speeds and meeting the computer industry's demand for more complex facilities.

An overall increase of telephone-type circuits between the U.K. and other countries is likely from 3,750 in 1970 to 21,000 in 1980. At the end of 1970 the U.K. had nearly 2,000 telephone-type circuits through submarine cables to other countries. By 1980 these will have increased to 11,000, mainly as a result of six additional 1,260-circuit cables across the North Sea and additional transatlantic cables, including a second cable to Canada, with 1,840 circuits, due to be in service by 1974. Satellite circuits will be up from 290 to 3,600 and the capacity of the microwave radio link to France will increase from 1,500 to 6,400 circuits.

Contract Placed for Cantat 2

CANTAT 2, the new high-capacity U.K.-Canada submarine cable that will more than double telephone links across the Atlantic, will be British made. A £22 million contract for the massive 1,840-circuit cable has been placed by the British Post Office and the Canadian Overseas Telecommunications Corporation with Standard Telephones and Cables Ltd.

With 1,840 circuits, the cable will have over 400 more circuits than all the existing transatlantic cables put together; and, in addition to telephone calls, it will be used for telex, telegrams and data transmission. It will be produced to an advanced design made possible by work at the Post Office Research Station at Dollis Hill, North London.

More than 2,800 nautical miles of cable will be laid to cover the 2,700-nautical-mile route between the British cable station in Widemouth Bay, Cornwall, and a new cable terminal to be built near Halifax, Nova Scotia. Altogether the complete cable will weigh little more than 15,000 tons, and for most of its length it will be less than two inches in diameter. Bringing the cable into service will cost about £30,500,000. This covers production, survey and development work and the laying operations. The cost will be shared by the British Post Office and the Canadian Overseas Telecommunications Corporation.

Two cable ships will be chartered to lay the cable. They are the Cable and Wireless cable ship *Mercury* and the powerful Canadian ice-breaker/cable-laying ship *John Cabot*.

CANTAT 2 will be the third undersea cable between the United Kingdom and Canada. The first transatlantic telephone cable—TAT 1, from Oban, Scotland to Clarenville, Newfoundland—was opened in 1956. CANTAT 1, first section of the Commonwealth Cable Network was laid between Oban and Hampden, Newfoundland, in 1961, with 80 circuits to carry calls between Britain and Canada and on to New Zealand, Australia and the Far East over the Commonwealth Pacific and South East Asia cable systems.

CANTAT 2 is primarily intended for Britain's communications with the North American continent. Since CANTAT 1 was laid the annual total of telephone calls between the U.K. and Canada has increased sevenfold. Calls from Canada to this country now occupy nearly 3½ million minutes a year and from U.K. to Canada about 2 million minutes. Calls from the U.S.A. account for nearly 13½ million minutes a year (compared with less than 2 million in 1960) and to the U.S.A. from Britain over 10½ million minutes (compared with 1½ million in 1960).

Since the construction of CANTAT 1 satellite communications have become established and these are providing an increasing proportion of transatlantic communication every year. But at the same time improvements in the technology of undersea cables allow the number of circuits to be increased greatly without a proportionate increase in cost. Because of this, transatlantic communications between Europe and North America—the busiest inter-continental route in the

world—can have new links added economically by submarine cables.

For example, whereas CANTAT 1 was laid at a cost of £100,000 a circuit, CANTAT 2 will cost only £16,700 a circuit.

The CANTAT 2 cable will be predominantly of light-weight design developed by the Post Office with an outer conductor of aluminium and the strength in a steel rope inside the inner copper conductor. Compared with armoured cables, it is cheaper to produce, easier to lay, and easier to bring to the surface for repair. CANTAT 1 was the first cable of this design. External armour is still used for additional protection on sections of the cable laid in shallow water.

The repeaters in the cable have to give a trouble-free life of more than 25 years and each of the CANTAT 2's 490 repeaters (there are 90 in CANTAT 1) is protected by a deep-sea pressure housing of proven design developed by the Post Office and Standard Telephones and Cables Ltd. They use separate amplifiers for each direction of transmission.

The transistors in the repeaters were developed by the Post Office and produced by the Post Office and ST & C. A very high standard of reliability is set for them, with a performance standard ensuring that in 25 years' operation less than one transistor in 4,000 will fail. About 3,200 transistors will be used in the CANTAT 2 repeaters in the main amplifying path. Meanwhile another 18,000 transistors will be exhaustively tested electrically and mechanically—some to destruction—to help in the control of the quality of those selected for the cable. The transistors use aluminium wires bonded to aluminium contacts in a process developed by the Post Office Research Department. This bonding has an impressive reliability performance with not a single failure in 40,000 bonds tested in production and 6,000 in transistors now on the sea bed.

Commercial capacity of 1,840 circuits spaced at 3 kHz intervals and arranged as 23 supergroups, use the frequency band 312–6,012 kHz in the A–B direction of transmission and 8,000–12,700 in the B–A direction. Four service order-wire circuits of nominally 3 kHz bandwidth each use the frequency bands 6,024–6,036 kHz in the A–B direction and 7,976–7,978 kHz in the B–A direction of transmission.

To select the best route for the cable the *John Cabot* is surveying the Continental shelves on both sides of the Atlantic ocean. Deep ocean areas are being surveyed this summer by a French cable vessel with British Post Office marine staff on board. In picking the route the Post Office will be helped by detailed information from many sources including the British and Canadian Hydrographic Offices, the National Institute of Oceanography, and the Bedford Institute of Oceanography in Canada. This information is vital to the surveyors picking a path through the valleys and passes of the mid-Atlantic ridge. Other factors that the route planners have to consider include the nature of the sea bed, other cables, and fishing grounds where there is heavy trawling.

Copyright

The entire contents of this Journal are covered by general copyright, and special permission is necessary for reprinting long extracts, but editors are welcome to use not more than one-third of any article, provided that credit is given at the beginning or end, thus: "From *The Post Office Electrical Engineers' Journal*."

The Board of Editors is not responsible for the statements made or the opinions expressed in any of the articles or the correspondence in this Journal, unless such statement is made specifically by the Board.

Subscriptions and Back Numbers

The Journal is published quarterly, in April, July, October and January, at 21p per copy: 31p per copy including post and packing (£1.24 per year) (3 dollars Canada and U.S.A., per year). Back numbers will be supplied, if available, price 24p (34p post paid) per copy. January and April 1969, October 1968, and all Journals earlier than July 1967 (except January and October 1966) are no longer available. Orders, by post only, to *The Post Office Electrical Engineers' Journal*, 2–12 Gresham Street, London, EC2V 7AG.

Employees of the British Post Office can obtain the Journal through local agents.

Binding

Readers can have their copies bound at a cost of £1.87½p plus 24p (40p overseas) return postage, by sending the complete set of

parts, with a remittance to Press Binders Ltd., 4 Iliffe Yard, London, S.E.17.

Remittances

Remittances should be made payable to "*The P.O.E.E. Journal*" and should be crossed "& Co."

Advertisements

All correspondence relating to advertisement space reservations, copy, proofs, etc., should be addressed to the Advertisement Manager, *The Post Office Electrical Engineers' Journal*, 2–12 Gresham Street, London, EC2V 7AG.

Communications

With the exceptions indicated above, all communications should be addressed to the Managing Editor, *The Post Office Electrical Engineers' Journal*, 2–12 Gresham Street, London, EC2V 7AG.

Model Answer Books

Books of model answers to certain of the City and Guilds of London Institute examinations in telecommunications are published by the Board of Editors. Details of the books available are given at the end of the Supplement to the Journal.

Stick-a-strip. The cable with instant impact that sticks anywhere.

Stick-a-Strip will stick to plaster, paint, tiles, glass and brickwork. So it'll go neatly along walls and skirting boards and lie flat under carpets. In the home or the office. Even in awkward corners where you can't swing a hammer, a special corner cover will take care of that.

It has a wide range of terminations for installing 'phones or low-voltage equipment such as radio or hi-fi speakers. And it saves you time, too. No stapling or sore thumbs. You just press it

gently into place and it stays put.

Stick-a-Strip's easy to store. Because it sticks to itself in a tidy roll when not in use. And it comes in 50 metre packs in grey or cream, to complement any colour scheme.

If you'd like to know more about Stick-a-Strip write, 'phone or telex : Standard Telephones and Cables Limited, Plastic Telephone Cable Division, Corporation Road, Newport, Monmouthshire, NPT OWS. Tel: 0633 72281 Telex: 49368

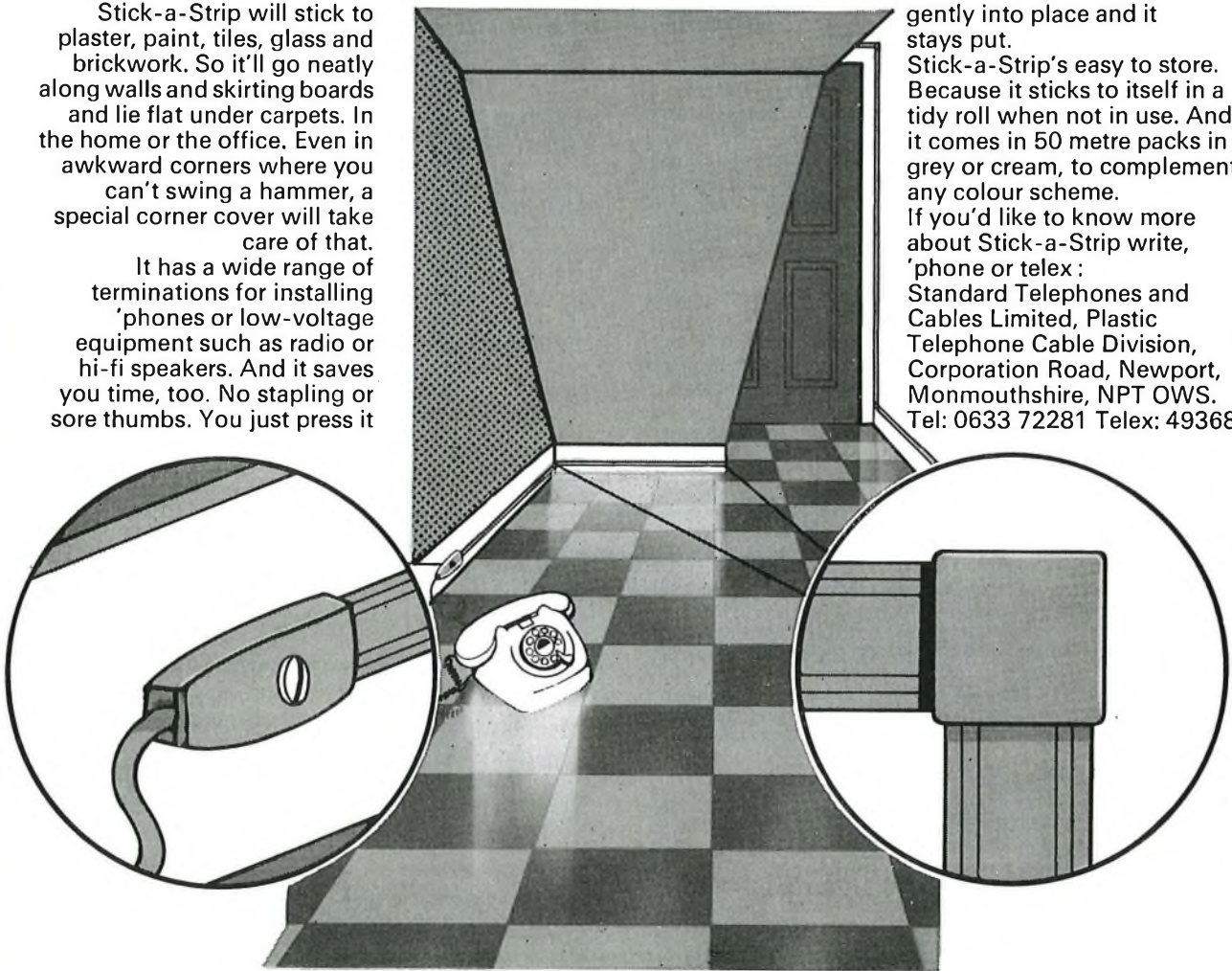

an associate of
ITT

Plastic Telephone Cable Division

STC

WHITELEY

Telephone Mansfield 24762

It makes sound sense to talk to Whiteley. Not only for audio but all signals from d.c. to r.f. Firstly we generate or transduce signals as you require. Then we make them louder, softer, squarer, pulsed, smoother or whatever to send down your wire or co-ax. We can ease the signals into the line. Boost them when they are weak, filter or re-shape. If they get lost we provide equipment to find them. At the other end we can reproduce them in quantity and quality. From packages that are attractive or rugged, attractively rugged, or, ruggedly attractive. The facilities and know-how are at Mansfield — come and sound us out.

FOR SOUND & SIGNAL CONTROL & MONITORING

Field and Exchange test equipment, low frequency and high frequency cable location equipment, line repeaters, transmitter and receiver insets, attenuators, filters and rheostats.

WHITELEY ELECTRICAL RADIO CO. LTD., Mansfield, Notts, England. Tel. Mansfield 24762
London Office: 109 Kingsway, W.C.2. Tel. 01-405 3074

CAMBION®

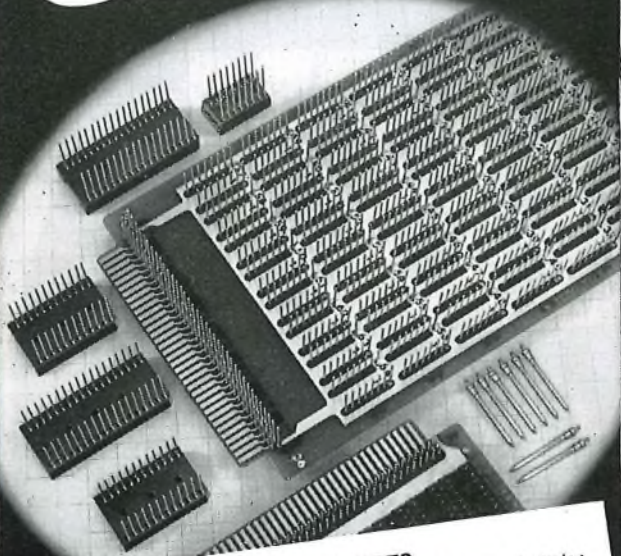

- WIRE WRAP PRODUCTS**
The CAMBION components for Wire Wrapping include:
- **Integrated Circuit Sockets** for 14, 16, 24, 36 lead dual-in-line I.C.'s.
 - **Socket Cards** Standard plug-in cards for high-density packaging of up to 126 I.C.'s.
 - **Terminal Pins & Cage Jacks** for printed circuit/discrete component connection.

Photographed on centimetre graph paper

Top-Quality Components

Cambion design and manufacture the world's most reliable professional electronic components.

- **SOLDER TERMINALS, INSULATED TERMINALS, TERMINAL BOARDS, ASSEMBLY TOOLING**
- **CAGE JACK CONNECTORS, PATCH CORDS, PLUGS**
- **I.C. ACCESSORIES, BREADBOARDS, SOCKETS ETC.**
- **WIRE WRAP TERMINALS, SOCKETS, CARDS**
- **R.F. COMPONENTS, CHOKES, COIL FORMS, COILS, MICROINDUCTORS, CAPACITORS**
- **THERMOELECTRIC DEVICES**
- **I.C. LOGIC ASSEMBLIES**
- **PANEL HARDWARE**

Write now for illustrated literature on over 22,000 Cambion guaranteed Catalogue items.
Cambion Electronic Products Ltd.
Cambion Works, Castleton,
Nr. Sheffield, S30 2WR
Tel: 0433 2 831 (Hope 831)
Telex: 54444



Hatfield are on the level...

with the new Hatfield Selective Level Measuring Set comprising Level Meter 1001 and Level Oscillator 1003 you can measure cross talk attenuation to 115dBm.



Two light weight units provide level measurements at any audio frequency in 140 and 600 systems, even in the presence of other signals.

Measurements range: +25 dBm to -115 dBm
Frequency range: 30 MHz. to 30 KHz.
Oscillator output range: +21 dBm to -105 dBm

Send for full details of Hatfield Selective Level Measuring Set and a copy of our Short Form Catalogue.

HATFIELD forward thinking in electronics

HATFIELD INSTRUMENTS LIMITED
Burrington Way, Plymouth PL5 3LZ, Devon.
Tel. Plymouth (0752) 72773/4 Grams: Sigjen, Plymouth. Telex: 45592
South-East Asia: for prompt service and deliveries, contact:
Hatfield Instruments (NZ) Ltd., P.O. Box 561, Napier, New Zealand.

Get Access* to your problem...

*... ACCESS EQUIPMENT LIMITED



leaders in the field with ZIP-UP Mobile Aluminium Staging, TALLESCOPE Mobile Work Platforms, BEANSTALK Hydraulic Work Platforms, MOUNTIE Safety Steps and many other products.

We have the equipment and the men to advise you on every installation and maintenance requirement —taking the guess-work out of getting overhead faster, safer and more economically.

All equipment is also available for hire.



SEND FOR BROCHURES NOW!



ACCESS EQUIPMENT LIMITED

Please send me ACCESS information.

Name

Address

P.O.E.1071

MAYLANDS AVENUE HEMEL HEMPSTEAD HERTS
TELEPHONE: HEMEL HEMPSTEAD 2311/6

Ferranti make stacks of connectors.
In a range wide enough to be able
to meet most demands from stock —
and at the right prices.

This is good news for computer and
system builders who know (or can guess)
just how good and reliable Ferranti
connectors are.

So — tell us what you want.

And look forward to a long and
happy connection with Ferranti.

If you don't want anything at the
moment why not get our comprehensive
catalogue to keep by you?

FILL THE GAP ON MY REFERENCE SHELF

Please send me your whole-range connector catalogue

Name _____

Position _____

Company _____

Address _____



POST TO: Ferranti Limited, Connector Sales,
Dunsinane Avenue, Dundee, Scotland, DD2 3PN

FERRANTI CONNECTORS

If you're ordering, fast delivery of substantial quantities can
be obtained from: Athena Semiconductor Marketing Co. Ltd.,
140 High Street, Egham, Surrey. Tel: Egham 6161 Telex: 23850



what you want we deliver.



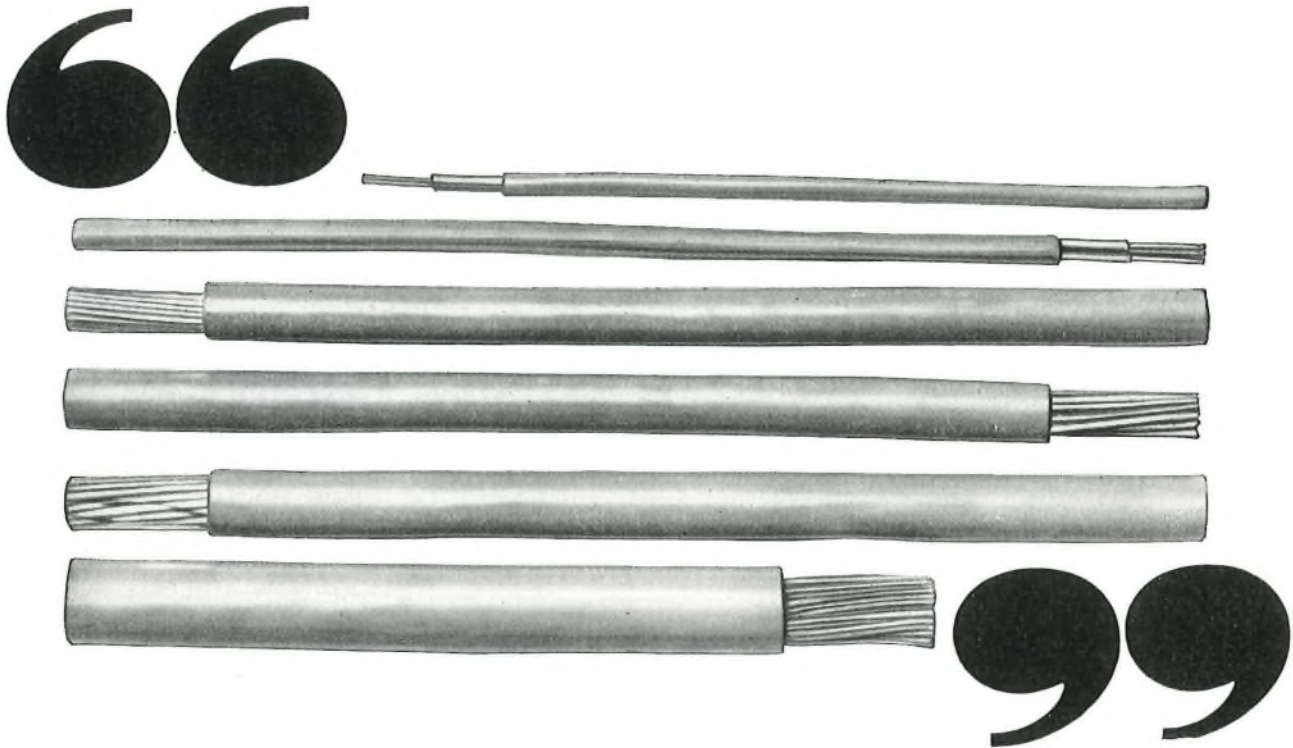

“**PIRELLI
GENERAL**”
and the power
of speech

Internal telephone communication systems call for the same degree of reliability as for national networks. Pirelli General manufactures a range of multipair and multiway internal telephone cables which are stocked for immediate delivery.

To reduce cross-talk in the multipair construction the pairs are twisted and laid-up with varying lays. Each cable has a distinct colour identification scheme for the cores or pairs which facilitates quick termination, and a Terylene ripper cord assists in quick removal of the pvc sheath. For further details ask for Publication MC3:1970.

PIRELLI GENERAL CABLE WORKS LIMITED · SOUTHAMPTON · TELEPHONE: SOUTHAMPTON 20381

NO TIME TO DELAY

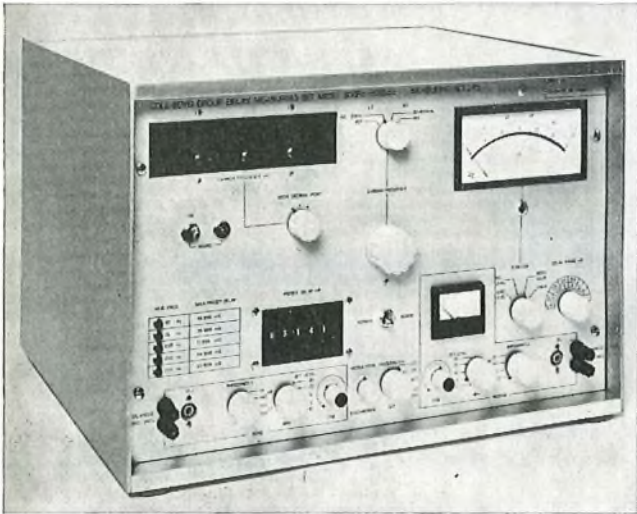

Accurate measurement is vital for dealing with GROUP DELAY DISTORTION. Using the COLE-BOYD Set M1010 (designated British Post Office set 37B) accurate measurements can be made at precise carrier frequency settings. End to end or midpoint circuit tests do not need a synchronising channel. The set is compatible with many other equipments. All this and much more is contained in a compact box, easily carried by one man. Send back the coupon today for our comprehensive illustrated brochure.

MANUFACTURING DIVISION

cole COLE ELECTRONICS LIMITED
 LANSDOWNE ROAD CROYDON
 CR9 2HB TEL: 01-686 7581

Please send me the full facts on **GROUP DELAY**

Name: _____

Position: _____

Company: _____

Address: _____

ENGINEERS!



Send for your **FREE** copy of 'ENGINEERING OPPORTUNITIES'

WHAT THIS BOOK WILL TELL YOU!
 How to get rapid promotion or a better-paid job · How to put some valuable letters after your name · How to make use of our free Appointments & Advisory Service · How to gain the technical knowledge employers readily pay for · How you can succeed in any branch of Engineering you like - whatever your education or experience.
74 PAGES FULL OF EXPERT ADVICE.

Now ready a brand new edition of this famous book which we would like every ambitious engineer to have - free. We anticipate a tremendous demand so send for your free copy now.
 'ENGINEERING OPPORTUNITIES' outlines our magnificent range of modern Home Study Courses and is packed with interesting and useful information. Don't miss this enlightening booklet.

ENSURE YOUR COPY BY POSTING COUPON NOW

To: BIET Dept. B3 Aldermaston Court, Reading RG7 4PF.

Tick subject that interests you. Aero Eng. Automobile Building
 Computers D'manship Electrical Electronics Management
 Mechanical Plastics Production Surveying TV & Radio
 Telecomms. Work Study AMIED AMIMI ANISE
 C.ENG. CITY AND GUILDS GENERAL CERTIFICATE OF EDUCATION

Other subjects _____

Please send 'ENGINEERING OPPORTUNITIES' without cost or obligation.

Name _____ Age _____

Address _____

Occupation _____

BRITISH INSTITUTE OF ENGINEERING TECHNOLOGY

MODEL ANSWER BOOKS

CITY AND GUILDS OF LONDON INSTITUTE
 TELECOMMUNICATION TECHNICIANS' COURSE

LINE PLANT PRACTICE A

TELECOMMUNICATION PRINCIPLES A

TELECOMMUNICATION PRINCIPLES B

ELEMENTARY TELECOMMUNICATION PRACTICE

RADIO AND LINE TRANSMISSION A

TELEPHONY AND TELEGRAPHY A

PRICE 37½p each (Post Paid 42p)

Orders may be sent to the *Journal* Local Agents or to
 The Post Office Electrical Engineers' Journal,
 2-12 Gresham Street, London, EC2 7AG

Marconi Data Transmission Systems

Marconi has a comprehensive range of data transmission equipment, being supplied for the British Post Office's Datel Service, which is for the rapid transmission of data over telephone circuits.

Marconidata U1120 Series (600/1200 band modem)

For the transmission of data over public or private telephone circuits at up to 1200 bauds

Marconidata U1140 Series (2400 band modem)

For the transmission of binary data at a fixed rate of 2400 bits per second

Marconidata U1150 Series High-speed Modem

For the transmission of high-speed data at 435k bits/sec (Datel Codec System)

Marconidata U1130 Series 23-Channel Multiplex/ Demultiplex Equipment

Enables data traffic to be transmitted over common bearer circuit with safe and rapid phasing.

Marconidata Dataplex Data interface unit

Enables data to be transmitted over multi-channel voice frequency telegraph systems



Marconidata multiplex/demultiplex equipment

Marconi Line Communications Division, specialists in digital transmission, including message switching, PCM, and error correcting equipment, part of the total systems capability of Marconi Communication Systems.

Marconi Communication Systems

Complete civil and military static and mobile communication systems

Message switching
Digital and data systems
Microwave and tropo systems
Mobile radio telephones
Specialized components

Satellite communications earth stations
H.F. and I.f. point-to-point systems
Television and broadcasting stations
Maritime and naval systems
Surveys, planning and commissioning

Marconi Communication
Systems Limited,
Chelmsford, Essex, England

A GEC-Marconi Electronics Company

MST

Marconi is the largest European manufacturer and exporter of h.f radio communications systems.

Marconi Self-Tuning (MST) h.f systems, worth over £14,000,000, have been sold to over 47 countries.

MST combines user economy with high quality performance.

MST reduces capital outlay and installation costs by reducing space requirements and the need for standby equipment.

MST reliability is increased by the maximum use of solid-state techniques and the incorporation of wideband amplifiers to minimize the number of moving parts.

MST centralized station control and remote control facilities, plus

MST reliability mean a reduction in manpower of as much as 5 to 1.

MST traffic carrying efficiency is greatly increased by frequency changing taking less than 1 minute.

Marconi Radio and Space Communications Division, designers and suppliers of h.f. and l.f. point-to-point systems, line-of-sight and tropospheric scatter microwave systems and space communications earth stations—part of the total system capability of Marconi Communication Systems.

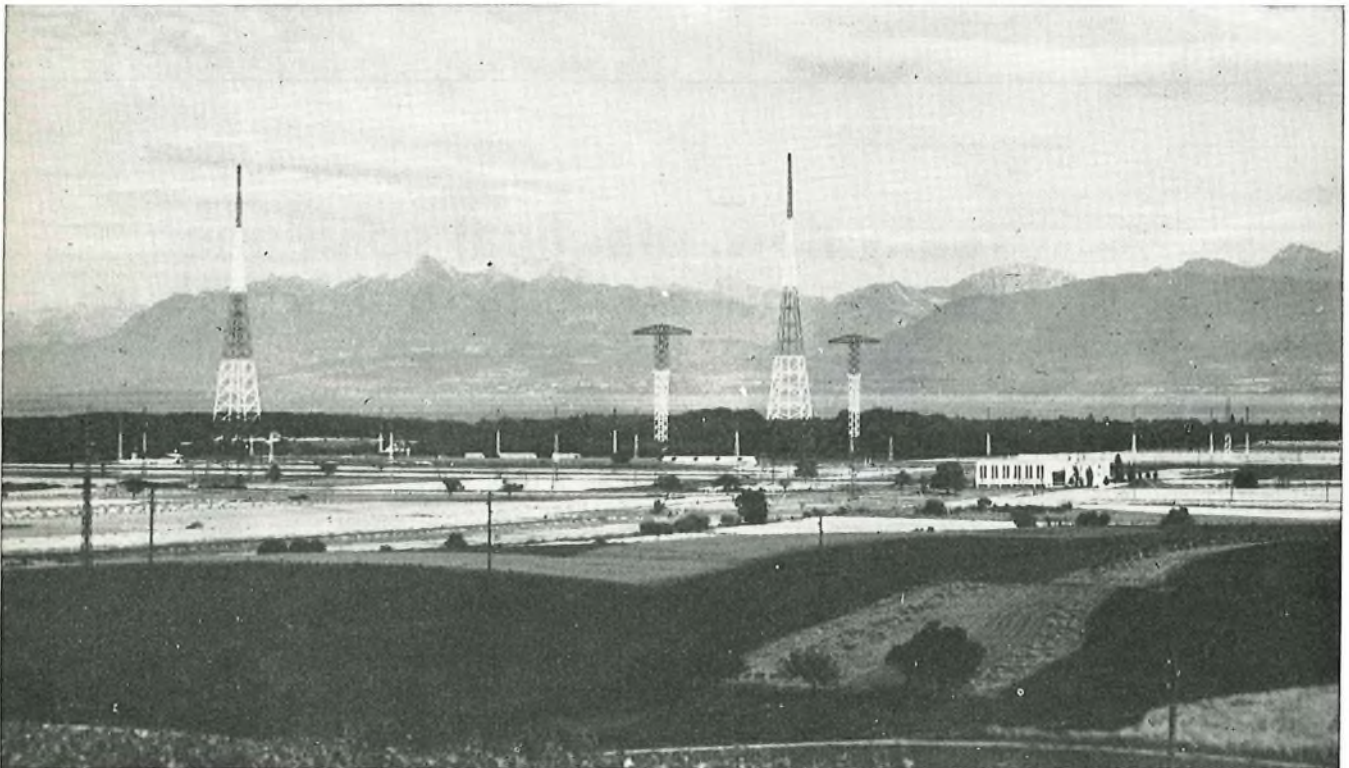

Radio Suisse photo

Marconi Communication Systems

Complete civil and military static and mobile communication systems

Message switching
Digital and data systems
Microwave and tropo systems
Mobile radio telephones
Specialized components

Satellite communications earth stations
H.F and l.f point-to-point systems
Television and broadcasting stations
Maritime and naval systems
Surveys, planning and commissioning

Marconi Communication
Systems Limited,
Chelmsford, Essex, England

A GEC-Marconi Electronics Company

INDEX TO ADVERTISERS

	<i>Page</i>		<i>Page</i>
Access Equipment Ltd	13	Hatfield Instruments Ltd.	13
British Institute of Engineering Technology	16	Marconi Communications Systems Ltd.	17, 18
Cambion Electronic Products Ltd	13	Pirelli General Cable Works Ltd.	15
Cole, Electronics Ltd.	16	Sellotape Products Ltd.	20
Communications Technology Corporation	19	Standard Telephones and Cables, Ltd.	5-9 & 11
Cray Electronics Ltd.	21	Telletra S.p.A	10
Ferranti Ltd.	14	Whiteley Electrical Radio Co. Ltd.	12
GEC-AEI Telecommunications, Ltd.	1-4		



really new, practical solutions to communications problems!



bullet bond clip

Sure bonding of any size or type cable with one size clip. Fast, fool-proof installation; has Bond Bar and insulator tubing accessories.

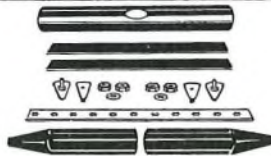

pic cable closure

Designed for aerial, free breathing Pic cable splices, gas plugging. Now, in clear, too, for buried encapsulations. 8 sizes, 1" to 6" ID. Special feature: expands to any length with extender.



ickypic II jelly compound

Waterproof filler for Pic cable core and splices, in disposable cartridges. Injection gun is fast, easy, sure. Always re-enterable; non-toxic material!



Q compound

Q is for Quick! Sets in 15 minutes or less, flows freely in cold temps. Water-clear. For plugging and encapsulation. In self-mixing Clipper Paks up to 500 grams or 1000 and 2000 gram cans.



ready access pull-out kit

Ends pull-out in Western Electric 49-type and other sizes of Ready Access terminals. Also, kits for new terminal installations. Low cost and they really work!



yellow jacket closure

Moisture-proof ready access closure for ground flush hand holes and for direct burial. Complete kit! Handles 100 pr. in and out, up to 12 service wires. Larger kits for up to 600 pair.

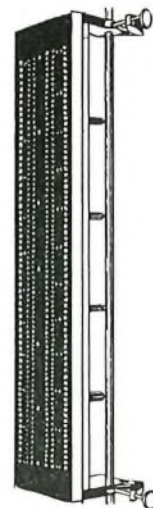

ace rapid restoration board

Restores 100 prs. pulp or PIC in less than 30 minutes! No stripping; insert wires, snap connection. Kits for 100, 200, 400, and 600 pair. Good for tagging, too.

write for our complete, idea-packed catalog:

COMMUNICATIONS TECHNOLOGY CORPORATION

2337 COLBY AVENUE, LOS ANGELES, CALIFORNIA 90064 (213) 478-5061

Representative enquiries invited



A rose by any other name...

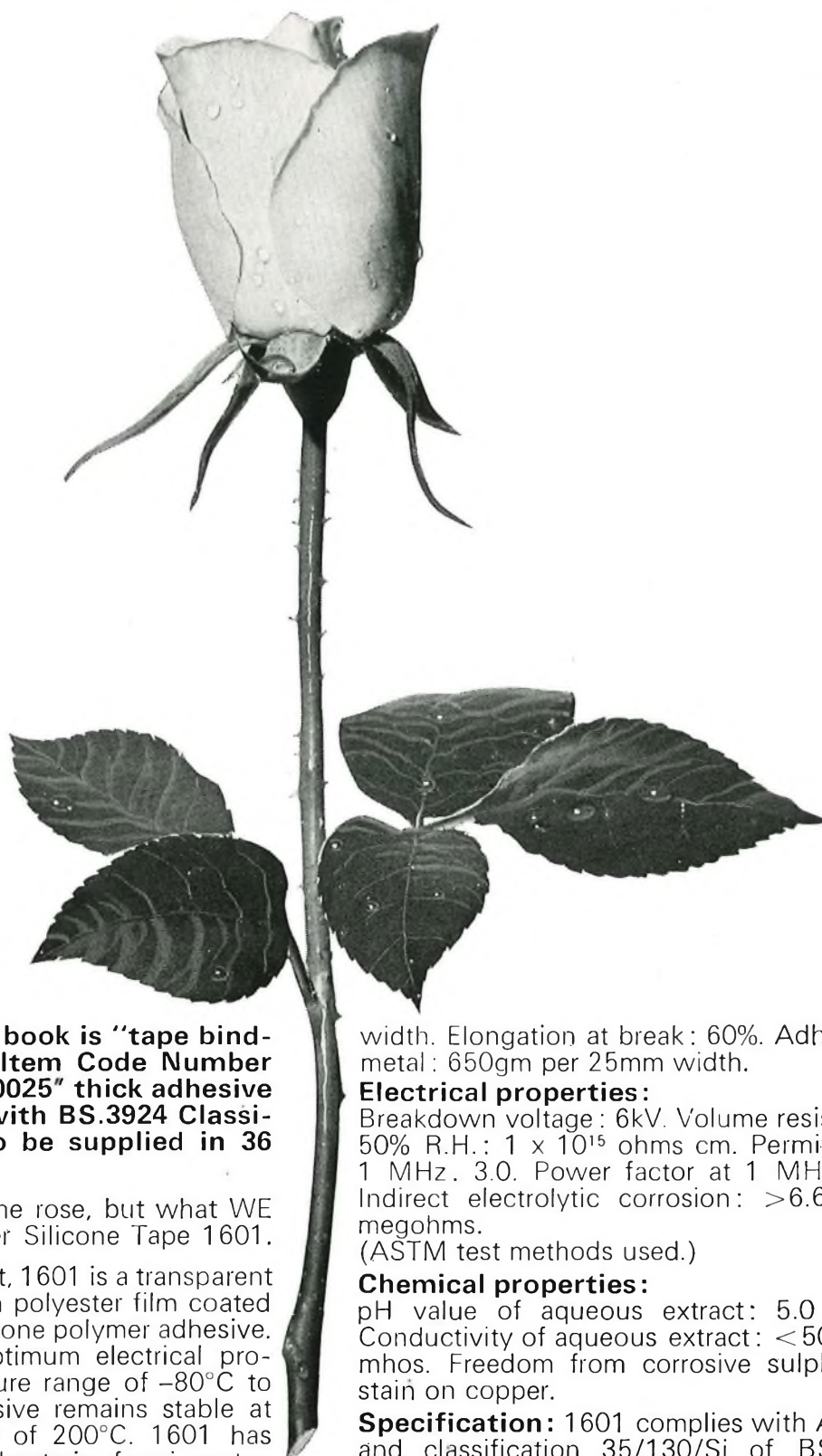

Its name in your rate book is "tape binding adhesive 12mm. Item Code Number 071763 transparent .0025" thick adhesive tape in accordance with BS.3924 Classification 35/130/Si, to be supplied in 36 yard reels."

No – we don't mean the rose, but what WE call 'Sellotape' Polyester Silicone Tape 1601.

But whatever YOU call it, 1601 is a transparent tape manufactured from polyester film coated with a thermostable silicone polymer adhesive. The tape retains its optimum electrical properties over a temperature range of -80°C to $+140^{\circ}\text{C}$ and the adhesive remains stable at temperatures in excess of 200°C . 1601 has excellent resistance to bacteria, fungi, water, salt water, acids and alkalis and good resistance to most alcohols, esters, ketones and oils.

Physical properties:

Base thickness: 0.025mm. Total thickness: 0.065mm. Tensile strength: 10kg per 25mm

width. Elongation at break: 60%. Adhesion to metal: 650gm per 25mm width.

Electrical properties:

Breakdown voltage: 6kV. Volume resistivity at 50% R.H.: 1×10^{15} ohms cm. Permittivity at 1 MHz: 3.0. Power factor at 1 MHz: 0.01. Indirect electrolytic corrosion: $>6.6 \times 10^4$ megohms.

(ASTM test methods used.)

Chemical properties:

pH value of aqueous extract: 5.0 to 7.5. Conductivity of aqueous extract: <50 micro-mhos. Freedom from corrosive sulphur: No stain on copper.

Specification: 1601 complies with AFS 292 and classification 35/130/Si of BS 3924.

Write for technical data sheets describing the full range of 'Sellotape' electrical products, or ask for our specialist representative to call.



Sellotape Products Ltd., Industrial Sales,
Sellotape House, 54-58 High St, Edgware, Middx, HA8 7ER
Telephone: 01-952 2345 Telex No. 262462

'Sellotape' is the Registered Trade Mark of Adhesive Tapes Limited.

a (DRC) company

TYPE 62

FULL RANGE

7 TO 14 DAY DELIVERY

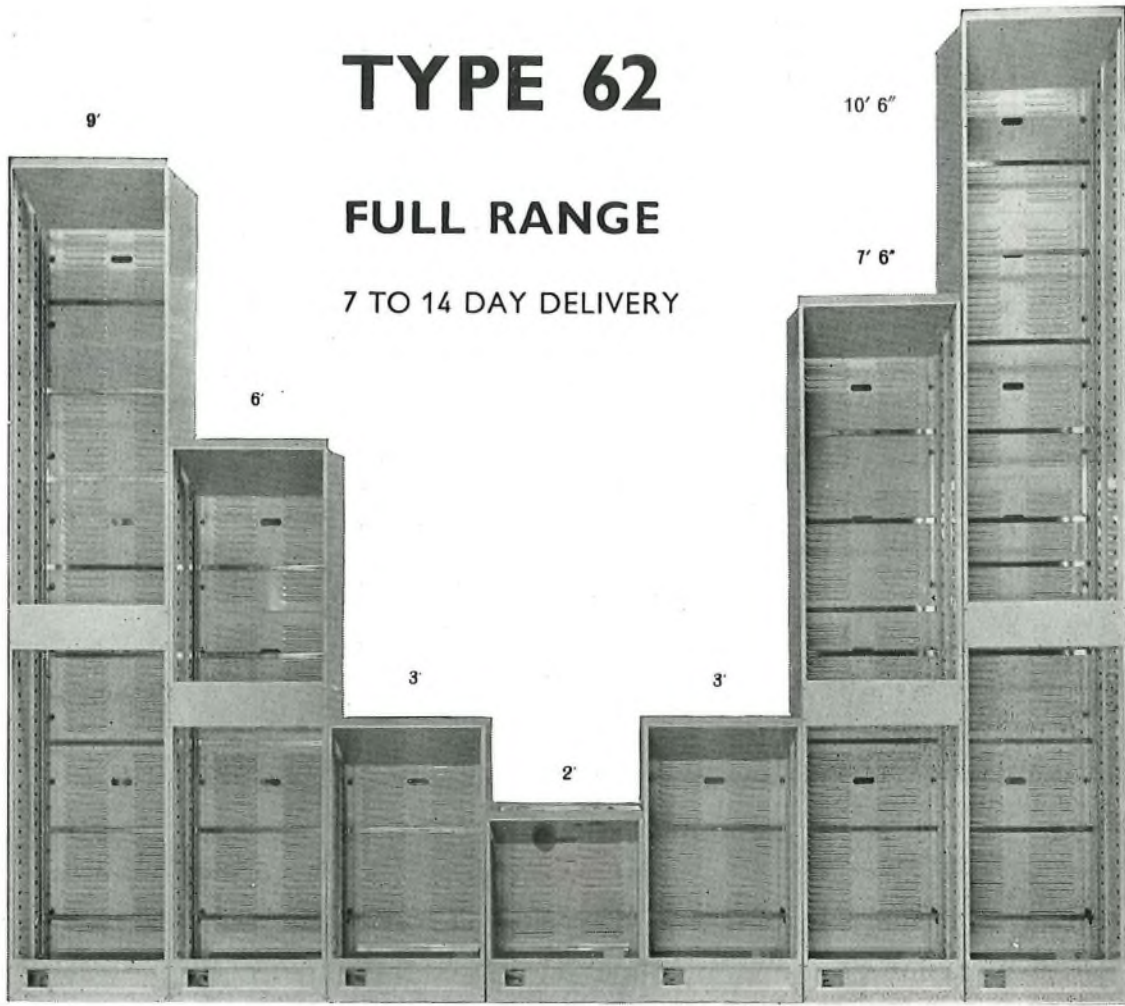

HIGH PRECISION MECHANICS

FOR INSTRUMENT ELECTRONIC AND AUTOMATION INDUSTRIES

TELECOMMUNICATIONS
MECHANICS

P.O. APPROVED

IMMEDIATE QUOTATIONS AND
TECHNICAL SERVICE

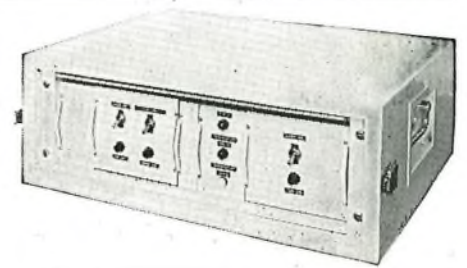

SHELF ASSEMBLIES

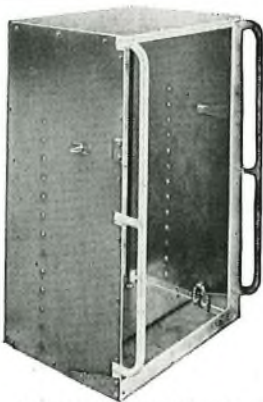

P.C.M. TRANSIT JIG



DATTEL MODEM

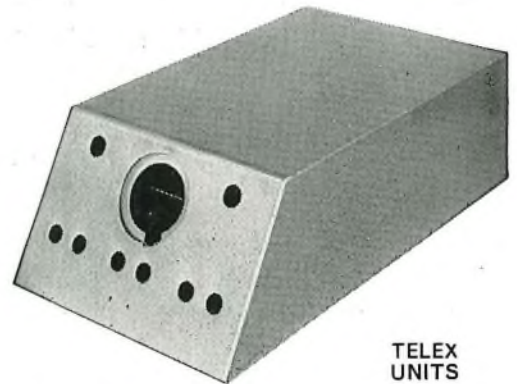

TELEX
UNITS

CRAY ELECTRONICS LTD

THAMES ROAD, CRAYFORD, KENT
TELEPHONE: CRAYFORD 26526