

*RA Roe*

THE POST OFFICE *Cromwell*  
ELECTRICAL ENGINEERS'  
JOURNAL



Vol. 54 Part 4

JANUARY 1962

## CONTENTS

	Page
INAUGURATION BY HER MAJESTY THE QUEEN OF THE NEW CABLE TO CANADA.....	219
CANTAT—A NEW SUBMARINE TELEPHONE CABLE SYSTEM TO CANADA.....	220
ACCIDENT-PREVENTION POSTERS.....	223
VENTILATION OF APPARATUS ROOMS	
R. W. Hopwood, B.Sc.(Eng.).....	225
A TESTER FOR THE COIN AND FEE CHECKING RELAY-SET	
D. H. Matthews.....	230
A CALLING AID FOR DISABLED SUBSCRIBERS	
J. D. Collingwood, A.M.I.E.E., A.M.Brit.I.R.E.....	233
A NEW FLAMEPROOF TABLE TELEPHONE WITH AN INTRINSICALLY SAFE HANDSET.....	234
MEASURING TECHNIQUES FOR THE INSPECTION OF APPARATUS PARTS	
R. J. Jeffrey, A.M.I.E.I.....	235
TRANSISTOR LINE AMPLIFIERS FOR SPEECH AND PROGRAM CIRCUITS	
D. Thomson, A.M.I.E.E.....	238
A TELEPHONE FOR SUBSCRIBERS WITH WEAK VOICES	
W. T. Lowe, A.M.I.E.E.....	242
THE THIRD INTERNATIONAL CONGRESS ON TELEPHONE TRAFFIC, PARIS, 1961.....	244
TESTING RADIO-TELEGRAPH AUTOMATIC ERROR-CORRECTING EQUIPMENT	
A. C. Croisdale, M.B.E., B.Sc.(Eng.), A.M.I.E.E., and A. F. Harrison, Graduate I.E.E., A.M.Brit.I.R.E.....	245
AN OPTICAL HEIGHT-MEASURING INSTRUMENT	
J. Stott, M.B.E.....	250
LOCATION OF REPEATER FAULTS ON SUBMARINE TELEPHONE CABLES	
F. Scowen, B.Sc., A.Inst.P., A.M.I.E.E.....	252
ELECTRONIC COMPUTER EXHIBITION AND SYMPOSIUM ON ELECTRONIC DATA PROCESSING, LONDON, OCTOBER 1961.....	257
MEETING OF THE COMMISSION MIXTE INTERNATIONALE, BOURNEMOUTH, SEPTEMBER 1961.....	258
FLOOD-TESTING OF THE MAGNETIC-DRUM REGISTER-TRANSLATOR.....	259
EXAMINATION AND EVALUATION OF NEW TYPES OF PAINT FOR POST OFFICE USE.....	261
A TESTER FOR SURGE-RESISTANT FUSES	
A. W. N. Garbutt.....	262
PROPANE GAS AS A FUEL FOR SMALL INTERNAL-COMBUSTION ENGINES	
P. S. White, B.Sc.(Eng.), A.M.I.E.E., and R. C. Senior.....	265
A MOTOR ALTERNATOR FOR A.C. SIGNALLING SUPPLIES	
J. H. Gee.....	268
A BATTERY-POWERED HEARING-AID HANDSET—HANDSET No. 5	
W. T. Lowe, A.M.I.E.E.....	271
A VERTICAL CHAIN CONVEYOR FOR LETTERS AND PARCELS	
W. Dickie, A.M.I.E.E.....	273
THE LIGHTING OF TELEPHONE APPARATUS REPAIR BENCHES	
D. A. Spurgin, A.M.I.E.E.....	274
NOTES AND COMMENTS.....	276
INSTITUTION OF POST OFFICE ELECTRICAL ENGINEERS.....	277
REGIONAL NOTES.....	278
ASSOCIATE SECTION NOTES.....	285
STAFF CHANGES.....	288
INDEX TO VOLUME 54.....	291
BOOK REVIEWS.....	222, 224, 237, 251, 260, 264, 272, 284, 290

Price 2s. 6d. (Post Paid 3s. 6d.)

Published in April, July, October and January by *The Post Office Electrical Engineers' Journal*,  
G.P.O., 2-12 Gresham Street, London, E.C.2.

Annual Subscription (post paid): Home and Overseas, 14s. (Canada and U.S.A., 2 dollars 25 cents).

# THE POST OFFICE ELECTRICAL ENGINEERS' JOURNAL

Vol. 54 Part 4

JANUARY 1962

## Inauguration by Her Majesty the Queen of the New Cable to Canada



ON 19 December 1961 Her Majesty the Queen inaugurated the new Anglo-Canadian transatlantic telephone cable (CANTAT) by making the first call to Mr. J. G. Diefenbaker, the Canadian Prime Minister, in Ottawa. The Queen made the call from Buckingham Palace and it was relayed by land-line to a ceremony at Lancaster House, presided over by the Secretary of State for Commonwealth Relations, the Right Honourable Duncan Sandys, M.P. Also present at the ceremony were the High Commissioner for Canada, the Honourable George A. Drew, Q.C., the Postmaster General, the Right Honourable Reginald Bevins, M.P., the Director General of the Post Office, Sir Ronald German, Mr. Norman C. Chapling and Mr. H. H. Eggers, Managing Directors of Cable and Wireless, Ltd., and other representatives of Commonwealth countries, foreign countries leasing circuits in the cable, the Post Office and the telecommunications industries of the United Kingdom and Canada. CANTAT is the first all-British transoceanic telephone cable system and it forms the initial link of the Commonwealth telephone cable.



# CANTAT—A New Submarine Telephone Cable System to Canada

U.D.C. 621.395.5:621.315.28

AT 23.45 Greenwich Mean Time on 21 November 1961 the final splice in a new transatlantic telephone cable system was consigned to the ocean off Newfoundland by H.M.T.S. *Monarch*. Linking Great Britain and Canada, this system is noteworthy in being a four-fold "first." It is:

- (i) the first all-British transoceanic telephone cable,
- (ii) the first transoceanic system to use rigid repeaters,
- (iii) the first transoceanic system to use both-way transmission over a single cable, and
- (iv) the first system to use the new light-weight, non-armoured, deep-sea cable.

It is, without question, the most advanced submarine cable system in existence today.

It will be recalled that the first transatlantic telephone cable system (TAT-1)<sup>1</sup>, planned in 1953 and brought into service in 1956, comprises two sections, each using armoured coaxial cable with 0.62 in. diameter polythene core. Between Oban, Scotland, and Clarenville, Newfoundland, there are two cables each with 51 flexible unidirectional repeaters of American design, providing a bandwidth of 144 kc/s, the equivalent of 36 4 kc/s-spaced telephone circuits, over a distance of about 1,960 nautical miles (n.m.). The terminal driving voltage is 2 kV d.c. at each end (2 + 2 kV total driving voltage). Between Clarenville, Newfoundland, and Sydney Mines, Nova Scotia, there is a single cable with 16 rigid both-way repeaters of British design, providing a bandwidth of 240 kc/s in each direction, the equivalent of 60 4 kc/s-spaced telephone circuits, over a distance of 330 n.m., the terminal driving voltage being 1.2 kV d.c. at each end or 2.4 kV at one end.

At the time when TAT-1 was planned, the American system was the only one which had been tested at ocean depths and its choice for the main ocean section was more or less inevitable. The British system, based on that used in home waters, had not yet been developed either for the distances or depths involved in the Atlantic crossing, nor could the rigid repeaters be laid without stopping the cable ship, which must be avoided in deep water with armoured cable.

TAT-2, laid in 1959, is a replica of TAT-1 with the European landing point at Penmarch, Brittany. It serves, primarily, Paris and Frankfurt.

As early as 1952 a start had been made at the Post Office Research Station on the design of a completely new type of coaxial cable for use in deep water, where armour wires are required only to carry the tension and not for protection. A major feature of the new design<sup>2</sup> was that it would not twist under tension. With armoured cable the steel wires are applied helically; this is structurally desirable and enables the cable to be coiled down in tanks. In deep water, high-tensile steel is essential and the long helical spring so formed twists under tension so that several thousands of turns are stored between the ship and the ocean bottom. If the ship stops the cable is likely to throw into bights at the bottom as the tension varies, and it is for this reason that repeater laying must be a continuous operation not involving the stopping of the ship; this makes it very difficult to lay rigid repeaters.

\* Owned by the British Government.

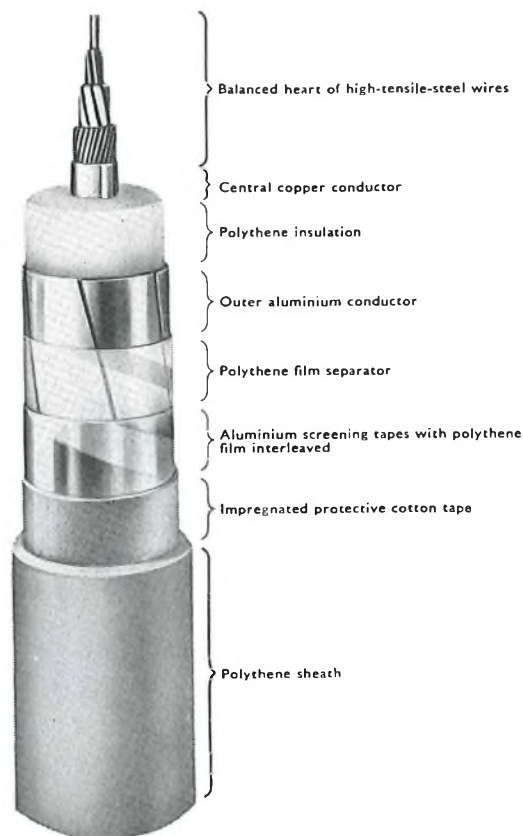

FIG. 1—LIGHT-WEIGHT SUBMARINE CABLE

The new cable based on these considerations, and commonly called "light-weight" cable (Fig. 1), consists of: a balanced heart of steel wires of about 130 tons/in<sup>2</sup> ultimate tensile strength comprising an inner core with right-hand lay and a single outer-layer with left-hand lay; a centre conductor of longitudinal copper tape, box-seamed; an outer conductor of aluminium which gives a large cable modulus, i.e. ratio of breaking strength to weight per mile in water, or the maximum length which can be suspended vertically; and an external polythene sheath. With a 0.99 in. diameter core the overall diameter is 1.3 in., almost exactly the same as that of a deep-sea armoured cable with 0.62 in. core, but with only two-thirds of the attenuation.

Early in 1957, only six months after the opening of TAT-1, it was agreed by Cable and Wireless, Ltd. (C. & W., Ltd.),\* and the Canadian Overseas Telecommunication Corporation (C.O.T.C.) that they would provide a large-capacity system to Canada<sup>3</sup> using British repeaters and a single light-weight cable. It is this system, known as CANTAT, which has just been completed. Like the earlier British systems it provides a bandwidth of 240 kc/s in each direction, equivalent to 80 3 kc/s-spaced telephone circuits; services provided will include telephony, telegraphy, program, data transmission and both normal and high-speed facsimile; the last enables a film to be transmitted frame by frame and so provides for slow-scan (delayed) television. Although C. & W.,



Ltd., is the British partner in the ocean-cable section, all buildings and plant in Britain are owned by the Post Office, who also operate the services in the usual way.

Necessary preliminaries to the manufacture of the deep-sea section were:

(a) To complete the design of the light-weight cable and to test it in laying operations at sea.

(b) To modify the design of the rigid repeaters:

(i) to withstand working pressures of up to 3 tons/in<sup>2</sup>, corresponding to Atlantic depths, and preferably up to 5 tons/in<sup>2</sup>, corresponding to the 4,000 fathoms which would be encountered in later projects, and

(ii) to operate up to 100 in tandem; this involved doubling the working voltage and providing an entirely new supervisory system to monitor and identify the repeaters.

(c) To design and provide ship's gear which could lay the repeaters without stopping the ship.

To tackle these problems and to engineer the ocean cable itself, the Submarine Cable Division at the Post Office Research Station was reconstituted, with the addition of engineers from C. & W., Ltd., as the Joint Submarine Systems Development Unit (Post Office/Cable and Wireless, Ltd.).

It must suffice for the present to say that all the problems were successfully overcome, including the design and provision of cable-ship laying gear consisting of a series of interconnected V-sheaves that can be driven or braked in the same way as the conventional drum which they replace. A bypass rope across the repeater traverses the sheaves and carries the laying tension while the repeater itself is transported past the laying gear at deck level.

In 1960 a system using repeaters of the type developed for CANTAT was laid between Middlesbrough, England, and Göteborg, Sweden.<sup>4</sup> This comprised 527 n.m. of

0.62 in. armoured cable with 29 repeaters in shallow water; it was an invaluable preliminary to CANTAT itself.

The CANTAT system (Fig. 2) extends from London to Montreal and is in four sections:

*CANTAT A*, the main ocean crossing between Oban, Scotland, and Corner Brook, Newfoundland, owned jointly by C. & W., Ltd., and C.O.T.C. This includes 550 n.m. of armoured cable in shallow water and across Newfoundland, together with 1,526 n.m. of light-weight cable in depths up to 2,250 fathoms. There are 90 repeaters and eight equalizers, the cable attenuation rising to 5,100 db against 3,200 db for TAT-1. The direct voltage required to energize the repeaters is 9.8 kV, half at each end, and the system provides a bandwidth of 240 kc/s in each direction over a single cable.

*CANTAT B*, a submarine cable system, 400 n.m. in length, owned and engineered by C.O.T.C., between Corner Brook and Grosses Roches, Quebec, on the south bank of the St. Lawrence River. This provides a bandwidth of 480 kc/s in each direction, using 0.935 in. armoured cable with 20 submerged repeaters. The entire section is in shallow water.

*CANTAT C*, the overland section between Grosses Roches and Montreal consisting of:

(i) Grosses Roches-Rimouski, 75 miles, using a Bell TJ microwave radio-relay system (11 Gc/s), with 3.5 miles of coaxial cable linking stations at Grosses Roches.

(ii) Rimouski-Montreal, 353 miles, using a Bell TD2 microwave radio-relay system (4 Gc/s).

*CANTAT D*, the overland section between London and Oban, in which there is diversity of routing. Two routes, London-Glasgow-Oban and London-Aberdeen-Inverness-Oban, are mainly 24-circuit carrier cables, and a third route, London-Glasgow-Oban, is coaxial cable except for 40 miles. Switching of carrier groups from one route to another is automatic.

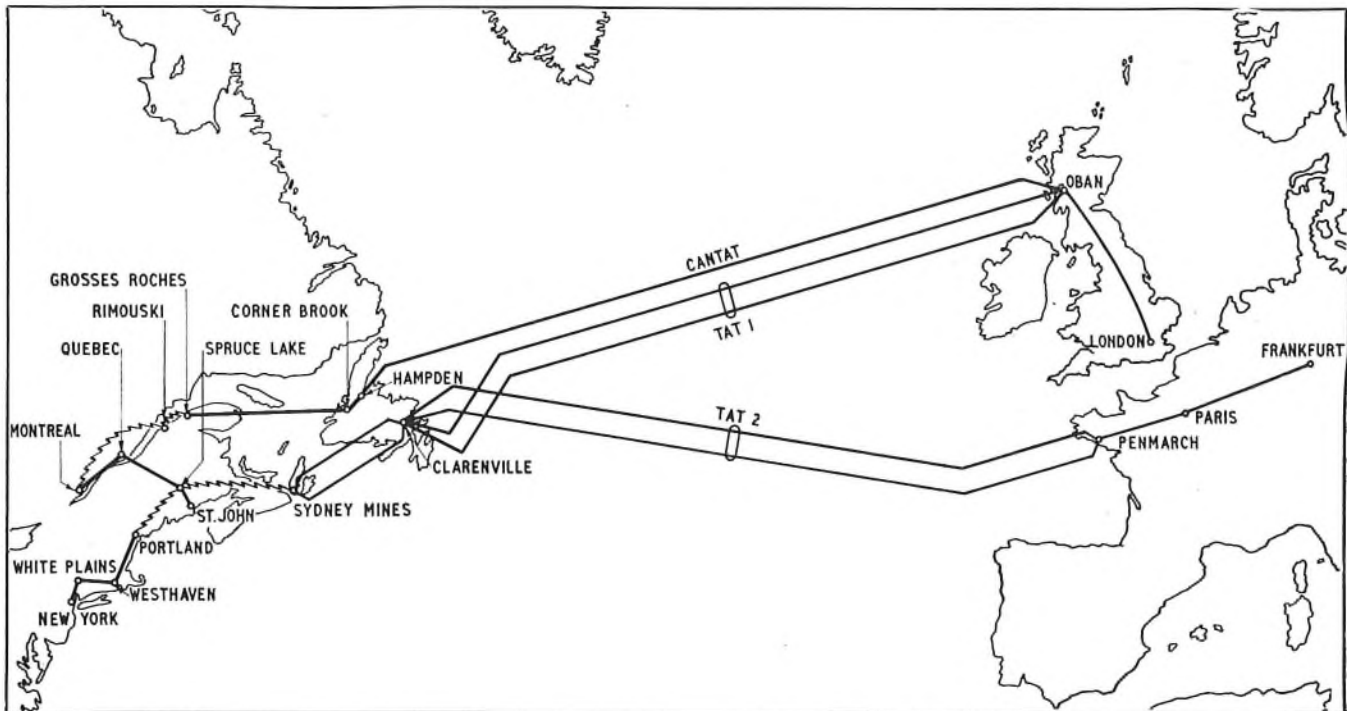

FIG. 2—ROUTES OF THE TRANSATLANTIC TELEPHONE CABLE SYSTEMS

The circuit distance between London and Montreal is therefore 3,850 or 4,050 statute miles depending on the routing between London and Oban.

The overland section of CANTAT A in Newfoundland between Hampden, in White Bay, and Corner Brook is 72 statute miles in length and includes four repeaters buried in wet ground. This section was engineered by C.O.T.C., being completed in 1960; two other submarine cable systems follow the same route over most of the distance.

Apart from the shore ends at Oban and Hampden, Newfoundland, which were laid by H.M.T.S. *Ariel* and C. S. *Albert J. Myer*, respectively, the whole of the submarine section of CANTAT A was laid in three operations, in the summer and autumn of 1961, by H.M.T.S. *Monarch*. Equipped with the new laying gear, this ship had already laid some 50 rigid repeaters and equalizers before the CANTAT project, and has now laid nearly 150.

An unforeseen problem which arose with TAT-1 was the anomalous decrease of attenuation on laying, amounting to nearly 2 per cent, and the continuing decrease after laying, which has already amounted to 13 db (0.4 per cent). One of the objects in designing the new light-weight cable was to eliminate, or at least to minimize, these changes<sup>5</sup> and in this success seems to have been achieved. Anomalous laying changes were almost negligible while the total change over 1,500 n.m. in five months, including the effect of temperature, was less than 2 db, equivalent to a mean temperature change of only  $\frac{1}{3}^{\circ}\text{C}$ .

CANTAT B was laid in July 1961 by H.M.T.S. *Alert*, which is also fitted with the new laying gear.

The lining-up of CANTAT A and of the overall system proceeded immediately after the final splice was completed and the system was ready for the opening ceremony on 19 December 1961. The quality of the transmission path is excellent and meets the target objectives. The noise on each of the five groups is such as to contribute less than 1 pW/km on the telephone channels; this is the preferred objective although the system was originally designed to meet the C.C.I.T.T.\* noise limit of 3 pW/km.

\* C.C.I.T.T.—International Telegraph and Telephone Consultative Committee.

Although the system will ultimately be equipped with the new high-efficiency 3 kc/s-spaced channel equipment,<sup>6</sup> standard 4 kc/s-spaced channel equipment is fitted in the first instance. With leased circuits it now seems that the system will be filled to capacity right from the start and provision of the 3 kc/s-spaced equipment is in hand. So great indeed are the traffic demands that consideration is already being given to the next cable to Canada; this despite the agreement to provide TAT-3<sup>7</sup> between Great Britain and the United States in 1963 and the challenge of communication earth-satellites. If such another cable is agreed it is likely to have a much greater circuit capacity than CANTAT.

On the recommendation of the Commonwealth Telecommunications Conference, London, July 1958, the CANTAT system will form the first link in the Commonwealth "round-the-world" submarine telephone cable system<sup>8</sup>; the complete system, some 30,000 n.m. in length and all to the CANTAT pattern, was estimated to cost £88 million, including £8 million for CANTAT. CANTAT will be followed immediately by COMPAC, the trans-Pacific system from Vancouver to Sydney<sup>8</sup>; the Sydney-Auckland section, 1,250 n.m., is due for completion in June 1962, and the entire 8,100 n.m. system by February 1964.

A later issue of the Journal will include technical articles, giving details of various aspects of the system and its performance.

R. J. H.

#### References

<sup>1</sup> The Transatlantic Telephone Cable. *P.O.E.E.J.*, Vol. 49, Part 4, Jan. 1957.

<sup>2</sup> BROCKBANK, R. A., and MEYERS, A. L. A New Deep-Sea Coaxial Cable. *P.O.E.E.J.*, Vol. 50, p. 7, Apr. 1957.

<sup>3</sup> A Proposed New Telephone Cable between the United Kingdom and Canada. *P.O.E.E.J.*, Vol. 50, p. 104, July 1957.

<sup>4</sup> The Anglo-Swedish Submarine Telephone Cable. *P.O.E.E.J.*, Vol. 53, p. 165, Oct. 1960.

<sup>5</sup> BROCKBANK, R. A. A Note on the Laying Effect and Aging of Submarine Telephone Cables. *P.O.E.E.J.*, Vol. 54, p. 20, Apr. 1961.

<sup>6</sup> LAW, H. B., REYNOLDS, J., and SIMPSON, W. G. Channel Equipment Design for Economy of Band-width. *P.O.E.E.J.*, Vol. 53, p. 112, July 1960.

<sup>7</sup> A Proposed New Cable System Direct to U.S.A.—TAT-3. *P.O.E.E.J.*, Vol. 53, p. 169, Oct. 1960.

<sup>8</sup> Proposed Commonwealth Pacific Telephone Cable System. *P.O.E.E.J.*, Vol. 53, p. 42, Apr. 1960.

## Book Review

"Modern Dielectric Materials." Edited by J. B. Birks, B.A., Ph.D., D.Sc., F.Inst.P., A.M.I.E.E. Heywood & Co., Ltd. 253 pp. 63 ill. 42s.

As the editor of this book says, few of the dielectrics used 40 years ago are still in use to-day, and even the exceptions, such as paper and Bakelite, have been greatly improved. Certainly, then, there is room for a book which reviews the properties of the dielectrics now available, and the present book covers much of the ground admirably. The reservations to be made are that it is the joint work of 11 authors, and for this reason it is inevitably uneven; and that in finding most of these authors within one firm, whose best-known product is power cables, the editor gave the book a bias which makes it less interesting to communications engineers than it might have been.

The longest and best part of the book is the editor's own survey of synthetic plastics. It gains by not being closely tied to particular applications. Chapters on paper, oils, rubber, silicones, ceramics, glass, mica, and textiles make reasonable use of the space allotted to them, but it is obvious that with so many subjects to cover in 250 pages they cannot enter into the degree of detail which some readers will need. Some of the chapters give plenty of references which will help to meet this difficulty, but others do not.

The book is well arranged; diagrams are good; the index is excellent. Trade names for materials are used freely, and manufacturers' data are quoted where they are useful. The book succeeds in being both a survey for the general reader and a work of reference for the specialist.

A. C. L.



## Accident-Prevention Posters

U.D.C. 659.133:614.8

**S**TUDY of the reports of accidents to Post Office engineering staff reveals that a high proportion of the accidents are due to failure to follow prescribed routine precautions. Accident-prevention posters are exhibited as part of a general campaign to combat this tendency to omit routine tests and standard precautions which should be a matter of habit.

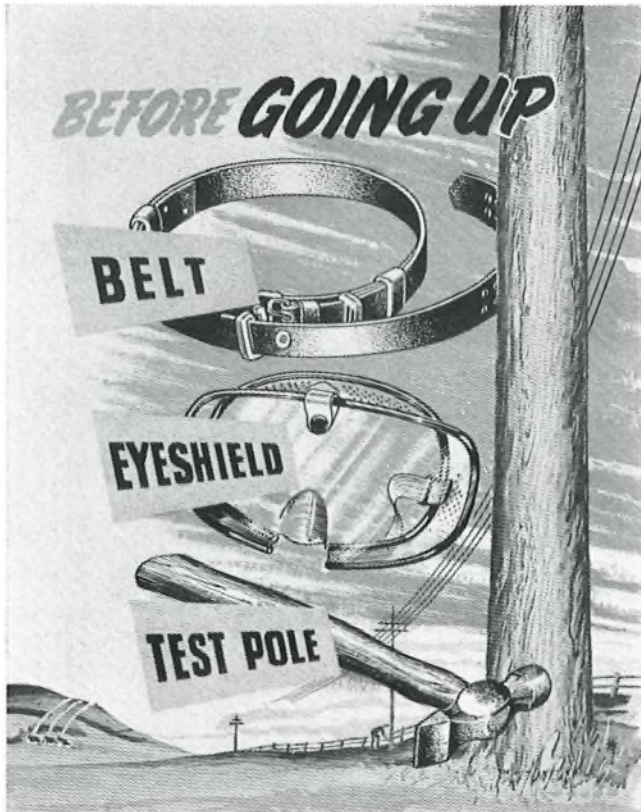

Many excellent safety-precautions posters are issued by the Royal Society for the Prevention of Accidents and other bodies. It is rare, however, for these to be applicable to the particular hazards which are most common in telecommunications engineering. Even when they are broadly applicable there are frequently objections to their use by the Post Office. It was therefore decided to produce a separate series of posters dealing exclusively with the more common types of accidents in which Post Office engineers are involved.

To obtain the maximum benefit from the use of posters an attempt has been made to follow the general approach used in commercial posters. As far as possible each poster embodies some originality in design or wording, or both, which will make a fresh appeal to the eye and mind of the reader. The use of this series of posters merely as adjuncts to training, or for the dissemination of information which can be published effectively by other means, has been avoided. For similar reasons each poster deals with a specific method of preventing accidents. General exhortations, such as "Look Out," "Take Care" and "Read RG 41," are too vague to have much positive effect. Each design shows, therefore, some

definite action to be taken, e.g. "Test Every Pole," "Use Your Eyeshields," "Exchange Worn Tools," making it quite clear what contribution the reader can make towards accident prevention.

A number of considerations have to be borne in mind when preparing the design of a new poster. Broad humour and flippancy are not appropriate to illustrate serious accident risks. Anything which might be interpreted as having religious or political significance, and anything which might be understood as a reference to individuals, must be avoided. Any design to which the staff could reasonably object is naturally useless; the approach which is too grimly realistic, e.g. showing pictures of wounds or blood, is not entirely ruled out, but it is unlikely to have quite the effect desired and obviously cannot be used freely. A poster illustrating the wrong method of carrying out an operation, in order to publicize the correct method, is thought to be unwise; a casual glance in passing at such a poster may well give the impression that the correct method is being shown, with unfortunate results. Care has to be taken to detect any incidental error which may appear in the background of a poster mainly illustrating another point. Not only is any such error likely to lead to an incorrect method of carrying out an operation but detection of the mistake may produce an understandable lack of confidence in the advice given.

Within this framework every effort is made to introduce as much variety as possible in the designs, the colours used, and the methods of reproduction, in order to arouse and to sustain interest in the campaign. The size of the posters, 17 in. by 14 in., is constant, being determined by





the size of the notice boards on which they will be displayed. Five or six different posters are used each year, and they go to some 1,600 separate points throughout the country for exhibition. Each copy is, therefore, normally on exhibition for about two months, but in special circumstances, e.g. in the engineering training schools, they have a rather longer life.

Good original ideas for accident-prevention posters which are not ruled out by one of the considerations mentioned earlier are difficult to obtain. The assistance of those members of the staff of all grades who submit suggestions through the Awards Scheme, or through Joint Production Committee channels, is much appreciated. Although all that is initially required is an apt slogan or the rough sketch of an arresting design, some enthusiasts obviously take considerable pains to produce complete posters.

From a suitable suggestion, modified as may be desirable for technical reasons, a commercial artist produces two or three sketches. One of these will probably be selected, subject perhaps to further slight amendment, for the finished design. When approval has been obtained from the representatives of the staff, arrangements are made for printing the posters by whichever process seems to be most appropriate to the particular design.

In addition to the posters produced by the Post Office Engineering Department, it is usual to issue each year one poster which has been produced by the Royal Society for the Prevention of Accidents in connexion with National Safety Week. This poster may not necessarily illustrate an aspect of Post Office engineering work, but it will be related to a general theme, such as "Guard Your Hands" or "Be Tidy," which must command support.

Posters are also issued by Regional Headquarters; these are entirely the responsibility of the Region concerned, except when funds are required to meet reproduction costs. These posters are useful supplements to the national series and, since the number of copies required is much less, it is economically worth while to deal with aspects which may be problems regionally but not nationally. This adds variety—always an asset—to the campaign, and the use of local talent may stimulate additional interest.

It is difficult to assess the value of the poster campaign. Few people will admit to being consciously influenced by advertisements, whether the subject is accident prevention or anything else. The actual figures of accidents are affected by a number of other factors and

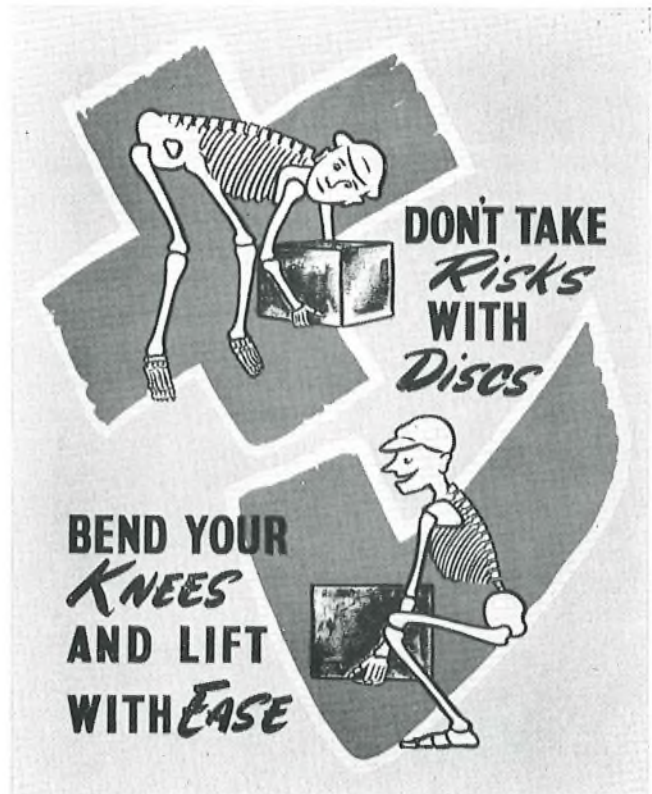

no firm conclusions can be drawn from them alone. There is no doubt, however, that the posters do have a beneficial effect, which, whether evaluated in economic terms or in terms of pain and distress avoided, is worth many times the the cost involved.

E. W. T. R.

## Book Review

"Basic Synchros and Servomechanisms." Parts I and II. Developed by Van Valkenburgh, Nooger & Neville, Inc., New York. The Technical Press, Ltd., London. Part I: viii + 119 pp. and approximately 150 ill. Part II: vi + 114 pp. and approximately 150 ill. 14s. per part.

These two manuals are an extension of a series on the fundamentals of electricity and electronics, developed by a New York firm of management consultants and method engineers for the U.S. Navy and later published for civilian use. The London edition has been adapted to British and Commonwealth usage by a member of the staff of R.E.M.E., Arborfield. The object of the manuals is to help in training staff engaged in operating, maintaining, and routine repair of, the equipment concerned.

Part I deals with synchros, including the appropriate

laws of electricity and magnetism, and with an introduction to closed-loop control systems. Part II deals in more detail with the error-detecting and controlling parts of systems. The emphasis throughout is on components with qualitative descriptions of the part played in the operation of the control system.

These manuals concentrate on a limited objective by the classroom method of "first you tell 'em what you're going to tell 'em; then you tell 'em; then you tell 'em what you've told 'em"—and then you tell 'em again and again. The illustrations, which occupy more than half the surface area of the manuals, are adapted to the teaching technique used: representational, rather than symbolic, diagrams are used whenever possible, and human interest is incorporated, even to the extent of replacing what in an ordinary textbook would be a circuit diagram by a picture of a man looking at a circuit diagram.

W. E. T.

# Ventilation of Apparatus Rooms

R. W. HOPWOOD, B.Sc.(Eng.)†

U.D.C. 697.9

Ventilation is necessary in most types of accommodation for the supply of oxygen and the control of temperature, humidity and odour. In many apparatus rooms it is also necessary to exclude dust from the air introduced, and this necessitates forced ventilation with dust filtration. The standards of ventilation required in various types of Post Office apparatus room are discussed and the methods of achieving such standards are described.

## INTRODUCTION

VENTILATION is necessary in most types of accommodation for the reasons discussed below. Rooms in which telecommunications apparatus is installed may, in addition, have special ventilation requirements such as the exclusion of dust or the extraction of hot air from equipment having a high heat dissipation. The ways in which these additional requirements are met are described later in this article.

### *Supply of Oxygen*

It is evident that, if a room is staffed, oxygen will be used up and must be replaced. Any fuel-burning appliance such as a gas-operated soldering iron also requires a supply of oxygen. At the same time carbon dioxide is formed, and the percentage of carbon dioxide instead of the percentage of oxygen in the air is often quoted as a criterion of safe ventilation. A drop in the oxygen content of the air from the normal 20 per cent down to 17 per cent (the proportion of carbon dioxide then being 4 per cent) is sufficient to extinguish a candle and make breathing very difficult.

### *Odour Control*

A minimum rate of ventilation is necessary to prevent unpleasant odours from becoming too noticeable. For example, the characteristic smell of bakelite varnish can be very pronounced with new apparatus, whilst a freshly polished floor can produce a strong smell due to the solvent used, temporarily necessitating a high rate of ventilation (the special use of ventilation to dispel dangerous fumes, vapours and gases to render accommodation safe will not be dealt with here).

### *Temperature Control*

If heat is being supplied to a room, due, for example, to heat dissipation from apparatus or solar heat gain through windows, walls and perhaps roof, then fresh-air ventilation is the most usual way of removing excess heat. In crowded rooms the heat to be removed may be mainly or entirely due to the occupants themselves.

### *Humidity Control*

Breathing results in water vapour accumulating in the air around a person, if the air is stagnant. A man seated at rest produces approximately 1.5 oz of water vapour per hour. The burning of fuels containing hydrogen, e.g. gas for soldering pots, also produces water vapour, 9 lb of water vapour being produced for each pound of hydrogen burnt. Fresh-air ventilation can be used to

prevent an undue rise of humidity in a room due to these causes.

The control of oxygen and of odours can be achieved by the introduction of a certain fixed minimum quantity of fresh air related to the number of people in the room concerned and the processes occurring. Thus, for theatres, music halls and similar places, a minimum of 1,000 ft<sup>3</sup>/hour per person is required by the London County Council.

Temperature and humidity are similarly controlled, but the effectiveness of a given quantity of air varies according to outside conditions. In summer, when cooling is normally most necessary, outside air may be quite warm and therefore relatively ineffective for cooling. For most of the year, however, outside air in the British Isles remains below 65°F. Usually, the air temperature only exceeds 70°F for short spells in July and August. Nevertheless, the difference between the permissible temperature inside and that outside is small, and it is usual in simple ventilation systems to allow the air temperature to rise by only 10°F in the process of absorbing heat from the room.

The quantity of fresh air introduced can be related to the size of room by measuring it in "air changes per hour" (a.c.h.). Thus 1 a.c.h. means that a volume of fresh air equal to the room volume is introduced each hour.

Assuming that all the ventilating air undergoes a temperature rise of 10°F, the following simple design rules apply:

(a) 300 ft<sup>3</sup>/min will remove heat at the rate of approximately 3,400 B.t.u./hour, which is almost equivalent to 1 kilowatt.

(b) 18 a.c.h. will remove heat at the rate of approximately 1 watt/ft<sup>3</sup> of room volume.

(c) For a ceiling height of 12 ft, as in apparatus rooms, 18 a.c.h. remove heat at approximately 12 watts/ft<sup>2</sup> of floor area, or approximately 1.5 a.c.h. are required to remove 1 watt/ft<sup>2</sup> of floor area.

For apparatus rooms the design limit of 10°F temperature rise for the ventilating air invariably means that the system is capable of delivering far more fresh air than is necessary for the control of the other three factors (oxygen, odours and humidity), and this enables economies to be made during winter running, when a greater temperature rise than 10°F can clearly be permitted.

## VENTILATION METHODS

There are two methods of simple ventilation, namely natural ventilation and forced ventilation. The term forced ventilation includes extraction systems, input systems and combinations of the two.

### *Natural Ventilation*

With well-placed openable windows or similar arrangements in rooms of moderate size, ventilation rates of the order of 8 a.c.h. or more can be achieved even on windless days, if the room temperature rises say 10°F above the outside air temperature. This form of ventilation is

† Power Branch, E.-in.C.'s Office.



obviously dependent on unobstructed space within the room, and becomes less effective if partitions, stacked stores, or apparatus racks obstruct the natural movement of the air.

#### *Forced Ventilation*

With forced ventilation, rates of 3-10 a.c.h. are common, and up to 60 a.c.h. can be achieved by very careful design without causing unpleasant draughts to sedentary work-people. Furthermore, the air supply outlets from ducting to room can be so placed in relation to internal partitions, racks, etc., that even ventilation throughout the space is ensured. A feature of forced-ventilation input systems is the ability to filter the incoming air, and this system is therefore used for installations where dirty air is objectionable and would otherwise enter the accommodation.

#### *Air Conditioning*

By air conditioning is meant a system in which the air used for ventilation is filtered and heated or cooled, according to requirements, and corrected for too-high or too-low relative humidity. Such a system is sometimes referred to as full air conditioning to distinguish it from partial air conditioning, in which filtering and cooling only are catered for, with perhaps incidental dehumidification under certain conditions. Air-conditioning systems are commonly installed where a very high degree of personal comfort is the aim, but they have applications in apparatus rooms and the like in special circumstances, some details of which are given later.

#### TELEPHONE EXCHANGE APPARATUS ROOMS

Provided no equipment using thermionic valves is installed, the heat released into a telephone exchange apparatus room by the equipment is likely to average a little over 1 watt/ft<sup>2</sup> of floor area. During the busy hour this figure may rise to 2.5-2.7 watts/ft<sup>2</sup>. Solar heat gain can add a maximum of 8 watts/ft<sup>2</sup>, assuming the window space is not greater than 30 per cent of the floor area and that half the windows have a southerly or south-westerly

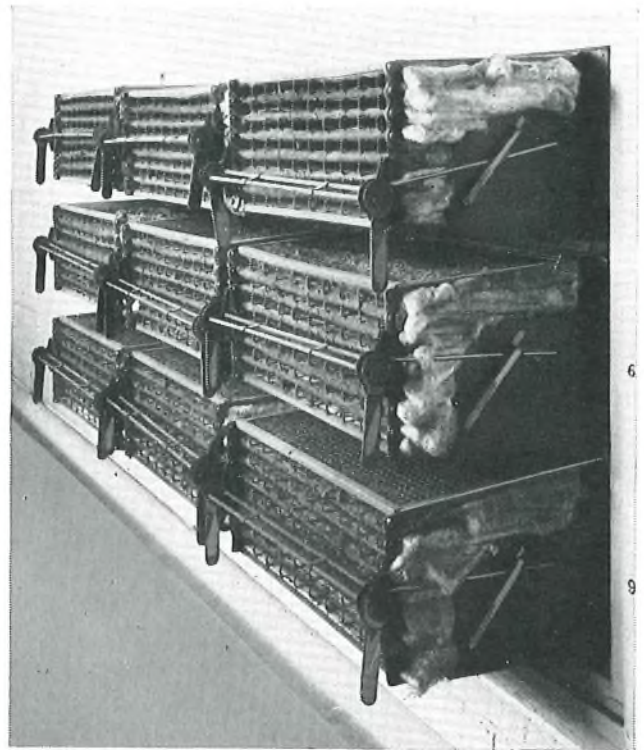

FIG. 2—TYPICAL TELEPHONE EXCHANGE PLENUM VENTILATION SYSTEM—VIEW OF FILTER

aspect. However, the maximum solar heat gain is not likely to coincide with the busy hour and should always be reduced by blinds, so that the general effect of the fluctuating heat load is that approximately 3 a.c.h. are required during summer weather.

This rate of air change could easily be obtained in most apparatus rooms by natural means, but exchange equipment is somewhat sensitive to dust and soot, so that in most urban districts it is necessary to filter the air that enters the room, and this immediately rules out natural ventilation.

#### *Standard System for Telephone Exchanges*

The standard system for telephone exchanges having a floor area exceeding 3,000 ft<sup>2</sup> consists of a central fan room having a centrifugal fan and a multi-sectioned renewable-element fabric air-filter. A typical arrangement is shown in Fig. 1 and 2.

The fan is designed to provide approximately 3 a.c.h. at a pressure of around 0.12 in. water gauge (w.g.) in the apparatus room. This pressure corresponds approximately to that produced on a building by a wind of 15 m.p.h. and helps to prevent air, and therefore dust, from entering the room through window joints, doors, etc. The windows in such apparatus rooms are kept closed, and a number of restricted outlets are provided fitted with flaps (Fig. 3) that close if wind pressure on the

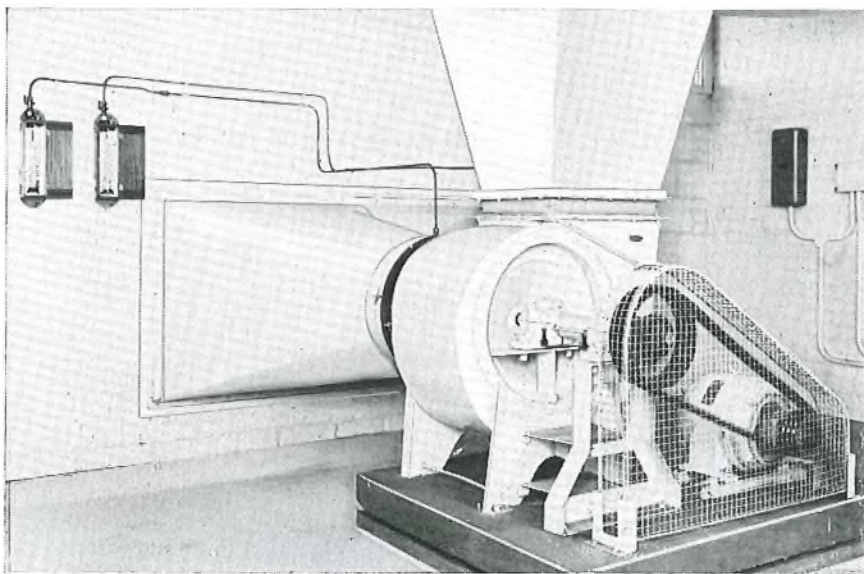

FIG. 1—TYPICAL TELEPHONE EXCHANGE PLENUM VENTILATION SYSTEM—VIEW FROM FAN SIDE



building exceeds the internal air pressure. Without these openings the average apparatus room would hold a pressure sufficient to make door opening and closing difficult, and the quantity of air delivered by the fan would be very much reduced.

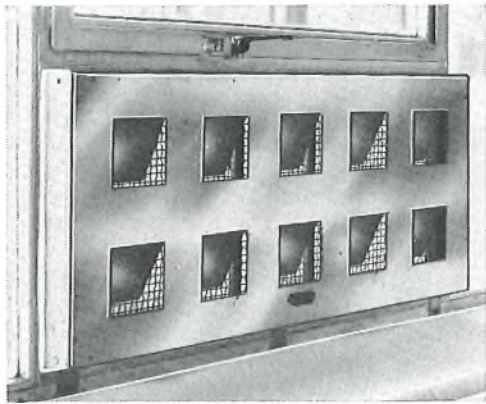

FIG. 3—FLAP-TYPE AIR OUTLET

*Air Filter.* The filter consists of a number of frames arranged to hold a special cotton material in a zig-zag formation to present a large area to the air stream in a minimum of building space. Fig. 4 shows one frame loaded with material. Each frame presents an area of 27 ft<sup>2</sup> of filtering material to the incoming air and is rated at 600 ft<sup>3</sup>/min. This gives a velocity through the material of 22.5 ft/min, and the pressure-drop across the filter varies from 0.15 in. w.g. with a clean filter to 0.5 in. w.g. when the filter needs changing.

The type of fabric filter used has an efficiency of 95 per cent in trapping particles over 5 microns\* in size but is not very effective against smokes, the particle size of which may be well below 1 micron. Nevertheless, the filter will trap a high percentage of ordinary dust, provided that the filtering medium is correctly loaded into the frames and the frames are properly secured to the main framework. This is of prime importance because, if a gap is left anywhere, the air velocity through it will greatly exceed the normal, and a significant proportion of the air will pass through it, thus bypassing the filtering medium.

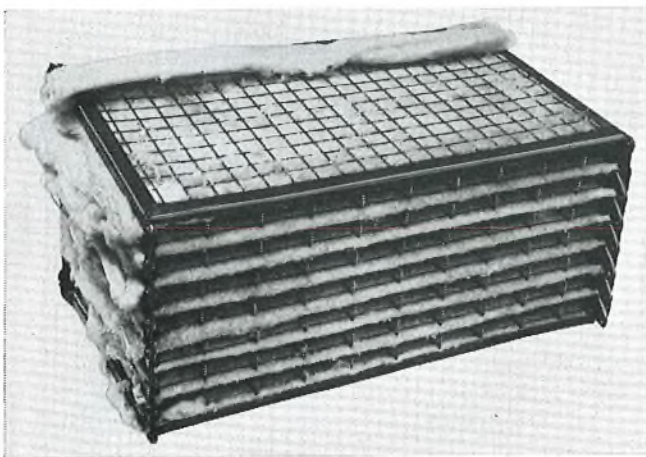

FIG. 4—"KONPAK" TYPE FILTER FRAME LOADED WITH COTTON FILTERING MATERIAL

\* micron—0.001 mm.

Viscous filters were used extensively prior to the introduction of the fabric filter described above, and many are still in service. The standard Post Office pattern consists of a frame some 2–3 in. deep, filled with brass ferrules retained by expanded metal. The filters are coated with a viscous oil to trap and retain dust, and cleaning and re-oiling them is necessarily a somewhat messy operation. If insufficiently drained after oiling they may pass oil into the ventilating system, and any smell in the oil may be noticeable in the apparatus room.

A "laundry" service is now becoming available whereby dirty cells are collected for treatment at a central depot. They are cleaned, re-oiled and centrifuged hot to remove excess oil. The oil contains an agent to cause it to become gelatinous as a further safeguard against leakage into the ventilation system. This service is in use experimentally in some Telephone Areas, with satisfactory results.

The efficiency of all viscous filters is however lower than that of the fabric types, particularly for trapping fine dusts.

*Air Distribution.* From the fan the air is fed into the apparatus room via ducts running at right angles to the suites of racks and fitted at intervals with special air-supply points. Until recently the standard arrangement was a structural duct fitted with fixed or revolving "punkah" louvre outlets (Fig. 5). These fittings give a fairly high-velocity narrow jet and are intended to break up pockets of stagnant air, the formation of which is

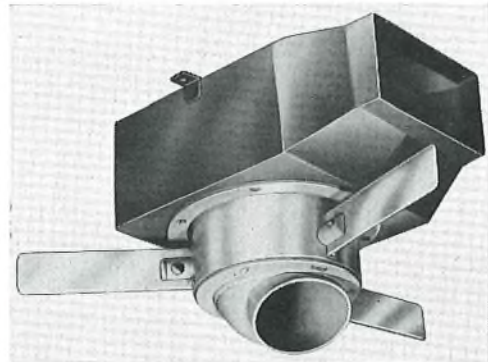

FIG. 5—ROTATING "PUNKAH" TYPE AIR-SUPPLY UNIT

encouraged by the tall, closely-spaced apparatus racks. The rotating type of outlet is driven by an air bleed, the speed being kept low by the resistance of the vanes rotating in more or less still air. The effect is to cover a large area of a room in an intermittent fashion.

The types of outlet just described have not been wholly successful during cool weather, owing to the noticeable draught effect they produce. Other types now being introduced give lower outlet velocities, and the diffuser-type outlet (Fig. 6) introduces room air with the

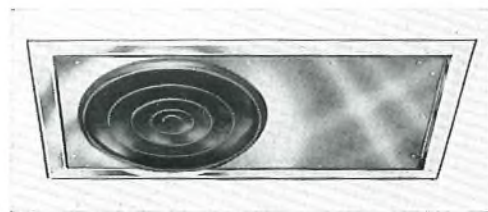

FIG. 6—DIFFUSER-TYPE AIR-SUPPLY GRILLE MOUNTED IN CEILING STRUCTURAL SUPPLY DUCT

fresh air to give a certain amount of pre-mixing. The sensation of draught can thus be largely eliminated.

#### REPEATER-STATION APPARATUS ROOMS

In repeater-station apparatus rooms the heat dissipated by the equipment is commonly 10–12 watts/ft<sup>2</sup>, calling for 15–18 a.c.h. for comfort. Normally no filtering is required, the apparatus not being particularly sensitive to dust, and the required rate of ventilation can be achieved by natural means, assisted by simple extract fans fitted in windows or walls, at high level.

#### APPARATUS ROOMS WITH HIGH HEAT DISSIPATION

Difficulty may arise where high heat dissipation occurs alongside relay equipment or selector banks so that a high rate of ventilation is required together with efficient filtration. The higher the ventilation rate the more efficient must be the filter to provide a given standard of protection from dust. By suitably arranging both input and extract fans and ducting, it is possible to extract the heated air directly from above the hot apparatus, and this permits a temperature rise of 15–20°F in the ventilating air instead of the usual 10°F. Dissipations up to 30 watts/ft<sup>2</sup> with localized areas of 45 watts/ft<sup>2</sup> have been dealt with in this way using only 27 a.c.h. for the whole room. Even so, the filtering problem can be considerable, and in smoky atmospheres the standard fabric filter is unsuitable for these extreme requirements.

#### *Electrostatic Precipitators*

The most promising alternative to the dry fabric filters previously described is the electrostatic precipitator, which can trap dust down to 0.1 micron in size, with very high efficiency. This filter works by causing the air stream to pass through a set of ionizing wires at a positive potential of 10,000–13,000 volts to earth and then between plates alternately at earth potential and at a positive potential of about 6,000 volts to earth. The dust particles become charged in the first stage and are deflected on to the earthed plates, to which they adhere. Periodically the dust is washed off the plates with a hose or by other means. Until recently such electrostatic filters have been expensive in first cost and difficult to

maintain, but the latest versions appear to be much improved and are cheaper. Fig. 7 shows such a dual-voltage electrostatic air-filter cell.

Electrostatic filters can now be arranged with automatic wash-down facilities, and the labour of filter changing and dirt disposal is thus eliminated. They are being used in approximately twenty Post Office installations and their use is likely to grow.

#### *Dry-Paper Filters*

There are also available dry-paper filters capable of the efficient filtration of particles of less than 1 micron in size, but such filters are very expensive in use and are of interest for special purposes only.

#### *Direct Cooling*

Since the ventilation problem in rooms with high heat dissipation is primarily one of heat removal, the direct removal of heat by refrigeration must be considered. The only convenient way of removing heat directly without redesigning the apparatus to be cooled is to use air as the medium. In this instance the outside ambient temperature is no longer a restriction, and the cooling air can be introduced at a temperature determined, within wide limits, by the needs of the system. Thus the possible temperature rise of the air within the room is increased and the quantity of ventilating air required is reduced. At the same time the cooling of the air increases its relative humidity and so provides a means of dehumidifying it if required.

Care must be taken, in designing such a ventilating plant, to avoid introducing air that is too cold or too moist into the apparatus room, since this can cause trouble locally even though the average conditions in the room are satisfactory.

Ventilating plants that include refrigeration are therefore air-conditioning plants as described earlier and are expensive to install and to maintain compared with a simple ventilating plant capable of equal heat dissipation. They have, however, two important advantages. Firstly, the reduced quantity of air required simplifies the filtering problem, and secondly, whereas a ventilating plant can never cool below outside shade temperature, a refrigerator removes this limitation. A number of plants of the partial or full air-conditioning type have been installed in Post Office premises for special purposes.

Small “packaged” cooling units are available that can be mounted in a wall or window. They are arranged to extract heat from the room by blowing air over the “cold coils” and to discharge the heat outside by blowing outside air over the “hot coils”. There is no direct interchange of air, so that fresh air for breathing and odour control must be introduced by other means. These units are useful where apparatus rooms become overheated and no accommodation is available for conventional plant. Fig. 8 shows a window unit rated at 11,000 B.t.u./hour.

#### NEW DEVELOPMENTS

#### *Small Ventilating Units*

Generally, a central fan-and-filter arrangement serving the required number of air supply points via ducting is likely to be cheaper than a large number of small ventilating units.

There are certain advantages, however, in separate units, as follows:

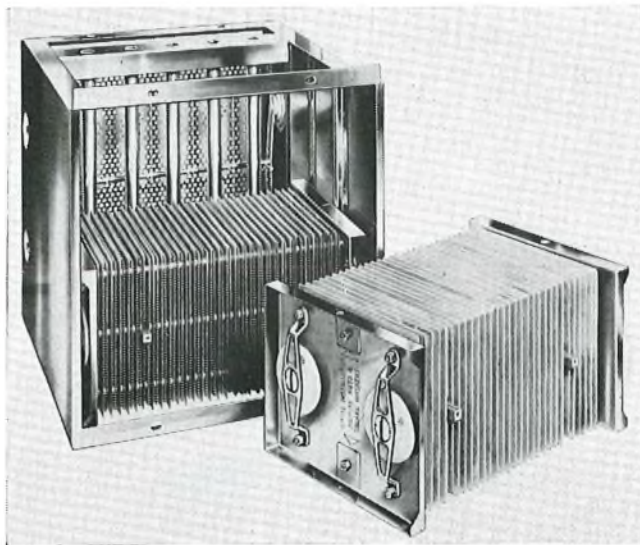

FIG. 7—DUAL-VOLTAGE ELECTROSTATIC AIR-FILTER CELL



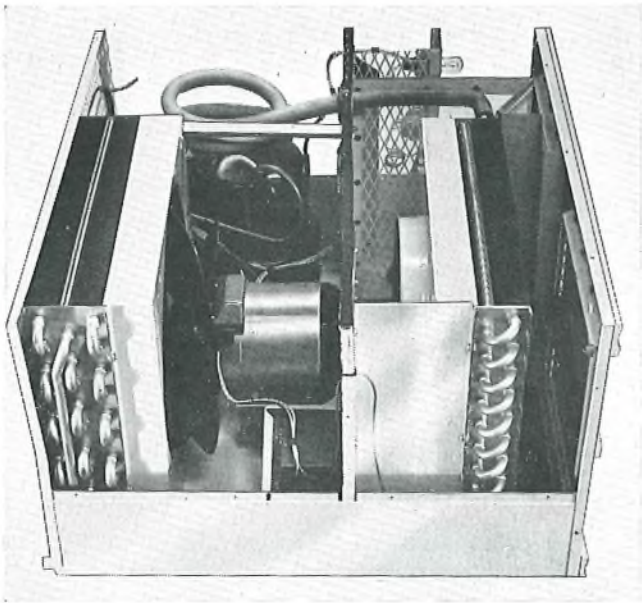

FIG. 8—"PACKAGED" COOLING UNIT ARRANGED FOR WALL OR WINDOW MOUNTING

- (a) No separate fan room is necessary.
- (b) The space required by ducting as well as the cost of ducting is saved.
- (c) Individual control of the units is possible.
- (d) Recirculation can be incorporated, and the ratio of fresh air to recirculated air can readily be varied.
- (e) Heaters can be incorporated in the units to give tempered air (at 65-70°F) or air warmed sufficiently to make other room-heating unnecessary.

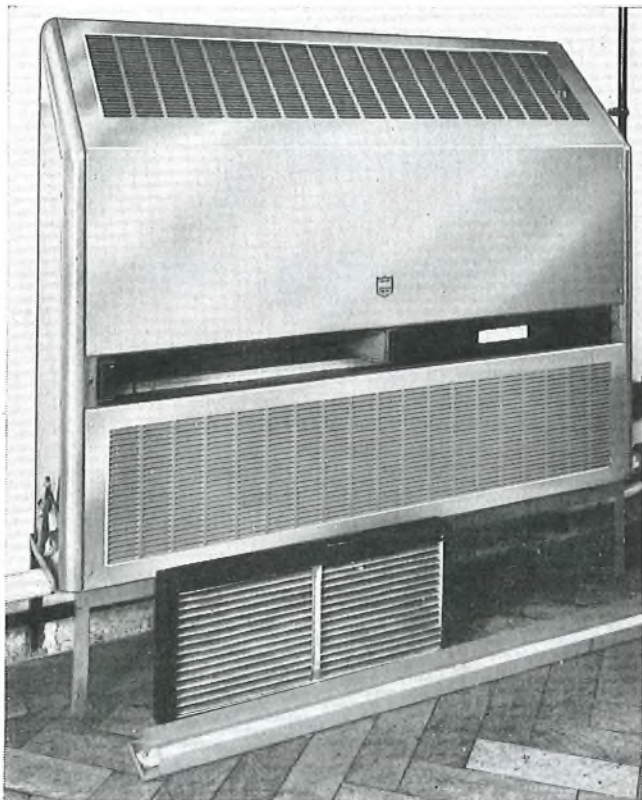

FIG. 9—SMALL HEATED VENTILATING UNIT SUPPLYING FRESH AIR OR RECIRCULATED AIR IN VARIABLE PROPORTION

In existing buildings it is often easier to arrange for a tempered air supply and for recirculation by small units than to modify an existing plenum plant.

Two units (Ventilating Units, Small, No. 1 and 2) have been developed and have been fitted experimentally in some twenty telephone exchanges. The units fit under windows and each replaces one radiator. Type 1 has an electric heater, whilst in Type 2 a finned-tube heater is connected to the normal hot-water heating system. An advantage of an electrically heated ventilation unit in an apparatus room is that it can be brought into immediate use should humidity troubles be experienced outside the normal heating season. Fig. 9 shows such a unit installed.

It is possible with these units to have both the water-fed heater and an electric heater fitted, the latter for use in emergency only, to combat humidity as described above.

Boxed-type glass-fibre filters, which cannot be readily cleaned, are provided on these units. They are quick and easy to handle and reasonably efficient, but at present expensive compared with the standard fabric material.

#### *Oil-Fired Air Heaters*

Combined heating and ventilation can in certain instances be achieved economically by using the recently developed automatic oil-fired air heaters. These consist of an air-to-air heat exchanger, one side of which is heated by a small pressure-jet type of oil-fired burner whilst the other side is fed with filtered air drawn through the heat exchanger by fan and fed by ducts into the space to be ventilated. Controlled recirculation is normally employed and close control of temperature can be achieved using a simple thermostat in the room to control the fan and burner. The unit can be used solely for ventilation in summer by switching off the burner, but under automatic control the ventilation rate will vary with the heat demand. The Joint Post Office and Ministry of Works Research and Development Group have arranged two experimental installations of this nature and others are planned. Glass-fibre filters are used in these devices.

#### CONCLUSION

To determine the best ventilating scheme for a specific requirement involves the consideration of many factors. In the main, for telephone exchanges mechanical systems cannot be avoided because of the need to filter the air, and it is not surprising that the choice of filter has a big effect on the cost of a scheme expressed as an annual charge. Different types of "throw-away" filter element vary in efficiency, dust-holding capacity, resistance to air flow and cost.

The glass-fibre boxed-type filter element is convenient to handle but is more expensive to use than the standard cotton fabric of comparable filtering efficiency. Considerable development is however taking place at the present time, and prices may fall. The electrostatic filter, with automatic control, is meanwhile becoming more competitive as labour costs involved in changing fabric filters rise.

#### ACKNOWLEDGEMENTS

The photograph for Fig. 7 was supplied by the Sturtevant Engineering Co., Ltd., and the photograph for Fig. 8 was supplied by Temperature, Ltd. Acknowledgement is made to both these firms.



# A Tester for the Coin and Fee Checking Relay-Set

D. H. MATTHEWS†

U.D.C. 621.317.799:621.395.663.6

A description is given of a tester which will be used to check the correct operation of relay-sets used for controlling calls and the collection of revenue from pay-on-answer coin-boxes. The tester enables a test cycle of approximately 60 tests to be made and, although manually controlled, special features enable the tester to be operated without an instruction manual.

## INTRODUCTION

THE coin and fee checking relay-set\* has been designed to control calls originating from a coin-box in areas where the S.T.D. service is in operation. The relay-set distinguishes between trunk and local calls, determines how much money the customer has put into the coin-box, and when the time allowed for this money has expired. It indicates to the customer when he should put money in the coin-box, prevents him from inserting it too soon, and clears down the call if he fails to insert the money within a predetermined period.

The complexity and cost of a tester for a relay-set, selector or other item of telephone exchange equipment is generally related to the complexity and relative importance of the item to be tested. Because the coin and fee checking relay-set is used in controlling the collection of revenue and ensuring that the customer obtains the full amount of time for which he has paid, it is necessary for a tester for this relay-set to be capable of applying a comprehensive range of tests, cost and complexity being subordinate considerations.

Approximately 60 tests are required to be made by the tester. These tests include checks that the relay-set

- (a) is neither overcharging nor undercharging,
- (b) guards itself against seizure by another caller during the progress of a call,
- (c) can repeat dialled pulses to the succeeding equipment,
- (d) can indicate to the operator the amount of money being put into the coin-box and the total amount put in for the call,

- (e) responds to various release signals, and
- (f) will accept an emergency call over a line of low-insulation resistance.

These and other tests are applied to the relay-set by means of a key-operated tester known as Tester TRT 60. The techniques adopted to enable this tester to be used without the aid of an instruction manual and the resultant appearance of the tester are described below.

## APPEARANCE

The general appearance of the tester is shown in Fig. 1. The layout of the key panel is shown in Fig. 2. Although the tester is key-operated, a number of tests are applied automatically. This reduces the time required for the test cycle and the space required on the key panel.

A rear view of the tester with the two side gates open to their fullest extent is shown in Fig. 3.

## ACCESS ARRANGEMENTS

### Access to the Relay-Set

Access to the relay-set is gained via three 12-way plug-ended cords. One of the access points controls the relay-set relay RT, two other points indicate that the

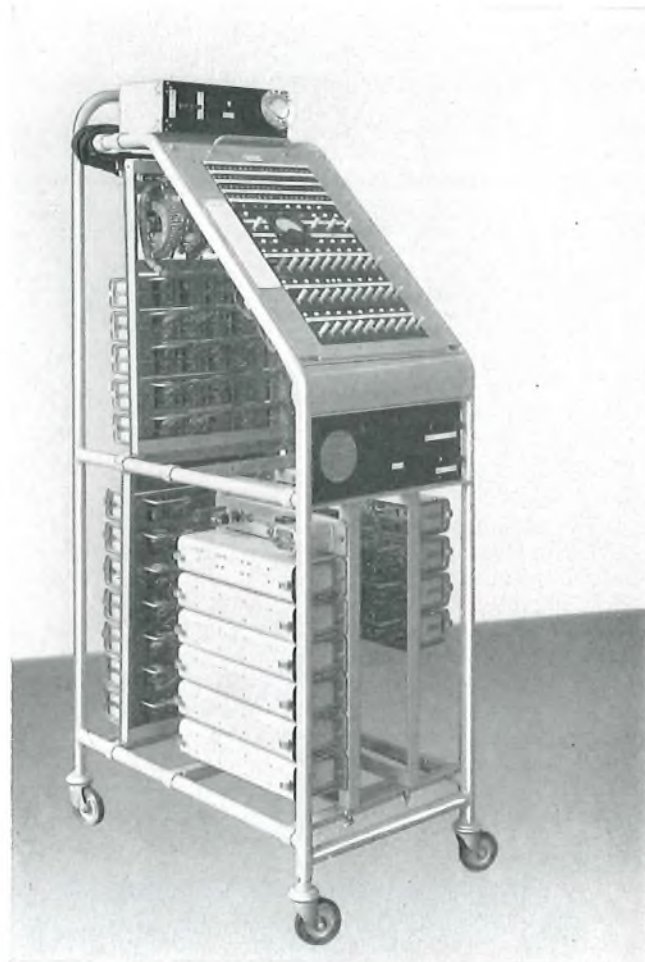

FIG 1—GENERAL APPEARANCE OF THE TESTER

plugs are in their jacks, and the remaining access points are used at various stages in the test cycle.

### Access to the Power Supplies

The tester is designed to work from the  $-50$ -volt supply. Certain test elements require, in addition, a positive battery supply of at least 45 volts; where this supply is available on the relay-set rack it is fed to the tester via a 4-way plug and cord which also connects the  $-50$ -volt supply and earth. In other exchanges the positive battery is obtained from a dry battery contained within the tester and the negative supply is obtained through the rack battery jack.

## PRINCIPLES OF OPERATION

### General

The tester has been designed so that all the instructions for operating the keys and for checking various condi-

† Telephone Exchange Standards and Maintenance Branch, E.-in-C.'s Office.

\* BASTOW, F. J., COLLINGWOOD, J. D., NEWELL, E., and PRICE, C. K. The Pay-on-Answer Coin-Box System. *P.O.E.E.J.*, Vol. 51, p. 343, Jan. 1959.

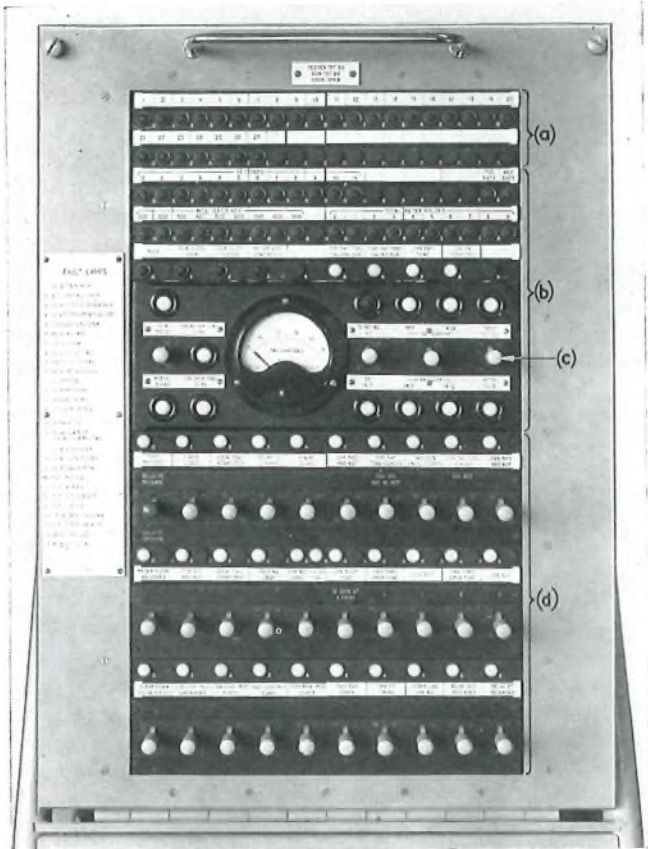

- (a) Fault lamps
- (b) Information lamps (green) and instruction lamps (white)
- (c) Non-locking keys
- (d) Test-cycle keys and O.K. lamps

FIG. 2—LAYOUT OF THE KEY PANEL

tions are given by the tester, and the maintenance engineer has no need to refer to an operating manual to apply the tests. This has been achieved by using the system described in the following paragraphs.

#### The Keys

Test-cycle keys are used to initiate a particular test or sequence of automatically-completed tests. The test-cycle keys are mounted in horizontal rows and are operated consecutively from left to right, beginning in the top left-hand corner. A test-cycle key, once operated, remains operated for the remainder of the test cycle; the signal to operate a particular key is given by a lamp, known as the O.K. lamp, mounted directly above the preceding key. When this lamp gives a steady glow the next test-cycle key is operated; when it flickers certain visual or aural checks must be made before the test cycle is continued.

Pulses needed to initiate certain relay-set operations or to position certain of the relay-set uniselectors are applied by non-locking keys, which are grouped together on the key panel remote from the test-cycle keys. The signal to operate one of these keys is given by a white lamp situated in the immediate vicinity of the key, generally in the direction to which the key must be operated.

#### Labelling

A key is labelled with a title that gives some indication

of the test being performed if the key controls a test that can be fully completed by the tester, i.e. a test for which the O.K. lamp gives a steady glow. A key that initiates a test which must be completed by the user is labelled with a title which tells the user the checks he must make when the lamp flickers and no reference is made on the label to the tests being performed.

#### General Indication of a Test Failure

In the ideal tester each test condition should check for only one fault condition, so that a test failure would mean a fault in only one part of the circuit. Unfortunately, such an ideal cannot be achieved with a tester for this relay-set without the use of considerably more access leads and a large increase in the time for the test cycle. Thus, whilst in some of the tests the reason for the failure to complete the test may be readily apparent, in other tests the failure may be due to any one of a number of items. In both instances, the only indication of a failure will be that the test O.K. lamp will fail to glow or flicker at its usual time after the operation of the associated test key.

#### Fault Lamps

It is possible to be more specific on the nature of a failure during certain tests where the tester must receive correct signals from a number of points. If in these tests

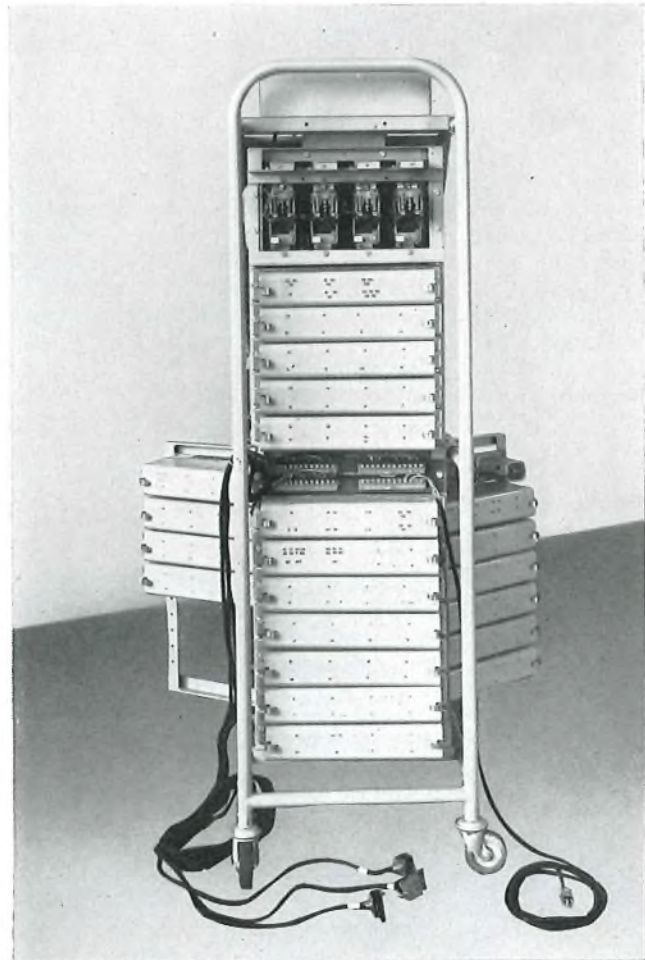

FIG. 3—REAR VIEW OF THE TESTER



any of the signals is missing, the test O.K. lamp will remain dimmed, but, as the tester now knows which signal is at fault it can display this information by lighting a lamp on the key panel. There are 27 faults that the tester is able to indicate in this manner; the lamps that indicate these faults are known as fault lamps, are red in colour and occupy the top two rows of the key panel. Because an adequate description of the type of failure is often too long to include on the label associated with the fault lamp, the lamps are numbered 1-27 and a large label on the left-hand side of the key panel relates the lamp number to the fault description.

#### *Information Lamps*

During the test cycle the tester applies two timing tests and also counts meter pulses. Lamps on the key panel indicate the progress of the timing tests and the total number of meter pulses received. These lamps are known as information lamps; they are green in colour and, except for one lamp which is mounted on the milliammeter panel, they are mounted immediately below the fault lamps.

#### *Instruction Lamps*

There are four aural tests that the user must make during the test cycle. The time to make these tests is indicated by the flickering of a white lamp which is suitably labelled. These four lamps, and the white lamps associated with the non-locking keys, are known as instruction lamps. Instruction lamps flicker for as long as the condition to be checked is present, and they cease flickering when the condition is removed.

#### *The Milliammeter*

The tester must have available a positive-battery supply to check that the relay-set will respond to signals from a manual board, and the tester design allows this supply to be derived either from a dry battery or from the relay-set rack. The appropriate tester element applies to the relay-set the lowest positive potential that might be applied in service. To obtain this potential a potential-divider is connected across either supply, and to allow for variations in the exchange voltage and, more particularly, in the voltage of the dry battery, a milliammeter is included in the element to act as a voltmeter. The opportunity was taken to include the non-locking keys and their lamps in a convenient grouping on the specially-designed milliammeter panel.

#### *The Dialling Unit*

Under certain conditions it is necessary to dial a metering test number, and a suitable dial, together with its instruction lamp, is mounted on the top of the tester for this purpose; this mounting is also used to house the dry battery and two keys that are used to condition the tester to the type of meter pulses that are sent into the relay-set and are received from it. As the relay-set can also be used as a meter-pulse conversion set it is possible that the tester will need to respond to different conditions

in the same exchange; for this reason keys are used instead of straps.

#### *The Amplifier Panel*

To enable the aural tests which have to be made during the test cycle to be completed, a simple one-valve loudspeaker amplifier is mounted on the front of the tester. Also mounted on this amplifier panel are a key, a pair of terminals, and the variable resistor for adjusting the positive potential used to simulate manual-board signals. When the key is operated the output of a pulse-generating relay used in the tester is extended to the two terminals where it may be measured by means of a suitable meter. The variable resistor has no knob and is adjusted by inserting a screwdriver through the panel; this prevents it from being accidentally altered in mistake for the amplifier volume control.

#### *The RELAY RT OPERATE key and RELAY-SET RELEASE key*

The RELAY RT OPERATE key and the RELAY-SET RELEASE key is a double-throw non-locking key which is used to operate the relay-set relay RT at the beginning of the test cycle, or to release this relay and hence disassociate the tester from the relay-set at any place in the test cycle. This key is mounted immediately to the left of the first test-cycle key and is distinguished from the test-cycle key by its red handle; the test-cycle keys have grey handles, the pulse keys on the milliammeter panel have yellow handles, and the key handles on the dial mounting and the amplifier panel are black.

#### SEQUENCE OF OPERATIONS

To operate the tester the appropriate plug is inserted into the left-hand jack of the left-hand relay-set: a green information lamp glows if the circuit is busy. If no lamp glows the RELAY RT OPERATE key is operated momentarily: this operates the relay-set relay RT and so busies the relay-set to normal traffic. The remaining two plugs are now inserted into their respective jacks and when this is done a TEST PROCEED lamp, mounted above the RELAY RT OPERATE key, glows. The next key is now operated and the test cycle begins.

If a failure occurs during the test cycle and it is required to retest the faulty element, all the test-cycle keys must be restored and the test cycle begun again to reach the point of failure, although in one or two instances a test can be repeated by restoring and re-operating the last-operated test-cycle key. A fault-free test cycle takes 3½-4 minutes to complete.

#### CONCLUSION

The tester for the general coin and fee checking relay-set, although a key-operated tester, is designed to be used without recourse to an operating manual. Tests have shown that the conventions and methods of operation are readily assimilated by persons who have had no prior knowledge of the tester, although it is, of course, necessary to refer to detailed documents when the need to clear a relay-set fault arises.



# A Calling Aid for Disabled Subscribers

J. D. COLLINGWOOD, A.M.I.E.E., A.M.Brit.I.R.E.†

U.D.C. 621.395.721.7 : 621.395.636

Trunking changes at some automatic exchanges have made it necessary to provide new arrangements to assist subscribers who, through some disability, are unable to dial for themselves. A device that can be associated with the telephone to enable the assistance code 100 to be signalled is described.

A SUBSCRIBER connected to an automatic exchange who, due to some physical disability, is incapable of dialling, has hitherto been enabled to obtain direct access to an operator by an exchange relay-set that connects his line to the manual switchboard. However, as a result of the revised trunking arrangements consequent upon the introduction of the dialling code 100 for obtaining the assistance of an operator, the existing relay-sets are no longer suitable in all instances. Where the present relay-set is unsuitable, it has been decided to provide service for disabled subscribers by a device (Sender No. 1) that can be fitted alongside the telephone. This device enables the code 100 to be signalled simply by pressing a button.

## Description

The sender is housed in a steel case approximately 6 in. × 4 in. × 3 in. high having a grey hammered finish; its appearance is shown in Fig. 1. The sender can stand beside the telephone with which it is to be used, or it can be wall-mounted.

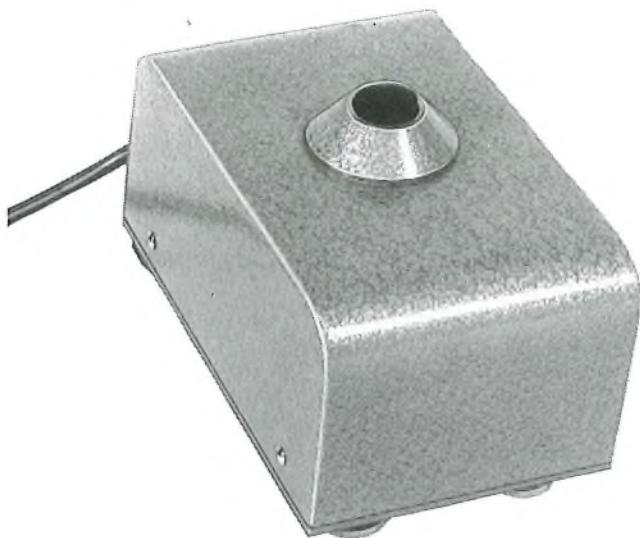

FIG. 1—DISABLED SUBSCRIBER'S CALLING AID

The mechanism consists of a pulsing wheel which, by means of a movable mask, can be arranged to signal 100 or 0, and which is driven, through gearing, by an electric motor. When the start button is pressed the motor is energized, and simultaneously a relay is locked-in to maintain the motor drive until one cycle of operation has been completed. A mechanically operated microswitch is used to halt the mechanism at this point, so that only one

complete cycle takes place whether or not the start button is held down continuously. In addition to the pulsing contacts, off-normal spring-sets are fitted, and the sender is connected to the telephone in such a way that the pulsing contacts are in series with, and the off-normal contacts are in parallel with, the corresponding contacts on the dial.

The sender is supplied with power from a 9-volt battery, and the motor, which is governed, maintains the correct pulsing rate until the battery voltage on load falls below 7.5 volts.

## Electrical Operation

A circuit diagram of the device is shown in Fig. 2 and the operation of the sender is described below.

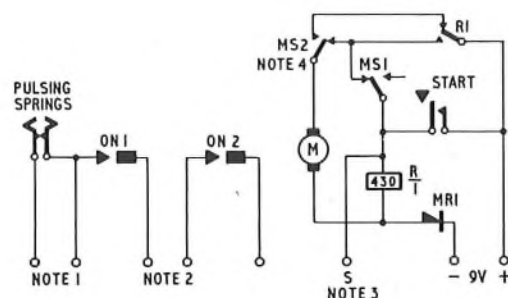

### Notes:

1. The pulsing contacts are in series with the corresponding contacts of the telephone dial.
2. The off-normal contacts, ON1 and ON2, are in parallel with the corresponding contacts on the dial.
3. Terminal S can be used for the connexion of a separate push-button.
4. Switch MS is operated mechanically after the pulse train is transmitted and is restored when the pulse wheel reaches its home position.

FIG. 2—CIRCUIT OF CALLING AID

The user lifts the receiver, waits until dial tone is heard and then presses the start button. This causes relay R to operate and lock itself via contact R1 operated and microswitch contact MS1 normal. Contact R1 also connects the battery to the motor, which commences to drive the pulsing wheel. The off-normal contacts ON1 and ON2 operate to short-circuit the telephone receiver and provide a loop for dialling. The pulsing contacts are then opened and closed by the pulsing wheel, and dial pulses are sent to line. At the end of the pulse train the microswitch MS is operated mechanically; contact MS1 changes over and relay R releases, provided that the start button has already been released. Contact MS2 changes over and maintains the motor-drive circuit via contact R1 released until the microswitch is restored to normal when the pulsing wheel reaches its home position.

Should the start button be held down by the user during the whole of the pulsing train, relay R remains operated and, when contact MS2 changes over, the motor drive is disconnected and the pulsing wheel comes to rest a few degrees short of its home position. When the button is finally released, the motor-drive circuit is re-established via contact MS2 operated and contact R1 released until the home position is reached and the microswitch is restored to normal.

† Subscribers' Apparatus and Miscellaneous Services Branch, E.-in-C.'s Office.

### Usage

The sender is primarily intended to enable the existing disabled subscribers' service to be continued when the assistance code 100 is introduced. However, if an able-bodied person uses the same telephone as the disabled user, the sender does not preclude calls being dialled in the normal way. Where this facility of dual use is required the new sender will also be provided in areas

where the assistance code 0 is in use.

The sender will be supplied, without charge, in cases of genuine need; it will not be provided on rental terms.

### Acknowledgements

The author wishes to acknowledge the assistance given by Messrs. Burgot Rentals, Ltd., who produced the prototypes of the sender.

## A New Flameproof Table Telephone with an Intrinsically Safe Handset

U.D.C. 621.395.721.4 : 614.83

THE development of a flameproof telephone poses the problem of the safety of the handset and cord, which cannot be of flameproof construction like the telephone case. A new flameproof table telephone has been developed, in which the difficulty has been overcome by making the handset and cord intrinsically safe.

The present flameproof table telephone\* (Telephone No. 266) was introduced a few years ago to meet the requirements of many industries and in particular the oil industry. In the design of the Mark II version of the Telephone No. 266 a degree of safety was achieved by adopting a suitable design and standard of construction for the handset and cord without modification to the circuit design. In the interests of further safety, however, the preferred arrangement is an intrinsically safe handset with the line current excluded from the transmitter and cord, thus eliminating the possibility of fire or explosion caused by a spark should the cord be severed or the transmitter connexions become faulty.

For flameproof equipment the components are housed in a specially constructed flameproof enclosure (telephone case in this instance) which will withstand an internal explosion and prevent the transmission from within of a flame that might ignite any prescribed inflammable gas or vapour in the surrounding atmosphere.

Intrinsic safety, which is achieved by circuit design and the choice of components, implies that any sparking that might occur either during normal working or under specified fault conditions is incapable of causing an explosion of the inflammable gas or vapour. Such a handset has been made possible in the development of a new flameproof table telephone (Telephone No. 702) by the use of a rocking-armature receiver as a dynamic microphone and a transistor amplifier associated with a telephone circuit of conventional design and suitable for use on lines of up to 1,000 ohms loop resistance. A standard handset cord carrying speech currents only is used.

A 2-stage amplifier is housed within the flameproof telephone case and is mounted together with the normal telephone components on an easily removable chassis.

The circuit of the new telephone is shown in the figure. Speech currents from the microphone are fed to the input of the first amplifier stage via transformer T3, which both

\* BELK, J. L., and WOODWARD, E. Flameproof Telephones and the Development of a Table Model. *P.O.E.E.J.*, Vol. 50, p. 215, Jan. 1958.

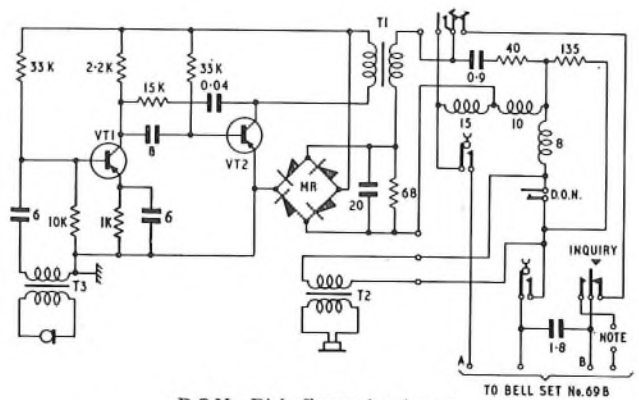

D.O.N.—Dial off-normal spring-set  
Note: These terminals are strapped when the inquiry facility is required.  
CIRCUIT OF THE NEW FLAMEPROOF TELEPHONE

matches the impedance of the microphone to the base circuit of transistor VT1 and isolates the microphone from the telephone circuit. The first stage is resistance-capacitance coupled to the second stage, VT2, which has an output transformer, T1, in its collector circuit. Amplified speech signals are fed into a standard telephone circuit at a point normally occupied by the transmitter. The microphone-amplifier combination provides an output to line approximately equal to that of a Transmitter-Inset No. 13 in the same circuit. The instrument line-current, passing through the 68-ohm resistor, provides the operating potential for the amplifier, to which it is applied through a rectifier bridge, thereby ensuring correct polarity with either direction of line current. The transmission loss due to this resistance is minimized by a 20  $\mu$ F tantalum-capacitor shunt.

As an additional safety precaution the handset receiver is connected to the telephone circuit through a 1 : 1 isolating transformer, T2.

With flameproof table telephones it is necessary to have a separate bell set which also accommodates the terminals for the line wires. A new bell set (No. 69B) has been introduced for use with the new telephone.

Certification by the Ministry of Power for both Telephone No. 702 and Bell Set No. 69B covers Groups II and IIIa of B.S.229 : 1957, Flameproof Enclosure of Electrical Apparatus.

T. J. J.



# Measuring Techniques for the Inspection of Apparatus Parts

R. J. JEFFREY, A.M.I.E.I.†

U.D.C. 620.11 : 531.7 : 621.395.6

The use of modern techniques employing high-grade measuring equipment is essential to the processes of inspection used by the Post Office in checking equipment and parts that it has purchased. These techniques, which have kept well abreast of the advances made by inspection departments in industry, have many different applications, often of a specialized character, and brief descriptions of some of them are given.

## INTRODUCTION

PARTS of many of the main engineering and tele-communications items used by the Post Office were formerly examined and tested for mechanical interchangeability by comparison with a pattern and then by fitting them into an otherwise complete assembly. This method, though laborious compared with modern practice, proved effective.

Expansion of the services provided by the Post Office increased both the range and quantity of items, and it became more difficult to provide storage space for the complete assemblies; to continue to inspect every item, as required by this method, was clearly uneconomical. Furthermore, many parts were purchased from suppliers other than the original manufacturers of the items, particularly during the recession period of the early 1930s, when competitive tendering for contracts became common. In addition, the Post Office tended towards the introduction of designs produced by agreement between itself and the main equipment manufacturers, and stocks of many items are now maintained without distinguishing between similar items made by different manufacturers.

Formerly, measurements were mostly dependent on simple devices such as micrometers and vernier slide gauges, but with the increase in the number of designs common to several manufacturers it became necessary to have separate testing staffs whose function was to ensure the interchangeability of all parts of the same type irrespective of their manufacturer, and also to keep check on the many gauges brought into use for day-to-day acceptance testing. Such interchangeability was achieved by closely examining parts at the commencement of production to check that they conformed with the appropriate drawings and by subsequently checking samples from deliveries throughout the run of the contract. The introduction of modern measuring equipment and measurement techniques, some of which are described in the following paragraphs, has considerably facilitated this and other inspection work.

## INSTRUMENTS AND APPARATUS USED

### *Measurement by Projection*

A ready means of checking parts, particularly those whose shape would make direct measurement a difficult and lengthy process, is provided by a projectograph giving magnified ( $\times 10$ ,  $\times 25$  or  $\times 50$ ) silhouette images. This instrument can be used in conjunction with standard templates, e.g. for screw-thread forms, or with scaled-up contour drawings, made on translucent materials, of forms such as those of involute gear teeth. Such a method does not, however, allow the degree of error to be accurately determined, although, by using a scaled

rule, close estimates can be made by comparing the image and template, nor does it permit the measurement of details, such as blind holes, that are visible only on the surface.

Both of the above requirements can, however, be met by using a universal projector (Fig. 1). With this instrument, the collimated light from a 250-watt high-pressure mercury-vapour lamp is passed across the object, which is mounted on a workplate that is movable under the control of drum micrometers. The range of movement

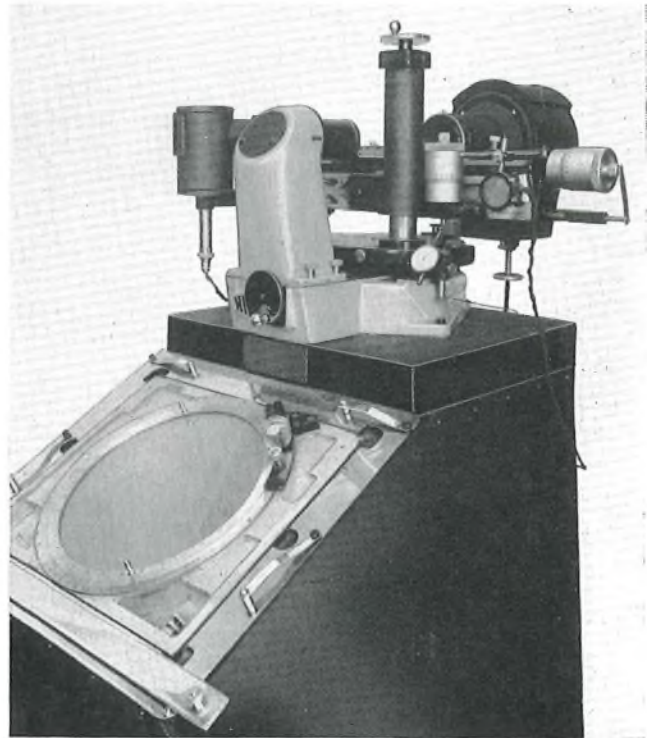

FIG. 1—UNIVERSAL PROJECTOR

is six inches by one inch, and the micrometers are scaled to read directly in "tenths" (one ten-thousandth part of an inch). The resulting image is magnified by the object lens, magnifications of  $\times 15$ ,  $\times 25$  and  $\times 50$  being obtainable, and projected via a mirror system on to the screen—a 10-inch diameter ground-glass plate with broken reticule lines accurately engraved upon it at right angles.

The plate with its frame, which carries two  $90^\circ$  protractor scales, is rotatable about its centre, and an associated vernier on the mounting enables readings of rotation, and hence angles on the object, to be made to an accuracy of one minute of arc. Due to the magnification, a movement of the object of one "tenth" is readily discernible at the higher powers, and even at  $\times 15$  the trained operator can measure to 0.0001 in.

Two surface-lighting units, mounted so as to project high-intensity narrow beams at any desired angle to the surface of the item being measured, are situated one on each side of the object lens. The light from these units

† Test and Inspection Branch, E.-in-C.'s Office.

is sufficient to project images at  $\times 50$  magnification from all but dull black surfaces, thus permitting measurement of blind holes and other surface details.

Similar in operation to the universal projector, tool-room microscopes provide the same degree of accuracy but are more compact. The light source for projection is a low-voltage filament lamp whose collimated beam passes through the base of the instrument and, being deflected vertically upwards by an angled mirror, passes through a glass plate in the centre of the worktable.

Items to be measured are laid flat on the glass, and the image, magnified in one instrument by up to 100 diameters, is projected via a prismatic optical system on to a ground-glass screen housed in a hood mounted immediately above the instrument. The reticule, fitted in the ocular head between the lens and the prism, can be quickly exchanged for one giving accurate profiles of British Association and standard Whitworth screw threads. The worktable is controlled by drum micrometers, the lateral movement being six inches and the cross-traverse two inches.

Angles are measured by rotating the reticule by a reduction gear controlled with a knurled knob, the angle of movement being read through a small magnifying eyepiece immediately below the screen. For surface illumination six low-voltage lamps are fitted in a small circular shade surrounding the object lens. Being each of low power (1.8 watts) these lamps do not provide sufficient light for surface projection, but for the same reason do not generate enough heat to distort cuprous metals or thermoplastic mouldings. When using surface lighting the screen hood is removed and the reticule

screen is viewed direct through an eyepiece, the projection light being reduced through a dense green filter.

#### *Check of Measuring Equipment*

To check the accuracy of all the measuring equipment, slip gauges of inspection grade are used. These, often called Pitter Gauges, are sets of gauge-steel blocks individually accurate to within five millionths of an inch with reference to national standards, and flat on their working surfaces to within one microinch. Various sets are used, the most popular being of 81 pieces from which any number can be placed together with a twisting action termed "wringing" to form any required reference length from 0.1 in. in incremental steps of 0.0001 in. to several inches, with an overall accuracy of better than a few hundred-thousandths of an inch.

#### *Measurement by Comparison*

Slip gauges are also frequently used for measuring gauges, bearings and ball races whose dimensions are specified within close limits. Either the direct "go-and-not-go" method, or comparison with the item under test by means of the electronic comparator (Fig. 2) is used. In the comparator the e.m.f., resulting from a phase-change caused by a stylus movement altering the values of differential inductances connected in series across a local oscillator, is amplified and fed to a microammeter. With the stylus resting on the reference length the controls are adjusted to set the pointer to mid-scale (marked zero) on the meter. Any change in the stylus position when the reference length is replaced by the length under test causes a deflexion of the pointer. The



FIG. 2—ELECTRONIC COMPARATOR



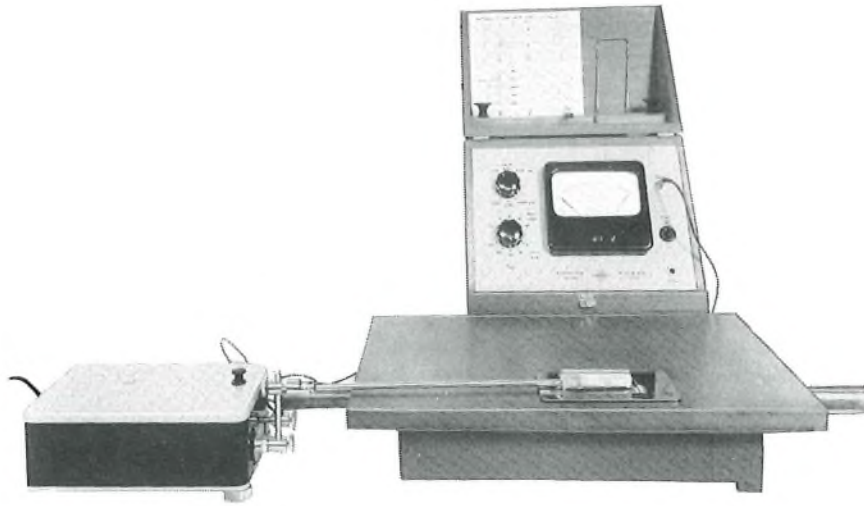

FIG. 3—APPARATUS FOR MEASURING SURFACE FINISH

meter is scaled to indicate stylus movement between  $\pm 0.005$  in., graduated in 0.0001 in. divisions, but for very fine measurement a switched gain control on the amplifier changes the range to  $\pm 0.0005$  in., graduated in 0.00001 in. The pressure on the stylus is made very low (6–8 grammes) to minimize damage to the surface under test.

#### *Measurement of Surface Finish*

Within recent years the method of specifying a surface finish has changed, such terms as “machined,” “ground,” “honed,” etc., being superseded by a definition of the surface texture in microinches relative to the hypothetical true plane. British Standard 1134 recommends the centre-line-average (C.L.A.) method, which is the arithmetic mean of the areas of “hills and dales” present on all surfaces other than optical flats. The apparatus (Fig. 3) used for this type of measurement consists of a diamond stylus with a tip radius of 100 microinches, mechanically coupled to a piezo-electric transducer. The

stylus is moved across the surface under test at a constant velocity of  $\frac{1}{8}$  in./second, and the transducer output is fed via an integrating network and amplifier to a meter scaled to show the surface texture in microinches (C.L.A.). Calibration of the apparatus is made possible by the use of precision reference specimens of standard roughness. They are electroformed reproductions of the standards in gold made by the American Standards Association in 1955 and universally recognized.

#### CONCLUSION

The development of metrology—the science of measurement—in the Post Office arose from the need for economical and effective inspection methods to ensure the high quality of equipment and apparatus required for the telecommunications services. With the growth of these services it is probable that a considerably greater application of metrology will be needed in the future.

## Book Review

“Servomechanisms.” P. L. Taylor, M.A., A.M.I.E.E.  
Longmans, Green & Co., Ltd. xiv + 418 pp. 259 ill.  
42s.

This book is intended as an introductory textbook on closed-loop control systems and is suitable for use in university or technical college courses. The author has both industrial and teaching experience.

The ground covered is what might be expected: the properties of the various electrical, mechanical, and hydraulic components used in closed-loop control systems, and the analysis and synthesis of systems, both in terms of frequency response and transient response, with particular attention to the problems of stability. The treatment is essentially of linear systems, although one chapter deals in a broad way with the effects of non-linearity. Sampled-data systems are not considered. There is a chapter on the transmission of continuously varying data over wire links, and a chapter on computation which includes a short, but excellent, description of digital computers, and a longer

treatment of analogue computers and simulators. There are 122 problems, with answers, grouped according to chapter.

The special feature of this book is its subdivision into parts requiring differing levels of mathematical technique. Part I contains a general, mostly qualitative, introduction. Part II deals with components, and with complete systems, their classification into conventional types, and the setting up of the system differential equations and transfer functions. The solution of these equations is not dealt with, but this does not prevent a great deal of information from being extracted from the equations in a way which should be of great help to the student in getting an appreciation of the physical significance of the equations. Part III goes on to the formal solution of differential equations by the Laplace Transform, and the application of complex variable theory to transfer functions.

The book is lucidly written in a style which, although somewhat mannered, is not unattractive. It should be very helpful to students working on their own as well as to those attending lectures.

W. E. T.

# Transistor Line Amplifiers for Speech and Program Circuits

D. THOMSON, A.M.I.E.E.†

U.D.C. 621.395.64 : 621.375.4

The present standard types of audio line amplifier and program line amplifier have been in use for many years. Amplifiers using transistors have now been developed to supersede the existing standard types, and the design and performance of these new amplifiers are described.

## TRANSISTOR AUDIO LINE AMPLIFIER

A TRANSISTOR amplifier has now been developed to supersede the present standard valve-type audio line amplifier (Amplifier No. 32). During the development of the new amplifier<sup>1</sup> a number of designs were evolved and tested. The main stages in the development were as follows:

(i) An amplifier was designed using the earliest junction transistors to become available in commercial quantities in this country. These transistors did not have a large enough power-handling capacity to enable a simple design to be adopted that would provide an output power of 50 mW as required by current circuit-utilization practice.

(ii) A second type of amplifier, using transistors that became available later, had a performance equal to that of the standard valve-type audio amplifier, but contained several electrolytic capacitors (250  $\mu$ F per amplifier). It was, however, considered that if the claims of long life that were being made for transistors proved justified, the reliability and life of such an amplifier might depend on the lives of these capacitors.

(iii) Further development led to the design of an amplifier giving the required performance. This amplifier contained one paper-dielectric capacitor (0.1  $\mu$ F), but, because it included no decoupling circuit, the design imposed a severe restriction on the impedance of the power supply.

The amplifier described in the following paragraphs is a modified version of the third design referred to above, but it includes a 4  $\mu$ F paper-dielectric capacitor for decoupling. The amplifier has been designed to operate from the normal repeater-station l.t. supply, or from a d.c. supply in the range 18–24 volts having the positive pole earthed, and dissipates about 330 mW. The production models are designed to be fitted on a 2-unit 51-type equipment panel<sup>2</sup> and occupy less than 2 inches of panel length (Fig. 1).

Small quantities (about 48) of each of the earlier designs were made and tested in the Post Office Research Station and later installed at various repeater stations for field trial. Useful data regarding the life and reliability of the transistors are being collected, and results so far amply justify the use of transistors for audio line amplifiers.

### Design Considerations

The amplifier is required to have an insertion gain, measured between 600-ohm resistances, of 30 db, and to have sufficient negative feedback to cater for wide manufacturing tolerances in transistor parameters. A 2-stage configuration is therefore necessary. The amplifier must be capable of delivering 50 mW of signal power to the load, with less than 5 per cent total harmonic

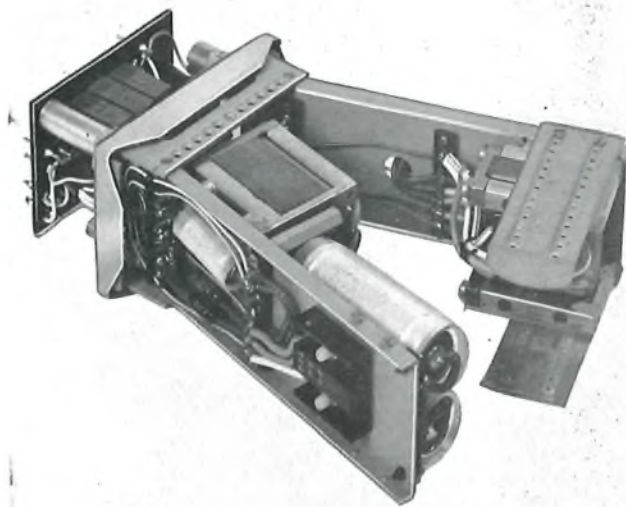

FIG. 1—TRANSISTOR AUDIO LINE AMPLIFIER (AMPLIFIER NO. 121)

distortion. Because the maximum theoretical efficiency under Class A operating conditions is 50 per cent, and since allowances must be made for losses in the output transformer and the direct-current stabilizing circuit, the transistor used in the output stage must have a collector dissipation of about 200 mW.

The basic circuit of the amplifier consists of a common-collector stage, having a high input impedance and a low output impedance, followed by a common-emitter stage having a low input impedance and a high output impedance. This configuration allows direct coupling between stages, thus avoiding the use of a coupling capacitor or transformer, and provides a phase reversal so that negative feedback can be applied easily from the collector circuit of the output stage to the base circuit of the input stage.

### Direct-Current Circuit

In the amplifier circuit (Fig. 2) the values of resistors R1, R2, R3, R4, R5 and R7 define the operating conditions for a given pair of transistors at one ambient temperature. Replacement of the transistors or a change in ambient temperature will produce a change in the operating conditions, and the design of the stabilizing circuit must ensure that such changes are kept within tolerable limits. The main transistor parameters that affect the operating conditions are

- (a) the common-emitter current gain,
- (b) the collector-base cut-off current, and
- (c) the base resistance.

† Post Office Research Station.

<sup>1</sup> BASSETT, H. G., THOMSON, D., and GREENAWAY, T. E. The Application of Junction Transistors to Audio-Frequency Telephone Line Amplifiers. *Proceedings I.E.E.*, Paper No. 2674R, May 1959 (Vol. 106, Part B, p. 290).

<sup>2</sup> HARRIS, E. T. C., and SPRATT, C. J. An Improved Form of Mechanical Construction for Transmission Equipment—51-Type Construction. *P.O.E.E.J.*, Vol. 51, p. 197, Oct. 1958.



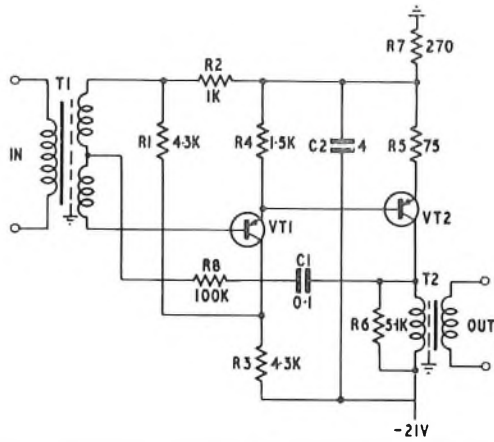

FIG. 2—CIRCUIT OF TRANSISTOR AUDIO LINE AMPLIFIER

The permissible manufacturing tolerances of these parameters can be determined, for a particular set of operating conditions at a given temperature, either directly, or indirectly from the transistor specification.

All these parameters vary with emitter current and collector-junction temperature, and the effect of taking into account the actual operating conditions and the range of ambient temperature over which the amplifier must operate is to widen considerably the specified tolerances. Transistors of types CV 7001 and CV 7002, having respective maximum collector dissipations of 50 mW and 250 mW, are used, and the direct-current circuit is designed so that, at an ambient temperature of 20°C and with average transistors, the respective collector currents are 1 mA and 14.5 mA and the collector-emitter voltages are 4 volts and 14.5 volts.

The performance of the direct-current stabilizing circuit is such that, with any combination of transistors that comply with their specifications at all ambient temperatures between 10°C and 45°C, the collector dissipation of the output transistor will not exceed 240 mW or fall below 175 mW. This ensures that the amplifier will always be capable of delivering 50 mW of signal power to the load with less than 5 per cent total harmonic distortion.

#### Amplifier Circuit

The presence of the un-bypassed stabilizing resistors affects the performance of the amplifier at signal frequencies. The effect of R5 (Fig. 2) is to increase the input and output impedances of the output stage and to reduce its gain, because of local series negative feedback. The effect of R3 is to apply a small amount of negative feedback to the first stage. The effect of R7 is very small except at very low frequencies, where the efficacy of the

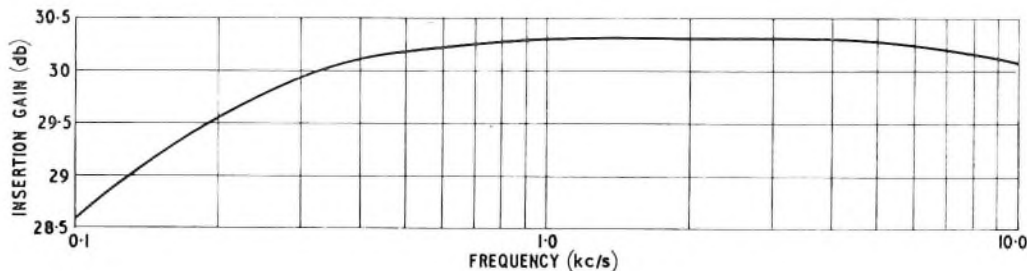

FIG. 3—GAIN/FREQUENCY CHARACTERISTIC OF TRANSISTOR AUDIO LINE AMPLIFIER

decoupling circuit is reduced as the reactance of capacitor C2 increases, and R7 then causes a reduction in gain.

If the negative feedback due to the direct-current stabilizing circuit is removed, the gain of the amplifier is approximately 60 db, and the input and output impedances are fairly high. The effect of the stabilizing circuit is to reduce the gain to about 45 db and to increase the impedances. Overall negative feedback from the collector of VT2 to the base circuit of VT1 via R8 and C1 is used to reduce the gain to 30 db and the input and output impedances to 600 ohms.

#### Performance

The performance of the amplifier is summarized in Table 1. Fig. 3 shows a typical gain/frequency characteristic and Fig. 4 a typical harmonic-distortion/output-level characteristic.

TABLE 1  
Performance of Transistor Audio Line Amplifier

Insertion gain at 800 c/s	30 ± 0.5 db
Gain/frequency response (relative to gain at 800 c/s) 300 c/s–6 kc/s	± 0.5 db
Total harmonic distortion (output level + 17 dbm*)	<5 per cent
Input and output impedances (expressed as a return loss against 600 ohms)	At 800 c/s, >20 db; at 300 c/s and 3,400 c/s, >15 db
Crosstalk attenuation between amplifier outputs at 800 c/s (common power-supply impedance 1 ohm)	>90 db

\*dbm—decibels relative to 1 mW.

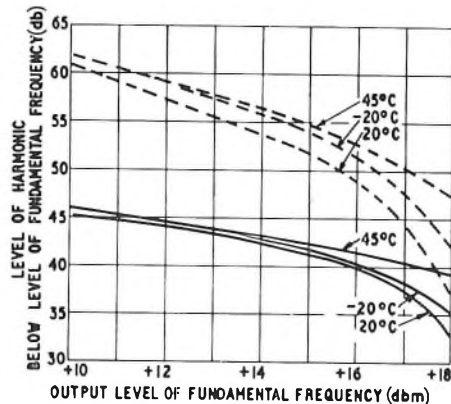

The curves relating to second harmonics are shown as full lines; those for third harmonics are shown dotted.

FIG. 4—HARMONIC-DISTORTION/OUTPUT-LEVEL CHARACTERISTIC OF TRANSISTOR AUDIO LINE AMPLIFIER

## TRANSISTOR PROGRAM LINE AMPLIFIER

At present, most program circuits, i.e. high-quality circuits for broadcast speech or music, are provided using phantom circuits on 24-pair 40 lb/mile paper-core-quad trunk carrier cables or on screened pairs in various types of multi-pair audio cables. With the existing standard amplifiers, line transformers and unbalanced constant-impedance-type equalizers, the quality obtainable on long circuits has been limited by amplitude/amplitude distortion and delay distortion at low frequencies. The effect of amplitude/amplitude distortion can produce a change of gain of 0.4 db per amplifier and 0.05 db per line transformer at 50 c/s if the signal level is changed by 25 db. On circuits of about 500 miles, gain changes of 12 db have been observed.

An amplifier using transistors has been designed to replace the present standard valve-type (Amplifier No. 35) and is intended to be used on many circuits, notably those at present provided on carrier phantoms, without the use of separate line transformers and using shunt-type equalizers. In this way the number of transformers in circuit per station will be reduced from four to two. Several variants of the new design are available, differing only in input and output impedance, and two versions, one having input and output impedances of 140 ohms and the other of 600 ohms, are being manufactured commercially. The amplifier described in the following paragraphs, however, is the original version that provided alternative output impedances of 150 or 600 ohms, obtainable by suitably strapping the windings of the output transformer.

The maximum gain of the standard valve-type program amplifier is 50 db, but for the great majority of circuits less than 30 db per station is required. The amplifier described here has a gain of 30 db. The extra complication of a 3-stage or 4-stage circuit that would enable additional gain to be provided was considered to be uneconomic, as two amplifiers in tandem (and a suitable pad) could be used in the few instances where extra gain would be required.

One of the principal aims of the design has been to ensure that the low-frequency amplitude/amplitude distortion is kept within tolerable limits.

The amplifier has been designed to operate from the normal repeater-station l.t. supply and dissipates about 1 watt. The production models are designed to be fitted on a 2-unit 51-type equipment panel and occupy  $3\frac{1}{4}$  inches of panel length (Fig. 5).

### Design Considerations

Two stages are needed to provide a gain of 30 db with adequate stability and linearity. A push-pull arrangement has been chosen because

- (a) it has an obvious advantage in linearity,
- (b) the reduction in polarization of the output transformer simplifies its design, and
- (c) such an arrangement simplifies the problem of avoiding the use of decoupling capacitors.

Each half of the push-pull circuit consists of a common-emitter stage driving what is essentially a common-collector stage. A disadvantage of this arrangement is that the output stage cannot be fully driven. This is overcome by transferring part of the load from the emitter to the collector circuit so that the properties of the output stage lie somewhat between those of a common-collector and common-emitter stage. The configuration allows direct coupling between stages and

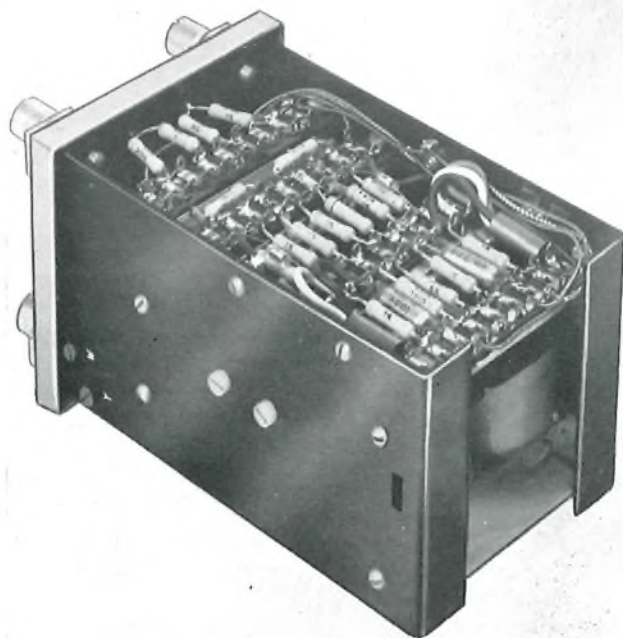

FIG. 5—TRANSISTOR PROGRAM LINE AMPLIFIER (AMPLIFIER NO. 135)

provides a phase reversal between the emitter circuit of the output stage and the base circuit of the input stage, so that both d.c. and a.c. negative feedback can be applied easily over the two stages.

Two transistors of the CV 7002 type, which together will dissipate 500 mW, are used in the output stage, and this enables an amplifier overload point at 100 mW to be obtained, with less than 0.25 per cent harmonic distortion at an output of 50 mW. These transistors have a minimum cut-off frequency ( $f_c$ ) of 750 kc/s, and because the amplifier has to operate up to 16 kc/s with negative feedback over two stages, it was considered desirable to use transistors of the CV 7004 type for the input stage. These have a minimum cut-off frequency ( $f_c$ ) of 3 Mc/s and a maximum collector dissipation of 27 mW.

### Direct-Current Circuit

Considering the direct-current circuit, the two halves of the push-pull circuit are in parallel, and it might appear that a common d.c. stabilizing circuit could be used in which the stabilizing resistors were placed in the common lead and would therefore contribute no losses at signal frequencies. However, due to the large variations in d.c. input admittance and current gain that occur with the transistors, such an arrangement could lead to emitter currents in the two output transistors that could differ by a factor of three. In the circuit used (Fig. 6), part of the stabilizing circuit is common (R3, R4 and R9) but the two halves are to some extent separate (R1, R8 and R12, and R2, R10 and R13). The two halves are stabilized by d.c. negative feedback via R8 and R10.

The nominal d.c. operating conditions were chosen to be:

- |               |                                |
|---------------|--------------------------------|
| Output stage: | Collector current—19.5 mA      |
|               | Collector-emitter voltage—10 V |
| Input stage:  | Collector current—2.3 mA       |
|               | Collector-emitter voltage—9 V  |

To prevent undue polarization of the output transformer, sufficient stabilization is used to ensure that the



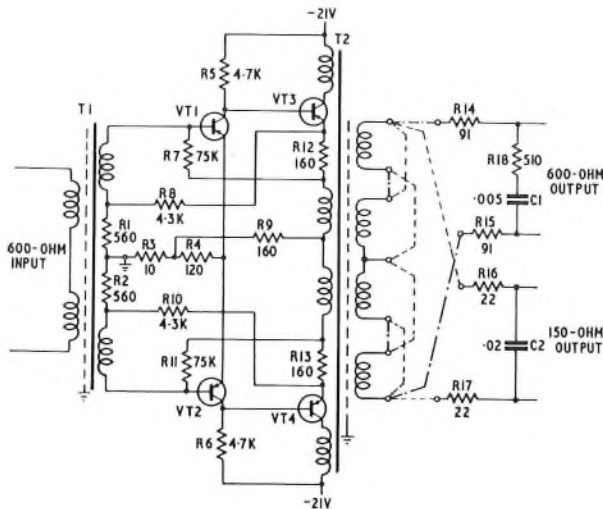

The output circuit connexions shown thus - - - - are used if an output impedance of 150 ohms is required. If an output impedance of 600 ohms is required the alternative connexions shown thus - - - - are used.

FIG. 6—CIRCUIT OF TRANSISTOR PROGRAM LINE AMPLIFIER

emitter currents in the output stage are  $19.5 \pm 1$  mA and that they do not differ from one another by more than 1 mA for any combination of transistors and at any ambient temperature between  $10^\circ\text{C}$  and  $45^\circ\text{C}$ .

#### Amplifier Circuit

The d.c. feedback used for stabilization of the transistor operating conditions also provides a.c. negative feedback, and the effect of this is to increase the input impedance, reduce the output impedance and reduce the gain. Additional a.c. negative feedback is applied from the emitter circuit of the output stage to the base circuit of the input stage via R7 and R11 to reduce the gain to 30 db and to define the input and output impedances. The amount of feedback used is sufficient to ensure that the gain of the amplifier will be  $30 \pm 0.75$  db at 800 c/s for any combination of transistors and at any ambient temperature in the working range.

#### Transformers

The main objectives in the design of the transformers have been to keep delay distortion and amplitude/amplitude distortion within tolerable limits at low frequencies. Delay distortion has been kept within such limits by extending the low-frequency response of the transformers well beyond that required from consideration of frequency response alone. Amplitude/amplitude distortion has been kept to a low value by ensuring that the loss produced by the transformer shunt inductances at the lowest frequencies concerned and at low signal levels is so small that, as the signal level is increased and hence the permeability of the core material increases, this loss

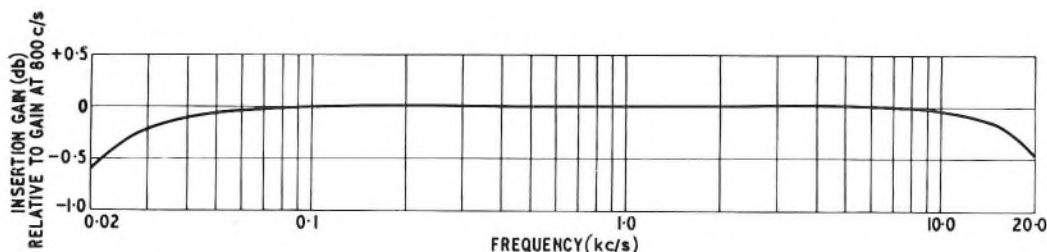

FIG. 7—GAIN/FREQUENCY CHARACTERISTIC OF TRANSISTOR PROGRAM LINE AMPLIFIER

cannot decrease appreciably. The impedance at which the output transformer operates has been kept low to ensure that the shunt inductance required is low and therefore, for a given core, the number of turns, and hence the polarizing ampere-turns due to out-of-balance collector currents in the output stage, are relatively low. The input transformer is astatically wound to reduce pick-up from stray magnetic fields.

#### Performance

The performance of the amplifier is summarized in Table 2.

TABLE 2  
Performance of Transistor Program Line Amplifier

Insertion gain at 800 c/s	$30 \pm 0.75$ db
Gain/frequency response, 30 c/s–15 kc/s, relative to gain at 800 c/s	$\pm 0.5$ db
Total harmonic distortion (output level + 17 dbm) at 1 kc/s or 100 c/s.	$< 0.25$ per cent
Input and output impedances (expressed as return losses against appropriate resistances)	At 800 c/s, 20 db; at 50 c/s and 10 kc/s, $> 15$ db; at 30 c/s and 20 kc/s, $> 10$ db.
Noise at amplifier output (broadcast weighted)	$< 0.25$ mV
Crosstalk attenuation between amplifier outputs at 4 kc/s (common power-supply impedance, 2 ohms)	$> 105$ db
Change in gain of amplifier at 50 c/s for signal-level change of 30 db	$< 0.05$ db
Delay at 50 c/s	$< 0.75$ ms

It is of interest to note that in the transistor amplifier the low-frequency amplitude/amplitude distortion is

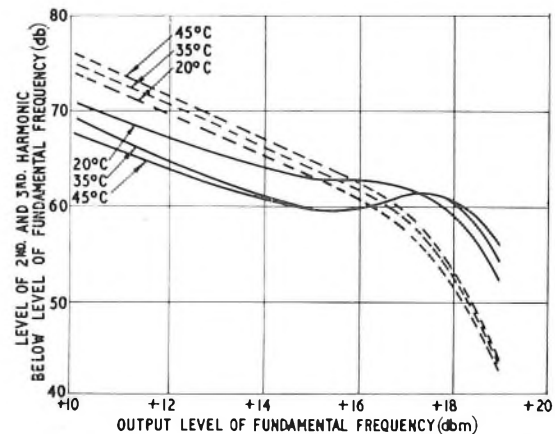

The curves relating to second harmonics are shown as full lines; those for third harmonics are shown dotted.

FIG. 8—HARMONIC-DISTORTION/OUTPUT-LEVEL CHARACTERISTIC OF TRANSISTOR PROGRAM LINE AMPLIFIER

improved by a factor of about eight over the standard valve-type amplifier and the delay at 50 c/s is reduced by a factor of about three.

Fig. 7 shows a typical gain/frequency characteristic and Fig. 8 a typical harmonic-distortion/output level-characteristic. In Fig. 8 the effect of change in ambient temperature on the distortion produced in the amplifier can also be seen.

#### FIELD TRIALS

Small numbers of some of the earlier designs of audio amplifiers are at present in use at four repeater stations. The gain and overload points of each amplifier have been measured at intervals of not less than a month. The numbers of transistors and the periods of their continuous operation to date are as follows:

92 transistors—3 years 6 months  
36 transistors—3 years  
66 transistors—2 years 5 months  
80 transistors—6 months

Since the first installation there have been three transistor failures. Each has resulted in a considerable change of gain and overload point of the amplifier. The faulty transistors were found to have deteriorated due to poor sealing of the capsule.

#### CONCLUSION

Some 24,000 transistor audio line amplifiers similar to the type described have been or are being manufactured and of these at least 10 per cent are in service. About 1,000 transistor program line amplifiers are being provided and a similar proportion are in service.

## A Telephone for Subscribers with Weak Voices

W. T. LOWE, A.M.I.E.E.†

U.D.C. 621.395.721.1:621.375.4

A special valve amplifier and telephone have been available for some years to assist subscribers with weak voices. This equipment has, however, several disadvantages, and it has now been redesigned using a transistor-type amplifier and a 700-type telephone.

**F**AINT speech is a comparatively rare ailment, but for those who suffer in this way it is a severe handicap, particularly for users of the telephone. The loss of voice is sometimes only temporary, as, for instance, during the few months' recovery period following a throat operation. For other people it is a permanent affliction due to defective lungs or vocal chords, and such persons may be able to talk only in a soft whisper, which may be inaudible over a telephone.

Several years ago a valve amplifier and a special telephone instrument were developed to assist these subscribers by amplifying their speech signals. This equipment, known as the Telephone No. 262 CB, gives a satisfactory transmission performance, but has the following shortcomings:

(a) The dry batteries used for the valve h.t. and l.t. supplies require frequent replacement.

(b) The amplifier, with its ON/OFF key, is housed in a plinth underneath a specially modified 200-type telephone but the amplifier is not readily adaptable for use with the new 700-type telephones.<sup>1, 2</sup>

(c) The equipment was developed for use on direct exchange lines and is not suitable for other types of subscribers' installation.

(d) The telephone is only available in black, as it is not economical to stock a special telephone, for which there is only limited demand, in a range of colours.

(e) The amplifier ON/OFF key can be left inadvertently in the ON position at the completion of a call. This is an embarrassment if the afflicted subscriber is not the sole user of the telephone.

(f) The valve used in the amplifier is now obsolete and maintenance replacements are unobtainable.

(g) The complete equipment is bulky and draws attention to the subscriber's affliction.

Modern equipment, incorporating a transistor-type amplifier, has therefore been developed to overcome the difficulties outlined above. This new equipment will replace the earlier telephone.

#### The New Equipment

The new amplifier (Amplifier No. 143A) is a single-stage transistor-type amplifier which draws its power from the telephone line; no additional power supply is required. The amplifier is fitted into a small plastic case 6 in. × 5 in. × 2 in. (Fig. 1), suitable for fixing to a

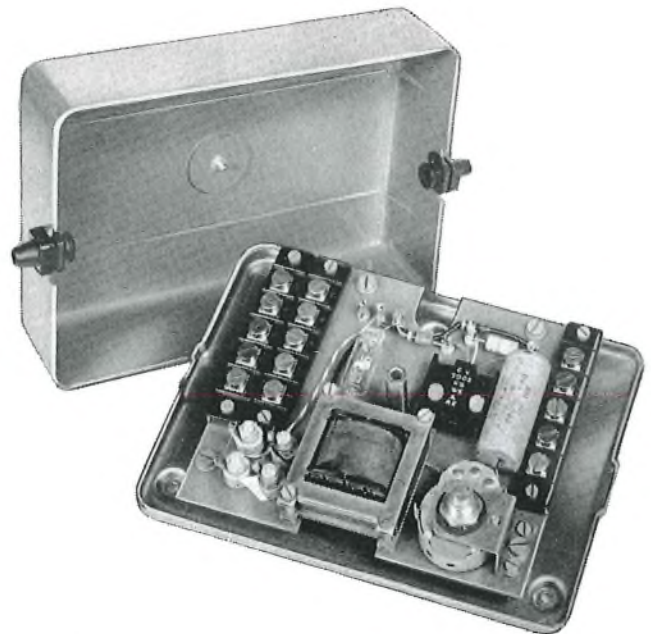

FIG. 1—LAYOUT OF AMPLIFIER UNIT

† Subscribers' Apparatus and Miscellaneous Services Branch, E.-in-C.'s Office.



wall or skirting board, and has only to be connected to a standard telephone (Telephone No. 710<sup>3</sup>) by a 9-way cord. Two push-buttons (marked ON and OFF) are fitted in the telephone, leaving two vacant push-button positions in the telephone available for other purposes. The ON push-button is arranged so that it is automatically released when the handset is replaced on the cradle, thus ensuring that the amplifier is switched out of circuit at the end of each call. If the ON push-button is not pressed, the telephone operates as a normal instrument.

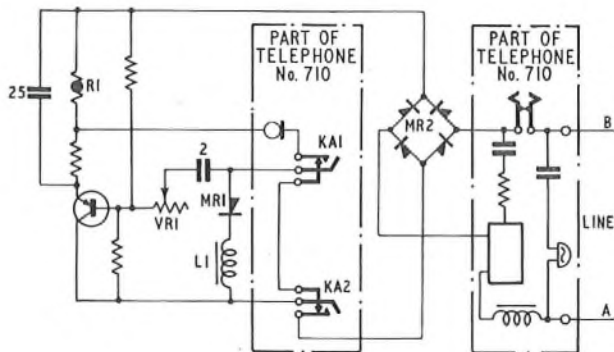

FIG. 2—AMPLIFIER CIRCUIT

#### Circuit Description

The amplifier circuit, shown in Fig. 2, contains a single transistor connected in the common-emitter configuration. With the ON push-button contacts, KA1 and KA2, operated, the handset transmitter is connected to the input circuit of the transistor and the telephone-line impedance acts as the collector load. Metal rectifier MR1 acts as an automatic voltage regulator, compensating for changes of voltage at the amplifier due to changes of line current: as the line current decreases the forward resistance of the rectifier increases and it therefore tends to maintain the voltage across the amplifier. The inductor, L1, prevents the regulator, MR1, acting as a shunt across the amplifier at speech frequencies.

Resistor R1 is a non-linear resistor with a positive resistance/temperature coefficient. It is part of the emitter-bias resistor chain and also carries the full line current. On short telephone lines, where the line current is a maximum, the resistance of resistor R1 rises to its maximum value and a large potential drop is developed across it. This gives a negative bias to the emitter and reduces the total collector-emitter voltage, thus preventing the overloading of the amplifier when it is used on a subscriber's circuit with high line current. The amplifier gives a maximum gain of at least 20 db with line currents in the range of 12–110 mA.

Full-wave bridge rectifier MR2, consisting of four germanium diodes, ensures the correct polarity of the d.c. power supply to the amplifier irrespective of line reversals. The gain control, VR1, is adjusted at the time of installation so that the afflicted subscriber's speech is transmitted to line at approximately the same level as speech from a subscriber with a normal voice. This is judged by a simple listening test at a distant telephone.

When using the amplifying telephone, the subscriber hears the normal level of sidetone in his receiver whilst talking. The presence of the speech amplifier introduces slight attenuation of the incoming speech signals, but the effect on intelligibility is negligible.

#### Conclusion

It is apparent from Fig. 3 that the new amplifier unit is compact and unobtrusive and that the telephone has the general appearance of a standard telephone. As a result, this new equipment will not draw attention to the subscriber's affliction.

#### References

- <sup>1</sup> SPENCER, H. J. C., and WILSON, F. A. The New, 700-Type Telephone. *P.O.E.E.J.*, Vol. 49, p. 69, July 1956.
- <sup>2</sup> SPENCER, H. J. C., and WILSON, F. A. The New 700-Type Telephone—Telephone No. 706. *P.O.E.E.J.*, Vol. 52, p. 1, Apr. 1959.
- <sup>3</sup> SPENCER, H. J. C. A Table Telephone with Four Push-Button Keys—Telephone No. 710. *P.O.E.E.J.*, Vol. 53, p. 190, Oct. 1960.



FIG. 3—TELEPHONE AND AMPLIFIER UNIT

# The Third International Congress on Telephone Traffic, Paris, 1961

U.D.C. 061.3:621.395.31

THE Third International Congress on Telephone Traffic was held in Paris, at the Ministry of Posts and Telecommunications, from 11–16 September 1961.

The first congress was held in Copenhagen in 1955 as a result of the initiative of Dr. Arne Jensen and other internationally-known figures concerned with the application of the theory of probability to telephone traffic problems. Because of the valuable interchange of ideas achieved and the obvious need for opportunities for people having this common interest to meet, a second congress was held at The Hague in 1958.

The participants in the third congress came from 18 countries and were representative, in the main, of national telecommunication administrations, telephone-operating companies, telephone-equipment manufacturers and universities. Among the 100 or so persons attending were three officers of the Engineering Department and one from the Inland Telecommunications Department of the Post Office.

Forty-six papers were presented to the congress; these ranged over the whole field of telephone traffic study and included such subjects as those mentioned below.

## *Link Switching Systems*

Link switching systems, in which the connexion between the calling and called parties is set up simultaneously at all stages and not by a step-by-step process, are increasing in importance but their engineering is hampered by the complexity of any mathematical model that attempts to describe their trunking. A great deal of effort is being directed, in several countries, to finding a solution that is an improvement on the well-known approximate formulae of Jacobaeus<sup>1</sup>, and one complete session was devoted to consideration of papers on this subject.

## *Interconnexion and Grading Problems*

Despite the time during which interconnexion schemes, including gradings, have been in use in telephone systems, the problem of their efficient design continues to attract attention. Because of the difficulty of exact solution of grading problems many approximate theories and empirical formulae have been put forward from time to time, and their relative merits are still the subject of dispute. A second session was devoted to papers on this subject.

## *Measurement of Telephone Traffic in Practice*

The principal contribution on the measurement of telephone traffic in practice dealt with a series of measurements in Sweden extending over several years. The most suitable period for traffic recording is not

readily determined, and opinions of administrations in this respect differ widely. The discussion of a paper reporting the recommendations of a working party of the C.C.I.T.T. on traffic recording for international circuits gave emphasis to this point.

## *Queueing Theory*

Papers on the theory of queueing, discussing the problem of a full-availability group of trunks carrying traffic with a negative-exponential distribution of holding times and recurrent input, and dealing with the technique of using derived Markov chains<sup>2</sup> represented a considerable step forward in the theoretical treatment of queues.

## *Theory of Overflow Traffic*

Some important contributions were made to the techniques of determining the size of final routes in schemes of automatic alternative routing, which are becoming increasingly common in telephone networks. The application of the "equivalent random traffic" theory to link switching systems was also discussed.

## *Simulation Techniques*

Simulation of telephone systems using digital computers was considered, as was the use of special-purpose traffic machines. It was apparent that both methods had advantages, but it is probable that, with the increasing availability of digital computers, simulation techniques using computers will be more widely employed.

In other papers the basis for the choice of the grade of service at which a system should operate was considered and the discussion that ensued indicated the widely-differing viewpoints held on this subject. Other subjects too diverse to be mentioned in this short report were also discussed, but all the papers had something useful to add to the present knowledge or suggested useful lines of progression for future work.

Committees set up at earlier congresses to compile a bibliography of literature dealing with traffic theory and to prepare an internationally acceptable vocabulary of definitions reported to the congress. Their work continues.

At the invitation of the Telecommunication Engineering and Manufacturing Association of the United Kingdom the fourth congress will be held in London in 1964.

A. C. C.

<sup>1</sup> JACOBÆUS, C. A Study on Congestion in Link Switching Systems. *Ericsson Technics*, Vol. 8, 1950.

<sup>2</sup> FELLER, W. An Introduction to Probability Theory and its Applications. Vol. 1 (Second Edition) (John Wiley & Sons, Ltd., 1957), Chapter 15.



# Testing Radio-Telegraph Automatic Error-Correcting Equipment

A. C. CROISDALE, M.B.E., B.Sc.(Eng.), A.M.I.E.E., and A. F. HARRISON,  
Graduate I.E.E., A.M.Brit.I.R.E.†

U.D.C. 621.394.3:621.371

The use of automatic error-correcting equipment is necessary on telegraph circuits connected via long-distance radio links. The problems involved in assessing the performance of error-correcting equipment are discussed, and the results are given of tests of prototype electronic equipment both in the laboratory and when connected to long-distance radio links. Possible methods of obtaining increased protection against errors in transmission are also discussed.

## INTRODUCTION

SINCE the introduction of commercial automatic error-correcting (ARQ) telegraph equipment<sup>1</sup> in 1953, new methods of evaluating and testing such equipment have been adopted. The original type of equipment, of Dutch, and later Swiss, manufacture, was electromechanical, but electronic equipment of British origin has subsequently become available, and transistor-type equipment is now being developed by several firms in this country.

The concept of the automatic correction of errors in radio-telegraph transmission is due to Dr. Van Duuren of the Netherlands Communications Services—a department of the Dutch Post Office. The principles of the system have been described in this journal<sup>1</sup> and it is likely that this system will be used throughout the world on point-to-point h.f. radio-telegraph links and possibly on ionospheric scatter and earth-satellite links also.

The Van Duuren ARQ system may be regarded as a "feedback" system since the detected errors are corrected by sending a signal over the return channel of the circuit to request from the sending end a repetition of the signal that has been incorrectly received. The basic protection against error is provided by the use of a fixed-ratio 7-unit code, invented by J. B. Moore of the Radio Corporation of America, in which all acceptable combinations comprise three Z elements and four A elements\*; the theoretical efficiency of this protection is shown in Fig. 1. However, the feedback action results in an increase in the effective redundancy of the system, since a detected error suspends printing for four character periods, and further devices are used during this suspense period to ensure that the received radio signal has fully recovered before traffic is resumed. Hence, the redundancy increases with the mutilation rate, and this is the ideal way of reducing undetected errors since it permits a high rate of transmission when the performance of the radio link is good. In fact, most commercial point-to-point h.f. radio links usually provide a satisfactory signal-to-noise ratio for over 90 per cent of the time; poor transmission, however, may occur in short bursts or cause long periods of difficulty.

Up to now a considerable amount of manual checking of the received radio signal has been necessary, first by the traffic (or switchboard) operator and then by the engineer at the receiving radio-station, but with the advent of fully-automatic telex working there will be no switch-

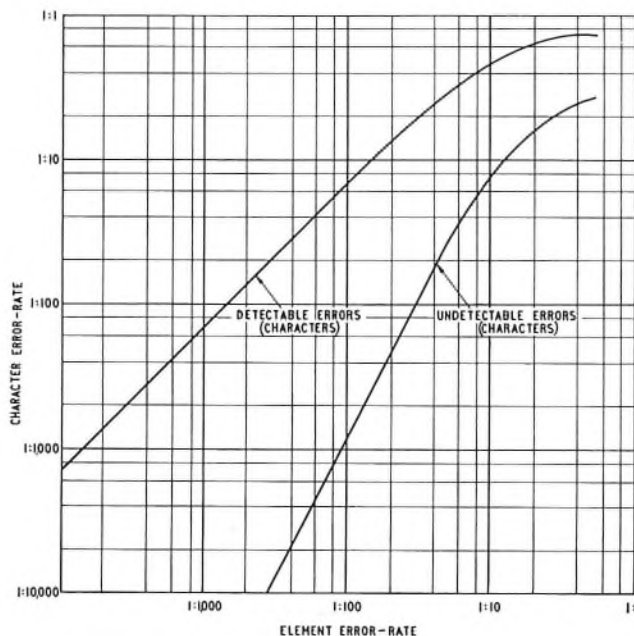

The probability of characters being in error is increased relative to the element error-rate because of the number (7) of the elements in each character.

FIG. 1—THEORETICAL EFFICIENCY OF 4A:3Z RATIO CODE

board operators. The receiving radio-station engineer is already at a disadvantage in dealing with synchronous telegraph systems because he cannot easily assess the performance of the radio circuit. For both these reasons it is desirable that a circuit condition should be derived that will enable the need for supervision to be eliminated. This may mean relaying back to the receiving radio station some information derived at the central traffic office or at the telex international switching centre.

In 1952 the Post Office started its own investigations into the use of error-detection and character-repetition equipment for use on radio-telegraph circuits. A laboratory-model 2-circuit terminal<sup>2</sup> was designed and constructed at the Post Office Research Station. This model was entirely electronic in operation and utilized cold-cathode tubes and thermionic-valve switching circuits. This equipment was later used as the basis for the development, by a manufacturer, of a commercial equipment<sup>3</sup> for which printed-circuit techniques and unit construction are used.

Methods of testing the prototype equipment in the laboratory in order to obtain an assessment of the equipment error rate distinct from the transmission-path error rate are described in the following paragraphs. The results of tests with commercially produced ARQ equipment connected to transatlantic radio links are also given.

Under certain conditions the protection given solely by the use of a special code, such as is used in the Van Duuren system, may be comparatively poor, and proposals are made for obtaining improved performance.

† Telegraph Branch, E.-in-C.'s Office.

\* The terms A element and Z element denote signal elements having polarities corresponding to those of start and stop signals, respectively.

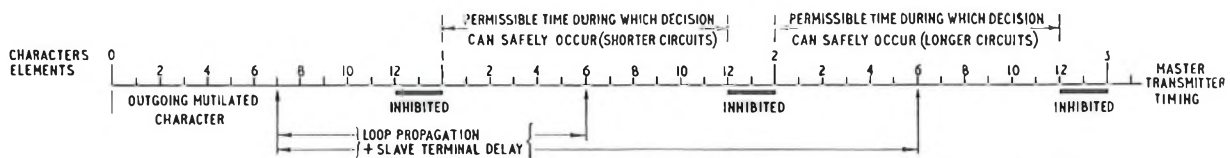

If an electromechanical ARQ equipment is the master equipment, the "request for repetition" (RQ) pulse may only vary  $\pm 6$  elements due to the long inhibit period.

FIG. 2—TIMING OF INHIBIT PERIOD

#### METHODS OF TESTING ARQ EQUIPMENT IN THE LABORATORY

There are certain novel requirements in testing automatic error-correcting equipment. To some extent such equipment corrects errors caused by faults within itself, and it is therefore necessary to devise means of testing the equipment under controlled conditions so that its error-detecting capabilities can be accurately assessed.

Since the detection system is based on a 7-unit code and all genuine combinations contain three Z elements and four A elements, it is desirable for test purposes to cause failures of the common signalling path that produce detectable errors, because undetectable errors would render the test results confusing. Fortunately, when such a code is used, errors that can occur due to breaks in the common path can be detected. Hence, by introducing a mixture of long and short disconnexions in the common path, the equipment is forced to perform the error-detection and signal-repetition cycle for varying periods. Each time the common path is disconnected the cycle of error-detection and repetition of the incorrectly-received character is initiated, and during the period of the disconnexion the repetition store is continually transmitting the stored characters and restoring itself, so carrying out a self-proving check on the storage circuits.

It is interesting to note that the characters (usually three) held in the store are stepped every  $145\frac{5}{8}$  ms, and in a half-hour test of continuous repetition these characters will have been stepped, within the store, 12,330 times. It is rare for any defect to occur in this part of the equipment, although the storage system on electromechanical ARQ equipment may utilize relay-switched capacitors.

More frequent breaks in the common path cause more operations of the error-detecting circuit so that, by having series of short breaks and long breaks, an adequate test of the basic functioning of the whole equipment may be made without any ambiguity in the test results since the output consists of a printed message, and errors are thus readily apparent.

To establish a standard of accuracy, it was considered that a laboratory test of 72 hours of intermittent disconnexions between two 2-channel terminals should not

result in more than one incorrect printed character, i.e. an equipment error rate of better than one in seven million printed characters.

The maximum propagation time on a world radio link (both ways) is about 130 ms and because the associated land-line voice-frequency telegraph equipments also contribute appreciable propagation delay, the Van Duuren repetition cycle normally allows for a total loop delay of about 290 ms, though this can be extended by the use of a 5-character or 8-character repetition cycle. Since every received character must be tested to determine whether it is genuine or not, there is a period during which the system must decide whether to transmit the next traffic character or to request a repetition. In electromechanical-type ARQ equipment this "decision" takes about 20 ms. During this interval there is some "indecision," and if the receiver timing, due to loop propagation delay, is such that the equipment can accept a new character for transmission within this period, the equipment cannot decide whether to transmit this character or to transmit the special signal indicating that repetition is necessary. This period of indecision is termed the "inhibit" or "danger" period (see Fig. 2).

On electronic equipment this inhibit period can be made very short, but it can be shown that errors in the received traffic may result when consecutive decisions to request a repetition occur immediately before and after such a period, due to small changes in propagation delay (see Fig. 3). Such changes are quite frequent, and it is, therefore, desirable to add artificially to the loop propagation time of the circuit by inserting a fixed delay in the transmission of the aggregate signals at the "slave" terminal to avoid the inhibit period at the "master" terminal by as wide a margin as possible. The delay is obtained by altering the relative phase difference between transmitter and receiver distributors at the slave terminal. As this phase difference, once set, remains fixed, it does

\* The master transmitter is free-running and the slave receiver is caused to be in synchronism with it. The speed of the slave transmitter is locked to that of the slave receiver, and the master receiver is caused to be in synchronism with the slave transmitter. The master receiver timing is, therefore, controlled indirectly by the master transmitter, via both radio links.

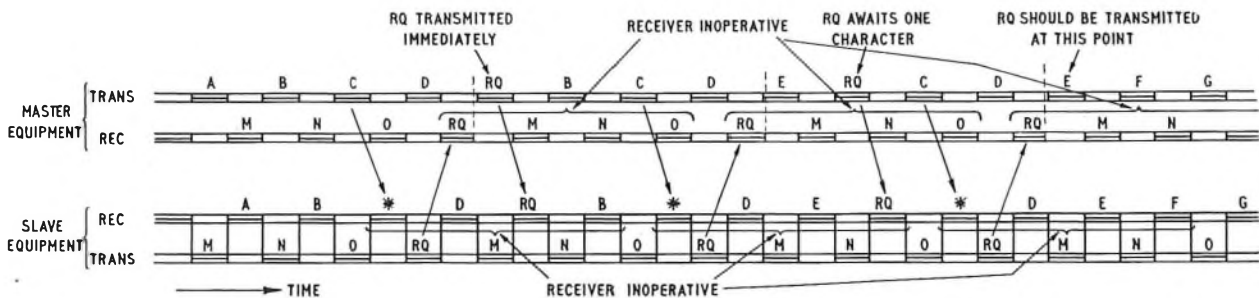

A, B, C...—Characters transmitted from master equipment to slave equipment.  
M, N, O...—Characters transmitted from slave equipment to master equipment.  
\*—Error detected.

RQ—"Request for repetition" signal.  
The alternate unmarked characters are those of the second channel of the ARQ system.

FIG. 3—EFFECT OF LOOP PROPAGATION TIME VARYING ABOUT AN EXACT MULTIPLE OF A CHARACTER LENGTH



not matter how close to the inhibit period the slave terminal operates.

The electrical tests of the prototype equipment were divided into three classes; those designed to test the equipment functionally, performance tests, and tests via radio circuits to discover whether the error-correcting capabilities agreed approximately with the theoretical performance.

#### FUNCTIONAL AND PERFORMANCE TESTS ON PROTOTYPE ELECTRONIC EQUIPMENT

##### *Functional Tests*

The functional tests consisted simply of operating the control switches and presenting the equipment with all the conditions it would meet in service, to check that it responded as intended. Speed of synchronization was measured and the automatic phasing to the incoming signals was checked. In this connexion "synchronization" refers to the continual correction of the local oscillator frequency to make it coincide with that of the incoming signals; "phasing" denotes the process of examining the incoming multiplexed signals and controlling the timing of the receiving equipment so that signals for each channel arrive when the receiver gates appropriate to that channel are open.

To test the automatic-repetition facilities a method of automatically breaking the d.c. connexion between the transmitter and receiver was used to simulate radio fades. The method used cannot produce any undetectable errors, providing each break is longer than a character period. A uniselector-controlled circuit was used to disconnect the lines; the uniselector was stepped by 6-second or 30-second pulses and wired to produce line interruptions of various periods up to 3 minutes. A relay operated directly from the 6-second pulses provided breaks of approximately 500 ms.

##### *Performance Tests*

The performance tests consisted firstly of measuring the telegraph distortion of the output signals and the input margin of the receiving equipments. The specified performance of the electronic equipment is a maximum of  $\pm 3$  per cent distortion on transmitted signals and a minimum input margin of  $\pm 45$  per cent.

A further important test was a check of the immunity against interference. Before the equipment was made, measurements were taken of the interference levels likely to be encountered within the London overseas telegraph terminal at Electra House. Pairs were selected in long cable runs from the control room, where the equipment was to be installed, to the operating rooms. The pairs chosen were adjacent to lines carrying the worst type of signal known for interference-generating properties, and measurements were made with an oscilloscope, using various types of termination and filtering. As a result of these measurements it was decided to specify immunity against test pulses of alternate polarity, of 40 volts amplitude and 250  $\mu$ s duration, on all signal wires entering and leaving the equipment. A generator of such pulses was constructed and used for the interference-immunity test.

As a further precaution the inclusion of a mains-borne-interference suppressor filter in the mains input leads was specified.

*Timing Tests.* For certain tests, e.g. measurement of the timing and duration of the inhibit period, a means of providing circuit propagation delay equivalent

to that experienced over land lines and radio paths to various parts of the world was needed. For this purpose a specially modified magnetic drum was used. The telegraph signals were recorded on the drum by on/off modulation of a 1 kc/s tone and converted back to double-current signals at the output of the device. The position of the reading head was made variable relative to that of the recording head, and propagation delays continuously variable from 80 ms to 550 ms were obtainable.

*Voltage-Margin Tests.* A convenient method of checking the stability of the equipment circuit design is to measure the h.t. voltage margin.<sup>4</sup> This entails raising and lowering the several h.t. supplies one by one and noting the values at which the equipment fails. These values should represent a minimum percentage change from nominal voltage equal to the percentage tolerances of the resistors employed.

Since the mains supplies from which the equipments are operated may be subject to gradual or sudden changes, these conditions were simulated on the prototype equipment. Sudden changes of 10 per cent (23 volts) were brought about by switching in and out additional transformer windings, and gradual changes were derived from a Variac transformer.

*Reliability Tests.* The final laboratory test consisted of running the equipment for 72 hours continuously. Artificial traffic was passed on all channels, and interruptions of the line were made automatically in each direction of transmission. The criterion was that not more than one error should appear on the copy due to equipment mis-operation, component failures being excepted. Teleprinters connected in parallel were used to eliminate the effect of machine faults. The traffic for each channel was derived from five arcs of a uniselector wired to produce a test message in 5-unit telegraph code—a method much more dependable than the use of test loops of perforated tape.

#### TESTS VIA RADIO LINKS OF PROTOTYPE ELECTRONIC EQUIPMENT

Tests of prototype equipment over a radio circuit were carried out via land-line connexions from the contractor's premises at Writtle to the London overseas telegraph terminal at Electra House and thence by normal routing, as follows:

Writtle–Electra House–Dorchester transmitting station, Dorchester–Barbados (14.605 Mc/s radio link using frequency-shift keying),

Barbados–Brentwood (19.055 Mc/s radio link using single-sideband transmission), and

Brentwood receiving station–Electra House–Writtle.

The ARQ equipment was operated back-to-back via the radio loop, and electronic counters were employed to determine the number of characters transmitted and the number of requests for repetition due to erroneous transmission over the radio paths. The number of repetition cycles was noted on each channel for each 1,000 characters transmitted, and the number of errors printed on the received copy was counted. The results indicated that the equipment was performing satisfactorily and the reduction of printed errors was as expected.

##### *Error-Rate Tests*

During the testing of the first production prototype equipment at Electra House, opportunity was taken to

make error-rate tests on a London-Barbados-London radio circuit. The aggregate speed was 96 bauds, the channel speed was 50 bauds, and the total number of characters transmitted was 450,000. The test circuit consisted of two radio paths in tandem and non-optimum frequencies were used, hence the conditions were not quite typical. It was noted that at one period adjacent-station interference caused a surprising number of undetected errors.

Fig. 4 shows the undetected-error rate/circuit-efficiency characteristic,\* and Fig. 5 shows the total number of characters transmitted for a given circuit efficiency.

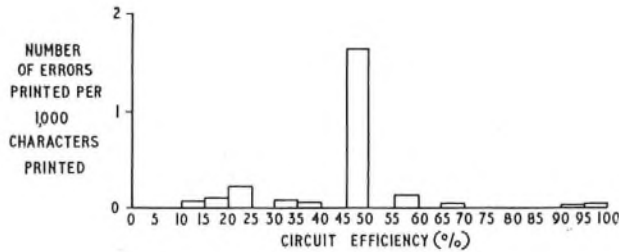

FIG. 4—UNDETECTED-ERROR RATE/CIRCUIT-EFFICIENCY CHARACTERISTIC FOR LONDON-BARBADOS-LONDON TEST

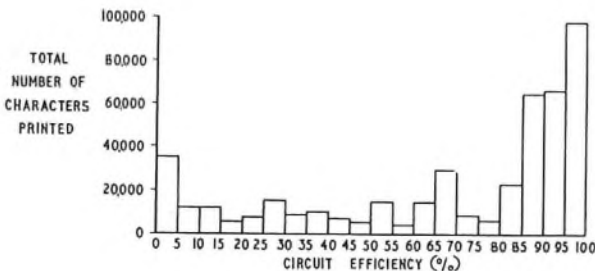

FIG. 5—TOTAL NUMBERS OF CHARACTERS TRANSMITTED AT VARIOUS VALUES OF CIRCUIT EFFICIENCY FOR LONDON-BARBADOS-LONDON TEST

The unexpected peak of errors at about 50 per cent circuit efficiency was due to the period of adjacent-station interference mentioned earlier. However, the sample was quite small (6,000 characters) and the conditions probably changed during the test to a period of very low circuit efficiency. Excluding this period the printed-error rate is worst when the circuit efficiency is 10–25 per cent.

Further tests were arranged on a New York-London radio circuit and error rates at various levels of circuit efficiency were recorded. The circuit was operated at an aggregate speed of 86 bauds and a channel speed of 45 bauds. It proved very difficult, however, to obtain results showing a circuit efficiency below about 40 per cent, and some simulated radio tests were made in the laboratory with artificial noise to try to check the worst operating condition for the ARQ system. Fig. 6 shows the undetected-error rate/circuit-efficiency characteristic, and Fig. 7 shows the total number of characters transmitted for a given circuit efficiency for comparison with Fig. 5.

The total number of characters transmitted in the radio tests was 931,000, but, in view of the wide range of conditions, this sample could only be said to give something like a confidence sample over the range of circuit

\*Circuit efficiency—Number of characters printed in a given time divided by the theoretical number of characters that could have been transmitted, i.e. if there had been no repetitions.

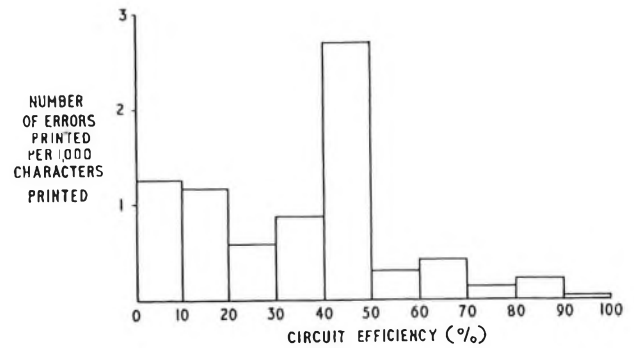

FIG. 6—UNDETECTED-ERROR RATE/CIRCUIT-EFFICIENCY CHARACTERISTIC FOR NEW YORK-LONDON TEST

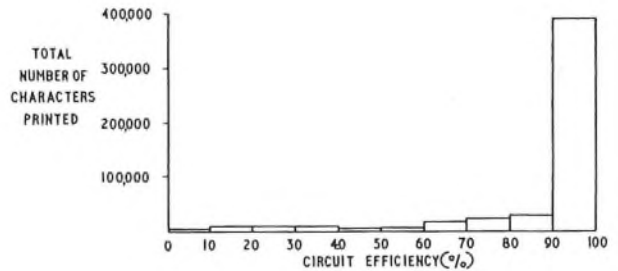

FIG. 7—TOTAL NUMBER OF CHARACTERS TRANSMITTED AT VARIOUS VALUES OF CIRCUIT EFFICIENCY FOR NEW YORK-LONDON TEST

efficiency 95–100 per cent, where the undetected error rate was about one in 50,000 characters. The radio tests were made during 1959 and early 1960, a period of high sunspot activity.

By a process of experiment with fading-cycle periods thought likely to upset the repetition cycle, it was found that if noise was cyclically injected in the signal path of an ARQ system a large number of errors could be produced. The worst periodic cycle was found to be 750 ms, at which value a circuit efficiency of 4 per cent was recorded, giving an undetected-error rate of 211 characters out of 260. This occurred in a period of 15 minutes.

The period of 750 ms is sufficient to permit the repetition cycle to be checked correctly, and the subsequent fade produces a probability of undetected error. Fortunately, a fading period of less than 2 seconds rarely occurs on h.f. radio circuits. During continuous noise less characters were received, but less errors were actually printed.

#### 7-Unit Monitor

One of the devices available for testing the quality of aggregate signals is the 7-unit monitor. This includes a special teleprinter that operates directly to the 7-unit code and prints special symbols for incorrect A : Z ratio signal combinations and for repetition signals. There are two types of monitor: one permits the locking of the teleprinter to the timing circuits of the ARQ terminal; the other can synchronize itself with the aggregate signal. The latter type may be used at radio stations for monitoring purposes and as a means of identifying transmissions.

#### SUGGESTIONS FOR IMPROVEMENT OF VAN DUUREN SYSTEM

The protection given by virtue of the code alone, as shown in Fig. 1, is comparatively poor with cyclic fading in heavy noise. Some higher degree of detection of errors could be obtained by a double check, in which two characters in succession are checked for correct A : Z



ratio and only if the second is satisfactory is the first character released to the printer.

Once the first error has been detected by the A : Z ratio check, repetition cycling will commence. There are then many ways of improving the undetectable-error rate by making the test for resumption of traffic more stringent. For example, if both channels of a 2-channel system are caused to cycle by an error occurring on only one channel, it would be necessary for both channels to have their repetition cycles checked before resumption of traffic. If a check is made on all the characters in the repetition cycles of each channel, every printed character would be preceded by several acceptable characters.

Another method could be the assessment of a low signal-to-noise ratio or of excessive signal distortion at the radio receiver. If the signal-to-noise ratio fell below a threshold level or the distortion exceeded say 40 per cent, the signal would be recognized as likely to cause an error. "Decision Feedback" is a term sometimes used to describe this type of operation. For simplicity the device should maintain the output at the last received polarity and hence produce detectable errors during the period of low signal-to-noise ratio or excessive distortion.

These methods would have disadvantages—the double-check method would require a stage of storage at the ARQ receiver and an additional character in the repetition cycle. The other methods would be more critical in accepting the received signal and hence would reduce the circuit capacity although reducing the error rate.

For many purposes the present repetition cycle is sufficient, but a telegraph system suitable for universal automatic switching and unskilled operating must be produced and for this the highest immunity to error, particularly during dial-selection periods, is necessary. It may also be necessary to provide accuracy sufficient for data transmission purposes.

A method has been suggested\* for enabling the correct phase relationship between terminals to be achieved or, if this relationship has been lost while the system is in service, for it to be restored automatically without any errors in the received copy having been caused.

The method proposed relies on the fact that on each channel one character in every four (for a 4-character repetition cycle) is inverted in polarity and re-inverted at the receiving end. This ensures that, for the 4A : 3Z ratio criterion to be satisfied, the inverted character must be received in its correct position. Hence, when the correct phase relationship is restored, the characters in a repetition cycle will be in correct sequence relative to those already printed.

The above method has the added advantage that channel-sharing equipment (which allocates successive characters in each group of four to four separate users) can be locked to this inversion pattern, thereby automatically achieving the correct phase relationship for each sub-channel.

With the advent of automatic telex (or gentex) using radio circuits, the serviceability or otherwise of the circuit must be determined automatically. There are two criteria:

\*International Radio Consultative Committee (C.C.I.R.) Report No. 108, Documents of the IXth Plenary Assembly, Los Angeles, 1959.

(a) the minimum performance which would permit new calls to be set up satisfactorily, since any error would give a wrong routing, and

(b) the conditions under which a call should be forcibly cleared because the increasing error rate would be likely to be unacceptable to the user.

Both conditions (a) and (b) can be determined by the criterion of circuit efficiency as defined previously, and this should possibly be 75 per cent integrated over 10 seconds for (a) and 30 per cent integrated over 30 seconds for (b). By reference to Fig. 6 it will be seen that at 75 per cent efficiency the error rate is very low, whereas at 30 per cent the error rate has increased to about one error in 1,000 characters printed and shows a fairly rapid increase in errors as the efficiency falls below 30 per cent.

To exploit this feature further, the detection of a circuit efficiency below, say, 30 per cent could be used to cause the system temporarily to suspend traffic clearance. Such a low circuit efficiency should be rare except when a radio circuit is virtually unusable. This system would have the effect of safeguarding all types of telegraph circuits, telex, public and leased, carried on the ARQ system, so that the error rate would be kept low under all radio conditions, which in fact is usually what the customers want, whether for telegraph purposes or data transmission. Data transmission would have to be restricted to periods of higher minimum circuit efficiency.

#### CONCLUSIONS

Experience obtained during testing and operating ARQ equipments on world radio links has proved that a high standard of equipment design and reliability is essential. Electromechanical equipment has proved reliable but requires considerable maintenance. The design and manufacture of electronic equipment has proceeded and novel methods of testing such equipment have been evolved.

Tests have been made on radio links, and curves showing the relationship between the actual circuit efficiency and undetected error rate have been produced. From these performance curves it can be shown that conditions for dialling a telex call, with a low probability of error, may be safeguarded by allowing establishment of new calls only when the circuit efficiency is high. The circuit efficiency must be assessed automatically, since there will be no operator.

A similar problem will occur with the deterioration of a radio link when a change of frequency is becoming necessary; monitoring of the performance of radio telegraph circuits at both Electra House and the radio receiving stations must be done automatically, though human intervention will probably be necessary to decide on the need to change frequency.

#### References

- <sup>1</sup> CROISDALE, A. C. Teleprinting Over Long-Distance Radio Links. *P.O.E.E.J.*, Vol. 51, pp. 88 and 219, July and Oct. 1958.
- <sup>2</sup> An Electronic Error-Correcting Multiplex Telegraph System. *P.O.E.E.J.*, Vol. 50, p. 44, Apr. 1957.
- <sup>3</sup> KELLER, P. R., and WHEELER, L. K. Automatic Error Correction. *Wireless World*, Vol. 65, p. 28, Jan. 1959.
- <sup>4</sup> HARRISON, A. F. Voltage-Margin Testing of Telegraph Electronic Switching Equipment. *P.O.E.E.J.*, Vol. 53, p. 173, Oct. 1960.

# An Optical Height-Measuring Instrument

J. STOTT, M.B.E.†

U.D.C. 535.8:526.94

The two standard methods used hitherto to measure the heights of overhead wires have their limitations and the misuse of one of them has resulted in a fatal accident. A new instrument that is more accurate and convenient to use is described.

FOR many years the two standard methods for measuring the heights of overhead wires have been to use a clinometer or height-measuring rods; both methods, however, have their limitations. The clinometer, for instance, is not particularly easy to use and is, in any event, more suitable for measuring the heights of poles or other large objects. Height-measuring rods (Rods, Clearance) are only suitable for determining the heights of, or distances between, overhead low-voltage power wires or telephone wires. If height-measuring rods are misused, such as attempting to determine the height of a high-voltage power conductor, there is a serious risk of accident. This point was given considerable emphasis when a survey officer was killed whilst attempting, incorrectly, to measure the height of 11 kV conductors.

This incident underlined the desirability of pressing on with the development, already well in hand, of a device which could quickly measure with the minimum of calculation the heights of overhead conductors or the vertical distances between them. After the basic design for such an instrument had been produced, an experimental model was made. Tests with this instrument showed it to be capable of the performance required,

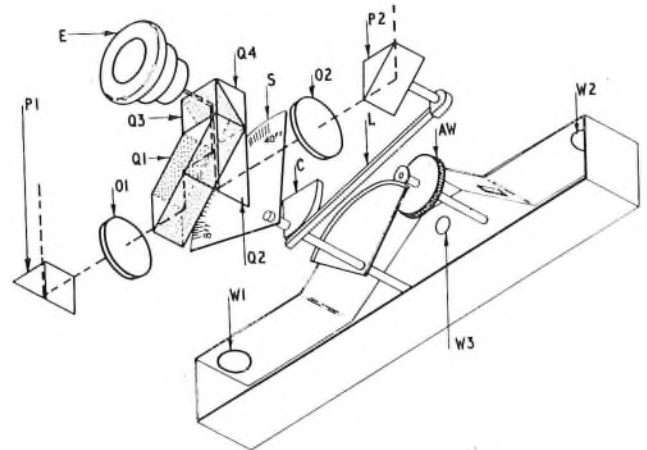

FIG. 2—SCHEMATIC DIAGRAM OF OPTICAL HEIGHT-MEASURING INSTRUMENT

and its optical design and construction were used as the basis for the specification and physical layout of a production instrument.

The optical height-measuring instrument (Fig. 1) is essentially a split-field range-finder with a 12 in. base. It has a magnification of three times to assist with the quick identification of Post Office and power-transmission lines up to heights of 40 ft above the eye-level of the user. Heights between 8 ft and 40 ft from the datum

line of the range-finder can be measured to within one half per cent of the actual height; thus, for an object at a height of 40 ft the maximum error is  $\pm 2\frac{1}{2}$  in., and at a height of 8 ft it is  $\pm \frac{1}{2}$  in. The height scale is clearly visible through the eyepiece and, although non-linear, it is reasonably evenly divided and is marked in feet with main subdivisions at 4 in. intervals and further divisions at 2 in. intervals. The eyepiece, which can be focused, is centrally placed and lies at right angles to the line of sight.

A schematic diagram of the instrument is shown in Fig. 2. Light from the object which is to be measured enters the instrument through the windows W1 and W2 and is reflected, by the right-angled prisms P1 and P2, along the base of the instrument to the two object lenses O1 and O2. The object lenses form images at the contact surface between prisms Q1 and Q2, the light rays having been reflected in prisms Q1 and Q2, as indicated in Fig. 2. Half of the contact surface between the prisms Q1 and Q2 is silvered,

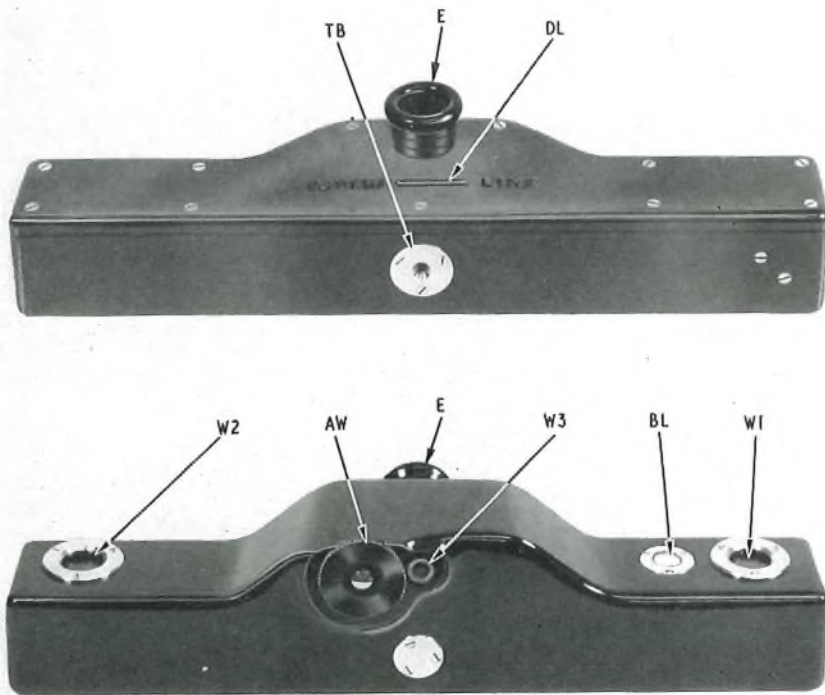

E = Eyepiece DL = Datum line TB = Threaded bush BL = Bubble level  
AW = Adjusting wheel W1 and W2 = Viewing windows W3 = Window to illuminate height scale

FIG. 1—OPTICAL HEIGHT-MEASURING INSTRUMENT

† External Plant and Protection Branch, E.-in-C.'s Office.



i.e. the half nearer the range scale, S. Thus, the lower half of the image seen through the focussing eyepiece, E, is formed by light coming through window W1, and the upper half is formed by light coming through window W2.

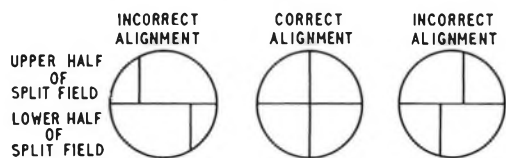

FIG. 3—SINGLE OVERHEAD CONDUCTOR AS SEEN THROUGH EYEPIECE

To adjust the instrument it is necessary to line up the two halves of the image, as shown in Fig. 3, and the two half images are aligned by rotating prism P2. The mounting of prism P2 (Fig. 2) is attached to lever L, which is actuated by cam C on the same spindle as the height scale, and cam C is rotated by turning the knurled adjusting wheel, AW. Thus, when the adjusting wheel AW is rotated, prism P2 and the height scale both rotate. The height scale is on transparent material and is illuminated by light through window W3.

The two half images formed at the contact surface between prisms Q1 and Q2 are reflected into the eyepiece by the silvered contact surface between prisms Q3 and Q4 (Fig. 2). A small strip of the contact face between prisms Q3 and Q4 is, however, left unsilvered, and through this unsilvered strip it is possible to see the height scale at the same time as the two half images of the object.

The main body of the instrument is a rigid aluminium casting (Fig. 1) which, apart from the eyepiece mounted on the top plate, contains all the components. Although it is intended that it should be used as a hand-held instrument, a bubble level, BL, and a threaded bush, TB, are provided so that it may be used, if desired, in conjunction with a tripod. The datum line, DL, of the height scale is marked on the top plate of the instrument, just beside the eyepiece.

The author gratefully acknowledges the assistance given to the External Plant and Protection Branch, E.-in-C.'s Office, by the Post Office Research Station, where the basic design and the experimental model were produced.

## Book Reviews

"The Theory and Design of Inductance Coils." V. G. Welsby, Ph.D., B.Sc.(Eng.), M.I.E.E., M.Brit.I.R.E. Macdonald & Co. (Publishers), Ltd. 232 pp. 57 ill. 30s.

A second edition commonly carries its subject further than the first; this one is unusual in that there are also inserted some new foundations in the form of a discussion of inductance in terms of electromagnetic field theory. The other main change is the use of a "modernized M.K.S. system" which seems to be the ordinary one with non-standard symbols.

The scope of the book remains as before: a guide to the design of inductors, having ferromagnetic or air cores, for frequencies up to about 10 Mc/s with perhaps an unacknowledged bias towards frequencies below 100 kc/s. Ferrite cores now have a chapter of their own; its emphasis on dimensional effects is perhaps excessive, and it is odd to find an air-gap described as "possible"—one would have thought it almost essential.

On many aspects of inductor design, the theory easily becomes too complicated to be useful; the policy in this book is to carry the theory as far as possible, and then supplement it by empirical methods if necessary.

On some not very important details the book is certainly wrong; on some points of opinion the reviewer would disagree with it; but it remains a useful general guide, giving plenty of practical details backed by sound theory.

A. C. L.

"Principles of Illumination." Prof. H. Cotton, M.B.E., D.Sc., M.I.E.E. Chapman & Hall, Ltd. xiii + 526 pp. 297 ill. 75s.

Not long ago the illumination engineer could usually base his calculations on the idea of point sources and largely ignore problems of shape and colour. The great diversity of electric-discharge lamps now available, with their varying spectral power distributions, has led to a corresponding diversity in colour appearance of sources and an even greater diversity in colour rendering of illuminated surfaces. At the same time, sources of small dimension are being replaced by

linear sources or by luminous areas of a variety of shapes.

This book attempts to give the illumination engineer a wider knowledge of fundamental principles than before, including colour, and is thought to be the most comprehensive single textbook on the subject in Britain.

The first five chapters (90 pp.) deal briefly with wave motion and radiation, optics, the spectrometer and the eye. Chapter VI deals with definitions and explanations of the main terms and ideas used in illumination work. A very thorough section follows (56 pp.) on the calculation of illumination at a point resulting from point sources, linear sources and illuminated areas. Colour is adequately dealt with in a very readable manner (44 pp.), and chapters are included on photometry and temperature radiation. Three chapters deal with electric-discharge lamps (52 pp.) followed by chapters on practical illumination calculations, daylighting calculations and street lighting. Included in the chapter on illumination calculations is a section on the so-called brightness engineering method of design, aimed at producing a pre-arranged pattern of apparent brightness throughout the illuminated space.

There is no doubt that a great deal of knowledge relevant to illumination engineering—taking a broad interpretation—is packed into this volume. It covers existing examination syllabuses and in many chapters goes beyond the present demand.

There is an unfortunate number of misprints in the text but most of them are sufficiently obvious not to give much trouble. A few, however, could confuse the student and should be rectified as soon as possible. Thus, in the worked example on page 99 it is stated that the total power of the radiant flux of a lamp is 3 watts, whereas what is intended is that the visible radiant flux power is 3 watts. On page 146, Lambert's Cosine Law of Emission is assumed to be known, without any discussion earlier in the book.

These errors and omissions are small, however, when compared with the total scope of the book, which can be recommended to any student wishing to understand both the theoretical and the practical aspects of illumination work. Excellent references to original work and further reading are given throughout the book.

R. W. H.

I.P.O.E.E. Library No. 2611.

# Location of Repeater Faults on Submarine Telephone Cables

F. SCOWEN, B.Sc., A.Inst.P., A.M.I.E.E.†

U.D.C. 621.395.64.004.64:621.315.28

The article reviews the methods which have been developed to enable terminal shore-station staff to locate a faulty repeater on a submarine telephone cable route containing submerged repeaters.

## INTRODUCTION

SUBMARINE cables were first laid during the middle of the nineteenth century, and since that time one of the cable engineers' worst problems has been that of locating a cable fault. Over the years many testing methods have been developed, each designed to locate a particular type of fault. An experienced cable engineer has gained sufficient knowledge from his experience of past faults to decide which tests he will use on any particular fault, and he can, in fact, locate a fault on a submarine telegraph cable very accurately.

During the 1920s and 1930s many telephone cables were laid between the United Kingdom and Europe and these cable links were able to transmit a wider frequency band with a top-frequency loss of not more than about 80 db. For example, the standard 0.62 in. coaxial submarine cable has a loss of approximately  $0.14 \sqrt{f}$  db/mile, where  $f$  is the frequency in kc/s; on a 25-mile cable the highest transmitted frequency would be about 560 kc/s and on an 80-mile cable about 60 kc/s. On such cables the telegraph-cable testing methods (based on d.c. or very-low-frequency techniques) could be augmented by high-frequency tests, which had been developed over many years for locating faults on land cable.

The high-frequency method is based on the fact that an electrical discontinuity, e.g. a fault, in a homogeneous cable will cause a portion of the signals incident on it to be reflected back to the sending-end where the reflected signals will combine vectorially with the sending-end voltage and current. Depending on the distance of the fault from the sending-end, and the frequency of the signal and its velocity of propagation, the sending-end impedance of the cable will be modified by the presence of the fault, and the sending-end impedance/frequency characteristic of the faulty cable will oscillate about the fault-free characteristic. From the frequency separation between adjacent peaks or troughs the distance to the fault may be determined. The method requires the two-way transmission of the testing frequencies over the cable.

In 1943 the British Post Office made and laid the first traffic-carrying submerged telephone repeater in the Holyhead-Port Erin cable and three years later made and laid a somewhat similar repeater in the Lowestoft-Borkum cable.\* This repeater amplifies the higher-attenuation upper half of the usable frequency band, but the lower half of the frequency band by-passes the amplifier. The repeatered cable is thus able to provide two-way transmission, one way using the unamplified low-frequency band, the other using the amplified high-frequency band. The insertion of a repeater roughly at the mid-point of the cable did not seriously increase the difficulty in locating a fault. If the low-frequency band is found to be normal and only the high-frequency band

is affected, the fault must be in the repeater. If both bands are affected the fault may be in either the cable or a common part of the repeater, and d.c. telegraph-cable type tests and the high-frequency tests used on un-repeatered cables can be used from each terminal station to locate the fault.

In 1950 the British Post Office and Standard Telephones & Cables, Ltd., each made and inserted several repeaters in tandem along submarine cables, with each repeater amplifying both directions of transmission over the link and so providing both-way amplified transmission circuits. On such cables the high-frequency fault-location tests could be made only on the lengths of cable between the shore and the nearest repeater, and only the d.c. telegraph-type tests could be used to locate an earth or open-circuit fault on the cable between the two end repeaters; these d.c. tests could not, however, locate a transmission fault in a repeater. The designers of the two systems had, therefore, to develop equipment which could be used to locate a transmission fault and the two equipments used are the first two described below.

## PULSED-TONE SUPERVISORY EQUIPMENT

The Post Office pulsed-tone method of transmission-fault location uses a radar-like technique<sup>1,2</sup>; pulsed signals are transmitted from one terminal station and as each pulse passes through a repeater it generates a pulse which travels back to the sending terminal. The pulses from the repeaters in the cable are displaced in time from each other and the return pulses are shown displaced in space on the face of a cathode-ray tube. A block schematic diagram of a typical repeater and the equipment provided at a terminal station is shown in Fig. 1. This diagram shows part of a single-cable two-direction transmission system which transmits a low-frequency band in the A station to B station direction and a non-overlapping high-frequency band in the opposite direction. When the performance of the system is to be measured, the line current is reversed for a short period

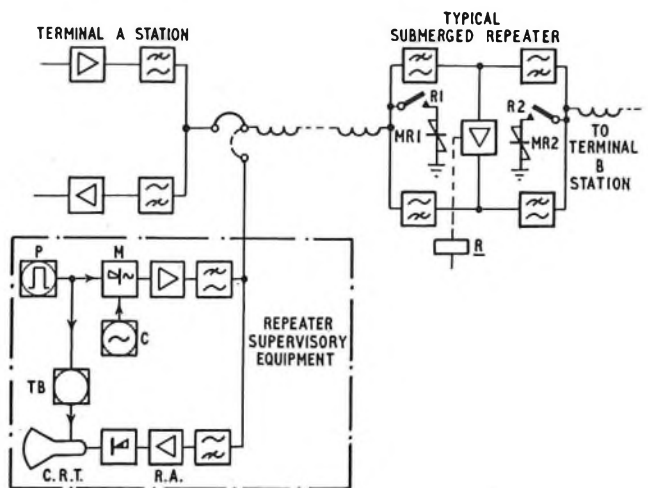

FIG. 1—BLOCK SCHEMATIC DIAGRAM OF PULSED-TONE SUPERVISORY EQUIPMENT

† Post Office Research Station.

\*The Holyhead-Port Erin repeater is no longer in use but the Lowestoft-Borkum repeatered cable is still working.



and is then restored to its original direction. The reversal operates relay R in each repeater, each relay R locking over its own contacts. Contacts of relay R connect non-linear devices MR1 and MR2 to the two terminals of the repeater. The U-links at the A and B stations are changed over to connect the submarine cable to the repeater supervisory equipment.

The supervisory equipment at the A terminal station comprises a d.c. pulse generator, P, whose output is connected to a time-base generator, TB, and a modulator, M. The latter is energized by the output of a carrier oscillator, C, which generates a frequency lying in the low-frequency band and whose second and third harmonics lie in the high-frequency band. The output from the modulator consists of short pulses of the carrier frequency, and these, after amplification, pass along the system and are attenuated by each successive length of cable but are restored to their original level by each successive repeater. At the A-station ends of the repeaters the pulses are at a very low level and the non-linear devices, MR1, at these ends of the repeaters do not generate any sensible level of harmonic pulse. At the B-station ends of the repeaters, however, the much higher level pulses act on the non-linear devices, MR2, and generate second and third harmonic pulses of substantial level. These generated pulses lie in the high-frequency band and thus pass back along the system to the sending end, where they are amplified by receive amplifier RA and then rectified; the rectified pulses are applied to the cathode-ray tube, which is also connected to time-base generator TB. The pulses which return to the A station from successive repeaters are separated in time by twice the propagation time of the length of cable between successive repeaters; the return pulses are thus displayed, separated in space, on the face of the cathode-ray tube.

The amplitude of a pulse received from a particular repeater depends on the total attenuation, at the fundamental and harmonic frequencies, of the cable between the A station and that repeater, the gains of the repeaters at the same frequencies, and the conversion loss, fundamental to harmonic, of the non-linear device. If the system is measured at intervals and a record is kept of the receive levels of the pulses from the repeaters along the route it is possible to determine the change in loop-gain, from the A station to each repeater and back, as the system ages. Fig. 2 is a photograph of a supervisory equipment showing a typical display.

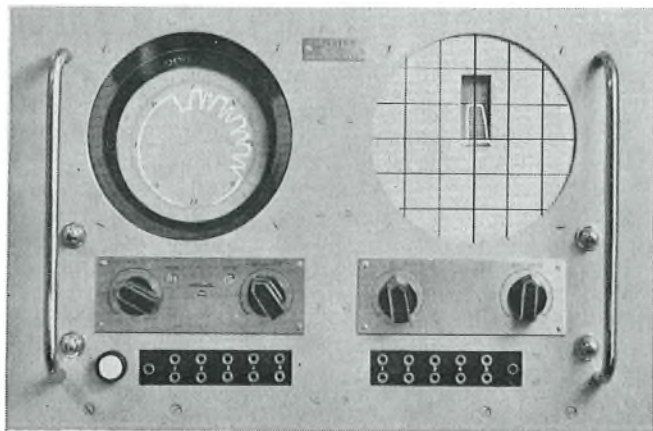

FIG. 2—PULSED-TONE SUPERVISORY EQUIPMENT SHOWING CATHODE-RAY TUBE DISPLAY

Similar measurements may be made from the B station, but here two modulators are used; each is fed with a pulse output from the pulse generator and each is energized from its own carrier oscillator. The frequencies  $f_1$  and  $f_2$  from these oscillators are both in the high band and are chosen so that  $f_2 - f_1$  and  $2f_2 - f_1$  lie in the low band. The intermodulation pulses of frequencies  $f_2 - f_1$  and  $2f_2 - f_1$  are generated in the A-station end non-linear devices, MR1, and, lying in the low-frequency band, are transmitted back to the B station where they are displayed on the cathode-ray tube face.

At the end of a test the line current is momentarily switched off, the R relays release, and when the line current is restored the system is left operating with the non-linear devices disconnected.

If the non-linear devices are not switched into circuit and pulses are transmitted along the system, harmonic or intermodulation pulses will be generated by the non-linear characteristics of the repeater amplifiers. These pulses will be of much lower amplitude than those generated by the non-linear devices but they can, nevertheless, be detected and displayed on the face of the cathode-ray tube, and their traces can be used to measure the change of individual amplifier non-linear characteristics that may occur during the life of the system.

In the event of a repeater transmission fault or of an earth fault on the cable, which still permits the cable to be energized from shore to shore or from shore to fault, measurements on the system will enable the maintenance engineers to determine how many good repeaters there are between either shore station and the fault, and this will be sufficient information for the initial cutting of the cable by the repair ship.

Equipment based on this principle has been used since 1950 on cables between the United Kingdom and the Continent and Ireland, and on the sections of the TAT-1<sup>3</sup> and TAT-2 cables between Newfoundland and Nova Scotia.

#### CONTINUOUS-TONE LOOP-GAIN SUPERVISORY EQUIPMENT

Standard Telephones & Cables, Ltd., developed a testing method by which the loop gain between the A station and each individual repeater may be measured.<sup>4</sup> Fig. 3 illustrates the equipment provided at the A station and in a typical repeater. At the B-station end of each

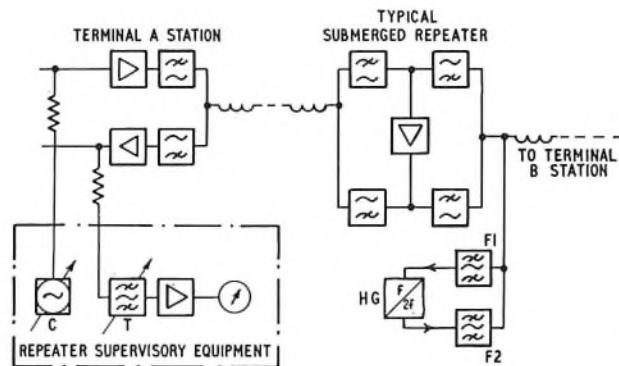

FIG. 3—BLOCK SCHEMATIC DIAGRAM OF CONTINUOUS-TONE LOOP-GAIN SUPERVISORY EQUIPMENT

repeater there are two band-pass filters, F1 and F2, and a harmonic generator, HG. An individual monitoring frequency  $f_n$  is allocated to each repeater, and these frequencies are either virtual carrier frequencies at the

upper end of the low-frequency band or are individual frequencies lying in a narrow band just above the lower band; each repeater's individual monitoring frequency  $f_n$  is the mid-band frequency of band-pass filter F1, and the mid-band frequency of band-pass filter F2 is  $2f_n$ .

To measure the loop performance of the system between the A station and the B-station end of a particular repeater, a test-tone at that repeater's monitoring frequency is sent along the system. At the chosen repeater, this tone passes through the first filter F1, is doubled in frequency by the harmonic generator HG and then passes through the second filter F2; the doubled signal is now in the high band and is transmitted back along the cable to the A station. A comparison between the level of the transmitted signal and that of the returned signal gives a measure of the loop gain of the system between the A station and the chosen repeater. As with the pulse equipment, regular measurements will enable any transmission changes to be observed, and they can be used to assist in locating a cable or repeater fault.

Equipment based on this principle was first used on the Netherlands-Denmark system<sup>5</sup> laid in August 1950, and, subsequently, on the Aberdeen-Bergen cable, laid in 1954, and the sections of the TAT-1<sup>3,6</sup> and TAT-2 cables between Newfoundland and Nova Scotia, laid in 1956 and 1959, respectively.

#### CRYSTAL-RESONATOR SUPERVISORY EQUIPMENT

In 1950 the Bell Telephone Laboratories of U.S.A. made and laid a submerged repeatered telephone cable link between Key West and Havana.<sup>7</sup> The link uses uni-directional flexible repeaters in two parallel cables and, because signals can pass along these cables in only one direction, the supervisory equipments described above are of no use on this cable link. Fig. 4 illustrates a typical repeater on this route. The active part of the

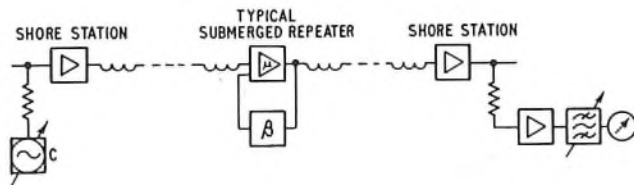

FIG. 4—BLOCK SCHEMATIC DIAGRAM OF CRYSTAL-RESONATOR SUPERVISORY EQUIPMENT

repeater is a negative-feedback amplifier, having a forward amplifying path of voltage gain  $\mu$  and a feedback path of amplification  $\beta$ ; as is well known, if  $\mu\beta$  is much greater than one, the voltage gain of the feedback amplifier is very nearly  $1/\beta$  and, thus, nearly independent of changes in  $\mu$ . In this repeater, the feedback path is shunted by a quartz-crystal resonator which, at its resonant frequency, reduces  $\beta$  to zero, and the voltage gain of the amplifier at this frequency is  $\mu$ . Each repeater along a cable has a specific resonant frequency for its crystal, and the resonant frequencies for all the repeaters lie just above the highest frequency used for the traffic-carrying channels.

Except for a narrow frequency band centred on the resonant frequency, the gain of each repeater matches the loss of a repeater section of the cable; thus, the whole cable link has a zero transmission loss over the frequency band used by the traffic channels, with sharp peaks of gain above this band, each peak being pro-

duced by only one repeater. The height of each peak is a measure of the forward gain of each repeater's amplifier, and by measuring and recording the peaks of gain it is possible to trace the valve changes in each repeater during its life.<sup>8</sup>

In addition to the information that may be obtained about valve changes, the presence of the resonators in the amplifiers may be used to locate a transmission fault. As is well known, thermal agitation of electrons generates a noise voltage which is always present on transmission channels (thermal noise); it is always present at the input of each repeater and is amplified in each repeater's amplifier and transmitted to the terminal repeater station. If the noise of a repeatered telephone cable system is measured in a narrow frequency band and this band is swept across the band occupied by the crystal resonator frequencies, it will be found that there is a peak of noise from each repeater. If there has been a transmission fault which still allows the system to be energized, it is possible by looking for these noise peaks at the receiving end of the system to determine how many working repeaters there are between the fault and the receiving end of the system.

This form of supervisory equipment has been used on the Key West-Havana link, the section of the TAT-1 cable between Scotland and Newfoundland,<sup>3</sup> the section of the TAT-2 cable between France and Newfoundland, and other links provided by the American Telegraph and Telephone Corporation during the past few years.

Of the three supervisory methods described so far only this last method is able to locate a repeater which is generating excessive noise, and then only if this noise has a spectrum which extends over the crystal-resonator frequencies. If noise is generated in one repeater, this excess noise will be transmitted along the cable to the receiving end; the noise at the input to each repeater between the repeater generating the noise and the receiving end will be higher than normal, and the noise peaks from these repeaters will likewise be higher than normal. The noise at the inputs of the repeaters on the sending-end side of the faulty repeater will be at the normal operating level and the noise peaks from these repeaters will be unaffected by the fault. It is, therefore, possible to infer that the faulty repeater is that one of those having high noise peaks which is farthest from the receiving end.

#### INSTANTANEOUS-NOISE DISPLAY METHOD

If the noise generated is intermittent and the system is a single-cable two-directional one, it is sometimes possible to locate a noise source without having to employ any supervisory equipment in the repeaters. The method used is based on the assumption that the instantaneous-noise spectrum is approximately uniform over the two transmission bands so that the envelopes of the noise in each band are very similar.

Assume that the system transmits a supergroup in each direction. At the A-station end of the system, the noise received in group 1 of the received supergroup is applied to one beam of a double-beam oscilloscope. At the B-station end, the noise received in one group is frequency changed, amplified so that it masks the normal noise and transmitted to the A-station end over the group 2 channel. At the A-station end, this noise is applied to the second beam of the same oscilloscope. The two traces will have very similar noise envelopes, but that arriving via the B-station end will lag behind that



from the A-station end by twice the transmission time of signals between the faulty repeater and the B-station end. From a knowledge of the oscilloscope scanning velocity the time delay between similar envelope characteristics may be estimated, and this may then be converted to the distance between the faulty repeater and the far end of the circuit.

#### FREQUENCY-CHANGER SUPERVISORY EQUIPMENT

More recently a supervisory device has been developed by the British Post Office<sup>9, 10</sup> which enables the loop gain between a shore station and any repeater, and also the noise power at the output of each repeater, to be measured; it can also be used to measure the non-linearity of each repeater. The Bell Telephone Laboratories, later and independently, developed a similar supervisory device<sup>11</sup> which, however, is designed to measure only loop gain. A block schematic diagram of a terminal repeater station and of a typical submerged repeater using the Post Office system is shown in Fig. 5. The

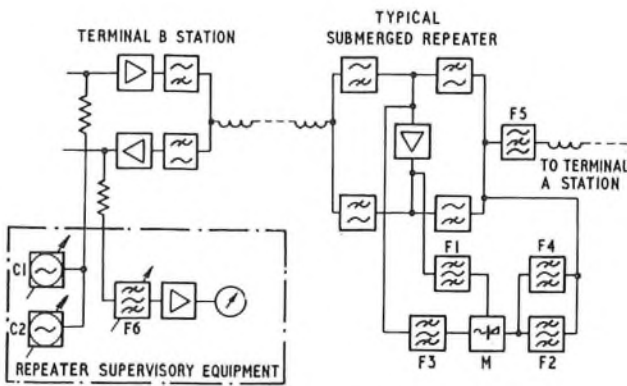

FIG. 5—BLOCK SCHEMATIC DIAGRAM OF FREQUENCY-CHANGER SUPERVISORY EQUIPMENT

system transmits a low band from the A station to the B station and a high band in the opposite direction; supervisory measurements are made from the B station, but it is possible for the equipment to be designed so that the tests are made from the A station.

The supervisory equipment present in each repeater comprises four band-pass filters, F1-F4, a band-stop filter, F5, and a modulator, M. If  $f_1-f_4$  represent the mid-band frequencies of the filters F1-F4, respectively, these frequencies have the following relationship:  $f_1-f_2=f_3=f_4-f_1$ ; filter F5 has the same mid-band frequency as F4. These frequencies are also chosen so that  $f_3$  lies below the lowest speech-signal frequency of the high-frequency band. As an example, the Anglo-Swedish repeaters<sup>12</sup> are designed to have the following transmission characteristics:

(i) A station to B station speech channels occupy the frequency band 60-300 kc/s.

(ii) B station to A station speech channels occupy the frequency band 360-552 kc/s and 560-608 kc/s.

(iii) Frequency  $f_1$  is of the order of 612 kc/s,  $f_2$  is of the order of 558 kc/s,  $f_3$  is of the order of 54 kc/s, and  $f_4$  is of the order of 666 kc/s.

At the B station the supervisory equipment comprises two variable-frequency oscillators, C1 and C2, connected to the transmit channel, and a variable-frequency filter, F6, with associated amplifier and meter connected to the

receive channel. Considering for the moment only the repeater shown, the loop gain between the B station and the repeater may be measured by adjusting oscillator C1 to generate a signal of frequency  $f_1$ , and oscillator C2 a frequency of  $f_2$ ; the variable-frequency filter F6 is adjusted to pass a signal of frequency  $f_3 (=f_1-f_2)$ . The two signals travel along the system to the repeater and there pass through the filters F1 and F2 to the modulator. In the latter they generate a difference signal  $f_1-f_2=f_3$ , and this, passing through filter F3, is transmitted back to the B station; here the signal  $f_3$  passes through filter F6 and is applied to the meter, on which its amplitude may be measured.

The modulator is so designed, and the oscillator levels are so adjusted, that the signal  $f_1$  acts as a switching carrier, and the conversion loss of the modulator,  $f_2$  to  $f_3$ , is constant over a wide range of levels of signal  $f_2$ . The difference in level between the output from oscillator C2 and the received signal  $f_3$  is a measure of the sum of the gains, at frequencies  $f_2$  and  $f_3$ , of the system between the B station and the repeater, the gain of the modulator in the repeater, and the gain of the terminal supervisory equipment. For the modulator to operate as described, both signals  $f_1$  and  $f_2$  must be present at its input terminals. If there are  $M$  different frequencies available for  $f_1$  and  $N$  for  $f_2$ , there are  $MN$  separate combinations of frequencies which may be associated with  $MN$  repeaters; this simplifies the design of the terminal supervisory equipment, oscillators C1 and C2 only having to be adjustable in  $M$  and  $N$  steps, respectively, and also reduces the number of different filters that have to be made for the repeaters. For example, if  $M$  and  $N$  are each equal to 10, 100 different repeaters can be made using only 10 different types of filter for F1 and 10 for F2.

In order to describe the operation of the supervisory equipment certain details about the characteristics of the filters in the repeater have been glossed over. In point of fact, filter F2 has a pass-band loss of some 25 db and that of filter F4 is approximately zero. This does not affect the performance of the system when loop-gain measurements are made, but it does make it possible to measure the noise at each repeater's output. If only a repeater's carrier frequency is sent along the system, that carrier will energize the modulator in that repeater and the noise present at the outputs of filters F2 and F4 will be frequency changed to the frequency band passed by filter F3 and will then be transmitted back passed by filter F3 and will then be transmitted back to the B station where it may be measured. Because of the pass-band loss of filter F2, the noise present at its output will be predominantly the thermal noise generated before and in the filter, and the system noise passing through filter F2 will be largely masked by the filter-generated noise. The system noise in the pass band of filter F4, however, will pass unattenuated to the modulator. This noise will have come largely from the repeater, because each of the filters F5 has a stop band wide enough to embrace all the repeater frequencies  $f_4$  on the route and will have prevented noise in the F4 pass band at one repeater from passing to the next along the route. Thus, if any one repeater generates an abnormal amount of noise, this fact will be apparent from the high frequency-changed noise which is measured from that repeater. All the measurements described above may be made with the system in service.

The non-linearity of any repeater may be measured by sending from the B station a signal of the appropriate  $f_1$  frequency, and two frequencies  $f_a$  and  $f_b$  both in the

high-frequency band, such that  $2f_A - f_B = f_2$ . The third-order non-linearity of the repeater will generate an intermodulation tone whose amplitude, when frequency-changed and transmitted back to the B station, will show up any repeater whose non-linearity has increased to such an extent that it affects the noise of the system.

Fig. 6(a) is a portion of a recorder chart showing the loop-gain characteristics of some of the repeaters on the Anglo-Swedish cable, and Fig. 6(b) shows in a similar manner the noise at the output of some of the repeaters on the same route.

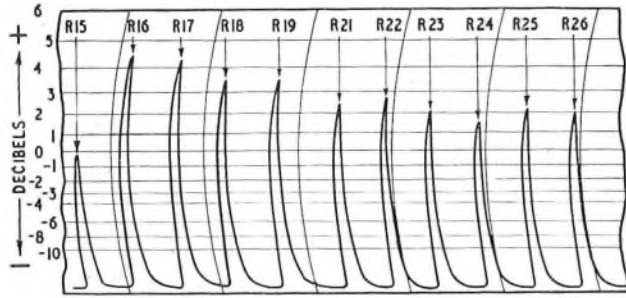

0 db on the scale corresponds to  $-46$  dbm receive level at the monitoring equipment  
(a) Loop-Gain Recording

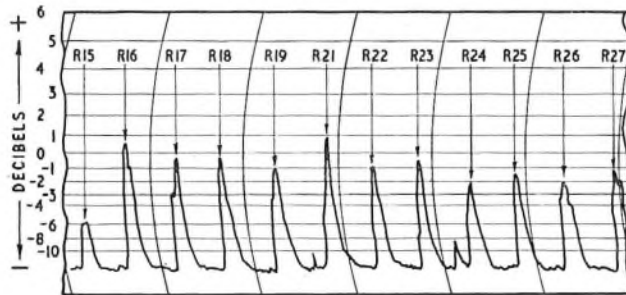

0 db on the scale corresponds to  $-95$  dbm receive level at the monitoring equipment  
(b) Noise Recording

FIG. 6—RECORDINGS MADE WITH FREQUENCY-CHANGER SUPERVISORY EQUIPMENT ON THE ANGLO-SWEDISH CABLE USING A SWEEP-FREQUENCY METHOD

This equipment was first provided on the Anglo-Swedish cable,<sup>12</sup> laid in 1960, and is fitted to all the repeaters of the CANTAT<sup>13</sup> A2 and A3 links, across the Atlantic and Newfoundland, respectively. It will also be fitted to all the repeaters of the COMPAC<sup>14</sup> link joining Australia to New Zealand, Fiji, Hawaii and Canada and due to be laid in the period 1962-4.

The equipment described above may be modified to use a pulse-transmitting and pulse-receiving supervisory terminal equipment instead of the variable-frequency oscillators and filters shown in Fig. 5. In such a modified system all repeaters would have identical supervisory equipments and the bandwidths of the filters F1 to F5 would be increased to allow the transmission of the pulses that would replace the individual supervisory frequencies. The terminal equipment would be modified to transmit short pulses from two fixed-frequency oscillators in a manner similar to that employed at a B station and shown in Fig. 1. As each pair of pulses passes through a repeater, the repeater's modulator will generate a difference-frequency pulse which will pass back to the B station; there it will be separated in time from the return pulses from all other repeaters on the route, and this would enable each repeater's return pulse

to be identified and its level measured. By sending only the carrier pulse the repeaters' noise levels could be measured, and by sending the carrier pulse and pulses whose intermodulation products include the second frequency sent for loop-gain measurements, the non-linear performance of each repeater could be investigated.

#### BRIDGE-CIRCUIT SUPERVISORY EQUIPMENT

One other fault-locating device will be described. It has its origin in the method sometimes used by submarine telegraph engineers on duplex cables. On such cables, duplex transmission uses a balanced-bridge circuit with the actual cable and a simulating cable network as adjacent arms. The simulating cable network comprises series-resistive and shunt-capacitive sections, each representing several miles of cable. A cable fault will alter the input impedance of the line, the bridge will be unbalanced, and a local record of the sent telegraph signals will appear. By trial, the simulating cable network would then be earthed or opened at various points until balance again occurred; the type and position of the fault on the cable could then be inferred from the position of the artificial fault.

This method has been improved and can now be applied to the transatlantic links of TAT-1 and TAT-2. The simulating cable network has sections representing each repeater and each repeater-section of cable over a low-frequency band, extending from zero to a few cycles per second but, instead of telegraph signals, regular reversals or sine-waves are used as the energizing signal. The use of such a device is not applicable to transmission faults which do not affect the very low-frequency characteristics; for such faults one of the equipments described earlier in this article would be required.

#### References

- <sup>1</sup>COOPER, W. H. B., and DUERDOTH, W. T. Improvement in or Relating to Testing Electrical Communication Systems. British Patent No. 621,687 (30 Mar. 1946).
- <sup>2</sup>COOPER, W. H. B. Improvements in or Relating to Communication Systems. British Patent No. 654,380 (3 Oct. 1947).
- <sup>3</sup>The Transatlantic Telephone Cable. *P.O.E.E.J.*, Vol. 49, Part 4, Jan. 1957.
- <sup>4</sup>ROE, F. O. Improvements in Arrangements for Locating Defective Submerged Repeaters. British Patent No. 656,188 (17 Feb. 1948).
- <sup>5</sup>ROCH, A. H., and ROE, F. O. The Netherlands-Denmark Submerged-Repeater System. *Proceedings I.E.E.*, Paper No. 1635, Feb. 1954 (Vol. 101, Part 1, p. 180).
- <sup>6</sup>BROCKBANK, R. A., WALKER, D. C., and WELSBY, V. G. Repeater Design for the Newfoundland-Nova Scotia Link. *Proceedings I.E.E.*, Paper No. 2249R, Jan. 1957 (Vol. 104, Part B, Supplement No. 4, p. 91).
- <sup>7</sup>ILGENFRITZ, L. M. The Key West-Havana Cable, Electrical Characteristics of Repeaters and Terminals. *Bell Laboratories Record* No. 30, p. 20, 1952.
- <sup>8</sup>Western Electric Co., Inc. Electrical Signal Transmission Systems and Repeaters Therefor. British Patent No. 702,397 (17 Dec. 1949).
- <sup>9</sup>SCOWEN, F. Improvements in or Relating to Amplifiers and Methods of Detecting Faults Therein. British Patent No. 791,277 (22 Sept. 1954).
- <sup>10</sup>BROCKBANK, R. A., and SCOWEN, F. Improvements in or Relating to Electronic Amplifiers. British Patent No. 828,061 (7 Feb. 1955).
- <sup>11</sup>Western Electric Co., Inc. Improvements in or Relating to Repeater Testing Arrangements in Electrical Signal Transmission Systems. British Patent No. 824,508 (27 Aug. 1956).
- <sup>12</sup>The Anglo-Swedish Submarine Telephone Cable. *P.O.E.E.J.*, Vol. 53, p. 165, Oct. 1960.
- <sup>13</sup>A Proposed New Telephone Cable between the United Kingdom and Canada. *P.O.E.E.J.*, Vol. 50, p. 104, July 1957.
- <sup>14</sup>Proposed Commonwealth Pacific Telephone Cable System. *P.O.E.E.J.*, Vol. 53, p. 42, Apr. 1960.



# Electronic Computer Exhibition and Symposium on Electronic Data Processing, London, October 1961

U.D.C. 061.3/.4 : 681.142.

THE second Electronic Computer Exhibition was held concurrently with a Data Processing Symposium during 3–12 October 1961 at Olympia (London). At the first exhibition held three years before, when the total number of computers operating in the United Kingdom was something over 100, 12 types of computer were on show, only three of these having transistor circuits. The 1958 symposium was, by and large, a recital of plans by business users to transfer work to computers, as at that time only a handful of firms had actually started operations with computers and a few more were buying time on a service basis. Many scientific and mathematic applications were fully working but these had scant mention as they were of little interest to the commercial world.

As a contrast the 1961 symposium endeavoured to outline in business terms the results achieved, and had more of a practical flavour. The object of the symposium was not to evaluate the technical performance of computers but rather to give an appraisal of their new possibilities to the management of potential user-firms. Papers in the first half of the symposium were contributed by speakers from the pioneer users, about half of whom had contributed to the earlier symposium and were now able to report on practical experience, mostly with business applications. The second half dealt with a variety of topics, and included the uses of computers for engineering calculations, production planning and market surveys, a review of computer service bureaux and character-recognition problems, and a description of new equipment.

The lack of a paper on data transmission was compensated for by the opening speaker, Sir Edward Boyle, Financial Secretary to H.M. Treasury, who directed attention to the current activities in this field by industry and the General Post Office. A gratifying number of inquiries were made at the General Post Office stand about the error-detecting equipment on display and about data transmission in general. Many of these inquiries were from potential clients not previously known to be interested.

Rather fewer computers were on display than last time and these were mostly the smaller ones, all but one having transistor circuits. A few of the larger computers were shown in spite of the difficulty of transportation, reassembly, and getting them working again within a tight time schedule, and of the cost of removing such valuable equipment from active service for two weeks. Other manufacturers used models and films to demonstrate the capabilities of their equipment.

No fundamental changes in circuit techniques were evident on the machines displayed, but improvements in logical design had greatly increased the capacity of the machines for work. Computers themselves have become physically smaller than three years ago; even so greater floor space is needed as many of the larger computers can handle more than one job at a time, with the consequence that the number of input and output equipments attached to a computer has greatly increased.

The progress that has been made in increasing the rate

at which information can be read into or taken from computers can be illustrated by the following examples of equipment on display: a magnetic-tape transport with a data rate of 180,000 characters per second; a printer which prints at 4,700 characters per second, a card reader reading cards at 2,000 per minute, and paper-tape punches and readers with character rates of 300 and 1,000 per second, respectively.

The rate at which computers work is now very much greater over the whole of the size range; indeed some computers in the small-medium size range are working at speeds greater than those of large computers available three years ago. At the top of the speed table is ATLAS which is expected to perform 1 million operations per second.

One aspect of present-day equipment is a design that will suit a variety of customers; this is not unlike telephone engineering practice where the configuration of standard parts is adjusted to suit the requirements. The attraction to the user is that additions can be made as demands on his computer increase.

The speed of access to the internal store and its size for both large and small computers are still on the increase. Some manufacturers are offering auxiliary storage in the form of large random-access stores with a substantial mechanical content in their construction, and these stores have an access time to information contained therein intermediate between that of magnetic-core stores and magnetic-tape transports. Perhaps the least satisfactory aspect of computer installations is the amount and complexity of the mechanical equipment they contain; this demands a disproportionate amount of maintenance compared with the electronic-equipment content.

An outstanding illustration of the reliability achieved by modern electronic equipment is a report that a computer, similar in type to that used at the Post Office Research Station, has run on three-shift working for half a year without a breakdown.

A sign that computers are coming of age is that, with more attention paid to aesthetics of design, the equipment has lost its laboratory appearance and is becoming more like the regular office machinery, with simpler push-button controls, typewriters for the use of the operator, and with the working parts out of sight. Other signs are the improvements in, and range of, ancillary equipment designed to make life easier for the operating staff and to give them the facilities wanted by an office user. Perhaps of greatest significance for the future is the general attachment to office machines of paper-tape punches and equivalent devices. This reduces operating costs, reduces the number of transcription errors and prepares, at the source, data suitable for direct application to a computer or to a data-transmission link.

It is estimated that there are now 350 computers working in the United Kingdom. The value of computers and ancillary equipment on show was £4 million and the Government alone expect to spend £15–20 million on automatic data-processing equipment within the next 10 years.

R.K.H.

# Meeting of the Commission Mixte Internationale, Bournemouth, September 1961

U.D.C. 061.3:351.817+351.824.11

**A**FTER 31 years the United Kingdom has again had the opportunity of acting as host to the Commission Mixte Internationale (C.M.I.), an international body set up in the 1920s at the suggestion of the C.C.I.F.\* (now the C.C.I.T.T.†) to consider technical problems affecting electric power, including traction, telecommunications, and the distribution of gas and water in pipes.

It is a function of the C.M.I. to witness and approve tests and techniques that involve the interests of two or more of the utilities mentioned. With this object in view the Electricity Council and the Post Office decided that British practices in cathodic protection, joint use of poles, plastic-sheathed underground telephone cabling and a special form of high-voltage power distribution should be demonstrated to the C.M.I. at a number of sites in the Bournemouth and Southampton Telephone Areas in the last week of September 1961.

The opening session of the meeting took place at Bournemouth on the morning of 26 September. The demonstrations that it was proposed to conduct were outlined and attention was drawn to the documents that had been prepared for the meeting. The items covered were as follows:

(a) Joint usage of poles by power and telephone administrations in the United Kingdom.

(b) High-voltage single-wire earth-return lines.

(c) Methods of measuring the interchange of current between a buried structure and the soil.

(d) Joint-user cathodic protection at Sturminster Newton.

(e) Tests to determine the variation of the effects of interaction between cathodically-protected and neighbouring structures.

(f) Alternating-current corrosion of underground structures, with demonstrations of a loop test on a ferrous gas main.

(g) Cathodic protection in the Southern Gas Board Area.

(h) Application of polythene to telecommunication cables in the United Kingdom.

During Tuesday afternoon the delegates were able to see a number of exhibits and demonstrations at the Southern Electricity Board's sports ground, Bournemouth. These included techniques used in cathodic-protection, pole assemblies illustrating joint use by power and telephone administrations, corrosion-testing instruments and equipment, corrosion samples, cathodic-protection ground-bed techniques, track-locating methods, various types of polythene cables and methods of jointing. A visit to Highcliffe Castle to see some of the processes involved in drawing-in and jointing a paper-insulated polythene-sheathed telephone cable followed.

The next day, Wednesday 27 September, the delegates were taken by coach to the village of Semley, a few miles

north of Shaftesbury, to examine a scheme, developed by the Southern Electricity Board and the Post Office under an existing national agreement, to provide low-voltage electric power supplies and telephone service for the inhabitants by means of the joint use of poles.

East Stour repeater station on the Post Office Salisbury-Exeter cable route was visited afterwards. Here the delegates were shown a typical cathodic-protection scheme as used by the Post Office for the protection of its lead-sheathed underground-cable network. Details of the cables at the repeater station and an indication of the extent of other cathodic-protection installations associated with the route concerned were given, together with the position and incidence of corrosion faults that had appeared in the past. The rectifier unit and methods adopted for its connexion to the underground cables and the ground-bed used with the cathodic-protection scheme were also shown, together with bonds to a water-pipe and the sheath of an electricity supply cable. Part of the ground-bed was exposed for examination.

Wednesday afternoon was spent examining and discussing the joint-user cathodic-protection scheme‡ at Sturminster Newton. Here, the following demonstrations were conducted:

(a) The Southern Gas Board gave details of the method of installing the ground-bed, and one wax-impregnated graphite anode was exposed for examination.

(b) The Poole and East Dorset Water Board and the Post Office demonstrated locating and making contact with gas and water mains to measure the resistance of pipe joints.

(c) The Post Office gave details of the general cathodic-protection scheme, the type of rectifier used, methods of bonding and of making potential measurements.

Thursday morning saw the delegates at Bramshaw in the New Forest for an inspection of a route of poles carrying 11 kV overhead power conductors and Post Office telephone subscribers' lines. A visit was subsequently made to a high-voltage single-wire earth-return power service to an isolated property at Ashurst, also in the New Forest. In this system, which originated in Australia and New Zealand and has been developed experimentally by the Southern Electricity Board in the United Kingdom, current is fed over a single wire operating at 6,350 volts to a transformer at the load point and then returns through the earth to the source of supply. There are thus possibilities of interference with nearby telephone services, and delegates were most interested in the steps taken to control such an installation to prevent interference.

After lunch the delegates witnessed a demonstration by the Southern Gas Board and the Post Office at Chandlers Ford near Southampton which showed that a well-wrapped cathodically-protected gas main causes little interference to other services buried near by. In the course of this demonstration, structure-soil potential measurements were taken on the gas-main and telephone-cable sheaths with the rectifier supplying the cathodic-protection current to the gas main switched on and off.

\* C.C.I.F.—International Telephone Consultative Committee.

† C.C.I.T.T.—International Telegraph and Telephone Consultative Committee.

‡ MORSE, L. E. A Joint-User Cathodic Protection Scheme. *P.O.E.E.J.*, Vol. 54, p. 101, July 1961.



The party was then taken to Hinton near Christchurch to see a number of demonstrations associated with a cathodically-protected gas main. Here, the British Electrical and Allied Industries Research Association staged a demonstration in which an alternating current of about 1 amp was induced in the gas main by means of a loop laid on the surface of the ground and carrying a current of about 160 amp. The induced current was measured by means of a search coil placed above ground over the gas main; only very small d.c. potential changes between the gas main and earth due to the flow of the alternating current were detected.

In another demonstration cathodic protection equipment on the gas main was switched on and off by means

of a mains-driven switch, and interference tests and measurements of current flowing in bonds were made on the telephone-cable sheaths. The method of bonding the gas main to the sheath of the electricity supply cable was also shown.

Much preparatory work was necessary at the various sites where demonstrations were staged for the C.M.I., and willing co-operation was given by the gas, water and electricity supply authorities concerned. Credit for the successful organization of the demonstrations is, however, largely due to the staff of the Director, South Western Region and the Telephone Managers' staffs at Bournemouth and Southampton.

S. J. L.

## Flood-Testing of the Magnetic-Drum Register-Translator

U.D.C. 621.395.341.72.001.4:621.395.625.3

The magnetic-drum register-translator equipment is used to control the routing of subscriber dialled trunk calls which originate in the director areas. Before the equipment was introduced into public service, trials were held to prove its reliability and one of the methods used to achieve this was to pass large numbers of simultaneous test calls through the equipment and assess the percentage which failed. A description is given of the novel methods used to originate the test-call program and determine the call-failure rate.

### INTRODUCTION

ONE method used to prove the reliability of the magnetic-drum register-translator equipment\* before it was introduced into public service was to make the equipment handle large quantities of artificial traffic and assess the rate of call failure. The artificial traffic was originated so that all the registers handled calls simultaneously: a technique known as flood-testing. The magnitude of this task prevented the calls being made manually, and an automatic system of originating the calls and checking the register output was developed. The digits of the test calls to be transmitted were pre-recorded, as a sequence of v.f. tones at standard dial speed and ratio, on a magnetic tape. The tape was then fed into a continuously-operated playback machine and the output used to operate a v.f. receiver, as shown in the block-schematic diagram. The d.c. out-

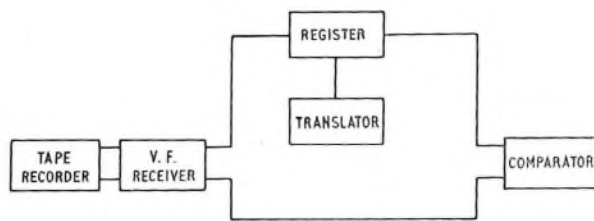

SCHEMATIC ARRANGEMENT OF TEST-CALL APPARATUS

put of the receiver was used to pulse the test call into the register. The appropriate routing digits sent from the

register, as directed by the translator, were fed into the "comparator" for comparison with check digits supplied from the tape. Failure of the routing digits to agree with the check digits resulted in a failure being recorded.

### TEST-CALL PROGRAM

The register-translator rack was equipped with a total of 47 registers. To enable a call to be set up simultaneously by each of the registers two test-call programs were recorded for use on each of four magnetic-tape playback machines. Each of these programs was used to originate calls to six registers, thus permitting a total of 48 simultaneous calls to be made. Both programs consisted of 91 test calls and the duration of the total program was 1 hour 40 minutes.

### Method of Recording

The magnetic tapes were prepared by recording v.f. pulses at standard speed and ratio, using two frequencies for each program. One frequency was used to record the digits used to originate calls and the other to record the check digits, i.e. the digits which corresponded to the expected output from the register. These two programs were interleaved on the tape on a call-by-call basis. This allowed maximum use to be made of the tape by permitting a call from the second program to be pulsed into a register whilst the previous call from the first program was being pulsed out from another register.

The frequencies of the international 2 v.f. system (2,040 c/s and 2,400 c/s) were used to record one program and those of the national 2 v.f. system (750 c/s and 600 c/s) for the other. The first call of program 1 was assembled by recording at 2,400 c/s the check digits, followed by the originating call digits at 2,040 c/s. The total value of the check digits equalled the total value of all the digits expected to be pulsed out from a register as a result of the originating call digits. The next call recorded on the tape was the first call of program 2 and was recorded in a similar manner but this time using 600 c/s for the check digits and 750 c/s for the originating call digits.

\* BENSON, D. L., and VOGAN, D. H. Controlling Register-Translators. Part 4—Magnetic-Drum Register-Translator. *P.O.E.E.J.*, Vol. 51, p. 291, Jan. 1959.

### *Tape Machines*

The program was fed into the registers using four commercial-type tape machines, selected because they were designed for continuous operation and were of robust construction. They were two-track machines, one track being operative in each direction of tape travel, reversing and track switching being accomplished by a relay operated via thin metal foil fitted at the appropriate position at each end of the tape.

### *Comparators*

The comparators were used to compare the total of the check digits with the total of the digits pulsed out from a register. The comparison could have been made by stepping a single Dekatron counter in an anticlockwise direction in response to the check digits and in a clockwise direction in response to the digits pulsed out from a register. If the register output was correct the counter would then have finished at the zero position. However, there was the risk of overlooking a fault if the check digits and the pulsed-out digits disagreed by ten or multiples of ten.

To decrease this risk two counters of unequal intervals were used, one a 10-position and the other a 12-position. These were both stepped simultaneously. For a false zero to occur using counters with these particular intervals the error between the pulsed-out digits and the check digits would have had to be 60—a rather unlikely event. If the counters failed to register zero this fact was recognized at the next seizure of the comparator, a fault registered on a 100-type meter associated with the comparator, and the counters reset to zero. Only ten comparators were provided so that only ten of the 47 registers were checked at any one time. Flexibility of connexion was provided to allow any one of the comparators to be associated with any one of the registers.

During the period of flood-testing each register was checked for approximately the same period.

During a period of three months the flood-testing equipment was running for 1,145 hours, and in this time over 3,000,000 calls were passed through the register-translator equipment. Of this total, 637,000 calls were checked on the comparators. From the call failures 19 faults were located, 15 on relay contacts and four in the electronic equipment. The electronic-equipment faults comprised one valve and one cold-cathode tube failure, one disconnexion in the wiring and a readjustment to the speed-control potentiometer.

### *Remote Monitoring*

To enable the fault position to be monitored outside normal working hours a remote-control equipment, which indicated to a caller the presence of a fault, was associated with an exchange line adjacent to the equipment. By dialling this number when the laboratory was unstaffed but flood-testing was in progress it was possible to ascertain the number of faults that had occurred since the monitor was last reset. When this exchange line was called, the ringing was tripped and connexion was made to a relay-set which fed out tones at distinctive rates dependent upon the number of faults. No faults gave a pulse of 600 c/s tone every 30 seconds, one to five faults gave a pulse of 600 c/s tone every six seconds, and six and over faults gave a pulse of 600 c/s tone every one second. Power-failure indication was given by feeding out 750 c/s tone simultaneously with the 600 c/s tone. During the initial stages of flood-testing this facility was used to enable testing to be continued whilst the laboratory was unstaffed and hence complete a large program in the shortest possible time. When a number of faults were indicated, the laboratory was visited and the faults corrected.

C. A. M.

---

## Book Review

“Electromagnetic Fields, Energy and Forces.” R. M. Fano, L. J. Chu, and R. B. Adler. John Wiley & Sons, Ltd., New York, and Chapman & Hall, Ltd., London. xv + 520 pp. 108 ill. 96s.

This is another volume in the Massachusetts Institute of Technology “core-curriculum” program in electrical engineering. In common with other volumes in this series, priority is given to basic principles and methods of analysis rather than to the presentation of current technology.

This book has been prepared for use by junior students who have completed two years of mathematics and physics and two terms of circuit theory. It does not pre-suppose a prior knowledge of vector analysis or of partial differential equations. The whole of Chapter 2 is devoted to a review of the more elementary properties of vectors, and introduces the more advanced concepts of vector analysis, which are used extensively in the subsequent chapters. The solutions of partial differential equations are discussed where they first arise in the solution of Laplace’s equation.

The first six chapters deal with electric and magnetic fields, and follow the classical approach of Maxwell; Maxwell’s equations are presented first in integral form, then developed in their differential form and applied to static fields. After a consideration of polarized matter as a field source, Maxwell’s equations are formulated for time-varying fields; at this stage the relation between circuit

theory and field theory is treated more carefully than is usual. Chapter 7 introduces the concepts of electromagnetic energy and power flow, with emphasis on the physical interpretation of Poynting’s theorem. The discussion of electromagnetic fields in stationary systems concludes with a chapter on the sinusoidal steady state; here the complex form of Maxwell’s equations and Poynting’s theorem are developed and applied. The last two chapters cover the electromagnetism of moving bodies and the process of electromechanical energy conversion. For completeness, the book concludes with a large appendix on the four-dimensional formulation of electrodynamics, developed by one of the authors (L. J. Chu). Electromagnetic energy transmission and radiation are covered in a companion volume by the same authors, so they are not included in this text-book.

Although following classical lines to a certain extent, this book has quite a modern approach to the subject. The text contains a lot of helpful explanatory material which tends to make it more readable. The lucidity, which is not common in works of this standard, is presumably due to the fact that the book is based upon class notes written while the material was being taught and developed. There is a useful list of references at the end of each chapter, with a résumé of each reference.

This book should be helpful to any serious student, with ample time for reading, who desires a sound understanding of the principles of electromagnetic field theory without the associated technology.

A. E. S.



# Examination and Evaluation of New Types of Paint for Post Office Use

U.D.C. 620.16:667.63

THERE have been many developments in paint technology in recent years. The most striking advances have been in the paints used industrially for finishing apparatus. Many novel materials have come into use for this purpose and improved methods of application are available. The literature supplied by paint manufacturers does not always supply the kind of information which the Post Office needs before adopting a new type of paint, and it is often necessary for an examination to be made. The following is a brief account of the methods and principles used in evaluating an industrial paint.

While some knowledge of the composition of a paint is useful, it is not possible to evaluate its performance from this alone and in practice much use is made of performance tests designed to reproduce the different hazards to which a paint finish is subjected in ordinary use. Consequently, before a finish can be assessed it is necessary to know something of conditions of application and use. Indeed a paint, as such, cannot be evaluated; it is necessary to consider a paint *finish* (including the material to which it is applied, the preparation of the surface, the method of application and so on) and to evaluate this.

It is necessary to distinguish between two main functions of an industrial paint. The first is decorative, to supply gloss or mattness, to colour, or to conceal blemishes, and must be judged subjectively (although there are laboratory methods of defining a finish once it has been selected). The second function, the ability to protect against corrosion, wear and tear, etc., is assessed by laboratory tests. The two functions are to some extent linked together; a paint which blisters, for example, is failing in both functions, but there are instances in which a good protective paint has poor decorative value and a choice has to be made.

The most important property of any paint is adhesion. It should not peel or flake spontaneously and it should not be easily removed by a chance knock. There are several methods of assessing this property, such as the "bend test," in which a panel is bent over a mandrel, and the "impact test," in which the surface is indented by a falling striker, but perhaps the most useful test is to incise the film into small squares and attempt to pick them off with a penknife (this is known as the "window test"). In a good film the adhesive bond is stronger than the cohesion of the film which consequently breaks before becoming detached.

Other properties which may be measured are flexibility, hardness, thickness, water resistance, gloss, rust inhibition, dirt retention, flame retardation and many others of more specialized nature. Most of the tests

measure a combination of several of these properties. The "bend test" assesses flexibility as well as adhesion; the "scratch hardness test" assesses both adhesion and hardness. The results of these tests need to be interpreted with caution.

The most difficult part of the evaluation of a paint finish, however, is the extent to which a paint film loses its desirable properties with age. A paint film ages partly as a result of chemical and physical changes in the film itself. The chemical changes which originally caused the paint to dry continue, more slowly, after the film is dry, and will eventually lead to its disintegration. These changes and others due to external agencies may be accelerated by radiant energy or heat, while chemical changes in the substrate of the film may lead to loss of adhesion. The selection of a set of conditions to simulate those of service is sometimes difficult, but below is a list of standard tests which may be used.

*Oven Bake.* Since most chemical reactions double in speed for each 7°C rise in temperature, a few hours heating at 100°C produces a useful acceleration of internal aging of a paint film.

*Salt Spray.* Usually applied to panels which have been scratched to expose the metal base. Primarily a test for rust inhibition.

*Weatherometer.* Combined "sunlight" and "rain." Useful for external paint systems.

*Water Immersion.* (Room temperature or boiling). Many films swell and discolour in water. Will reveal poor adhesion.

*Industrial Atmosphere.* Exposure to combined water spray and sulphur dioxide. Simulates the atmosphere of an industrial town.

*Fugitometer and Mercury Vapour Lamps.* For studying the effect of light alone. The results are not reproduced well in ordinary service but the test is useful for detecting light-fugitive pigments.

Enough has been written to show the kind of test that is used in evaluating a paint finish. The significance of the results of such tests is still a matter of controversy among paint technologists, but they do serve to eliminate low-quality paints without much expenditure of time. For comparison of the merits of high-quality paints there is no reliable alternative to a controlled field trial.

Throughout this note there has been no mention of enamels. The distinction between paints and enamels is now very nebulous. Most paints which are stoved and many that are not are called enamels, and it is interesting to note that many new materials are called "coatings." The same methods of test are used for paints, enamels, lacquers, varnishes and "coatings."

P. E. T.

# A Tester for Surge-Resistant Fuses

A. W. N. GARBUTT †

U.D.C. 621.317.799:621.316.923

A tester has been developed for the measurement of the surge-resistant characteristics of fuses, and it provides pulse trains of from one to six unidirectional pulses derived from a 50 c/s mains supply. Using an internal transformer only, the maximum peak pulse current is 25 amp, but this may be increased to 200 amp by the use of an external transformer.

## INTRODUCTION

A TYPICAL surge-current characteristic covering the first few cycles applied to a mains transformer from the time of switching on is shown in Fig. 1. Since the heating effect on a fuse connected in the primary circuit will be proportional to the square of the current, it will be seen that, if a fuse of the ordinary type is capable of carrying the surge current, it can give little protection against other currents considerably in excess of normal. It is indeed common practice to use fuses having a rating of five to ten times that which would be chosen for full protection of the circuit.

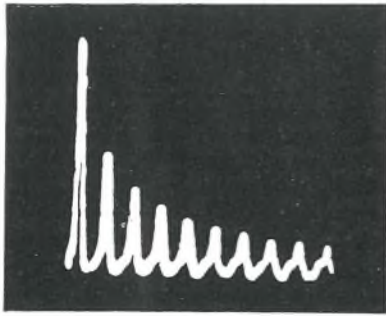

FIG. 1—TYPICAL SURGE-CURRENT CHARACTERISTIC

Recognition of the limitations of ordinary fuses has led to a demand by designers for surge-resistant fuses. Ideally, a surge-resistant fuse should have a heat dissipation/time characteristic with a square-law relationship to a smooth curve drawn through peak current values, such as shown in Fig. 1. In practice, sufficient protection is given by fuses that can withstand a short initial overload and yet, over a longer period, protect a circuit against a moderate increase of working current above normal.

The provision of surge-resistant fuses has led to the need for a tester to check that such fuses possess the required characteristics.

The tester to be described was designed not only to test surge-resistant fuses but also to serve as a standard method of test for inclusion in design specifications. Since fuse manufacturers will require similar equipment, it was most important to avoid undue complexity or stringent calibration arrangements. These requirements precluded the use of a direct-current pulse test, and it was decided that the use of mains-derived half-cycle pulses would make possible a suitable design.

### Preliminary Tests

A large number of tests were made on surge-resistant fuses of normal current ratings between 50 milliamp and

5 amp. The tests consisted of passing various pulse trains of up to eight pulses of a current sufficient to make each fuse glow. An approximate relationship was established between the number of pulses in the train and the current required. It was found that, by using a train of six pulses, it was possible to provide an adequate test of surge-resistant properties and, at the same time, to limit the current required to practical values.

For present types of surge-resistant fuse a peak value of 150 amp is needed, and the equipment was designed for a maximum current of 200 amp to give a reasonable margin for future needs.

## GENERAL DESCRIPTION OF TESTER

It was considered desirable to make the tester mobile and as self-contained as possible. To retain mobility, while still being in a position to deal with as large a range of fuses as possible, the peak current from the internal transformer was limited to 25 amp, using a thyatron as a switch. For currents in excess of 25 amp, an ignitron is used for control purposes, with a large external transformer. For the high current ranges, the thyatron and internal transformer are used to prime the ignitron.

The earlier tests had established that, to limit the heating of circuit components such as the controlling resistors and transformer windings, it was sufficient to use items whose ratings were not exceeded by more than a factor of 10. A suitable voltage for the thyatron is 500 volts r.m.s., and the internal transformer therefore provides 500 volts at 2.5 amp rating. Variable series resistors, ranging from 5 to 5,000 ohms, control the value of the test current.

Fig. 2 shows a block schematic diagram of the tester; the external appearance is shown in Fig. 3. The thyatron is normally held in the non-conducting state by a high negative grid bias. It is caused to pass current during selected periods by a change of bias. This is derived from the voltage developed across the cathode resistors of a Dekatron counter driven at 50 c/s from the mains supply. The selection of the number of pulses forming the train is determined by the number of cathodes of the Dekatron used, and is controlled by means of a pulse-train switch. A buffer-valve stage is included between the Dekatron and thyatron to relieve the Dekatron cathodes of the thyatron grid-current loading. The Dekatron has one cathode normally disconnected. This may be reconnected by a push-button start key which, at the same time, disconnects an adjacent cathode. The mains supply is permanently connected to the drive electrodes, but the Dekatron operation is restricted to one cycle of the cathodes, since cyclic operation will cease when the disconnected cathode is reached, and the glow will remain on the preceding cathode. The timing of successive pulse trains is, therefore, under the control of the operator, but the length of time that the start key is held operated does not affect the pulse train.

The Dekatron drive supply is in phase with the thyatron supply, so that movement of the Dekatron glow takes place when the thyatron is not conducting. The operation of the start key, therefore, causes the

† Test and Inspection Branch, E-in-C.'s Office.



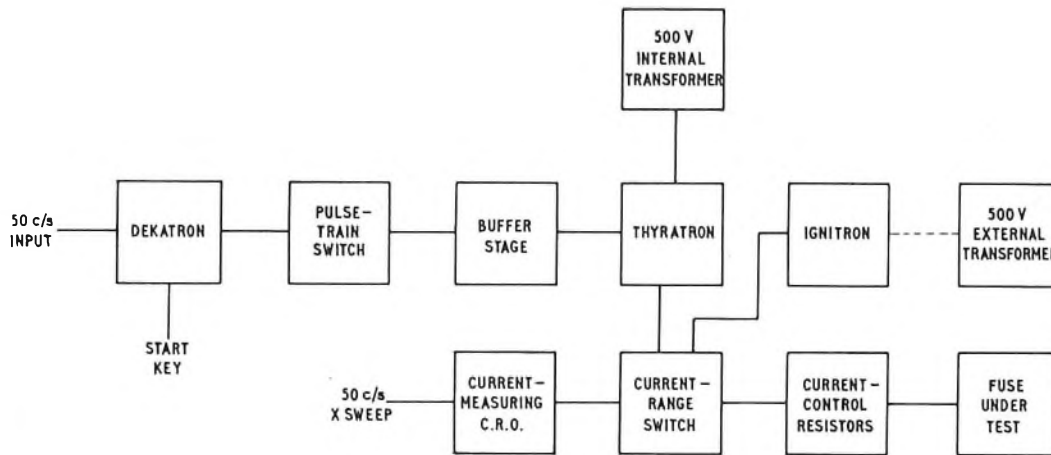

FIG. 2—BLOCK SCHEMATIC DIAGRAM OF TESTER

thyatron grid to be made positive, for a number of half-cycles determined by the position of the pulse-train switch, at times when a positive half-cycle is being applied to the thyatron anode, a corresponding half-cycle current pulse passing through the fuse under test.



FIG. 3—TESTER FOR SURGE-RESISTANT FUSES

For currents greater than 25 amp, the thyatron anode current, which is fixed at 25 amp for the purpose, is passed through the ignitron from primer to cathode, causing a pulse of ignitron current of similar duration,

adjustable by the same variable resistors, to be applied to the fuse.

#### Measurement of Current Amplitude

A cathode-ray tube is used for the measurement of current through the fuse under test. The tube is used for direct indication, without a Y amplifier. The current is measured from the voltage drop across a resistor in series with the fuse. A full-scale deflexion is produced by 200 volts, and the mask provided is engraved with 10 divisions. The value of the series resistor is selected by the current range switch and varies from 1 ohm at 200 amp to 400 ohms at 0.5 amp.

The current range switch also selects the variable resistors to be used for the control of current for each range, to prevent accidental overloading that might otherwise occur.

The X sweep is mains derived and suitably phased, so that the indication on the screen is an approximate sine wave.

Brilliance, focus and X and Y shift controls are provided as well as a variable control for the h.t. supply to the tube. Since the sensitivity of the tube will vary due to mains-voltage variations, a monitoring voltmeter having a single calibration mark is used, in conjunction with the variable control, to maintain the accuracy of the current calibration.

When large currents are being drawn from the mains supply during testing, considerable voltage fluctuations are produced and, to avoid the consequent effect on the tube h.t. supply, the smoothing and decoupling circuit has been given a long time-constant.

#### Test Jig and Safety Device

The test jig contains suitable clips and connectors for present types of fuse and has a transparent hinged cover. When the cover is opened, the start key is rendered inoperative by a concealed switch, so that accidental operation of the key, during the insertion or removal of a fuse from the jig, cannot cause a shock to be given to the operator.

#### Waveform Errors

The current waveform produced by the tester is very close to that of the mains supply, except for errors at the leading and trailing edges. The leading-edge error is due

to the initial voltage necessary to cause the thyatron to conduct; the trailing-edge error is due to the minimum conducting voltage of the thyatron. The thyatron grid voltage is closely controlled, and the errors may be considered as constant for all practical purposes and dependent upon the type of thyatron used. No difficulty is expected in obtaining agreement between various testers that may be constructed, provided that the thyatrons and supply voltages are similar.

#### CONCLUSIONS

The equipment has been in use for a wide range of tests over a period of two years and has proved very satisfactory for its purpose. Much useful information has been obtained on the behaviour and construction of surge-resistant fuses. Tests can be carried out close to the destruction point of a fuse, and studies of fatigue have been made to prove the ability of fuses to function satisfactorily after subjection to high surge currents.

---

## Books Received

"The Dynamical Theory of Sound." Reprint of second edition. Horace Lamb. Dover Publications, Inc., New York, and Constable & Co., Ltd., London. viii + 307 pp. 86 ill. 12s.

This new Dover edition is an unabridged and unaltered reprint of the second edition published in 1925; it is issued in paper-back form under Dover Publications' science reprint program. The book is a comprehensive mathematical treatment of the physical aspects of sound, covering the theory of vibrations, the general theory of sound, and the equations of motion of strings, bars, membranes, pipes, and resonators. Also included are chapters on plane waves, spherical waves, and simple harmonic waves.

A concluding chapter covering the analysis of sound sensations, the influence of overtones on quality, and the Helmholtz Theory of Audition extends the domain of the book to include physiological acoustics. The author in his preface to the 1925 edition made the following comments on this section of the book: "In the latter part of the book a number of questions arise which it is hardly possible to deal with according to the stricter canons even of mathematical physics. Some recourse to intuitional assumptions is inevitable, and if in order to bring such questions within the scope of this treatise I have occasionally carried this license a little further than is customary, I would plead that this is not altogether a defect, since attention is thereby concentrated on those features which are most important from the physical point of view."

"Optics and Optical Instruments." B. K. Johnson. Dover Publications, Inc., New York, and Constable & Co., Ltd., London. viii + 224 pp. 234 ill. 13s. 6d.

Following two introductory chapters on reflection, refraction and focal-length measurements, and a third chapter on the eye, the author, who is an assistant professor at Imperial College of Science and Technology, London, explains with the aid of numerous illustrations how working models of telescopes, microscopes, photographic lenses and optical projection systems may be set up. Included in each chapter are descriptions of basic experiments for determining the accuracy, power, angular field of view, amount of aberration, and other facts about these instruments. The concluding chapter deals with optical glass and the problems associated with its production and testing.

This new Dover Publications' edition, in their paperback science reprint series, is an unabridged and unaltered republication of the second edition published in 1947 under the former title "Practical Optics." The book, while it is essentially one with a practical nature, gives sufficient theory to enable the practical work to be carried out intelligently, and should lead to a better understanding of the action of lenses and prisms.

"Physics, the Pioneer Science." 2 volumes. L. W. Taylor. Dover Publications, Inc., New York, and Constable & Co., Ltd., London. Volume I: xlv + 395 pp. 211 ill. 16s. Volume II: xlv + 452 pp. 340 ill. 16s. (Volumes I and II: 32s.).

This two-volume book is another reprint in the Dover Publications' paper-back science reprint series. It is an unabridged and unaltered republication of the first edition originally published in 1941. The book is divided into five sections, sections on Mechanics, Heat, and Sound comprising Volume I, while Volume II is comprised of sections on Light and Electricity. The M.K.S. system of units has been used throughout. Problems, together with their numerical answers, have been included at the end of most chapters.

The relationship of the historical and conventional approaches, which is the basis of this book, is discussed by the author in his preface from which the following extract has been taken. "The method which this text uses is that of an historical approach, not so much to physics as a whole as to its various sub-topics in turn. It should be emphasized that this is not a history of physics, nor even a history of the ideas of physics, though the latter might perhaps be defended in this connexion. The table of contents will show that the subject matter has been organized along quite conventional lines. In addition, and this requires emphasis, an inspection of the text will show that the mathematical treatment which is the rosetta stone of the physical sciences, and which properly characterizes all of the better current textbooks of physics, has been retained in this one. But the conventional subject matter, along with its mathematical treatment, has been embedded in an historical matrix. Besides the exposition of a given physical concept, an attempt has been made to present a clear and thorough picture of its evolution."

"The Radio Amateurs' Examination Manual." Compiled by B. W. F. Mainprise, B.Sc.(Eng.), A.M.I.E.E., and published by the Radio Society of Great Britain. iv + 60 pp. 49 ill. 5s.

This paper-back book, published on art paper, has been prepared to give guidance to prospective amateur radio operators. There are seven chapters, with headings as follows: Licence requirements and conditions, Interference, Receivers, Circuits, Calculations, Aerials and propagation, and Appendices.

The subject-matter is treated mainly in question and answer form; the answers may be somewhat more detailed than can be written in full during the three-hour period of the Radio Amateurs' Examination as they have been prepared to cover a possibly wider scope than the actual questions that may be set in a given year. Questions which were set during recent years for the Radio Amateurs' Examination, and which are appropriate to the subject matter of the chapter, are reproduced at the end of each chapter. Licence conditions and regulations are dealt with in detail and, so that a candidate may have the actual wording at hand, the full General Post Office text is included in the Appendices.



# Propane Gas as a Fuel for Small Internal-Combustion Engines

P. S. WHITE, B.Sc.(Eng.), A.M.I.E.E., and R. C. SENIOR†

U.D.C. 621.433:547.213

Small portable engine-driven generating sets are used by cable jointers to provide power for lighting and electrically-operated tools and aids. There are advantages, including the important factor of increased safety, in using propane gas instead of petrol for these generating sets. The method of using propane as a fuel for such equipment and the results obtained during field trials are described.

## INTRODUCTION

COMMERCIAL propane is a gas at normal atmospheric temperatures and pressures. It is, however, liquefiable by the application of pressure of the order of 80 lb/in<sup>2</sup> and can, therefore, be stored as a liquid in small transportable pressure-vessels. These properties of propane account for three important practical advantages it has as a fuel compared with petrol or paraffin:

(i) No special arrangements are necessary to vaporize the fuel before use.

(ii) The vapour pressure provides motive power to transfer the fuel from the storage cylinder to the point of use.

(iii) The risk of spilling fuel, particularly when refuelling, is very greatly diminished.

A favourable economic appraisal based on these and other factors led to the adoption of propane as a fuel for cable-plumbing purposes,\* the petrol blowlamp being superseded by a gas torch. A gas stove was introduced at the same time for heating jointing compounds and water.

As a parallel development, the possible use of propane as a fuel for small internal-combustion engines was considered. Portable 24-volt generating sets are available for use by jointing staff to provide power for electric light, soldering irons, cable driers, etc. These sets have 4-stroke air-cooled engines of 100–120 c.c. capacity, and their conversion for propane operation would go a long way towards excluding pourable liquid fuels from jointing operations. This is desirable from a safety viewpoint because of the numbers of accidents that have occurred when refuelling generating sets.

Whilst considerable use is made of propane as an engine fuel in America, where the gas occurs naturally, preliminary enquiries in this country some 4 years ago indicated that very little development work had taken place here. Since then, in co-operation with engine manufacturers and the liquefied-petroleum gas industry, experimental propane-driven generating sets have been tested in service.

## PROPANE AND PETROL COMPARED

In this country propane is principally derived from two sources,

(i) refinery distillation columns, the gas being separated by distillation under pressure, and

(ii) refinery cracking and re-forming processes.

The many different substances derived from crude petroleum are separated in the refineries into groups which after purification become commercial products

such as fuel gases, petrols, kerosene, diesel oils, lubricating oils, greases and waxes. These groups of products have successively higher boiling-point ranges. The relationship between the gaseous fuels and commercial petrols is shown in Table 1.

TABLE 1  
Classification of Gaseous and Liquid Hydrocarbon Fuels

Hydrocarbon	Boiling Point at Atmospheric Pressure (°F)	Approximate Vapour Pressure at 70°F (lb/in <sup>2</sup> )	Category
Methane C <sub>1</sub> H <sub>4</sub>	-259	—	Natural Gas
Ethane C <sub>2</sub> H <sub>6</sub>	-128	560	
Propane C <sub>3</sub> H <sub>8</sub>	-44	117	Liquefied Petroleum Gases
Propylene C <sub>3</sub> H <sub>6</sub>	-48	147	
Butane C <sub>4</sub> H <sub>10</sub>	31	29	
Butylenes C <sub>4</sub> H <sub>8</sub>	19-34	44	
Pentanes C <sub>5</sub> H <sub>12</sub>	49-97	—	Liquid Hydrocarbons (Petrols)
Hexanes C <sub>6</sub> H <sub>14</sub>	122-155	—	
Heptanes C <sub>7</sub> H <sub>16</sub>	174-209	—	
Octanes C <sub>8</sub> H <sub>18</sub>	211-258	—	
Nonanes C <sub>9</sub> H <sub>20</sub>	252-303	—	
Decanes C <sub>10</sub> H <sub>22</sub>	293-345	—	

Commercial propane is principally a mixture of pure propane (C<sub>3</sub>H<sub>8</sub>) and another refinery-produced gas, propylene (C<sub>3</sub>H<sub>6</sub>). The physical properties of commercial propane depart from those of pure propane according to the proportion of propylene present. This proportion is limited by Post Office specification to 50 per cent.

Commercial petrol in its varying grades has several possible constituents plus additives to improve the anti-knock rating of the fuel. It follows, therefore, that comparative figures given in Table 2 for certain physical properties of the two commercial fuels are typical only.

TABLE 2  
Typical Properties of Commercial Petrols and Commercial Propane

Property	Commercial Petrols	Commercial Propane
Specific gravity of liquid at 60°F	0.70-0.77	0.50-0.51
Specific gravity of gas at s.t.p. (Air = 1)	—	1.4-1.55
Boiling point (°F)	96°-408°	-40°
Volume of gas per pound of liquid at s.t.p.	—	8.6-8.7 ft <sup>3</sup>
Octane number	80-85	95-100
Gross calorific values at 60°F		
B.t.u./lb	21,000	21,500
B.t.u./gallon	155,000	111,000
Ignition temperatures		
At atmospheric pressure (°F)	860°	950°-1,080°
At 200 lb/in <sup>2</sup> absolute (°F)	560°	700°
Inflammable Limits (volumetric percentage in air)		
Upper limit	6.0	7.0-9.5
Lower limit	1.5	2.0-2.4
Air: fuel ratio for chemically complete combustion by weight	15 : 1	15.7 : 1

† External Plant and Protection Branch, E.-in-C.'s Office.

\* DONOVAN, J. G., and THARBY, R. An Experimental Gas Plumbing Outfit for Cable Jointers. *P.O.E.E.J.*, Vol. 50, p. 88, July 1957.

When considered specifically as a fuel for internal-combustion engines, it is apparent that propane has several advantages compared with petrol.

As will be seen from a comparison of octane numbers (Table 2), the anti-knock properties of propane are distinctly superior to those of the petrols normally in use. This is due in part to a higher ignition temperature delaying spontaneous combustion until a higher pressure is reached in the combustion chamber. Thus, the thermal efficiency of an engine converted for propane operation can be improved if the compression ratio can be raised.

Several other possible advantages arise from the gaseous nature of propane. Since, for instance, it resembles more nearly a perfect fluid than does petrol vapour, a more intimate and thorough mixing with the air is obtained in the carburettor and manifold. This should result in more nearly complete combustion, with consequent reduction in the carbon-monoxide content of the exhaust gases and in carbon deposits in the combustion chamber.

With a gas fuel there cannot be the dilution of crankcase oil that can occur with liquid fuels due to incomplete combustion. Cold starting is also likely to be improved, since the propane will be available for use already vaporized even at the lowest atmospheric temperatures likely to be encountered in this country.

Propane is a lighter fuel than petrol and this is a possible disadvantage. By weight the two fuels have nearly the same calorific values, but by volume, due to the differing densities, propane has a 25 per cent lower heat content. For the heat-energy input to remain unchanged after conversion from petrol working, a greater quantity of gaseous fuel, together with the air to burn it, must be taken in to the engine in the same time. In a constant-speed engine this extra charge for a given load is automatically arranged, within the limits of throttle adjustment, by the mechanical governor.

In the petrol-engine fuel system it is generally possible to identify four stages, i.e. the fuel-storage tank, primary pressure-regulation by fuel pump or by gravity feed, secondary pressure-regulation at the carburettor float chamber, and lastly the carburettor. The same stages are identifiable in the fuel system of the propane-gas driven engine; the mechanical differences in the actual equipment provided result from the fact that the fuel is vaporized at a different point in the system.

Gas at a pressure of 80 lb/in<sup>2</sup> or more, depending on the temperature, is taken through the primary pressure-regulation stage consisting of a standard Post Office high-pressure regulator attached to the storage cylinder (see Fig. 1). The output pressure is constant at 8 lb/in<sup>2</sup>. The second stage of pressure regulation, to near atmospheric pressure, takes place at a specially designed low-pressure regulator mounted on the engine. Incorporated in this regulator is a vacuum valve that operates only on a pressure reduction communicated from the engine, thus ensuring that no gas flows to the carburettor when the engine is idle. A press-button is provided for manual operation of the valve to release gas for carburettor priming purposes prior to starting the engine.

The gas carburettor for the small engine is a simple device. It is designed to measure out the fuel and mix it with air in the correct ratio. Ideally, the mixture should be varied to suit starting and load conditions, but early work on these lines demonstrated that fuel savings were marginal and did not justify the added cost of a more complicated carburettor. Accordingly, efforts were concentrated on achieving simplicity of operation, robustness and low maintenance costs.

The carburettor adopted for trial on portable 500-watt 24-volt generating sets is situated behind the air filter (Fig. 2) and consists simply of a  $\frac{7}{16}$  in. diameter mixing tube into which a smaller diameter tube enters at right angles to form the gas entry. This arrangement provides a gas-rich mixture suitable for idling and for the development of maximum power rather than for economy.

#### PRACTICAL TESTS AND TRIALS

Two portable 500-watt 24-volt generating sets with Villiers Mark 10 engines were converted for propane operation in the manner already described. They have been submitted to bench tests as well as field trials, with the following results.

(a) The engines started easily in all weathers.

(b) The fall in power output at full load was not more than 5 per cent.

(c) Fuel costs were some 10 per cent greater than for similar petrol-driven sets.

(d) The carbon-monoxide content of the exhaust gases showed some improvement over petrol-driven engines.

(e) The average propane fuel consumption on full load was 1.2 lb/hour. A set will therefore run for some 10 hours on a 12 lb cylinder

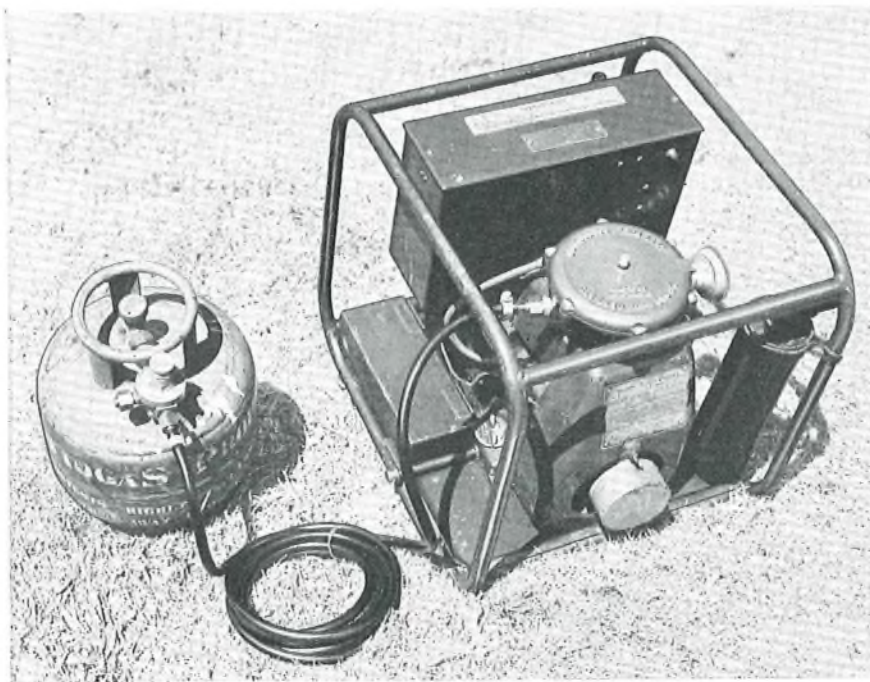

The primary pressure-regulator is mounted on the gas cylinder and the low-pressure regulator is fitted on top of the engine.

FIG. 1—PROPANE GAS-DRIVEN 500-WATT 24-VOLT D.C. GENERATING SET



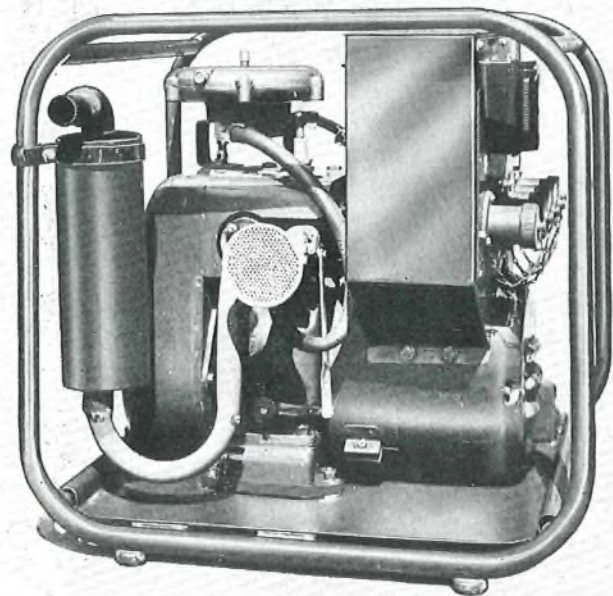

FIG. 2—LOW-PRESSURE REGULATOR AND GAS FEED TO CARBURETTOR OF PROPANE GAS-DRIVEN GENERATING SET

of gas; petrol sets run for approximately 3 hours on one tank of fuel.

(f) It was confirmed that engines using gas fuel are cleaner. The fuel-intake side of the engine remains completely free of evaporation residues, and carbon-deposit formation in the combustion chamber is not so rapid. Larger-scale trials will be necessary to assess the related savings in maintenance costs.

(g) The compression ratio was raised on one experimental engine by machining the cylinder head. It was found that any worthwhile improvement in thermal efficiency necessitated increasing the ratio beyond the limit considered desirable by the engine manufacturer.

#### ECONOMIC FACTORS

The following factors, although not yet clearly assessable in terms of actual savings in costs, none the less serve to indicate the probable economic effects of using propane instead of petrol as a fuel.

#### Capital Cost

So far as small engines are concerned there is likely to be little difference in capital cost between propane-driven and petrol-driven versions of the same engine. This takes into account the cost of the engine-mounted secondary pressure-regulator for the engine using propane, but assumes no provision of a high-compression cylinder-head.

#### Depreciation

Longer economic life is expected due to diminished fire risk and reduced engine wear, the increase in life being estimated at about 15 per cent.

#### Operating Cost

Fuel consumption shows some variation between similar engines utilizing either fuel. Based on the amount of fuel actually consumed and contract prices for fuel, the operating cost of an engine using propane is approximately 10 per cent higher than that of a similar petrol-driven engine. This increased fuel cost will be offset to a certain extent by savings in engine oil and to a very much greater degree by the elimination of wastage through spilling, evaporation and other losses.

#### Maintenance Costs

Reduced engine wear due to the complete elimination of lubricating-oil dilution is expected to increase running hours between oil changes and also between major overhauls. Maintenance costs should, therefore, decrease with the use of propane. The extent of the decrease is estimated at 20 per cent.

#### CONCLUSIONS

The results of the tests made so far are encouraging, and the stage has been reached where large-scale field trials are to begin. The equipments concerned will be portable electric generating sets, one type having a capacity of 500 watts at 24 volts d.c., and the other a capacity of 2 kilowatts at 110 volts a.c. Both types will be converted from petrol working.

The reduction in carbon-monoxide content of the exhaust gases has not so far been as great as hoped for. It has to be remembered, however, that the engines tested had to be operated with the fuel-air mixture giving maximum power output to compensate for the effects of the lower volumetric calorific value of propane. Such a mixture is essentially richer than that required to give chemically complete combustion, since excess fuel has to be provided to ensure that all oxygen is burned out of the charge. With a rich mixture, carbon monoxide must be present.

Higher thermal efficiencies can certainly be reached through higher compression ratios, but it is apparent that special high-compression engines would be required to take the fullest advantage of the superior anti-knock properties of propane. Such engines are unlikely to be available in this country in the near future. Further development is, however, contemplated in this direction, using conversions of the Onan 2-kilowatt 110-volt set.

#### ACKNOWLEDGEMENTS

Acknowledgements are due to Messrs. Villiers (Engineering), Ltd., Calor Gas (Holdings), Ltd. The Lipton L.P. Carburettor Co., and L.P. Gas, Ltd., for their assistance and co-operation.

# A Motor Alternator for A.C. Signalling Supplies

J. H. GEE†

U.D.C. 621.313.3 : 621.395.63

A description is given of the motor alternator (Dynamotor 43A) used for generating signalling frequencies and control pulses for the signalling systems used for the semi-automatic operation of the continental telephone services. The speed of the machine is controlled within limits of  $\pm 0.25$  per cent of its nominal speed by means of a magnetic amplifier.

## INTRODUCTION

**S**IGNALLING frequencies for a.c. signalling systems are generated by oscillators or by motor alternators, which are provided as common equipment. Distribution of the signalling frequencies from the generating equipment to the racks of relay-sets is by 2-wire feeders; a distribution transformer is provided for each group of 40 circuits. This transformer, together with a resistance network, provides the correct sending voltage for the relay-sets.

When the frequency tolerances are greater than 0.1 per cent motor alternators have a number of advantages over oscillators. They can be designed to operate from the normal exchange 50-volt battery supply and are, therefore, independent of a.c. mains supply. Facilities can be provided cheaply for measuring the speed of the machine and at the same time assessing the drift of the signalling frequencies. Alternators have a low output impedance with good regulation, and this permits distribution of the a.c. signalling supplies to a large number of relay-sets without voltage variations due to changes of load. When several supplies of different frequencies are required they can generally be provided from one machine which, having a common control and monitoring equipment, is less expensive and occupies less rack space than the equivalent all-electronic equipment. Furthermore, if d.c. or a.c. time pulses are required for distribution they can be provided by the machine at very little extra cost.

To maintain the speed of a motor alternator within very close limits, e.g.  $\pm 0.25$  per cent of the nominal speed, allowing for temperature rise in the machine and supply-voltage variations between the limits of 46 to 52 volts, is the most difficult design consideration. Mechanical governors of various types have been used in the past; these generally have a contact action which controls the motor speed by varying the current in the field circuit. This type of governor is suitable for controlling the machine speed to within  $\pm 1$  per cent of the nominal, but it becomes expensive in design when limits of the order of  $\pm 0.5$  per cent or less are required, and, generally, frequent readjustment is necessary. However, the recent production of a greater range of stable and efficient magnetic materials and of suitable rectifiers has made possible the development of improved magnetic amplifiers, and these are finding increasing use as motor controllers. Such motor controllers have no moving parts or contacts and can be adjusted by simple controls while the machine is running.

† Telephone Exchange Standards and Maintenance Branch, E.-in-C.'s Office.

<sup>1</sup> TURNBULL, M. G. Introduction of Semi-Automatic Operation of Continental Telephone Service. *P.O.E.E.J.*, Vol. 52, p. 89, July 1959.

The potentialities of this method of controlling a motor alternator were investigated, and a prototype magnetic-amplifier-controlled machine was developed to supply signalling frequencies of 600 c/s and 750 c/s for the national 2 v.f. signalling system. This machine proved successful and the magnetic-amplifier type of speed control was subsequently used for the machine now provided to generate the signalling frequencies for the international 1 v.f. and 2 v.f. signalling systems which are used for the semi-automatic operation of the continental telephone services.<sup>1</sup>

## MOTOR ALTERNATOR

### Facilities

The motor alternator developed for the provision of the a.c. signalling supplies for the international 1 v.f. and 2 v.f. signalling systems is shown in Fig. 1; it is known as a Dynamotor 43A. The motor alternator is driven from the exchange 50-volt battery supply, and has six separate alternator windings each capable of providing 4 watts at 20 volts into a non-inductive load, with a regulation of  $\pm 0.5$  volt over the complete range from no load to full load. The signalling frequencies generated are 1,000,

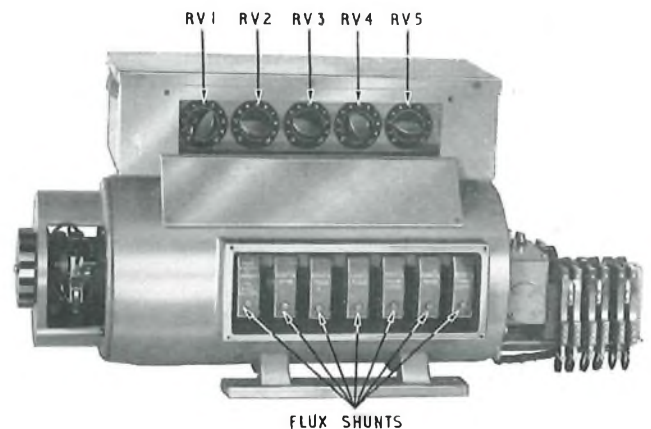

FIG. 1—DYNAMOTOR 43A

2,280, 2,040 and 2,400 c/s, plus an additional 2,040 c/s and an additional 2,400 c/s; the latter two are mixed externally to provide a compound tone by connecting the two supplies in series. An additional 1,000 c/s supply at 35 volts is generated for speed-control purposes.

Two specially-phased series of pulses are provided for use in the forcible release of the switching equipment. One series of pulses are known as the S pulses and the other series as the Z pulses. Each series of four pulses is provided from cam-operated spring-sets and the pulses occur as follows:

- (i) 0.25-second pulse every 5 seconds.
- (ii) 0.25-second pulse every 15 seconds.
- (iii) 0.25-second pulse every 20 seconds.
- (iv) 0.25-second pulse every 30 seconds.

Connexions for the motor, alternators and pulse supplies are taken via a multi-way plug, which enables the



machine to be easily disconnected from the change-over and distribution rack on which it is mounted.

### Motor

The motor is a two-pole series-field machine having a nominal design speed of 2,800 rev/min when connected to a 50-volt supply. This enables the controlled speed of 2,400 rev/min to be reached rapidly when the motor is connected to the supply. In addition to the main field-coils, two auxiliary control field-coils, one aiding and one opposing, are wound on the main field poles. These auxiliary fields are used in conjunction with the magnetic amplifier to control the speed of the motor.

The motor is started by direct connexion to the 50-volt supply and takes a full-load current of 2.5 amp with a peak starting current of three to four times the full-load current. To enable the speed to be checked a small disk, marked round its periphery with alternate black and white segments of equal size, is fitted to the end of the shaft adjacent to the motor. At its nominal governed speed the shaft rotates at 2,400 rev/min; by arranging for the disk to have 15 black and 15 white segments the pattern will appear stationary when the disk is viewed with a stroboscope of the tuning-fork type operating at a frequency of 150 c/s. Speed errors are indicated by the motion of the pattern either in the direction of rotation of the shaft if the speed is fast, or in the reverse direction if the speed is slow. The percentage speed error can be determined by counting the rate at which either black or white segments pass a fixed reference point, a speed error of 0.5 per cent being indicated by a drift of three black or white segments per second.

### Alternator Assembly

The alternator assembly consists of several separate alternator units equally spaced along the body of the machine, with approximately 1 in. separation between adjacent units to reduce to an acceptable level the induction from one unit to another. Each alternator forms a completely self-contained unit.

Each alternator stator is laminated and was designed to form two main or salient poles into which the output windings are laid. The pole faces are slotted to form teeth whose shape determines the wave shape of the alternator output; the pitch of these teeth depends on the frequency required from the alternator. The field system is provided by two permanent magnets embedded in the stator. The rotor, which is also formed from a stack of laminations of the same thickness as that of the stator, is clamped to the armature shaft.

The rotor has a number of projections formed round its periphery, the number depending on the signal frequency required and the speed of the rotor.\* When the rotor revolves the projections cause the reluctance of the magnetic circuit to vary, producing a variation in the flux linking the output winding and thereby generating an e.m.f. By careful design and skewing of the rotor projections relative to the rotor axis the e.m.f. generated can be made to have the form of a sine-wave with a total harmonic content of less than 5 per cent. A typical rotor and stator are shown in Fig. 2.

Each alternator output is adjustable over the range  $20 \pm 2$  volts by means of the flux shunts shown in Fig. 1.

\* Signal frequency,

$$f = \left( \frac{\text{Speed in rev/min} \times \text{number of rotor projections}}{60} \right) \text{ c/s.}$$

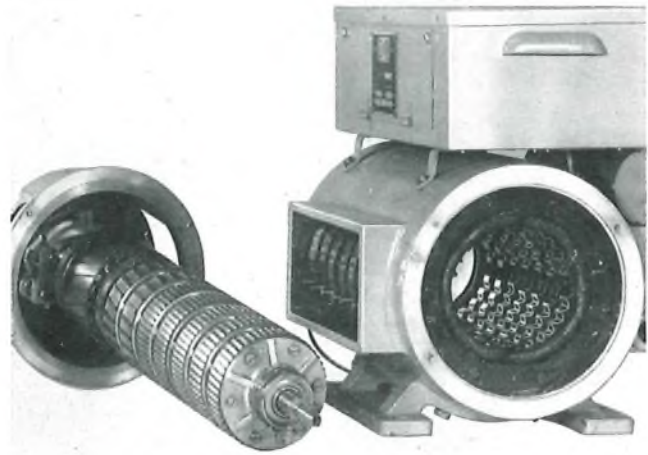

FIG. 2—TYPICAL ROTOR AND STATOR OF MOTOR ALTERNATOR

This method has been found to give a simple and accurate adjustment.

### Gear Box and Interrupters

The gear box is provided with two camshafts, one driven at 5 rev/min and the other at 12 rev/min. The speed reduction is obtained by a worm on the main motor shaft driving a transverse layshaft, which, by two further worm-gears of suitable ratios, drives the two camshafts at their respective speeds. Lubrication of the gear box is by the conventional gear-box technique, a dip stick being provided to check the oil level.

The interrupter spring-sets have tungsten contacts and are suitable for switching an inductive load of up to 5 amp when provided with a  $1 \mu\text{F}$  capacitor-type spark-quench.

### Cams

The cams, of 1.48 in. diameter, are made from synthetic resin-bonded paper. The profile of, and the number of humps on, individual cams will depend upon the following factors:

(a) The ratio of the contact make to the contact break periods required from the spring-set.

(b) The smallest reasonable diameter to achieve an adequate hump for the shortest pulse at a reasonable camshaft speed.

(c) The speed of the camshaft that can easily be obtained, bearing in mind the need to keep the design of the gear box simple and the number of gears in a train to a minimum, preferably not more than two pairs in order to keep backlash within tolerable limits.

(d) The type of cam follower used on the spring-set to obtain minimum contact bounce; this will also determine the maximum number of humps that can be provided around the periphery of the cam.

For both the S and Z pulses the pulse length is nominally 250 ms with limits of  $\pm 25$  ms, and the pulses are required at intervals of 5, 15, 20 and 30 seconds. The  $250 \pm 25$  ms pulse every 5 seconds is generated directly from spring-sets operated by cams on the 12-rev/min camshaft. The provision of satisfactory pulses at the longer periodicities cannot be made by the operation of a single spring-set from a cam on either the 5-rev/min or the 12-rev/min camshaft due to difficulties in the spring-

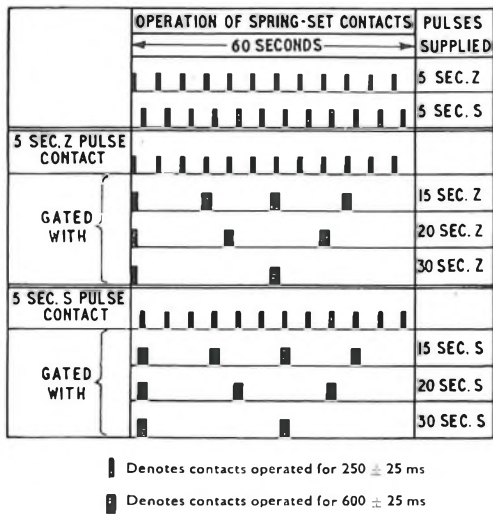

FIG. 3—PRINCIPLE OF GATING TECHNIQUE TO OBTAIN S AND Z PULSES

set and cam-profile designs.<sup>2</sup> It is possible, however, to obtain pulses of  $600 \pm 25$  ms directly from spring-sets operated from the 5-rev/min camshaft, and the other pulses which are required are generated by connecting the spring-sets on the 12-rev/min camshaft in series with spring-sets on the 5-rev/min camshaft. The principle of this gating technique<sup>2</sup> is illustrated in Fig. 3.

Each cam is provided with a reference mark, indicating the point where the make contacts of the spring-set close, to enable individual cams to be phased together when necessary. The cams are assembled together with spacers in groups of four to form a unit which, when riveted together, is known as a cam assembly. Care is taken to ensure that the spring-set load is fairly evenly distributed throughout the  $360^\circ$  of rotation so that the motor and gear box is presented with an approximately constant load. The cam assembly is secured to the shaft by means of two socket-headed grub-screws.

#### MAGNETIC-AMPLIFIER SPEED CONTROL

The circuit of the magnetic-amplifier speed control is shown in Fig. 4; it operates in the following manner. The amplifier is driven from a 1,000 c/s alternator winding that supplies current to the auxiliary motor fields via the output windings on transducers TD1 and TD2. Each transducer has four windings on a pair of cores with closed magnetic circuits (the cores are shown as straight lines for simplicity); the output windings are so arranged on the centre limb of each core that at the fundamental frequency of the supply, i.e. 1,000 c/s, they produce no voltage variations in the other windings. The signal, bias, balance and feedback windings carry direct currents derived from bridge rectifiers, and by changing the total flux produced in each core it is possible to approach the saturation point of the cores; this reduces the impedance of the output windings and hence, regulates the current supplied to each auxiliary field.

The signal winding on TD1 is fed via transformer T1, the primary of which is tuned with capacitor C2 so that it resonates at 1,060 c/s. The correct motor speed produces a signal of 1,000 c/s in this resonant circuit, which is a frequency occurring on the steeply rising portion of

<sup>2</sup> RUSSELL, P. S., GORTON, B. D., LUMBER, A. L., and CUMMINGS, W. S. Pulse-Generation and Traffic-Control Equipment for Periodic Metering. *P.O.E.E.J.*, Vol. 51, p. 324, Jan. 1959.

the frequency/voltage characteristic of the circuit. When the motor speed increases, the supply frequency increases towards the resonant frequency and the voltage across transformer T1 rises, producing a large increase of signal current. At the same time the bias current increases, but to a lesser degree, due to the voltage rise from the alternator. The overall effect is that the flux produced in transducer TD1 by these two windings in opposition is less than the flux produced at normal speed; the impedance of the output winding therefore increases and a reduced current flows in opposing-field winding CF1. For practical operating conditions the effect must be amplified by a feedback winding which, being supplied from the output winding via rectifiers MR4, also has its current reduced, further decreasing the core flux and hence the opposing-field-winding current.

Rectifiers MR4 also supply current for the signal winding on transducer TD2. The combined effect of the reduction in this signal current and an increase in the balance current via rectifiers MR3 is to increase the flux in transducer TD2, reduce the impedance of its output winding, and thus increase the current via rectifiers MR5 in aiding-field winding CF2. Therefore, due to the current changes in the two auxiliary field windings caused by this push-pull action, the flux per pole of the motor will be increased and the motor speed reduced.

The reverse effect is produced when the motor speed falls below normal, i.e. the flux per pole is reduced and the motor speed increases.

The capacitor C3, connected across the feedback winding, increases the time constant of the amplifier by providing a delay in the effect of this winding and so prevents instability or hunting when a very rapid change of machine speed occurs. The variable resistors RV1–RV5 are included in the amplifier to enable adjustments to be made to the individual parts of the circuit so that

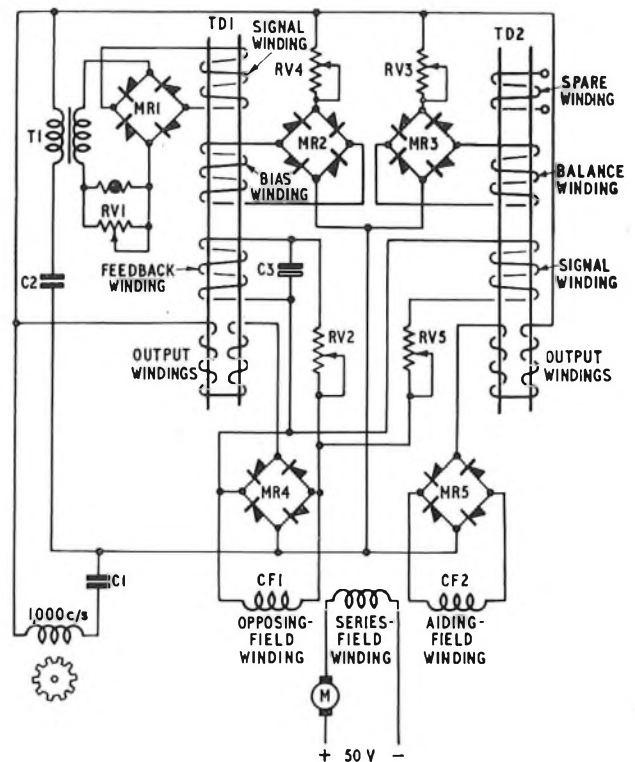

FIG. 4—MAGNETIC-AMPLIFIER SPEED-CONTROL CIRCUIT



the optimum performance can be obtained from the speed control circuit.

#### Adjustment of the Magnetic Amplifier

The initial adjustment of the variable resistors in the amplifier (RV1–RV5) is carried out during manufacture of the machine and these settings are recorded on a plate inside the lid of the control box. Under normal conditions it should only be necessary to make adjustments to the speed control, RV4. However, over long periods of service it may be found necessary to carry out a complete readjustment of the circuit due, for example, to component deterioration.

To find the optimum position for each control necessitates a series of tests extending over a period of two or three hours since, having found the amplifier setting which enables the machine to maintain a speed within the specified limits after reaching its normal running temperature, it will need a recheck to ensure that the machine will still meet the speed limits when it is cold. It has been found by laboratory tests that, providing a fixed sequence of adjustments is adopted, setting of the amplifier is comparatively simple.

#### FUTURE DEVELOPMENT

The machines described have been in service for two years and their success has led to the design of machines (Dynamotor 46A) using a similar type of speed control for the new national 1 v.f. signalling system (Signalling System A.C.9). Since no pulses are required for this system the machine does not include a gear box. The machine should therefore be capable of running for very long periods with little attention.

A large proportion of the present annual maintenance charges is due to the daily-routine manual speed-check of the machine. If new signalling systems are developed requiring frequency supplies of closer tolerance than 0.25 per cent, then it may prove economical to take advantage of improved techniques and build in a self-checking circuit which could also be used to obtain closer speed control of the machine.

#### ACKNOWLEDGEMENT

The author wishes to acknowledge the assistance and information given by the manufacturers of the machine, Dynamo & Motor Repairs, Ltd., of Wembley.

## A Battery-Powered Hearing-Aid Handset—Handset No. 5

W. T. LOWE, A.M.I.E.E.†

U.D.C. 621.395.613.383 : 621.375.4 : 621.395.92

A telephone handset containing a transistor amplifier deriving power from the telephone line is already available for subscribers requiring amplified reception. For use at installations where the requisite power cannot be derived from the telephone line, a battery-powered handset amplifier has been developed.

IN a recent article<sup>1</sup> describing a handset giving amplified reception for deaf subscribers, it was explained that the transistor amplifier derived its power from the transmitter feed-current and required a minimum of 30 mA to ensure satisfactory performance. To provide hearing-aid facilities at installations where the transmitter current is less than 30 mA, a second version (Handset No. 5) has been developed in which local power for the amplifier is provided by two small dry batteries housed within the body of the telephone instrument. The two batteries are held in a specially-designed container that clips to the internal framework of the telephone instrument.

When the new type of handset is installed, an additional switch-hook spring-set is fitted inside the telephone instrument to connect battery power to the amplifier when the handset is lifted. The battery supplies power for the amplifier only and not to the carbon-granule transmitter, which, in a common-battery type telephone, is supplied in the usual way from the line current.

#### Description of Handset

For reasons of economy, the same method of con-

† Subscribers' Apparatus and Miscellaneous Services Branch, E.-in-C.'s Office.

<sup>1</sup> Lowe, W. T. A New Telephone for Deaf Subscribers—Handset No. 4. *P.O.E.E.J.*, Vol. 53, p. 24, Apr. 1960.

struction and assembly of the amplifier has been adopted for the new handset as was used for the version deriving power from the line (Handset No. 4). The amplifier panel is inserted in the hollow handle of the handset, and the volume control is mounted in the same position near the ear-cap. A 6-way cord instead of a 4-way cord is, however, required for connecting the handset to the telephone instrument. The new handset is available in three colours—black, ivory and grey.

A circuit diagram of the battery-powered amplifier is given in Fig. 1. The circuit differs from that of the line-powered amplifier in two main respects:

(i) A voltage-regulator is not fitted because the voltage of the dry battery remains nearly constant during its useful life.

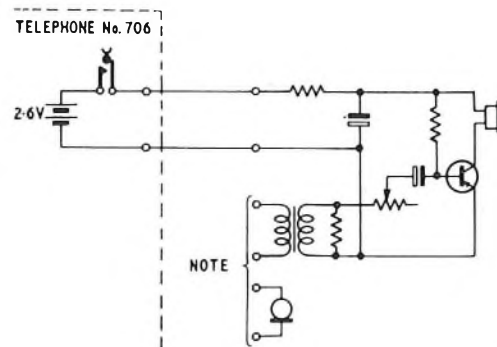

Note: These terminals are connected to the telephone terminals normally used for the receiver and transmitter of a standard handset.

FIG. 1.—CIRCUIT OF BATTERY-POWERED HANDSET AMPLIFIER

(ii) A polarity-guard rectifier is not fitted since the amplifier is not affected by line reversals.

The electrical performance of the amplifier is identical to that of the line-powered amplifier and will not therefore be described in further detail. The amplifier current is approximately 3 mA.

Printed wiring is used on the amplifier panel, and external connexions are made to four screw-terminals on the tail of the panel.

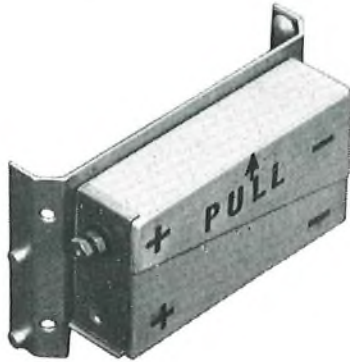

FIG. 2—BATTERY CONTAINER

#### Battery Container

The aluminium container (Fig. 2) for the two dry batteries is constructed in two parts. The upper part is a removable lid and the lower part is welded to a carrier which clips to the switch-hook framework inside the 700-type telephone instrument.<sup>2</sup> The positive and negative terminals for the battery connexions are plainly marked on the container to ensure that the batteries are correctly inserted. Battery reversal is likely to damage the transistor amplifier.

#### Batteries

Two dry batteries are used, each 2 in.  $\times$   $\frac{1}{2}$  in. diameter approximately and known commercially as "penlight" size. Because the current required is small, the life of the battery is virtually the shelf-life, i.e. the time taken for the battery to lose, by internal chemical action, a specified percentage (usually 10 per cent) of its rated capacity while in storage without supplying any external current.

There are several types of penlight batteries, differing in construction and performance, and the one recom-

<sup>2</sup> SPENCER, H. J. C., and WILSON, F. A. The New 700-Type Table Telephone—Telephone No. 706. *P.O.E.E.J.*, Vol. 52, p. 1, Apr. 1959.

## Book Review

"Analogue Computers." I. T. Eterman. Translated by G. Segal and translation edited by B. H. Venning. Pergamon Press, Ltd. ix + 264 pp. 124 ill. 50s.

This book has been produced from the original Russian by the combined efforts of a translator, G. Segal, and a technical editor, B. H. Venning, from Southampton University's electronics department.

An introductory chapter deals with the specification of dynamic physical systems by differential equations, and with examples such as electronic oscillators, aircraft motion, and projectile trajectories. Subsequent chapters deal with: (a) the electronic and mechanical elements used in analogue computers, and the simplifications and approximations that

are necessary, or at any rate generally used, for the more complicated functions required; (b) current Russian machines (with illustrations); (c) operating procedures; (d) the use of analogue computers to solve mathematical problems different from those arising in normal applications, e.g. solution of algebraic equations and solution of boundary-value (rather than initial-value) problems in differential equations; (e) theoretical estimation of errors in the solution of dynamic problems. There are 43 references, of which six are non-Russian; there is no index.

mended for the hearing-aid handset is the ZM9 Mallory-type mercury battery. The reasons for this are:

(a) It has a long shelf-life of at least 1½ years. In contrast, a Leclanché-type battery of similar size may have a shelf-life of only 3–6 months.

(b) It has a sealed leak-proof container, and therefore will not swell or exude noxious chemicals that could cause corrosion inside the telephone instrument even when the useful life of the battery is exceeded.

(c) The voltage remains nearly constant at approximately 1.3 volts/cell during the complete discharge period (Fig. 3).

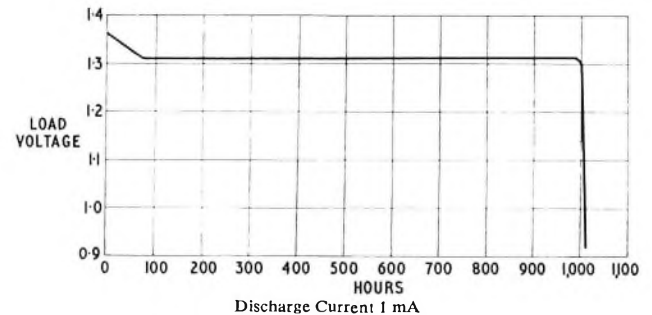

FIG. 3—VOLTAGE/DISCHARGE PERIOD CHARACTERISTIC OF MERCURY-TYPE CELL

Batteries of the Mallory type are based on a mercuric oxide/potassium hydroxide/zinc combination and are extremely stable over a wide range of temperature and humidity conditions. They can also withstand momentary short-circuits.

It is important to note that the central pole of these cylindrical mercury-type batteries is negative, whereas in Leclanché-type batteries the central carbon rod is the positive terminal. The polarity of the terminals of mercury-type batteries is clearly marked on the body, and should not be confused with that of the more familiar Leclanché type.

Replacement batteries will be purchased locally in sufficient quantities to meet immediate requirements only. They are obtainable from most chemists and radio shops. Furthermore, the two batteries will always be renewed simultaneously, otherwise electrolysis of the weaker battery may occur.

#### Conclusion

The Post Office is now able to offer hearing-aid facilities on any type of telephone installation by the use of either the line-powered handset amplifier or the newly-introduced battery version described above.

are necessary, or at any rate generally used, for the more complicated functions required; (b) current Russian machines (with illustrations); (c) operating procedures; (d) the use of analogue computers to solve mathematical problems different from those arising in normal applications, e.g. solution of algebraic equations and solution of boundary-value (rather than initial-value) problems in differential equations; (e) theoretical estimation of errors in the solution of dynamic problems. There are 43 references, of which six are non-Russian; there is no index.

This book is essentially for the mathematician who wishes to use analogue computers. The mathematical level is high, especially in the very useful chapter on error estimation.

W. E. T.



# A Vertical Chain Conveyor for Letters and Packets

U.D.C. 621.867.3:656.851

IN 1958, at Gloucester station sorting office, the need arose for a mechanical aid which could convey 90 bags of packet mail and approximately 40,000 letters vertically from the ground floor to the first floor, within a peak period of half an hour. Separate discharge positions for packets and letters were required, letters which had already been faced and sorted before loading had to remain undisturbed during transit, and the office layout demanded that the aid should be compact. A vertical chain conveyor was designed to meet these special requirements.

## *Loading and Unloading of the Conveyor Carriers*

The chain conveyor is fitted with a number of carriers of the type which has become standard in Post Office

with a ramp clamped to the track. Alternate carriers are fitted with the release arm on opposite sides of the track to ensure that the carrier is discharged at the correct point.

## *Design Features of the Conveyor*

The carrier attachment bracket is long enough to ensure that bags and trays do not foul the chain during ascent. The bracket is attached to the chain at two points to keep the torque at the suspension points within the limits specified for the chain. Attachments at the pivot points are tolerably loose to enable the conveyor to negotiate the very tight horizontal and vertical track bends. The conveyor runs at 60 ft/min and is driven, through suitable reduction gear, by a 1 h.p. motor.

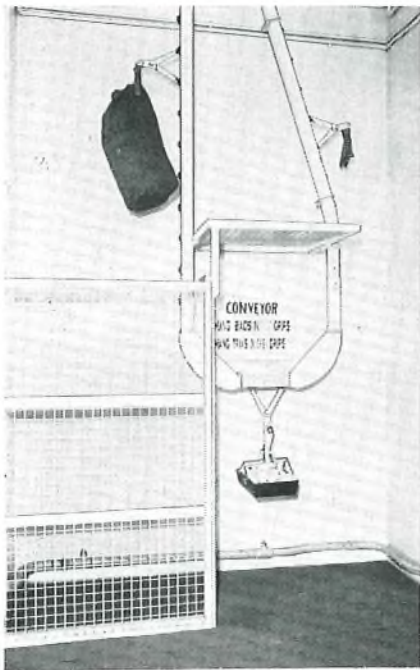

FIG. 1—LOADING POINT ON GROUND FLOOR

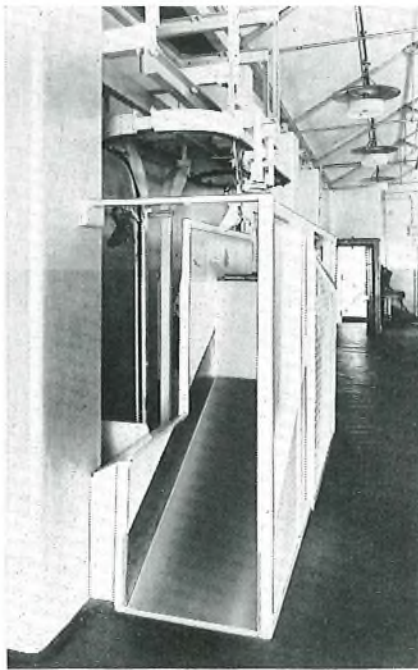

FIG. 2—DISCHARGE CHUTE ON FIRST FLOOR FOR PACKET BAGS

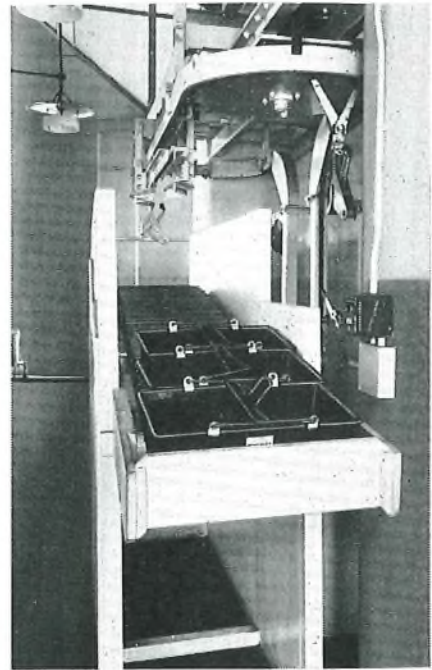

FIG. 3—ROLLER CONVEYOR ON FIRST FLOOR FOR LETTER TRAYS

chain-conveyor practice.\* These carriers are painted red and grey alternately and are loaded on the ground floor (see Fig. 1). Bags of packets are attached to the red carriers and trays of letters to the grey carriers. On the first floor, packet bags are automatically released on to a chute, shown in Fig. 2, and letter trays drop on to a section of roller conveyor, shown in Fig. 3. Storage capacity is provided for six bags and eight trays at the respective discharge points.

The bags or trays are released from the carrier when the release arm associated with each carrier engages

## *The Letter Tray*

The letter tray, specifically designed for the installation, holds either 800 short letters or 400 long letters. The tray handles are designed to fall flat immediately the tray reaches the roller conveyor section on the first floor. When the trays are empty the handles are folded back so that the trays can be stacked one within another.

## *Assessment of Performance of the Conveyor*

The conveyor is the first vertical mail-carrying chain conveyor used by the British Post Office. The installation has given more than two years satisfactory service from both the operation and mechanical aspects, and further similar schemes are under consideration. W. D.

\* SMITH, W. J., and ROGERS, J. D. Chain Conveyors in Postal Engineering. *P.O.E.E.J.*, Vol. 51, p. 53, Apr. 1958.

# The Lighting of Telephone Apparatus Repair Benches

D. A. SPURGIN, A.M.I.E.E.†

U.D.C. 628.976

The method of lighting apparatus-repair benches has recently been reviewed and improved lighting standards are being introduced. A fluorescent lamp will be used for general illumination of a bench, supplemented by a low-powered adjustable bench lamp for specific work where the general level is inadequate.

## INTRODUCTION

THE efficient operation of a telephone system relies on its apparatus being correctly maintained. To facilitate this operation, much of the equipment is removed from the apparatus racks to a repair bench. In order that an engineer may examine equipment on the bench without eye strain adequate illumination of the equipment must be provided in such a way that light is not accidentally directed into his eyes causing glare, and shadows are not created by himself or other objects. The manner in which repair benches are now to be illuminated is the subject of this article.

## ILLUMINATION LEVEL

In the Illuminating Engineering Society's (I.E.S.) Code\* illumination levels are recommended for various types of work, the work done on telephone equipment being divided into two categories, namely, "Assembly Shops—Fine Work, e.g. radio and telephone equipment . . ." and "Inspection Shops (Engineering)—Fine Work, e.g. radio and telephone equipment . . ." For both classes of work the code recommends an illumination of 70 lumens per ft<sup>2</sup>.

As a result, however, of experiments conducted to determine the level actually required for repair benches used by Post Office staff, a level of 50 lumens per ft<sup>2</sup> from general overhead lighting is to be provided, supplemented by local lamps for the more detailed adjustment work.

## POSITIONING OF LIGHTING FITTINGS

The source of general lighting for illuminating a repair bench must be so positioned that the light has an uninterrupted path to the apparatus to be illuminated. When a man is standing upright in front of a bench the top of his head may be more than 6 ft above the floor. If shadows are to be avoided the light must be directed on to the equipment from above an imaginary line drawn from the top of his head to the lowest point of the apparatus being examined (see Fig. 1).

The human eye has a very wide field of vision and is capable of seeing objects which subtend angles of approximately 50° above to 70° below the line of sight and almost 90° to each side. It is essential, therefore, that whilst the overhead lighting fittings must be placed so as to project the light downwards on to the bench they must not be placed so far forward as to be within the field of vision of the man while he is working. It is consequently desirable that the light source should be suspended as far above the floor as possible. A clear height above the floor of at least 6 ft 4 in. is also necessary if the fittings are not to be a hazard to a tall man working at the bench.

† Power Branch, E.-in-C.'s Office.

\* The I.E.S. Code. Recommendations for Good Interior Lighting, 1961. Published by the Illuminating Engineering Society.

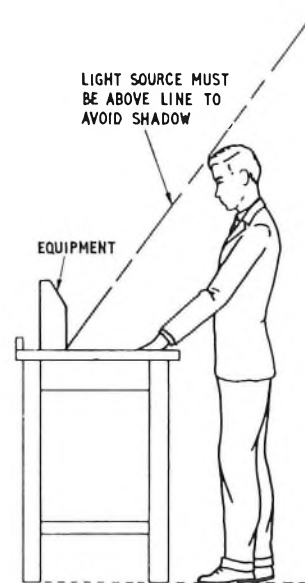

FIG. 1—LINE ABOVE WHICH LIGHT MUST BE PLACED IF SHADOWS ARE TO BE AVOIDED

In the new design, a single fitting is placed so that the centre of its lamp is greater than 6 ft 8 in. above the floor and 12 in. from the front edge of the bench. When a man is standing at the bench the fitting is, therefore, slightly above and behind his head.

In order to obtain the illumination level required for general lighting of the bench with the lamp in the selected position it is possible to use either an 80-watt fluorescent lamp or a 300-watt tungsten-filament lamp. If a tungsten-filament lamp were to be used some 200 watts of heat would be radiated by the source and might cause discomfort to staff working at the bench. With a fluorescent lamp this radiant heat is reduced to about 25 watts. Furthermore, a tungsten-filament lamp, being a source of relatively small proportions, may cause the body of the engineer to cast hard shadows on the bench. With the long light-source of the fluorescent lamp such shadows are almost eliminated. It is for these reasons that a fluorescent lamp is used to provide the general lighting of the bench.

The total desired illumination level could have been obtained by increasing the level of the general lighting. If this were done by means of a more powerful fluorescent lamp those parts at the front of the equipment would be illuminated almost without shadow. Due to the nature of equipment, however, other inside parts would be in shadow and detailed examination of them would be difficult. To overcome this an adjustable bench-mounted inspection lamp has been selected so that parts being examined can be directly illuminated and thrown into relief as required. A satisfactory illumination level is obtained from a 25-watt tungsten-filament lamp when it is placed in a comfortable working position of about 18 in. from the apparatus. An internally frosted lamp is used so that the parts being inspected are evenly illuminated.



Two sizes of bench are used for apparatus repair, a one-man bench 4 ft 3 in. long and a two-man bench 6 ft 6 in. long. On both types of bench a 5 ft 80-watt fluorescent lamp is used for the general lighting and an inspection lamp is provided at each working position.

#### ASSEMBLY

The position in which a work bench is sited varies widely from building to building. In some buildings it is placed in a permanent position in an apparatus room whilst in others it is placed in a space earmarked for equipment extension and will, therefore, have to be moved at some future date. This dictates that the bench and its lighting fittings should be built as a complete portable unit. A typical apparatus-repair bench equipped with the new method of lighting is shown in Fig. 2.

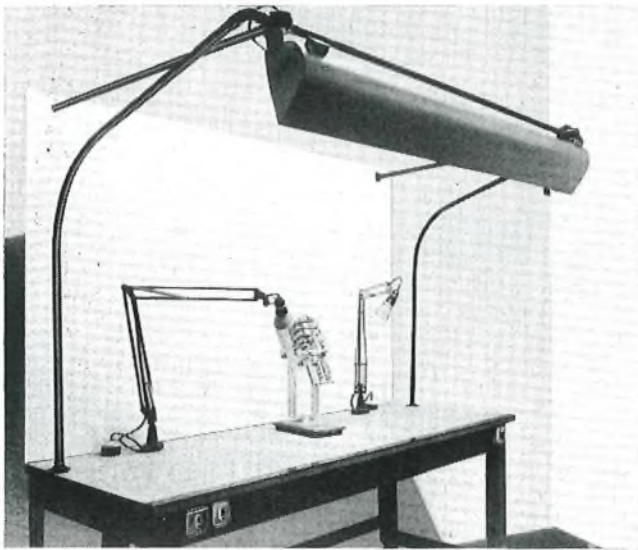

FIG. 2.—TYPICAL REPAIR BENCH SHOWING THE LIGHTING FITTINGS

#### Fluorescent-Lamp Fitting

The fluorescent-lamp fitting has to be supported without obstructing the front corners of the bench, and must be positioned so that it is over and behind the head of a man working at the bench. Thus, because of the need to use a cantilever to support the fitting its weight is of importance. Hence the load on the cantilever is reduced as much as possible by using a fitting in which the control gear for operating the fluorescent lamp is located remotely from the lamp housing. This reduces the weight of the lamp fitting from 20 lb to 9 lb. The framework is made from 1 in. diameter conduit as this is readily available and can be easily formed on site. Use of conduit has the added advantage that it is able to contain the wiring to the fluorescent-lamp fitting.

#### The Backboard

Because the benches are likely to be placed in positions where the surroundings are rather dark, a light-coloured backboard is placed at the rear of the bench to help to reduce shadows and to reflect light, which otherwise would be lost, on to the work. An eau-de-nil colour is used for the backboard as this was found to cause little glare. This backboard, which is fixed to the framework from which the fluorescent-lamp fitting is supported, is also useful as a background against which the adjustment of relay contacts can be examined. The reflector used

to control the light of the fluorescent lamp is shaped so that the backboard and the bench top are evenly illuminated.

#### Inspection Lamp

The inspection lamp used on these benches is the result of combining two commercial units. The mechanism for the lamp was chosen because it is easy to adjust and yet is very stable in use. It is also robust enough to withstand the roughest treatment which it is likely to experience. The reflector chosen is small, and can thus be placed into a confined space in a piece of equipment, and is shaped so that it concentrates the light from the lamp into a very small area.

#### Miscellaneous Equipment

The inspection lamps are operated at 25 volts, derived from the main electricity supply using a transformer. This transformer is fixed, together with the fluorescent-lamp control gear, to a wooden backboard attached to the back rails of the bench beneath the working surface.

Separate switches are provided for controlling the inspection lamps and the fluorescent-lamp fitting and these are fixed in the front rail of the bench just beneath the working surface.

In addition to the lighting fittings the bench can be provided with a power-supply socket which is also fitted in the front rail. In repeater stations this socket is supplied at 25 volts from a low-voltage transformer and is intended to supply a soldering iron. In telephone exchanges the socket is supplied from the exchange battery and is used for supplying a soldering iron and equipment which is being tested.

#### ALTERNATIVE DESIGNS

The bench and its associated lighting fittings is approximately 4 ft wide overall. It may not be possible, therefore, to install it as designed in every instance, and to enable it to be used in places where space is restricted some minor alterations can be made.

If space is such that the fluorescent-lamp fitting cannot be mounted on the bench, the fitting and its supporting framework is not provided and the general illumination is provided by two 150-watt internally-silvered spot lights fixed overhead to either the ceiling or convenient ironwork. Under these conditions the illumination is lower than would be obtained with the fluorescent-lamp fitting but is considerably higher than that provided by the standard form of gangway lighting.

When a wide gangway of an apparatus room is used as a maintenance area, and the wall is well decorated with a light-coloured paint, the backboard and the fluorescent-lamp fitting are not fitted to the bench and the general lighting is obtained by suspending the fluorescent-lamp fitting from overhead.

#### CONCLUSION

The system of lighting described has been provided on a number of benches. The reactions of the staff using them indicate that the system is very successful, and measurements confirm that the desired illumination level is being provided in practice.

#### ACKNOWLEDGEMENTS

Acknowledgement is due to the Study Group on the Lighting of Engineering Working Accommodation, at whose instigation the method of lighting described in this article was developed by the Engineering Department.

## Notes and Comments

### J. A. Lawrence, T.D., M.I.E.E.

Mr. Lawrence, who was appointed Staff Engineer of the new Telephone Electronic Exchange Systems Development Branch in August 1961, has a wide knowledge of telecommunications practice. He entered the Post Office Engineering Department as a Youth-in-Training in 1927, and within six years success in the Probationary Inspector's examination led to his employment in the Telephone Branch Circuit Laboratory in charge of a testing group. In 1937 he passed the Probationary Assistant Engineers' examination and was employed in Telephone Branch on general studies of d.c. signalling and pulsing.

As a Second Lieutenant in the Supplementary Reserve he was mobilized in 1939 and served in France and Belgium. In September 1940 his specialized knowledge of switching techniques led to his transfer to the Royal Air Force, where he dealt with the design and layout of plotting and interception equipment for all types of radar stations and organized the maintenance of computers used in the radar network. He was also associated in a consultative capacity with the design of computers for navigational use. He completed his active service on the Continent, organizing the restoration of essential land-line and radio services, and was demobilized in 1945 with the rank of Squadron Leader.



On his return he commenced the study of the development of subscriber trunk dialling, and in this connexion visited Sweden and North America in 1947 to study the systems and trends of development in those countries; promotion to Senior Executive Engineer in 1948 gave him charge of a group continuing these studies. In 1950 he took charge of a group in Telephone Branch set up to study the application of electronic techniques to telephone systems, and since 1956 he has played a large part in the Joint Electronic Research projects and has made important contributions to their progress. He was appointed Assistant Staff Engineer in 1957, and in 1961 again visited North America as a member of a team to

study the state of electronic-exchange development in that continent.

In spite of the pressure of his job, Mr. Lawrence joined the Territorial Army in 1949, improving the breadth of his telecommunications knowledge and gaining experience in the organization of functional units. He retired in 1961 with the rank of Major and the award of the Territorial Decoration.

Mr. Lawrence is inventive and enthusiastic, and has a flair for taking advantage of new techniques in solving problems. He has been the author of many papers and articles dealing with future trends in telecommunications, particularly in the switching field. He is respected by all who have come into contact with him. He was a natural choice for the post concerned, and he now faces a difficult and onerous task with the confidence born from hard experience, carrying with him the best wishes of his many friends inside and outside the Post Office and in many foreign countries.

W. J. E. T.

### Supplement and Model Answer Books

Students studying for City and Guilds of London Institute examinations in telecommunications are reminded that the Supplement to the Journal includes model answers to examination questions set in all the subjects of the Telecommunication Technicians' Course. Back numbers of the Journal are available in limited quantities only and students are urged to place a regular order for the Journal to ensure that they keep informed of current developments in telecommunications and receive all copies of the Supplement.

Books of model answers are available for some telecommunications subjects and details of these are given at the end of each Supplement.

### Notes for Authors

Authors are reminded that some notes are available to help them prepare the manuscripts of the Journal articles in a way that will assist in securing uniformity of presentation, simplify the work of the Journal's printer and draughtsmen, and help ensure that authors' wishes are easily interpreted. Any author preparing an article for the Journal who is not already in possession of the notes is asked to write to the Managing Editor to obtain a copy.

It is emphasized that all contributions to the Journal, including those for Regional Notes and Associate Section Notes, must be typed, with double spacing between lines, on one side only of each sheet of paper.

Each circuit diagram or sketch should be drawn on a separate piece of paper; neat pencil sketches are all that are required. Photographs should be clear and sharply focused. Prints should preferably be glossy and should be unmounted, any notes or captions being written on a separate sheet of paper. Negatives or plates are not needed and should not be supplied.

### Journal Binding

This issue completes Vol. 54 and readers wishing to have the volume bound should refer to page 294 for details.



# Institution of Post Office Electrical Engineers

## Annual Awards for Associate Section Papers— Session 1960-61

The Judging Committee having adjudicated on the papers submitted by the Local Centre Committees, prizes and Institution Certificates have been awarded to the following in respect of the papers named:

*First Prize of £7 7s.*

G. E. Gorringe, Technical Officer, London Centre—"The Electronic Digital Computer."

*Prizes of £4 4s. each*

D. G. Rossiter, Technical Officer, Bath Centre—"The Atom and its Energy."

J. R. S. Lawson, Technical Officer, Dundee Centre—"Microwaves for the Layman."

B. T. Hatch, Technical Officer, Tunbridge Wells Centre—"Cathodic Protection."

R. W. Winn, Technical Officer, Tunbridge Wells Centre—"An Introduction to Electrical Design and Installation in Large Buildings."

In addition, the following papers, which were considered worthy of submission to the Judging Committee for the main awards, have been awarded a prize of one guinea each:

J. B. Leonard, Technical Officer, Aberdeen Centre—"Subscriber Trunk Dialling."

B. F. Cracknell, Technical Officer, London Power Centre—"Lubrication."

J. Keegan, Technical Officer, London Power Centre—"Wadsworth Lifts, K.E.B.—No. 3, 7 and 8 Power-Operated Door Lifts."

J. Monaghan, Technical Officer, Newcastle-on-Tyne—"The Duties of the Post Office Works Supervisor."

C. W. Read, Technical Officer, Bath Centre—"Transistors."

P. J. Froude, Technical Officer, London Power Centre—"Fundamental Electronics."

The Council of the Institution is indebted to Messrs. P. L. Barker, D. E. Blake and F. Warren for kindly undertaking the adjudication of the papers submitted for consideration, and to Mr. P. L. Barker, Chairman of the Judging Committee, for the following report:

The award of the first prize to Mr. G. E. Gorringe for his paper on "The Electronic Digital Computer" is merited by its good presentation and the competent manner in which it deals with a subject that is playing an ever increasing part in science and business, including that of the Post Office. It makes clear the need for the use of binary arithmetic and describes various memory devices for the storage of the electrical pulses corresponding to numbers. This is followed by a detailed description, well supplemented by diagrams, of the working of a computer, and achieves the author's object of giving a good insight into a subject with which many are not familiar.

The paper on "The Atom and its Energy" deals with a topical and fascinating subject in an interesting and lucid manner. The author covers first the theory of atomic structure, then gives a historical review of the development of atomic physics followed by descriptions of the generation of atomic energy by fission and fusion with a reference to the use of these phenomena in the atom and hydrogen bombs. The peaceful uses also are not overlooked.

The paper on "Microwaves for the Layman" starts with an interesting review of the historic milestones in the development of radio, starting with James Clark Maxwell's theoretical considerations on electromagnetic radiation in 1864. This is followed by a survey of the whole spectrum of known frequencies and the uses to which various parts of it are put. The paper deals next with microwaves and the valves used for their generation and amplification. It also touches on the aerial systems used. The last section covers the various uses of microwaves including communications,

radar, spectroscopy and radio astronomy. The paper is well supported by diagrams and exhibits.

The paper on "Cathodic Protection" points out the seriousness of the extent of corrosion of underground cables and, after describing different types of corrosion, it introduces the cathodic-protection principle of protecting underground metallic structures. It goes on to explain how this principle is applied to Post Office cable networks either by the local use of reactive anodes or by the connexion of a voltage to the network to cause current to pass through it via a sacrificial earth system, thus making all parts of the network negative with respect to the adjacent earth. The author then deals clearly with the important aspect of the effect—sometimes adverse—of cathodic-protection schemes on the plant of other utility undertakers.

The paper entitled "An Introduction to Electrical Design and Installation in Large Buildings" is a presentation of the practical as well as the design problems which arise in this work. It deals first with the design of lighting systems, stressing the need to avoid glare. Then, after touching on the assessment of the power required, the paper goes on to describe the two main forms of power distribution within a building and how the emergency lighting system is integrated with them. Installation problems are then described. The paper is accompanied by a series of informative diagrams.

S. WELCH,  
*General Secretary.*

## Additions to the Library

Library requisition forms are available from Honorary Local Secretaries, from Associate Section Centre Secretaries and representatives, and from the Librarian, I.P.O.E.E., G.P.O., 2-12 Gresham Street, London, E.C.2.

2647 *Sir Isaac Newton*. H. D. Anthony (Brit. 1960).

Portrays the life and work of Newton within the framework of contemporary history.

2648 *A Guide to Technical Writing*. C. Baker (Brit. 1961).

A concise guide on technical authorship.

2649 *Introduction to Probability and Statistics*. H. L. Alder and E. B. Roessler (Amer. 1960).

A standard textbook intended as an introduction to the subject for students in various fields.

2650 *A First Course in Sound Recording and Reproduction*. "Decibel" (Brit. 1961).

Written primarily for the reader with a reasonable knowledge of electronics as applied to sound broadcasting, but the general reader should be able to follow the book.

2651 *Automatic and Fluid Transmission*. J. G. Giles (Brit. 1961).

Records the history and describes the operating performance of all the more important mechanisms now available.

2652 *Printed Circuits*. J. M. C. Dukes (Brit. 1961).

Endeavours to provide the essential background to design at all frequencies up to 10,000 Mc/s.

2653 *Wires and R.F. Cables*. G. W. A. Dummer and W. Blackband (Brit. 1961).

One of the series on *Radio and Electronic Components*. Written from the viewpoint of the user to enable him to choose the best component for his requirements and to understand its fundamental characteristics.

2654 *Mathematical Puzzles and Diversions*. M. Gardner (Amer. 1961).

A collection from *Scientific American*.

2655 *Aids to Physics* (Two volumes). F. J. Jackson and

2656 P. C. Gibbs (Brit. 1961).

Designed to assist students at Advanced Level G.C.E.

W. D. FLORENCE,  
*Librarian.*

# Regional Notes

## Home Counties Region

### CUTTING STEEL PIPES

The cutting of a single steel pipe seldom presents any problem. Cutting a nest of steel pipes is more difficult because of the lack of access and the size of cables in the bores.

In the Canterbury Area, recently, an old manhole had to be demolished and a non-standard manhole built in its place. This entailed cutting 18 in. off 24 steel pipes in the manhole. After excavation, 17 of the pipes were cut using pipe cutters and a Skilsaw. However, the weather and the nature of the subsoil made it imperative that the manhole be constructed before all the steel pipes had been cut.

Experimental cuts were made by cutting a steel pipe containing a cable with an oxy-acetylene torch. Asbestos string and ordinary asbestos-cement ducts, 2 in. and 3¼ in., were used to protect the cable in the pipe and the results were very encouraging. The type of cut required took only four minutes, under the ideal conditions. It was decided to cut the remaining seven pipes using this method, although all but one of the pipes to be cut contained cables. These included a cable of 4 screened pr., 40 lb/mile + 220 pr., 20 lb/mile; one of 4 screened pr., 40 lb/mile + 138 pr., 20 lb/mile, one of 54 pr., 40 lb/mile, another of 400 pr., 6½ lb/mile and finally a 200 pr., 6½ lb/mile unit twin cable.

Experience showed that:

(i) The heat of the flame caused no damage to the cables providing the cut was made at a tangent.

(ii) The red and white heats at the cut were prevented from damaging the cables by ensuring that all the packing was continued 6 in. beyond the cut.

(iii) The miniature explosions caused by moisture in the asbestos-cement duct could not be avoided but did no damage.

(iv) The jagged edges of the cuts were easily filed down or chipped away.

(v) The inability to pack large cables completely was not important provided the cutting was carried out only where there was asbestos protection.

(vi) Smoke and flame from burning grease and pitch were easily extinguished by using a hand blower, although an extractor device would probably be more efficient so far as the smoke is concerned.

(vii) This method offers a tremendous saving in man-hours; cutting with pipe cutters and a Skilsaw is a very slow, tedious operation. It was estimated that the time required to cut the remaining seven pipes in the very congested conditions existing would have taken one man 2½ weeks.

Using an acetylene cutter only 36 manhours were required and the cost of the hire of the oxy-acetylene plant and operator was £10.

(viii) It would be advantageous to cut the pipes when the excavation is made and before the manhole is constructed. This would give easier access and dispersal of smoke and dissipation of heat. Wedging open the pipes would also make the work easier.

(ix) The cuts can be made so that the ends of all the pipes are level. This is impossible when cutting in a manhole with pipe cutters.

(x) The method requires an expert to operate the plant and, providing he understands the difficulties and dangers involved before he starts, he will find the job a simple one.

B. J. A.

### SUBWAY AT CAMBRIDGE (TRUMPINGTON) REPEATER STATION

Cambridge (Trumpington) repeater station is located on a large site 70 yd from the main London road, to which the only access is a 15 ft wide reinforced-concrete road between cottage gardens.

All services to the repeater station are provided in this road. They comprise a 6 in. foul sewer (with four inspection manholes), surface water drains, water and gas mains, a 2-way multiple duct for electricity cables and four 9-way multiple ducts in square formation. A type RT8 manhole at the main-road end, along with the other undertakers' services, completely blocked the entrance.

As all but two of the spare ways in the 36-way multiple duct were earmarked for additional CJ and MU cables, the proposal to open Cambridge trunk non-director exchange and to extend the repeater-station building precipitated a request to augment the lead-in by 47 ways.

Efforts to purchase strips of land giving access to the site proved unsuccessful as did attempts to secure a satisfactory private wayleave to cross the adjacent cottage garden. It was, therefore, proposed to lay octagonal ducts in a tunnel to be driven below the existing manhole and lead-in ducts.

When difficulty was experienced with the building of the tunnel it was decided locally that a reinforced concrete subway 5 ft 6 in. wide and 8 ft high internally, 70 yd long, constructed within 10 ft of the surface and designed to incorporate the space occupied by the 36-way duct would be a more satisfactory solution. The contractor agreed to construct this as an alternative to tunnelling.

As the access road would be closed to traffic for some weeks, arrangements were made to stock-pile fuel for the repeater station and 250 yd<sup>3</sup> of sand and aggregate were transported to the site before excavation commenced in mid-December. The excavation was lined with interlocking steel shuttering and the four 9-way multiple ducts were suspended on ropes attached to 9 ft lengths of pole timber placed across and along the trench.

The end walls of a R11 and the RT8 manholes were demolished to admit the subway, and concreting the floor and walls commenced in mid-January 1961. The gas service pipe was diverted overground temporarily and, with the consent of the Ministry of Works, the foul-sewer manholes were altered where necessary to give clearance for the subway.

To reduce congestion in the RT8 manhole and to avoid major reconstruction of the manhole, which would cause prolonged dislocation of traffic, the floor was lowered by 2 ft.

When the walls of the subway had been constructed to within 2 ft of roof level, the ducts were lowered on to scaffold boards and "Acrow stands" on the subway floor, and slewed to form two groups of 18 ways close to the subway walls. The ducts remained undamaged throughout the work. After stripping the overhead supports, raising the walls and casting the roof (a 7 in. slab with 12 in. beams at 2 ft 10 in. centres) began in mid-March and the subway was completed in early April.

A Post Office gang of five men then removed the ducts from the cables, cleared approximately 26 tons of debris to the surface and lifted all cables, including four coaxial and two low-capacity carrier cables, to high-level brackets on the 8 ft wall-type bearers in five days. In spite of the magnitude of the task and the difficult conditions in which the men worked, none of the cables was damaged.

Two ventilator pipes were provided, and anchor irons were placed in the roof at 10 ft intervals to facilitate the handling of heavy cables on high-level brackets; a gas-detector alarm and 24-volt lighting system are being installed. The cable bearers, at 2 ft 6 in. centres, will accommodate 30 layers of cables—probably equivalent to 150 duct ways.

The space available in the subway after removal of the earthenware ducts suggests that where difficulty is experienced in forecasting lead-in requirements or where ground space for multi-way duct laying is restricted—a situation which is becoming increasingly aggravated by the scarcity of suitable building sites—the provision of lead-in subways presents a practicable and satisfactory solution to the problem.

K. C. H.



## London Telecommunications Region EXPERIMENTAL POLYTHENE CABLES

Two experimental 2,000-pair polythene-sheathed and polythene-insulated cables were installed as part of the local-line network for the Pinner automatic telephone exchange transfer scheme.

The cables, being much lighter in weight than the largest size of local cable, were drawn in by the "long length" cabling method. Lengths of cable up to 335 yd long were drawn in, thereby reducing the number of joints, the cost of installation and the fault liability. No lubrication of the cables was necessary during the drawing-in operations, and consequently the work was much cleaner. Communication was necessary to co-ordinate the operations at widely-separated jointing chambers and a land-line circuit was set up for this purpose.

The ducts were rodded in advance and light polythene-fibre draw ropes were provided in the bores allocated to the new cables. The bores were tested and cleaned by drawing a mandrel and brush through before cabling started. Steel-cored sisal rope was used in the actual drawing-in operation. To obtain the rope lengths necessary two standard lengths of rope, 220 yd long, were joined using thimbles and eye splices connected by a keystone link.

This type of cable does not retain a bend or set, and due to its elasticity tends to straighten out. In manholes where the cables were pulled through, and the ducts were not in line with the cable supports, some difficulty arose in fixing the cables to the wall brackets. This was overcome by special stirrups which anchored the cables to the wall-type cable bearers. If the channels were not in a suitable position additional channels were fitted, fixed by bolts inserted into the wall with a plug-firing tool. The special stirrups were also used in similar conditions at certain jointing and turning points.

Where, at some manhole positions, fleeting through would have been necessary, the cables were drawn out and up the manhole shafts. The cable end was then fed into the next section and pulled forward. There was no difficulty in getting the bight drawn down standard manhole shafts of 2 ft 2 in. square.

The problem of fixing the cables to the tacking bars in the exchange cable chamber and the cable trough at the foot of the M.D.F. was solved by the local manufacture of wooden blocks bored to the cable diameter and bolted to the bars.

Both cables were terminated direct on to the M.D.F. fuse mountings, the cables being formed initially into 200-pair groups below the floor level; the groups were then brought through the floor below each vertical. This method made working easier and was considered preferable to forming out 2,000 pairs above the floor level. The 200-pair groups were protected where they passed through the floor with split-polythene tubing. The lacing of the 4-lb conductors required care to avoid cutting the wires with the lacing twine. Protection was given with insulating tape where the forms were tied to the M.D.F. members.

A feature of the cables supplied by the two manufacturers was the mirror-image colour scheme. With this arrangement like units were always opposite when jointing regardless of the direction in which the cable had been drawn in. This was an advantage and avoided "crossed" and bulky joints.

The jointing of the cables produced no particular problems. Polythene jointing sleeves were used for the conductor joints using the "pair-joint" method in which the A-wire is jointed with a sleeve; this sleeve is then inserted into a larger sleeve which forms the B-wire joint.

Small hot-air dryers were used for manhole drying as it was deemed inadvisable to use naked flames close to the polythene joints or near the scrap ends which had accumulated while jointing was in progress. The hot-air dryers also helped to remove dampness from the joints and improved the insulation resistance. Two experimental 24-volt heating trays were also tried and found to be moderately

successful. Silica gel was placed in each joint before the final wrapping with insulating paper.

The brass sleeves and the joints were sealed with expansion plugs which were lubricated with silicone grease to make it easier to slide them into position. A torque wrench was used to tighten the nuts on the pressure plates. It was necessary to re-tighten the cap nuts at intervals during the following days due to the compression of the polythene sheath. Schrader valves were soldered into each brass sleeve and local pressure tests of each joint made; after pressure-testing, the valves were covered with screwcaps. Both cables will be pressurized as soon as the necessary equipment is available.

For the purpose of the exchange transfer each 2,000-pair cable was teed into the existing lead-covered cable network. Lead plugs were made and plumbed to the existing subsidiary cables, the brass sleeves of the joints being soldered to the plugs and the other ends sealed on to the polythene cables by the expansion plugs.

These polythene cables are in a multiple-way duct route together with standard lead-covered cables and there is, therefore, a possibility that at some stage it will be necessary to open lead-sheathed cable joints which are adjacent to the polythene cables. As a safety precaution polythene cables and joints will be protected with asbestos blankets while gas torches are used adjacent to them. Sheets of asbestos cloth approximately 3 ft 6 in. by 2 ft have been issued to the jointing staff for this purpose.

F. A. H.

## AVENUE TELEPHONE EXCHANGE: RENEWAL OF MAIN BATTERIES

The installation of the third director exchange unit at Avenue telephone exchange in London necessitated an increase in the battery capacity from 10,000 ampere hours to 14,190 ampere hours. The old battery had been in use for 20 years and the opportunity was taken to install a standard-type battery. In view of the large physical size of the cells, alterations had first to be made to the battery room. The battery circuit-breakers and discharge and coupling switches were originally mounted on a slate panel in a small room inside the battery room. The battery circuit-breakers were replaced by ones of larger capacity mounted in fume-tight cabinets whilst the control switches were transferred to the new power panel in the adjacent power room. The space vacated was utilized to form part of the enlarged battery room. A further increase in size was made by annexing part of the cable chamber.

The batteries were originally laid out in four sections, due to the position of main pillars. Each battery occupied the whole length of the battery room and, in consequence, the positive busbars for each battery also ran the whole length of the room. Had a similar layout been adopted for the new batteries, a cross-sectional area of 20 in<sup>2</sup> of copper would have been required for each battery busbar. An alternative layout was, therefore, used with battery No. 1 at one end of the battery room and battery No. 2 at the other. This not only reduced the length of copper busbar but also enabled the cross-sectional area of each busbar to be reduced to 15 in<sup>2</sup>, resulting in a considerable economy in the amount of copper busbar used.

To enable the new No. 1 battery to be installed it was necessary first to clear the space occupied by half of each of the old batteries. Owing to the capacity of the cells required it was not possible to install a temporary battery so one battery was formed by using 12 cells from battery No. 1 and 13 from battery No. 2. This then enabled half of the room to be cleared, as described below, for the installation of the new No. 1 battery.

Battery No. 1 was used to float the load, the battery circuit-breaker associated with No. 2 battery was taken out and the negative end of the battery was temporarily tied direct to the battery busbar. The load was then transferred to battery No. 2. The positive bar from battery No. 1 was

cut, leaving the positive and earth for the load on battery No. 2. Temporary connexions were then made from the positive end of battery No. 1 to cell 13 of battery No. 2, and cell 12 of battery No. 1 was disconnected from cell No. 13 and connected via a battery circuit-breaker to the battery No. 2 busbar at the power board. Thus, on closing the circuit-breaker, cells 1-12 of battery No. 1 were in parallel with cells 13-25 of battery No. 2. It was then only necessary to cut away the plates of cell 14 of battery No. 2 and the connexion between the main busbar and cell 25 to leave the load on half of each battery at one end of the room.

In view of the age and condition of the old battery, a 50-kilowatt d.c. mobile charging set was standing by on an adjacent site with the cables already connected to the power board. To enable charging of the single battery to be carried out, 200-amp capacity counter-e.m.f. cells were connected in series with the load via suitable switches, the charging being restricted to periods when the discharge fell below this figure.

To keep the period that the exchange standby was reduced to one battery as short as possible, the "turn round" was carried out by direct labour using staff of the Regional power section during the light-load period over a week-end, and the battery contractor started on the Monday morning with the work of replating.

Ensuring that the 50-volt battery supply to the exchange was not interrupted was mostly a problem of size, as each battery has a capacity of 14,000 ampere-hours and the battery busbars consist of five bars of 8 in.  $\times$   $\frac{1}{2}$  in. copper in parallel. The estimated saving in copper and installation work using the method described instead of following the original layout was £500.

D. G. P.

#### P.A.B.X. FOR LONDON OFFICE OF SHELL INTERNATIONAL PETROLEUM

Two large buildings have been erected alongside the River Thames on  $7\frac{1}{2}$  acres of the South-Bank Festival-of-Britain site to serve as the London offices of the Shell International Petroleum organization. The two buildings are separated by the railway approach to Hungerford Bridge but are connected at basement level by three service subways. The upstream building rises to 10 floors, with a tower block a further 15 floors high; the downstream building is 10 floors high. The buildings are heated or cooled by a concealed water system and, to minimize heat losses or gains and also to help in soundproofing, the windows are double glazed. Comprehensive air conditioning is provided. It is estimated that by the end of 1962, nearly 6,000 people will be working in the buildings, and occupation of the downstream building started on 16 October 1961, the day the new P.A.B.X. was opened.

The P.A.B.X., which was designed, manufactured and installed by Automatic Telephone & Electric Co., Ltd., in consultation with the Post Office, has a cordless-type switchboard and embodies novel features. When the P.A.B.X. was opened the extension multiple had a capacity of 4,500 lines, with provision for an ultimate capacity of 7,000 extensions. The P.A.B.X. is connected to the public network by 97 outgoing barred-trunk exchange lines, 103 incoming exchange lines, and 40 outgoing full-facility exchange lines. There is also a private-wire network consisting of 130 private wires, external extensions and inter-switchboard circuits, some of which are accessible to an extension user by code dialling. The manual board consists of 19 positions with, in addition, two inquiry positions and a supervisor's position; all these positions were specially designed for Shell Petroleum Co., and are unique in appearance. The extensions have the usual facilities of recall, inquiry and transfer. In addition, an extension can be barred access to the exchange lines or the private-wire network, or both. Trunk barring, automatic recording of trunk calls, special night-service facilities, and night-watchman's patrol record are also provided.

The apparatus room contains 96 racks of equipment, an M.D.F. and two I.D.F.s. The racks, which are all 10 ft 6 in. high, comprise 40 racks of two-motion switches, 36 racks of rotary line switches and 20 racks of relay-sets. The décor of the room is unusual in that the ceiling and walls are a deep matt red, the pillars are black, and the floor is stone coloured; the racks and cabling are cream coloured, with grey apparatus covers. The power plant comprises two batteries, each consisting of twenty-five 1,500-ampere-hour open-type cells, floated by a rectifier (No. 76G) under the control of a power switchboard (No. 3C).

In the two buildings there is a total of 11 telephone-cable risers; the risers are connected on each office floor to a comprehensive under-floor trunking system with outlets at frequent intervals. Boxes under each window are also connected to the trunking system, and in these boxes power units and block terminals for plan 107 extensions and key-callers are fixed. There will be 4,550 telephones of the 700-type connected to the P.A.B.X., made up of 150 plan 1A, 1,200 plan 2, 400 plan 107, and 2,250 direct, extensions. In addition there will be 110 master and 632 side stations connected in 42 key-caller groups. The telephone wiring required amounted to 1,720 wire miles; the block wiring of the two buildings, the cables linking them, and the exchange cables together required 1,975 wire miles. The gross man-hours which will have been expended on all forms of Post Office work when the installation is completed will amount to 88,000 manhours.

It is of interest to note that over the 15 months during which work on this P.A.B.X. has been progressing no less than 71 P.A.B.X.s No. 1, and 32 P.A.B.X.s No. 3 and cordless types of P.B.X. amounting to a gross capacity of 1,864 exchange lines and 12,098 extensions have been brought into service for other customers in the City Telephone Area. There are at present firm orders for 41 P.A.B.X.s No. 1, and 13 P.A.B.X.s No. 3 and cordless types of P.B.X. on which preliminary work has started. It is thought that P.A.B.X. construction of this magnitude in one Telephone Area is quite unparalleled.

B. S.

#### ROYAL VISIT TO POST OFFICE SAVINGS BANK

To mark the occasion of the Centenary of the founding of the Post Office Savings Bank in 1861, the staff were honoured on 25 October 1961 by a visit from Her Majesty Queen Elizabeth the Queen Mother to their headquarters in Blythe Road, West Kensington. During her visit the Queen Mother graciously consented to open the new Chetwynd Exhibition Hall, the modern inquiry office, and the centenary gates, and also to unveil a tablet erected in the main entrance hall to commemorate the event. The visit was relayed by closed circuit television to those members of the staff who work at other offices in London.

Engineering facilities required for Her Majesty's visit were provided by the North Postal Engineering Section, London Postal Region. The ceremonial opening of the centenary gates was initiated by remote control from the main reception hall. For this purpose each gate was operated by a concealed motor and gearing, with a wire-rope drive to the gate.

Outside the front of the building 22 30-foot flagpoles were erected in line with and between the 50-year-old trees, which are now in their prime. A 500-watt floodlight was fitted at the front of each pole and arranged to illuminate the adjacent flag. Four 1,000-watt floodlights were set to illuminate the central motif above the main entrance and a further two 500-watt floodlights were set up in the two towers to light the main flag above the building.

A canopied approach from the road to the main building was illuminated above a nylon fabric ceiling by 36 80-watt fluorescent tubes. This was to ensure that Her Majesty's arrival could be televised. Decorative lighting was provided on the dais, though the general effect of this was lost under the glare of the lighting for the television cameras.



The arrangements went smoothly in spite of the demands made upon the electric-lift services in transporting about 1,200 staff between the reception hall and the lower floors in 20 minutes.

R. D. G.

### CLOSED-CIRCUIT TELEVISION

The Fleet Building in Farringdon Street, London, has 15 floors, is 165 ft high, and contains the City Area and Long-Distance Area Telephone Managers' Offices, as well as the Telegraph Training School, Telephonists' Reception Centre, part of the Engineering Training School, the permanent Telecommunications Exhibition (the museum), the London Telex exchange, an assembly hall of fine proportions and two conference rooms.

On 11 April 1961 the Lord Mayor of London, accompanied by the Postmaster-General, performed the opening ceremony of the building during which a commemorative plaque in the entrance hall and certain decorative panels on the face of the building were unveiled. The unveiling operations were shown to an audience of 250 people and, due to the restricted space on the pavement in Farringdon Street and in the entrance hall, closed-circuit television was used.

The guests were seated in the assembly hall from the stage of which the opening ceremony was performed. A 17 in. screen television receiver was provided on the stage and four 21 in. screen television receivers were provided in the body of the hall to enable the guests to witness the ceremony.

Two 625-line cameras were used. One was fixed and focused on the plaque; the other was mounted on the roof of an outside-broadcasting vehicle stationed in Farringdon Street and was equipped with a zoom lens to enable the outside of the building to be observed.

A camera-control unit was housed in a room at the rear of the hall and the diagram shows the distribution of circuits to and from the control room. The pictures produced by

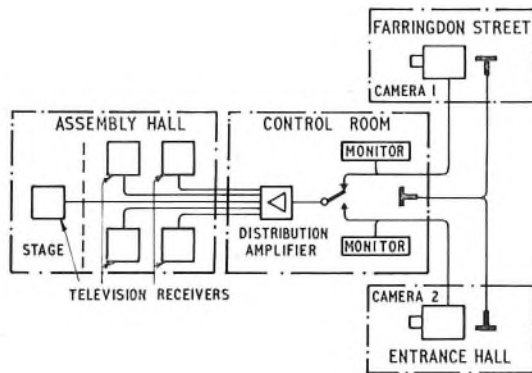

ARRANGEMENT OF CLOSED-CIRCUIT TELEVISION CIRCUITS AT THE OPENING OF FLEET BUILDING

both cameras were monitored at the control point and a speaker circuit was used to direct the officer operating the camera in Farringdon Street.

The plaque in the entrance hall was illuminated with six 250-watt photoflood bulbs housed in reflectors. The camera operator was able to observe the Lord Mayor as he was about to press the button to unveil the plaque, and at this point the motor-driven window curtains in the hall were closed to focus the attention of the audience on the television receivers.

The occasion and the use of the equipment provided valuable experience in the conduct of such an exercise.

E. B. M. B.

### Midland Region

#### POST OFFICE WORK ON THE GREAT NORTH ROAD

With the virtual completion of the Post Office works in

connexion with the Great North Road improvement scheme at Colsterworth and Ponton a review can now be made of some of the work involved.

Nearly 4,000 yards of 9-way multiple duct have been laid, with excavations down to 14 ft and a minimum trench width of 3 ft; the changing over and rebalancing of four MU, CJ, and local cables; the lowering by 8½ ft and slewing by 10 ft of a 5-way multiple duct containing coaxial, carrier and audio cables for about 1,000 yd; the building, or demolition and rebuilding of some 35 manholes of various sizes, and numerous short lengths of S.A.D. and 2-way and 4-way multiple duct have been laid. Although the duct and man-hole work was all in solid sandstone, which presented some problems to the contractor, there has only been one interruption to service throughout the work, which has taken nearly 12 months.

Two factors made the slewing and lowering rather unusual. The existing duct is the now obsolete 5-way multiple duct and a loading point existed in a section to be lowered. It was expected that some ducts might be broken but split ducts were unobtainable and only after many enquiries were a few old ducts located in the Home Counties Region. These were made available and a local masonry firm cut them longitudinally into four sections. The ¾ in. lost by each cut was made good by T-shaped wooden inserts which restored the bore diameter and prevented the ingress of concrete which was used to strengthen the ducts. To ensure their final linearity 6 ft long wooden plugs were inserted in the "firing holes."

Where loading coils had to be lowered, the ducts were suspended for a distance of 60 yd on each side of the man-hole, which was then partly demolished. The loading-coil joints and stubs were protected and braced to the loading-coil cases and the track. The whole structure was then suspended with chain hoists from 20 ft lengths of 9 in. rolled-steel joists. The manhole demolition was then completed and the new manhole partly rebuilt 6 ft lower. Because the old and new manholes were built in solid rock it called for more than usual care whilst working below the suspended plant. The loading-coil structure and track on both sides of the manhole were then lowered simultaneously to the new level.

Owing to the care taken in the lowering and slewing there were very few broken ducts and tests have indicated that the track is still in good condition. The operation saved the considerable expense of new plant over a much greater distance.

The road contractor and the Ministry of Transport authorities have expressed their appreciation of the co-operation that has been received from all our staff who have been concerned.

C. L. G. B.

### CABLE DIVERSIONS—BIRCHFIELD (BIRMINGHAM) UNDERPASS

The Birmingham Area has now completed large-scale duct and cable diversions brought about by the construction of a 420 yd long vehicle underpass at Birchfield Road, an important junction on the City's outer-ring road. The underpass is the first of several which will make the A34 an express motor-way northwards from the City. Commenced in September 1960, the underpass is expected to be in operation by March 1962, having cost almost a million pounds.

Sixteen duct-ways existed along the route. Among the 11 trunk cables in the ducts were the Birmingham-Manchester No. 3 and 4, both six-tube coaxial cables. Some 3,600 local-cable pairs were involved, and altogether the work involved jointing 22,000 pairs and changing over 24,000 pairs. It was also necessary to divert 700 yd of 24-way multiple duct and 750 yd of local duct. Two particular points of difficulty within the diversion area were the Birchfields Exchange main outlet and a distribution junction at the nearby intersection of two main roads.

Local cables feeding districts east and west of the underpass were diverted completely out of the improvement area via roads not affected. By carrying this out at a very early stage a large amount of cable was cleared from possible damage by excavations.

The diversions of the MU, CJ and CL cables running from the City northwards through the underpass area proved more difficult. Despite early provision of the 24-way multiple duct throughout three-quarters of the affected area, actual cable-laying and diversion was held up pending provision of duct at the approaches to, and across, a new railway bridge which was scheduled for construction later in the civil engineering contract.

Timing of the civil engineering contract was such that the existing railway bridge, across which the existing duct route lay, was scheduled to be blown up within 12 weeks of the completion of the new railway-bridge pipe bay. The period was inadequate by normal standards for duct provision, cabling, testing and change-over to the new route.

Several steps were taken to meet the situation. An unusual feature was the provision of 24 ways of concrete-enclosed pitch-fibre duct across a 20 ft wide, 15 ft deep subway excavation. This was achieved by placing two sheet-steel piles side-by-side across the excavation with soldiers (steel pins projecting upwards) provided at short intervals to hold the timbering in position. The duct was, in fact, provided in mid-air and in this way it was possible to proceed farther with the ductwork immediately the bridge pipe bay became available.

Arrangements had previously been made to stagger change-over points to achieve quicker testing and change-over. This, combined with shift working throughout and considerable effort on the part of all concerned, enabled the existing cables to be recovered only a few days before the old railway bridge was blown up. No alteration of the demolition date was possible in view of the considerable train diversions arranged by British Railways for that date.

The construction of a major underpass entails close co-ordination between the resident civil engineer and all services. Many problems are overcome throughout the work but without doubt the most important factor in the planning of a Post Office diversion of this nature is the study of the civil program and ensuring that the consequent organization and phasing meet the vital dates.

C. H. T.

#### TELEPHONE SERVICE FOR A SERIOUSLY DISABLED SUBSCRIBER

In the Birmingham Area special facilities were required for an automatic-exchange subscriber who was almost totally disabled due to a serious illness. The subscriber was limited to a very restricted movement of the right hand, which made it impossible to lift the handset of a normal subscriber's instrument or to use the dial.

Although a Sender No. 1 and Loudspeaking Telephone No. 1 would have met the special needs of this subscriber, supply difficulties of these newly developed items made delay inevitable and the provision of a locally constructed arrangement was investigated.

In addition to the limitations imposed by the subscriber's very restricted movements, it was necessary to position the equipment so that it could be easily moved clear of the patient's bed to facilitate medical attention. The provision of telephone facilities for other members of the subscriber's family, without disturbing the special bedside arrangement, was an additional requirement.

The problem was solved by installing disabled subscribers' calling equipment at the automatic exchange which routes all outgoing calls to the manual board without dialling.

At the subscriber's end, the existing instrument was replaced by a Telephone 706 CB. An additional Telephone 706 CB with a Handset No. 4 (deaf-aid telephone) was pro-

vided for the patient. The Handset No. 4 was permanently removed from the telephone and supported in position close to the patient's head by means of an "Anglepoise" fitting secured to the wall. The Anglepoise fitting is a proprietary article, and was specially adapted by the manufacturers, with a handset clip of their own design and the necessary balancing adjustments to support it in any required position. The handset was positioned some 4 or 5 inches from the patient's head with the volume control pre-set at the required optimum position.

A key fitted in the centre of the dummy dial was used to control the bedside telephone. The patient can make outgoing calls or answer incoming calls simply by operating the key. A miniature key was modified to take a standard lever-key handle, and by increasing the leverage in this way the effort required to operate it is well within the physical capacity of the patient.

The normal Telephone 706 CB is used by the other members of the household and the bell of this instrument rings on incoming calls.

W. C. and W. G. D.

#### A NEW EXCHANGE AT STAFFORD

On Saturday, 29 July 1961, at 2.30 p.m. the new automatic telephone exchange at Stafford, installed by A.E.I., Ltd., was opened by Alderman Mrs. E. Wilford, Mayor of Stafford, and the CB10 manual board, with 34 positions and equipped capacity for 2,800 lines, was closed after 28 years' service. The inaugural subscriber dialled-trunk call was made to the Mayor of Peterborough and displayed step-by-step to the 200 guests.

The new exchange, situated in Eastgate Street, has an initial multiple capacity of 4,700 lines and is a 4,000-type non-director group switching centre with S.T.D. facilities and a cordless-type auto-manual switchboard of 24 positions.† Thirty-two exchanges have routes to Stafford exchange, and trunk traffic is carried over routes to Birmingham, Burton-on-Trent and Stoke-on-Trent.

Transfer of the subscribers' lines was made by teeing into the local network and, since the repeater station was to remain in the old exchange building, tie cables were provided to extend the 2-wire ends of the amplified trunk circuits to the new exchange. Incoming junction circuits from the parented U.A.X.s were modified to facilitate testing and transfer, without further alteration to the signalling conditions, or attendance at the U.A.X.

The transfer from the manual exchange to automatic working with S.T.D., a cordless switchboard and pay-on-answer coin boxes was made in four stages.

Seven weeks before the new exchange was opened the cordless switchboard was brought into service with a number of new outgoing trunk circuits and some temporary circuits to the old manual exchange from a local spare level, level 6, to enable operators to be trained. Selected P.B.X. subscribers agreed to pass timed calls over particular lines and when a call was received on one of these lines it was extended, unchallenged, to the cordless switchboard by means of plug-ended cord circuits terminating on level 100 relay-sets. The operator-in-training therefore received calls via the queue and completed them over the trunk circuits as required. In the event of a local call being incorrectly routed to the cordless switchboard, level 6 was used by the operator to return the call to the old manual exchange for attention.

Three weeks later all the outgoing trunk circuits were transferred to the new exchange so that the condition of the trunk routes could be brought up to the high standard necessary for S.T.D. working. To carry the CB10 exchange outgoing trunk traffic, 30 loop-disconnect pulsing circuits were provided to the new exchange and, by code dialling,

† CHEESBROUGH, J., Stafford Cordless Switchboard. *P.O.E.E.J.*, Vol. 54, p. 201, Oct. 1961.



the CB10 operator could obtain a trunk circuit on the route required. Large numbers of test calls were made at this stage and equipment and routes were brought up to standard.

Two weeks before the transfer the remainder of the trunk and junction circuits were transferred and inter-dialling facilities provided. Access to Stafford subscribers via the CB10 local multiple were obtained over the level 6 route, which was increased to 127 circuits. Parent exchange subscribers and dialling-in operators were instructed to dial 6 for Stafford numbers. Non-parented exchanges remained connected to the CB10 exchange to avoid instructing out-of-area subscribers in temporary dialling arrangements.

The final phase, the transfer of subscribers' lines to the new automatic exchange and the opening of the S.T.D. service, was completed without incident and whilst post-transfer testing of the 3,200 lines was in progress the guests were escorted over the building in small parties. An exhibition of S.T.D. panels with an invitation to set up an S.T.D. call to recorded announcements proved very popular.

W. C.

#### North Western Region

#### EXPERIMENTAL LEAD-IN AT KNUTSFORD AUTOMATIC TELEPHONE EXCHANGE

The first trial in this Region of a new technique for providing ducts into exchange buildings has been successfully carried out at Knutsford automatic telephone exchange. With this method pitch-fibre pipes are assembled to form a nest, using prefabricated concrete spacers held rigidly together with vertical and horizontal tie bars secured by spire nuts, as shown in the photograph. Concrete is then poured over the nest and vibrated to secure a dense and watertight block.



DUCTWORK AT KNUTSFORD TELEPHONE EXCHANGE

The Knutsford exchange lead-in was formed with twenty  $3\frac{1}{2}$  in. internal diameter pitch-fibre pipes in a five-high by four-wide formation. The trench was 72 ft in length and the pipe nest was built up in sections each 5 ft long. The pipe sections were jointed with spigots and sockets cut in the body of the pipes and, therefore, no increase in overall

diameter occurred at joints. The lead-in is thought to be of particular interest because of the use of vibrated concrete and the speed with which the work was carried out.

The excavation of the trench was completed in  $1\frac{1}{2}$  days by two men using a mechanical excavator. The laying of the 6 in. reinforced-concrete base, using ready-mixed concrete, and the assembly of the pipe nest was carried out by four men in two days, and the placing and vibrating of 19 cubic yards of ready-mixed concrete was completed by the same men in six hours.

The ready-mixed concrete specified for the work was of 4,000 lb/in<sup>3</sup> strength at 28 days. The  $\frac{3}{4}$  in. graded aggregate mix, with a water-to-cement ratio of 0.6 by weight, was readily forced around the pipes with a 2 in. poker-type vibrator placed between the pipes and the wall of the trench.

The work was carried out by the Ministry of Works, using a specification prepared by the External Plant and Protection Branch, Engineering Department, and the success of the experiment was due in no small measure to their enthusiastic co-operation.

R. C.

#### TEMPORARY BRIDGE SUPPORT FOR A MULTIPLE-DUCT TRACK

A problem facing the Manchester College of Science and Technology was how to acquire more land for expansion when its immediate neighbour was the River Medlock which, due to its meandering course, affected a considerable area of land. A decision was made to divert the river through a culvert and thus release the area for college extensions. However, one of the main trunk routes out of Manchester, carried in four 9-way ducts, was subject to interference by the scheme, and a normal diversion of the track concerned would have cost almost £100,000. It was agreed, therefore, to allow the consulting engineers to design a bridge which would temporarily support the track crossing the course of the proposed culvert, while the culvert was being constructed.

The two most important factors to be considered in the bridge design were (a) the alignment of the ducts should not be disturbed throughout the whole operation and (b) the final reinstatement should provide adequate support. An additional problem of a slight lateral bow in the sloping duct line also had to be considered. The final design was approved by the Post Office and work commenced at the end of March last year.

Two concrete pillars were built at each end of the section of track to be supported, and the ends of the main girders of the temporary bridge were placed on these so that the duct line was straddled by them. At this stage the ducts were still supported by the undisturbed earth, but precautions had been taken to prevent lateral movement of the nest of ducts by lashing strong wire round the ducts at intervals.

Strips of wood were packed between the bridge girders and the ducts to prevent any further sideways movement. Small excavations were made near each duct joint to allow channel irons to be passed underneath the duct nest; these irons formed the main bearers for the duct track. To support the channel irons, rods, threaded at each end, were passed through them and also through the steelwork of the lowest girders of the bridge on both sides of the duct nest. Nuts were then screwed finger-tight on the ends of the rods prior to the final adjustments.

The most difficult problem which faced the designer was to prevent a vertical displacement of the ducts when the earth supporting them was removed.

This was resolved by placing planks of wood on the top girders of the bridge and distributing dry bricks, equal in weight to the final load (comprising duct and cable, etc.), evenly along the bridge. In this way the bridge was deflected by an amount equal to that which it would experience with the true load. Whilst the bridge was deflected under this artificial load, the fixing nuts on the tie rods were tightened

with the aid of a torsion spanner until a torque of 8–11 lb was registered. This method ensured that the channel bearers were just taking up the true load. The final operation was to remove the bricks and excavate beneath the ducts in preparation for the culvert. The fact that there was no movement in the duct line throughout the operation was a measure of the success of the design.

The reinstatement was effected when the section of the culvert had been completed. A layer of concrete was built up to within 3 in. of the bottom edge of the ducts and allowed to harden off; the remaining 2 in. were then packed with more concrete. Finally, the tie bars were removed and the bridge dismantled but the channel bearers were left in place to provide additional support to the duct line.

The cost of the whole operation was approximately £2,000—a very small amount compared with the original estimate of £100,000 for diverting the track.

D. H.

### Scotland

#### ROADWORKS IN SOUTH SCOTLAND

The main road-improvement project being carried out in Scotland at present is the improvement of the Carlisle–Glasgow trunk road. As the new dual-carriageway is being constructed on the line of the existing road a large amount of temporary and permanent rearrangement of main and local cables is required.

At the village of Beattock in Dumfriesshire, a junction for east–west and north–south trunk roads, a diversion involving the construction of over-bridges, underpasses and associated slip-roads is in progress. The work which has to be done includes the recovery of heavy overhead trunk routes, and the temporary and permanent replacement of the Carlisle–Glasgow No. 3 coaxial cable, Edinburgh–Leeds No. 1 and 2 carrier cables, Carlisle–Glasgow No. 1 and 2 carrier cables, Glasgow–London audio cable, Beattock–Moffat junction cable, and various local cables.

At Broomlands, the 4-tube 306-pr., coaxial cable had to be recovered from a road bridge over the main Glasgow–London railway line to allow the existing bridge to be demolished and construction of the new bridge to be completed. As a temporary measure, 400 yd of interruption cable were drawn into a duct line laid in a diversion road

across the partially constructed new bridge and taken down to the existing road. At a later stage permanent replacement cable will be laid across the new bridge. The total length finally renewed will be  $1\frac{1}{2}$  miles and will be joined at the south end of the diversion by 10 miles of cable which is being replaced over 15 miles of roadworks.

On the Edinburgh–Dumfries road, north and south of Beattock, the nature and extent of the roadworks are such that the cables affected have to be temporarily replaced by aerial cables. On the north section the cables affected are the Edinburgh–Leeds No. 1 and 2 carrier, the Carlisle–Glasgow No. 1 and 2 carrier, the Beattock–Moffat junction cables and a local cable. The 915 yd of cable will eventually be replaced in the verge of the completed road.

On the south section the four 24 pr., 40 lb/mile carrier cables were again affected, together with the 4 screened pair 40 lb/mile + 275 pr., 25 lb/mile Glasgow–Liverpool–London audio cables and a local cable. Interruption cable had to be provided for over 325 yd. Stout poles were placed at 30 yd spacing and three suspension wires erected. Two suspension wires were erected at the same level on each side of the pole, 1 ft from the top, and the third was erected on the road side  $2\frac{1}{2}$  ft below. The first of each set of carrier cables was lashed by machine to one of the top suspension wires and the other carrier cable was hand-lashed. Additionally, one suspension wire carried the local cable. The Glasgow–Liverpool–London cable was double hand-lashed at ground level and then raised into position by blocks and tackle. The jointing and change-over of the circuits presented no problem on the audio cables, but on the coaxial and carrier cables, operations had to be carefully timed to avoid interruptions to circuits carrying transatlantic telephone traffic and the Scottish television program. Co-operation with the Regional transmission group ensured that the change-overs were carried out speedily and efficiently.

Close co-operation with the road engineers at the design and construction stages has been achieved. The necessary ductwork forms an integral part of the road works contract and often expensive interruptions have been avoided by careful phasing so that existing cables are placed in their permanent position before any excavation work is begun on their original track.

A. B. and A. M.

---

## Book Review

“Electron Optics in Television.” I. I. Tsukkerman. Translated by L. A. Fenn, M.Sc. Pergamon Press, Ltd. viii + 290 pp. 138 ill. 55s.

Electrons in motion in a vacuum tend to travel in straight lines unless some influence such as a magnetic or electric field is brought to bear upon them. Such fields can cause a beam of electrons to be bent or reflected in a manner somewhat analogous to the way in which light is refracted or reflected—hence the term “electron optics” for the highly specialized science dealing with this subject.

Many devices using electron-optical principles are used in television, ranging from the well-known cathode-ray display tube which is now a feature of almost every home in the country, to the more complex camera tubes used at the studio end of the system. A fairly comprehensive range of these devices, including the special tubes for colour television, is described briefly in the first chapter of the book. The occasional rather quaint terms used (for example, on page 1: “the vacuum electrical instruments of television. . .”) underline the fact that this book is translated from the Russian but do not detract from its value.

Chapter 2 deals with the fundamental laws governing the motion of electrons in magnetic and electric fields, and, as might be expected, is highly mathematical. Brief mention is included, however, of the electrolytic-tank and rubber-membrane methods of investigating some electron-optical problems. Chapters 3, 4 and 5 deal progressively with the generation, focusing and deflexion of electron beams. The section on deflexion includes some of the special problems associated with colour tubes.

The final chapter deals with the formation of electronic images in certain types of camera tube. Here the photographic image is first converted into an electron-charge image and transferred to the target electrode before scanning, a principle used in the super-iconoscope and super-orthicon tubes. The special requirements of the transfer section of the tube, where this process is carried out, are described with, inevitably, some fairly complicated mathematics.

The book has been based on a course of lectures given by the author at one of the major Russian research institutes. To the student who wishes to specialize in this branch of science it is undoubtedly a valuable work, but the mathematics and the price will probably prevent it from becoming a widely-read best seller.

T. K.



# Associate Section Notes

## Reading Centre

The Reading Centre, which began 12 months ago with 15 members attending a meeting held in a basement, can look back on its first year with a certain amount of satisfaction. The membership now stands at near the two-hundred mark and we have had an interesting program of lectures and visits. The visit to the Shell-Mex installation on the Isle of Grain is particularly worthy of mention.

At the annual general meeting held in April (our poorest meeting for numbers) the previous year's Chairman, Secretary and Treasurer were re-elected, but the committee has one or two new faces. Our Centre's first President, Mr. E. W. Weaver, has left Reading to become Telephone Manager, Birmingham, and we wish him success in his new appointment. In Mr. Weaver's stead we welcome Mr. G. A. Bennet as Telephone Manager, Reading. Mr. Bennet has kindly accepted the invitation to the Presidency of the Reading Centre.

Our program for the 1961-62 session is quite varied and includes: a talk on railway signals and communications; a debate on the motion "That this centre shall hold a debate"; a talk on colour photography; "Transistors," by Mr. D. J. Harding of the Post Office Research Station, Dollis Hill; "Planning Group" by two members of the centre; and visits to a signal box and Whitbreads Brewery.

We look forward with confidence to our second year.

H. R. M.

## Ipswich Centre

At the time of writing the Ipswich Centre is exactly four years old, and it is gratifying to know that our membership has grown from 84 to the present 212 in these four years. The monthly meetings have always been well attended and our summer visits have never lacked overwhelming support. This has given a sense of satisfaction to our committee and makes their job so much more worthwhile.

The 1961 summer program has again proved a great success; starting in May with a visit to the engineering works of Messrs. Davey Paxman at Colchester, it was agreed by all who attended that the visit was most interesting and instructive. In June, an all-day visit to Marconi's works at Chelmsford gave members an opportunity to see the many aspects of the radio industry and, since some of the equipment seen has been provided in the area, a keen interest was shown by all.

July brought a visit to one of our local works, Messrs. Ransome, Sims & Jefferies, where agricultural machinery is manufactured. This is one of the major industries of Ipswich and our members spent a most enjoyable and instructive time at these works. The B.B.C. Television Centre was visited in August and proved to be the highlight of our summer program. The time spent there passed all too quickly and a repeat of this visit seems to be indicated. Our last visit of the summer was to our local waterworks and supplemented a talk given during our winter program by Mr. Ringrose, the waterworks engineer. This visit was a most interesting one and gave members an opportunity to see in practice the system described in the previous talk.

The 1961-62 winter program started on 19 October with a film show which, as during previous sessions, proved to be most popular. The winter program also includes such subjects as "The Port of Ipswich" and "The Pay-on-Answer Coin-Box," and we look forward to an enjoyable winter session.

E. W. C.

## Edinburgh Centre

The opening meeting of the current session consisted of a talk on "Stage Lighting," given by one of our members, Mr. A. Robertson; this proved to be a most interesting

lecture, with many different types of lamps on display. It was regrettable, however, that so few members were able to attend, especially in view of the fact that we increased our membership during the past year from 107 to 136.

The following office-bearers were elected for session 1961-62: *Chairman*: Mr. R. P. Donaldson; *Secretary*: Mr. D. S. Henderson; *Treasurer*: Mr. A. G. Gilmore; *Librarian*: Mr. P. J. Peebles; *Committee*: Messrs. D. M. Plenderleith, D. Stenhouse, W. Paterson, A. Robertson and D. Stewart.  
D. M. P.

## Lincoln Centre

The winter session commenced on Monday, 2 October, with a well-attended meeting. The speaker, Mr. H. Culkin, of the North Eastern Region Director's office, described "Mechanical Aids," using slides and a film on the Simon hydraulic platform to illustrate his talk. The interest stimulated by this talk gave a good send-off to the program and resulted in a gratifying attendance by our external staff.

On Tuesday, 10 October, a small party from the Lincoln Centre accepted an invitation from the North Lincolnshire Branch of the Radio Traders Retail Association to attend a film meeting presented by Mullard, Ltd. Three films were shown in the course of the evening, and many questions regarding semiconductors were answered.

L. W. B.

## Leeds Centre

The 1961-62 session opened with an illustrated talk by one of our members, Mr. P. Broadbent, entitled "Northumbrian Sketch," and on this occasion we invited friends and relatives.

In October we visited the Granada studios in Manchester where we saw, amongst many other things, some of the sets used on television programs. Also in October we visited the factory of British Insulated Callender's Cables, Ltd., at Prescott, to see some of the processes used during the manufacture of telephone cables, and the automatic copper rolling mill, which was of particular interest. The Company entertained our party to a most enjoyable lunch.

E. B. B.

## Scunthorpe Centre

Members of the Scunthorpe Centre spent a very enjoyable and interesting evening in July at the local Civil Defence Headquarters examining equipment. During the course of the visit two films, one on the jet engine and another concerning nuclear explosions, were seen.

The current session opened with a paper entitled "The Fire Brigade," given by the Scunthorpe Divisional Fire Officer, and a visit to the fire station is to be made at a later date. A visit was made during October to the railway station at York to inspect the signalling system. A party of members travelled to Cleethorpes as guests of Mullard, Ltd., to attend a film show; the films shown were "Transistors" and "Appleton Layer."

As a result of a challenge from the Grimsby Centre the Scunthorpe Centre met them on 12 December for a quiz. The venue was Brigg and, to ensure fair play, the Rev. W. Dudman kindly consented to officiate as Quiz-master.

H. V. P.

## Middlesbrough Centre

On 16 May the 1960-61 annual general meeting was held. The accounts were audited and a committee elected as follows: *Chairman*: Mr. R. V. Costello; *Secretary*: Mr. N. Williams; *Assistant Secretary*: Mr. D. A. Pratt; *Treasurer*: Mr. K. J. Ashworth; *Librarian*: Mr. M. A. Landers. The evening's business was concluded by an interesting and instructive film show.

During the first half of the 1961-62 session the following activities took place:

October: "Electrical Engineer at Sea." A lecture by Commander J. C. Turnbull.

November: "Tees Journey." A talk by Mr. P. Barton.

December: "American Visit." A talk by Mr. S. Gill.

A visit to the steelworks of Dorman Long & Co., Ltd. The remainder of the 1961-62 program includes the following:

January: Film show.

February: "Cable Corrosion," A lecture by Mr. W. G. Dunsire.

March: A visit to the Wilton works of Imperial Chemical Industries, Ltd.

April: Annual general meeting.

The Centre is looking forward to an interesting and well-supported second half of the session, and a cordial invitation is extended to all to attend our meetings.

K. J. A.

#### Sheffield Centre

The second half of the summer session comprised visits to Somnus Bedding Manufacturers of Nottingham, Dixon's Paper Mills in Sheffield, and a return visit to Automatic Telephone & Electric Co., Ltd., Liverpool, to whom we are indebted for an interesting visit and excellent hospitality.

The winter session opened with a lecture on "Polythene-sheathed Underground Cables," by Mr. H. C. S. Hayes, External Plant and Protection Branch, Engineering Department. All who attended agreed that this was a most outstanding lecture.

Another first-class lecture was presented by Mr. C. E. E. Clinch, Main Lines Development and Maintenance Branch, Engineering Department, who spoke on "Time Assignment Speech Interpolation." After speaking about the technical and economic aspects of the system, the speaker discussed, in answer to a question, the possibility of using a simplified TASI equipment on the inland telephone system.

J. E. S.

#### Portadown Centre

The inaugural meeting of the Portadown Centre was held in the telephone exchange on 28 September, 1961. Mr. Benzies, Vice-Chairman of the Northern Ireland Senior Section presided. Mr. A. H. C. Knox, President of the Associate Section, had arranged to open the Centre and give an address but, unfortunately his arrangements had to be cancelled due to unforeseen circumstances. "When in trouble go to the Telephone Manager"—this we did, and at very short notice Mr. R. E. Jordan kindly undertook to open the Centre. His address on "Appraisements and Promotion" was most interesting and instructive, and a very lively discussion followed.

The following office bearers were appointed: *President*: Mr. W. C. Vidler; *Chairman*: Mr. A. G. Anderson; *Secretary*: Mr. W. J. Pollock; *Treasurer*: Mr. W. Chambers; *Committee*: Messrs. M. Jones, A. Rusk, R. Aughy and J. McMahon.

We wish to thank all those who contributed so much towards the formation of the Centre, and we feel confident that with an opening attendance of 60 a successful future is assured.

W. J. P.

#### Brighton Centre

This winter's program began with a very well-attended meeting held on 4 October. A talk was given by Mr. E. J. T. Hitchin on a topical subject, "Towards S.T.D.," in which Mr. Hitchin outlined some of the problems arising during the planning stages of S.T.D., with particular reference to the Brighton telephone area, which made the talk all the more interesting.

At the next meeting on 7 November a talk on "Tape

Recording" was given by Mr. H. J. Houlgate of the B.B.C. Engineering Design Department, and during December Mr. F. E. Burke, of the British Oxygen Company, gave a talk on welding.

Visits to Tamplin's Brewery, Brighton, the M.G. car factory, Abingdon, and the Skefco Ball Bearing Co., Luton, were well attended and appreciated by our members.

At the annual general meeting Mr. J. James presented the section with a new typewriter. Mr. James is a founder-member of this section and is still serving the committee as librarian. His very generous action has been greatly appreciated by us all.

G. F. C.

#### Bletchley Centre

At the time of writing this report the membership stands at 70, an increase of 21 members since the inaugural meeting.

At the first meeting of the Centre, Messrs. F. H. Daniels and E. E. Whall were elected as auditors for the ensuing year. The showing of the films "Metal of the Centuries" (dealing with the history of copper) and "Marham Marshalling Yards" followed the meeting.

An evening visit to Painton and Co., Ltd., Northampton, took place in August. Members saw a wide variety of electrical components, ranging from resistors to h.f.



MEMBERS OF THE BLETCHELY CENTRE VISITING  
PAINTON AND CO., LTD.

attenuators, in the process of manufacture. The simplicity in manufacturing close-tolerance components was very much admired. We are indebted to Mr. Ward and his colleagues for showing us around the factory.

The winter program of the Centre has been arranged, and so far only one meeting has had to be changed as the speaker was unable to attend. Mr. A. F. J. Lee, the Principal of the Home Counties Regional Training Centre, was kind enough to give a talk, "The Engineers (and Others) Look Ahead." The talk covered the changing problems of the engineering and clerical staff, and what the individual should do to adapt himself to the new conditions.

It is most encouraging to see how well the membership is supporting this young Centre. This very fact gives us great hope for the future.

A. J. H.

#### Swansea Centre

The inaugural meeting of this Centre was held on Thursday, 21 September, at Telephone House, Swansea. The Area Engineer, Mr. W. K. Edwards, opened the meeting in the absence of officers, who had later to be elected. He wished the Centre all success and promised complete co-operation. This view was also shared by our Telephone Manager, who was invited to speak at the meeting. The



officers of the branch were then elected and are as follows: *Chairman*: Mr. W. C. Berry; *Treasurer*: Mr. W. P. Rundle; *Honorary Secretary*: Mr. N. L. Williams; *Committee*: Messrs. R. H. Thomas, K. G. Rice, P. G. Wilson and R. L. Gard.

Mr. Alston, our Telephone Manager, then spoke of his experiences in Iraq and illustrated a most interesting lecture with his own colour film. During his lecture the audience, which included many guests from various branches of the Telephone Manager's Office, gained a much broader view of the difficulties confronting a Post Office official abroad. We realized also the tremendous responsibilities placed upon someone who represents Her Majesty's Government abroad.

All too soon the lecture concluded and those present were invited to ask questions. These were very ably answered by the Telephone Manager in a most humorous way.

A later meeting of the Committee planned an interesting program for the coming months and an extensive recruitment drive was started which, at the time of writing, has yielded quite a number of new members. Our next meeting, held in November, was a mixed film show, depicting aspects of motor racing, road craft and oil refining. For these films we are indebted to the generosity of the Shell Mex and B.P. organization.

N. L. W.

#### Shrewsbury Centre

At the annual general meeting held on 6 October the following officers were elected: *Chairman*: Mr. J. Fleming; *Vice-Chairman*: Mr. P. K. Nicholson; *Secretary*: Mr. H. Christmas; *Treasurer*: Mr. R. G. Poulson; *Committee*: Messrs. E. Dodd, W. Dodd, J. Swanick, G. Ridgway, R. Jervis and R. L. Howie.

Our first meeting was held on Monday, 6 November, when a lecture with coloured slides was given by Mr. Glyn Roberts. The subject was "Survey of Water Resources in Kenya"; Mr. Roberts has just completed a survey of Kenya and this lecture proved to be very interesting.

H. C.

#### Bath Centre

At the annual general meeting held in April, the following officers were elected for the year: *Chairman*: Mr. H. C. Foote; *Vice-Chairman*: Mr. L. W. F. Vranck; *Treasurer*: Mr. R. P. Bowers; *Librarian*: Mr. A. F. Arlett; *Secretary*: Mr. D. G. Rossiter; *Assistant Secretary*: Mr. W. J. Rossiter.

In May a party of 25 visited the works of the Westinghouse Brake & Signal Co., Ltd., at Chippenham, Wiltshire. The company undertake an extremely wide range of engineering work, and the party saw such differing jobs as foundry work and precision germanium-diode construction.

Also in May a special general meeting was held to discuss the future of the annual "Telecommunications Ball"; one of the things decided was that its rather ostentatious title should disappear. The new Dance Secretary and his committee were given many suggestions to invigorate and revive the function. As a step in the right direction the telephonists are now represented on the committee by two co-opted members. We wish the team every success in restoring the popularity of this event.

A visit was made to the Atomic Energy Establishment, Winfrith, by a full capacity party of 30; before visiting the experimental establishment of the Atomic Energy Authority, the morning was spent at Lulworth Cove. After bathing and suitable light refreshment, the party reported at 2 p.m. and was received by a senior official of the United Kingdom

A.E.A. A short film explaining the elementary principles of nuclear reactions, proved most useful in understanding the processes and equipment seen on the tour of the extensive premises.

The third motor treasure-hunt was held on the evening of Friday, 18 August. The winner, Mr. A. Parfitt, scored 94 per cent, and so completed his second successive win. Close runner-up was Mr. J. D. Silcox (88 per cent). Congratulations to the winner and his crew; the organizers are, however, considering his elevation to the experts class for any future event.

The year has started well, and there is much promising material in hand; we hope to maintain your support and encouragement.

D. G. R.

#### London Centre

The annual general meeting was held in May, when the following officers and committee for the London Centre were elected: *Chairman*: Mr. A. G. Welling; *Vice-Chairman*: Mr. H. A. Horwood; *Treasurer*: Mr. W. C. Peck; *Assistant Secretary*: Mr. W. H. C. Upton; *Visit Secretary*: Mr. W. C. Hatch; *Librarian*: Mr. G. Milne; *Radio Secretary*: Mr. K. K. Smith; *Editor*: Mr. E. S. Glyn.

The following Area Chairmen were also elected: *West Area*: Mr. W. Smylie; *Test Section*: Mr. D. Brede; *S.W. Area*: Mr. G. E. Tansley; *S.E. Area*: Mr. J. W. Clayton; *North Area*: Mr. R. F. Gulliver; *N.W. Area*: Mr. R. T. Jones; *Long Distance*: D. Mather; *East Area*: Mr. D. G. Randall; *City Area*: Mr. E. A. Saunders; *Circuit Laboratory*: Mr. J. J. Gutteridge; *Cable & Wireless*: Mr. F. Keennemund.

The September talk, "The Work of the Post Office Cable Ships," given before the Centre in the new Fleet Assembly Hall by Captain J. P. F. Betson, O.B.E., who for 12 years was Commander of H.M.T.S. *Monarch* and is now Deputy Submarine Superintendent Submarine Branch, was an appraisal of the staff of a cable ship. Slides and film were shown illustrating the work of a cable ship. This talk brought to our members another aspect of telecommunications and was very much appreciated.

Some 90 members listened to Mr. D. L. Benson, Telephone Electronic Exchange Systems Development Branch, Engineering Department, on 11 October giving his lecture on "Use of the Magnetic Drum for S.T.D. in London." His talk described how S.T.D. traffic from London director exchanges is routed to a central installation where register-translators control the routing and charging for each call. This was a most stimulating talk and many questions were asked during discussion time.

On Tuesday, 14 November, Mr. F. C. Mead, Training Branch, Engineering Department, gave a talk on "The Problem of Technical Study for Post Office Staff—C. & G. and O.N.C."

An additional Centre lecture was held in the South-West Area on 17 October. The talk was on "S.T.D. as it Affects the Non-Director Exchange," by Mr. B. B. Gould, of Telephone Exchange Systems Developments Branch, Engineering Department. On Thursday, 26 October, Mr. R. H. Crooks gave a talk "S.T.D. as it Affects the Director Area" to the North West Area.

The Inter-Centre quiz between Brighton and London took place in Fleet Building on 23 November, 1961. We should be very interested to hear from other Centres who would be prepared to enter a Technical Quiz between Centres.

A. G. W.

# Staff Changes

## Promotions

Name	Region, etc.	Date	Name	Region, etc.	Date
<i>Assistant Staff Engineer to Staff Engineer</i>			<i>Inspector to Assistant Engineer—continued</i>		
Lawrence, J. A.	E.-in-C.O.	18.8.61	Morris, L. A.	L.T. Reg.	8.8.61
<i>Regional Engineer to Regional Engineer and Telecommunications Controller</i>			Wykes, C. J.	Mid. Reg.	17.8.61
Knox, J.	N.W. Reg. to N.I.	28.8.61	Wild, F.	Mid. Reg.	22.9.61
<i>Area Engineer to Telephone Manager</i>			<i>Technical Officer to Assistant Engineer</i>		
Hamilton, R. N.	H.C. Reg.	22.7.61	Golding, W. J. A.	E.T.E.	10.7.61
<i>Executive Engineer to Senior Executive Engineer</i>			Cowan, R. H.	Scot.	21.3.61
Stovold, A. T.	E.-in-C.O.	17.7.61	Graham, A. I. A.	Scot.	18.4.61
Scholey, E. A.	N.E. Reg.	2.7.61	Taylor, I. S.	Scot.	3.7.61
Piggott, T. W.	S.W. Reg.	10.7.61	Wilkes, W. D. G.	N.E. Reg.	7.7.61
Hancock, A.	Mid. Reg.	24.7.61	Luccock, A. K.	N.E. Reg.	4.7.61
Addison, R. V.	Mid. Reg. to N.W. Reg.	14.8.61	Ricketts, G. T.	Mid. Reg.	7.7.61
Ellis, D. R. B.	E.-in-C.O.	29.8.61	Keldie, T. M.	Scot.	5.6.61
Wraight, F. A. A.	H.C. Reg. to E.-in-C.O.	29.8.61	Williams, J.	N.E. Reg.	7.7.61
Glanville, J. H.	H.C. Reg.	8.9.61	Hindson, G. V.	N.E. Reg.	7.7.61
Collings, J. I.	S.W. Reg. to W.B.C.	11.9.61	Beard, J. A.	S.W. Reg.	10.7.61
Harrison, M.	N.E. Reg. to Mid. Reg.	18.9.61	Wilmer, H. C. S.	L.T. Reg.	31.7.61
Low, A. T.	E.-in-C.O.	29.9.61	Wyatt, G. T.	L.T. Reg.	31.7.61
Back, R. E. G.	E.-in-C.O.	29.9.61	Handscombe, K. C.	L.T. Reg.	31.7.61
<i>Executive Engineer (Open Competition)</i>			McGhie, L. S.	L.T. Reg.	31.7.61
Hoskyne, R. F.	E.-in-C.O.	21.3.61	Russell, R.	L.T. Reg.	31.7.61
Lines, P. W.	E.-in-C.O.	15.3.61	Beable, D. F.	L.T. Reg.	31.7.61
Coldrick, E. A.	E.-in-C.O.	2.8.61	Penrhyn, A. L.	L.T. Reg.	31.7.61
Copping, B.	E.-in-C.O.	31.7.61	Owen, E.	N.W. Reg.	30.6.61
Griffiths, G. L.	E.-in-C.O.	15.8.61	Bolan, N.	N.W. Reg.	31.7.61
<i>Assistant Engineer to Executive Engineer</i>			Fisher, J. A.	N.W. Reg.	5.7.61
Bettelley, F. F.	H.C. Reg.	15.5.61	Seabrook, C. T.	E.-in-C.O.	10.8.61
Hobden, H. A.	L.T. Reg.	13.7.61	Boniface, I. G.	E.-in-C.O.	10.8.61
Shipman, E.	N.E. Reg.	15.6.61	Cawley, K.	N.W. Reg.	27.7.61
Quilty, M. J. T.	S.W. Reg. to L.T. Reg.	4.7.61	Oldham, G. G.	N.W. Reg.	26.6.61
Loome, T. H.	H.C. Reg.	3.8.61	McLean, W. H.	N.W. Reg.	1.8.61
Marsham, C. H.	L.T. Reg. to E.-in-C.O.	4.9.61	Misselbrook, J. F.	E.-in-C.O.	10.8.61
Hawkins, N. V.	Mid. Reg.	9.8.61	Barlow, T. R.	N.W. Reg.	27.7.61
Busby, K. D.	L.T. Reg. to E.-in-C.O.	23.8.61	Pizey, H. J. E.	E.T.E.	18.8.61
Macmahon, P. J.	L.T. Reg. to E.-in-C.O.	23.8.61	Walker, R. H.	N.W. Reg.	27.7.61
Hepplestone, L.	E.-in-C.O.	27.8.61	Powell, H. J.	Mid. Reg.	17.8.61
Ash, B.	E.-in-C.O.	23.8.61	Coates, A. A.	N.W. Reg.	30.6.61
Garbutt, A. W. N.	E.-in-C.O.	23.8.61	Allison, J. W.	N.W. Reg.	24.8.61
Clemetson, K. N.	E.-in-C.O.	23.8.61	Curtis, S.	S.W. Reg.	29.8.61
Munt, E. F.	E.-in-C.O.	1.9.61	Lemon, S. J.	N.I.	16.8.61
Thurlow, N. T.	E.-in-C.O.	11.8.61	Hutchinson, A. N.	N.E. Reg.	4.9.61
Daggett, T. K.	E.-in-C.O.	11.8.61	Folkard, A.	Scot.	10.8.61
Spiceley, V. H.	E.-in-C.O.	1.9.61	Hitchin, D. J.	S.W. Reg.	10.8.61
Halton, K.	E.-in-C.O.	11.8.61	Lock, A. E.	S.W. Reg.	10.8.61
Barr, D. J.	E.-in-C.O.	1.9.61	Maunder, W. H.	S.W. Reg.	10.8.61
Walker, S. H.	N.E. Reg.	7.9.61	Owen, W. K.	E.T.E.	4.9.61
Lloyd, E. G.	N.I.	7.9.61	Kimber, K. R. F.	S.W. Reg.	11.9.61
Green, D.	N.E. Reg. to Mid. Reg.	25.9.61	Woodfield, H. A.	Mid. Reg.	18.9.61
Rowbothom, F. J.	N.I.	7.9.61	Gilder, L. O.	N.W. Reg.	4.9.61
Heathcote, S.	Mid. Reg.	7.9.61	Lambert, E. F.	W.B.C.	30.8.61
Veasey, D. W.	Mid. Reg.	7.9.61	Rogers, R. T. C.	S.W. Reg.	18.9.61
Page, F. A. T.	Mid. Reg. to N.W. Reg.	28.6.61	Tinker, M. W.	N.W. Reg.	20.9.61
Pointing, J. F.	H.C. Reg. to Mid. Reg.	9.10.61	<i>Draughtsman to Assistant Engineer</i>		
<i>Inspector to Assistant Engineer</i>			Smith, G. R.	N.E. Reg.	8.7.61
Aitken, J. A.	Scot.	29.3.61	<i>Technical Officer to Inspector</i>		
Spicer, J. A.	S.W. Reg.	13.6.61	Pritchard, H. S.	W.B.C.	3.7.61
Crookbain, E. W.	L.T. Reg.	31.7.61	Birch, T. H.	W.B.C.	20.7.61
Waller, W. A.	L.T. Reg.	31.7.61	Teall, I. H. T.	S.W. Reg.	31.8.61
Farr, H. T.	L.T. Reg.	31.7.61	Kelly, F. G.	S.W. Reg.	4.9.61
Carmichael, G. L.	L.T. Reg.	31.7.61	Wright, C. K.	N.E. Reg.	4.9.61
Broomfield, A. G.	L.T. Reg.	31.7.61	Pawley, G. F.	W.B.C.	11.9.61
Reynolds, D. G.	L.T. Reg.	31.7.61	Pike, R. C.	W.B.C.	26.9.61
Norman, I. M.	N.W. Reg.	17.7.61	<i>Technician 1 to Inspector</i>		
Burke, M. A.	N.W. Reg.	9.6.61	Somerville, J. F.	Scot.	1.5.61
Williams, C. H.	W.B.C.	8.8.61	Martin, A. D.	Scot.	1.5.61
Mogg, G. E.	W.B.C.	21.8.61	Kelday, J.	Scot.	8.5.61
			Pigden, G. E.	Mid. Reg.	7.7.61
			Ward, J.	N.W. Reg.	30.6.61
			Lowe, H.	N.W. Reg.	14.8.61
			Spender, J. W.	N.W. Reg.	17.7.61



Promotions—continued

Name	Region, etc.	Date	Name	Region, etc.	Date
<i>Technician I to Inspector—continued</i>			<i>Draughtsman to Leading Draughtsman</i>		
Wheatley, C. ..	N.E. Reg. ..	11.8.61	Garrett, J. F. ..	E.-in-C.O. ..	26.6.61
Gallagher, J. ..	N.W. Reg. ..	27.7.61	Allan, D. A. ..	Scot. ..	26.6.61
Pedder, J. ..	N.W. Reg. ..	27.7.61	Whitehouse, J. ..	W.B.C. to N.W. Reg. ..	3.7.61
Russell, F. G. H. ..	S.W. Reg. ..	10.8.61	Taylor, C. S. ..	N.E. Reg. ..	19.6.61
Bushby, J. H. ..	N.W. Reg. ..	19.6.61			
Stanfield, W. D. ..	N.I. ..	16.8.61	<i>Executive Officer to Higher Executive Officer</i>		
Paxton, A. C. ..	N.E. Reg. ..	4.9.61	Just, W. ..	E.-in-C.O. to Treasury ..	8.8.61
Mullen, H. ..	W.B.C. ..	13.9.61	Pollock, K. J. M. (Miss)	E.-in-C.O. to Customs and Excise ..	21.8.61
<i>Scientific Officer (Open Competition)</i>			<i>Clerical Officer to Executive Officer</i>		
Enoch, R. D. ..	E.-in-C.O. ..	16.8.61	Trimmer, E. A. M. (Miss)	E.-in-C.O. ..	10.7.61
Fudge, R. E. ..	E.-in-C.O. ..	23.8.61	Fenn, R. C. ..	E.-in-C.O. ..	21.8.61
<i>Assistant Experimental Officer (Open Competition)</i>			Gardner, V. E. ..	Savings Bank Department to E.-in-C.O. ..	8.8.61
Rowledge, E. (Miss) ..	E.-in-C.O. ..	10.8.61			

Retirements and Resignations

Name	Region, etc.	Date	Name	Region, etc.	Date
<i>Executive Engineer</i>			<i>Inspector—continued</i>		
Slater, G. H. ..	E.-in-C.O. ..	15.7.61	Blatchley, W. F. ..	S.W. Reg. ..	24.8.61
Symonds, A. E. J. ..	E.T.E. ..	3.2.61	Harvey, H. A. E. ..	S.W. Reg. ..	30.9.61
Proctor, F. H. ..	H.C. Reg. ..	21.2.61	Butcher, A. C. ..	L.T. Reg. ..	30.9.61
Williamson, F. J. ..	L.T. Reg. ..	16.3.61	Pope, F. (Resigned) ..	W.B.C. ..	4.9.61
Dootson, G. W. ..	H.C. Reg. ..	20.4.61			
Wheatley, E. K. ..	L.T. Reg. ..	31.5.61	<i>Principal Scientific Officer</i>		
Hall, G. W. ..	S.W. Reg. ..	12.6.61	Orchard, H. J. (Resigned)	E.-in-C.O. ..	15.8.61
Bailey, E. A. ..	L.T. Reg. ..	10.7.61			
Brown, E. B. ..	L.T. Reg. ..	31.7.61	<i>Experimental Officer</i>		
Walker, H. ..	E.-in-C.O. ..	30.6.61	Phippen, J. H. (Resigned)	E.-in-C.O. ..	31.8.61
Hudson, G. J. (Resigned)	E.-in-C.O. ..	17.7.61	Morris, F. (Resigned)	E.-in-C.O. ..	31.8.61
Harris, H. B. (Resigned)	E.-in-C.O. ..	14.7.61			
Deacon, T. A. F. ..	E.-in-C.O. ..	1.8.61	<i>Scientific Officer</i>		
Streeter, A. R. ..	E.-in-C.O. ..	10.8.61	Foster, J. R. (Resigned)	E.-in-C.O. ..	31.8.61
<i>Assistant Engineer</i>			<i>Assistant Experimental Officer</i>		
Honeyman, J. B. ..	Scot. ..	26.6.61	Engvall, P. G. ..	E.-in-C.O. ..	22.8.61
Smith, R. W. A. ..	E.T.E. ..	30.6.61	(Resigned)		
Thompson, W. L. ..	N.E. Reg. ..	7.7.61	Yule, S. K. (Miss)	E.-in-C.O. ..	25.9.61
Gooderham, J. O. ..	N.E. Reg. ..	8.7.61	(Resigned)*		
Beresford, A. T. G. ..	L.T. Reg. ..	14.7.61	<i>Temporary Assistant (Scientific)</i>		
Carter, F. C. ..	L.T. Reg. ..	20.7.61	Bruce, C. J. (Resigned)	E.-in-C.O. ..	25.8.61
Willis, S. T. ..	L.T. Reg. ..	31.7.61	Hodges, M. T. ..	E.-in-C.O. ..	25.8.61
Allam, F. H. ..	W.B.C. ..	31.7.61	(Resigned)		
Barlow, O. N. ..	N.W. Reg. ..	7.7.61	Ollis, L. K. (Miss)	E.-in-C.O. ..	31.8.61
Gould, J. W. ..	N.W. Reg. ..	17.7.61	(Resigned)		
Beynon, H. T. ..	Mid. Reg. ..	20.7.61	Solman, A. J. ..	E.-in-C.O. ..	31.8.61
Jenkins, T. G. ..	N.W. Reg. ..	28.7.61	(Resigned)		
Littlefair, W. R. ..	N.W. Reg. ..	31.7.61	Reed, M. (Resigned) ..	E.-in-C.O. ..	8.9.61
Rowe, W. A. ..	N.E. Reg. ..	1.8.61			
Ford, E. ..	Mid. Reg. ..	8.8.61	<i>Technical Assistant II</i>		
Edwards, H. L. ..	L.T. Reg. ..	11.8.61	Wilson, H. ..	Mid. Reg. ..	11.7.61
Brown, W. E. ..	Mid. Reg. ..	11.8.61			
Irwin, A. E. ..	E.-in-C.O. ..	16.8.61	<i>Leading Draughtsman</i>		
Brown, S. ..	E.T.E. ..	18.8.61	Johnstone, R. F. ..	Scot. ..	6.4.61
Sergent, T. (Resigned)	E.-in-C.O. ..	31.8.61	Minza, G. ..	Mid. Reg. ..	20.7.61
Thomas, V. F. (Resigned)	E.-in-C.O. ..	31.8.61	Glazier, G. H. ..	H.C. Reg. ..	2.9.61
Dewar, J. ..	Scot. ..	1.9.61	Popplewell, L. ..	Scot. ..	15.9.61
Traynor, W. S. ..	N.W. Reg. ..	3.9.61			
Dolman, R. A. ..	Mid. Reg. ..	16.9.61			
Packer, E. J. ..	E.-in-C.O. ..	16.9.61			
Hughes, H. B. ..	W.B.C. ..	30.9.61			
<i>Inspector</i>					
Stephens, T. G. ..	S.W. Reg. ..	31.7.61			
Allman, H. ..	N.W. Reg. ..	12.8.61			

\*Miss S. K. Yule is continuing as a disestablished officer with E.-in-C.O.

**Transfers**

Name	Region, etc.	Date	Name	Region, etc.	Date
<i>Senior Executive Engineer</i>			<i>Assistant Engineer—continued</i>		
Roberts, W. G.	.. E.-in-C.O. to H.C. Reg.	.. 12.6.61	Turton, R.	.. L.T. Reg. to N.E. Reg.	.. 28.8.61
Rubin, M. J.	.. E.-in-C.O. to E.T.E.	.. 3.7.61	Brookes, D.	.. E.-in-C.O. to H.C. Reg.	.. 11.9.61
Attwood, J. W. A.	.. War Office to Mid. Reg.	.. 8.8.61	<i>Senior Assistant (Scientific)</i>		
<i>Executive Engineer</i>			Hemming, L. H. .. Ministry of Aviation to E.-in-C.O. .. 1.9.61		
Wraight, F. A. A.	.. H.C. Reg. to Ceylon	.. 10.7.61	<i>Assistant (Scientific)</i>		
Spurlock, K. E.	.. S.W. Reg. to W.B.C.	.. 1.6.61	Smith, A. F. .. E.-in-C.O. to D.S.I.R. .. 31.7.61		
Marsh, R. V. R.	.. N.W. Reg. to Mauritius	.. 21.8.61	<i>Senior Draughtsman</i>		
Burton, A. J. H.	.. E.-in-C.O. to Ghana	.. 31.7.61	Holding, H. J. .. L.T. Reg. to H.C. Reg. .. 6.6.61		
Oatey, R. W.	.. E.-in-C.O. to L.P. Reg.	.. 11.9.61	<i>Leading Draughtsman</i>		
Gaut, R. G.	.. E.-in-C.O. to War Office	.. 25.7.61	Body, L. R. .. N.E. Reg. to S.W. Reg. .. 5.6.61		
<i>Assistant Engineer</i>			Dolman, C. T. N. .. N.W. Reg. to W.B.C. .. 5.6.61		
Scott, R. J.	.. L.P. Reg. to Prison Com- mission .. ..	.. 1.6.61	<i>Executive Officer</i>		
Crawford, A.	.. Nigeria to E.-in-C.O.	.. 5.7.61	Ogilvie, H. G. ... .. E.-in-C.O. to Treasury .. 16.7.61		
Jones, A. W.	.. E.-in-C.O. to H.C. Reg.	.. 10.7.61			
Davenport, D. K.	.. E.-in-C.O. to N.W. Reg.	.. 24.7.61			
Hammersley, S.	.. E.-in-C.O. to W.B.C.	.. 31.7.61			
Higgs, G. C. C.	.. E.-in-C.O. to France	.. 9.8.61			

**Deaths**

Name	Region, etc.	Date	Name	Region, etc.	Date
<i>Regional Engineer</i>			<i>Experimental Officer</i>		
Robins, A. G. . . . .	.. Scot. .. ..	.. 13.8.61	Cole, J. F. . . . .	.. E.-in-C.O. .. ..	.. 25.6.61
<i>Executive Engineer</i>			<i>Senior Draughtsman</i>		
May, R. H. . . . .	.. N.W. Reg. .. ..	.. 11.7.61	Mitchell, A. P. . . . . Scot. .. .. 22.8.61		
Sharpe, G. E. . . . .	.. Mid. Reg. .. ..	.. 18.9.61	<i>Leading Draughtsman</i>		
<i>Assistant Engineer</i>			Fuse, S. H. . . . . E.-in-C.O. .. .. 4.6.61		
Muir, R. . . . .	.. Scot. .. ..	.. 16.7.61			
Marlow, W. C. . . . .	.. L.T. Reg. .. ..	.. 28.7.61			

**Book Review**

“Electronic Maintainability.” Vol. 3. Edited by F. L. Ankenbrandt. Reinhold Publishing Corporation, New York, and Chapman & Hall, Ltd., London. viii + 312 pp. 75 ill. 80s.

“Maintainability” is rather sardonically defined, by one of the contributors to this volume, as the word which has replaced “reliability,” “. . . as the candidate most likely to solve all operational problems.” Several other contributors wrestle with its definition, and attempt to express it in numerical form for the purposes of specification and control. Thus, it is suggested that maintainability might be measured as the “mean time to return to service after a fault,” or, alternatively, as the “probability of returning to service within a specified interval.”

The book is based on 29 papers delivered to the Third Electronic Industries Association Conference on Maintainability of Electronic Equipment, held at San Antonio, Texas, and it exhibits the two principal failings of such conferences, namely, repetition and pot-boiling by those who have been goaded into speaking but have little to say. Despite these faults, the book makes numerous pertinent comments on maintenance; for instance, 21 questions are

listed for checking new designs, and these would convince equipment designers that maintainability is not to be achieved without substantial effort—if only they could be persuaded to turn to p. 50 and read them.

There is a general feeling among the contributors that the increasing complexity of electronic equipment is placing heavy burdens on field maintenance men, especially in the matter of diagnosis, which even now is said to occupy some 60 to 80 per cent of the repair time. The growing use of replaceable units means that field maintenance will be concentrated on finding and replacing faulty units, which will be repaired elsewhere if at all; and this means that training might concentrate more on methods of broad diagnosis and less on the details of electronic-circuit operation. As electronic systems become more complex it may be necessary to hand over fault diagnosis to built-in automatic test equipment, or even to a central computer interrogated by transmitting to it a code-group specifying the symptoms of the fault. Ironically, the increasing reliability of electronic equipment will itself present a maintenance problem, by reducing the field-man’s opportunities to practise his art.

This book can be recommended to anyone concerned with maintenance, with the warning that it is one to dip into rather than to wade through. F. J. M. L.



# The Post Office Electrical Engineers' Journal

Volume 54, April 1961—January 1962

## INDEX

	PAGE NO.		PAGE NO.
<b>A</b>		<i>C (continued)</i>	
A.C. Signalling Supplies, A Motor Alternator for Accident Prevention Posters .. .. .	268 223	COLLINGWOOD, J. D. A Calling Aid for Disabled Sub- scribers .. .. .	233
Aerial Feeders, A Swept-Frequency Method of Locating Faults in Waveguide .. .. .	27	Commission Mixte Internationale, Bournemouth, September 1961, Meeting of the .. .. .	258
Aging of Submarine Telephone Cables, A Note on the Laying Effect and .. .. .	20	Component Reliability in Post Office Equipment .. .. .	40
Alert, H.M.T.S. .. .. .	134	Computer Exhibition and Symposium on Electronic Data Processing, London, October 1961, Electronic .. .. .	257
Amplifiers for Speech and Program Circuits, Transistor Line .. .. .	238	Conveyor for Letters and Packets, A Vertical Chain .. .. .	273
Analysers for the Frequency Range 25-140 Mc/s, A Spectrum (S) .. .. .	179	Co-ordination of the Cathodic Protection of Buried Structures .. .. .	101
Anglo-Swedish Submarine Telephone Cable, The Equaliza- tion During Laying of the .. .. .	48	Cordless Switchboard, Stafford .. .. .	201
Apparatus Rooms, Ventilation of .. .. .	225	Cover for Carriageway Manholes and Joint-boxes. A New Frame and .. .. .	164
Associate Section Notes .. .. . 64, 143, 213,	285	CRISP, A. J., and BLANCHARD, C. H. Supergroup Deriva- tion Equipment .. .. .	196
Automatic Letter Sorting—The Luton Experiment .. .. .	31	CROISDALE, A. C., and EVANS, H. E. Time-Division- Multiplex Telegraphy on the Transatlantic Telephone Cable .. .. .	113
<b>B</b>		CROISDALE, A. C., and HARRISON, A. F. Testing Radio- Telegraph Automatic Error-Correcting Equipment .. .. .	245
Battery-Powered Hearing-Aid Handset—Handset No. 5, A BAXTER, E. C., and WILCOCK, A. Fleet (London) Auto- matic Telex Exchange .. .. .	271 53	<b>D</b>	
BLANCHARD, C. H., and CRISP, A. J. Supergroup Derivation Equipment .. .. .	196	DANIELS, E. E., and FORSTER, A. E. T. Subscriber Dialling of International Telex Calls .. .. .	103
BORDISS, H. J. K., and DAVIES, A. P. A 12 Mc/s Coaxial Line Equipment—C.E.L. No. 8A .. .. .	73	Data Processing, London, October 1961, Electronic Computer Exhibition and Symposium on .. .. .	257
BROCKBANK, R. A. A Note on the Laying Effect and Aging of Submarine Telephone Cables .. .. .	20	DAVIES, A. P., and BORDISS, H. J. K. A 12 Mc/s Coaxial Line Equipment—C.E.L. No. 8A .. .. .	73
Buried Structures, Co-ordination of the Cathodic Protection of .. .. .	101	de Jong, N. C. C. (Promotion to Staff Engineer) .. .. .	139
<b>C</b>		Derivation Equipment, Supergroup .. .. .	196
(C.C.I.T.T.), New Delhi, December 1960, Second Plenary Assembly of the International Telegraph and Tele- phone Consultative Committee .. .. .	130	Development of a Non-Staining Material for Telephone Feet (S) .. .. .	100
Cable System to Canada, CANTAT—A New Submarine Telephone .. .. .	220	Dialling of International Trunk Telephone Calls by United Kingdom Subscribers .. .. .	92
Cable Systems, Speaker Equipment for Submarine .. .. .	118	Dials from the Test-Desk, Testing of Subscribers' .. .. .	58
Cable, The Equalization During Laying of the Anglo- Swedish Submarine Telephone .. .. .	48	DICKIE, W. A Vertical Chain Conveyor for Letters and Packets .. .. .	273
Cable to Canada, Inauguration by Her Majesty the Queen of the New .. .. .	219	Director—Final Results of the Field Trial, The Experi- mental Electronic .. .. .	178
Cables, A Note on the Laying Effect and Aging of Sub- marine Telephone .. .. .	20	Disabled Subscribers, A Calling Aid for .. .. .	233
Cables, Location of Repeater Faults on Submarine Telephone .. .. .	252	<b>E</b>	
Cabling for Telephone Exchanges, Over-Ceiling .. .. .	82	Electronic Computer Exhibition and Symposium on Electronic Data Processing, London, October 1961 .. .. .	257
Call Offices, New Lower-half Wallboards for Pay-on- Answer Coin-Boxes in Public .. .. .	175	Electronic Director—Final Results of the Field Trial, The Experimental .. .. .	178
Calling Aid for Disabled Subscribers, A .. .. .	233	Engineer-in-Chief's Library Information Service, The .. .. .	111
CANTAT—A New Submarine Telephone Cable System to Canada .. .. .	220	Equalization During Laying of the Anglo-Swedish Submarine Telephone Cable, The .. .. .	48
Cathodic Protection of Buried Structures, Co-ordination of the .. .. .	101	Error-Correcting Equipment, Testing Radio-Telegraph Automatic .. .. .	245
Cathodic-Protection Scheme, A Joint-User .. .. .	95	Evaluation of New Types of Paint for Post Office Use, Examination and .. .. .	261
Central Service-Observation Equipment Using a Transistor-Controlled Motor-Uniselector .. .. .	9	EVANS, H. E., and CROISDALE, A. C. Time-Division- Multiplex Telegraphy on the Transatlantic Telephone Cable .. .. .	113
Central Telegraph Office, The Closing of the .. .. .	186	Examination and Evaluation of New Types of Paint for Post Office Use .. .. .	261
CHEESBROUGH, J. Stafford Cordless Switchboard .. .. .	201	Exhibition and Symposium on Electronic Data Processing, London, October 1961, Electronic Computer .. .. .	257
Closing of the Central Telegraph Office, The .. .. .	186	Experimental Electronic Director—Final Results of the Field Trial, The .. .. .	178
Coaxial Line Equipment—C.E.L. No. 8A, A 12 Mc/s .. .. .	73	<b>F</b>	
Code Marks in Automatic Letter-Facing and Sorting Machines, Use of Phosphorescent .. .. .	180	Ferrous Tapes, The Cold Rolling of Very Thin .. .. .	51
Coding Desk and Code-Mark Reader for Use with Automatic Letter-Sorting Machines .. .. .	122	Finlayson, Captain I. R. (Promotion to Submarine Superintendent) .. .. .	60
Coin-Box for Subscribers' Installations, A Pay-on- Answer .. .. .	176	Flameproof Table Telephone with an Intrinsically Safe Handset, A New .. .. .	234
Coin-Boxes in Public Call Offices, New Lower-half Wallboards for Pay-on-Answer .. .. .	175		
Cold Rolling of Very Thin Ferrous Tapes, The .. .. .	51		

	PAGE NO.		PAGE NO.
<i>F (continued)</i>		<i>L (continued)</i>	
Fleet (London) Automatic Telex Exchange ..	53	Leech, Captain W. H. (Retirement) ..	60
Flood-Testing of the Magnetic-Drum Register-Translator ..	259	Leeds Parcel-Sorting Office, The Mechanization of ..	151
FORSTER, A. E. T., and DANIELS, E. E. Subscriber Dialling of International Telex Calls ..	103	Letter-Facing and Sorting Machines, Use of Phosphorescent Code Marks in Automatic ..	180
FORSTER, C. F. Use of Phosphorescent Code Marks in Automatic Letter-Facing and Sorting Machines ..	180	Letter-Sorting Machines, Coding Desk and Code-Mark Reader for Use with Automatic ..	122
Frame and Cover for Carriageway Manholes and Joint-Boxes, A New ..	164	Letter Sorting—The Luton Experiment, Automatic ..	31
Furniture for Use in Engineering Installation Offices, New Designs of ..	57	Letters and Packets, A Vertical Chain Conveyor for ..	273
Fuses, A Tester for Surge-Resistant ..	262	Library Information Service, The Engineer-in-Chief's ..	111
<b>G</b>		LIDBETTER, E. J., and HALLIDAY, C. M. A New Small Cordless P.M.B.X. Switchboard ..	22
GARBUTT, A. W. N. A Tester for Surge-Resistant Fuses ..	262	Lighting of Telephone Apparatus Repair Benches, The ..	274
GEE, J. H. A Motor Alternator for A.C. Signalling Supplies ..	268	Location of Repeater Faults on Submarine Telephone Cables ..	252
GERARD, P. S., and PILLING, T. Automatic Letter Sorting—The Luton Experiment ..	31	LORD, G. W. The Cold Rolling of Very Thin Ferrous Tapes ..	51
GRIFFITHS, D. C. The Engineer-in-Chief's Library Information Service ..	111	Loudspeaking-Telephone No. 1, A Loudspeaking Telephone without Voice Switching— ..	1
<b>H</b>		Loudspeaking Telephone without Voice Switching—Loudspeaking-Telephone No. 1, A ..	1
H.M.T.S. Alert ..	134	LOWE, W. T. A Battery-Powered Hearing-Aid Handset—Handset No. 5 ..	271
HALLIDAY, C. M., and LIDBETTER, E. J. A New Small Cordless P.M.B.X. Switchboard ..	22	LOWE, W. T. A Telephone for Subscribers with Weak Voices ..	242
Handset No. 5, A Battery-Powered Hearing-Aid Handset— ..	271	LOWE, W. T., and WILSON, F. A. A Loudspeaking Telephone without Voice Switching—Loudspeaking-Telephone No. 1 ..	1
HARRISON, A. F., and CROISDALE, A. C. Testing Radio-Telegraph Automatic Error-Correcting Equipment ..	245	Luton Experiment, Automatic Letter Sorting—The ..	31
Hearing-Aid Handset—Handset No. 5, A Battery-Powered ..	271	<b>M</b>	
HEARN, A. F. L., and JENNINGS, S. W. A New Frame and Cover for Carriageway Manholes and Joint-Boxes ..	164	Magnetic-Drum Register-Translator, Flood-Testing of the Manholes and Joint-Boxes, A New Frame and Cover for Carriageway ..	259
Height-Measuring Instruments, An Optical ..	250	Material for Telephone Feet, Development of a Non-Staining (S) ..	100
Her Majesty the Queen of the New Cable to Canada, Inauguration by ..	219	MAURER, C. J. Dialling of International Trunk Telephone Calls by United Kingdom Subscribers ..	92
HIX, K. W. Solderless Wrapped Joints in Telephone Exchanges ..	204	MAY, C. A. New Methods of Meter-Pulse Registration ..	168
HOOPER, J. A Swept-Frequency Method of Locating Faults in Waveguide Aerial Feeders ..	27	Measuring Techniques for the Inspection of Apparatus Parts ..	235
HOPWOOD, R. W. Ventilation of Apparatus Rooms ..	225	Mechanization of Leeds Parcel-Sorting Office, The ..	151
HORROCKS, P., and PILLING, T. Coding Desk and Code-Mark Reader for Use with Automatic Letter-Sorting Machines ..	122	Meeting of the Commission Mixte Internationale, Bournemouth, September 1961 ..	258
HUTT, B. J., and JARVIS, J. R. Pulse Code Modulation (Part 2) ..	189	Meter-Pulse Registration, New Methods of ..	168
<b>I</b>		Modulation, Pulse Code (Parts 1 and 2) ..	86, 189
Inauguration by Her Majesty the Queen of the New Cable to Canada ..	219	MORSE, C. E. A Joint-User Cathodic-Protection Scheme ..	95
Inspection of Apparatus Parts, Measuring Techniques for the ..	235	Motor Alternator for A.C. Signalling Supplies ..	268
Installation Offices, New Designs of Furniture for Use in Engineering ..	57	<b>N</b>	
Institution of Post Office Electrical Engineers ..	61, 140, 209, 277	NEW, A. A. Component Reliability in Post Office Equipment ..	40
Internal-Combustion Engine, Propane Gas as a Fuel for Small ..	265	New Designs of Furniture for Use in Engineering Installation Offices ..	57
International Congress on Telephone Traffic, Paris, 1961, The Third ..	244	New Flameproof Table Telephone with an Intrinsically Safe Handset, A ..	234
International Telex Calls, Subscriber Dialling of ..	103	New Frame and Cover for Carriageway Manholes and Joint-Boxes, A ..	164
International Trunk Telephone Calls by United Kingdom Subscribers, Dialling of ..	92	New Lower-half Wallboards for Pay-on-Answer Coin-Boxes in Public Call Offices ..	175
<b>J</b>		New Methods of Meter-Pulse Registration ..	168
JARVIS, J. R., and HUTT, B. J. Pulse Code Modulation (Part 2) ..	189	New Small Cordless P.M.B.X. Switchboard, A ..	22
JEFFREY, R. J. Measuring Techniques for the Inspection of Apparatus Parts ..	235	Note on the Laying Effect and Aging of Submarine Telephone Cables, A ..	20
JENNINGS, S. W., and HEARN, A. F. L. A New Frame and Cover for Carriageway Manholes and Joint-Boxes ..	164	Notes and Comments ..	60, 139, 208, 276
Joint-Boxes, A New Frame and Cover for Carriageway Manholes and ..	164	<b>O</b>	
Joint-User Cathodic-Protection Scheme, A ..	95	O'BRIEN, E. J. C. The Closing of the Central Telegraph Office ..	186
Joints in Telephone Exchanges, Solderless Wrapped ..	204	Optical Height-Measuring Instrument, An ..	250
JONES, T. L. H.M.T.S. Alert ..	134	Over-Ceiling Cabling for Telephone Exchanges ..	82
<b>L</b>		<b>P</b>	
Lawrence, J. A. (Promotion to Staff Engineer) ..	276	P.M.B.X. Switchboard, A New Small Cordless ..	22
LAWRENCE, J. P. The Unit Method of Automatic Telephone Exchange Design ..	14	Packets, A Vertical Chain Conveyor for Letters and ..	273
Laying Effect and Aging of Submarine Telephone Cables, A Note on the ..	20	Paint for Post Office Use, Examination and Evaluation of New Types of ..	261
		Papers and Articles on Telecommunications and Other Scientific Subjects ..	70
		Parcel-Sorting Office, The Mechanization of Leeds ..	151
		Pay-on-Answer Coin-Box for Subscribers' Installations, A ..	176



	PAGE NO.
<i>P (continued)</i>	
PILLING, T., and GERRARD, P. S. Automatic Letter Sorting—The Luton Experiment .. .. .	31
PILLING, T., and HORROCKS, P. Coding Desk and Code-Mark Reader for Use with Automatic Letter-Sorting Machines .. .. .	122
Posters, Accident Prevention .. .. .	223
POVEY, J. A., and ROBERTS, W. G. Over-Ceiling Cabling for Telephone Exchanges .. .. .	82
Program Circuits, Transistor Line Amplifiers for Speech and .. .. .	238
Propane Gas as a Fuel for Small Internal-Combustion Engines .. .. .	265
Pulse Code Modulation	
Part 1—An Introduction to Pulse Code Modulation ..	86
Part 2—An Experimental 12-Channel Equipment ..	189
<b>R</b>	
Radio-Telegraph Automatic Error-Correcting Equipment, Testing .. .. .	245
Reader for Use with Automatic Letter-Sorting Machines, Coding Desk and Code-Mark .. .. .	122
Recent Developments in Automatic Telephone Exchange Trunking .. .. .	157
REDBURN, L. A., and STEPHENSON, M. Speaker Equipment for Submarine Cable Systems .. .. .	118
Reflectometers .. .. .	37
Regional Notes .. .. .	62, 142, 210, 278
Register-Translator, Flood-Testing of the Magnetic-Drum Reliability in Post Office Equipment, Component .. .. .	40
Repair Benches, The Lighting of Telephone Apparatus ..	274
Repeater Faults on Submarine Telephone Cables, Location of .. .. .	252
ROBERTS, W. G., and POVEY, J. A. Over-Ceiling Cabling for Telephone Exchanges .. .. .	82
ROGERS, J. D. The Mechanization of Leeds Parcel-Sorting Office .. .. .	151
<b>S</b>	
SCOWEN, F. Location of Repeater Faults on Submarine Telephone Cables .. .. .	252
SCOWEN, F. The Equalization During Laying of the Anglo-Swedish Submarine Telephone Cable .. .. .	48
Second Plenary Assembly of the International Telegraph and Telephone Consultative Committee (C.C.I.T.T.), New Delhi, December 1960 .. .. .	130
SENIOR, R. C., and WHITE, P. S. Propane Gas as a Fuel for Small Internal-Combustion Engines .. .. .	265
Service-Observation Equipment Using a Transistor-Controlled Motor-Uniselector, Central .. .. .	9
SEYMOUR, E. H. A Pay-on-Answer Coin-Box for Subscribers' Installations .. .. .	176
SEYMOUR, E. H. New Designs of Furniture for Use in Engineering Installation Offices .. .. .	57
SEYMOUR, E. H. New Lower-half Wallboards for Pay-on-Answer Coin-Boxes in Public Call Offices .. .. .	175
Solderless Wrapped Joints in Telephone Exchanges ..	204
Sorting Machines, Use of Phosphorescent Code Marks in Automatic Letter-Facing and .. .. .	180
Sowton, C. W. (Promotion to Staff Engineer) .. .. .	208
Speaker Equipment for Submarine Cable Systems .. .. .	118
Spectrum Analyser for the Frequency Range 25–140 Mc/s, A (S) .. .. .	179
Speech and Program Circuits, Transistor Line Amplifiers for .. .. .	238
SPURGIN, D. A. The Lighting of Telephone Apparatus Repair Benches .. .. .	274
Staff Changes .. .. .	67, 158, 215, 288
Stafford Cordless Switchboard .. .. .	201
STEPHENSON, M., and REDBURN, L. A. Speaker Equipment for Submarine Cable Systems .. .. .	118
STOTT, J. An Optical Height-Measuring Instrument ..	250
Submarine Telephone Cable System to Canada, CANTAT—A New .. .. .	220
Submarine Telephone Cables, A Note on the Laying Effect and Aging of .. .. .	20

	PAGE NO.
<i>S (continued)</i>	
Submarine Telephone Cables, Location of Repeater Faults on .. .. .	252
Subscriber Dialling of International Telex Calls .. ..	103
Subscribers' Installations, A Pay-on-Answer Coin-Box for Supergroup Derivation Equipment .. .. .	176
Surge-Resistant Fuses, A Tester for .. .. .	196
Swept-Frequency Method of Locating Faults in Waveguide Aerial Feeders, A .. .. .	262
Symposium on Electronic Data Processing, London, October 1961, Electronic Computer Exhibition and ..	27
<b>T</b>	
Telegraphy on the Transatlantic Telephone Cable, Time-Division-Multiplex .. .. .	113
Telephone Calls by United Kingdom Subscribers, Dialling of International Trunk .. .. .	92
Telephone Exchange Design, The Unit Method of Automatic .. .. .	14
Telephone Exchange Trunking, Recent Developments in Automatic .. .. .	157
Telephone Feet, Development of a Non-Staining Material for (S) .. .. .	100
Telephone for Subscribers with Weak Voices, A .. .. .	242
Telephone with an Intrinsically Safe Handset, A New Flameproof Table .. .. .	234
Telephone without Voice Switching—Loudspeaking-Telephone No. 1, A Loudspeaking .. .. .	1
Telex Calls, Subscriber Dialling of International .. ..	103
Telex Exchange, Fleet (London) Automatic .. .. .	53
Test-Desk, Testing of Subscribers' Dials from the .. ..	58
Tester for Surge-Resistant Fuses, A .. .. .	262
Testing of Subscribers' Dials from the Test-Desk .. ..	58
Testing Radio-Telegraph Automatic Error-Correcting Equipment .. .. .	245
Third International Congress on Telephone Traffic, Paris, 1961, The .. .. .	244
THOMSON, D. Transistor Line Amplifiers for Speech and Program Circuits .. .. .	238
Time-Division-Multiplex Telegraphy on the Transatlantic Telephone Cable .. .. .	113
Transatlantic Telephone Cable, Time-Division-Multiplex Telegraphy on the .. .. .	113
Transistor Line Amplifiers for Speech and Program Circuits .. .. .	238
Trunking, Recent Developments in Automatic Telephone Exchange .. .. .	157
12 Mc/s Coaxial Line Equipment—C.E.L. No. 8A, A .. ..	73
<b>U</b>	
Unit Method of Automatic Telephone Exchange Design, The .. .. .	14
Use of Phosphorescent Code Marks in Automatic Letter-Facing and Sorting Machines .. .. .	180
<b>V</b>	
Ventilation of Apparatus Rooms .. .. .	225
Vertical Chain Conveyor for Letters and Packets, A ..	273
VIGAR, C. D. Central Service-Observation Equipment Using a Transistor-Controlled Motor-Uniselector .. ..	9
<b>W</b>	
Wallboards for Pay-on-Answer Coin-Boxes in Public Call Offices, New Lower-half .. .. .	175
WATT-CARTER, D. E. Reflectometers .. .. .	37
Waveguide Aerial Feeders, A Swept-Frequency Method of Locating Faults in .. .. .	27
WHERRY, A. B. Recent Developments in Automatic Telephone Exchange Trunking .. .. .	157
WHITE, P. S., and SENIOR, R. C. Propane Gas as a Fuel for Small Internal-Combustion Engines .. .. .	265
WHYTE, J. S. Pulse Code Modulation (Part 1) .. .. .	86
WILCOCK, A., and BAXTER, E. C. Fleet (London) Automatic Telex Exchange .. .. .	53
WILSON, F. A., and LOWE, W. T. A Loudspeaking Telephone without Voice Switching—Loudspeaking-Telephone No. 1 .. .. .	1

## BOARD OF EDITORS

D. A. BARRON, M.Sc., M.I.E.E., Chairman.  
 L. F. SCANTLEBURY, Whit.Sch., A.C.G.I., D.I.C., M.I.E.E.  
 T. H. FLOWERS, M.B.E., B.Sc.(Eng.), M.I.E.E.  
 W. J. E. TOBIN, B.Sc.(Eng.), A.C.G.I., D.I.C., M.I.E.E.  
 G. J. MILLEN, A.M.I.E.E.  
 D. J. HARRIS, B.Sc.(Eng.), A.M.I.E.E.  
 R. F. WALDEGRAVE.  
 E. DAVIS, A.M.I.E.E., Managing Editor.  
 A. G. LEIGHTON, B.Sc.(Eng.), A.M.I.E.E., Deputy Managing Editor.  
 J. MARTIN, B.Sc.(Eng.), A.M.I.E.E. } Assistant Editors.  
 R. A. SUDELL }  
 B. FARR, A.B.I., Secretary-Treasurer.  
 B. CROSS, Advertisement Manager.

### Copyright

The entire contents of this Journal are covered by general copyright, and special permission is necessary for reprinting long extracts, but editors are welcome to use not more than one-third of any article, provided that credit is given at the beginning or end thus: "From *The Post Office Electrical Engineers' Journal*."

The Board of Editors is not responsible for the statements made or the opinions expressed in any of the articles in this Journal, unless such statement is made specifically by the Board.

### Subscriptions and Back Numbers

The Journal is published quarterly, in April, July, October and January, price 2s. 6d. (3s. 6d. post paid) per copy or 14s. per year post paid (2 dollars 25 cents, Canada and U.S.A.). Back numbers will be supplied, if available, price 2s. 6d. (3s. 6d. post paid) per copy. Copies of the April 1959 and all earlier Journals are no longer available. Orders should be sent to *The Post Office*

*Electrical Engineers' Journal*, G.P.O., 2-12 Gresham Street, London, E.C.2.

Employees of the British Post Office can obtain the Journal through local agents.

### Binding

Readers can have their copies of volumes bound at a cost of 15s. by sending the complete set of parts to the local Post Office distribution agent or to *The Post Office Electrical Engineers' Journal*, G.P.O., 2-12 Gresham Street, London, E.C.2.

### Remittances

Remittances should be made payable to "*The P.O.E.E. Journal*" and should be crossed "& Co."

### Advertisements

All correspondence relating to advertisement space reservations, copy, proofs, etc., should be addressed to the Advertisement Manager, *The Post Office Electrical Engineers' Journal*, G.P.O., 2-12 Gresham Street, London, E.C.2.

### Communications

With the exceptions indicated above, all communications should be addressed to the Managing Editor, *The Post Office Electrical Engineers' Journal*, G.P.O., 2-12 Gresham Street, London, E.C.2. Telephone: HEADquarters 1234.

### Model Answer Books

Books of model answers to certain of the City and Guilds of London Institute examinations in telecommunications are published by the Board of Editors. Details of the books available are given at the end of the Supplement to the Journal.

**More** for less...

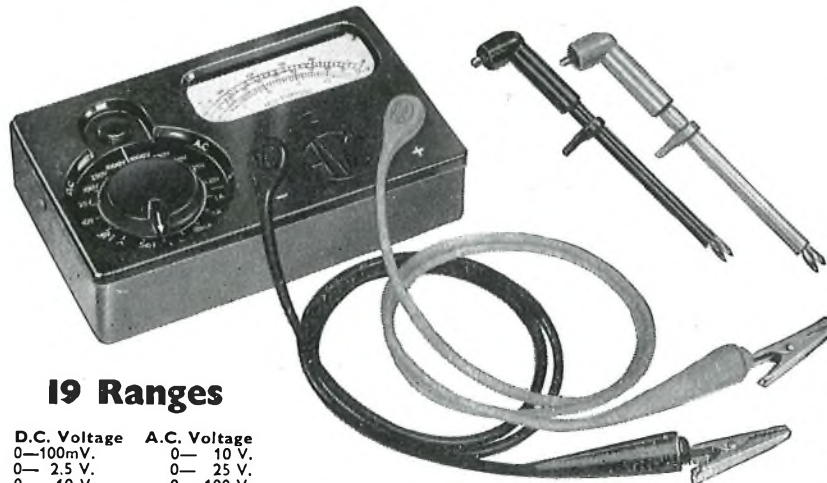

### 19 Ranges

<b>D.C. Voltage</b>	<b>A.C. Voltage</b>
0-100mV.	0- 10 V.
0- 2.5 V.	0- 25 V.
0- 10 V.	0- 100 V.
0- 25 V.	0- 250 V.
0- 100 V.	0-1000 V.
0- 250 V.	
0-1000 V.	
<b>D.C. Current</b>	
0-100µA	
0- 1mA	
0-10mA	
0-100mA	
0-20,000Ω	
0-2MΩ	
	0- 1 A

List Price: **£9 : 10s.**

complete with test Leads and Crocodile Clips.

Leather case if required 39/-

Size 5½ × 3½ × 1½ in.  
 Weight: 1 lb. approx.

**DESIGNED** to offer the widest possible range of accurate and reliable measurements at the lowest possible price, the versatility and usefulness of the Multiminor are further extended by specially designed leads. These leads, available at no extra cost, will accept crocodile clips or PRODCLIPS.

The Multiminor takes full advantage of the possibilities of printed circuit techniques to achieve outstanding compactness and economy of weight. The scale is clear and open. The fine red coloured pointer and effectively damped movement facilitate easy and rapid reading.

For use in Radio, TV, Electronics, Motor Vehicles, domestic appliances, workshop equipment, you'll find the Multiminor a great little meter!

**Use PRODCLIPS with the Multiminor (Pat. No. 748811)**

These cleverly designed spring-loaded insulated prods are the complete answer to a long-standing problem. Press the trigger to open. release to grip. Keep your hands free no matter how difficult of access your test points may be! **15/- per pair**

...with the

**MULTIMINOR**

Write now for illustrated literature to:

**AVO LTD** AVOCET HOUSE · 92-96 VAUXHALL BRIDGE ROAD  
 LONDON S.W.1

VICTORIA 3404 (12 lines)



A MEMBER OF THE METAL INDUSTRIES GROUP OF COMPANIES



# CANTAT

The new all-British cable from the British Isles to Newfoundland is equipped with 90 submerged telephone repeaters. All these were manufactured by

# STC



62/1C

*Standard Telephones and Cables Limited*

TRANSMISSION SYSTEMS DIVISION · NORTH WOOLWICH · LONDON E.16



## VALUABLE FREE BOOK



### Tells You How to Pass Your C. & G. or Promotion Exam. at First Attempt!

All Post Office personnel who are anxious to obtain early promotion should at once send for a copy of our handbook "ENGINEERING OPPORTUNITIES" which, among other intensely interesting matter, describes our unique methods of preparation for the G.P.O., LIMITED COMPETITIONS for appointment as Assistant Engineer, Executive Engineer, Traffic Officer, Telecommunications Traffic Superintendent; CITY AND GUILDS EXAMINATIONS for the Telecommunication Technicians' Certificate and for individual subjects—Mathematics, Engineering Science, Engineering Drawing, Elementary Telecommunication Practice, Telecommunication Principles, Radio and Line Transmission, Telegraphy and Telephony, Line Plant Practice. It also contains details of our courses covering the City and Guilds Examinations in Electrical Engineering Practice, the Grad. Brit.I.R.E. and A.M.S.E. Examinations, in addition to a wide range of non-examination courses in all branches of engineering—Radio and Electronics, Electrical, Mechanical, etc.

We also provide tuition for the Radio Amateurs' Examination and the P.M.G. Certificates for Radio Operators, with or without Morse training. Details are given in the handbook.

**We definitely guarantee  
"NO PASS—NO FEE"**

If you intend to make the most of today's opportunities, you cannot afford to miss reading "ENGINEERING OPPORTUNITIES." It tells you everything you want to know to secure advancement, and describes many opportunities you may now be missing through lack of information—Send for your copy today—FREE and without obligation.

BRITISH INSTITUTE  
OF ENGINEERING TECHNOLOGY  
369 COLLEGE HOUSE,  
29-31 WRIGHT'S LANE, LONDON, W.8

# BIET

## MINIATURE AND MICROMINIATURE ELECTRONICS

G. W. A. Dummer, M.B.E., M.I.E.E.  
and J. W. Granville, B.Sc., Ph.D.

An important addition to the literature of electronics. Here are clear, non-mathematical descriptions of the workings of miniature circuits and micro-circuits, with specifications of thirty-four types of transistor. Both the authors are with the Royal Radar Establishment: Mr. Dummer is the author of several other authoritative books on electronics. 45/- net.

## TELEPHONY : VOLUMES I AND II

J. Atkinson, M.I.E.E.

Universally regarded as the standard work on the subject, this is the completely revised edition of Herbert and Procter's original study. The first volume is devoted to the signalling and switching aspects of telephony, while the second deals with Automatic Exchange systems. Between them they cover the complete syllabus of the City and Guilds examinations in Telephone Exchange Systems. Vol. I. 40/- net.

Vol. II. 55/- net.

**PITMAN** Parker St., Kingsway, London, W.C.2

# Ernest Turner

## Electrical Measuring Instruments

Ideally matching contemporary panel design, the Ernest Turner Model 703, illustrated here, is enhanced by the flush-fitting surround. A high degree of accuracy is adequately supported by the easy-to-read scale and clean dial layout. Full details of the range of rectangular electrical measuring instruments and flush mountings are contained in Leaflets 85/G and 85/AF, available on request.

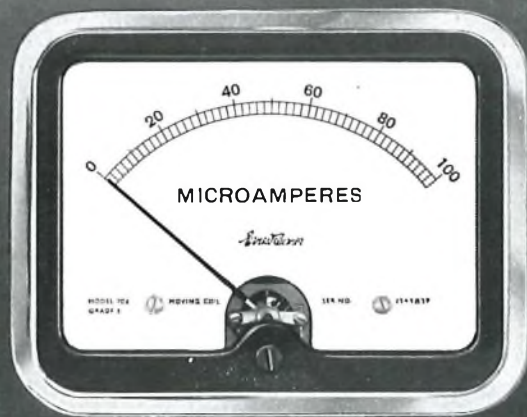

**Ernest Turner Electrical Instruments Ltd**  
HIGH WYCOMBE · BUCKINGHAMSHIRE · ENGLAND



# STC

## telecommunication cables



Contractors to the  
British Post Office  
British Railways  
British Commonwealth  
Government Depts.  
And numerous Home and  
Overseas administrations

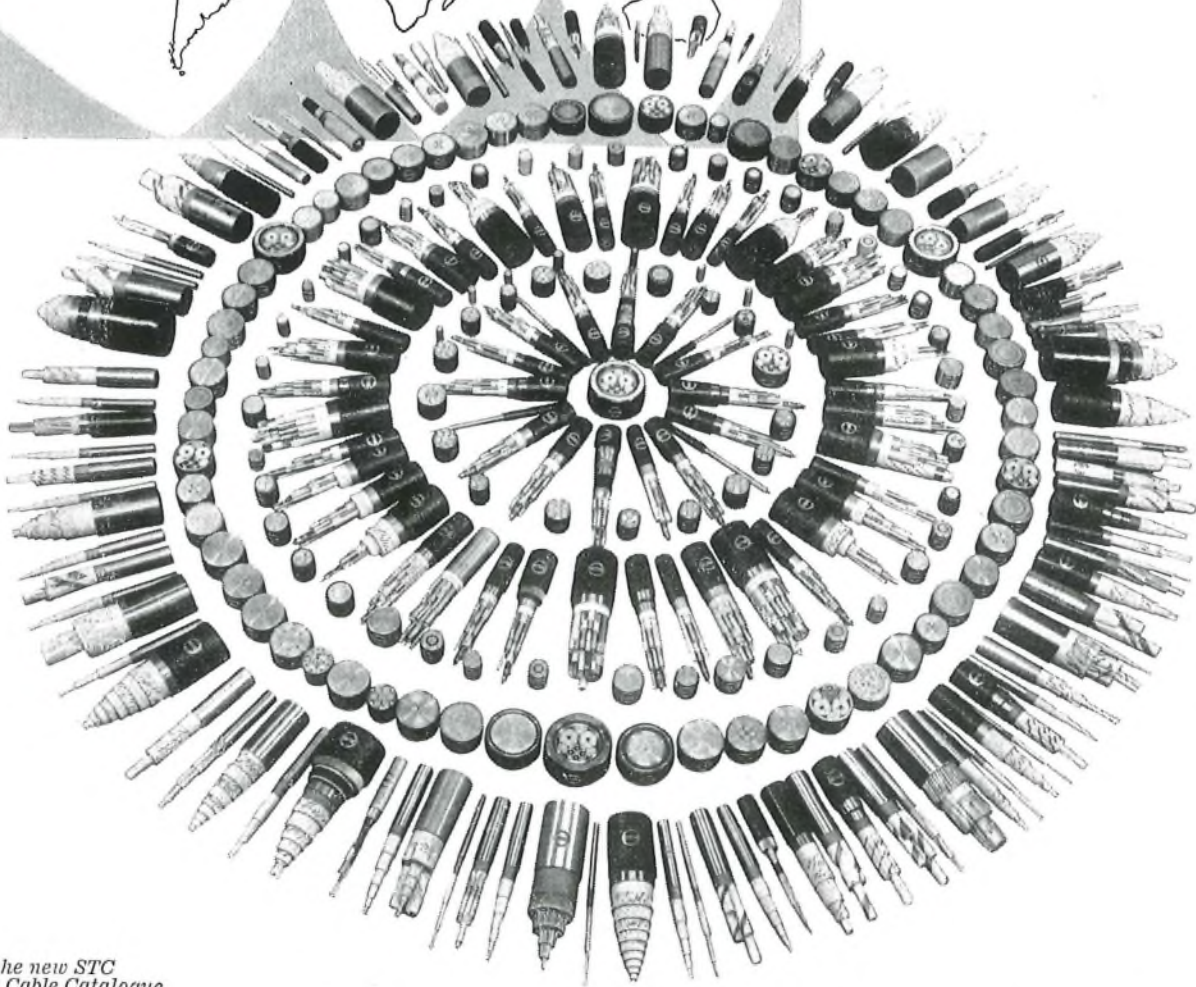

Write for the new STC  
Telephone Cable Catalogue  
B/102

STC DEVELOP, MANUFACTURE, AND INSTALL ALL TYPES OF TELECOMMUNICATION CABLES



c1/5B

*Standard Telephones and Cables Limited*

TELEPHONE CABLE DIVISION: NORTH WOOLWICH · LONDON E.16





# Rectifiers

FOR

## ANGLO - SWEDISH SUBMERGED COAXIAL CABLE

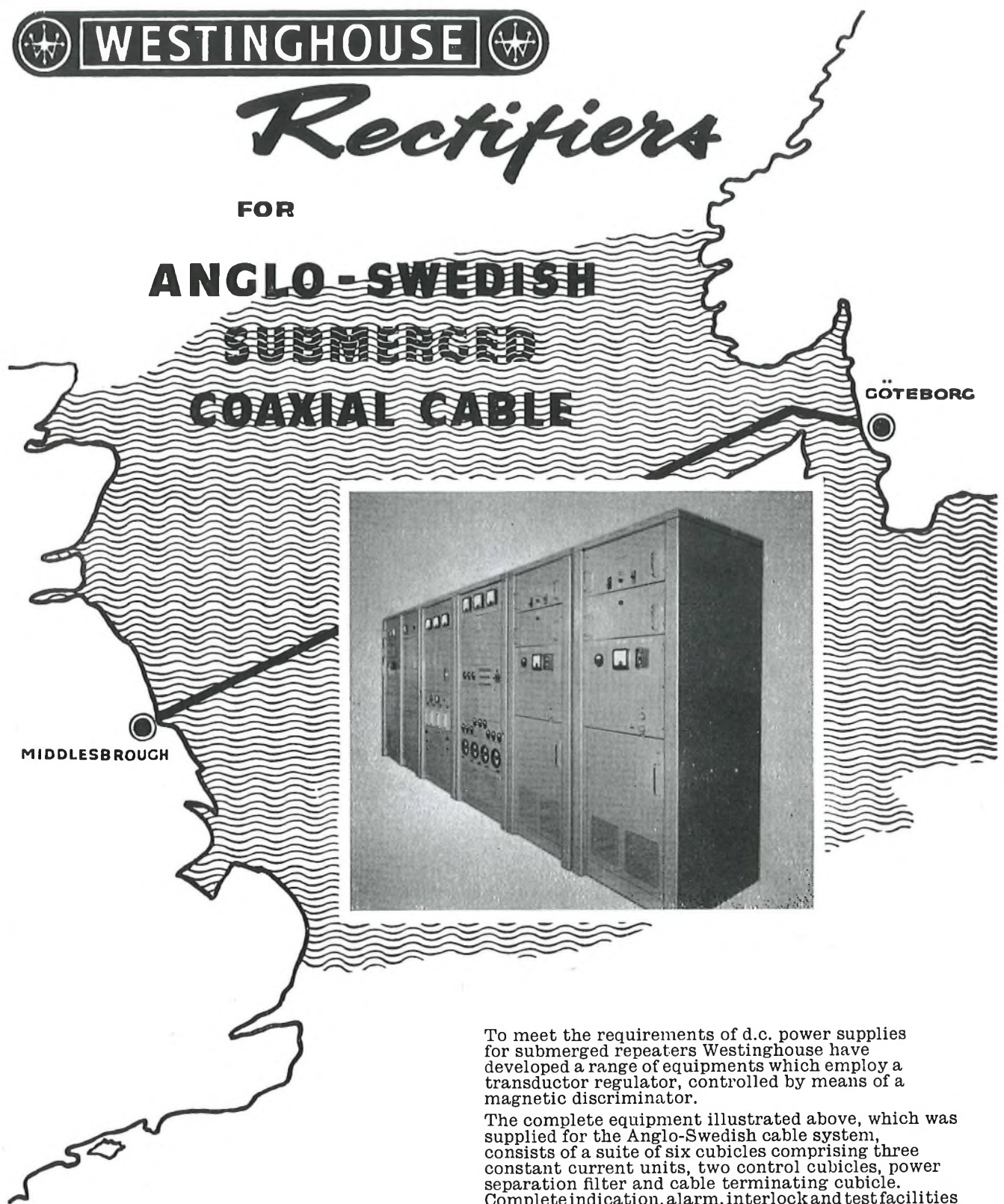

To meet the requirements of d.c. power supplies for submerged repeaters Westinghouse have developed a range of equipments which employ a transducer regulator, controlled by means of a magnetic discriminator.

The complete equipment illustrated above, which was supplied for the Anglo-Swedish cable system, consists of a suite of six cubicles comprising three constant current units, two control cubicles, power separation filter and cable terminating cubicle. Complete indication, alarm, interlock and test facilities are built into the equipment.

Other equipments are at present in the course of being supplied for the Transatlantic Cable System, H.M.T.S. Monarch, and the Bermuda Manahawkin Link.

For full details of Westinghouse rectifiers for telecommunications please write to Dept. P.O. 10/61, Rectifier Division (Special Products)  
WESTINGHOUSE BRAKE AND SIGNAL CO. LTD • 82 YORK WAY, KING'S CROSS • LONDON, NI.

Terminus 6432



- used in communication networks in 18 countries.
- oscillator cavities and T.W.T. circuits available or 'tailored' to individual requirements.

H-wave Oscillators  
Range 5.6 to 7.8 Gc/s

Klystrons

Coaxial Line Oscillators  
Range 0.5 to 5 Gc/s

Backward Wave Oscillators  
Range 4 to 40 Gc/s

Travelling Wave Tubes  
Medium power and low noise tubes,  
Range 2.5 to 7.5 Gc/s

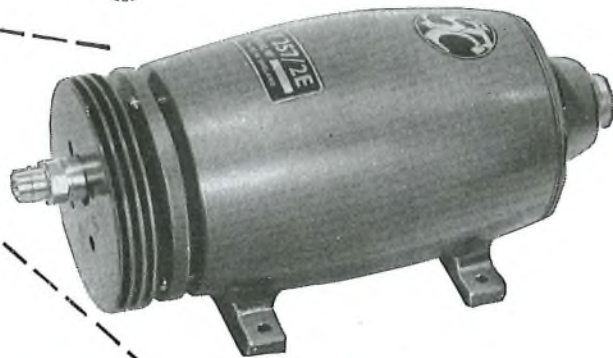
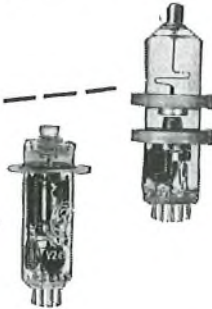

# STC

## MICROWAVE TUBES

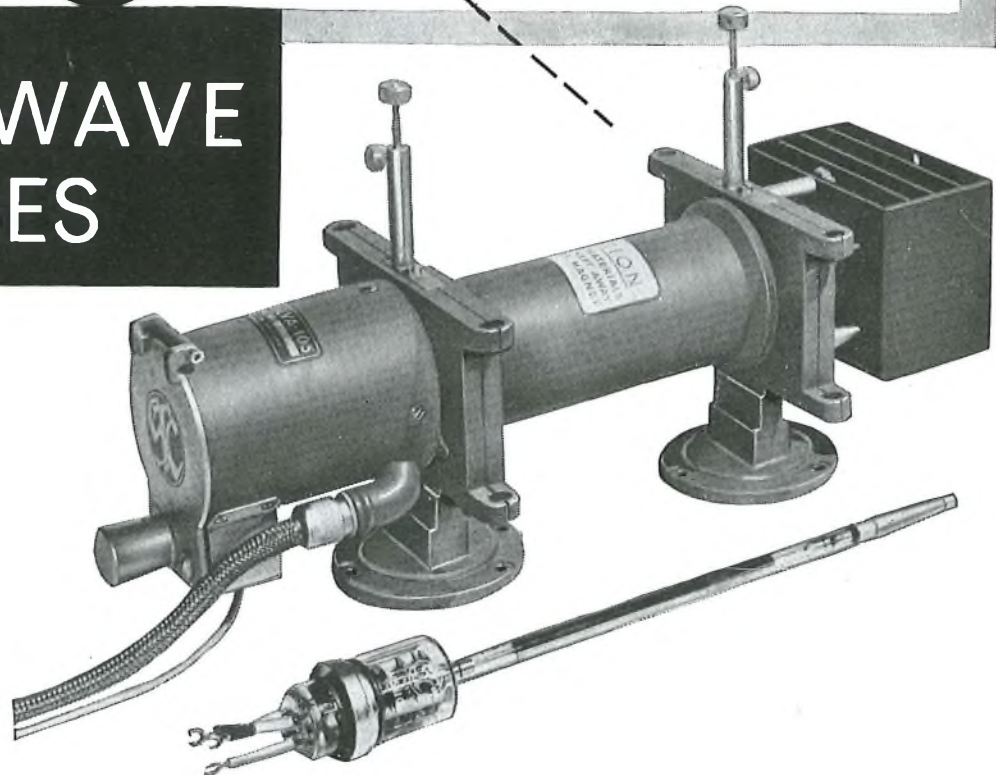

Send for brochure MS/113—  
STC MICROWAVE TUBES



61/13MS

**Standard Telephones and Cables Limited**

VALVE DIVISION: BRIXHAM ROAD · PAIGNTON · DEVON  
LONDON SALES OFFICE · FOOTSCRAY · KENT · FOOTSCRAY 3333



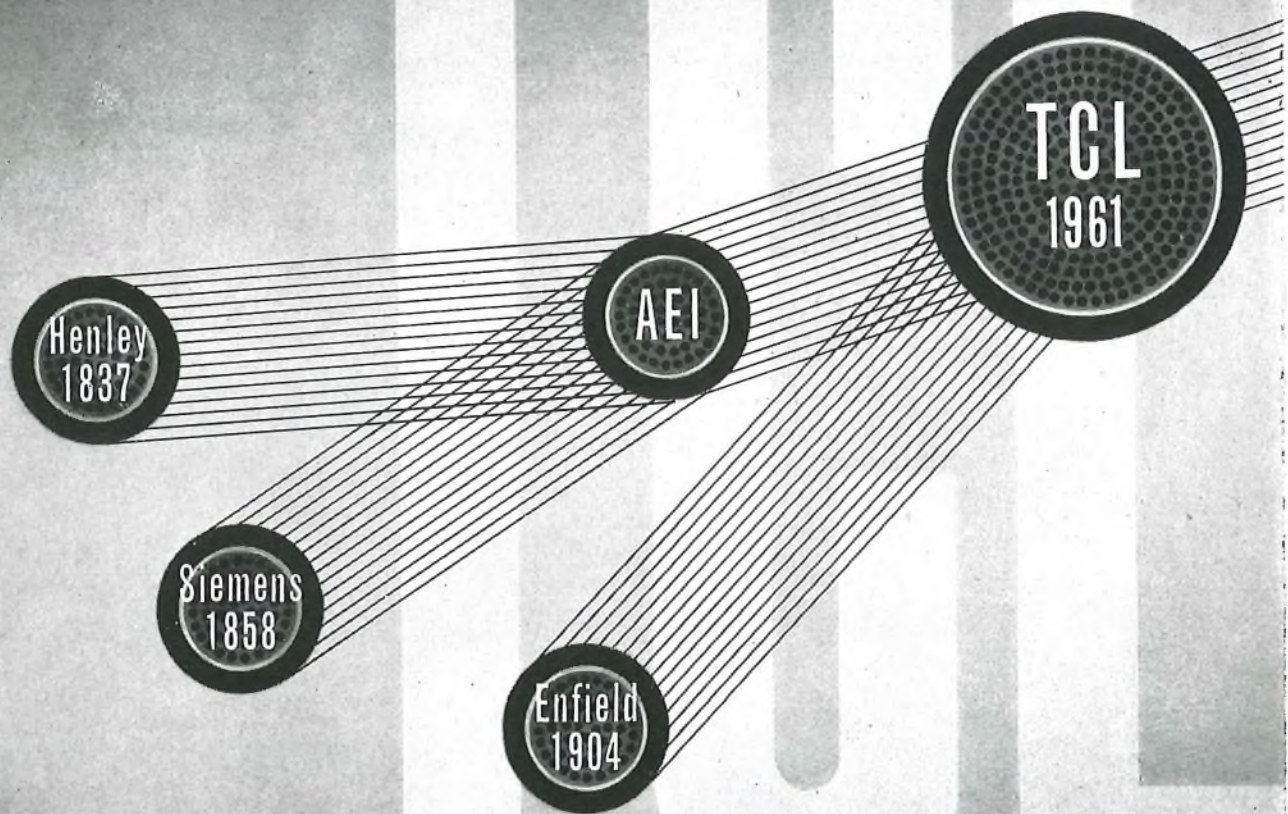

background  
to a new  
name

**TELEPHONE CABLES LIMITED** combines in a single manufacturing and trading unit the experience and resources of several companies, each with vast experience in the production and installation of telephone cables.

As a unit, established in Dagenham more than 50 years ago, it is now the most modern factory in the United Kingdom for the production of plastic and paper insulated telephone cables, with facilities which enable prompt deliveries and service to be assured.

CHEQUERS LANE, DAGENHAM, ENGLAND TELEPHONE: DOMINION 6611 CABLES: DRYCORE DAGENHAM



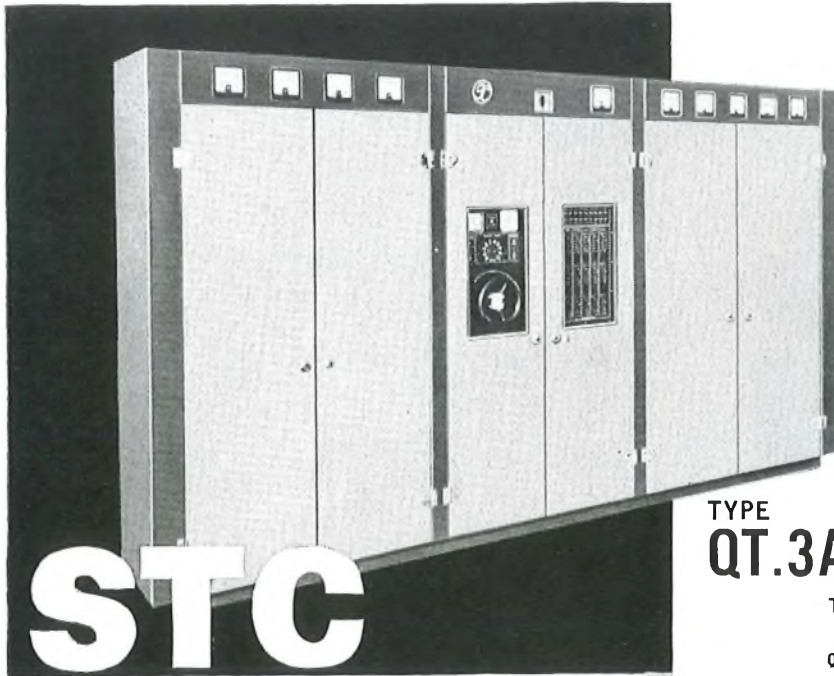

# STC

medium and  
high power  
ISB and  
general purpose  
transmitters

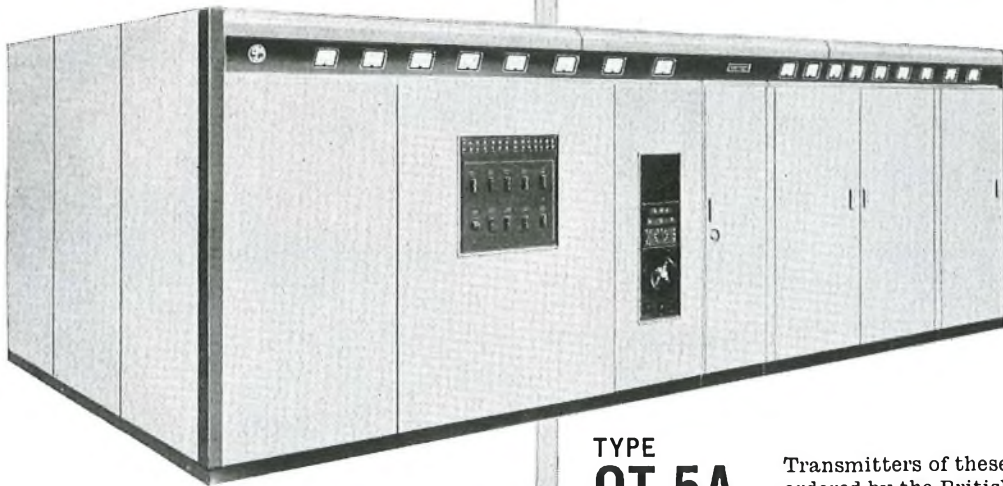

TYPE  
**QT.5A**

This versatile range of transmitters covers a variety of service requirements and is suitable for operation in widely differing climatic conditions.

STC's many years experience in the design and manufacture of radio transmitters is reflected in the high efficiency, reliability, robust construction and ease of operation of the equipments.

Whereas a high degree of standardization permits economy in spares holdings, the flexibility of design enables users' special requirements to be embodied into the equipments.

Type	Frequency Range	Output Power
QT.3A	2.5—28 Mc/s	8 kW for single frequency operation or 8 kW p.e.p. for multichannel working.
QT.4A	4—27.5 Mc/s	20 kW for single frequency operation or 30 kW p.e.p. for multichannel working.
QT.5A	4—27.5 Mc/s	85 kW for single frequency operation or 80 kW p.e.p. for multichannel working. Instantaneous change to high efficiency low power working.

- Suitable for Radio Telephone and Telegraph Links
- Automatic Tuning and Loading
- v.s.w.r. Monitor
- Synthesizer or Crystal Control
- Rapid Fault Location by Metering and Lamps
- Tuning and Loading automatically corrected for varying v.s.w.r.
- Full Remote Control
- Suitable for unattended operation

Transmitters of these types have been ordered by the British Post Office.



61/9E

**Standard Telephones and Cables Limited**

RADIO DIVISION : OAKLEIGH ROAD · NEW SOUTHGATE · LONDON N.11





**G.E.C.**

# **BROADBAND RADIO EQUIPMENT**

once again chosen by the

## **BRITISH POST OFFICE**

**SHF**

### **Leicester**



**Peterborough  
Shrewsbury  
Stokenchurch**

GEC has been awarded contracts to supply and install further extensions to the national broadband microwave network. Two SHF radio channels are to be provided in each direction between Leicester and Peterborough, Leicester and Shrewsbury and Leicester and Stokenchurch.

These systems will operate in the 6000 Mc/s frequency band and can be extended by the addition of further RF channels. One RF channel acts as a standby channel to several working channels and can be switched in automatically in the event of failure or degradation of a working channel. The equipment conforms to the latest CCIR recommendations.

A contract has also been received for a UHF link between Alderney and Jersey in the Channel Islands. This link will provide three unidirectional channels for television (video plus sound) in the direction Alderney to Jersey. This system will employ GEC radio equipment operating in the 2000 Mc/s frequency band.

**UHF**

### **Alderney – Jersey**

*For further information, please write for Standard Specification SPO 5555*

## **FOR TELECOMMUNICATIONS**

TRANSMISSION DIVISION

THE GENERAL ELECTRIC COMPANY OF ENGLAND

Telephone Works · Coventry · England · Works at Coventry · London · Middlesbrough · Portsmouth

# ASSEMBLED AND TESTED—IN HALF THE TIME

Equipment manufacturers can now reduce the assembly and test time for wound coil assemblies by as much as 50 per cent by including Mullard Vinkors, the world's most efficient ferrite pot cores, in their equipment designs.

No grinding of cores is necessary to obtain accurate inductances. The inductance of coils to be wound can be predetermined to within

$\pm 5$  per cent of the value required. After the coils are assembled and mounted, a final adjustment to an accuracy of better than 0.02 per cent can be achieved by the self locking adjustor.

Contact Mullard for full details of the wide range of Vinkors, which cover frequencies between 1 Kc/s and 3 Mc/s.

## Mullard **VINKOR**

ADJUSTABLE POT CORE ASSEMBLIES



MULLARD LIMITED · COMPONENT DIVISION · MULLARD HOUSE · TORRINGTON PLACE · LONDON W.C.1

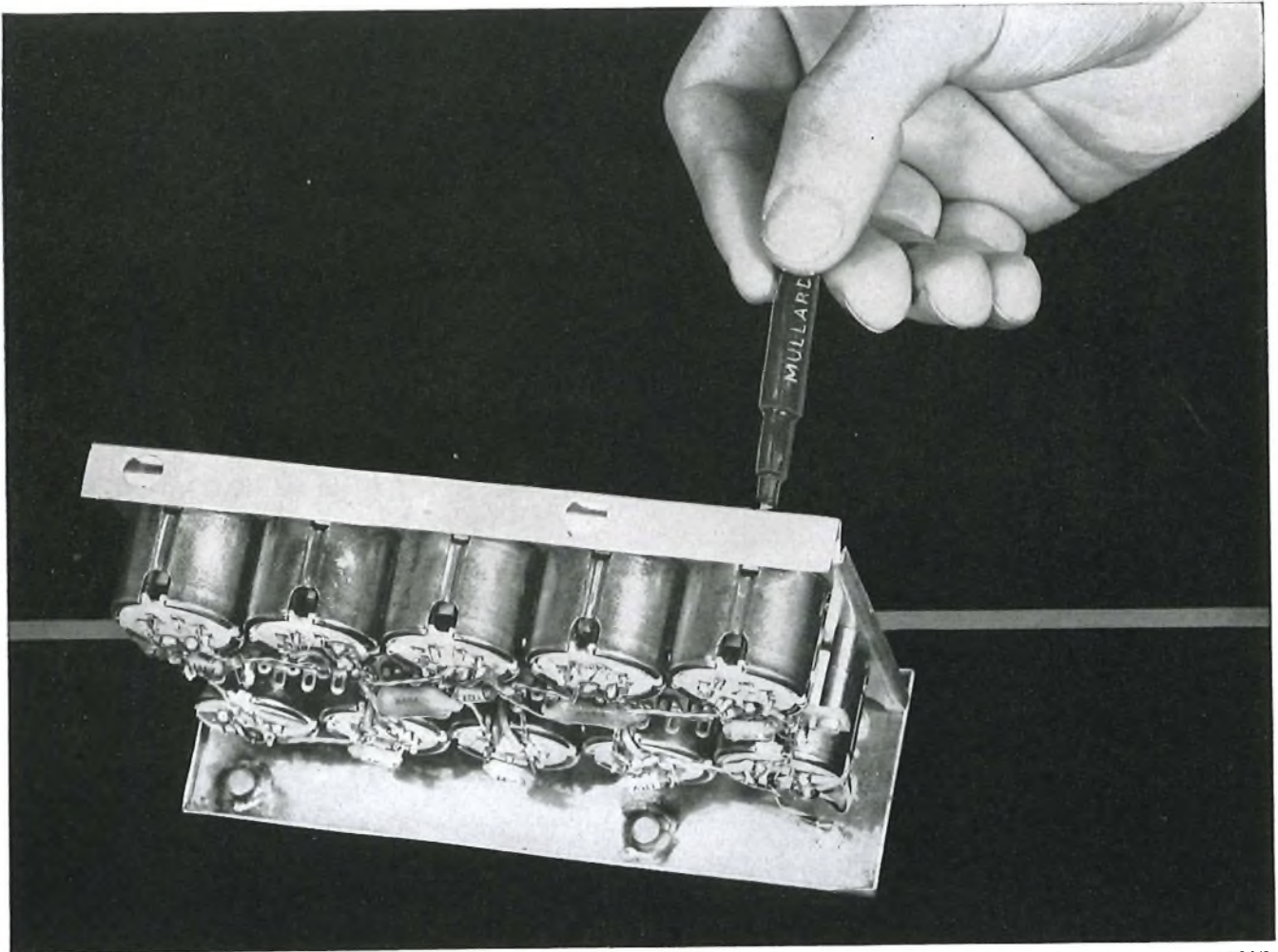





*These colourful telephones and the "Prescall" Master Station were moulded by Birkbys Ltd., Liversedge, Yorkshire, from 'Diakon' acrylic polymer for Automatic Telephone and Electric Company Ltd.*

## 'Diakon' puts colour on the line

Handsets and cases moulded in 'Diakon' acrylic polymer have a depth of colour you can get in no other moulding material. This glistening beauty is unaffected by years of use. 'Diakon' polymer offers all these other advantages:—

- \* Resistance to staining (including staining by nicotine or polishes).
- \* High impact strength.
- \* Good electrical insulation qualities.
- \* Dimensional stability, even in humid atmospheres and at high temperatures.

*Write to I.C.I. for more information about 'Diakon' acrylic polymer.*



*"Prescall" Master Station*

### 'DIAKON' POLYMER

*'Diakon' is the registered trade mark for the acrylic polymer manufactured by I.C.I.*

IMPERIAL CHEMICAL INDUSTRIES LIMITED • LONDON • S.W.1

DN13





PISTOL GRIP



SPADE



STAR

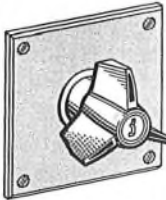

CRUCIFORM

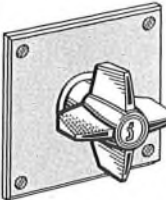

These new shapes are now available  
to all users

Trawsfynydd, the latest of Britain's nuclear power stations, will incorporate more than 2,500 Austinlite rotary control switches. They are designed to meet the exacting requirements of the Central Electricity Generating Board and of the main contractors, Atomic Power Constructors Limited.

Modern power station practice demands that switch duties be identified by the shape of the operating handle. To meet this requirement Austinlite produced these special designs.

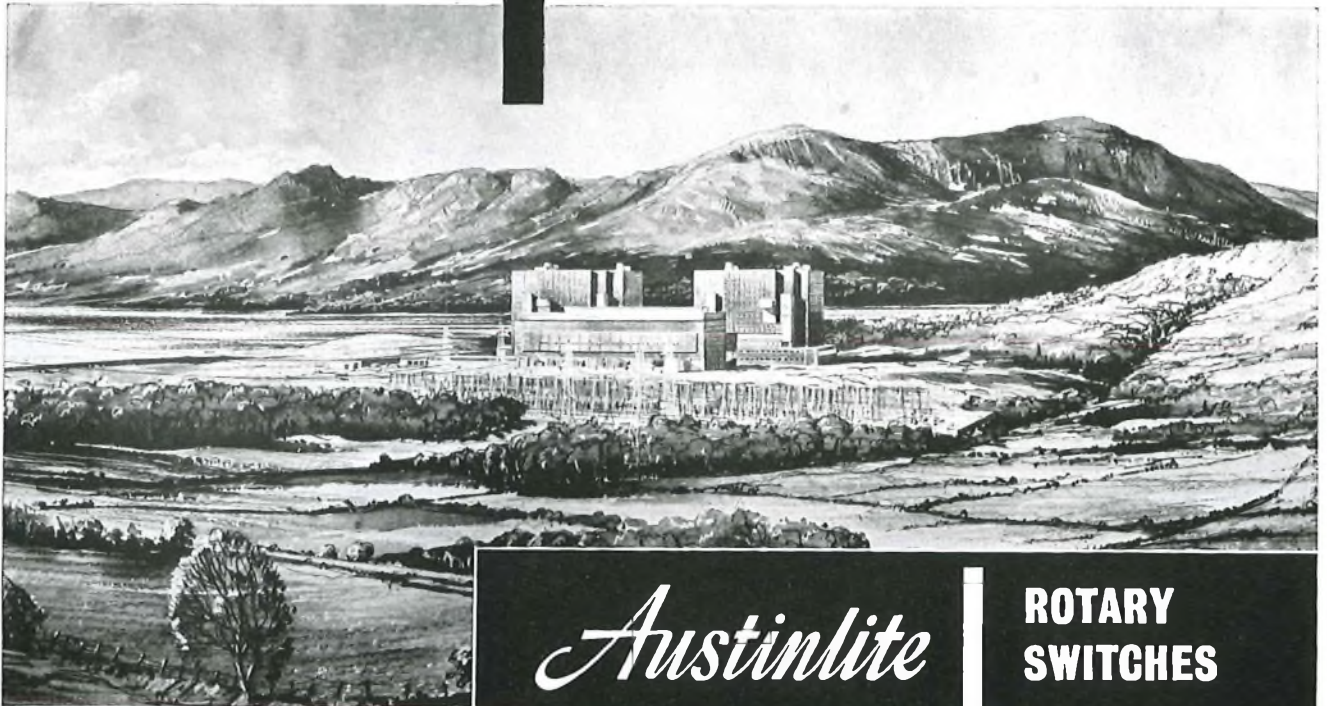

(Artist's impression of Trawsfynydd  
by courtesy of C.E.G.B.)

*Austinlite*

**ROTARY  
SWITCHES**

● custom-built by Stone-Chance Limited

**ENQUIRIES:** To help us to give prompt service, enquiries should now be addressed to Austinlite Ltd., Pickersleigh Road, Malvern Worcs., or to the London Office :- Schomberg House, 82 Pall Mall, S.W.1.



# HOW TO PASS YOUR CITY AND GUILDS TELECOMMUNICATIONS EXAMS—BY POST

The new Bennett College Telecommunications Courses were prepared under the supervision of one of the country's top telecommunications men, W. S. Procter, O.B.E., M.I.E.E., F.R.S.E., Chief Regional Engineer, London Telecommunications Region.

The first and second year subjects are:

FIRST YEAR 1. Practical Mathematics. 2. Engineering Science. 3. Engineering Drawing. 4. Elementary Telecommunications Practice.

SECOND YEAR 1. Mathematics for the Telecommunications A. 2. Telecommunications Principles A. 3. Radio and Line Transmission A. 4. Telephony and Telegraphy A. 5. Line Plant Practice A.

Other subjects will be introduced later.

The certificates awarded by the City and Guilds Institute are of special value to employees of the Post Office Telecommunications Branches, and the Radio and Telecommunications industry, whether engaged in the manufacture or the maintenance and operation of Telecommunications apparatus.

Post this coupon off at once for more information

To: THE BENNETT COLLEGE (DEPT. 24WSP) Sheffield  
Please send me details of the new Telecommunications Courses

NAME \_\_\_\_\_

ADDRESS \_\_\_\_\_

AGE \_\_\_\_\_

Personal postal tuition through the famous Bennett College!

## The CARPO GRAMME GAUGE

for  
accurate  
measurement  
of tension  
on Contacts,  
Relays,  
Switchgear,  
etc.

INCORPORATES MAXIMUM  
READING INDICATOR AT  
NO EXTRA COST

The Carpo Standard Model incorporates both tolerance indicators and maximum reading indicator, allowing an accurate reading to be taken when the gauge itself is not visible. A robust but highly sensitive instrument acting in both directions. The 5 gramme model has jewelled movement. Two models cover ten pressure ranges.

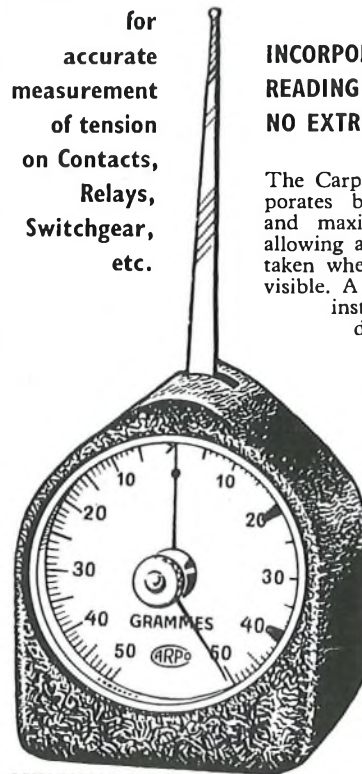

Made under  
licence from Correx

5 GRAMME MODEL  
£3 15 0

SMALL MODELS:  
£3 10 0 and £3 15 0

LARGE MODELS:  
£7 15 0 and £9 15 0

Special discounts for  
large quantities

Write or 'phone for  
illustrated leaflet

OBTAINABLE FROM

**J. P. FILHOL LTD.** MILLERS ROAD, WARWICK  
TELEPHONE: WARWICK 559  
MANUFACTURERS OF JEWEL BEARINGS AND PRECISION TURNED PARTS

British scientists are constructing instruments for three vital experiments in the first British satellite to be launched by the Americans. The total weight of these equipments will make a payload of 20 lbs.

## The First Anglo-American Scout Satellite

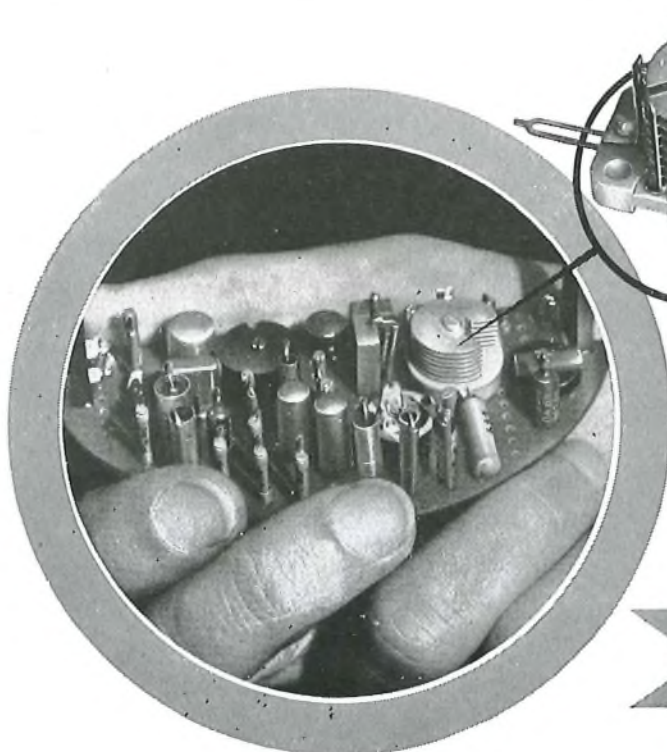

Imperial College, London, are providing equipment for the study of Cosmic rays. Ionospheric studies will be carried out by University College, London, and The University of Birmingham. The latter under the direction of Professor J. Sayers are contributing an instrument for the study of the *free electron population density* in space and of the *electrostatic potential of the satellite vehicle* relative to its space environment.

At Oxley's we are proud that our trimmer capacitors and barb insulators have been chosen by Professor J. Sayers' team for use in their project. The trimmer capacitors are used in a radio frequency bridge circuit upon which the experiment to measure electron density is based. It is, therefore, essential that component stability under adverse environmental conditions is maintained in order that accuracy of scientific measurements is in no way altered.

For full technical information for these and other Oxley products, write to:—

# OXLEY

**OXLEY DEVELOPMENTS COMPANY LTD.**  
ULVERSTON LANCASHIRE  
Telephone: Ulverston 3306 Cables: Oxley, Ulverston



# THERE'S A WORLD OF EXPERIENCE IN EVERYTHING MARCONI'S DO



*The Post and Telegraph Authorities of more than 80 countries  
rely on Marconi telecommunications equipment*

**SURVEYS** ★ Marconi's telecommunications survey teams are at work in many parts of the world. Marconi's is the only company maintaining a permanent research group working entirely on wave propagation.

**INSTALLATION** ★ Marconi's installation teams undertake complete responsibility for system installation, including erection of buildings and civil engineering works as well as the installation of the telecommunications equipment and auxiliary plant.

**PLANNING** ★ Marconi's vast experience is reflected in the quality of its system planning organisation which is constantly employed on planning major telecommunications systems for many parts of the world.

**MAINTENANCE** ★ Marconi's provide a complete system maintenance service and undertake the training of operating and maintenance staff, either locally or in England. Marconi's will also establish and manage local training schools for Post and Telegraph Authorities.

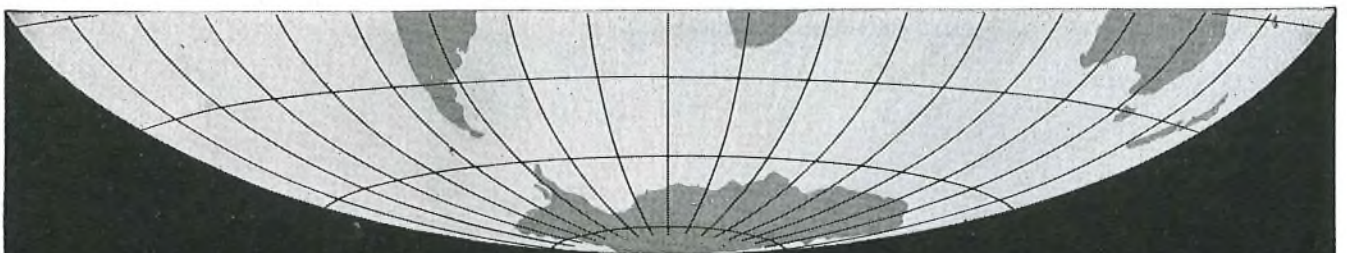

## MARCONI

COMPLETE COMMUNICATIONS SYSTEMS SURVEYED, PLANNED, INSTALLED, MAINTAINED

COMMUNICATIONS DIVISION, MARCONI'S WIRELESS TELEGRAPH COMPANY LIMITED, CHELMSFORD, ESSEX, ENGLAND.



# Take a look and you'll find...

FORMICA Industrial Laminates playing an important part in many public services. In telephone communications, for instance, dependability is of the first importance. For this reason FORMICA paper-based laminates — with high installation properties, yet wafer thin — were selected for the uni-selectors and relays in the Line and Finder Unit (shown here) manufactured by Standard Telephones and Cables Limited.

You'll find FORMICA Industrial Laminates in just about every type of British product—from the smallest relay to the largest computer. High quality is backed by unsurpassed technical service. Formica Limited make paper, glass, fabric and copper-clad laminates, engraving material and interlaminar prints.

## **FORMICA\*** INDUSTRIAL LAMINATES

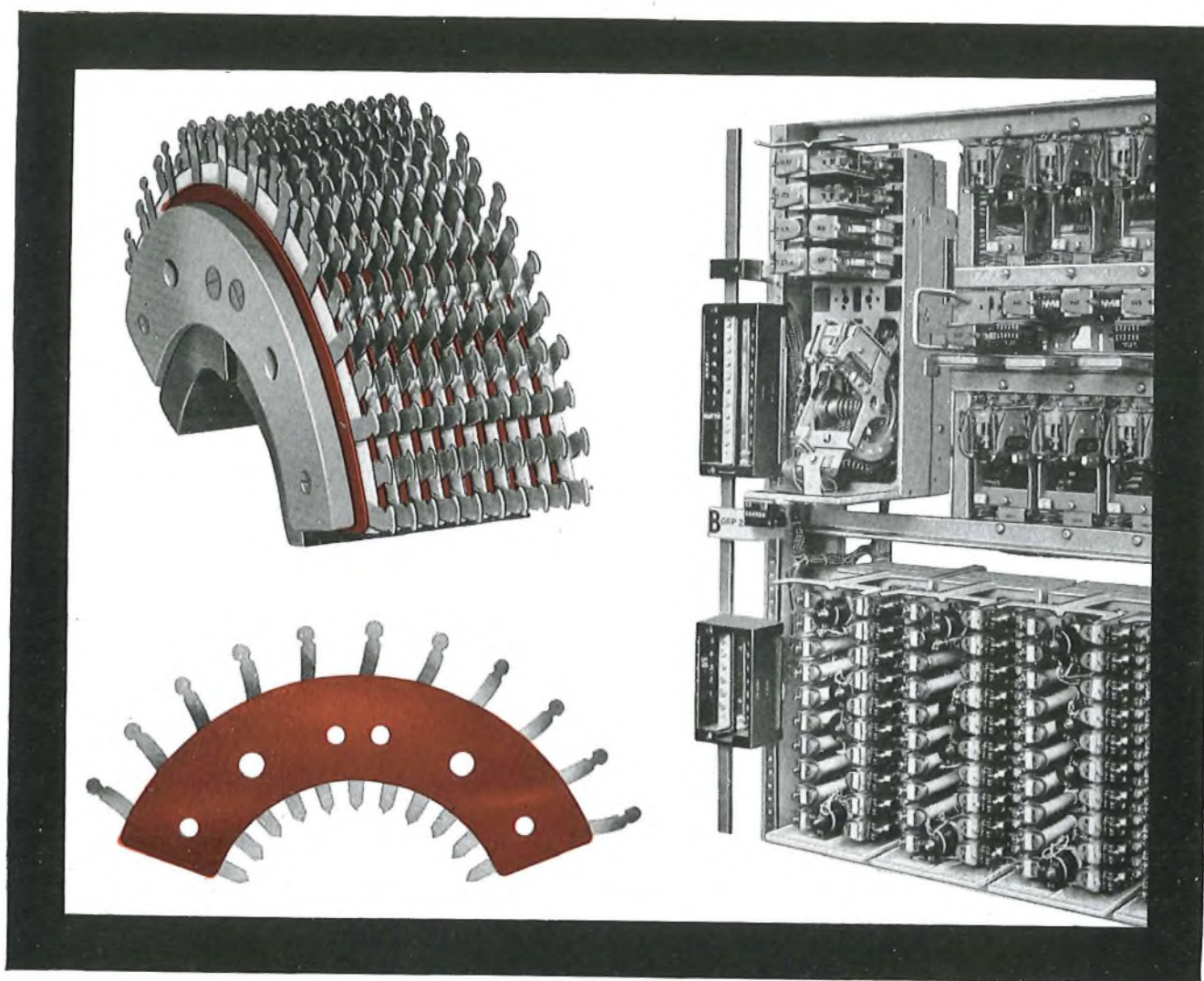

*For full information on FORMICA Industrial laminates write to :*

**FORMICA LIMITED** (Industrial Laminates Division)

84-86 REGENT STREET, LONDON, W.1.

TELEPHONE: REGENT 8020

\*FORMICA is a registered trademark



**ATE**  
Transmission  
Equipment  
Type CM

**GROUP TRANSLATING  
EQUIPMENT GT5-A**  
FOR MULTI-CHANNEL CARRIER SYSTEMS

PUBLICATION  
**TEB  
3103/1**

Automatic Telephone & Electric Co Ltd  
80, Strand, London, W.C.2, England



**ATE**  
Transmission  
Equipment  
Type CM

**CHANNELLING  
AND SIGNALLING  
EQUIPMENT  
CT12A**  
FOR MULTI-CHANNEL CARRIER SYSTEMS

Automatic Telephone & Electric Co Ltd  
80, Strand, London, W.C.2, England



**ATE**  
Transmission  
Equipment  
Type CM

**3 CHANNEL CARRIER  
TELEPHONE SYSTEM  
W3C**  
FOR OPEN-WIRE LINES

Automatic Telephone & Electric Co Ltd  
80, Strand, London, W.C.2, England



**ATE**  
Transmission  
Equipment  
Type CM

**COAXIAL LINE  
EQUIPMENT  
C300A**

Automatic Telephone & Electric Co Ltd  
80, Strand, London, W.C.2, England



**ATE**  
Transmission  
Equipment  
Type CM

Automatic Telephone & Electric Co Ltd  
80, Strand, London, W.C.2, England

**ATE**  
Transmission  
Equipment  
Type CM

**BAS  
FEA**

**R60B**  
FOR RADIO LINKS

Automatic Telephone & Electric Co Ltd  
80, Strand, London, W.C.2, England



**ATE**  
Transmission  
Equipment  
Type CM

**12 CHANNEL  
CABLE CARRIER  
TELEPHONE SYSTEM  
C12G**

PUBLICATION  
**TEB  
3201/2**

Automatic Telephone & Electric Co Ltd  
80, Strand, London, W.C.2, England



**ATE**  
Transmission  
Equipment  
Type CM





# 14

## technical brochures describe the new **A.T.E.** transistorised telephone carrier equipment **TYPE CM** for cable, radio and line systems

### BASIC UNITS

- TEB 3001 Transmission Equipment Type CM Basic Features
- TEB 3101 Channelling and Signalling Equipment—CT12A
- TEB 3102 Signalling Equipment
- TEB 3103 Group Translating Equipment—GT5A
- TEB 3104 Supergroup Translating Equipment—ST5A

### CABLE SYSTEMS

- TEB 3201 12-Channel Cable Carrier System—C12G
- TEB 3202 Coaxial Line Equipment—C300A

### RADIO MULTIPLEX TERMINALS

- TEB 3301 Multiplex Equipment—R24B
- TEB 3302 Multiplex Equipment—R60B
- TEB 3303 Multiplex Equipment—R3A
- TEB 3304 Multiplex Equipment—R120C
- TEB 3305 Multiplex Equipment—R300C

### OPEN WIRE SYSTEMS

- TEB 3401 3-Channel Open-Wire Carrier Systems—W3C
- TEB 3402 12-Channel Open Wire Carrier Systems—W12H

WRITE NOW FOR THE BROCHURES YOU REQUIRE TO:—

## **AUTOMATIC TELEPHONE & ELECTRIC CO. LTD.**

Strowger House, Arundel Street, London, W.C.2.  
Telephone: TEMple Bar 9262





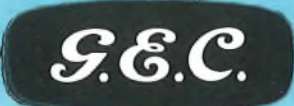

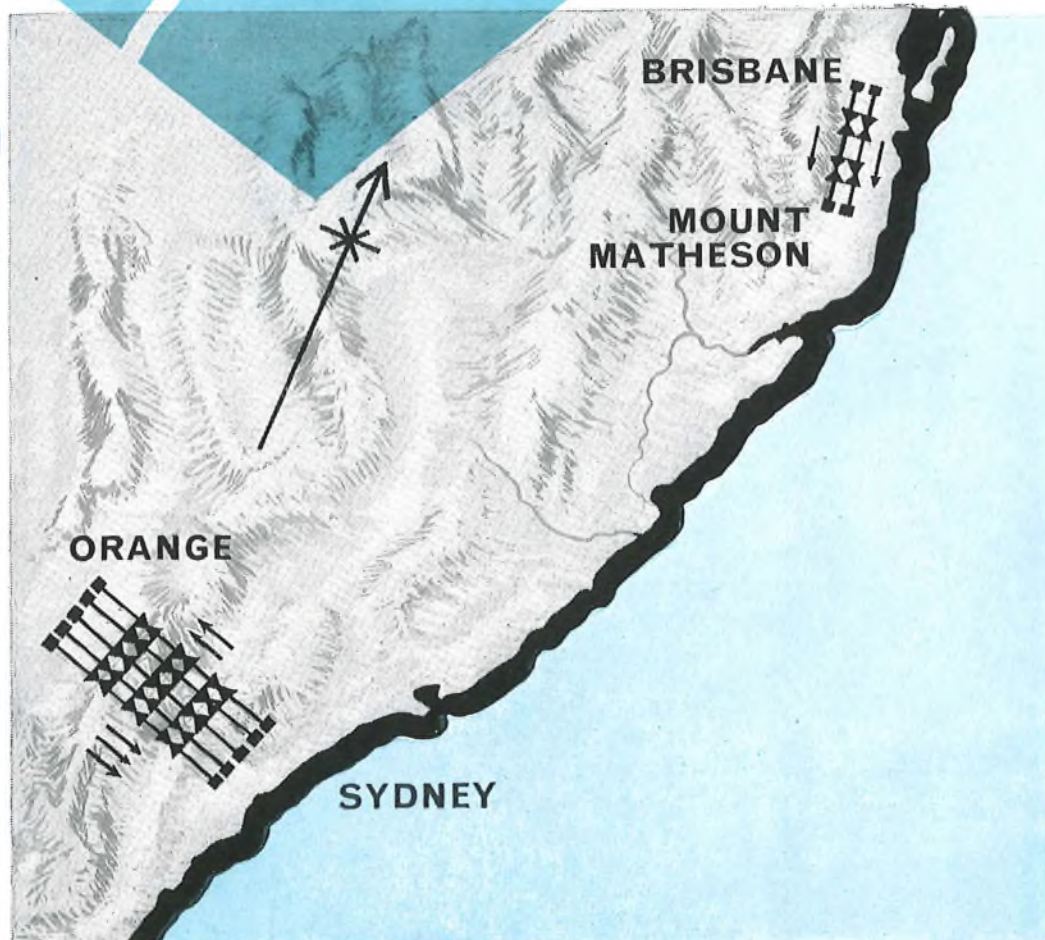

# SHF Broadband



**KEY**

 REPEATER

 TERMINAL



**EVERYTHING FOR TELECOMMUNICATIONS**

Transmission Division

**THE GENERAL ELECTRIC COMPANY LIMITED OF ENGLAND**

TELEPHONE WORKS · COVENTRY · ENGLAND  
Works at Coventry · London · Middlesbrough · Portsmouth

*For further information,  
please write for Standard  
Specification SPO 5555*



# Radio Equipment comes to Australia

The G.E.C. is to provide radio equipment for two S.H.F. radio relay systems for the Australian Post Office, one between Sydney and Orange and the other between Brisbane and Mount Matheson.

The Sydney-Orange link will be equipped to provide a bothway telephony system and a one-way television link. One channel in each direction will be used as a standby (protection) channel and will be switched into service should a working channel fail or become degraded.

The Brisbane-Mount Matheson system will

provide a duplicate (main and standby) one-way television link.

Each radio frequency channel operates in the 6000 Mc/s frequency band and is capable of carrying 960 speech channels or a television programme.

Equipment will be supplied for five repeater stations, two between Brisbane and Mount Matheson and three between Sydney and Orange. The equipment conforms to C.C.I.R. recommendations and is the latest in a long series of highly successful G.E.C. radio equipments.

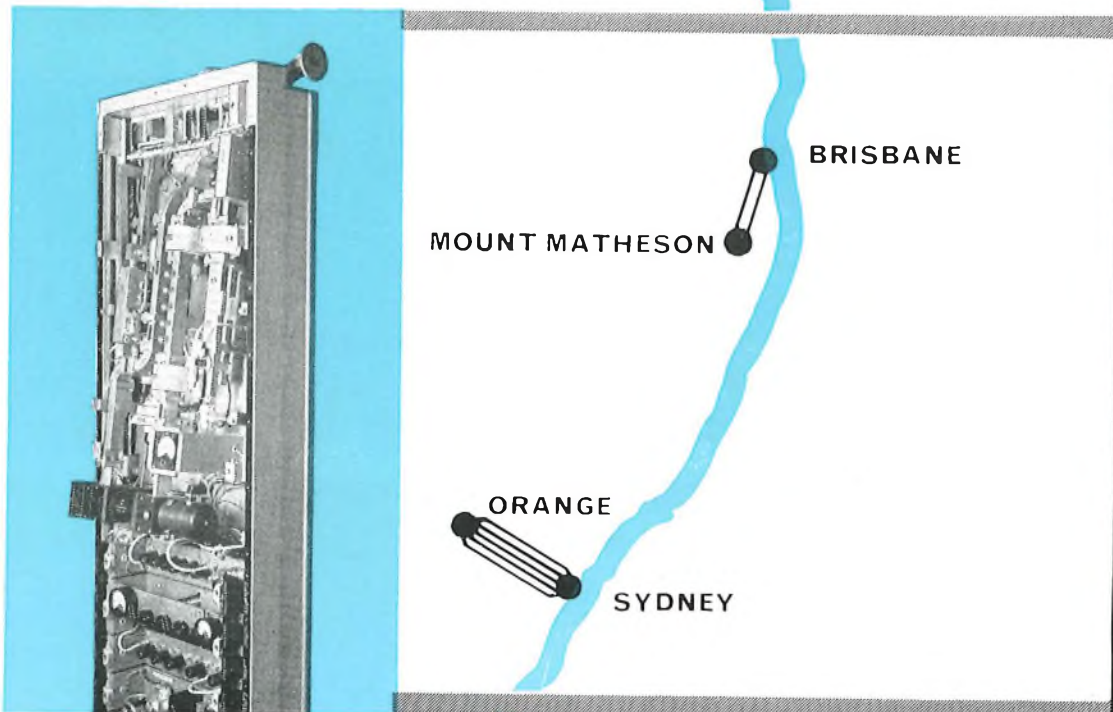

# SILVER STAR CAPACITORS

## encapsulated

Here are two new silvered mica capacitors for use in filters and other professional equipment.

Synthetic resin encapsulated, they can be used either on printed circuits or in conventionally-wired assemblies. The encapsulation technique employed, in conjunction with Silver Star fired construction, ensures outstanding long-term and cyclic stability.

Two sizes (C22E and C33E) together cover the capacitance range 5 to 33,000 $\mu\text{F}$  with a minimum tolerance of  $\pm 0.5\%$  for values above 200 $\mu\text{F}$ .

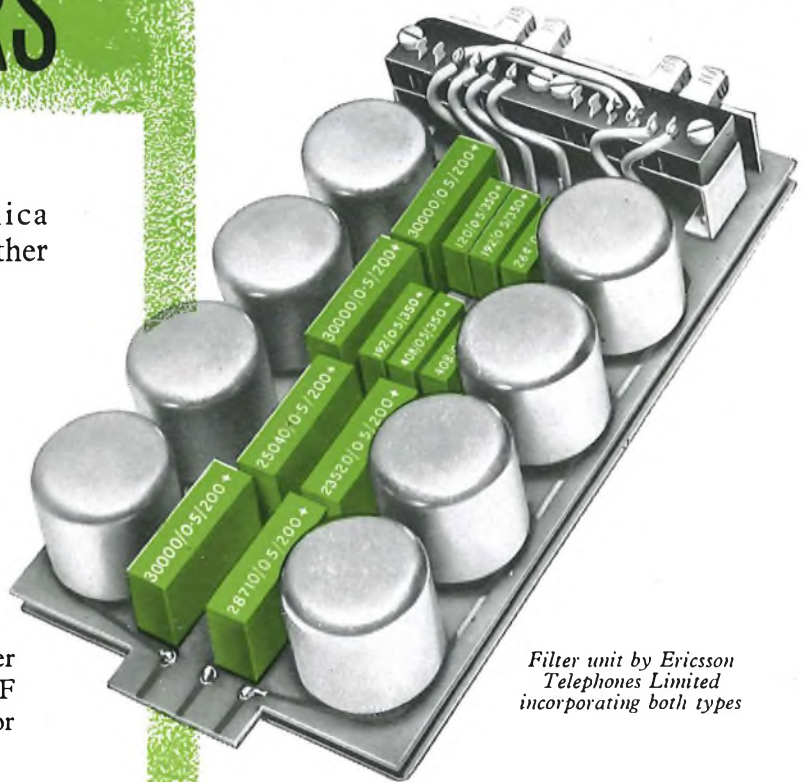

Filter unit by Ericsson  
Telephones Limited  
incorporating both types

- Precise rectangular section\*
- Parallel terminations for 0.1 inch or 0.2 inch module printed circuits
- Service temperature range—55°C to +100°C
- Conform to Class H1 of British Services' Climatic Specification
- Fired construction
- Exceptional long-term and cyclic stabilities
- Pass Services' requirements for solderability and ruggedness
- Two peak working voltages: 200 and 350
- Silver Star<sup>(n)</sup> quality

\* Both body sizes conform to American and NATO specifications. Body size of C22E conforms to British Defence Specification

One of the specialised products of

**Johnson Matthey**

JOHNSON, MATTHEY & CO., LIMITED  
73-83 HATTON GARDEN, LONDON, E.C.1  
Telephone: Holborn 6989  
Vittoria Street, Birmingham, 1.  
75-79 Eyre Street, Sheffield, 1.

Telephone: Central 8004  
Telephone: 29212

E11/670

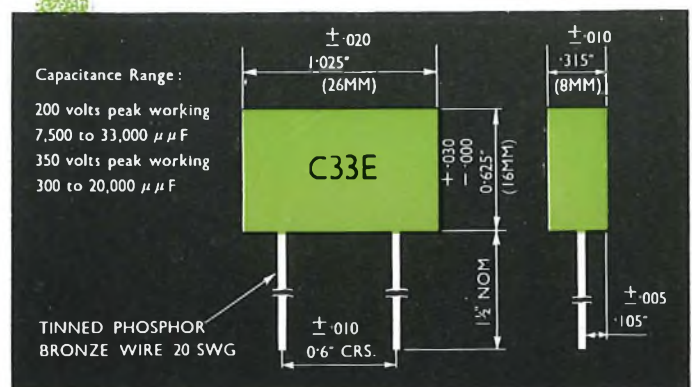
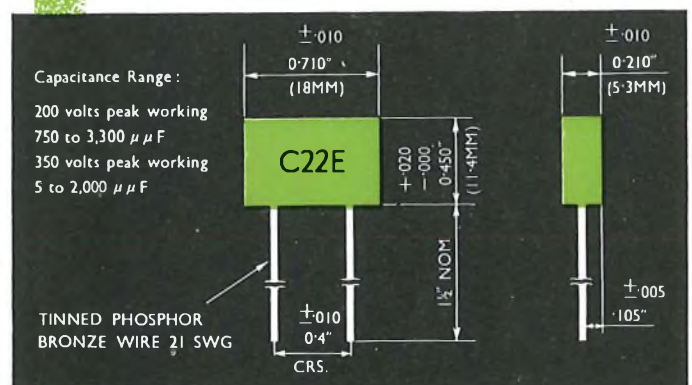





G.N.T. 5-Unit Transmitter Model 20



G.N.T. Two-Level Line Commutator

# G.N.T.

## INSTRUMENTS

- Complete range of Wheatstone equipment
- Complete range of special Morse training equipment
- G.N.T. 5-unit Transmitters with one or two sensing heads
- G.N.T. Converters for Morse or Cable Code to 5-Unit or 5-Unit to Morse or Cable Code
- G.N.T. Tape Readers for 5, 6, 7 or 8 Unit Tape

# GREAT NORTHERN TELEGRAPH WORKS

4 SYDHAVN PLADS  
COPENHAGEN DENMARK

LONDON OFFICE:  
5 ST HELENS PLACE EC3

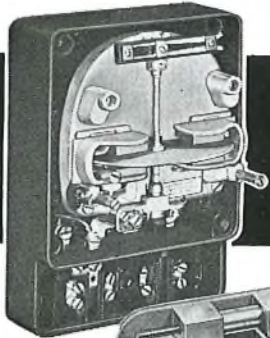

## permanent magnets for ELECTRICITY METERS

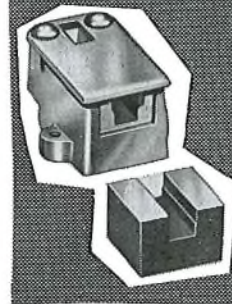
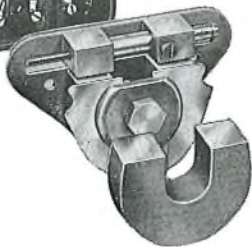

For many years Eclipse magnets have been chosen for eddy-current braking duty, not only in electricity meters but in power relays and many damping devices. They have been chosen particularly for new development work. Eclipse accumulated experience is then invaluable.

# Eclipse

## PERMANENT MAGNETS for industry

Eclipse publication "Permanent Magnets Summarized" contains a special illustrated section on eddy-current braking magnets.

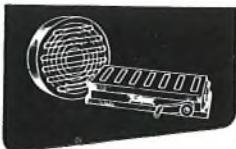

Made by the designers and manufacturers of Eclipse Permanent Magnet Chucks  
JAMES NEILL & CO. (SHEFFIELD) LTD · SHEFFIELD · ENGLAND

MIO

**G.E.C.**

**THE  
COMPLETE  
TELE-  
COMMUNICATIONS  
SERVICE**

**RESEARCH**

**DEVELOPMENT**

**DESIGN**

**MANUFACTURE**

**SURVEY**

**PLANNING**

**INSTALLATION**

**MAINTENANCE**

*Transmission Division*

**THE GENERAL ELECTRIC CO LTD  
OF ENGLAND**

**TELEPHONE WORKS · COVENTRY · ENGLAND**

*Works at Coventry · London · Middlesbrough · Portsmouth*



SPOTLIGHT No. 2

Cubic  
Inches  
2500

**DESIGN &  
MANUFACTURE**

2000

1500

B.P.O. No. 6 System  
Pre-1940  
2880 cu. ins.



B.P.O. No. 7 System  
Pre-Type 51  
1378 cu. ins.



**DESIGN**

Progress in the miniaturisation of channel & signalling equipment from 1940 to 1961.

1000

Type 51  
670 cu. ins.



500

Type 56 (Valved)  
206 cu. ins.



Type 56 (Transistored)  
138 cu. ins.



**MANUFACTURE**

Part of our comprehensive test facilities.

Designed for quantity production to satisfy the ever increasing demands of our world-wide markets, GEC transmission equipments combine reliability with economy. Compact to minimise floor area requirements yet incorporating maximum accessibility for ease of maintenance, GEC equipment design is ideally suited to both large and small Administrations. Meticulous care during assembly plus exhaustive testing at each stage of production from components to racks culminating in a complete system test before shipment ensure trouble-free operation.



**G.E.C.**

**EVERYTHING FOR TELECOMMUNICATIONS**

Mallory not only build unique 'Sound Power' into their batteries— they've solved the problem of keeping it there. Mallory battery cell cases play no part in the electro-chemical process: they resist corrosion, protect cell materials. Double seals, specially moulded gaskets, new sealing techniques also help to make Mallory batteries leakproof. These and other original features help to underwrite the claim— Mallory batteries are the greatest dry cell development for more than eighty years. They are fadeproof not only on the shelf but on the job. They offer a constant voltage discharge over a very long life to all manufacturers who wish to miniaturise their products and retain full 'Sound Power'.

## Mallory batteries

do not leak

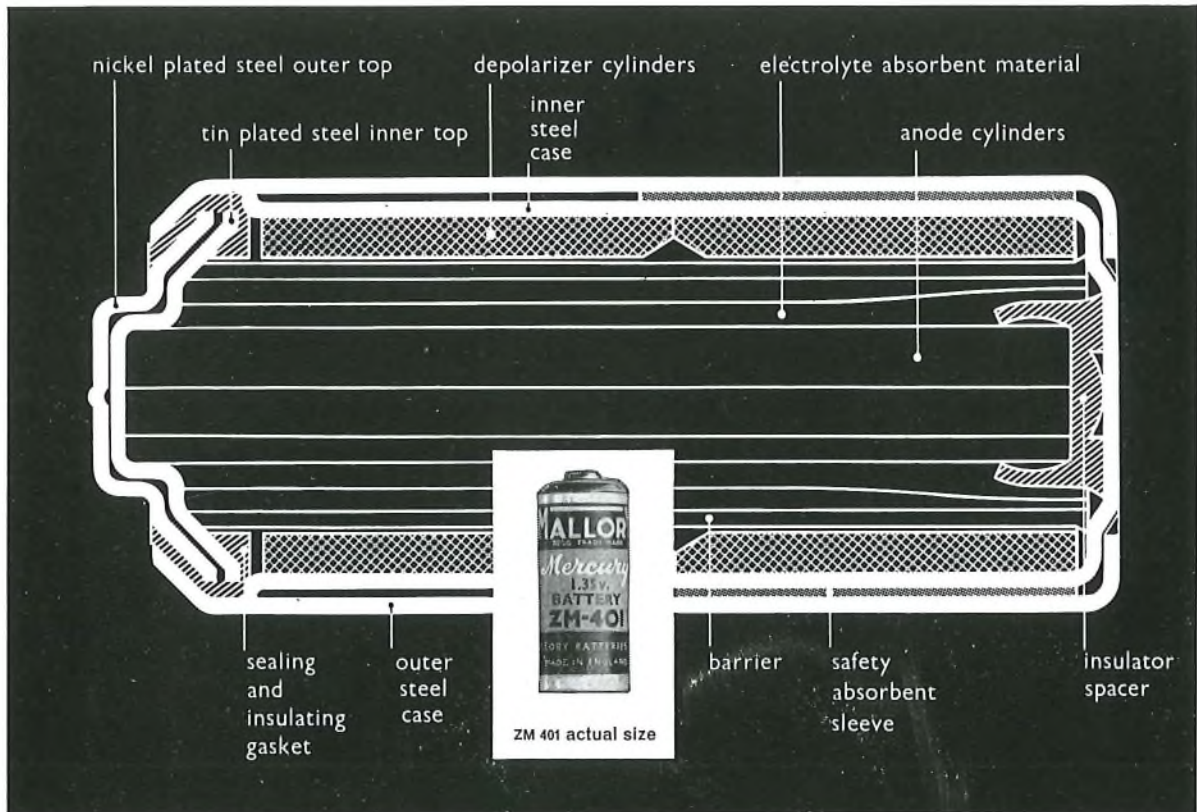

Manufacturers are advised to consult Mallory at the design stage so that full benefit can be gained from the world's most space-saving source of power.

Please write for literature to

**Mallory Batteries Limited,**  
33 Duke Street, London W1

# MALLORY

*miniature batteries for powerful applications*



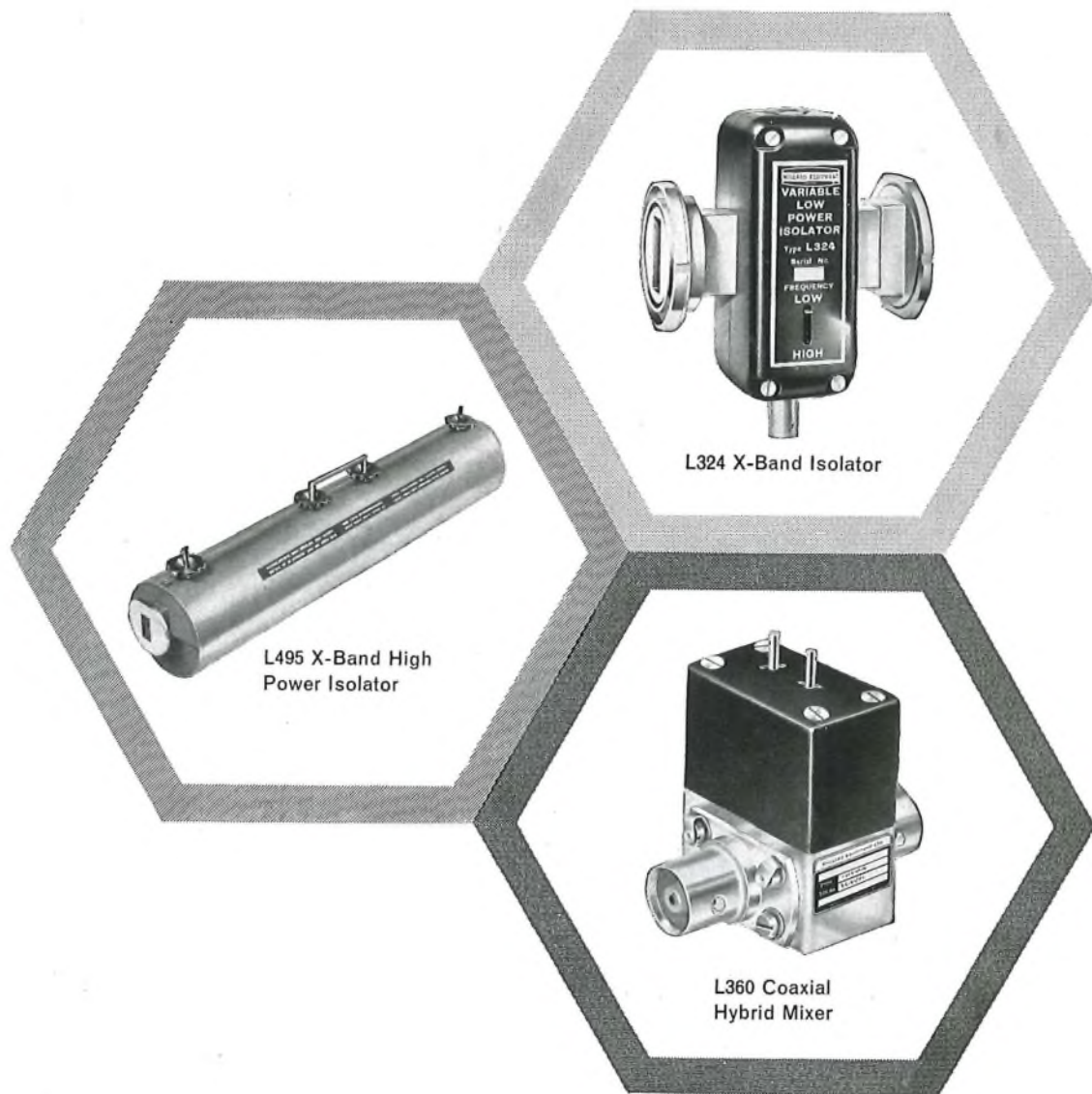

## more microwave devices

Typical of the rapidly growing range of microwave devices available from Mullard Equipment Ltd. are 1 to  $11\frac{1}{2}$  kMc/s Broadband Hybrids and Mixers, the first of their kind manufactured in Britain. Other products in the range include Isolators and Filters; most elements in the range can be provided in either coaxial or waveguide form. If you are working on a microwave project the chances are that Mullard Equipment Ltd. has already solved some of your component problems for you. Write today mentioning your particular microwave component requirement and we shall be pleased to advise you.

Please quote reference AH/684/1

**MULLARD EQUIPMENT LIMITED**

Manor Royal, Crawley, Sussex.  
Telephone Crawley 28787



for underground security...

# Glazed Vitrified Clay Conduits

Our telecommunications—lighting systems and power lines are vital. For permanence—how right to use **glazed vitrified clay conduits**—there is no adequate substitute.

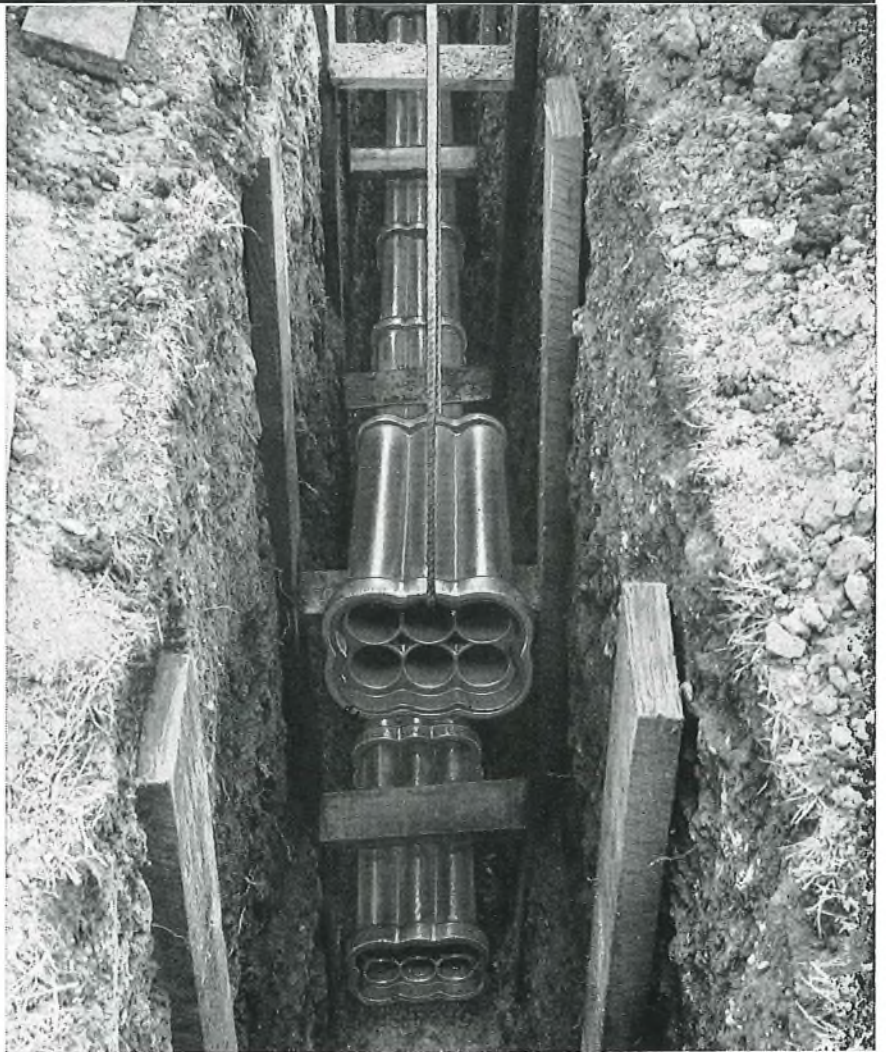

*For information write to the Engineer*

**NATIONAL SALT GLAZED PIPE MANUFACTURERS' ASSOCIATION**  
Hanover Court, Hanover Square, London, W.1.  
Telephone: MAYfair 0364



# PAYNTON PW SWITCHES

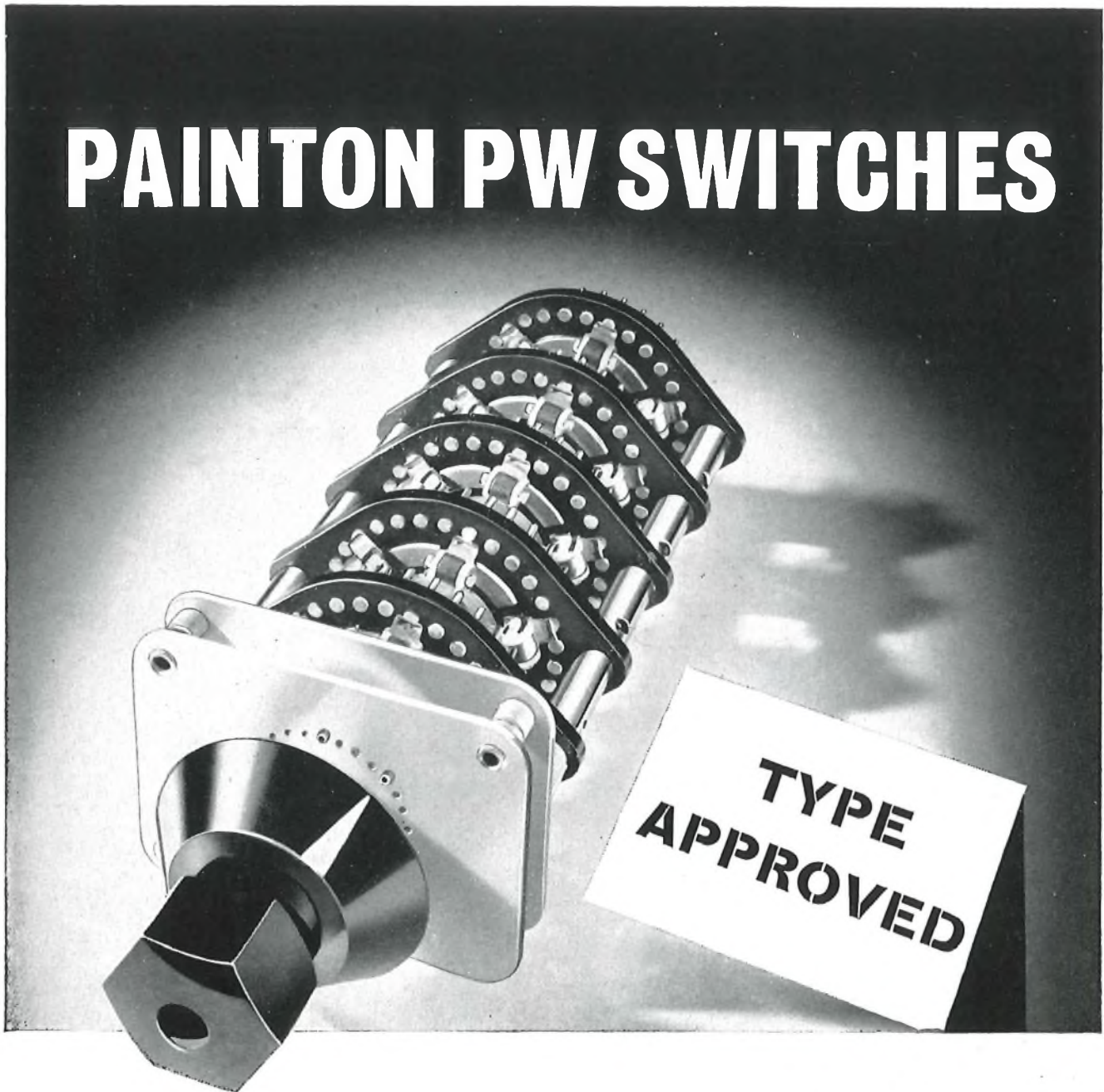

The heavy duty range of Painton PW Rotary Stud Switches are Type Approved to DEF 5154 and have a long history of successful and reliable operation in many important applications. Both Heavy Duty and Standard types are available.

RECENTLY INTRODUCED—a new 6 pole version in both heavy duty and standard ranges.

We would like you to have full information about these components. Please write for technical details.



## Painton

& CO. LIMITED

KINGSTHORPE · NORTHAMPTON

Tel: 34251 (10 lines) Grams: 'Ceil' Northampton Telex: 31576



# ETELUX

**Designed & manufactured  
exclusively by ERICSSON**

Easily convertible to wall mounting for use in kitchen, hall or any location where table space is limited.

Dial illumination can be provided for use at night.

The ETELUX may be employed either directly connected to an exchange line (when a small bell is incorporated in the terminal block) or as a parallel instrument.

A press button may be fitted for party line working or operator recall.

The Etelux has a technical performance equal to that of the Etelphone and can be supplied in full tropical finish.



# ...the new *luxury* telephone



**ELEGANT** and **COMPACT**, this well styled instrument is particularly suited to bedroom or lounge. It is shaped to make telephoning as effortless as possible and its contours enable it to be picked up with ease and held comfortably in the palm of the hand. **LIGHT** in **WEIGHT** yet eminently stable when dialling owing to the built-in rubber base pad.

**COLOURS** are **LIGHT-FAST** and have been chosen for compatibility with a wide range of interior decorations:



Aqua Jade

Rose Grey

Alice Blue

Dusky Pink

Blush Ivory

The moulded base is **Kashmir Beige** and the dial finger wheel is **Silver Gilt**. Desk and HMT cord is **Bronze Lustre**.

For further information please write to :-



**ERICSSON TELEPHONES LIMITED • ETELCO LIMITED**

Head Office: 22 Lincoln's Inn Fields, London, W.C.2. Tel: HOLborn 6936. Works: Beeston, Nottingham & Sunderland.

WHEN LENGTHS OF DEEP SEA CABLE ARE HANDLED ABOARD H.M.T.S. MONARCH

*Preformed*

**HOLDS  
THE  
LINE....**

*H.M.T.S. Monarch which has laid the deep sea telephone cable to Canada as part of a projected Commonwealth round-the-world link-up. Photograph by courtesy of H.M. Postmaster-General.*

... because the unique Helical gripping of PREFORMED Dead Ends\* gives low localised stress. It holds the extra high tensile steel core of this revolutionary type cable through five slip surfaces without damaging the polythene sheath. This is an outstanding example of the extreme holding power of PREFORMED Dead Ends. Easily and quickly applied—PREFORMED Dead Ends are the discerning engineers choice.

Other Preformed Products Include:

**LINE GUARDS**—for conductor protection at insulators

**LINE SPLICES**—full tension joints

**PATCH RODS**—for repair of strands

**GUY GRIP Dead Ends**—the most economical way of making-off stays

**ARMOR GRIP SUSPENSION ASSEMBLY**—a revolutionary suspension clamp

**SPLICE SHUNTS**—for overheated joints

**BUNDLED CONDUCTOR SPACER UNITS**—the best twin conductor spacer

\*Patent Application Number 817535

Send for Technical Brochure available in ENGLISH, FRENCH, GERMAN or SPANISH

**PREFORMED LINE PRODUCTS**

(GREAT BRITAIN) LIMITED

ANDOVER · HAMPSHIRE · ENGLAND · TELEPHONE · ANDOVER 4045

Other products mentioned are covered by patent and patent application Nos. 817055, 817534, 805333, 817643, 817644, 788 908, 817535

Agents in Countries Throughout the World

Manufactured under licence from PREFORMED LINE PRODUCTS CO., CLEVELAND, OHIO, U.S.A.

H.P. 8699





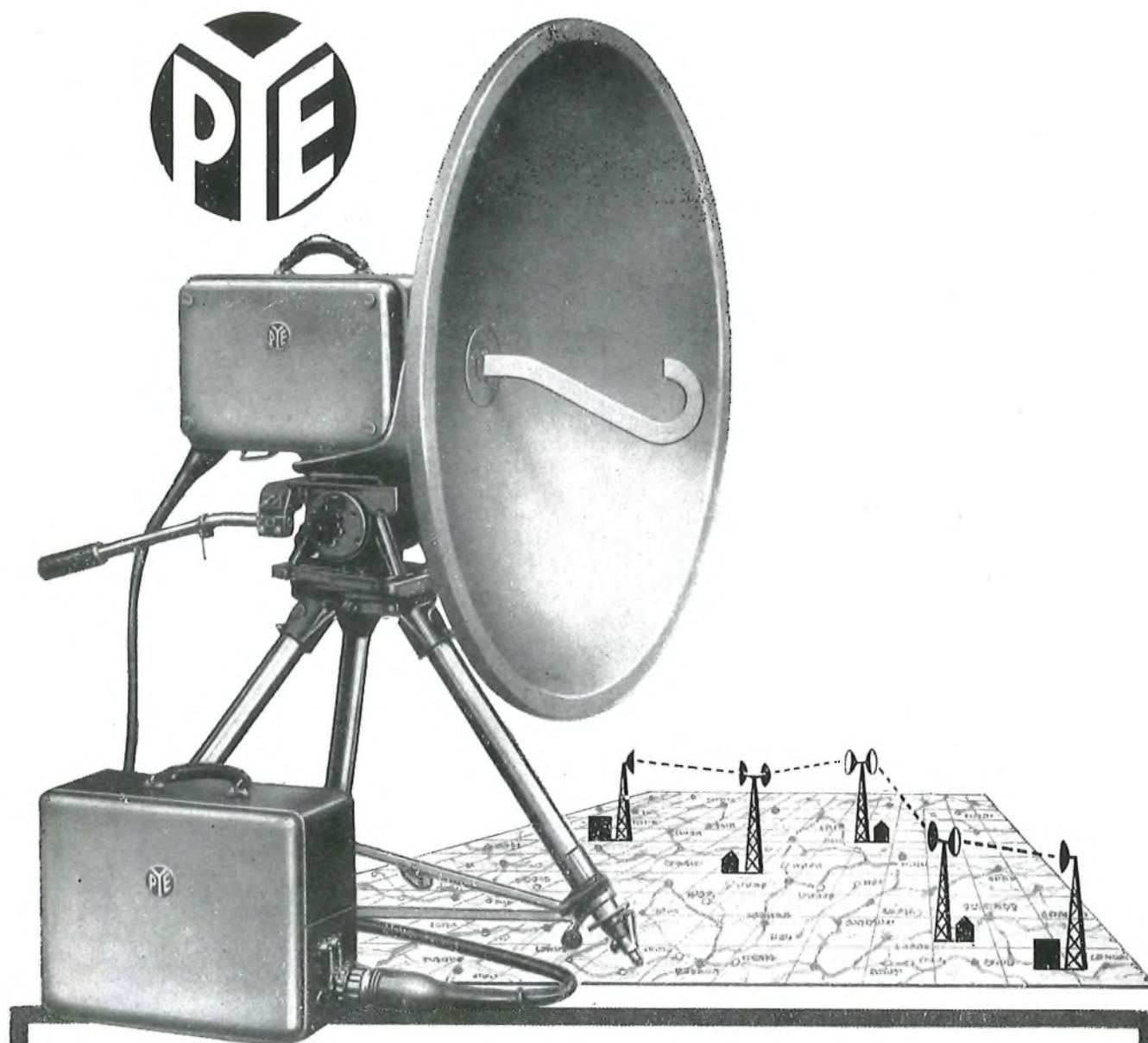





## Portable and Fixed Station Equipment for **MICROWAVE TELEVISION LINKS**

For the transmission over long distances of complete television programmes via a number of links, the Pye P.T.C. M1000 equipment provides portable or fixed units for simultaneous radiation in the microwave band of vision and audio signals. Effective communication can be maintained over 50 miles or more per link, with only one watt of power. Frequency ranges are available between 5925 Mc/s and 7500 Mc/s, with excellent frequency stability. In portable form each unit is conveniently carried in luggage type cases and is easily assembled on site. Adaptors for 19-inch rack mounting are available for fixed station applications.

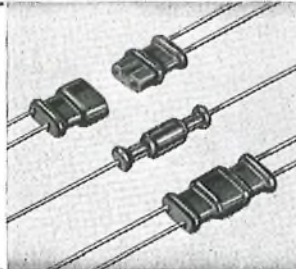
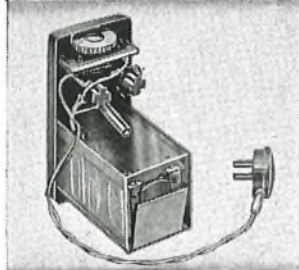

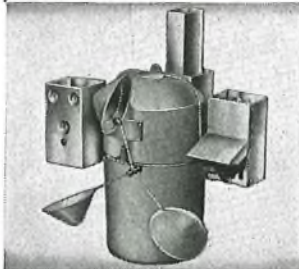
PYE TELECOMMUNICATIONS LTD., CAMBRIDGE, ENGLAND

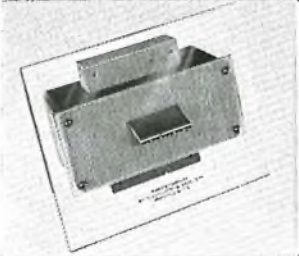
<h1>WHITELEY</h1>	
	<h2>electronic components</h2>
<h2>are building</h2>	
	<h2>a high reputation</h2>
<h2>for quality</h2>	
	<h2>and reliability</h2>

The items shown here are representative of the extensive variety of products manufactured by the Whiteley organisation. Our technical resources are available for the development and production of specialised components for the electronic industry.

*Get in touch with them NOW...*

**WHITELEY ELECTRICAL RADIO CO LTD**

MANSFIELD · NOTTS · Telephone: Mansfield 1762-5

**ADCOLA**  
REGISTERED TRADE MARK  
 (Regd. Trade Mark)

**SOLDERING INSTRUMENTS and EQUIPMENT**

*Illustrated*  
**L64  $\frac{3}{16}$ " DETACHABLE BIT MODEL IN PROTECTIVE SHIELD L700 FITTED WITH ACCESSORIES FOR BIT CLEANING, ETC.**

**ALL VOLT RANGES 6/7 to 230/250 VOLTS**

**British and Foreign Patents and Registered designs**

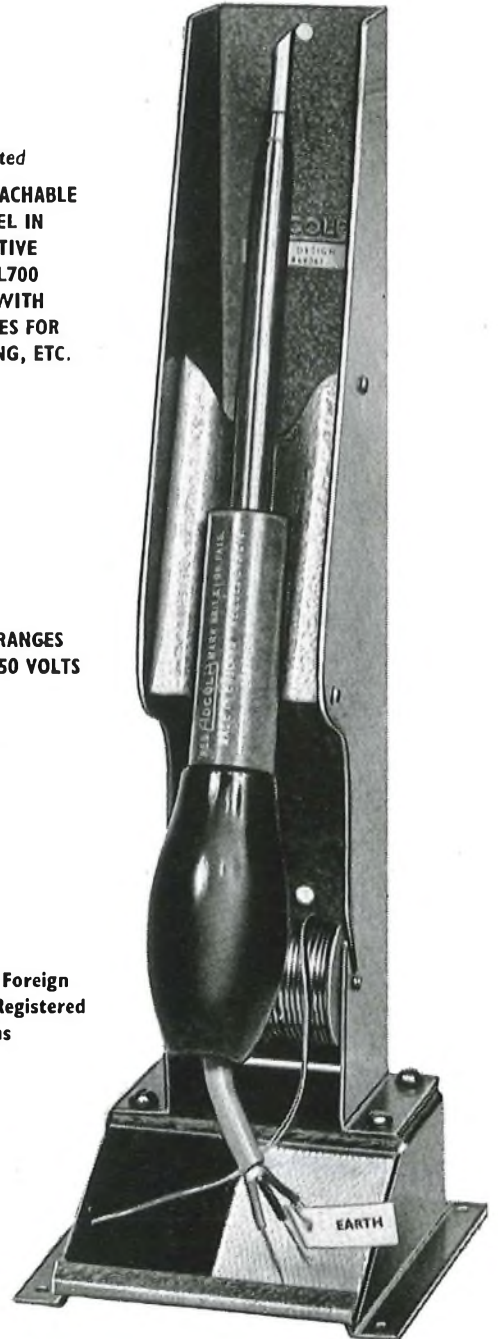

*For further information and full illustrated catalogue apply head office*

**ADCOLA PRODUCTS LIMITED**  
**GAUDEN ROAD, CLAPHAM HIGH STREET,**  
**LONDON, S.W.4**

Telephones: MACaulay 3101 and 4272

Telegrams: SOLJOINT



# COMPLETELY SELF-CONTAINED

with signalling, carrier and power supplies

# and FULLY TRANSISTORIZED

**TMC  
R4A FIVE CIRCUIT  
CHANNELLING  
for Radio Links**

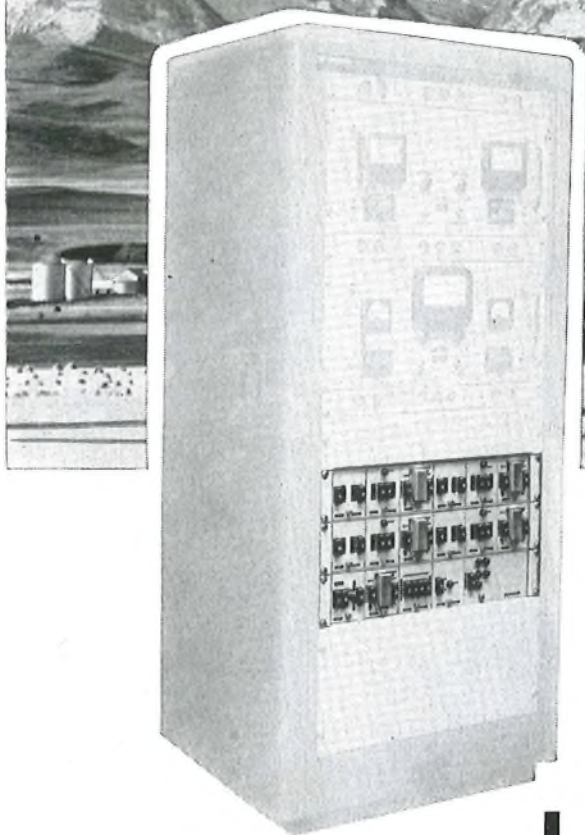

*TMC R4A channelling mounted with Pye Telecommunication Ltd's VHF radio terminal equipment PTC 810/820.*

**CHANNELS** Audio plus 4 carrier derived

**OVERALL BANDWIDTH** 0.3 to 28.3 kc/s

**CHANNEL BANDWIDTH** 300 to 3,400 c/s complying with CCITT recommendations on all channels including audio.

**IMPEDANCE** To radio 600 ohms To audio 600 ohms

**SIGNALLING** Frequency 4,300 c/s  
Deviation—180 c/s Level—18 dbm0

**LEVELS** To radio transmitter —37 dbm  
From radio receiver —8 dbm

The R4A is small, compact, weighs only 65lb. yet provides 5 high quality speech circuits with full facilities, for use anywhere in the world — from a small community in the Canadian Rockies to a police network in a large urban area.

- \* Self-contained — with in-built signalling, carrier and power supplies.
- \* Alternatively, available as separate panels or as a set of fully wired and linked panels for fixing to existing racks.
- \* Compact plug-in units may be sub-equipped as required to provide 1, 2, 3 or 4 simplex or duplex speech channels with or without signalling.
- \* Fully transistorized—21V d.c. or built-in a.c. mains supply.
- \* Power consumption only 10VA.
- \* Full signalling and control on the audio and carrier circuits.
- \* Frequency-shift "E & M wire" signalling is insensitive to variations in level.

**THE TMC R4A IS AVAILABLE IN QUANTITY ON SHORT DELIVERY AND AT A COMPETITIVE PRICE**



Further information from:

**TELEPHONE MANUFACTURING COMPANY LIMITED**

Transmission Division, Sevenoaks Way, St. Mary Cray, Orpington, Kent, England. Orpington 26611

**Selling Agents:** *Australia & New Zealand:* Telephone Manufacturing Co. (Australasia) Pty. Ltd., Sydney, New South Wales. *Canada & U.S.A.:* Telephone Manufacturing Co. Ltd., Toronto, Canada. *Also represented in other countries.*



# SPECIALISTS IN REPEATERED SUBMARINE TELEPHONE CABLE SYSTEMS

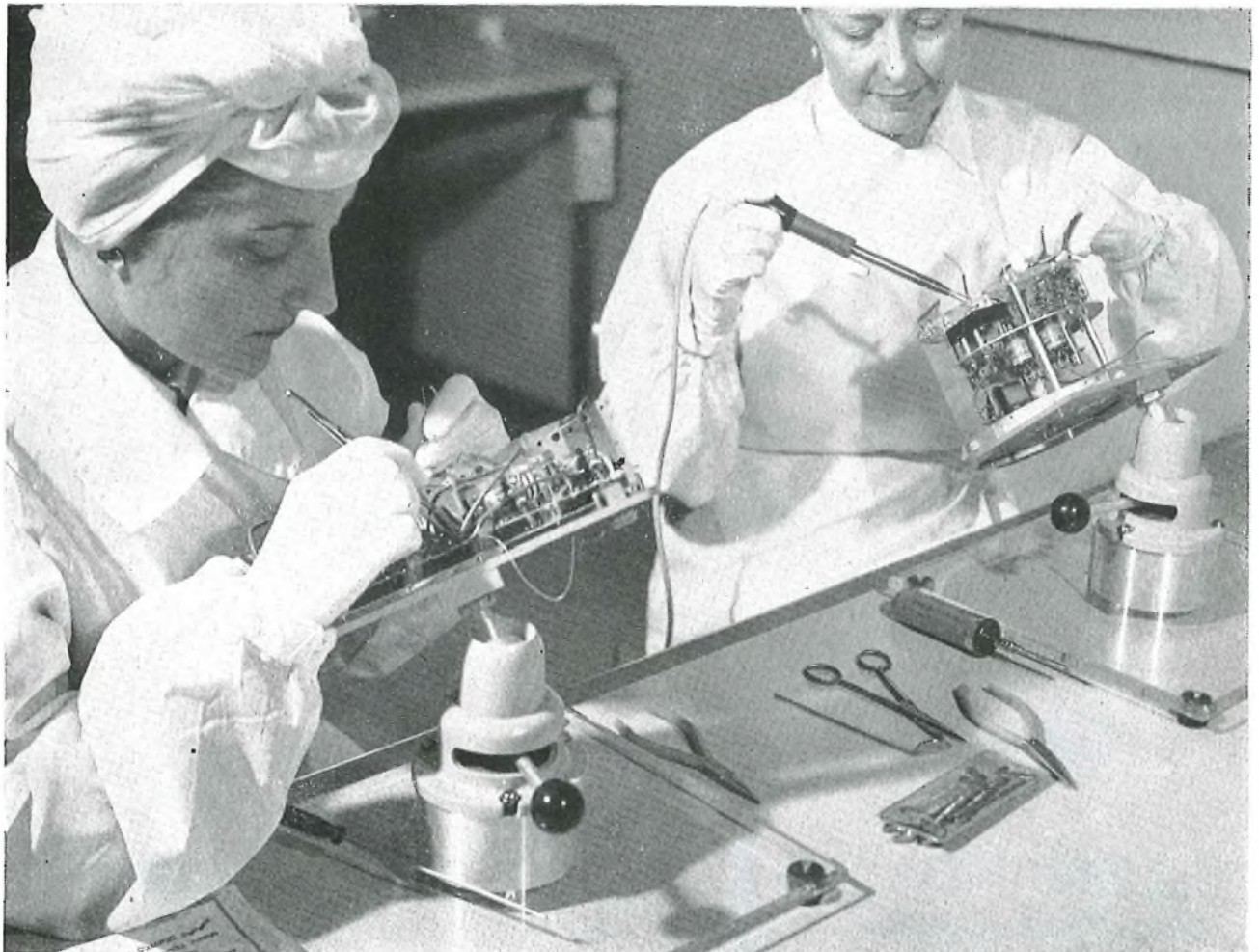

*Wiring and assembly of units for Submerged Repeater*

Submarine Cables Ltd., specialise in complete submarine telephone cable systems—cable, submerged repeaters, cable laying and terminal equipment.

Submarine Cables Ltd. developed the new unarmoured (lightweight) cable designed by the British Post Office and the Company's factory at Greenwich has supplied this type of cable for the first Commonwealth link (called CANTAT) between Scotland and Canada, to the order of the Canadian Overseas Telecommunication Corporation and Cable and Wireless Ltd. Their Repeater Division at Erith, Kent, has made the submerged repeaters for the CANTAT extension from Newfoundland up the St. Lawrence River, to the order of the Canadian Overseas Telecommunication Corporation.

Submarine Cables Ltd., backed by over a hundred years of experience, are in a position to give expert technical advice on any submarine-cable telecommunications problem.

## SUBMARINE CABLES LIMITED

*Owned jointly by Associated Electrical Industries Ltd. and British Insulated Callender's Cables Ltd.*

HEAD OFFICE: Mercury House, Theobald's Road, London WC1 · Telephone: HOLborn 8711 · Telegrams: Telsiem, London, Westcent. · Cablegrams: Talsiem London WC1 WORKS: Telcon Works, Greenwich: Ocean Works, Erith, Kent.



# DOUBLING THE CHANNELS in

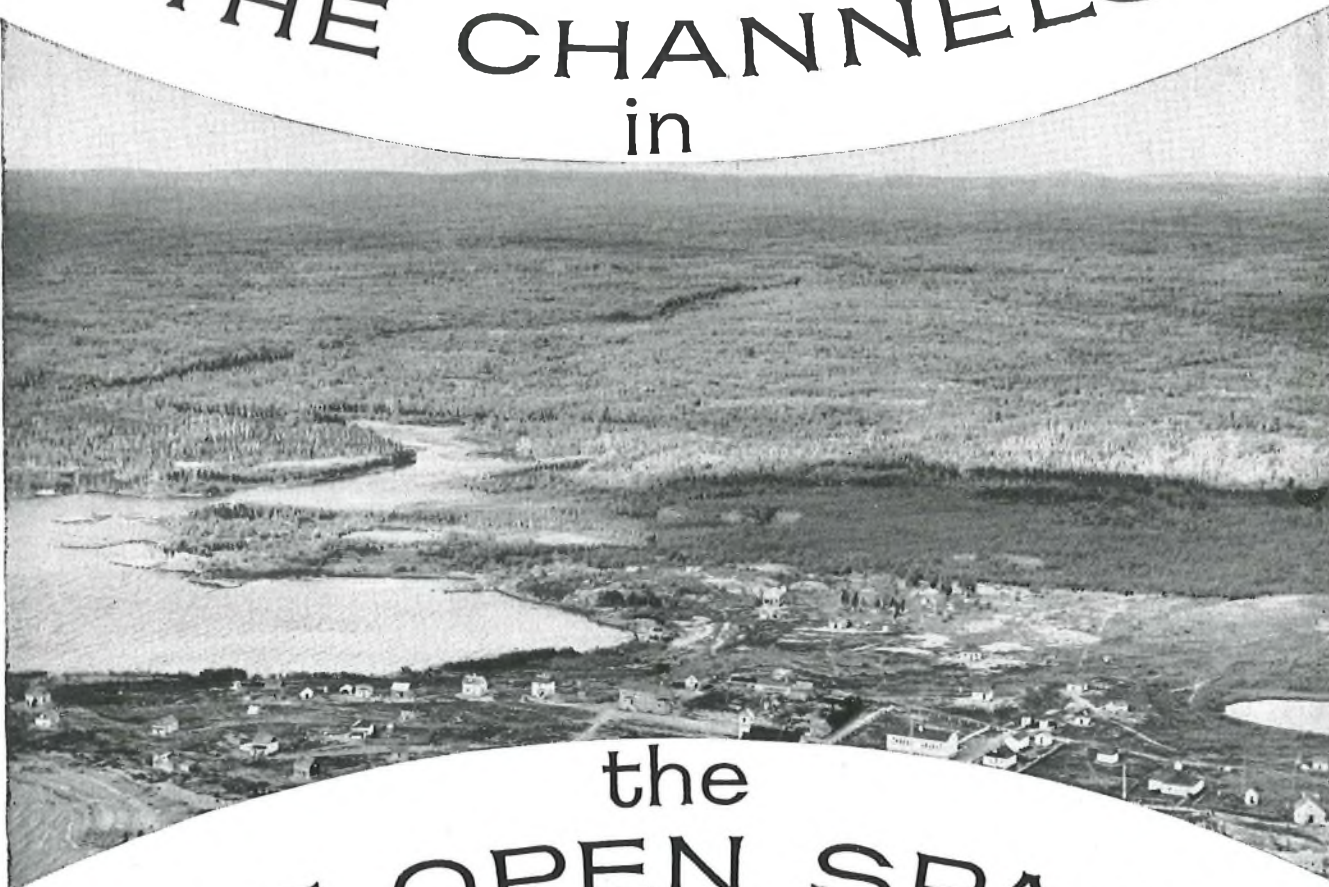

# the WIDE OPEN SPACES

Such is the geographical nature of our world that it still attempts to defy communications. Vast areas of sparsely inhabited country often make the installation of additional bearers uneconomical! This is where TMC 2 kc/s Spaced Carrier Telephone Equipment can solve the problem. It provides 24 telephone circuits within CCITT basic group 'B' limits of 60 to 108 kc/s, and can be incorporated with most cable, radio and open wire systems. Economy of bandwidth is achieved by efficient utilisation of the frequency band, employing a novel modulation plan. TMC 2 kc/s

Spaced Carrier Telephone Equipment doubles the channels on existing bearers or it can provide a reserve of extra circuits to meet emergencies.

#### RANGE

Channel bandwidth:	300 to 2200 c/s
Overall bandwidth	60 to 108 kc/s
Impedance—Audio:	600 ohms balanced
Impedance—GDF Point:	75 ohms unbalanced or 135 ohms balanced
Levels at GDF Point:	-37 or -42 dbm transmit -5 or -8 dbm receive
Power consumption:	245 VA

Requires external carrier supplies of 72, 76, 80, 84, 88, 92 and 96 kc/s.  
24-circuits contained on two standard 9 ft. high racksides.

## TMC

## 2 kc/s SPACED CARRIER TELEPHONE EQUIPMENT

Further information from:

**TELEPHONE MANUFACTURING COMPANY LIMITED**

Transmission Division, Sevenoaks Way, St. Mary Cray, Orpington, Kent, England. Telephone: Orpington 26611

#### Selling Agents:

Australia and New Zealand: Telephone Manufacturing Co. (Australasia) Pty Ltd.

Sydney, New South Wales

Canada and U.S.A.: Telephone Manufacturing Co. Ltd., Toronto, Canada

Also represented in other countries

A MEMBER OF THE  GROUP OF COMPANIES

## INDEX TO ADVERTISERS

	PAGE		PAGE
Adcola Products, Ltd. . . . .	32	Oxley Developments Co., Ltd. . . . .	13
Automatic Telephone & Electric Co., Ltd. . . . .	16-17	Painton & Co., Ltd. . . . .	27
Avo, Ltd. . . . .	294	Pitman, Sir Isaac, & Sons, Ltd. . . . .	2
Bennett College, The . . . . .	13	Plessey Co., Ltd., The . . . . .	38
British Institute of Engineering Technology . . . . .	2	Preformed Line Products (Great Britain), Ltd. . . . .	30
Ericsson Telephones, Ltd. . . . .	28-29	Pye Telecommunications, Ltd. . . . .	31
Filhol, J. P., Ltd. . . . .	13	Shell-Mex & B.P. Gases, Ltd. . . . .	37
Formica, Ltd. . . . .	15	Standard Telephones & Cables, Ltd. . . . .	1, 3, 5, 7
General Electric Co., Ltd., The . . . . .	8-9, 18-19, 22-23	Stone-Chance, Ltd. (Austinlite) . . . . .	12
Geat Northern Telegraph Co., Ltd. . . . .	21	Stonebridge Electrical Co., Ltd., The . . . . .	36
Imperial Chemical Industries, Ltd. . . . .	11	Submarine Cables, Ltd. . . . .	34
Johnson, Matthey & Co., Ltd. . . . .	20	Telephone Cables, Ltd. . . . .	6
Mallory Batteries, Ltd. . . . .	24	Telephone Manufacturing Co., Ltd. . . . .	33, 35
Marconi's Wireless Telegraph Co., Ltd. . . . .	14	Turner, Ernest, Electrical Instruments, Ltd. . . . .	2
Mullard, Ltd. . . . .	10, 25	Westinghouse Brake & Signal Co., Ltd. . . . .	4
National Salt Glazed Pipe Manufacturers' Association . . . . .	26	Whiteley Electrical Radio Co., Ltd. . . . .	32
Neill, James, & Co. (Sheffield), Ltd. . . . .	21		

# FLUSH MOUNTING RESETTABLE METERS

This 3 figure meter as adopted for subscriber trunk dialling is an example from a complete range of electro-mechanical counters. Manual and electrical reset types for indication, pre-determined counting, printing and readout are available.

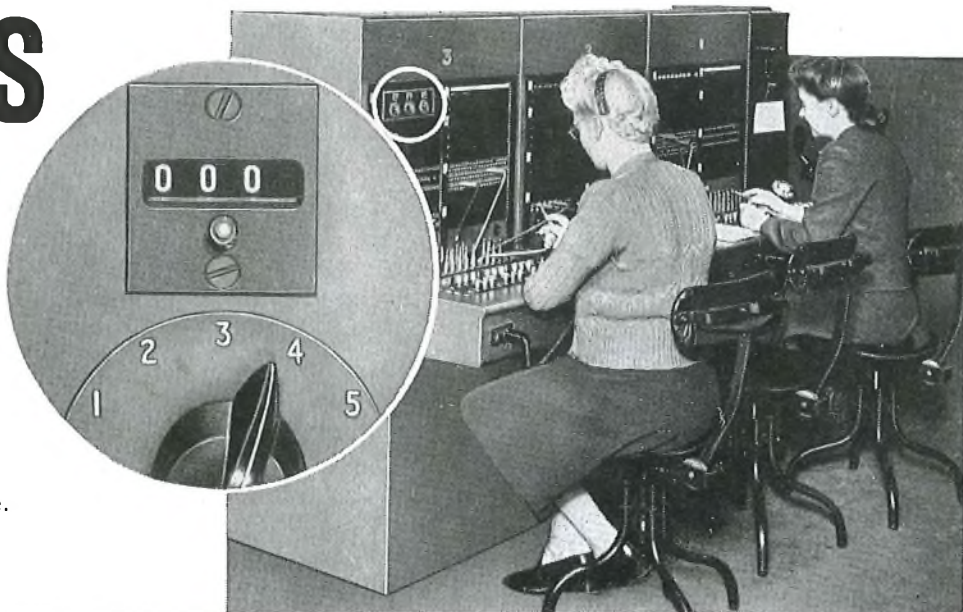

**THE STONEBRIDGE ELECTRICAL CO. LTD.**

6 QUEEN ANNE'S GATE • LONDON, S.W.1 Telephone: TRAlfalgAr 1444

CONTROLS & INSTRUMENTS

**STONEBRIDGE**

Agents and Licensees in U.K. for 'SODECO' Geneva



Space Heating is easy  
and economical with  
**PROPAGAS Propane**

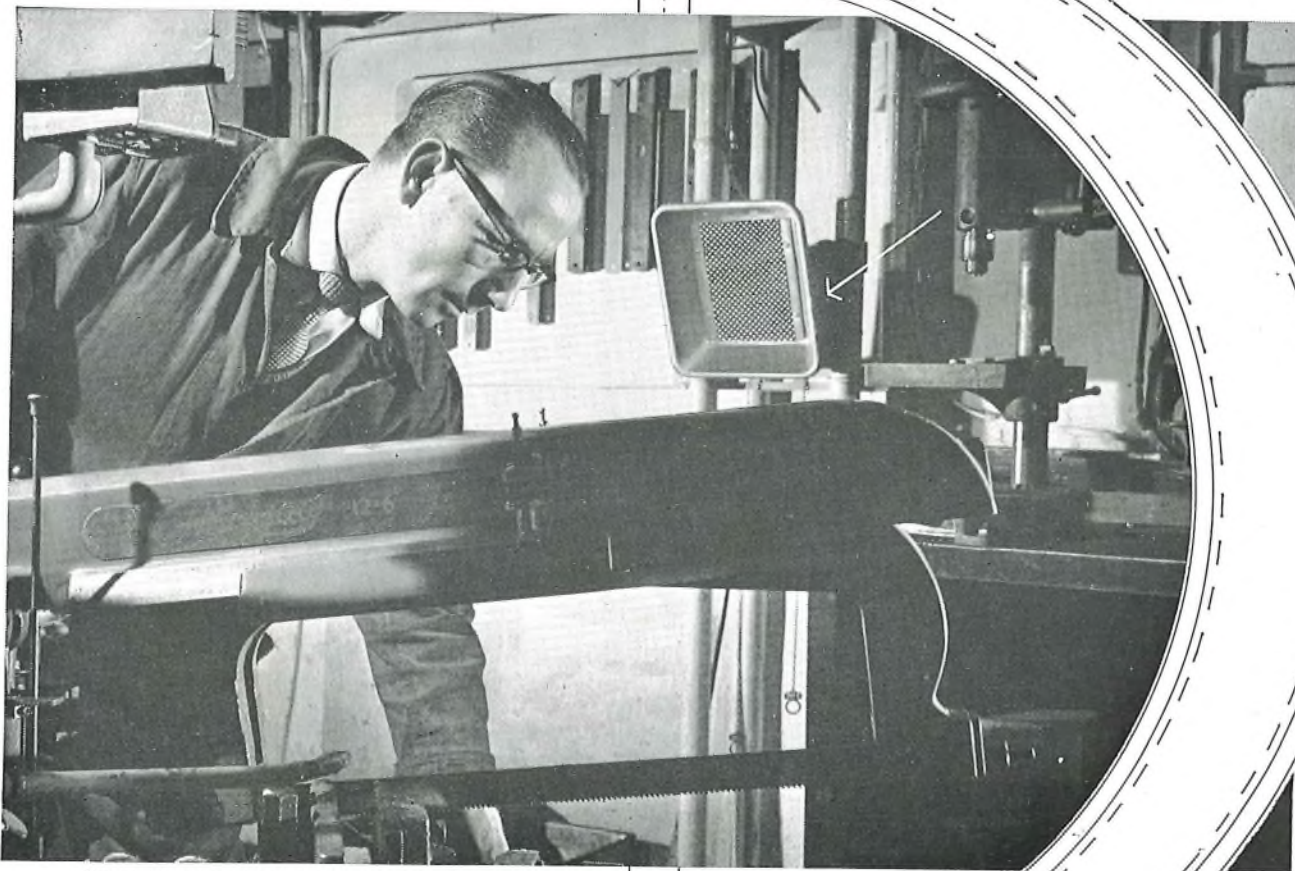

*Photograph by courtesy of The Rex Hacksaw & Tool Manufacturing Co Ltd*

# PROPAGAS

PROPANE

## PRECISION FUEL

Quick, trouble-free and economical, PROPAGAS propane is in general use throughout the country for permanent or temporary space heating in factories, workshops, church halls and large buildings.

## for radiant heaters

PROPAGAS propane and BOTTOGAS butane are the Precision Fuels for industrial furnaces, the glass industry, air heaters, bitumen and mastic heating, floodlights, blow torches, fork lift trucks, agriculture.

*PROPAGAS propane and BOTTOGAS butane come from the British Refineries of the Shell and BP Groups. They are backed by a nationwide distribution service and technical resources second to none.*

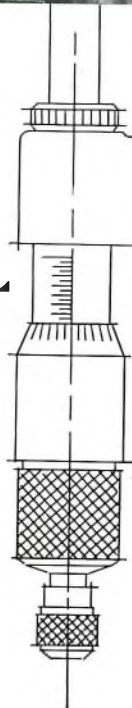

**Shell-Mex and B.P. Gases Limited**  
(Regd. users of Trade Marks)

Cecil Chambers, 76-86 Strand, London WC2 Phone: TEMple Bar 1234

**Plessey**

**Aerial  
Exchange  
feeds  
80 receivers  
from one  
aerial**

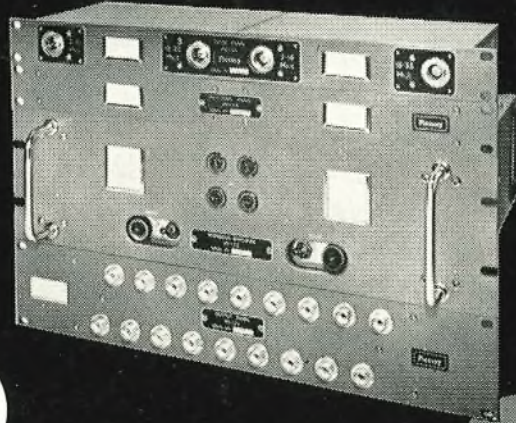

- 2 Mc/s to 30 Mc/s overall coverage ; uses four basic units.
- Optional additional units link any receiver to any of several arrays.
- Standard unit range speeds maintenance, simplifies installation.
- Complete system gives ultimate capacity of 80 receivers working to 12 aerial arrays.
- Electronic switching minimises noise, heightens long-term reliability.
- Zero overall insertion loss; high-gain, low-noise wideband amplification.
- Easily arranged for dual-diversity working.

**Comprehensive details of this flexible range of equipment are available on request.**

**Plessey**

**Telecommunications Division** · Electronic and Equipment Group  
THE PLESSEY COMPANY LIMITED · Ilford · Essex · Tel: Ilford 3040  
*Overseas Sales Organisation : Plessey International Limited*