

RA Roe Peterfeld

THE POST OFFICE ELECTRICAL ENGINEERS' JOURNAL

Vol. 48

JULY 1955

Part 2

CONTENTS

	PAGE
PROVISION OF NEW TRUNK CABLES ACROSS THE FORTH BRIDGE—J. Gerrard, A.M.I.E.E.	65
A NEW TYPE OF TELEGRAPH POWER PLANT—R. C. Belton, A.M.I.E.E.	71
PROTECTION OF TELECOMMUNICATION LINES FROM INDUCED VOLTAGES BY THE USE OF GAS DISCHARGE TUBES—H. Fielding, A.M.I.E.E.	76
AN INSTRUMENT FOR THE MEASUREMENT AND DISPLAY OF V.H.F. NETWORK CHARACTERISTICS—J. S. Whyte, B.Sc.(Eng.), A.M.I.E.E.	81
A DIAL PULSE GENERATOR—A. W. N. Garbutt	84
LONDON TRUNK KINGSWAY EXCHANGE—F. V. Partridge, A.M.I.E.E., and C. G. Grant, A.M.I.E.E.	87
A TEN-KILOWATT LOW-PASS FILTER—E. R. Broad, B.A., and E. J. P. May, B.Eng., A.M.I.E.E.	94
A NEGATIVE IMPEDANCE CONVERTER FOR USE AS A TWO-TERMINAL AMPLIFIER—J. R. Tillman, D.Sc., A.R.C.S.	97
THANET CORDLESS SWITCHBOARD—L. A. Missen, R. A. Snook and E. J. T. Hitchin	102
A FREQUENCY MODULATOR FOR BROAD-BAND RADIO RELAY SYSTEMS—I. A. Ravenscroft, A.M.I.E.E., and R. W. White, B.Sc., A.M.I.E.E., F.Inst.P.	108
IMPEDANCE DIALLING—H. N. Wroe, Ph.D., B.Sc.(Eng.), A.M.I.E.E.	110
AN AREA PLANNING AND GENERAL PURPOSE VEHICLE—G. H. Slater, A.M.I.E.E.	112
“MOSAIC”—AN ELECTRONIC DIGITAL COMPUTER, Part 1—The Store and Arithmetic Units—Allen W. M. Coombs, Ph.D.	114
NOTES AND COMMENTS	117
INSTITUTION OF POST OFFICE ELECTRICAL ENGINEERS	117
REGIONAL NOTES	118
ASSOCIATE SECTION NOTES	120
STAFF CHANGES	123
BOOK REVIEWS	70, 86, 101, 113

Price 2/6 net

THE INSTITUTION OF POST OFFICE ELECTRICAL ENGINEERS



Redifon

Radio Communications Division

REDIFON LIMITED, BROOMHILL ROAD, LONDON, S.W.18.

Tel: VANdyke 7281

A manufacturing Company in the Rediffusion Group

Redifon are playing a leading part in the development of long distance radio teleprinter services. The G.67 transmitter and the R93 or R151 receiver form an ideal basis for this type of link with speedy and accurate message handling capacity.

R.151. The most up-to-date receiver for space diversity reception of teleprinter signals within the 2-28 Mc/s frequency range. Built for extremely high quality performance, the R.151 is offered at remarkably low cost.

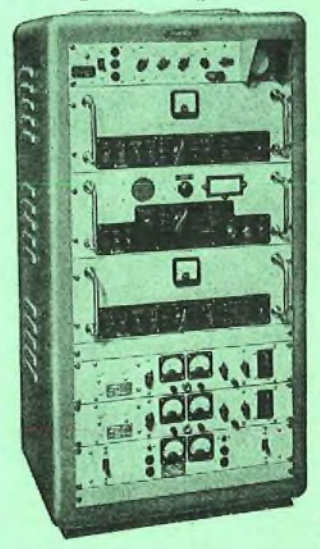

TELECOMMUNICATIONS

By A. T. Starr, M.A., Ph.D., M.I.E.E. 35/- net. "In 450 pages, Dr. Starr has produced a comprehensive book embracing the whole field of telecommunications. To achieve this the book is written in a succinct style with economy of description and explanation; at the same time, accuracy, clarity and completeness are not sacrificed . . . Both as a textbook and as a handbook it is strongly recommended."—*The Engineer*.

TELECOMMUNICATIONS PRINCIPLES

By R. N. Renton, A.M.I.E.E., Executive Engineer, Engineer-in-Chief's Office, G.P.O. A widely used book which has proved its value to students of Telecommunications Engineering, and especially those about to take the City and Guilds examination in the subject. Illustrated. 37/6 net. "Can be confidently recommended to all students of Telecommunications." —*Post Office Communications Journal*.

PITMAN

Parker St. • Kingsway • London, W.C.2

VALUABLE FREE BOOK



Tells You How to Pass Your C. & G. or Promotion Exam. at First Attempt!

All Post Office Engineering personnel who are anxious to obtain early promotion should at once send for a copy of our handbook "ENGINEERING OPPORTUNITIES," which among other intensely interesting matter describes our unique methods of preparation for **TECHNICAL APPOINTMENTS IN THE POST OFFICE** (Assistant Engineer—New Style and Assistant Traffic Superintendent), **CITY AND GUILDS EXAMINATIONS** in Principles of Telecommunications (1-5), Radio (1-4), Telephone Exchange Systems (1-3), Telegraphy (1), Line Transmission (1 and 2), Lines Plant Practice (1 and 2), Mathematics for Telecommunications (1-5), Electrical Engineering Practice (Prelim. Inter. and Final), and outlines a wide range of non-examination courses in all branches of Electrical, Mechanical, Civil, Automobile, Aeronautical and Radio Engineering.

Assistant Engineer and Assistant Traffic Superintendent. Open competitions now resumed. Age extensions for established Civil Servants. Ask us for full details

We definitely guarantee "NO PASS—NO FEE"

If you intend to make the most of to-day's opportunities, you cannot afford to miss reading "ENGINEERING OPPORTUNITIES." It tells you everything you want to know to secure advancement, and describes many opportunities you may now be missing through lack of information. Send for your copy to-day—**FREE** and without obligation.

BRITISH INSTITUTE OF ENGINEERING TECHNOLOGY
369 COLLEGE HOUSE,
29-31 WRIGHT'S LANE, LONDON, W.8

BIET

THE POST OFFICE ELECTRICAL ENGINEERS' JOURNAL

Vol. 48

July 1955

Part 2

Provision of New Trunk Cables Across the Forth Bridge

J. GERRARD, A.M.I.E.E.†

U.D.C. 621.395.51:621.315.29:624.2

This article describes the installation of new telephone cables across the Forth Bridge and the special methods of construction necessary to deal with vibration, load deflection and thermal expansion and contraction of the bridge.

INTRODUCTION

THE laying of a new cable in normal circumstances rarely presents features of any great interest, but the recently completed provision of new cables across the Forth Bridge produced many problems worthy of recording. These problems, arising from the vibration, load deflections and thermal expansion and contraction of the huge steel structure, when coupled with unusual applications of aerial cabling, cabling in troughing and on walls, necessitated a range of operations which almost exhaust the repertoire of the cable engineer's art. This article shows how these problems were successfully solved.

The methods of placing earlier telecommunications cables and a detailed description of the mechanical features of the bridge structure have previously been published¹; it is proposed to continue the story from 1950, i.e., after an interval of 14 years. It was not until 1950 that failures began to occur in the cables on the bridge; an indication of the excellent construction work when they were laid.

Fig. 1 is a general view of the bridge from the southern end, and the construction of the bridge is shown diagrammatically in Fig. 2, from which it will be seen that the bridge is not solidly connected throughout, but at the north

and south ends of the cantilever sections, i.e., at the North Pier and the Jubilee Arch, and also at one end of each of the two girder spans, continuity is maintained through rolling members to allow freedom for expansion and contraction. At these points expansion boxes, or as they are more generally termed "slack boxes," are therefore provided in the steel trough carrying the cables.

CABLING ARRANGEMENTS EXISTING IN 1950

In 1950 there were five cables existing across the bridge:—

- PCMT 38/70 CJ cable connecting open lines.
- PCMT 54/70 Edinburgh-Stirling.
- PCMT 160/40 Dundee-Edinburgh No. 1.
- 2-PCQT 24/40 Aberdeen-Edinburgh Nos. 2 and 3 carrier cables.

Between Jubilee Arch and the North Pier all these cables were laid solid in a steel trough with a bitumastic compound, and the trough had inside measurements of only $6\frac{3}{8}$ in. \times 9 in. deep, except at the expansion boxes. The available space for new cables, from the top of the compound to the underside of the cover, did not exceed $3\frac{1}{2}$ in. at any point.

Approaching the slack box from each side, each lead-covered cable was jointed to a rubber-covered cable laid through the box with sufficient slack to allow for the maximum contraction of the cable on either side. At maximum temperature the amount of cable entering the slack box due to expansion was approximately 10 in. Each rubber-covered cable was protected by a watertight flexible metallic tube and sealed into the joint by means of Ozokerite tape and Chattertons compound. When low insulation developed on one of the cables it was found that the constant flexing of the metallic tube had caused it to open at the top of the arch formed by the slack cable, allowing moisture to pass down the outside of the rubber sheath and penetrate the layers of tape and compound into the joint. Until this time there had been no faults on the cables, but it was then evident that the life of the expansion joint could only be of the order of 14 years and, to avoid increasing maintenance charges, redesign was put in hand.

At the same time the Bridge Engineer drew the attention of the Post Office to the fact that the elm blocks on which the troughing was laid on the asphalt footway were being hammered into the asphalt. This gave concern for two reasons.

(a) Cavities, in which water was accumulating, were being formed in the asphalt, and in some cases the fabric



FIG. 1.—GENERAL VIEW OF BRIDGE AND SOUTHERN APPROACH.

† Senior Executive Engineer, External Plant and Protection Branch, E.-in-C.'s Office.

¹ "Forth Bridge Cables." B. Davies. *P.O.E.E.J.*, Vol. 30, Part 2, July 1937.

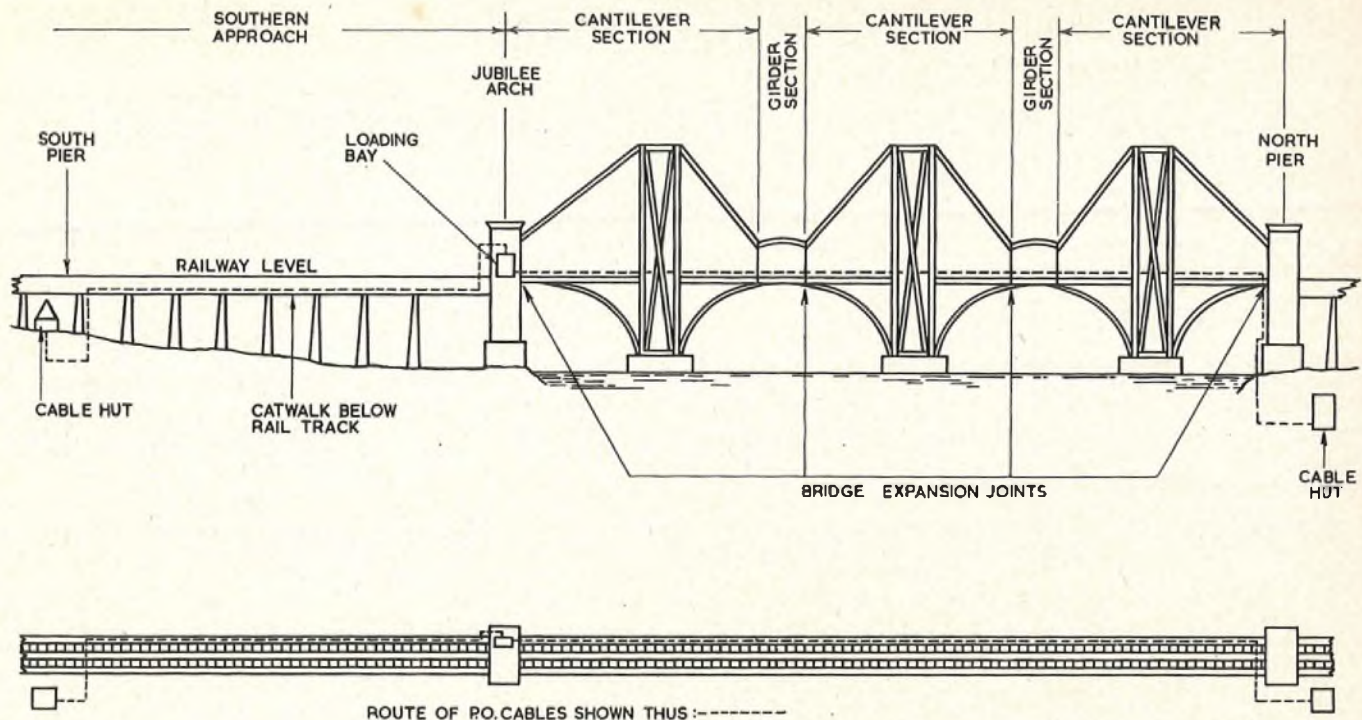

FIG. 2.—DIAGRAM OF BRIDGE SHOWING POSITION OF CABLES.

of the bridge was being exposed to rusting at points which could not be treated by the normal painting operations.

(b) It is necessary to have a 1 in. space beneath the trough to allow water from the footway to flow away to drainage holes, cut in the girder behind the troughing. As the troughing became bedded direct on to the asphalt, access to these drainage points was prevented. Any operations on the bridge involving the troughing were, therefore, conditional on it being raised and the footway reinstated to the satisfaction of the Bridge Engineer.

This, therefore, was the position in 1950 when it was proposed to lay another cable across the bridge.

ADDITIONAL CABLE REQUIREMENTS

Following an initial proposal to route a new coaxial cable across the bridge, a survey was made and, although the minimum bending radius for coaxial tubes would be approached at certain points, no real difficulties were to be expected. Flexibility at the expansion points could be provided by the use of coaxial interruption-type cable. However, the proposal to provide a coaxial cable was abandoned in favour of audio cables and the existing conditions were re-examined to determine how best the maximum numbers of pairs could be provided and what this maximum would be.

The minimum number of additional pairs for immediate requirements was 750 and to meet even short-term development 1,000 pairs had to be provided. It was extremely doubtful if this number of pairs could be accommodated in the limited space in the troughing, and, even if they could, the trough would be completely filled. A proposal to enlarge the trough was rejected by the Bridge Engineer, because making it wider would cause further encroachment on to an already dangerously narrow footway, and any increase in height would interfere with the travelling cradles used by the painting staff. A concession to increase the height and length of the expansion boxes was, however, obtained.

To meet transmission requirements at least half the new circuits were required in 20-lb. gauge so that two cables would be required. After many discussions it was agreed

that one PCQT 542/20 and one 4 SC/40 + 444/10 would be provided and, to make room for these in the trough, certain of the existing cables would be replaced by cables of lighter gauge, as follows:—

38/70	} Combine and replace by 96/20.
54/70	
160/40	Replace by 160/20.

A further complication was that, as the new cables would be loaded at the standard spacing of 2,000 yards, accommodation for two loading pots had to be found on the bridge. After careful examination and consultations with the Bridge Engineer, it was found that the only possible position where two loading pots could be accommodated was in a bay under the Jubilee Arch. This point therefore became the datum point from which all the 2,000-yard loading coil sections were measured on the new cables.

INSTALLATION OF NEW CABLES

Having decided the sizes of cables to be provided, attention was focused on how best to carry out the work, having regard to the cost and also the urgency. Weather conditions on the bridge are such that outside work is normally limited to the period April-September, any extension of this period being quite fortuitous. Although it was considered that to provide an entirely new trough, lay new cables, and then recover the old cables would have been the cleaner job there were objections to this course. There is insufficient room on the west side of the bridge to accommodate a second trough even temporarily, and on the east side there is existing a casing containing Railway Company's cables. The P.O. steel trough, although some 16 years old, is still in excellent condition and replacement would have involved considerable expense and delay. It was decided, therefore, that the existing troughing would be retained, but, in order to carry out the repairs to the footway, it was necessary to remove all the cables from the trough.

As a preliminary step, to interrupt the cables over the bridge, one 254/20 cable with a thin lead sheath and polythene protection was provided between the loading points in the cable huts at each end of the bridge. This cable was lashed to the handrail supports along the catwalk of the

southern approach and to the handrail of the bridge on the cantilever sections. Into this cable were diverted all the pairs from the 38/70, 54/70 and 160/40 cables, thus releasing them for recovery. The two 24/40 carrier cables were not provided until 1938, and as a laboratory examination of a small sample of sheath showed that it was in good condition, with no signs of intercrystalline disintegration resulting from vibration, it was considered safe to remove the cables from their existing position, as described later, without interrupting service.

The Southern Approach.

The cables from the south side, after passing up the face of the South Pier, are run on an aerial cable-suspension system for approximately 600 yards to the Jubilee Arch. This aerial suspension system is on the west side of a catwalk which runs between the South Pier and the Jubilee Arch beneath the railway tracks.

The suspension wires are supported on T-shaped brackets fixed to the bridge girders (see Fig. 3). By interrupting the



FIG. 5.—TERMINATION OF CABLE SUSPENSION WIRES.

out from the South Pier ends. Fig. 5 shows these terminations and tighteners.

Cabling in this section was accomplished from ground level and the method by which it was carried out is worthy of note. In the 600-yard section there are intermediate jointing points so that for the three larger cables five jointing lengths are involved and for the three smaller cables four lengths, this being governed by the capacity of the cable drums. One suspension wire was equipped with 3-in. cradle-type cable rings from the South Pier to the first jointing point back from the Jubilee Arch. The first cable length was then pulled up from the drum at the foot of the South Pier over cable guides, as shown in Fig. 6, into

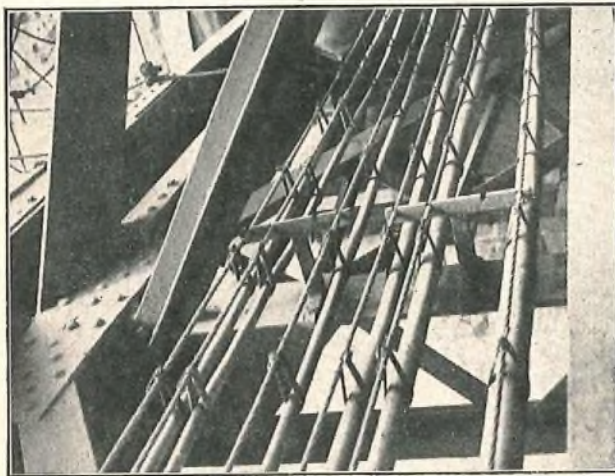

FIG. 3.—T-BRACKETS SUPPORTING CABLE SUSPENSION WIRES.



FIG. 4.—INTERRUPTION CABLE ON CATWALK.

existing audio cables, and removing the carrier cables from the suspension wires to the handrail supports, as shown in Fig. 4, it was possible to completely renew and strengthen the suspension wires and terminations. The original suspension wires were of 4-strand 8-s.w.g. galvanised iron and in the 600 yards there were three intermediate terminations. The new suspension wires are of 7-strand 8-s.w.g. steel and are terminated at the ends only, tensioning being carried

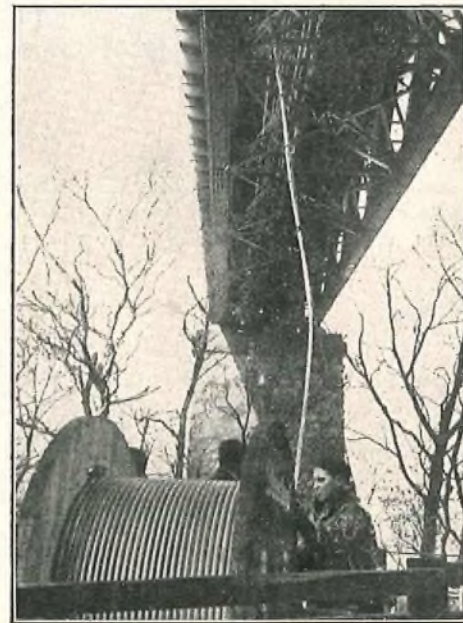

FIG. 6.—CABLING ON THE SOUTHERN APPROACH TO THE BRIDGE.

the ringed suspension wire and straight through until it approached the jointing point. It was then diverted across and drawn into rings on its correct suspension wire. The second and subsequent cables were dealt with in the same way until all six cables were in position on the correct suspension wires from the Jubilee Arch to the first joint towards the South Pier. As soon as each cable was in position the cradle-type rings were removed and replaced by rawhide suspenders to prevent ring cutting. This procedure was then repeated for the next length, and so on

until all lengths were in position right back to the South Pier.

Looking northwards from the South Pier the positions of the new cables are as shown in Fig. 7. It will be seen that this arrangement allows for two further cables over this section if required at a later date.

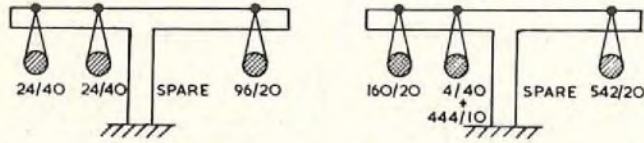

FIG. 7.—POSITION OF CABLES ON T-BRACKETS.

At the approach to the Jubilee Arch, the cables leave the suspension wires and are laid on a platform through the side girders to the face of the arch itself, as shown in Fig. 8. From this point they are cleated to boards on the vertical

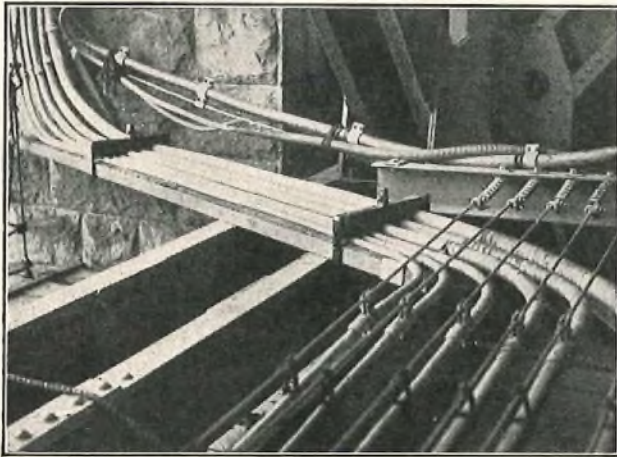

FIG. 8.—CABLES LEAVING SUSPENSION WIRES AT JUBILEE ARCH.

face of the arch up and over on to the railway level.

The cables on the platform and on the vertical run have been protected by sheet iron casing against flying sparks from passing trains, and also from damage by travelling cradles or other equipment used by the bridge maintenance parties.

Clearance and Refitting of Troughing.

As already mentioned, the first work to be undertaken before any new cables were installed in the troughing was to make good the damage to the footway. After removing the cover from the troughing, the two carrier cables, which were the last to be laid and consequently the uppermost cables in the trough, were carefully lifted and secured to the handrail without any interruptions to the service. The remaining three cables, already interrupted by the 254/20 cable, were then removed from the trough and scrapped. These cables were heavily embedded in a petroleum bitumen compound specially blended to prevent it setting hard, but, as the work was carried out in mid-summer when temperatures were high and the compound correspondingly soft, it was possible to lift out the cables and clear the residue of the compound from the trough with very little effort.

The empty troughing was next lifted, the elm blocks removed and brackets welded to each of the vertical girders supporting the handrail. Each bracket has an upturned lip at the front edge, to prevent the troughing sliding off, but as an additional safeguard and to prevent bouncing, the trough was also welded to each lip. At the same time the asphalt footway was made good by using the "Indasco" process, which gave excellent results.

Jubilee Arch Cabling Details.

The Jubilee Arch is a convenient point to commence a description of the cabling of the cantilever sections of the bridge, because it is at this point that the changeover from aerial cabling to cabling in the troughing occurs and the loading pots are installed.

Fig. 9 shows the cables and loading coils in position at the

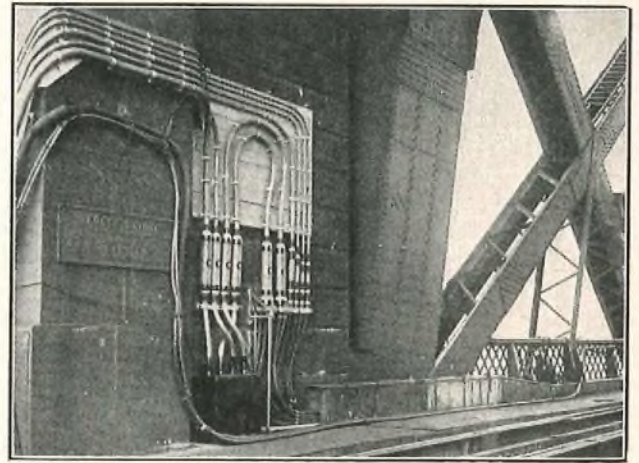

FIG. 9.—LOADING COILS AT JUBILEE ARCH.

Jubilee Arch, and the 254/20 interruption cable and the two working carrier cables before they were recovered. It will be noted in Fig. 9 that the two largest cables, i.e., the 542/20 and 4 S.P./40 + 444/10, after being jointed through the loading pots, are each taken to a large plug joint in which they are broken down into four and three smaller cables, respectively, as shown in Fig. 10. The other cables retain their size throughout.

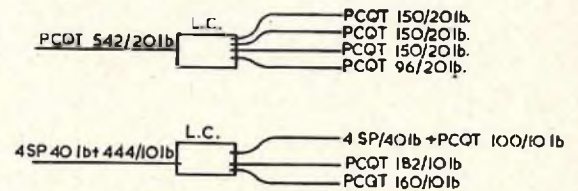

FIG. 10.—ARRANGEMENT OF AUDIO CABLES AT LOADING POINT.

There are two reasons for breaking down the larger cables:—

- (a) To reduce the cable size so that over the cantilever sections the full length of approximately 600 yards can be cabled in one length, avoiding joints in the troughing between the expansion boxes.
- (b) The seven smaller cables give much more flexibility than two large cables when they change from lead to neoprene sheathing at the expansion boxes.

Thus there are 11 cables, instead of six, to be laid in the troughing. One further point, however, must be mentioned. It was stated earlier that the end of the cantilever section at the Jubilee Arch was a "free end" on rollers so that a varying amount of slack cable must be catered for between the joints on the arch and the troughing. The cables leaving the two plug joints and the four straight joints, shown on the right in Fig. 9, have neoprene sheaths instead of lead, to give the necessary flexibility. At the bottom of the bend they rest on a sliding board supported by two steel rods which form a hinged stirrup from a bracket mounted near the plug joints. Flexibility and freedom of movement is, therefore, provided at this point for the cables until they pass over the expansion gap on to the cantilever section, where they are jointed to antimonial lead-sheathed cables in the trough.

Cabling on Cantilever Sections.

Laying out the cables over the cantilever sections followed the normal practice. By arrangement with the Railway Authority the down track was closed to normal traffic on four Sundays; the cable drums were mounted in railway trucks and the cable was paid off as the train steamed slowly across the bridge. Fig. 11 shows cabling in progress



FIG. 11.—CABLING ACROSS BRIDGE FROM TRAIN.

on one occasion. The sheaths of the cables are of lead containing 1 per cent. antimony to resist vibration fatigue and are protected with hessian tape and compound with a whitewash finish. It is considered that having the bitumen-compounded tape on the cable affords a much better "key" when the trough is filled with compound than would be the case if bare lead-sheathed cables were used. A layer of felt is first placed in the bottom of the trough, and as each layer of cables is placed in position and filled in with compound a further layer of felt is placed on top before the next layer of cables is placed in position. The compound used is a cold-setting compound which does not harden completely and the layers of felt prevent the cables gradually settling to the bottom of the trough. Fig. 12 shows to scale a typical cross-section of the troughing with the 11 cables in position. It will be seen that, although room has now been made for the accommodation of the additional 990

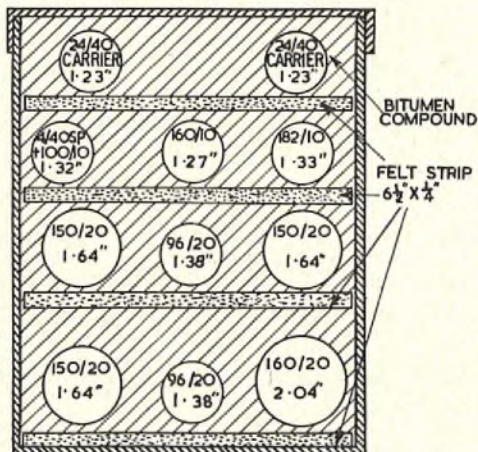

FIG. 12.—SECTION THROUGH TROUGHING SHOWING POSITIONS OF CABLES.

pairs, there is little doubt that by repositioning the two carrier cables yet another cable of about 160/20 or equivalent could be accommodated if required.

Expansion Boxes and Flexibility Arrangements.

The method of providing the required flexibility at the Jubilee Arch has already been described, but the method used at the second and third expansion points is also of interest. Each lead-covered cable is jointed into one having a neoprene sheath, and to accommodate the 11 joints it is necessary to increase the height of the trough. At a point about 27 ft. from the slack box the trough increases in height from the normal 9 in. to 18 in. over a distance of 9 ft. and in this section the grouping of the cables is changed to that shown in Fig. 13. This is necessary because it is impossible to place three joints side by side in the width available. The joints of each layer are staggered, those on the bottom layer being made nearest the slack box.

To seal the joints between the lead and neoprene-sheathed cables a special lead sleeve is used. This sleeve is dressed down on to the lead-sheathed cable on one side and plumbed in the normal manner. The other end of the sleeve has sweated into it a threaded brass collar into which is inserted a rectangular-section neoprene ring between two brass pressure plates. Finally, a brass bush is screwed into the collar, compressing the neoprene ring between the two pressure plates and causing it to seal tightly down on to the cable.

An exploded view of a compression joint is shown in Fig. 14. The compound filling in the trough extends over each lead sleeve, leaving the brass gland exposed.

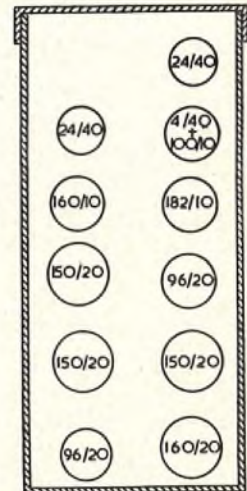

FIG. 13.—SECTION THROUGH TROUGHING SHOWING CHANGED POSITION OF CABLES APPROACHING SLACK BOXES.

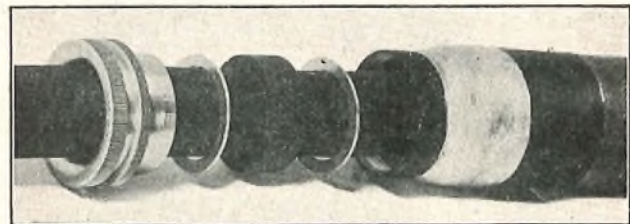

FIG. 14.—EXPLODED VIEW OF SEALING GLAND.

The slack box itself consists of a steel chamber 6 ft. 6 in. long, 1 ft. 9 in. wide and 1 ft. 9 in. high. At one side it is welded to the troughing, but at the other side the troughing is free to move, as shown in Fig. 15, in which the far side is the free end. A wooden arch, over which the neoprene cables are laid, is placed in the bottom of the box, and it is arranged that at a time of maximum contraction the steel troughing enters the box by 1 1/2 in., and there is 1/2 in. of slack in the cables. At maximum expansion approximately 11 1/2 in. of troughing enters the box and 12 in. of slack cable must be accommodated for each of the 11 cables.

As expansion occurs the cables lift from the wooden arch and slide up the sloping "slip board" placed in the side of the box. Both cables and slip board are lubricated with a graphited grease to facilitate this movement, and it is because of this grease that the cable sheaths are of neoprene and not rubber as on the original installation.

Approaching the North Pier the lead-covered cables again

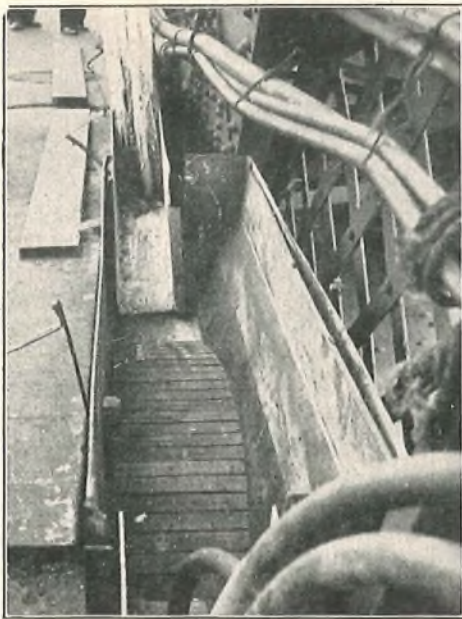

FIG. 15.—INTERMEDIATE SLACK BOX.

are jointed to neoprene-sheathed cables, but the flexibility arrangement is somewhat different. Each cable is covered with a flexible monel-metal tube and is led out of the trough and over the side of the bridge to a jointing position underneath the rail level. The jointing position is a platform

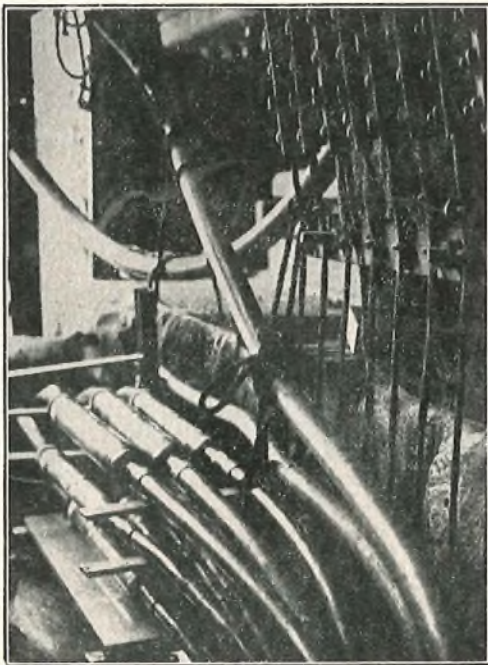

FIG. 16.—JOINTING PLATFORM AND SUSPENSION WIRE TERMINATIONS ON NORTH PIER.

Book Review

"Ibbetson's Electric Wiring Theory and Practice." Revised by C. R. Urwin, A.C.G.I., A.M.I.E.E. E. & F. Spon, Ltd. 296 pp. 119 ill. 11s. 6d.

This is the ninth edition of a book that has achieved great popularity among beginners and students in the field of electrical wiring of buildings. By far the greater part is devoted to the practical aspect; theory being disposed of in some 60 pages. The cramping of this important aspect is unfortunate as it has led to an inadequate treatment, particularly of the

fixed at the top of the North Pier, from which the rollers supporting the end of the cantilever section are oiled. Fig. 16 shows this jointing position with the joints in position on standard P.O. cable bearers and brackets. There is adequate length and flexibility between the troughing above and these joints to accommodate the expansion. The cables at this position are finally jointed back again to lead-sheathed cables which are then clamped to the vertical steel suspension wires, the terminations of which are also shown in Fig. 16. Clamped to these suspension wires, the cables drop vertically for a distance of over 120 ft. to ground level where they pass into a manhole to become normal underground cables.

CONCLUSIONS

When describing a work as complex as cabling across the Forth Bridge, where every operation has interest and a great deal of hazard, it is difficult to decide which features to include and which to omit, but it is hoped that the foregoing description has covered the more interesting and novel aspects.

It would be wrong to conclude this article without a mention of the really excellent part played by the Edinburgh P.O. staff who had the task of renewing the aerial cable-suspension system and erecting the vertical suspension wires on the South Pier and North Pier. Also, great credit is due to them for the excellent manner in which the first interruption cable, 254/20, was erected and jointed, and the Edinburgh-Aberdeen carrier cables lifted from the steel troughing on to the temporary position on the handrail. The 254/20 interruption cable had a thin lead and polythene sheath because it was considered that a plain lead cable temporarily lashed to the handrail and thus exposed to severe wind in addition to the normal bridge vibration would have a very short life, whereas with the type chosen, even if the lead did break up through vibration fatigue, the polythene would prevent the ingress of any moisture for a long period. In fact, the cable was in its temporary position for well over a year without any trouble becoming evident.

The new cabling work was successfully carried out by Standard Telephones & Cables, Ltd., to whom much credit is due. On a work of this magnitude, with the hazards of height and adverse weather, a set-back could be excused, but such was the organisation and engineering of the work that it progressed smoothly from start to finish.

ACKNOWLEDGMENTS

The author acknowledges with thanks the assistance given in the preparation of this article by colleagues in the E.-in-C.'s Office, by Mr. McKendrick, of P.O. Headquarters, Scotland, and by Mr. Costain, of S. T. & C., Ltd.

Acknowledgment is also made to Mr. Bell, the Forth Bridge Resident Engineer, for his valuable co-operation at all stages of the work; and to the Civil Engineering Department of British Railways for assistance given in the design of supporting brackets and expansion point rollers for the steel casing and for the preparation of drawings.

The photographs used for Figs. 6 and 11 are reproduced by courtesy of S. T. & C., Ltd.

A.C. theory, and it is to be expected that the newcomer to this subject will experience some difficulty.

This shortcoming is more than compensated by the excellence of presentation of the practical information. A very wide field is covered and, although it is inevitable that much subject matter has had to be excluded to keep the book within bounds, the amount of really useful information that has been included is surprising.

The book can be recommended to those students who require a broad knowledge of the many practices in vogue at the present time.

E. A. I.

I.P.O.E.E. Library No. 166.

U.D.C. 621.311.6:621.394.441

The power plant described in this article is designed to ensure continuity of supply to A.C.-operated ("51-type") M.C.V.F. telegraph equipment. The supply is provided by a single-phase alternator driven, under normal conditions, by a 3-phase motor connected to the mains and, under mains-failure conditions, by a D.C. motor working off telegraph batteries; the three machines are mechanically coupled and run continuously. Changeover from A.C. to D.C. drive on mains failure and subsequent restoration to A.C. drive are automatic, resulting in a "no-break" supply to the telegraph equipment. Electronic devices are incorporated in the plant to give automatic speed regulation, and automatic voltage and phase synchronisation of alternators when paralleling machines.

INTRODUCTION

APPROXIMATELY four years ago multi-channel voice-frequency telegraph apparatus designed in accordance with New Equipment Practice ("51-type" equipment) was introduced into general use, the design being a radical departure from that of the earlier types. An essential feature of the new practice is the use of indirectly-heated valves and, in line with modern valve-operating technique, 220V H.T. on the valve anodes. The equipment is also designed to function directly off the public supply at 50 c/s, this facility being given by the provision of power packs, which are integral with each individual rack of equipment.

The earlier types of M.C.V.F. equipment use directly-heated valves and anode supplies of 130V, requirements provided by battery float systems using rectifier or generator plants for power conversion. The use of a floating battery automatically gives continuity of power supply to the valves on failure of output of the rectifiers or generators.

This article outlines a method employed to ensure continuity of power supplies to A.C.-operated equipment at terminal stations of considerable size where the M.C.V.F. equipment is used to feed a large teleprinter automatic switching (T.A.S.) centre. The method used meets the recommendations of the C.C.I.T., which state that preferably no break should take place in the power supply, but if that is impossible the duration of the break should not exceed 150 mS. If the break exceeds 150 mS there is a possibility of all selectors held in the T.A.S. centre being released, and on the restoration of the supply the equipment may be overloaded by the simultaneous seizure of a large number of selectors.

POSSIBLE TYPES OF STANDBY EQUIPMENT

When it became apparent that the 51-type equipment was to be used extensively, the following schemes were considered for stations where an engine standby set would be required:—

- (a) An equipment normally supplied with A.C. from the mains via a suitable voltage stabiliser and, connected in parallel, an A.C. machine running as a synchronous motor. On mains failure a D.C. motor coupled to the A.C. machine drives this as an alternator, the public supply being disconnected; the $\pm 80V$ telegraph battery provides the energy to drive the D.C. motor. The equipment load returns to the public supply on its restoration.
- (b) As for (a) but with the addition of a D.C. generator to supply the valve anodes. During the starting period of the engine set a small auto-start motor-alternator serves to maintain the valve heaters, and a 220V battery the anode supplies.
- (c) An A.C. machine to run as a synchronous motor in parallel with the equipment, with a flywheel coupled so as to supply, on mains failure, energy to drive the A.C. machine as an alternator and start an engine via a magnetic clutch; the public supply automatically taking over the equipment load on supply restoration

and the machine set restoring to the normal condition.

- (d) A 3-phase induction motor providing the drive for an alternator, flywheel and D.C. motor coupled together. On failure of the public supply and hence the A.C. motor drive, the D.C. motor, operated from batteries, takes over the set drive, with automatic restoration to the A.C. motor on return of the public supply; the flywheel giving up energy during motor-switching periods.

Schemes (a) and (c) were investigated thoroughly but at the time a suitable reverse power relay was not available and difficulties arose with detecting public supply failure and then restoring the set drive without breaks in excess of 150 mS.

Scheme (b) was attractive except for the provision of a 220V battery and the difficulty in obtaining a motor-alternator that would take load in much less than 4 sec., i.e. the period for which valve cathodes will continue to emit satisfactorily after heater supply failure.

Scheme (d), however, appeared very suitable for the following reasons:—

- (i) simplicity in operation,
- (ii) the plant can be constructed using items already in production, and
- (iii) since it is necessary to provide a $\pm 80V$ battery for teleprinter and M.C.V.F. system supplies in telegraph terminals, the increase in size of plant required to give the reserve for the A.C. plant is relatively easy to cater for.

GENERAL DESCRIPTION OF PLANT

The type of set adopted under scheme (d) above, is one which gives true no-break A.C. power facilities and it has been designed to run continuously, providing a single-phase A.C. supply at 240V. A block schematic diagram of the set is shown in Fig. 1.

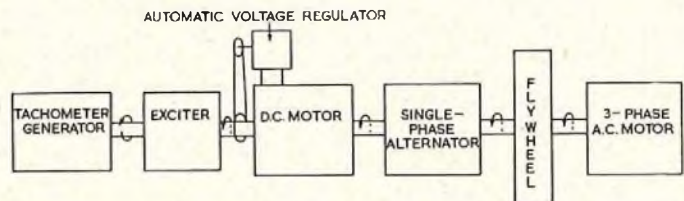

NOTE: ALL MACHINES MECHANICALLY COUPLED AND RUN TOGETHER CONTINUOUSLY

FIG. 1.—BLOCK SCHEMATIC DIAGRAM OF NEW TELEGRAPH POWER PLANT.

While the public supply is normal, the drive for the set is taken from a 3-phase induction motor. When the public supply fails, the set drive is automatically taken up by the D.C. motor operating from the telegraph batteries, and on the restoration of the 3-phase supply, the induction motor automatically takes over the set drive again. To maintain the speed during the switching operations entailed in transferring and restoring the drive, a small flywheel is provided, fitting on the alternator extension shaft.

All the machines are coupled together and run con-

† Executive Engineer, Telegraph Branch, E.-in-C.'s Office.

tinuously. The machines are mounted on a cast-iron bed-plate set up very accurately on concrete piers, with Mascalite pads introduced between the pier and the bed-plate to prevent vibrations being transmitted from the machine to the power room floor. When the machines are erected they are lined up in the usual way, but dynamic balancing is used to correct any vibration inherent in the set when run up to speed. A Davey-type vibrometer is used for this purpose.

The plants were designed to a general specification prepared by the Post Office, covering control gear contained in cubicles and the rotating machine sets. Station loads of 4, 8, 10, 15, 20 and 30 kVA can be supplied by combinations of 4, 10 and 15 kVA sets. The stations are usually installed with two machine sets initially, one taking load and the second spare, and a third set is provided ultimately to give double the output, with two sets taking load and the third spare.

Two machine sets are shown in Fig. 2. The component parts, reading from right to left, are as follows:—

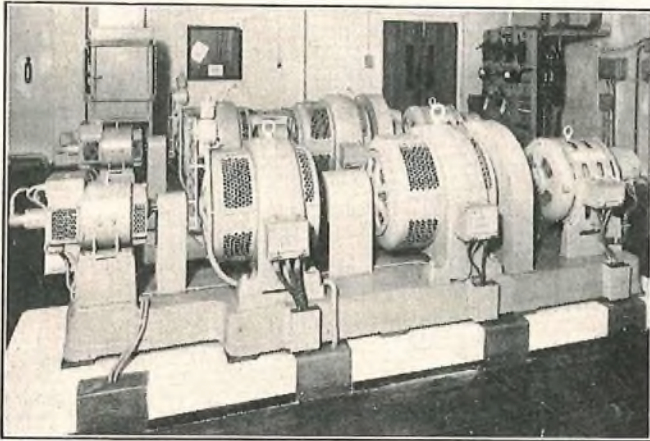

FIG. 2.—TYPICAL INSTALLATION OF MACHINE SETS.

- (i) Three-phase-wound rotor slip-ring induction motor, with slip-rings continuously rated and not fitted with brush-lifting apparatus. The motor is protected by a screen and fitted with ball bearings.
- (ii) Flywheel of cast steel, suitably encased.
- (iii) Single-phase alternator with the field winding on the stator and the output taken via slip-rings from the rotor. This machine is also protected by a screen and fitted with ball bearings.
- (iv) Shunt-wound D.C. motor with interpoles. The armature is of normal design, but two windings are provided on each field pole. It is also protected by a screen and has ball bearings.
- (v) Isenthal automatic voltage regulator, belt-driven from a pulley on the shaft extension of the D.C. motor, upon which it is mounted.
- (vi) Alternator exciter of conventional shunt-wound type, protected by a screen and fitted with ball bearings.
- (vii) Tachometer generator—a small alternator with a permanent magnet field on the rotor, in which the output taken from windings on the stator is proportional to the speed of rotation of the rotor. Rubber-bushed couplings are provided between (i) and (ii), (ii) and (iii), and (iii) and (iv), a leather coupling being provided for the drive for (vii).

The plant is designed to give an output frequency, when fully loaded, of approximately 48.5 c/s when on A.C. or D.C. drive. On A.C. drive this frequency will be obtained with the normal slip that occurs in the A.C. motor, when the supply frequency is 50 c/s. When on D.C. drive, the speed

is maintained by an automatic speed regulator at a frequency which is adequate for the power packs and rectifier units supplied. The output voltage from the sets is maintained at $240V \pm 1\frac{1}{2}$ per cent. from 1/10 to full load.

The A.C. motor operates from a 415V (or 365V), 3-phase, 50 c/s supply, and the D.C. motor from the telegraph 80 + 80V battery, with the two batteries in series to give 160V nominal.

The input voltage and frequency limits down to which the 415V A.C. motor plant is designed to operate before changing to D.C. drive are 350V and/or 48 c/s. Restoration to A.C. drive is effected when the supply voltage rises to 375 and the frequency to 48.5 c/s. (The same percentage change is allowed in the case of the 365V machines.) Drive transfer and restoration are controlled by contact voltmeters and frequency meters.

The control gear for the machines caters for all operations, except that of starting the set from the batteries, and is contained in a suite of cubicles. There are two types of cubicle provided in the suite: a "machine control" cubicle which contains all the gear appropriate to the individual machine set, and a "common control and distribution" cubicle (one per station) for those controls common to all machine sets and the station distributors.

BRIEF DESCRIPTION OF OPERATION

Machine Sets.

An outline of the circuitry is shown in Fig. 3. Resistance starting is provided for the 3-phase induction motor and timed contactors are provided to short-circuit the separate sections of the starting resistors at predetermined intervals. The set is started by operating two switches to the required positions, these switches completing the energising circuit to the A.C. motor-starter contactors and the D.C. motor field respectively, after which starting operations are controlled automatically.

Normally, the set runs up to maximum speed and then at predetermined intervals the short-circuit is removed from the final stage of the starter resistance, causing the set speed to vary over a frequency range of approximately 2 c/s for synchronising purposes. This speed variation can be stopped by operating a further switch when it is desired to test the set at maximum speed or connect it to de-energised bus-bars.

Full protection is provided for the A.C. motor by a P. & B. Gold thermal protective relay and "instantaneous" magnetic overload relay. The thermal relay also gives phase-failure protection. The limits to which the protective devices are set are as follows:—

Thermal protective relay—Persistent overload currents in excess of 120 per cent. full-load current in the supply to the machine. Phase-unbalance currents in excess of 14 per cent. of full-load current.

Instantaneous protective relay—Overload currents in excess of 500 per cent. of full load current.

The alternator is designed to produce as nearly as possible a sinusoidal waveform with a low harmonic content. (That this has been achieved can be judged by the fact that the third harmonic, which predominates, is of the order of 3 per cent. of the fundamental voltage on full resistive load.) Protection is given by "dashpot"-type overload relays that are set to operate at 125 per cent. full-load current. Further protection is provided by a voltage relay across the alternator-output leads, which trips the set off the bus-bars if the alternator volts exceed 280 and extends an alarm if they drop below 225V. A frequency meter indicates the set speed conditions. The output of the alternator is connected to the load bus-bars by a contactor, the operate circuit of the contactor being closed by push-button when connecting an alternator to a dead bus-bar,

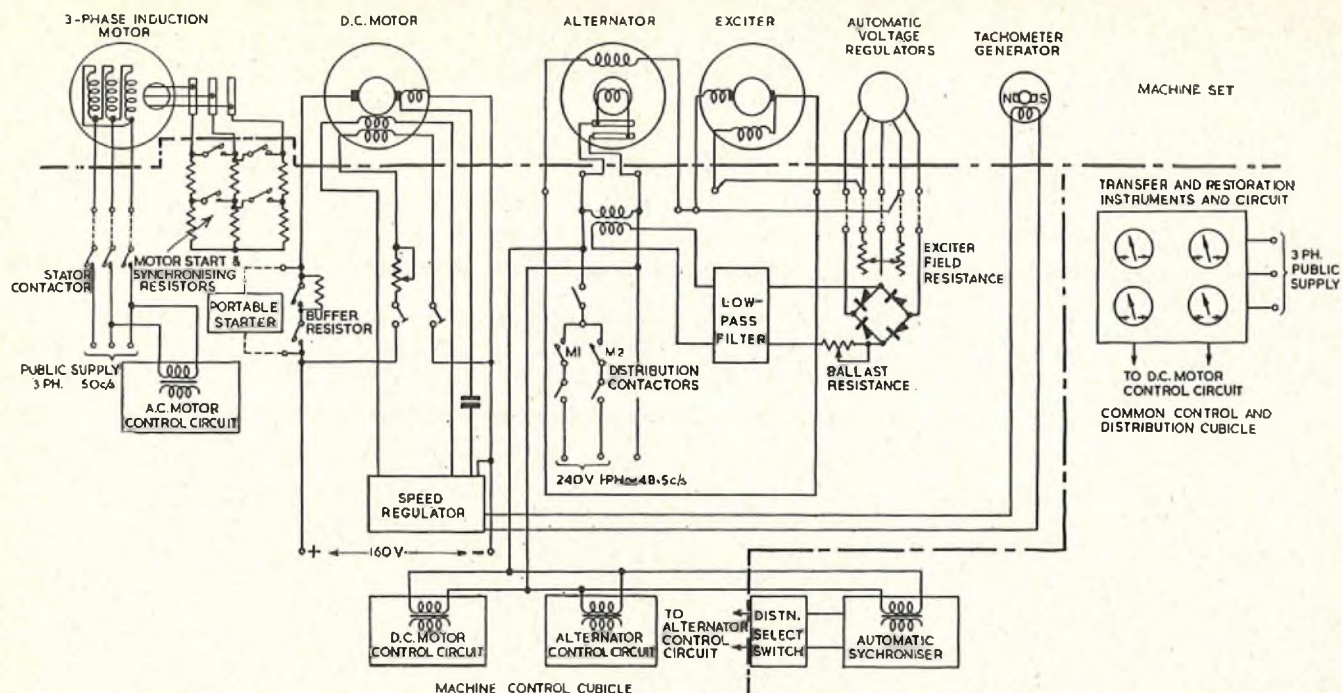

FIG. 3.—SIMPLIFIED CONTROL CIRCUIT AND MACHINE CONNECTIONS.

and by an automatic synchroniser (described later) when paralleling with an energised bus-bar.

The flywheel is used to maintain the set speed during the time taken for the contactor to connect the supply to the armature of the D.C. motor and for the motor to take up the load (approximately 150 mS). It is also of use, when using the automatic synchroniser, in slowing down the rate at which the speed varies when the A.C. motor-speed control device is operating.

The D.C. motor operating on a nominal voltage of 160V must continue to run at a constant speed under conditions of varying battery voltage (172-148V) and load changes, and an automatic speed regulator is therefore provided which controls the speed by varying the strength of the motor field. Control is effected by the auxiliary field winding producing a magnetic flux opposing the main field.

The speed regulator is an electronic device (described later) which, due to the characteristics of the thyatron valve used in the regulator, does not take control of the D.C. motor speed until 5 minutes after it is switched on. Therefore, to ensure D.C. motor-speed control at all times and to reduce cold/hot speed regulation, the regulator and the fields of the D.C. motor are continuously excited while the set is running, whether the drive is by A.C. or D.C. motor. When it is desired to change the drive from the A.C. motor to the D.C. motor, two contactors operate; the first to operate connects the D.C. motor armature to the battery via a buffer resistance, which limits the initial surge current to 150 per cent. of full-load current. Approximately 150 mS later the second contactor operates and short-circuits the buffer resistor, the D.C. motor then running normally to drive the set until the A.C. drive returns. Overload protection is provided by magnetic overload detection relays.

The excitation current for the field of the alternator is provided by a shunt-wound generator connected to the common shaft line via a flexible coupling, the generator output being controlled by the Isenthal vibrating-contact-type voltage regulator. The regulator consists of an iron-cored solenoid, the plunger of which raises and lowers an upper pair of contacts according to the current flowing in the solenoid winding (which is proportional to the

voltage applied). When the current in the solenoid is small the plunger lowers the upper contacts to make contact with a lower pair vibrated by a cam rotating at 1,500 r.p.m. The effect of lowering the upper contacts is to prolong their "make" period, while raising them extends the "break" period. In this way the current in the exciter field and hence the strength of the alternator field is controlled. The current in the solenoid coil is controlled by external resistors and by a spring bearing on the plunger spindle. By suitable adjustment the regulator can be made to hold the alternator voltage at a desired level. The solenoid current is taken from the output of the alternator being controlled, via a transformer and bridge-connected metal rectifier circuit. The presence of harmonics in the alternator voltage waveform will contribute to this current and introduce an error into the voltage at which the alternator output is controlled. To reduce this error a low-pass, shunt-derived filter is connected in the circuit between the transformer and rectifier.

The tachometer generator provides a voltage output (proportional to the set speed) which is fed into the automatic speed regulator circuit (Fig. 3) where it is compared with a stabilised reference voltage. The resultant is applied via an electronic device to control the D.C. motor speed.

Machine Control Cubicles (Fig. 4).

The machine control cubicles, approximately 3 ft. deep and 3 ft. wide, are steel framed and clad with mild steel sheet. Inside the cubicle is a contactor panel extending nearly the full height and width of the cubicle. Mounted on the front of the panel are the contactors and relays used in the individual set control, and on the rear (or on the cubicle framework) are the A.C. motor-starting resistors, D.C. motor-buffer resistor, contactor-economy resistors, transformers, rectifiers and various other items of apparatus. Access to these components is via two sheet panels.

Access to the front of the contactor panel is by two hinged doors on the front of the cubicle, with locks to prevent unauthorised access. The top door carries meters indicating set output voltage and frequency, A.C. and D.C. motor currents and load current; and the thermal protective relay, control switches, indicator lamps and fuses. Mounted

Automatic Speed Regulator (Fig. 5).

The essential parts of an automatic speed-regulating system are (a) a device for assessing the speed continuously, (b) a method of comparing the information provided by this device with a reference, and (c) a means of applying the result of (b) to effect correction when necessary.

As pointed out previously, the tachometer generator provides a means for assessing the speed at any time, its output being rectified and compared with a constant voltage derived from a 160V rectified A.C. supply stabilised by a two-electrode cold-cathode tube.

The outputs from the tachometer generator and from the stabilised source are connected in the grid circuit of a triode D.C. amplifier circuit. The result of changes in voltage from the tachometer generator will be to change the anode current in the triode and hence the voltage across the anode load resistance.

The anode load resistance is part of the grid circuit of a thyatron, a circuit which includes a phase-change device and a D.C. level-change potentiometer. The grid circuit is driven, via the phase-change circuit, with A.C. from the input power transformer which also supplies A.C. to the anode circuit of the thyatron. The relative phase of the two alternating currents is so arranged that changes of

D.C. level in the grid-cathode circuit produce corresponding changes in the average anode current of the thyatron.

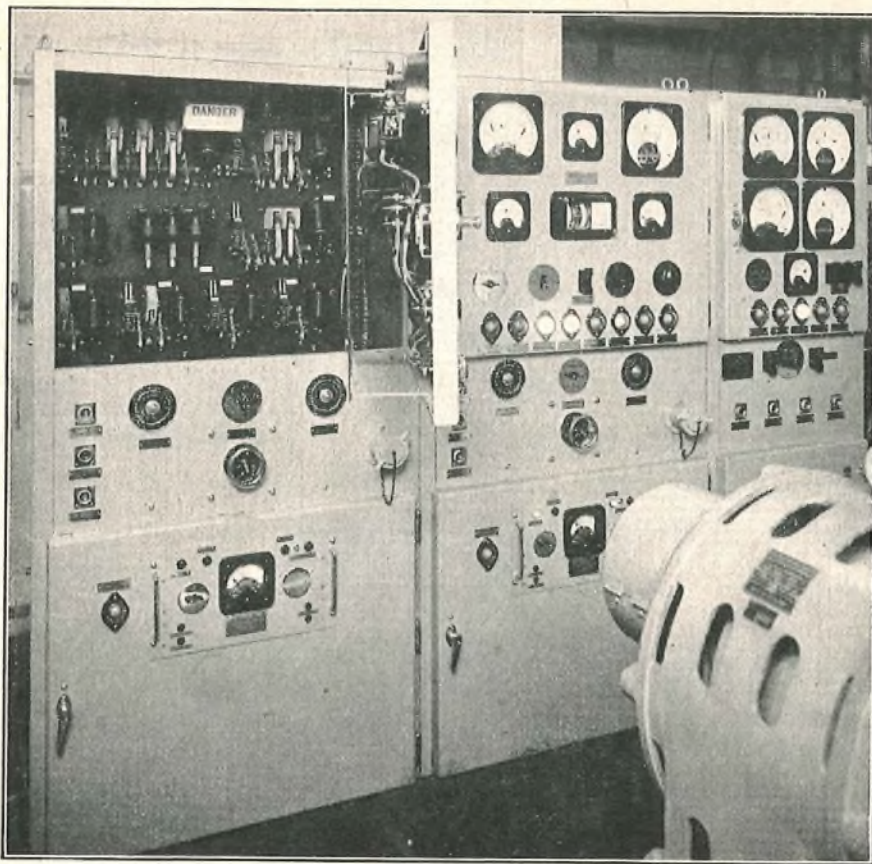

FIG. 4.—CONTROL CUBICLES AT A TYPICAL INSTALLATION.

on the bottom door is the electronic speed regulator.

The dividing strip between the doors carries the field and ballast resistors and test push-buttons. Running from side to side through the centre of the base of the cubicle is a bus-bar chamber, containing the A.C. and D.C. input leads and the output leads, and in the front of the base is a multiple isolator switch by which the cubicle can be disconnected from the mains supplies and outgoing feeders. A portable D.C. starter, with which the sets can be started from the batteries, is provided for use in an emergency.

Common Control Cubicles.

The common control and distribution cubicle, fitted one per station, is similar to a machine control cubicle except that it is only 2 ft. 6 in. wide (see right-hand side of Fig. 4). Its contactor panel holds those control contactors appropriate to functions common to all cubicles, such as synchronising and paralleling of alternators, and transfer of individual set drive from A.C. to D.C. or vice versa. Transfer and restoration contact-meters are mounted on the top door of the cubicle. The transfer volt-meter transfers the drive when the incoming supply volts fall to 350V, the restoration voltmeter restores the set to A.C. drive when the volts rise to 375 (provided that the frequency is above 48.5 c/s). The transfer frequency meter transfers the drive when the incoming supply frequency drops to 48 c/s, and the restoration meter restores the set to A.C. when the frequency is 48.5 c/s (provided that the volts are above 375). A further meter is provided to enable the individual phase voltages to be checked.

On the bottom door is mounted the automatic synchronisation unit and on the centre strip between the two doors are the push-buttons that give the facility of connecting an alternator to dead busbars and also a switch to select the distributor to which an incoming machine will be connected.

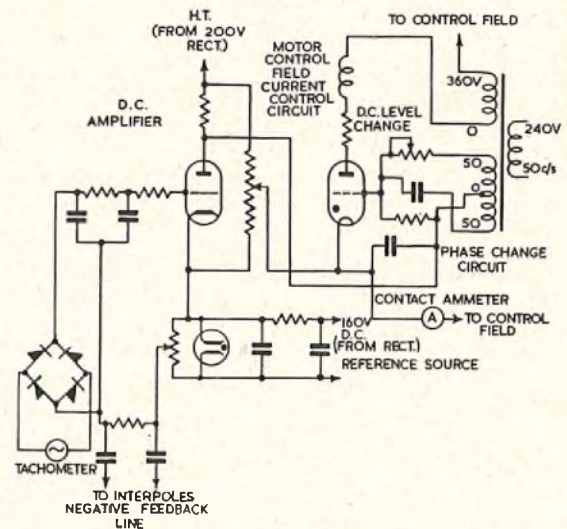

FIG. 5.—BASIC CIRCUIT OF AUTOMATIC SPEED REGULATOR.

Also included in the anode-cathode circuit of the thyatron is the auxiliary-field winding of the D.C. motor. The current changes taking place in the anode-cathode circuit of the thyatron, caused by changes in D.C. level in the grid-cathode circuit, will thus appear as flux changes in the auxiliary field and will vary the main field flux proportionately to the required change.

The circuit described has a servo action and will oscillate under certain conditions. To prevent oscillation, a feedback circuit is provided whereby voltage changes occurring across the interpoles (voltages proportional to torque and

speed changes) are fed back so as to oppose the voltage changes from the tachometer generator. With this addition the circuit will be stable under all conditions.

D.C. power for the various parts of the circuit is supplied by metal rectifiers and smoothing circuits where required, and A.C. power is taken from the single-phase alternator via transformers. In order to prolong valve life, time switches delay the application of H.T. to the valve anodes until the cathodes are at the correct operating temperature. The longest delay provided is on the thyatron where a period of five minutes applies.

The circuit is monitored by a contact ammeter in the auxiliary-field circuit and when the current deviates from the normal close limits an alarm is extended via the ammeter contacts. Manual controls are provided to vary the speed at which the D.C. motor is controlled for setting up initially and also for synchronising purposes, and although each set has its own speed-control unit, all units are interchangeable.

Automatic Synchronisation Detection Unit (Fig. 6).

This unit, which is a device patented by the manufacturer, detects when the incoming alternator is exactly in phase with the machine already connected to the bus-bars. The

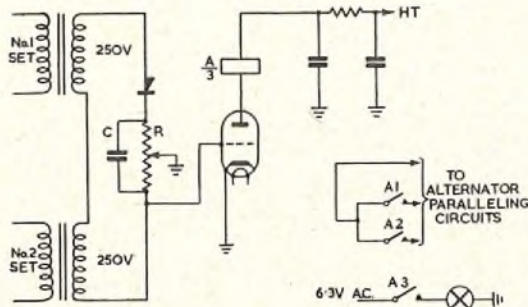

FIG. 6.—AUTOMATIC SYNCHRONISATION DETECTION UNIT.

voltages from the loaded and unloaded alternators are taken to the unit via two transformers with matched secondary windings, and the outputs of the secondary windings are connected together in antiphase via resistor R so that when the primary voltages are exactly in phase and of the same voltage, no current flows through R. The voltage developed across R is made unidirectional by a series rectifier and produces negative bias on the triode. The time-constant circuit RC ensures that a voltage is maintained across R until no current flows in it for a period sufficiently long for the charge on C to leak away, returning the grid to cathode potential and allowing anode current to flow. Connected in the anode circuit is a 3,000-type relay, A, that will operate only when the grid is at negligible negative potential and considerable anode current flows. Contacts A1, A2 complete the operate circuit of the alternator contactor and thus connect the alternator to the bus-bars.

The sensitivity of control can be varied, R being a potentiometer. D.C. power for the valve is derived from a transformer and metal rectifier unit with a thermal delay switch to protect the cathode.

The use of this unit facilitates the operation of the plant by making the paralleling of alternators fully automatic, safeguarding against paralleling machines when out of phase, which, with the inertia of the flywheels, would impose heavy mechanical strains.

OPERATION IN THE FIELD

In general, this type of plant has performed satisfactorily

and, in particular, the electronic units have all been trouble-free to date.

An unexpected difficulty in operation was encountered when the first set was used to take the station load. This was due to the transformer/rectifier units of the power packs forming the load having a non-linear characteristic, and therefore carrying harmonic currents of considerable magnitude. These produced harmonic voltages across the alternator, which is of comparatively small size (4, 10 and 15 kVA) and therefore of relatively high internal impedance.

The effects of poor waveform are, (a) the voltmeter used to indicate the alternator voltage (being a moving coil instrument with rectifier) registers a voltage that is the average of the distorted waveform, and when the set is loaded this shows a considerable fall in voltage due, in some degree, to the change of waveshape; (b) difficulty in obtaining automatic synchronisation is experienced due to dissimilar waveshapes being supplied to the synchroniser from the loaded and unloaded machines; and (c) difficulty in obtaining satisfactory voltage control is experienced due to the Isenthal regulators being affected by the poor waveform.

A wave analysis of the output waveform with the machine connected to the station load had shown that the predominant harmonic produced was the 3rd (30V); the 5th and 7th harmonics were also present to a lesser degree. To improve the waveform a 3rd harmonic filter was connected in parallel with the load; this offered low impedance to the 3rd harmonic and very little voltage appeared across it (6V). The effect of this was to improve the apparent set regulation* (no load to full load) from 20 to 12V. In an effort to improve this still further a 5th harmonic filter was connected in parallel with the 3rd harmonic filter, but although the 5th harmonic was reduced, the apparent set regulation was still 11V. Further tests revealed that the Isenthal regulator was contributing 6V to the regulation figure and a low-pass, shunt-derived filter was connected in series with the Isenthal circuit. The apparent set regulation was then improved to 7V, no load to full load, and on normal load changes an apparent regulation of better than ± 1 per cent. obtained.

The practice is now to set all plants up initially using R.M.S.-reading meters, and to reset when changes in the station load, sufficient to cause the apparent set regulation to alter, have been made.

Experience in the field has shown that adequate protection of the A.C. motor against the effects of excessive unbalance between phases can be given when the thermal elements of the P. & B. Gold relay are adjusted to trip the set when the current unbalance is in excess of 14 per cent. The phase-unbalance conditions normally encountered are sufficiently below this to avoid unnecessary tripping of the machine protection.

The main contractor to the Post Office for the provision of the 51-type M.C.V.F. telegraph apparatus was Standard Telephones & Cables, Ltd.; the Electric Construction Co., Ltd. designed and manufactured the power plant.

ACKNOWLEDGMENT

It is desired to acknowledge the assistance given by colleagues in Telegraph Branch in preparing this article.

* The actual regulation of the set may be quite satisfactory, comprising only the variation in fundamental voltage caused by load changes plus the error introduced by the A.V.R. when operating from a supply with a non-sinusoidal waveform. It is impossible, however, to read this fundamental voltage on the rectified moving coil instruments as they indicate average values for fundamental plus harmonics, giving the apparent set regulation, which may be much greater than the actual.

Protection of Telecommunication Lines from Induced Voltages by the use of Gas Discharge Tubes

H. FIELDING, A.M.I.E.E.†

U.D.C. 621.3.013.71:621.316.933.6

This article describes the design objectives and basis of design of gas discharge tube installations for the protection of telecommunication lines against voltages induced by faults on adjacent power lines. Particular reference is made to a method of determining the minimum earth electrode resistance which need be obtained for satisfactory protection.

INTRODUCTION

THE induction in telecommunication lines of a voltage at fundamental frequency when an earth fault occurs on a high-voltage power line which runs parallel to the telecommunication line, is a well-known phenomenon. The directives of the C.C.I.F. for the protection of telecommunication lines against the adverse effects of power line induction recommend that:—

- (1) For overhead circuits, or cable circuits fitted with lightning protectors or with equipment which has a direct connection with earth, the circuits are considered as being exposed to danger if the longitudinal induced voltage exceeds 430V.
- (2) Cable circuits terminated on transformers but neither earthed nor fitted with lightning protectors between wires and earth, are considered as being exposed to danger if the longitudinal induced voltage exceeds 60 per cent. of the lowest of the test voltages to earth of the cable and its accessories, such as transformers and loading coils.

In Great Britain it is the normal practice to require electricity authorities to limit the earth fault current of any power line to such a value that the voltage induced in any telecommunication circuit will not exceed 430V. Such earth fault current limitation is, however, not always practicable, particularly with main transmission lines, and cases arise where the power line earth fault current will induce a voltage appreciably greater than 430V. Protective measures are then necessary on the telecommunication circuits. One of the methods of reducing the induced voltage between a telecommunication circuit and earth is to connect three-electrode gas discharge tubes between the wires and earth.

The function of the discharge tubes can be explained by considering a line exposed to induction connected to earth at each end by earth electrodes of zero resistance. The induced voltage will cause a current to flow such that the voltage drop along the line exactly neutralises the induced voltage; in other words, the induced voltage is dissipated in the line impedance. In practice, of course, the line cannot be earthed all the time and, furthermore, earth electrodes of zero resistance are impracticable. Gas discharge tubes are devices for earthing the line when the induced voltage reaches a certain value.

Construction and Characteristics of Gas Discharge Tubes.

The characteristics of gas discharged tubes and the circumstances in which they have been used are described in previous articles.^{1,2} A tube consists fundamentally of three tungsten electrodes in a heat-resisting glass envelope which contains a mixture of neon and argon gases. Two electrodes are brought to an Edison screw cap for connection through a holder to the wires of a telephone pair. The third

† Executive Engineer, External Plant and Protection Branch, E.-in-C.'s Office.

¹ "Telecommunications Problems Arising from Hydro-Electric Schemes in Scotland." H. Fielding and E. C. Swain. *P.O.E.E.J.*, Vol. 45, p. 104.

² "An Improved Gas Discharge Tube for Line Protection." F. Jones. *P.O.E.E.J.*, Vol. 45, p. 108.

electrode is connected to an earth cap. To ensure the presence of free ions at all times a spot of radioactive compound is fired onto the glass seal of the earth electrode.

From the point of view of protection it is desirable that the striking voltage of the tubes be as low as possible, but a lower limit is set by the voltages normally employed in telecommunication circuits. Because of this, it is specified that the tubes must not operate at a voltage lower than 150V R.M.S. at 50 c/s. All tubes, however, will operate at a striking voltage of 250V. Although the striking voltage may vary between 150V and 250V it is assumed that the striking voltage of all tubes is 250V R.M.S. The acceptance specification aims at obtaining tubes which, after striking, will reduce the voltage appearing across them to a low value. An investigation of the variation of voltage during striking and arcing² has shown that in a typical voltage waveform, voltage "spikes" may occur at the beginning and end of half-cycles. The duration of the spikes is, however, very short and it is normally assumed that the voltage appearing across the tube during arcing is of the order of 70V R.M.S. at 50 c/s.

DESIGN OBJECTIVES IN GAS DISCHARGE TUBE INSTALLATIONS

The simplest application of gas discharge tubes is to provide a tube on each exposed circuit at each terminal exchange and to connect the earth terminals of the tubes to the exchange earth electrode system. On the induction of a sufficiently high voltage in the communication circuits the tubes break down into arc discharge and pass a current which may reach 5A, or greater, per line electrode. In Fig. 1 is shown a simple circuit consisting of a wire uniformly exposed to a power line throughout its length. The wire is fitted with tubes at each end and the resistances of the earth electrodes are R_1 and R_2 . When an induced

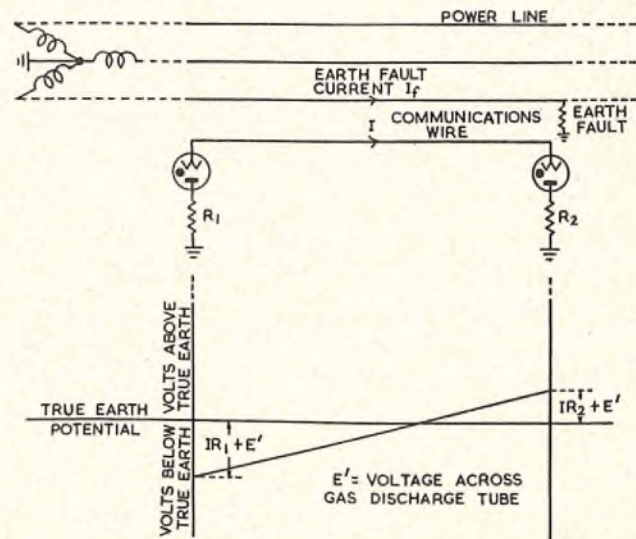

FIG. 1.—VOLTAGE DISTRIBUTION ALONG COMMUNICATIONS WIRE UNIFORMLY EXPOSED TO A POWER LINE THROUGHOUT ITS LENGTH.

voltage causes the tubes to operate, a current I will flow along the wire and through the tubes and earth electrodes. The voltage appearing across each earth electrode will be determined by the resistance of the earth electrode and the current I flowing through it. The voltage to earth at each end of the wire will therefore be the sum of the voltages across the earth electrode and across the gas discharge tube. The voltage distribution along the wire will be a maximum at each end and zero at some point in the exposure, as shown.

When the power line is fed from both ends and the neutral point of the line windings of both feeding transformers is earthed, as is the case with almost all main transmission lines, voltages acting in opposite directions will be induced in the communication circuits if a power line earth fault occurs at an intermediate point in the exposure, as shown in Fig. 2. With this condition it is possible for a high

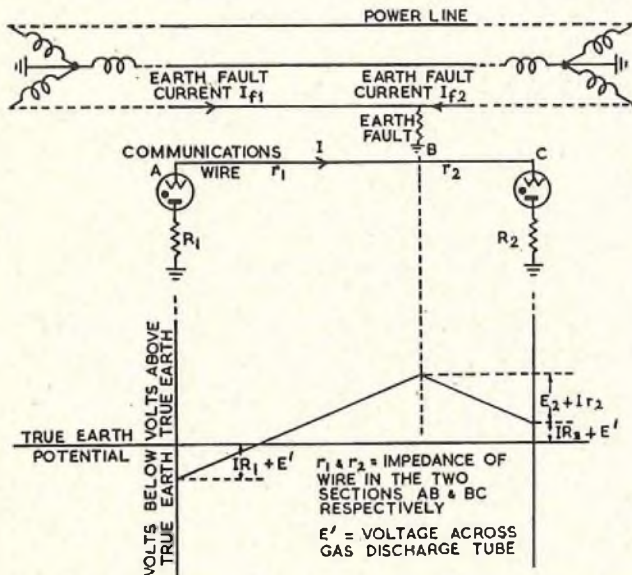

FIG. 2.—VOLTAGE DISTRIBUTION ALONG COMMUNICATIONS WIRE WITH A POWER LINE EARTH FAULT AT AN INTERMEDIATE POINT IN THE EXPOSURE.

line-to-earth potential to exist close to the fault even if the terminal gas discharge tubes operate. In Fig. 2, the earth fault currents I_{f1} and I_{f2} induce voltages in the communication wire which act in opposite directions. The wire is again provided with tubes at both ends. Fig. 2 depicts the conditions when the voltage E_1 induced between A and B by I_{f1} is higher than the voltage E_2 induced between B and C by I_{f2} , and the difference between the two induced voltages is sufficiently high to operate the tubes. It will be seen that however low the values of the earth electrode resistances R_1 and R_2 , the line-to-earth potential at a point on the wire opposite the fault on the power line will be greater than the smaller of the two induced voltages, and may therefore be of a high value. If the fault on the power line was at such a point that the two induced voltages were equal, then the gas discharge tubes situated at the ends of the wire would not operate, and the potential to earth of the wire at the point opposite the fault would equal the induced voltages.

The provision of gas discharge tubes at intermediate points along the route is a safeguard against this type of occurrence. A further reason for providing intermediate tubes is to ensure that the circuits will be protected when they are broken at any point, since it will generally be under these conditions that men will work on the line.

In the design of gas discharge tube installations the Post Office has set itself the following objectives:—

- (i) The voltage to earth appearing at the ends of protected circuits shall be reduced to a value not exceeding the C.C.I.F. permissible limit of 430V.
- (ii) The voltage to earth appearing at the free end of a telecommunication wire broken at any point in the exposure shall not exceed 600V.

These voltages would, of course, normally appear only for the very short period between the occurrence of the fault and the operation of the power circuit-breakers.

BASIS OF DESIGN

If it were necessary to cater only for condition (i) gas discharge tubes connected to the circuits at the ends of the exposure would suffice. In order to meet condition (ii), however, tubes connected to the circuits at intermediate points in the exposure are generally required.

It will be clear that when the induced voltage does not exceed 600V, both requirements would be satisfied if gas discharge tubes were fitted at the ends of the circuits only. If the induced voltage were between 600V and 860V the arrangement in Fig. 3 would be satisfactory. As shown,

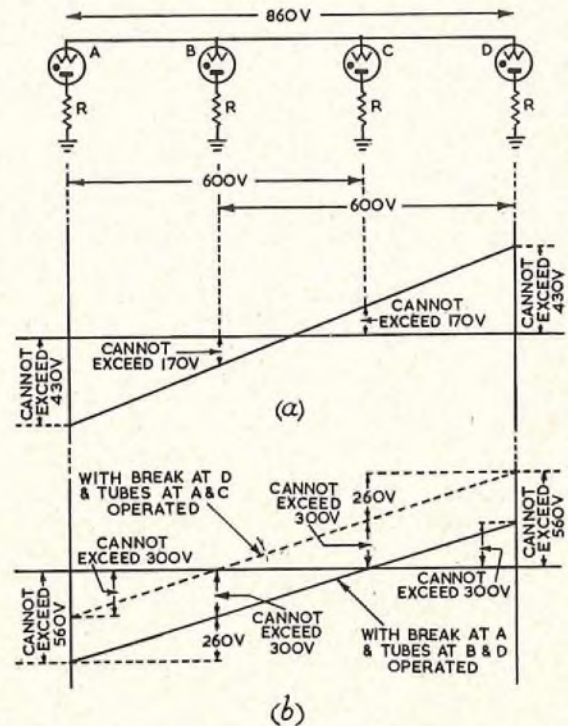

FIG. 3.—VOLTAGE DISTRIBUTION ALONG A COMMUNICATIONS WIRE FOR INDUCED VOLTAGES 600-860V.

- (a) WIRE UNBROKEN.
- (b) WIRE BROKEN AT POINT A OR D.

two intermediate gas discharge tubes have been introduced at points such that the induced voltages A-C and D-B do not exceed 600V. When the lines are unbroken the maximum voltage to earth appears across the tubes and earth electrodes at A and D, and if the earth electrodes are of the same resistance then this voltage cannot exceed 430V. When the lines are unbroken the tubes at B and C will not operate because the voltage applied to them is less than 250V, the nominal striking voltage. When the line is broken the maximum voltage to earth appears when the break is at A or D. If the break is at A the tubes at B and D will operate, and if the earth electrodes are of the same resistance the voltage across these tubes and earth electrodes cannot exceed 300V. The voltage to earth appearing at the end of the break at A is, therefore, the voltage induced between A and B plus the voltage across the tubes and

earth electrode at B and cannot exceed 560V. A similar voltage appears when the break is at D. If the break is to the right of B none of the tubes will operate, and the voltage to earth at the broken end equals the voltage induced between B and D, i.e., 600V; and similarly when the break occurs to the left of C. In these simple cases the resistances of the earth electrodes to which the tubes are connected are not important provided they are low compared with the impedance to earth of the line terminations and are all of approximately the same resistance.

If the induced voltage is greater than 860V the arrangement shown in Fig. 4 meets the required conditions pro-

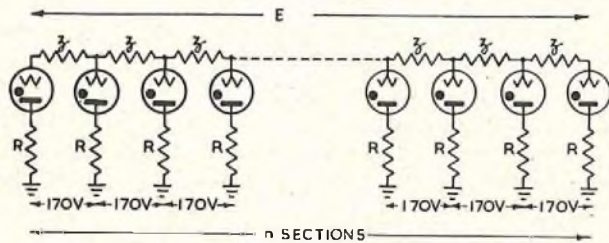

FIG. 4.—CONNECTION OF GAS DISCHARGE TUBES TO COMMUNICATIONS WIRE IN WHICH INDUCED VOLTAGE EXCEEDS 860V.

vided the resistance R of the earth electrode systems is such that the voltage to earth at any gas discharge tube point does not exceed 430V. When the line is unbroken the maximum voltage to earth appears at the terminal gas discharge tube points. The maximum voltage to earth which can arise under broken line conditions is when the line is broken near one of the terminal gas discharge tubes, in which case the voltage is that at the penultimate gas discharge tube point plus the 170V between this point and the break. The value of R , the resistance of each earth electrode system, given by the following relation will ensure that the voltage to earth at any gas discharge tube point does not exceed 430V:—

$$430 - E' = \frac{170nR - 2E'R}{nz + 2R}$$

where, E' = the voltage across the arc of a gas discharge tube,

n = the number of gas discharge tube sections, and
 z = the parallel earth-return impedance per section of all the protected telecommunication wires.
 (See Appendix I.)

The value of R given by this relation is the value which would cater for condition (i) if tubes were placed only at the ends of the circuits; that is, it is the value which would reduce the voltage at the ends of the circuits to 430V even if none of the intermediate gas discharge tubes operated. As the greater part of the cost of most gas discharge tube installations on open-wire lines is spent in the provision of earth electrode systems it is desirable that the effect of operated intermediate gas discharge tubes be taken into account in order to avoid the expense of providing earth electrodes of unnecessarily low resistance.

When a power line fault occurs at a point in the exposure the voltage induced in some sections will be greater than that induced when the fault occurs at the position which gives rise to the full exposure; as mentioned above, when the power line is fed from both ends voltages in opposite directions are also induced in the communication lines. These questions of increasing fault current with decreasing length of exposure, and the induction of voltages in opposite directions when the power line is fed from both ends, are difficult to allow for in a general treatment. Usually, however, it has been found that a design based upon equal spacing of tubes and equal earth electrode resistances is satisfactory.

EARTH ELECTRODE RESISTANCES ALLOWING FOR EFFECT OF OPERATED INTERMEDIATE TUBES

In the following discussion it is assumed that the induced voltage per unit length is the same throughout the exposure, a condition often approximated to sufficiently closely in practice. It is also assumed that the gauge of the wire does not change in the exposure. The idealised system may then be represented as shown in Fig. 5, where gas discharge

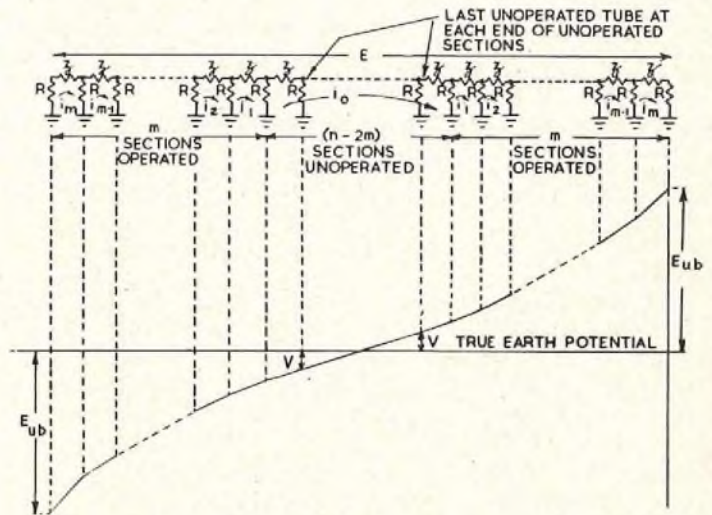

FIG. 5.—VOLTAGE DISTRIBUTION ALONG COMMUNICATIONS WIRE FOR IDEALISED SYSTEM OF PROTECTION.

tubes are placed at $n + 1$ points on the lines, dividing the lines into n equal sections. The voltage induced in each wire is E ; thus, the voltage induced in each section is E/n . In Fig. 5 all the lines have been replaced by a single equivalent wire, as shown in Appendix I. The effect of the voltage drop across the gas discharge tubes is ignored until later.

Gas discharge tubes may not operate when a voltage lower than 250V is applied to them. When the earth fault current flows throughout the exposure the tubes at the ends of the exposure are subject to the greatest voltage and are, therefore, likely to operate first, thus reducing the voltage across the intermediate tubes. If the voltage across the penultimate tubes were then sufficient these tubes would operate, thus further reducing the voltage across the tubes which were still unoperated. It is thus clear that some of the central tubes may not operate.

The voltage distribution on the lines is indicated in Fig. 5. The gas discharge tubes at all points where the voltage to earth of the lines is less than 250V are assumed to be unoperated. When the lines are unbroken the maximum voltage to earth is E_{ub} at the terminal gas discharge tube points. As has been stated previously, the maximum voltage to earth which can arise under broken line conditions is when the line is broken near one of the terminal gas discharge tubes. Thus, the design objectives will be met if E_{ub} does not exceed 430V and $(E_{ub} + E/n)$ does not exceed 600V.

It is shown in Appendix 2 that E_{ub} is given by:—

$$E_{ub} = \frac{E}{n} \sqrt{\frac{R}{z}} \times \frac{\sinh m\theta + (n - 2m) \sinh \frac{\theta}{2} \cdot \cosh \frac{2m + 1}{2} \theta}{\cosh \frac{2m + 1}{2} \theta + (n - 2m) \sinh \frac{\theta}{2} \cdot \sinh (m + 1) \theta} \dots (1)$$

where, E = the voltage induced in each wire on the tele-communications line,

- n = the number of sections,
- $\theta = \cosh^{-1} (1 + z/2R)$,
- z = the parallel earth-return impedance per section of the telecommunication wires in ohms,
- R = resistance of the earth electrodes in ohms, and
- m = number of sections of operated tubes at each end of the network.

Before E_{ub} can be calculated from equation (1) it is necessary to determine m .

The value of m is found by a process of trial. It will be seen from Fig. 5 that the voltage distribution on the communications line in the unoperated sections is a straight line and that the centre point of the communications line is at earth potential. The last unoperated tube at each end of the unoperated sections is therefore subjected to a higher voltage than the unoperated tubes nearer the centre of the line. It is shown in Appendix 2 that if m sections of tubes are assumed to operate at each end of the network then the voltage V which would appear at the last unoperated tube at each end of the unoperated sections is given by:—

$$V = \frac{(n - 2m - 2)E}{2n} \times \frac{\cosh \theta/2}{\cosh \frac{2m+1}{2} \theta + (n - 2m) \sinh \frac{\theta}{2} \cdot \sinh (m+1)\theta} \dots (2)$$

The number of operated sections can be found from equation (2) by a process of trial. For example, if $m = 1$ is first tried in this equation then the value of V obtained is the voltage which appears at the third tube along the network from each end assuming that only the end and penultimate tubes operate. If this voltage is greater than 250V then it can be assumed that these tubes would operate and $m = 2$ is now tried in order to determine whether the fourth tubes along the line from each end would operate. This process is repeated until the number of operated sections is obtained. The value of E_{ub} can now be obtained from (1).

Equations (1) and (2) are the basic equations and the technique in determining the value of R , the resistance of the earth electrode systems, which would meet the design objectives making allowance for the effect of operated intermediate tubes, is first to determine an approximate value of R and then, using this approximate value of R , to determine m (the number of operated sections at each end) from (2). As shown below it is then possible to determine a more accurate value of R from (1).

An upper limit to the value of R is obtained by assuming that all the tubes operate. The corresponding value of E_{ub} can be obtained by inserting $n = 2m$ in (1), giving:—

$$E_{ub} = \frac{E}{n} \sqrt{\frac{R}{z}} \cdot \frac{\sinh \frac{n\theta}{2}}{\cosh \frac{n+1}{2} \theta} \dots \dots \dots (3)$$

A lower limit to the value of R is obtained by neglecting the function of θ occurring in (1) which in practice always has a modulus slightly less than unity, giving:—

$$E_{ub} = \frac{E}{n} \sqrt{\frac{R}{z}} \dots \dots \dots (4)$$

Summary of Procedure in a Practical Case.

The procedure in a practical case is as follows:—

- (a) The parallel earth-return impedance of the telecommunication wires is obtained from the formula quoted in Appendix 1. For open wires it is usually sufficient to assume a value of 1 ohm per mile for the reactive component of this impedance.

- (b) The line is divided into n sections in each of which the induced voltage is approximately 170V.
- (c) A lower limit to the value of R is obtained from (4), assuming $E_{ub} = 430V$.

$$\text{i.e., } 430 = \frac{E}{n} \sqrt{\frac{R_{min}}{z}}$$

An upper limit to the value of R is obtained from (3).

$$\text{i.e., } 430 = \frac{E}{n} \sqrt{\frac{R_{max}}{z}} \cdot \frac{\sinh \frac{n\theta}{2}}{\cosh \frac{n+1}{2} \theta}$$

where, $\theta = \cosh^{-1} (1 + z/2R_{min})$.
 (In evaluating θ , and therefore $\sinh n\theta/2$ and $\cosh \frac{n+1}{2} \theta$, the value of R_{min} determined in (c) is used.)

In practice, it is very often found that the mean of R_{min} and R_{max} is a very good approximation to the value of R .

- (d) Using this approximate value of R for the determination of θ , $m = 1$ is tried in equation (2) in order to determine whether or not the ante-penultimate gas discharge tubes operate. If the value of V , the voltage across the ante-penultimate gas discharge tubes obtained from (2) is greater than 250V it is assumed that these tubes will operate, and $m = 2$ is now tried to determine whether or not the third tubes from the end break down. The process is repeated until the number of operated sections, m , at each end has been obtained.
- (e) Using the value of m found from (d) and the approximate value of R , the value of E_{ub} , the maximum voltage to earth when the lines are unbroken, is determined from (1).
- (f) Assuming that for small variations in R the calculated value of E_{ub} varies as $R^{1/2}$ (see (1)), a closer value is now calculated from

$$R = R_{approx.} \times \left(\frac{430}{E_{ub}} \right)^2$$

- (g) The above process (d)-(f) is now repeated until a value of R which makes E_{ub} close to 430V is determined.

When the appropriate value of R has been obtained it is necessary to make allowance for the voltage drop across the gas discharge tubes. As mentioned previously it is assumed that this voltage drop is 70V R.M.S. and, therefore, the earth electrode resistance R should be reduced to allow for this tube drop. If R_A is the value after allowing for the tube drop, then,

$$R_A = R \left(1 - \frac{70}{430} \right)$$

All electrodes on the system are then installed with about this value of resistance. Even when allowance is made for the effect of operated intermediate tubes, the resistance of the required earth connections when a fairly large number of circuits require protecting and the induced voltage is high, are often of such a value that they are expensive to obtain, or difficult to provide, in high-resistivity ground. Typical examples of installations on overhead lines have been described previously.^{1,3}

With installations for cable circuits it is possible to considerably simplify the procedure described above. It is almost always possible to obtain earth connections of a resistance lower than 2 ohms by making use of the lead sheath of the cable. Due to the comparatively small gauge

³ P.O.E.E.J., Regional Notes, Vol. 42, p. 177.

of cable conductors, earth electrode resistances of this order are generally more than adequate even for comparatively large cables and therefore the expense of providing special earth electrode systems is avoided.

CONCLUSION

During the past few years little damage has been experienced on lines which are protected by gas discharge tubes although it is known that earth faults have taken place on the power lines concerned on a number of occasions. Any trouble has generally been in the form of blown fuses which form part of the standard protective equipment at the ends of all overhead circuits.

ACKNOWLEDGMENTS

The author is indebted to a number of past and present members of the Protection Group of the External Plant and Protection Branch. Acknowledgments are due to Messrs. E. C. Swain and T. B. M. Neill who were concerned in the application of gas discharge tubes for protecting Post Office lines affected by the early 132 kV lines of the North of Scotland Hydro-Electric Board.

APPENDIX 1

The self-impedance of open-wire earth-return circuits.

It can be shown that the self-impedance, Z , of a group of N similar conductors connected in parallel and with earth return is given with sufficient accuracy for practical requirements by,

$$Z = \frac{r}{N} + 1.59 \times 10^{-3} f + j 4.66 \times 10^{-3} f \log_{10} \frac{216}{A_g \sqrt{f}} \quad \text{ohms per mile,}$$

- where, r = effective resistance of one conductor in ohms per mile,
- f = frequency in c/s,
- ρ = earth resistivity in ohm-cms.,
- $A_g = [(ka)^N D_{12}^2 D_{13}^2 D_{14}^2 \dots D_{1N}^2 D_{23}^2 D_{24}^2 \dots D_{2N}^2 D_{34}^2 D_{35}^2 \dots D_{3N}^2 \dots D_{N-1,N}^2] \left(\frac{1}{N}\right)^2$
- $D_{nm} = \sqrt{(h_n - h_m)^2 + x^2}$ = radial separation of conductors n and m , in ft.,
- h_n, h_m = heights of conductors n and m , in ft.,
- x = horizontal separation of conductors n and m , in ft.,
- a = radius of each conductor, in ft., and
- k = a factor accounting for the internal flux of a single conductor (0.78 for a solid non-magnetic conductor).

The third term gives the inductive reactance of the system and is laborious to calculate for other than small values of N . The value, however, does not vary rapidly with variation in N and in practical calculations for gas discharge tube installations it is usually sufficient to assume a value of 1 ohm per mile at 50 c/s for this inductive reactance.

APPENDIX 2

Derivation of Equations (1) and (2).

Since the centre point of the line in Fig. 5 is at earth potential the equivalent circuit for half the line may be drawn as in Fig. 6.

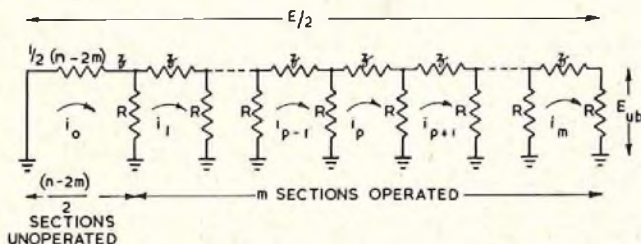

FIG. 6.—EQUIVALENT CIRCUIT OF HALF OF EXPOSED TELECOMMUNICATIONS LINE.

For the current in the p^{th} mesh we have

$$(i_p - i_{(p-1)}) R + i_p z + (i_p - i_{(p+1)}) R = \frac{E}{n} \dots \dots \dots (i)$$

which can be rewritten,

$$i_{(p+1)} - 2i_p \left(1 + \frac{z}{2R}\right) + i_{(p-1)} = - \frac{E}{nR} \dots \dots \dots (ii)$$

The solution of (ii) may be written in the form

$$i_p = i_p' + i_p'' \dots \dots \dots (iii)$$

Where, i_p' is the solution of the homogeneous equation

$$i_{(p+1)}' - 2i_p' \left(1 + \frac{z}{2R}\right) + i_{(p-1)}' = 0 \dots \dots \dots (iv)$$

and i_p'' is any particular solution of (ii).

To solve (iv), since,

$$\cosh (p+1)\theta + \cosh (p-1)\theta = 2 \cosh p\theta \cosh \theta$$

$$\text{and } \sinh (p+1)\theta + \sinh (p-1)\theta = 2 \sinh p\theta \cosh \theta$$

the functions $\cosh p\theta$ and $\sinh p\theta$ will satisfy (iv) provided $\cosh \theta = 1 + z/2R$ (θ , being a function of z , is thus a function of frequency).

The general solution of (iv) may thus be written,

$$i_p' = A \cosh p\theta + B \sinh p\theta \dots \dots \dots (v)$$

where A and B are constants.

To obtain a value of i_p'' we assume

$$i_{(p+1)}'' = i_p'' = i_{(p-1)}'', \text{ giving immediately } i_p'' = E/nz.$$

The complete solution of (i) is thus,

$$i_p = A \cosh p\theta + B \sinh p\theta + E/nz, \theta = \cosh^{-1} (1 + z/2R) \dots \dots \dots (vi)$$

At the centre mesh of unoperated sections

$$\frac{n-2m}{2} z i_0 + (i_0 - i_1)R = \frac{n-2m}{2n} E \dots \dots \dots (vii)$$

From (vi),

$$i_0 = A + E/nz, i_1 = A \cosh \theta + B \sinh \theta + E/nz, \text{ so that}$$

(vii) becomes,

$$A [R(1 - \cosh \theta) + \frac{n-2m}{2} z] - BR \sinh \theta = 0 \dots \dots (viii)$$

or, since $z = 2R (\cosh \theta - 1)$

$$B = A (n - 2m - 1) \tanh \theta/2 \dots \dots \dots (ix)$$

Also, since $i_{m+1} = 0$

$$A \cosh (m+1)\theta + B \sinh (m+1)\theta + E/nz = 0 \dots \dots (x)$$

Solving (ix) and (x) gives,

$$A = - \frac{E}{nz} \times \frac{\cosh \theta/2}{\cosh \frac{2m+1}{2} \theta + (n-2m) \sinh \frac{\theta}{2} \cdot \sinh (m+1)\theta} \dots \dots (xi)$$

$$B = - \frac{(n-2m-1) E}{nz} \times \frac{\sinh \theta/2}{\cosh \frac{2m+1}{2} \theta + (n-2m) \sinh \frac{\theta}{2} \cdot \sinh (m+1)\theta} \dots \dots (xii)$$

The increase in voltage per unoperated section (measured from the centre) is $(E/n - i_0 z) = -Az$. Therefore the voltage to earth which appears at the last unoperated tube at each end of the unoperated sections is given by,

$$V = \frac{(n-2m-2) E}{2n} \times \frac{\cosh \theta/2}{\cosh \frac{2m+1}{2} \theta + (n-2m) \sinh \frac{\theta}{2} \cdot \sinh (m+1)\theta} \dots \dots (xiii)$$

The maximum voltage to earth (that at the terminal tubes)

$$E_{ub} = i_m R = AR [\cosh m\theta + (n-2m-1) \tanh \frac{\theta}{2} \sinh m\theta] + \frac{ER}{nz}$$

which reduces to,

$$E_{ub} = \frac{E}{n} \sqrt{\frac{R}{z}} \times \frac{\sinh m\theta + (n-2m) \sinh \frac{\theta}{2} \cdot \cosh \frac{2m+1}{2} \theta}{\cosh \frac{2m+1}{2} \theta + (n-2m) \sinh \frac{\theta}{2} \cdot \sinh (m+1)\theta} \dots \dots (xiv)$$

An Instrument for the Measurement and Display of V.H.F. Network Characteristics

J. S. WHYTE, B.Sc.(Eng.), A.M.I.E.E.†

U.D.C.621.317.755;621.396.813.029.62

An instrument is described in this article, which has been developed for the measurement of the group-delay/frequency and gain/frequency characteristics of V.H.F. networks. The equipment presents the information in the form of a panoramic display on a cathode-ray tube. A discrimination of 1×10^{-9} secs. is obtainable over a bandwidth of about 20 Mc/s centred on 60 Mc/s. Gain/frequency characteristics can be displayed and measurements made with a discrimination of about 0.1 decibel.

INTRODUCTION

A RECENT series of articles in the Journal¹ has drawn attention to the rapid development in the United Kingdom of microwave radio links for broadband communication systems, and has indicated that such systems are shortly to be introduced into the national trunk telephone network. It will be evident that when this occurs those concerned with the maintenance of the systems will be faced with new problems involving measuring instruments and techniques which will at first be unfamiliar. It is the purpose of this article to describe a new instrument that has been developed for the measurement of group-delay distortion, which is one of the important circuit parameters in microwave systems. The instrument has already played an important part in the laboratory development of intermediate-frequency equipment.

THE MEANING AND IMPORTANCE OF GROUP-DELAY

The existing coaxial cable network employs frequency allocation multiplexing using amplitude modulation of C.W. carriers. As is well known, freedom from inter-channel crosstalk requires a high degree of linearity of the line amplifier input/output amplitude characteristics, and practical systems for large numbers of channels were only made possible with the advent of the negative feedback amplifier.

The microwave systems at present being designed will use the same baseband multiplexing arrangements as the coaxial cable systems so as to permit easy integration into the existing network, and the baseband signal obtained from the multiplexing equipment will be frequency- or phase-modulated on to an R.F. carrier signal. The choice of angular modulation* rather than amplitude modulation is dictated primarily by the difficulty of making microwave and I.F. amplifiers having adequate linearity to transmit satisfactorily amplitude-modulated multi-channel signals. Freedom from inter-channel crosstalk with frequency modulation systems depends not on input/output amplitude linearity but largely on maintaining adequate linearity of the phase/frequency characteristic of all networks in the signal path.

If a network which is transmitting a frequency-modulated signal has a phase/frequency characteristic which includes a square-law component, second order distortion of the modulation will occur; similarly, a cubic-law component will give rise to third order distortion, and so on. For the purposes of design, and also of measurement, it is convenient to consider the derivative of the phase/frequency characteristic which is called the group-delay/frequency characteristic. On differentiation the linear, square and cubic-law components of the phase characteristic become uniform, linear and square-law components, respectively, of the group-delay characteristic. The uniform component causes no distortion, and the other components are often

added together and called the "delay-distortion" introduced by the network.

To obtain a physical idea of the effect of delay-distortion on an F.M. signal, consider the simple case of a tone modulated signal being transmitted through a network. If the phase characteristic of the latter is not linear with frequency, the output signal will have a phase modulation on it which was not present on the input signal. Since a frequency discriminator is also responsive to phase modulation, this results in a distortion output from the demodulator in addition to the wanted output due to the modulating tone.

The principal function of the Measuring Set No. 11B, which is to be described, is the measurement of delay-distortion in I.F. amplifiers, and it will do this with a discrimination of one millimicrosecond (1×10^{-9} secs.).

PRINCIPLE OF OPERATION

Group-delay may be measured by examining the increment of insertion phase-shift occurring over a known frequency interval, as illustrated in Fig. 1. The frequency

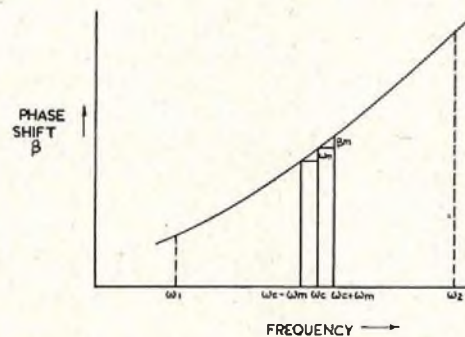

FIG. 1.—MEASUREMENT OF THE SLOPE OF A PHASE/FREQUENCY CHARACTERISTIC.

interval ω_m may be fixed by using a modulated test signal and it is then only necessary to measure the phase difference β_m between the original and received modulations.

The group-delay, t_g , is given by:—

$$t_g = \frac{d\beta}{d\omega} \dots \dots \dots (1)$$

$$\text{and therefore, } t_g \approx \frac{\beta_m}{\omega_m} \dots \dots \dots (2)$$

This approximation makes the assumption that over the interval of frequency occupied by the modulated test signal, the group-delay is uniform.

If the carrier frequency ω_c is now moved across the frequency band from ω_1 to ω_2 (Fig. 1) the variations of slope of the β , ω curve result in proportional variations of β_m . If the constant component of delay is to be ignored, these variations of β_m give all the necessary information and can be measured relative to an arbitrary reference phase, such as the value of β_m at midband.

Fig. 2 shows a simplified block schematic diagram of the apparatus. The modulator is frequency-modulated simultaneously at 1 Mc/s with deviation about ± 0.5 Mc/s and at

† Executive Engineer, Radio Experimental and Development Branch, E-in-C.'s Office.

¹ P.O.E.E.J., Vol. 47, p. 63.

* The term angular modulation includes not only frequency and phase modulation but also modulation systems intermediate between these two, such as may be produced by the use of pre-emphasis in the modulator.

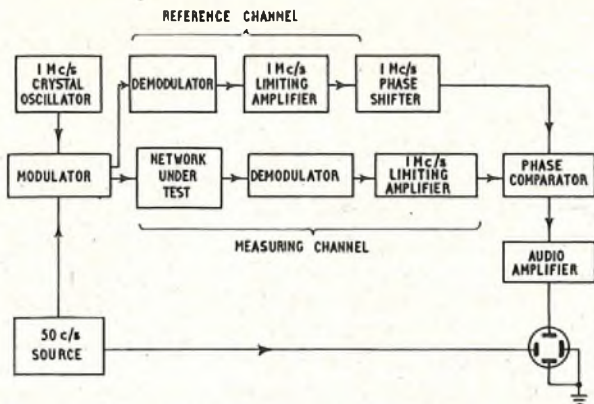

FIG. 2.—SIMPLIFIED BLOCK SCHEMATIC DIAGRAM OF EQUIPMENT.

50 c/s with deviation adjustable up to ± 10 Mc/s. This signal is then passed through the network under test and demodulated. The 1 Mc/s component in the demodulator output is phase-modulated, the phase deviation being proportional to delay-distortion. The reference phase is obtained from a separate demodulator driven directly from the modulator; by this means the delay distortion introduced by the modulator and demodulator circuits can be cancelled out. The phase comparator is of the quadrature

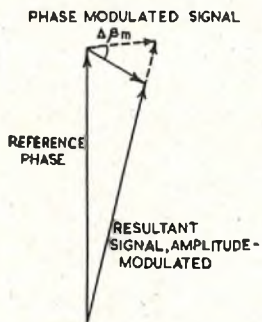

FIG. 3.—VECTOR DIAGRAM ILLUSTRATING THE OPERATION OF A QUADRATURE-TYPE PHASE COMPARATOR.

type and its operation is explained by reference to Fig. 3. Both the signals applied to the phase comparator are passed through amplitude limiters which remove any amplitude modulation which may be present. When the two signals are added in the manner shown in the vector diagram, the resultant signal is amplitude-modulated and, provided the phase deviation is small, the depth of modulation is proportional to β_m and hence to delay-distortion. The envelope of this signal is used, after detection, to give a vertical deflection to the beam of a cathode-ray tube. The phase shifter shown in the reference channel on Fig. 2 enables the vectors to be set in the correct

relationship. The horizontal deflection is made proportional to the scanning voltage amplitude and hence to the instantaneous frequency of the modulator, so that the C.R.T. display represents a group-delay/frequency characteristic of the network under test.

PRACTICAL ARRANGEMENT OF APPARATUS

The diagram in Fig. 4 shows the practical arrangement of the Measuring Set No. 11B.

The two 60 Mc/s switches shown in the "Measuring Channel" are electronically operated changeover switches which are driven at 25 c/s in synchronism with the timebase. Alternate traces therefore include the delay distortion in the paths marked A and B, respectively. If the reference network shown in the A path is a short, carefully matched cable, the corresponding display will show the residual delay distortion in the apparatus and will approximate to a straight line. In the B position of the switch the characteristic of the network under test will be superimposed upon this baseline. The setting of the 1 Mc/s variable phase shifter required to give the desired quadrature relationship of the two signals in the phase comparator (see Fig. 3) will depend partly on the value of the constant component of group-delay (t_0) in the network under test. When the reference network in the A path is a short length of cable, its t_0 is very small (in a typical case about 2×10^{-9} secs.) and if the network under test has a large t_0 (200×10^{-9} secs. might be encountered in a multi-stage amplifier) different settings of the 1 Mc/s phase shifter are required for the A and B positions of the H.F. switches. To enable this to be done a pair of 1 Mc/s changeover switches is introduced after the demodulator and these switch into circuit an additional variable phase shifter on the A path.

If either of the phase shifters is incorrectly set by 180° the resulting display will be inverted. To confirm that correct adjustment has been made a sense-check unit is incorporated. This unit, when operated, loosely couples a parallel tuned circuit to the signal path, which gives a downward dip in the delay characteristic at the resonant frequency, when the phase shifters are correctly set.

In order to obtain a delay calibration, use is made of the fact that 10 millimicroseconds delay introduced into the H.F. path produces 3.6° phase change at 1 Mc/s (from equation (2)). By switching in and out of circuit this amount of phase shift after the demodulator, synchronously with

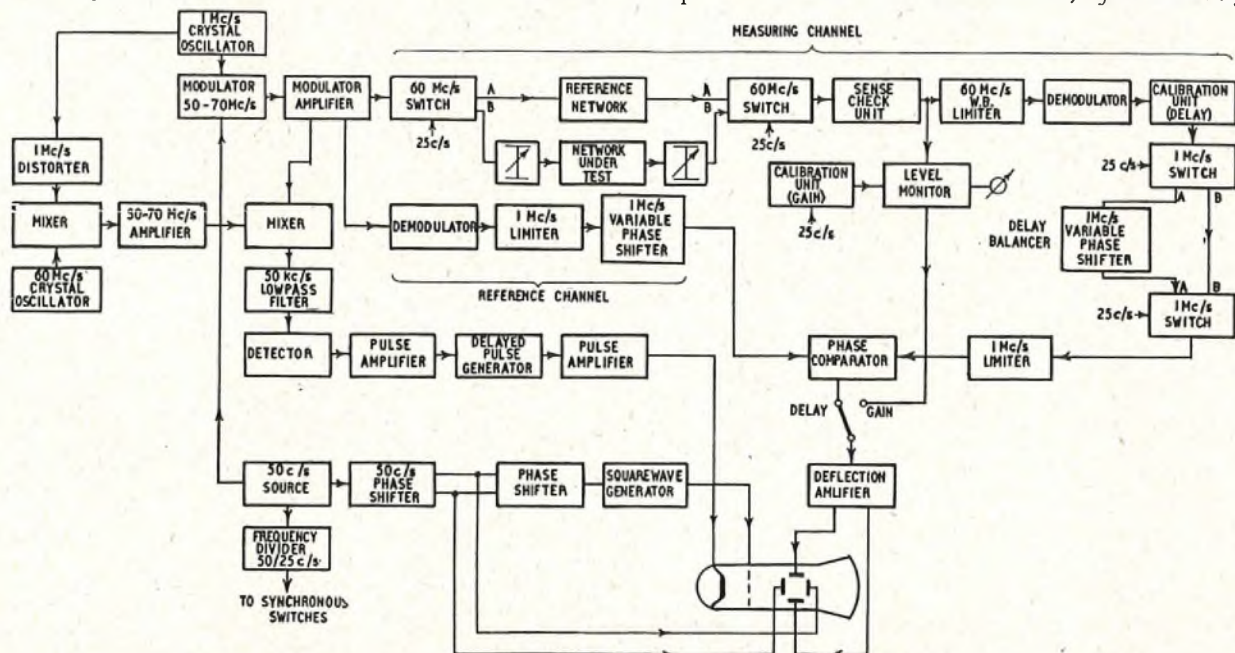

FIG. 4.—BLOCK SCHEMATIC DIAGRAM OF THE COMPLETE MEASURING SET.

the timebase, a double trace display is obtained in which the separation of the two traces corresponds to 10 millimicroseconds. When the calibration unit is switched on, the H.F. switches are not operated.

To obtain a frequency calibration of the horizontal trace a beat frequency technique is used. An output from the modulator goes to a mixer stage in which beats are produced between this signal and a crystal-controlled reference frequency signal. The latter may be either 60 Mc/s or 60 Mc/s plus 1 Mc/s sidebands extending ± 10 Mc/s. From the low-pass filter following the mixer, pulses are obtained whenever the modulator frequency corresponds to one of the reference frequencies, and this pulse is used to brighten the cathode-ray tube trace. Owing to the delay experienced by the test signal between the modulator and the cathode-ray tube deflector plates (mainly in the 1 Mc/s amplifiers) it is necessary to delay the frequency marker pulses by a similar interval before applying them to the cathode of the cathode-ray tube. This is done by a Phantastron circuit adapted to work as a delayed pulse generator having variable delay.

In addition to displaying delay distortion the equipment can readily be arranged to display the gain/frequency characteristics of the network under test. The amplitude of the signal applied to this network is independent of its instantaneous frequency. Any amplitude variations present on the signal at the output of the network under test are therefore due to variations in its gain with frequency. All that is necessary is to use the envelope of the output signal, after rectification, for vertical deflection of the cathode-ray tube beam as an alternative to the output from the phase comparator.

As a matter of practical convenience the crystal detector used for this purpose is preceded by a wideband amplifier having a uniform gain/frequency response. By switching the gain of this amplifier between two values separated by 1 db., and driving this switch synchronously at half timebase speed, a double trace is obtained in which the separation of the traces corresponds to 1 db., so giving a calibration of the vertical scale.

MECHANICAL ARRANGEMENT AND TYPICAL DISPLAYS

The equipment is built as a self-contained unit in trolley form, and Fig. 5 shows the general appearance. A 6-in. flat-faced cathode-ray tube is used, and this is provided with a removable measuring graticule and a retractable viewing hood for excluding extraneous light. Two pairs of push-button attenuators on the front panel are used respectively to set the level into the network under test, and the level into the measuring set from the network under test. The controls on the right-hand side panel of the instrument are associated with the H.F. switching circuits.

As examples of typical displays which may be obtained using the equipment, photographs of two displays are reproduced. Fig. 6 shows the delay distortion characteristic of a typical 60 Mc/s I.F. amplifier. The upper trace is that taken via the amplifier and the lower trace is that due to the measuring equipment alone. The bright spots on the trace are frequency-markers spaced at 1 Mc/s intervals, the centre spot being at 60 Mc/s. The separation between the two curves at 60 Mc/s corresponds to 5×10^{-9} secs. Fig. 7 shows the gain/frequency characteristic of the same I.F. amplifier measured over the same frequency range. Again the upper curve is the response including the amplifier under test, and the lower response is that due to the equipment alone. The separation between the two curves at 60 Mc/s corresponds to 0.5 db.

The maximum bandwidth that can be displayed by the

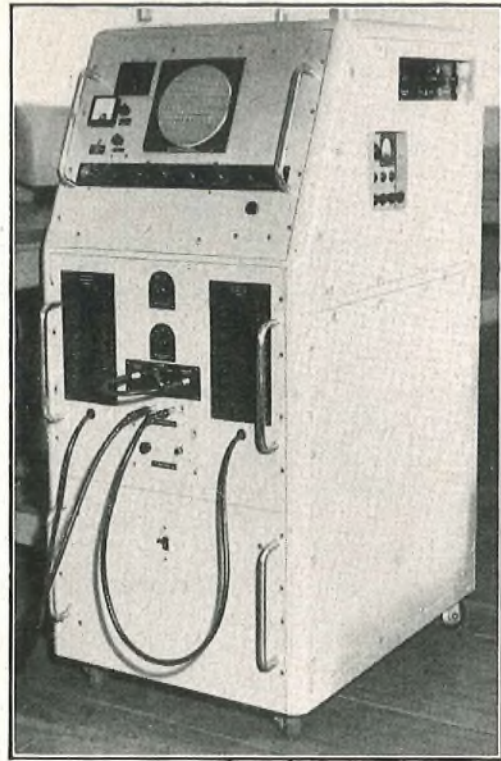

FIG. 5.—GENERAL APPEARANCE OF MEASURING SET No. 11B.

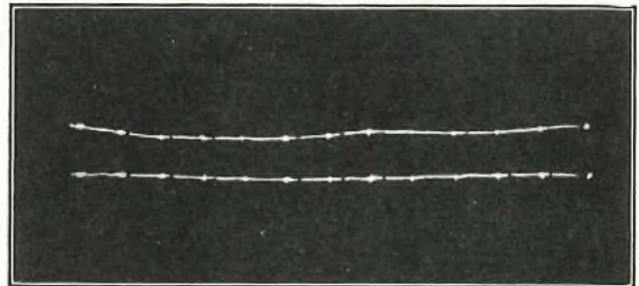

FIG. 6.—DELAY DISTORTION CHARACTERISTIC OF TYPICAL 60 Mc/s I.F. AMPLIFIER.

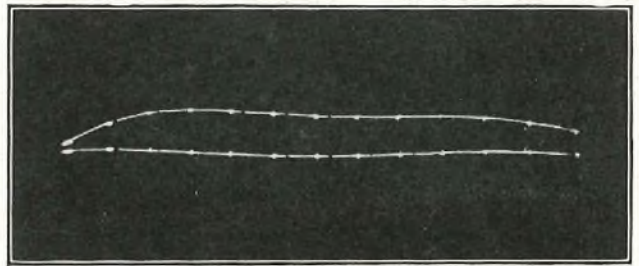

FIG. 7.—GAIN/FREQUENCY CHARACTERISTIC OF TYPICAL 60 Mc/s I.F. AMPLIFIER.

instrument is about 20 Mc/s. The discrimination for delay distortion measurements is about 1×10^{-9} secs. and for gain/frequency characteristics about 0.1 db.

CONCLUSIONS

The equipment described has been extensively used in laboratory development work on I.F. amplifiers which will form component parts of V.H.F. radio relay systems for the transmission of television or multi-channel telephony circuits. As these systems come increasingly into use in the Post Office network, measurements of delay distortion will become a familiar part of maintenance work.

A Dial Pulse Generator

A. W. N. GARBUTT†

U.D.C.621.373.431:621.395.636.1.001.4

The pulse generator described in this article was designed primarily for the calibration of dial testers used in acceptance testing of dials, but in view of the facilities which it offers, it has a wide range of other uses. The generator provides trains of from 1 to 11 pulses, or a continuous train of pulses, with a speed range of 8 to 14 p.p.s., and having any break pulse ratio* between 1 and 99 per cent.

INTRODUCTION

IN acceptance testing of new or repaired equipment, decisions to accept or reject the product depend on measurements made with the test gear employed. Errors in this test gear may result in the purchase of large quantities of unsatisfactory items, or in the rejection of large quantities of satisfactory items. It is, therefore, of great importance, both to the purchaser and to the manufacturer, that test gear used for acceptance-testing purposes should be accurate, and that its accuracy should be confirmed at suitable intervals.

One of the most important aspects of the acceptance testing of dials is the measurement of speed and ratio, and this is now carried out with electronic dial testers which are considerably more robust and more accurate than the mechanical testers which they superseded.

It is nevertheless evidently necessary that dial testers, whatever their type, should be checked periodically and if necessary readjusted. This demands a means of calibration of high stability and accuracy, which at the same time is simple and rapid in operation, of robust construction and easy to maintain under practical conditions of use. Development work on this problem has resulted in the production of a dial pulse generator which adequately fulfils these requirements and which has been adopted by the British Post Office for calibrating its dial acceptance-test gear.

The use of this device is not, however, confined to dial acceptance testing. Since it provides a robust and accurately controlled source of pulses, whose speed and ratio can be adjusted within close limits, it is likely to find use in a number of applications.

For the calibration of dial test sets, a train of 11 pulses is required. The first 10 pulses must be variable over the range 8 to 12 p.p.s. in steps of 0.5 p.p.s., and must be accurate within ± 0.1 p.p.s. for speed testing. The break pulse ratio must be adjustable in steps of 1 per cent. between the limits 62 per cent. and 72 per cent., with an accuracy of 0.2 per cent.

A number of types of generator, both mechanical and electronic, were considered and several were experimented with before a satisfactory design was evolved. The types of generator originally considered and tested were not self-calibrating, and, therefore, required a means of measurement to close limits in addition to a means of generation. Also, it was found that while mechanical generators could be made to give greater freedom from short-term variations, they suffered from contact bounce. It was, therefore, decided to direct effort towards the development of an electronic generator which would be of adequate stability, and which would be self-calibrating.

DESCRIPTION OF THE PULSE GENERATOR

Basic Principles.

The basis of the pulse generator is a reliable oscillator of a suitable frequency range, the output of which is fed to two counting stages which produce a marking pulse at the beginning of every 100 cycles fed in. The marking pulse represents the beginning of each break pulse. Each cycle, therefore, is equivalent to 1 per cent. of a pulse-spacing

period. Arrangements are provided for the selection at one cycle (1 per cent.) intervals of any cycle between 1 and 99 to provide a second pulse to terminate the break period, the remaining cycles providing the make period.

Counting is performed by three cold-cathode dekatron counters. The first counts individual cycles and provides a driving pulse to the second counter at 10-cycle intervals. The second counter produces a pulse for every 100 cycles. A third dekatron is used to count the number of complete pulses and provides a stop pulse at the end of the complete pulse train.

Fig. 1 is a block schematic diagram showing the functions of the various stages.

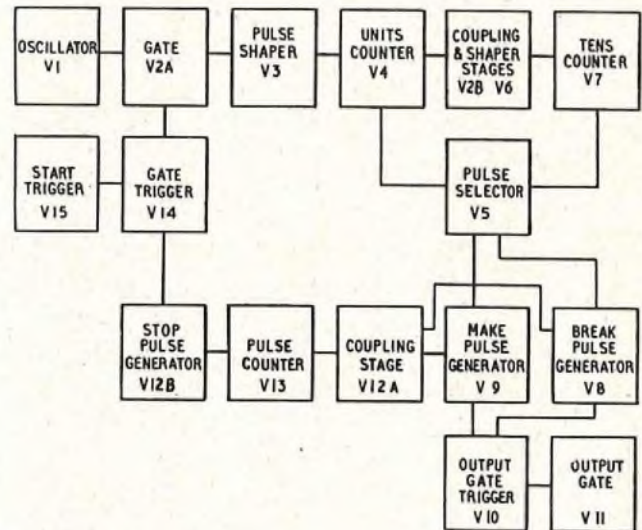

FIG. 1.—BLOCK SCHEMATIC DIAGRAM OF DIAL PULSE GENERATOR.

Oscillator.

The oscillator consists of a double-triode valve operating as a resistance-capacitance oscillator. A 12-position switch is used to change the frequency in steps of 50 c/s from 800 to 1,300 c/s and then in a single step of 100 c/s to 1,400 c/s. This gives a range of pulsing speeds from 8 to 13 p.p.s. in steps of 0.5 p.p.s., and also a pulsing speed of 14 p.p.s. This range was selected to cover the primary requirements of the generator and also other possible uses.

A thermistor ensures a reasonably constant output over the frequency range and assists in maintaining constant frequency should the supply voltage vary. More attention has, in fact, been paid to frequency stability than to waveform, which is not important in this application. A preset adjustment enables frequency drift to be corrected when necessary, this control being common to all frequencies. An external oscillator may, if required, be connected via a jack point to provide for pulsing speeds outside the normal range.

The range of speeds over which the generator will work satisfactorily without modification has been found to be 0.5 to 18 p.p.s. (50 to 1,800 c/s).

Gate, Gate Trigger, Start Trigger and Stop Pulse Generator.

The Gate valve operates under the control of the Gate Trigger to prevent the oscillator output from reaching, or to allow it to reach, the counting stages. The operation of the Start Key causes a pulse from the Start Trigger to

† Assistant Engineer, Test and Inspection Branch, E.-in-C.'s Office.

* Pulse ratio is defined as the ratio, usually expressed as a percentage, of the pulse duration to the pulse spacing.

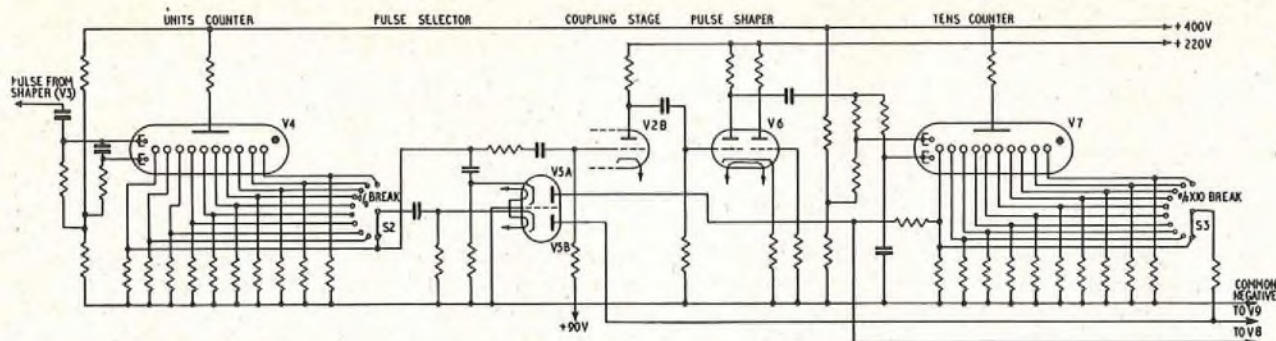

FIG. 2.—COUNTING AND ASSOCIATED STAGES.

operate the Gate Trigger in a manner such that the Gate valve is biased normally and oscillations are allowed to pass to the counting stages. At the end of the selected pulse train, a pulse from the Stop Pulse Generator reoperates the Gate Trigger to bias the Gate negatively below cut-off.

Start and Reset Keys.

The circuit is so arranged that once the Start Key has been operated, it plays no further part in the functioning or timing of the circuit operation, which cannot then be changed except by the operation of the Reset Key. The Reset Key restores the Gate Trigger, the Output Gate Trigger and the Start Trigger to the ready position for the start of another train and under these conditions the Output Gate Trigger causes the Output Gate to provide a continuous make.

Pulse Shaper.

The shaping stage which precedes the counting stages is a single-stroke multi-vibrator, which gives a steep-sided wave input to the counting stages to ensure reliability of timing in the operation of the units counter. This ensures the greatest possible accuracy of ratio.

Counting and Associated Stages (Fig. 2).

In order that the circuit operation may be more easily followed, a brief description of the dekatron counter and its operation is given below. Two of the counters used in this application are of the Ericsson GS10B type, the other being a GS12C, the figures in the title indicating the number of cathodes. The GS10B consists of a common disc-shaped anode surrounded by 30 pin-type electrodes. Every third pin is led out separately to a connection point as a cathode, making 10 in all. The two pins between each cathode are referred to as Guides 1 and 2. All Guide 1 pins are commoned internally and Guide 2 pins are similarly connected.

If the anode is connected to the positive side of a 400V supply through a current-limiting resistor, and each individual cathode is connected to the negative side of the same supply through other resistors, a glow will surround one cathode. The guide electrodes are given a small positive bias and a phase-changing network, consisting of a resistor and capacitor, is connected between Guides 1 and 2.

The application of a negative pulse of suitable shape and amplitude to the guide electrodes causes the glow to move from the cathode on which it is resting to the more negative adjacent guide pin. Owing to the phase-changing network, one guide will become negative in advance of the other. When, in a brief time, the negative potential on the first guide commences to drop, the second guide will be acquiring a negative potential and the glow will, therefore, transfer to this guide. In due course, the negative potential on the second guide will drop below a critical value, and since the glow cannot transfer back to the first guide due to the

positive standing bias, it therefore transfers to the next cathode. In this manner, the glow transfers from cathode to cathode at each applied negative pulse, finally arriving back at the starting cathode on the tenth pulse. It should be noted that the glow is not extinguished at each pulse, but is transferred. To this fact the dekatron owes its superior operating speed over other types of cold cathode valve. The glow may be made to pass directly to any cathode by the application of a 140V negative potential via a capacitor, and this facility is used for resetting to zero.

The resistor in series with each cathode is used to indicate the cathode on which the glow is resting at any particular instant by the potential drop across the resistor, and also provides a source of driving pulses for succeeding dekatrons for every 10 input pulses.

As stated previously, the first object of the dekatron counters and the associated stages is to provide a pulse at the beginning of each 100 cycles of the oscillator to mark the start of the break pulse. This pulse is repeated at 100-cycle intervals. To enable any ratio to be selected, it must be possible to provide a second pulse at any cycle from 1 to 99 in each 100 cycles. This facility is given by means of two selector switches wired to the 10 cathodes of the two dekatrons V4 and V7.

The manner in which this pulse is selected is best understood if each group of 100 cycles is considered to be divided into 10 sub-groups, 0-9, 10-19, 20-29, etc. Switch S2 allows any cycle from the first to the tenth of each sub-group to be selected, and pulse selector V5, under the control of S3, allows the required sub-group to be selected.

V5 is a double diode and selects both "make" and "break" pulses. The "break" pulse occurs when the glow on both dekatrons is resting on the tenth cathode, i.e., at the beginning of each 100 cycles. At this instant, V5A passes current because of the potential drop across the cathode resistor of V7, which allows the voltage pulse across the cathode resistor of V4 to pass. This pulse, being positive, may only pass from cathode to anode of V5A when V5A is conducting in the opposite direction, and can, therefore, only occur once every 100 cycles. V5B will similarly pass a pulse in accordance with the settings of S2 and S3 which will enable any cycle from 1 to 99 to be selected and used to determine the duration of the "break" period. The switches give direct reading in steps of 1 per cent. and 10 per cent. ratio, which are correct at any pulse speed.

The design of the associated stages is governed by the following requirements. Firstly, in order to produce pulses at any setting between 0 and 9 per cent. of S2, and with S3 set at any multiple of 10 per cent., it is necessary that the glow should remain on each cathode of V7 during the entire period required for the production of 10 pulses by the cathodes of V4 and must only move to another cathode during the period of transfer of the glow from cathode 0 to cathode 1 of V4.

Secondly, it is necessary to achieve maximum operating speed. The timing of the counting operations may be summarised as follows:—

If T_1 = the time that the glow rests on a cathode of V4,

and T_2 = the time required for the transfer of the glow from cathode to cathode of V7,

then $T_1 + T_2$ should be as short as possible while still giving reliable operation of the dekatrons. The maximum speed occurs when $T_1 + T_2$ = one cycle, but in practice it would be difficult to achieve this rate of working and the maximum speed of the arrangement used is 18 p.p.s. This allows a reasonable working tolerance.

The pulse input to V4 is shaped by V3 so as to have a steep-sided wave form, which gives satisfactory operation of V4 and has a positive to negative ratio such that the glow remains on a cathode of V4 for approximately one-third of a cycle at maximum speed. For the remainder of the cycle, the glow is on the guide electrodes or is in transit between two cathodes.

To ensure that the operation of V7 takes place during the transfer of the glow from cathodes 0 to 1 of V4, the driving pulse is derived from cathode 0 of V4 in the following manner.

V2B inverts and amplifies the positive pulse from cathode 0 of V4, and feeds the resultant negative pulse to V6. V6 is normally biased to cut-off by the voltage drop across the cathode resistor, and the leading edge of the negative input pulse does not, therefore, produce any change in anode current. However, the trailing edge of the input pulse produces a negative pulse at the anode of V6, which is fed to V7.

The input to V7 consists of a succession of short negative pulses, which ensure a short transit time between cathodes, the movement taking place after the production of the tenth pulse by V4, which cannot, therefore, be clipped.

"Break" and "Make" Pulses, Output Gate Trigger and Output Gate.

The pulse output from the two diodes of V5 consists of short pulses marking the start and end of the required break periods. These are fed to V8 and V9 respectively, which in turn produce suitable pulses for the operation of the Output Gate Trigger (V10) (see Fig. 1). A pulse from V8 causes V10 to bias the Output Gate (V11) below cut-off, and a following pulse from V9 re-operates V10 to alter the bias on V11 and allow anode current to flow. V11 thus avoids the use of mechanical contacts. The chief drawback of this arrangement is the necessity to provide an additional battery supply to overcome the D.C. resistance of the valve under "make" conditions. (The valve chosen (CV 1075) will safely pass up to 100 mA before grid current commences.)

Where necessary a high-speed relay may be used as a buffer, due allowance being made for the error introduced.

Pulse Counter, Coupling Stage and Stop Pulse Generator.

The outputs from V5 via V8 and V9, V10 and V11 give a continuous pulse train. The pulse counter, V13, enables a pre-determined pulse train to be selected. A train of 11 pulses ending in a "break" is needed for the calibration of dial test sets. To allow the use of the generator for other purposes, facilities have been provided for the production of a continuous train, and for the production of pulse trains from 1 to 10 pulses beginning and ending in a continuous "make." The driving pulse for the Pulse Counter is derived from V8 when it is desired to end the train in a "make," and V9 when a "break" is required. The pulses are inverted by the Coupling Stage and fed to the counter. When the glow arrives at the selected cathode of the counter a pulse is fed to the Stop Pulse Generator, which in turn operates the Gate Trigger and Gate as previously described.

Generator Tests and Performance.

The entire operation of the generator may be checked step by step with a double-beam oscilloscope. By comparing the oscillator output with the pulse output from any cathode of V4, regularity of operation and the accuracy of pulse ratios of 1 to 10 per cent. may be assessed. By checking against the input to V11, ratios from 1 to 10 per cent. may be measured directly, and the reliability of "make" and "break" pulses checked with the oscilloscope time base frequency one-tenth that of the internal oscillator of the pulse generator. Irregular operation of the dekatrons is obvious to visual inspection and is readily located.

The generator is not much affected by mains supply variations or hum level, and no special stabilising or smoothing is, therefore, necessary. Tests show errors of less than 0.02 per cent. for ratio. The speed error is dependent only upon oscillator frequency stability, which is adequate where a limit of ± 0.1 p.p.s. is required. The oscillator was originally adjusted by means of the common pre-set adjustment to be within ± 0.04 per cent. at each pre-set speed, and there has been no appreciable drift.

CONCLUSION

The generator has proved remarkably successful for its intended purposes, and enables rapid checks of dial test sets to be made without difficulty. It has further uses in connection with many types of pulse-operated equipment, and items such as Testers No. 43 (dial speed tester) may also be tested, provided an additional high-speed relay is wired in the output stage of the generator. Since it is possible by the use of an external oscillator to produce pulses of up to 2-sec. duration, the generator has also been used for the testing and calibration of Relay-lag Test Sets.

Where it is desired to use an oscilloscope to observe the operation of apparatus being tested with the generator, the internal oscillator jack gives a ready means of synchronising the oscilloscope time base to allow the recording of recurrent operations.

Book Review

"Alternating Current Machines." A. F. Puchstein, T. C. Lloyd and A. G. Conrad. Third Edition. Chapman & Hall, Ltd., London. 721 pp. 422 ill. 68s.

This book of 720 pages and over 400 illustrations provides (as would be expected from its size and price) a complete course on alternating current machines. The only major omission is the analysis of transient conditions. The treatment is largely mathematical, but the student needs little more than a good knowledge of vectors. Transformers, alternators, induction motors (single and poly-phase), synchronous motors and converters, mercury arc rectifiers, single-phase commutator motors and repulsion motors are fully covered.

Generally, the subjects are dealt with under the headings: construction, operating characteristics, calculation of characteristics from test data, and analysis of various related phenomena.

The reader here will regret that the many references include none to British publications. Wherever standard tests and specifications are mentioned these refer to those of the American Standards Association, and the occurrence of such words as "gotten" in a few places in the text are other reminders that this book was not intended primarily for British students. It is very well written, the explanations are lucid, and it is obvious that great care has gone into its production.

A. E. P.

London Trunk Kingsway Exchange

F. V. PARTRIDGE, A.M.I.E.E.,
and C. G. GRANT, A.M.I.E.E.†

U.D.C. 621.395.722:621.395.5

The opening of London Trunk Kingsway exchange, in October 1954, as a trunk tandem unit, completed a further step towards the present objective of single-operator control on all inland trunk calls. The unit, designed on non-director principles and using the Post Office standard motor uniselector, caters for a maximum of 5,000 trunk circuits and handles primarily "through" traffic. The design and installation of this large unit presented a number of unusual features which are described in the text.

INTRODUCTION

THE mechanisation of the trunk service started in 1939 with the introduction of two-voice-frequency dialling between zone centres. The initial scheme enabled operators at one zone centre to complete calls by dialling to distant subscribers, provided they were within the central automatic area of the distant zone centre. While this scheme effected a saving of operators, there still remained a considerable number of calls that had to be handled by more than one operator.

The present objective is to obtain single-operator control on all trunk calls and with the opening of the Kingsway trunk non-director unit on the 30th October, 1954, the mechanisation of the inland trunk service was advanced a stage further. This unit, designed as a trunk tandem, enables operators at all zone and directly connected group centres and at certain other London exchanges to dial direct to subscribers on zone or auto group centres directly connected to the Kingsway unit; dialling-out is also catered for. With the future opening of trunk tandems at other centres the dialling range of operators will be further increased and single-operator control will be obtained on a high percentage of trunk calls.

GENERAL DESIGN

The Kingsway unit has been designed to cater for a maximum of 5,000 trunk circuits and, although this unit will be used primarily as a "through" or tandem unit, 20 per cent. of its capacity can be used for switching calls, referred to as terminal traffic, to and from the London group. Prior to the opening of Kingsway the London group covered an irregular area roughly 40 miles across, following the boundary of the London Telecommunications Region except for a bulge of over 10 miles on the north-west border into the Home Counties Region. At the opening of Kingsway the boundary of the London group was altered to reduce its size to that of the director area, which is 12½ miles radius. Thirteen new group centres were created to serve the remainder of the old London group. A few minor exchanges outside the director area have, however, been included in the London group because they are served by auto-manual boards within the director area.

The decision to permit Kingsway to handle some terminal traffic has necessitated the provision of capacity at Kingsway for serving an outgoing trunk junction network, of about 2,000 circuits, for distributing incoming trunk traffic to all minor exchanges in the new, reduced size, London group. Traffic originated within this group is catered for by the provision of capacity on Kingsway for serving a further 2,000 junctions connected to the manual boards at which this originating traffic is controlled.

It was decided that Kingsway should be the only trunk tandem or through-unit in London and, as this has a maximum capacity of 5,000 trunk circuits, relief in the future will be given by diverting some through-traffic from Kingsway by progressively reducing the size of the London zone. This will be achieved by the setting up of a zone

centre at Reading to be followed by others at Cambridge and Tunbridge Wells. Until Kingsway has been relieved of some of its through-traffic, it will be necessary to continue to use the Toll A non-director unit for switching some of the tandem traffic within the Toll area.

Trunk Kingsway is designed as a non-director step-by-step unit having a mixed 2- and 3-digit numbering scheme and using the Post Office standard motor uniselector.¹

Trunk circuits are switched on a two-wire basis and the following methods of signalling have been catered for:—

2 V.F. dialling—Signalling System A.C.1.²

Generator signalling from selector levels—Signalling System A.C.3.

Long Distance D.C. dialling—Signalling System D.C. No. 1.

Single commutation D.C. dialling—Signalling System D.C. No. 2.

Loop-disconnect dialling.

Dialling out to C.B. exchanges including bridge control auto-manual boards.

Dialling out to sleeve control auto-manual boards.

Signalling systems other than loop-disconnect have line terminating relay sets and both incoming and outgoing types of relay sets have been designed to provide a selector holding earth on the private wire.

Because of the forward hold feature provided by the majority of the incoming circuits it is not necessary to provide auto-to-auto relay sets on or between selector levels serving the outgoing loop-disconnect junctions to exchanges in the director area, except to cover the comparatively few calls that both come in and go out over loop-disconnect circuits. There are, however, two exceptions. Certain of the older London director exchanges having pre-3,000-type relays and served by junctions of over 800 ohms resistance require an impulsing aid, and this is provided by trunking calls to these exchanges via an auto-to-auto relay set containing an impulse regenerator. The other exception is that on short trunk circuits, worked on a loop-disconnect basis, a relay set is required on the outgoing selector level to control access to a route placed in "delay." By careful segregation of the traffic so that auto-to-auto relay sets are encountered only when required, their number has been kept low; as a consequence it was decided to have only one type, namely, the auto-to-auto relay set with regenerator and delay busy relay. As the selectors used are battery testing, a simple battery-testing circuit had to be provided on all outgoing circuits not having relay sets.

The trunking principles are shown in Fig. 1. Levels 7, 8 and 9 carry terminal traffic to exchanges in the London group and the diagram shows how, by segregation, calls requiring an impulsing aid, or a holding condition, are routed via between-level relay sets. It will be seen that segregation has been reduced to a minimum by using a group of outgoing levels to serve C.B. exchanges, while another group serves the older exchanges having pre-3,000-type relays and junctions over 800 ohms resistance.

Level "0" is used exclusively for special services. The code 01 is for assistance and is routed to sleeve control positions in Faraday Building. In addition to the Faraday trunk boards, there are in London three trunk control centres (T.C.C.) which were set up to relieve Faraday. In

† Senior Executive Engineers, London Telecommunications Region.

¹ "The Post Office Standard Motor Uniselector." C. A. May, *P.O.E.E.J.*, Vol. 46, p. 79.

² "Signalling System A.C. No. 1 (2 V.F.)." D. C. Smith, *P.O.E.E.J.*, Vol. 44, pp. 66 and 118.

NOTES:

1. One level per test rack.
2. Levels 3, 4, 5 and 6 are trunked in a similar manner to level 12. The level arrangements shown are typical and are not necessarily those used at Kingsway.
3. Auto-auto relay sets with regenerators are used on levels serving loop-disconnect routes to exchanges outside the 12 1/2-mile circle. When a route is in delay its outgoing relay sets are included in this group.
4. C.B. exchanges due to convert to auto during the design period are included in this group.
5. Battery testing to earth testing conversion relay sets.

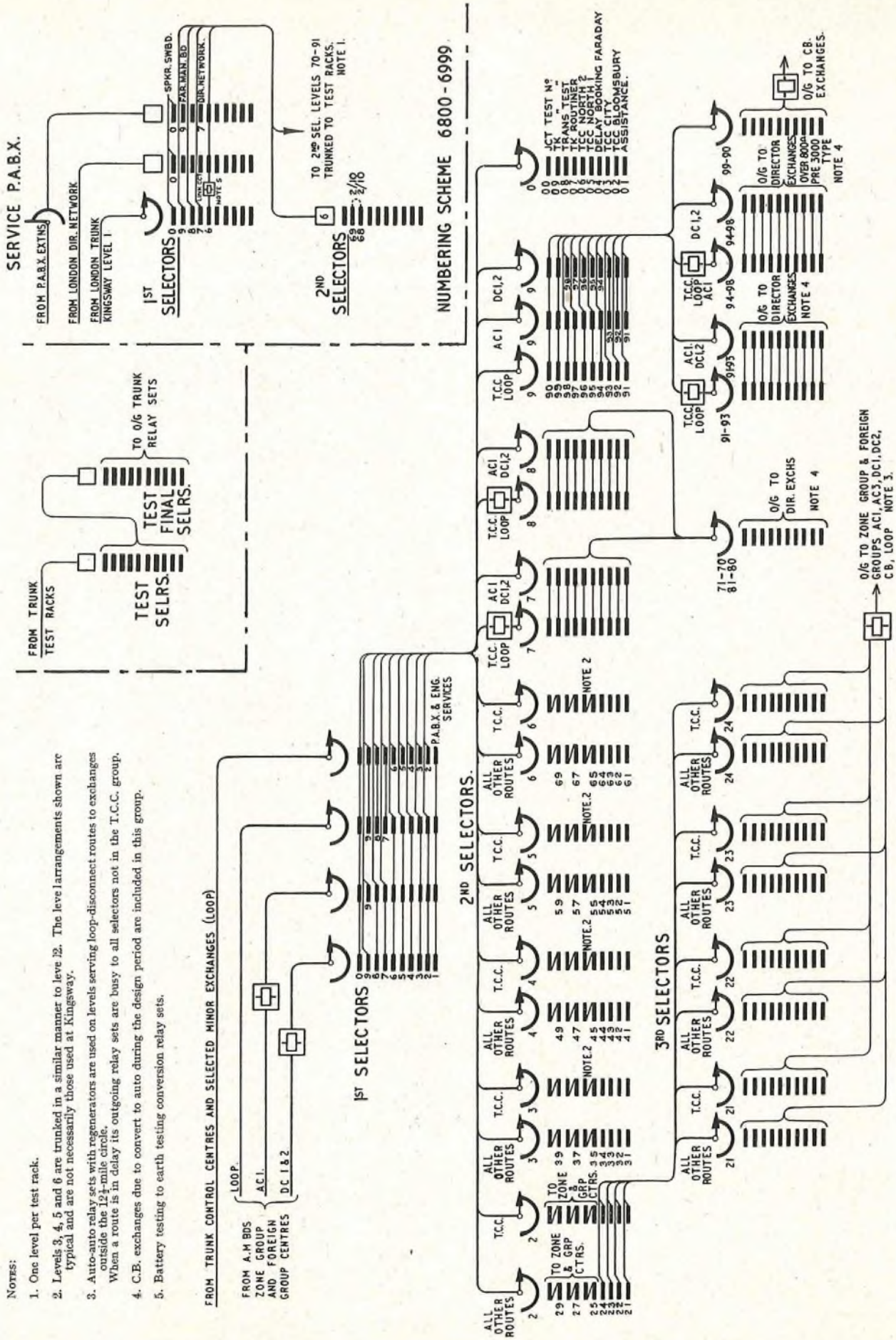

FIG. 1.—TRUNKING PRINCIPLES.

addition, further relief has been given by the introduction of local control of trunk traffic and at the present time over 40 per cent. of the trunk traffic originated in London is controlled at director exchange auto-manual boards.

When a trunk route is placed in delay all traffic from the London group for that route is set up and controlled at the T.C.C.s, including Faraday, and at a few of the larger director exchange auto-manual boards. The remainder of the auto-manual boards in the director area will, on dialling the code of the route in delay, receive the delay announcement and have to book the call at the T.C.C. selected to handle the delay traffic from that auto-manual board.

The three T.C.C.s are known as Bloomsbury, which is trunked from 02, City, trunked from 03, and North, which contains two trunk suites connected to levels 05 and 06. The delay booking level 04 appears on the Faraday manual board and is used by operators outside the London group.

The remaining routes obtained via the "0" level are allocated as follows:—

07-Trunk Routiner relay sets, which are required to work in conjunction with trunk circuit routiners at distant trunk exchanges.

08-Transmission Test Number equipment which enables testing officers at distant trunk exchanges to make transmission tests without the co-operation of staff at Kingsway.

09-Trunk Test Number circuit, used when testing incoming trunk circuits from distant exchanges.

00-Junction Test Number circuits, used when testing incoming junction circuits from exchanges in the London group.

Level I is not used for normal traffic, but provides access to the trunk test racks and to the P.A.B.X. serving the Kingsway installation. Levels 2-6 are used for access to zone and group centres, the larger routes being trunked from second selectors and the remainder from third selectors.

To allow operators handling delay traffic to obtain access to routes in delay, while at the same time returning the appropriate delay announcement to other operators, it is necessary to keep the two types of traffic segregated throughout that part of the exchange serving those levels with access to zone and group centres. The typical grading chart, Fig. 2, shows the resulting two gradings for T.C.C. and non-T.C.C. traffic. Both gradings are teed to the same outgoing relay sets but with different P-wire connections. When a route is placed in delay, the operation of the delay relay in all outgoing relay sets on that route still permits access from the T.C.C. group of selectors, but causes the relay sets to test engaged to selectors in other groups. Selectors not in the T.C.C. group are therefore caused to pass over all normal outlets and search for a verbal delay relay set from which the appropriate announcement is returned. If all delay relay sets are engaged then busy tone is returned. Busy tone is applied when congestion occurs between ranks of switches, but an announcement "no lines

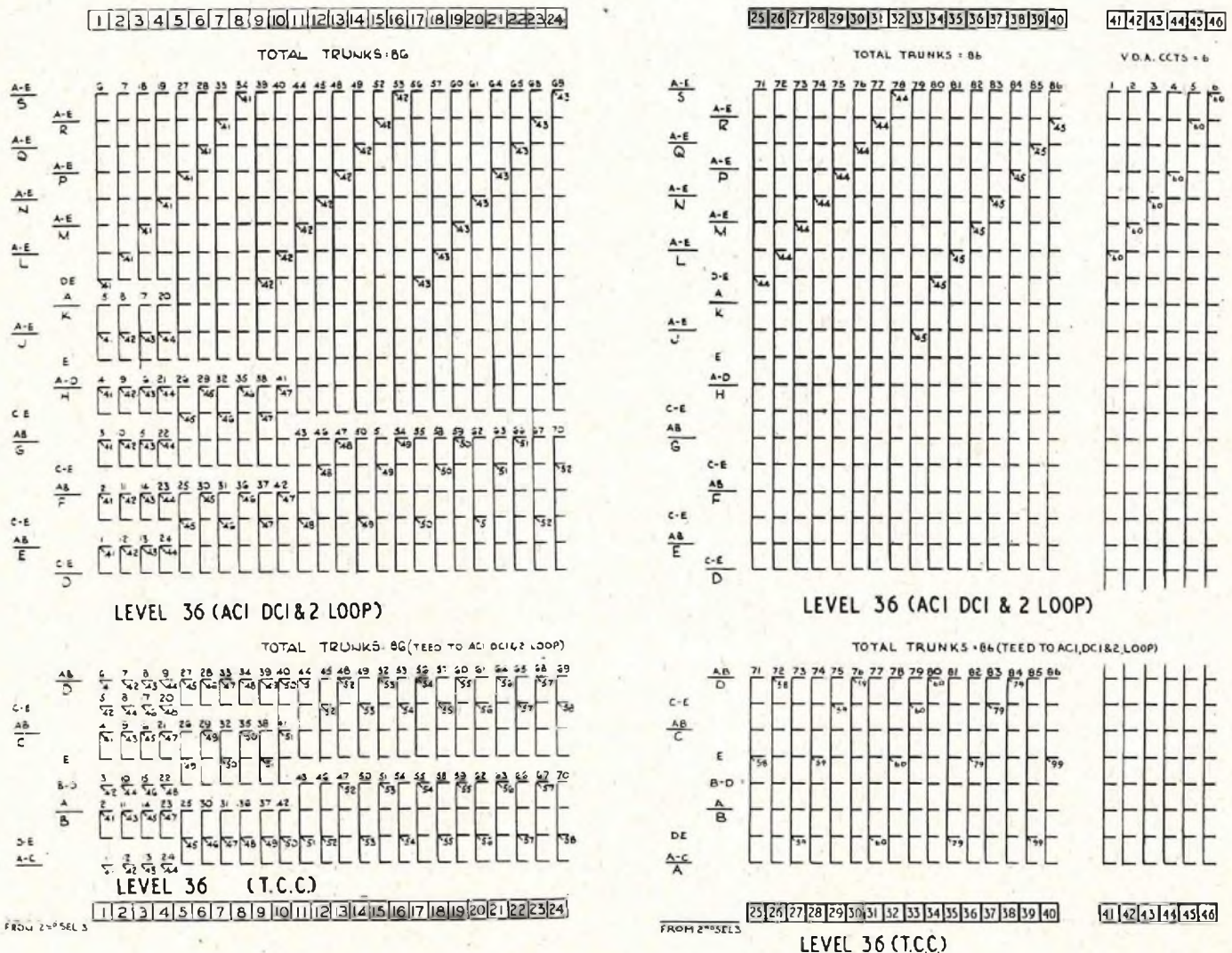

FIG. 2.—TYPICAL GRADING CHART.

London" is applied when selectors fail to find a free outgoing circuit.

As described more fully elsewhere,³ the motor uniselector group selector can be arranged to provide an availability of either 20 or 40, but as each 40-availability group occupies in effect two levels, a number of possible dialling codes are lost. The trunking arrangements, Fig. 1, illustrate this by showing three 40-availability routes on level 2, which makes codes 26, 28 and 20 unavailable. Operators dialling these codes receive N.U. tone.

In designing the exchange an availability of 40 has been provided only on outgoing trunk routes where a material economic advantage is obtained and this occurs where the number of circuits exceeds 22, or the sum of the outgoing plus bothway circuits exceeds 20. It has therefore been necessary to have a margin of spare levels not only to cater for additional routes, but so that as existing routes grow, they can be changed from 20- to 40-availability. An availability of 20 is used for switch-to-switch gradings and for all outgoing junction routes.

Before the grading charts could be prepared it was necessary to know those trunk circuits required for secondary uses, because such circuits are liable to be switched out of service at specified times, or when required to replace some special circuit that has become defective. Further, to minimise the effects of cable or transmission equipment breakdowns, the circuits on the London-Birmingham route, for example, have been distributed over five different cable routes and this procedure has been followed as far as practicable on all trunk routes.

On a route having full-availability the efficiency of the circuits remaining, after some have been lost through switching or cable breakdown, is unaffected by the position of the circuits on the selector bank outlets. It was decided, however, to place circuits having secondary uses on late choice outlets as, carrying less traffic, they are not so likely to be engaged when required to be switched.

When a route is graded, efficiency is better maintained if switched circuits are placed on as early choice outlets as possible. In addition, the circuits in the various cable routes have to be distributed over the grading, so that under cable breakdown conditions the maximum efficiency is obtained from the remaining circuits.

The preparation of the grading charts for a unit of this size was a job of considerable magnitude and the use of the motor uniselector group selector necessitated a new form of grading chart to indicate that odd levels occupy outlet contacts 1-20 and even levels 21-40. In addition, it was necessary to show that verbal delay announcement relay sets for odd levels are connected to contacts 44, 45 and 46 and for even levels to contacts 41, 42 and 43. Also, where more than three verbal delay announcement relay sets were required on a 20-availability route, or more than six on a 40-availability route, it was necessary to show the grading of these relay sets. In all, 509 gradings were prepared, which is about three times the number required for a large director exchange.

To keep the grading charts to the standard size it was necessary to use two charts for each 40-availability route and a typical large grading is shown in Fig. 2. In addition, it was not possible on gradings prepared for outgoing trunk routes to show particulars of the outgoing circuits and relay sets. This difficulty was aggravated both by the size of the gradings and by the large number of racks and the consequent high rack numbers that had to be used. Separate schedules were therefore prepared, showing the relationships between selector outlet numbers, relay set numbers, engineering numbers of circuits, alternative use of circuits and the designating letters, A, B, C, etc., used to show the

³ "The Motor Uniselector Type Group Selector for Trunk Switching." A. J. Barnard, *P.O.E.E.J.*, Vol. 46, p. 108.

distribution of circuits over alternatively routed cables.

Bothway working is not catered for on the trunk junctions and only to a small extent on trunk routes, where it is limited to a component of the total circuits on a route. Difficulties arise in designing a grading containing both unidirectional and bothway circuits and consequently a bothway component is provided only on full-availability routes.

The characteristics of trunk traffic are such that some routes have a morning peak load while others have an evening peak. Some economies in switch provision have therefore been obtained by a judicious mixing of routes over the various ranks of selectors.

It will be seen from the trunking diagram, Fig. 1, that the use of non-director step-by-step principles has resulted in an essentially simple, though by no means small, switching unit, in which the amount of apparatus used for setting up any one call has been kept to a minimum. A disadvantage of such a design is that although spare levels have been left where growth is expected, some future rearrangements will be inevitable, particularly as routes requiring 40-availability must occupy adjacent levels. Such changes will necessitate alterations to the visible index files at all manual boards routing calls via the Kingsway unit. Further, the segregation of selectors to cater for delay working and impulse regeneration, or to provide a selector hold condition, makes the unit less flexible and consequently more likely to require the regrouping of selectors as traffic conditions change.

EXCHANGE EQUIPMENT

The decision to use the Post Office standard motor uniselector conditioned much of the exchange design work. It was arranged that this high-speed switch, together with the Post Office uniselector No. 2, should be equipped throughout on standard 10 ft. 6 in. × 4 ft. 6 in. racks, wired as graded group selector racks; a view of some of the racks is given in Fig. 3.

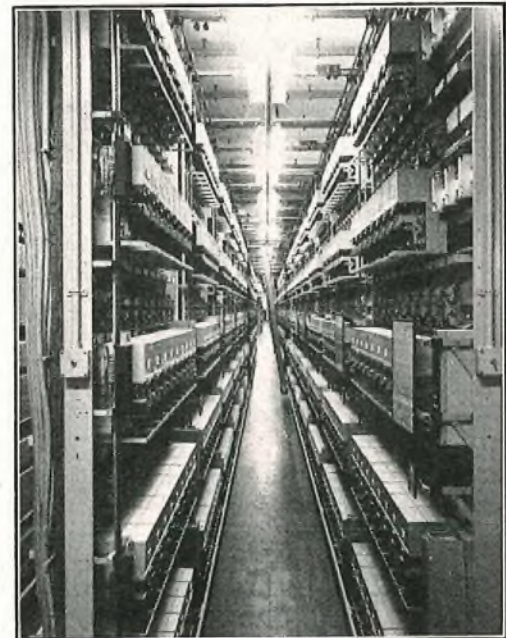

FIG. 3.—GROUP SELECTOR RACKS.

The plant listed in Table 1, together with 16 M.A.R.s, access racks and traffic recorders, comprise the main equipment.

TABLE 1
Quantities of Main Items of Plant

	Racks	Switches/ Relay Sets
Motor uniselectors	312	13,751
Motor unselector routiners	9	
<i>Relay Sets</i>		
A.C.1	128	2,918
A.C.3	5	479
Auto-to-auto with regenerator	25	640
D.C.1	10	378
D.C.2	18	663
Outgoing to C.B. with delay switching	7	701
Bothway remote sleeve control with delay switching	5	388
Delay switching control circuit V.D.A.	3	500
M.U. selector overflow and spare level	2	224
Miscellaneous relay sets	3	84
<i>Routiners</i>		
Relay set routiners	9	
Outgoing trunk and junction routiners	7	
<i>Frames</i>		
Main distribution frame No. 1	1	78 verticals
Main distribution frame No. 2	1	28 verticals
Intermediate distribution frames	4	266 verticals total

All routiners are associated with automatic fault recorders,⁴ that for the trunk and junction routiners being located in the test room to facilitate the ready circulation of docket. A docket tube system is used for the distribution of docket from a central fault table to various points in the exchange.

The M.D.F. No. 1 on which audio cables are terminated is equipped with protectors in the normal way, but M.D.F. No. 2 is fitted with connection strips only, for the termination of (a) cables from the repeater stations for circuits derived from the carrier and coaxial systems, and (b) tie circuits from the protected M.D.F., and for cables to the test rack terminations for both (a) and (b) (see Fig. 4).

The test racks form a suite of 21 racks for trunk testing and a suite of 6 racks for junction testing. For the immediate

⁴ "The Fault Recorder or Docket Printing Machine." T. F. A. Urben, P.O.E.E.J., Vol. 45, p. 115.

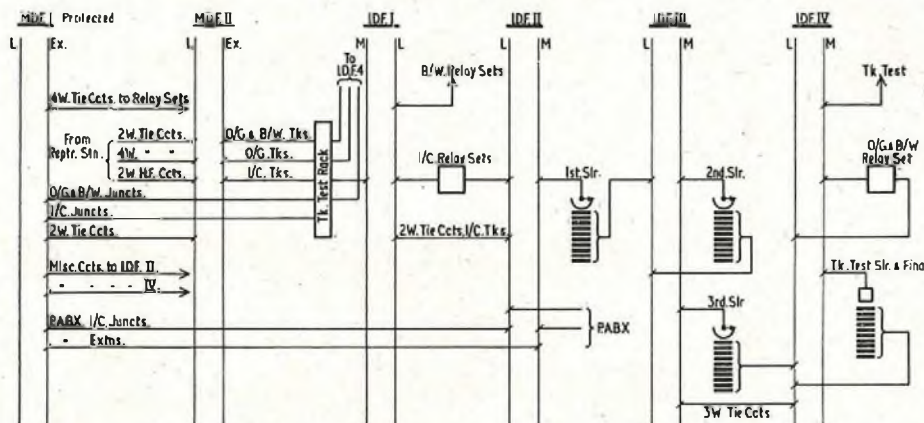

FIG. 4.—MAIN CABLING SCHEME.

busying of individual trunk circuits or carrier groups or systems, three test racks are fully equipped with 3,460 busy keys for individual trunks and 240 keys for coaxial groups and systems, which effect the operation through remote busying relays.

Each trunk test rack is to be equipped with Oscillators No. 32 giving ten test frequencies between 300-3,400 c/s, which can be switched to line through the test cord circuit. Pending provision of this facility, test frequencies of 800 c/s and 1,600 c/s are available. Provincial test clerks may test the transmission efficiency of their trunk circuits to Kingsway by dialling "08" to connect with a selector level relay set which transmits to the calling exchange a 1,600 c/s frequency. By dialling the appropriate code a distant test clerk can be routed to a Kingsway test clerk for further transmission tests. To allow the testing of an outgoing circuit through the associated relay set, each trunk test rack has access to the trunk test and final test selectors, and can thus connect with the relay set on its exchange side.

Within the exchange section of the accommodation is located the Inland Transmission Room. Its primary function is to co-ordinate the engineering operations for the setting up and testing of new and rearranged circuits. This installation consists of a suite of 25 racks of equipment, 18 racks in pairs providing 9 A.C.-D.C. test positions and the remainder serving for high-grade circuit testing, peak-programme metering, recording and miscellaneous uses. Tie cables have been provided between the Inland Transmission Room, M.D.F. No. 1, R.D.F. No. 1 and the "music" distribution frame in the Repeater Station.

Service traffic within the exchange is switched by a 200-multiple P.A.B.X. equipped with 2,000-type selectors combined with one rack of motor uniselectors. Service calls from provincial centres are switched initially through the main Kingsway equipment as indicated in Fig. 1.

Rack lighting and space lighting throughout is fluorescent; the loading is four 80-W lamps for each apparatus gangway of five or six racks and two such lamps in the corresponding wiring gangway. The lighting arrangement at a Distribution Frame can be seen in Fig. 5.

POWER PLANT

The designed maximum output of 4,000 amperes to the 50-volt exchange power-distribution board required careful consideration of the type of plant which would make the best use of the available accommodation. It was decided to employ dry-plate rectifier equipment and to develop control gear which would be entirely automatic in operation and which, together with two 5,000-A.H. batteries, would function as a divided battery float system. For the main floating system, four 1,000-amp rectifiers, each with its transformer and automatic regulator unit were

planned (three initially and a fourth to follow with growth of the service), together with two 500-amp units. The latter may be switched out of the float system and used for charging purposes.

The rectifiers, served from three-phase feeds from the individual transformers, comprise identical tank units of 250-amp rating in groups of four, or two, which are erected in brick cubicles along the front of which the horizontal D.C. float bars are run. Within each tank, banks of selenium rectifiers are arranged on a frame supported in transformer oil, the temperature rise being controlled by cooling tubes passing water at the rate of 15 gallons per minute. In the unlikely event of the tank oil temperature reaching

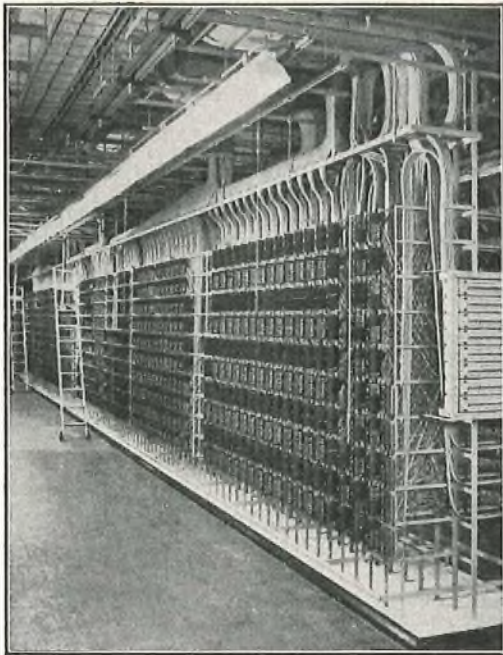

FIG. 5.—DISTRIBUTION FRAME.

65°C, a thermostat control shuts down the rectifier plant, and at a higher temperature within the cubicle, fusible links will operate CO₂ release apparatus to suppress flame; the oil may be jettisoned on to a shingle bed within the cubicle. To facilitate removal from a cubicle, and replacement, each tank is fitted with wheels which normally rest on runners fitted at a level above the exchange floor to coincide with the loading level of the removal trolley—see Fig. 6.

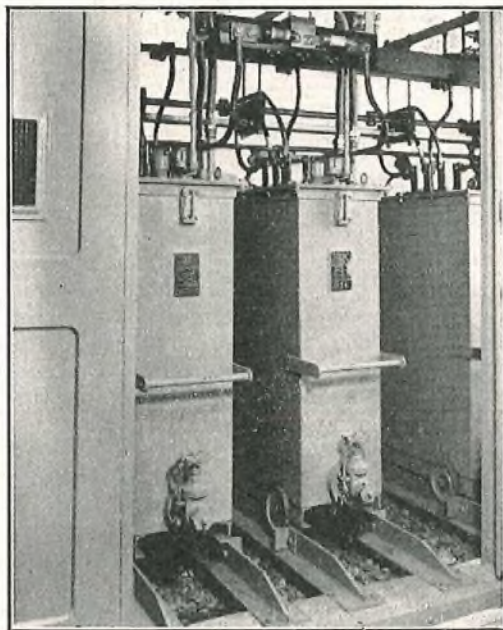

FIG. 6.—RECTIFIER TANK UNITS.

The mains supply of 415 volts, 3-phase, to each transformer is regulated, within ± 88 volts variations of the mains supply, to obtain a steady output voltage of 55 volts D.C. to the float busbar under varying load conditions. Regulation of output and operation of contactors is individual to each float rectifier and is effected by an induction regulator, the motor drive of which is controlled by a voltage relay responding to the potential difference at the battery switching panel. Switching-in of a rectifier occurs when the preceding control unit is current-loaded to

more than 95 per cent. of its capacity; a signal is then given, operating the A.C. and the D.C. contactors and causing the additional rectifier to share the load. The last rectifier to be switched-in is voltage-controlled and will remain in circuit, or be released, according to the potential difference at the battery-switching panel. The exchange filter is of unusual size, comprising three units which together weigh approximately 10 tons, and for which special transport from works was necessary.

In Fig. 6 is seen the interior of a 1,000-amp cubicle (only three of the four 250-amp tanks can be seen): the transformers and regulators, which face their rectifier cubicles, can be seen in Fig. 7.

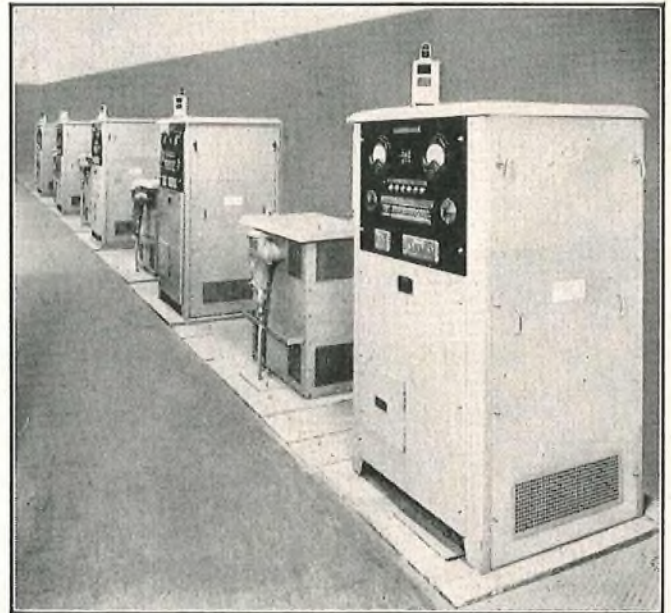

FIG. 7.—POWER TRANSFORMERS AND REGULATORS.

The busbar run from the rectifiers to the power-distribution board (Fig. 8) is 195 ft. From the distribution board, through the mains and sub-mains systems, the total busbar length exceeds 1,400 ft., and aluminium bars, 20 tons in weight, varying in size from 2 ft. \times $\frac{1}{2}$ in. to 8 in. \times $\frac{1}{2}$ in. and up to seven bars per pole have been installed (see Fig. 8). Where multi-bars per pole are necessary, positive and negative bars are interleaved and this has necessitated protection against mechanical damage, in the form of sheet-metal trunking, the cover of which is solid, while the sides and base are perforated.

Busbars from the batteries to the power-distribution board are of copper, seven 9 in. \times $\frac{1}{2}$ in. bars per pole. Here the total weight of metal is 18 tons, which at one point of concentration reaches a loading of 1 ton per foot run. When erecting the busbars each joint was tested for conductivity as the work progressed, high-tensile strength bolts being used to allow of sufficient compression to ensure a sound junction. All bars are carried within slotted blocks of "Permalit" insulant, mounted in brackets suspended from ceiling fixings. Fig. 9 shows part of a busbar run during installation. The 3-phase 46-volt A.C. cable from transformers to the charge/float rectifiers needed careful triangulation to avoid the heating of brackets, and corresponding power losses.

The mains supply is available from two alternative feeders, but four 300-kVA diesel generator standby sets are now being provided to serve both the exchange and repeater station in the event of complete mains failure.

The extensive distribution is concentrated on the power-distribution board through the four circuit-breakers shown

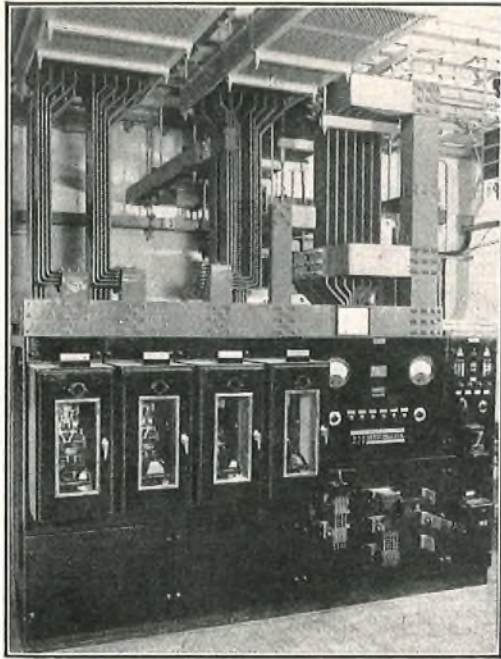

FIG. 8.—POWER-DISTRIBUTION BOARD.

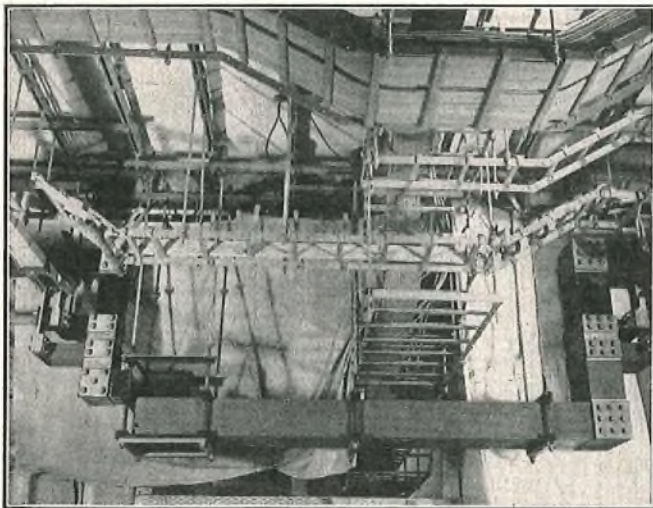

FIG. 9.—POWER DISTRIBUTION BUSBARS AND CABLE RACKING.

in Fig. 8 (two are rated at 1,200 amps, one at 1,600 amps, and one at 2,000 amps); a major fault will therefore isolate a limited section of the plant for test and examination, although such an incident would of course affect traffic throughout the system.

INSTALLATION PLAN

The planning of the installation operations commenced early in 1950, and the contractor's course of action was planned on the understanding that full accommodation with normal access would be complete on 1st July, 1952.

It was decided by the contractor, Siemens Bros. & Co., Ltd., to install all overhead ironwork, cable racks, etc., and to run all cables in advance of delivery of equipment racks. For ceiling fixings it was decided to use screw sockets in the ceiling at predetermined points; and for wall fixings, angle iron at rack height along each wall. Ceiling loading at various points needed careful study as loads up to 700 lb. were met.

Cable rack locations needed special attention to negotiate

room junctions and bends where head room was acutely restricted, and throughout the exchange it was essential to ensure that, notwithstanding the size of cabling cross-section, access to all runways would be possible for future cleaning and maintenance attention. It was evident from the cabling plan that cable runs from the trunk test racks to the incoming and outgoing relay sets would be of the order of 200 yards or more and would introduce the risk of crosstalk. It was therefore decided that such lengths should comprise switchboard cable of special manufacture having a capacitance unbalance between adjacent pairs of not more than 70 pF in a factory length.

INSTALLATION

Installation of the exchange commenced on the appointed day, 1st July, 1952, but contrary to planning, only a very limited portion of the accommodation could then be made available to the contractor. Access to site was also restricted, but the pre-cabling as planned allowed of immediate progress being made and maintained in a situation which could not admit of equipment deliveries. As the provision of accommodation progressed the contractor's staff immediately extended their activities, hence there was no stoppage, or loss of time. Delivery of selector racks fully equipped with motor uniselectors commenced in March, 1953, and the full installation progressed without major difficulty thereafter.

Altogether three miles of racking were erected, carrying 337 miles of switchboard cable, of which 108 miles were specially manufactured for the long runs. All cabling converged on two M.D.F.s and four I.D.F.s and the concentration was heavy at many points. Consideration of this in the planning stages provided considerable relief by locating routiner access racks *en suite* with selector racks rather than grouping them separately.

Economy of cable and a further reduction of cable cross-sections was effected by the cabling arrangement depicted in Fig. 4, where selectors and some relay sets are seen to be cabled from frame to frame instead of across a frame in the more orthodox manner. Fig. 4 indicates only the main cabling scheme and omits much of the detail.

The exchange was opened to traffic at 9.0 a.m. on 30th October, 1954, following a transfer operation which commenced on the previous afternoon. To ensure smooth co-operation at all stages, including the preceding traffic trials, the requirements were previously discussed with the Engineering Department and the provincial Regional representatives at engineering and traffic conferences in London.

Final information for planning the necessary trunk circuits and channels was not available until the end of July, 1953, and, as the work had to follow immediately that for London Trunk Faraday Stage 1, the issue of advices for more than 2,000 trunk circuits was compressed within the period of mid-December, 1953, to the end of January, 1954.

The transfer operations required switching operations at Kingsway on 1,226 outgoing and both-way, and 876 incoming trunks, while 429 and 380, respectively, needed to be switched at distant ends. The L.T.R. junctions, though considerable, presented no difficulty.

The success of this entire project from the initial planning in 1949 to the opening date was the result of full co-operation between all concerned in the Post Office and Siemens Bros. & Co., Ltd.

ACKNOWLEDGMENTS

Acknowledgment is made to Siemens Bros. & Co., Ltd., for the photographs used for Figs. 3 and 5-9.

A Ten-Kilowatt Low-Pass Filter

U.D.C. 621.372.542.2:621.396.828:621.396.61

E. R. BROAD, B.A., and
E. J. P. MAY, B.Eng., A.M.I.E.E.†

The design and construction of a low-pass filter suitable for connection to the output of a 10-kW radio transmitter are described. The filter suppresses by about 60 db. all harmonics in the television frequency band 40-70 Mc/s. An explanation of the apparent misbehaviour of the filter in the field is also given.

INTRODUCTION

THE problems encountered in dealing with interference with television reception have been many and varied. The sources of interference have ranged from powerful electric locomotives to elegant hair-dryers and from household appliances to medical apparatus. The methods adopted to solve these problems have, in general, been the provision of decoupling, or elementary filters, and screening. With the spread of television reception throughout the country, complaints of interference caused by short-wave (Band 7) radio transmitters have increased. The radiation of these transmitters on harmonic frequencies, while satisfying the needs of the communication band, interferes with television reception in the frequency band 40-70 Mc/s. Once again the solution to the problem lies in screening and filtering not only the power supplies to the transmitter but also the radio frequency output.

The filtration of the radio frequency output, unlike the filtration or decoupling of power supplies, requires the use of an electrical network which must be designed with a high degree of precision and may be complex in structure. A description of the design and construction of such a network, in the form of a low-pass filter capable of handling powers of the order of 10 kW, is given in this article.

Experiences with this filter at radio stations have shown that its effectiveness may be nullified by radiation other than from the transmitting aerial, particularly where screening of the transmitter is elementary. This effect will also be discussed.

GENERAL CONSIDERATIONS

Most of the complaints of this type of interference come from television viewers in the immediate vicinity of the radio transmitting stations. The field strength and frequency of the television signals vary considerably from station to station. For the radio frequency filter to be useful at all the radio stations it must provide sufficient discrimination against the harmonic frequencies over the frequency band 40-70 Mc/s to meet the case of lowest field strength. For this purpose a discrimination of the order of 60 db. is considered adequate.

The range of the fundamental frequencies of Post Office short-wave transmitters is from 4 to 28 Mc/s. If the filter is inserted between the transmitter and transmission line it is important that its input impedance should be approximately equal to that of the line over this frequency range, otherwise the tuning of the transmitter may be seriously affected. A filter designed to give a reflection coefficient of less than 0.1 (modulus) at its input terminals when the output is correctly terminated is likely to be satisfactory.

Another aspect to be considered is the dissipation of power in the elements of the filter. This must be kept to a minimum to avoid overheating of the filter and consequent diminution of radiated power. A figure of 0.5 per cent. of the power transmitted is considered reasonable.

Reliability must be a major consideration in the construction of the filter. It is therefore imperative that any capacitors used in the filter should have a large factor of

safety or be self-healing in the event of voltage breakdown, so that the filter is not put out of commission by excessively high voltages which can occur on the transmission lines under certain circumstances. To meet this consideration and that of cost, for the close tolerance capacitance values required in a filter, the use of air-dielectric capacitors is indicated.

THEORETICAL DESIGN

It is clear from the foregoing considerations that a low-pass filter is suitable. The exacting requirements for the reflection coefficient in the passband indicate that a "synthetic" basis of design should be adopted.

It can be shown that for a four-terminal reactive network the insertion loss is simply related to the reflection coefficient. From this relation it follows that for this filter the insertion loss in the passband must be less than 0.044 db. Darlington's method¹ of network synthesis, using an image parameter reference filter, shows that for a low-pass filter of cut-off 29 Mc/s the requirements can be met with some margin by using three sections. In fact, the maximum insertion loss in the passband can be made as low as 0.011 db., corresponding to a maximum reflection coefficient of 0.05.

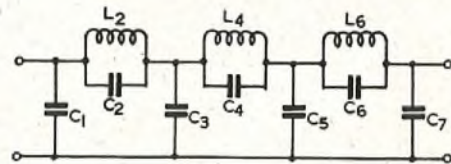

FIG. 1.—THE LOW-PASS FILTER CIRCUIT.

Using m values of 0.7, 0.77 and 0.89, the calculated insertion loss behaviour of the filter network of Fig. 1 is as shown by the curve of Fig. 2. Calculation of the network

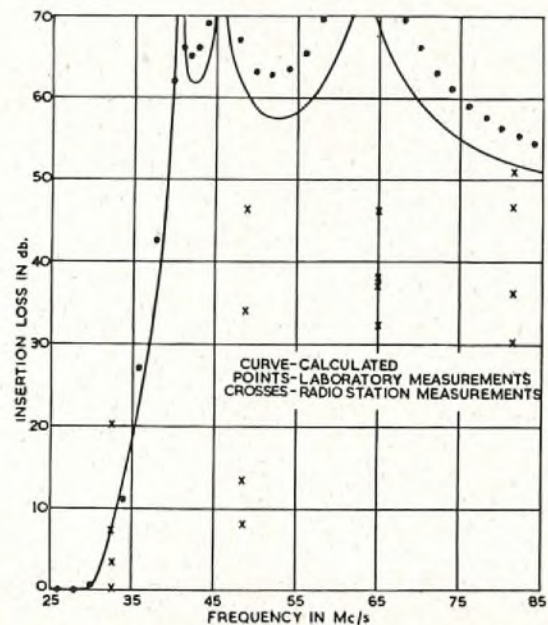

FIG. 2.—INSERTION LOSS/FREQUENCY BEHAVIOUR OF THE FILTER.

† The authors are, respectively, Senior Executive Engineer and Executive Engineer, Radio Experimental and Development Branch, E.-in-C.'s Office.

¹ "Synthesis of Reactance 4-poles," S. Darlington, *Bell Lab. Monograph* No. B1186.

gives the values shown in Table 1 for 75, 90, 150 and 300-ohm filters.

TABLE 1
Element Values

Element	Filter Impedance				Units
	75	90	150	300	
L_2	0.31	0.37	0.62	1.24	micro-henries
L_4	0.51	0.61	1.01	2.02	
L_6	0.49	0.59	0.98	1.95	
C_1	24.2	21.4	12.8	6.42	micro-farads
C_2	49.7	41.4	24.8	12.4	
C_3	93.9	78.3	47.0	23.5	
C_4	24.2	20.2	12.1	6.06	
C_5	105.2	87.7	52.6	26.3	
C_6	12.8	10.7	6.41	3.21	
C_7	48.6	40.5	24.3	12.2	

The circuits L_2C_2 , L_4C_4 and L_6C_6 tune to frequencies of 40.61, 45.45, and 63.60 Mc/s respectively.

For balanced transmission lines two filters of half the nominal line impedance are used, one in each line.

CONSTRUCTION

In this section specific details of the construction of the 300-ohm filter will be given. The construction of filters of other impedances will be similar. A photograph of a sectional model of the 300-ohm filter is shown in Fig. 3.

It will be seen that the main parts of the filter consist of copper tubing of three sizes. One end of each of the inner tubes is closed with a plate having a central hole. The filter is assembled on an axial rod consisting of alternate sections of threaded brass rod and insulators. These insulators serve to couple the sections of brass rod and to support the

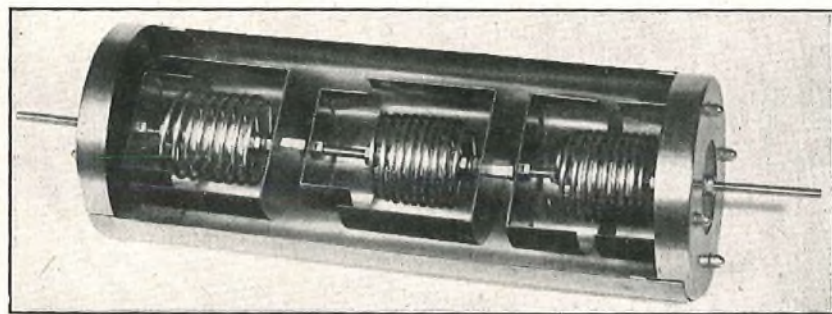

FIG. 3.—SECTIONAL MODEL OF 300-OHM FILTER.

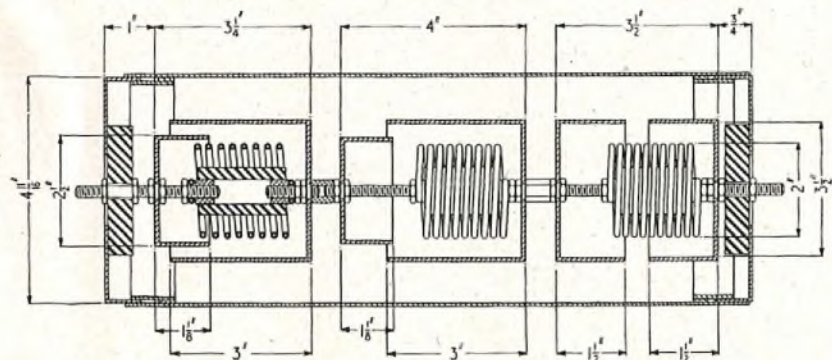

FIG. 4.—MECHANICAL DETAILS OF 300-OHM FILTER.

ends of the inductors. The brass rod sections between the insulators are each divided into two parts coupled by threaded brass bushes. By this means the filter can be separated into three parts for the purposes of adjustment. Further mechanical details are indicated in Fig. 4.

The inductors are made from $\frac{1}{8}$ in. dia. copper tubing and details are given in Table 2 below.

TABLE 2
Details of Inductors

Element	Inductance μH	Turns	Internal Diameter of Coil (in.)	Length of Coil (in.)
L_2	1.24	$7\frac{1}{2}$	$1\frac{1}{4}$	$2\frac{1}{4}$
L_4	2.02	$9\frac{1}{2}$	$1\frac{1}{2}$	$2\frac{1}{4}$
L_6	1.95	$9\frac{1}{2}$	$1\frac{1}{4}$	$2\frac{1}{4}$

The order and method of assembly is given in the next section as it is allied with the process of adjustment.

It will be seen from Fig. 4 that every surface within the outer tube plays a part in the provision of the capacitances indicated in the circuit diagram of Fig. 1. In addition, the pairs of inner tubes or "cups" serve as screens around the inductors and prevent interaction between them. Clearances are sufficient to allow the filter to pass about 10 kW with an adequate margin against voltage breakdown.

ASSEMBLY AND ADJUSTMENT

The components are assembled in three similar groups, or sub-assemblies, each centred around an inductor. The two appropriate lengths of threaded brass rod, an insulator and the inductor are assembled together. On to the rods are placed the associated "cups" or inner tubes, as indicated in Fig. 3. These cups are screwed on until they are in the positions indicated in Fig. 4. A measurement of the inductance at low frequency is then made and any necessary adjustment carried out by slight expansion or compression of the coil.

The anti-resonant circuit formed by the inductor and its associated cups is now adjusted to the correct frequency.

To do this it is necessary to enclose the sub-assembly in a short cylindrical case of the same diameter as the outer tube of the completed filter. Adjustment is made by screwing one of the cups towards or away from the other by a small amount. In the cylindrical case the sub-assembly forms a simple filter giving one peak of loss which occurs at the tune frequency of the anti-resonant circuit.

After adjustment of the three sub-assemblies in this manner, they are coupled together mechanically by the two brass bushes, previously referred to, and placed in the outer tube, as shown in Fig. 4, with the spacers at either end. No further adjustment is necessary and the filter is complete.

PERFORMANCE

The insertion loss, taken between resistive terminations, of a filter constructed in the manner outlined above, was measured in the laboratory at a number of frequencies. The results obtained are shown by the dots on Fig. 2. It will be seen that there is reasonably close agreement with the calculated curve.

The crosses on Fig. 2 represent the results obtained when measuring the apparent effectiveness of the filter at sites around a radio transmitting station. The four results at

each of four frequencies are representative of those obtained at eight receiving sites for tests using the 2nd, 3rd, 4th and 5th harmonics of a single fundamental frequency. The apparent effectiveness of the filter bears no relation to the insertion loss measurements made in the laboratory.

Explanation of Apparent Loss of Effectiveness on Site.

At first some of the results obtained with the filter at radio stations appear to indicate that it is of little effect in reducing the harmonic radiation. In a sense this is true but it is not the filter which is being ineffective. If during the tests at radio stations the receiver used is affected by radiation, upon which the filter has no effect, at the harmonic frequencies, then it can be shown that the act of inserting the filter can, in fact, result in an apparent increase in the field strength at the harmonic frequency under certain circumstances or, on the other hand, give a greater decrease than one would expect.

The field strength is measured by the voltage induced in the receiving dipole aerial. If the existence of some second radiator other than the transmitting aerial and unaffected by the insertion of the filter is assumed, the induced voltage is the resultant of two component voltages. The first, V_1 , is induced by the radiation from the transmitting aerial and the second, V_2 , is induced by the assumed second source of radiation. That this second source may, in fact, be a number of different radiators will not affect the argument which follows. In this case the voltage V_2 induced in the receiving aerial is itself to be regarded as the resultant of all the separately induced voltages which are unaffected by the insertion of the filter.

The two voltages V_1 and V_2 will, in general, differ in both magnitude and phase. Let V_r be the resultant voltage before insertion of the filter and V' , that afterwards, corresponding to the two component voltages V'_1 and V_2 . Fig. 5 shows a representation of these voltages for three cases (a), (b) and (c) in which the filter discrimination has been taken as 12 db.

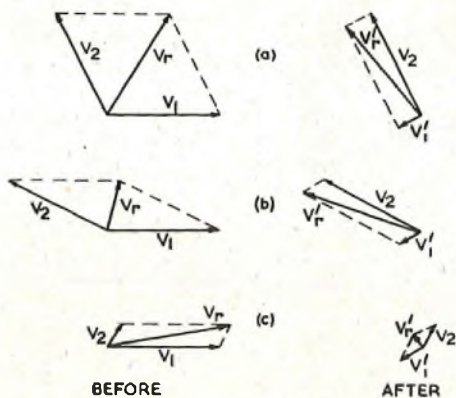

FIG. 5.—COMPONENT AND RESULTANT VOLTAGES INDUCED IN A RECEIVING AERIAL BEFORE AND AFTER INSERTION OF THE FILTER IN THE TRANSMITTER OUTPUT.

For case (a) the two component voltages V_1 and V_2 have been taken as of equal magnitude but differing in phase by about 120°. It is shown that the resultant voltages V_r and V' , are equal in magnitude and the filter has apparently no effect. For case (b) the phase difference between V_1 and V_2 has been increased to 150-160°. The voltage V' , is now greater than V_r , in magnitude and the filter appears to give a gain instead of a loss. Case (c) has been chosen to show that the filter can appear more effective than it really is. The magnitude of V_2 has been made equal to that of V'_1 and then V' , is less than one-quarter of V_r .

These special cases have been chosen to show how the relative magnitudes and phase of the component voltages V_1 from transmitting aerial and V_2 from other sources can

combine to give quite erroneous results for the effectiveness of the filter as measured around a radio station. In fact, it explains how such results can and do vary from receiving site to receiving site. In Fig. 6 is given a plot of the area,

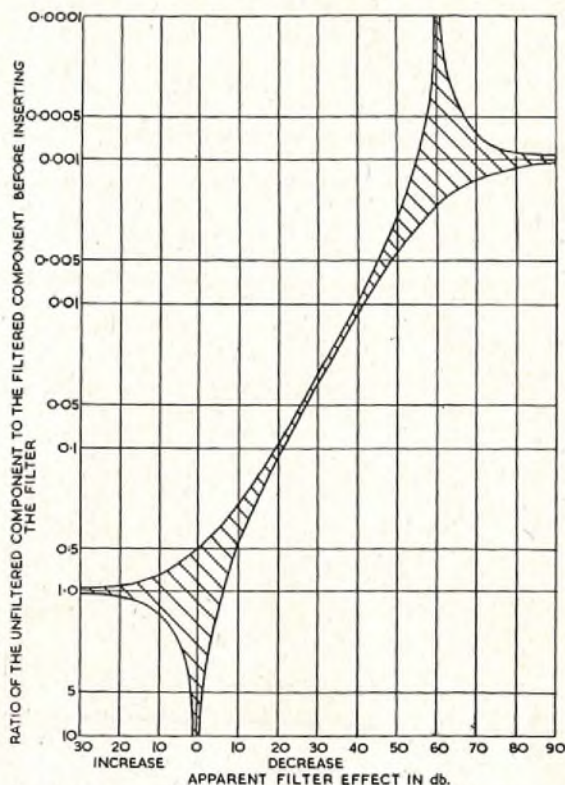

FIG. 6.—APPARENT EFFECT ON SITE OF A FILTER HAVING A DISCRIMINATION OF 60 DB.

shown hatched, within which the measured filter effectiveness may lie for a filter discrimination of 60 db. and for various relative magnitudes of the voltages V_1 and V_2 .

It is clear from Fig. 6 that the measurements of filter effectiveness at sites around a radio station can only give with certainty a value correct to within 1 db, if the second component voltage, V_2 , is less than one ten-thousandth of V_1 , the first component voltage, i.e., that which is affected by the insertion of the filter. When the ratio V_2/V_1 lies between one-half and one two-hundredth, the measurement gives no real indication of the effectiveness of the filter, but rather a measure of the ratio of the two component voltages. For ratios greater than one-half, the measurements are, in general, meaningless. Insertion of the filter may give gains or small losses or appear to have no effect whatsoever.

CONCLUSION

The facts stated in the section on performance and the explanation that followed indicate that the filter is effective in reducing the radiation at harmonic frequencies over the band 40-70 Mc/s, from the transmitting aerial. The apparent ineffectiveness of the filter has been shown to be due to the existence of other sources of harmonic radiation.

To prevent interference with television reception at sites close to a radio transmitting station, in addition to installing a filter of the type described, attention must be given to the screening or suppression of these other sources.

ACKNOWLEDGMENTS

The authors wish to express their appreciation of the work of their colleagues, Mr. G. P. Anderson and Mr. R. F. French, and of others who rendered valuable assistance in the construction and testing of model filters. Thanks are also due to the staff of the radio stations at Bodmin and Ongar for their co-operation during field tests.

A Negative Impedance Converter for use as a Two-Terminal Amplifier

J. R. TILLMAN, D.Sc., A.R.C.S.†

U.D.C. 621.3.011.21:621.375.232:621.372.5

Negative impedance, though no new concept, can now be realised in practice with accuracy, long-term stability and flexibility, by means of suitable negative impedance converters. The basis of one design and its performance are described.

INTRODUCTION

NEGATIVE impedance, the combination of negative resistance with positive or negative reactance, is no new idea in telecommunications. Negative resistance, indeed, has long been the key to many oscillators, neutralising the losses in the two-terminal resonant circuit. In some active components or circuits, negative resistance (dV/dI) reveals itself by direct measurements of voltage (V) and current (I), e.g. in the dynatron, but more often only by A.C. measurements, when a reactance may also be detected. Although many designs of negative resistance have been considered good practice for oscillators, where considerable and possibly varying amounts of over-compensation for losses can often be tolerated, their general use in networks has never been undertaken, despite the advantages indicated by theory. The reason for the reluctance on the part of the circuit designer is, or at least was, simple. The early negative resistances were too dependent on properties of the active elements, which were either not controlled during manufacture or changed with life, and which could not be stabilised in a simple way.

However, much progress was made in the 1940's, as a result of which one or two designs offer a negative resistance whose constancy derives from using the conventional properties of thermionic valves stabilised by negative feedback.^{1,2}

Following these improvements and other work, the idea of highly stabilised* negative impedances has arisen.^{3,4} The negative impedance is no longer an intrinsic property of the active device used (as, for instance, is the negative resistance exhibited by a transistor or an arc discharge), but derives from the combination of a passive network having an impedance Z_0 and a negative impedance converter—an active circuit having an impedance ratio ($-k$) which is negative, at least over some useful range of frequency and signal level (see Fig. 1). In this way a new



FIG. 1.—COMBINATION OF A NEGATIVE IMPEDANCE CONVERTER (ABCD) AND A PASSIVE IMPEDANCE (Z_0) TO GIVE NEGATIVE IMPEDANCE.

component has become available which has constancy and, of equal importance, flexibility, in that both Z_0 and k are, within limits, separately under the control of the circuit designer.

The purpose of this article is limited to describing one design of negative impedance converter which has proved well able to meet the requirements set in one, commonly met, transmission application. Before the design is described, however, explanations must be given of the division

† Senior Principal Scientific Officer, Post Office Research Station.

* In writing of negative impedances it becomes very difficult to resist using the word stable (and occasionally its derivatives), in different contexts, to mean two different things: firstly, constant in the face of ageing of the components and changing of the supply voltages, etc., and secondly, non-oscillatory. When no doubt can exist as to its meaning, stable is used; but when doubts could arise, another word(s) has been substituted.

¹ For references see end of article.

of negative impedances, as electrical quantities, into two types and of their possible uses as two-terminal amplifiers, i.e. their ability to amplify signals in both directions when inserted into two-wire circuits.

Negative impedances are either short-circuit-stable or open-circuit-stable, a most important division which can, as Bode⁵ has shown, be considered fundamentally in terms of poles and zeros in the complex frequency plane. For the present purpose, however, it can be described more suitably in terms of steady-state behaviour. Thus a short-circuit-stable negative impedance Z_n can be terminated by a network of impedance Z_{ext} without oscillation resulting, provided the locus of Z_{ext}/Z_n does not include the point $(-1, 0)$; an open-circuit-stable unit requires that the locus of Z_n/Z_{ext} shall not include $(-1, 0)$.

The choice of which type to use in a particular application can usually be made without difficulty. Thus in designing an oscillator using a negative resistance as the active element, a short-circuit-stable unit is required for use with a parallel resonant circuit and an open-circuit-stable unit with a series-resonant circuit. Of more relevance to this article is the choice for use as a two-terminal amplifier which is to increase the power delivered into a load of impedance Z_{01} from a generator; also (since generalisation serves no purpose here) of impedance Z_{01} . Two connections are possible (see Fig. 2(a) and (b)); a negative impedance

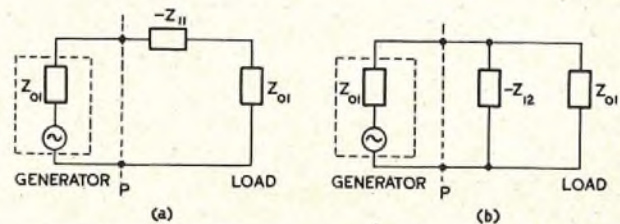

FIG. 2.—CONNECTION OF A NEGATIVE IMPEDANCE BETWEEN A GENERATOR OF INTERNAL IMPEDANCE Z_{01} AND A LOAD.

$-Z_{11}$ can be connected in series with the generator and load, or one of $-Z_{12}$ in shunt. The voltage gains achieved are

$$2Z_{01}/(2Z_{01} - Z_{11}) \text{ for Fig. 2(a)}$$

and $(2/Z_{01}) / \left(\frac{2}{Z_{01}} - \frac{1}{Z_{12}} \right)$ for Fig. 2(b).

Let $Z_{11} = c' Z_{01}$, or $\frac{1}{Z_{12}} = c' \frac{1}{Z_{01}}$,

so that the voltage gain resulting from the insertion of the negative impedance is $2/(2 - c')$. If $c' = c$ where c is real and positive, the relationship between voltage gain in db

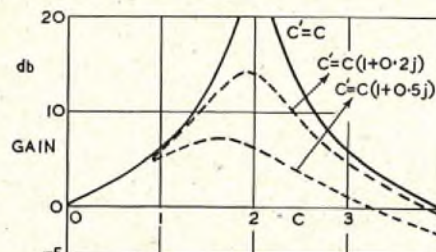

FIG. 3.—GAIN RESULTING FROM THE INSERTION OF NEGATIVE IMPEDANCE BETWEEN A GENERATOR AND LOAD.

and c is given by the continuous curve of Fig. 3. When c is less than 2 no phase shift is introduced, but when c is greater than 2 there is a phase shift of π . In practice the ratio c' can be complex; gain can still result as the two broken curves, for which $c' = c(1 + 0.2j)$ and $c' = c(1 + 0.5j)$, show, c still being real. Gain is now accompanied by other values of phase shift. The generalisation to include complex values of c' is not now considered much further however. There are two values of c , one less than 2 and the other greater than 2, which will provide a given value of gain, and the user must choose between them. There are two good reasons for choosing that with c less than 2. Firstly, as the full curves of Fig. 4 show, the return loss presented to the

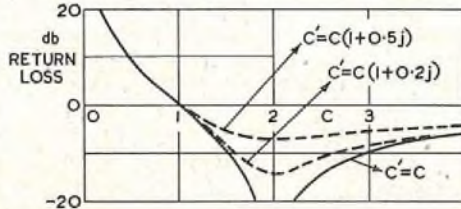

FIG. 4.—RETURN LOSS RESULTING FROM THE INSERTION OF NEGATIVE IMPEDANCE BETWEEN A GENERATOR AND LOAD.

generator at P (see Fig. 2) is greater, for a given gain, at the appropriate value of c less than 2 than at that greater than 2. (Once again two broken curves are included, by way of illustration, one for each of two complex values of c' .) Secondly, because the voltage gain, G , is $2/(2 - c)$, it follows that the magnitude of $(dG/G)/(dc/c)$ is $Gc/2$, i.e. the fractional change in G for a given fractional change in c is, for a given gain, proportional to c and is therefore less for $c < 2$ than for $c > 2$.

If $c' = c$ is less than 2 and the configuration of Fig. 2(a) is used, $-Z_{11}$ ($= -cZ_{01}$) is to be closed with $2Z_{01}$; because $(2Z_{01}/Z_{11}) > 1$, instability and oscillation result unless $-Z_{11}$ is open-circuit-stable. On the other hand, in Fig. 2(b), $-Z_{12} = -Z_{01}/c$ is to be closed with $Z_{01}/2$; freedom from oscillation now demands that $-Z_{12}$ be short-circuit-stable. When a two-terminal amplifier is used as in Fig. 2(a) it is said to be series-connected; when used as in Fig. 2(b) it is shunt-connected.

The amplification provided by the connection of either $-Z_{11}$ or $-Z_{12}$ as in Fig. 2(a) or (b) respectively, is clearly unchanged when the generator is shifted to the right-hand terminating impedance Z_{01} ; and thus the two-terminal amplifier provides, simultaneously, equal gain in each direction, a statement which remains true even when the two impedances, shown each equal to Z_{01} , are made unequal.

With the advent of negative impedance converters such as that now described, the existence of two types of negative impedance no longer presents the designer with two separate problems. For if the negative impedance $-kZ_0$ presented at the terminals AB of a converter (see Fig. 1), when Z_0 closes the terminals C and D, is open-circuit-stable, that, $-Z_0/k$, produced at CD when Z_0 closes A and B is short-circuit-stable and conversely. One type of negative impedance is the dual of the other.

THE BASIC IDEA

If an impedance Z_0 is connected between the output and input of an amplifier of voltage gain m , zero output impedance ($Z_{out} = 0$) and infinite input impedance ($Z_{in} = \infty$) as in Fig. 5(a), the impedance presented at the terminals AB is $-Z_0/(m - 1)$. For suppose a small voltage v to be impressed across AB. The amplifier produces a voltage mv at its output terminals and a current $\frac{(m - 1)}{Z_0} v$ must flow through Z_0 and out at A (the amplifier

input consuming no current as defined). Hence the conversion ratio is $-k = -\frac{1}{m - 1}$; a little consideration will show that the unit is stable when its two terminals AB are short-circuited, and unstable when open-circuited.

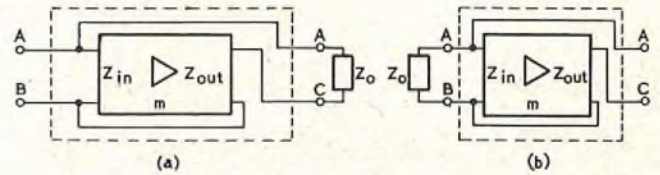

FIG. 5.—BLOCK SCHEMATIC DIAGRAM OF TWO NEGATIVE IMPEDANCES.

If however Z_0 is connected as shown in Fig. 5(b), the impedance presented at the terminals AC is $-Z_0(m - 1)$; for if a small current i is fed in at A and out at C it must generate a voltage $Z_0 i$ at A with respect to B which becomes amplified to $mZ_0 i$ at C. Hence a voltage $(m - 1)Z_0 i$ appears at C with respect to A. The impedance conversion ratio is $-(m - 1)$ and the unit is stable when its two terminals AC are open-circuited and unstable when short-circuited.

The unit within the broken lines of Fig. 5(a) or (b) is a negative impedance converter; little importance attaches to the fact that one terminal, A, is common to the two pairs AB and AC.

Because Z_0 is a passive network, the changes in $-Z_0/(m - 1)$ or in $-(m - 1)Z_0$ with ageing, etc., arise mainly from changes in $(m - 1)$, but can, as will be shown, be minimised by suitable design.

In order to utilise the basic idea in the generation of a specified negative impedance, Z_n , three components are in general necessary: firstly a suitable positive impedance, secondly an amplifier with the properties given above and thirdly, usually, a coupling transformer (e.g. to convert the impedance produced to one which is balanced with respect to earth). The first requirement is so dependent on the relationship between negative impedance and frequency required that it must be dealt with in respect of each application separately; the third is sufficiently conventional to require no detailed consideration here. The second requirement is well met by a feedback amplifier as described in the next section.

CIRCUIT CONFIGURATION OF A NEGATIVE IMPEDANCE CONVERTER

Fig. 6 shows the essence of a circuit which offers a very close approximation to the ideal amplifier required. The components required to ensure correct biases, decoupling of the H.T. supply, etc., are omitted from it in order to concentrate attention on the more important components. The voltage negative feedback, applied via R_N to R_K ensures that the gain ceases to be much dependent on the properties of V1 and V2, that the input impedance remains very high indeed and that the output impedance is low

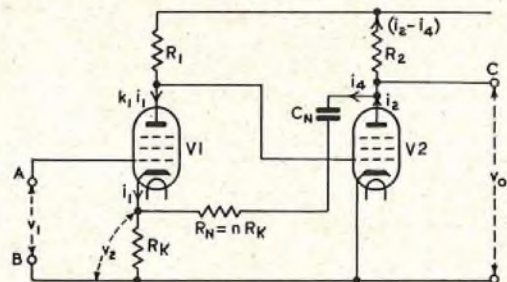

FIG. 6.—BASIS OF THE AMPLIFIER CIRCUIT.

(though not indistinguishable from zero). A sufficient analysis of the circuit can be obtained from the five equations:

$$\begin{aligned} i_1 &= g_1(v_1 - v_2) \\ i_2 &= k_1 g_1 R_1 (v_1 - v_2) g_2 \\ R_2(i_2 - i_4) &= v_0 \\ (v_0 - v_2) &= i_4 n R_K \\ v_2 &= (i_4 + i_1) R_K \end{aligned}$$

where all currents (i) and voltages (v) are alternating, g_1 is the rate of change of cathode current of V1 with change of grid-cathode voltage, and $k_1 g_1$ and g_2 are the mutual conductances of V1 and V2 respectively. They yield

$$\frac{v_0}{v_1} = m \approx (n+1) \left[1 + \frac{g_1 R_2}{(n+1)A} - \frac{R_2(1+p)}{R_K A} - \frac{(n+1) + np}{A} \right] \dots \dots (1)$$

where $p = g_1 R_K$ and $A = k_1 g_1 R_1 g_2 R_2$ (the gain without feedback). For the moment, C_V is assumed to present negligible impedance at all relevant frequencies.

Advantages result from operating V1 at a very low cathode current, I_{k1} , provided the bandwidth required of the converter is only a few tens of kc/s; firstly, although g_1 is thereby reduced, g_1/I_{k1} increases so that, for a given H.T. voltage, $k_1 g_1 R_1$ and hence A can be increased. Secondly, R_K can be increased—without $g_1 R_K$ becoming unduly large—ensuring little consumption of power in the feedback impedance, $nR_K + R_K$. Equation (1) then reduces, sufficiently accurately, to

$$m = (n+1) \left[1 - \frac{n+1+np}{A} \right] \dots \dots (2)$$

The dependence of m on the valve parameters is contained only in the second, smaller, term of equation (2); thus

$$\frac{\delta m}{m} \approx \frac{n+1}{A} \left[\frac{\delta g_1}{g_1} + \frac{\delta g_2}{g_2} \right] + \frac{np}{A} \frac{\delta g_2}{g_2} \dots \dots (3)$$

If $n = 1$ (a good choice for many purposes) and $g_1 R_K \approx 8$, a practical possibility,

$$\frac{\delta m}{m} = \frac{2}{A} \frac{dg_1}{g_1} + \frac{10}{A} \frac{dg_2}{g_2}$$

A can easily be made 200 or more, 1,000 is possible if two small H.F. pentodes are used as V1 and V2) so that m is almost independent of g_1 and only slightly dependent on g_2 . m becomes a complex quantity outside some band of frequency—at low frequencies when $1/\omega C_N$ becomes significant compared with nR_K , and at high frequencies when either the reactance across R_K , due for instance to the cathode/heater capacitance of V1, ceases to be many times R_K or the phase shift in A becomes large. Reactance across R_K can be compensated for by proportionate reactance across nR_K . The imaginary part of m is very small in the units designed over the frequency range 50–20,000 c/s, which includes all the working range of the two-terminal amplifiers in which it is to be used, but even so, the designer must take note of m outside this range, because, through its control of Z_n , it affects the margin against oscillation at any frequency in any application.

The output impedance Z_{out} of the feedback amplifier is easily shown to be approximately $(n+1+np)R_2/A$; in units designed so far it is 100–300Ω, which is small compared with the values of Z_0 best suited to the units, 5–10kΩ. Clearly Z_{out} forms part of Z_0 when Fig. 5(a) applies, so that by designing the passive network to have an impedance $Z_0 - Z_{out}$, the unit will behave as if Z_{out} were zero and Z_0 had in fact been connected between A and C. When Fig. 5(b) applies, the passive network connected between A and B must be increased by $Z_{out}/(m-1)$ for the same purpose. But Z_{out} changes as A changes, so that if initially,

$$Z_{out} = \frac{1}{q} Z_0 \quad (\text{Fig. 5(a)})$$

$$\text{or } Z_{out} = \frac{-Z_n}{q} = \frac{Z_0(m-1)}{q} \quad (\text{Fig. 5(b)}),$$

a fall in A to $A/2$ results in an increase in Z_{out} , as much as twofold if a fall in g_2 only is responsible; Z_n will then change by about $1/q$ th. (Because Z_0 can be complex and Z_{out} is nominally resistive, the change in Z_n deduced is approximate only.)

A PRACTICAL DESIGN AND ITS PERFORMANCE

One practical design has been engineered in some detail. The circuit is based on Fig. 6, but a double triode replaces the two small pentodes originally used, with some saving of space and components, but some loss in A and hence of constancy of performance. A remains high however. Because the negative impedance required for the first application had a modulus of about 1000Ω a coupling transformer of conventional design, with turns ratio of 2.5:1, has been added (see Fig. 7). Its presence does,

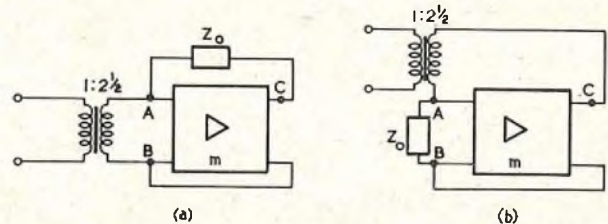

FIG. 7.—ADDITION OF COUPLING TRANSFORMERS TO TWO NEGATIVE IMPEDANCES.

however, introduce new features in the performance of the unit. Thus, if the unit is being used as in Fig. 2(a), i.e. is composed as Fig. 7(b), the shunt inductance of the transformer may cause oscillation at some very low frequency, where phase shift through the amplifier can become large before m falls below unity, unless Z_0 is shunted by an inductance equal to or less than $1/(m-1)$ th that presented by the transformer to terminals AC with the winding remote from AC open-circuited. If the unit is being used as in Fig. 2(b), i.e. is composed as in Fig. 7(a), leakage inductance may cause oscillation at some high frequency, where once again phase shift through the amplifier can become large before m falls below unity, unless an inductance is inserted in series with Z_0 , of magnitude at least $(m-1)$ times that presented by the transformer to terminals AB with the winding remote from AB short-circuited. Neither correction complicates the design seriously or calls for components of very low loss or to close tolerances, unless much larger gains are to be demanded in one of the uses shown in Fig. 2 than have so far been suggested. More exact and complete correction can be obtained by the use of a second transformer, coupling Z_0 to the unit, as for instance in Fig. 8(c); the requirements of the second transformer compared with those of the first, and any changes in Z_0 , are straightforward.

When the signal level at a negative impedance is made to exceed some limit, non-linear distortion becomes intolerable. In the unit described the negative feedback ensures that, below the overload point, harmonic production is very slight; the overload point can be calculated sufficiently accurately from a knowledge of the permissible excursion of the anode of V2, of the turns ratio of any transformers fitted and of Z_0 and m .

The unit need have no controls other than one of n , via the ratio R_N/R_K . Control of R_K is preferred because one end of it is at earth potential. Detailed consideration has yet to be given to maintenance of the unit, but no difficulties are foreseen; some measurement of the space currents of

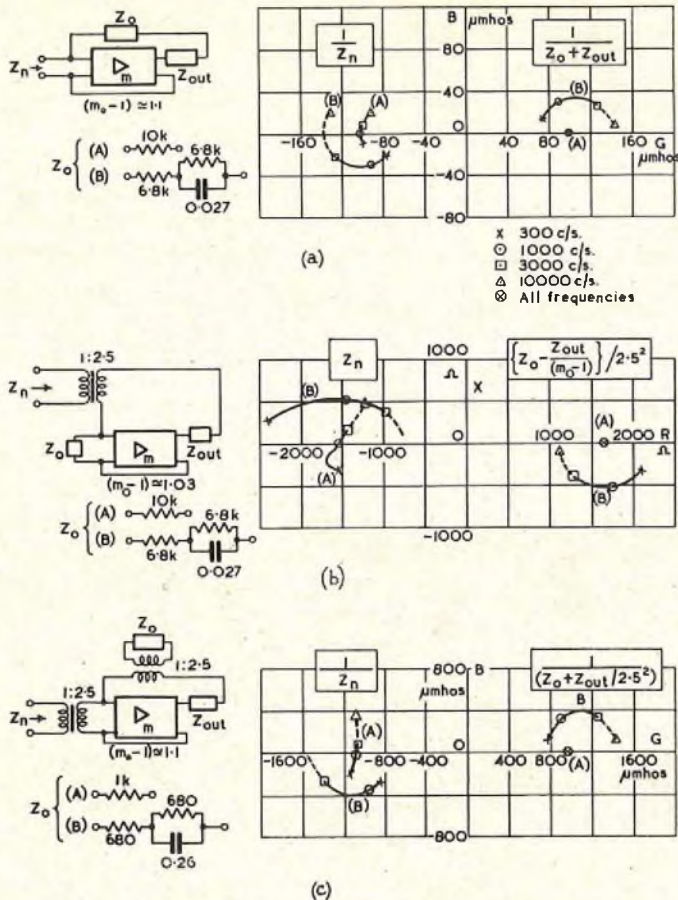

FIG. 8.—EXAMPLES OF TYPES OF NEGATIVE IMPEDANCE (Z_n):
 (a) SHORT-CIRCUIT-STABLE TYPE WITH NO TRANSFORMER INCLUDED.
 (b) OPEN-CIRCUIT-STABLE TYPE WITH TRANSFORMER COUPLING.
 (c) SHORT-CIRCUIT-STABLE TYPE WITH TWO-TRANSFORMER COUPLING.

V1 and V2 will probably suffice for a test of valve ageing. That of V2 can conveniently be made with a robust meter via the voltage across its cathode-bias resistor (not shown in Fig. 6), but that of V1 demands a more sensitive meter or a change of operating conditions during the test. R_N and R_K are the only important components whose performance is not stabilised by the negative feedback; they should therefore be of good quality.

Performance.

The performance of the unit can be expressed in several ways, e.g. by plots of m against frequency and supply voltages, which are of value to the user. The general reader will perhaps be more interested in the specific examples of Z_n presented in Fig. 8 which were obtained when several simple networks were used in turn as Z_0 . (Admittance, $G + jB$, or impedance, $R + jX$, is used as appropriate.) In Fig. 8(a), where no transformer couplings are used, Z_n is very closely $-Z_0/(m_0 - 1)$, where m_0 is the gain at frequencies where the reactive elements are negligible. In Fig. 8(b), where the coupling transformer and compensating inductance are introduced, rather more divergence is apparent (the impedance conversion of the transformer being allowed for) in the band of frequencies 300–3000 c/s and much more outside the band. Fig. 8(c) shows that the use of two transformers (even though not carefully matched) reduces the divergence considerably. The use of more complicated networks to provide Z_0 does not, in general, involve any more departure of Z_n from the values expected.

The long-term stability of Z_n should conform to the ideas already expressed. The variation with loss of mutual conductance of the valves obeys the equations developed,

and that from changes of supply voltages can also be calculated from an estimate of their influence on the properties of the valves; the latter variation is normally so small as to be negligible in applications to line transmission and the former small enough to allow considerable deterioration of the valves before their replacement is necessary.

FURTHER DISCUSSION

Although the constancy of performance of networks containing active devices was once regarded as being an order or two poorer than that of networks lacking active devices, the generalisation has lost much of its force with the widespread use of negative feedback. Accordingly the constancy of performance of the negative impedance converter described departs so little from perfection as to be a matter of secondary concern when uses in line transmission are considered—a statement applying with about equal force to one or two other designs recently described. Indeed, the factors which limit the useful performance of the negative impedance converter as a two-terminal amplifier (providing gain in both directions when suitably inserted into a two-wire circuit as in Fig. 9) are now

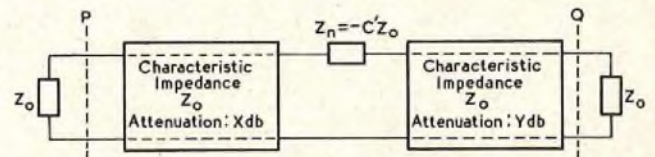

FIG. 9.—INSERTION OF A SERIES-CONNECTED NEGATIVE IMPEDANCE IN A TWO-WIRE TRANSMISSION CIRCUIT (PQ) TERMINATED WITH ITS CHARACTERISTIC IMPEDANCE.

mainly those which would apply to the use of an ideal converter. They are (a) the difficulty of combining high and constant gain with a wide variety of impedances terminating the transmission circuit at each end and (b) the poor return losses resulting from the introduction of Z_n . Indeed, it seems certain that a study of both must precede an assessment of the extent to which negative impedance amplifiers should be included in transmission systems. The first factor must set a limit to the reduction of the overall loss of the transmission link. The second factor, for which some data were given in Fig. 4, restricts the use in other ways.

Suppose a series-connected negative impedance Z_n is inserted as shown in the very simple example of Fig. 9. The return loss of the link at the left-hand side is

$$2X + 20 \log_{10} \frac{|2 - c'|}{|c'|} \text{ db.}$$

if $c' = 1, 4/3$ and $3/2$ (giving gains in each direction of 6 db., 9.5 db. and 12 db. respectively) the return loss is $2X, 2X - 6$ db. and $2X - 9.5$ db. respectively. The return loss at the other end is

$$2Y + 20 \log_{10} \frac{|2 - c'|}{|c'|} \text{ db.}$$

If $X \approx Y \approx 5$ db. and the overall transmission loss is to be reduced to 3 db., the return losses at the two ends will each be about 8 db. only. The low return loss is usually tolerable if the link is not to be extended, but may set an upper limit to the permissible transmission time of any circuit of which the link is to form a part, thereby limiting the flexibility of the complete network. Similar considerations apply to the shunt-connected unit. Considerations of circuit stability, of minimum risk of overloading and of one intolerably low return loss usually require that the unit be fitted as near as possible to the middle of the line (i.e. X should equal Y in Fig. 9).

Negative impedance converters of much wider bandwidth than that now considered are possible—the circuit of Fig. 6

can form the basis of a unit, capable of good performance up to approximately 1 Mc/s and having good long-term stability, provided H.F. pentodes are used and greater anode currents drawn. They can then play a part in network design generally and indeed some detailed work, showing some striking advantages, has already been done with negative resistances to this end.⁶ The wider band units may not, however, find any major use as line amplifiers.

CONCLUSIONS

One practical form of negative impedance, resulting from the combination of a negative impedance converter and a passive network is already in widespread use in the U.S.A.⁷ The alternative design of converter now described is based on ideas some ten years old, but seems assured of an equally good long-term stability and to be of comparable utility in the transmission network. It should require little maintenance and little test equipment.

The questions which arise when its use as a two-terminal amplifier is considered in detail require a separate article; it is sufficient to say here that most of them are little concerned with the detailed design or performance of the negative impedance converter, if only one is to be inserted in any one link.

If converters are to be used only one at a place in the transmission system, no major advances in valve units can be foreseen, but more compact units, consuming less power,

and of very high long-term stability, seem possible by the use of transistors (some have already been described).⁸ The use of negative impedance converters in fields hitherto restricted to passive components is only just being seriously explored, but shows promise of much improved network performance at small cost.

ACKNOWLEDGMENT

The author acknowledges with thanks the assistance given by Mr. R. J. May on the experimental work and the helpful discussions held with several colleagues, particularly Mr. E. C. H. Seaman.

References.

- ¹"Some Characteristics of a Stable Negative Resistance." Brunetti, C., and Greenough, L., *Proc.I.R.E.* Vol. 30, p. 543.
- ²"Electronic Negative Resistors." Tillman, J. R., *Wireless Eng.* Vol. 22, p. 17.
- ³"Stabilized Negative Impedances." Ginzton, E. L., *Electronics* Vol. 18, July, p. 140; Aug., p. 138; and Sept., p. 140.
- ⁴"Theory of the Negative Impedance Converter." Merrill, J. L., *B.S.T.J.* Vol. 30, p. 88.
- ⁵"Network Analysis and Feedback Amplifier Design." Bode, H. W.
- ⁶"The Transistor as a Network Element." Bangert, J. T., *B.S.T.J.* Vol. 33, p. 329.
- ⁷"Negative Impedance Telephone Repeaters." Merrill, J. L., Rose, A. F., and Smethurst, J. O., *B.S.T.J.* Vol. 33, p. 1055.
- ⁸"Transistor Negative-Impedance Converters." Linvill, J. G., *Proc.I.R.E.* Vol. 41, p. 725.

Book Reviews

"Servomechanism Practice." William R. Ahrendt. McGraw-Hill Book Company, Inc. 349 pp. 280 ill. \$7.00.

This book supplements the theory in a college course on servomechanisms with material on circuitry, electrical and mechanical components, and practical problems of design and manufacture. Theory is not neglected, but is treated in a thoroughly workmanlike manner. Like other McGraw-Hill books it is well written, with logical development of the argument, illustrations are clear and to the point, and no difficulties are glossed over or ignored.

Starting with the straightforward exposition of a simple servomechanism, the author indicates the functions and requirements of each component part, and from there goes on to examine the parts in detail, with particular reference to the effects of departure from the ideal. There are two useful chapters on magnetic and rotating amplifiers, one on hydraulic systems in general, and several on design, manufacture, adjustment and testing of servomechanisms in general.

Problems and questions provided at the end of the book form a review of the material in each chapter, and there is a very useful summary of essential theory in an appendix.

I.P.O.E.E. Library No. 2288.

A. W. M. C.

"Amplitude-Frequency Characteristics of Ladder Networks."

E. Green, M.Sc. Published by Marconi Wireless Telegraph Co., Ltd. 155 pp. 88 ill. 25s.

One of the stumbling blocks in the synthesis methods of ladder network design has been the need to find the roots of a polynomial. The design of certain types of ladder network can, however, be reduced to simple formulae involving only the circular and hyperbolic functions. The author discusses the design of these networks of up to five branches and reduces the difficulties still further by the provision of various curves. He deals with the proportioning of the networks to give amplitude-frequency characteristics of three types, A, B and C. Type A is an under-coupled (having regard to a pair of coupled tuned circuits) or peaked response, Type B is a critically-coupled or maximally-flat response, while Type C is the familiar over-coupled or equal ripple response. For the

mathematician, Type B corresponds to a Butterworth function and Type C to a Tchebycheff function.

The design information is presented in a form suitable for band-pass networks but can readily be used for low-pass networks. The method of applying the information to the design of high-pass and band-stop networks is also indicated.

The book should prove invaluable to those engaged on the design of networks associated with valves. The problems which arise in television transmitters and broad-band amplifiers receive special attention as also the broad matching of reactive loads such as aerials. The design of stagger-tuned and stagger-damped circuits for band-pass amplifier chains is also fully discussed.

The method of approach follows that of M. Dishal in his paper on "The Design of Dissipative Band-Pass Filters Producing Desired Exact Amplitude-Frequency Characteristics," *Proc.I.R.E.*, Vol. 37, pp. 1050-1069, September, 1949. This method may be unfamiliar to some network designers and the symbolic language used may prove a difficulty in using the book until it has been learnt.

Because of this and the rather disjointed form of presentation, the book cannot be "read" easily, but must preferably be "studied" with the aid of pencil and paper. Some of the mathematics are by no means rigid. The use of "analogous" rather than "equivalent" low-pass and band-pass networks leads to difficulty with a factor of two when dealing with transient response and is thus somewhat misleading.

The section on low-pass and band-pass filters is hardly suitable for low-frequency applications, but is of value in the design of microwave filters.

The presentation of so much of the mathematical background is inevitable, but the book could have been made easier to use as a reference work for engineers if the tables and curves had been collected together in a slightly different manner free of some of the mathematical argument. The examples used offset this in some degree, and show how the information may be used and where it can be found.

The author and publishers are to be congratulated on a valuable contribution to the art of network design.

E. R. B.

Thanet Cordless Switchboard

U.D.C. 621.395.65:621.395.722

L. A. MISSEN, R. A. SNOOK
and E. J. T. HITCHIN†

This article describes a cordless switchboard installation at Thanet exchange and gives brief details of the trunking principles, construction of the switchboard positions facilities provided and layout of the switchroom.

INTRODUCTION

THE mechanisation of trunk switching in this country provided a unique opportunity of reconsidering the design of the auto-manual switchboard. Among the possible improvements, two were considered of prime importance:—

- (a) a better switchroom layout,
- (b) a call queueing system which would ensure that incoming calls were answered in strict order of arrival.

To arrange for (a) meant eliminating the incoming and outgoing multiples, and to provide (b) automatic storage and distribution of incoming calls were necessary. The cordless switchboard meets these requirements; incoming and outgoing traffic is switch-controlled and the equipment on the switchboard is reduced to signal lamps, chargeable time clocks and control keys. The switchroom layout that can be arranged is seen from Fig. 1, which is a view of Thanet (Margate) exchange, where the first cordless auto-manual switchboard in this country was opened on the 26th March, 1955. This article gives a brief description of the new switchboard and its associated equipment, which were developed by the Post Office in collaboration with Siemens Brothers & Co., Ltd.

TRUNKING PRINCIPLES

As shown in Fig. 2, each incoming circuit terminates on a relay-set which is jumpered to a distributor hunter (25-point uniselector) with outlets graded before passing to the distributor (200-outlet motor uniselector). The banks of the distributor give access to 20 queue places and all the connecting circuits in one "field." Ideally the distributor

†Mr. Missen is an Assistant Engineer in the Telephone Development and Maintenance Branch, E.-in-C.'s Office; Mr. Snook and Mr. Hitchin are Assistant Engineers in the Home Counties Region.

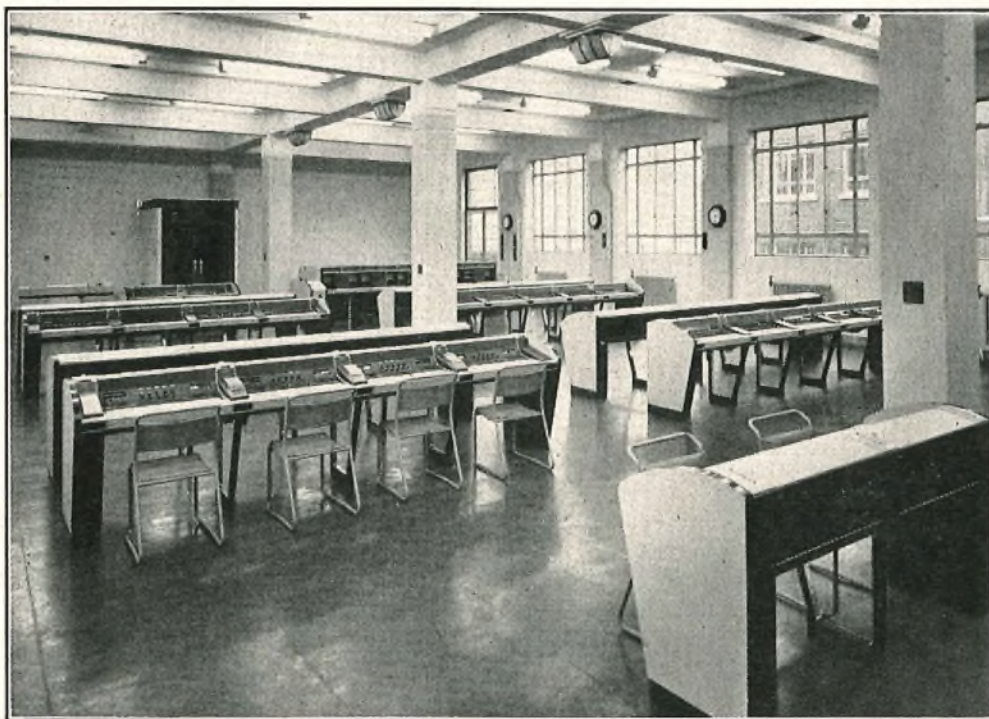

FIG. 1.—GENERAL VIEW OF THE SWITCHROOM AT THANET EXCHANGE.

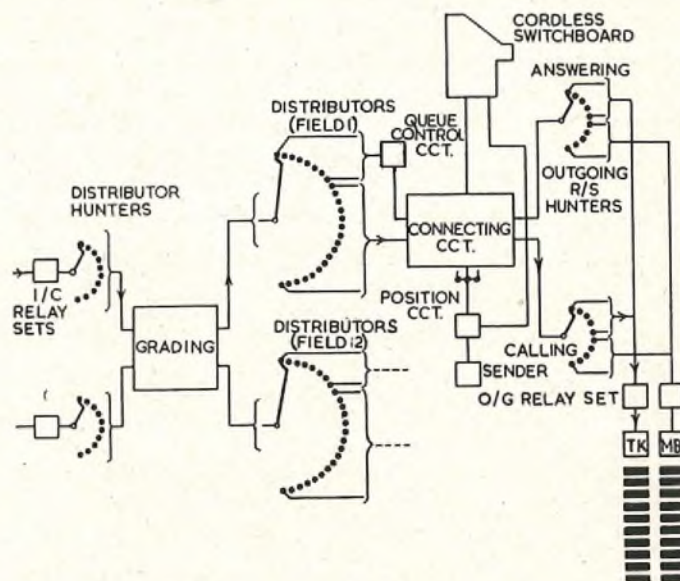

Fig. 2.—TRUNKING PRINCIPLES OF CORDLESS SWITCHBOARD.

should have access to all the connecting circuits on all appropriate positions, but where these exceed in number the outlets on the switch it is necessary to divide the exchange into "fields," each with its own queue. Thanet has two "controlling" fields, one of 18 positions and one of 14 positions. Provision has been made for an ultimate layout of 46 controlling positions and for the equipment for a third field. The grading between the distributor hunters and the distributors is designed to give a balanced distribution of traffic between the fields, and at the same

time maintain a symmetrical grading of reduced availability when either field is closed. Outgoing traffic is routed via outgoing relay-set hunters; each connecting circuit has two of these, one on the calling side and one on the answering side, the latter being required for reversed traffic. The hunters are standard 50-outlet uniselectors providing 23 outlets to a local (M.B.) group of 1st selectors and 23 outlets to a trunk (TK) group of 1st selectors.

It is interesting to note that once the call has been established, the transmission path does not pass through the manual board, although the operator still retains full operating facilities. The cordless board is, in effect, a remote-control unit for the automatic switches. This principle was adopted during development to overcome possible accommodation difficulties under

trunk mechanisation. Although the scheme increases the number of wires between the switchboard and the apparatus room, it does allow the switchboard to be situated remote from its associated automatic exchange without incurring additional transmission loss.

SWITCHBOARDS, DESKS AND CONTROL PANELS

Switchboard Design.

There are four types of cordless position: controlling, incoming, training and enquiry. The first three are similar in construction and their general appearance can be seen from Fig. 1. The positions are assembled in suites consisting of end positions incorporating pedestals used for the entry of cables and power supplies, and intermediate positions supported on light open frameworks. The pedestals and frameworks are cast in aluminium alloy and their tops are joined by aluminium sheets, providing a continuous cable trough along the suite. Over each pedestal and each framework is another alloy casting which houses the visible index file, and between these castings are pivoted turrets carrying the signalling lamps, keyshelf equipment and pigeon holes for tickets. In front of the keys is a flat writing surface covered with non-slip plastic material in a neutral tint. This light colour is repeated along the top of the switchboard and on the ends, which are closed by plastic panels and edged with dark brown. The keyshelf, the back and all the under parts of the switchboard are also finished in dark brown, but the supporting frameworks are relieved by a polished metal trim. The boards have a maximum height of 3 ft. 1 in. and an overall width per position of 2 ft. 9 in.

Position Equipment.

The face equipment of a controlling position is shown in Fig. 3. To preserve a smooth contour, lamp opals are not used; the 6-V lamps shine through stencils in a dark translucent display screen behind the key panel. This screen slopes so as to be at right-angles to the telephonist's line of vision, and is so made that the stencilled letters are invisible when the lamps are not glowing. A new design of lamp jack is used and the lamps can be removed from the rear of the screen. All 6-V lamps on the position are A.C. operated; a transformer fitted in one of the pedestals feeds two suites of positions.

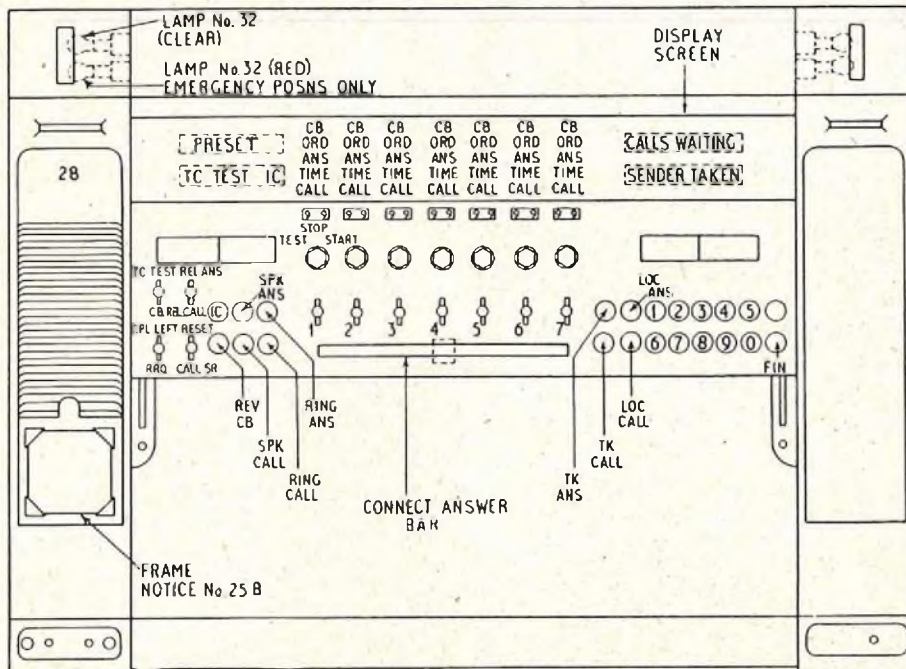

FIG. 3.—FACE EQUIPMENT OF A CONTROLLING POSITION.

To provide maintenance access from the rear of the positions, the key panel and lamp panel form a single unit (turret) hinged at the front (Fig. 4). The key associated with the "Connect Answer" bar and the Speak/Monitor

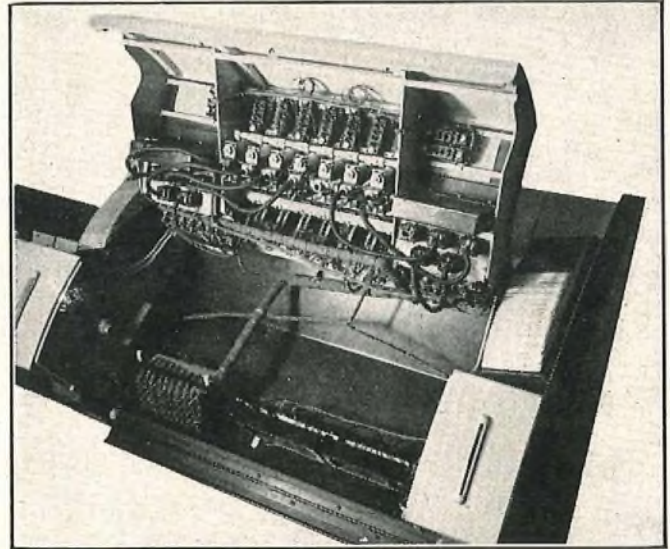

FIG. 4.—VIEW OF UNDERSIDE OF KEY AND LAMP PANEL OF A CONTROLLING POSITION.

keys of the seven connecting circuits are the only keyshelf items permanently wired; the chargeable time clocks, position keys and keysender keys are suitably grouped and terminated on cords and plugs for easy replacement.

Pilot lamps are fitted on the top of the turret on either side of the position, being used for:—

- (a) *Call Supervisor.* White lamps glow on either side of the position when the "Call Supervisor" key is operated.
- (b) *"999" Call.* (See "999 Service.")
- (c) *Waiting Call Alarm.* White pilot lamps glow at either end of a selected suite if a call arrives on an unstaffed field or, if the Night key on the Control Console (described later) is operated, whenever an incoming call occurs.

(d) *Supervisory Alarms.* When the Night key is operated the pilot lamps (white) on each side of the concentration positions function as supervisory pilot signals.

(e) *Section Supervisor's Circuit.* An incoming call to the section supervisor lights the pilot lamps (white) at the ends of the appropriate suites. A section supervisor's telephone jack is fitted at the right-hand end of each suite, the jacks on two adjacent suites being joined in parallel to form one circuit.

The layout is similar on an incoming position, except that there are ten connecting circuits; chargeable time clocks with their associated lamp signals are not fitted, neither are coin-box discrimination facilities provided.

Enquiry Positions (Fig. 5).

The construction of the enquiry positions follows generally that of the other cordless-type switchboards, but the supporting frameworks are replaced

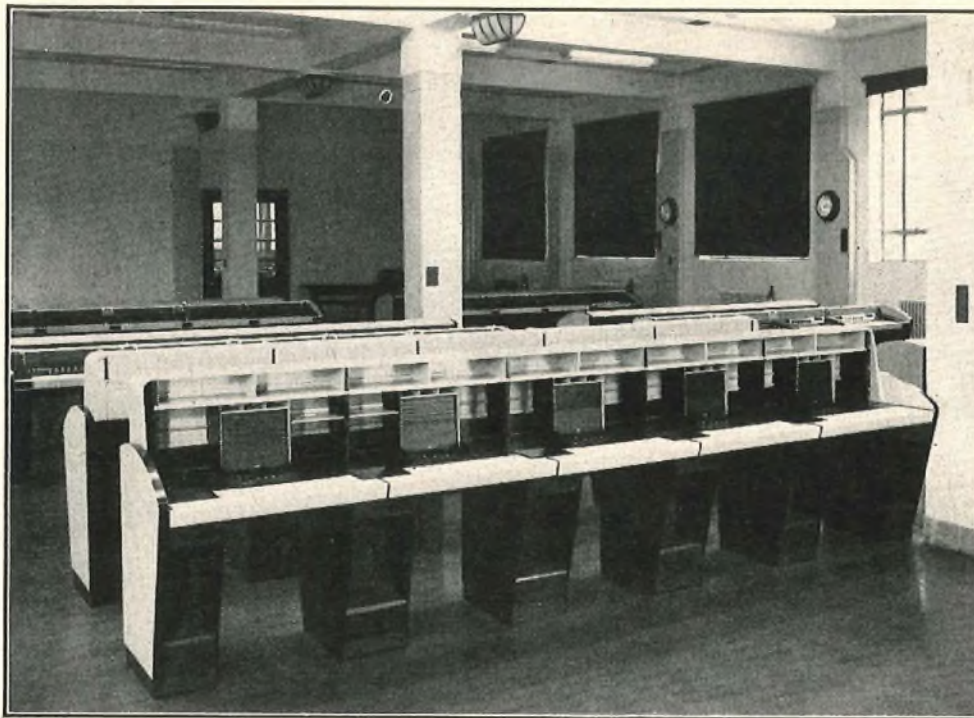

FIG. 5.—ENQUIRY POSITIONS.

by additional pedestals required for holding directories. The operating equipment consists of a hinged keyshelf, a pivoted Night-service display panel and a fixed display screen, the rest of the superstructure forming bookcases. A card trough at desk level is provided in place of the visible index file.

These positions handle a variety of services, each requiring a different answering phrase to be used by the operator who must, therefore, be able to identify the type of incoming call. This is arranged by providing separate queues for each service or group of services, together with a scheme of call identification signals which indicate the category of a call arriving on a position. Equipment is provided for eight queues, each with its own Connect Answer key, as follows:—

- Queue 1—EQ. Enquiry
- Queue 2—INT. Service and Changed Number Interception
- Queue 3—NS. Class "A" night service
- Queue 4—RRQ. Route and rate quoting
- Queue 5—FXT. Fixed time call and personal call monitor
- Queue 6—FM. Faults monitor
- Queue 7—DQ. Directory enquiry
- Queue 8—Spare

Call identification lamps indicate the type of call on any connecting circuit on the position when the Speak key of that connecting circuit is operated. Thus the appropriate identification lamp glows when a call first arrives on a connecting circuit (because the Speak

key will be operated) and subsequently whenever the Speak key is re-operated.

With Class "A" Night Service, for which the exchange operator functions as the P.B.X. operator, the call identification lamp will show the name and/or number of the subscriber to whom the call is being made.

Each position has four connecting circuits and a 12-digit keysender, but timing facilities and coin-box discrimination are not provided.

Training Positions.

Two training units, each consisting of one trainee-control position and two trainee practice positions, were installed at Thanet in advance of the remainder of the equipment. The keyshelf layout of the trainee positions resembles that of a controlling position, except that only five connecting circuits are provided. The

trainee-control position is equipped with keys and lamp signals by means of which artificial traffic can be passed through the two trainee practice positions and standard calling and answering conditions can be simulated. The operation of the keysenders on the practice positions can be checked on a 12-digit display on the control position. The suite of four practice positions and the two control positions can be seen in the foreground of Fig. 1.

Supervisor's Desk (Fig. 6).

This is a commercial type of metal desk adapted to match the cordless switchboard. The plastic-covered top carries a small control turret which houses the keys, lamps

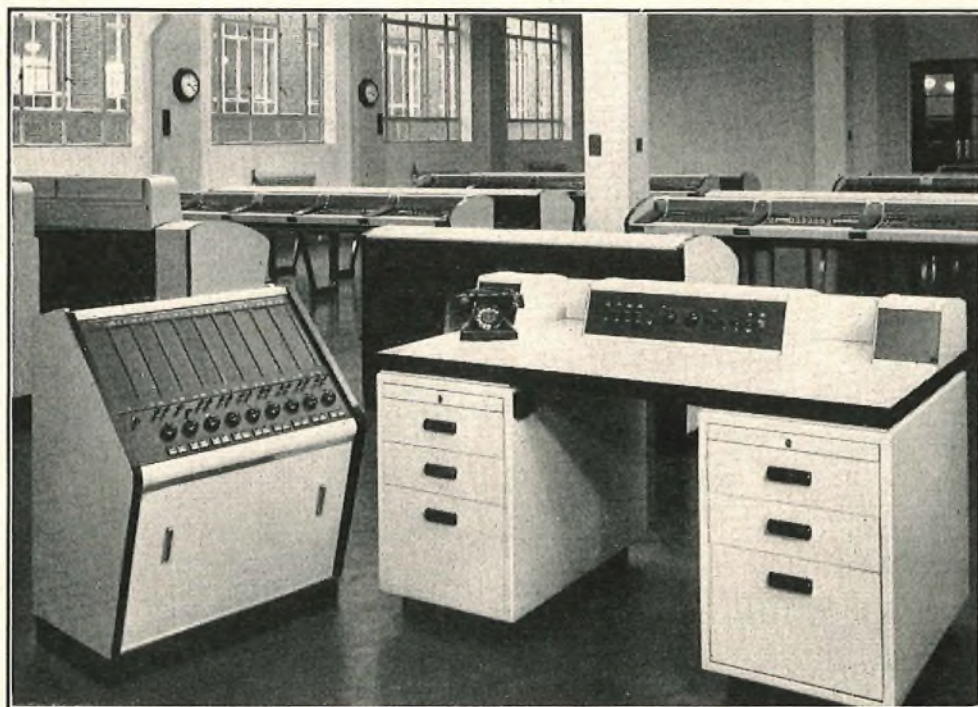

FIG. 6.—SUPERVISOR'S DESK AND CONTROL CONSOLE.

and switches. The two small end turrets form recesses on either side of the central turret which can be used in place of correspondence trays. The facilities provided are similar to those in a sleeve-control exchange.

Control Console.

To give the supervisor an indication of the state of traffic and to assist in the general management of the switchboard, a Control Console is fitted adjacent to the supervisor's desk (Fig. 6). On this console are lamp displays of the "barometer" type indicating, for each field, the number of positions staffed, the waiting time of the call at the head of the queue and the number of calls in the queue. Two meters per field record the total number of incoming calls and the total waiting time, and from these readings the average time to answer over any given period can be determined. The console also houses various alarms and control keys (e.g., the "Night" key controlling the "Waiting Call Alarm" and the "Supervisory Alarm") as well as the miscellaneous services normally fitted on the cable-turning section in a sleeve-control exchange.

Section Supervisors' Panels.

To assist the section supervisors, the state of the traffic on their particular fields is indicated on subsidiary display panels fitted on the walls at convenient points in the switchroom. Apart from the omission of the Positions Staffed display, these panels repeat the appropriate field displays on the Control Console.

OPERATING FACILITIES

General.

The general operating facilities are very similar to those provided by the sleeve-control switchboard. A call waiting in the queue lights the "Calls Waiting" lamp. The operation of a speak key of a free connecting circuit followed by the depression of the "Connect Answer" bar causes the call at the head of the queue to hunt for the allocated connecting circuit. The "Calls Waiting" lamp is extinguished (unless further calls are waiting) and when the call arrives on the connecting circuit the "Ordinary" or "C.B." circuit engaged lamp will glow, depending on whether the call is from an ordinary subscriber or from a call office, the discriminating signal being applied by the incoming relay set. The appropriate lamp will glow for the duration of the call. A 12-digit keysender, individual to each position, enables the operator to set up an outgoing call on the answering or calling side of any connecting circuit and to direct the call to the local automatic selectors or to the trunk switches. If more than 12 digits are required the sender is picked up a second time. The "Sender Taken" lamp glows from the time the sender is taken into use until it has finished pulsing out. Calling and answering supervisory facilities are provided and each connecting circuit on the controlling positions has a chargeable time-clock and time-check lamp. On incoming calls, timing is automatically set to ordinary or coin-box conditions. On reversed calls, the operator can change the timing conditions to coin-box working by depressing the "Revert C.B." key. The anti-clockwise position of the clock-control knob is used in conjunction with the "TC Test" and "C.B." key for routine testing.

If there are no calls waiting, the position can be "preset" by operating a Speak key and depressing the "Connect Answer" bar. The "Preset" lamp will then glow until an incoming call picks up the allocated connecting circuit.

Calls are released by the operation of the "Release Answer/Release Call" key.

"999" Service.

A "999" call operates the normal emergency red lamps and buzzer; at the same time, six allocated controlling positions are barred from taking calls from the normal queue, and immediately any of these positions is set to take a call, the "999" call passes directly to the marked connecting circuit. Red pilot lamps light on either side of the position handling the call and remain alight till the call is released. When the "999" call has been answered, acceptance of calls from the normal queue is automatically restored.

Route and Rate Quoting (R.R.Q.).

On the operation of an R.R.Q. key, a position finder picks up the calling position and extends the call to the R.R.Q. queue on the enquiry positions, where the operator accepts each call in turn by operating the Speak key of a free connecting circuit and depressing the R.R.Q. Connect Answer key. The R.R.Q. operator releases each call by operating the Release Answer key.

Sender Test.

To test her keysender an operator keys 002 on a free connecting circuit. This picks up the sender test equipment, which returns a distinctive tone to the operator, who then depresses the digit keys in three pre-arranged sequences. At the end of each sequence the appropriate tone is returned to the operator to indicate whether the sender is functioning correctly or not.

Fault Monitor and Hold Circuit.

Facilities are provided whereby a faulty connection held by an operator on a connecting circuit may be transferred by the Fault Monitor to special holding equipment which, having picked up the faulty connection, disconnects it from the connecting circuit and allows the operator to re-dial the call. Once picked up by the holding equipment, a faulty connection can be released only by the engineering staff. Access to the fault holding equipment is via level 1 of the Trunk 1st selectors.

Time to Answer Control.

The division of the controlling positions into two fields necessitates some control of the traffic going to each field if reasonable equality of "time to answer" is to be preserved. This is achieved by an automatic control, functioning as follows:—

All incoming calls are timed automatically immediately they enter a queue.

As soon as the longest waiting time of a call in a queue exceeds 5 sec., the queue is closed and further calls are diverted to the other field. The queue will remain closed until either the waiting time of the call at the head of the queue has dropped below 5 sec., or the other queue has a call which has waited 5 sec. If the latter is the case, then the first queue is re-opened and both queues remain open until one of them has a call which has waited 10 sec. when the action is repeated. This process continues at 15, 20, 30, 40, 60, 90 and 120 sec. At 120 sec. both queues are closed and busy tone returned to subsequent callers until the maximum waiting time in one queue falls below 120 sec. in which case this queue re-opens. As the time to answer improves the time control point is successively lowered until it is again operating at 5 sec.

THANET TRUNKING SCHEME

The way in which the cordless trunking principles have been applied at Thanet can be seen from Fig. 7. All "0" level traffic originated by subscribers in the automatic area and by subscribers on the parented U.A.X.s is routed

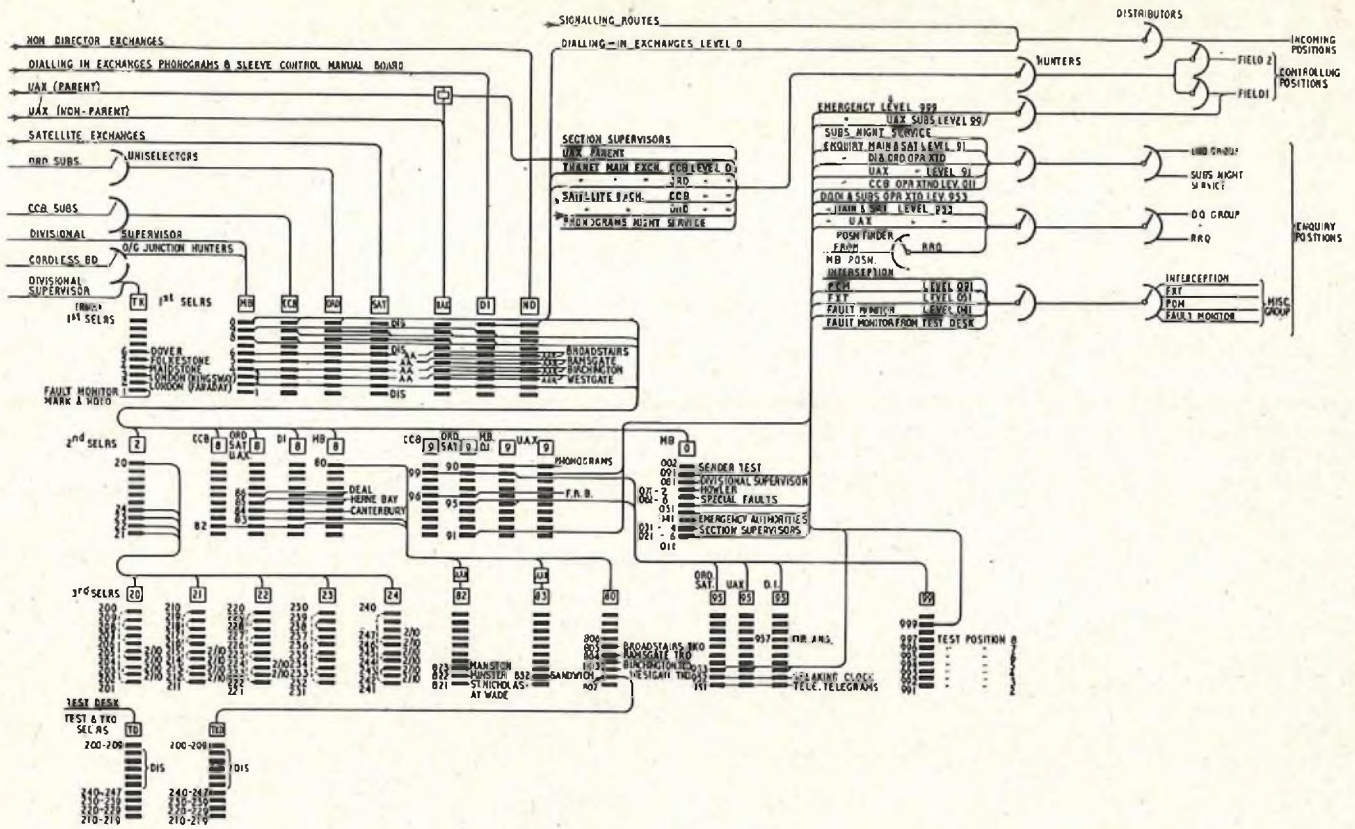

FIG. 7.—TRUNKING SCHEME AT THANET EXCHANGE.

to the controlling positions. Emergency-call traffic is routed to selected positions in field 1, by-passing the distributors serving that field. There are only two incoming positions and these will handle traffic from level "0" of the dialling-in group of 1st selectors and from one route working on a C.B. signalling basis. The appropriate relay sets in these instances are connected directly to special incoming distributors which use standard uniselectors and provide a queue of five places with access to all the 20 connecting circuits on the incoming suite.

The 10 enquiry positions are each capable of handling calls from any of the eight sources shown, but it may be desirable from an operating point of view to arrange for certain positions to handle only one type of call. The enquiry distributors can provide up to four queues for four different sources of traffic, provided the total numbers of queue places does not exceed 20. At Thanet, the enquiry traffic has been divided into three groups:—

1. { Enquiry—10 queue places
 Night Service—5 queue places
2. { Directory Enquiry—10 queue places
 Route and Rate Quoting—5 queue places
3. { Interception—10 queue places
 Fault Monitor—5 queue places
 FXT and P.C.M.—1 queue place

The multiples of the three groups of enquiry distributors are commoned so that each distributor has access to all the connecting circuits on the enquiry positions.

The loss of direct access to U.A.X.s from the outgoing junction multiple meant that the trunk-offering condition had to be applied by the auto-auto relay sets and it was essential that the facility should only be available to the local operator. Dual access relay sets were, therefore, developed through which trunk offering conditions can be applied only via the manual-board selectors.

There are a number of services which, on a sleeve-control switchboard, are connected to the outgoing junction multiple. For the cordless board, selector level access had to be provided. While this could be done from final selectors, it would have meant altering the signalling conditions on a number of standard circuits. To avoid this, and also to save switches, a special group selector with 2-digit selection of 1 to 10 lines was developed and has been provided at Thanet on the "0" level of the manual-board 1st selectors, where, besides giving access to the exchange services, use has been made of the switch to give 3-digit access to the emergency authorities, i.e., Fire (031), Police (032), Ambulance (033) and Lifeboat (034).

EXCHANGE EQUIPMENT

It was arranged that the installation of the cordless switchboard should coincide with an extension of Thanet exchange, for which G.E.C. were responsible. The extension included the provision of additional equipment and re-arrangements to afford multi-metering facilities, an increase in subscribers' multiple, the provision of A.C.1 and D.C.2 signalling equipment for trunk mechanisation and the provision of all standard selector equipment (together with one or two special items) for the termination of circuits from the cordless board equipment. The provision and installation of all equipment directly associated with the cordless board, however, was carried out by Siemens Brothers & Co., Ltd.

The equipment directly associated with the cordless positions is installed in the original apparatus room and will "grow" towards the existing equipment, whilst the new relay-set racks are installed in a new apparatus room on the ground floor.

To obtain space in the existing switchroom for the cordless switchboard, it was necessary to take over an office and also recover nine of the sleeve-control positions.

A partition was then erected across the switchroom to separate the two types of switchboard. Since the switchboards had to be cabled via holes in the floor under the end pedestals of the individual suites, the location of the steelwork in the floor and the presence of two ventilating ducts in the apparatus room ceiling had to be taken into account. A check made with a modified mine detector¹ (kindly lent by the Telephone Manager, Colchester) enabled a course to be plotted over which a straight line of holes could be provided, and an arrangement was adopted using five-position suites on one side of the room and four-position suites on the other. A compact layout was produced and space for the 20-year development ensured. The cordless switchboards were situated directly above the associated equipment in the apparatus room below, thus simplifying the cabling scheme. A plan of the switchroom is shown in Fig. 8.

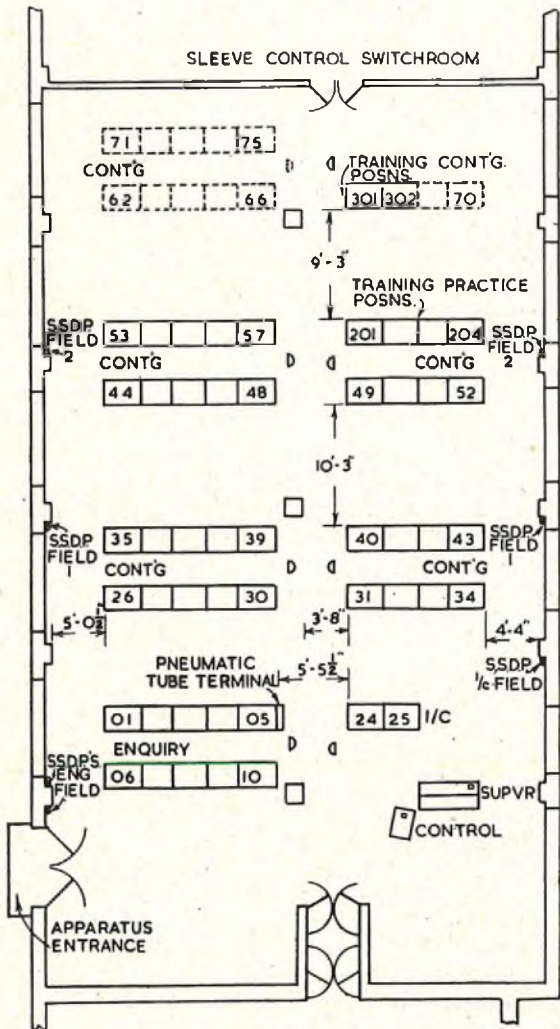

FIG. 8.—LAYOUT OF SWITCHROOM.

For the equipment associated with the cordless switchboard, the following 10 ft. 6½ in. × 4 ft. 6 in. racks were installed:—

Distributors	7 racks
Distributor hunters	5 racks
Outgoing relay set hunters	6 racks
Queue relay sets	4 racks
Position and connect relay sets	6 racks
Operators' telephone relay sets	1 rack
Senders	2 racks
Incoming relay sets	7 racks
Miscellaneous relay sets	2 racks
Strip mounted equipment (on 10 ft. 6½ in. × 2 ft. 9 in. frame-works)	10 racks

An additional Traffic Recorder Access rack has been provided for recording on the distributors, levels "9" and "0", U.A.X. non-parent and transfer circuits. A new alarm equipment rack provides a negative 50V fuse panel for miscellaneous lamp circuits, a jack panel for the distribution of earth and loop tones, and relays for the extension of alarms from outlying exchanges.

The equipment I.D.F. was extended and 29 verticals were allocated for the cordless switchboard equipment.

Power Plant.

To meet the combined requirements of the extension to the automatic exchange and the cordless switchboard installation, a new power room has been provided and a Divided Battery Power Plant, size F, installed in place of the original power plant. A stand-by D.C./A.C. generator set with an output of 3 kW has also been installed.

CONCLUSION

The introduction of an entirely new design of switchboard was a major undertaking. From an engineering point of view there will be great interest in the performance of the equipment, which has many novel features, both in circuit design and mechanical construction. On the traffic side the effect of new operating methods on the speed of handling traffic and the quality of service will no doubt receive careful study.

Experience will probably show the need for minor alterations to facilities and equipment, but all who have been concerned with the development and installation of the cordless switchboard are confident of its performance.

ACKNOWLEDGMENTS

The authors would like to express thanks to their colleagues in the Engineer-in-Chief's Office and in the Home Counties Region for their help in the preparation of this article, and also to Siemens Bros. & Co., Ltd., for permission to reproduce the photographs used for Figs. 1, 5 and 6.

¹ "The Uses of a Mine Detector." Regional Notes (H.C.R.), P.O.E.E.J., Vol. 45, p. 94.

Book Received

"A Textbook of Wireless Communication Technique." Vol. 1—The Physical Principles of High-Frequency Technique. H. G. Möller. Springer-Verlag, Berlin. 261 pp. 288 ill. DM29.40.

The first volume of this textbook covers the physical and mathematical principles of high-frequency technique and serves as an introduction to the specialised fields of study.

The principles and fundamental laws are illustrated by examples and problems, enabling the student to obtain mathematical solutions independently of physical observation. Information is included on the basic ideas of the classical fields of high-frequency technique—covering oscillatory circuits, thermionic valves and wave propagation—and on microwave and radio measuring techniques. Basic physical observations on semi-conductors, rectifiers and transistors are also dealt with.

A Frequency Modulator for Broad-Band Radio Relay Systems

I. A. RAVENSCROFT, A.M.I.E.E., and
R. W. WHITE, B.Sc., A.M.I.E.E., F.Inst.P.†

U.D.C. 621.376.32: 621.396.65

This article mentions some of the modulation requirements in broad-band microwave radio relay systems, and describes in outline an unusual frequency modulator of high linearity.

INTRODUCTION

BROAD-BAND transmission systems, capable of carrying a television signal or many hundreds of telephone channels, are playing an ever-increasing part in the expansion of national and international telecommunication networks. These systems can be provided either by coaxial cables or by microwave radio links, and a recent article in this Journal¹ has stressed the growing importance of the latter technique.

The use of frequency modulation, with or without some degree of pre-emphasis, is almost universal in broad-band microwave systems. In the transmission of 405-line monochrome television signals, the usual peak-to-peak deviation (sync. level to full white) is some 6 Mc/s, and video frequencies up to about 3 Mc/s are significant; but, as links in current development may be expected to be still in use, say, 15 years from now, a designer would be very short-sighted if he did not cater to some extent for modulation frequencies appreciably higher than 3 Mc/s. The base-band or modulation frequency range of a 600-channel telephony system extends from 60 kc/s to over 2.5 Mc/s, and the deviation is usually about 200 kc/s r.m.s. for a tone at test level on one channel; but an overload capacity of some 14 Mc/s peak-to-peak deviation is generally called for. Transmission requirements are very stringent, and non-linear distortion and noise have to be kept to extremely low levels—especially in the multi-channel telephony case.

The design of frequency modulators of unusually high linearity and very low noise level is one of the major problems in the design of broad-band radio links. In the majority of existing microwave links, the frequency modulator operates directly at the transmitted carrier frequency; but there are a number of advantages in modulating at the intermediate frequency (I.F.) which is used in the receiving equipment. For example, the modulator is then quite independent of particular frequency allocations, and the flexibility of systems—especially under fault or emergency conditions—is very appreciably increased. Interconnection and switching of links at I.F. are facilitated, and modulators can be tested rapidly and conveniently when investigating fault conditions, as they can be operated directly into any desired demodulators. Reflex klystrons fairly suitable for use as microwave frequency modulators have been available for about ten years, but it is only in the last few years that direct I.F.-type frequency modulators have approached the order of performance required for broad-band systems.

DESCRIPTION OF I.F. MODULATOR

The modulator to be described is based on the well-known ladder-network type of resistance-capacitance phase-shift oscillator. Such oscillators, with cathode followers as the variable resistance elements, have been used as scanning signal generators,^{2,3} and they can be tuned electrically over a wide range of frequencies; but their linearity of sweep is not very good, and it is difficult to use them satisfactorily with high modulating frequencies. The basic arrangement of a much more suitable type of frequency modulated oscillator⁴ is shown in Fig. 1. The circuit employs the dynamic input resistances of two grounded-grid valves as variable resistance elements, and a very

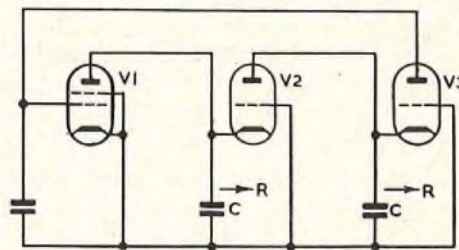

FIG. 1.—SIMPLIFIED CIRCUIT OF MODULATOR.

much simplified explanation of its mode of operation is as follows.

Principle of Operation.

In this oscillator loop (Fig. 1), V1 may be regarded as the amplifier and is generally a pentode or tetrode valve; V2 and V3 are triodes, and are usually (but not necessarily) identical valves. The anode load of V3 is approximately capacitive, while the anode loads of V1 and V2 are complex with approximately equal resistive and capacitive components at the frequency of oscillation. The phase shifts in the three stages are thus approximately 90° for V3, 180° + 45° for V1 and 45° for V2, and the frequency of oscillation is given approximately by the simple formula

$$f = \frac{1}{2\pi CR} \text{ cycles/sec.}$$

where R = dynamic input resistance of each grounded-grid valve (ohms) and C = total shunt capacitance across each cathode circuit (farads).

As the load impedance of each grounded-grid valve is small compared with its anode resistance, the dynamic input resistance is given approximately by

$$R = \frac{1}{g_m} \text{ ohms}$$

where g_m = mutual conductance (amps/volt).

The frequency of oscillation is therefore given by

$$f = \frac{g_m}{2\pi C} \text{ cycles/sec.}$$

i.e., the frequency of oscillation is directly proportional to the g_m of the grounded-grid valves. Thus, if valves are used which have a linear relationship between g_m and grid voltage, the frequency of oscillation is (to a first approximation) directly proportional to grid voltage, and the modulation characteristic is therefore substantially linear. If the total shunt capacitance C is 20 pF and the slope of mutual conductance against grid voltage is 2 mA/volt per volt, then the oscillator would be expected to have a sensitivity of about 16 Mc/s per volt. A more detailed theoretical treatment, taking into account such factors as transit time, leads to slightly lower sensitivity figures than are indicated by the simple formula.

† The authors are, respectively, Executive Engineer and Senior Executive Engineer, Radio Experimental and Development Branch, E.-in-C.'s Office.

¹ "An Introduction to the Principles of Waveguide Transmission." C. F. Floyd and W. A. Rawlinson. *P.O.E.E.J.*, Vol. 47, pp. 63 and 153.

² "Wide-Range Deviable Oscillator." M. E. Ames. *Electronics*, May 1949.

³ "Wide-Range Variable Frequency Oscillator." A. Cormack. *Wireless Engineer*, September 1951.

⁴ Patent Application No. 77/51. R. Hamer and I. A. Ravenscroft.

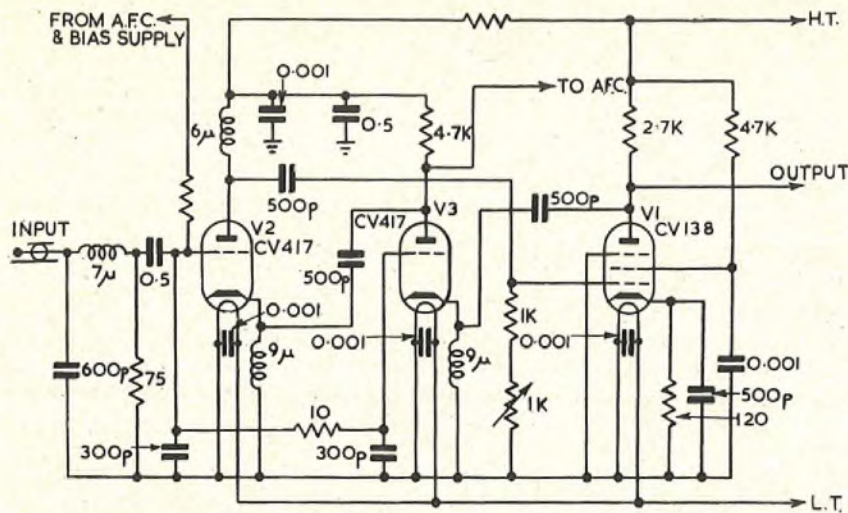

FIG. 2.—TYPICAL MODULATOR CIRCUIT.

Circuit Details.

A circuit diagram of a typical frequency modulated oscillator using this principle is shown in Fig. 2. This oscillator operates at a mean frequency of 35 Mc/s, and for use as a modulator it is followed by one frequency doubler stage to obtain the standard I.F. of 70 Mc/s. In the practical layout and wiring of this circuit, reasonable precautions must be taken to minimise lead inductances and unwanted capacitances.

For optimum operation, it is important that the amplitude of the R.F. oscillations should be small, and one way in which this can be achieved is by using a relatively low screen voltage on the pentode valve. The chokes in the cathode circuits of the grounded-grid stages are chosen so that the effective capacitance across each stage is not markedly changed from normal at the carrier frequency of 35 Mc/s; but the reactances of these chokes should be small at the highest modulating frequency to minimise amplification of distorted modulating signals. A variable resistance across the grid circuit of the pentode provides a simple linearity control which can be used to balance out other sources of second order distortion in the characteristic of frequency against applied voltage. There are some advantages to be gained by operating the triode stages at a low mean value of g_m , provided that the sensitivity and linearity can be maintained, and it is interesting to note that the modulated oscillator can be operated satisfactorily at an H.T. consumption of under 15 mA total for the three valves.

Some form of automatic frequency control (A.F.C.) system is, of course, necessary to stabilise the mean frequency of the oscillator. This may be provided conveniently by extracting the signal from the cathode circuit of the otherwise unloaded grounded-grid valve, and applying it to a stable 35 Mc/s discriminator followed by a D.C. amplifier stage. The control voltage thus generated is applied to the grids of the grounded-grid valves, together with an adjustable bias supply for manual tuning. It is desirable that the capacitive load on the oscillator formed by the A.F.C. circuit should be similar to that provided by the R.F. output circuit.

Performance.

The modulation frequency response is largely dependent on the input filter, and for the circuit shown is substantially constant up to 3 Mc/s. Some idea of the linearity and frequency range of the oscillator may be derived from the static characteristic shown in Fig. 3. The dynamic characteristic differs only slightly from this static characteristic. When the oscillator is correctly aligned and followed by stages having adequate bandwidth and accurately adjusted group delay, the level of non-linear distortion is almost independent of modulation frequency up to about 2 Mc/s, and at least approaches the standard required for 600-channel telephony systems. The overall sensitivity is very high—some 20 to 25 Mc/s per volt (measured at 70 Mc/s) compared with the figure of about 1 Mc/s per volt typical of a 4,000 Mc/s reflex klystron—yet the level of unwanted frequency modulated

noise is not by any means excessive.

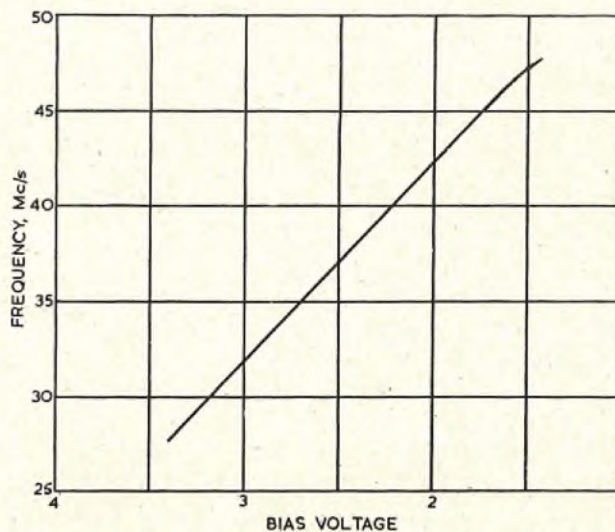

FIG. 3.—STATIC CHARACTERISTIC.

CONCLUSIONS

The frequency modulated oscillator which has been described is a simple and reliable device, and can make use of readily available and well-tried valves. When employed as a modulator in a broad-band radio relay system, it can provide a standard of performance adequate for monochrome television or 240-channel telephony signals; but when 600 channels have to be transmitted and C.C.I.F. standards have to be maintained, the margin in hand for inevitable ageing and gradual deterioration of performance during actual service is not yet adequate.

It is hoped that further development work, which is now in progress, may lead to improved forms of this I.F. modulator; but it is believed that the performance of the unit described above already compares very favourably with that obtainable from single-cavity reflex klystron modulators.

Impedance Dialling

H. N. WROE, Ph.D., B.Sc.(Eng.), A.M.I.E.E.†

U.D.C. 621.395.636:621.316.973

On some subscriber's circuits isolating transformers are used for protection against the effects of power line faults. A.C. dialling can be employed over such circuits by an "Impedance Dialling" system which consists, in essence, of a relay controlled by an oscillator in which oscillation is inhibited, or permitted, by changing the impedance of the subscriber's apparatus. The author explains the main characteristics of such a system and outlines an arrangement successfully operated on subscribers' circuits in the network of his Administration.

INTRODUCTION

THE system of signalling outlined in this brief article originated in the search for a method by which isolating transformers could be retained in exchange lines serving electric power stations, when the local public exchange was converted from magneto to automatic working.

Exchange lines serving electric power stations have frequently to be protected against serious rises in station earth potential which certain power line faults can produce. A very convenient and reliable form of protection is the insertion of a highly insulated isolating transformer into the exchange line at the power station. As long as magneto working is employed this presents no signalling problem; but where dialling is required, retention of the transformer is normally regarded as being impracticable, and other, less satisfactory, means of protection are adopted.

The degree of safety, and the flexibility in fixing the location of the subscriber's equipment (particularly with P.B.X.s) afforded by the isolating transformer are such that a system of dialling permitting its retention would be a distinct advantage. Such a system must, of course, employ A.C. signals, and, since it is to be employed on subscriber's circuits, must be inexpensive. For practical purposes the second requirement is as important as the first, and by considering the limitations it imposes one can deduce what essential characteristics the system must possess.

GENERAL SYSTEM CHARACTERISTICS

Telephone service to power stations must be reliable, particularly during power line faults. Consequently the power mains cannot be employed directly as a source of signal power; earth-return signalling is undesirable; and any signal generators used at the subscriber's terminal would require standby batteries. Now signal generators of any kind are not cheap and their cost, plus that of the batteries and auxiliary apparatus, would be excessive. Furthermore, the provision of a signal generator as part of the subscriber's apparatus would generally call for maintenance skill of an order higher than that normally necessary for subscriber's installations. Thus, there must be no signal source at the subscriber's terminal, and, therefore, any system such as those used for trunk V.F. signalling, where the signal is generated at the point of its initiation, is inadmissible.

The provision at the exchange of active apparatus, such as a signal generator, presents no problem because batteries and a skilled maintenance force are already available there.

From the foregoing remarks the following primary characteristics of the required system may be deduced:

- (1) A.C. signalling.
- (2) Loop signalling.
- (3) Active apparatus must be confined to the exchange; but control of the signal must be effected by the manipulation of passive devices at the subscriber's terminal.

From these considerations it is clear that what is required

is the A.C. counterpart of the C.B. system. Since the C.B. system provides "loop dialling" and functions essentially by virtue of variations in line resistance, dialling by means of the A.C. system, which necessarily depends upon impedance fluctuations, has, by analogy, been christened by the author "impedance dialling." The A.C. system may, therefore, be entitled the "Impedance Dialling System" (I.D. System).

While the C.B. and I.D. systems are very alike, the latter suffers a disadvantage from which the former is free—unless special measures are taken the signalling current will interfere with speech. Possibly this could be avoided by the use of filters, but these are expensive and might interfere with pulsing. What is needed is an arrangement by which the signal E.M.F. is applied to the line at the exchange during the circuit idle condition, can be switched off when the subscriber seizes the line, and replaced when he releases it, all these changes being brought about by impedance variations at the subscriber's telephone. When considered for the first time this requirement appears difficult to meet. Nevertheless it can be met with a device in which the E.M.F. can be switched on and off merely by changing an impedance, e.g., the valve oscillator.

Subscriber's lines are necessarily short, so that, for audio frequencies at least, a variation in termination impedance, Z_T , at the subscriber's telephone will be reflected in a corresponding change in the impedance, Z_E , presented by the line at the exchange. Thus, when $Z_T = 0$, Z_E is low and has a value Z_{E1} , while if $Z_T = \infty$, Z_E rises to a high value Z_{E2} . If Z_E is suitably included in the circuit of a valve oscillator the condition for oscillation can be made to depend upon it. The output of the oscillator can be caused to operate a relay, either directly, or via a valve detector, and so convert the A.C. signal to D.C. loop signals.

Z_E and, therefore, Z_T need assume limiting values only at the frequency, f_s , to which the oscillator is tuned. Indeed, this is essential to avoid interference with speech and ringing currents; and Z_T must be produced by tuned circuits. Consequently it cannot, in practice, be either zero or infinite, and can merely assume low or high values. To avoid distortion of speech by the tuned circuits, and to guard against interference with the oscillator by speech currents, f_s must lie at an extremity of the audio frequency band.

To summarise then: in essence the I.D. system consists of a relay controlled by an oscillator in which oscillation is inhibited, or permitted, by changing the impedance of the subscriber's apparatus from one extreme to the other.

For convenience in obtaining components the first model was operated with $f_s = 3$ kc/s. The system was of the "open-circuit" type (i.e., Z_E high with the circuit in use) and satisfactory operation on cable circuits up to $1\frac{1}{4}$ miles long was obtained.

Theoretical considerations and measurements on various lengths of line indicated that, despite the reduction in the self-impedance of the isolating transformer, the limit of line length could be very much increased by taking f_s to the other end of the V.F. band. It also became evident that, by using a "short-circuit" type of system, better performance could be obtained and the use of any but cheap components rendered unnecessary.

† The author is in the Office of the Engineer-in-Chief, Department of Posts and Telegraphs, Dublin.

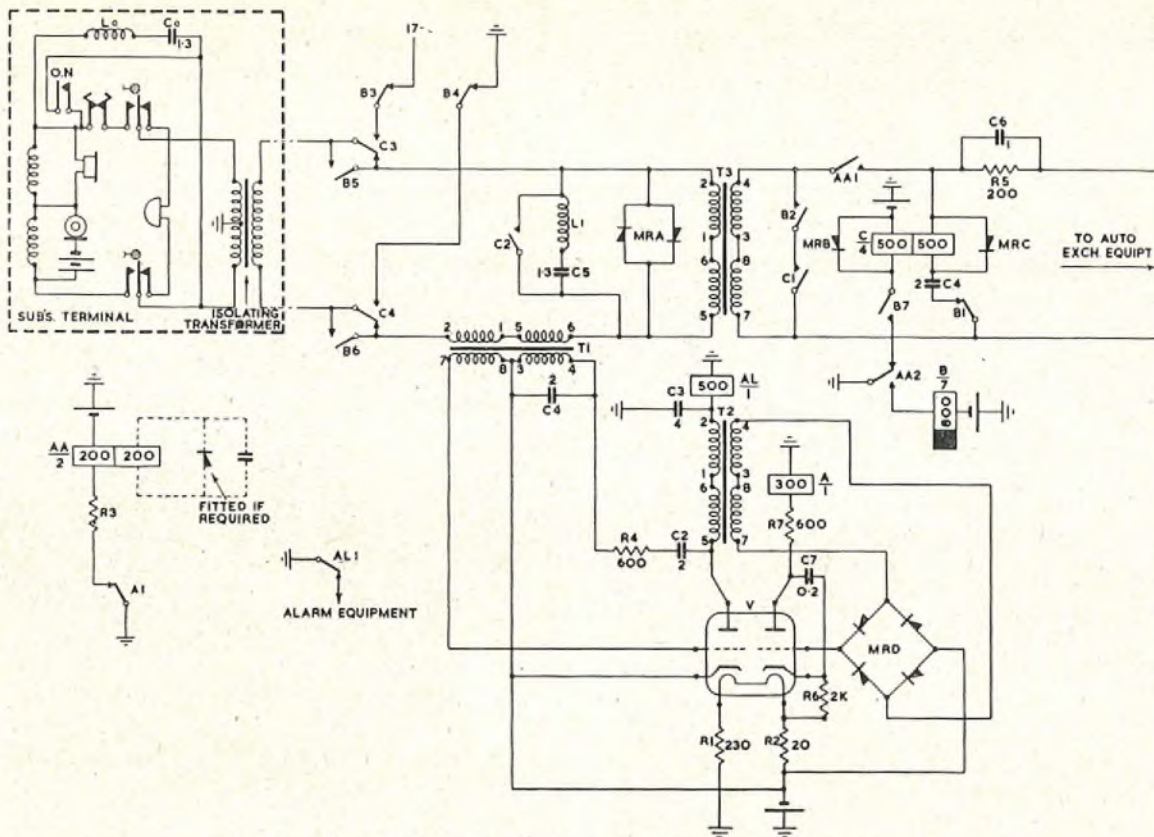

FIG. 1.—SIMPLIFIED CIRCUIT OF IMPEDANCE DIALLING SYSTEM.

A PRACTICAL IMPEDANCE DIALLING SYSTEM

Fig. 1 is a simplified circuit of a practical system.

The oscillator comprises one-half of the double triode V, the feed-back path, R4, C2, and the tuned circuit consisting of C4 and the 3-4 winding of T1. Its output is fed via T2 to a rectifier bridge, MRD, where it is rectified so as to bias forward the other half of V which forms the detector stage and in the anode circuit of which is a sensitive relay A. In the absence of oscillator output the detector stage is biased to cut-off by the D.C. potential developed across R2.

The L1-C5 combination is tuned to f_s to eliminate, at this frequency, the impedance of the line looking towards the automatic exchange. Thus the effective impedance across the 2-6 winding of T1 is simply Z_E .

When the circuit is idle it is terminated at the subscriber's terminal by the bell. Consequently $Z_E = Z_{E2}$, the oscillator oscillates, the detector stage is biased forward, and A operates. AA is, therefore, unoperated and the loop to the automatic exchange equipment is open.

The signal frequency, f_s , is nominally 140 c/s, and the upper limit of line loop resistance is, for cable circuits, at least 600 ohms. The actual limit for cables or open-wire lines has not yet been determined. The system operates from a 50 V supply.

The resistor R5 ensures that excessive current is not drawn from the automatic exchange equipment and that T3 is not too heavily polarised. Capacitor C3 by-passes voice-frequency currents. The alarm relay, AL, monitors the power-supply and the continuity of the valve heater circuit.

On an outgoing call, removal of the subscriber's handset substitutes for the bell the L_a-C_a branch which, being tuned to f_s , causes Z_E to become Z_{E1} . Oscillations are inhibited by the heavy load shunting the oscillatory circuit, A releases, and AA operates. AA closes the D.C. loop and operates B which isolates C.

During each break pulse of the dial, the line is open-

circuited at the telephone instrument, allowing Z_E to rise to its maximum value and permitting oscillation. During each make-pulse the line is short-circuited and Z_E falls to its minimum value, thus terminating oscillation. Relay A operates during the break pulses and causes relay AA to repeat the pulses to the automatic equipment. Relay C, operating in the conventional manner at the first pulse, provides a low-impedance pulsing loop on both A.C. and D.C. sides of the oscillator unit, and also makes doubly certain that D.C. surges do not interfere with the oscillator. Noise from the first forward pulse which occurs before C has operated is sufficiently suppressed by the metal rectifiers MRA and by T1 and T3.

When at the end of the call Z_E rises to Z_{E2} , the re-establishment of oscillation operates A, and the automatic exchange equipment is released when AA releases.

On an incoming call, interrupted ringing current from the final selector operates relay C intermittently and so enables the subscriber's bell to be rung in the standard manner, as well as periodically restoring the oscillator unit to circuit in readiness for the subscriber answering. When this occurs, Z_E falls to Z_{E1} , and hence, as soon as C is normal, A releases, and the ringing is tripped by AA. Subsequent circuit operation is as for an outgoing call.

The system, as described, has been in use on a number of power station circuits for several years. There appears also to be a possibility of its having another field of application in the provision of dialling on the side-circuits of phantom junctions.

ACKNOWLEDGMENT

The author wishes to thank the Minister for Department of Posts and Telegraphs, Ireland, for permitting the use in this article of material from official sources. He also gladly records his debt to Messrs. R. C. McCormick, and E. de Lacey, for their assistance in the experimental work.

An Area Planning and General Purpose Vehicle

G. H. SLATER, A.M.I.E.E.†

U.D.C. 629.113

A description of a general purpose vehicle for the transport of staff engaged on planning and development, exchange construction, precision testing and other duties. The vehicle is a Morris Commercial Utilibus and carries a party of six including driver.

INTRODUCTION

WITH the current methods of providing and maintaining the telecommunication system, it is economically advantageous in many cases to convey a number of men in official transport over considerable distances to and from the site of the work.

Until recently this need has been met by modifying existing vehicles but, although this arrangement has served satisfactorily, the increased need for carrying extra passengers, particularly for conveying staff engaged on exchange construction work, has caused attention to be directed towards providing a vehicle designed for the purpose.

Concurrently with the passenger problem the provision of suitable transport for staff employed in planning and development duties required attention, since, for this purpose also, modified standard vehicles showed certain limitations.

It also came to light, during recent investigations, that there is a need for a cable test van for use in conditions where the larger and more expensive test van described in a previous article¹ could not be justified.

It was therefore decided to develop a vehicle to meet all three requirements and, bearing in mind the existing range of vehicles in service, a Morris Commercial Utilibus (basically a Morris Commercial 10 cwt. "J" type vehicle similar to the 10-cwt. van Type 1 recently brought into service) was chosen as the basis of the new vehicle. A general view of the new vehicle is shown in Fig. 1.



FIG. 1.—THE NEW VEHICLE.

DESCRIPTION OF NEW VEHICLE

In rearranging the interior of the commercial vehicle, seating was an important consideration and it was decided to make provision for seating six persons including the driver.

To provide for carrying four passengers in the rear of the vehicle the nearside seat of the Utilibus was retained, this seat being suitable for accommodating three persons comfortably. On the offside a single seat immediately

behind the driver was also retained but a bench seat on the offside was removed to make space for a large folding table suitable for laying out maps when the vehicle is being used on development and planning duties.

The passenger seating accommodation in the rear of the vehicle is shown in Fig. 2. Both seats can be folded



FIG. 2.—VIEW SHOWING PASSENGERS' SEATS.

back against the side of the vehicle and secured by leather ties, leaving a clear floor space for carrying stores and equipment, thus extending the use of the vehicle to that of light stores carrying should occasion demand. The space beneath the nearside seat forms two lockers, one on either side of the wheel-arch, which can be secured with a padlock in conjunction with a hasp and staple, the latter being attached to the underside of the seat which forms the lid of the lockers.

To facilitate the carrying of an extension ladder (8 ft. 6 in., closed; 20 ft., extended) it was necessary to re-mount the driver's seat on a metal frame-work in place of the pressed metal tool box provided, so that the space beneath the seat could be effectively used to stow the forward end of the ladder. In effecting this rearrangement it was decided to change both driver's and front passenger's seats to the Post Office standard type of seat; and to use the displaced tool-box for mounting the front passenger's seat as this needed to be set back to provide adequate leg room for the passenger and to allow for the fitting of the folding table set immediately in front of the passenger's seat and above the engine casing. By covering in the nearside step-well a level floor was formed immediately in front of the passenger seat with the advantage of providing easy and unrestricted access via the nearside door as well as a comfortable riding position. The driver's seat is adjustable in the forward and rearward directions, and this facility has also been extended to the passenger's seat so as to provide a comfortable position when the table is in use.

The table in the rear of the vehicle was built as an independent unit for securing to the floor and side of the vehicle body. In designing the table unit it was arranged that when it is in the closed position (Fig. 2) the unit projects into the vehicle body by no more than the thickness of the table top beyond the width of the wheel-arch over

†Executive Engineer, External Plant and Protection Branch, E.-in-C.'s Office.

¹"A New Cable Test Van." G. H. Slater. *P.O.E.E.J.*, Vol. 47, p. 173.

which the table unit is mounted. This gives the maximum available floor space and facilitates the housing of the extension ladder, which, at the forward end, must enter the space beneath the driver's seat. To guide the ladder into position and to provide protection for the table top in the closed position, a rubbing strip was fixed between the two aluminium alloy angles securing the table unit to the floor. The table top is secured in position, when lowered, by two turnbuttons which turn into slots in the table edge so as to avoid any projections.

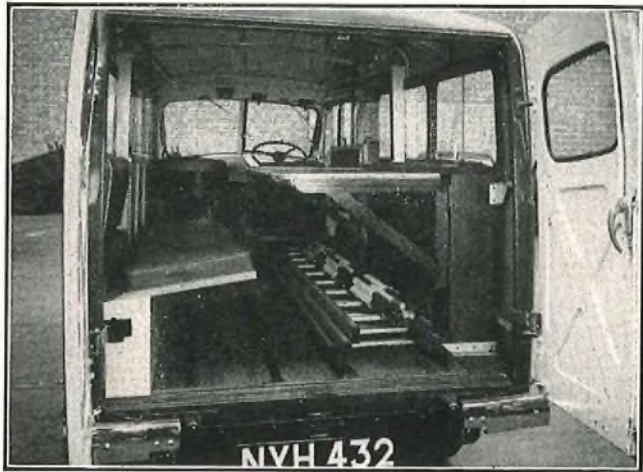

FIG. 3.—VIEW SHOWING TABLE IN RAISED POSITION.

Book Reviews

"Magnetic Alloys and Ferrites." Consulting Editor, M. G. Say. George Newnes. 200 pp. 114 ill. 21s.

This is one of a series of books written for the professional engineer and technician who desires the latest information.

There is a useful opening chapter on ferromagnetic theory by Professor Brailsford; in this, M.K.S. units are used exclusively. There is also an Appendix in which these units are briefly described, and in between there are the several chapters by specialist authors who have not been consistent in their nomenclature, M.K.S. and C.G.S. units being sometimes used side by side. Although we shall probably have to become familiar with the M.K.S. system, the average engineer handling magnetic questions in this country may find it a mixed blessing.

Some precious space is wasted by descriptions of manufacturing details which are not full enough to be useful to anyone who would need to know about them.

The book presents a wide survey of applications for magnetic materials and gives data appropriate to these uses; examples of those not always described are magnetostrictive alloys, compensating alloys, micropowder magnets and magnetic recording materials. For the serious student there are adequate lists of references at the ends of the chapters. A blemish, which is not peculiar to this book, is the failure to distinguish between published data and the properties about which the professional engineer may really want to know—the properties attainable in practice.

The book is well illustrated and engineers will probably find it a useful handbook covering a wide field in a small compass and describing some materials of recent introduction which may play a part in future progress. One cannot help feeling that fewer pictures and more data would help him even more.

C. E. R.

"Transistor Audio Amplifiers." R. F. Shea. Chapman & Hall, Ltd., London. xiii + 219 pp. 190 ill. 52s.

The author of this book recently edited one entitled "Principles of Transistor Circuits," for which high praise was

The table, raised in position for use, is shown in Fig. 3 which also shows the extension ladder in position, together with a set of survey rods. It is not possible to raise and lower the table with the ladder in place, but this is considered to present no real disadvantage.

The frame-work of the table unit, to which the hinged supports and top are secured, has been arranged to provide two deep pockets, one at each end, for stowing rolled maps, and in the space between these pockets, above the wheel-arch, a partitioned compartment provides accommodation for Engineering Instructions, Telephone Directories and the forms associated with planning and development duties. Pencil grooves in the top rail of the unit, together with an edge moulding, complete the table equipment. When erected, the top of the table is horizontal—a slight disadvantage on planning and development duties, when a sloping table may be preferred, but essential when the vehicle is employed on precision testing.

A light fixed above the table provides a measure of general illumination within the vehicle for those occasions when it is necessary; and to complete the internal equipment a handle on the inside of the rear doors facilitates the opening of these doors from the inside of the vehicle and so provides ready means of exit from the rear of the vehicle.

ACKNOWLEDGMENT

Acknowledgment is made to those members of the Motor Transport and Construction Branches who co-operated with the author in the development of the vehicle described.

offered. He has now attempted to deal with a specific group of applications of the transistor, but, in several ways, with very much less success. He begins with some considerations fundamental to transistor applications and with transistor parameters, mainly in graphical form. Nearly a quarter of the book is then devoted to specifications—of currently available American junction transistors—such as one finds on data sheets issued by manufacturers. It is difficult to find justification for all this, particularly as there is so much near-repetition. Some of the key properties of the three configurations, grounded-base, grounded-emitter and grounded-collector are then stated, and bias stabilisation touched upon. Means of coupling consecutive stages and their effectiveness are described. Noise, impedance matching and frequency limitations are briefly considered and the positioning of volume controls in amplifiers is discussed.

Properties of Class A amplifiers are presented with only little reference to tandem working and no mention of negative feedback to reduce non-linearity or to control input and output impedance. Class B power amplifiers receive rather more attention; this method of use may well be important in domestic radio receivers. The final chapter is devoted to practical examples. Details are given of two three-stage transformer-coupled, grounded-emitter hearing aids, one using a tapped 3V battery and the other a single 1.5V cell, and of an aid using complementary symmetry in a Class B output stage. A gramophone pre-amplifier, an electronic megaphone giving an output of 0.5W and a high-power amplifier using two high-power transistors in Class B to deliver nearly 15W with a harmonic content of 5 per cent. or less, are also described.

The book will hardly satisfy anyone wishing to do more than copy the designs given, with, perhaps, modifications to suit transistors of slightly different characteristics. The basis of design is often stated but rarely developed and very little analysis is given. Results are presented in numerous graphs; some will be very useful for reference or design purposes, but others could be deleted to save something approaching duplication. The presentation is generally very good, but the price is high.

J. R. T.

I.P.O.E.E. Library No. 2287.

"Mosaic"—An Electronic Digital Computer

ALLEN W. M. COOMBS, Ph.D.†

Part 1.—The Store and Arithmetic Units

U.D.C. 681.142:518.5

This article, to be published in four parts, describes a high-speed electronic computer designed at the Post Office Research Station for the Ministry of Supply. Part 1 explains the need for such a machine and goes on to give a general description of two of the chief components, the Store and the Arithmetic Unit. Part 2 will complete the outline by describing the other two chief components, the Control Unit and the Input-Output mechanism. Part 3 will be devoted mainly to the use of the machine, particularly as regards Programming. The electronic techniques employed will be discussed in Part 4.

INTRODUCTION

MODERN physics propounds many problems, the answers to which can be obtained only by numerical analysis. Moreover, the problems can involve such an amount of arithmetic that even with the aid of desk machines a single calculation may take many weeks, or indeed months, with a corresponding dissipation of man-hours. Sometimes, the speed of obtaining the result is all-important; for instance, weather forecasting will be much more of an exact science than it is, when all the relevant factors can be incorporated into the calculation and yet permit the answer to be obtained before it is out of date. Even where speed is not vital, man-power may be, and so the need has existed for some sort of machine which could solve long and tedious numerical problems by itself—or at least without the continued supervision of a human operator to "tell it what to do next." The sort of problem envisaged might involve groups of 50 or 60 simultaneous equations with a variety of right-hand sides, non-linear functions, solutions of the Laplace equation for various complex boundary conditions, roots of Polynomials for a wide range of coefficients and so on. Such problems normally arise in ballistics, crystallography, field physics, nuclear physics and statistical analysis of all kinds. There are also applications in commerce and economics, in engineering design, and in the region where engineering and economics meet.

The need is met by the modern high-speed electronic digital computer. To solve particular problems, many special-purpose machines have been built, ranging from the anti-aircraft gunnery predictor up to the differential analyser and down to the slide-rule. Such machines are nearly always "analogue" machines—that is to say, they substitute the problem to be solved by an analogous problem having a more easily controllable physical manifestation, such as wheel movements for aircraft flight, or lengths for logarithms. Their accuracy depends on the skill with which mechanical devices can be made, and the accuracy with which voltages and movements can be measured; it is rarely better than 0.1 per cent. The digital computer, on the other hand, uses no accurate measuring processes. It simply works on the numbers representing the parameters of the problems, applying the basic arithmetical processes of addition, subtraction and comparison. A hundred-fold increase in accuracy in an analogue machine implies a hundred-fold increase in size, whereas the corresponding increase of two decimal digits in a digital computer may make little difference to the overall size of the machine. Since the digital machine uses only the simplest of arithmetical processes, it can be made comprehensive in application, in much the same way that bricks will make any sort of house, but pre-fabricated sections only a limited variety. The sequence of elementary operations, which of course varies from problem to problem, is devised in advance for each complete computation by the mathematician in charge of the machine, and incorporated in a "programme" of instructions for the machine to obey.

†Principal Scientific Officer, Post Office Research Station.

"Mosaic" is a general-purpose electronic digital computer, designed at the Post Office Research Station for the Ministry of Supply. It is installed at Malvern, and is now in full operation. The purpose of this series of articles is to describe the general functioning of the machine and the electronic techniques used in its construction.

In common with all other digital computers, Mosaic possesses four basic elements, which are the Store, the Arithmetic Unit, the Control, and the Input-Output Mechanism. The manner in which these separate parts work together will be indicated later; they will first be treated separately.

THE STORE

The number of separate arithmetical operations in even a small calculation may be very large when each operation is limited to a simple addition or subtraction. Digital machines must therefore be designed to carry out any one such operation at very high speed, and in fact Mosaic can add together two numbers, each the binary equivalent of 12 decimal digits (2^{40}) in $70 \mu\text{s}$. Clearly, to use the machine time efficiently, it must be possible to feed the instructions in at a comparable rate, and since this is well outside the scope of any human operator, it follows that the whole programme of instructions must be fed into the machine in advance and held in some form of store which will allow the machine to draw on it at high speed as the computation advances. In addition to storing the instruction programme, the store must hold the data figures relating to the problem being solved, interim results (the sort of figure one scribbles in the margin) and possibly the numerical values of such physical constants as π and e . It must also act as the intermediary between the essentially low-speed input and output gear and the high-speed computing circuits. It is therefore a vital part of any digital computer.

The essence of a storage unit is that it shall be capable of exhibiting more than one physical state, that its changes of state shall be reversible and that it shall be able to retain any one of its states for a finite time. For use in a high-speed computer, it is also necessary that the state shall—in some way—be readable at high speed. Thus, a capacitor might be made to store a decimal digit by being charged to one of 10 discrete levels of potential and, if the leakage were low enough, this potential could be read off as and when required. However, storing decimal digits in this or analogous ways is very unsatisfactory. It is not easy to obtain a rapid and reliable answer to the question "How much charge has this condenser?" without altering the charge state in the act of reading it, and with the certainty that the charge has not altered since the store was set up. It is much more convenient and practical if the only question to be answered is "Has this condenser a charge or not?"—and this ON-OFF or binary characteristic is common to the whole range of possible storage units. It is particularly true of non-linear and saturable devices, and of those where wide manufacturing tolerances or variations with age occur. It is therefore normal for digital computers

to store their information in the binary mode—as binary digits—rather than in the decimal mode. Thus, in such stores, a valve is either fully conducting or cut off, a transformer is always saturated either forwards or backwards, and a mechanical strain is either there or not there. The binary technique is usually extended into the computing circuits as well, for circuits to add or multiply binary numbers are far simpler than those to add or multiply decimal numbers.

Mosaic is no exception to the general rule, both storage and arithmetic being carried out in the binary mode. Storing information in a stable and rapidly accessible manner is the most difficult single problem to be solved in the design of a computer, and this has led to the storage technique being the most variable factor over the whole range of current machines. Mosaic uses the ultrasonic delay line, which is a form of mechanical strain storage. If a pipe filled with an elastic fluid is terminated at each end with a diaphragm, and if one diaphragm is made to vibrate, then a mechanical disturbance will be propagated down the line in the form of longitudinal waves, at the speed of sound in the fluid. The vibrations will be received and reproduced by the second diaphragm at a fixed interval of time later, depending on the distance travelled by the waves—i.e., the length of the pipe. Now suppose that the original vibration had consisted of a series of bursts of oscillation, each burst lasting for only a 1/1,000 part of the total transit time of the compressional waves. It would be possible to insert up to 1,000 such bursts into the line before the first reached the receiving diaphragm—in other words, the fluid could store 1,000 binary digits of information. To perpetuate the memory, it is merely necessary at this time to feed the output back into the input, so making the stored information circulate indefinitely.

So much for the general nature of the delay line store. Of course, there will be deterioration of pulse shape in a transit of the line, and small variations in transit time, both of which would cause rapid loss of the information if allowed to accumulate over many transits. Therefore, the pulses or bursts of oscillation require to be re-shaped and re-synchronised before each and every transit, so it is not quite true to say the output is fed back into the input. More accurately, a new input is “gated” into the line under control of the output. Then, the transit time for any practical line, say, 6 ft. long, is only about 1 mS, so if 1,000 bursts are required, each must last only 1 μ S, which implies an oscillation frequency of the order of 10 Mc/s. No diaphragm could produce this, but the effect of a diaphragm is conveniently obtained with an X-cut quartz crystal excited into thickness vibration. The elastic fluid is, not very conveniently but necessarily, mercury for various reasons such as acoustic impedance matching to quartz, stability, low attenuation and electrical conductivity. There must be a means for “writing” a binary pattern of pulses into the circulating system, obliterating a previous pattern if necessary, and means for “reading” the contents of the system into the functional part of the machine, in this case without destroying the stored pattern. Both these operations can take place at the point of regeneration, where the output is re-inserted into the line.

Fig. 1 gives an indication of the circuits and controls required for a single delay line in Mosaic, with a portion of a typical pulse pattern in the mercury. The main store consists of a battery of 64 lines each capable of holding 640 binary digits at a pulse frequency of 570×10^3 pulses/sec. All numbers and programme instruction “words” are 40 binary digits long, so a single line can hold 16 such numbers or words, a total of about 1,000 for the machine. The period of a complete circulation of any one pulse is known as a “major cycle” and the period covering the

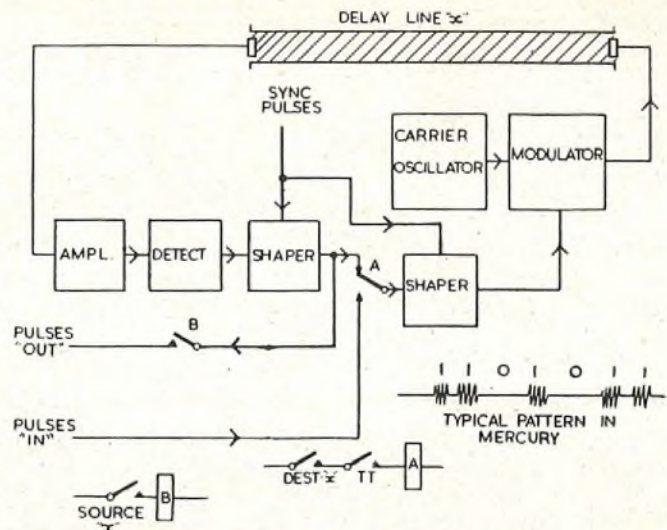

FIG. 1.—BLOCK SCHEMATIC DIAGRAM OF MERCURY DELAY-LINE SWITCHING CIRCUITS.

passage of a single 40-digit word past a given point as a “minor cycle”; there are therefore 16 minor cycles of 70.2 μ S in a major cycle of 1.12 mS. If a single word of the 16 in a line has to be replaced, it is necessary that the recirculation path be broken and the appropriate source of “pulses in” be connected during, and only during, the minor cycle when the superseded word is flowing through the regeneration circuit. Therefore, the switch A (which is of course electronic although drawn in relay form) is operated only during this relevant minor cycle; this is achieved by making it an “AND” switch, operated by the joint “ON” condition of two leads “DEST. x” and “TT,” both derived from the control circuits, and indicating respectively that this particular delay line (x) is to be used, and that the time is now ripe for the transfer.

Since there are 16 words to a line, with access only during the regeneration stage, it follows that it may be necessary to wait up to 15 minor cycles for a particular word to appear. The difficulty is not serious in the case of the programme words, for they can be arranged in the store so that for the most part they are flowing out of their several lines and through the regenerators at the instant when they are required by control—a system known as “optimum programming.” It is much more serious for the numerical data, and accordingly the store contains 32 short delay lines each capable of holding only one complete 40-digit number. The numbers proper to a particular part of a computation are fed into these in advance, and thereafter are of course available continuously, since their circulation time is only a minor cycle. The “population” of the short lines will be continually changing during the course of a computation.

The general mechanical arrangement of the storage lines is shown in Fig. 2. The store is sensitive to temperature differences between lines (of as little as 1°C), because of corresponding variations in velocity of the pulses travelling down the lines; therefore the entire stack of 64 long lines and 32 short lines is mounted in a metal-lined thermally-insulated container, itself surrounded by a cavity wall, and is installed in a separate room from the electronic equipment. The question of temperature sensitivity will be returned to later, in Part 4.

THE ARITHMETIC UNIT

There are two ways in which arithmetical operations can be performed by digital computers. Suppose, for instance, that the operation is that of adding together two 40-digit binary numbers. Then it is possible to add all 40 columns simultaneously, bank-clerk fashion, a process known as

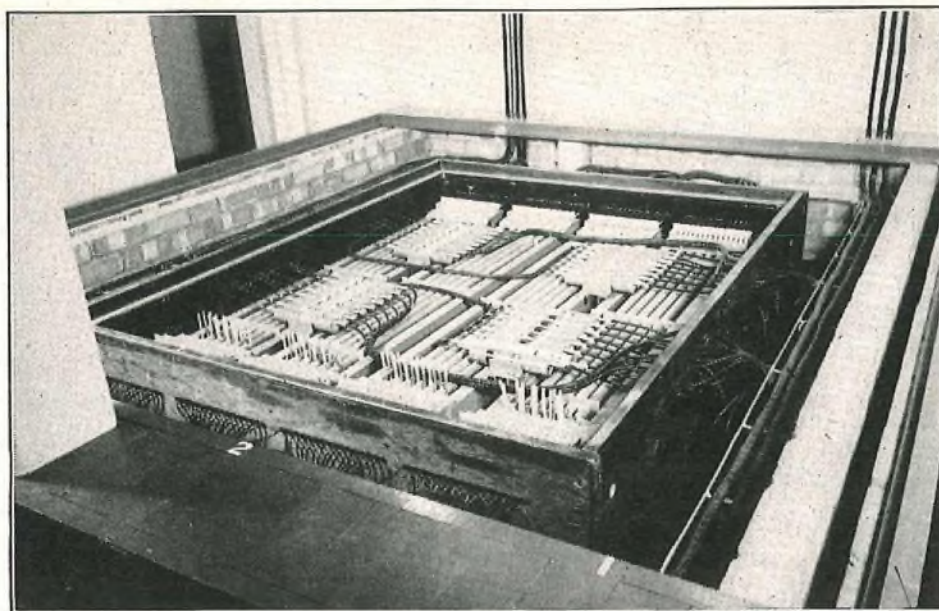

FIG. 2.—MERCURY DELAY-LINE STORE.

“parallel” working. This is a very rapid method, but requires a large amount of equipment—one adder per digit. The alternative procedure is to take one column at a time, starting with the least significant digit and carrying forward as required at each stage. This “serial” technique is slower but far more economical as a single adder network is used throughout. The speed difference is not so great as it might appear, for it is usually arranged that a machine with a fundamentally low digit frequency is arranged to use simple adding networks in the parallel mode, while a high-speed machine will use a single complex adder in the serial mode. The serial method has a certain advantage in that a fault in the single adder network will rapidly be shown up, and it is particularly suited to a delay-line store, since in such a store the digits are in any case passed in series through the withdrawal point in the recirculation unit.

Mosaic carries out its arithmetical operations in the serial mode. The fundamental operation is to extract two numbers from the store, operate on the two in some way, derive an answer as the result of that operation, and consign the answer back to the store. There is a choice as to the nature of the operation itself; it may be addition, subtraction or multiplication in the normal arithmetical sense, or it may be a “logical” operation involving the comparison of the two original numbers digit by digit. The logical operations are “AND” (multiplication), “OR” (Boolean addition) and “NOT EQUIVALENT TO” (addition

TABLE 1
Arithmetic and Logical Operations in Mosaic

Operation	ADD (+)	SUBTRACT (-)	AND (&)	OR (V)	NOT EQUIV. TO (\neq)
NUMBER A	11010111 (= 215)				
NUMBER B	01110010 (= 114)				
	(Least significant digit on the right)				
NUMBER C					
1. Binary	(1)01001001	01100101	01010010	11110111	10100101
2. Decimal	329	101	Not significant	Not significant	Not significant

(To be continued)

without carry) and they have a variety of uses—for instance, in checking the sign of a number. Table 1 shows the numbers “C” resulting from the application of various operations to two 8-digit binary numbers “A” and “B.” It will be observed that the sum of the two numbers involves a carry-over into the 9th digit position, and the 40-digit Mosaic numbers may similarly produce a carry into the 41st digit, a contingency which must be provided for in the programme.

In addition to these operations, a “delay” function is provided, which will “shift” a given number “A” a specified number of positions towards the most significant end—that is, it will multiply by a specified power of two, more easily and rapidly than the complete multiplier unit, though with a limit on the magnitude of the number “A” to be operated on. Fig. 3 shows the general arrangement of the arithmetic unit in schematic form. The operations, apart from multiplication, take place in precisely the time taken by a 40-digit number to pass a given point—that is, one minor cycle, or about 70 μ S—but the multiplier requires

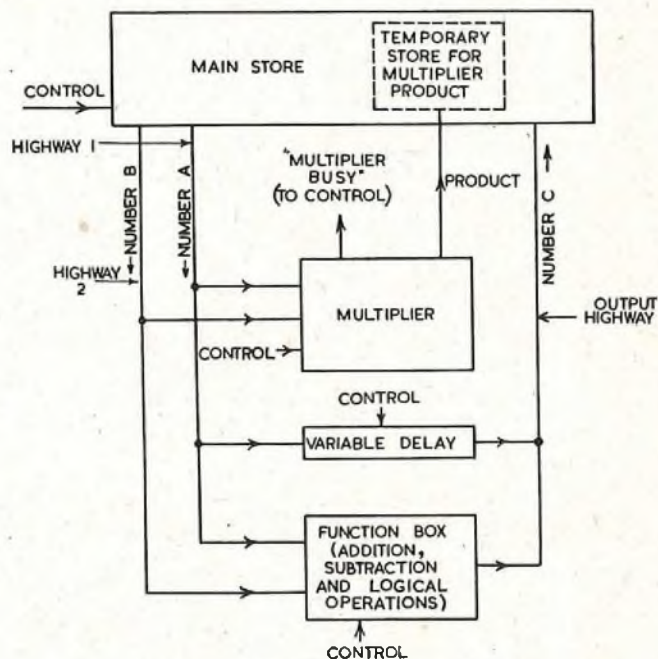

FIG. 3.—BLOCK SCHEMATIC DIAGRAM OF ARITHMETIC UNIT.

about 6 mS to produce its answer. Therefore, when a multiplication is called for, it is arranged that the multiplier is “sealed off” from the rest of the machine while the operation is carried out; the other functions of the machine can continue to be employed, and the result of the multiplication, the product, is placed in a temporary store of its own which can be read out by the control circuits as and when required, just as though it were a part of the main store—as indeed, physically, it is.

Notes and Comments

Birthday Honours

The Board of Editors offers congratulations to the following members of the Engineering Department honoured by H.M. The Queen in the Birthday Honours List:

Bournemouth Telephone Area	.. C. K. Spencer	.. Technical Officer British Empire Medal
Brent Radio Telephony Terminal	.. W. D. H. Lockerby	.. Technical Officer British Empire Medal
Engineering Department	.. S. F. Alexander	.. Technical Officer British Empire Medal
London Telecommunications Region	J. H. Jenkins	.. Draughtsman British Empire Medal
Southampton Telephone Area	.. C. A. Steedman	.. Executive Engineer Member of the Order of the British Empire
Stoke-on-Trent Telephone Area	.. L. B. Gould	.. Technician I British Empire Medal

J. R. Tillman, D.Sc., A.R.C.S.

Dr. J. R. Tillman, Senior Principal Scientific Officer in charge of the Electronics Division of the Post Office Research Station since 1952 and a frequent contributor to this Journal, has recently been awarded the degree of Doctor of Science at London University for his work in physics and electronics. We offer sincere congratulations to him on obtaining this high academic distinction.

The Institution of Telecommunication Engineers, India

We note with interest that the Institution of Telecommunication Engineers, inaugurated in New Delhi, India, in November, 1953, has rapidly grown to a considerable stature in its membership and activities, having already more than a thousand members on its rolls. Its membership is drawn from various government-operated communication agencies, the three Defence Services, research institutes and

industry. A quarterly Journal of the Institution of Telecommunication Engineers is proposed to be published and the first issue of the Journal is already in the press. Talks and discussion meetings are now arranged periodically at New Delhi, the headquarters of the Institution, and similar activities are being planned at Bombay, Calcutta, Madras, Poona, Bangalore and Jabalpur.

Editorial Appointments

Mr. G. E. Styles, Managing Editor of the Journal since 1947, has resigned from this post owing to a change in his official duties, and the Council of the Institution has appointed Mr. W. A. Humphries, formerly Assistant Editor, to take his place. The new Assistant Editor is Mr. E. Davis.

The Board takes this opportunity of thanking Mr. Styles for his services in helping successfully to maintain both the standard of the Journal and its financial position during a period that was not without difficulties.

Institution of Post Office Electrical Engineers

Essay Competition 1954/55—Results

A Prize of £5 5s. 0d. and an Institution Certificate have been awarded to the following competitor in respect of the essay named:—

W. T. Webb, Technician IIA, Fareham (S.W. Region).
"A diary of storm-work around Fareham."

Prizes of £3 3s. 0d. each and Institution Certificates have been awarded to the following four competitors:—

E. H. Piper, Technical Officer, Bournemouth (S.W. Region).
"Technology and the individual."

W. Mercer, Technical Officer, Portpatrick (Scotland).
"Earth currents in submarine cables; their tidal origins and character."

C. Biddlecombe, Technical Officer, Engineering Dept. (Test Section). "Quality control by sampling in the London Test Section."

R. A. Lodge, Technical Officer, Brentwood (E.T.E.). "A survey of international radio telegraphy."

Institution Certificates of Merit have been awarded to:—

V. A. E. Fountain, Technical Officer, Engineering Dept. (Research Branch). "Electronic telegraph apparatus."

A. R. Brown, Technical Officer, Truro (S.W. Region).
"Shared service in practice; methods, difficulties and possible future."

A. C. Button, Technical Officer, Brighton (H.C. Region).
"Organised training in the field."

W. J. Phillips, Technical Officer, Penarth (W. & B.C.).
"The excavation of the ground by explosives."

J. R. Haggart, Technical Officer, Edinburgh (Scotland).
"An introduction to the transistor."

The Council of the Institution records its appreciation to Messrs. W. S. Proctor, A. E. Morrill and H. E. Francis, who kindly undertook to adjudicate upon the essays entered for the competition.

N.B.—Particulars of the next competition, entry for which closes on the 31st December, 1955, and a review of the above-mentioned prize-winning essays, will be published later.

Associate Section—New Arrangements for Deduction of Subscriptions from Pay

The Council of the Institution is pleased to record that it has been successful in obtaining authority—as from 1st April, 1955—for the collection of subscriptions from members of the Associate Section by deduction from pay at any Centre where the facility is requested. The introduction of the new scheme will relieve a number of the difficulties experienced in the past, and should prove invaluable in obtaining increased membership figures. Furthermore, it will now be possible for Associates, by the payment of an inclusive subscription deducted from pay, to receive each quarterly issue of the P.O.E.E. Journal, an arrangement which should prove of great convenience.

Literature describing the operation of the scheme, with a supply of membership consent forms, was distributed early in the year to all interested parties, including existing Associate Section Centres and Associate Section Liaison Officers, from whom those interested may obtain further information.

H. E. WILCOCKSON, *Secretary.*

Additions to the Library

2247 *Radio Laboratory Handbook*. M. G. Scroggie (Brit. 1954).
Designed to fill the gap between the home experimenter's literature and the professional textbooks.

2248 *Magnetic Amplifier Circuits*. W. A. Geyger (Amer. 1954).
A practical exposition, in as simple as possible a treatment, of the fundamental principles and applications of magnetic amplifiers with special reference to magnetic servo amplifiers.

2249 *Lubricating and Allied Oils*. E. A. Evans (Brit. 1954).
Gives an insight into the application and properties of lubricating oils.

2250 *Earth Conduction Effects in Transmitting Systems*. E. D. Sunde (Amer. 1949).

A comprehensive treatment of the subject.

W. D. FLORENCE, *Librarian.*

Regional Notes

North-Eastern Region

LIFTING JACK FOR SWITCHBOARD MULTIPLES

Some time ago it became apparent that the lifting jacks used for raising the subscribers' multiple cables at the rear of the switchboards in Huddersfield manual exchange, in order to gain access for faulting, would have to be replaced because of their worn-out state.

It was thought that these old-type jacks, which required a good deal of manual strength to manipulate, and which were quite costly to manufacture, could be improved by the adaptation of a hydraulic car jack; this would considerably reduce the manual strength required for the operation of the lifting jacks and at the same time would reduce the cost of manufacture by about one-third. Accordingly, a new type of lifting jack was designed in the Telephone Manager's Drawing Office, Bradford.

The new jack (shown in the photograph) employs a standard type of hydraulic car jack which enables the multiple to be gently raised or lowered without straining the wiring, in contrast to the previous method of driving in wooden wedges

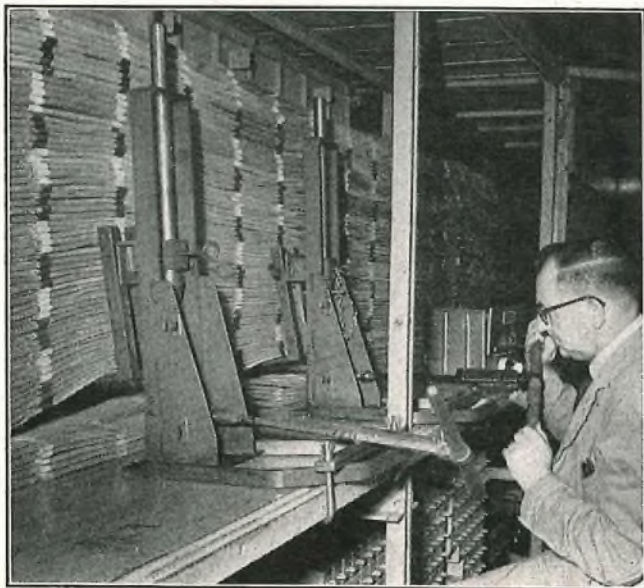

THE NEW JACKS IN USE AT HUDDERSFIELD EXCHANGE.

until the desired clearance was obtained. This previous method frequently resulted in damage to the cable braidings both above and below, and in addition, the resulting compression was liable to damage the wire insulation.

The jack consists of a fabricated welded steel frame machined to accommodate a shoe-block slide. A clamp is fixed in the frame to hold the jack in position when operated. The standard type of hydraulic car jack is modified to accommodate the actuating shaft which is of 1½-in. silver steel bar, suitably drilled for fixing the position of the shoe block and so enabling a range of lift to be achieved. A ring adjuster is fixed to the jack to provide for the slack in cables being taken up prior to operating the hydraulic lift. It is possible for one operator to use two jacks simultaneously and thus secure an even lift over the section of multiple affected.

The jack is being used with success in various parts of the country and has resulted in increased efficiency and saving to the Post Office.

C. S. S.

North-Western Region

DAMAGE TO SHEET STEEL POLES

During a blizzard which occurred in the Tideswell area of the Peak district on 16th January, 1955, a light pole route in an exposed position about 1,150 ft. above sea level received the full impact of the severe icing and high winds which prevailed.

Snowdrifts of 10-12 ft. prevented access to the route until

18th January, 1955, when it was found that an intermediate portion of the route, which was carrying ten 70-lb. C.C. wires at 60-yds. spacing, had collapsed. This portion of the route consisted of seven 24-ft. light sheet steel poles, interspaced with one light wooden pole. Six of the steel poles had collapsed at the junction of the bottom section, with the seams of both this and the intermediate portion burst and torn. The upper portions were lying at right-angles to the route with the bottom sections free from corrosion and firm in the ground.

The route was erected in 1950 to provide service to several hill farms and was in a fairly straight line in rocky ground near a dry stone wall. Wooden poles formed the remainder of the route and, from conditions found on accessible routes in the vicinity, it is assumed that the ice formation on the wires probably had a diameter of 3 in.-4 in., with the high wind at right-angles to the route. The wooden poles at each end, and interspersed with the steel poles had remained erect.

Development of the route had been greater than expected and the route was carrying a full load for a normal situation. It is understood that this is the first case of damage of this nature to sheet steel poles, other than to individual poles.

J. N. C.

Midland Region

BEESTON (NOTTINGHAM) NEW AUTOMATIC EXCHANGE

A new replacement standard non-director 2,000-type telephone exchange with 3,700 multiple has been installed by Ericssons Telephones, Ltd., and was brought into use on 29th January, 1955. The old exchange building has been extended by the addition of another floor and the interior walls are matt finished in a light cream colour on three sides, the fourth side being light grey.

All racks and associated metal covers are stove-enamelled light grey, stove enamelling being used to eliminate any possible chemical interaction with the cream-coloured PVC-sheathed and insulated switchboard cable. All overhead cable racks and supports are cream-enamelled and with their associated cables blend into the background of the cream-coloured ceiling, producing an impression of height and brightness which is a marked contrast to the old exchange. I.D.F. connection strips are faced with white plastic designation strips engraved with black characters which give maximum ease of identification.

The switchboard cable is worthy of special note. The smooth finish of the plastic sheath will make cleaning easy and the elimination of wax fumes and the dirt associated with stripping and terminating textile covered cables should help to keep the fault liability of the switches and relay sets at a very low figure.

A. H.

Wales and Border Counties

REARRANGEMENTS AT NEWPORT (MON.) AUTOMATIC EXCHANGE

At midnight on 19th February, 1955, a transfer operation of unusual complexity took place, involving number changes to all subscribers, re-allocation of subscribers' calling equipment and multiple, and the rearrangement of gradings on subscribers' and manual board levels.

Newport was one of the earliest automatic exchanges provided in this country; installation commenced in 1913 but, owing to the war, completion was delayed until 1916. The original equipment was of the Stowger type, provided by the Automatic Telephone Manufacturing Co. (now A.T. & E. Co.) using vertically mounted relays, but prior to the current work, extensions had been carried out with 2,000-type equipment using both linefinder and uniselector subscribers' equipment. In 1951 the original group selectors were replaced, leaving 3,000 lines served by Keith Line Switch and side-switch-type Final Selector equipment, which have been taken out of service by the operation to which these notes refer. Of the original equipment only the M.D.F. and I.D.F. now remain.

A new wing to the building has been erected for additional exchange equipment and for postal purposes, but the accommodation which this has provided is separated from the existing apparatus by the switchroom. The original M.D.F. and I.D.F. had already been extended to the physical limit, so that it was decided that the new wing should house additional subscribers' equipment with associated M.D.F. and I.D.F., and

that a separate part of the exchange area should be served by it, the external cables from which would be terminated on the new M.D.F., while the remainder of the exchange area would continue to be served from the existing M.D.F. The trunking of the new equipment would, however, be integrated with the existing 2,000-type equipment which, at the same time, would be converted from a 4-digit to a 5-digit numbering range. The Keith Line Switches and the original Final Selectors would be recovered.

Prior to the transfer the external cables serving the area to be segregated, were diverted to the new M.D.F. and the cut-away ends used as temporary tie cables between the new and existing M.D.F.s, so that the actual diversion from one M.D.F. to the other presented no unusual difficulty. But the transfer operation had to free the Keith Line Switch equipment for recovery and the subscribers connected to it were divided between the areas to be served by the two M.D.F.s. Also there was no existing 2,000-type equipment spare to facilitate the manoeuvre. It was therefore necessary that existing 2000-type equipment, freed by transfer of subscribers to the apparatus in the new wing, should at the same time be taken up by subscribers, hitherto served by Keith Line Switches, who were to continue to be connected through the old M.D.F. This was possible because of the simultaneous conversion to 5-digit working.

The subscribers were therefore in the following categories:—

1. Those in the area to be transferred to the new M.D.F. and equipment. These were served from Keith Line Switches and from existing 2000-type equipment.
2. Those in the area to be served by the existing 2000-type equipment and retained on the old M.D.F., of whom some remained on their existing subscribers' equipment and the remainder were removed from Keith Line Switch equipment to existing 2000-type equipment vacated by subscribers transferred to the new equipment. The sorting of shared and exclusive lines was an additional complication in this group.

At the same time, an additional rank of switches had to be

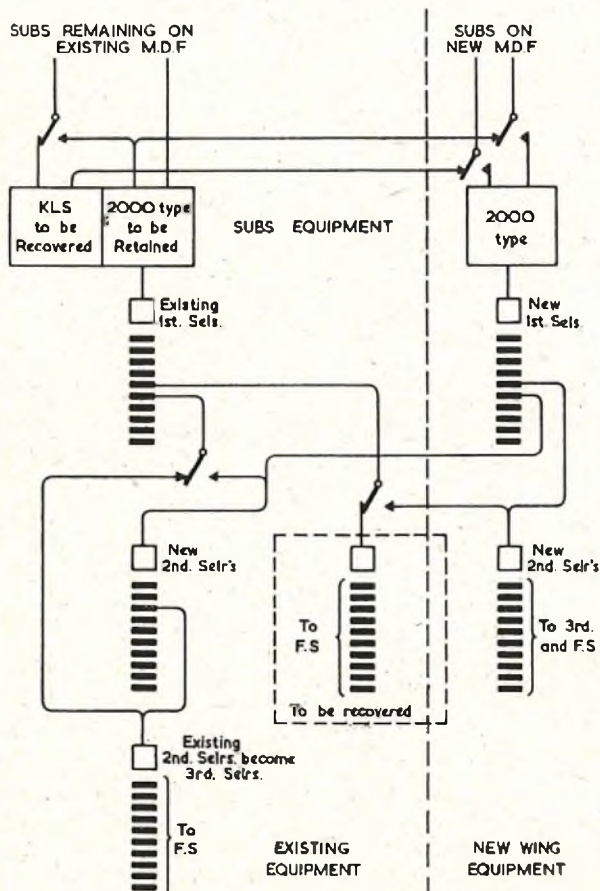

ESSENTIAL FEATURES OF TRUNKING FOR REARRANGEMENTS AT NEWPORT (MON.) EXCHANGE.

introduced. These were trunked from two levels, until then in use for the 4-digit range, which had to be completely regrouped and graded. Gradings for the Manual Board levels had also to be rearranged to meet redistributed traffic. The usual call-through test of new equipment could not cover these rearrangements and that part of the testing had therefore to be deferred until after the transfer.

The use of a large number of keys and change-over strips was necessary, together with a complicated system of records and labelling during the interim period. The diagram shows the essentials of the transfer scheme but excludes such details as grading changes, changed number arrangements, etc. In practice the change-over contacts shown were a combination of single make or break contacts and wedges in the M.D.F. protectors. Following the transfer, at Saturday midnight, only the emergency lines were tested by the traffic staff, the usual engineering tests of subscribers' circuits and the remainder of the traffic tests being deferred until Sunday morning. The night period was spent carrying out a call-through test of the rearranged gradings.

The successful completion of the work is to the general satisfaction of all concerned and those directly involved deserve congratulation.

S. E. N.

London Telecommunications Region

NEW TELEVISION CABLE

The decision of the B.B.C. to build a new London Television Transmitter in the grounds of the Crystal Palace, and of the I.T.A. to use a nearby site at Beaulieu Heights (on the northern outskirts of Croydon) have necessitated the provision of a special coaxial cable nearly ten miles long linking these sites with their central control points.

At the time of writing these notes (May 1955) most of the new ductwork required has been laid and much of the cable has been drawn in and jointed by the contractor (Standard Telephones and Cables Ltd.).

The main section of the cable is of a special type, carrying three 0.975-in. coaxial cores, six 40-lb. screened pairs (for sound channels) and seventy-six 20-lb. pairs which are to be loaded, some of them being used for control purposes and the rest for junctions between Museum and Livingstone Exchanges. The screened pairs occupy one of the worming spaces, and the 20-lb. pairs the other two. The centre of the cable, between the coaxial cores, is empty but will be useful as the cable will be pressurised.

A three-core coaxial cable with 0.975-in. tubes is the largest which can be drawn into a standard duct, its diameter being approximately 2.9 in. over the protective wrapping. The route had to be specially surveyed because of the large bending radius required, 2 ft. 3 in.; equivalent to the inside radius of a large cable drum. This work was started about twelve months ago, and considerable changes had to be made before a satisfactory route could be planned. It is of interest to record that when first proposed, a single-core cable of about 1.5 in. diameter was specified.

When the larger cable was proposed the route originally planned was found unsuitable because of the bending radius requirement. It was found, however, that by building a new route about 1,600 yards long through the Camberwell New Road, about 420 yards could be cut from the overall length of the route and that loading points in the Centre and City Areas, with the addition of one new loading manhole in South East Area, enabled existing loading manholes between Denmark Hill and Crystal Palace to be used with spacings well within tolerance.

At the Crystal Palace Parade a full-size cable will enter the Palace grounds to serve the B.B.C. Two cores will be extended to the new B.B.C. transmitter building now under construction. Two smaller cables will be laid along the Crystal Palace Parade to Livingstone Exchange, a single core 0.975 in. coaxial cable and a composite cable of 4/40 lb. screened pairs and 34/20 lb. for control circuits and junctions. This distance is a little over 2,000 yards. The cable is being terminated and equalised in a screened enclosure in the Livingstone Test Room. The I.T.A. site is adjacent to the exchange and is served by a smaller cable of twin 0.375 in. coaxial cores.

Inside the Crystal Palace grounds a cabinet is being installed

at which it will be possible to switch spur cables if required. The whole cable, almost 9 miles for the B.B.C. and about 10 miles for the I.T.A., operates without intermediate amplifiers and, therefore, may function in either direction.

A. F. T.
H. E. J. E.

Home Counties Region

LIFE OF PLANT

The label reproduced below was recovered from the interior of a joint on a 400/10 P.C. Twin cable in St. Paul's Road, Portsmouth, in February, 1955. Despite the age of the joint, there was no discoloration of the label, and the inscription, in ink, was as legible as when placed in the joint 47 years ago.

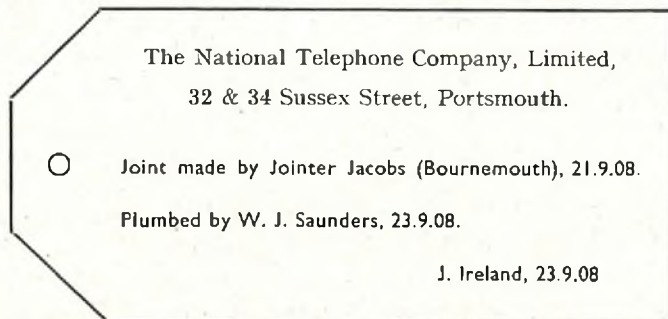

The condition of the conductor joints, paper sleeves and insulation was unimpaired by the passage of 47 years. This is the more remarkable as, in 1940, a large church and public hall in St. Paul's Road were destroyed by fire after bombing, and the small manhole containing this joint was covered with burning debris and inundated with water from the fire-fighting operations. This certainly supports the contention that a well-made cable joint should last for "ever," if it is not disturbed.

F. J. G.

UNWANTED "PROTECTIVE CLOTHING"!

At Laidon, Essex, in the Southend Telephone Area a subscriber's fitter found the complete skin of a grass snake

twisted around the components of an old-type line protector, as shown in the associated photograph. The protector, of which the cover was loose, was fitted above the entrance-door to the hall of an old country farmhouse. The house had been unoccupied for some time, but for a period the furniture was

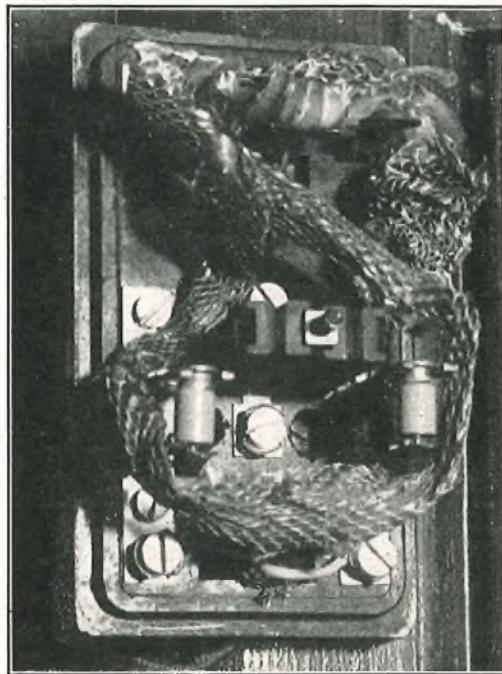

SKIN SHED BY SNAKE INSIDE A SUBSCRIBER'S LINE PROTECTOR.

left *in situ*. It is assumed the grass snake slithered up a piece of furniture adjacent to the door-post and entered the protector cover through an aperture of less than $\frac{1}{2}$ in. The capacity of the cover is approximately 16 cu. in. and the overall length of the snake was about 15 in.

A. W. R.

Associate Section Notes

Darlington Centre

The Centre's main activities during the latter part of the 1954-55 session were:—

15th February, 1955.—Mr. W. J. Costello gave a talk on "The No-Break A.C. Power Plant" and introduced this new development in a confident and easy style, many points being raised and cleared in the discussion.

3rd March, 1955.—"Colour Photography," by Dr. W. C. Fothergill, M.D. This second visit by the doctor to the Centre was an assured success, with an attendance of 45. On this occasion colour photographs, taken by the doctor during the period October, 1953-February, 1955, were projected on to the screen, and their detail and clarity were a delight to the eyes. The descriptive talk and the discussion went with a swing and the chairman with great reluctance had to call time; a hearty vote of thanks was accorded to Dr. Fothergill who promised another visit in the future.

15th March, 1955.—A party of 11 Darlington Centre members journeyed to Middlesbrough to attend the presentation of the National Award by the Chief Regional Engineer (Mr. C. A. Beer) to Mr. E. O. M. Grimshaw. A talk on "Automatic Exchange Maintenance in Other Countries," by Mr. R. W. Palmer (Central Training School), was thoroughly enjoyed and some interesting developments were revealed during the subsequent discussion.

19th April, 1955.—"The Romance of Penicillin," by Dr. V. G. Crowley. Members were again treated to an outstanding talk given in a most novel manner—coloured

balls, representing atoms, being used to illustrate the building up of compounds and formulae. The history of medicine was traced from its origin to the present advanced state. A detailed report of the talk would take up too much space, but every word of it was followed with keen interest. There was no hesitation in the moving of an especial vote of thanks to Dr. Crowley, who in reply expressed his pleasure and satisfaction with the interest shown by the members.

17th May, 1955.—Annual General Meeting.

Thus another session ended with everybody satisfied with the programme, but a real problem remains—the choice of the night for talks; perhaps a ballot to ascertain the largest number of members for one night in each month would find the solution.

The announcement (in the April issue of the Post Office Electrical Engineer's Journal) of the promotion of Mr. C. E. Calveley to Staff Engineer in the E.-in-C.'s Office prompts the Centre to extend their heartiest congratulations to our former President who paid a visit to Darlington and addressed the members.

C. N. H.

Hull Centre

This Centre concluded its 1954-55 session with the Annual General Meeting on Wednesday, 13th April, 1955.

The highlight of the session was a talk on "The History of Horology" given by Professor Paul G. Espinasse, of Hull University. This talk covered the development of timepieces from the water clock to the present day. Also, we borrowed from the Gaumont-British Film Library a very good series of films on Atomic Theory. The films were 16-mm. sound, and

covered Atomic Theory from the Atomic Weight Table of Dalton to the discussion of Rutherford and work done in America from 1939 up to the use of the first Atomic Bomb.

A visit was arranged to the B.I.F. Castle Bromwich, for Saturday, 7th May, 1955, the journey being made by most of the Centre's members.

At the Annual General Meeting, except for one change in Committee, the 1954-55 officers were re-elected:—

Chairman: Mr. E. Rackley; *Vice-Chairman:* Mr. J. Battarbee; *Hon. Treasurer:* Mr. R. Baker; *Secretary:* Mr. L. Johnson; *Committee:* Messrs. C. Burn, R. Hall, R. Hudson, G. Porter, C. Rowland and F. Soper.

The hope was expressed that some of the meetings would be attended by new members, especially some of the more recent recruits of the Post Office and Hull Corporation Telephone Staffs. L. J.

Middlesbrough Centre

A meeting was held at the Cleveland Institute, Middlesbrough, on the 15th March, 1955, on the occasion of the presentation of the national awards won by two of our members for the best papers read at Associate Section meetings during 1953-54. Mr. Grimshaw received an award of £4 4s. 0d. and Mr. Hamilton £1 1s. 0d. The latter also received the Chief Regional Engineer's prize. We offer our congratulations to our two colleagues and our sincere thanks to Mr. C. A. Beer who made the presentations.



PRESENTATION OF I.P.O.E.E. AWARD FOR ASSOCIATE SECTION PAPER, 1953/54, TO MR. E. O. M. GRIMSHAW BY MR. C. A. BEER, C.R.E., N.E. REG.

[Left to Right:—Mr. R. W. Palmer, Principal C.T.S.; Mr. F. W. Allen, Area Engineer; Mr. E. O. Grimshaw; Col. Sutcliffe, T.M.; Mr. C. A. Beer; Mr. G. A. Finch and Mr. W. J. Costello, Secretary and Chairman of Middlesbrough Centre.]

On the same evening Mr. R. W. Palmer, Principal of the Central Training School and leader of the working party which visited America, gave a talk on "Automatic Exchange Maintenance in Other Countries." Slides were of considerable help in describing the various methods employed in America, Sweden, etc. In conclusion Mr. Palmer compared methods employed by the British Post Office with those observed on the tour. An interesting discussion followed and Mr. Palmer answered questions most fully. We feel that the audience, which included the Telephone Manager and Area Engineer, and also members from the Darlington Centre and Senior Section, went home feeling highly satisfied with the success of the meeting. G. F.

Glasgow and Scotland West Centre

The programme this year was the most extensive yet undertaken by the Centre and included the following:—

Mr. R. W. Palmer, Assistant Staff Engineer, speaking on "The American Visit"; Mr. Jas Adair, former Procurator Fiscal of Glasgow, on "Old Glasgow and its Street Characters"; Mr. J. Dixon, Area Engineer, on "Metal Rectifiers"; Mr. H. J. Revell, Deputy Telephone Manager, on "The Provision of P.O. Buildings"; Dr. A. W. M. Coombs, Research Station, Dollis

Hill, "On Building a Thinking Machine"; Mr. R. H. Garner, Principal of Burnbank College of Engineering, speaking on "Practical Television"; and finally a film show. This session's visits were to G. & J. Weirs, of Cathcart; Glasgow University Engineering Laboratory; Port Dundas Distillery; "Times" Newspaper Office; Coates Observatory; Yarrow's Shipbuilders, Scotstoun, where at a later date a party from the Centre witnessed a launching; Gartshore No. 10 Training Pit, and finally an afternoon outing to Prestwick Airport which ladies also attended and during which some of our members participated in a pleasure flight over the Heads of Ayr.

In spite of our varied programme attendances have not been good but it is hoped that they will improve next year. J. F.

Edinburgh Centre

The session ended with two meetings during March, Mr. J. Loughlin giving a most interesting paper on "Atomic Power" and Mr. J. R. Haggart one on "An Introduction to the Transistor."

A most interesting and varied programme has been carried through during the past few months and attendances have improved slightly at the meetings. The committee feel, however, that attendance could be improved and a drive to increase the membership will take place this coming session, when it is also hoped that more members will take advantage of the numerous facilities offered by the Centre.

At the A.G.M., in April, the following were elected to the 1955-56 committee:—

Chairman: Mr. W. F. Irvine; *Secretary-Treasurer:* Mr. J. R. Haggart; *Committee:* Mr. T. J. Potter, Mr. J. G. Ferguson, Mr. J. Kellard, Mr. J. H. S. Phillips. J. R. H.

Dundee Centre

We have now ended another session in which some very profitable and enlightening evenings have been spent. The programme was a full one, giving us such items as a discussion on the Productivity Team Report on automatic telephone exchange maintenance; a paper on the punched-card filing system; a discourse on the growth of the Telephone and a paper on timing devices as used in the Post Office. We also made visits to Ferranti's Radio Works and a large Transformer Works. Those who have taken full advantage of what has been offered have expressed their appreciation.

For the coming session the committee have again set themselves to bring something new and interesting to the membership. To enliven the proceedings it is intended to combine two seemingly unrelated topics by relating them in a novel manner.

Several visits are proposed, including a paper mill, jute mill, lino works and large bakery. When the programme has been completed it will include something of interest for most members and it would be a great encouragement to the committee if members take full advantage of the programme. R. L. T.

Bath Centre

At the Annual General Meeting, held on the 6th April, 1955, the following officers and committee were elected:—

Chairman: A. L. Mainstone; *Vice-Chairman:* L. W. Vranck; *Treasurer:* R. P. Bowers; *Secretary:* C. E. Martin; *Assistant Secretary:* R. A. Farnsworth; *Committee:* T. R. Faulkner, P. E. Smith, J. D. Silcox, G. A. E. Buckley; *Auditors:* C. W. Read, W. R. Hutchins.

During the past year there have been two visits to the B.B.C. Studios at Lime Grove and visits to the Avon Rubber Works, Melksham, and the car division of the Bristol Aeroplane Co. at Filton.

The winter session opened on the 22nd September, 1954, with a paper on "Magnetic Escapements," by Mr. C. F. Clifford. The paper was illustrated by a large number of working models.

On 14th October, 1954, the Bath and Barnstaple Centres held a Quiz, which Barnstaple won by one point. It is hoped that a return Quiz can be held during the 1955-56 Session.

On 8th December, 1954, Mr. W. J. Pemberton gave a paper entitled "Mechanical Aids in the Post Office."

Mr. L. G. Semple, Regional Director, S.W. Region, was present at the Annual Telecommunications Ball at the Pump

Room on the 3rd February, 1955, when just under 300 people attended this most enjoyable function.

On the 15th February, 1955, Mr. J. Meade read an interesting paper on "Modern Efficiency Methods."

A full and interesting programme is under preparation for the 1955-56 Session, and it is hoped that all members will give their support.
C. E. M.

Dollis Hill Centre

The Dollis Hill Centre can claim to have had a successful winter and spring session which will best show in its increase of 52 new members, bringing the total to 380 out of a possible staff of 560.

The lectures for the session have been diverse in subject and well received in the large lecture hall at the Research Establishment. The most recent talks, by Mr. C. F. Sayers on "Quartz Crystals and Their Applications," and by Dr. A. W. M. Coombes on "Making a Thinking Machine," left no doubt in the minds of those attending the talks that the lectures were of the highest standard.

The visits continue to be popular and the programme included visits to a wide variety of manufacturers covering engineering, industrial and technical processes.

On the 16th March, 1955, the Centre held its Annual General Meeting and the following officers were elected: *Chairman*: Mr. G. W. Smith; *General Secretary*: Mr. W. Denby; *Treasurer*: Mr. F. Thomas; *Librarian*: Mr. A. A. Allmark; *Vice-Chairman and Talks Secretary*: Mr. H. Hawkins; *Visits Secretary*: Mr. C. A. Jackson; *Radio Secretary*: Mr. R. T. Whitlock; a further 14 Group Representatives were elected to the committee from various groups of the Centre. Future programmes were discussed and the problem of attracting new members received attention.

Looking ahead, the committee hopes to provide a wide and varied programme likely to appeal to the whole membership, and in return it is desired that the new committee will receive the full support of all members.
W. D.

Brighton Centre

The 1955 Session started with a film show, and the four films shown proved to be as interesting as previous shows. This time we saw "More Power to Uganda," in colour, showing the construction of an overhead power line; "The Manufacture of Plastics," again in colour; "The Production of the Diesel-Electric Railway Locomotive;" and finally optical science and its uses in industry and the medical world, entitled "To Greater Vision."

February brought us a lecture by our old friend, Mr. H. V. Thorpe, of the Senior Section, who dealt very ably with a topical and vast subject, namely, "Atomic Energy and its Meaning."

The last meeting was for another lecture, this time by one of our own members, Mr. L. Brazier, who spoke to us on "Telecommunications in Rural Areas." It was Mr. Brazier's first attempt at lecturing and he made a very good job of it. It is hoped that in the coming session more of our members can be induced to give a paper on a subject of their own choosing.

We would mention also that three visits to the B.B.C. were made at the beginning of the year by parties from Brighton, Worthing and Eastbourne.

Once again the attendances at the meetings have been encouraging, averaging between 30 and 40, but we would still like to see more coming along. The strength of the Section is still on the increase, and this session we have enrolled over 20 new members.
K. E. G.

Medway Centre

An Associate Centre of the I.P.O.E.E. was formed at Chatham on 6th October, 1954, to be known as the Medway Centre. At the first meeting a talk was given by Mr. Knox on "Promotion in the Post Office," and since then regular monthly

meetings have been held, with speakers on widely differing topics, from which some lively discussions ensued. A visit has also been paid to the B.R. locomotive works at Ashford where a party of 30 members spent a very interesting afternoon.
E. J. R. S.

London Centre

The twelfth session of the London Centre ended on a successful note when Mr. E. F. H. Gould, Staff Engineer of the Test and Inspection Branch, E.-in-C.'s Office, talked on "The Testing and Inspection of P.O.E.D. Engineering Stores," at the Annual General Meeting held at the I.E.E. In all, nine talks were arranged during the session, and average attendance was approximately 70. Visits were another very popular feature, and in all 81 visits were arranged, varying from the National Physical Laboratory to the Royal Society for Prevention of Accidents; most members visited the Ford Motor Co. at Dagenham, but the most popular were visits to Broadcasting House.

The third main object of the London Centre, that of circulating technical periodicals, achieved a record; 5,260 periodicals were distributed by the Centre Librarian; and local Librarians boosted this by their own Area/Section purchases to the extent of a further 500 periodicals. Our Librarian, Mr. F. E. Baker, is also in charge of the Technical Advice Panel (TAP); this is a means of answering queries on a great number of different subjects. If the answer cannot be supplied by reference to the back-number file of all periodicals circulated, then the Librarian will call upon a member of the Panel who specialises on that subject.

The London Centre would like to extend to Mr. C. E. Calveley best wishes in his new appointment in the E.-in-C.'s Office. We were very sorry to lose his services as President of the Associate Section, for he has done much for the Associate Section during his term of office; both as Chairman of the Centre Liaison Officers meetings and speaking to Centres all over the country. The new President is Mr. R. W. Palmer, the new Principal of the Central Training School, to whom best wishes are extended in both his new appointments.

At the Annual General Meeting held on Tuesday, 25th May, 1955, the following officers were elected for the 1955/56 session:—

Chairman: A. G. Welling; *Vice-Chairman*: C. Biddlecombe; *General Secretary*: B. C. Hatch; *Treasurer*: W. C. Peck; *Editor*: P. Sayers; *Visit Secretary*: M. R. G. Rump; *Radio Secretary*: N. Bryan; *Librarian*: F. E. Baker.

P. S.

Lancaster Centre

A very optimistic Annual General Meeting took place on the 6th April, 1955. Mr. Triffitt, Area Engineer and our President, was in the chair, supported by Mr. Gould, Senior Section Secretary, and Mr. Roberts, Area Training Officer and our Liaison Officer.

A bright idea for a Summer Outing is to visit Leyland Motors Works at Preston on a Saturday morning in September, lunch at the Post Office Canteen and afterwards watch Preston North End before finally returning home after, we hope, a very happy day.

Mr. Gould spoke on the new scheme of deduction of membership fees from weekly pay, the decision to participate or not being left in the hands of the committee, who will sound the feelings of the members upon this matter.

Many suggestions were received for subjects to be taken in the next Winter Session, and the Area Engineer will seek to obtain a member of the Engineer-in-Chief's Office to give a paper on the "Transatlantic Cable."

The officers of the Centre are:—*President*: L. A. Triffitt, B.Sc., Area Engineer; *Chairman*: C. Murray; *Vice-Chairman*: W. Briggs; *Secretary*: W. E. Greenwood; *Treasurer and Librarian*: M. Keenan; *Committee*: Messrs. Southgate, Clark, Woodall and Grundy; *Auditors*: Messrs. Busby and Yates.
W. E. G.

Promotions—continued.

Name	Region	Date	Name	Region	Date
<i>Tech. I to Inspector</i>			<i>Tech. I to Inspector—continued.</i>		
Bowman, E. R.	E.-in-C.O.	3.2.55	Goddard, P. D.	L.T. Reg.	25.11.54
Yearsley, H. A.	Mid. Reg.	19.11.54	Janes, C. K.	L.T. Reg.	31.1.55
Silvester, G. J.	Mid. Reg.	6.12.54	Bright, E. G.	S.W. Reg.	27.1.55
Rowell, H. A. V.	Mid. Reg.	29.1.55	Taylor, F. W.	S.W. Reg.	10.1.55
Williams, A. R.	Mid. Reg.	13.12.54	Watkins, J. S.	S.W. Reg.	26.1.55
Birmingham, W. B.	W.B.C.	21.2.55	Crewe, C. W.	S.W. Reg.	18.11.54
Earwalker, A. H.	W.B.C.	23.12.54	Kirkpatrick, J.	S.W. Reg.	2.1.55
Smith, A. C.	N.W. Reg.	11.2.55	Brown, D.	S.W. Reg.	19.1.55
Hoyle, S.	N.W. Reg.	18.2.55	Darnley, S. C. T.	S.W. Reg.	5.3.55
Coupland, F. C.	N.W. Reg.	21.2.55	Milan, J. H.	S.W. Reg.	3.1.55
Simkin, F. J.	N.W. Reg.	21.2.55	Chappell, J. J.	H.C. Reg.	22.11.54
George, R. W.	L.T. Reg. to L.P. Reg.	5.2.55	Wilson, R. G.	H.C. Reg.	10.1.55
Brandie, A.	Scot.	7.3.55	Wilson, C. R.	Scot.	12.4.55
Robertson, W.	Scot.	13.3.55	Aitken, J.	Scot.	1.4.55
Mackinnon, A.	Scot.	27.3.55	Wilson, W. C.	N.I.	4.4.55
Maguire, E.	N.I.	20.12.54	McLeod Norman, I.	N.W. Reg.	14.4.55
Patterson, H.	N.W. Reg.	8.3.55	Potts, R.	N.W. Reg.	14.4.55
Burley, A.	N.W. Reg.	8.3.55	Whittaker, W.	N.W. Reg.	25.4.55
Schofield, J. W.	N.W. Reg.	8.3.55			
Reeves, J. E.	L.T. Reg.	25.11.54			
Annesley, R.	L.T. Reg.	25.11.54			
Wilkinson, J. E.	L.T. Reg.	25.11.54			
			<i>Sur. Sc. Offr. (Open Competition)</i>		
			Hale, H. S.	E.-in-C.O.	28.1.55

Transfers

Name	Region	Date	Name	Region	Date
<i>Sur. Exec. Engr.</i>			<i>Asst. Engr.—continued.</i>		
Davies, R. C.	E.-in-C.O. to N.W. Reg.	4.4.55	Borrett, W. G.	E.-in-C.O. to Ministry of Supply	1.1.55
<i>Exec. Engr.</i>			Hirst, G. A.	Scot. to N.W. Reg.	12.2.55
Stanford, C. J.	E.-in-C.O. to Geneva	1.5.52	Pengelly, I. E.	Colonial Service to L.T. Reg.	14.2.55
Seymour, P. W.	E.-in-C.O. to P.O., Australia	8.3.51	Wilson, A.	L.T. Reg. to Nigeria (temporary)	24.2.55
Shepherd, J.	N.W. Reg. to Malaya	16.11.51	Davies, W.	E.-in-C.O. to Mid. Reg.	27.2.55
Burton, A. J. H.	E.-in-C.O. to Gold Coast	10.2.55	Graty, H. J.	Mid. Reg. to L.T. Reg.	21.2.55
<i>Asst. Engr.</i>			Faulkner, R. A. R.	E.-in-C.O. to Ministry of Supply	27.2.55
Lanfeair, J. S.	E.-in-C.O. to S.W. Reg.	1.2.55	Williamson, H. M.	E.-in-C.O. to S.W. Reg.	1.3.55
Fowler, R. H. Q.	E.-in-C.O. to H.C. Reg.	6.2.55	Nichols, L. J.	E.-in-C.O. to W.B.C.	6.3.55
Crosby, E.	E.-in-C.O. to H.C. Reg.	6.2.55	Wilkinson, G. J.	W.B.C. to Ministry of Transport and C.A.	1.3.55
Green, K. J.	H.C. Reg. to Colonial Service	14.2.48	Forty, A. S.	H.C. Reg. to E.-in-C.O.	18.4.55
Curry, W. R.	E.-in-C.O. to Ministry of Supply	14.2.55	Singleton, N.	E.T.E. to Ministry of Transport and C.A.	18.4.55
			Trask, G. W. F.	E.-in-C.O. to P.O., Australia	20.9.49

Retirements and Resignations

Name	Region	Date	Name	Region	Date
<i>Asst. Staff Engr.</i>			<i>Asst. Engr.—continued.</i>		
Evans, G. T.	Loan to War Office	17.2.55	Vickers, W.	E.T.E.	28.2.55
<i>Senr. Exec. Engr.</i>			Blaney, H. J.	N.I. Reg.	16.3.55
Whittaker, A. W.	L.T. Reg.	28.2.55	Grigg, G.	H.C. Reg.	1.3.55
Pettitt, V. R.	E.-in-C.O.	21.3.55	Dadd, W. F.	L.T. Reg.	16.3.55
<i>Exec. Engr.</i>			Lloyd, A. V.	W.B.C.	2.3.55
Manners, W.	W.B.C.	15.11.54	Langskaill, R. S.	Scot.	31.3.55
Pales, F. A.	E.T.E.	15.2.55	Cook, G. H.	N.E. Reg.	29.4.55
Shephard, A. C.	E.-in-C.O.	23.2.55	Calvert, W.	N.E. Reg.	30.4.55
McPherson, J. W.	E.-in-C.O. (Resigned)	26.2.55	Taverner, H. S.	L.T. Reg.	15.4.55
Andrews, W. E. T.	H.C. Reg.	14.3.55	Bazeley, G. H.	L.T. Reg.	24.4.55
Butcher, W.	N.W. Reg.	31.3.55			
Muir, W. W.	Scot.	30.4.55	<i>Inspector</i>		
<i>Asst. Engr.</i>			Beynon, B. J. A.	N.E. Reg. (Resigned)	11.3.55
McLeod, J.	Scot.	18.2.55	Kemp, R. W.	L.T. Reg.	27.3.55
Gammon, P. W. J.	E.-in-C.O. (Resigned)	22.2.55	Manning, G. H. M.	L.T. Reg.	6.2.55
Read, A. W.	N.E. Reg.	28.2.55	Borwick, F. B.	L.P. Reg.	4.2.55
			Phillips, W.	N.E. Reg.	7.4.55
			Monk, R.A.T.	L.T. Reg.	31.3.55

Deaths

Name	Region	Date	Name	Region	Date
<i>Regl. Engr.</i>			<i>Exec. Engr.</i>		
Longmore, F. W.	W.B.C.	17.2.55	Butters, W.	H.C. Reg.	23.3.55
			Atkinson, J.	H.C. Reg.	3.4.55

Deaths—continued.

Name	Region	Date	Name	Region	Date
<i>Asst. Engr.</i>			<i>Asst. Engr.—continued.</i>		
Hyde, W.	N.W. Reg.	19.2.55	Seward, B. A.	Mid. Reg.	18.4.55
Barr, T.	Scot.	3.3.55	<i>Inspector</i>		
Nottingham, H.	L.T. Reg.	22.3.55	Samuel, J. H.	N.E. Reg.	8.3.55
Thomson, W. J. R.	N.E. Reg.	25.3.55	Cork, E.	H.C. Reg.	16.3.55
Bleach, A. J.	N.E. Reg.	31.3.55	Ainsley, W.	N.E. Reg.	10.4.55

DRAUGHTSMEN

Promotion			Resignation		
Name	Region	Date	Name	Region	Date
<i>D'man to Ldg. D'man.</i>			<i>D'man.</i>		
Marks, A. E.	E.-in-C.O.	28.6.54	Heale, C. J.	E.-in-C.O.	25.9.54

Transfer

Name	Region	Date
<i>D'man.</i>		
Lockwood, R. R.	E.-in-C.O. to H.C. Reg.	17.11.54

CLERICAL

Promotions

Name	Region	Date	Name	Region	Date
<i>H.E.O. to S.E.O.</i>			<i>E.O. to H.E.O.</i>		
Smith, G. S.	E.-in-C.O.	20.12.54	Parry, C. R.	E.-in-C.O.	10.3.55

Retirement

Name	Region	Date	Name	Region	Date
<i>E.O.</i>			<i>H.E.O.</i>		
Smart, C. H.	E.-in-C.O.	4.2.55	Rose, A. R.	E.-in-C.O.	22.1.55

BOARD OF EDITORS

Col. J. READING, M.B.E., E.R.D., B.Sc.(Eng.), M.I.E.E., Chairman.
 W. WEST, O.B.E., B.A., M.I.E.E.
 L. F. SCANTLEBURY, Whit.Sch., A.C.G.I., D.I.C., M.I.E.E.
 H. G. BEER, Whit.Sch., A.C.G.I.
 C. E. CALVELEY, O.B.E., E.R.D., B.Sc.(Eng.), M.I.E.E.
 A. F. STOLLARD.
 A. E. BAVIN, A.M.I.E.E.
 W. A. HUMPHRIES, T.D., A.M.I.E.E., Managing Editor.
 J. H. BROADHURST, A.M.I.E.E.
 E. DAVIS, A.M.I.E.E.
 A. J. HUTCHISON, Secretary-Treasurer.

} Assistant Editors.

Copyright

The entire contents of this JOURNAL are covered by general copyright, and special permission is necessary for reprinting long extracts, but Editors are welcome to use not more than one-third of any article, provided credit is given at the beginning or end thus: "From the *Post Office Electrical Engineers' Journal*."

The Board of Editors is not responsible for the statements made or the opinions expressed in any of the articles in this JOURNAL, unless such statement is made specifically by the Board.

Communications

All communications should be addressed to the Managing Editor, *P.O.E.E. Journal*, Engineer-in-Chief's Office, Alder House, Aldersgate Street, London, E.C.1. Telephone: HEADquarters 1234. Remittances should be made payable to "The *P.O.E.E. Journal*" and should be crossed "& Co."

Binding Cases

Cases for binding are available, and may be obtained from the Local Agents for 3s. Subscribers can have their copies of volumes bound, at a cost of 10s. 6d., by sending the complete set of parts to the Local Agents or to the *P.O.E.E. Journal*, Engineer-in-Chief's Office, Alder House, Aldersgate Street, London, E.C.1. Orders for binding for Vols. 1-19 should indicate whether the original binding case with black lettering, or the later pattern with gold, is required. Cases with gold lettering are the only type stocked from Vol. 20 onwards.

Back Numbers

The price of the JOURNAL, which is published quarterly, is 2s. 6d. (2s. 9d. post free) per copy, or 11s. per annum, post free. Back numbers can be supplied, subject to availability of stocks, at 2s. 6d. each (2s. 9d. post free). Orders for back numbers may be sent to the *P.O.E.E. Journal*, Engineer-in-Chief's Office, Alder House, Aldersgate Street, London, E.C.1, or to the Publishers.

Employees of the British Post Office can obtain the *Journal* through Local Agents at the reduced price of 2s. per copy.

Advertisements

All communications relating to space reservations should be addressed to the Advertisement Editor, *P.O.E.E. Journal*, Alder House, Aldersgate Street, London, E.C.1. Communications regarding advertisement copy, proofs, etc., should be addressed to the Publishers, Messrs. Birch & Whittington (Prop. Dorling & Co. [Epsom] Ltd.), 49 Upper High Street, Epsom, Surrey.

PRINTED PAPERS

The following papers contributed to the proceedings of the Institution have been printed by the authority of the Council and may be obtained, while still in print, from "THE LIBRARIAN, THE INSTITUTION OF POST OFFICE ELECTRICAL ENGINEERS, G.P.O. (ALDER HOUSE), LONDON, E.C.1."

The price per copy is 2s. 6d. (2s. 8d. post free and Corporate Members of the Institution and Members of the Associate Section have the privilege of purchasing copies at the reduced price of 1s. 6d. net.

- No. 140. "SOME NON-METALLIC SUBSTANCES AND THEIR CHARACTERISTICS."—Capt. N. F. CAVE-BROWNE-CAVE, B.Sc., A.M.I.E.E. 1931.
- †No. 146. "LAYING ARMoured CABLE BY MEANS OF A MOLE-DRAINER."—L. G. SEMPLE, B.Sc.(Eng.), and R. O. BOOCOCK, B.Sc.(Eng.). 1932.
- No. 148. "STORES SPECIFICATIONS AND ACCEPTANCE TESTING."—Capt. J. LEGG, B.Sc., A.M.I.E.E. 1933.
- †No. 165. "PROPERTIES AND TESTING OF DIELECTRIC MATERIALS."—J. F. DOUST and W. J. SULSTON, M.Sc., A.Inst.P. 1936.
- †No. 166. "CHEMISTRY AND COMMUNICATIONS."—D. W. GLOVER, M.Sc., A.I.C. 1937.
- †No. 169. "CROSSTALK."—H. C. S. HAYES, A.M.I.E.E., R. A. SEYMOUR and P. R. BRAY, M.Sc.(Eng.). Grad.I.E.E. 1938.
- No. 173. "AUDIO-FREQUENCY RIPPLE FROM D.C. POWER SUPPLIES IN COMMUNICATION ENGINEERING."—H. R. HARBOTTLE, B.Sc., D.F.H., M.I.E.E., J. A. SHEPPARD, B.Sc., A.M.I.E.E., and D. L. RICHARDS, B.Sc. 1939.
- No. 174. "METALLURGY AND COMMUNICATIONS."—E. V. WALKER, B.Sc., A.R.S.M. 1940.
- No. 179. "INTRODUCTION OF U.A.X. MULTI-METERING IN THE LEEDS AREA."—H. G. COPE. 1941.
- †No. 182. "LONDON INLAND TRUNK SERVICES."—W. H. SCARBOROUGH, A.M.I.E.E. 1943.
- †No. 187. "CABLING PROBLEMS IN SUBWAYS AND TUNNELS."—T. G. TURLEY, A.M.I.E.E. 1945.
- †No. 191. "PIEZO-ELECTRIC QUARTZ AND ITS USE IN TELECOMMUNICATIONS."—C. F. BOOTH, M.I.E.E., and J. L. CRIGHTON, A.M.I.E.E. 1946.
- †No. 193. "IMPROVEMENTS IN TELEPHONE SIGNALLING."—S. WELCH, M.Sc.(Eng.), A.M.I.E.E., and C. H. J. FLEETWOOD, A.M.I.E.E. 1949.
- †No. 196. "WIRE BROADCASTING."—F. HOLLINGHURST, B.Sc.(Eng.), A.C.G.F.C., M.I.E.E., and W. PRICKETT, A.M.I.E.E. 1949.
- †No. 197. "THE POSSIBILITIES OF SUPER-HIGH FREQUENCY RADIO AND WAVEGUIDE SYSTEMS FOR TELECOMMUNICATIONS."—W. J. BRAY, M.Sc.(Eng.), A.C.G.I., D.I.C., A.M.I.E.E. 1948.
- No. 198. "INTRODUCTION AND APPLICATION OF TRANSMISSION PERFORMANCE RATINGS TO SUBSCRIBERS' NETWORKS."—G. A. B. FUDGE, A.M.I.E.E. 1949.
- †No. 199. "SOME APPLICATIONS OF ELECTRONIC METHODS TO TELEGRAPH APPARATUS."—R. O. CARTER, M.Sc.(Eng.), A.M.I.E.E., and L. K. WHEELER, B.Sc.(Eng.), A.M.I.E.E. 1949.
- †No. 200. "TRENDS IN THE DESIGN OF LINE TRANSMISSION EQUIPMENT."—R. J. HALSEY, B.Sc.(Eng.), A.C.G.I., D.I.C., M.I.E.E. 1949.
- †No. 201. "TRUNK MECHANISATION."—A. J. THOMPSON and J. H. BROADHURST, A.M.I.E.E. 1951.
- No. 202. "THE COLD-CATHODE TUBE IN TELEPHONE SWITCHING CIRCUITS."—J. A. LAWRENCE, A.M.I.E.E. 1952.
- †No. 203. "SUBSCRIBER TRUNK DIALING IN THE UNITED KINGDOM."—D. A. BARRON, M.Sc., M.I.E.E.
- No. 204. "A.C. SIGNALLING—A REVIEW OF CURRENT PROBLEMS."—B. R. HORSFIELD, A.M.I.E.E., and D. C. SMITH, B.Sc.(Eng.), A.M.I.E.E.
- †No. 205. "COAXIAL CABLES—SOME PRACTICAL ASPECTS OF THEIR DESIGN AND MAINTENANCE."—G. E. ROSSITER, A.M.I.E.E.

† The Council have awarded Institution Medals for these papers.

INDEX TO ADVERTISERS

	PAGE
Adcola Products, Ltd.	xxxiv
Airmec, Ltd.	xiv
Alton Battery Co., Ltd., The	xxxvi
Austinlite, Ltd.	xxi
Automatic Coil Winder & Electrical Equipment Co., Ltd.	xx
Automatic Telephone & Electric Co., Ltd.	xxix-xxx, xxxv
British Electric Resistance Co., Ltd., The..	vii
British Institute of Engineering Technology	ii
British Insulated Callender's Cables, Ltd.	iv
Cathodeon Crystals, Ltd.	xxxii
Edison Swan Electric Co., Ltd., The	xxxix
E.M.I. Institute	vi
Ericsson Telephones, Ltd.	xxii
Ferranti, Ltd.	xxxviii
General Electric Co., Ltd., The	ix-x, xvii-xviii, xxiii-xxiv
Great Northern Telegraph Co., Ltd.	xii
Hackbridge Cable Co., Ltd.	vi
Hivac, Ltd.	xiv
Marconi Instruments	xix
Marconi's Wireless Telegraph Co., Ltd.	xiii
Muirhead & Co., Ltd.	xxxviii
Mullard, Ltd.	xxxvii
National Salt Glazed Pipe Manufacturers' Association	xxx
Painton of Northampton	xxvii
Pirelli-General Cable Works, Ltd.	xxxix
Pitman, Sir Isaac, & Sons, Ltd.	ii
Racal, Ltd.	v
Redifon, Ltd.	ii
Siemens Brothers & Co., Ltd.	xxxiii
Skillman, T. S., & Co., Ltd.	xxv-xxvi
Smith, Frederick, & Co.	iii
Standard Telephones & Cables, Ltd.	viii, xv-xvi
Sullivan, H. W., Ltd.	xi
Telephone Manufacturing Co., Ltd.	xx
Tungstone Products, Ltd.	xxxviii
Turner, Ernest	vii
Westinghouse Brake & Signal Co., Ltd.	xi
Winn & Coales, Ltd.	vi

for the right connection

ANACOS
REGD.

telephone line wire

FREDERICK SMITH & COMPANY
ANACONDA WORKS, SALFORD, 3, LANCs.
Incorporated in The London Electric Wire Company and Smiths Limited.
Associated with The Liverpool Electric Cable Co. Ltd. and Yacrite Wire Co. Ltd.



*May we give you
a piece of our mind?*

Our technicians are always glad to give you the benefit of their experience. Why not get together before planning that electrical job? The chances are that you will save yourself time and trouble.

The BICC Technical Advisory Service has been helping solve customers' problems for many years. Advice is given on the selection, application and installation of electric cables and wires for every purpose—and on the wide range of associated equipment manufactured by BICC.

This service, of course, is entirely without obligation.

BICC

**Technical Advisory
Service**



BRITISH INSULATED CALLENDER'S CABLES LIMITED
21 BLOOMSBURY STREET, LONDON, W.C.1

ANNOUNCING THE

RACAL

YAGI AERIAL ARRAY

DESIGNED TO WITHSTAND
WINDS OF 110 M.P.H.

SINGLE FREQUENCY WORKING
IN BAND 148-216 MC/S

16 DB FORWARD GAIN

75 OHMS IMPEDANCE WITH
MAX V.S.W.R. OF 1.2:1 OVER
BANDWIDTH OF ± 2 MC/S

SIDE LOBES 10 DB
BELOW MAIN LOBE

HORIZONTAL OR VERTICAL
POLARIZATION

SINGLE YAGI AERIALS
AVAILABLE INDEPENDANTLY

RACAL LIMITED

BRACKNELL BERKS.

TEL.: BRACKNELL 941
GRAMS.: RACAL BRACKNELL

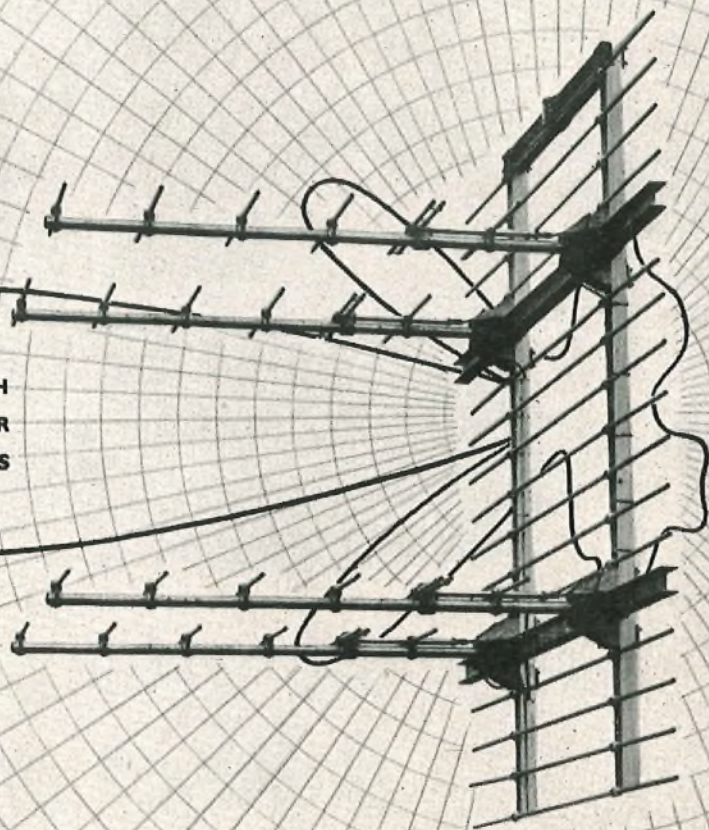

Hackbridge Cables



for
every
purpose

Contractors to the G.P.O., National Coal Board, British Railways, C.E.A. and British and Colonial Government Departments.

HACKBRIDGE
Cable Company Limited

KELVIN WORKS · HACKBRIDGE · SURREY

In Association with Bryce Electric Construction Company Ltd.



Denso

Denso Anti-corrosion, Waterproofing and Sealing Products have won an unrivalled reputation in the field of Telecommunications by virtue of their reliability in the most testing conditions. Whether for the anti-corrosion protection of cables, the waterproofing of cable ends and openings, or the sealing of ducts and entries, their non-hardening and non-cracking qualities ensure unfailing service.

WINN & COALES LTD.

DENSO HOUSE, CHAPEL ROAD, LONDON, S.E.27

Phone: GIPsy Hill 4247/B.

Grams: Denselte, Westnor, London.

PASS YOUR CITY & GUILDS CERTIFICATES AND P.M.G. CERTIFICATE

We offer comprehensive home training in a wide range of subjects, including P.M.G. Certificates, City and Guilds Grouped Certificates in Telecommunications, A.M.Brit.I.R.E. Examination, Radio Amateur's Licence, Radio and Television Servicing Certificates, General Radio and Television Courses, Radar, Sound Recording, etc. Also Courses in all other branches of Engineering.

With the following Courses, Practical Kits are available.

Radio, Television, Mechanics, Electricity, Chemistry, Photography, Carpentry; also Draughtsmanship, Commercial Art, Amateur S.W. Radio, Languages, etc.

Write now

for FREE BROCHURE stating subjects of interest to:

E.M.I. INSTITUTES

Dept. 97, GROVE PARK ROAD, LONDON, W.4

An Educational Organization serving the E.M.I. Group of Companies, including

"HIS MASTER'S VOICE", MARCONIPHONE, COLUMBIA, etc.

10.64 7/55

**ELECTRICAL MEASURING
INSTRUMENTS & EQUIPMENT**

designed and built for
specific requirements in
INDUSTRY AND RESEARCH

Contractors to:
Post Office, H.M. Admiralty, Ministry of Supply,
National Coal Board, etc.

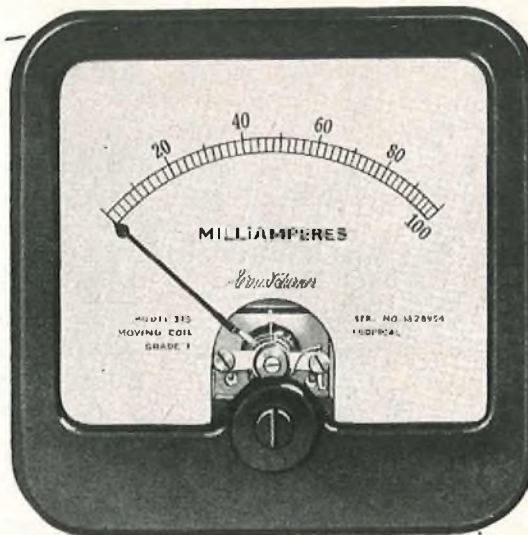

ERNEST TURNER ELECTRICAL INSTRUMENTS LIMITED
CHILTERN WORKS • HIGH WYCOMBE • BUCKS.

Telephone:
HIGH WYCOMBE 1301-2-3

Telegrams:
"GORGEOUS, HIGH WYCOMBE"

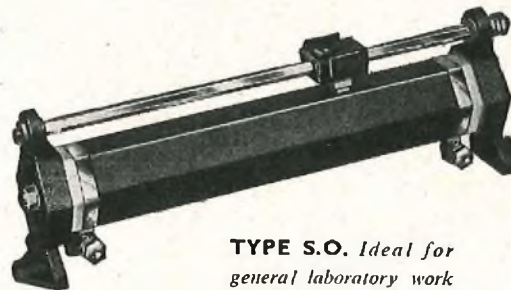

TYPE S.O. *Ideal for general laboratory work where high voltages are not employed.*

Sliding Resistances

**EMBODY 30 YEARS' EXPERIENCE IN THE
MANUFACTURE OF CONTROL EQUIPMENT**

BERCO Sliding Resistances are widely employed in Laboratory research, industry and all types of electronic work. Smooth action is ensured by the copper graphite self lubricating brush mechanism. Hexagonal tube ensures rigidity and great mechanical strength. A very wide range of resistances for all applications is available, and we are now able to offer greatly improved delivery.

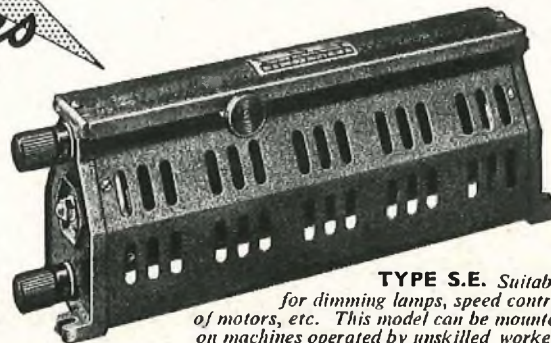

TYPE S.E. *Suitable for dimming lamps, speed control of motors, etc. This model can be mounted on machines operated by unskilled workers on account of the complete protection given by the cover.*

THE BRITISH ELECTRIC RESISTANCE CO. LTD.

Queensway, Ponders End, Middlesex. Telephone: Howard 1492. Telegrams: Vitrohms, Enfield.

FOR DIRECT TRANSMISSION OF TV signals

Recently added to the extensive range of high quality communication cables developed and manufactured by Standard Telephones and Cables Limited is polythene insulated Video Cable, designed for the transmission of television signals up to $3\frac{1}{2}$ miles without the need for intermediate amplifiers. Introducing a new economy for short-range television cable links, the **Standard** Video Cable provides balanced circuits of low loss, excellent impedance uniformity and its special screening reduces interference to negligible levels. Several video pairs can be stranded into a cable to give flexibility and multiplicity of the video channels.



— Note these Features — — — — —

- ★ Low loss 16db per mile at 4 Mc/s.
- ★ High degree of impedance uniformity
- ★ Specially designed screening
- ★ Multi-pair construction

CABLE - another Advance by Standard



Standard Telephones and Cables Limited

Registered Office: Connaught House, Aldwych, W.C.2

TELEPHONE LINE DIVISION: North Woolwich, London, E.16

G.E.C.

Britain's microwave leaders announce

The New 60/120-CIRCUIT U.H.F. TELEPHONY SYSTEM SPO 5500

THIS FREQUENCY-MODULATED SYSTEM, conveying either 60 or 120 circuits, operates in the 1700-2300 Mc/s band. Long systems show a minimum of modulation distortion since non-demodulating repeater stations are used.

- ★ Conveying one super-group of 60 circuits, the SPO 5500 system achieves, in all respects, the performance laid down by C.C.I.F. for international co-axial cable networks.
- ★ In addition, the channel spacing, intermediate frequency and transfer levels comply with the standards laid down in the C.C.I.F. Documents 66 and 69.
- ★ Spur routes and local baseband traffic are catered for in the design of the system, since at repeater stations any signal from the baseband is injected or extracted without demodulation of the "through traffic."

The system handles two super-groups of 60 circuits each, with a total signal/noise performance in the worst channel only 6 db below that recommended for C.C.I.F. international co-axial cable networks.

The most modern construction practice permits all panels to slide into place on guides, being connected into service by plug-in sockets. No wiring is disconnected for the removal of a panel.

Each rack has a meter panel, giving readings of all valve anode and grid currents, crystal currents, R.F. amplifier output power and all non-mains voltages.

No voltage higher than 300V is encountered in the equipment.

The use of co-axial cable for feeders eliminates the expense of wave-guides.

A terminal rack complete with transmitter and receiver is single-sided, so that two racks may be mounted back-to-back or side by side as illustrated. They are economical of floor space, occupying only $20\frac{1}{2}$ " \times $8\frac{1}{2}$ " and are only 9' high.

For further details write for Standard Specification SPO 5500.

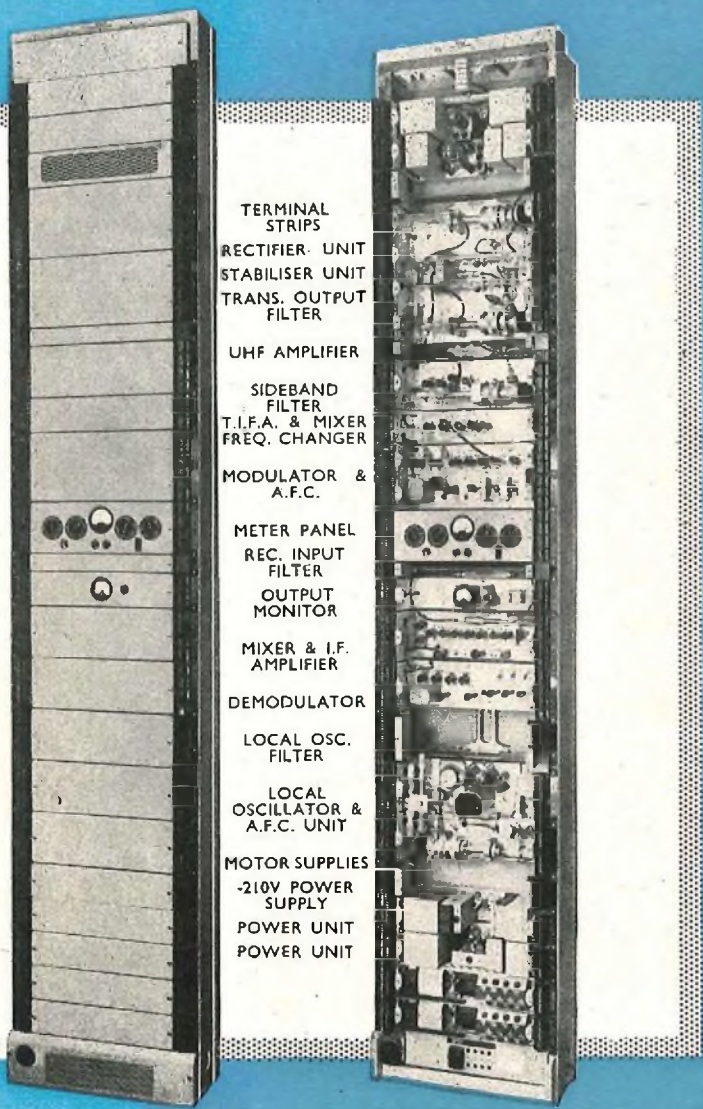

- TERMINAL STRIPS
- RECTIFIER UNIT
- STABILISER UNIT
- TRANS. OUTPUT FILTER
- UHF AMPLIFIER
- SIDEBAND FILTER
- T.I.F.A. & MIXER
- FREQ. CHANGER
- MODULATOR & A.F.C.
- METER PANEL
- REC. INPUT FILTER
- OUTPUT MONITOR
- MIXER & I.F. AMPLIFIER
- DEMODULATOR
- LOCAL OSC. FILTER
- LOCAL OSCILLATOR & A.F.C. UNIT
- MOTOR SUPPLIES
- 210V POWER SUPPLY
- POWER UNIT
- POWER UNIT

G.E.C.

lead the march of progress in the microwave radio field. In addition to telephony, G.E.C. television links are playing vital roles in many national and international networks, and are in continuous manufacture both at home and abroad. Up-to-date equipment design promotes economy of space, accessibility of components, and ease of maintenance in all G.E.C.'s telephone and television transmission equipment.

THE C.C.I.F. 'CIRCUIT FICTIF' WITH 9 POINTS OF DEMODULATION IN 2500 Km.

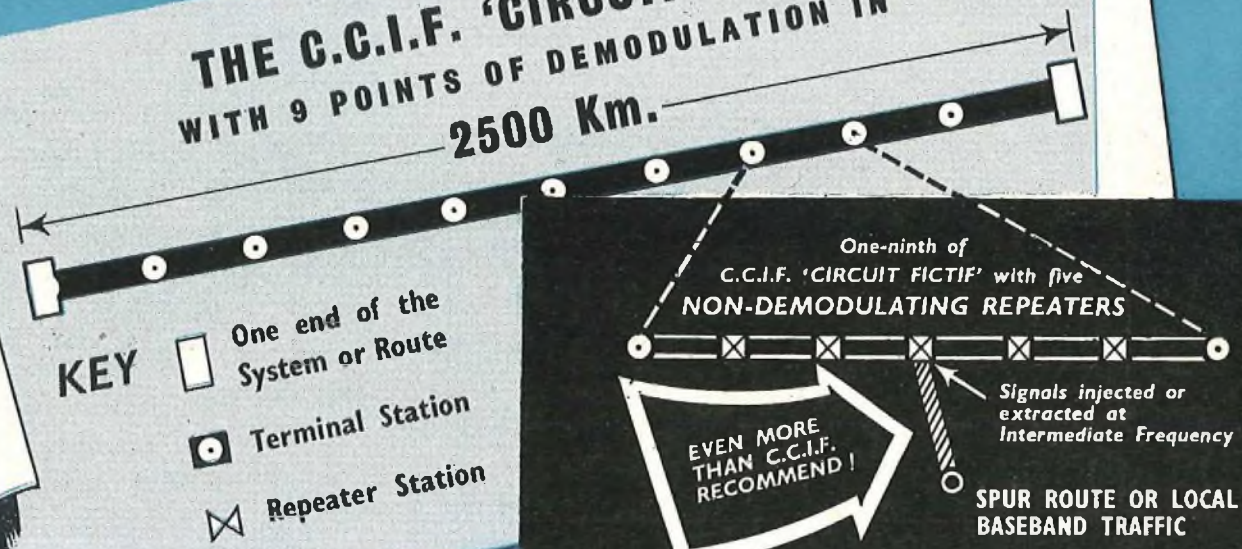

- KEY**
- One end of the System or Route
 - Terminal Station
 - ⊗ Repeater Station

★ The cost of the radio equipment is about half that for copper wire alone to provide 60 ccts. by 12-cct. carrier systems on open-wire routes.



Constant DC Voltage

DC Voltage limits $\pm 1\%$ despite:—

- * AC voltage fluctuations of -10 to $+6\%$.
- * Frequency variations of 48 to 52 cps.
- * Load variations of 5% to 100% and self-protecting on overload.

The above are typical limits of our range of constant DC voltage equipments. Electronic, magnetic or mechanically regulated equipments are available and can also be designed to meet customers' specific requirements. Consult us for the most satisfactory solution to your problems—take full advantage of the WESTINGHOUSE SERVICE.



CONSTANT POTENTIAL RECTIFIERS

Write for details to:—

Dept. P.O.7, WESTINGHOUSE BRAKE & SIGNAL CO. LTD., 82 York Way, King's Cross, London, N.1

Telephone:— TERminus 6432

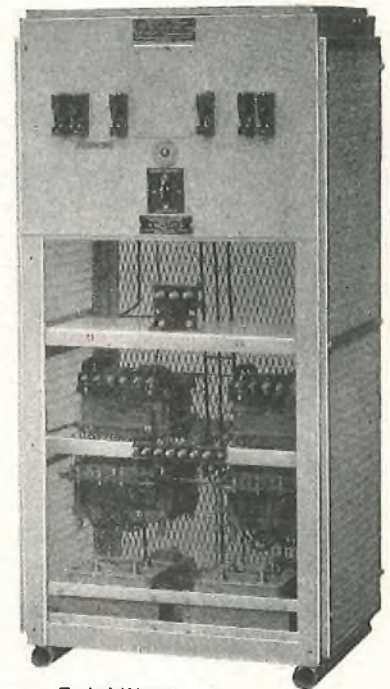

Typical Westac

IMPROVEMENT IN THE ACCURACY OF DECADE RESISTANCES

We have pleasure to announce that the well-known and novel

SULLIVAN and GRIFFITHS

DUAL DIAL DECADE RESISTANCE BOXES

FOR ALL FREQUENCIES

have now been improved in accuracy to

0.05 PER CENT

Moreover, the windings are now of **Manganin** in order to reduce the temperature coefficient; more important still, to improve the long period of stability and make them as suitable for all direct-current purposes as they are for alternating currents of all frequencies.

Screened Resistances of guaranteed accuracy exactly similar to our well-known Decade Resistances but specially arranged so that one box of a given number of dials gives many different values of maximum resistance. Thus a three-dial box (as illustrated) may be used for instance for

three decades of Thousands, Hundreds and Tens	a total of 10,000 ohms.
or three decades of Hundreds, Tens and Units	a total of 1,000 ohms.
or three decades of Tens, Units and Tenths	a total of 100 ohms.
or three decades of Units, Tenths and Hundredths ,	a total of 10 ohms.

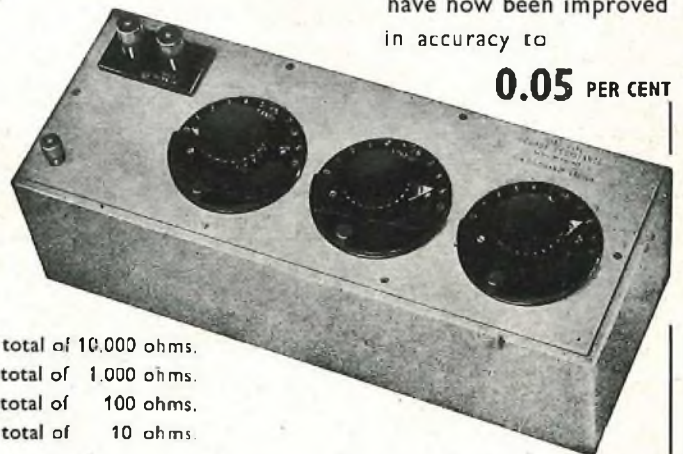

H. W. SULLIVAN LIMITED

LONDON, S.E.15

Telephone: New Cross 3225 (P.B.X.)

The advantages of such a system will be obvious, for in addition to the economy involved much space is saved and the residual resistance and inductance is much reduced.

The resistances are available in 3-dial, 4-dial and 5-dial types with subdivision of 0.001% down to 0.001 ohm if necessary, depending of course on the number of dials incorporated.



UNDULATORS

MODELS 309 & 310

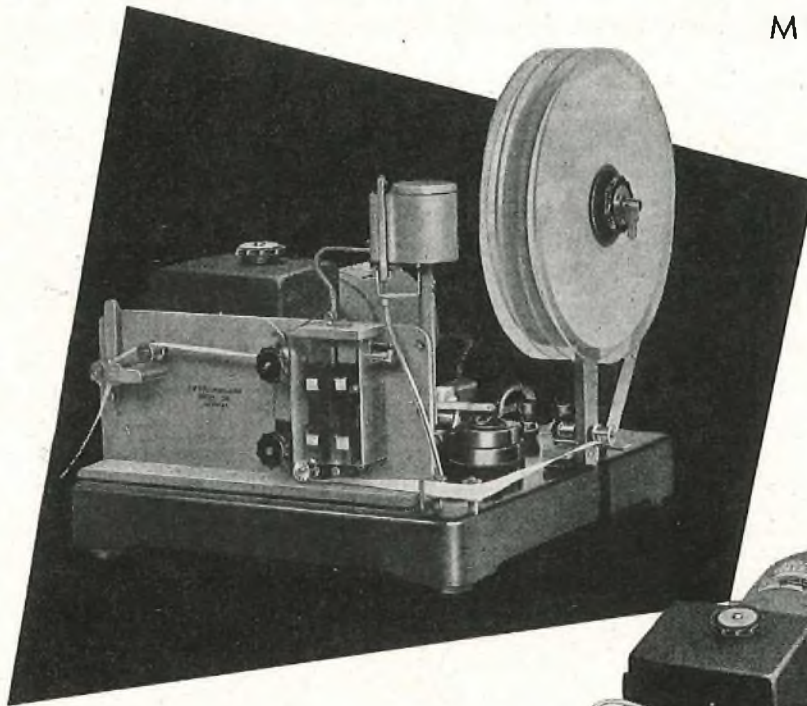

◀ Model 309 with single recording part.

Model 310 with two recording parts.

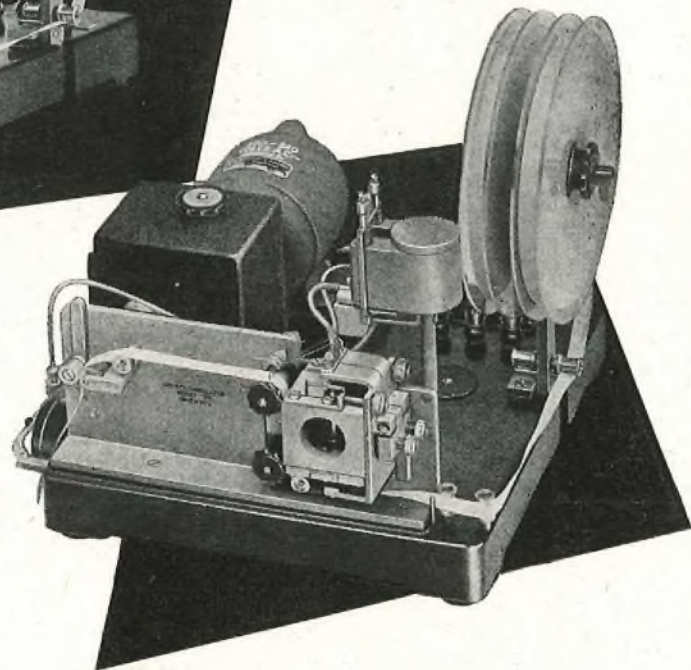

Both models can record signals up to 300 w. p. m. Supplied with A. C. or D. C. motors, as required.

Also manufactured with built-in amplifiers under catalogue numbers 311 and 312 for single and double recording, respectively.

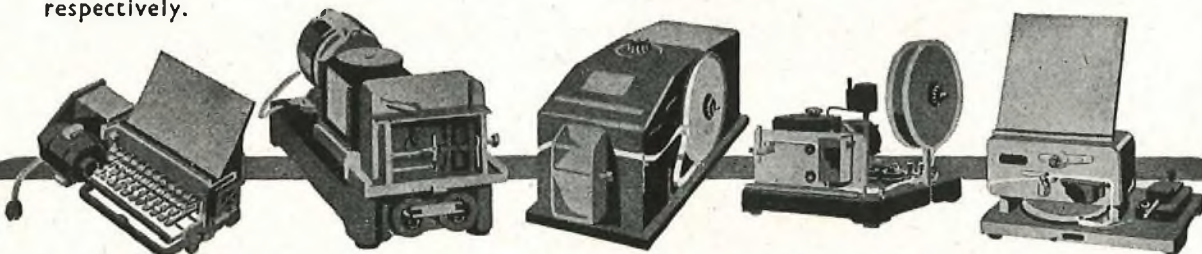

GREAT NORTHERN TELEGRAPH WORKS

DIVISION OF THE GREAT NORTHERN TELEGRAPH CO. LTD.

4, SYDHAVNS PLADS
COPENHAGEN SV, DENMARK

LONDON OFFICE: 5, ST. HELEN'S PLACE
LONDON E. C. 3.

Marconi Double Diversity Telegraph Recording Unit

TYPE HU.12

Shown here is the HU.12, in the bench mounting cabinet where it fits on top of the power unit. It can also be built into a standard rack which houses the associated receivers.

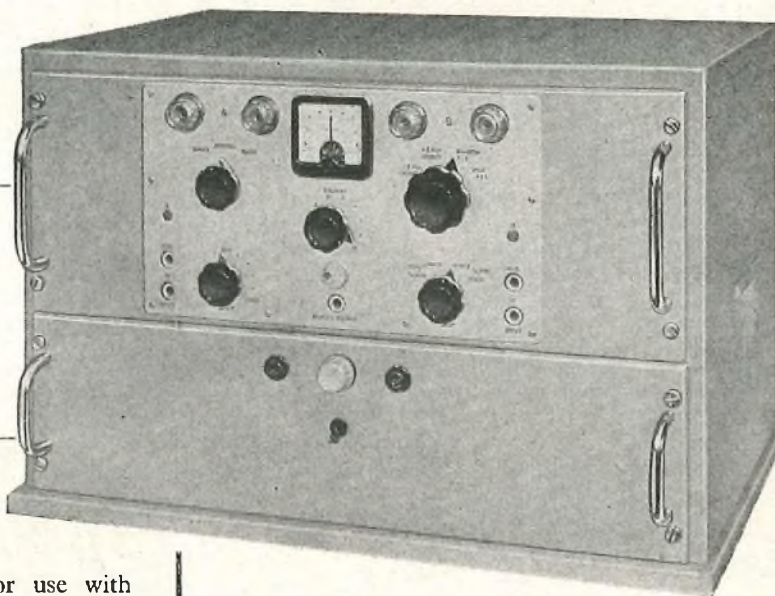

The HU.12 unit is designed for use with two suitable receivers of frequency shift or on-off telegraph transmissions in double diversity. The combined AF outputs of the receivers are converted into double current signals to operate an undulator, relay or other 'space-mark' type of equipment requiring a current up to 30 mA. No receiver modification is necessary except, perhaps, adjustment of the BFO frequency.

Satisfactory recording is possible should the first oscillator drift up to ± 800 c/s.

FEATURES:-

- ⊕ Electronic path diversity selector for FSK will function when difference between paths exceeds 4 db.
- Alternative DC output suitable for a low resistance undulator (20 + 20 ohms) is provided.
- Neon indicators for visual tuning of FSK reception.
- Front of panel control for pre-set 'mark' and 'space' current adjustment, filter selection and signal bias.

Over 80 countries now have Marconi equiped telegraph and communication systems. Many of these are still giving trouble free service after more than 20 years in operation.



Lifeline of communication

MARCONI

COMPLETE COMMUNICATION SYSTEMS

Surveyed, planned, installed, maintained

MARCONI'S WIRELESS TELEGRAPH CO. LTD., CHELMSFORD, ESSEX

Partners in Progress with The 'ENGLISH ELECTRIC' Company Limited LC 13



5kV IONISATION TESTER TYPE 732

for non-destructive
testing of insulation

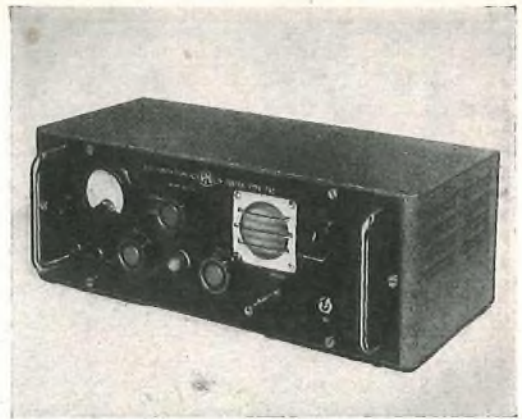

THE AIRMEC 5kV IONISATION TESTER TYPE 732 provides a non-lethal method of ensuring that the life of an electrical component, cable or equipment is not shortened by ionisation currents occurring at or below the working voltage. It enables the quality of insulating materials to be determined and provides an excellent means of testing components for faulty impregnation and dampness.

● **Direct Test Voltage:** Continuously variable between 250 and 5000 volts.

● **Ionisation Indication:** Audible indication of ionisation currents is given by means of a loud-speaker. A phone jack enables external phones or meter to be used. The threshold voltage at which ionisation occurs is thus immediately determined.

● **Resistance Measurement:** A meter indication of both voltage and leakage current is given, thus enabling the insulation resistance to be determined.

● **Safety:** The high impedance of the voltage source limits the maximum current to a very low value.

● **Available from stock**

Full details of this or any other Airmec instrument will be forwarded gladly upon request

AIRMEC
L I M I T E D

HIGH WYCOMBE

BUCKINGHAMSHIRE

ENGLAND

Telephone: High Wycombe 2060.

Cables: Airmec, High Wycombe.

Perfection in Miniature

ARANEUS DIADEMATUS
(the common garden spider)

weaves its web with a thread 0.007 mm in diameter, with a tensile strength of about 2 grams.

The "40 series" valves, one of the Hivac ranges of highly specialised subminiature types, uses a tungsten filament of approximately the same diameter but having a tensile strength more than five times as great.

Hivac Limited

STONEFIELD WAY, VICTORIA ROAD
SOUTH RUISLIP, MIDDLESEX

Subminiature, miniature and midget valves, electrometers, cold-cathode tubes, transistors, indicator and switchboard lamps, neon indicator lamps.



TELEPHONE: Ruislip 3366

P5

Communication

Standard Systems in Service



The first 60-channel carrier telephone cable to be supplied by a British manufacturer is now being installed by the Department of Posts and Telegraphs of the Government of India under the supervision of Standard Telephones and Cables Limited.

Linking Calcutta and Asansol, a distance of approximately 138 miles, this important cable, developed and manufactured by **Standard**, provides further evidence of the Company's lead in communication cable engineering.

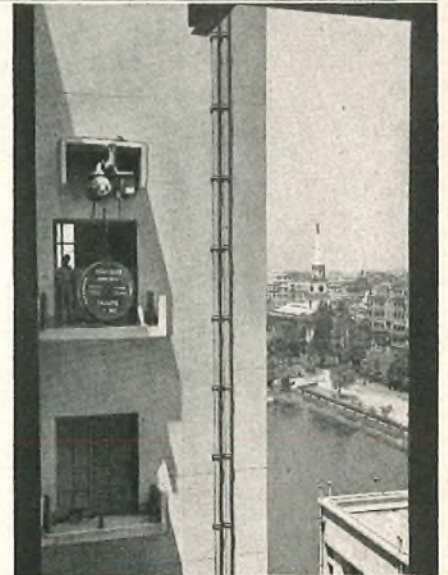

Standard Telephones

(TELECOMMUNICATION)

Connaught House, Aldwych,

Cairo

Dublin

Johannesburg

and Control

One of the largest telecommunication engineering organisations in the British Commonwealth **Standard Telephones and Cables Limited** is engaged in the research, development, manufacture and installation of all types of communication and control systems.

Concerned with every aspect of telecommunications engineering, the Company is in an unrivalled position to undertake, within its own organisation, the co-ordinated planning of complete communication projects involving interdependent systems of various types.

Standard products include:-

Systems:—

Telecommunications Line Transmission
Radio Broadcasting, Communication and Navigation
Railway Communication and Control
Telephone and Telegraph
Supervisory and Remote Indication and Control
Sound Reproduction
Municipal and Industrial Fire Alarms
Street and Airfield Lighting Control
Signalling (Office and Factory)
Communication Cable
Power Cable

Equipment:—

SenTerSet Selenium rectifier equipment
Power Factor Correction
Heat Treatment
Broadcast Studio equipment
Transmission Testing apparatus
Cable Testing equipment
Loading Coils

Components:—

Quartz Crystals
Transistors
Capacitors and Interference Suppressors
Germanium Rectifiers and Photoelectric Cells
Thermionic Valves

Magnetic Materials

Thermistors
Relays
SenTerCel Selenium Rectifiers
Rubber, Plastic and Textile insulated cables and wires

and Cables Limited

ENGINEERS)

London, W.C.2, England

Karachi

New Delhi

Salisbury

G.E.C.

UHF TELEVISION

G.E.C. microwave TV equipment has been chosen by Canadian National and Canadian Pacific Railroads for their London – Windsor (Ontario) link.

Canadian Broadcasting Company TV programmes are picked up at London and relayed to Windsor, 120 miles away, through repeater stations at Dutton, Duart, Rhodes and Leamington. This one-way channel is already in service. The complete installation, proceeding to a firm delivery schedule, looks forward to two further stages. A second, reversible channel is being installed first, and then the original channel is to be made reversible. Supervisory equipment is being supplied for unattended operation of the complete two reversible links.

The TV equipment is of the standard G.E.C. pattern, system SPO 5551 operating in the 1700-2300 Mc/s band. It is suitable for the transmission of 405-line, 525-line or 625-line pictures.

Typical 9 ft. racks of G.E.C. system SPO 5551 microwave TV equipment.

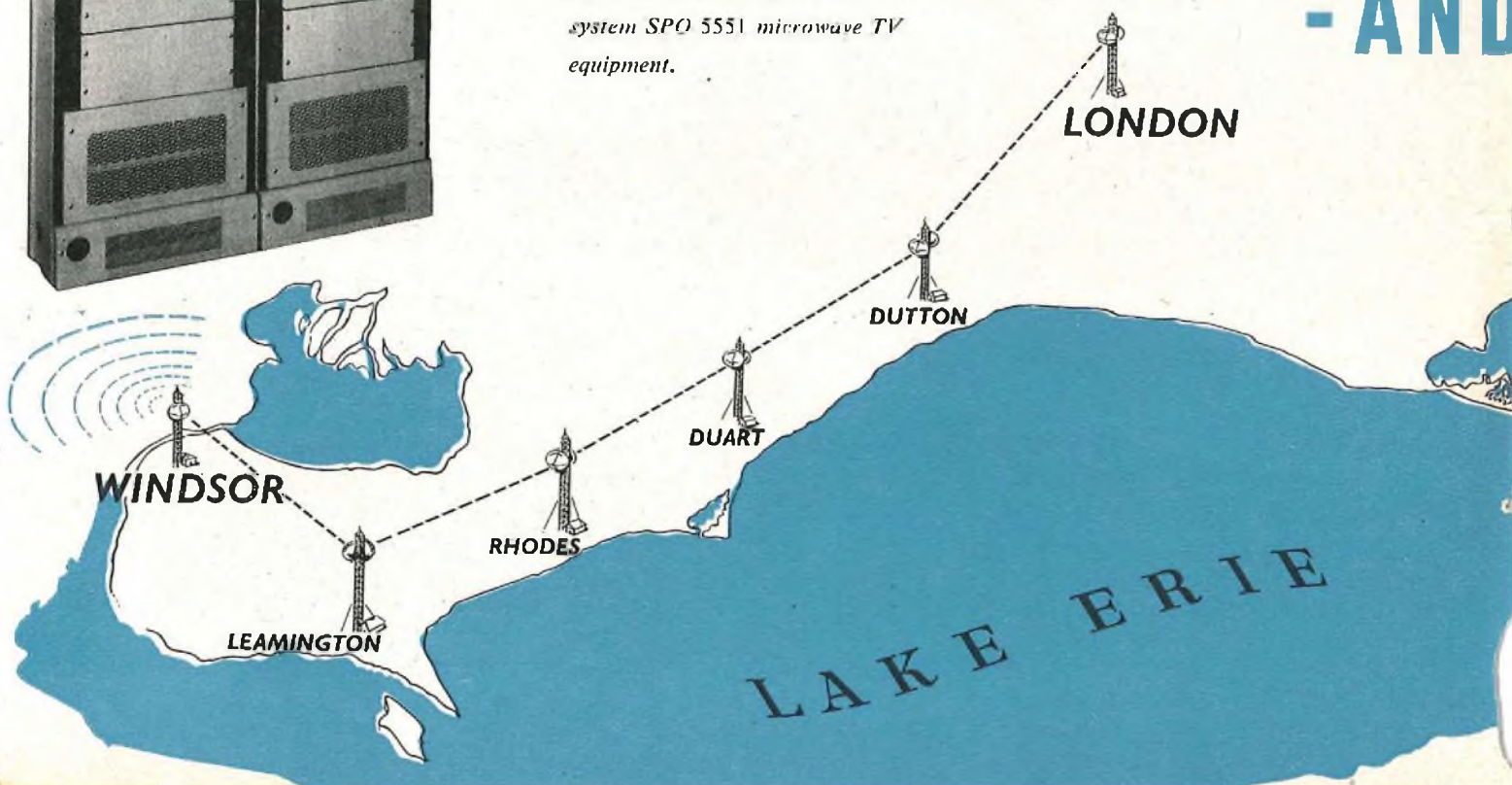
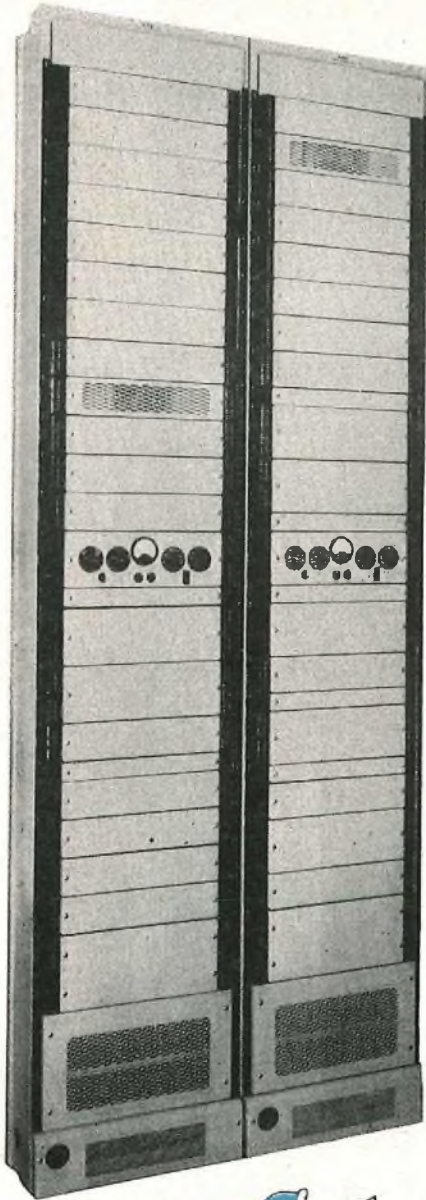



LINKS-

London-Birmingham

London-Norwich

London-Wenvoe

Wrotham-Swingate-Cassel

Generosa-Jungfrauoch-Chasseral

Uetliberg-Chasseral-Romont-Dôl

NOW

CANADA!

Supplied through

CANADIAN GENERAL ELECTRIC CO. LTD.,

THE GENERAL ELECTRIC COMPANY LTD. OF ENGLAND,

Telephone, Radio and Television Works,

COVENTRY · ENGLAND

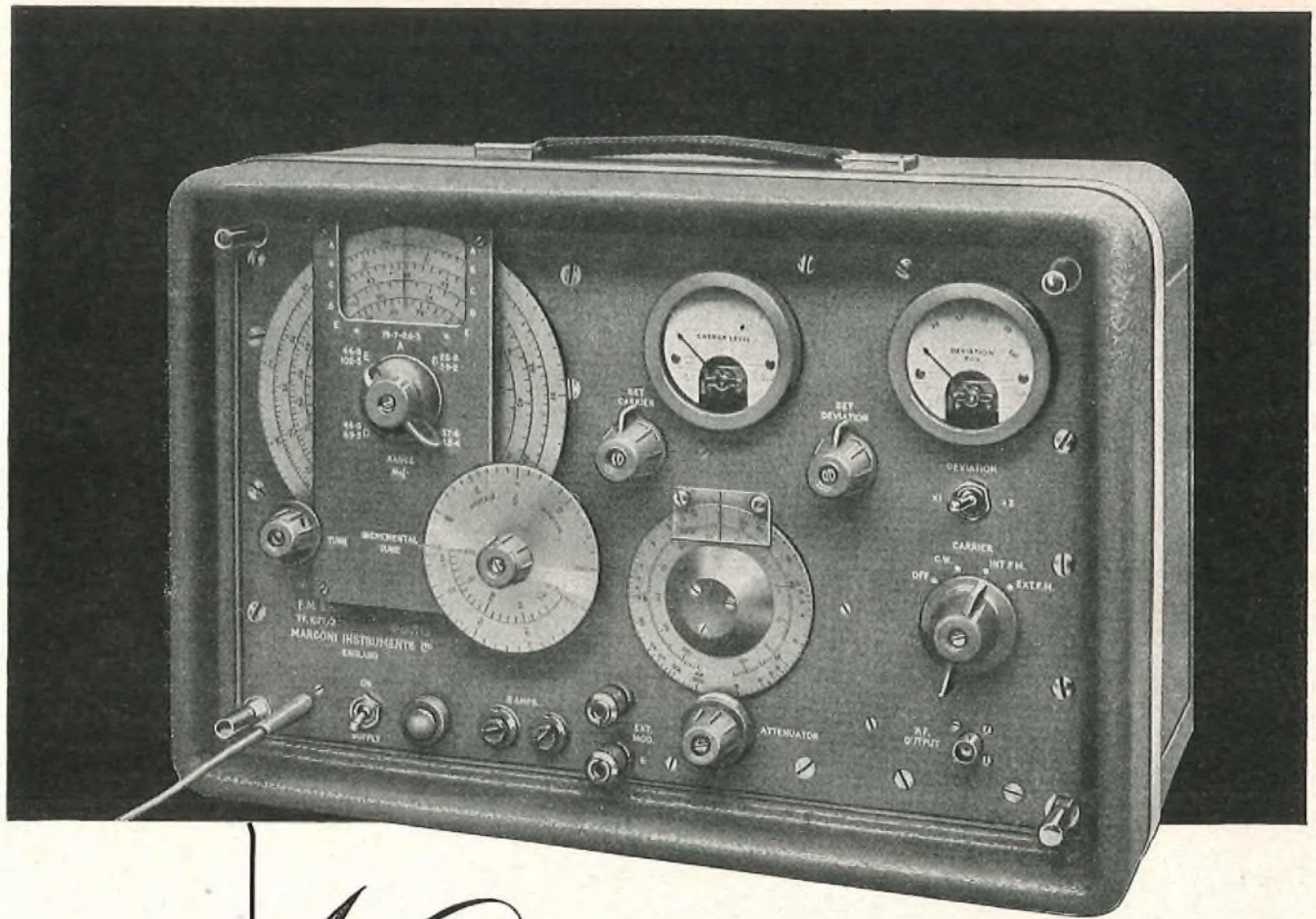

A *New* **MARCONI**
FM SIGNAL GENERATOR

TYPE TF 1077/2

FREQUENCY RANGE 19.7 to 102.5 Mc/s DEVIATION up to 100 kc/s



**STAND
 No. 1
 BLOCK B**

MARCONI INSTRUMENTS

SIGNAL GENERATORS • BRIDGES • VALVE VOLTMETERS • Q METERS • WAVEMETERS
 FREQUENCY STANDARDS • WAVE ANALYSERS • BEAT FREQUENCY OSCILLATORS

MARCONI INSTRUMENTS LTD • ST. ALBANS • HERTS • Telephone: ST. ALBANS 6160/9

30 Albion St., Kingston-upon-Hull. Phone: Hull Central 16144. 19 The Parade, Leamington Spa. Phone: 1408

Managing Agents in Export:
 MARCONI'S WIRELESS TELEGRAPH CO. LTD. • MARCONI HOUSE, STRAND, LONDON, W.C.2.

CARPENTER

POLARIZED RELAYS

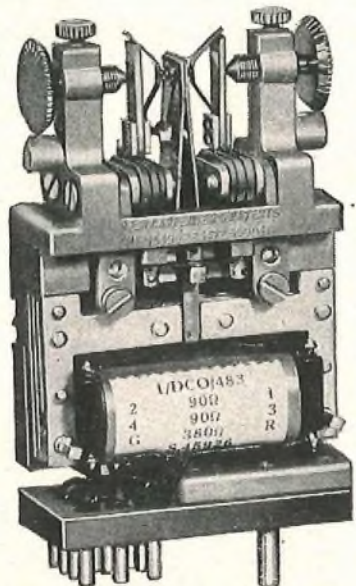

have these outstanding features

- HIGH OPERATIONAL SPEED • HIGH SENSITIVITY
- FREEDOM FROM CONTACT REBOUND
- NO POSITIONAL ERROR • HIGH CONTACT PRESSURES
- ACCURACY OF SIGNAL REPETITION
- EASE OF ADJUSTMENT

The Carpenter Polarized Relay will respond to weak, ill-defined or short-duration impulses of differing polarity, or it will follow weak alternating current inputs of high frequencies and so provide a continuously operating symmetrical changeover switch between two different sources.

Dimensionally the Type 4 relay illustrated is interchangeable with the type "3000" Relay and can be supplied to fit directly to the drilling normally provided for the "3000" Relay.

Manufactured by the sole licensees

TELEPHONE MANUFACTURING CO. LTD

Contractors to Governments of the British Commonwealth and other Nations



HOLLINGSWORTH WORKS, DULWICH, LONDON, SE21

Telephone GIPsy Hill 2211

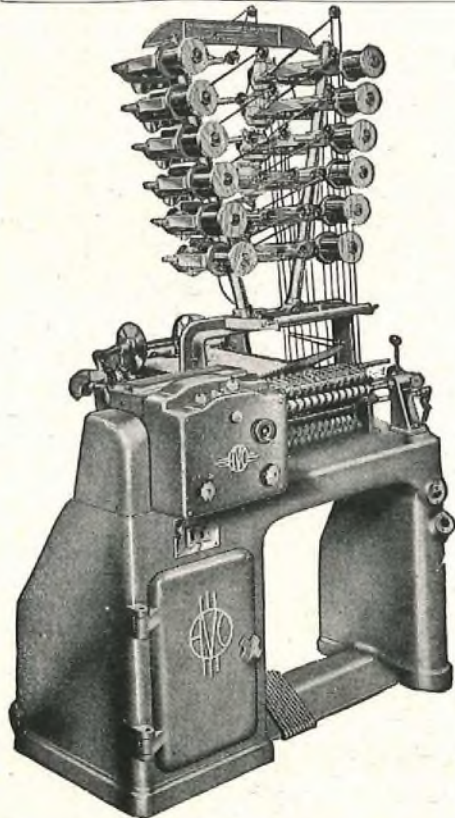

DOUGLAS AND MACADIL

Automatic
COIL WINDERS

The large illustration depicts the improved "Douglas" Fully Automatic Multi-Winder, specially developed for the high speed production of large quantities of coils with or without paper interleaving. It will produce round, square

or rectangular coils up to 6 in. each in length and up to 4½ in. diameter. As many as 12 smaller coils can be wound simultaneously within the total available winding length of 15 in. at headstock speeds of between 600 and 2,000 r.p.m.

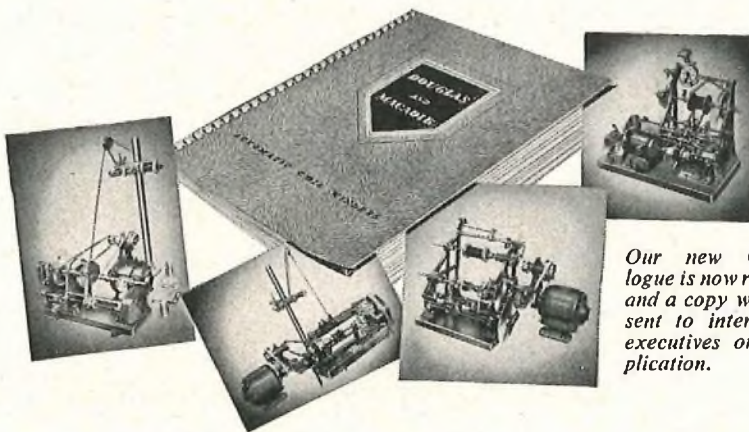

Our new Catalogue is now ready, and a copy will be sent to interested executives on application.

Sole Proprietors and Manufacturers

THE AUTOMATIC COIL WINDER & ELECTRICAL EQUIPMENT CO., LTD

Avocet House, 92-96 Vauxhall Bridge Road, London, S.W.1

VICTORIA 3404 (9 lines)



Difficult to fit?

There are generating problems which standard generating plant solves perfectly. There are others so unusual that no standard plant could conceivably fit them. These are the problems Austinlite engineers enjoy most. They are prepared to go anywhere in the world to discuss their solution.

It does not matter whether the plant will be required to run continuously for months without attention; to isolate

delicate equipment from mains that are subject to voltage surges; or to take over instantly when a mains supply fails. Provided there is a solution, Austinlite plant can be built which will ensure a steady, unbroken, flow of power. Made-to-measure generating plant is Austinlite's forte. But not the only kind they make. There are standard types of Austinlite Generating Plant which fit many jobs perfectly. Quite difficult jobs. For the idea that links all types of Austinlite plant, standard *or* made-to-measure, is the idea of utter reliability.

Austinlite **AUTOMATIC GENERATING PLANT**
Tailor-made by STONE-CHANCE LTD.

Two NEW miniature Relays

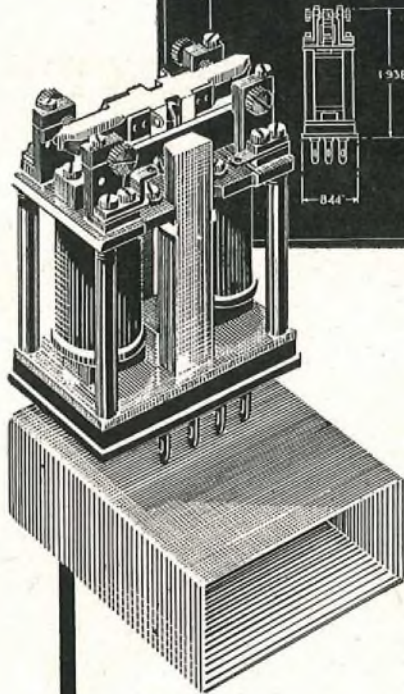

1 Polarised Relay

- ★ High magnetic sensitivity
- ★ Large winding space • High copper efficiency
- ★ Symmetrically balanced movement
- ★ High Thermal and Shock stability
- ★ Low susceptibility to magnetic interference

2 Type 1A Relay

- ★ Exceptionally high sensitivity
- ★ Balanced movement
- ★ High Thermal and Shock stability
- ★ Hermetically sealed

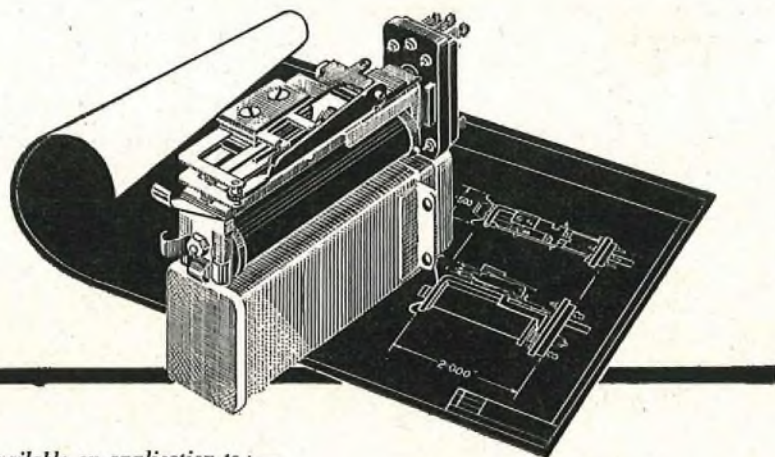

TELEPHONES
Ericsson
LIMITED

Catalogue available on application to: —

Head Office: 22 LINCOLN'S INN FIELDS LONDON WC2 Tel: HOL. 6936

E.17

Selector SE 50 ...

Nowhere in a telephone exchange is the reliability of Selector SE50 more fully proved than by its excellence in doing the exacting job of a linefinder.

Selector SE50 stays adjusted in this most arduous function—showing the soundness of its basic design, with the wear-reducing maximum of metal-to-metal contact area for all mechanical movement and the absence of bending adjustments.

In addition, the vertical-marking bank is attached to the selector frame, and thus needs no separate manipulation when the linefinder is jacked-in or out. The vertical wiper, of a simple design that gives consistent contact pressure during vertical motion, rotates with the selector shaft away from its bank, thus eliminating any form of level-marking trouble during rotary hunting. Space is saved by the use of only two relays for each 200-outlet linefinder. The simple circuit has common control relays for a group of switches.

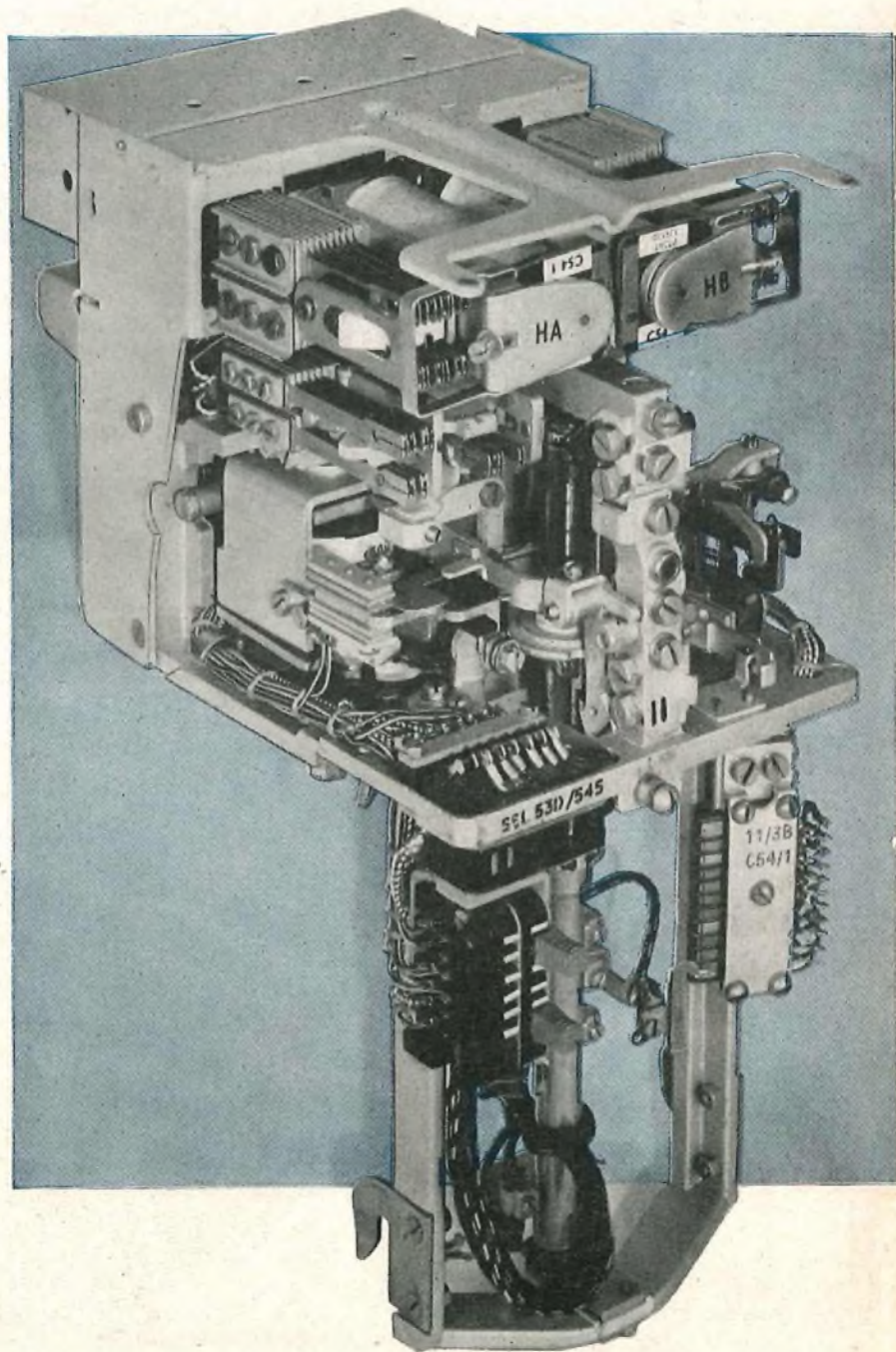

the universal switch

as group selector



final selector



Discriminating
selector repeater



and as *LINEFINDER*

Interesting features in Strowger exchanges by G.E.C. using the SE50 as a 200-outlet linefinder:

No linefinder normally has to hunt over more than five bank levels, because of the simple multiplying method. The possibility of wear is reduced and speed of search increased. An allotter fault does not tie up linefinders or group selectors because, through self-routining, any faulty allotter is automatically relieved by another.

A subscriber's line fault, if it causes 'linefinder chase,' extends an automatic alarm even before dialling commences.



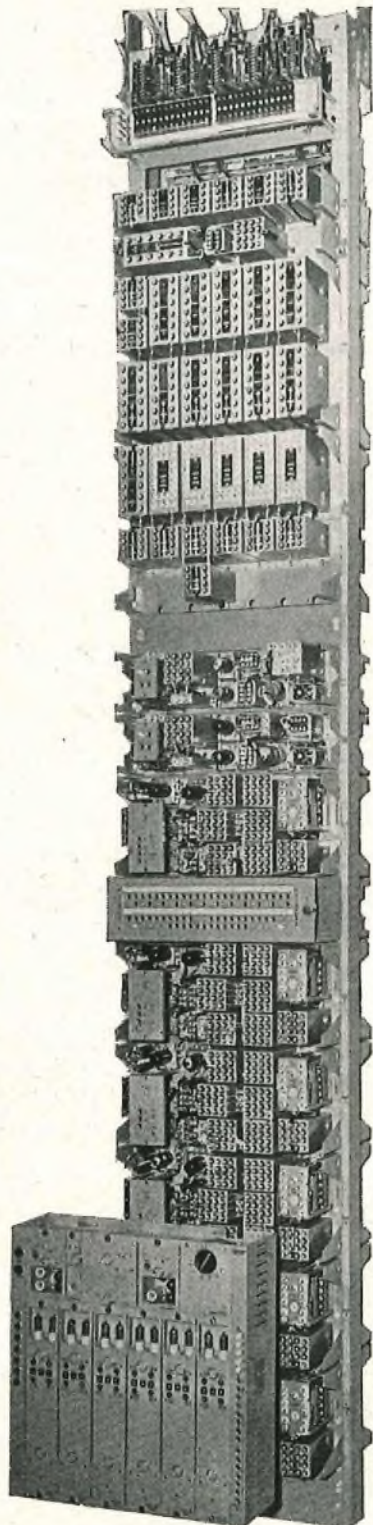

SKILLMAN

Short Distance Carrier

With FULL 3,400 Cycle Band!

* Six channels per pair of single cable or twelve channels per pair of double cable. Old type inter-exchange cables in city networks can be counted on to give at least 30% pairs suitable for carrier working, i.e. cable capacity is doubled.

* No repeaters required on most city networks. Hence extra circuits obtainable in a few hours.

* The equipment often proves economic over distances as short as 2 miles by providing temporary extra traffic capacity, and thus delaying investment of funds until traffic has grown enough to occupy a reasonable proportion of new cable capacity (e.g. 12 extra carrier channels may easily be cheaper than the minimum economic new cable providing, say, 100 extra channels).

* Signalling is by low-level tone, present continuously during speech, and having a frequency of 0 cycles (i.e. the carrier frequency). Thus the circuits are the same as for D.C. paths, and voice operation troubles non-existent.

* All channels adjustable to low or zero transmission loss, and when required can give a gain.

The small panel on the left is the same as that on the right and replaces the entire bay shown behind.



T. S. SKILLMAN & CO. LTD., Grove Park, Colindale, London, N.W.9

T. S. SKILLMAN & CO. PTY. LTD., Cammeray, Sydney, N.S.W.

We now announce the removal of the last difference between our very simple and cheap short-distance carrier equipment and the usual long-distance equipment. We can now offer the equipment with a full 3,400-cycle band, in every respect being identical with the earlier equipment but with 5-Kc/s spacing. Even wider bands can be obtained if required.

- 6 Kc/s spacing
4,100 cycle circuits
- 5 Kc/s spacing
3,400 cycle circuits
- 4 Kc/s spacing
2,800 cycle circuits

Normal copper inter-office line with small relay group for repeating impulses. This is cut at X and reconnected as shown.

Five new lines indistinguishable from D.C. lines in all respects, except superior speech transmission performance. Relay groups identical with those on D.C.

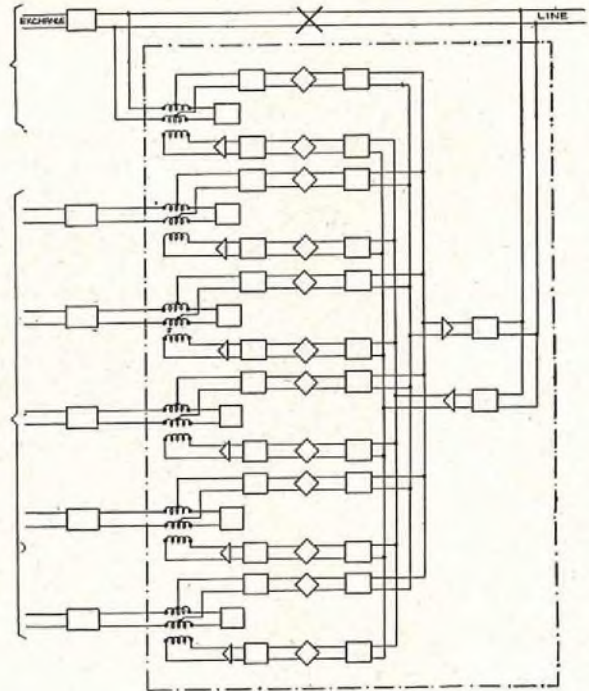

All the equipment within the dotted line is mounted on the panel shown below.

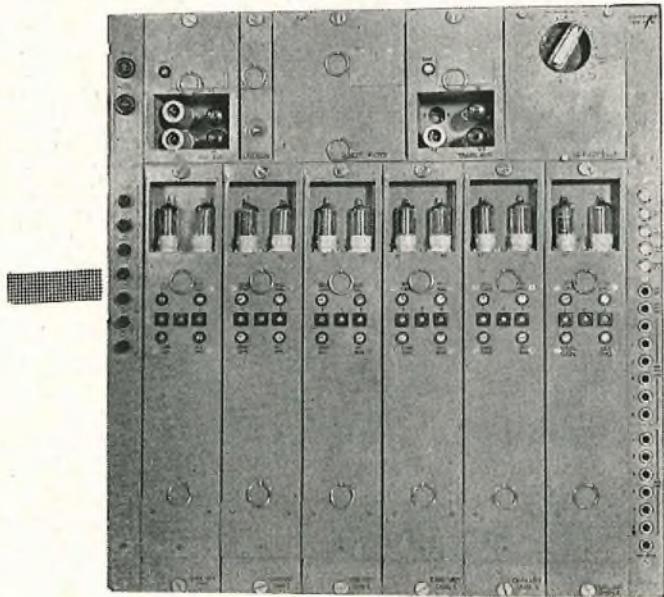

SKILLMAN'S are world pioneers of short haul or "junction" carrier systems. Over £500,000 worth of the old style equipment indicated opposite is in service, much of it for over 4 years.

The miniaturised form is now available, on a 21" panel with 60 channel ends plus power supply on one 19" rack. Installation involves connecting only new junction relay groups, power (A.C.) and carrier supply and deloading the junctions.



By Appointment to the Professional Engineer

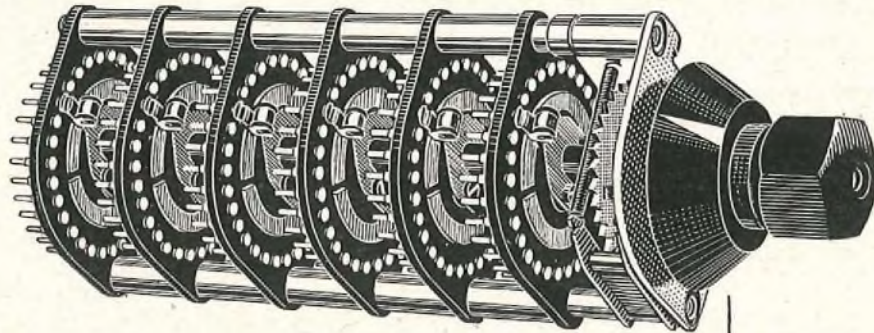

PAINTON WINKLER SWITCH

VOLTAGE RATING: 250 volts A.C./D.C. (maximum).

CURRENT RATING: 0.5 amp. (maximum).

Switching up to 29 positions (single-pole) per bank, or up to 30 positions per bank for 360° rotation.

SINGLE, DOUBLE, THREE-POLE or FOUR-POLE.

Painton Winkler Switches can be supplied for either 'Make-before-Break' or 'Break-before-Make' operation.

1-6 BANKS OPERATED FROM A COMMON SHAFT.

Each switch has an adjustable stop device, by which the switch can be set to the number of positions required.

AVERAGE CONTACT RESISTANCE: BETTER THAN 0.004 OHMS.

The distinctive Painton knob type K21, with the 'adjustable skirt' feature has been specially designed to operate Painton Winkler Switches.

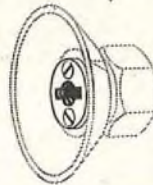

The white pointer can easily be lined up with dial markings. The friction-plate can be loosened by two screws, allowing the skirt of the knob to rotate.

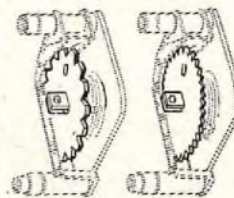

'Break-before-Make' or 'Make-before-Break' operation.

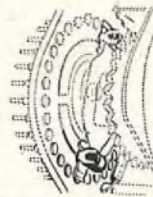

The 'direct-link' wiper provides a low capacity and inductance connection between the individual contact studs and the collector ring, and because the wiper is freely pivoted a constant and even contact pressure is obtained.



The contact studs are moulded into the nylon-filled phenolic resin panel, and though normally Silver-plated, can be specially Rhodium-plated if required. The rigid stems of the contact studs are tinned to facilitate soldering connections.

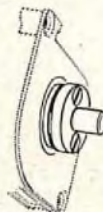

The number of operating positions can be altered. Two stop plates can be adjusted by loosening a friction-plate clamped by two screws.

PAINTON
Northampton England

***Designed to
meet G.P.O. specifications***

TUNGSTONE Batteries have been designed to meet Post Office and British Standards specifications. They are being used in Telephone Exchanges and Power Stations, etc., all over the British Isles; in Australia, India, New Zealand, Egypt, South Africa, West Indies, etc.

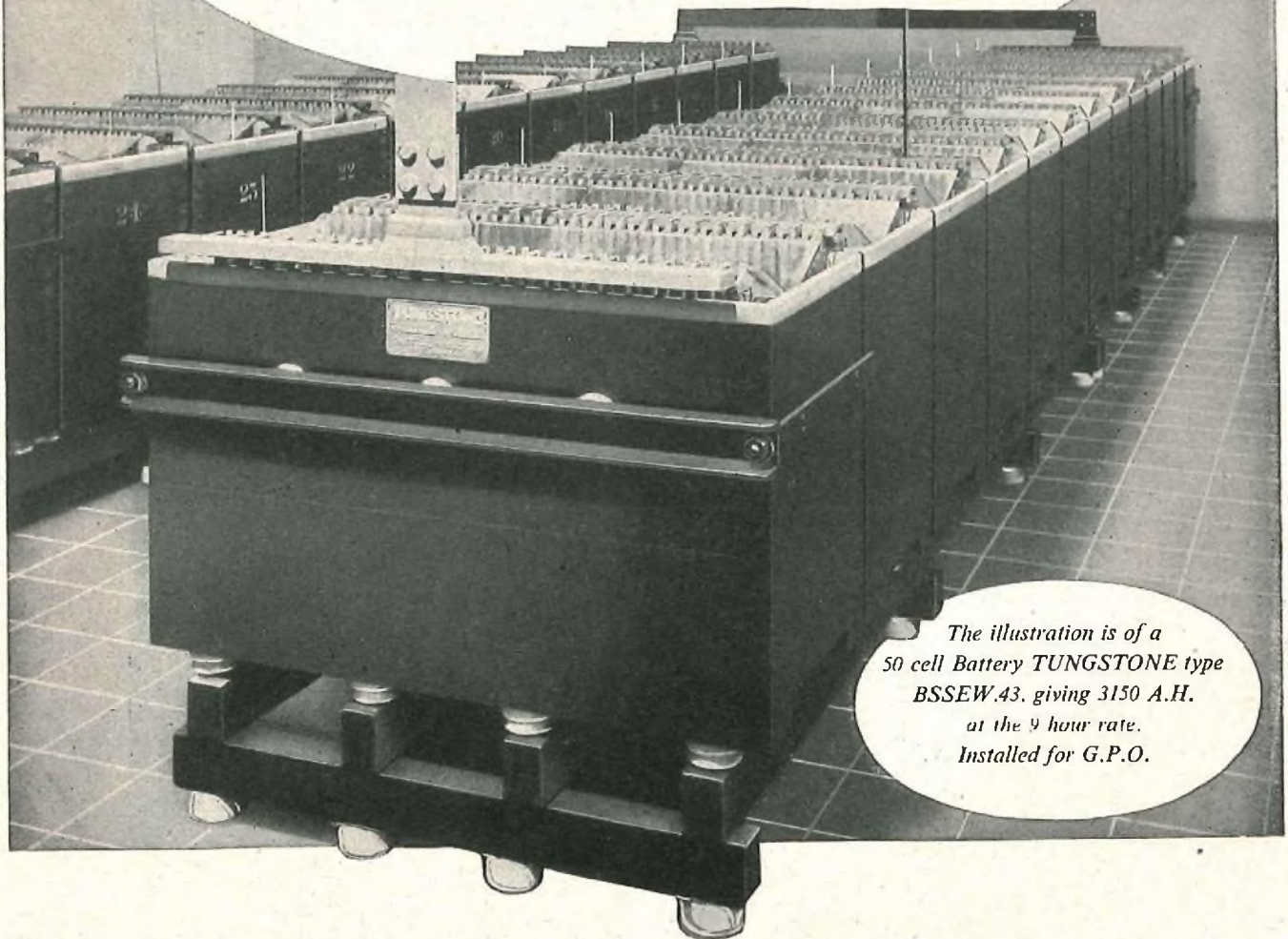

*The illustration is of a
50 cell Battery TUNGSTONE type
BSSEW.43, giving 3150 A.H.
at the 9 hour rate.
Installed for G.P.O.*

TUNGSTONE Batteries

TUNGSTONE PRODUCTS LIMITED

10 SALISBURY SQUARE, LONDON, E.C.4 · WORKS: MARKET HARBOROUGH, LEICS.

PC 11

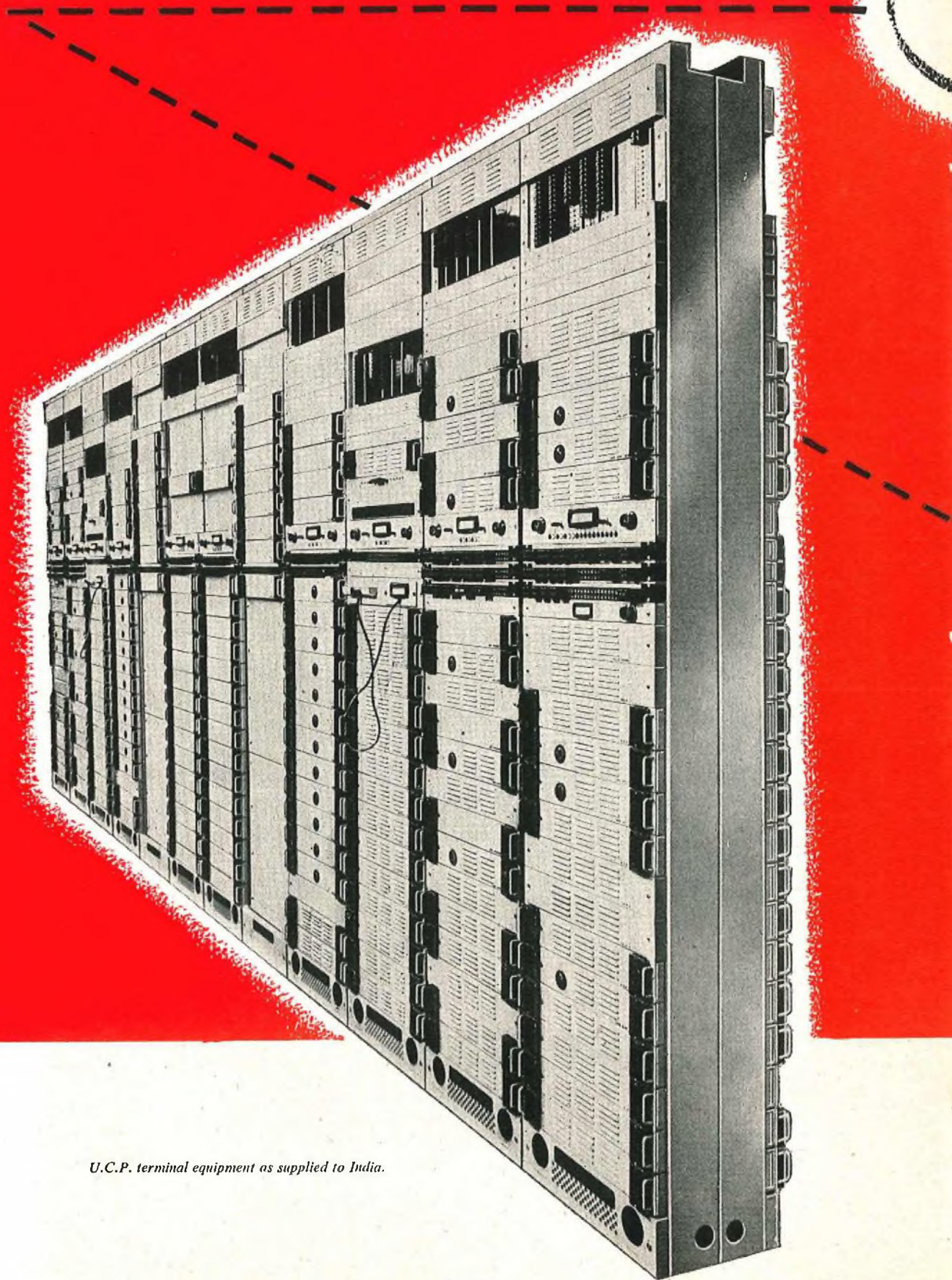

U.C.P. terminal equipment as supplied to India.



DESIGNED

for continuous service

A. T. E. line transmission equipment is designed on a unit-construction principle, found by experience to be best suited to the needs of operating administrations. The various fundamental circuit operations are performed by functional units ; these are small self-contained assemblies designed for rapid fixing to a panel frame which plugs into the bayside. As certain basic circuit functions are common to a number of systems the functional units are themselves applicable to another type of circuit or system and as they are self-contained supplies can quickly be fed from a common maintenance stock. Continuity of service to the subscriber remains while any necessary maintenance routines are carried out.

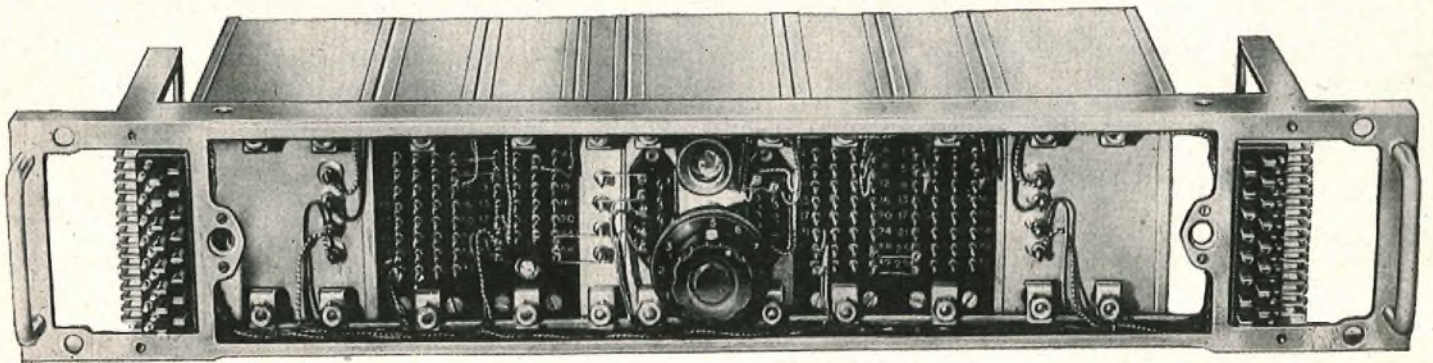
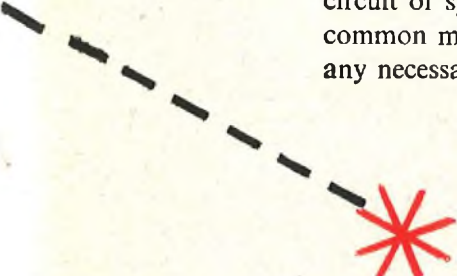

AUTOMATIC TELEPHONE & ELECTRIC CO LTD

RADIO AND TRANSMISSION DIVISION
Strowger House, Arundel Street, London, W.C.2
Phone: TEMple Bar 9262 Grams: Strowgerex, London

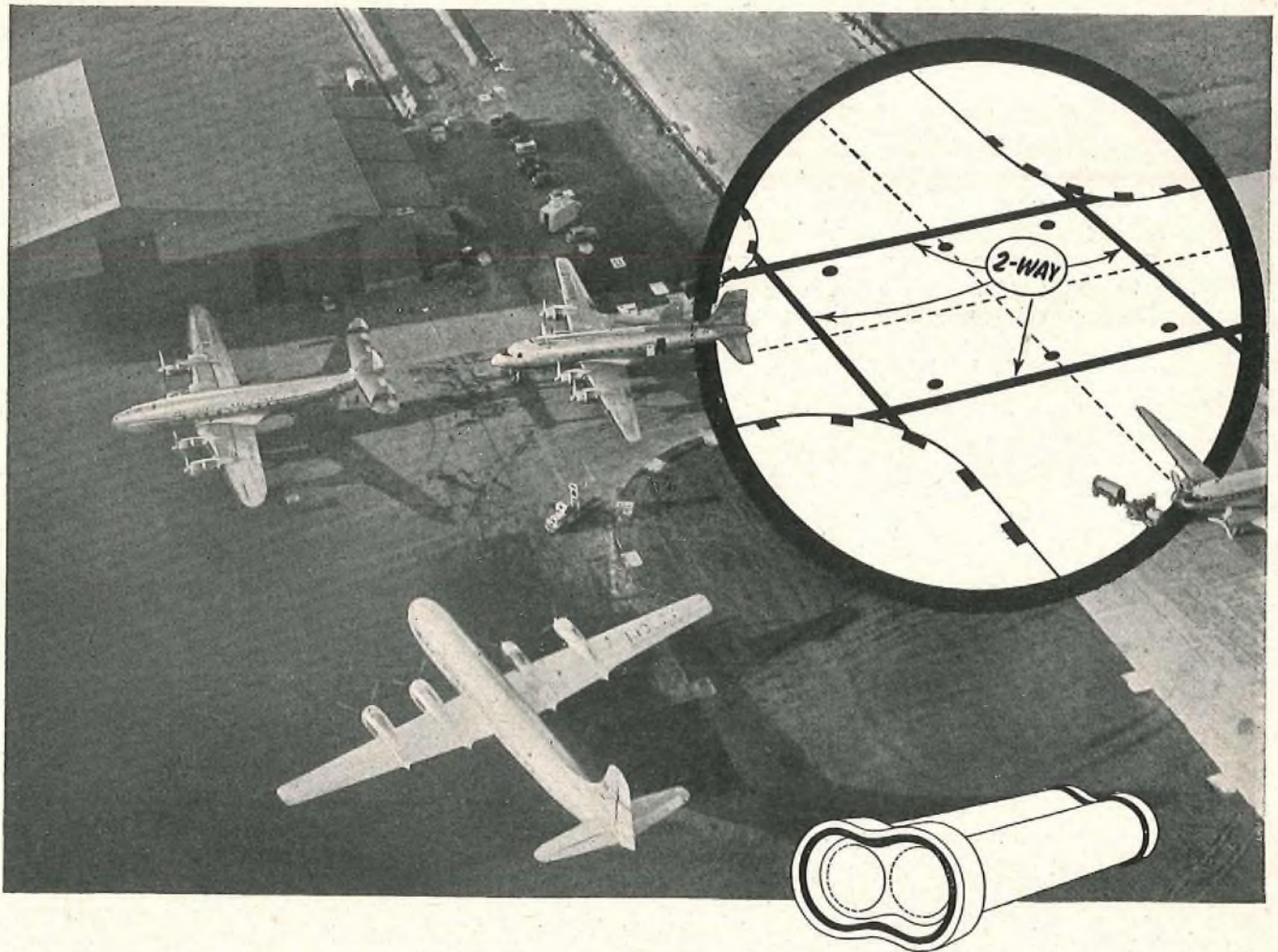

Under an Airport Runway

***If you never
want to have
to dig them
up again
put down***

This is a key point in an airport runway pattern. You lay electric cables under here, to serve the runway lights. Those cables must be easy to get at, easy to service. So you run your cables through conduits — in this case 2-way conduits.

If anything goes wrong with those conduits, if they have to come up again — think of the chaos. Think what would happen at a big airport. Last year *in August alone* London Airport handled nearly 9,500 aircraft and 210,000 passengers. A lot depends on those conduits — you never want to have to dig them up again.

That's why, at London Airport, they put down conduits of salt glazed vitrified clay.

Salt glazed conduits are glassy smooth and hard as nails. They are acid-resisting. Sulphates in the soil cannot corrode them. They go down for good! The same applies to the hundreds of salt glazed *drainpipes* that are out there too. Safe and efficient, salt glazed conduits and pipes can — and do — stay down for centuries.

Salt Glazed



pipes and conduits

NATIONAL SALT GLAZED PIPE MANUFACTURERS' ASSOCIATION



CATHODEON

Quartz Crystals

FOR
RELIABLE
FREQUENCY
CONTROL

Prompt Delivery, all types, 2,000—20,000 kc/s
When ordering 10X replacements, why not use our hermetically sealed Type 2XL?

CATHODEON CRYSTALS LIMITED

LINTON · CAMBRIDGESHIRE · Telephone LINTON 223

SIEMENS MULTI-CHANNEL A.C. TELEGRAPH EQUIPMENT

TYPES CTS/6—CTS/24

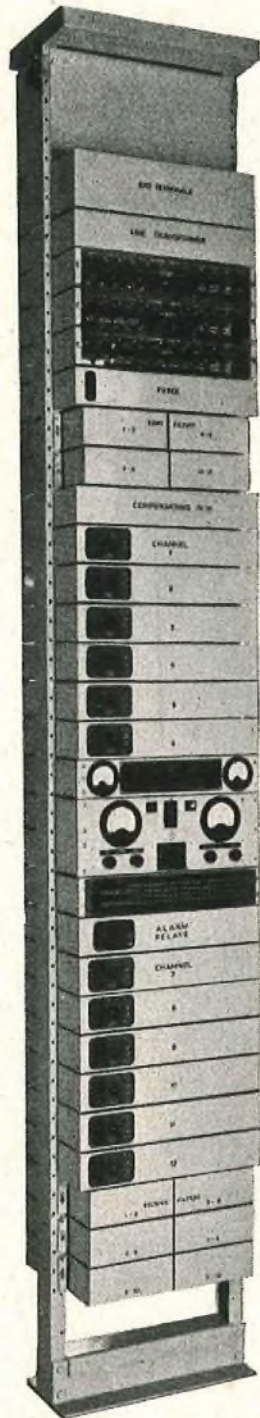

CHANNEL BAY

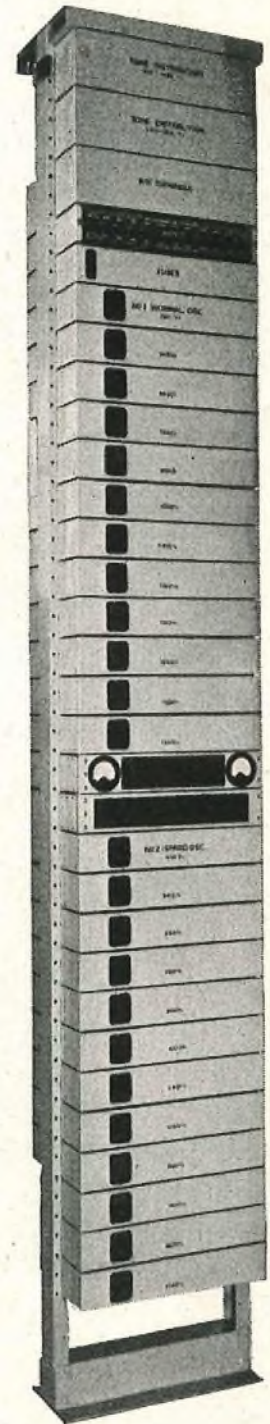

OSCILLATOR BAY

FEATURES:

From 6 to 24 channels available.

Mounts 12 channels on one side of a 10' 6" bay.

Additional channels beyond 12 obtained by group modulation.

Associated bays provide duplicate generators or valve oscillators for tone supplies or for channel and group frequencies.

Capacity of bays, 10 systems.

Tone frequencies are 420 to 3,180 c/s at 120 c/s spacing, and equipment complies with CCIT requirements in all respects.

Wide transmission level range for low distortion.

Sending modulator and receiving detector-amplifier panels readily detachable for maintenance by plug and jack connections.

Equipment operates from 24V and 130V batteries or from separate A.C. mains Power Bay.

Testing equipment provided as standard on the Channel Bay.

Further particulars on application



SIEMENS BROTHERS & CO., LIMITED

WOOLWICH . LONDON . S.E.18

Telephone: Woolwich 2020

SOLDERING
INSTRUMENTS and
ALLIED EQUIPMENT
by **ADCOLA**
PRODUCTS LIMITED
(Regd Trade Mark)

DESIGNED FOR

**Sound Equipment
AND
Bench Line Assembly**

Bit Sizes

$\frac{1}{8}$ " to $\frac{1}{4}$ "

Volt Ranges

6-7v to 230-250v

For CATALOGUES apply

HEAD OFFICE & SALES

ADCOLA PRODUCTS LTD.

GAUDEN ROAD, CLAPHAM HIGH STREET,
LONDON, S.W.4

Telephone: MACaulay 4272

CONTRACTORS TO
BRITISH & OVERSEAS GOVERNMENTS

ACTUAL
SIZE

3/16"
Detachable
Bit
Instrument
List 64

Protective
Shields
List 68



Telephone Talk



FOR MORE THAN FIFTY YEARS telephone engineers have grown up with automatic telephony. There are many systems in use throughout the world, each outstanding in some particular characteristic; ingenious circuitry, precision equipment, operational facilities. The most well known and widely adopted system is the Strowger step-by-step system, so called because

calls are completed through trains of selectors stepping directly in unison with the impulses dialled by the subscribers. The selectors are individually driven. These two features give the system a simplicity and flexibility not shared by other systems and account for the fact that over 66% of the world's telephones are Strowger. The advantages of a simple system are obvious. There is less likelihood of anything going wrong and when a fault does develop it is easily located and immediately put right. A new switch is simply plugged in to the place of the faulty one while this is being re-adjusted.

In the early days it was considered desirable for all the selectors to be periodically examined, to see if they still measured up to the mechanical and electrical tolerances previously specified. This meant that a staff of skilled adjusters had to be maintained in each exchange solely for the purpose of trying to prevent faults occurring; hence the name "preventive maintenance," given to this form of supervision.

At that time knowledge of metal fatigue and stresses was not so extensive as to-day, nor were special alloys and hardening treatments developed to anything like the same extent as has since occurred. It is likely then that many possible faults were rectified before they could cause a degradation of the public service and, more important, a great accumulation of experience was collected which has been of great value in recent investigations in the subject. These investigations were carried out over a lengthy period by Automatic Telephone & Electric Co. Ltd. and their purpose was to establish whether, in view of the great strides made in selector development, it was really necessary or desirable to

continue the cult of preventive maintenance, which is still normal practice even to-day in many telephone exchanges throughout the world. Details of the investigations are fully described in a bulletin "The case for a new approach to maintenance," a copy of which will be forwarded on request.

Experiments were conducted on the Type 32A Mark II selector, which is a logical development of the 1932 model, and incorporates those refinements which the Company's experience in the art of automatic telephony suggested as necessary in the light of modern requirements. Advances in recent years in metallurgy have also been applied in the manufacture and treatment of those parts subjected to wear.

Briefly the experiments compared batches of production selectors. Some were subjected to a "twenty year" life test with the normal preventive maintenance-routine and periodical checking and re-adjusting. Others were run for the same "life span" with no attention whatever apart from "annual" lubrication. The results, which have been amply proved by repeated experiments, are interesting.

Of ten selectors life-tested to an equivalent of twenty years with no attention other than annual lubrication there were a total of seven mechanism faults. The same selectors were given a further twenty years run and at the end of this period there were fourteen additional mechanism faults. During the forty-year run, the wipers had been changed and banks cleaned.

An additional batch of ten selectors was put through the normal preventive maintenance routines in a life test of twenty years and this time there was a total of twenty mechanism faults. The total number of service faults was fifty-three, as opposed to twenty-two for those selectors not put through the preventive maintenance routines.

The Company's conclusions, which will be of interest to all telephone administrations, may be simply stated. Preventive maintenance is neither necessary nor desirable; it is necessary only to lubricate and clean the mechanism at regular intervals. The observance of this simple routine will ensure reliable performance indefinitely, the factor above all upon which the administration and the subscribers depend for good service and economic operation.



AUTOMATIC TELEPHONE & ELECTRIC CO. LIMITED

AT7881-A



It does you good to look around you here. You'll never see farms in better heart or villages in better shape or cottage gardens more skilfully tended, than you will from the roads and lanes round Alton. And in Alton itself you'll find plenty of evidence of the local belief that what's worth doing is worth doing well. The reason? Possibly this belief—less widely held than it was, some people think—flourishes best where families take root, and cottager, no less than squire, grows up with a sense of belonging—by right of birth. In the Battery Works son still follows father at the bench—as proud of his skill as his father was, as touchy concerning his personal standard of work. And as proud, and with equal right to be, of the workmanship Alton men put into Alton batteries.

ALTON *Batteries of Merit*

Alton stationary batteries: 10 to 15,000 ah. Also in regular production renewal plates for all makes of battery, British and Continental.

THE ALTON BATTERY COMPANY LIMITED, ALTON, HANTS · Telephone: ALTON 2267 and 2268 · Telegrams: BATTERY, ALTON

A.28

Improved filter units

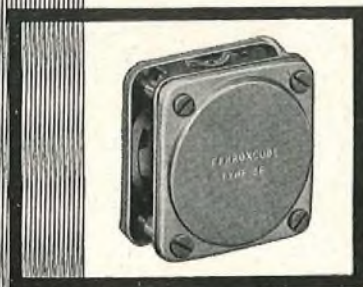
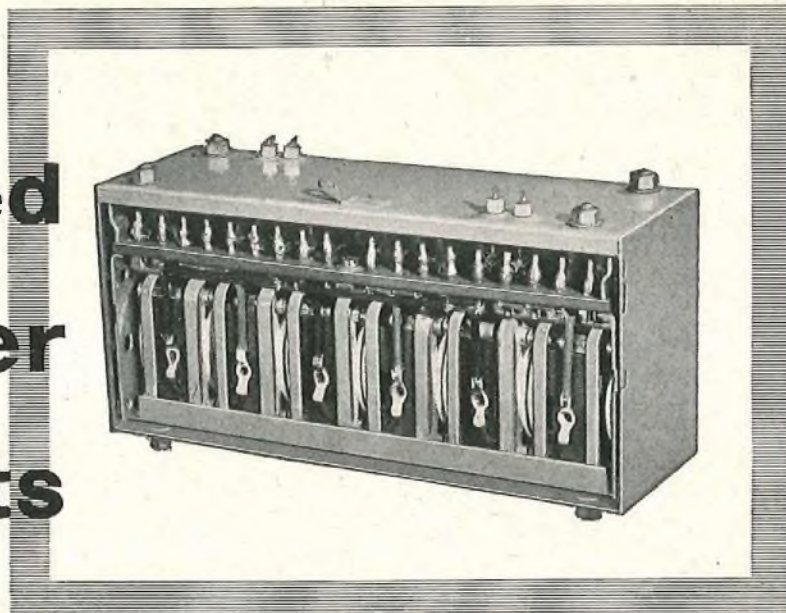

with Ferroxcube pot cores

- 1 *High performance combined with small size and light weight.*
- 2 *Designed and built to customers' individual requirements.*
- 3 *Long term stability, even under conditions of temperature variation.*

High quality electrical filter units built around Ferroxcube cores can now be supplied to communications equipment designers' individual specifications. These filter units have significant advantages over comparable types designed without the use of Ferroxcube, particularly in the frequency range 300 c/s to 500 kc/s. For audio frequencies the use of Ferroxcube cores permits the winding of compact coils with very high inductances. This results in a considerable reduction in the size and cost of the associated condensers and hence of the filter unit as a whole. The high Q values obtained for a given volume, especially above 10 kc/s, enable sharp cut off characteristics and low pass-band losses to be achieved, while negligible stray flux facilitates the production of compact and mechanically robust filters. Electrical filter units are among a number of high quality components now being made available by Mullard. Full details of the complete series of components will be gladly supplied upon request.

Mullard



'Ticonal' alloy permanent magnets
Magnadur permanent ceramic magnets
Ferroxcube ferro-magnetic cores.

MULLARD LTD • COMPONENTS DIVISION • CENTURY HOUSE • SHAFTESBURY AVENUE • WC2
(MI463A)

**THIS INTERESTING QUARTERLY
WILL BE MAILED FREE TO ANY
PART OF THE WORLD**

For almost a century Muirhead & Co. Limited have manufactured precision electrical instruments, and to-day the range of products include measuring instruments for education and industry, synchros and remote control systems and facsimile transmitters and recorders.

Each issue of "Technique" contains details of the newest Muirhead products and of scientific developments in which Muirhead instruments have played an important part. If you think this publication would interest you, we shall be pleased to place your name on our mailing list. Write under your business letterhead to the address given below.



MUIRHEAD

PRECISION ELECTRICAL INSTRUMENTS

136

MUIRHEAD & CO. LIMITED • BECKENHAM • KENT • ENGLAND

FERRANTI
7-Range
CLIP-ON AMMETERS



TYPE 'L' (Right). 0-10-25-50-100-250-500-1,000 Amps. Specially designed for use on porcelain-clad fuses and heavy-duty conductors up to 4 in. dia. Write for List IN.17.L.

TYPE 'A'. 0-10-25-50-100-250-500-1,000 Amps. Write for List IN.17A.

TYPE 'V'. 0-10-25-100-250-1,000 Amps, and 0-150-600 Volts. Write for List IN.17V.

A leather case with shoulder strap is available for all models at extra charge

FERRANTI LTD • MOSTON • MANCHESTER 10 • ENGLAND

London Office: KERN HOUSE, 36 KINGSWAY, W.C.2

F1140

TELEPHONE DISTRIBUTION

EQUIPMENT

ENGINEERS WHO ARE INTERESTED
IN TELEPHONE DISTRIBUTION EQUIP-
MENT ARE INVITED TO REQUEST
SECTION T.C.13 OF OUR TELECOM-
MUNICATION CABLES CATALOGUE.

TELEPHONE:
SOUTHAMPTON
22141 (5 lines).

IRELLI GENERAL
CABLE WORKS, Ltd., SOUTHAMPTON

TELEGRAMS
"PIGEKAYBEL
SOUTHAMPTON"

EDISWAN

Telephone Line Protectors

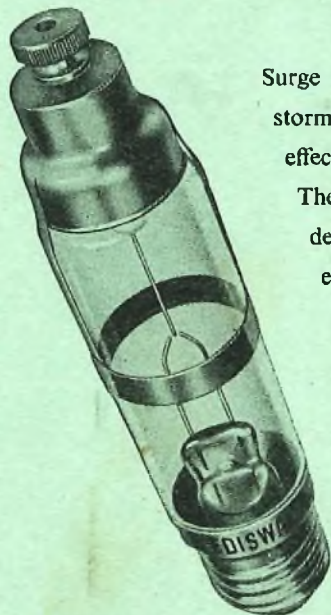

Surge currents induced on telephone lines by electric storms or breakdowns on neighbouring power lines may be effectively controlled by Ediswan telephone line protectors.

These special electrode gas discharge tubes have been developed in collaboration with G.P.O. Engineers to provide economical and effective protection for telephone systems without impairing the service.

Full details of these protectors and their application is given in the Ediswan publication C.1581 which is available on application.

THE EDISON SWAN ELECTRIC CO., LTD.

155 CHARING CROSS ROAD, LONDON, W.C.2

Member of the A.E.I. Group of Companies

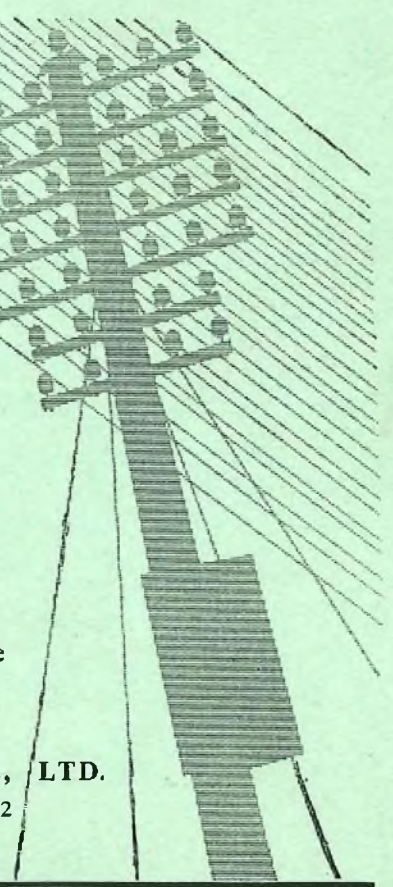

TE107