

VOL. 38

JANUARY, 1946

PART 4

CONTENTS

	PAGE
FOREWORD TO VICTORY NUMBER—A. J. Gill, B.Sc., M.I.E.E., F.I.R.E.	97
THE AIR RAID WARNING SYSTEM—G. B. W. Harrison, B.Sc., A.M.I.E.E.	98
CHANNEL ISLANDS COMMUNICATIONS AND THE WAR—W. R. Tyson, B.Sc.(Eng.), A.M.I.E.E. ..	102
THE BOMBER LINES—A. G. Robins, A.M.I.E.E.	105
FIGHTER COMMAND COMMUNICATIONS—A. M. Hanna	109
THE BATTLE OF THE ATLANTIC AND THE POST OFFICE—G. A. Alston, F. E. Bland, B.Sc.(Eng.), A.M.I.E.E., C. F. Perryman and C. E. Worthington	113
POST OFFICE EQUIPMENT FOR RADAR—P. A. Marchant, A.M.I.E.E., and K. M. Heron, A.M.I.E.E. ..	117
THE TELECOMMUNICATIONS NETWORK FOR DEFENCE— Part I—The Defence Teleprinter Network—F. E. Nancarrow, O.B.E., A.R.C.Sc., M.I.E.E.	121
Part II—The Network of Telephone Circuits and the Defence Telecommunications Control—H. R. Harbottle, O.B.E., B.Sc.(Eng.), D.F.H., M.I.E.E.	125
SAFEGUARDING TELECOMMUNICATIONS IN WARTIME—H. F. Epps, B.Sc., A.M.I.E.E.	127
THE RECEIVING END OF "COVENTRATION"—O. D. Robinson, A.M.I.E.E.	132
POST OFFICE CABLE COMMUNICATIONS FOR THE INVASION ARMIES—J. Rhodes, B.Sc.(Eng.), A.M.I.E.E.	136
HEADQUARTERS NOTES	140
REGIONAL NOTES	145
NOTES AND COMMENTS	154
STAFF CHANGES	157
INDEX TO VOLUME 38	159

Price 1/- net



QUARTZ PLATES

Standard Crystals cover 3.5/10 Mc/s. — but can be supplied for other frequencies and for a wide range of frequency-temperature characteristics.

Made in hundreds of thousands per annum for the services all over the world.



*for
Communication
Equipment*

Made by

SALFORD ELECTRICAL INSTRUMENTS LTD.

PEEL WORKS, SALFORD, 3.

Proprietors: **THE GENERAL ELECTRIC Co. Ltd., of England**

*For large scale
Electrical
Purposes*



It is noteworthy where Tudor accumulators are to be found fulfilling the most important duties: over 500 British Power Stations installed Tudor. Many Tudor installations rank among the largest in the land and have an enviable reputation for long-lived reliability. No matter whether they were installed only yesterday, or over thirty

years ago—as many of them were—they are to-day functioning with consistent efficiency.

SAFETYLYTE is the Tudor Emergency Lighting System, which is automatic and instantaneous in operation. It is installed in thousands of schools, hospitals, factories and other large buildings.



TUDOR ACCUMULATORS

THE TUDOR ACCUMULATOR CO. LTD
50 GROSVENOR GARDENS, LONDON, S.W.1

THE POST OFFICE ELECTRICAL ENGINEERS' JOURNAL

Vol. XXXVIII

January, 1946

Part 4

VICTORY NUMBER

FOREWORD BY THE CHAIRMAN, BOARD OF EDITORS

THE victorious conclusion of World War No. 2 enables some account to be given of the part played by Post Office engineers at home and this issue of the *P.O.E.E. Journal* has been devoted to this subject.

It is perhaps not generally realised that every gun site, barrage balloon, observer corps post, radiolocation station, air raid siren, N.F.S. station, civil defence post, Home Guard headquarters, etc., depended upon the Post Office telecommunications service for its efficient operation. R.A.F., Bomber, Fighter and Coastal Command aerodromes, similar U.S.A.A.F. stations, Army camps and depots, and Naval establishments required vast networks of wires to link up remote sites in all parts of the country. The Foreign Office, too, was an insatiable customer for radio and line equipment and circuits for its intelligence services. On top of this the Royal Ordnance Factories, key industries and other Government Departments made heavy demands on the Post Office, which the dispersal of industry and the migration of population under the Government evacuation schemes accentuated.

For the public service a large amount of work was involved in safeguarding essential circuits and repairing damage due to enemy action. Arrangements had also to be made throughout the country for allowing "essential" subscribers priority over "non-essential" subscribers, involving alterations to every automatic telephone exchange in the country.

Nor were the demands on the Post Office confined to requirements in the United Kingdom. The Post Office put at the disposal of the Services the facilities of its many laboratories, where a variety of problems of a highly technical nature were tackled, and co-operated in the development of many types of Service equipment, undertaking the purchase and testing of most of the telecommunication equipment required by the Services abroad. It also undertook, in collaboration with the Services, Supply Ministries and the Board of Trade, the control of the manufacture and supply of line telecommunication equipment and cable for all users, including the Dominions, Colonies and Allied Countries. Post Office cable ships and radio stations provided and maintained external communications between this island fortress and the rest of the Allied Countries and featured prominently in the "D" Day arrangements.

Frequently the Post Office's services were requested for non-telecommunications tasks; for instance, the Post Office inspected the Morrison and Anderson shelters for the Home Office and co-operated in the design of the H.A.I.S. cable used for P.L.U.T.O. Other tasks included the provision of remote control facilities for lighting decoy fires; the development of means of locating buried persons and unexploded bombs, etc.: the list could be extended almost indefinitely.

To describe all these activities in the space allowed by the Paper Control is impossible. All that is attempted in this issue is to outline briefly some of the major tasks accomplished. Naturally the subjects chosen are the more spectacular ones, but it must not be inferred from this that the Journal is unmindful of the many less spectacular jobs undertaken by an overloaded and diluted staff—one-third of the Post Office engineering staff were serving with the Armed Forces—often under conditions of considerable hardship and danger; jobs which were just as essential to ultimate victory as those which received most of the limelight.



The Air Raid Warning System

G. B. W. HARRISON, B.Sc., A.M.I.E.E.

U.D.C. 621.395.74 : 614.8

A record of experience of operating the air raid warning system in the British Isles during the war, with references to the communication requirements.

The National Air Raid Warning System.

DEVELOPMENT and operation of the Air Raid Warning System was greatly the concern of the General Post Office. The requirements were a raid reporting system, so that on a map in a Service "operations room" could be plotted movement of both hostile and friendly aircraft, a communication system by which to disseminate air raid warning messages and remote control systems for sounding sirens on receipt of warning messages.

To keep pace with continual changes in enemy tactics, the system was under development throughout the war. Although, because of the need for economy in lines and equipment its telecommunications may have fallen short of the ideal, they proved sufficient for the job asked of them.

The Raid Reporting System.

Security still prohibits detailed description of the raid reporting system, but the needs of a raid warning organisation will be realised from consideration of the basic principles of raid reporting in this country. Co-ordinates of aircraft movement with reference to a standard gridded map of the British Isles were obtained from the Radar organisation and the Royal Observer Corps. The country was covered by a network of "posts" manned by members of the Royal Observer Corps, who reported by telephone to their respective headquarters, referred to as their centres, movements of all aircraft they saw or heard. The high standard of skill shown by these observers in the recognition of aircraft had to be seen to be believed, and was the result of ceaseless training and their keenness for the work. At each of the centres situated throughout England, Scotland and Wales was displayed, on a gridded map table, the tracks of all aircraft reported by the Observer posts proper to the centre concerned, and on an adjacent table there were also displayed tracks being plotted by neighbouring centres, together with relevant Radar information.

Warnings.

Air raid warnings employed in this country at the end of the European war were of two types, public and industrial. The public or National Air Raid Warning messages were four in number, namely :

Red, the siren "Alert."

White, the siren " Raiders Past."

Purple, the order to extinguish lighting otherwise exempted from the blackout regulations.

Purple-cancel-purple, used in certain areas only, to cancel the Purple.

One of these messages, selected according to pre-

vailing movement of hostile aircraft, would be issued as nearly simultaneously as possible to a block of territory about 20 miles square.

Industrial air raid warnings and subsequent release signals were given by bell codes to groups of factories. These warnings, by comparison with the public Alert, indicated a state of imminent danger.

Public Warning Distribution.

It was necessary to make extensive use of the public telephone network for the distribution of these messages, and it so happened that telephone groups or associations of groups proved in general of suitable size for warning districts. The basic requirement then was, with a minimum and known delay, to pass the message from the Air Raid Warning Officer who initiated it to the recipient who needed it. The communication channel for distribution is given in Fig. 1. The private wire from the warning centre terminated as a lamp signalling circuit at an ordinary telephone operator's position at the district distributing centre, usually a telephone group centre exchange. A loud sounding buzzer was also brought in by the calling equipment to help in affording the messages absolute priority for reception and distribution.

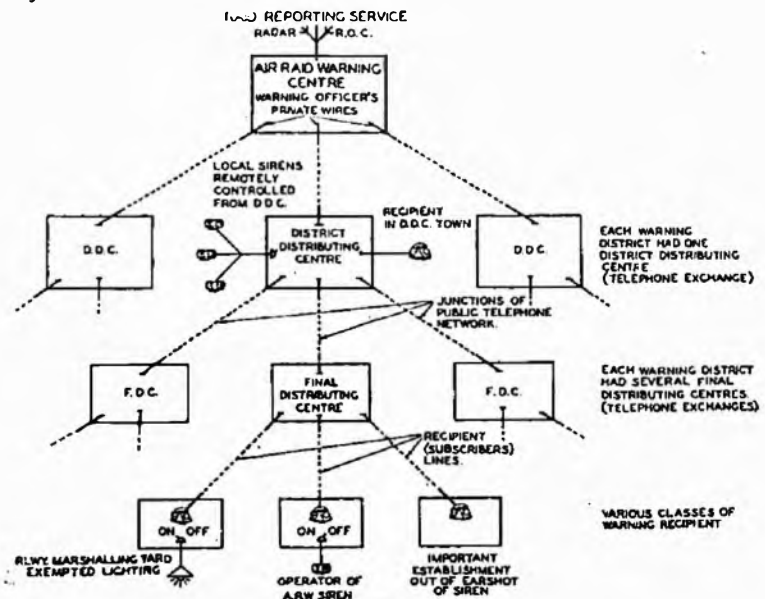

FIG. 1.—AIR RAID WARNING DISTRIBUTION.

The operator receiving the message at the district distributing centre immediately threw a key which lit a special and appropriately coloured signal lamp at all distributing positions. Hung up on the cornice rail of each such position was a millboard with the air raid message distributing list printed on it. On seeing the light the telephone operator took down the list

corresponding to its colour and proceeded with the distribution on her own initiative. Supervisors backed up and checked the distribution at each stage.

Outward from the district distributing centre all messages were passed over the public network. This had an unknown delay potential in that calling equipment could not be specially marked to give the operator any way of discriminating between air raid warnings and other calls. Moreover, if all junctions including alternative routings were engaged, the breaking down of another, quite likely urgent call, introduced difficulty and delay. By night these troubles were forestalled by setting aside junctions to be used as private wires for the sole purpose of passing air raid messages.

The final link in the chain was the ringing of the recipient. In some instances recipients rented a separate line for air raid warning calls. Cases of failure to answer promptly were taken up on behalf of the Ministry of Home Security by the local Chief Constable.

Because of the late stage of a raid at which industrial warnings were issued, their instantaneous and reliable dissemination was essential. This was achieved by a bell code signal with a distinctive variation to indicate the end of danger. A monitoring signal was usually provided for the warning officer to show that the signal had gone out from the relay set at the distributing exchange, which was in some cases as far as 20 miles distant.

A skeleton circuit showing the arrangements adopted by the Welsh and Border Counties Region is shown in Fig. 2. An associated timing circuit driven

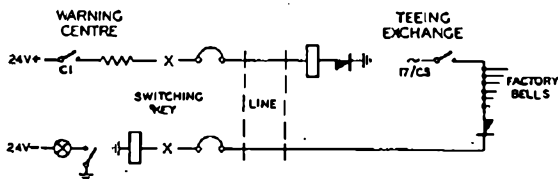

FIG. 2.—TYPICAL CIRCUIT FOR DISTRIBUTION OF INDUSTRIAL WARNINGS.

by one- and six-second clock pulses arranged that, when the alarm key was thrown, relay C was operated for one second on and one second off for half a minute, and, when the release key was operated, relay C was operated continuously for half a minute.

Liaison between Warning Centres and Tally of Warnings.

To ensure continuity in the plotted track of an aircraft moving across the country, each reporting centre kept all adjacent ones apprised of the details of the aircraft's progress as reported by their own Observers. To economise plant this liaison was maintained over one-way circuits. By the courtesy of the Royal Observer Corps the operational inter-centre "tellers" were instructed to tell to adjacent centres of air raid warnings issued by the warning officers at their own centre. The warning officer had consequently to let his colleague the teller know quickly of warnings he gave, without, at the same time, causing a disturbance in the operations room

by his actions. At the suggestion of the Ministry of Home Security, the Engineer-in-Chief (S. Branch) developed a simple but eminently satisfactory circuit by which a lamp display was given to the tellers simultaneously with the main display in the reporting centre.

The sequence of operations following a decision of the warning officer to issue a red warning was this. First he would call the district distributing centre operator over the private wire, give her the message and receive acknowledgment of its acceptance. Then he would throw the key to light red lamps against the name of the district on the main centre display panel and on the small display strip in front of the inter-centre teller. The teller then told the warning, e.g. "Southend Air Raid Warning Red" to all adjacent centres, afterwards depressing the cancel key. This extinguished only the teller's display, leaving alight the main display as a reminder to the warning officer that the Southend warning district was under a red warning.

At adjacent centres, plotters who listened continuously on the telling lines from the neighbouring centres controlled keys to display in their own centre the warnings they heard. This display helped warning officers in their own decisions by making known to them warnings issued and cancelled by their neighbouring colleagues. It also enabled warning officers at selected centres to report to Regional Headquarters warnings obtaining in each Civil Defence Region. This was of value in connection with operation of the Civil Defence Services.

Remote Control of Sirens.

One criterion of a satisfactory warning system is that any delay between the decision to warn and the recipients (e.g. the public) becoming apprised shall be a known minimum and constant figure. Delay in transmission of warning messages over the public telephone network is inevitable so that it was essential not to add to it by delay in sounding the sirens after receipt of the message. To this end remote control of sirens was advocated.

The Post Office system "A" was the common straightforward and simple system most often employed. Exchange control was a desirable elaboration by which the telephone exchange operating staff receiving a message for distribution could sound the sirens from the switch room. The simple system "A" provided instantaneous remote control of all sirens up to 30 miles distant, if desired, and automatic timing of the wails of the alert by switching the siren motor on and off at pre-arranged intervals by means of timing cams on a synchronous motor shaft. Exchange control gave, in addition to these advantages, automatic timing of the duration of the whole alert or raiders passed ("all clear") signal.

Heating of sirens by a 1 kW unit in each voice box to prevent seizure due to frost was not remotely controlled from a central point but by a thermostat located near to each siren.

The "Cuckoo" Siren Attachment.

The "Cuckoo" attachment was a device developed by the Research and Experiments Branch of the

Ministry of Home Security as a distinctive siren signal for use on Royal Air Force stations and in certain coastal districts.

The usual air raid warning siren unit was a 4 h.p. electric motor with sirens mounted on either end of the motor shaft. Both ends sounded simultaneously, notes differing in pitch in the ratio of 6 : 5. The cuckoo attachment allowed one end to sound alone by prohibiting entry of air to the siren blades of the other end. Thus, when each end was closed alternately, a sound said to resemble the notes of a cuckoo was obtained. When both ends were closed at the same time the siren, although running, was silent, so that by manipulation of both valves simultaneously a code of short or long blasts could be

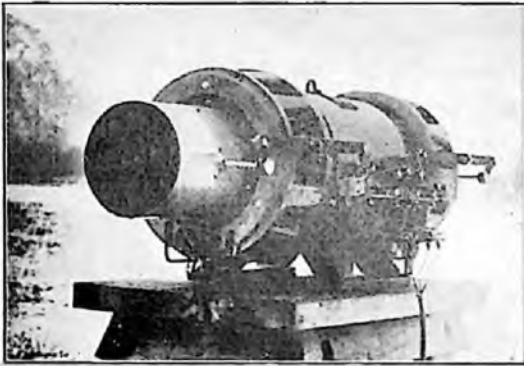

FIG. 3.—SIREN WITH "CUCKOO" ATTACHMENT.

sounded. The photographs, Figs. 3 and 4, show a siren fitted experimentally with the attachment, and

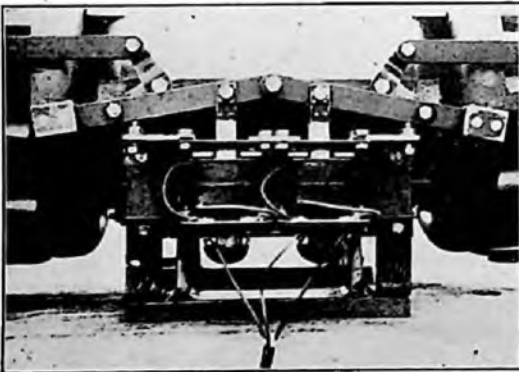

FIG. 4.—OPERATING LINKAGE OF "CUCKOO" ATTACHMENT.

a close up of the operating linkage. The Post Office system "A" exchange remote control circuit afforded remote control of the cuckoo butterfly valves from the standby control, usually at the local police station, as well as the sounding of the normal public air raid warnings from the local telephone exchange on receipt of the appropriate message.

London.

The delay between the warning officer initiating the message and the sirens voicing in the London Central Warning District was eventually reduced to about five seconds. To achieve this all sirens in that district

were put under control of one button in New Scotland Yard, and the warning officer at the warning centre responsible was given a private wire to the Yard.

The remote control installation, a development of the Post Office system "A," was arranged with live line testing because of the need for the utmost reliability, and several emergency standby systems were kept in reserve. These were :—

- (1) The Police teleprinter network to divisional siren sub-controls.
- (2) The G.P.O. standard warning distribution arrangements which normally gave the message to the sub-controls.
- (3) Wireless telephony between either New Scotland Yard or, indirectly, the warning officer and the sub-controls.

An outline of the London remote control system is given in Fig. 5 : 50 c/s mains were fed through an auto wailer, which interrupted the supply five seconds on three seconds off, to a frequency changer which changed the frequency to 100 c/s, at which frequency the whole system was operated. This supply fed a number of transformers, each feeding, via the individual control pairs, a contactor at a sub-control section station, or a local siren via a direct siren pair. The contactor at the sub-control in turn fed a number of siren contactors over direct siren pairs. An indicator alarm system was incorporated as a continuous test of the lines against earths or contacts.

Testing of Sirens.

Once a week the siren motors were momentarily switched on while an observer posted at each instrument watched to see whether it rotated freely. This was a satisfactory and virtually noiseless test both of the sirens and of part of the remote control apparatus. It was recommended that a sound test be held each month, unless the sirens had just been used to give a warning. To prevent alarm the time of the test was advertised and the "all clear" signal used before and after it. Finally, five times a year, maintenance examination and overhaul was called for. The state of maintenance of the sirens had considerable influence on the important factor of the time taken to voice when switched on.

Conclusions.

Operation of the Air Raid Warning System in this war led to the conclusion that such a system should be technically and politically flexible to meet changes in enemy tactics. Then there must be absence of delay, particularly incalculable delay, in its dissemination system. This would rule out the method by which the public telephone network was used in this war. The siren or equivalent remote control system must be instantaneous in operation, very reliable and preferably self-testing. A standby system, even then, is desirable. The sirens or other warning instruments must speak instantaneously after being energised.

The General Post Office did much during this war to keep pace with the demands of the Ministry of Home Security for improvements in the system, and

tribute to their work was paid by the Minister in the House of Commons.

Acknowledgments.

The writer gratefully acknowledges permission from the Secretaries of State for Home Affairs and of the

Air Ministry to publish this article, and permission from the Engineer-in-Chief's office to include diagrams of the circuits developed by them. The photographs of the cuckoo siren were provided by the Research and Experiments Branch of the Home Office.

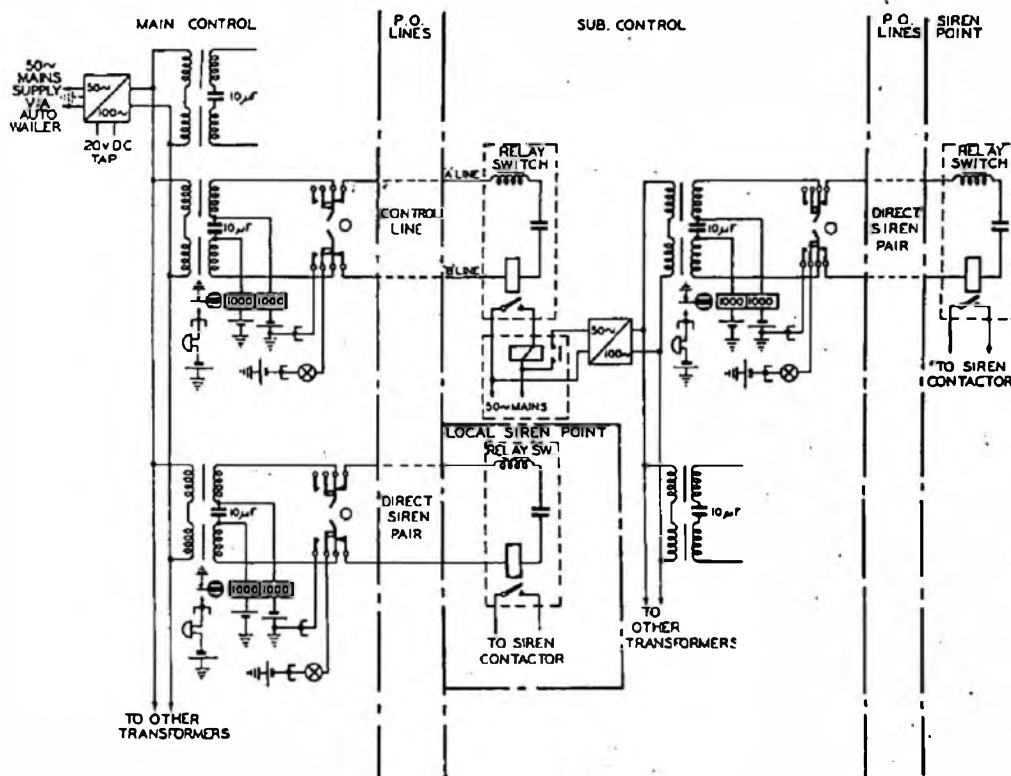

FIG. 5.—CIRCUIT ARRANGEMENTS FOR REMOTE CONTROL OF SIRENS.

Improvements in Army Telephones

During the war a detailed investigation into the requirements and performance of communication equipment in fighting vehicles was undertaken by the Engineer-in-Chief's Research Branch. When it is realised that the noise in a tank may reach 130 db. above threshold, a noise which renders ordinary conversation impossible and may be above the threshold of feeling, it will be appreciated that not only are the conditions to be met extremely severe, but that difficulties in testing are very great.

Measurements were made of noise level, and of the spectrum of the noise, in various tanks, and powerful loudspeakers and associated equipment arranged to simulate these. The tests, which were all articulation tests, were carried out by a selected team of Youths-in-Training. Adequate rest intervals were necessary, and periodic tests of their hearing, to ensure that this was not being more than very temporarily impaired.

It was found, as was to be expected, that the circuit as a whole had to be considered as a unit, but that it was necessary to have a smooth frequency response characteristic. To avoid intermodulation between the speech and noise a linear microphone and receiver is necessary, and this necessitates the use of moving-coil microphones and equalised receivers. A somewhat rising frequency characteristic was found useful.

The design of the receiver earpads was also overhauled, and the final result was a system which was the best anywhere in use, although later the Americans produced equipment with similar performance. It is not possible to quote any performance figures for the receipt of radio signals from outside, but the internal communication under extreme conditions (130 db. ambient noise) gave syllable articulation of the order of 40 per cent., rising to 75 per cent. if the noise level were reduced to 105 db. above threshold.

Channel Islands Communications and the War

W. R. TYSON, B.Sc.(Eng.), A.M.I.E.E.

U.D.C. 621.395.5

A brief description of the efforts to provide alternative communications to France in the desperate period of 1940 and of the period of occupation of the Islands. Mention is made of communications provided by the Germans during their occupation and of the restoration following liberation.

Introduction.

THE Channel Islands have been British possessions since the Norman conquest and possess a very considerable measure of self-government, their laws incorporating a number of very quaint and interesting traditions. The largest islands are Jersey (45 square miles) and Guernsey (25 square miles), the only other islands of the group of note being Alderney and Sark, which are both under the jurisdiction of Guernsey.

Jersey and Guernsey each has a telephone service provided and maintained by the local authority through the medium of the States Telephone Department, but responsibility for the postal and telegraph services, and telephonic communications with the mainland and between islands, is vested in the British Post Office. For engineering purposes the Islands form part of the Bournemouth Telephone Area, in the South-Western Region, and a small permanent engineering staff is maintained on each of the two main islands.

Telegraphic communication with the outside world was instituted in 1860, and the first telephonic link with the mainland was established in March, 1931. Telephonic communications with the mainland were strengthened in 1936 by the establishment of a short wave radio link between Chaldon (Dorset) and Fort George (Guernsey).

Developments in the immediate Pre-war Period.

In 1938 a modernisation of the cable communications to the Islands was embarked on. A concentric type cable was laid from Dartmouth to Guernsey (Fort Doyle) and from Guernsey (Saints Bay) to Jersey (Plemont) (Fig. 1), with a land link across

Guernsey from Fort Doyle to Saints Bay, passing through the States telephone exchange at St. Peter Port. A 14 pr/40 P.C.Q.T. cable was used on the land links across the island of Guernsey and from Plemont to St. Helier on Jersey, and a 12-circuit Carrier System No. 6 installed, having line amplifiers at the Fort Doyle (Guernsey) cable hut and terminal equipment at St. Helier, Jersey, in huts, pending the erection of a permanent repeater station building.

The whole of the work involved in this project was completed, tested and opened for public service on August 1st, 1939, with the initial provision of six London-Jersey trunk telephone circuits on a 12-circuit Carrier System No. 6, affording six go and six return channels.

By this time the war clouds were gathering and it was decided to strengthen communications with the continent by extending the system to Rennes in Brittany. Accordingly a concentric cable was laid between Jersey (Fliquet) and Pirou on the Cherbourg peninsula, the system at St. Helier being extended across the island to Fliquet by a 4-wire overhead circuit. A 4-wire overhead circuit extended the system from Pirou to Rennes, where it joined the main French communication system. A 1 + 4 carrier system over this route to Rennes was opened successfully in September, 1939.

Developments after the Outbreak of War.

With the outbreak of war a decision was made to duplicate the concentric cable system to make available additional channels. Concentric cables were laid from Dartmouth to Guernsey (Fort Doyle), Guernsey (Saints Bay) to Jersey (Plemont), and Jersey (Fliquet) to France (Pirou). Two balanced pair self-locating Siemens type cables were laid to cater for the land links from Fort Doyle to Saints Bay in Guernsey and Plemont to St. Helier, and St. Helier to Fliquet in Jersey. From Pirou a 4-core balanced pair plus one quad 40 lb. cable was required to connect to the main French system at St. Lo in Normandy, and since it was mainly a military commitment it was decided that the cable should be laid by a British contractor (Standard Telephones & Cables, Ltd.) under Post Office supervision.

Laying of the Balanced Pair Cable from Pirou to St. Lo.

In January, 1940, a Post Office staff consisting of one Chief Inspector with five Works Supervisors from

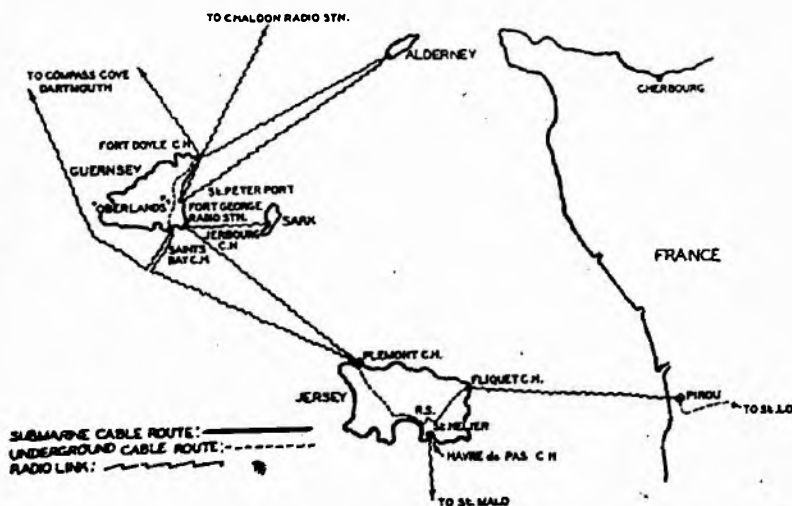

FIG. 1.—CHANNEL ISLANDS COMMUNICATIONS.

the Bournemouth Telephone Area under the overall control of the H.Q. War Group arrived in France to supervise the work of excavation and laying of the armoured cable between Pirou and St. Lo. Concurrently, officers from Engineering Headquarters arrived to supervise the installation of the repeater station at St. Lo.

It was the original intention that the excavation for the Pirou-St. Lo cable should be undertaken by military labour, but owing to other commitments this plan did not mature, and eventually the work had to be carried out with civilian labour. Progress was rather slow by British standards and much work still remained to be done when the blow fell in May, 1940, and the Channel ports and French coast as far as Abbeville passed into German hands. This meant the severing of most of the main cross-Channel cables and the importance of the Channel Isles link became paramount. Accordingly the greatest possible pressure was brought to bear on all concerned to expedite completion of the work, but the increasing difficulties of cross-Channel transport created serious delays in the delivery of cable, etc., it being necessary to land the cable at St. Malo and haul by road for nearly 150 miles.

In late May and early June the position became desperate and for nearly a week very few of the staff had any sleep, as a supreme effort was made to complete the work. The Germans dropped a few bombs with little effect, the roads were crowded with refugees, and occasionally members of the staff were detained for questioning by the French police as suspected spies, but still the work went on. News that the submarine cable had been landed at Pirou about June 10th, 1940, acted as a wonderful tonic to the staff and within a few days the land section of the cable was completed, tested, and pronounced fit for service. Efforts were also made at this juncture to pick up and restore to service the old Jersey to St. Malo single-core submarine cable which had been abandoned some years before, but although the ends were picked up and tests were pressed forward by E.-in-C.'s Test Branch officers events moved so rapidly that it was not possible to bring the cable into use. On June 15th it was decided to evacuate the staff from France, and the way to Boulogne being closed, two private cars were hired to transport the staff to St. Malo. The roads were crowded with refugees travelling west, but St. Malo was reached eventually and after prolonged negotiations with the military commander the staff were allowed to leave in a small paddle steamer carrying 1,500 military personnel, which reached Southampton without further incident on June 16th, 1940.

Events in the Islands immediately preceding the Occupation.

The permanent staff engaged on the Islands consisted of five men in Guernsey (including three men on rota duties at the Fort George radio station) and three in Jersey, and these men maintained the whole of the telegraph and long distance telephone plant. When the Germans seized the Channel ports the strategic importance of the plant on the islands increased very considerably and it was considered

essential to station an Inspector on the islands. Accordingly an Inspector took up duties there on May 28th and he was just in time to supervise the landing of the shore ends of the submarine cables on Guernsey and Jersey. These cables were laid by H.M.T.S. *Ariel*, the landings taking place at the various cable huts between May 31st and June 11th.

On June 6th staff from the E.-in-C.'s Office arrived in the islands to supervise the installation of new type carrier equipment designed to afford 24 circuits and temporary equipment required to set up another 1+4 carrier system to France via Fliquet and Pirou. Work proceeded rapidly on the carrier equipment; but by June 18th the military situation had deteriorated to such an extent that it was decided to evacuate all staff except those required for maintenance of skeleton communications.

It became known on June 19th that the islands were not to be defended and instructions were issued for as much radio and carrier equipment as possible to be salvaged and brought to England on the boat evacuating the staff. All staff, except one lineman on each of the two main islands, but including contractors' men engaged on the installation of the carrier equipment, were safely embarked on the s.s. *Biarritz*, together with the salvaged equipment, and sailed at 9 a.m. on the 20th, arriving at Southampton at 3.30 p.m. the same day.

Requests were made by the civil authorities in the Islands to retain the Guernsey and Jersey linemen to maintain communications, and this request was acceded to on the understanding that every endeavour would be made to evacuate these officers when their services were no longer essential. It was reported on June 29th by the lineman at Guernsey that the harbour was now empty and no further boats were expected. At 10.55 a.m. on July 1st communication with the Islands was suspended and advice was later received that the Islands had been occupied by enemy forces.

On July 2nd a determined attempt was made to evacuate the two linemen. An R.A.F. speed boat, escorted by four Coastal Command "Blenheim" fighter-bombers, was despatched from Weymouth and reached Guernsey just after noon. The officer-in-charge of the boat landed and made representations to the Bailiff for the release of the Guernsey lineman, but these were refused, and in the light of the fact that German planes were now reported to be landing on the Guernsey airfield the officer was forced to return to his boat. By this time enemy aircraft were coming in with low-level machine gunning and dive-bombing attacks on the harbour and the boat was forced to leave, being attacked repeatedly during the whole of the return journey to Weymouth. Two of the escorting Coastal Command aircraft were lost in the engagement.

Thus on July 1st, 1940, opened one of the darkest periods in the history of the Islands, and one which was destined to last for nearly five years.

The Period of Occupation.

The linemen on the two islands (Mr. P. G. Warder, S.W.1, Jersey, and Mr. L. LeHuray, S.W.2 (now S.W.1) Guernsey), were instructed by the Germans

to carry on with normal maintenance work, but were not allowed to visit sub-offices or cable huts without an escort (Fig. 2).



FIG. 2.—STATES TELEPHONE DEPARTMENT JOINTER WORKING UNDER ESCORT ON SUBMARINE CABLE AT FLIQUET.

An elaborate communication system was built up by the Germans during the period July, 1940, to the summer of 1943, with underground repeater stations and control points at suitable points, but in the summer of 1943 the work on the communication system slowed up considerably. The linemen, having little maintenance work to do, occupied themselves in repairing postmen's cycles, and when opportunity offered repairing the crystal sets, by which they and their friends were able to listen to the B.B.C.

On the whole, damage to the Post Office plant due to the occupation was not extensive. One instance was the demolition of the Cable Hut at Fort Doyle, a gun emplacement (Fig. 3) being constructed adjacent to the original site.

Liberation of the Islands and Setting up of Skeleton Communications.

On VE day, May 8th, 1945, the lineman on Jersey decided to take over without waiting for liberation and, presenting himself at the Jersey repeater station, informed the officer-in-charge of the guard that he intended to take over the building on behalf of the British Post Office. The officer clicked his heels, saluted, and said, "Very good, Mr. Warder," and the repeater station was once more British property.

The first party containing members of the Post Office staff landed at St. Peter Port, Guernsey, on May 12th, 1945, and proceeded with all speed to Fort George to set up an initial radio link with Chaldon, using mobile 6-channel radio equipment. Contact was first established with Chaldon on May 14th, and by 10 a.m. on May 16th teleprinter traffic was passing over the first circuit, being quickly

followed by the remainder of the channels giving four London-Guernsey telephone circuits and two teleprinter circuits.

A second party sailed from Plymouth on May 20th in an American landing craft, and took with them mobile 1 + 3 and 1 + 4 terminal carrier equipments plus a quantity of stores suitable for the repair of underground plant and cables. It was soon appreciated that as the Germans had set up a fortified communications centre at Oberlands, which is at the approximate centre of the island, and diverted all cables to this point, this would be the obvious choice for the key point of the temporary communications system.

During the occupation the Germans had recovered the two balanced pair cables from St. Peter Port to Fort Doyle, but fortunately had laid a 6-pair armoured cable from Fort Doyle to Oberlands, so it was decided to set up two mobile 1 + 3 equipments at Oberlands and two 1 + 4 equipments at the States telephone exchange at St. Peter Port. Meanwhile the work of picking up the concentric submarine cables was proceeding despite extensive minefields, and on May 25th the first cable was proved through from Dartmouth to Fort Doyle. The original 14 pr/40 cable from Fort Doyle to St. Peter Port had been very severely damaged by the Germans and strenuous efforts were necessary before the circuits were finally got working.

The cables to Jersey were found to be in fairly good order and it was possible on June 21st to open up communications on both the Dartmouth/Jersey

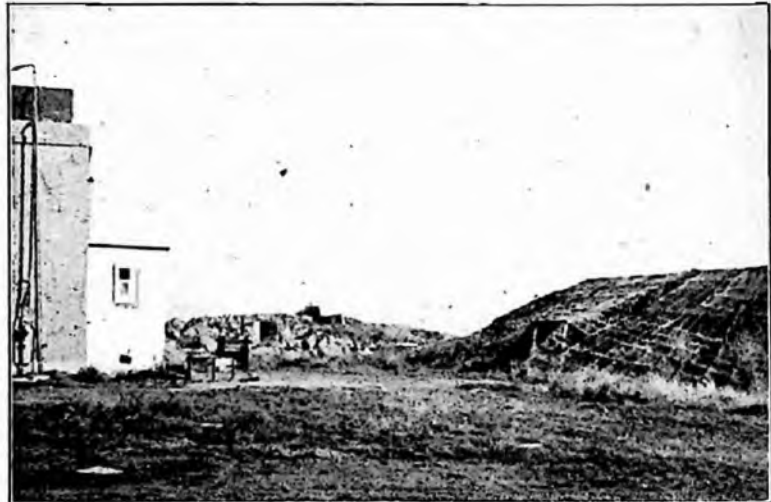

FIG. 3.—GERMAN GUN EMPLACEMENT ADJACENT TO ORIGINAL SITE OF CABLE HUT, FORT DOYLE.

and Dartmouth/Guernsey cables.

Acknowledgments.

The information contained in this article has been gathered from various sources, but in particular from the excellent official reports of Mr. F. Holmes, M.B.E., and Mr. C. R. Dickenson, both of the South-Western Region, who have been intimately concerned with Channel Island communications.

The Bomber Lines

A. G. ROBINS, A.M.I.E.E.

U.D.C. 621.395.74

The article gives a brief review of the land line communication system provided by the Post Office for Bomber Command. It indicates the growth of the system with the expansion of the Bomber force and refers to some special facilities which were provided.

Introduction.

THE importance of the land line system serving R.A.F. Bomber Command may be accurately assessed by the following extract from a letter sent to the Director-General of the Post Office by Air Chief Marshal Sir Arthur Harris, C.-in-C. Bomber Command, on May 22nd, 1945.

"In this hour of achievement of victory in Europe, I wish to express my appreciation of the invaluable work performed by the Post Office in providing and maintaining the land line communication system used by Bomber Command.

"The first requirement of the bomber offensive is efficient communication. The ability to carry out detailed planning without delay and to co-ordinate the bombing effort in the light of the most recent Intelligence information is of the utmost importance. Rapid transmission of information to headquarters and of operational orders to squadrons is, therefore, essential, and can only be obtained from a highly developed and flexible communication system.

"This the G.P.O. has provided in Bomber Command throughout the war. Not only has the land line network met the operational requirement referred to above, but it has also been a prime factor in reducing the difficulties of administration which are inevitable in such a highly centralised and complex organisation as Bomber Command. Furthermore, land lines have played an essential part in the use of many offensive and defensive devices and have thus been instrumental in the saving of bomber aircraft and their crews."

The letter concludes by expressing appreciation and thanks for the work carried out by the Post Office on behalf of Bomber Command.

Organisation.

The organisation of Bomber Command and some details of the procedure followed in planning an operation, have been described in the Ministry of Information publication entitled "Bomber Command" (Section XII). The organisation of the Command has not remained static throughout the war years, and since the communication layout is related to the organisation it will be appropriate to review the method of control.

The essential feature is that the bomber squadrons situated on a group of airfields are controlled by the Air Officer Commanding the Group, who has a separate Group Headquarters with the appropriate staff officers. There are a number of Bomber Groups, and they are all controlled by the Air Officer Commanding in Chief at Headquarters, Bomber Command.

By mid 1944 the organisation had grown to:—

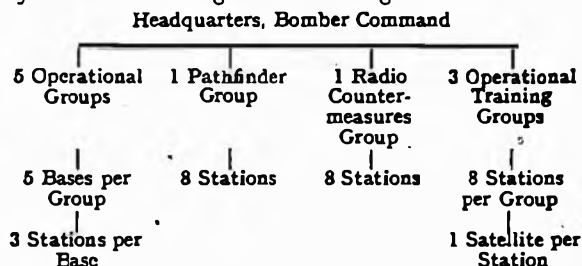

These are the main lines of the bomber organisation for which the Post Office provided communication facilities, but there is one other aspect of R.A.F. organisation that deserves mention because of its effect upon communications. At all formations in the R.A.F. there is a clear division of responsibility between the air staff who deal with operational matters and the administration staff who are responsible for the availability of airfields, aircraft, personnel and equipment in order that the air staff can function.

Growth.

The growth of the land line network kept pace with the increase in the bomber force, and the magnitude of the expansion is indicated by the following comparison between the communication facilities which existed in Bomber Command in 1939 and 1945. The figures quoted do not include those airfields and headquarters controlled by the U.S.A.A.F. in 1945.

	1939	1945
P.B.X. positions	32	472
Telephone Stations	1,250	15,200
Teleprinters	20	640
Private Wires, Tariff D & E ..	40	875
Private Wires, Teleprinter ..	20	985

The above indicates that the growth was considerable, but it does not accurately represent the amount of engineering work carried out in rearrangements to meet the changing needs of the organisation. The communication facilities were provided, in the main, with standard plant and equipment, but there were some special facilities which are described later.

In view of the division of responsibility between the air staff and administration staffs and to ensure that there should be no delay to the important operational messages, two separate communication networks were provided, Operations and Administration, to all formations.

Airfields.

Each airfield was equipped with a 2-position Admin. P.B.X., 1-position Ops. P.B.X., speech and teleprinter

private wires to its Group or Base, exchange lines and aerial masts.

A large amount of cabling has been provided for each airfield including :

- (a) An outlet cable, or where practicable, two outlet cables on alternative routes to give access from the main cable network to the airfield.

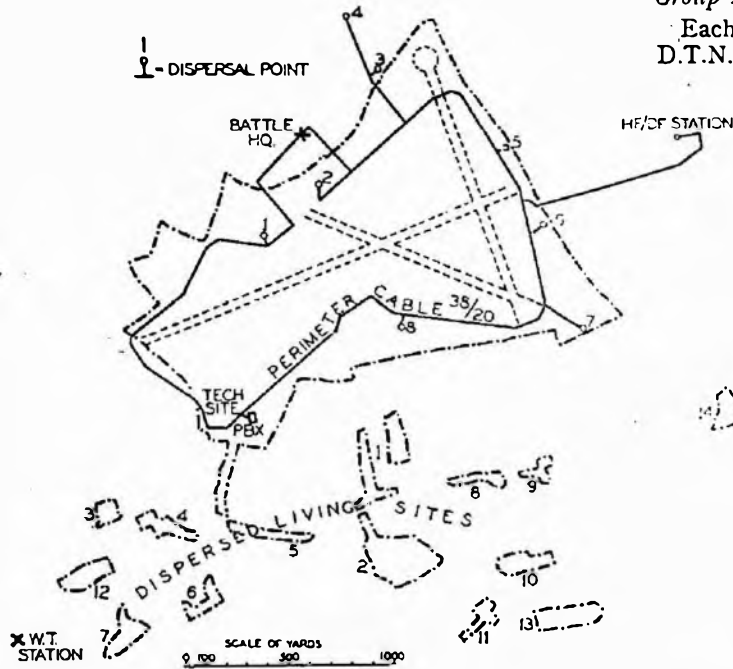

FIG. 1.—LAYOUT OF TYPICAL BOMBER AIRFIELD.

- (b) A distribution network for the local extensions.
- (c) A perimeter cable to serve aircraft dispersal points, defence posts, airfield controller and remote control circuits for the Standard Beam Approach equipment.
- (d) Remote control cables to the Wireless Transmitting and High Frequency Direction Finding Stations.

The general layout of a typical airfield is shown in Fig. 1.

The teleprinter facilities at the airfield were provided as part of the D.T.N. system,¹ and in many cases 4-channel V.F. equipment was installed.

Base H.Q.

The facilities were similar to those provided at the airfield except that the existing 2-position P.B.X. was replaced by a 3-position P.M.B.X. 1A to serve the

¹ P.O.E.E.J. Vol. 38, page 121.

base and station. The only departure from standard was the adoption of a 3-panel multiple for the board, as this gave an improved layout from an operating point of view.

Eight-channel V.F. telegraph equipment was provided for the teleprinter communications.

Group Headquarters.

Each Group Headquarters was served by a large D.T.N. station installed in accommodation provided by the Air Ministry.

The Group Headquarters were accommodated in large country houses, and as it was frequently difficult to find suitable rooms for the D.T.N. equipment, it was necessary to design a building which could accommodate all signals requirements. A 30-ft. Nissen hut was used for the purpose as it could be erected in the vicinity of the main headquarters building with a minimum of labour. The layout of D.T.N. apparatus in a Nissen hut is shown in Fig. 2.

To meet the traffic requirements of the group a 3- or 4-position Admin. P.B.X. was installed with a 1- or 2-position Ops. P.B.X. An Admin. teleprinter switchboard and an Ops. teleprinter concentrator were provided to give flexibility and economy in the use of teleprinters. Speech and teleprinter facilities were provided from each group to each of its bases, to Command, to one of the main

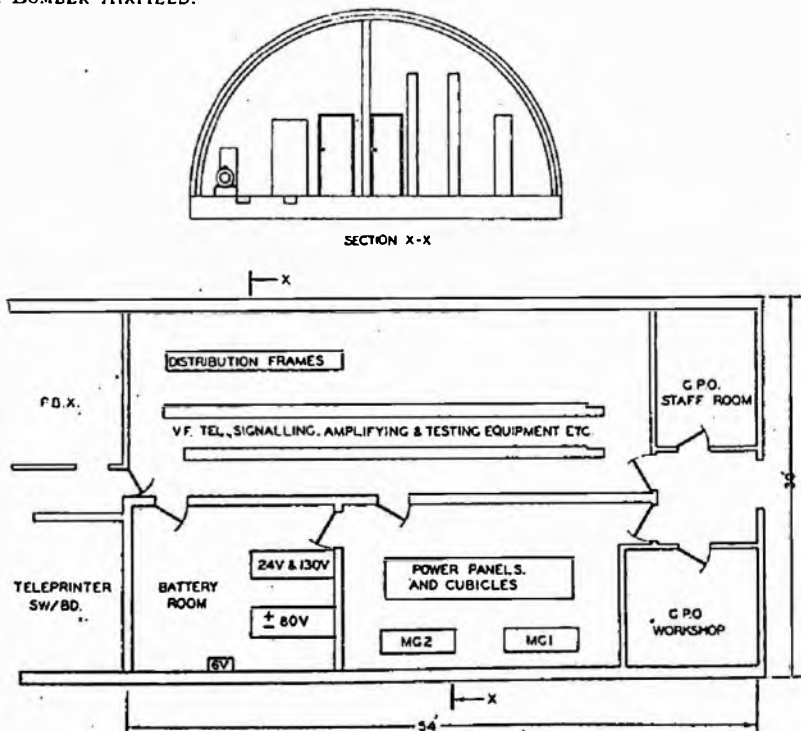

FIG. 2.—TYPICAL LAYOUT OF D.T.N. EQUIPMENT IN NISSEN HUT.

switching centres at Central, South-West or North-West Central, together with lateral private wires between certain Group Headquarters. Exchange lines were also provided.

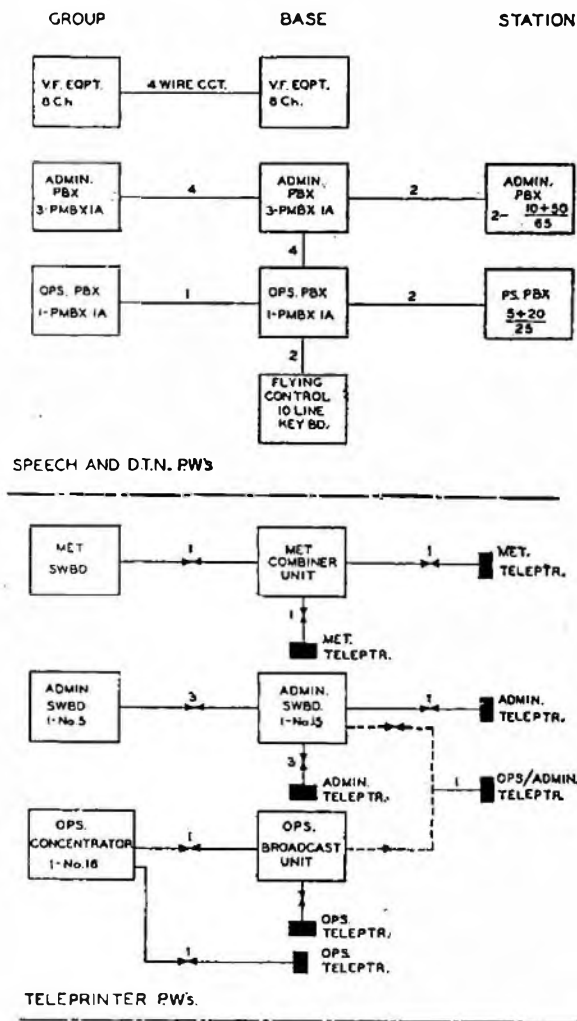

FIG. 3.—PRIVATE WIRE FACILITIES FOR BASE ORGANISATION.

Headquarters, Bomber Command.

This was provided with a 12-position sleeve control P.B.X., a 2-position Ops. P.B.X., a 3-position Admin. teleprinter switchboard and an Ops. teleprinter concentrator. A large D.T.N. station was installed to serve the headquarters. The whole of this equipment was accommodated in two well-protected underground buildings.

An extensive telephone and teleprinter network radiated from H.Q.B.C. to all Group H.Q., to other Commands, to the Air Ministry, to the main switching centres, and to many other establishments concerned with the operation of the Command. Exchange lines were

also provided to give access to firms and organisations which were not connected to the private wire network. They also served as an alternative routing in the event of a major breakdown in the private wire network.

Private Wire Network.

The scale of private wires provided for the base organisation is indicated in schematic form in Fig. 3. The majority of the speech private wires were 4-wire amplified circuits with an overall transmission equivalent of 3 db. Generator signalling was usual, using 500/20 ringers or AC/DC repeaters. The teleprinter private wires were generally routed on V.F. telegraph systems.

To safeguard against loss of communications to any station, as the result of a cable breakdown, a comprehensive scheme of alternative routing was adopted. Each D.T.N. centre and many airfields had at least two outlet cables to the main cable network. Mobile D.T.N. and operations equipment was available to facilitate the restoration of communications in emergency. As an aid to the maintenance of operational communications all private wires were routed via a change-over panel so that faulty operations circuits could be rapidly patched out with Admin. circuits. These changes could be effected by R.A.F. personnel if P.O. staff were not available.

Teleprinter facilities were provided by standard D.T.N. equipment.

Special Facilities.

Telephones.—Special lamp signalling telephones were developed for the use of the operations staff. The lamps were accommodated in the dial dummy of a standard H.M.T. (Tele. 332) and the relays were housed in the base of the telephone.

A 2-circuit telephone (AD 752) was developed with a switching key in a false base to the H.M.T. which permitted the telephone to be connected to an Ops. or Admin. extension line as desired. This telephone is illustrated in Fig. 4.

Privacy Equipment.—To provide increased security in the transmission of operational orders by telephone privacy equipment was developed and introduced in 1941. This equipment was provided at all Bomber Command formations.

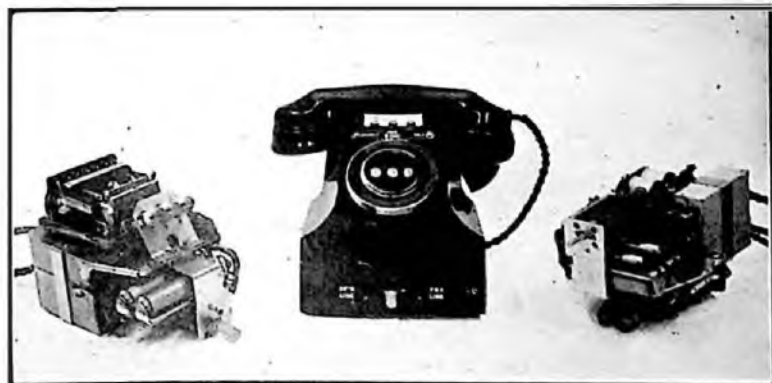

FIG. 4.—2-CIRCUIT LAMP SIGNALLING TELEPHONE.

Conference Facilities.—The provision of speech conference facilities on the operations private wire network was essential to permit the required co-ordination of the bomber effort, and the operations P.B.X. at Bomber Command was ultimately equipped with two conference amplifiers, one with a capacity of 32 lines, the other with a capacity of 16 lines. The lines used were the normal operations speech circuits which were switched to either amplifier as required by keys mounted in the face equipment of the switchboard. The conference amplifiers (Units Amplifying No. 36) were designed as eight-way units and were coupled to produce the required capacity.

At Group headquarters single eight-way conference amplifiers were provided, but these did not meet the full requirements, and subsequently the flight planning conference equipment with loudspeaker reception was introduced. This equipment enabled the Group Headquarters to hold a full conference with station and squadron commanders, and all interested parties.

The facilities were provided by using the existing private wires to make up a four-wire omnibus circuit to all points; the transmit and receive sides of this circuit being connected to common line amplifiers at the Group Headquarters. Attenuators were inserted in the lines at the Base Headquarters to maintain a sensibly constant level at all reception points, irrespective of the line characteristics. The arrangement is shown in schematic form in Fig. 5.

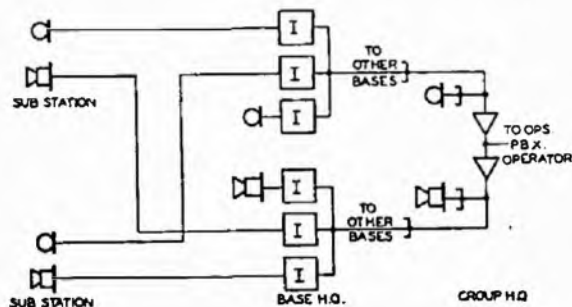

FIG. 5.—SCHEMATIC DIAGRAM OF FLIGHT PLANNING CONFERENCE CIRCUIT.

The private wires were switched as necessary from the Ops. P.B.X. to the conference equipment by keys controlled by the operators at the Ops. switchboards.

Intruder Warning System.—The hostile intruder aircraft constituted a constant potential danger to the aircraft returning from operations, since it was necessary to use the airfield lighting system to enable our aircraft to land, and this naturally invited attention from the intruder. Many schemes were devised and tested to advise the bomber airfields of the approach of enemy aircraft in order that arrangements could be made to divert our bombers to safer airfields, but it was difficult to reduce the time delay in the passage of information to a sufficiently low figure.

The arrangement finally adopted was to set up plotting tables at each Bomber Group Headquarters, and to provide communications to the tellers at the appropriate R.O.C. centres and fighter groups. In this way the Group Headquarters obtained informa-

tion in respect of enemy aircraft as soon as it was available, and the position of the raiders was plotted. When it became apparent that raiders were approaching an airfield belonging to the group, the progress of the raid was told to the airfield and the appropriate action could be taken.

The lines to the R.O.C. and fighter groups were provided by P.U.T. (prolonged uninterrupted trunk) calls set up over the public network and the flight planning conference equipment was used to distribute the information to the bases and stations.

Telegraph Equipment.—The telegraph equipment was standard plant developed for the D.T.N. system, and it is proposed therefore to record only those features which are believed to be special to Bomber Command.

To deal with the very heavy operational teleprinter traffic at Headquarters, Bomber Command, the majority of which was broadcast to a large number of addresses, it was found necessary to install two auto-transmitters and reperforators. This equipment considerably reduced the line time required to send the broadcast messages and considerably simplified the problem of retransmitting messages. The retransmission of a message was frequently necessary because of the difficulty of obtaining a free circuit to all addresses simultaneously, and on occasions was due to the failure of a teleprinter during the broadcast; since the operational orders were measured by the yard of teleprinter paper, rather than in words, retransmission by hand was a serious problem.

Key switching was provided to enable the auto-transmitters and reperforators to be associated with any of ten local teleprinters. The arrangement adopted permitted any out station to hold up a broadcast for a short time if their teleprinter was not ready to accept the message.

Meteorological Network.—The work of Bomber Command was dependent upon accurate forecasts of the weather conditions, and Met. stations existed on every airfield. The Met. service was provided with an extensive teleprinter broadcast network; Met. teleprinter switchboards were installed at every Group Headquarters. Each Met. Station had its teleprinter P.W. to the Group Met. Switchboard which was also connected to the Met. Centre (E.T.A.) at Dunstable.

W.T. Remote Control.—To ensure the continuity of radio communication to aircraft an extensive emergency remote control network was provided which enabled any Group Headquarters to use any R.A.F. transmitter in the country. Usually these remote control circuits were routed on V.F. telegraph channels normally used as Admin. teleprinter circuits. Switching facilities were provided at Group Headquarters, Bomber Command and other D.T.N. stations, so that the lines could be rapidly set up as control circuits when required. Facilities were provided at H.Q.B.C. to permit the simultaneous control of a number of W.T. Stations. The equipment was similar in principle to that used for teleprinter broadcasting.

Fighter Command Communications

A. M. HANNA

U.D.C. 621.395.72 : 621.395.74

A brief summary of some of the telecommunications facilities provided by the Post Office for the Operational Control of the R.A.F. fighter planes during the war.

Introduction.

A COMPLETE account of the telecommunications facilities provided for Fighter Command by the Post Office Engineering Department during the war is beyond the scope of this article. Space will permit only of a brief survey of a few of the arrangements provided for the operational control of fighters.

The Fighter Organisation.

In the first place it may perhaps be appropriate to

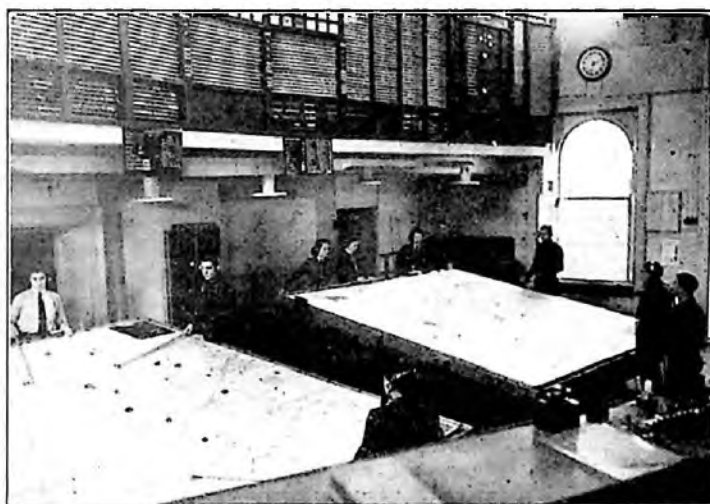

FIG. 1.—PLOTING TABLES AND "TOTE" DISPLAY PANEL.

describe in very broad outline the principle upon which the fighter organisation was based in order that the need for the various telecommunications facilities may be the more easily understood.

The length and breadth of Great Britain was divided into sectors each in control of several airfields in its area. These sectors were grouped together on a regional basis and came under the supervision of conveniently placed Groups, each of which in turn was responsible to Headquarters, Fighter Command. During the Battle of Britain there were some 35 Sectors, 7 Groups and Headquarters, Fighter Command. Each of these 43 stations possessed a main and an emergency operations room. Each Group possessed in addition a main and emergency filter room. The emergency operations and filter rooms were a replica of the main operations and filter rooms, and were provided as far as possible with 100 per cent. duplication of the land line communications which could be made available

at short notice by switching arrangements at pill-boxes or at conveniently placed telephone exchanges or repeater stations.

Generally speaking, each operations or filter room consisted essentially of the following main features:—

- (i) Two or more plotting tables;
- (ii) A "tote" display panel; and
- (iii) A three-tiered balcony.

The plotting tables (Fig. 1) consisted of large maps of the area controlled by the particular station on which plots of the course of friendly and hostile aircraft and shipping were made by distinctive symbols appropriately placed on the map. During periods of activity as many as twenty plotters would be grouped around each table, each plotter engaged in plotting information obtained from a separate source.

The tote (Fig. 1, top) displayed a multiplicity of information ranging from meteorological conditions in the vicinity, to details of the height, strength and identity of aircraft related to the plots on the map tables. The tote was manipulated by tote operators located at the rear of the display panel.

The balconies (the uppermost of which is shown in Fig. 2 and overlooks the scene in Fig. 1) were occupied by the Controller and his deputies, and many special duty officers responsible for the necessary liaison work between the operations room and radar stations, Royal Observer Corps centres and gun and searchlight batteries.



FIG. 2.—BALCONY OVERLOOKING SCENE ILLUSTRATED IN FIG. 1.

Although all operations rooms were basically similar, their functions differed considerably. Thus it was that at Headquarters, Fighter Command the "picture" on the plotting table was of the general situation obtaining throughout the whole of the fighter territory, whereas at group operations rooms a picture of the situation in its own area and that of adjacent areas was available in greater detail. The situation depicted at a sector operations room was complete down to the last detail so far as its particular area was concerned.

The headquarters controller held a watching brief over the general progress of the battle and called in the assistance of other groups if in his opinion a particular group appeared to require reinforcements. The group controller's function was to decide which sector or sectors were to deal with a raid and to instruct the controllers at those sectors as to the number of squadrons to employ. Finally, it was the sector controller's duty to be able to manoeuvre his fighters, with whom he was in radio-telephone communication, into the most favourable position for interception and attack. With an abundance of information before him this resolved itself into a matter of straightforward strategy.

Communications.

It is evident that a vast and intricate network of communications was necessary to keep such an organisation furnished with up-to-date information derived from a multiplicity of sources. A skeleton diagram of the main requirements for the distribution of plotting information is given in Fig. 3.

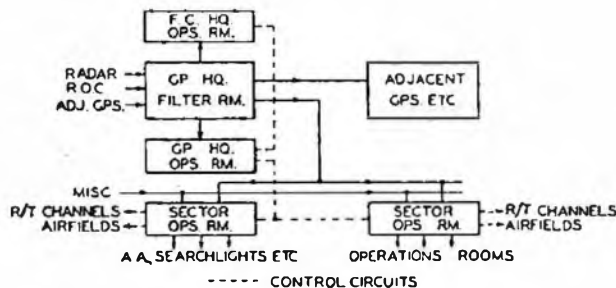

FIG. 3.—DISTRIBUTION OF PLOTTING INFORMATION.

The main sources of raid information were the Royal Observer Corps centres and radar stations, which maintained a constant "watch" over land and sea areas respectively. When the approach of aircraft was recorded on the detecting apparatus at these stations the information was passed by "tellers" over direct speech circuits to group filter rooms (Fig. 4), where it was plotted on the tables. Here the information was speedily co-ordinated and was re-told in detail by observers on the balcony via speech broadcast circuits to the group operations room and to sector operations rooms within the group area. Other observers relayed the information in lesser detail (that is, the "highlights") to adjacent groups

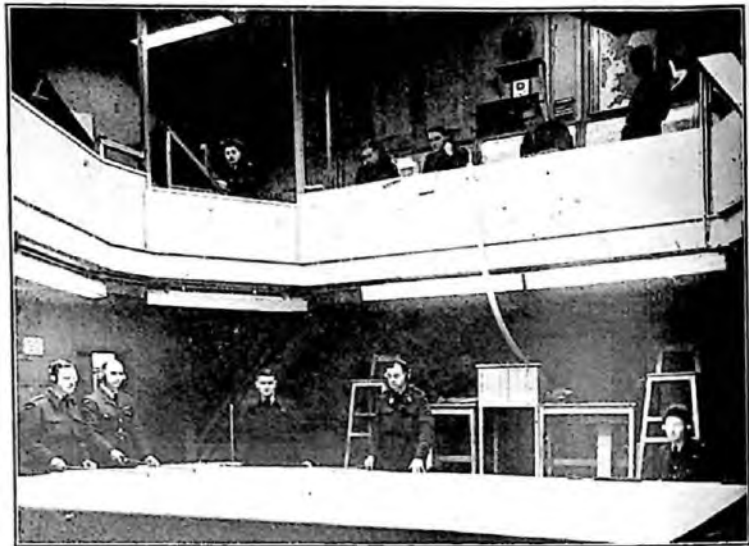

FIG. 4.—GROUP FILTER ROOM.

and to Headquarters, Fighter Command. Similarly, observers in the sector operations room passed all relevant information obtained from the plotting table to anti-aircraft and searchlight operations rooms and to Balloon Command. Speech circuits also existed between the sector operations room and such points as the flying control tower located at each airfield and to the radio telephone transmitting and receiving stations. Liaison and intelligence circuits connected with the plotting organisation existed between all the stations mentioned.

Plotters' Equipment.

The majority of plotting circuits in use by Fighter Command were of the unidirectional, point-to-point type. Within a station they were routed via a Floor Supervisor's keyboard (for monitoring purposes) and a patching panel, to predetermined plotting positions. Point-to-point circuits were necessary by virtue of the continuous nature of the information passed, and because the shortest of switchboard operating delays could not be tolerated.

The patching panel provided a large measure of flexibility inasmuch as any particular plotting circuit could be connected to any desired plotting position at the table. This facility was especially useful when the map, which was often composed of removable sections, was moved up or down or across the table. During slack periods it was possible to couple several plotting circuits to one plotting position, effecting a reduction in the number of plotters on duty. This is illustrated in Fig. 1, where at 2.30 p.m. five plotters only were necessary to cope with twenty plotting circuits terminated at the furthestmost table.

As may quite easily occur where uni-directional circuits are employed, a disconnection may exist unnoticed during slack periods. To avoid this possibility an 800 c/s pip-tone of 100/150 ms. duration was transmitted from the telling end at half-minute intervals, its absence at the plotting position being indicative of the existence of a fault condition.

The plotter's position comprised a standard C.B. operator's telephone circuit using a double headgear receiver and transmitter (Fig. 5). The "raid"

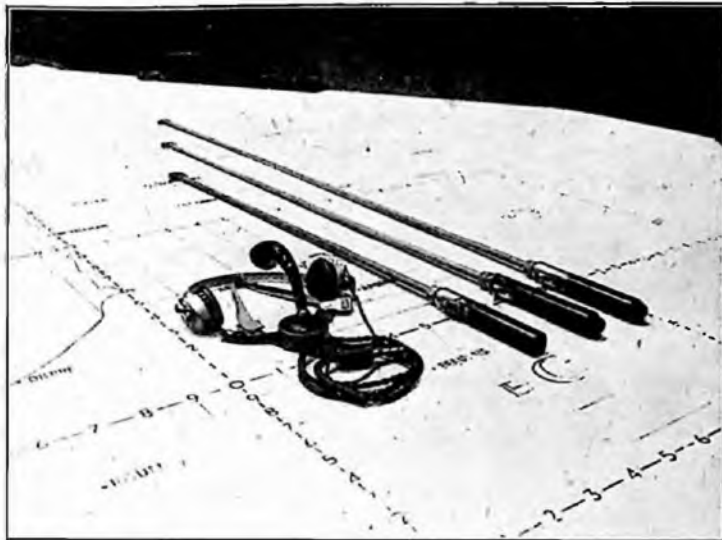

FIG. 5.—EQUIPMENT PROVIDED AT PLOTTER'S POSITION.

information, which was plotted on the table, was interspersed periodically by tote or ancillary information. This information was preceded, however, by the word "Tote" followed by a brief pause, during which the plotter extended the plotting line to the tote position by operating a key conveniently fitted at the edge of the table. Keeping the key depressed, the plotter monitored the message passed and at its conclusion released the connection. The reverse action of the key connected the plotter's transmitter to the tote position, so that any inaccuracy in the information subsequently displayed on the tote panel could be rectified.

Approximately one thousand head and breast sets were constantly in use for plotting purposes in Fighter Command. The plotting rods shown in Fig. 5 were not provided by the Post Office. It may, however, be of interest to note that a press switch on the handle of the rod connected a dry cell within the handle to a small electro-magnet at the remote end of the rod. The plotting symbols consisted of soft iron stampings and were thus readily moved from one position to another.

Operations Keyboards.

The operations officers, previously referred to as occupying positions on the balconies, were each provided with an operations keyboard. Access to remote stations with which the officer's particular duty was concerned was available from the keyboard. Inter-keyboard circuits for communication between officers within the operations

room and circuits to the operations P.B.X. were also provided.

The keyboards were designed, manufactured and installed, in common with all other line telecommunications equipment, by the Post Office. They were of the lamp-signalling, ancillary type and were produced in five sizes accommodating 1, 5, 10, 20 and 30 lines respectively. The thirty-line keyboard is shown in Fig. 6.

The opportunities of performing maintenance work in operations rooms were few and far between; for this reason all auxiliary signalling equipment, speaking sets, etc., were accommodated in the apparatus room, the bare essentials only being fitted in the keyboard.

Two speaking positions were provided on each keyboard, access to any line being effected by operating the line key to the appropriate speaking position. Signalling was effected by the operation of a common signal key which extended 17 c/s to line, the 17 c/s being converted if necessary to any other desired method of signalling by signal conversion units located in the apparatus room. A calling and an engaged lamp in respect of each line were located above the line key. Limited switchboard facilities were provided for use in exceptional circumstances.

The 20- and 30-line keyboards were provided with broadcast facilities in addition to those already mentioned. When these facilities were required, a multiphone amplifier located in the apparatus room was associated with the keyboard and could be connected to either speaking position by the operation of the appropriate amplifier key. For fitting and maintenance reasons the connection strips were not fitted inside the keyboard but were attached to 30-in. tails from which point they were cabled to the apparatus room distribution frame. Normally the

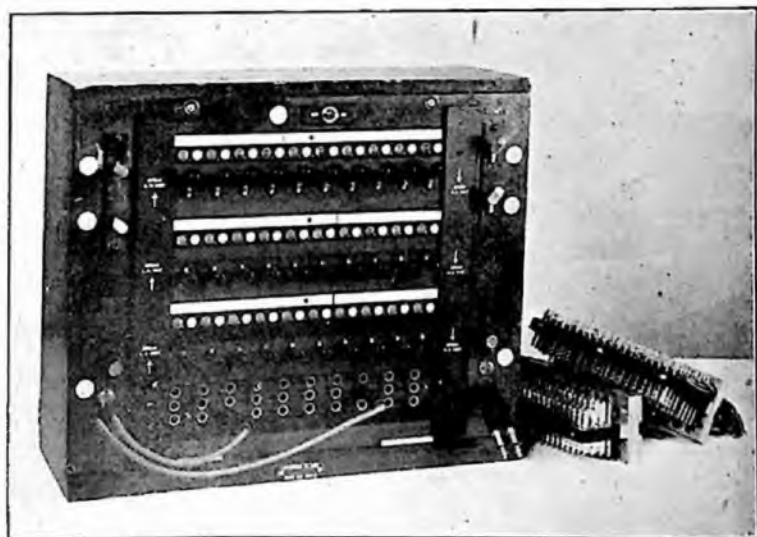

FIG. 6.—30-LINE "OPERATIONS" KEYBOARD.

keyboards were let into the table top, as may be observed in the bottom left-hand corner of Fig. 2, but could be installed in the upright position if desired.

V.H.F. R/T Keyboards.

Communication between aircraft in flight and the sector controller was maintained by radio-telephony, each sector station being allotted a certain number of frequencies on which to operate. Shortly before D-Day it was decided to reorganise the V.H.F. R/T control system and to increase the number of frequencies available at each sector. Existing Air Ministry equipment was not suitable for the proposed new scheme and the Post Office was requested to undertake the design and production of the new control equipment required.

The V.H.F. R/T transmitting and receiving stations were divided into two classes, referred to as "local" stations and "forward relay" stations. The former were usually about three miles distant from the sector operations room, and the latter approximately 100 miles away. Usually the local stations operated on twelve frequencies and the forward relays on eight. The frequencies in use at the forward relays were duplicates of a corresponding number of frequencies at the local station, thus affording greater radio coverage on those frequencies.

The land line connections between the R/T stations and the sector operations room were referred to as "channels" and consisted of 4-wire circuits.

In the operations room the local and forward relay channels were terminated on a twenty-three line R/T keyboard at the controller's position and were ancillaried to eight other deputy-controllers positions. Each channel was also connected to a separate R/T monitor's position where it was permanently monitored. When a signal from an aircraft was heard by the monitor (and if the monitor was unable to deal with the situation), a controller was called into circuit by the operation of a signalling key which caused the calling lamp associated with the particular channel to glow on each of the controller's keyboards.

The facilities provided by the keyboards may be summarised as follows:—

Controller's position.

- (i) Access to any of twenty R/T channels for monitoring and transmitting purposes.
- (ii) Bothway signalling and intercommunication facilities to any monitor's position.
- (iii) Remote switching of the R/T transmitter and automatic attenuation of the R/T receiver during sending.
- (iv) Access to D/F stations.

Monitor's positions.

- (i) Permanent connection to the "receiver" half of one channel only.

- (ii) Bothway signalling and intercommunication facilities to all controller's positions.
- (iii) Remote switching of the R/T transmitter and automatic attenuation of the R/T receiver during sending.

Operations P.B.X.

By virtue of the vital nature of the messages passed over them, the majority of circuits terminated on the operations keyboards were of the point-to-point type. Access to the lesser important circuits was made via the operations P.B.X. The operations P.B.X. consisted normally of a four-position P.M.B.X. No. 1A switchboard, on which were terminated lines to satellite airfields, aircraft dispersal points, flying control offices, etc.

65-Line Switchboards.

The standard P.O. 65-line P.B.X. switchboard served many important functions in the Fighter Command organisation. Prominent among these were the administrative services at all stations, the flying control arrangements at airfields and the movement liaison service at group headquarters.

The flying control P.B.X. situated in the flying control tower on airfields provided intercommunication between the flying control officer and such points as the ambulance service, crash tender, Sandra beacons, Fido control and dispersal points. Communication was also available through this P.B.X. to the parent sector and group headquarters.

Perhaps the most important 65-line switchboard was that serving the movement liaison service (M.L.S.). A fighter pilot upon sighting an aircraft could not afford to hesitate before deciding upon the action to be taken. All the more important was it, therefore, that pilots should be aware of the movement of all other friendly aircraft in the area. Terminated on the M.L.S. switchboards at all group headquarters, therefore, were circuits connected via numerous switching points to all other flying commands, over which were reported in advance the proposed movements of aircraft belonging to those Commands. The type, number, height, course and calculated time of arrival in any particular area were reported and the information was passed to all sectors concerned. To prevent the enemy obtaining previous knowledge of proposed raids the transmission of all such circuits was scrambled, frequency changers being incorporated in the circuits at guarded points.

Acknowledgments.

The author is indebted to the Officer Commanding, Headquarters, Fighter Command for the use of the photographs, and to Mr. E. W. Johnson, late Post Office Liaison Officer, Headquarters, Fighter Command, for the helpful suggestions and information he has furnished.

The Battle of the Atlantic and the Post Office

U.D.C. 621.394.74 : 621.395.74

A brief description of the provision by the Post Office of the communication facilities required by the Navy and Air Force during the Battle of the Atlantic.

G. A. ALSTON,
F. E. BLAND, B.Sc.(Eng.), A.M.I.E.E.
C. F. PERRYMAN and
C. E. WORTHINGTON

Introduction.

IT is well known that one of Germany's principal aims was to starve this country by the destruction of shipping by air attack, U-boats and surface raiders. To counter these activities, convoys were introduced with as much air and surface protection as possible. The headquarters of the organisation was originally at Plymouth, ideally situated before the occupation of France. Convoys from the North and South Atlantic and the Mediterranean were all controlled from there.

When France fell in 1940, and the Channel ports and southern approaches to Britain became unusable due to the proximity of the enemy bases, it was decided to move the organisation further north. After intensive search, Liverpool was selected as the headquarters of the Command. A deciding factor in the choice of Liverpool was its ideal situation as a communication centre. It was truly said that the Battle of the Atlantic was a fight to secure the life-line of this country, and it was equally true that the nervous system of the organisation which controlled this tremendous battle was the network of communications provided by Post Office services.

Organisation of the Naval and Air Forces.

Before a survey is made of the work the Post Office was called upon to do, it may be well to outline the organisation to be served. The protection of the convoys, and the location and destruction of enemy forces, required full-scale co-operation between the Navy and Air Force. The organisation was therefore a combined one in the closest sense, the headquarters being known as an Area Combined Headquarters (A.C.H.Q.), with an Admiral as Commander-in-Chief.

The naval organisation requiring communications comprised the Flag Officers in charge of the Western Approaches ports and bases—Cardiff, Milford Haven, Liverpool, Greenock, Glasgow and Northern Ireland. Included in these groups were the escort bases for destroyers and corvettes at Greenock, Belfast, Londonderry, Milford Haven and Liverpool. The merchant vessels were handled by the big commercial ports which in Western Approaches were Liverpool, the Clyde Cardiff and Belfast. All this demanded the provision of literally hundreds of telecommunication installations. All the main bases were linked by

teleprinter and telephone to the focal point at A.C.H.Q., which in turn had circuits to the Admiralty and the C-in-C.'s of the adjacent territories, viz., Rosyth, Plymouth and Chatham. Of even greater operational importance than the foregoing was the remote control wireless telegraphy (W/T) network, by which it was possible to keep in touch with ships at sea and control operations.

The R.A.F. organisation, known as 15 Group, was a Group of Coastal Command, created mainly to fight in the Atlantic battle. The bases, one of which is shown in Fig. 1, were sited as near the scene of operations as possible, which meant Northern Ireland, the West of Scotland and the Western Islands, and catered for long range aircraft and flying boats. All these bases were connected by telephone and teleprinter direct to H.Q. 15 Group at Liverpool. In addition, as for the Navy, there was a most important remote control (W/T) network, for controlling aircraft, reporting sightings, etc.



FIG. 1.—SEAPLANE BASE IN NORTHERN IRELAND.

The Liverpool Headquarters.

The new headquarters was set up in a partially completed block of modern steel and concrete offices; a concrete fortress with a 7 ft. 6 in. roof and 3 ft. 6 in. wall being constructed in the basement and lower ground floors to house operational staff and their communication plant. The work was completed in January, 1941, all staffs working on a 24-hour basis in spite of air raids of almost nightly occurrence.

Two duct routes were led from the building, these fanning out into five separate routes immediately outside. The telephone service was provided by a 9-position sleeve-control type P.M.B.X. which catered for operational and administrative traffic. How large the administrative traffic was can be gauged from the fact that the naval personnel under the C.-in-C.'s command numbered over 100,000—larger than the peace-time strength of the whole Navy. The P.M.B.X. was served equally by naval and R.A.F. private wire circuits and was manned jointly by WRENS and WAAFS. A 3-position teleprinter switchboard (No. 8) was installed to carry administrative teleprinter traffic, give broadcast facilities and concentrate naval teleprinter lines.

The Naval Signal Office was equipped with 20 teleprinters, together with an automatic perforator and transmitter for broadcasts. On an average day, 700/800 signals were handled, though at times the number soared to 1,400. An interesting feature was a duplex teleprinter type installation provided by the Western Union Cable Company which shared one of the transatlantic cables with the Admiralty. U.S.A. H.Q., etc., in Britain, the A.C.H.Q. "channel" being extended to the C.-in-C.'s opposite number on the Western Atlantic seaboard. This installation was provided after America had declared war and enabled the two H.Q. staffs to have immediate contact without recourse to wireless.

The R.A.F. Signals Section commenced with an installation of over 50 teleprinters working on operational and administrative circuits to stations, lateral links to H.Q. Coastal Command, other Groups and D.T.N. tails. It was subsequently agreed to put all operational circuits on a concentrator (Teleprinter Switchboard No. 16) and share the lines between a smaller number of machines.

Incorporated in the Group was an Air Ministry meteorological broadcast unit which collected weather observations from the West of Scotland, Northern Ireland, North-western England and North Wales. In addition a special transatlantic meteorological bulletin was continually received by teleprinter from the "Transat" headquarters. In no work was up-to-date accurate knowledge of weather more important than when flying or sailing straight into the prevailing weather in the Atlantic. Many a convoy diversion and many a direction to aircraft has been determined solely by weather forecasts, derived from information fed incessantly for 24 hours a day, seven days a week over the teleprinter network. This information was sent direct to the Liverpool A.C.H.Q., and not as usual to local collecting centres, although the system required some circuits as long as 600 miles.

Remote control wireless telegraph circuits were set up from Liverpool to stations scattered over the British Isles as well as nearby stations. The circuits were duplicated on alternative routes on account of their importance, all stations being remotely controlled from the A.C.H.Q. In all, over 420 private wires radiated from A.C.H.Q., many of them several hundred miles long.

The equipment in the A.C.H.Q. building included

a Telematic house telephone system, which gave the Commander-in-Chief and his staff conference facilities without the assistance of an operator, an important matter even within an operational headquarters. Special loudspeaking telephone equipment was provided and used for the daily joint conference with the Admiralty, Coastal Command and other Commanders-in-Chief.

Most of the foregoing work was completed for the opening of A.C.H.Q. in Liverpool. Six weeks afterwards, in mid-March, 1941, following a severe air raid, Liverpool H.P.O. was burnt out and the V.F. telegraph equipment and repeater station there seriously damaged. Although seriously affected, A.C.H.Q. communications were restored in a short space of time.

The first week in May, however, saw an all-out eight-night blitz on the centre of Liverpool, during which the building containing the three main Post Office exchanges was burnt out, and A.C.H.Q. lost 95 per cent. of its communications.

By dint of extraordinary efforts, Bank repeater station was fully in service again within eight days and, meanwhile, emergency bays of mains-operated equipment were installed in A.C.H.Q. and Lancaster House and main cables cut in. Restoration of most circuits was completed within ten days and only just in time: on May 22nd the *Bismarck* and her escorts left Norway to destroy our shipping, an elaborately planned *coup* doubtless not unconnected with the extended blitz on the centre of Liverpool. A.C.H.Q. survived, and was able to co-ordinate and control the search which was so successfully terminated by the sinking of the enemy on May 27th. The tense atmosphere in the Control Room (Fig. 2) during that operation will not easily be forgotten by those who were present.

A reserve headquarters was equipped at Lord Derby's seat, Knowsley Hall, 11 miles from Liverpool, and within a reasonable distance of the North-west Central switching centre which was set up later. All equipment was duplicated, and over 150 circuits could be switched at seven different points. Trial runs at the reserve headquarters were carried out with great success, but fortunately it was never required in actual service.

Northern Ireland Bases.

Two large naval bases were opened at Belfast and Londonderry, with smaller centres at Larne and Bangor. Belfast had a 4-position C.B.9 switchboard and 10 teleprinters fed by 124 private wires, as well as 23 switchboards located at subsidiary establishments. Londonderry was equipped with a 7-position P.M.B.X. No. 1A, a teleprinter switchboard and eight teleprinters.

Coastal aerodromes were established at Aldergrove, Limavady, Nutts Corner and Ballykelly, with flying boat bases at Lough Erne and Killadeas. As most of these bases were in the west, the existing routes were quite inadequate to meet the demands. Special expedients had to be adopted to obtain the requisite number of circuits, including the use of phantoms on 10 lb. star-quad cable and emergency repeaters housed in roadside huts. A 3-channel overhead

carrier system and a 4-channel V.F. system were installed between Londonderry and Lough Erne, later to be superseded by new cable routes. A large D.T.N. station was opened at Londonderry, and a 12-channel D.T.N. station at Limavady, with other installations at Lough Erne, Aldersgrove and Nutts Corner.

The whole communication facilities were greatly improved when the Dundonald interservice switching centre was opened in the latter part of 1941. A large percentage of the circuits from the west were routed clear of Belfast by a ring cable running through Antrim, Lisburn and Dundonald, which was provided as security against air raid interruptions.

laid to the south side of the Haven to feed the Pembroke Dock area.

Additional speech channels were provided between Cardiff and Swansea by utilising mobile repeater stations.

The main naval headquarters was in Cardiff, where a 5-position C.B. No. 9 switchboard, a teleprinter switchboard and six teleprinters were installed. Dependent on this installation were those at Swansea, Newport, Barry and Avonmouth, and numerous smaller establishments.

Scottish Aspects of the Work.

The problem of providing extensive communications in the West of Scotland gave rise to so many diffi-

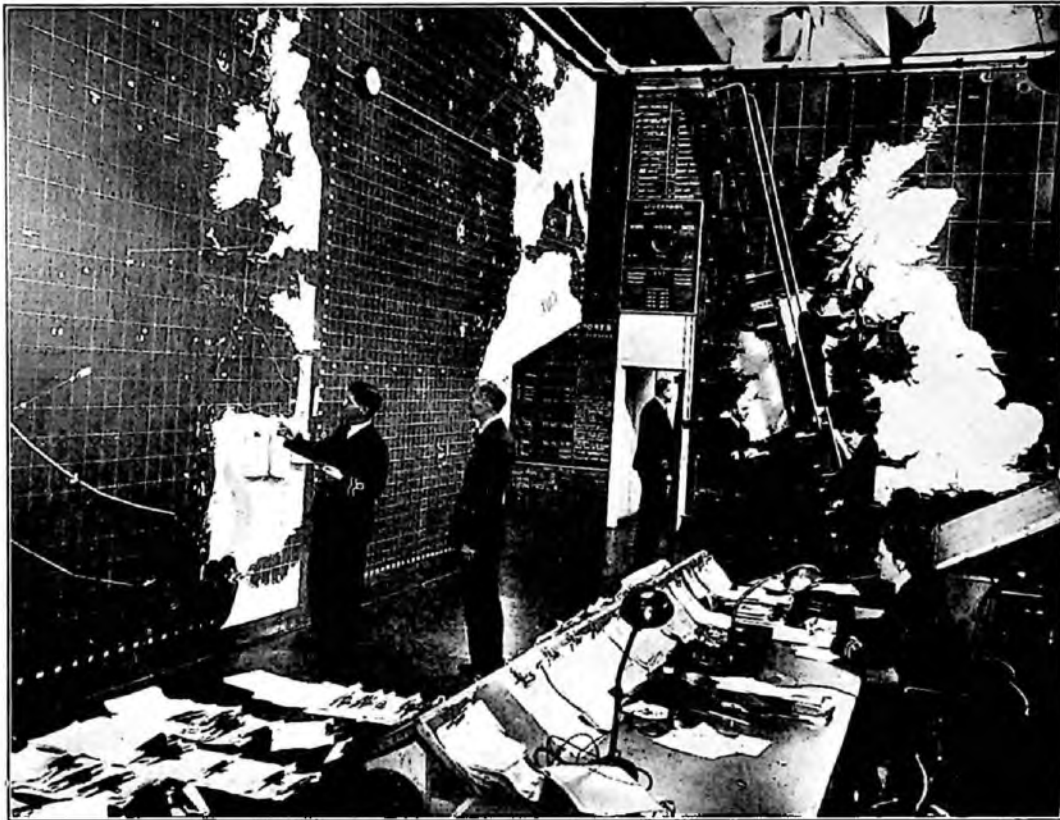

FIG. 2.—CONTROL ROOM—AREA COMBINED HEADQUARTERS.

South Wales Ports.

The South Wales ports played their part with the operational base at Milford Haven and the main commercial ports of Cardiff and Swansea. The Flag Officer's installation at Milford Haven consisted of a large multiple switchboard, teleprinter room and operations room. The headquarters was duplicated at the South Hook Fort and the circuits partially fed through a bypass cable.

To meet the requirements a 308/20 aerial cable with pole-mounted loading coils was erected on the existing pole route between Carmarthen and Milford Haven. This work involved over 1,000 extra stays to strengthen the routes, which work was largely done by U.S.A. personnel. A 138/20 submarine cable was

culties that it is considered that this aspect of the work warrants somewhat fuller description.

Ample facilities were in existence between Liverpool, Carlisle and Glasgow. Glasgow was already linked northwards to Inverness by carrier and audio routes via Aberdeen and Fort William, which had been greatly augmented to meet the requirements of the Home Fleet base at Scapa Flow. However, to serve Islay, Campbeltown, Tiree, and widely separated points in the Outer Hebrides, was a different problem. The map (Fig. 3) gives some idea of the plant provided and the long distances and circuitous routings involved.

The assembly of convoys and their escorts in Scottish waters was largely centred on the Clyde.

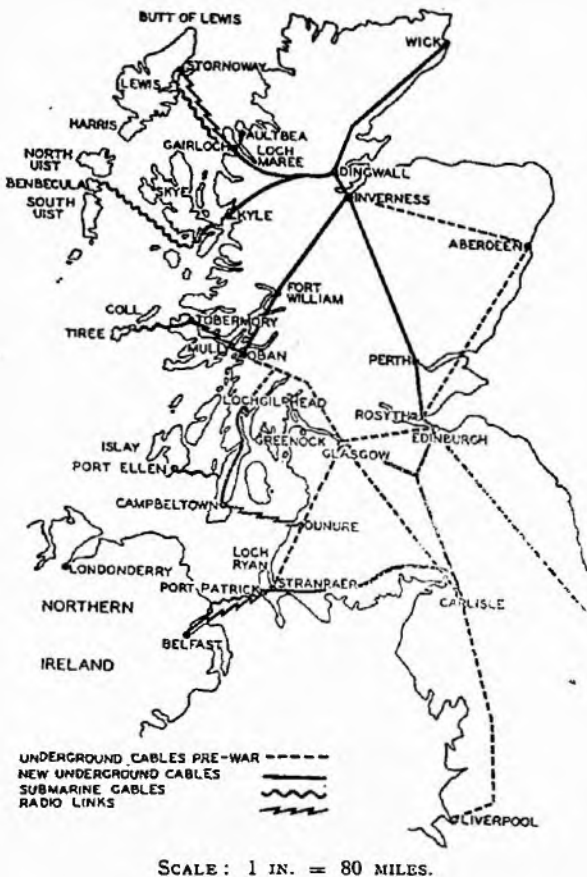

FIG. 3.—ILLUSTRATING WARTIME GROWTH OF UNDERGROUND CABLE NETWORK IN SCOTLAND.

At Greenock telephone requirements grew until some 80 separate establishments existed, the telephone traffic being later concentrated on a few larger switchboards. A suite of 20 teleprinters was installed to handle the signal traffic. An interservice telephone and telegraph switching centre was set up at Cambuslang, near Glasgow, which was of great value in the provision of communications in the West of Scotland.

Campbeltown was chosen as a submarine and R.N.A.S. training centre, and the links to Glasgow were augmented by the laying of an underground cable to Lochgilphead and the establishment of a radio link across the Firth of Clyde to Dunure in Ayrshire. These routes also carried circuits to the seaplane base, aerodrome and various radar stations on Islay, being extended by 4-channel carrier systems on submarine cables from the Mull of Kintyre.

Flying boat and naval bases were established at Stranraer and Oban. Their requirements were catered for by the extension of trunk cables and the provision of the usual terminating equipment. Two

14/20 carrier cables were provided from Stranraer to Carlisle, with intermediate repeater stations, primarily to provide additional Irish circuits. The repeater plant was installed in prefabricated buildings, often before there were windows.

The more northerly islands of Tiree, Benbecula and Lewis are well out in the Atlantic, and so were chosen as sites for fighter and coastal aerodromes.

Before the war Tiree was served by a single-core cable, its seven party line subscribers working to Tobermory exchange on the island of Mull, 30 miles away. This primitive service was replaced by a new submarine cable carrying five carrier systems, each providing one audio and two carrier circuits. Mull was linked back to Oban, the terminal of the mainland network, by 6-channel radio links. A teleprinter signal from Tiree to Liverpool thus suffered at least nine changes in frequency.

Benbecula, lying a third of the way up the 100-mile-long chain of islands known as the Outer Hebrides, was before the war one of the quietest of inhabited places. Provision of outlets for the aerodrome at Benbecula presented a problem which was solved by laying a 54-mile length of coaxial type solid dielectric submarine cable to Loch Slapin in Skye. This cable was originally manufactured for a Nice-Ajaccio link, but has found a home in colder and stormier waters. The coaxial cable is extended by balanced pair cable to Kyle, where the carrier terminal is situated.

The most northerly point in the Command was Stornoway, where a coastal station and naval base were established. Stornoway was already linked to Ullapool on the mainland by radio, the circuits being extended on a 3-circuit carrier system superimposed on aerial lines to Inverness. It was necessary, however, to open up a new route and a second radio link was constructed to work from Stornoway to a point between Gairloch and Aultbea. The repeater station on the mainland was sited at the head of the loch and a 3 kV power cable and an unloaded telephone cable were run between the 12-circuit carrier terminal and the wireless station. The conditions for laying the two ducts required were the worst that can be imagined, as the road to be followed is narrow and built for much of its length around the edge of high cliffs. From Gairloch repeater station the circuits were routed in an armoured audio cable to Achnasheen, where it joined a similar cable from Kyle of Lochalsh and thence to Inverness.

Conclusion.

To conclude, one may perhaps quote the words of the Commander-in-Chief, Admiral Sir Max K. Horton, G.C.B., D.S.O., when he said: "... the circuits have been provided and maintained efficiently, enabling me to have at all times excellent communications within my Command. I can assure you that this contributed in no small measure to the successful outcome of the Battle of the Atlantic."

Post Office Equipment for Radar

P. A. MARCHANT, A.M.I.E.E. and
K. M. HERON, A.M.I.E.E.

U.D.C. 518.5 : 621.395.658 621.392.43 : 621.396.67 : 621.395.342

The article describes some of the interesting equipment developed by the Post Office and used by the Air Ministry at Radar stations.

Introduction.

WHEN the first secrets of radar were made public, interest was largely focused upon its use for the detection of aircraft. With a knowledge of the first principles of radar it is undoubtedly this application that comes readily to mind. It was, in fact, the obvious channel for early development quite apart from strategical necessity.

The Air Ministry was not slow to appreciate the immense value of radar to augment the existing air defence reporting scheme and to extend the area of observation considerably beyond the shores of Britain. Accordingly, the development of a chain of reporting stations was projected in the very early stages, and was, in fact, in operation at the outbreak of war.

The vital link, as with all previous reporting schemes, was communications. It was inevitable, therefore, that the services of the Post Office should be enlisted at an early stage. But this was not all. There were other problems which, it was realised, could be readily solved by the use of telephone switching technique and the assistance of the Post Office was sought in the development and production of the equipment required.

Historical Survey.

Co-operation was first established in 1938 when the Air Ministry approached the Post Office regarding the development of equipment for use with the east coast chain of reporting stations. Development proceeded with all speed, and by early 1940 it was possible to provide equipment for all stations covering likely areas of approach. From 1940 onwards an ever-increasing Air Ministry programme had to be met. The number of existing types of stations was increased to cover all areas. New types to meet the constantly changing operational needs were projected, developed and established almost in one operation.

It was not long before the spotlight of urgency changed from reporting stations to interception stations and thence to controlling stations concerned primarily with offensive operations. During the same period the programme of mobile stations, both for home and overseas use, increased considerably. In all these stations P.O. equipment had to be installed, varying from small keyboards to racks of automatic equipment, etc. Finally the records showed that 66 different types of stations had been dealt with and a grand total of 365 fixed and 644 mobile stations had been equipped.

Space does not permit of the description of the communications equipment, and the remainder of the article will be devoted to a brief outline of some of

the more interesting items of special equipment which were produced.

THE CALCULATOR

However impressive the towering aerial arrays, high-powered transmitters and bays of receiving equipment at a main reporting station might be, it is with the final answer that the operational side are concerned and how soon that answer can be transmitted to a control centre in a readable form. The electrical calculator was developed to obtain this final answer from the radar information.

The Problem.

The message to be transmitted to the control centre is required in the following form:—

- (a) A map reference position.
- (b) A height in feet.
- (c) A number of aircraft.

The map reference is required in the form A1234, where the letter defines a particular map square of side 100 km., the first two figures represent the distance in kilometres along the "x" ordinate and the last two the distance along the "y" ordinate, within that square.

Fig. 1 represents the face of the cathode ray tube on the radar receiver. The length of the trace represents the full range of the station (e.g. 300 km.). The deflection E is an echo denoting the presence of aircraft at a range "R" from the station.

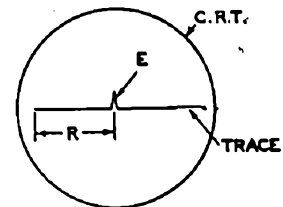

FIG. 1.—FORM OF TRACE ON CATHODE RAY TUBE OF RADAR RECEIVER.

The angle of bearing ($G\theta$) or angle of elevation ($G\alpha$), dependent upon whether bearing or height measurements are being taken, is given from the angular setting to which the gonio control must be rotated for 'E' to be at minimum amplitude. The value of R can be read directly from a scale along the trace. The number of aircraft can be estimated only from the formation of the echo.

The values of $G\theta$, $G\alpha$ and R can be read directly, but require conversion into message form. A further complication is that neither $G\theta$ nor $G\alpha$ is a true value and must be corrected to the true angles of bearing θ and elevation α respectively. The correcting factors which must be applied are dependent upon the surrounding terrain and thus upon the angle of bearing. They are values which must be predetermined for each station.

There are therefore the following requirements to meet before the information given is available in message form.

- (a) *Bearing*—to measure $G\theta$ —apply correction to obtain θ —evaluate $R \sin \theta$ and $R \cos \theta$ to obtain the answer in the form A1234.
- (b) *Height*—to measure $G\alpha$ —apply correction to obtain α —evaluate $R \sin \alpha$ to obtain the height.
- (c) A further requirement was that (a) and (b) should be determinable for any one of eight different aerial systems, each having different $G\theta$ and $G\alpha$ correction factors.

Circuit Principles.

The underlying principle used to perform these calculations was that the banks of motor uniselectors acted as squared paper, the wipers corresponding to the abscissæ of the curves $R \sin \theta$, etc., and positions

When the range and bearing controls have been set, the depression of a start key causes the G switch to rotate to the $G\theta$ marking. $G\theta$ is corrected by the translation field to true θ . Switch A then rotates to true θ . Wipers of the RC switch corresponding to $\sin \theta$ and $\cos \theta$ are selected by the A switch. The banks of the RC switches are wired such that all contacts having the same values of $R \sin \theta$ or $R \cos \theta$ are connected together and wired away to the banks of X and Y switches. The RC switch rotates to the value of "R" and thus the products of $R \sin \theta$ and $R \cos \theta$ are selected. The X switch then rotates to the $R \sin \theta$ marking and the Y switch to the $R \cos \theta$ marking. The function of the X and Y switches is to convert the values $R \sin \theta$ and $R \cos \theta$ into the form A1234 and light corresponding lamps on a display.

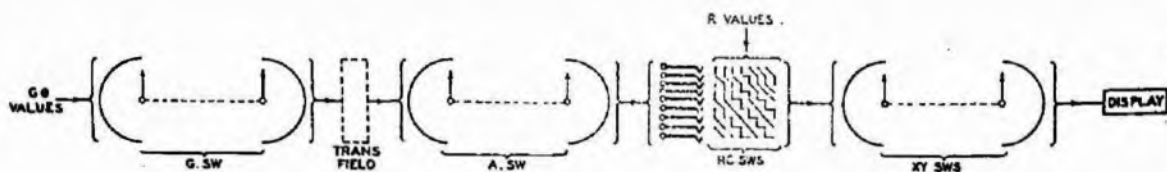

FIG. 2.—CIRCUIT PRINCIPLES OF THE CALCULATOR.

around the banks representing the ordinates. Fig. 2 shows a simplified schematic of the arrangements for the determination of map references.

The height cycle is very similar except that the corrections to be applied are somewhat more complicated and that the $R \sin \alpha$ values can be wired directly to the lamp display.

The number of aircraft is included in the lamp display, the appropriate lamps being lighted by the depression of keys on the receiver.

The equipment was arranged as shown in Fig. 3. Siemens No. 17 motor uniselectors were used to obtain the high speed of searching and the bank capacity required. A third rack was included at a later date to provide for an increase in facilities.

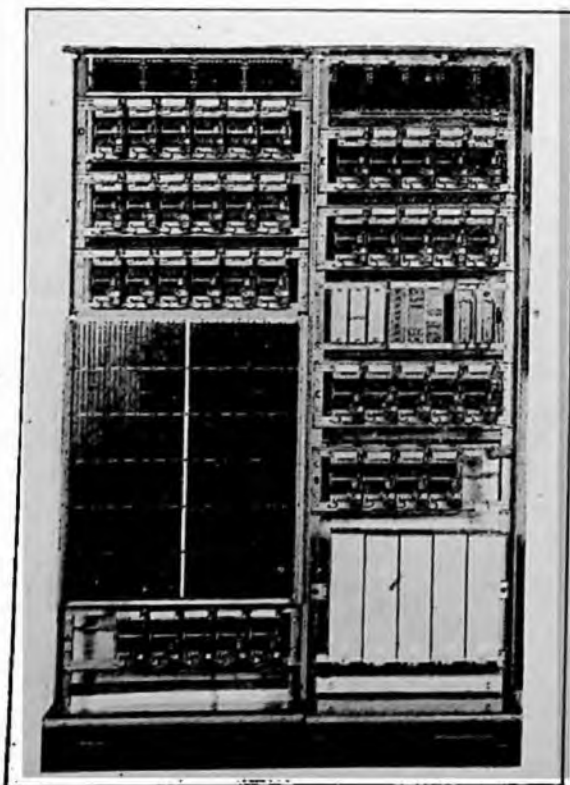

FIG. 3.—ELECTRICAL CALCULATOR EQUIPMENT.

THE MESSAGE RECORDER

As the field of application of radar widened, the increase in operating personnel and reporting circuits was such that a reduction in both became desirable. A scheme was therefore projected to enable aircraft plots to be automatically recorded at the reporting station, forwarded to the filter room in the form of a teleprinter message, and then converted into a voice message, to be received as such by the filter room plotters.¹

Increased efficiency was expected to result at the reporting station and a reduction in the number of physical circuits by the use of multi-channel working. For various reasons the sending and filter room portions of the scheme were abandoned and only the equipment at the reporting end was completed. This equipment was known as the message recorder and incorporated all facilities for transmitting to line.

The Problem.

The message to be transmitted to the filter room

¹ P.O.E.E.J. Vol. 38, page 109.

was of the form of 10592 AB123C XY1234 N12 46 where

10592 was the time in hours, minutes and tenths of minutes.

AB123C was the raid designation for the raid under consideration.

XY1234 was the map reference.

N was the type of aircraft, i.e. hostile or friendly.

12 was the number of aircraft.

46 was the height in thousands of feet.

With the spoken message the time and raid designation were a matter of paper record only. The remainder of the information was given on the calculator display.

The following requirements had to be met:—

(a) The provision of timing equipment and a means of injecting the raid designation into the recorder.

(b) The provision of equipment capable of converting the time, raid designation and calculator display into a form such that automatic control of a standard teleprinter could be effected.

An additional condition, which was covered by the use of a standard teleprinter, was that it should be possible at all times to send a message by manual operation.

Circuit Principles.

The principle used was to cause conditions to be applied to the banks of a motor uniselector, in accordance with the message to be transmitted, and by rotation of this uniselector to apply earth pulses to a remote control unit, which in turn operated the teleprinter.

A simplified schematic of the arrangement is given in Fig. 4. The timing element was produced by an

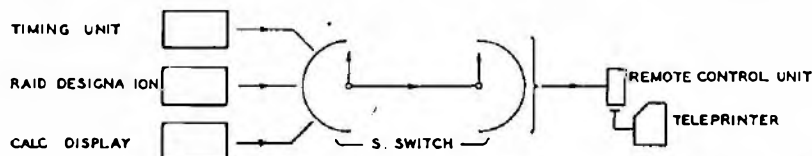

FIG. 4.—CIRCUIT PRINCIPLES OF MESSAGE RECORDER.

arrangement of uniselectors controlled from a Clock No. 46. The raid designation was recorded by the insertion of lettered plugs into a jack field, the plugs being strapped internally such that a different condition for each letter or number could be applied to the banks of the send switch. The calculator display lamps were wired direct to the banks of the send switch.

The send switch commenced rotation as soon as a calculator display was set up. In accordance with the markings applied to the selection arcs of the bank, so pulses were transmitted to the remote control unit, thus operating the appropriate teleprinter keys.

The recorder equipment, consisting of five 24-way relay sets, three Siemens motor uniselectors, five

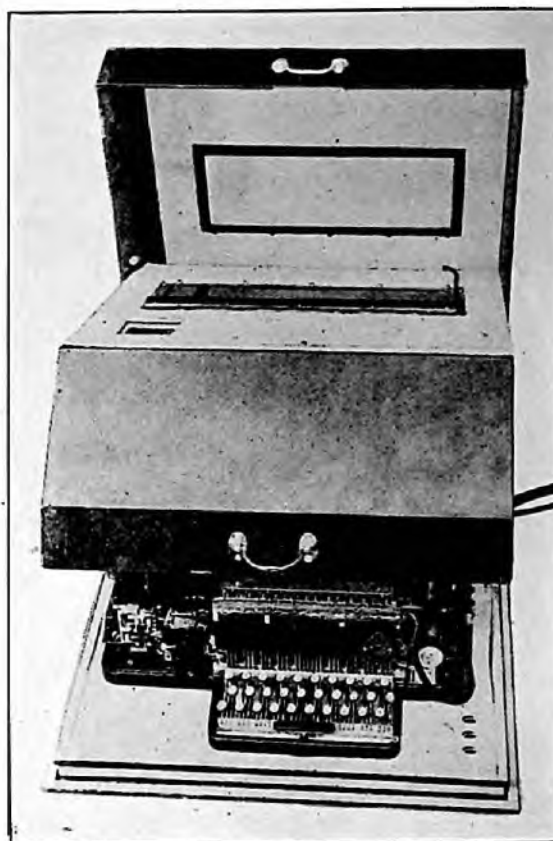

FIG. 5.—REMOTE CONTROL UNIT AND TELEPRINTER WITH SILENCE COVER.

standard uniselectors and a test panel, was mounted on an auto apparatus rack 8 ft. 6 in. by 2 ft.

The remote control unit is shown in Fig. 5. The unit consists of a group of electro-magnets designed to mount over the keyboard of a Teleprinter No. 7B, so arranged that plungers associated with the magnets operate the teleprinter keys. The silence cover, specially designed to reduce noise in the operations room, is also shown.

HEIGHT SIGNALLING EQUIPMENT

This equipment was designed for use at interception stations, where a control officer had to guide fighter aircraft so that they could make contact with enemy raiders. The information which the controllers used in giving directions to the fighter pilot was derived from two sources, namely, (a) a plan position indicator (P.P.I.) showing on a cathode ray tube the range and bearing of the fighter and raider with respect to the control station, and (b) a height finder, from which heights of aircraft were given. The controller was able to observe the P.P.I. display directly, but the height finder was necessarily located in a different part of the operations room. Means had therefore to be found for signalling height

measurements across to the controller as quickly as possible and at the same time to show the difference between the heights of the target and fighter. Also the heights had to be displayed in other parts of the operations room. To enable these facilities to be given the height-signalling equipment was developed.

The Problem.

The requirements may be summarised as follows :—

- (a) To provide a means whereby the height information as read by the height finder could be recorded in the form of a remote lamp display.
- (b) To provide a means of determining the difference in the heights of the fighter and target and display this information.
- (c) To enable (a) and (b) to be carried out for four separate interceptions simultaneously.

Circuit Principles.

To enable the information to be recorded and displayed, plunger keys were incorporated in the radar equipment and lamp displays installed as required. The information keyed was stored on groups of relays, each number being translated into a "Radix 2" expression. By such representation, subtraction of the two numbers was conveniently effected, because any number expressed in radix 2 terms is made up entirely of the digits 1 or 0, which is readily expressible on relays, since 1 or 0 can be represented by the operated or unoperated condition of the relay respectively. Then by testing the operated and unoperated conditions the difference can be recorded on a further group of storage relays.

The control equipment, consisting entirely of 3,000 type relays, was mounted on a standard 2,000 type rack 8 ft. 6 in. by 2 ft. 9 in. Strip-mounted relay sets were used and cables to the displays and controls were distributed from connection strips mounted on the rack. A fully equipped rack accommodated four interception circuits and one operations room display.

THE COMPUTER TYPE 60A

This equipment was designed for use in bomber control stations whose function was to transmit signals to pathfinder aircraft in the vicinity of the target, and thereby control the plane during its "run up" and release of target indicators, etc. Two control stations were involved in the operation and were known as Cat and Mouse stations. The Cat kept the bomber on a specified approach course and the Mouse gave instructions as to when the indicators should be released. The latter requirement involved an accurate timing device and facilities for sending code signals to the aircraft. For this purpose the computer was designed.

The Problem and Circuit Principles.

At the Mouse station a trace was provided on a cathode ray tube closely embracing the target area.

This trace is represented by Fig. 6. A, B and C are artificial echoes and represent points on the approach run. A plane flying along the prescribed course is displayed as a further echo on the trace.

The problem was to measure the time taken for the aircraft to fly from A to B, and then determine

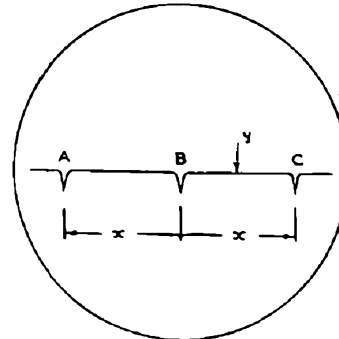

FIG. 6.—FORM OF TRACE ON CATHODE RAY TUBE EMBRACING TARGET AREA.

the point *y* at which the release signal must be given to the aircraft. Also to send code signals to the aircraft at certain intervals, giving warning of approach to point *y*.

The circuit principle followed was :—

- (a) To step a uniselector under the control of a fixed impulse rate as the plane echo travelled from A to B.
- (b) To step a further uniselector an equivalent time, less the time of bomb fall (*y* to C), at which point a release signal was sent to the aircraft. The time of bomb fall was preset on a group of keys and adjusted according to the height of the aircraft.

The "approach" messages were sent by the depression of keys mounted on the receiver, the actual code being decided by relay circuits.

The equipment was mounted in duplicate on a special apparatus rack at the Mouse station. The control keys, etc., were mounted on the radar equipment.

Conclusions.

Successful accomplishment of the Air Ministry's requirements was made possible by the co-operation of the parties involved. In this respect mention should be made of the Air Ministry Telecommunications Research Establishment from whom many of the basic ideas originated, of the Post Office Factories Department, Messrs. Siemens Bros. and others who were responsible for production, and of the Engineer-in-Chief's Circuit Laboratory and the Regions who carried out the installation work.

Permission from the Director of Signals, Air Ministry, to publish this article is gratefully acknowledged.

The Telecommunications Network for Defence

U.D.C. 621.394.74

Part I. The Defence Teleprinter Network

F. E. NANCARROW,
O.B.E., A.R.C.Sc., M.I.E.E.

An outline of the arrangements made to provide and maintain a comprehensive teleprinter network for the Defence Services. Reference is made to the use of telegraph switchboards and the provision of mobile units for emergency purposes.

Introduction

IN the years prior to the war, the demand on the Post Office by the Services for private wire teleprinter communications was not great, but even then the fact that the location of the Service terminal was, in many cases, remote from the main centre of the civil communication network was making it difficult to provide telegraph circuits which were capable of giving stable service. When early in 1938 a clearer picture emerged of the possible requirements of the Admiralty and Air Ministry for telegraph circuits the suggestion was put forward by the Post Office Engineering Department, and accepted by the Services, that such requirements would best be met, and indeed could only be met, by the setting up of a network partially independent of the civil network and in which the V.F. terminal equipment should be located in Service establishments. The acceptance of this principle meant that the Services would provide accommodation wherever necessary to house the V.F. terminal equipment and power apparatus deemed necessary by the P.O. Engineering Department to meet the plans put forward by the Services and that on their part the Post Office would be responsible for the provision of maintenance personnel at points remote from their usual location. In addition it eased the position regarding

the provision of the private wire telephone requirements since the projected telegraph terminals could also include telephone amplifying and signalling equipments and thus allow of the setting up of 4-wire circuits between all the Service establishments.

In 1938 Treasury authority was given for the

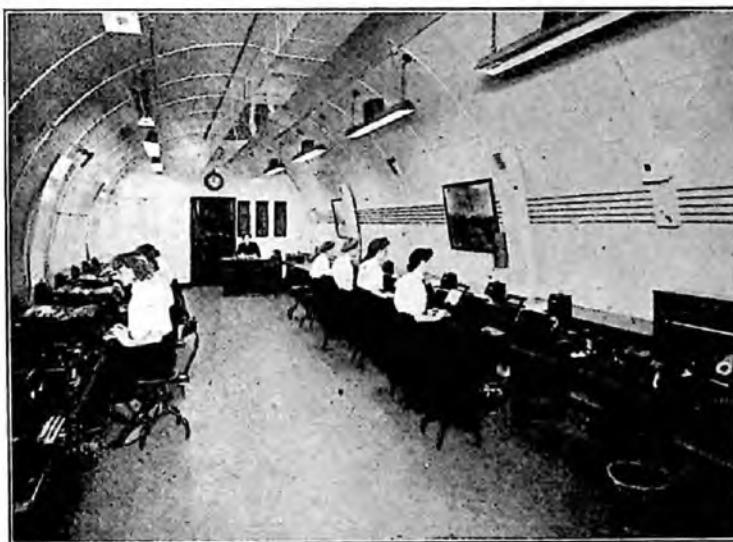

FIG. 2.—TELEPRINTER ROOM ASSOCIATED WITH SWITCHBOARD (FIG. 1).

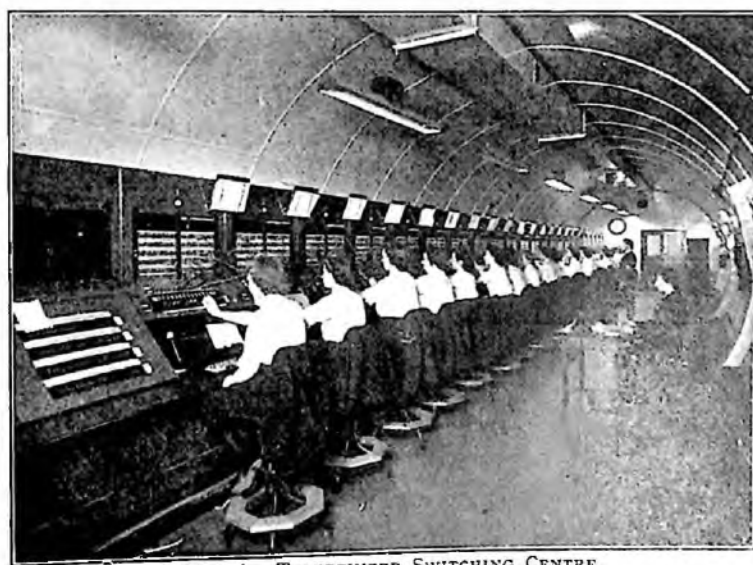

FIG. 1.—TELEPRINTER SWITCHING CENTRE.

provision of a telegraph network based on these principles which was to be of the same order of size as that which then existed for civil purposes and which the P.O. Engineering Department committed themselves to complete within three years. In an undertaking of this nature it was necessary to have a name and the scheme was dubbed the "Defence Teleprinter Network," which name has stuck throughout the war years although, as is usual with such titles, shortened to the initials D.T.N.

At its inception the scheme provided for all the then projected telegraph requirements of the Air Ministry serving Fighter, Bomber, Coastal and Maintenance Commands together with associated services, for the requirements of the Admiralty in linking up their various establishments in this country and in a similar manner for the War Office. As may well be imagined the advent of the war and the course of the war wrought many changes and it is of interest that the output reached during

one of the war years was equal in magnitude to the original scheme, such had the demand grown for telegraph services.

Engineering Developments.

The engineering operation required to meet the original demand was very large for the telegraph side of the P.O. Engineering Department and also for the contractors concerned in the provision of the terminal apparatus since it involved a rate of production, installation and testing much greater than had



FIG. 3.—POWER PLANT FOR D.T.N. STATION.

hitherto been called for. Some of the projected telegraph installations were quite large—as large as any then existing in this country—and had an allowance for growth, and the design of suitable power plants to meet the various requirements was a problem to itself. Moreover, whilst telegraph circuits serving operational, intelligence and meteorological needs were intended mainly to be on a point-to-point basis, it was desired that administrative circuits should be on a switched basis, and to meet such a requirement the P.O. Engineering Department set out to design suitable telegraph switchboards.

A main factor in the smooth engineering functioning of the telegraph service in this country is that the equipment and method of operation is standardised, and this factor of standardisation was held to be essential in an activity associated with defence or war since it lends ease and rapidity of maintenance. Thus the power units which were developed were initially of three types to meet the varying ranges of loads which could be foreseen and the switchboards of two types, one suitable for multiple operation and the other for

single position working. The requirements which arose during the war necessarily modified this concept, but the ideal of standardisation was never out of sight or mind.

The nature of the switching of teleprinter circuits which was required is illustrated by Fig. 1, which shows one of the larger switching centres, of which type there were eventually five distributed at discrete points about the country. The switchboard shown was made up of 24 positions and catered for some 500 lines and one of the end sections, in fact the cable turning section was equipped with a broadcast panel (see left-hand side of Fig. 1) to allow of two simultaneous broadcasts of each up to 40 lines. Fig. 2 shows the associated teleprinter instrument room dealing with overflow and other traffic. In this room were provided facilities for manual and automatic perforation and automatic transmission of messages.

Fig. 3 illustrates the type of power unit installed during the later war years to provide for the filament and anode voltage supplies for the telegraph and telephone terminal equipment at a medium size D.T.N. station.

Development of the D.T.N.

In a review of this nature it is quite impossible to give any comprehensive picture of the network of telegraph circuits which were eventually set up, and indeed such a picture would involve a detailed description of the organisation of the various Commands of the three Services as well as that of the Foreign Office. Suffice it to say that the circuits provided in the network extended to all parts of the British Isles, that teleprinter switchboards could be found in the Orkneys and teleprinters in the most unexpected of places—even in the Western Isles of Scotland.

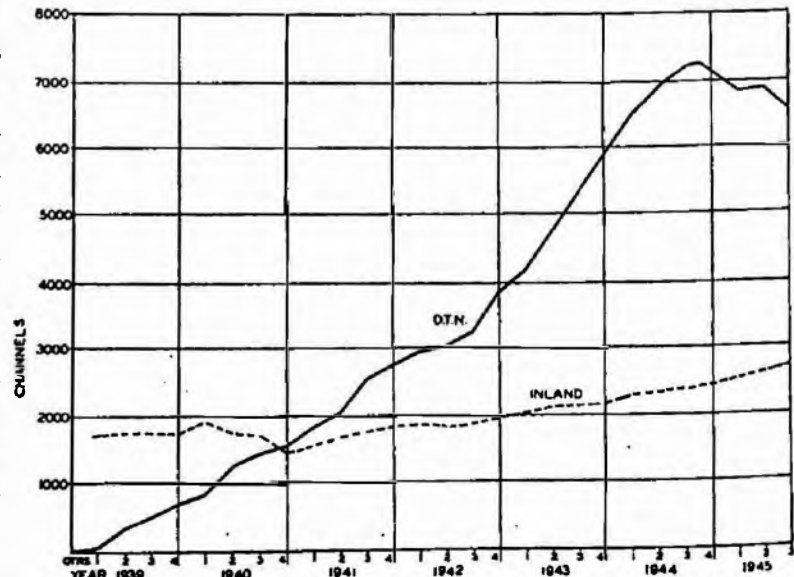

FIG. 4.—GROWTH OF V.F. TELEGRAPH CHANNELS DURING THE WAR.

The first multi-channel voice frequency telegraph system of the Defence Teleprinter Network was opened on 31st March, 1939, between Uxbridge No. 1 and Faraday Building, London, to be followed on 4th April, by a system between Uxbridge No. 1 and Stanmore No. 1, and from then on the story is one of the continuous opening of systems month by month up to the end of the war. The suffix after Uxbridge and Stanmore has an especial interest in that a numeral of higher order would indicate that the location of the original apparatus had changed, perhaps gone deeply underground or into more operationally convenient quarters, and that the P.O. Engineering Department had been involved in the operation of duplication of apparatus and subsequent recovery from the obsolete quarters. As may well be imagined there was a great deal of such work to be done.

The curves given in Fig. 4 show how the channels provided by the multi-channel voice frequency telegraph equipment grew during the war years. It will be seen that by late 1940 the provision had reached the total of the Inland Service network and by late 1944 was some two and a half times as great. It will be seen also that the Inland Service was not standing still during the war years—it had of course to provide for all the war requirements of industry and Government Departments other than the fighting services—the relative curve showing how the losses due to war damage, indicated by the fall of the curve, had been more than replaced by the end of 1944.

Meteorological Network.

A striking example of what can be achieved by modern telegraphic methods is afforded by a part of the Defence Teleprinter Network which provides for the meteorological services. This is a purely telegraph network linking many hundreds of stations scattered throughout the British Isles, all of which can be connected to a central controlling station for the simultaneous reception of information. Broadly, the controlling station can be likened to a central hub from which the spokes, some fifty in all, radiate to sub-centres and from each of these sub-centres radiate spokes, varying up to twenty in number, connected to stations. At each of the sub-centres teleprinter switchboards allow intercommunication of stations or the connection of all the stations to the main centre. This arrangement allows of the collection of weather information by the sub-centre from its stations and transmission to the main centre where it is received both as a typed message on a teleprinter and as punched slip on a reperforator. The aggregate information is then transmitted through the agency of an automatic transmitter simultaneously to all the stations in the network. This is by far the largest self-contained teleprinter network set up in this country and it is a matter of pride to those responsible for its provision that its vital functions have continued uninterrupted throughout the war years.

Service to the American Forces.

The advent of the American forces into this country gave rise to a very large demand for telegraph com-

munications and in the main this was catered for as part of the requirements of the Services, through whom the demands were made upon the Post Office. Where, however, it was desired to use American teleprinters the problem was posed as to how best to resolve the difference in teleprinter speed and method of line operation as between British and American practice. A solution was found in the adjustment of the motor governor of the American machine and the design of an adaptor unit which enabled American equipment to work its British counterpart. Many hundreds of these adaptors were provided for use by the American forces. In addition to the telegraph services provided in this country, a number of teleprinter switchboards were supplied to the American forces operating on the Continent.

A special feature of the service provided for the American forces was the teleprinter circuits set up between this country and Washington. Using a radio circuit to bridge the Atlantic and the frequencies



FIG. 5.—D.T.N. MOBILE TELEGRAPH TERMINAL (VIEWED FROM FRONT).

from multi-channel voice frequency telegraph equipment to modulate the transmitter and conversely multi-channel telegraph receiving equipment to translate the radio reception, it has been possible to operate successfully up to six teleprinter circuits across the Atlantic using a single radio circuit. Fading was countered by a system of frequency diversity whereby four of the voice frequency telegraph channel frequencies were utilised for each telegraph channel, two for the marking signal and two for the spacing signal

and by the utilisation of a specially designed quick-acting gain control on the telegraph receiving apparatus.

Mobile Telegraph Units.

In the early stages of the D.T.N. it was decided that it was very desirable to have available mobile telegraph terminal equipments to allow of the emergency restoration of any station receiving damage due to enemy action and also to allow of the urgent provision of telegraph service in advance of the installation of permanent equipment. The Air Ministry provided the vehicles and arranged for the fitment of the special bodies, interior lighting and strengthening of chassis to the design and requirements of the P.O. Engineering Department. Some thirty vehicles were provided during the war years containing various combinations of four, twelve and sixteen channel voice frequency telegraph equipments, together with telephone amplifying and signalling apparatus, as well as the necessary power equipment to provide the supplies to the valves and for line signalling. The units depended upon an outside source of 200-240 A.C. supply for their primary power. The maximum number of telegraph channels catered for in any one unit was thirty-six, and some idea of the equipment is given in Fig. 5. The vehicle in this case was a Tasker trailer.

Happily in no case was the service of these units called upon to meet damage due to enemy action, although a similar unit made to cover damage to public service telegraph apparatus was used to replace the power unit at a D.T.N. station which had been put out of action by an enemy bomb. The units, however, did yeoman service throughout the war years in meeting circuit requirements in advance of permanent installations and most particularly in the complex communication network set up to provide for the operations preceding D-day. A large proportion of these units was shipped to the Continent after D-day and it is understood that they rendered valuable

service. In addition to this type of mobile unit a smaller number of mobile teleprinter rooms were designed and constructed. Each vehicle contained a No. 13 type telegraph switchboard catering for 30 lines with broadcast facilities, and a suite of six teleprinter positions together with the necessary power equipment. These units also served their purpose in this country and, like the others, found their way into useful service on the Continent after D-day. Fig. 6 gives a picture of the inside of such a unit.

Global Figures.

Some idea of the engineering effort involved in the provision of the D.T.N. can perhaps be given by quoting figures.

Thus to date a total of 562 terminals containing multi-channel voice frequency telegraph equipment have been set up in premises provided by the various Services and 146 such terminals, for various operational reasons, have been closed down; 174 of the terminals were of the type and size requiring the provision of power equipments of one or other of the three sizes previously mentioned; the others operated off the mains supply. Some of the terminals were very much larger than any previous concentration of such equipment and required special power arrangements. The number of multi-channel systems provided totalled 1,500, corresponding to 12,660 telegraph channels, whilst 775 systems, corresponding to 5,850 channels were ceased. The engineering of this work involved the issue of 1,106 contracts and 210 works specifications and the preparation of some 825 accommodation plans.

More than 10,000 telegraph circuits of all kinds were provided up to the peak period of August-October, 1944; this figure is net and takes no account of the large amount of rearrangements and cessations which were continually taking place due to operational needs. The operation of these circuits has demanded a continuous supply of teleprinters, and well over 10,000 have been absorbed to meet D.T.N. requirements. In addition to teleprinters, auxiliary apparatus such as teleprinter tables, rectifiers, etc., etc., have been produced and supplied in corresponding numbers. Many of the circuit terminations took the form of large teleprinter instrument rooms, up to aggregations of 200 instruments, necessitating the preparation of engineering specifications for their installation.

To provide for the switching of the telegraph circuits eight different types of switchboard were ultimately developed and between five and six hundred operating positions were manufactured and installed to meet various requirements.

Co-ordination of Work.

The mass of voice frequency telegraph equipment was provided and, in the main, installed by Standard Telephones and Cables Ltd., and to ensure that the



FIG. 6.—INTERIOR OF MOBILE TELEPRINTER ROOM.

closest co-operation was maintained between the Service requirements and production and installation, a committee was set up early in 1938 representing the P.O. Engineering Department, Service Departments and the contractors. This committee met monthly from June, 1938, to September, 1944, and its labours contributed greatly to the smooth execution of the many works involved. The teleprinter terminal equipments, teleprinter instrument rooms and teleprinter switchboards were engineered and installed throughout the network by the P.O. Engineering Department.

To ensure the efficient operation of the network with its tentacles spread to parts of the country hitherto unaccustomed to modern telegraph methods, a small advisory maintenance body was set up at Headquarters composed of officers expert in voice frequency telegraph apparatus whose function was to tour the various D.T.N. terminals and help and advise those concerned in the operation and maintenance of the equipment. Their efforts have done much to maintain the uniformly high standard of efficiency achieved in the field despite the hardships imposed by war conditions.

Part 2.—The Network of Telephone Circuits and the Defence Telecommunications Control

H. R. HARBOTTLE,
O.B.E., B.Sc.(Eng.), D.F.H., M.I.E.E.

A brief description of the network of private telephone circuits used by the Defence Services and the arrangements made for planning and provision of the necessary plant when speed of completion was a vital consideration.

Introduction.

AS has already been pointed out, the Defence Teleprinter Network comprises a system of telegraph channels and, for the majority of these, telephone type circuits were necessary. In addition, however, a very large number of private telephone circuits was required by the Services for operational and administrative purposes. In this brief review it will be generally impossible to describe the method of operating these circuits and their precise functions. Nevertheless, it is hoped that some idea will be gleaned of the vital importance and extent of the communications provided.

Emergency Circuits.

Prior to the actual outbreak of war a comparatively small network of private telephone circuits had been arranged for the Services. This comprised a number of long distance circuits, normally in use for the public system and capable of being switched at short notice (6 hours, 24 hours and upwards) to form a network of about 500 private telephone circuits; and a much greater number of permanently rented circuits under 15 miles radial length. The former (switchable) circuits were known as Emergency Circuits and were switched from time to time for exercises (e.g. the Coast Defence Exercise—C.D.X.—of August, 1939). Included in them were circuits for:

(a) *Mobilisation.*—To cater for the anticipated additional traffic from the Admiralty, War Office, and Air Ministry to Naval bases, Army and R.A.F. Commands respectively.

(b) *Operations.*—These were required for such formations as Royal Observer Corps, Searchlights, A.A. guns and Coast Defence guns.

(c) *Movement of Stores, etc.,* e.g. to improve the communication facilities between Commands, Units and Depots.

The majority of these emergency circuits were switched into service during

the last fortnight in August, 1939, and, subsequently, most of the additional circuits requested were provided on a permanent basis. Emergency facilities were retained in some instances so that (a) the drain on the public system could be reduced, and (b) a network of circuits could be made available quickly for a particular operation as, for example, the bombing of Norway.

Size of the Network.

The growth, during the war years, of the network of private telephone circuits, each over 25 miles in radial length (including the circuits, normally 4-wire, required for the multi-channel voice frequency systems of the D.T.N.) is shown in Fig. 1, together with its effect on and the later growth of the public trunk system. The initial fall in the latter resulted from the switching of the emergency circuits referred to above. It will be observed that the size of the Services long distance telephone network reached a peak of 9,300 (or nearly one and a half times

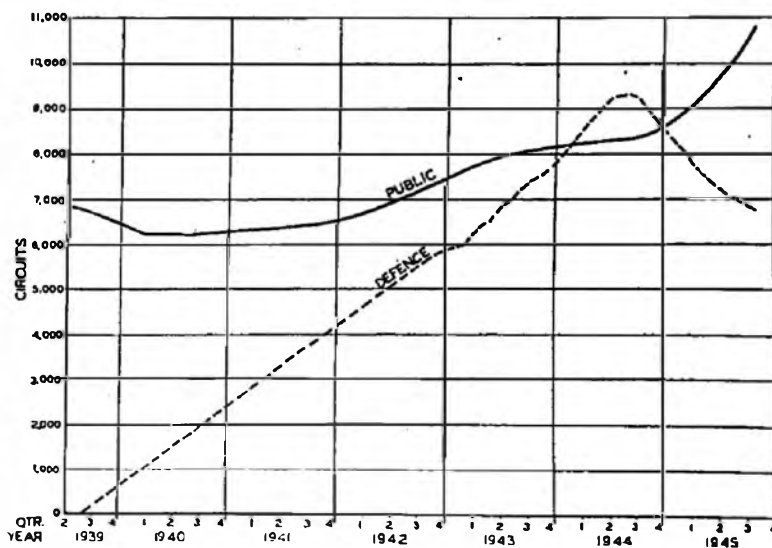

FIG. 1.—GROWTH OF TELEPHONE CIRCUITS OVER 25 MILES RADIAL LENGTH.

the pre-war public trunk system) in August, 1944—after "D" day. This lag was caused by the flying bomb menace. It is estimated that the total number of private telephone circuits (including those under 25 miles radial) in use by the Services in August, 1944, exceeded the astonishing total of 60,000.

PLANT PROVISION

To meet this extensive increase in circuits it was necessary to augment considerably the main underground plant in the country. The following facts will indicate the magnitude of the work carried out by the Post Office and its contractors:—

(a) *Audio*.—More than 400 main audio cables of various sizes and lengths were laid during the war.

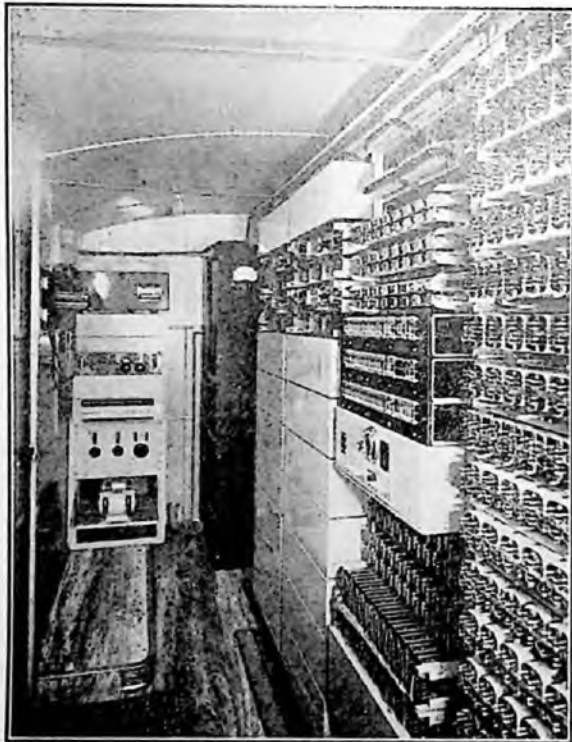

FIG. 2.—EQUIPMENT IN MOBILE REPEATER STATION.

(b) *Carrier*.—Concurrently, two 24pr/40 12-circuit carrier cables were laid on each of 36 routes and 28 of these routes were either wholly (for 288 telephone circuits) or partially equipped.

(c) *Co-axial*.—Under schemes carried out during the period 1939-1945 circuits totalling 408 were brought into service. In addition, extensions to existing schemes were carried out and a considerable length of new cable for future coaxial systems was laid.

To appreciate more readily the amount of work involved, it should perhaps be stated that the main underground system of this country which had been

built up during a period of 25 years was almost doubled during the five years of war.

Improvisation.

Despite the efforts made to rapidly augment the permanent plant, frequent urgent demands for additional communications on existing routes and to outlying districts, where extensive communication facilities had not previously been required, necessitated continued recourse to non-standard methods of plant and circuit provision.

One example occurred when it was apparent that the French would capitulate in 1940, and active steps were being taken to improve the air defence for S.W. England. A fighter sector was established at Middle Wallop airfield and considerable long distance communications were required quickly. The urgency demanded the exploitation of temporary expedients well in advance of the provision of permanent plant (a new underground cable from Andover to Salisbury). In this case two 19 pr. I.R.V. interruption cables were erected between Salisbury exchange and Middle Wallop airfield—a distance of approximately 12 miles—and a mobile repeater station (Fig. 2) fitted with mains-operated amplifiers and 500/20 ringers was moved to the airfield.

THE D.T. CONTROL ORGANISATION

In the planning and provision of the vast communication system built up for the Services during the war, certain changes in peace-time procedure had to be introduced so that urgent requests could be dealt with promptly, and for this purpose the D.T. Control organisation was set up. The focal point of this organisation was in the War Group of the Engineer-in-Chief's office, which acted in close association with other Headquarters Branches.

A private wire telephone network radiated from a telephone switchboard in the War Group to Regional D.T. Controls, which also had ready access to Regional records. Similarly, these Regional D.T. Controls had private telephone circuits to Area D.T. Controls and other important points, e.g. R.A.F. Group Headquarters, situated within the Region. By means of this system routing information could be passed by telephone from Headquarters to all the Regions concerned with the result that new private circuits or alternatives to operational communications interrupted by damage to plant could be set up within a matter of hours. To avoid inaccuracies and still further increase the speed of transmitting circuit information to personnel directly responsible for provision, the D.T. Control telephone network was supplemented by a teleprinter network, the focal point of which was also in the War Group. This extended to all Regions and most Areas and had broadcast facilities which enabled routing details, etc., to be sent simultaneously to the Regions and Areas directly concerned.

Throughout the war the D.T. Control organisation was staffed by competent personnel on a 24-hour basis, including Saturdays and Sundays.

Safeguarding Telecommunications in Wartime

H. F. EPPS, B.Sc., A.M.I.E.E

U.D.C. 621.395.72 : 621.395.74

An article describing the principles adopted for safeguarding telecommunication services, both public and defence, in wartime, and drawing on experience in London to exemplify their application.

Introduction.

ALTHOUGH the exacting conditions of war are not normally taken into account when planning and providing telecommunication requirements, the ability of an organisation to maintain essential services, both public and defence, under the stress of an enemy's attack is of vital importance to the community's security and morale. This account of measures which were taken for safeguarding telecommunication services against interruption by air raid damage relates mainly to those carried out in London, but they are, it is thought, substantially representative, at least in principle, of those undertaken in the country generally, though the scale, and possibly the variety, of the individual works may have differed considerably. Space does not permit an exhaustive description of all the many measures which were taken in London, and consequently reference must necessarily be limited to a selection of those which were outstanding, either in magnitude or character.

SAFEGUARDING THE PUBLIC SERVICE

Trunk and Toll Exchanges.

Among the most important schemes devised in expectation of the outbreak of war were those which were intended to ensure the continuity of at least a proportion of the trunk and toll services, amounting in London to about one-third of the normal. Five trunk and eleven toll detached switching centres were established in London at selected exchanges adjoining the main cable routes, and situated at distances between 5-10 miles from the existing trunk and toll exchanges. Two conditions were provided for; one, the possible loss of the existing trunk and toll exchanges, and the other, the severance of the cables between the trunk and toll exchanges and the detached switching centres.

The external work in setting up these switching centres entailed the interception of 24 main cables for the Trunk emergency scheme, and 27 cables for the Toll scheme. For the switching centres, a considerable quantity and variety of trunk and toll equipment was required and installed.

The method of dealing with the calls was substantially similar whether the "full" scheme, i.e. all the switching centres were brought into operation, or the "partial" scheme was implemented, when only those detached centres affected by the cable damage were in operation. Traffic was routed by calling a pre-

arranged number on a P.B.X. final selector, or numerical selector, to an operator at the detached centre, where the trunk calls were dealt with on a delay basis, and the toll calls completed, if possible, on demand. The effectiveness of these arrangements was given a searching test on the 24 occasions on which the "partial" scheme was brought into operation during the heavy and persistent bombing.

The heavy bombing attacks during the autumn and winter of 1940-41 emphasised the vulnerability of the existing London Toll A and B exchanges. It was decided, therefore, to automatise the service as much as possible and install the automatic equipment for Toll A and the replacing sleeve control manual exchanges for those routes which could not be converted, in Faraday Building, South-east Block, which, being a modern steel-framed building, provided a substantial measure of security for both the equipment and operating staff. The Toll B routes which could be automatized were accommodated on spare capacity of the trunk automatic equipment. For a detailed account of the toll exchanges, readers are directed to an earlier article¹.

Trunk Exchange in "Citadel."

Although the safeguards for the trunk service just described typify the principle of dispersion adopted in many parts of the country, they were not regarded as adequate for the important concentration of equipment in the Faraday block of buildings in London.

¹ P.O.E.E.J., Vol. 35, page 105.

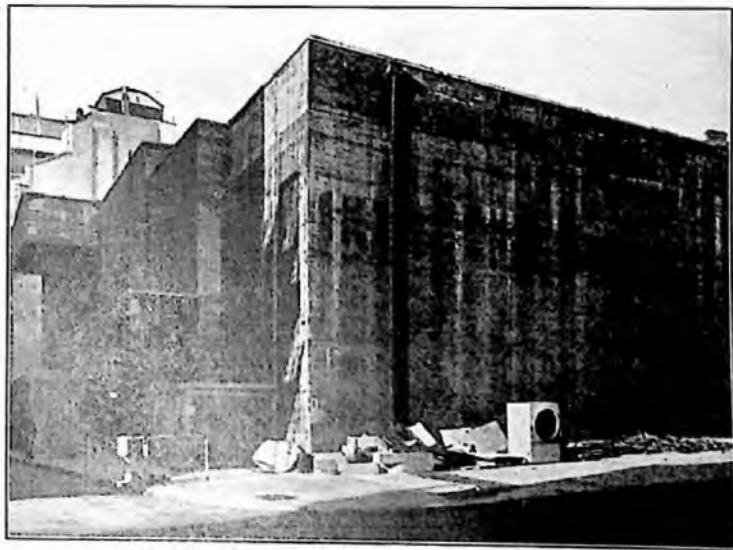

FIG. 1.—CITADEL TRUNK EXCHANGE BUILDING.

It was decided, therefore, at the end of 1940, to proceed with the construction, as quickly as possible, of a "fortress" type of structure on the vacant site adjoining Faraday Building, North Block, which would be proof against direct hits by medium size bombs, and in which the services could be maintained during the attacks.

The "Citadel," as this structure subsequently came to be known, was an exceptionally heavily reinforced concrete building, without windows, and having walls between 6 ft. and 3 ft. thick and a roof 7 ft. 6 in. in thickness. As the Citadel was intended to function as a separate entity, in the literal sense of a fortress, such comprehensive facilities as dormitories, artesian well, fuel storage tanks, ventilating, air conditioning and gas filtration plants were provided, so that the services could operate without being impaired by the conditions prevailing outside. The continuity of power supply was also ensured by the provision of diesel engine-driven alternators². An exterior view of Citadel is shown in Fig. 1.

The scheme for the Citadel trunk exchange was planned to meet the following two principal conditions:—

- (1) To provide a limited trunk service if both the Faraday North and South Buildings, which accommodated the existing trunk equipment, were destroyed.



FIG. 2.—CITADEL TRUNK SWITCHBOARD.

- (2) to operate in conjunction with the trunk switchroom in Faraday South Building if the switchrooms in Faraday North Building were lost.

An additional feature of the scheme was that the

P.O.E.E.J., Vol. 35, page 115.

exchange could function normally as an extension to the trunk switchboard in Faraday South Building, and thus share the traffic.

The manual equipment of the Citadel trunk



FIG. 3.—TRUNK TEST RACKS IN CITADEL.

exchange comprises 204 standard 6 ft. 8½ in. sleeve-control positions, 136 of which were equipped as demand or delay positions, 41 as incoming positions and 27 as dual purpose positions, together with a number of record and miscellaneous positions and desks. A large quantity of a variety of associated signalling and transmission equipment was also installed. Typical views of the switchroom and some of the equipment are given in Figs. 2 and 3.

The construction of the Citadel was commenced in May, 1941, and completed in the exceptionally short time of seven months for such an elaborate structure. The installation of the considerable amount of equipment and the completion of the line plant arrangements were accomplished just as expeditiously in nine months, and the exchange was finally brought into service in November, 1942.

Local Exchanges.

Provision for the loss, or interruption of the service of local exchange plant had, of course, also to be made, and suitable arrangements devised in advance for the speedy restoration of those services which were of vital importance.

The general principle adopted in planning the restoration of these circuits was to divert them to selected junction cables to neighbouring exchanges; or, if the available plant was insufficient or unsuitable, to install a switchboard and use the available pairs as junctions to the nearest exchange. At some

exchanges certain essential lines were intercepted, so that they could be readily diverted in an emergency.

Two of the more notable arrangements made were the provision of an emergency manual exchange (Monarch) in the City of London equipped for 6,000 lines and the installation of a duplicate tandem exchange.

Telegraphs.

The war-time experience of telegraphs in London furnished a striking example of the wisdom of providing in advance standby equipment against the possible loss of the main office. Without this provision the destruction of the Central Telegraph Office on December 29th, 1940³, would have been disastrous and would have entailed prolonged dislocation of telegraph traffic. As it was, circuits were switched and diverted to reserve offices, which came into service smoothly and without undue delay. The bulk of the traffic was taken by two main emergency installations, known as C.T.O. "R" and "X."

The emergency scheme was ready shortly after the outbreak of the war, and consisted of four reserve offices, which, known as C.T.O. "R," "X," "Y" and "Z," were designed to fulfil particular functions.

C.T.O. "R" was the first reserve office for all important inland circuits in the C.T.O. It was equipped with 180 teleprinter positions, 30 positions for high speed Wheatstone working, 120 phonogram positions and 20 printergram positions. Owing to the proximity of C.T.O. "R" to the main office, a second and remote reserve office was provided in protected sub-ground accommodation, specially designed for the purpose. This office, C.T.O. "X," was equipped with 65 teleprinter positions. In addition to the equipment mentioned, both these reserve offices were provided with four 18-channel V.F. systems.

The two remaining reserve offices were associated with C.T.O. "R" and comprised C.T.O. "Y," the reserve for phonogram circuits in C.T.O. "R," and C.T.O. "Z," the reserve for overseas circuits in C.T.O. With the loss of continental circuits in 1940, this latter office became redundant.

Line Plant.

Although some measure of security was achieved by the provision of alternative routing, the risk of extensive damage to the heavy concentration of trunk and junction cables in the central area was so serious as to make it imperative to adopt an exceptional and notable safeguard by diverting a number of the cables to the public and Post Office tube railways, and a deep tunnel which was specially constructed during the war to accommodate Post Office plant.

The construction of this tunnel, which is 7 ft. in diameter, and at a depth varying between 70 ft. and 100 ft. below the surface proceeded from three working shafts, one of which was retained as the leading-in point for the cables. A lift of sufficient capacity to take full size cable drums was installed in this shaft. Owing to the need for conserving iron during the critical period of the war, the greater part of the tunnel was lined with reinforced concrete segments instead of the customary cast iron. Plant was installed for the ventilating, draining and lighting of the tunnel. At one point an enlarged offset was constructed to accommodate loading pots. Among the arrangements for cabling was the provision of specially designed roller skates, which were attached to the cables to facilitate their movement to the appropriate section of the tunnel. A total of 60 cables with an aggregate mileage of 62 was installed in the tunnel, in which about 150 cables can ultimately be accommodated. A typical view of the tunnel showing the cables in position is given in Fig. 4.

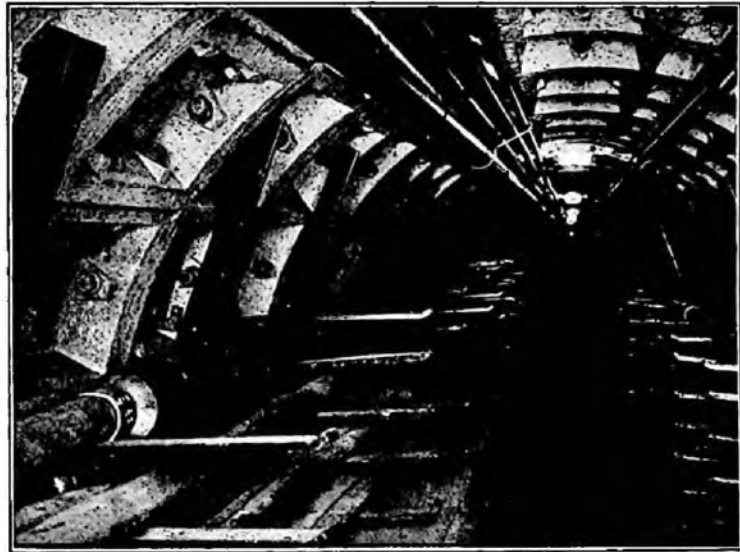

FIG. 4.—CABLES IN TUNNEL.

SAFEGUARDING DEFENCE COMMUNICATIONS

Protection for defence communications was in general more elaborate and certain in its function than that provided for public communications, owing to the fundamental importance of maintaining the continuity of their service. In London this objective was finally achieved by putting the plant deep underground, or in exceptionally strong reinforced concrete structures having walls several feet in thickness. The most notable and comprehensive scheme of this character was the tunnel system constructed for the Service Departments.

Deep-level Protection.

This tunnel system is a comprehensive scheme of deep-level protection in the vulnerable central area for equipment and cables, carrying vital defence communications from the buildings of the Service

³ P.O.E.E.J., Vol. 38, page 11.

Departments to other parts of the country. Associated with these specially constructed tunnels are the public and P.O. tube railways.

The ultimate scheme represents the accretion of five principal component schemes, which were pro-

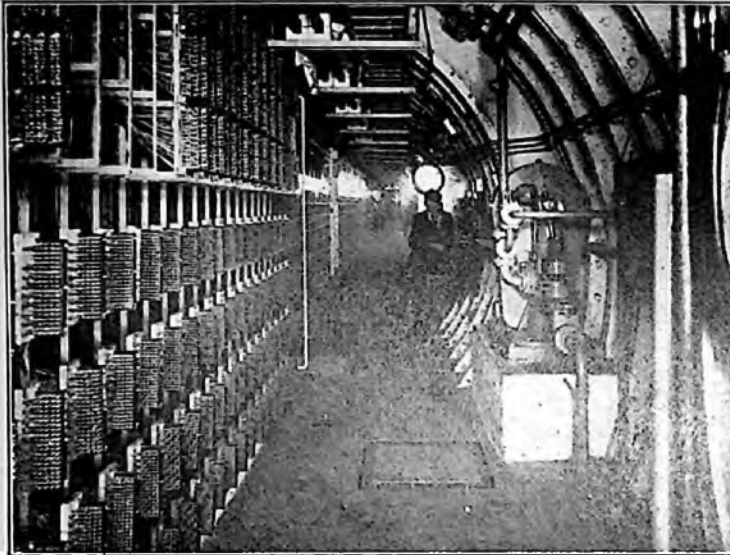

FIG. 5.—M.D.F. AND REPEATER EQUIPMENT IN DEEP-LEVEL PROTECTION.

ceeded with at various times during the war. The initial scheme, commenced in December, 1939, was a tunnel 12 ft. in diameter and at a depth of about 100 ft., which, intended at the time solely for cable protection, is connected by short lateral tunnels of 5 ft. diameter to the Service Departments and Federal exchange. The latter is a protected exchange in sub-ground accommodation and was provided at the outbreak of the war to give an uninterrupted service for the principal officers in Government Departments. Access to the main tunnel for Post Office personnel is provided by an automatic lift and emergency staircase in a shaft at an exchange, which is connected to the main tunnel by an 8 ft. diameter lateral tunnel. The cables from the buildings of the Service Departments, after being taken through 12-in. steel bore tubes connected to the smaller lateral tunnels, are terminated on the M.D.F. in the main tunnel. A portion of this M.D.F. can be discerned in Fig. 5.

It was obvious that the main tunnel would afford absolute security for telephone and telegraph equipment, the first installation of which was accordingly proceeded with and completed in the summer of 1941 to meet the increasing requirements for defence communications. This equipment, which has been added to from time to time, and now provides for about 4,000 working circuits, includes among the many constituent items, 71 18-channel V.F. systems, 26 carrier systems, 13 coaxial cable terminals and 864

audio amplifiers. A small portion of this equipment may be seen in Fig. 6.

During 1941-42 major extensions of the tunnel, which more than doubled its length, were carried out, affording underground access between various Service Departments and accommodating a teleprinter switching centre.

In all, a total of 1 mile 740 yards of tunnel has been constructed under the various schemes associated with the tunnel system and six shafts with passenger lifts provided. The tunnel system is connected via the tube railways to the Citadel building.

These specially constructed tunnels and the public and P.O. tube railways have been extensively used to give deep-level protection to cables carrying vital communications. A total of 72 miles of cable has been laid in P.O. tunnels, 116 miles in public tube railways and 20 miles in the P.O. railway.

"Citadel" Protection.

The tunnel system and its connection with the tube railways is an outstanding example of absolute protection for both telecommunication equipment and cables, but there were many other schemes during the war where circumstances only warranted, or made practicable, a lesser degree of physical protection. The Service Departments had many subsidiary installations for operational control, which, situated in areas subject to desultory bombing,



FIG. 6.—V.F. TELEGRAPH EQUIPMENT IN DEEP-LEVEL PROTECTION.

accommodated very important equipment. As this equipment could not be replaced with sufficient speed without serious interruption to the operational control, it was essential to provide very substantial protection for the installations. The associated line plant, although equally important, could be more

readily restored in the event of damage, and, moreover, the resulting interruption could be minimised by the provision of alternative routing. The physical protection for such installations usually took the form of a massive reinforced concrete structure, either wholly or partly below ground, with walls and roof several feet in thickness and the interior subdivided to limit blast effects from direct hits which might penetrate the structure.

In the London Telecommunications Region there were nearly a dozen such structures, many accommodating a considerable amount of telephone and telegraph equipment. Fig. 7 shows a view of the switchboard installed in one of these Citadels. This particular P.M.B.X. was a C.B. No. 10 40 V, comprising 35 positions equipped with 1,700 lines and 240 junctions. In addition, the installation included telegraph equipment for 123 teleprinters and other equipment for the remote control of radio transmitters.

Steel pipes for leading in the cables at alternative points were laid during the construction of the Citadels.

Supplementary Security for Line Plant.

In London the tube railways were used extensively to give deep-level protection for a few miles for the cables radiating from the central equipment. Beyond the emergent points from the tube railways, however, the cable routes were as vulnerable as any other underground plant at shallow depth, and with the persistent and widely dispersed bombing in 1940-41, the incidence of damage to these routes was sufficiently serious to require special measures to mitigate the effects of the interruptions.

The scheme adopted entailed the linking up, by circumferential cables, of the radial cable routes in the tube railways at a number of selected interception centres located not far from the emergent points. Included in the scheme were many of the surface trunk cables, which were intercepted at exchanges adjoining the main routes. At several places where the circumferential and radial routes intersected, and exchanges were not conveniently situated to intercept

them, substantial pill-box structures, in which an interception frame was installed, were constructed. Interruption by bomb damage to any of the radial cable routes could thus be readily restored by suitable re-routing of the circuits over the circumferential cables at the interception centres.

The London scheme, started in the late autumn of 1940 and completed during the following year, involved the laying of 250 miles of loaded cable of various sizes. An interesting feature in the cabling work was the completion of the circumferential cable system across the Thames by using the 12 ft. diameter pilot tunnel at Dartford, which had been constructed



FIG. 7.—SERVICE DEPARTMENT SWITCHBOARD IN PROTECTED ACCOMMODATION.

before the war in preparation for building the main vehicular tunnel.

The inclusion of the surface trunk cables in the scheme enabled not only defence circuits to be re-routed, but also important trunk circuits which had been interrupted by bomb damage to the radial routes, a facility which exemplified the duality of purpose of the Post Office telecommunication network in the national prosecution of the war.

Location of Buried Bombs

A considerable amount of theoretical and practical work has been carried out on the question of locating buried bombs. Two problems are involved, first, the actual location of the bomb (the path in the earth is frequently violently curved), and second, the determination whether the bomb is a dud or of the delayed-action type.

The methods explored were acoustic (audio), super-sonic, radio reflection, and various electrical proposals. Of these the most promising was an electrical method based upon the change in the mutual impedance of two coils when placed near the bomb. In clear ground, bombs buried 15 ft. could be detected, but in practice the presence of buried pipes renders the results

seriously liable to error, and even for this distance considerable bridge power is necessary. A range of two or three feet could be obtained with small coils lowered down 4 in. bore holes, but indications were not too certain due to losses in the earth.

It was found that the determination whether or not the delay-action clock mechanism was working required that the search microphone be placed actually in contact with the bomb. Otherwise the earth attenuation and miscellaneous noises picked up completely masked the ticking. A contact microphone and associated amplifier were produced by the Post Office for this purpose and supplied as a prototype to the Research Department, Woolwich.

The Receiving End of "Coventration"

O. D. ROBINSON, A.M.I.E.E.

U.D.C. 614.8 : 621.395.73

Damage to Post Office plant caused by air attack and the subsequent restoration of service is described in this article. The facts are based on Coventry's experience as being typical of Blitz conditions, but illustrations are included covering damage in other parts of the country.

Introduction.

YOU may remember perhaps, although it is over five years ago, five years stiff with events of first historical magnitude, that in its early morning broadcast on November 15th, 1940, the B.B.C. told the people of all the world that the German Luftwaffe had made a vicious raid on Coventry. So vicious was this raid and so paralysing in the German view that the enemy coined the new verb "to coventrate" to describe it. Compared with results of the R.A.F.'s subsequent attacks and the more recent complete annihilation achieved by the uranium bomb, "coventration" may now be regarded as a more bearable form of massacre and devastation, but let there be no mistake, it was a terrible experience, a dreadful affair of "blood, tears, toil and sweat." Fig. 1 gives some idea of the devastation caused. The people of the ancient stricken city will always regard it, and the following April attacks, as the major incidents in their own and their city's lives.

Coventry makes no boast that it was the hardest-hit city. The reason Coventry is telling its story is that it was the first provincial city to suffer a major attack; it was the pioneer of the martyred towns. This account of its particular "blitz" is written, not because its sufferings were peculiar, but because the story of Coventry is also the story of Hull and Plymouth, and Liverpool, Birmingham, Manchester and Sheffield, of Cardiff and Swansea, Portsmouth and Southampton, of Glasgow and Belfast, of Bristol, of the "Baedeker" towns, Canterbury, Exeter, Norwich, York and Bath, of all the "tip and run" towns on the south coast and in fact all the bombed and blasted places, except London, which has, with its later V1 and V2 afflictions, a story all its own.

Here then is the story of the Coventry attacks, particularly as they affected the Post Office telephone and telegraph plant, the common services plant and the men of the Post Office Engineering Department, who built it and maintained it.

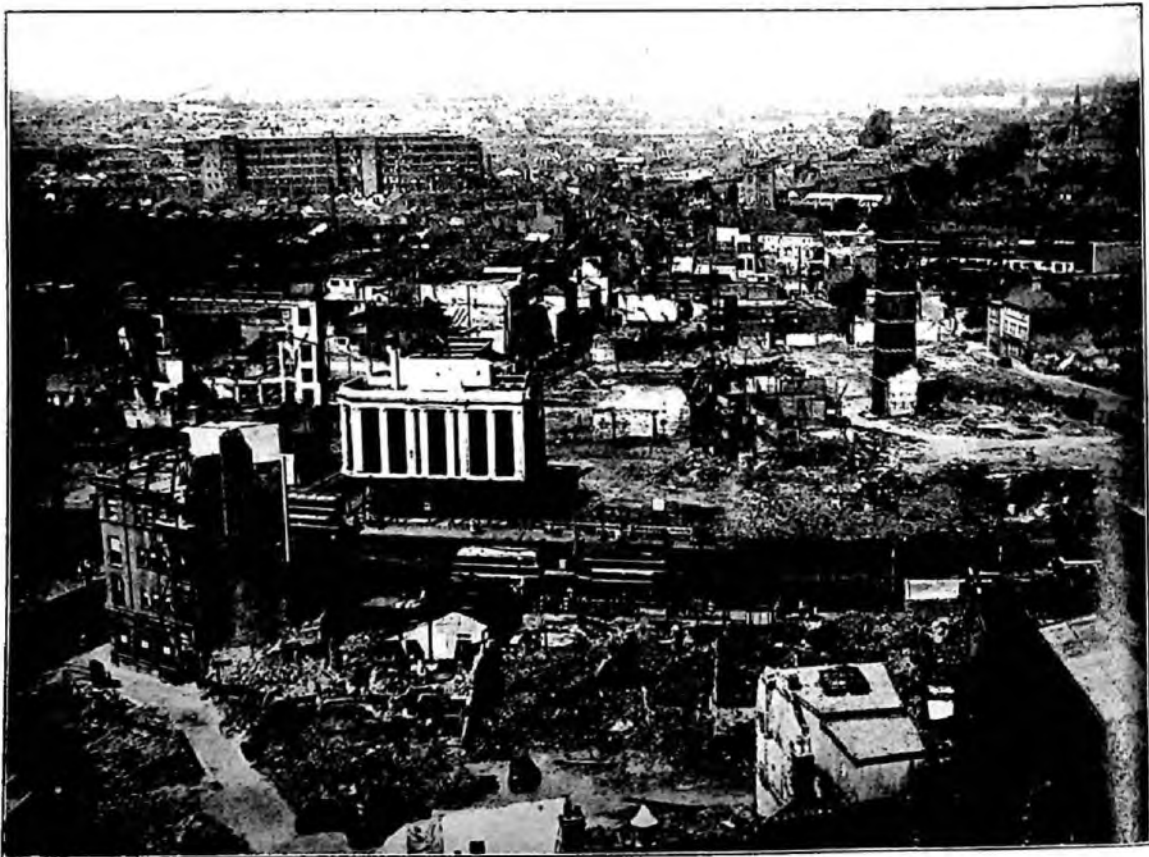

FIG. 1.—CENTRE OF COVENTRY AFTER BLITZ OF NOVEMBER 14TH-16TH, 1940.

The Main Blitz.

The great attack of November 14th-15th, 1940, was not Coventry's baptism of fire by any means. According to the carefully recorded details in the D.T. log book there had been 30 previous occasions when bombs had actually dropped on the city. Do you remember the monotonous broadcasts that the enemy had attacked the West Midlands? Coventry shared this honour about 50-50 with Birmingham. Many of these earlier raids were of considerable magnitude, judged from the standard of the loss of life and damage to property, but damage to Post Office plant was not extensive. The latter suffered most severely on October 23rd, 1940, when 260 lines were put out of order. As an indication of the size of these attacks examination of the D.T. log book reveals many occasions upon which the entries of the "addresses" of H.E. and incendiary incidents covered several quarto pages.

This was the period when the sirens were sounded regularly night after night for months; the time when the facetious-minded were saying "Jerry's late to-night," or "what's keeping him to-night?" the time when in many households someone would get up a "sweep" on the exact time of the sounding of the siren. Such was the jocular, defiant, proud-to-be-in-the-front-line, but rather tense, atmosphere of November 14th, 1940, when in the afternoon of a day of exceptional autumn sunshine a lone enemy fighter flew over the city and formed a large question-mark, complete with dot, with its vapour-trail in the blue sky. Whether this was accidental or intentional we may never know, but it certainly happened.

The fine day was followed by a night of quite remarkable brilliance. A full moon and a completely still and cloudless sky with a display of stars such as astronomers dream of provided the enemy with as perfect a night for a big attack as he could possibly hope for. On this night of calm and breathless beauty the people sensed that such an opportunity would not be missed, but no one I am sure anticipated anything like the attack which developed.

The sirens went at 7.10 p.m. From then, hardly without pause, successive waves of aircraft flew in from all points of the compass, at intervals of only a few minutes, until at 6.17 a.m. the "all clear" was sounded. Eleven hours and seven minutes of continuous bombing. The official estimate of the number of machines used was 400. The total weight of bombs dropped was 400-500 tons, and there seems no doubt that some machines made two journeys in the one night.

It was soon evident that the centre of the city was the main target and in a very short time many serious fires were raging. The outer reaches were by no means neglected, however, and the centre, which seemed to be one large fire, was surrounded by rings of isolated fires reaching out to a radius of two miles.

The engineering staff on duty were two in the D.T. Control and three in the main exchange. In addition, one man was in attendance at the City's A.R.P. report centre.

The D.T. Control was on the ground floor of Telephone House, which is in the centre of the city. Another member of the staff proceeded to the D.T. Control as soon as he realised the raid was going to be a serious one. Telephone House is a large, modern building, the ground floor of which, with the exception of the D.T. Control room and one other, consists of shops, and one of these was a branch of a well-known firm dealing in cycle accessories and similar goods. An incendiary bomb fell into this shop through the window and within a short time, owing to the inflammable nature of the shop's contents, produced a major fire. This fire engulfed the shop's storeroom above on the first floor and then commenced to burn away the floor of a room on the second floor, which is the largest single room occupied by the Telephone Manager's clerical staff. The three officers on duty vigorously attacked the fire in this room and their efforts kept it under until the brigade could attend to its source below.

Meanwhile, over at the exchange, the large number of line faults was rapidly putting the exchange out of action by the engagement of selectors, and finally a complete congestion occurred. Trunk and junction circuits which remained serviceable were of no use because none of the subscribers could obtain a selector. Eventually, *the only remaining link with the outside world* was the P.W. between the Area D.T. Control and the Regional D.T. Control at Birmingham. All the requests for outside aid made by the Civic and Military Authorities and the Fire Service were passed over this single remaining line. The famous phrase, "Seldom . . . has so much been owed by so many . . ." might appropriately be quoted.

The water-supply failed in a large part of the city quite early in the raid and the reinforcements for the fire services, when they arrived, were rendered ineffective for this reason. Among all the circuits which were affected on the night were the Observer Corps and Gun Operations room networks.

The electricity supply to the exchange failed and the exchange staff wisely decided to plug out every circuit on the M.D.F. to save the exchange batteries and release all the links. Vital circuits were quickly tested and those which were in order were put through and received service. The complete breakdown was for not more than two hours.

For their services during the night one officer was awarded the richly deserved honour of the George Medal and two others the British Empire Medal.

The ancient but gloomy wisecrack which tells how all good things come to an end applies equally to the bad things (although they seem to be with us longer), and shortly before dawn there were enough sirens still capable of functioning to inform the populace that it was all over for that night at least.

Figs. 2 and 3 are included to illustrate typical damage to exchanges caused by air raids on this country.

Restoration of Services.

An attempt to picture the city as it appeared the following morning would be an attempt to describe the indescribable. To me now it is an impression of fires everywhere burning unchecked, miles of waterless hose-pipes, filth and rubble, glass and more

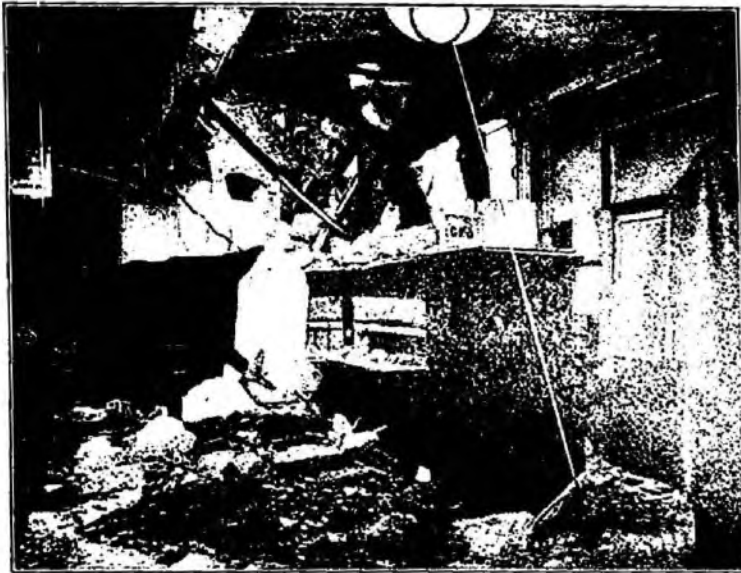

FIG. 2.—DAMAGE TO A MANUAL EXCHANGE (GREENWICH, LONDON).

glass, craters and wrecked transport. Silent but for the shuffle of thousands of feet. No one spoke because the occasion was not one for words.

The first shock over, the people set about clearing up the mess. Even before the study of human nature was called psychology, people knew that overwrought emotions could be soothed by hard work, and certainly many found relief for their feelings in the multiplicity of jobs to be done. Our own staff was no exception and all who were able made their way to their various headquarters at the earliest possible moment. Happily, not one of the engineering staff lost his life in this attack, but many had their homes wrecked and some were injured.

The first and obvious thing to do was to assess the magnitude of the task, to find out what was working and what was not, and staff was allotted at once to test every line at the main exchange and the satellites at Gibbet Hill, Foleshill and Tile Hill. An immediate survey of every cable track was undertaken to find out exactly where repairs were necessary. This was done in relays on foot, each man reporting back hourly. The main points of damage on multiple-way tracks were quickly ascertained and staff detailed to each.

Individual D.P.'s were next examined,

the circuits on them being checked with the D.P. cards. A report was made for each, indicating where the subscribers' premises were intact and which circuits were in consequence capable of restoration.

Urgent attention was given to the Gun Operations room, which although undamaged was isolated by cable faults. The operations room was removed to a gun-site some four miles from the centre of the city and with the help of military personnel all gun stations and searchlights were connected to the new operations room by dusk the same day. The Observer Corps received similar treatment, but as they did not move, restoration of some circuits was delayed until certain cables had been repaired.

One of the most pressing needs was the restoration of power to the many large P.B.X.'s in the city. This was done by means of primary cells. The subscribers' fitting group dealt with 80 such cases within three days.

At Telephone House, the Head Post Office and the exchange, water, gas, electricity and sewers had all failed and the Engineering Division dealt with the supply of substitute services. Electricity was restored by the provision of six 6 kW petrol-driven sets, plus 2 kW sets for some points. These were obtained promptly by Regional action. This battery of petrol-driven sets was sufficient for the exchange,

the telegraphs and some lighting for the Head Post Office and Sorting Office. A 30-cwt. van was fitted with as large a tank as could be accommodated in it and water was fetched from Rugby for the Post Office and Inland Revenue Department. Chemical lavatories were supplied by the Ministry of Works



FIG. 3.—DAMAGE TO AN AUTOMATIC EXCHANGE (VICTORIA EXCHANGE, BIRMINGHAM).

and distributed and emptied by Engineering staff. The Area A.R.P. Officer took charge of this important work. He prevented the normal lavatories from being used by the brilliantly simple process of painting the seats with creosote. Some cooking facilities and a small amount of heating were supplied by paraffin stoves provided by the Ministry of Works and kept replenished by Engineering staff.

I should like at this stage to pay high tribute to the many who made offers of help. The Regional Director, Chief Regional Engineer and other senior officers were early on the scene, and their support and the speed with which they obtained assistance in the shape of additional staff and supplies were invaluable.

And what shall be said of the Inspectors and the men who did the actual work? No praise could be too high. Not a man spared himself. They worked until they fell asleep at their work and then went on



FIG. 4.—DAMAGE TO UNDERGROUND PLANT (BRIXTON, LONDON)

working when they awoke; unhonoured and unsung, undeterred by delayed-action bombs, by manholes full of water and sewerage, as typified in Fig. 4, by the proximity of tottering buildings; red-eyed and scrubby of chin they stuck it, all of them, until order was produced out of chaos.

What *did* they do? Here is the story in figures.

On November 14th, 1940, the number of working lines in the Coventry multi-office area was 6,298.

On November 15th the number of working line in the same area was 1,205.

There were in all 5,093 faulty exchange lines.

There were 415 separate cable faults in nearly that number of fractured duct tracks.

There were some 2,000 extensions faulty.

There were 799 trunks and junctions faulty.

If you count each fracture in a pair of wires, each wire down, each instrument destroyed or damaged as a separate fault, there were 23,228 faults.

The London-Birmingham coaxial cable was cut in three places.

Other trunk cables were cut or crushed at points too numerous to specify.

The progress of restoration is shown hereunder as the percentage restoration week by week:—

	<i>Exchange Lines and Extensions</i>	<i>Trunks and Junctions</i>
At the end of one week . .	22.2%	100%
At the end of two weeks	46.5%	
At the end of three weeks	66.5%	
At the end of four weeks	78.9%	
At the end of five weeks	83.7%	
At the end of six weeks . .	91.0%	
At the end of seven weeks	100%	

The Regional Commissioner and the City Reconstruction Panel supplied lists of subscribers for priority of restoration and as far as possible these were adhered to. If the selection of a particular line for prior restoration would have held up the ordered progress of the work, discretion was exercised.

The Second Main Raid.

On April 8th and 10th, 1941, the enemy did it again. Almost the mixture was as before, but this time the Section Stock was destroyed and the instrument room and telegraph overhaul centre at the Head Post Office were gutted by fire.

The latter catastrophe was particularly disappointing to the Post Office fire fighters, because no less than 79 incendiary bombs were extinguished from a shower which fell on and around the Head Post Office and exchange. It was only the odd one or two bombs which eluded their valiant efforts which finally resulted in the fire getting a firm hold. Restoration was quicker, as we had learnt the lessons of our

own previous "blitz" and those of the other heavily bombed towns, but the cable damage was even more severe in certain parts.

There is no space to more than mention the auxiliary services, such as the telephone bureaux for bombed-out subscribers, and the changed number equipment which were installed, or the epic struggle with Coventry exchange plant to keep it functioning after its complete immersion in steam, brickdust, ordinary dust, smoke and fumes.

Such then is the belated story of the receiving end of "Coventration," told with as great a degree of accuracy as records and memory can supply. Maybe there are better pens than mine for the telling of it, but there is no one with a deeper knowledge or appreciation of the work of the Post Office engineers during this stirring period of Coventry's six-hundred years of history.

Post Office Cable Communications for the Invasion Armies

J. RHODES, B.Sc. (Eng.), A.M.I.E.E.

U.D.C. 621.395.44 : 621.395.5 : 621.394.441

In support of the invasion armies the Post Office provided an extensive network of communications in this country linked to the Continent by a number of submarine cables over which carrier telephone and V.F. telegraph circuits were operated. The first circuit to the beachhead was in operation on D-day +4. The scheme is outlined in this article.

Introduction.

IN May, 1940, immediately after Dunkirk, all the cable communications to the Continent which had been built up since before the last war came to a rapid end. From that date, it was realised that at some future date it would be necessary to rebuild the large network which had existed, and the requirement was kept under continuous review.

For the South Coast Submarine Cable Scheme, which was the title given to the provision of cable communications for the invasion forces, very little advance information was available, and, in addition, unlike the more leisurely peacetime provision, circuits would be required immediately a cable had been landed. A further complication was that the planning and preparation of the scheme had to be carried out in complete secrecy.

Although the matter had been kept under review in the Post Office, discussions with the military authorities first took place in 1942, and during that year and in 1943 a number of strategic landing points were chosen in the south of England.

At some of these sites, special blast-protected, partially buried buildings were erected to accommodate the estimated quantity of terminal equipment for the maximum number of submarine cables which might be necessary from each point. Where possible, these buildings were situated near main audio and 12-circuit carrier cable routes to facilitate the extension of circuits in this country. For safety, since the possibility of German Commando raids on this coast could not be excluded, the buildings were situated a short distance inland and cable huts were provided at each point close to the beaches.

From a survey of the distances from southern England to the Continent, it will be seen that the minimum and maximum lengths are 20 and 125 nautical miles, and that the scheme had to be fully flexible to cater for this wide margin. It was decided, therefore, that carrier working, using standard concentric type submarine cable should be employed throughout.

With carrier working on concentric type cable, the number of circuits obtainable is dependent upon

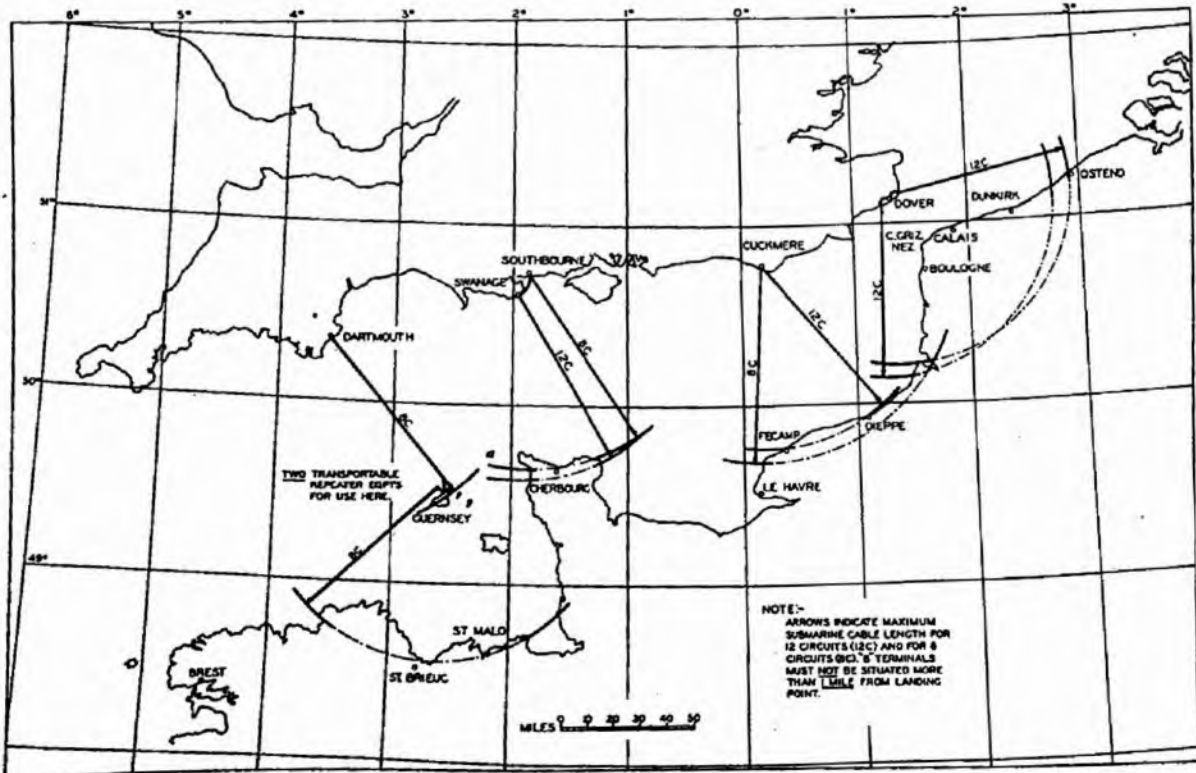

FIG. 1.—EXTRACT FROM ONE OF THE PLANNING MAPS FOR 12-CIRCUIT EQUIPMENT.

the highest frequency which can be transmitted over a given total attenuation. On this principle, bearing in mind the wide range of cable lengths to be encountered, it was decided to divide the terminal equipments into three standard types.

Terminal Equipment.

The three main categories of carrier terminal equipment were :—

- (a) Equipment to provide three speech and six voice frequency telegraph channels over any length of submarine cable up to 125 nautical miles.
- (b) Equipment to provide twelve speech circuits (any one of which would be capable of carrying an 18-channel V.F. telegraph system) and also one speaker circuit on any cable length up to 65 nautical miles, using K-gutta type cable, or 72 nautical miles using polythene type cable. This equipment was capable of working over longer lengths, but under such circumstances, of course, would provide a reduced number of circuits. It was necessary, therefore, to specify in detail the areas in France which could be used as landing points for cable to carry 12 circuits, and an extract from one of the planning maps for this purpose is shown in Fig. 1.
- (c) It was also realised that as the invasion armies were built up for the final push into Germany, the number of circuits required could not be provided on a 12-circuit basis and equipment to provide 60 channels on one cable was also prepared. This equipment required a cable length not exceeding 30 nautical miles, which can be obtained only in the Straits of Dover.

3-Circuit Equipment.—One set of standard 3-circuit terminal equipment modified to permit working over a cable attenuation of approximately 95 db. was installed in advance in the repeater stations at each of the chosen cable landing points in this country, and in addition, eleven terminal equipments (eight "B" type and three "A" type) were installed as self-contained mobile repeater stations in vehicles. The "B" type equipments were for use on the French side of the scheme and the mobile "A" type equipments were for use at unforeseen cable landing points in this country, or to replace permanent buildings damaged by enemy action.

12-Circuit Equipment.—The terminal equipment to provide twelve speech circuits per cable consisted basically of standard P.O. No. 7 type 12-circuit equipment, modified to enable the system to be worked over a cable attenuation of 100 db. For the English ("A" type) end, one mobile and nine transportable equipments were prepared, and for the Continental ("B" type) end, four mobile and eight transportable equipments prepared. The "A" type equipments were so designed that the circuits could be produced either on an audio basis at the coastal repeater stations, or could be connected

directly into the 12-circuit network of this country.

The mobile equipments were installed in Bedford Tasker type vehicles supplied by the Air Ministry. Figs. 2 and 3 show external and internal views of these vehicles.

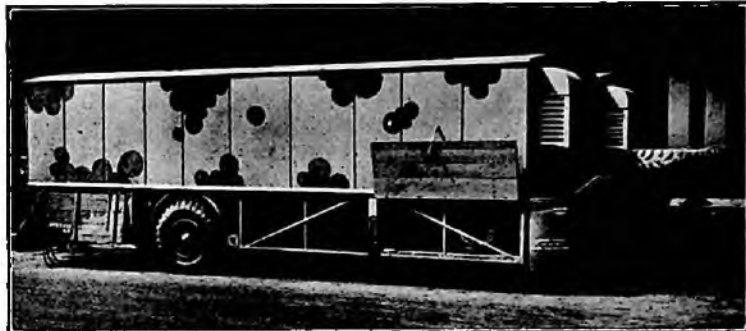

FIG. 2.—VEHICLE FOR 12-CIRCUIT CARRIER EQUIPMENT.

The transportable type equipments were mounted on standard bays (Fig. 4), but to enable the rapid erection in any building available on the Continent, they were arranged to be self-supporting and the whole of the cabling was cut, preformed and each wire tagged and numbered in advance. This was also carried out for the transportable equipments for the British side, since they were not installed in the British coastal repeater stations until it was definitely known what cables would be laid from these points. This was necessary as account had to be taken of

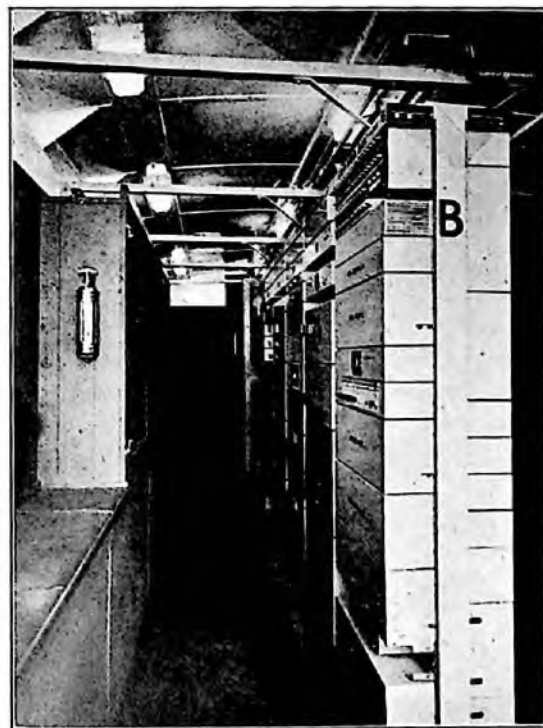

FIG. 3.—INTERIOR OF VEHICLE FITTED WITH 12-CIRCUIT CARRIER EQUIPMENT.

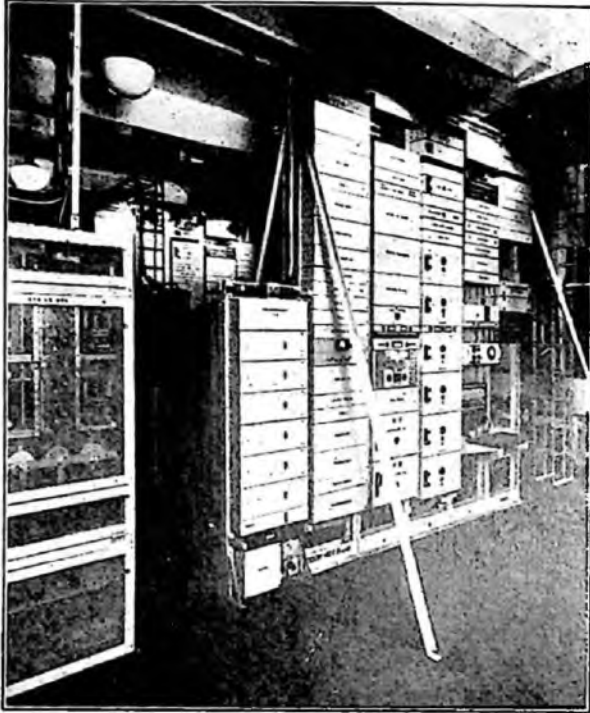

FIG. 4.—TRANSPORTABLE 12-CIRCUIT CARRIER EQUIPMENT.

the unknown factors regarding the course of the battle and also the possibility of severe enemy air attacks during the early stages of the operation. At the Continental end, it was envisaged that the mobile equipments would be connected to the cables in the first instance to provide almost immediate service, and that these would be followed later by the erection of a transportable set of equipment in any suitable equipment found in the locality, thus releasing the mobile equipments for further use around the coast as the operation proceeded.

60-Circuit Equipment.—For the 60-circuit portion of the scheme, two complete sets of equipment were provided; that for the British side was installed in the repeater station at Dover Combined Headquarters and connected by balanced pair cables to the landing points at Abbotscliffe and St. Margaret's Bay repeater stations.

The special equipment for each type of system outlined was designed and built at the P.O. Research Station.

The British Inland Network.

An inland network of high-grade telephone circuits was built up during the 12 months before D-day to serve the British and U.S. military, naval and air forces in connecting the main and subsidiary Combined Headquarters and other Service establishments with the submarine cable repeater stations and the twelve Army cross-Channel radio-telephone stations which were scattered along the South Coast between Dover and Plymouth.

By D-day, more than 20,000 miles of zero-loss equalised 4-wire circuits had been provided, as well as a considerable mileage of order-wires and control circuits.

Preparation of the Cable Ships.

The preparation of the cable ships for the tasks ahead was put in hand at an early date and they were heavily gunned in comparison with merchant ships of similar size. Additional degaussing, protection of a type fitted to a comparatively few special duty ships was provided to enable the ships to work with some measure of safety in shallow waters.

The loading of the ships began in December, 1943, with H.M.T.S. *Monarch*, completing on January 4th, 1944, with a length of 54 nauts of K-gutta and paragutta concentric cable. The remainder of the D-day fleet of cable layers were loaded up with concentric cable in May—H.M.T.S. *Iris* with 64 nauts of paragutta cable; H.M.T.S. *Alert* with 49 nauts of K-gutta cable; H.M.S. *St. Margarets*, lent to the Post Office by the Admiralty for the first Channel lays, was loaded with 63 nauts of paragutta cable. In addition, the Admiralty, with advice from the Submarine Section, had converted three Thames barges for the special purpose of landing the shore ends, and two of these—H.M. Barges *Leslie* and *Norman*—were each loaded with 8½ nauts of concentric cable. The third barge, *Conway*, joined the fleet shortly afterwards.

Large scale mining operations in the seaways and heavy attacks on shipping by air and sea as a counter-measure by the enemy were generally to be expected in an operation such as the invasion of Europe, and thus arrangements had to be made so that between cable ground and loading point the voyages of the cable ships should be reduced to the minimum. After considering several proposals it was finally decided to use a merchant ship as a cable store. The store ship could then be based at a convenient point and the cable ships could berth alongside at short notice to load such additional stocks as were required. The ship provided by the Ministry of War Transport for this purpose was the s.s. *Empire Flaminian*, an old Ellerman Wilson Line cargo ship, which during May, 1944, loaded up with 177 nauts of concentric cable. On this stock being used she was loaded for a second time in July, 1944, with a further cargo of 183 nauts of cable.

Shortly after loading, the cable barges left the Thames for Portsmouth to await D-day and *Iris*, *Alert* and *St. Margarets* left the Thames for Poole Bay on June 5th, D-1, in the first convoy of merchant ships for the beachheads. The *Monarch* and *Empire Flaminian* left the Thames on June 8th, D+2, for Portsmouth.

The Invasion.

The first cable was laid by the two Post Office ships *Iris* and *Alert*. The landing point in this country was at Southbourne, near Bournemouth, and the *Iris* commenced laying the cable on Thursday, June 8th (D+2), and the *Alert* landed the cable at Longues, the predetermined point, on the Normandy beachhead at midnight on June 9th. The first cable telephone conversation from the Continent to this country since 1940 immediately took place and by the night of June 12th, using 3-circuit equipment,

three speech and six telegraph channels were available. The cable was 105 nautical miles long.

The traffic on the cable was such that it was decided almost immediately to lay a second cable, and this was carried out by H.M.S. *St. Margarets* in conjunction with the Post Office ship *Monarch*. The cable was completed on June 17th and was 109 nautical miles long. As far as is known, this was the longest submarine cable in the world at that time used for carrier speech transmission. Equipment similar to that on the first cable was fitted.

The two next cables were laid from Swanage to Querqueville on the Cherbourg Peninsula, one by H.M.T.S. *Iris* and the other by H.M.S. *St. Margarets*, and were completed on July 30th and 31st respectively. These cables were 62 and 63 nautical miles long and were fitted with the 12-circuit equipment extended on a high frequency basis into the British 12-circuit network.



FIG. 5.—3- and 12-CIRCUIT CARRIER EQUIPMENT IN UNDERGROUND ACCOMMODATION AT CUCKMERE.

From this time onwards, cables were laid to follow the advancing armies. Circuit requirements were growing rapidly and also due to the difficulties of long line extensions in France from the original landings, it was more advantageous to lay direct cables to strategic points giving better access to the various British, American and Allied ground and air force headquarters.

The next two cables were laid from Cuckmere to Le Puits (near Dieppe) by H.M.T.S. *Ariad*. These cables were 69 and 66 nautical miles long and were the

first of the polythene type. The first cable was landed towards the end of September, and each was equipped to provide 12 circuits. A view of the underground repeater station housing the terminal equipment at Cuckmere is shown in Fig. 5.

Then followed four cables across the Straits of Dover with 12-circuit groups extended to London on a high frequency basis on the inland 12-circuit network.

As the armies advanced, the provision of cable communication to Belgium was the next requirement, particularly to the vital port of Antwerp. Plans had been made and equipment was available for new cables to Belgium, but it was found possible to repair quickly two of the pre-war cables from Dumpton Gap to La Panne. By the use of phantoms and army single-circuit carrier equipment in a modified form, 16 circuits were obtained on the 1926 cable and 18 circuits on the 1930 cable in the early part of December, 1944.

Early in 1945, the armies had advanced into Holland, and the call immediately arose for circuits to that country. On this route also it was found to be more expeditious to repair and re-equip some of the original Aldeburgh-Domburg cables.

From November, 1944, work had been proceeding on the 60-circuit schemes across the Straits of Dover, and early in March, 1945, one of the *St. Margaret's Bay-Sangatte* cables, initially equipped for 12 circuits, was converted for 60-circuit operation. Work had also been proceeding on the equipping of the 12-circuit cable which was laid between Calais and Paris in the early part of the war and never brought into operation; 12-circuit terminal equipment was installed at Amiens and Paris, and mobile 12-circuit intermediate amplifier equipment at eight stations on the route.

Early in June, 1945, a second *St. Margaret's Bay-Sangatte* cable was converted from 12- to 60-circuit operation, and during that month two 12-circuit groups were made available between London and Amiens, followed by two 12-circuit groups London to Paris, the first four groups ever carrying circuits on a high frequency basis, directly from London to inland towns in France.

Conclusion.

In the short space available, it has only been possible to give a brief summary of the build-up of circuits to the Continent from D-day. Each cable was a complete scheme in itself; some of the schemes originally planned were never brought into operation. Alternatives had to be provided in case of damage or change of plans.

As an indication of the magnitude of the scheme the small but very important number of circuits working to the Continent shortly after D-day increased to the extent that in October, 1945, there were in existence approximately 220 speech circuits and 170 telegraph circuits.

Acknowledgment is made to Capt. E. W. Firmin and Dr. N. W. J. Lewis for assistance in the preparation of this article.

Headquarters Notes

Test and Inspection

It is not possible in the space available to deal with any of the aspects of the testing and inspection work in detail, but the following notes may be of some interest.

Cables.

Well before the war, in anticipation of the effects of air attack on the cable networks, provision was made for emergency stocks of trunk cable and a number of dumps were selected at various parts of the country where bulk reserves of a large range of sizes of cable were stored. These reserves when drawn upon were replaced as soon as possible.

Ministry of Supply Cable, Wire and Line Stores.

The supplies of all types of lead covered dry core cable for the Army were obtained through the Post Office and very large quantities of this were inspected. The outstanding item was the 14/40 P.C.Q.T. and P.C.Q.L. of which some 13,000 miles were manufactured, the output rising to over 600 miles per month during the peak period. Over 50,000 tons of hard drawn copper, mainly 200 lb. per mile, was also inspected and large quantities of general line stores items, including wood arms.

Submarine Cables.

During the war, apart from the standard gutta-percha submarine cable for repair stock, the most important submarine cable manufactured was the coaxial carrier type. This was first insulated with paragutta, but as polythene became available for Post Office use this improved dielectric was utilised with a consequent saving in rubber and improved electrical characteristics of the cable. In all about 1,700 miles of this cable have been manufactured, tested and accepted at works.

Telephone and Telegraph Equipment.

The falling off in the amount of inspection on telephone exchange equipment after the commencement of the war enabled the Post Office to offer assistance to the C.I.E.M.E. on the inspection of telecommunication equipment required by the Army. Arrangements were then made for the Post Office to inspect on behalf of the C.I.E.M.E. all carrier and repeater equipment and many other items, such as command switchboards, switch sections for W.D. trunk exchanges, field telephones, fullerphones, generators, microphones and buzzers. Very large numbers of components and spares were also dealt with.

In 1942 the Post Office took over the inspection of the whole of the output of teleprinters for use in all services, and other telegraph items also came under inspection, including auto transmitters, high speed morse apparatus, perforators, printers, Wheatstone transmitters and receivers, and the spares for all this equipment reached almost astronomic proportions.

A large variety of special air defence and radio equipment for war purposes was produced in the Post Office factories during the war which came under inspection at the London and Birmingham Test Sections. The following items give some idea of the wide field covered.

Air Defence.—Switchboards of various types, key-boards, transmitting and signalling equipment, plotting and controllers' tables, D.T.N. table coders, control units, display panels, night signalling equipments, detonator controls, siren controls.

Radio.—Ultra short wave transmitters and receivers, H.F. transmitters, aerial switching equipments, Army wireless sets repaired by P.O. factory.

Mobile Equipments (fitted on Motor Vans).—Bomber station operational vans. Bomber station telecommunication vans. Mobile 12-circuit and 3-circuit carrier equipments. Mobile ultra short wave equipments.

Another important radio item was the lifeboat emergency set, of which large numbers were inspected at contractors' works.

A.R.P.

Some of the earliest work having a direct connection with the war arose in 1939, when a request was received from the Ministry of Home Security for assistance in the inspection of Anderson shelters, which were being ordered in large numbers. A total of 2,485,000 were dealt with, on a sampling basis, and later inspection was carried out on 640,000 bunks for shelters, 241,000 smoke generators and finally 1,184,000 Morrison shelters.

During the same period the Post Office Stores Department was dealing with various clothing and other items for the Ministry of Home Security, including firemen's leggings, axes and rubber gloves, which also involved inspection work. Large numbers of respirators fitted with transmitters or repaired by the Post Office factory were tested for gas tightness on dummy heads, approximately 117,000 being dealt with.

Operation Pluto.

Post Office assistance was sought by the Ministry of Fuel and Power (Petroleum Division) in the early developments of "Operation Pluto" and in addition to giving advice on the make-up and specification of the H.A.I.S. cable used as a submarine pipeline, the inspection of the manufacture of the cable at the various cable works was undertaken by the Post Office for the Petroleum Warfare Department. The make-up of the cable and the arrangements made for laying it from specially adapted ships have already been very fully described in the technical press from information supplied by the Petroleum Warfare Department.

F. O. B.

Telegraphs

During the earlier stages of the war, work in connection with the public telegraph service was largely concerned with arrangements to counter the effects of possible damage by enemy action. This work mainly consisted of the provision of reserve telegraph instrument rooms, the provision of a limited number of operating positions in protected accommodation and the division of voice frequency telegraph installations between two or more locations. In addition a unit type of phonogram equipment, completely wired and readily transportable, was made available. In London steps were early taken to cover the effects of damage to the Central Telegraph Office by the construction in underground protected accommodation of two large telegraph offices, each completely equipped for the immediate operation of some 100 teleprinter positions. Each office was provided with voice frequency telegraph equipment capable of being switched to the more important provincial centres and each was capable of operating independently of any outside source of power. One of these installations, near the Central Telegraph Office, allowed of the continuance of traffic during air raid conditions and both justified their provision when the Central Telegraph Office was destroyed by fire in December, 1940.¹

A policy of decentralisation of the telegraph work at Provincial Zone Centres by transfer to Area Centres was adopted in 1941, which necessitated a considerable increase in the teleprinter and phonogram facilities at these latter offices. To provide for the additional teleprinter circuits at the Area Centres some rearrangement and extension of the voice frequency telegraph network was necessary, including the transfer of existing equipment, provision of new equipment and the opening of new voice frequency telegraph stations. At the same time further decentralisation of traffic operation in London was provided by the opening of four main ring offices in May and June, 1941, and the linking of these offices to the provincial centres by the installation of voice frequency telegraph terminals away from the main installation. A further protection against enemy damage was taken by the installation of a large block of voice frequency telegraph terminal equipment in underground accommodation in London. Concurrently with these changes, work was proceeding steadily with the modification of the power arrangements at all the large telegraph offices to ensure a 24-hour battery reserve in the case of the breakdown of the external source of power supply.

To further cater for emergencies arising from enemy damage four mobile units, each equipped with three 12-channel telegraph terminals as well as line amplifier, signalling and the necessary power equipment, were provided and located at suitable points throughout the country.

In retrospect it is striking how little was the loss due to enemy action of V.F. telegraph terminal equipment and in comparison how heavily the telegraph instrument rooms suffered. The greatest

loss of V.F. terminal equipment occurred when the Central Telegraph Office was burnt out and although the equipment at the Liverpool Head Post Office was put out of action in March, 1941, it was salvaged and used in the alternative location. In contrast to this we have to mourn the total loss of or heavy damage to the telegraph instrument rooms at Liverpool, Birmingham, Bristol, Plymouth, Exeter, Cardiff, Coventry and Bridlington.

The deconcentration of the telegraph network was not achieved without an increase in the average number of transactions to complete the transmission of a telegram, thus involving greater staff. During 1942 it was decided to make an attempt to ease the staff position and plans were formulated for the introduction of a manual switching scheme to permit the through-switching of teleprinter circuits to the larger offices on the lines of the switching system already in operation on the Defence Teleprinter Network. This involved, besides the switchboards, the provision of additional voice frequency telegraph systems and teleprinters; installation was commenced in 1943 and the first stage of the scheme, with switchboards at Birmingham and Leeds, was brought into operation in February, 1944. The extension of the scheme, involving transfer of equipment from below ground to more normal quarters, is still in progress and is expected to be completed by the end of 1946.

In addition to catering for the public telegraph service the channels of the inland system have been utilised to provide private telegraph networks, with switchboards, for various Ministries, the B.B.C., Petroleum Pool and News Interests, both British and American, and for industrial organisations engaged in the war effort. Quite early in the war, arrangements were made with the cable companies to set up emergency headquarters to their main London offices; this involved the cutting of the main Western Underground telegraph cables and the installation of changeover arrangements allowing of circuit diversions at short notice. Later in the war elaborate arrangements were made to cover the possibility of damage to the Atlantic cables by the setting up of telegraph terminals linked to radio stations.

Close co-operation has been maintained with the Astronomer Royal's Department to ensure the emission of the time signals from the emergency headquarters and to reduce errors due to propagation over the telegraph network set up for the purpose.

Space forbids any account of the loss of telegraph communications with our Continental neighbours, but one sea communication remained, that to Iceland. This circuit was operated, pre-war, on a simplex basis from Aberdeen. A new type of repeater, developed by the Research Branch, was installed at Lerwick, in the Shetlands, and the circuit has been successfully operated duplex from London during the war years. It is perhaps appropriate to close this short resumé with the statement that telegraphic communication with France, Belgium, Holland and Norway is again established and in operation.

F. E. N.

¹ P.O.E.E.J. Vol. 28, p. 11.

Radio

In addition to the radio transmitting and receiving stations which were available for overseas service in 1939, it was found necessary during the war to build a permanent transmitting station at Criggon (Montgomery), housing one very powerful V.L.F., two L.F. and 14 H.F. transmitters, an emergency transmitting station at Kingsbury (Middlesex), carrying five H.F. transmitters, a similar station at Edinburgh for four H.F. transmitters, and a reserve receiving station employing some 50 aerials at Whitchurch (Shropshire). The provision of the Kingsbury and Edinburgh stations was a measure to ensure communication to the last in the event of invasion. Criggon is comparable in size with the Rugby station and presented many problems which were aggravated by the prevailing difficult supply position. Thus the design of the V.L.F. aerial system is almost unique, since in view of urgency and of steel and labour shortages it was necessary to employ the minimum number of masts, and the aerial is slung between three 600 ft. self-supporting steel towers and anchorages built on the top of an adjacent steep hill. (By comparison the V.L.F. aerial at Rugby employs twelve 820 ft. lattice steel masts.) The general problem of providing the maximum possible number of overseas circuits received a severe setback in March, 1943, from a fire at Rugby (not due to enemy action) which necessitated the rebuilding of the V.L.F. telegraph and the L.F. telephone transmitters. The work was completed expeditiously, and the very important telegraph service was carried in the interim period by the Criggon station which was then available. Standby diesel-electric sets, generating over 1,000 kW each, were installed at the three main transmitting stations to ensure continuity of supplies. Remote control by radio of the distant radio transmitters was arranged to cover loss of land line communications.

All these stations have been in almost continuous operation and many unusual types of service have been provided. Thus the Rugby and Leafield stations with the aid of the Radio Telephony Terminal played a part in military operations in June, 1940, when a service was improvised for interfering with enemy operational signals. Later a similar facility was introduced for the Air Ministry. A more normal type of service was the setting up and operation of highly efficient broadcast telegraph services for the Press Agencies. Consequent on cessation of supplies from Germany of Hell Schrieber senders and printers, the design of machines for production in this country was undertaken, and many units were supplied to other Departments.

After the fall of France an emergency communication system comprising 32 medium frequency stations was established to provide radio circuits between important centres throughout the country, and mobile single-channel and multi-channel telegraphy and telephony sets were made available to provide reserves against damage to essential circuits by enemy action. Some 80 telephone circuits were also added to the trunk network using V.H.F. radio links. Incidentally a number of 6-channel V.H.F. radio-

telephone sets mounted in vans as mobile stations were supplied for Army use. The first two experimental models saw active service in France in 1940, where they provided useful circuits, and some of the later sets were used for cross-channel communications during the invasion of Normandy.

Equipment designs, and frequently the installation work, were carried out for special radio stations, viz., interception stations for the Foreign Office and the War Office (one was the largest receiving station in the country), direction-finding stations for the Admiralty, M.F. stations for the Home Office, and stations for communicating with resistance groups in enemy occupied territory. In co-operation with the Admiralty and Ministry of War Transport distress radio transmitters have been developed for use in ships' lifeboats and the production of some 3,400 radio sets for lifeboats has been engineered.

The various radio experimental laboratories throughout the war period were concerned primarily with work for operational applications, and two phases of the work, concerned respectively with defence against enemy air attack and our own offensive air action, have been singled out. For defence, the "masking" schemes were devised and operated for re-transmitting enemy radio beacon signals and thereby rendering his navigation difficult, and the provision of an extensive masking network at short notice was a very important factor in the air blitz of 1940 and 1941. It resulted in many bombers failing to find their target and is reputed to have caused some to land in this country. At a later stage a number of mobile masking systems were provided for service abroad. For the air offensive very important parts of the ground and air-borne equipment (quartz crystal frequency generators) for the GEE navigational aid which made possible the effective large-scale bombing of Germany were developed in the Dollis Hill radio laboratory. An important part was also played in the large-scale production of very high grade quartz crystals for Services establishments and by the work of the Telecommunications Quartz Technical Sub-Committee which, under the chairmanship of a member of Radio Branch, has advised on all technical matters and maintained liaison between research and manufacture and also with the U.S.A.

Some of the war-time developments have direct application to peace, notably the improvements in repeaters and terminal equipment for the coaxial cable system, extensions on which provided much-needed circuits; multi-channel telephone circuits can now be extended over V.H.F. radio links, and multi-channel telegraph and teleprinter working came into use on some overseas radio links.

In conclusion, it will be appreciated that it is impossible in the space available to do justice to the activities of many of the staff or to do more than indicate briefly just a few of the major developments in radio with which the Post Office was concerned.

A. H. M.

Telephones

The design and provision of telephones and switching facilities employing automatic equipment to meet the special needs of the Services provided a major contribution to the war effort. In conjunction with the S/AD, the Telephone Branch were responsible for the technical designs. The equipment was tested and perfected in the Circuit Laboratory. Prototypes were produced and equipment assembled when the numbers required did not justify factory production and speedy delivery was of paramount importance. They also carried out the installation of equipment in the field, in all parts of the British Isles. In all, approximately 2,800 separate works were completed. A few representative samples are described in the following notes.

Electrical Calculators.

These complex automatic switching equipments, employing 3000 type relays and Siemens motor uniselectors, were installed at 55 C.H. radar stations around the British Isles, to translate the settings of the radar controls into visual displays, giving full information of the enemy aircraft position and strength; 129 were installed, including 32 at two training centres.

Mobile Radio Units.

Over 620 convoys of motor vehicles from one to three units were equipped with telephone communication facilities.

Detonator Selector and Gunflash Simulating Circuits.

Circuits were designed to select and explode detonators which would

- (a) Ignite dummy fires.
- (b) Touch off charges, to simulate gunflashes with intent to deceive the enemy airmen.

A total of 2,034 were constructed of which 224 were made in the Circuit Laboratory, together with 10 portable testers.

Post Office Mobile Signal Units.

These units were provided in 1940 and were operated under the control of Post Office liaison officers with the Forces. They were designed to facilitate the rapid provision of line communications for the Army in home defence and operational exercises, using, where possible, the existing public network. Each unit comprised two vehicles fitted with tools and spares for line construction and was manned by a crew of selected Post Office workmen. Over 50 M.S.U.s were at one time in service.

Radio Telephony Training Equipments.

These equipments provided facilities for training pilots on the ground in R/T procedure. Provision was made for six pupils and one instructor. Standard aircraft unit components and flying helmet telephones were used. Over 100 sets were installed at R.A.F. and Naval Stations, including 11 on Aircraft Carriers.

Censorship Arrangements.

Throughout the war period, it was necessary for security reasons to introduce widespread facilities for censoring on the inland telephone traffic, overseas trunk and junction routes and certain subscribers' lines. A large variety of portable manual observation equipments were designed which could be readily associated with the various classes of circuits, either at the exchange or in remote premises. Facilities were provided for a tone to be applied by the censor to mask suspected conversations.

Government Trunk Pool Scheme and Refuge Switchboards.

The appropriation of public trunk circuits for the defence services resulted in the serious degradation of the normal trunk service; many of the most important trunk routes had to be worked on a delay basis. To ensure a comparatively high grade of service for certain Government Departments and other important subscribers, arrangements were made at selected exchanges for the appropriation of certain public trunks during specified times and their diversion from their normal switchboard position to specified (pool) positions on which the priority subscribers were terminated as Trunk subscribers. Calls for such subscribers could thus continue to be handled on a demand basis.

Multi-Lingual Conference Sets.

Facilities provided enabled interpreters to transmit translations telephonically direct to the head sets worn by eight delegates. Means were also provided whereby a delegate could signal for a repeat translation or a translator could signal to the delegate or chairman to speak up.

Fixed Ground Control Interception Units.

Full intercommunication facilities were provided at 21 stations engaged in the complex operation of fighter interception. Staff were employed practically continuously at one or more stations between January, 1942, and January, 1945. The work ran into 18 stages involving nearly 380 separate jobs.

Automatic Camera Control for Bombers.

A relay unit was designed and 20 constructed to control the focal plane shutter and film motor winding gear of aircraft cameras to enable pictures to be taken automatically during bombing attacks. They were successfully employed on the raid at Lübeck.

Grading Device for Multi-Photoprinting.

A relay set was designed for the Air Ministry, Photographic Section, to control the sequence of operations in grading the density of negatives prior to printing and the choice of the number of prints taken off each negative.

C.W.B.

Lines

Apparatus for Emergencies.

One of the first considerations was the safeguarding of the main network from bombing. What might be called preventive measures were adopted in many places by arranging repeater stations on the outskirts of big towns with cables ringing the towns, so that through circuits could be operated even though the town was subjected to bombing. The time for repair of cables was cut by having key cable stocks at various points in the country. Equipment was more difficult to deal with and, in addition to holding stocks of standard repeater apparatus, a number of items were designed for particular use in emergencies. In certain circumstances it was anticipated that mobile equipment might be required and a number of mobile audio and intermediate 12-circuit carrier stations were built.

Work Directly for the Defence Services.

Very early in the war the Post Office offered its assistance to the Services on communication matters and in mid-1940 a committee was formed under Post Office chairmanship on which the War Office and Ministry of Supply were represented.

One of the jobs undertaken was the equipping of a number of vehicles for mobile telecommunications units.

The following vehicles were supplied:—

22 vehicles equipped with mains operated amplifiers, signalling apparatus and teleprinters supplied to the Air Ministry.

38 vehicles equipped with rebayed S.T. & C. 3-circuit carrier equipment, modified for use on radio links, supplied to the Air Ministry.

81 vehicles for the War Office fitted with racking, cupboards, test jack field, main frame and with power and transmission wiring to accommodate portable Army telecommunication equipment.

4 vehicles equipped with amplifiers and signalling equipment supplied to the War Office.

Special vehicles were also equipped and a cable balancing programme worked out at high speed and shipped to Egypt for a network in the Nile Delta. This was subsequently to play a useful part in the activities during the Battle of El Alamein.

Extension of the Inland Main Line Network.

Largely to meet requirements of Services and Ministries, the pre-war single wire mileage of main underground cable which was 6,000,000 miles acquired in 25 years, was supplemented to the extent of 4,000,000 miles in five years. Details of the number of private telephone circuits for the Services in this country and of the D.T. Control arrangements made to deal with urgent Service requests are given elsewhere in this issue.

H.M. Telegraph Ships.

The cable ships were engaged from early in 1939 in laying and maintaining numerous cables for the Services and for general defence requirements in addition to their normal duties. A steam lighter (better known as a "puffer" on the West Coast),

the *Glencloy*, was chartered and with a party from a cable ship has been stationed at Stromness since the autumn of 1939 for the purpose of maintaining and laying Service cables in the Scapa area; a duty performed under some of the worst weather conditions to be experienced on the British coasts.

The first "warlike operation" was the cutting of the Borkum-Fayal 1926 and the Borkum-Vigo 1929 cables by *Alert* on September 3rd, 1939—she sailed from Dover only 53 minutes after the declaration of war.

Assistance was given to the Admiralty in the maintenance of anti-submarine cables and apparatus before there were sufficient naval vessels provided for this purpose. The submarine cables of the various cable companies were also repaired on numerous occasions, the work ranging from the South-Western Approaches almost to the Arctic Circle, under the most trying conditions and when constant watch had to be kept for the enemy under the sea and in the air; obviously a cable ship at work is the ideal "sitting target."

The cross-channel communications required by S.H.A.E.F. and provided after D-Day are dealt with in another part of this issue.¹

The work of the cable ships was not accomplished without grievous loss, however—*Alert* was lost with all her gallant company on February 24th, 1945, and *Monarch* was mined on April 16th, 1945, with the loss of three lives.

Major Developments carried through.

Probably the largest development was the changeover to the No. 7 Carrier system which saved space and gave a much wider speech band width, as well as other advantages. A changeover was also made to coaxial type cables, which enable the Department to make use of less duct space than was required for 12-circuit carrier and was more economic of intermediate buildings and apparatus. The No. 7 type channel apparatus can also be used on these cables, and therefore complete flexibility is obtained between 12-circuit and coaxial apparatus.

The audio side has not been forgotten and a new simple, feed back amplifier was developed, requiring less space than other types and giving far better performance.

Submarine cables also have played a major part in the War and two developments may perhaps be mentioned. The normal concentric type cable used for multi-circuit working had an insulating core of paragutta or K gutta. This was replaced by polythene, which besides giving an improved electrical performance made us less dependent on raw materials from enemy occupied territories. It was realised also that by the use of submerged repeaters, extra circuits could be obtained for a comparatively small cost and what was more important, with a saving in raw materials and labour, and this caused the submerged repeater development to be initiated.

R. M. C.

¹ P.O.E.E.J. Vol. 38, page 136

Regional Notes

Home Counties Region

Owing to its geographical situation the Home Counties Region was a front line Region during the war. At the onset the Region had already provided a huge and complicated network of air-raid warning circuits and the nucleus of a network for Observer Corps and Ack Ack Command; the latter posts were often located on the outskirts of civilisation and presented ticklish problems from an engineering aspect. Then followed schemes to provide communications for evacuated Government Departments, involving additional long-line networks and many large P.B.X. installations, all of which had to be completed within the shortest possible time. Emergency schemes covering the more important exchanges were next evolved, these being directed to the maintenance of service should such exchanges be put out of service by bombing or sabotage. Areas within the coastal belt had also to prepare and organise schemes to cover the mass evacuation of Area staffs in the event of invasion and large scale raids by enemy troops. Defence Telecommunications Control (D.T.C.) networks were set up in each Area and staffed on a 24-hour basis; these controls were the focal point for all works programmes for the defence services and also for all restoration and emergency measures. Concurrently with these initial schemes a heavy programme of works was developing in the provision of vast line networks and innumerable complex installations for that mighty weapon of war, the R.A.F. Of this immense organisation the Region had more than the average quota of aerodromes under Fighter Command, the Tactical Air Force, Coastal Command, and Bomber Command, including Bomber Command H.Q.s, R.A.F. and U.S.A.A.F. Due to its vulnerability to air attacks, the Region also had a heavy quota of works in connection with "Radar" (R.D.F.) and other special R.A.F. installations, including enemy "Beam" deflection (G.B.) stations and "Beam" provision stations (Oboe) for the R.A.F. "Pathfinders." The majority of these stations were located in inaccessible and rural localities far away from any existing line networks.

Another heavy quota of works was involved in the setting-up of Civil and Military H.Q.s and establishments forming the backbone of the anti-invasion defence organisation. These included Aldershot Command, Eastern Command, South-Eastern Command, alternative G.H.Q.s, and three Civil Regional Commissioners H.Q.s, and other special measures associated with the development of the coastal belts into the first lines of defence against invasion. All these works had to be executed with depleted staffs who, notwithstanding day and night bombing and sleepless nights, were always ready and on the job when wanted. Absenteeism was unknown and all worked with that grim determination and a solidarity of opinion behind the war effort, with a cheerfulness after grim times, so characteristic of the British workman.

The works provided for purely defensive measures

had barely dropped below peak requirements when schemes were set afoot to build up that vast network of communications ultimately required for the greatest endeavour of all—"D" day. These involved the provision, by-passing, and alternative routings of thousands of circuits required to link up Command H.Q.s, Sub Area H.Q.s, Marshalling Areas, Embarkation Points, Ordnance, Medical Services, Security, Movement and Traffic Control, Advanced Landing Grounds for aircraft, and shore connections for submarine cables. Long distance P.W.s were also provided to link up laterally all other Marshalling Areas and for communications back to Commands and higher formations. The works involved in the setting up of the two principal H.Q.s for Combined Operations, Dover and Portsmouth, would, in themselves, provide a story which could not be told in a few hundred words, and the battle H.Q.s provided for S.H.A.E.F. could equally be regarded as a story in itself. The demands of the Allied Military Command for communications were very great; miles upon miles of cables and ducts, teleprinters by the hundreds, switchboard positions by the dozens, plotting rooms with all their complicated apparatus and involved networks, land-lines for the radio links destined to maintain communications with the attacking forces during the actual invasion. Large houses would be commandeered for military purposes overnight, and in each instance a communication network had to be provided. Aerial cables, V.I.R. interruption cables, anything which could carry a circuit, was hastily run out, and in many instances the speed of the operations was such that often the premises were occupied for a few hours only by the Unit concerned.

One example of the speed by which demands for the services had to be met was the setting up of communications for the balloon and Ack Ack barrages, south-east of London, to meet the menace of the flying bombs. Some 1,750 telephones, 85 switchboards, and over 1,200 circuits, involving some 65,000 manhours of work, were installed and working within four weeks of the date of the demand. Later, when the direction of the attack changed, another and similar network was set up at equally short notice on the east and north-east sides of London.

In spite of the fact that some 2,000 workmen from a total of 6,000 were released to the Forces all demands made upon the Region during wartime were met. Many large works were undertaken and completed by the local staff using direct labour, as time and labour conditions did not permit placing the works out to contract. In actual fact the successful completion to time of many large and involved schemes was due in no small measure to the complete elimination of peacetime procedure. The Region has every reason to be proud of its wartime efforts and of the magnificent response to all calls made by the staff, whose inherent sense of duty and devotion to the national effort was an inspiration to all concerned.

L. O. G.

Welsh and Border Counties Region

In the limited space available it is possible to give only a brief resumé of some of the major events occurring in the Region during the war years.

Of the bombing of Swansea on three successive nights in February, 1941, much could be written of the effects on departmental plant and the efforts of the staff to restore service. Although a direct hit was made on the head post office the damage to the telephone exchange equipment was negligible. The drawing office and D.T.C. room at Telephone House were destroyed, but most of the records were salvaged. Repairs of severe damage to main and local cables were impeded by flooding of roads and man-holes, debris and unexploded bombs. Various expedients were used in overcoming restoration difficulties and the ingenuity and untiring efforts of the staff enabled repairs to be effected in good time. Fig. 1 illustrates a typical temporary repair work.



FIG. 1.—TEMPORARY REPAIRS.

When the D.T.C. room at Telephone House was hit, the inspector on duty had a remarkable escape. The bomb (Fig. 2), 9 ft. 9 in. by 2 ft. 4 in., tore through the



FIG. 2.—BOMB IN TELEPHONE HOUSE, SWANSEA.

building, taking the inspector with it, to the basement, where he recovered to find himself lying on top of the bomb and almost ringed by fire. He got

clear of the wreckage, received first aid, and although badly injured, brought into use the emergency switchboard and remained on duty until relieved. For his courage and devotion to duty he was awarded the George Medal. Fig. 3 shows a view from Telephone House taken after the three consecutive night raids.

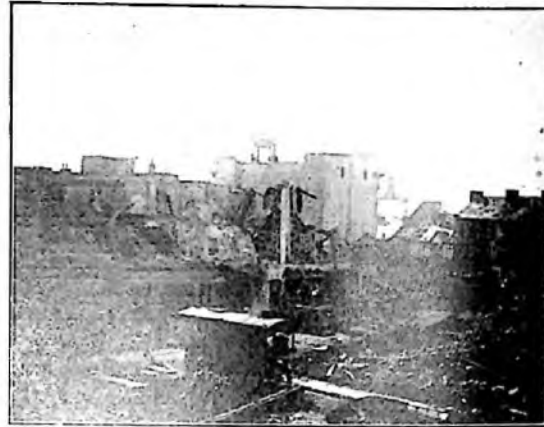

FIG. 3.—VIEW FROM TELEPHONE HOUSE, SWANSEA.

Cardiff Head Post Office had a number of near misses from bombs, and apart from broken glass, little damage was done until the night of March 3rd, 1941, when the fighting of an incendiary bomb fire in the false roof of the instrument room resulted in severe damage by water to the whole of the telegraph ancillary suites, individual teleprinter positions and P.F. and T.T. suites, together with the failure of the power and lighting services. By the hard work of all concerned, the majority of the circuits were back in service by 7 a.m. next morning.

Turning to pre-"D" day operations, the conversion of the derelict Hubberston Fort, Milford Haven, into a United States Headquarters was a case where the time factor had to be beaten. The building was reconditioned, land and sea cables laid, D.P.'s erected, and switchboards and telephones installed at a rate which impressed our American Allies, many unorthodox methods being used. Having served its purpose, the Fort is now deserted except for rats.

During 1941, determined attempts were made by the enemy to prevent the use of the Haven at Milford. Air attacks and mine laying were frequent. It was important at this time that communications should be maintained, and when the submarine section of a main cable became faulty in September, 1941, action was prompt and effective. The Admiralty released H.M.T.S. "Alert" (Commander, Captain Oates), to deal with the emergency.

Another phase of "D" day operations was the erection of 143 miles of Spiral 4 cable on P.O. poles in the Region. American repeaters were installed in Post Office premises en route and the whole job was surveyed and completed by the joint efforts of American Signals personnel and Post Office staff in 11 days.

H. C. A. L.

North-Eastern Region

It is not possible in the short space available to write a full account of the N.E. Region's war activities, but the following abridged version will give some idea of the contribution made.

Defence Circuit Provision and Telecommunications Control.

Headquarters Region and Area D.T.C.'s were connected by a special network enabling continuous attention to be given to defence circuit requirements. Between September, 1939, and August, 1945, this organisation provided a total of 10,150 defence circuits, specifically numbered in the private wire series and routed wholly or partially through the N.E. Region, this figure being exclusive of 1,139 scheduled defence local ends provided for E.C. circuits.

Defence Stations.

Communications were set up for five observer centres and 300 observer posts; two Army corps H/Q; one fighter group H/Q; five fighter sector stations; four bomber group H/Q; 83 other Service aerodromes (including 19 bomber bases, 35 bomber stations and other miscellaneous types, e.g., fighter satellite; coastal; training, etc.); 4 fire force areas; 5 gun operations rooms; 2 Naval Flag Officers' H/Q; 4 main radar stations; 2 Regional Commissioners' Headquarters; 3 wireless stations and numerous smaller defence stations.

For stations under the control of Bomber Command 16 18-channel and 76 4-channel M.C.V.F. telegraph equipments; 350 Teleprinters No. 7; 4 Teleprinter Switchboards No. 8 and 19 No.15; 75 P.M.B.X.1A positions for Admin. purposes (with provision for 4,000 extensions; 1,000 tie lines and 300 exchange lines); 22 single position P.M.B.X's 1A for Ops. purposes; 40 P.B.X's 10+50/65 and 40 P.B.X's 5+20/25 were provided, together with flight planning networks, loudspeaker installations, privacy equipment, plotting room and intruder warning facilities.

For the fighter group and 5 sectors, 20 18-channel and 20 4-channel M.C.V.F. telegraph equipments and 100 Teleprinters No. 7 were provided, together with a transfer, in each case whilst operational, to an off-site operations room, with full switching facilities to an emergency operations room.

At various defence establishments a total of 55 D.T.N. stations were set up.

External Field Work.

Perimeter cables for 88 service aerodromes were provided involving 400 miles (10,000 pair miles) of cable. To meet the outlet requirements of these 88 aerodromes, 16,500 pair miles of cable (almost wholly balanced and in some instances loaded) were laid by direct labour.

On-site requirements at each aerodrome necessitated the provision of what was effectively a minor development scheme. Excluding outlet cables this work entailed the erection of some 6,500 poles and the provision of some 1,600 miles of cable.

Overhead routes near airfields often constituted flying obstructions and over 300,000 M/H's were involved in providing underground cable and re-covering open routes. In exceptional cases diversion of underground plant was necessary.

At one W.D. wireless station the work involved the erection of 32 masts from 63 ft. to 84 ft. high; 150 masts from 105 ft. to 126 ft. high; provision of some 3,000 stays, the blocks for which required the mixing and laying of 1,720 tons of concrete; the erection on-site of 394 poles; 82 miles of wire and 7.5 miles of coaxial cable. In addition to this, two alternative outlet cables were laid. The internal work included the laying of some 30 miles of internal coaxial cable and the terminating of 10,000 coaxial feeder connections on special plugs, sockets and switching keys.

To meet defence circuit requirements generally 15 junction cables (total 126 miles or 7,420 pair miles) and 9 trunk cables (total 59 miles or 8,500 pair miles) were laid by direct labour.

Restoration and Emergency Schemes.

Refuge telephone switchboards were installed in 55 telephone exchanges, comprising 18 auto manual and 37 manual suites, and in 9 of the most important towns emergency switchboards were installed in protected accommodation.

Protected telegraph instrument rooms were provided in the basements of H.P.O.s at 18 of the more important towns and in the 8 most important towns alternative accommodation in a separate building was earmarked and partially equipped in advance.

Ring cables were laid round Hull and Newcastle and 10 strategic bridges carrying important main cables were by-passed by means of subaqueous cables.

1,308 air raid damage cases affecting Post Office plant were reported, including 4 telephone exchanges, viz., Bridlington, Leeds Central, York and Whitley Bay

The Government Department Evacuation Scheme.

To provide communications for Air Ministry, Ministry of Supply and Post Office staff evacuated to Harrogate, 55 C.B.9 sections and 28 10+50/65 P.M.B.X's were installed in 22 requisitioned hotels. A 25-position C.B.10 exchange (named "Swift") was installed by direct and loaned contract labour in huts on a site acquired for some of the evacuated staffs.

Staff and Maintenance.

At the outbreak of war 496 men out of a staff of 3,636 were released to the Forces, the releases gradually increasing and reaching a peak of 1,790 by March, 1945. The number of female assistants was 45 at April, 1941, gradually increasing to a peak of 510 by June, 1943, and thence gradually decreasing to 340 by September, 1945.

The labour expenditure on War Maintenance between September, 1939, and March, 1945, was approximately 1,507,000 M/H's.

S.A.F.A.

Northern Ireland Region

Until war became imminent, Northern Ireland had no naval base, very few troops and only one military aerodrome. Towards the end of August, 1939, a naval base with telecommunications on a very modest scale was established in Belfast; the Army garrison at Victoria Barracks, Belfast, was put on a "war footing"—so far as telecommunications were concerned—by the provision of a speech private wire to the War Office; the military aerodrome at Aldergrove was in use at that time solely as a training centre for the Auxiliary Air Force and no additions were made to its telecommunications. Except for the installation of telephones for Civil Defence, essential industries, etc., Post Office engineers in

Northern Ireland. The new Base Headquarters was to be ready for operation by May 25th, 1941. Even after drastic appropriation of public trunk circuits insufficient circuits were available between Belfast and Londonderry to meet the needs, and as the second cable which had been planned for this route could not be laid by the target date, phantoms were set up on 10 lb. star quad cable pairs. Amplifiers were available at the repeater stations along the route, but in one section the attenuation of the phantoms was greater than the gain that could be obtained from amplifiers, and for this reason amplifier equipment held for emergency purposes was installed in a wooden hut erected by the roadside at a point about half-way along the section. Fortunately it was possible to obtain a power supply from a high tension power line which crosses the road at this point.

Belfast Naval Base Headquarters also had to be moved to larger premises in 1941. Later, when America entered the war, considerable work was done by American technicians in improving the Base at Londonderry. New yards for the use of the Allied navies were constructed on Lough Foyle and three camps for the accommodation of personnel were built in the vicinity. New line plant to serve each of these sites was installed by the Post Office. The switchboards, extensions and line plant within the sites were, however, provided by the U.S. Authorities. The whole of the telephone plant provided by U.S. Authorities was replaced later by the Post Office.

Notification in June, 1941, of the Air Ministry's intention to set up a Fighter Group in Northern Ireland made it necessary to put in hand a very extensive programme for the provision of main trunk cables, all of which had to be completed and ready for service by September 25th, 1941, the target date for the establishment of the Group. Parliament Buildings, Stormont, was chosen as Group Headquarters and the Sectors were located at Eglinton near Londonderry, St. Angelo near Enniskillen and Ballyhalbert in the Ards Peninsula. A Filter Room was sited in Dundonald Village and a number of additional Radar and D/F Stations were located in various parts of Ulster, involving the construction of long overhead lines. An Air Inter-Service Switching Centre was also established at Dundonald as part of the general scheme.

Two large D.T.N. stations and two new repeater stations were set up and three repeater stations were removed and extended. Although the whole of the work as planned could not be completed within the three months allotted, by improvising where necessary, the complete network of communications required by the Group was installed and ready for service on the target date. C. E. W.



FIG. 1.—MAIN UNDERGROUND CABLE NETWORK.

Northern Ireland did not have the opportunity of contributing much to the war effort until the fall of France in May, 1940.

The main trunk network in Northern Ireland was under-developed before the war, the combined lengths of all main trunk underground cables, including those connected to submarine cables to Great Britain, being only 240 miles in an area of about 5,500 square miles. The main underground network in 1939 and its growth up to 1945 is shown in Fig. 1.

After the fall of France the Services expanded rapidly in Northern Ireland. An Army Command, known as British Troops in Northern Ireland, was established with headquarters near Belfast and having strong contingents of troops along the Eire Border ready to meet a possible invasion of Southern Ireland. A naval base was set up at Londonderry and a number of aerodromes were established.

The Naval Bases at Belfast and Londonderry expanded rapidly. Early in 1941 the Headquarters at Londonderry had to be moved to larger premises and given increased communications, including additional telephone and teleprinter P.W.'s to other naval and air force formations in Great Britain and

Scottish Region

Edinburgh and Greenwich Mean Time.

It was long a closely guarded secret that Edinburgh has been for some years a source of time signals normally emanating from Greenwich.

In the Royal Observatory, Edinburgh, were located both the highly specialised staff and equipment necessary to supplement, and when the emergency occurred, to replace certain vital services at a critical time. It is not possible to do more than mention the chief signals generated :—

(1) *B.B.C. "6 Pip" Signal.* This familiar signal has been available whenever required. It was recently revealed that it was used for Artillery Fire Control synchronisation.

(2) *Speaking Clock.* Correcting signals have been transmitted each hour. By the interconnection of the circuits from North and South a direct V.F. circuit was provided between the two observatories.

(3) *International Time Signal.* This vernier time signal is radiated from Rugby and various other W/T stations. The accuracy required is of the order of one millisecond in a 24-hour interval, and to provide and maintain this service required a constancy of performance both of lines and apparatus which is a source of pride to all concerned. The actual transmission of signals since 1944 has been effected by a quartz clock of the Post Office Group IV type constructed by the Radio Branch.

J.W.B.

Leuchars Aerodrome Beam Approach Outer Marker Beacon.

This beacon is situated on a sandbank in St. Andrews bay opposite the famous old Golf Course. The supply of control circuits involved the provision of 1,850 yards of subaqueous cable, which was received in one length, having a total weight of 5 tons.

Because of shallow water over the sandbanks between the beacon and the shore landing point, it was necessary to obtain a flat-bottomed barge to accommodate drum and crew. The first problem was to get the drum into the barge from a sandy beach.

A number of rolled steel H sections were obtained and laid on their sides, the drum battens removed and the steel joists used as rails. A small jetty was built of scaffolding poles and the joists continued along this and down into the barge.

Laying commenced from the staging on which the beacon was situated. It had been intended to use a small motor boat to tow the barge, but owing to the strong head-wind, the motor boat was found incapable of doing the work. Even though a larger boat was standing by, it could not be used because of shallow water. It was then decided to use a kedge anchor and pull the barge ashore by hand, the motor boat being used to lay the anchor ahead of the barge.

The handling of the drum and cable on this job might suggest to some that the Dundee Area had almost anticipated the "Pluto Conundrum."

S.J.S.

Combined Operations Fighter Direction Tenders.

When the Air Ministry decided to modify and equip three landing craft as fighter direction tenders, it fell to the Glasgow Telephone Area to provide the intercommunication facilities aboard these vessels. The tenders were equipped with radar for locating enemy aircraft and with wireless for the direction and control of friendly aircraft.

Speed of communication between the various points was essential, and these facilities were provided by interconnected lamp-calling keyboards which formed the communication links between the G.C.I., P.P.I. and filter rooms, the transmitter and receiver cabins, the bridge and the general control centre. Intercommunication between control cabins and from ship to shore was provided by a house exchange system, modified for working to all types of exchange.

A novel feature was that the C.B. telephones were modified for lamp-calling with separate signalling conductors. All main links between keyboards had alternative routing.

Members of the Glasgow engineering staff were aboard one of these ships during trials, as a result of which improved interlinking between radar room, bridge, plotting table and wireless receivers was found desirable. During the trials, the R.A.F. operating and maintenance staff of all three ships were instructed in the operation and maintenance of the plant provided by the Post Office.

W.J.G.

Scapa Flow, the Home Fleet Base.

When the Home Fleet anchored there during exercises in 1938, Scapa Flow was undefended and land line communication was available only over an omnibus call office circuit. During the war Scapa became the main base for the Home Fleet and was called by Mr. Winston Churchill the best defended naval base in the world. Line communications were provided by two cables encircling the Flow with long radiating spurs to guns, aerodrome, radio stations, etc. Administrative traffic was circulated over a combined services network and the largest of the five main switching centres was a 12-position sleeve control P.M.B.X. at Lyness. Shetland figured in the Orkney defences, while Lerwick was the base for gun-running operations to the patriots in Norway. Early in 1940 amplified internal circuits were provided routed in 60 miles P.C.Q.L. cable, unbalanced, laid out over moorland or tied to fences. This cable was later replaced by a loaded armoured cable which was extended northwards to the tip of Unst. Concentric type submarine cables carrying group modulated carrier systems were used to link Shetland to Orkney via Fair Isle and Orkney to the mainland. Southwards between Wick and Inverness coaxial systems were used.

The engineering staff in Orkney in 1938 consisted of three linemen. At the peak period in 1944 supervising officers alone comprised one Assistant Engineer, two Chief Inspectors and eight Inspectors.

C.F.P.

North-Western Region

The North-Western Region, covering some 5,000 square miles of territory stretching from Merseyside to the Solway, naturally had a great part to play in the war activities of the Post Office. The Battle of the Atlantic, a continuous fight to defend Britain's supply lines, was controlled from a headquarters in Liverpool, and the story of the Department's contribution to that effort is told elsewhere in this issue.¹

During a period of over four years of strenuous endeavour, many thousands of telecommunications installations and circuits were provided and maintained for all arms of the fighting services, civil defence and war industry; scores of emergency schemes, ranging from the duplication of a single instrument to the provision of complete standby exchanges and the laying of hundreds of alternative main and subscribers' cables, were carried out; and a variety of staff arrangements to meet emergency conditions were devised and brought into operation.



PICCADILLY GARDENS, MANCHESTER, DECEMBER, 1940.

However, the present restricted space only allows reference to a few of the events of the period.

Altogether some 338 air raid warnings were given in the Manchester Telephone Area. Of outstanding importance in their consequences to the Department's plant were the two heavy raids occurring on successive nights in December, 1940, when the city suffered extensive damage from the joint effect of fire and high explosive bombs. Over 8,000 subscribers' installations and 23 cables, including several important trunk cables, were put out of action. The staff saved Central exchange from total destruction by fire in face of most dangerous odds, and having saved the building and most of the equipment, they set to work with a will on the task of reconditioning, which proceeded with such speed that the exchange was only out of service for 30 hours. As a result of this brilliant piece of work, and also the successful fighting of fires at the Trafford Park exchange, situated in the highly important and

¹ P.O.E.E.J. Vol. 38, page 113.

vulnerable industrial and dock area of the city, honours and commendations, including one George Medal and three British Empire Medals, were awarded.

The photograph reproduced from the publication "Front Line" (1940-41), illustrates the grim fate that overtook one side of Piccadilly Gardens, Manchester, in December, 1940.

The air attacks on Liverpool culminated in a series of very heavy raids early in May, 1941, and on the morning of Sunday, May 4th, the Liverpool organisation found itself without a home and facing the loss of Bank, North and Central, the three principal telephone exchanges in the city. The original trunk exchange, damaged in earlier raids, and the emergency installation which had taken its place were beyond all hope of repair, the cable system and overhead lines were damaged in hundreds of places and thousands of subscribers' premises were destroyed. Over 5,000 lines on neighbouring exchanges were also out of action.

Under previous emergency arrangements a trunk service had been based on the new switchboard in Lancaster House, and this was extended quickly. In four months full trunk facilities were virtually restored. In addition, 400 subscribers were given service from an emergency manual exchange, in the basement of Lancaster House. The major relief, however, was obtained by the opening of a new automatic exchange, which was under construction to replace "Royal." The new exchange, known as "Advance," had facilities for serving 6,000 subscribers and was opened in June, 1941. Complete facilities were restored by the opening of North automatic exchange in the spring of 1942, and Central automatic exchange in April, 1943.

With regard to telegraphs, after the Head Post Office basement became untenable, working was transferred to the basement of Lancaster House. A further emergency instrument room with 50 teleprinters was

brought into use at Eagle House and, in the spring of 1942, a new instrument room and phonogram suite at Littlewoods' Building, Old Hall Street, finally came into operation.

In the Preston Area, coming events cast their shadow as far back as 1937, when a section of the countryside was transformed into a Royal Ordnance Factory of the first magnitude. Later on, other important war industries were set up by the I.C.I. When hostilities commenced, the plans already made for the evacuation of Government Departments were brought into action. All the necessary installations were provided in the minimum time as a result of the whole-hearted, seven-day-a-week efforts of the staff.

In all Areas, the loyalty, courage, unity of purpose, and devotion to duty of the members of the staff were the chief factors in the success of the Department's efforts to meet the country's need for extra war-time communications.

London Telecommunications Region

The war-time experience of the L.T.R. is distinguished by its duration, variety and magnitude of the many tasks undertaken. As London was the directive and administrative centre in the prosecution of the war and an important area of munitions production, the telecommunication requirements for essential services were naturally both extensive and considerable.

The wartime experience falls broadly into three divisions; viz., provision of service, repair of bomb damage and measures for safeguarding. As the last division has been dealt with in another article in this issue of the JOURNAL¹, no further reference will be made in this brief survey. With regard to the other two aspects, an exhaustive account is not possible in the space of these notes, but it is hoped that it will convey an impression of the L.T.R. in wartime.

Maintenance of Telecommunication Services.

The maintenance of telecommunication services in the L.T.R. during wartime was dominated, except for a lull of some months in 1942, by bomb damage to the Department's plant, which was experienced from the first small incident on June 18th, 1940, to almost the last days of the war. In this period, four phases of attack may be discerned, viz.: the heavy and persistent bombing of 1940-41, the spasmodic attacks in 1943-44 which developed into the short but intensive raids in the spring of 1944, the flying bomb attacks between June and September, 1944, and finally the rocket bombs which were experienced from September, 1944, to April, 1945.

The first of these series of attacks was the most damaging to the Department's plant, and occasioned widespread interruptions to the service, mainly owing to the cumulative effects produced by the daily bombing over a period of five months. During this time, 123 exchange buildings were damaged, at 22 of them major damage to the equipment being sustained. Among the latter were five in which the equipment was completely destroyed, and full restoration of the service by transferring the lines to a replacing exchange was necessary. In addition, as has been mentioned in a previous article in the JOURNAL², the C.T.O. became a total loss in the fire raid on the night of December 29th, 1940.

Line plant naturally suffered more severely, owing to its greater vulnerability and the successive daily toll of damage caused by the prolonged bombing to which the London area was subjected, made exceptionally heavy demands on the Regional repair resources. As a statistical index of the extent of the damage, it should be mentioned that 1,500 trunk, junction and subscribers' main cables were affected.

In the second phase of attack the raids were short and sharp, but as they were not repeated with the daily persistency of those of 1940-41, damage was

not so widespread and did not tend to become cumulative.

The characteristic effect of the flying bomb attacks on the Department's plant was that, as the explosive force was largely superficial, external plant was little affected, but buildings suffered considerably from blast. Damage occurred to 76 exchanges, but at only three of them was the equipment affected to the extent of causing serious interruption of the services.

In the final stage from September, 1944, to April, 1945, the attack consisted mostly of rocket bombs, supplemented with occasional plane-launched flying bombs. Fortunately this attack, though the most insidious, was not intense, and damage was comparatively light. The buildings of 24 exchanges sustained damage, but no serious incident involving external plant occurred.

Provision of Telecommunications Services.

Conditions in the London area inherently created exceptional demands for the provision of telecommunication services for war purposes, and the aggregate quantities of plant provided, both internal and external, were very considerable and constitute an impressive record. For the numerous P.B.X.s which were installed, for instance, several of them equivalent in size to a large public exchange, some 400 C.B.10 and 1,500 P.M.B.X. 1A positions were used, apart from correspondingly large numbers of smaller switchboards.

The requirements for operational control at the headquarters of the Fighting Services made exceptionally heavy demands, both for ordinary telephone apparatus and the special equipment required for main operations rooms, a dozen of which were established and equipped in the Region. The amount of equipment provided for the associated D.T.N. installations was on a similarly impressive scale. There were in all nine D.T.N. stations, in which 153 M.C.V.F. systems of various sizes and 600 teleprinters were installed.

An interesting example of the provision of telecommunications services occurred when the flying bomb attack was launched in June, 1944. Communications had to be provided at short notice, and with the utmost despatch, for 1,750 balloon sites and 61 operational control points. The communication network entailed the provision of some 500 miles of 1 pr. braided wire, and seven miles of 38 pr. and 58 pr./20 cable.

This brief survey would be incomplete without a tribute to all grades of the Regional engineering staff, whose unswerving devotion to their manifold duties enabled all the multifarious requirements of the capital's telecommunications services in wartime to be fully satisfied, and thus contributed in no small measure to the achievement of final victory.

H. F. E.

¹ P.O.E.E.J. Vol. 38, p. 127 ² P.O.E.E.J. Vol. 38, p. 11.

Midland Region

The geographical position of the Midland Region resulted in a wide variety of work being undertaken by the engineering staff and a share in most schemes, operational and otherwise, designed to further the work of winning the war. The industrial expansion of the Midlands meant full pressure on the installation staff in connecting essential lines, not only at the outset of hostilities, but as evacuation of industry took place from more vulnerable areas in 1941 and as the needs of the armament and ordnance factories grew. Thus on the western side of the Region the requirements of industry were being met, whilst on the eastern side the defensive and offensive efforts of the R.A.F. occupied the engineers truly day and night. Some idea of the distribution of the latter work is given by the number of airfields in each Area, which was as follows: Stoke 4, Birmingham 13, Coventry 13, Nottingham 13, Leicester 17, and Peterborough 25; a total of 85. These included stations of every variety, bomber, fighter and trainer and invariably required the provision of perimeter cables and alternative outlets at the opening dates. At later dates, many rearrangements were made to meet the changing requirements of the R.A.F. and U.S.A.A.F.

The stations were served from R.A.F. Bomber and Fighter Group Headquarters located within the Region. Each of these headquarters included full D.T.N. facilities and developed continuously from 1939 onwards. In 1940 a further Bomber Group Headquarters was set up, followed by an Operational Training Group Headquarters in 1943. Cranwell R.A.F. Training College was in full operation throughout with a complement of 154 teleprinters in use for training of Signals personnel.

An estimate of the plant provided between 1942 and 1945 has been attempted from the progress reports of the time. In that period 694 miles of underground cables were laid and 153 miles of aerial cable erected to serve as perimeter and outlet cables, to remove obstructions to flying and for service to radio stations; it involved 230 miles of new duct routes. Naturally the magnitude of the work called for special efforts and methods. It was seen very early that the mole-drainer method of laying cable direct in the ground was particularly suited to this work and the development of this in 1941 has already been described in this JOURNAL.¹ Included in the above figures are 153 miles laid by mole-drainer and many hours of labour were thereby saved.

In the early part of the war, the *magnum opus* of the Birmingham, Coventry and adjacent Areas was the Government Department Evacuation (G.D.E.) Scheme which centred on Stratford and Worcester. This provided for the possible movement of the seat of Government to the provinces. In some cases hutment sites were built to accommodate the staff concerned; in other cases existing institu-

tions, hotels and large residences were acquired. The exchanges installed for their use became known under code names, such as "Longfellow" for the Air Ministry at Worcester and "Chaucer" for the War Office at Droitwich, but poetic justice demanded the designation "Hogsnorton" for the B.B.C. Headquarters at Woodnorton near Evesham. Over 50 P.B.X. installations (including one of 20 positions CB10) were fitted by the Birmingham Area and 21 were installed in the Coventry Area; a cabling network was designed and provided to make the area secure for its lines of communication (the Backward Area Development). Fortunately, the G.D.E. scheme had not to be put into full operation, but the majority of the installations were taken over and used by the Service departments. At Malvern one hutment site became H.M.S. "Duke" (unsinkable) and the boys' College was re-equipped for the now well-known Telecommunication Research Establishment (T.R.E.) of the Air Ministry—the back-room boys of Radar.

A brief reference to air raid damage seems inevitable. Fortunately, none of the exchanges were actually destroyed, but both Coventry and Birmingham Head Post Offices suffered and had their telegraph instrument rooms demolished, calling for the introduction of emergency arrangements. The Birmingham drawing office was gutted by fire with the loss of practically all the records. Birmingham had 76 bombing raids, but the worst from the point of view of damage was in November, 1940, when totals of 6,800 subs' lines, 3,200 junctions and 1,200 trunk lines were affected. To guard against loss of service should both Telephone House and Midland exchange in Birmingham be put out of action, a ring-main cable was laid round the city at approximately three miles radius. Manual switchboards were installed in protected accommodation at six exchanges on the ring and main cable routes were intercepted at these points. Similar schemes were installed on a smaller scale at Coventry, Leicester and Nottingham.

The Midland Region made a considerable contribution to the fighting services. Of a pre-war complement of 3,590 workmen, no less than 1,613—approaching 50 per cent.—have been mobilised. Difficulties, notably on the maintenance side, were great, but the policy of winning the war at all costs was followed. The number of inspectors mobilised was 40 out of a total of 278, and 15 higher ranks (up to and including C.R.E.) from the Region entered the Forces. To overcome the loss of workmen every possible use was made of female assistants, and at October, 1943, the number employed was 788. It is safe to say that without these the contribution would have been much smaller. In the times before D-Day approximately 100 men were loaned to the southern half of the country for a period of about a year to play their part in the preparation for the invasion.

W. H. B.

¹ P.O.E.E.J., Vol. 35, p. 41.

South-Western Region

Originally a "safe area," work was initially chiefly on schemes for reception from evacuation areas. Dramatically becoming a very vulnerable defence area, with the fall of France, feverish provision for "defence" began. This continued through the difficulties of the bombing of Britain and then, with extensive provision for the Americans, the work gradually changed to an offensive character; the Region finally emerging a front line offensive area heavily committed in the invasion of Europe.

Evacuation Schemes.

Notable schemes were Bath (Admiralty), Cheltenham (War Office) and Gloucester (Air Ministry). Initially, local plant was augmented and P.B.X.'s installed in colleges and hotels, etc. Later semi-permanent hutments were built to relieve acute accommodation problems, involving further provision. Installations ranged from small P.B.X.'s to a 22-position B.E.C.B. No. 10.

Channel Islands

With the fall of Northern France and the consequential loss of continental communications, augmentation of the circuits via the Channel Islands for the Allied Command became imperative. Strenuous and most praiseworthy endeavour was made, but almost as soon as cables were laid and linked up with the French network the territory was overrun by the enemy. A separate article describes incidents relating to the occupation of the Islands.¹

Underground Stations.

Safe accommodation 80 ft. underground was provided for some very extensive installations of exceptional importance, e.g.:

No. 10 Group R.A.F. H.Q.'s (Filter Room, Main "Ops" Room, Met. & D.T.N. boards, 10-position P.M.B.X.).

Switching centre (S.W. Central) (25-position No. 9 Teleprinter board, Broadcast suite, V.F. systems: 12-position P.M.B.X.).

A Bristol Aeroplane Co.'s factory (P.A.B.X.).

Group centre exchange (Hawthorn—16-position).

Repeater station (24 carrier groups).

Main cables were laid linking up with the Bristol-London and Bristol-Salisbury tracks and these, with local cables, gave ample outlets in all directions.

Much of the work below ground required special construction and much ingenuity.

Plymouth A.C.H.Q. and C.H.Q.

Area Combined Headquarters for R.N. and R.A.F. (Coastal Command) was originally installed at Devonport. In 1940, for security, it was moved inland—a fortunate move, as the administrative switchboard which remained was later destroyed. In 1942 Headquarters was moved back into protected accommodation at Devonport, but some Units had again to be moved inland due to rapid expansion in 1943. The final installation was a 9-position teleprinter switchboard, 15-position sleeve

control P.M.B.X., 2-position "Ops" switchboard and numerous keyboards, etc.

Combined Headquarters of Allied Forces for invasion of Europe was installed in underground accommodation (commenced in 1942). A 16-position P.M.B.X. 1A and 4-position "Ops" were installed and ready by March, 1944.

Augmenting of line plant and equipment for the 494 teleprinter and 570 speech P.W.'s existing by "D" day was a critical problem.

Air Raid Damage.

Bristol, Plymouth, Southampton, Bath and Exeter suffered severely and there was widespread damage in coastal areas. A difficult case of restoration followed the loss of Southampton Central auto. exchange and manual board due to destruction of the emergency exchange, accompanied by widespread cable damage. Other major damage included Exeter H.P.O., Plymouth H.P.O. and T.M.O., Portland D.T.N., Devonport exchange and two Section Stocks destroyed and Bristol H.P.O. extensively damaged, the telegraph instrument room being totally destroyed and subsequently restored in the basement.

R.N.A.S.

The system of Fighter Direction used for aircraft carriers was developed at a R.N.A.S. in the Region. The site was laid out in "shore ships," each being a "mock up" or replica of ship's quarters. The communications for Plot Compilation and Operational Groups designed to meet Admiralty requirements were built up with component parts mounted and wired on site.

Battle Training Ground—Practice for D-Day Landings.

An extensive area of South Devon fringing the Plymouth and Exeter Areas was evacuated in late 1943 for a United States "Assault Training Area." East Allington and Torcross exchanges were recovered with subscribers' installations in the five exchange areas involved.

"Operation Overlord."

A major portion of the springboard for the invasion, comprising the South-West (American) Zone and most of the Central (Combined British and American) Zone, was in this Region. The efficient handling of the operation depended largely on the communications networks.

The Region also co-operated in provision of the cross-channel communications, the South Coast Radio Scheme being the first stage and carrier over concentric cables, laid with great speed and heroism by the cable ships, the second. Equipment and shore-ends at Southbourne repeater station and Swanage were provided in advance.

External Plant Provision.

Space does not permit of the full story of rush provision of external plant, but the fact that trunk and junction plant in the Region was increased by 125 per cent. and subscribers' plant by 45 per cent. gives some idea of the work involved.

¹ P.O.E.E.J. Vol. 38, page 102.

Notes and Comments

Roll of Honour

The Board of Editors deeply regrets to have to record the deaths of the following members of the Engineering Department :—

While serving with the Armed Forces or on Post Office Duty.

Aberdeen Telephone Area ..	Erskine, E. C. ..	Skilled Workman, Class II ..	Signalman, Royal Signals
*Birmingham Telephone Area	Dawson, P. J. ..	Unestablished Skilled Workman	Flying Officer, R.A.F.
Birmingham Telephone Area	Oldbury, G. T. ..	Unestablished Skilled Workman	Flight Sergeant, R.A.F.
Birmingham Telephone Area	Perry, J. W. ..	Skilled Workman, Class II ..	Lieutenant, Reconnaissance Corps. Sergeant, R.A.F.
Canterbury Telephone Area	Stevens, W. H. R.	Skilled Workman, Class II ..	Flight Sergeant, R.A.F.
Chester Telephone Area ..	Davies, J. E. ..	Unestablished Skilled Workman	Signalman, Royal Signals
Dundee Telephone Area ..	Smith, A. ..	Skilled Workman, Class II ..	Lance Corporal, Royal Signals
Edinburgh Telephone Area..	Coventry, D. K.	Clerical Officer ..	Signalman, Royal Signals
Edinburgh Telephone Area..	Macfie, A. B. ..	Skilled Workman, Class II ..	Able Seaman, Royal Navy
Engineering Department ..	Francis, T. H. E. *	Unestablished Skilled Workman	Sergeant Major, R.E.M.E.
Engineering Department ..	Newell, C.E. ..	Motor Mechanic ..	Sergeant Navigator, R.A.F.
Engineering Department ..	Phelan, P. ..	Unestablished Skilled Workman	On Post Office Duty
Engineering Department ..	Voss, L. C. ..	Assistant Engineer ..	On Post Office Duty
H.M.T.S. Alert ..	Baldwin, F. S. B.	Seaman Cable Hand ..	On Post Office Duty
H.M.T.S. Alert ..	Bates, H. ..	Chief Steward ..	On Post Office Duty
H.M.T.S. Alert ..	Blamey, R. F. ..	Asst. Steward ..	On Post Office Duty
H.M.T.S. Alert ..	Brookshaw, J. C.	Seaman Cable Hand ..	On Post Office Duty
H.M.T.S. Alert ..	Booker, R. E. ..	Stoker ..	On Post Office Duty
H.M.T.S. Alert ..	Button, R. S. ..	Seaman Cable Hand ..	On Post Office Duty
H.M.T.S. Alert ..	Cant, P. W. ..	Asst. Steward ..	On Post Office Duty
H.M.T.S. Alert ..	Cassingham, J. ..	Third Engineer ..	On Post Office Duty
H.M.T.S. Alert ..	Cornwell, W. F.	Seaman Cable Hand ..	On Post Office Duty
H.M.T.S. Alert ..	Cronin, H. T. ..	Purser ..	On Post Office Duty
H.M.T.S. Alert ..	Dellow, E. G. N.	Second Officer ..	On Post Office Duty
H.M.T.S. Alert ..	Dernellweek, E. J.	Stoker ..	On Post Office Duty
H.M.T.S. Alert ..	Dixon, J. ..	Second Officer ..	On Post Office Duty
H.M.T.S. Alert ..	Dowle, C. J. ..	Storekeeper ..	On Post Office Duty
H.M.T.S. Alert ..	Drury, F. A. ..	Quartermaster ..	On Post Office Duty
H.M.T.S. Alert ..	Ellis, P. W. ..	Seaman Cable Hand ..	On Post Office Duty
H.M.T.S. Alert ..	Everall, F. J. ..	Seaman Cable Hand ..	On Post Office Duty
H.M.T.S. Alert ..	Fisher, H. C. ..	Chief Engineer ..	On Post Office Duty
H.M.T.S. Alert ..	Gilchrist, F. A. ..	Seaman Cable Hand ..	On Post Office Duty
H.M.T.S. Alert ..	Godden, A. V. ..	Seaman Cable Hand ..	On Post Office Duty
H.M.T.S. Alert ..	Gregory, A. ..	Quartermaster ..	On Post Office Duty
H.M.T.S. Alert ..	Hempsall, F. A. ..	Carpenter ..	On Post Office Duty
H.M.T.S. Alert ..	Hope, F. ..	Cable Engine Driver ..	On Post Office Duty
H.M.T.S. Alert ..	Hunter, W. T. C.	Seaman Cable Hand ..	On Post Office Duty
H.M.T.S. Alert ..	Hurford, H. F. ..	Seaman Cable Hand ..	On Post Office Duty
H.M.T.S. Alert ..	Insole, A. ..	Seaman Cable Joiner ..	On Post Office Duty
H.M.T.S. Alert ..	Jones, G. H. ..	Seaman Cable Hand ..	On Post Office Duty
H.M.T.S. Alert ..	King, W. T. ..	Leading Stoker ..	On Post Office Duty
H.M.T.S. Alert ..	Kitt, E. K. J. ..	Asst. Steward ..	On Post Office Duty
H.M.T.S. Alert ..	Mackey, V. W. ..	Leading Stoker ..	On Post Office Duty
H.M.T.S. Alert ..	MacLeod, N. A. ..	Wireless Operator ..	On Post Office Duty
H.M.T.S. Alert ..	Maple, W. J. ..	Donkeyman ..	On Post Office Duty
H.M.T.S. Alert ..	Martin, L. S. ..	Asst. Steward ..	On Post Office Duty
H.M.T.S. Alert ..	Millar, J. G. ..	Ship's Doctor ..	On Post Office Duty
H.M.T.S. Alert ..	Millard, G. H. ..	Seaman Cable Hand ..	On Post Office Duty
H.M.T.S. Alert ..	Oates, J. G. B. ..	Commander ..	On Post Office Duty
H.M.T.S. Alert ..	O'Beirne, H. W.	Asst. Cable Foreman ..	On Post Office Duty

* Rank incorrectly shown as Sergeant in October, 1945, issue.

H.M.T.S. Alert	Payne, F. W.	..	Second Cook and Baker	On Post Office Duty
H.M.T.S. Alert	Peters, G. R.	..	Seaman Cable Hand	On Post Office Duty
H.M.T.S. Alert	Phillips, D. C.	..	Quartermaster	On Post Office Duty
H.M.T.S. Alert	Prince, E.	..	Third Engineer	On Post Office Duty
H.M.T.S. Alert	Robinson, R. A.	..	Fourth Engineer	On Post Office Duty
H.M.T.S. Alert	Sharp, F. S. G.	..	Seaman Cable Hand	On Post Office Duty
H.M.T.S. Alert	Shepherd, W. E. S.	..	Boatswain	On Post Office Duty
H.M.T.S. Alert	Skelton, W. G.	..	Quartermaster	On Post Office Duty
H.M.T.S. Alert	Smith, E. J.	..	Asst. Steward	On Post Office Duty
H.M.T.S. Alert	Smith, W.	..	Cable Foreman	On Post Office Duty
H.M.T.S. Alert	Stivey, J. C.	..	Third Officer	On Post Office Duty
H.M.T.S. Alert	Taws, J. C.	..	Fourth Officer	On Post Office Duty
H.M.T.S. Alert	Tickner, W. J.	..	Chief Cook	On Post Office Duty
H.M.T.S. Alert	Wade, A. G.	..	Stoker	On Post Office Duty
H.M.T.S. Alert	Wakefield, R. C. S.	..	Second Steward	On Post Office Duty
H.M.T.S. Alert	Williams, E. H.	..	Asst. Steward	On Post Office Duty
Leeds Telephone Area	Leadbeater, J.	..	Unestablished Skilled Workman	Flying Officer, R.A.F.
Leeds Telephone Area	Norris, F. J.	..	Unestablished Skilled Workman	Signalman, Royal Signals
Liverpool Telephone Area	Devereau, G. S.	..	Skilled Workman, Class II	Flight Lieutenant, R.A.F.
Liverpool Telephone Area	Ready, D. W.	..	Unestablished Skilled Workman	Flying Officer, R.A.F.
London Telecommunications Region	Bradley, A. A.	..	Skilled Workman, Class II	Flying Officer, R.A.F.
London Telecommunications Region	Brown, G. H.	..	Unestablished Skilled Workman	Flight Sergeant, R.A.F.
London Telecommunications Region	Cook, D. F.	..	Unestablished Skilled Workman	Flight Sergeant, R.A.F.V.R.
London Telecommunications Region	Geiger, A. G. B.	..	Unestablished Skilled Workman	Signalman, Royal Signals
London Telecommunications Region	Hope, C. E.	..	Skilled Workman, Class I	Lance Corporal, R.E.M.E.
London Telecommunications Region	Lane, D. H.	..	Skilled Workman, Class II	Sergeant, Royal Signals
London Telecommunications Region	Ludbrook, W. F. J.	..	Skilled Workman, Class II	Lance Corporal, Royal Signals
London Telecommunications Region	Marshall, A. J.	..	Skilled Workman, Class II	Flying Officer, R.A.F.
London Telecommunications Region	Packham, R. E. S.	..	Unestablished Skilled Workman	Sergeant, R.A.F.
Middlesbrough Telephone Area	Anthony, B. E. A.	..	Skilled Workman, Class II	Corporal, Royal Signals
Middlesbrough Telephone Area	Nixon, G.	..	Skilled Workman, Class II	Sergeant, R.A.F.
Newcastle-on-Tyne Telephone Area	Richardson, S.	..	Unestablished Skilled Workman	Flight Sergeant, R.A.F.
Newcastle-on-Tyne Telephone Area	Storey, A.	..	Youth-in-Training	Flight Sergeant, R.A.F.
Nottingham Telephone Area	Pegg, A. P.	..	Unestablished Skilled Workman	Signalman, Royal Signals
Peterborough Telephone Area	Stubley, E. J.	..	Skilled Workman, Class II	Flying Officer, R.A.F.
Portsmouth Telephone Area	Burroughs, K. D.	..	Youth-in-Training	Sergeant, R.A.F.
Portsmouth Telephone Area	Venables, A. E.	..	Unestablished Skilled Workman	Flying Officer, R.A.F.
Reading Telephone Area	Bull, E. O.	..	Skilled Workman, Class II	Flight Sergeant, R.A.F.

Recent Awards

The Board of Editors has learnt with great pleasure of the honours recently conferred on the following members of the Engineering Department :—

While serving with the Armed Forces.

Bedford Telephone Area	..	Armour, F. J.	..	Skilled Workman, Class II	Staff Sergeant, R.E.	British Empire Medal and Mentioned in Despatches
Brighton Telephone Area	..	Talbot, T. H.	..	Unestablished Skilled Workman	Lieutenant, Royal Navy V.R.	Mentioned in Despatches

Bristol Telephone Area ..	Ricketts, H. ..	Skilled Workman, Class II	Sergeant, Royal Signals	British Empire Medal
Cambridge Telephone Area ..	Cooper, H. B.; D.F.C.	Skilled Workman, Class II	Flight Lieutenant, R.A.F.	Distinguished Service Order
Chester Telephone Area ..	Jones, W. R. M.	Skilled Workman, Class II	Sergeant, Royal Signals	Mentioned in Despatches
Dundee Telephone Area ..	Blyth, W. ..	Skilled Workman, Class I	Sergeant, Royal Signals	Military Medal
Edinburgh Telephone Area ..	Ferguson, D. D. S.	Skilled Workman, Class II	Flying Officer, R.A.F.	Distinguished Flying Cross
Engineering Department ..	Edwards, H. W. F.	Inspector ..	Squadron Leader, R.A.F.	Air Force Cross
Engineering Department ..	Fliitt, C. C. ..	Motor Mechanic..	Flight Sergeant, R.A.F.	British Empire Medal
Engineering Department ..	Kriegel, A. A. ..	Inspector ..	Major, Royal Signals	Mentioned in Despatches
Engineering Department ..	Lee, F. ..	Motor Mechanic..	Conductor, R.E.M.E.	British Empire Medal
Engineering Department ..	Reynolds, E. G.	Executive Officer	Company Sergeant Major, Royal Signals	Mentioned in Despatches
Guildford Telephone Area ..	Hack, J. G. W.	Skilled Workman, Class II	Corporal, Royal Signals	Military Medal
Lancaster Telephone Area ..	Richardson, A...	Skilled Workman, Class II	Corporal, Royal Signals	Military Medal
London Telecommunications Region	Miles, G. E. ..	Skilled Workman, Class II	Lance Sergeant, Royal Signals	British Empire Medal and Mentioned in Despatches
London Telecommunications Region	Stares, W. H. ..	Skilled Workman, Class I	Corporal, Royal Signals	British Empire Medal
Manchester Telephone Area	Carnson, L. B.	Inspector ..	Captain, Royal Signals	Member of the Order of the British Empire
Manchester Telephone Area	Jones, F. ..	Skilled Workman, Class II	Corporal, Royal Signals	Military Medal and Mentioned in Despatches
Manchester Telephone Area	Linfoot, R. ..	Skilled Workman, Class II	Lance Corporal, Royal Signals	Mentioned in Despatches
Middlesbrough Telephone Area	Firth, E. ..	Unestablished Skilled Workman	Lance Corporal, Royal Signals	Military Medal
Northern Ireland Region ..	Edwards, G. R.	Skilled Workman, Class I	Major, Royal Signals	Mentioned in Despatches
Scotland West Telephone Area	Dempster, H. ..	Skilled Workman, Class II	Flying Officer, R.A.F.	Distinguished Flying Cross
Southampton Telephone Area	Fielder, R. R. ..	Skilled Workman, Class II	Flying Officer, R.A.F.	Distinguished Flying Cross
Southend-on-Sea Telephone Area	Wooster, C. B...	Inspector ..	Lieut.-Colonel, Royal Signals	Member of the Order of the British Empire and twice Mentioned in Despatches

Supplement

The demands of the Victory Number and the amount of paper available have necessitated the suspension of the Supplement for this issue. The Supplement will be supplied as usual with the April, 1946, and subsequent Journals.

Appointment

The Board of Editors offers its congratulations to Col. A. G. McDonald on his promotion from Assistant Staff Engineer to Chief Motor Transport Officer.

Staff Changes

Promotions

Name	Region	Date	Name	Region	Date
<i>Asst. Staff Engr. to Staff Engr.</i>			<i>S.W.1 to Inspr.—continued.</i>		
Gemmell, W. T. ..	E.-in-C.O. ..	1.11.45	Hughes, H. S. ..	E.-in-C.O. ..	1.12.45
<i>Asst. Staff Engr. to C.M.T.O.</i>			Clark, R. M. ..	Scot. Reg. to E.-in-C.O.	1.12.45
McDonald, Col. A. G. ..	E.-in-C.O. ..	1.12.45	Cox, D. S. ..	E.-in-C.O. ..	1.12.45
<i>Exec. Engr. to Asst. Staff Engr.</i>			Barnard, A. J. ..	H.C. Reg. to E.-in-C.O.	1.12.45
Salter, L. F. ..	E.-in-C.O. ..	16.10.45	Machen, G. F. ..	E.-in-C.O. ..	1.12.45
<i>Area Engr. to Reg. Engr.</i>			Williams, J. B. F. ..	H.C. Reg. to E.-in-C.O.	1.12.45
Berkeley, G. S. ..	L.T. Reg. ..	1.10.45	Jones, R. A. ..	E.-in-C.O. ..	1.12.45
<i>Phys. or Chem. to Sen. Phys. or Chem.</i>			Banfield, D. F. ..	E.-in-C.O. ..	1.12.45
Hourigan, H. F. ..	Test Section, B'ham..	3. 9.45	Morgan, T. L. ..	N.E. Reg. to E.-in-C.O.	1.12.45
Downes, A. D. W. ..	Test Section, London	3. 9.45	Rance, J. W. ..	E.-in-C.O. ..	1.12.45
<i>Chief Off. to Commander</i>			Fudge, E. W. ..	L.T. Reg. to E.-in-C.O.	1.12.45
Evans, C. M. G., M.B.E. ...	H.M.T.S. "Neptune" to H.M.T.S. "Ariel"	30.11.45	Smith, G. S. ..	L.T. Reg. to E.-in-C.O.	1.12.45
<i>Chief Insp. to Asst. Engr.</i>			Vernon, D. H. ..	E.-in-C.O. ..	1.12.45
Clifford, F. G. ..	E.-in-C.O. ..	12.11.45	Taylor, M. R. ..	E.-in-C.O. ..	1.12.45
Pratton, L. W. ..	E.-in-C.O. ..	12.11.45	Green, J. ..	N.I. Reg. to E.-in-C.O.	1.12.45
Baker, H. ..	E.-in-C.O. ..	12.11.45	Lord, G. W. ..	E.-in-C.O. ..	1.12.45
<i>Inspr. to Asst. Engr.</i>			<i>S.W.2 to Inspr.</i>		
Urban, T. F. B. A. ..	E.-in-C.O. ..	12.11.45	**Horrocks, P. ..	N.W. Reg. ..	1.12.45
Pickard, R. J. ..	E.-in-C.O. ..	12.11.45	McLeod, A. M. ..	Scot. Reg. to E.-in-C.O.	1.12.45
Glazier, A. W. ..	E.-in-C.O. ..	12.11.45	McDaid, N. F. ..	Scot. Reg. to E.-in-C.O.	1.12.45
Reynolds, J. ..	E.-in-C.O. ..	12.11.45	**Lumber, A. L. ...	L.T. Reg. ..	1.12.45
Varrall, J. E. ..	E.-in-C.O. ..	12.11.45	Boggs, R. J. ..	H.C. Reg. to E.-in-C.O.	1.12.45
Turner, R. J. ..	E.-in-C.O. ..	12.11.45	Kyme, R. C. ..	H.C. Reg. to E.-in-C.O.	1.12.45
Thomas, J. F. P. ..	E.-in-C.O. ..	12.11.45	Butterworth, J. ..	N.W. Reg. to E.-in-C.O.	1.12.45
Richards, C. W. C. ..	W. & B.C. Reg. to E.-in-C.O. ..	12.11.45	<i>U.S.W. to Inspr.</i>		
Mason, H. J. S. ..	E.-in-C.O. ..	12.11.45	Reynolds, F. H. ..	E.-in-C.O. ..	1.12.45
Thomson, W. E. ..	E.-in-C.O. ..	12.11.45	Marsh, S. B. ..	E.-in-C.O. ..	1.12.45
French, J. A. T. ..	E.-in-C.O. ..	12.11.45	Gill, J. S. ..	E.-in-C.O. ..	1.12.45
Neill, T. B. M. ..	E.-in-C.O. ..	12.11.45	Holmes, D. ..	N.E. Reg. to E.-in-C.O.	1.12.45
Kimber, G. H. ..	E.-in-C.O. ..	12.11.45	Erskine, G. A. ..	E.-in-C.O. ..	1.12.45
Southerton, T. H. ..	E.-in-C.O. ..	12.11.45	**Stanford, C. J. ..	H.C. Reg. ..	1.12.45
Goldsmith, F. H. ..	Scottish Reg. to E.-in-C.O. ..	12.11.45	Lloyd, H. F. ..	E.-in-C.O. ..	1.12.45
Marchant, H. J. ..	E.-in-C.O. ..	12.11.45	Haward, J. W. G. ..	E.-in-C.O. ..	1.12.45
Smith, W. J. ..	H.C. Reg. to E.-in-C.O.	12.11.45	Rutterford, L. F. ..	E.-in-C.O. ..	1.12.45
<i>S.W.1 to Inspr.</i>			Gerard, P. S. ..	E.-in-C.O. ..	1.12.45
Orchard, H. J. ..	E.-in-C.O. ..	1.12.45	Kauffmann, B. ..	E.-in-C.O. ..	1.12.45
Colston, I. S. ..	N.I. Reg. to E.-in-C.O.	1.12.45	Benson, D. L. ..	E.-in-C.O. ..	1.12.45
Gregory, M. S. E. ..	E.-in-C.O. ..	1.12.45	Huckle, M. N. ..	L.T. Reg. to E.-in-C.O.	1.12.45
Haley, G. ..	E.-in-C.O. ..	1.12.45	Seymour, P. W. ..	E.-in-C.O. ..	1.12.45
Brown, S. F. ..	E.-in-C.O. ..	1.12.45	Bastow, F. J. ..	E.-in-C.O. ..	1.12.45
Horton, G. P. ..	E.-in-C.O. ..	1.12.45	Cobbe, D. W. R. ..	H.C. Reg. to E.-in-C.O.	1.12.45
Clinch, C. E. E. ..	L.T. Reg. to E.-in-C.O.	1.12.45	Browne, S. ..	E.-in-C.O. ..	1.12.45
<i>S.W.1 to Inspr.</i>			<i>D'sman Cl. I to Sen. D'sman.</i>		
Orchard, H. J. ..	E.-in-C.O. ..	1.12.45	Mulvey, G. P. ..	E.-in-C.O. ..	1. 9.45
Colston, I. S. ..	N.I. Reg. to E.-in-C.O.	1.12.45	<i>D'sman Cl. II to Inspr.</i>		
Gregory, M. S. E. ..	E.-in-C.O. ..	1.12.45	Humphrey, M. C. ..	L.T. Reg. to E.-in-C.O.	1.12.45
Haley, G. ..	E.-in-C.O. ..	1.12.45	<i>D'sman Cl. II to D'sman Cl. I</i>		
Brown, S. F. ..	E.-in-C.O. ..	1.12.45	Flynn, L. A. ..	H.C. Reg. to N.E. Reg.	14.11.45
Horton, G. P. ..	E.-in-C.O. ..	1.12.45	Sheldrake, J. M. ..	L.T. Reg. ..	18.10.45
Clinch, C. E. E. ..	L.T. Reg. to E.-in-C.O.	1.12.45	<i>D'sman Cl. I to Sen. D'sman.</i>		

*† On loan to other Government Departments

Retirements

Name	Region	Date	Name	Region	Date
<i>Staff Engr.</i>			<i>Exec. Engr.</i>		
Fulcher, H. W. ..	E.-in-C.O. ..	30.11.45	Thatcher, C. H. ..	L.P. Reg. ..	17.10.45
<i>Chief M.T.O.</i>			Williams, L. E. ..	Scot. Reg. ..	31.10.45
Burns, W. C. ..	E.-in-C.O. ..	30.11.45	White, H. ..	L.T. Reg. ..	31.10.45
<i>Dep. C.R.E.</i>			<i>Asst. Engr.</i>		
Edgerton, T. H. ..	L.T. Reg. ..	30.9.45	Wood, J. A. ..	E.-in-C.O. ..	30.9.45
<i>Reg. Engr.</i>			Ings, S. H. ..	E.-in-C.O. ..	30.9.45
Pate, C. H. V. ..	L.T. Reg. ..	30.9.45	<i>Chief. Insp. with Allce.</i>		
Barlow, T. F. ..	N.E. Reg. ..	15.11.45	Anderson, J. B. ..	N.E. Reg. ..	30.9.45

Retirements—continued.

Name	Region	Date	Name	Region	Date
<i>Chief Insp.</i>			<i>Insp.—continued.</i>		
Skeoch, W. ..	Scot. Reg. ..	30.8.45	Stephens, H. N. ..	S.W. Reg. ..	15.10.45
Watkins, L. E. ..	L.T. Reg. ..	18.9.45	Clarke, C. ..	L.T. Reg. ..	27.10.45
Eynott, F. C. ..	H.C. Reg. ..	30.9.45	Ashdown, C. ..	N.I. Reg. ..	31.10.45
Prattent, H. J. ..	Mid. Reg. ..	17.10.45	Allen, J. F. ..	L.T. Reg. ..	22.11.45
Searle, C. T. ..	L.T. Reg. ..	10.11.45	Stephens, H. R. ..	L.T. Reg. ..	7.12.45
<i>Insp.</i>			Mason, M. T. ..	E.-in-C.O. (resigned) ..	7.12.45
Stewart, J. ..	Scot. Reg. ..	28.8.45	Edwards, A. W. J. ..	E.-in-C.O. (resigned) ..	7.12.45
Pye, H. ..	L.T. Reg. ..	31.8.45	<i>M.T.O. Cl. III</i>		
Flack, J. L. ..	L.T. Reg. ..	31.8.45	Dunn, C. ..	E.-in-C.O. (resigned) ..	31.10.45
Coulson, A. J. ..	H.C. Reg. ..	31.8.45	<i>D'sman Cl. I</i>		
Suter, F. H. C. ..	W. & B.C. Reg. ..	22.9.45	Waddington, A. ..	E.-in-C.O. ..	30.11.45
Sutherland, J. S. ..	W. & B.C. Reg. ..	30.9.45			

Transfers

Name	Region	Date	Name	Region	Date
<i>Regl. Engr.</i>			<i>Asst. Engr.—continued.</i>		
Cooper, M. C. ..	N.I. Reg. to S.W. Reg. ..	1.11.45	Chubb, E. ..	Scot. Reg. to E.-in-C.O. ..	7.11.45
Somerville, H. B. ..	S.W. Reg. to N.I. Reg. ..	1.11.45	<i>Insp.</i>		
<i>Exec. Engr.</i>			Middleton, A. M. ..	L.T. Reg. to E.-in-C.O. ..	1.9.45
Lucas, F. N. ..	E.-in-C.O. to N.E. Reg. ..	1.12.45	Groves, F. W. ..	L.T. Reg. to H.C. Reg. ..	1.11.45
Barker, P. L. ..	E.-in-C.O. to W. & B.C. Reg. ..	12.11.45	Toft, G. ..	Mid. Reg. to E.-in-C.O. ..	19.11.45
<i>Area Engr.</i>			Eccles, J. ..	Mid. Reg. to E.-in-C.O. ..	16.11.45
Bevis, W. F. ..	N.E. Reg. to H.C. Reg. ..	9.12.45	Culkin, H. ..	E.-in-C.O. to N.E. Reg. ..	20.12.45
<i>Asst. Engr.</i>			Hardie, J. B. ..	E.-in-C.O. to Scot. Reg. ..	9.12.45
Powning, S. H. ..	To W. & B.C. Reg. in absentia ..	11.10.45	Fletcher, J. L. ..	E.-in-C.O. to N.E. Reg. ..	9.12.45
			<i>D'sman Cl. I</i>		
			Harmon, J. F. ..	E.-in-C.O. to Factories Dept. ..	18.10.45

Deaths

Name	Region	Date	Name	Region	Date
<i>Asst. Engr.</i>			<i>Third Officer</i>		
Voss, L. C. ..	Test Sectn., London (Death presumed whilst on Post Office Duty) ..	24.2.45	Stivey, J. C. ..	H.M.T.S. "Alert" (Death presumed whilst on Post Office Duty) ..	24.2.45
Davey, F. R. ..	E.-in-C.O. ..	27.8.45	<i>Fourth Officer</i>		
Horn, T. ..	E.-in-C.O. ..	2.10.45	Taws, J. C. ..	H.M.T.S. "Alert" (Killed whilst on Post Office Duty) ..	24.2.45
<i>Chief Insp.</i>			<i>Chief Engr.</i>		
Bull, S. W. ..	S.W. Reg. ..	2.9.45	Fisher, H. C. ..	H.M.T.S. "Alert" (Killed whilst on Post Office Duty) ..	24.2.45
Brough, D. ..	Scot. Reg. ..	22.9.45	<i>Third Engr.</i>		
Dilkes, G. H. ..	Mid. Reg. ..	18.10.45	Prince, E. ..	H.M.T.S. "Alert" (Death presumed whilst on Post Office Duty) ..	24.2.45
<i>Insp.</i>			Cassingham, J. ..	H.M.T.S. "Alert" (Death presumed whilst on Post Office Duty) ..	24.2.45
Barrett, G. F. ..	L.T. Reg. (Death on Active Service) ..	20.8.45	<i>Fourth Engr.</i>		
Clarke, W. H. ..	L.T. Reg. ..	23.8.45	Robinson, R. A. ..	H.M.T.S. "Alert" (Death presumed whilst on Post Office Duty) ..	24.2.45
Claydon, R. J. ..	L.T. Reg. ..	17.9.45	Thornborrow, W. ..	H.M.T.S. "Alert" (Killed whilst on Post Office Duty) ..	16.4.45
Horrocks, H. ..	N.W. Reg. ..	25.9.45	<i>D'sman Cl. I</i>		
Parker, W. ..	N.W. Reg. ..	28.9.45	Kiff, N. C. ..	L.T. Reg. ..	17.10.45
<i>Commander</i>					
Oates, J. G. B. ..	H.M.T.S. "Alert" (Death presumed whilst on Post Office duty) ..	24.2.45			
<i>Second Officer</i>					
Dellow, E. G. N. ..	H.M.T.S. "Alert" (Death presumed whilst on Post Office Duty) ..	24.2.45			
Dixon, J. ..	H.M.T.S. "Alert" (Killed whilst on Post Office Duty) ..	24.2.45			

Clerical Grades—Promotion

Name	Region	Date	Name	Region	Date
<i>Staff Officer to P.C.</i>					
Boyd, R. ..	E.-in-C.O. to Mid. Reg. ..	10.9.45			

NOTE.—The fact that goods made of raw material in short supply owing to war conditions are advertised in this Journal should not be taken as an indication that they are necessarily available for export.

50-range Model 7
Universal AvoMeter



'AVO'

Meters that Matter

THE world-wide use of "AVO" Instruments is striking testimony to their outstanding versatility, precision and reliability. In every sphere of electrical test work, they are appreciated for their dependable accuracy, which is often used as a standard by which other instruments are judged.

Sole Proprietors and Manufacturers

THE AUTOMATIC COIL WINDER & ELECTRICAL EQUIPMENT Co. Ltd
Winder House, Douglas Street, London, S.W.1

Phone : VICTORIA 3404-8

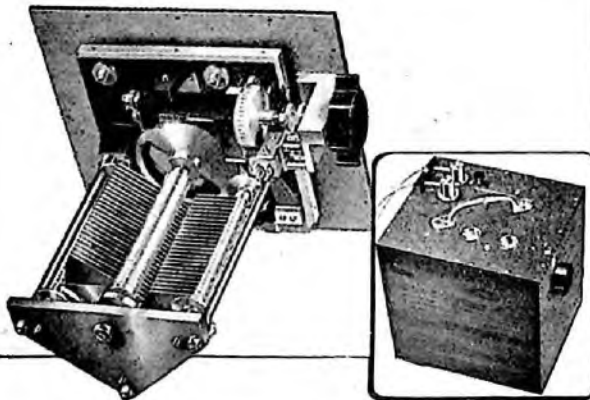

BRIEF SPECIFICATION

CAPACITANCE. 50 μ F min. 1,250 μ F max.
LOSS ANGLE. Approximately 1 micro-radian in a dry atmosphere; 7 micro-radians in 75% relative humidity, for the frequency range 50 c.p.s. to 10,000 c.p.s.
DRIVE. Worm reduction gear, 50 : 1 ratio.
SCALE READING. To 1 part in 5,000 direct reading; To 1 part in 20,000 by interpolation.
BACKLASH. Not exceeding 1 part in 20,000.
DIMENSIONS. 12 $\frac{1}{2}$ x 10 x 13 $\frac{1}{2}$.

Write for Bulletin B-537-A giving further particulars.

MUIRHEAD AND COMPANY LIMITED, ELMER, END,
BECKENHAM, KENT. TELEPHONE: BECKENHAM 0041-0042

FOR OVER 60 YEARS DESIGNERS AND MAKERS OF PRECISION INSTRUMENTS

A Standard of Zero Loss Angle

VARIABLE AIR CONDENSER TYPE D-14-A

This three-terminal double-screened condenser is provided with a guard circuit which ensures that the dielectric of the plate-to-plate capacitance is composed entirely of air. This, together with the special surface treatment of the plates reduces the plate-to-plate power loss to a quantity which can be disregarded even when measuring the smallest power factors.

MUIRHEAD



PRINTING TELEGRAPH APPARATUS

TELEPRINTERS
HIGH SPEED MORSE INSTRUMENTS
RELAYS
AND REPEATERS

CREED AND CO. LTD
CROYDON



How much can you
condense a condenser



Midget Condensers

Midgets in size but giants in performance are these U.I.C. Miniature Condensers. Especially suitable for use in the latest Service type miniature radio transmitters and receivers, they are efficient and dependable under all climatic conditions. Made to specification K.110. Type approved. Full details on request.

UNITED INSULATOR CO. LTD.
12-22 LAYSTALL ST., LONDON, E.C.1
Tel: TERminus 7383 (5 lines) Grams: Calanal, Smith, London

THE PIONEERS OF LOW-LOSS CERAMICS

LINK THE WORLD'S RESOURCES . . .

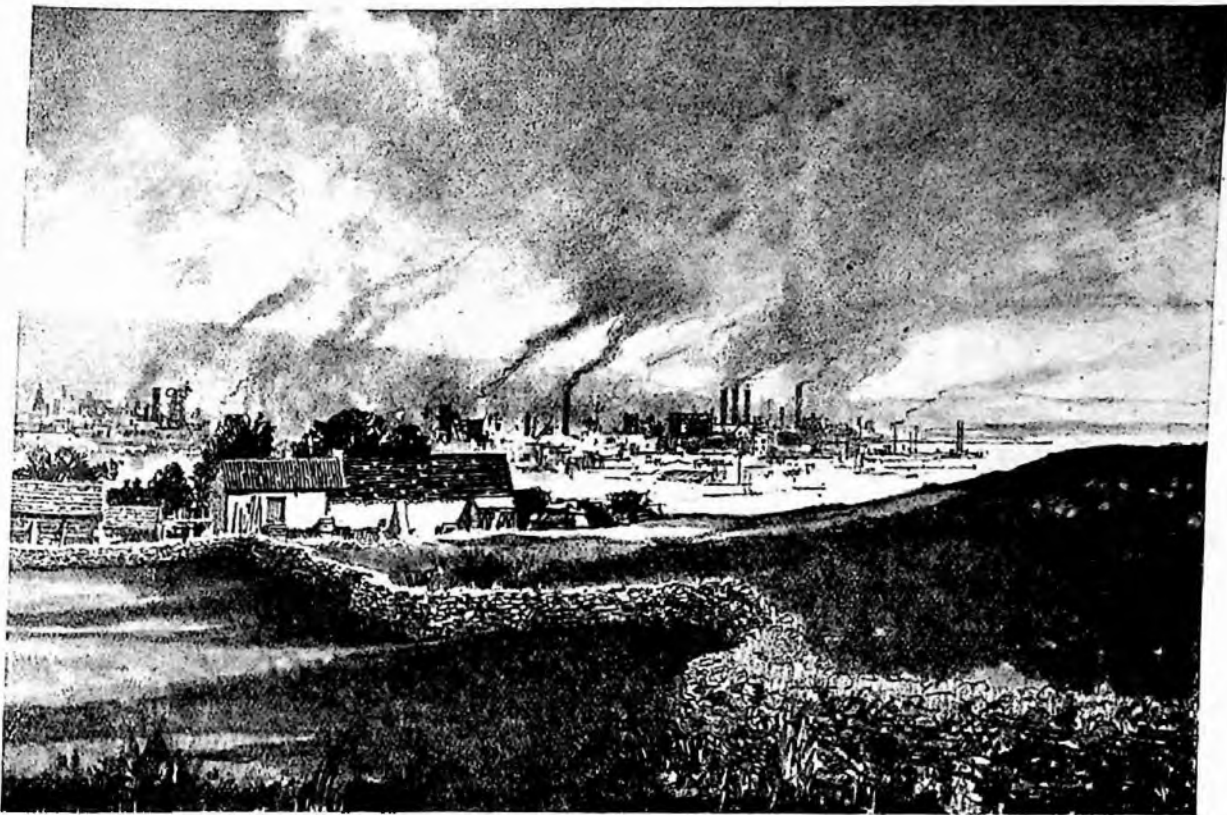

IN THE HIVES OF INDUSTRY

The Earth is a vast storehouse containing everything for the support of human life, whilst to man has been given the power to work with his hands and to apply the inventive genius of his brain. The construction of manual and machine tools and the manufacture with their aid, of small articles and bulk commodities is generally highly localised; its situation is controlled by the presence of a coalfield, a mineral deposit or the like. There arise the industrial districts . . . towns of furnaces and trip hammers, whirring machinery and smoking chimneys. To provide telephone service for their incessant internal activity several main automatic telephone exchanges of moderately large capacity are required. The swift, scientific precision of Strowger Automatic Telephone Equipment, its mechanical speed and efficiency and its inhuman ability to work unceasingly and untiringly are strikingly appropriate to the ever-increasing numbers of Hives of Industry for which it is providing service.

with
STROWGER
TELECOMMUNICATIONS

AUTOMATIC TELEPHONE & ELECTRIC CO. LTD
Export Dept.—NORFOLK HOUSE, NORFOLK ST., LONDON, W.C.2

STROWGER WORK • TEMple Bar 9262
LIVERPOOL 7 • ENGLAND

A7041-B2



THE STROWGER DIAL

- has the function of a subscriber's "key" which "opens the door" to all other subscribers.
- has the advantage of being international in its application; there is no language problem in its use.
- has its speed controlled by a centrifugal governor with a normal setting giving a speed of ten impulses per second.
- has an impulse period of 100 milli-seconds duration of which 66.6 milli-seconds are a "break" period and 33.4 milli-seconds are a "make" period.
- has a "free wheel" action which prevents return motion of the finger plate from the finger stop from affecting operation.
- has mechanism which masks the equivalent of two impulses to increase the time between dialling one number and the next; this ensures that the automatic exchange equipment has ample time to complete its switching functions.
- has complete protection from extremes of heat, humidity, dust-laden atmospheres, etc.
- has the spring assembly in the form of a self-contained unit; various combinations of slant springs can be supplied if necessary to suit different types of telephones and circuits.
- has a specially constructed worm-wheel with an oil impregnated fibre washer which renders it self-lubricating.
- has a ratchet mechanism with teeth punched and shaved to ensure absolute uniformity.
- has many points of design which enable adjustments to be made simply and quickly on subscribers' premises.



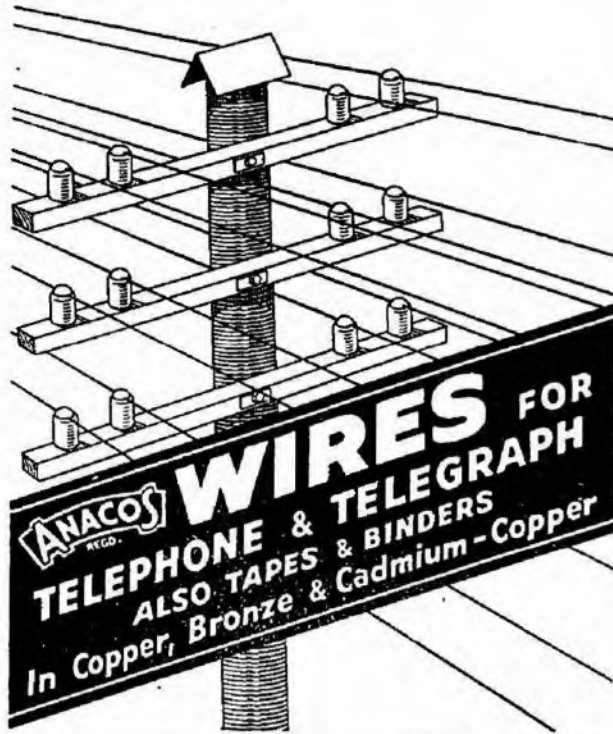

FREDERICK SMITH & CO. LTD. (Incorporated in The London Electric Wire Company and Smiths, Limited.)
ANACONDA WORKS, SALFORD, 3, LANCs.
 Telephone : BLACKFRIARS 8701 (9 lines) Telegrams : "ANACONDA" MANCHESTER

for HIGH • HIGHER and
 HIGHEST FREQUENCIES!

TENAPLAX Co-axial Cable



SOME TENAPLAX CABLES HAVE
60% AIR INSULATION
 Patented method of construction
 reduces losses to a minimum.

- • Plastic Cover
- • Electrical Screening
- • Alkathene Sleeve
- • Braided Alkathene Filaments
- • Conductor

We also make : RADIO SLEEVING • INSULATING TUBING
 SPECIAL TUBING FOR CONVEYING LIQUID FOOD, ETC.
 COVERED WIRES AND CABLES. Write to :

TENAPLAX LTD., 7 PARK LANE, LONDON, W.1

METAL RECTIFIERS

for use in Repeater Stations

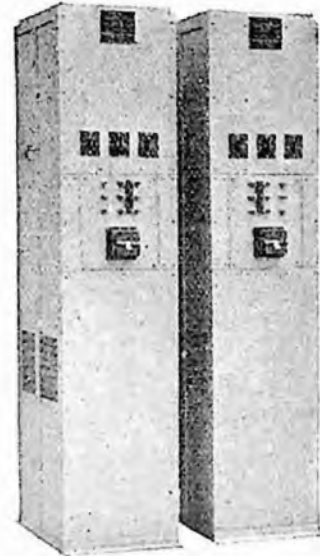

Rectifiers have been designed on the Moving-coil Voltage Regulator principle to "float" small H.T. and L.T. batteries in Repeater Stations, a large capacity "stand-by" battery being brought into service in the event of a mains failure.

Housed in the same cubicle as the "float" rectifier is a rectifier and transformer for recharging the stand-by battery, this circuit also acting as a stand-by to the "float" rectifier.

Also included is a trickle-charge rectifier to maintain the "stand-by" battery in good condition.

A typical equipment is illustrated, and consists of (a) rectifier and transformer for floating the L.T. battery, rectifier and transformer for recharging the "stand-by" L.T. battery and rectifier and transformer for trickle-charging the stand-by battery; and (b) identical equipment for use with the H. T. battery.



*the versatile rectifier
 of outstanding reliability*

WESTINGHOUSE BRAKE & SIGNAL CO., LTD.
 Pew Hill House, Chippenham, Wilts.

SIEMENS

TELECOMMUNICATION EQUIPMENT

AUTOMATIC TELEPHONE EXCHANGES
including the following types

Trunk	T.A.X.
Main	M.A.X.
Rural	R.A.X.
Unit	U.A.X.
Private	P.A.X.
Private Branch	P.A.B.X.

MANUAL EXCHANGES
of all types

CARRIER TRANSMISSION EQUIPMENT

TELEPHONE INSTRUMENTS
of all types

TELEPHONE SWITCHING EQUIPMENT

PROTECTIVE DEVICES

RELAYS

TELEPHONE CABLES, WIRES & CORDS

LOADING COILS

MARINE RADIO EQUIPMENT

SHIPS' TELEGRAPHS & TELEPHONES

CELLS & BATTERIES
Dry, Fluid and Inert



*Designed for service
in all parts of the world*

BY close attention to technical detail the Company has maintained its position in the forefront of Telecommunication Engineers throughout its long experience. Its products enjoy a world-wide reputation for sound design and technical excellence.

The Company undertakes the supply and installation of complete Automatic and Manual Telephone Exchanges for Public and Private service, Automatic and Manual Trunk Exchanges, all types of Telephone Cables for Trunk and Local Service, Carrier Transmission Equipment and Cables, Radio Equipments for Ships.

**SIEMENS BROTHERS
& CO., LIMITED
WOOLWICH
LONDON, S.E.18**

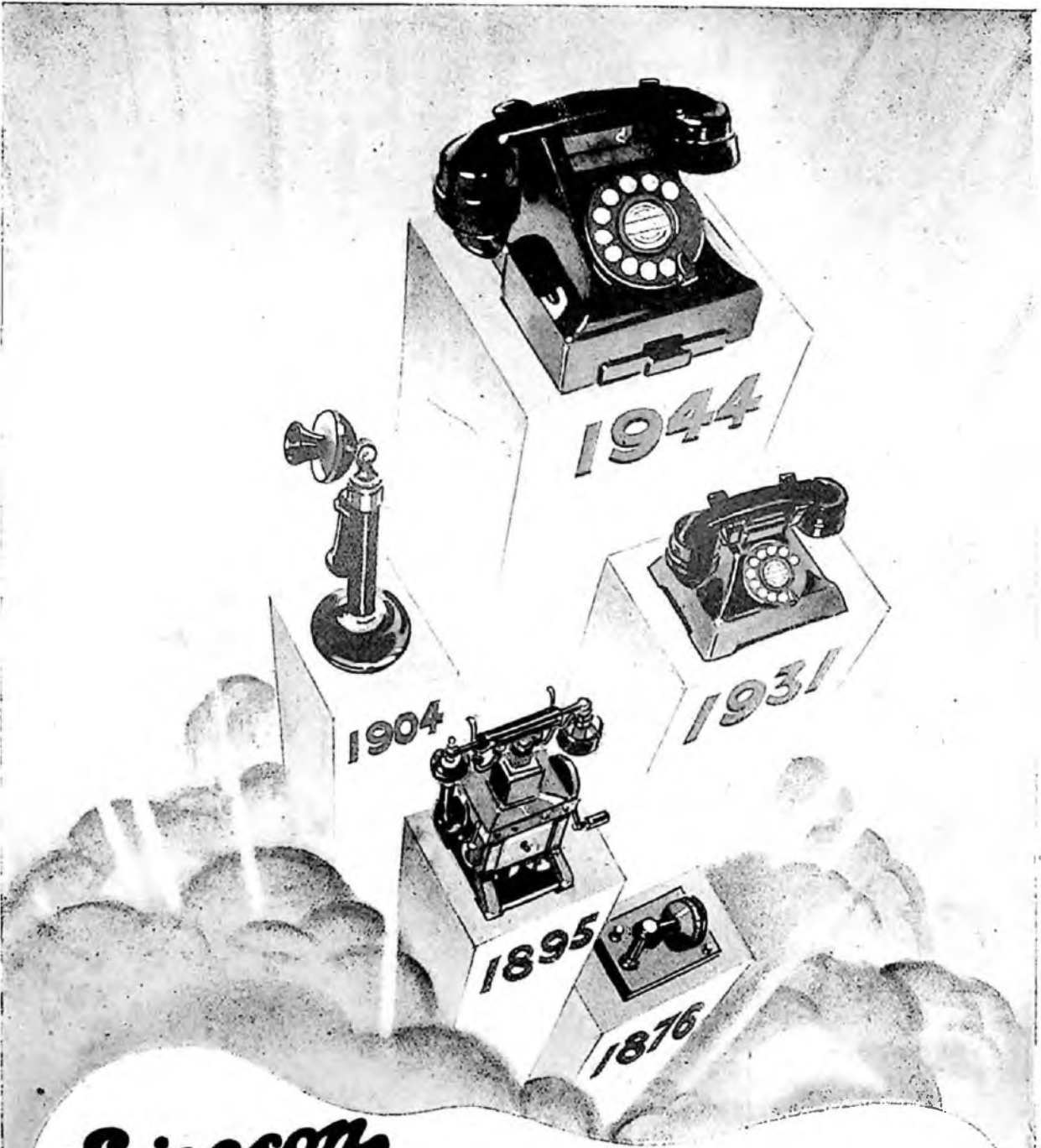

Ericsson

66 years of steady progress in telephony and its applications sees Ericssons in their extensive plant to-day utilising Modern Plastics for the improvement of telephone design and efficiency.

Ericssons have unrivalled experience in

the production of telephone equipment required to function under tropical and similar extreme conditions—taking full advantage of the application of Plastics in this connection.

Enquiries welcomed.

ERICSSON TELEPHONES LTD., Head Office: 58, Kingsway, London, W.C.2. Tel.: -HOL. 6936. Works Beeston, Notts.

CAPCO

REGISTERED TRADE MARK

QUARTZ AND GLASS CUTTING

MACHINES WITH AUTOMATIC, GRAVITY or HAND FEED

ALSO

JIGS — FIXTURES and ATTACHMENTS

available for dealing with "QUARTZ" of every known size or type
LATEST DESIGN

*incorporates higher cutting speeds. Totally enclosed transparent splash guards
giving greater protection for the operator from cutting Lubricants*

WRITE FOR DETAILS.

CAPLIN ENGINEERING CO. LTD.

25 years of service to the engineering
and allied trades.

Well over one thousand "CAPCO"
machines in use to-day, including hun-
dreds of special machines and apparatus.
"CAPCO" is synonymous with accuracy.

*Designers and manufacturers of Capco Sound-on-Film recorders and equipment. Capco built recorders are in use at
A.B.P.C., Elstree, Pathe News and British Pictorial Productions, etc. Patentees and manufacturers of Capco Enamelled
Wire Cleaning machines.*

BEACONSFIELD RD WILLESDEN, LONDON, N.W.10

Sole Agents : CAPCO (Sales) LTD.

Telephone : WILlesden 0067-8

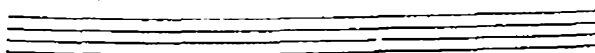

STANDARD WITH THE BRITISH POST OFFICE

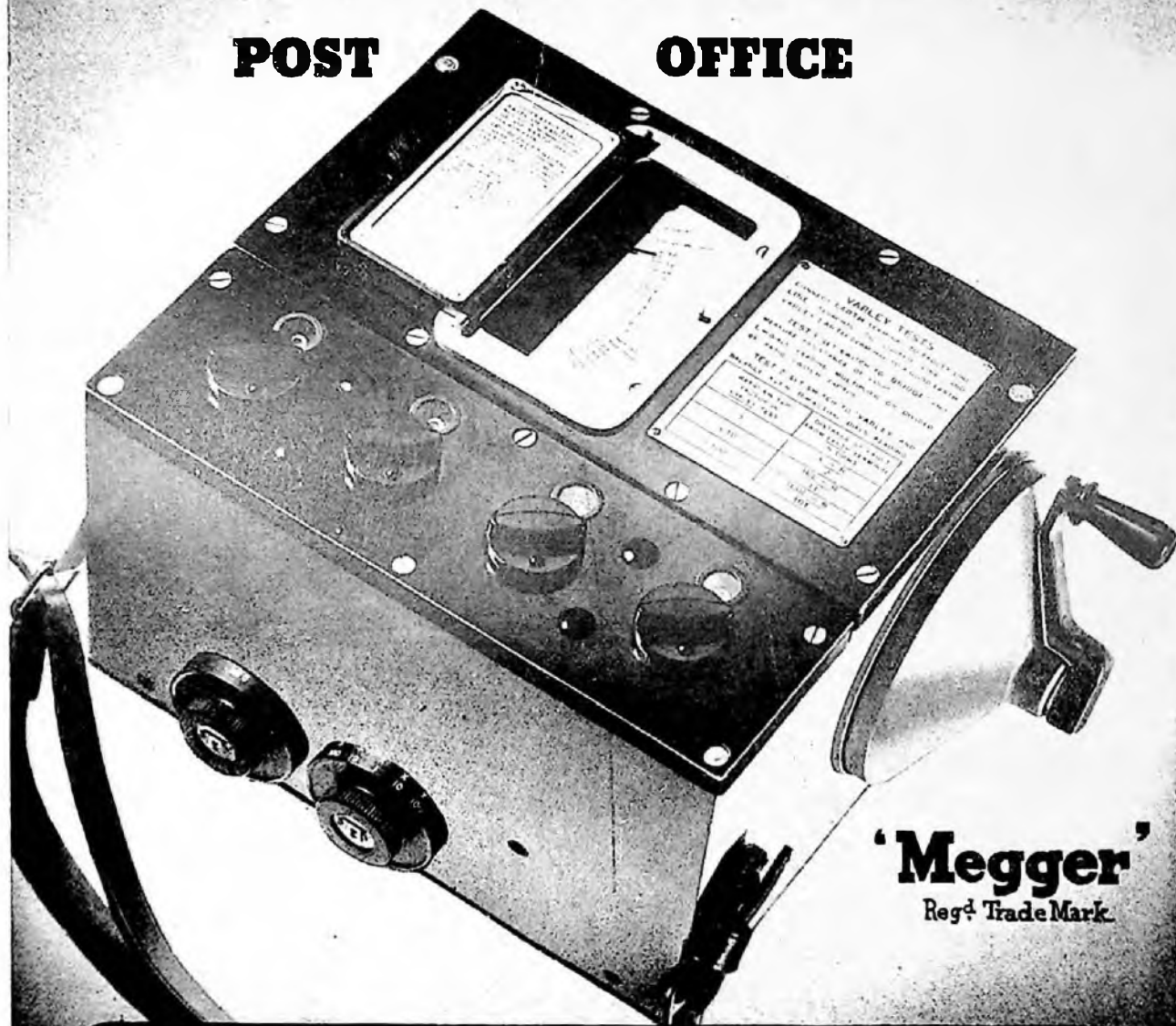

THE BRIDGE-MEG TESTING SET used by the British Post Office is a portable, self-contained instrument combining the functions of an Insulation Tester and a Wheatstone Bridge; it can be used for fault location by the Varley Loop method. Facilities can also be provided whereby, with the use of an external galvanometer and resistance box, the instrument may be used for making Murray Loop tests. Insulation range 100 megohms at 500 volts. Bridge range 0.01 to 999,900 ohms. Size 7x8 $\frac{3}{4}$ x12 ins. Weight 12 $\frac{3}{4}$ lbs. Mains operated instruments are also supplied to the British Post Office. Ask for list X 267.

EVERSHED & VIGNOLES LTD., CHISWICK, LONDON, W.4
 TELEPHONE: CHISWICK 1370 * TELEGRAMS: "MEGGER" CHISK, LONDON

MORE POWER TO LOCHABER!



Despising all other weapons, the clansman trusted to his claymore and superb swordsmanship

THE old-time history of Lochaber is that of highland clans, highland feuds and the 'forty-five'. But today the power of this wild and picturesque district no longer lies in the claymore; it comes instead from one of the greatest industrial developments of recent times which, promoted at a cost of millions of pounds, harnesses the waters of the countryside to generators that give an immense output of electrical power. A new page to highland history indeed! . . . and one in which it is recorded that an Alton battery has been installed in the hydro-electric station for emergency and other important duties.

ALTON

BATTERIES OF MERIT

THE ALTON BATTERY COMPANY LTD., ALTON, HANTS

Sole Suppliers of Fuller Stationary Batteries

Telephone : Alton 2267 and 2268 Telegrams : 'Battery, Alton'



MAINTAINING EFFICIENCY

THE HIGH STANDARD OF EFFICIENCY
OF PIRELLI - GENERAL TELEPHONE
CABLES IS MAINTAINED BY THE
CONTINUOUS RESEARCH WORK OF
AN EXPERIENCED TECHNICAL STAFF.

TELEPHONE,
SOUTHAMPTON
2141 (3 lines)

PIRELLI-GENERAL
CABLE WORKS, Ltd., SOUTHAMPTON.

TELEGRAMS
"PIREKAYBEL"
SOUTHAMPTON

lbs AND £s

... 4,416 Good Joints
TO THE LB. - THEREFORE
MORE TO THE £.

Of course, Ersin Multicore 3-Core Solder is not as cheap as ordinary solder—but it costs less in the end. The three cores of Ersin flux being continuous, there is no waste of either labour or material, and no dry joints even with the majority of highly oxidised components. One pound of sixteen S.W.G. Ersin Multicore Solder will give as many as 4,416 sound joints which can be trusted to remain sound, both electrically and mechanically. Firms engaged on government contracts are invited to write for reference sheet and samples of Ersin Multicore Solder Wire—approved by the A.I.D. and G.P.O. for all purposes where resin is specified.

ERSIN MULTICORE

THE SOLDER WIRE WITH 3-CORES OF NON-CORROSIVE ERSIN FLUX

MULTICORE SOLDERS LTD., Mellier House, Albemarle Street, London, W.1.

Telephone 1
REGent 1411 (P.B.X. 4 lines)

