

THE POST OFFICE ELECTRICAL ENGINEERS' JOURNAL

VOL. 32

OCTOBER, 1939

PART 3

CONTENTS

	PAGE
OPENING OF HEADQUARTERS EXCHANGE — M. G. Holmes, B.Sc.(Eng.), A.M.I.E.E., and E. J. Harrold	159
THE FINANCIAL EFFECTS OF RECENT REDUCTIONS IN TELEPHONE CHARGES (INLAND SERVICE)—H. Townshend, B.A. ..	165
SPECIAL EVENTS—TELEGRAPH ARRANGEMENTS—G. E. Carr ..	174
THE SUPPLY OF POWER FOR TELEPHONE EXCHANGES—G. M. Mew, B.Sc.(Eng.), A.M.I.E.E.	184
THE SWANWICK CONVENTION	191
THE EFFECT OF NOISE AND INTERFERING SIGNALS ON TELEVISION TRANSMISSION—R. F. J. Jarvis, Ph.D., and E. C. H. Seaman, B.Sc.	193
BOOK REVIEWS	183, 190, 199
LOCAL LINE DEVELOPMENT PLANT—F. Guest	200
CONSTANT IMPEDANCE EQUALISERS : SIMPLIFIED METHOD OF DESIGN AND STANDARDISATION—F. Pyrah	204
A NEW POWER PLANT FOR P.M.B.X's.—W. S. Atherton	212
NOTES AND COMMENTS	216
INSTITUTION OF POST OFFICE ELECTRICAL ENGINEERS	216
DISTRICT NOTES	217

Price 1/- net

THE INSTITUTION OF POST OFFICE ELECTRICAL ENGINEERS



G.E.C.

ACCURATE MEASUREMENT

Accurate measurement, the essential of progress, necessitates the use of good instruments, and nowhere is this more important than in radio.

Good instruments can be designed and produced consistently only as the result of great experience in experiment and research extending over many years.

Salford Electrical Instruments Ltd. have been making first quality instruments for half a century, and their products are to be seen in constant use in Power Houses, Test Rooms and Laboratories all over the world.

Instruments in sizes from 2" upwards are available for almost every electrical measurement. The 2½" flush or projecting types are specially suited for radio purposes, and may be supplied as:—Milliammeters, Microammeters, Ammeters, and Voltmeters, D.C. and A.C.

Portable types are also made in most of these ranges. For H.F. measurements a range of Valve Voltmeters is available.

Please write for descriptive list S.27, and state particular instruments in which you are interested.



SALFORD ELECTRICAL INSTRUMENTS LTD.

PEEL WORKS, SALFORD, 3.

Telephones: BLACKFRIARS 8888 (3 lines) Telegrams and Cables: "SPARKLESS, MANCHESTER"

PROPRIETORS: THE GENERAL ELECTRIC CO., LTD., OF ENGLAND

WHEN 'SPECIALS' ARE CALLED FOR

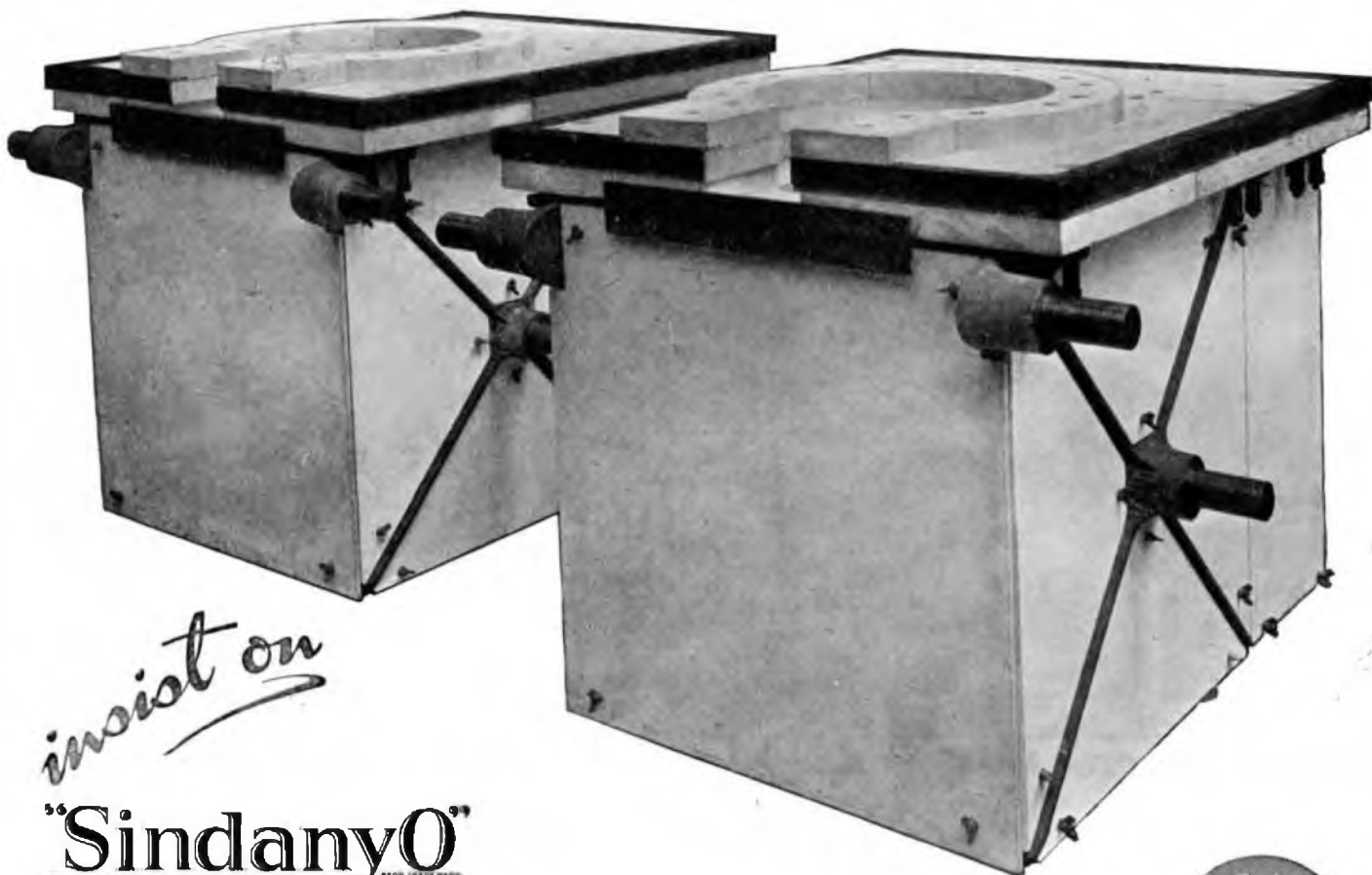

insist on

"Sindanyo"

Asbestos Electric

**ARC & HEAT
RESISTING BOARDS**
— NATURAL GRADE —

In accordance with B.S.S. 737/1937



When special conditions are encountered, or unusual arc and heat-resisting materials required, Natural Grade "SINDANYO" Electric Arc and Heat Resisting Boards offer a solution to most difficulties. The material is highly satisfactory for a variety of purposes, such as arc shields, flash barriers, arc chutes and resistance mountings. The heat-resisting properties of this material make it particularly suited for conditions where temperatures up to 350° C. are likely to be encountered, and this it will withstand without loss of mechanical strength. The material can be readily machined and is suitable for a wide range of uses. The illustration above shows two bodies for high frequency furnaces built by the Metropolitan-Vickers Electrical Co. Ltd., to whom we are indebted for permission to reproduce the photographs.

TURNERS ASBESTOS CEMENT CO. (Branch of Turner & Newall Ltd.) TRAFFORD PARK, MANCHESTER

UNIVERSAL

DIRECT READING WAVEMETER

INCORPORATING THERMAL COMPENSATED COILS

Linear frequency "Law" ensures accurate simple arithmetical interpolation.

Calibration as a generator independent of valve replacement.



List No. R.800DA.

DIRECT READING SCALES engraved in Kilocycles/sec. fitted if desired.

Dynatron and Visual Indicating Absorption without change of calibration.



List No. R.800D.

RANGE 30 to 15000 kc/s (20,000 kc/s when using Absorption Unit)

SCALE READING ACCURACY 0.03%

CALIBRATION ACCURACY 0.1%

FREQUENCY STABILITY 0.003%

List No. R.800A or R.800D.

PRICE £46.10.0

(List No. R.800DA., £53)



List No. R.800A.

H. W. SULLIVAN LIMITED

LONDON, S.E.15

Telephones :
NEW CROSS 3225 (P.B.X.)

Telegrams :
STANDELECT PECK LONDON.

"Sullivan" guarantees accuracy

EDISWAN

TELEPHONE LINE PROTECTOR PANELS

EDISWAN-SHOTTER-GREETHAM PATENT

(British Patent No. 353924)

for the protection of telephone systems against surges induced by faults on neighbouring power lines

Of the difficulties attendant upon the employment of overhead systems one of the most serious is to ensure uninterrupted working of the telephone system, by providing adequate protection against induced surges caused by switching or line faults in adjacent power lines or by lightning.

The Ediswan Patent Protectors provide the solution. They are inert at the normal working pressure of the telephone line, they keep the voltage on the line down to a pre-determined figure by providing a path of low resistance to earth whereby the surge is cleared and they again become inert immediately the surge is cleared.

They ensure simultaneous discharge of both lines and are capable of clearing heavy discharges without detriment to the system or the protector.

Ediswan Telephone Line Protectors have now been in use by Supply Companies for many years.

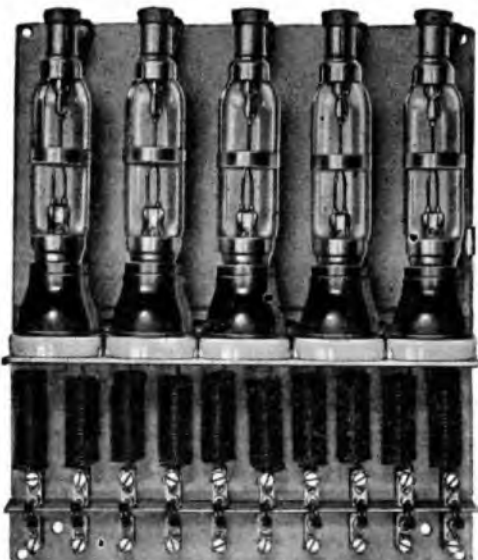

5-circuit panel for overhead lines incorporating choke coils, spark gaps, etc.

THE EDISON SWAN ELECTRIC CO. LTD., 155 CHARING CROSS ROAD, LONDON, W.C.2

capco

REGISTERED TRADE MARK

Quartz Cutting Machine

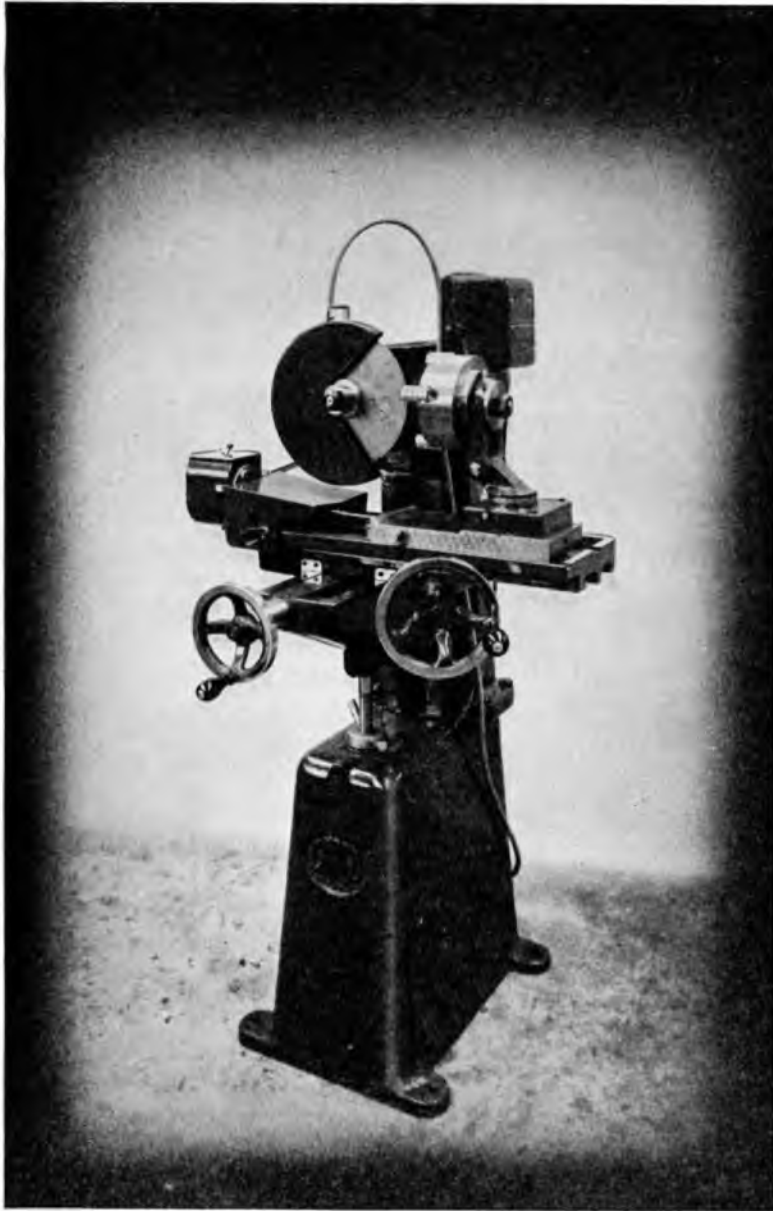

Designers and Manufacturers of Capco Sound-on-Film recorders and equipment. Patentees and Manufacturers of Capco Enamelled Wire cleaning machines.

Illustration shows latest Model of the Quartz Cutting Machine developed and designed in collaboration with engineers of the Radio Branch of the Post Office.

Similar machines have been supplied to the Post Office and to the leading Telephone and Radio Manufacturers.

Standard and heavy duty cutting machines with high rates of cutting to accuracies of $\cdot 001$ in.

Fixtures to hold any shape of crystal can be supplied.

Acknowledged to be the finest machine of its kind for this class of work.

Manufacturers :

CAPLIN
ENGINEERING CO. LTD.

Precision Engineers

BEACONSFIELD RD., WILLESDEN
LONDON, N.W.10

Telephone :
Willesden 0692.

Cables :
Caplinko, London.

ESTABLISHED 1918

SIEMENS

CONTRACTORS FOR THE
MANUFACTURE AND LAYING OF
TELEPHONE CABLES

AERIAL • UNDERGROUND • SUBMARINE WITH CONTINUOUS
OR COIL LOADING

LOADING COILS



LAYING SUBMARINE TELEPHONE CABLES

SIEMENS BROTHERS

WOOLWICH, LONDON

Telephone : V 1000



E CABLE ACROSS AN ESTUARY

RS & CO. LIMITED

LONDON, S.E.18

DOLWICH 2020

ARP

MADE SAFE & PERMANENT WITH RAWPLUG FIXING DEVICES

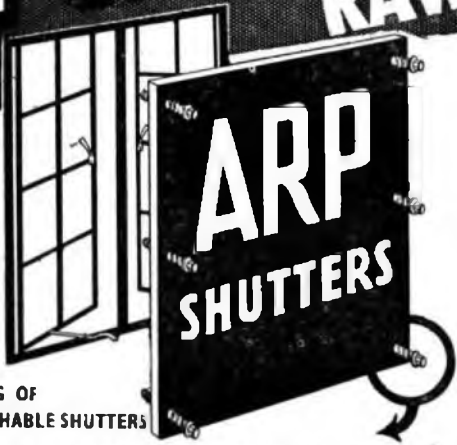

FIXING OF
DETACHABLE SHUTTERS



Blast, Splinters and Flying Glass: *The best way to obtain protection against blast, splinters and shattered glass is to fit metal or wooden shutters over the windows. At nights, shutters serve the dual purpose of protecting against blast and obscuring the light, thus obviating the need for blinds or curtains. Rawbolts or Rawplugs ensure that these shutters are fixed quickly and absolutely securely without damage to walls or decorations.*

The War Office, Air Force, Admiralty, G.P.O., Metropolitan Police, L.C.C., and Municipal Authorities everywhere, have universally adopted Rawplug Fixing Devices—they are using them for securing A.R.P. shutters, swing shutters, black-out curtains, partitions, electric light fittings, clothes racks, brackets for fire equipment, seats, ventilation, and air filtration appliances, etc.

DARKENING OF WINDOWS :

The Government has stated that plans are being made on the assumption that war may last for 3 years, owners of premises are, therefore, taking immediate steps to replace their temporary A.R.P. fittings with more permanent ones, which can be conveniently operated.

There is a Rawplug of a size and type for every class of work, from the fixing of curtains and blinds to the holding down of heavy machinery and other fixtures where a strain of over 20 tons may have to be contended with.

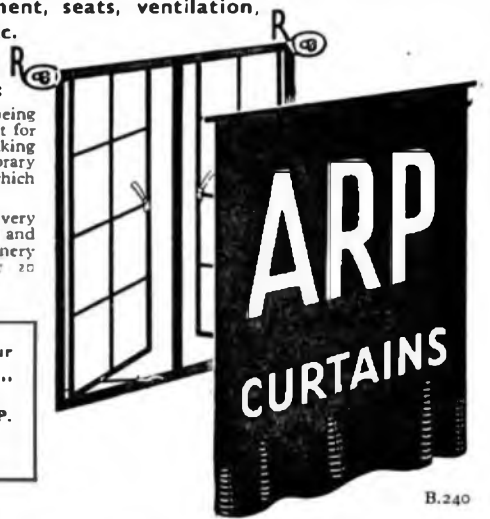

B.240

Write for copy of our latest "Fixing Devices" book and special A.R.P. folder.

The Rawplug Co., Ltd., Rawplug House, Cromwell Road, London, S.W.7



MODEL NO 5A TAPE TELEPRINTER

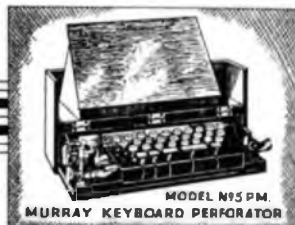

MODEL NO 5 PM MURRAY KEYBOARD PERFORATOR



MODEL NO 6 S TELEPRINTER AUTO TAPE TRANSMITTER

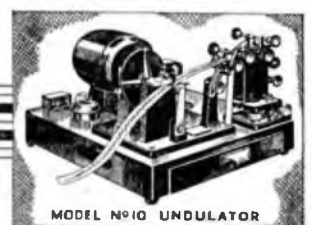

MODEL NO 10 UNDULATOR



MODEL NO 7 TR TELEPRINTER REPERFORATOR

ILLUSTRATED are some of the instruments manufactured to provide printing telegraph machines to meet all modern communication requirements.



MODEL NO 9 MORSE KEYBOARD PERFORATOR

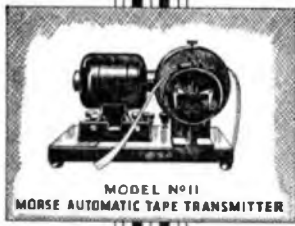

MODEL NO 11 MORSE AUTOMATIC TAPE TRANSMITTER



MODEL NO 7 PACE TELEPRINTER WITH COMMERCIAL TYPEWRITER KEYBOARD

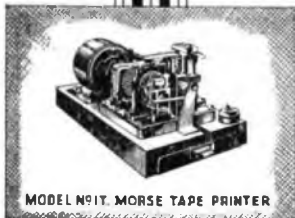

MODEL NO 1 T MORSE TAPE PRINTER

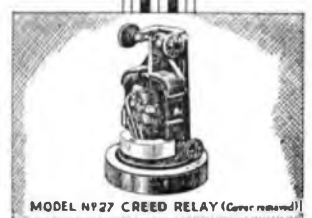

MODEL NO 27 CREED RELAY (Cover removed)

CREED & CO. LTD.

Telephone :— Telegraph House Telex :—
Croydon 2121 CROYDON Croydon Telex 1082

DON'T WAIT FOR MR. HITLER

Don't wait for Mr. Hitler to decide your fate, be the master of your own destiny. Do not wait for better times, the ideal opportunity never arrives. We have to make the best of existing conditions, a duty we owe to ourselves and to our country is to make the best of abilities now ; we cannot wait for those abilities to develop unaided—they must be trained.

By becoming efficient in your vocation you can give the best service to your country and to yourself. The more you increase your earning power the better it is for your country and for yourself personally. War or no war, earning power always brings its possessor to the front.

YOU CANNOT MAKE MONEY BY SAVING

If you save 10s. per week for 10 years you have only got £260, but if you spend 2s. 6d. per week for 12 or 18 months on a correspondence course, you give your brains a chance to earn thousands of pounds, then there is no need to save. Savings are likely to vanish, but earning capacity is a permanent investment.

DO ANY OF THESE SUBJECTS INTEREST YOU ?



Accountancy Examinations
Advertising and Sales Management
Agriculture
A.M.I. Fire E. Examinations
Applied Mechanics
Army Certificates
Auctioneers and Estate Agents
Aviation Engineering
Banking
Blue Prints
Boilers
Book-keeping, Accountancy and Modern Business Methods
B.Sc. (Eng.)
Building, Architecture and Clerk of Works
Builders' Quantities
Cambridge Senior School Certificate
Civil Engineering
Civil Service
All Commercial Subjects
Commercial Art
Concrete and Structural Engineering

Draughtsmanship. All branches
Engineering. All branches, subjects and Examinations
General Education
G.P.O. Engineering Dept.
Heating and Ventilating
Industrial Chemistry
Institute of Housing
Insurance
Journalism
Mathematics
Matriculation
Metallurgy
Mining. All subjects
Mining, Electrical Engineering
Motor Engineering
Motor Trade
Municipal and County Engineers
Naval Architecture
Novel Writing
Pattern Making
Play Writing
Police, Special Course
Preceptors, College of

Press Tool Work
Pumps and Pumping Machinery
Radio Communication
Radio Service Engineering
Road Making and Maintenance
Salesmanship, I.S.M.A.
Sanitation
School Attendance Officer
Secretarial Exams.
Sheet Metal Work
Shipbuilding
Shorthand (Pitman's)
Short Story Writing
Speaking in Public
Structural Engineering
Surveying
Teachers of Handicrafts
Telephony and Telegraphy
Television
Transport Inst. Exams.
Weights and Measures Inspector
Welding
Wireless Telegraphy and Telegraphy
Works Managers



If you do not see your own requirements above, write to us on any subject. Full particulars free.

STUDY AT HOME IN YOUR SPARE TIME



CAN YOU CHANGE MY EXPRESSION ?

IF SO, YOU MAY BE THE ARTIST THAT COMMERCE IS WAITING FOR.

Just try it for yourself. Trace or draw the outline and then put in the features.

There are hundreds of openings in connection with Humorous Papers, Advertisement Drawing, Posters, Calendars, Catalogues, Textile Designs, Book Illustrations, etc.

60 per cent. of Commercial Art Work is done by "Free Lance Artists" who do their work at home and sell it to the highest bidder. Many Commercial Artists draw "retaining fees" from various sources, others prefer to work full-time employment or partnership arrangements. We teach you not only how to draw what is wanted, but how to make buyers want what you draw. Many of our students who originally took up Commercial Art as a hobby have since turned it into a full-time paying profession with studio and staff of assistant artists; there is no limit to the possibilities. Let us send full particulars for a FREE TRIAL and details of our course for your inspection. You will be under no obligation whatever.

Jim Duck

ART DEPT. 24

I HAVE HELPED THOUSANDS OF OTHERS . .

... and when I say thousands, I do not exaggerate, as I can produce well over 10,000 unsolicited testimonials from grateful students who, through our Postal Training, have achieved their life's ambition.



If it is your desire to make progress and establish yourself in a good career, write to us for free particulars on any subject which interests you, or if your career is undecided, write and tell us of your likes and dislikes, and we will give you practical advice as to the possibilities of a vocation and how to succeed in it. You will be under no obligation whatever.

J.W. Bennett



Dept. 24, THE BENNETT COLLEGE, SHEFFIELD

EVERY DEPARTMENT IS A COMPLETE COLLEGE : EVERY STUDENT IS A CLASS TO HIMSELF

JOURNALISM

Short Story, Novel and Play Writing
There is money and pleasure in Journalism and in Story Writing. No apprenticeship, no pupilage, no examinations, no outfit necessary. Writing for newspapers, novels or pictures is not a gift; it is a science that can be acquired by diligent application and proper guidance. It is the most fascinating way of making part-time profitable. Trained ability only is required, we do the training by post. Let us tell you all about it.

DEPARTMENT OF LITERATURE 24

If you attend to this now, it may make a wonderful difference to your future.

COUPON—
CUT THIS OUT

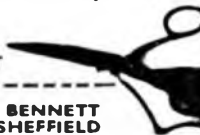

To Dept. 24, THE BENNETT COLLEGE LTD., SHEFFIELD
Please send me (free of charge)

Particulars of
Your private advice about
(Cross out line which does not apply)

.....

PLEASE WRITE IN BLOCK LETTERS

Name

Address

.....

SELENIUM RECTIFIERS IN SERVICE

1

BATTERY CHARGING



Battery Chargers
incorporating S.T.C.
Selenium Rectifiers.

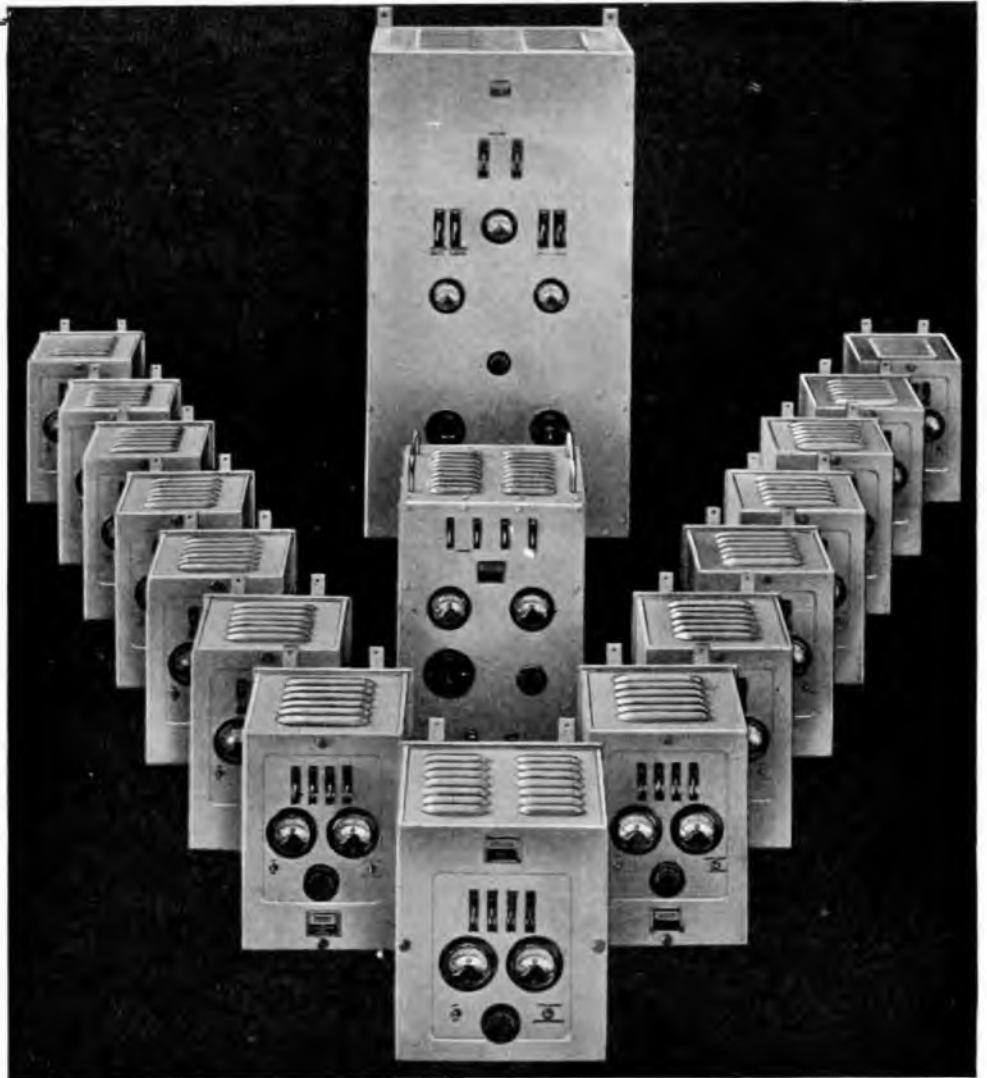

THE illustration shows a group of battery chargers used in conjunction with S.T.C. Remote Control equipment.

Battery chargers are available for any number or type of cell and any required output current. They are designed by engineers with wide experience of their application in practice and their outstanding features are simplicity of control and accessibility of all parts. Long life, high efficiency and trouble-free service are secured by the use of high-grade components.

These chargers incorporate the *Standard* Selenium Rectifier, which is manufactured at our New Southgate Works and is fully described in Bulletin S.R.150 which will be gladly sent on request.

Standard Telephones and Cables Limited

OAKLEIGH ROAD, NEW SOUTHGATE, LONDON, N.11

Telephone : ENTERPRISE 1234

THE POST OFFICE ELECTRICAL ENGINEERS' JOURNAL

Vol. XXXII

October, 1939

Part 3

Opening of Headquarters Exchange M. G. HOLMES, B.Sc.(Eng.), A.M.I.E.E., and E. J. HARROLD

U.D.C. 621.395.24

A few historical notes on the old Official Switch P.A.B.X., latterly known as NATIONAL 6321, are followed by a description of the non-director 2,000 type equipment in Wood Street building known as HEADquarters exchange, to which all the P.A.B.X. extensions have been transferred.

Introduction.

HEADQUARTERS exchange, which is the new name for the official Post Office P.A.B.X., was opened on Saturday, April 29th, 1939, at 1.30 p.m., replacing the old Official Switch P.A.B.X., NATIONAL 6321. The passing of the old P.A.B.X., which was of the Keith line switch Strowger type, marks another stage in the disappearance from the British Post Office telephone system of the pioneer exchanges on the experience of which the large modern automatic network in the country has been based.

One thousand and sixty-nine extensions on the P.A.B.X. were transferred to the new equipment, which is in effect a public automatic exchange of non-director type with access to the director area from level 7 of 1st selectors and, as far as incoming calls are concerned, forms part of the director network by virtue of the name HEADquarters being allocated and brought out on the translation fields of all level 4 directors in the exchanges in the 12½-mile circle, so that calls dialled by subscribers on these exchanges are routed straight to any extension on the HEADquarters exchange.

Before the new equipment is dealt with in detail it may be of interest to describe the method of cut-over and the main features of the old P.A.B.X. equipment which was brought into service in July, 1912, and has worked very satisfactorily under stringent traffic conditions for nearly 27 years. The equipment was similar to that installed at Epsom automatic exchange in the same year and was accommodated in the basement of the C.T.O. building.

Opening of Official Switch.

The actual opening time and date of Official Switch, as it was then called, was 3 p.m., on Saturday, July 13th, 1912, and followed closely the opening of Epsom Exchange¹, which was the first public automatic exchange to be opened in the British Isles. The installation of the automatic equipment at Epsom and Official Switch was carried out concurrently by the Automatic Telephone Manufacturing Co., Ltd., now the Automatic Telephone and Electric Co., Ltd.

It is rather interesting to read in papers from the Official Switch file that the cut-over was effected by cutting the main frame jumpers to disconnect the old manual board and that the heat coils were then inserted to connect the lines to the new equipment, these operations being completed in about 20 minutes' time. This was followed by linemen visiting each telephone and confirming that the system was working satisfactorily by passing calls to the testing telephones. The testing after the transfer continued until 9 p.m. on Saturday and was recommenced at 8 o'clock on Sunday morning. It continued all day and was completed at 10.30 p.m. with the exception of one or two minor matters.

Another interesting point was that each 100-line unit was equipped with 70 lines only, as it was anticipated that the peak traffic would be very high for a few days after the opening. This happened in fact, and the Automatic Telephone Manufacturing Company's installers from America stated that they had never experienced an exchange where the traffic was heavier ;
¹P.O.E.E.J., Vol. 5, p.121.

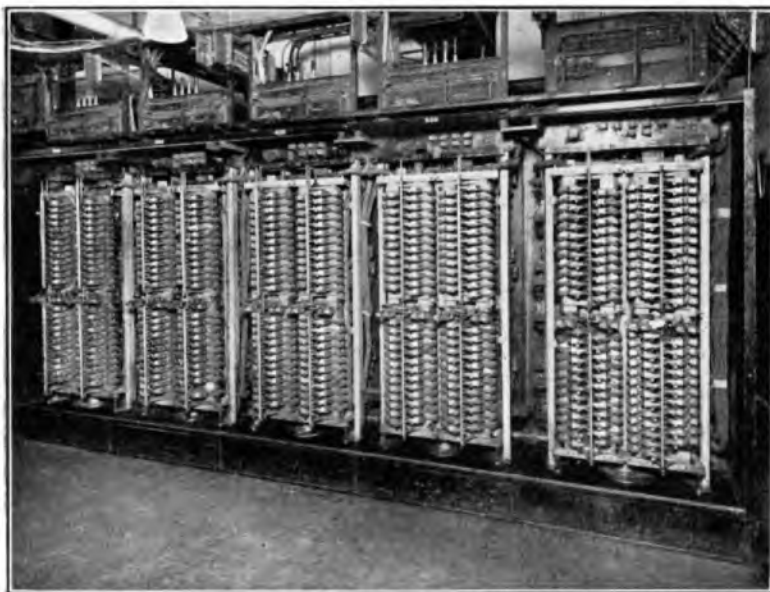

FIG. 1.—GENERAL VIEW OF THE ORIGINAL LINESWITCH EQUIPMENT INSTALLED IN OFFICIAL P.A.B.X.

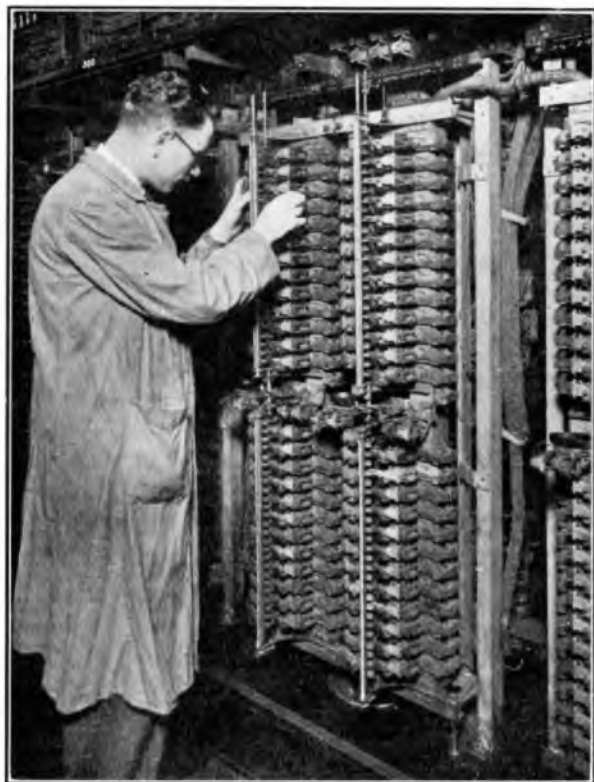

FIG. 2.—CLOSE-UP VIEW OF ORIGINAL LINESWITCH EQUIPMENT.

it was hoped, therefore, that Official Switch would furnish valuable information with regard to the general utility and efficiency of automatic plant.

During the years that followed the Great War, Official Switch played a large part in the gradual development of Strowger automatic telephony to its present advanced state, much valuable information being obtained on the durability of various parts such as mechanisms, relay contacts, etc., the correct periodicity of routine maintenance tests, details of various classes of faults, fault recording procedure and other kindred matters.

Official Switch Equipment and its Growth.

Official Switch equipment as it existed in 1939 had grown in six stages, the line switch and final units supplied for the penultimate stage being of the standard uniselector type in use at the time. The equipment has given an efficient service over a long period, an excellent proof of the robustness of design of the equipment in general and, in particular, the Keith line switch which was the pioneer of the present uniselector.

The various stages of growth, with details of manufacture, are given in Table I.

It will be seen that the 9,400 unit was of the more modern Strowger type, whereas the last extension in 1936 comprised three units recovered from Epsom exchange, which, itself, gave excellent service over a period of 24 years. The numbering scheme, as can be seen from Table I, was mixed 3 and 4 digit type.

Fig. 1 gives a general view of a line switch board of the original equipment, and Fig. 2 gives a close-up of

TABLE I

Year Installed	Unit No.	Remarks.
1912	200-600	Original installation: units manufactured in Chicago (Figs. 1 and 2).
1913	700-800	It is understood that these two units were the first manufactured by the Automatic Telephone Manufacturing Co. in their new factory at Liverpool, and incorporated the first self-aligning feature.
1925	9,200	This unit was previously in use at Wylies Exchange.
1926	9,300	This unit was previously in use at Gretna and Hadley.
1932	9,400	This unit was installed by the Post Office, being specially manufactured by the Automatic Telephone Manufacturing Co., utilising line switches that were supplied by the Department.
1936	9,500 9,600 9,700	These units were previously in use at Epsom exchange.

this board. Fig. 3 shows unit 600 with details of the final selectors.

A further point of interest in the life of the exchange was that up to 1933 access to the public system had



FIG. 3.—UNIT 600, SHOWING DETAILS OF FINAL SELECTORS.

to be obtained via the manual board, but during that year a change was made in that level "0" was utilised as a direct level to exchange lines on National director exchange so that by dialling "0" before the 7 digits of a London director area number any number in this area could be obtained by direct dialling. As level "0" was used for this facility, level 11 had to be picked up for assistance calls and enquiries, etc.

Other features of the trunking scheme, which is illustrated in Fig. 4, were direct access to Cornwall

During the crisis week of September, 1938, the traffic exceeded the 100,000 mark, and it speaks well for the robustness of the equipment and the efficiency of the maintenance staff that in spite of its age the equipment stood up well to this, the heaviest load of its existence. Towards the end of its life over 600 calls passed via the manual board during an average busy hour. The manual board formed part of the A suite in the Wood Street switch-room.

It was apparent, however, that the time was due

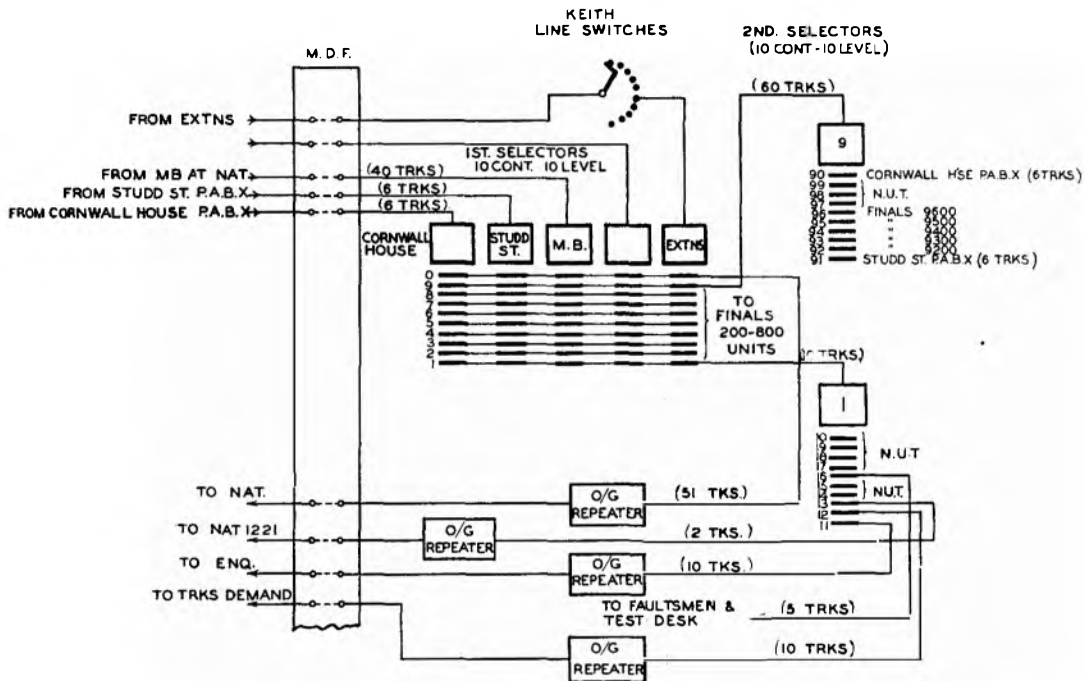

FIG. 4.—TRUNKING DIAGRAM OF THE OLD EXCHANGE.

House (L.T.R.) P.A.B.X. and Studd Street (Stores Department) P.A.B.X. by dialling-out codes 90 and 91 respectively, Union House (L.T.R.) 113, Trunk Demand Suite (Faraday Building) 112. Lines from dialling-out levels on Cornwall House and Studd Street P.A.B.X.'s terminated on 1st selectors, and access was obtained from various Post Office manual P.B.X.'s by terminating inter-communicating lines on line switches and also giving such lines a final selector number.

Table 2 gives an idea of the growth of traffic on the equipment from 1934 to 1939, during which period the overall increase was nearly 64 per cent.

TABLE 2
Calls metered at Final Selectors

Year	Average Calls per week
1934	58,000
1935	60,000
1936	67,000
1937	78,000
1938	90,000
1939	95,000

for replacement by more modern equipment, especially in view of the importance of the installation in its function of supplying telephone service to many of the most important branches of the Post Office and the decision to effect the replacement was made in 1935.

Details of Headquarters Exchange Equipment.

The new automatic switching equipment was manufactured by Messrs. Ericssons Telephone Co. and installed by them in the Wood Street building. It is of the 2,000 type, suitable for working in conjunction with the existing apparatus at Metropolitan and National exchanges and into the equipment of the London director system.

Nine sleeve-control positions in the Wood Street switchroom, previously used for controlling Toll traffic, were modified by the Automatic Telephone and Electric Co., the original manufacturers, who also provided additional calling equipments and switching equipment for night service concentration.

Details of the main portion of the equipment provided and installed for the opening are shown in Table 3; in addition, further equipment is now being added under Extension No. 1, and column 3 of this table indicates the total quantity of equipment when the extension is completed.

TABLE 3

Circuit	Quantity at opening	Quantity when Extension No. 1 is completed
Line and cut-off relays	1,600	2,000
Primary start relay sets	8	10
Primary finders (Fig. 5)	304	380
Primary control relay sets	24	30
First selectors (200 outlet), local	220	276
First selectors (200 outlet), incoming manual	44	44
First selectors (200 outlet), incoming auto	143	168
Second selectors (100 outlet)—(Fig. 6)	42	51
Second selectors (200 outlet)	190	220
Final selectors (200 ordinary)	212	261
Final selectors (200 ordinary with 2/10 P. B. X. facilities)	30	30
<i>Relay Sets (Fig. 7) :</i>		
Dialling in HEA 1234	50	50
Outgoing to P.A.B.X.'s	19	19
Outgoing to P.M.B.X.'s	94	94
Outgoing to trunks	12	12
Speaking clock	1	2
Secondary finders	60	60

Fig. 5 shows the primary finder racks, Fig. 6 2nd selector racks, and Fig. 7 the relay set racks.

An independent M.D.F. separate from the Metropolitan-National exchange frames, but with access to the latter via specially constructed jumper racking, was provided, and consists of 12 verticals with an ultimate capacity for 2,000 line circuits, 240 circuits for outgoing junctions, 100 circuits for incoming



FIG. 6.—SELECTOR RACKS.

junctions and 40 miscellaneous circuits to the I.D.F.

The trunking scheme for the new equipment is shown in Fig. 8. A prominent feature of the Head-



FIG. 5.—PRIMARY FINDER RACKS.

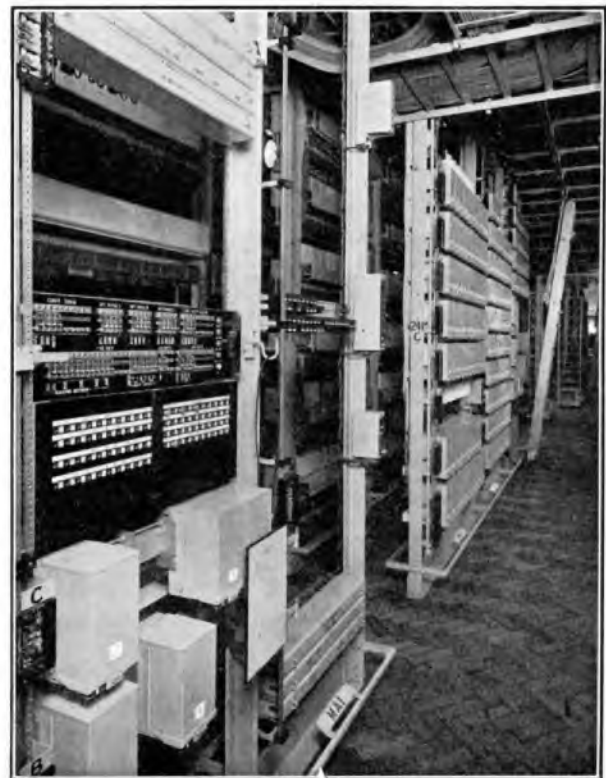

FIG. 7.—RELAY SET RACKS.

quarters exchange is the large number of levels allocated to dialling-out codes to afford communication with various Post Office departments in buildings not directly associated with those buildings in which Headquarters extensions are provided. In the old P.A.B.X. the majority of the P.B.X.'s shown on Table 4, which is a list of the dialling-out codes, were ordinary numbers on the P.A.B.X., but matters have now been simplified by the extensive use of 1 and 2-digit dialling-out codes. All the P.B.X.'s and P.A.B.X.'s in Table 4 have direct access into the Headquarters exchange. P.B.X. lines terminate on

TABLE 4

Dialling-out Code	To
5	Stores Department, Studd Street.
7	National first code selectors.
9	L.T.R. engineering (Waterloo 8000).
61	A.G.D., Telephone House.
62	L.P.R., Mount Pleasant.
63	Stores Department, Bedford Street.
64	Post Office Savings Bank.
65	A.G.D., City Gate House.
66	L.T.R., Union House (National 1221).
68	L.T.R., Cornwall House (City 2000).
60	M.O.D., Manor Gardens.
81	L.T.R., Faraday Building (Central 0101).
82	Engineering Department, Dollis Hill Research Station.
89	Stores Department, Mount Pleasant.
0	Headquarters manual board.
TO	Toll.
TR	Trunks.
TE	Telegrams.
TI	Speaking clock.
EN	Engineering faults.

(a) CIRCUITS IN METROPOLITAN AND NATIONAL AREA

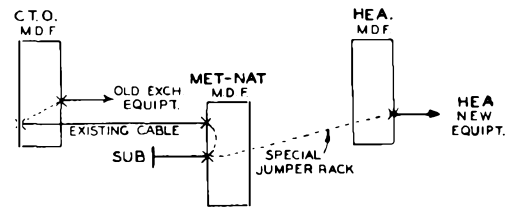

(b) CIRCUITS IN C.T.O. & HEADQUARTERS BUILDINGS

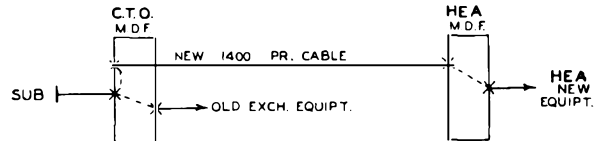

(c) CIRCUITS TO VARIOUS AREAS THAT WERE RE-ROUTED TO BRING THEM VIA WOOD ST. BUILDING

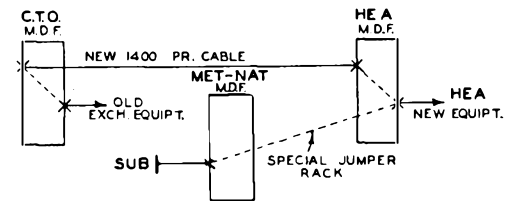

FIG. 9.—JUMPERING AND TEEING ARRANGEMENTS.

line and cut-off relays and P.A.B.X. lines direct on 1st selectors. The dialling-out codes for toll, trunks, telegrams, speaking clock and engineering faults are the first two letters of the normal codes used for such services in the London director system.

All extension numbers are now four-figure numbers in the 2,000 and 3,000 series. In general the change from the old mixed 3- and 4-digit numbering scheme involved pre-fixing 3-figure extension numbers by 2 and changing the first digit 9 of the 4-figure extension numbers to 3. It will also be noted that the 35 unit is of 2 to 10 P.B.X. type to cater for small P.B.X.'s which may be terminated on the Headquarters exchange. Level 7 provides access to the director area, the circuits of this level being connected direct to 1st code selectors on National exchange into which the 7-digit director area number is dialled. With regard to incoming traffic from the director area all calls for Headquarters from director exchanges are routed via a level in Holborn Tandem exchange, and 92 circuits have been taken from this level to 1st selectors in the Headquarters exchange. If the caller knows the extension number he can obtain the extension direct by dialling HEA followed by the 4-digit extension number; if the extension number is not known the caller dials HEA 1234 and the call is routed from level 1 of 1st selectors to the manual

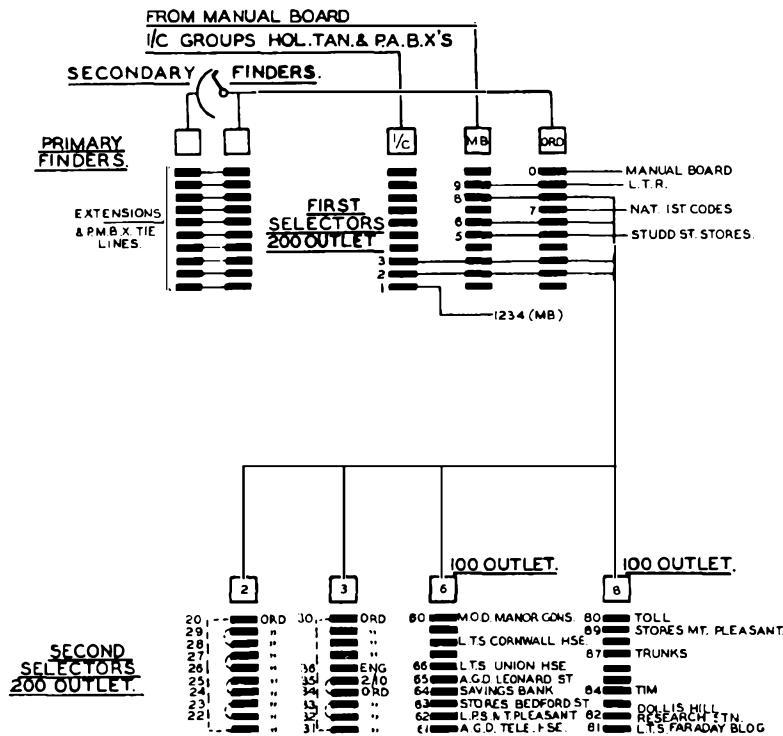

FIG. 8.—TRUNKING DIAGRAM OF THE NEW EXCHANGE.

board, the digits 2, 3 and 4 being dissipated in the manual board relay set.

Opening Arrangements.

To enable the extensions of National 6321 to be routed to the new Headquarters main frame a new 1,400 pair tie cable was provided between the frame of Official Switch located in the basement of the Central Telegraph Office and the frame located on the third floor of Wood Street building.

The jumpering and teeing arrangements between the MET-NAT and HEA frames are shown in Fig. 9 (a) and the tees on the C.T.O. frame are shown in Fig. 9 (b). Some of the circuits from C.T.O. were re-routed to bring them via MET-NAT frame and are shown in Fig. 9 (c). The need for the three foregoing schemes was due to the lines existing on NATional 6321 being distributed to various buildings and other areas in the Region which were served by cables terminating either on the C.T.O. frame or on the frames in the Wood Street building.

Method of Transfer.

The transfer was effected by inserting wood wedges into the protectors on the C.T.O. main frame to disconnect the lines from the losing exchange equipment and the withdrawal of the wedges from the protectors on the Headquarter main frame to connect the lines to the new equipment. This operation was completed satisfactorily in under 4 minutes as compared with 20 minutes taken 27 years ago at the original opening of Official P.A.B.X.

Immediately following the change-over the usual tests were carried out on every circuit from the test final selectors and were completed in 40 minutes with satisfactory results. In addition to the tests from the test final selectors, over 100 telephones were actually tested by visiting engineering officers who

passed calls from each instrument to the testing telephones and so verified that the new exchange equipment was working satisfactorily. These visits were considered necessary on account of the many offices not being staffed on Saturday afternoon. All the instruments not visited were tested by the traffic staff on the following Monday morning by passing calls to each instrument in the usual way from the testing telephones.

Change-over keys were also operated at the time of transfer at Holborn Tandem exchange, Cornwall House P.A.B.X. and at the Stores Department, Studd Street P.A.B.X. The keys were necessary to bring into service the new junctions to Headquarters exchange, the level at Holborn Tandem being connected to N.U. tone temporarily to obviate calls being routed prematurely into the new equipment before its opening.

A new directory was issued to coincide with the transfer, but it was considered necessary, owing to the change of number from NAT 6321 to HEA 1234, to continue staffing the NAT 6321 manual board for a period after the transfer. In this manner callers were advised of the change of number.

Conclusion.

No attempt has been made in these notes to describe details and equipment, but it is hoped that the main points of interest have been covered. The photographs will be useful for comparison between the original and present types of automatic equipment used by the Post Office. Thanks are due to the Photographic Section of the Editorial Branch, Engineer-in-Chief's Office for taking the photographs and colleagues in the L.T.R. for supplying information on the various stages of growth of the Official Switch exchanges.

TELEGRAPH AND TELEPHONE PLANT IN THE UNITED KINGDOM
TELEPHONES AND WIRE MILEAGES. THE PROPERTY OF, AND MAINTAINED BY
THE POST OFFICE IN EACH REGION AND ENGINEERING DISTRICT AS AT 30TH JUNE, 1939.

Number of Telephones	OVERHEAD WIRE MILEAGES					Region or District	UNDERGROUND WIRE MILEAGES					
	Telegraph	Trunk	Junction	Exchange*	Spare		Telegraph	Trunk	Junction†	Exchanget	Telephone Spares	
											Trunk	Junction‡
1,190,793	324	502	1,456	58,057	5,688	London	24,703	317,350	974,036	3,288,781	126,380	279,068
150,749	1,350	976	10,124	58,732	12,977	S. Eastern	6,027	141,284	26,516	399,110	75,558	24,616
181,933	1,737	7,593	24,190	120,932	16,040	S. Western	19,693	146,562	17,719	373,972	82,154	25,308
129,203	2,082	8,808	21,195	90,081	21,516	Eastern	7,645	176,014	23,468	272,130	135,198	29,507
148,328	2,338	7,904	18,373	77,735	29,530	N. Midland	9,419	234,822	25,398	310,876	120,128	28,024
166,785	1,244	4,254	15,826	82,781	20,805	S. Midland	10,881	207,542	41,047	419,772	68,802	38,323
86,386	952	4,077	16,429	61,080	11,562	S. Wales	6,156	93,572	18,811	164,536	73,576	20,249
219,320	1,608	8,750	22,018	94,204	18,487	N. Wales	12,156	246,572	108,352	465,346	137,738	43,034
360,194	330	2,334	7,786	76,255	20,204	N.W. Region	16,373	275,182	132,168	992,608	183,040	69,484
42,505	1,810	6,736	6,590	20,286	1,745	N. Ireland	1,904	16,154	7,956	91,408	24,310	5,076
308,045	3,698	10,827	21,676	107,818	30,756	N.E. Region	18,239	290,520	80,934	751,920	205,968	52,728
284,301	4,735	21,671	31,750	111,439	29,820	Scot. Region	12,743	238,020	43,094	563,217	189,464	44,540
3,268,542	22,208	84,432	197,413	959,400	219,130	Totals	145,939	2,383,594	1,499,499	8,093,676	1,422,316	659,957
3,218,704	26,100	91,950	203,868	934,794	210,935	Totals as at 31 Mar., 1939	140,927	2,349,598	1,446,804	7,970,602	1,260,656	624,611

* Includes low gauge spare wires, i.e. 40 lb.

† Includes all spare wires in local underground cables.

‡ Wholly junction cables.

The Financial Effects of Recent Reductions in Telephone Charges (Inland Service)*

U.D.C. 654.15.013.2 : 654.15.031.8

H. TOWNSHEND, B.A.,
Accountant General's Dept.

The author shows how the financial effect of a rate-cut is measured, gives details of the principal rate-cuts of 1934 and 1936, and estimates their net financial effect.

THE MEASUREMENT OF THE FINANCIAL EFFECT OF A RATE CUT.

THE financial effect of everything that the telephone administration does is to be seen in the published commercial accounts of the telephone service, especially in the overall figures each year of expenditure on income account, of revenue and of the surplus; but the accounts inevitably lump together the results, not merely of the rate reductions which have been made, but of all other decisions made by the administration—for example, changes in wages and in technical methods—and also the results of a good many independently determined decisions of people not concerned with the telephone administration. If business men feel that times are good, still more, if they think times are improving, and launch out optimistically into spending on projects which they think will bring in profits to them later, or if the Government launches out in projects involving loan expenditure, in other words, if the total rate at which money is being spent increases for any reason, people's incomes go up, and they proceed to spend more money on telephone service, which has in effect become cheaper to them even if the charges remain the same. The converse process need not be exemplified as it is only too familiar. This kind of thing, which has in fact happened on a huge scale within the last few years, reflects itself immediately and vigorously in the telephone commercial accounts. Other factors also influence the position, especially in the short run. Consequently, if the results of the commercial accounts since 1934 are reviewed (Table 1), and it is taken for granted that their vagaries represent the results only of the reductions in rates which have been made during that period, one can be led to

conclusions which it is quite easy to show to be absurd.

The main rate-cuts were made in 1934 and 1936. It seems incredible, but there are people who take the simple view that the rapid increase in the telephone surplus after 1934 was neither more nor less than the result of the stimulating effect on the growth of the service of the 1934 rate cuts. Still more incredible, there is a tendency among the same simple souls to point to the fall in the telephone surplus since 1936, shake their heads, and deprecate the rashness with which in that year the telephone administration gave away public money in reductions of charges. Of course, that kind of thing is just silly. Anyone ought to be able to see that the telephone surplus would certainly have increased after 1934, with other profits, and would probably have fallen after 1936 with other profits, even if the charges had been left quite unaltered. The question is by how much? How much better off, or worse off, is the Post Office than it would have been without the rate-cuts? And since there is no possible way, if one looks at the commercial accounts alone, of distinguishing between the effects of the rate-cuts and the effects of other factors, that kind of talk leads nowhere. There is another obvious difficulty, namely, that the commercial accounts do not separate the profits on those parts of the service which have been made cheaper to the user, from those on other parts the charges for which have remained unchanged. To measure an effect one must isolate it.

There are two ways of proceeding which may be called the analytic and the synthetic way. So far as is possible both are used, and examples of each will be given.

The Analytic Method.

The analytic method proceeds in the following manner. When the price of an item of telephone service is reduced, the financial effect is composed of three factors. These three factors always operate, in greater or less degree, and no other factors influence the financial effect—at least initially. First, a certain amount of revenue from existing business is sacrificed. Existing customers pay the new rates for this business instead of the old rates, and the service has to do without the aggregate difference. This amount can be calculated by simple arithmetic and is known to the Post Office beforehand. It represents simply a transfer of income from the Post Office to a section of the public. Secondly, the lower charges call forth a certain amount of new business. This may come either from old or from new customers. Its value represents an addition of income to the Post Office (though it does not follow that there is a corresponding loss of income to the public—that depends on what the Post Office does with the money; but that is

TABLE 1.
COMMERCIAL ACCOUNTS—TELEPHONE INCOME
AND EXPENDITURE

Year	Telephone Income	Telephone Expenditure	Surplus (excluding Interest on Capital)
1930-31	£ 22,844,000	£ 22,501,000	£ 343,000
1931-32	23,569,000	22,997,000	572,000
1932-33	24,440,000	24,030,000	410,000
1933-34	25,921,000	24,528,000	1,393,000
1934-35	27,046,000	25,361,000	1,685,000
1935-36	28,929,000	26,802,000	2,127,000
1936-37	30,950,000	29,478,000	1,472,000
1937-38	32,649,000	32,220,000	429,000

*This article was originally prepared as a Paper read before the Post Office Telegraph and Telephone Society in April, 1939.

outside the subject of this article). This figure can only be estimated beforehand. One might suppose that after the event it could be calculated with certainty, but a little reflection will show that this is not so. After the change it is known exactly what the revenue from the part of the service in question is, but it is not known what it would have been if the charge had not been cut, and it is the difference between the two that constitutes the figure required.

There is another important point to be noted here, about the amount of new business induced by a rate-cut. It concerns the time factor. Obviously the amount of new business induced by a rate-cut is not likely to accrue all at once. This new business may be appreciable from the outset, if the cut is a striking one and gets good publicity, or it may be quite small; but it may be expected to grow, at least for a time, until the public gets used to the new charges and settles down to them—until it has made up its mind, so to speak, how many calls or telephones or whatever it may be that it wants at the new price. As a rule, several estimates are made of the induced business accruing from an important rate-cut at various intervals after the change. One might suppose that this could be repeated until a stable figure was reached, which one could be fairly sure measured the induced business correctly; but here the old difficulty is met again. The induced business at any time is the total volume of business less that which would have been secured without the rate-cut. But, as has been pointed out in connection with the commercial accounts, other factors besides the charges affect the volume of business; and some of these factors are varying all the time. After a couple of years, or less, it is apt to become quite impossible to measure the induced business at all, since it is no longer practicable to make a reasonably accurate guess at what the volume of business would have been if the rate-cut had not been made. Thus the measurement of this second factor, the induced revenue, is a tricky business, and the result is always to some extent a matter, not of fact, but of opinion. But this does not mean that all opinions are equally likely!

Then there is the third factor to be assessed. This is the cost of handling the induced business, and is doubly speculative. It can only be reckoned by assessing the cost of handling an additional unit of the business (a trunk call of the type in question, a residential telephone, or whatever it may be that has been reduced in price) and then multiplying this cost by the volume of the induced business. But, as is explained above, this volume is speculative. Then the assessment of the cost of handling a unit of additional business is itself a process open to much doubt. The average cost of handling a unit of business is or should be known, though even the measurement of this is not without its difficulties, as will be seen later. But there is usually no reason at all to suppose that the cost of handling additional business will work out to be the same as the average figure. It may be handled at less than the average cost, in which case the rate-cut will reduce the average cost of handling; or it may cost more than the average, in which case the cut will increase the average cost of handling. In point of fact, it is extremely important to take this

factor into account because the administration tries to choose rate-cuts in such a way as to reduce the average cost of handling. That is, types of business are selected for rate reductions (allowing for other considerations of policy which have to be taken into account) in which it is believed that the cost of handling additional business will be less than the average cost per unit. One of the objects of trying to measure the financial effect of the cut is to see if a reduction in the average cost per unit has been obtained (in which case further reductions in the same direction may be made when conditions permit), or whether a mistake has been made (in which case the next rate-cuts ought to be made elsewhere). In attempting to assess the average cost per unit, the time factor comes in here too. In this matter of financial effects, static figures purporting to show the position at a particular date are never enough to get at the root of the matter; the concern is essentially with a moving picture of trends, which are elusive things.

The analytic way of assessing the financial effect of a rate-cut then amounts to this: the loss of revenue on the existing business affected is calculated; the volume of the new business induced by the cut is estimated, and hence its revenue value at the new rates is determined; finally, the cost of handling this induced business is estimated. These are three separate computations. Then the net loss caused by the cut is measured by subtracting the second figure from the first and adding the third. Thus the net loss incurred equals the loss on existing business, less the revenue from induced business, plus the cost of handling the induced business. If this works out negative the financial effect has been a net gain.

The Synthetic Method.

The synthetic method looks quite simple, as it consists just in measuring the profit on the particular service affected before and after the cut, and watching its subsequent trend. This is done by measuring the average revenue and the average cost per unit of service. The difference between these is the average profit per unit of service. Then the profit is determined by multiplying the average profit by the volume of business which, when measured after the cut, naturally includes the induced new business. This evades the awkward problem of measuring the cost per unit of additional business, as distinct from the average cost per unit of the existing business. As will be seen at once, this procedure really begs the question, since it makes no allowance for any changes in the profit per unit of business which may have been brought about by causes other than the rate-cut. Nevertheless, if done soon after the change of charges is made (that is, before the other causes affecting profitability, which in general are continuous and more or less gradual, have time to make much difference compared with the sudden effect of the rate-cut), it gives the best possible measure of the initial effect of the cut. Also it is obviously useful in itself to know how the profitability of any particular type of service is varying, even if one cannot be sure how far the variations are due to rate policy and how far to other causes.

RECENT IMPORTANT TARIFF REVISIONS.

Table 2 is a list of the reductions in charges which will be discussed. These are only the main rate-cuts;

TABLE 2.
ESTIMATES OF GROSS REVENUE CONCEDED ON
EXISTING BUSINESS AT THE DATES OF RECENT
IMPORTANT TARIFF REVISIONS.

Date of Revision	Description	Gross Annual Revenue conceded on existing business
1.10.34	Cut in business tariff and introduction of business small user tariff	£ 474,000
1.10.34	Cut in residence tariff	780,000
1.10.34	Trunk charges cut on calls over 100 miles (including introduction of 1s. night call and of a maximum day rate of 4s.)	500,000
1.5.36	Trunk charges cut (largely on morning calls over 35 miles: maximum day rate of 2s. 6d.) ..	600,000
1.10.36	Residential subscriber's tariff—50 free calls	562,000
1.10.36	Cut in business standard tariff ..	416,000
1.10.36	Cut in business small user tariff ..	76,000
Total annual revenue transferred to the public initially		£3,408,000

a number of minor ones, the effect of which is measured in the same way, will not be dealt with as they are of much less importance to the general financial position of the telephone service.

The table shows the gross revenue given away on the business being done at the time of the change, in each case. This is only the first factor in the financial effect, as measured by the analytic method, and is given here by itself, not as a measure of the financial effect but as an indication of the order of importance of the various major cuts. As stated above, whatever the other effects, the initial loss of revenue on existing business is the amount of income transferred immediately by the cut from the Post Office to the public, whether the public chooses to take its benefit out in cash or in more (induced) telephone service.

It is worth examining these figures in this light. It will be seen that the total annual revenue transferred to the

public initially amounts in round figures to £3½ millions. This money has really been given away. It is not a hypothetical figure, such as that sometimes quoted, of the extra amount the public would have to pay now for their telephone service if the rates had not been cut. Such a figure would be much greater and is not given here, for no effective answer is seen to the criticism that it would be fictitious. If the rates were higher than they are, there would be fewer subscribers and fewer calls, so that the public would not in fact be paying the amount in question, but this £3½ millions is a real figure. Returning to the commercial accounts (Table 1), it will be seen that there has never been a surplus of anything like this amount. Yet this money has been given away and there is still a surplus. The explanation turns partly on the other factors governing the financial effects of rate cuts, namely the value of the new business induced and the cost of handling it, but it will be seen that these factors only give a partial explanation.

Table 3 shows the net financial effect of the rate-cuts, in each case during the first 12 months of their operation, as measured in the analytic way. The 1934 cuts, which are now too far distant for very detailed analysis to be useful, have been grouped together because their effects have become merged in the effects of other causes, some external to the Post Office and some internal, the latter including the later rate cuts (of 1936). The figures in Table 3 in regard to these 1934 cuts go back to the year ended September, 1935. The cuts in the standard business tariff and in the small user business tariff which were made together in 1936 have also been grouped together.

Column (1) shows the initial loss of revenue on existing business—the same figures as before, with one adjustment (namely the inclusion of the minor changes made at the same time—these are included

TABLE 3
ESTIMATES OF NET ANNUAL COST OF RECENT IMPORTANT TARIFF
REVISIONS IN THE FIRST FULL YEAR OF THEIR OPERATION.

Date of Revision	Description	(1) Gross Revenue conceded initially	(2) Revenue from new business induced	(3) Cost of handling induced business	(1) - (2) + (3) Net cost
		£ per annum	£ per annum	£ per annum	£ per annum
1.10.34	All concessions made on that date (including minor changes such as cut in H.M.T. charges and imposition of connection charges on new subscribers)	1,850,000	1,169,000	560,000	1,241,000
1.5.36	Trunk Call reductions (2s. 6d. maximum day rate) ..	600,000	280,000	40,000	360,000
1.10.36	Fifty Free Calls to residential subscribers	562,000	323,000	348,000	587,000
1.10.36	Business rental concessions (standard and small user tariffs)	495,000	60,000	48,000	483,000
Total net cost					£2,671,000

because the corresponding figures for the other columns are not all available separately). Column (2) shows the estimate of revenue from new business attracted in the first year. Column (3) gives the estimates of the cost of handling this induced business; and finally column (4), the entries in which are obtained in each case by subtracting the entry in column (2) from that in column (1) and then adding the entry in column (3), gives the answer, obtained by this method, to the question, what was the financial effect of the cut?

It is proposed, at this point, to comment in rather general terms on these figures, and later to go in more detail into the figures for two of the rate cuts, viz. the 1936 50-free-call concession to residential subscribers and the reductions in the trunk call charges. First, as regards the total net effect of all these important rate reductions. According to these figures, the Post Office has given away in effect over £2½ millions a year net in the last 5 years in reduction of charges, out of a surplus which has never at any time reached £2 millions a year. How was this conjuring trick performed?

Probably the reader's first reaction will be to question the figures. The figures—at least those in columns (2) and (3)—are certainly only approximate estimates. They may well be considerably out. Some of them are criticised below, and they should be read in the light of these criticisms, but the biggest figures are those in column (1), which cannot be far out, since they are the result of applying simple arithmetic to the figures of the business actually done at the time—numbers of trunk calls, of residential and business lines etc., and there is no scope for serious error there. The total net effect (sum of column (4)) is indeed about a million pounds different from the measured total of column (1), which has been discussed. But even if columns (2) and (3) are largely out, their difference will only be wrong to a comparatively small extent. (If, for example, the amount of induced business has been exaggerated probably also the cost of handling it will have been exaggerated, and vice versa). It is this difference which enters into column (4). Even if, after all, this difference is 25 per cent. out, that error would amount to only a quarter of a million pounds in the aggregate, and the total financial effect as measured in this way would still be a net annual loss of an amount bigger than any surplus the Post Office has ever had to lose. The conjuring trick can't be exposed by questioning the figures. The answer is that it has been done, as conjuring tricks usually are, by the engineers. Technical progress has rapidly reduced the cost of handling a unit of business. When this happens, the cost of handling new business is less than the average cost of handling all the business; that is to say the telephone service is operated—at all events a considerable part of it—under conditions of what the economists call "increasing returns." This is not universally true of telephone business, but it was true of the bulk of the business at the time and place under review. This is partly allowed for, it is true, in the figures of column (3), but only in so far as the new business was estimated to have been induced by the rate cuts. Now there has certainly been a lot of new business in addition to that so induced. The telephone

service has expanded every year for nearly twenty years back, and would certainly have expanded in every one of the last five years, even if the charges had not been cut—though not by so much. Thus, at least on an average over a period of years, the engineers are increasing the surplus for the Post Office. By cutting the charges the increase has partly been given away to the users; the Post Office is letting them have at least the greater part of the benefit derived from the increasing technical economies effected. On the other hand, if this had not been done, a good part of those economies would not have been realised.

This point will be put more concretely taking trunk calls as an example. Modern transmission methods—cables replacing overhead wires, loaded cables of light gauge replacing unloaded ones of heavy gauge, the use of phantoms and of carriers, etc.—enable additional traffic to be carried, *provided there is enough of it*, more and more cheaply. Rate cuts increase the volume of traffic; thus they pay for themselves partly; and in so far as they do not, they are paid for out of the technical economies realisable anyhow in the growing service. But if the rate cuts had not been made the cost of handling trunk calls, per call, would now be higher than it is; either the laying of economical modern cables would have had to be restricted for lack of traffic to fill them; or when laid, they would have remained so lightly loaded that the economy of using them would have been swallowed up by the cost of the idle channels.

The Financial Effects of the 1934 Cuts.

Returning to the figures in Table 3 and considering, first, the 1934 cuts as a whole, it will be seen that the induced business was very large and that the estimated cost of handling it was relatively very small, amounting only to about 50 per cent of the revenue it brought in. The new business induced was large for three reasons. First, because the cuts—they are shown in detail in Tables 4 and 5—were concentrated to a considerable extent in two fields—residential subscribers' rentals and long-distance trunk call charges—where there was latent demand waiting to be tapped; secondly because they were driven home to the public concerned by intensive publicity; and thirdly because they were made at the right psychological moment, very soon after people had begun to realise belatedly that the country was emerging from the depth of the 1929-32 trade slump. Business was already fairly good, and was getting better; the country had just got over a curious temporary setback which occurred in the summer of 1934; everyone with money felt like spending, and a good many people had rather more money to spend than for several years previously. The Post Office, and especially its telephone service, was in the air—anyhow it was in the films and the press—and the new spenders spent a good deal on the telephone wares which were offered them with the bait of "cut prices." That is why the induced business was large.

It was relatively cheap to handle for two reasons. First the technical conditions which make and keep the cost of handling additional business below the average cost of handling existing business. Secondly, the Post Office had unavoidably accumulated a good

TABLE 4.
EXCHANGE LINE TARIFF REVISIONS OF 1.10.34 AND 1.10.36.
QUARTERLY RENTALS—LONDON AND PROVINCES
(In the Four Large Cities an intermediate rate
applies throughout.)

	Before	1.10.34-	After
	1.10.34	30.9.36	1.10.36
LONDON			
	£ s. d.	£ s. d.	£ s. d.
Business Standard :			
Exclusive Line	2 0 0	1 18 0	1 15 6
Auxiliary Line	1 15 0	1 13 0	1 8 0
Business Small User ..	—	1 12 0	1 9 6
		+Surcharge	+Surcharge
Residence :			
Exclusive Line	1 12 6	1 6 0	1 6 0 (Incl. 50 Free Calls)
Auxiliary Line	1 10 0	1 3 6	1 3 6
PROVINCES			
	£ s. d.	£ s. d.	£ s. d.
Business Standard :			
Exclusive Line	1 15 0	1 12 0	1 9 6
Auxiliary Line	1 10 0	1 7 0	1 2 0
Business Small User ..	—	1 6 0	1 3 6
		+Surcharge	+Surcharge
Residence :			
Exclusive Line	1 7 6	1 0 0	1 0 0 (Incl. 50 Free Calls)
Auxiliary Line	1 5 0	0 17 6	0 17 6

deal of spare plant-capacity during the trade depression just preceding, when demand for telephone service, as for anything else, was slack, and so could carry quite a lot of additional business, by just taking up the spares, at much less than average cost. This process of taking up spares is not, of course, permanent, like the effects of technical progress. When the extra spares are all taken up, if not before, new plant must be put down and the cost of handling the additional business which has been attracted reverts, as it must, to a higher level. But this higher cost is still at the

TABLE 5
REDUCTIONS IN TRUNK CALL CHARGES OF 1.10.34
CHARGES FOR A 3-MINUTE CALL
(The only alteration as regards calls under 75 miles was that after 1.10.34 calls in the period
5 a.m. to 9 a.m. were charged at afternoon rates)

MILES	BEFORE REVISION			AFTER REVISION			
	7 a.m. to 2 p.m.	2 p.m. to 7 p.m.	7 p.m. to 7 a.m.	9 a.m. to 2 p.m.	2 p.m. to 7 p.m.	7 p.m. to 5 a.m.	5 a.m. to 9 a.m.
	s. d.	s. d.	s. d.	s. d.	s. d.	s. d.	s. d.
75-100	2 6	2 0	1 3	} 2 6	} 2 0	} 1 0	} 2 0
100-125	3 0	2 3	1 6				
125-150	3 6	2 9	1 9	} 3 0	} 2 6	} 1 0	} 2 6
150-200	} 4 6	} 3 3	} 2 3				
200-250				} 3 6	} 3 0	} 1 0	} 3 0
250-300	} 5 6	} 4 0	} 2 9				
300-350				(maximum rates)			
Each additional 100 miles or part thereof	1 0	0 9	0 6				

level corresponding to the more efficient new types of plant provided when the spares ran out; that is to say, it is still below the average cost. Moreover, the new business is increasing all the time. So the position in 1934 was that the exceptional spare plant position gave temporary help in financing the large initial loss of revenue, due to the rate cuts, on existing business. After that the Post Office had to rely on a more normal rate of profit on its growing new business. In other words, it had to rely on its fortunate technical position of operating under conditions of increasing returns. The course of the commercial account surplus showed that it was right in reckoning that it could safely rely on this factor, but this was only so because of the technical economy realised by using, and using on a large scale, plant of the new and more efficient types which the engineers had made available. It is desired to stress the way in which a progressive rate policy fits in with technical progress. Either without the other is stultified.

This leads to another point. The 1934 cuts had the benefit, not merely of the steady progress of technical economies—those are still going on—but also, as has been pointed out, of the “super-margin” (to use a phrase of Sir Henry Bunbury’s) of spare plant. The 1936 cuts had the former but not the latter. The super-margin is of no financial help in the long run; but it is a very present help in the short run. That is one important reason why the short-run effects of the 1934 cuts were better than the short-run effects of the 1936 ones. But it does not follow that the long-run effects of the 1936 cuts will be less favourable than those of the 1934 ones—it is too soon, of course, to tell.

Financial Effects of the 1936 Cuts.

It will be seen that in 1936 the Post Office gave away between £1½ millions and £1¾ millions of revenue on existing business. (Column (1) of Table 3). It got back, in the first year, some £660,000 of revenue from induced new business—this time only a little over one third of the revenue given away, against nearly two thirds on the 1934 cuts; and it had to spend perhaps £450,000 to carry this induced business, though this last figure is very speculative for reasons given below. Altogether a much less immediately profitable affair than the 1934 cuts, viewing each of the two sets of rate reductions as a whole. The reasons have already been indicated. For the induced new business, the position was something like this. The three factors which operated in 1934 to give such a quick response in

new business were, first, the choice of the services in which the cuts were made, secondly, the intensive publicity they were given, and thirdly, the improving state of trade and incomes generally. Now in 1936, one of the cuts—amounting to nearly one-third of the whole in financial importance, was not chosen with a view to bringing in induced new business. It was made for reasons of policy, although it was not expected to bring in any material new business. This was the reduction in the standard business tariff rentals. This particular rate cut was not expected to have much other financial effect than to benefit the existing business users, and it had just about the effect expected. It is honest to mention here that the administration did hope for some response in the way of additional subscribers from the cut in the small business user tariff—a tariff which had met with quite a good response when it was first introduced in 1934. In fact the response in this field in 1936 was disappointing; but the service is a relatively small one, and not of over-riding financial importance; about 23 per cent. of the business subscribers are now on the small user tariff, but this represents a much smaller proportion of lines and of revenue.

The other two cuts were the 50 free calls to residential subscribers and the trunk call reductions (Table 6). These cuts were, as rate reductions usually are, designed to secure new business, and as will be seen from the figures they did secure it to a satisfactory extent, but not to the extent of the cuts of 1934. The reason is that the position in 1936 was less exceptionally favourable in regard to both the other factors which govern the volume of the new business induced by rate cuts.

Business and incomes were, it is true, still well on the upgrade; the recession did not begin till about midsummer 1937, and it may safely be assumed that it hardly affected the figures here given, which relate, as has been emphasised, to the first year of the operation of the rate cuts, but neither the nature of the cuts, nor the moment, were so psychologically opportune as in 1934. There was a good press; but the half-crown maximum for day trunk calls, and even the 50-free-call concession to residential subscribers, were definitely less sensational than the 1s. night trunk call. Besides, a second set of big Post Office telephone

rate reductions was in the nature of things less striking as front-page news than the first one, only two years earlier. Nevertheless, if one takes only the two cuts intended to produce new business, the trunk call charge reductions and the 50 free calls, it will be seen that they succeeded in this object to a very substantial extent. Taking them separately, the trunk cuts, giving away £600,000 of revenue on existing business, brought in new business in the first year to the value of £280,000; and the 50-free-call concession, giving away only £562,000, brought in no less than £323,000 in the first year. It was the cost of handling the new business, particularly of handling the new subscribers brought in by the 50 free calls (for it proved to bring in new subscribers rather than additional calls), which was the relatively unfavourable factor. The effect of the 50 free calls is examined in more detail later.

THE REDUCTIONS IN TRUNK CALL CHARGES.

The Shilling Night Trunk Call.

Table 7 shows the actual cuts in the night charges; they affected only calls over 75 miles in distance and increased progressively with distance. Since this is an article on financial effects, no detailed traffic figures will be given; all readers will know that the result was, as anticipated, a proportionately enormous and permanent growth in the volume of long-distance night traffic.

TABLE 7.
THE 1S. NIGHT TRUNK CALL (1.10.34).

Miles	Old Rates for a 3-Minute Call (7 p.m.—7 a.m.)	New Rates for a 3-Minute Call (7 p.m.—5 a.m.)
	s. d.	s. d.
75-100	1 3	1 0
100-125	1 6	1 0
125-150	1 9	1 0
150-250	2 3	1 0
250-350	2 9	1 0
350-450	3 3	1 0
Etc.	+6d. per 100 miles or part thereof	1 0 (maximum rate)

For the financial effect, the results can best be shown by the synthetic method because the effect of the rate cut was rapid and out of all proportion to the effect of any other factor. Since it became necessary to provide lines on a number of the longer routes to cater for the night peak (after 7 p.m.), it was felt necessary to keep a specially close watch on the financial position of the night service. Obviously, the 1s. rate does not cover, and is not intended to cover, the cost of line-plant. It is an off-peak rate, designed to attract fill-up traffic; that is to say, it is based on the assumption that, by and large, the morning peak is the biggest

TABLE 6
REDUCTIONS IN TRUNK CALL CHARGES OF 1.5.36
CHARGES FOR A 3-MINUTE CALL
(There was no reduction on calls of 15-35 miles)

MILES	BEFORE REVISION			AFTER REVISION		
	9 a.m. to 2 p.m.	5 a.m. to 9 a.m. 2 p.m. to 7 p.m.	7 p.m. to 5 a.m.	9 a.m. to 2 p.m.	5 a.m. to 9 a.m. 2 p.m. to 7 p.m.	7 p.m. to 5 a.m.
	s. d.	s. d.	s. d.	s. d.	s. d.	s. d.
7½-10	0 3	0 3	0 3	} 0 3	0 3	0 3
10-12½	0 4	0 3	0 3		0 3	0 3
12½-15	0 5	0 4	0 3	} 0 4	0 4	0 4
35-50	1 6	1 0	0 9		1 3	0 9
50-75	2 0	1 6	1 0	} 1 6	1 6	1 0
75-125	2 6	2 0	1 0		2 0	1 0
125-200	3 0	2 6	1 0	} 2 6	2 6	1 0
200-300	3 6	3 0	1 0			
over 300	4 0	3 6	1 0		(maximum rates)	

load and governs the provision of line-plant, so that any excess of revenue from night calls over the cost of operating them is profit. The problem was to make sure that, on an average over the country, this was still the position. On some individual routes it obviously is not; but the trunk tariff, and indeed our telephone tariff generally, is designed, not to fit places individually, but in relation to the average conditions over the country. Therefore, after the introduction of the 1s. rate, the demand night calls were costed separately, taking into account not merely the operating costs, but also the full plant cost of all lines and exchange positions put into service specially for the night traffic. This was a conservative basis, for the following reason. The additional plant taken up to cater for the night calls on routes where the night peak is heavier than the day peak consists of spare lines and positions, and the immediate cost of bringing these into service is very small. But the margin of spare lines, repeaters and exchange equipment is reduced and this brings nearer the time when new cables, etc., will have to be provided. These accelerations will be repeated on each occasion when new plant is required in the future on the routes or at the exchanges concerned; and the costings assume that the present value of the cost of these accelerations is equivalent to the full annual charges on the additional plant taken into use. This, however, is only accurate if one ignores future technical economies which may have taken place before the new plant is actually wanted. Thus the administration is measuring, in respect of the plant used, not the actual cost of the rate cut but maxima which may never be reached. Moreover it is sometimes possible, by patching together shorter circuits on which the day load is greater than the night load, to make up long circuits at night on routes where the night peak exceeds the day peak without providing any additional plant for the night load. This last source of economy, which has proved so far disappointing, is also ignored in the calculations. It is also important to note that the figures for the various post-revision rates shown in Table 8 do not represent variations in the cost with

time; the differences are due to errors of sampling, and what is significant is their broad average. They show a satisfactory overall margin of revenue over cost.

The net financial results of the introduction of the shilling night trunk call have therefore been these:— First, immediately after the cut, the Post Office was carrying roughly three times the former volume of traffic at about one-third the profit per call—that is to say, at about the same total long-run profit. (The short-run profit was of course, higher.) So the public was able to afford three times as many evening long-distance calls as before, and the Post Office did not lose a penny, even in the first year. Secondly, the practice of using the trunk service in the evening has now become an established habit among the British public—a habit which did not exist at all before 1934—and the Post Office is catering for this habit on a remunerative basis. Thirdly, a little extra money was made temporarily by filling up some of the exceptionally large margin of plant which was lying idle at the time.

The Reductions in Charges for the Day Trunk Call.

The story of the charges for day trunk calls is really only intelligible if one considers the 1934 and 1936 cuts together, since they were successive steps in a long-term policy.

It will be seen from Table 5 that the 1934 cuts were concentrated on the longer distances, that is, on calls over distances of 100 miles or more, and that the cuts grow heavier the longer the distance. In March, 1934, the charges on these calls were, by European standards, high; the service was highly profitable per call, but the use made of it was restricted, and this, of course, restricted the total profit. In fact, in March, 1934, of all calls in this country costing 3d. or more, less than 5 per cent. were over 100 miles. Trunk calling was still more or less a business luxury. Hence on the one hand a substantial cut at these ranges could be made with comparatively small loss of revenue on existing business, and on the other hand such a cut might be expected to bring in a high proportion of induced new business. Further, the state of technical progress was, as it still is, such that additional traffic could be carried in large quantities at much less than the average cost. These considerations explain the nature of the cuts chosen. As regards the financial effect, in the first year no less than £530,000 worth of new business was secured for a sacrifice of only £500,000 on existing business; and all this new business was handled at a cost of only £130,000. Thus, these heavy cuts cost only about £100,000 net in the first year. These figures also include the night cuts, that

TABLE 8.
COST AND REVENUE PER CALL OF NIGHT DEMAND CALLS.
(ROUGHLY THE 1/- CALL).

Date	Cost per Call	Revenue per Call	Profit per Call	Profit as a percent. of Revenue	Estimated Annual Volume of Traffic	Total Annual Profit
PRE-REVISION 1933-34 ..	8.46d.	20.13d.	11.67d.	58.0%	4,100,000 calls	£200,000
POST-REVISION (Samples)						
October, 1934 ..	10.34d.	15.40d.	5.06d.	—	—	—
November, 1934 ..	11.54d.	15.83d.	4.29d.	—	—	—
January, 1935 ..	13.41d.	15.83d.	2.42d.	—	—	—
October, 1936 ..	10.60d.	16.80d.	6.20d.	—	—	—
March, 1937 ..	13.40d.	18.22d.	4.82d.	—	—	—
Year commencing 1.10.34 ..	—	—	Say 4.00d.	25% approx.	10,900,000 calls	£180,000

is the 1s. night trunk call, and therefore for the day cuts alone the results, though very good, are a little less favourable. The 1936 day cuts (the night rates were unchanged) were of a similar kind, but less striking in degree, for obvious reasons. The Post Office still concentrated on the longer distances, but carried the field lower. (Table 6.) The maximum charge for a 3-minute inland call, which had been effectively 6s. 6d. before the 1934 cuts, and which then became 4s., was reduced still further to the rather attractive figure of 2s. 6d. But the existing traffic on which revenue had to be sacrificed was bigger, and the scope for inducing new traffic smaller. Thus the Post Office had to give away £600,000 a year on existing business with less striking effect than it had been able to secure by giving away £500,000 in 1934, and it got back £280,000 worth of new traffic in the first year as compared with £530,000 in 1934. This new traffic was, however handled extremely cheaply at the outset by the use of the temporary gain derivable from the super-margin of spare plant in financing the initial loss on a rate cut.

The position may be summed up by stating that during the last five years the Post Office has converted the long distance internal trunk service of Great Britain from a definitely dear and relatively little-used service to a service which is moderately cheap and fairly widely used.

The 50-free-call Concession.

In 1934 a substantial cut was made in the rentals charged to residential subscribers. (Column (2), Table 4). The standard charge was reduced to the attractive figure of £1 a quarter, at least in the provinces generally. The charges in the four biggest provincial cities and in London are higher, though they were cut proportionately in the 1934 revision. But every subscriber had still to pay, over and above his rental, for every call he made. The rental was still not really a measure to the potential subscriber of the amount he would have to pay for the service he wanted. It was still what the Americans call a "readiness-to-serve" charge. The effect of this was to make the cost of a residential subscribers' service, measured as a cost to him per call, much higher than the cost of a business man's service, similarly measured. It is not asserted that this is the right way to look at it, but it is a way of looking at the cost of service which, rightly or wrongly, is often adopted by potential subscribers. The answer that a commercial traveller's car, used every day, costs him less per mile than the cost per mile of a similar private car, sparingly used, is all right as far as it goes. It is true that differences of cost

of this sort are inevitable, but the point is that the 1936 free call concession reduced the difference. These things are usually matters of degree. In spite of retaining the readiness-to-serve charge feature, the 1934 cuts were very successful in attracting new subscribers. In 1936 it was decided to make what may be called a bold bid and to offer a positively new attraction (new in this country, that is to say), namely an allowance of 50 free local calls a quarter, worth one penny each. The customer still hanging about outside the door of the shop was to be tempted in by an inclusive offer; if 50 penny calls a quarter were all he was likely to want, he could get his telephone service for £1 a quarter down. No unforeseen bills! (As will be realised residential subscribers only are referred to—the main field of potential expansion.) Further, it was hoped that perhaps the concession, by making local calls look less like individual items of avoidable expenditure, might cause people to use them, and let their households use them, more freely, and so increase the average residential subscriber's calling rate, which was low in comparison with some other countries. In so far as this happened the concession would help to pay for itself. In fact, it was hoped to get both more subscribers and more calls per subscriber. Before giving the financial figures, it will be stated at once that the former hope was amply fulfilled and the latter hope partially disappointed, with the result that the financial estimates turned out just about right.

Before so important a step was decided upon, very careful estimates of its probable effect were made; and after the change had been put into effect, attempts were made to measure what the effect had actually been. The figures are shown in Table 9—as before, they relate to the first full year during which the concession was in operation. This table shows the effect on revenue only—i.e., it takes into account the first two factors governing the net financial effect of the change, but not the third factor—the cost of handling the induced new business. This last factor is

TABLE 9.
FIFTY FREE CALL CONCESSION—OCTOBER, 1936.
(Residential Subscribers)
REVENUE EFFECT.

	(1)	(2)	(3)	(4)	(5)
	Quarters ended :				Total for Year
	Dec., 1936	March, 1937	June, 1937	Sept., 1937	
	£	£	£	£	£
(a) Loss of revenue from free call concession to existing subscribers	142,000	140,000	137,000	143,000	562,000
(b) Induced revenue from calls in respect of all subscribers ..	43,000	82,000	60,000	45,000	230,000
(c) Difference = net loss of call revenue	99,000	58,000	77,000	98,000	332,000
(d) Induced revenue from rentals of new subscribers	10,000	24,000	29,000	30,000	93,000
(e) Difference = net loss of revenue	89,000	34,000	48,000	68,000	239,000

The last line shows total effect on revenue, i.e., ignoring the cost of handling induced new business.

in point of fact particularly important in this particular rate cut, and will be dealt with separately.

The table shows the effect on revenue separately for each of the first four quarters in which the new rates were operating—columns (1) to (4). Column (5) gives the total for the first year—that is the sum of columns (1) to (4). Of the 5 rows of figures, the first is the loss on existing business. Only call revenue was affected; residential rentals as such remained unchanged. The induced new business was of two kinds, the induced additional calls from all subscribers (new and old), and the induced new subscribers' rental business. The revenue brought in from these is shown separately in the second and fourth rows. Both types of gain have to be subtracted from the loss on existing business to get the net revenue position (the cost side is ignored at this stage).

As a rule, the loss of revenue from existing business is calculated precisely beforehand. Here, however, to do this would have necessitated analysing several millions of subscribers' accounts; instead a sample was used. In estimating the induced revenue a similar but improved process of sampling was used, and the loss on existing business was recalculated. The total value of the free calls during the first year of the concession is put at about £635,000, of which it is estimated that £562,000 was in respect of subscribers existing at the date of the concession, viz. September 30th, 1936. The balance is attributable to additional subscribers, induced and other, secured during the year.

As regards induced subscribers, the number of these gained in the first year is put, in the light of events, at about 27,000. This had been guessed in advance at 21,000; so in this respect the Post Office did definitely better than it had anticipated. The induced revenue from these subscribers' rentals is shown in row (d); it is a steadily mounting figure during the four quarters, since rental gains, in contrast to call gains, are cumulative.

The induced revenue from local calls from all subscribers, new and old, is shown in row (b). It will be seen that it reached its maximum in the second quarter of the concession. In the first quarter, it is reasonable to assume that the position was affected by a lag in increased use by existing subscribers, while new subscribers on the average probably provided only half of a full quarter's call revenue. There is a further consideration, in that, as regards the induced new subscribers, there is not only induced revenue from their outgoing calls, but also induced revenue from calls incoming to them. The full effect of this would not have been felt in the first quarter. So it is not surprising that the concession had its maximum effect in inducing new call revenue in the second quarter. In the last two quarters the decline can no doubt be attributed to a return to more normal figures.

If the call charge position is considered as a whole, the position shown in Table 10 results. It shows that the percentage of free to chargeable local calls increased steadily throughout the year; and also that the percentage of the subscribers affected who did not exceed their free call allowance—that is those whose rental covered the whole of their local telephone

service—rose after the March quarter. It seems reasonable to attribute these results to two factors:—first, the steadily decreasing effect of the concession, secondly, the fact that the new subscribers induced by the concession to come on to the telephone for the first time are not likely to be large call users, and a

TABLE 10.
FIFTY FREE CALL CONCESSION.
PERCENTAGE OF FREE TO CHARGEABLE LOCAL CALLS IN
THE FIRST FOUR QUARTERS.

Quarter ending	%
December 1936	37·2
March 1937	37·8
June 1937	38·7
September 1937	45·6

PERCENTAGE OF (RESIDENTIAL) SUBSCRIBERS NOT
EXCEEDING THEIR FREE CALL ALLOWANCE.

Quarter ending	%
December 1936	13·0
March 1937	12·2
June 1937	12·8
September 1937	15·6

good proportion of them are likely to try not to exceed the free call limit.

Information regarding the cost of handling the induced new business is very meagre. Unfortunately, the costing technique of the Post Office does not yet enable the cost of local service to be measured anything like so precisely as the cost of trunk service.

As rather more than half the telephones are now on automatic exchanges, a very large and increasing proportion of the cost of handling local calls is plant cost. This means that the cost of handling additional local call traffic (this is by no means the same thing as the average cost of handling existing local call traffic) depends to an enormous extent on its incidence, that is to say, whether it falls during or outside the exchange busy-hour. There is also another difficulty, that in the short run, such cost depends almost entirely on whether the additional traffic happens to accrue in areas where there is spare plant, or alternatively in areas where it necessitates new construction; and this last consideration applies equally to the cost of handling new subscribers' rental business. This being so, it is possible to measure only very roughly the cost of handling the new business induced by the 50-free-call concession in the first year. The administration cannot be at all sure how this concession has affected the commercial accounts up to date. It can use only an approximate estimate of the cost in the long run. The long-run cost of handling the induced business is estimated at about £384,000—rather more than the corresponding revenue from the same business.

Acknowledgment.

The author is indebted to Mr. Holman of the Telephone Finance Branch of the Accountant General's Department, who has taken a lot of time and trouble in abstracting from very voluminous material the documents containing the figures which seemed best to illustrate the points it was desired to make.

Special Events—Telegraph Arrangements

G. E. CARR

U.D.C. 621.394

The article describes the provision that is made for dealing with telegraph traffic at race meetings and other special events, and how the advent of the teleprinter and V.F. telegraph working have simplified the engineer's task.

Introduction.

IN the United Kingdom there now are more than 13,000 permanent Post Offices where telegrams are accepted over a counter for transmission to any other office, and for any part of the world to which telecommunication exists, but since the time when the earliest public offices were established there always has been a demand for special telegraphic facilities which, by reason of their unusual and incidental nature, could not be dealt with satisfactorily by the normal offices. It is the methods by which these demands are met that are described in this article.

The causes which occasion special provision of telegraph facilities are collectively referred to as "Special Events," and invariably they are items of public interest. The majority of these occurrences are sports meetings, and of these, horse-racing events are perhaps the most important from a point of telegraph provision.

If special events are divided into two main groups, viz., (1) horse-racing events and (2) other events, it will be found that in group (1) the type of traffic and its duration are common features, but considerable variety exists in requirements and conditions under which the temporary services have to be made, whereas in group (2) excepting for a few instances, the requirements and conditions are more uniform and variety is found in the incidence of the traffic. The events in the two main groups can be divided under headings indicative of the kind of temporary or additional telegraph provision which they require.

Race Meetings.

- (a) Important meetings where an office with full telegraphic facilities is provided in the course enclosure.
- (b) Meetings where it is convenient to arrange for a messenger service to and from a neighbouring Post Office; and
- (c) Meetings of minor importance where the volume of traffic can be dealt with by telephone-telegram working.

Other Events.

- (d) Recurrent events held at the same place;
- (e) Recurrent events but held at different places; and
- (f) Events chiefly of a political or social nature.

RACE MEETINGS

The earliest temporary telegraph offices were provided as the result of putting one of the oldest English sports—that of horse-racing—on a commercial basis. Public races were established about 1610, when running matches for testing the skill of riders and endurance of their mounts were held at recognised places. The running of horses over a given distance led to comparisons as to their qualities and ability to beat other horses, and certain places became

known for their running or testing grounds. These were simply roped-in tracts of open land and varied considerably in length. It was about 1640 when the first public races were held at Newmarket, which ever since has been noted for this sport.

About 1865 "gate-money" meetings came into fashion, and the courses were surrounded by barricades of one form or another, so that to see the racing one had to pay a fee which usually varied according to the position of view. Not all courses were enclosed however, for to-day some of the well-known old courses, for instance, Epsom, Doncaster, Goodwood and York, are open meetings in the sense of free admission to the greater part of their courses.

In 1875 the Newmarket course was re-established on modern lines. White rails were substituted for the old-fashioned ropes and stakes, the grand stand with its appendage of refreshment rooms, telegraph office, stables, hacksheds and rings, was constructed under the auspices of Sir John Astley, and from that time the grand-stand telegraph office at Newmarket has opened for traffic at each of the eight annual meetings, at which there are in all 29 days of racing and about 174 races are run. It is, perhaps, of interest to note that in comparison with the few prizes and plates of the order of 50 guineas as in olden days, the annual value of the prizes won in horse-racing on Newmarket Heath now approximates £125,000.

With the passing of time almost every licensed race-course has been provided with direct telegraphic communication during the periods racing is in progress. For the past 50 years there has been little change in the number of horse-race courses in the United Kingdom, but since those early days telegraphic traffic has increased considerably, especially after the introduction of the sixpenny telegram in 1890. Although the telephone has latterly taken some of the traffic, extensive telegraph provisions have to be made for present-day important racing events.

Type of Traffic.

The message traffic is more or less common to all events in this class, and the times of rush hour and peaks loads are characteristic. Little traffic is dealt with at course offices before 11.30 a.m., but after this time the number of messages increases rapidly. Reports to press offices, experts' opinions, "information" and telegraphed commissions, inward and outward, are typical of the traffic.

A rush of traffic is associated with the first race of the day—at 1 o'clock or thereabouts—and also with the races which follow at intervals. The most important race of the day, usually about 3 p.m., is accountable for a peak load in the day's traffic. Press messages of varying lengths are forwarded, some being distributed simultaneously to many centres. The load slackens after the last race, which seldom is later than 5 o'clock, and the traffic in hand, chiefly press, is cleared before closing the office.

Course Offices.

When telegraph provision is made at a race-course the temporary office is invariably situated in or adjacent to the grand stand, and this gives rise to the telegraphic code GS office in the same manner that TS, the inland code for the Central Telegraph Office, originated from Telegraph Street. The course office may be situated in a wooden structure, a part of the authority's offices or a brick building erected exclusively for the purpose.

Where the GS office is a wooden structure, usually in the form of a large hut, it is suitably partitioned into an office-counter part and an instrument room. When the public part is external to the office building the counter and booths are protected from the weather by a wide veranda cover extending the length of this part. Messages for dispatch are received over the counter and dealt with as in ordinary post offices, and then passed to the instrument room for transmission.

Messages arriving for the racing public are posted on a large board in charge of a postal official and are distributed in a similar manner to letters in the poste restante service. Where the addressee is known, delivery is made by messenger direct from the office.

In a few instances, an additional small office is provided at another part of the private enclosure but supplied only with counter equipment, the messages being carried to and from the GS office by messengers. At Ascot, however, the additional Silver Ring office at one time was connected to the GS office by pneumatic tube, but being hand operated by the messenger staff, the air pump was often in trouble. For some years now the Silver Ring office at Ascot has been equipped with telegraph apparatus and is a complete temporary office.

Where circumstances permit, a portion of the racing authorities building is used for the GS office, and at some courses brick buildings have been erected specially. In recent instances where the grand stand and course offices have been rebuilt, notably Epsom and Goodwood, the appointment of the telegraph office has been given generous consideration by the racing authorities. These modern offices, fitted with electric light and power available for heating, may be described as palatial in comparison with those of some of the older course offices, where usually there is no heating apparatus other than oil stoves and lighting, when necessary, is by oil lamps.

The present Epsom special event office is a large one. The instrument room is situated on the first floor of the grand stand, to which messages from the counters in post offices serving the paddock, Tattersall's and other enclosures, are sent by pneumatic tubes.

Where circumstances make it unnecessary, e.g. because the race-course is a short distance from a permanent telegraph office, or where local restrictions prevent the establishment of a fully equipped course office, provision of a GS office with counter facilities only suffices, and messengers on cycles carry the messages between the temporary office and the local post office. Extra staff and apparatus are then provided at the local office for the required period.

At lesser important race meetings where the volume of traffic is not sufficient to warrant the provision of modern telegraph apparatus, the installation of one

or two telephone-telegram circuits to the GS office is adequate. In earlier days, however, before the introduction of T.T. working, all these relatively minor race-courses were provided with an instrument room fitted with simple sounder circuits, and many of them had quadruplex circuits to deal with the peak load traffic.

The counter equipment at race-course offices is similar to that provided at an ordinary office giving full telegraphic facilities to the public.

Local Lines.

Although most race-course sites are away from commercial centres, more often than not they are close to a main road leading to the local city or town, and the road generally carries a pole route of telegraph wires. Sometimes the nearest main route of telegraph lines is a railway or canal route.

From a terminal pole inserted at a convenient point on the main route, spur lines are carried to the course. A test-box on the terminal pole into which the main lines reserved for the event traffic are looped and the spur lines terminated, provides a means of connecting the event office into the telegraph network. This calls for nothing more than a re-arrangement of the straps or links in the test-box. At the event office, the local lines are terminated in the usual way on a terminal block or a cabinet when a large number of lines are so terminated, and this is situated at a convenient position in the part used for the instrument room. In circumstances where it is desirable to preserve the amenities at the course, the lines are taken underground for a convenient distance.

Sufficient local lines are provided for the heaviest demand at any particular race-course, and are maintained as permanent plant, but are not subjected to the usual periodical testing. Tests, however, are made prior to bringing the lines into service. When not in use the local lines are isolated at the pole test-box and the main route lines are connected through. It is usual for the local aerial route to carry also the telephone pairs as may be required for the racing authorities, and the booths sometimes provided in or adjacent to course offices.

Main Lines.

During the past decade some very important changes have been made in the methods of operating the inland telegraph service, notably the introduction of teleprinter and voice-frequency working, and as a consequence changes have taken place in the routing of main lines. At a later stage in this article present-day practice in special event arrangements is contrasted with that obtaining some 30 years ago.

OTHER EVENTS

The temporary telegraph provisions for events other than horse-racing differ from the former group in one major respect, that usually they call for nothing more than additional circuits and apparatus at some permanent telegraph office. The message traffic is dealt with via the counter at this local office, the counter and instrument staff being augmented as required. There are, however, occasions where a temporary office with instrument-room equipment is necessary, and dependent upon the character of the event, so the office may be set up in a marquee, hut,

or other building. Some of these events are catered for by a mobile Post Office.

The traffic at these events is mainly press messages, and the times of the busy periods for different events vary widely, and, of course, are largely dependent upon the character of the occurrence.

Recurrent Events Held at the Same Place.

In this class are found many sporting items, and certain places are identified with a particular kind of sport. By way of example, Douglas, Isle of Man, is noted for motor-cycle trials. Southport is well known as a centre for both sporting and non-sporting "events," which include golf championships, tennis tournaments, and in the non-sporting class, Union and professional conferences.

Water sports, such as rowing and yachting races, are responsible for considerable increases in local traffic during the period the event is in progress. Henley is associated with river sports, and sea yachting regattas are held annually at Torquay and the nearby seaports in turn, and on the Clyde a "Yachting Fortnight" is held for which extra circuits through to London are necessary to cope with the increase in traffic. Cowes Regatta calls for some fairly extensive telegraph provision and includes the special arrangements for direct telegraph and telephone circuits to the Court Post Office on board the Royal Yacht when Royalty are present.

Golf occasions its share of special event arrangements. Important matches are held at such well-known centres as St. Andrews, Deal, Hoylake, and when international and open championships are contested it is not exceptional to provide as many as seven teleprinter circuits for a period of about eight days additional to existing circuits to these places.

It is possible to go on quoting events in connection with almost every kind of sport not forgetting cricket and football. With the former are the many county matches which are annual events, and test matches always occasion a special event arrangement. Wembley Stadium has its special event office, which is a very busy one when football finals and other sporting events are in progress.

Another phase of special event arrangements, not for sporting items but of considerable public importance, are the various horticultural and livestock shows. At Bisley, where rifle shooting contests are held annually, six circuits for a period of 22 days are required for the traffic which emanates when the National Rifle Association holds its meeting.

Fairs, exhibitions and shows in connection with many trades and items of public interest have their individual demands

for additional facilities. Olympia, White City and Earls Court, London, are well known for a variety of shows and exhibitions, and at each of these an internal post office is opened for telegraph traffic and other postal services that are made available to visitors.

Recurrent Events Held at Different Places.

These comprise some of the agricultural and similar kind of shows which, although annual events in themselves, are given at different places each year, and may occur at the same place in cycles of anything up to six years. The Royal Show and the Royal Welsh Eisteddfod are examples. During the past three years the former event has been held successively at Bristol, Wolverhampton and Cardiff, and the latter event at Fishguard, Machynlleth and Cardiff. For the Royal Show it is usual to provide 10 telegraph circuits, for a period of six days, at a temporary office set up in the showground.

Political and Social Events.

Some of these events are of annual occurrence and may be, but not necessarily, held at the same place each year. The varied nature of these events will be apparent from the following:—Trade union and international conferences, congresses and similar gatherings.

Finally there is a smaller group of events, mostly non-recurrent, which includes items such as launchings and maiden voyages of big ships, air races and reviews of the defence forces. The Coronation of King George VI, the Service Reviews and incident social occasions in 1937 called for some extensive temporary provisions. In times of political and international crises, demands for additional telegraphic facilities have to be met, sometimes at the

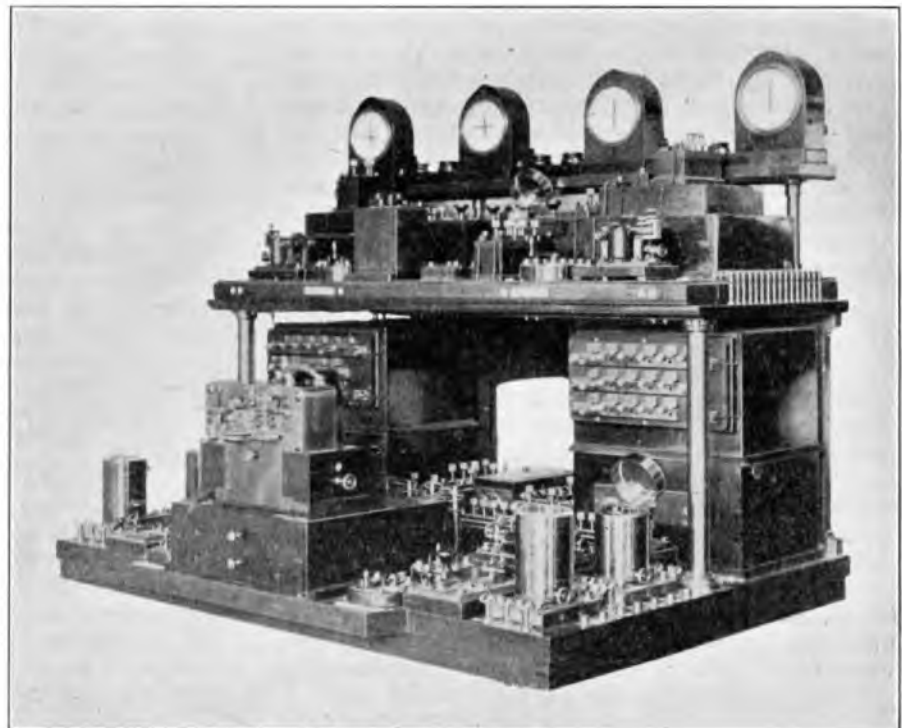

FIG. 1.—AN OLD TELEGRAPH REPEATER.

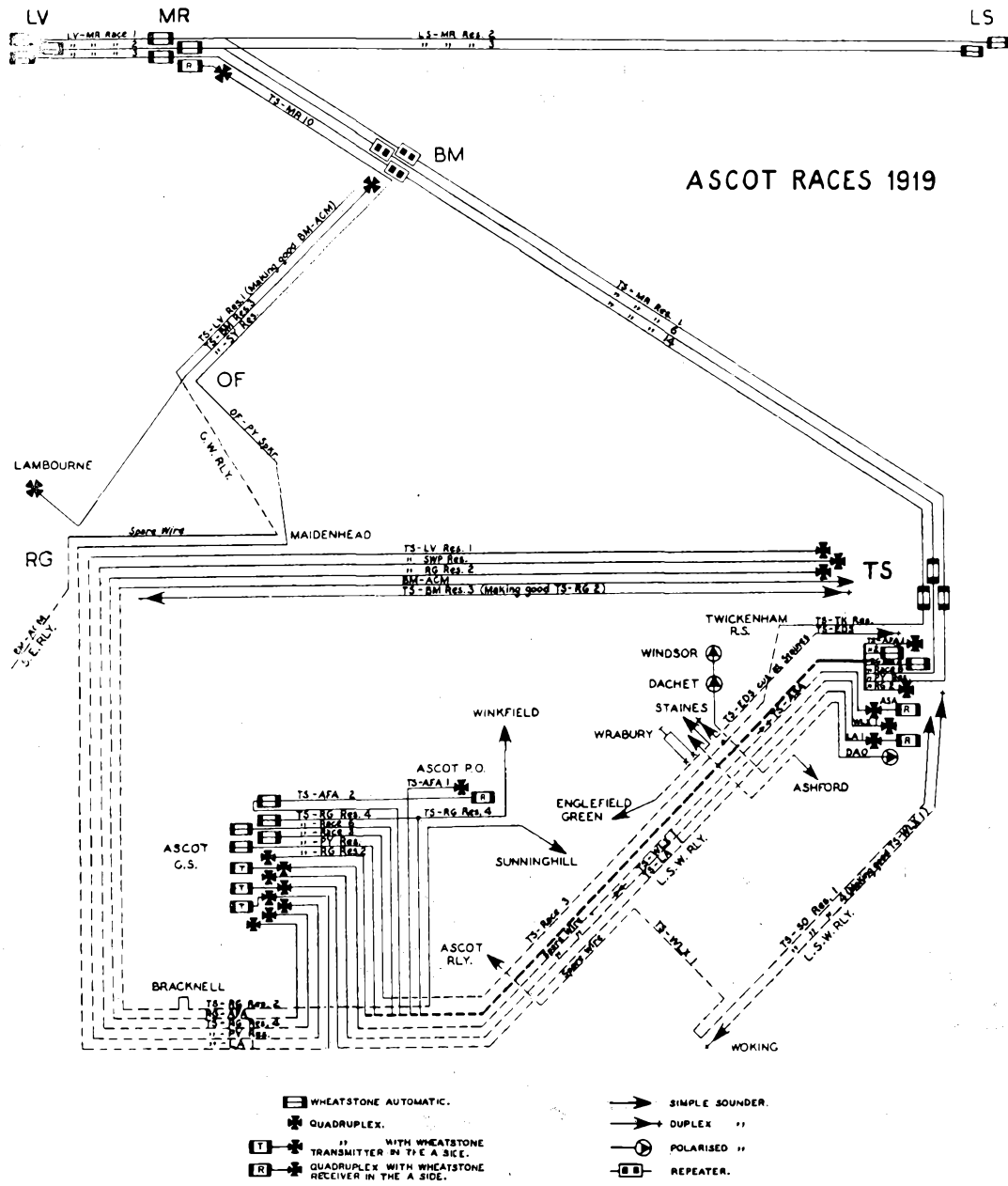

FIG. 2.—Circuits Provided for the Ascot Races, 1919.

very shortest notice. Where the provision is of a temporary nature it is usually dealt with as a Special Event arrangement.

{THIRTY YEARS AGO}

London was the centre of the inland system, and from its Central Telegraph Office radiated an extensive network of aerial telegraph lines giving direct communication to all provincial towns of importance. The routes carried a relatively large complement of spare wires which were not only spare or reserve wires for replacing permanent circuits that became faulty, but also formed the lesser network of wires for providing special event circuits. Some of the wires were used so frequently that they were allocated permanently as race wires.

Circuits.

With important events (both racing and non-racing) invariably it was necessary to provide long distance omnibus circuits for the simultaneous distribution of press traffic. At this period Parliamentary speeches and those made by noted people at various places up and down the country were usually reported verbatim, and special circuits would be set up for the occasion.

As a general rule, circuits operated under special event conditions could be worked satisfactorily up to about 200 miles, and for greater distances a telegraph repeater was introduced at one of the large offices through which the circuit passed. A telegraph repeater is shown in Fig. 1.

Bad weather conditions and the troubles to which

aerial lines are subject provided many problems for the circuit-controlling staff at the Provincial Test Box, C.T.O., and at times it was with difficulty that sufficient circuits could be maintained in working order.

The circuit and apparatus arrangements for Ascot Races in 1919, shown in Fig. 2, are those actually employed on that occasion and are typical of the earlier days. The key to the symbols indicates the multiplicity of types of telegraph systems used.

Staff.

The staff for both counter and instrument-room work at the race-course offices was originally provided entirely from the Central Telegraph Office, and 30 years ago it was ordinary routine for the "Special Section" to provide as many as 85 telegraphists for duty at Ascot G.S. Office. Some 50 operators were employed in the instrument-room alone, and at busy times about half of them would be punching Wheatstone slips with hand-operated perforators and the remainder operating the quadruplex sets and weight-driven Wheatstone transmitters.

In later times the attendance of the C.T.O. Special Section visiting staff was confined to instrument operating, and later still, when local staff became proficient to deal with this specialised work, to events in the southern counties only.

Apparatus and Equipment.

At the Central Telegraph Office the temporary circuits were terminated in the "Special Division" which contained some fifty or more positions equipped with the different types of apparatus for working with any of the sets at event offices. A photograph of this division (Fig. 3) illustrates the old style telegraph apparatus.

The instruments and other apparatus for setting up the temporary offices were drawn as required from an extensive stock held in London. Local engineering staff under the guidance of an expert mechanic wired the apparatus into working telegraph sets on tables



FIG. 3.—THE OLD SPECIAL EVENT DIVISION AT THE C.T.O.

which formed the only permanent furniture in racing event offices. Battery power was supplied from wet or dry primary cells and in a large office so many cells were required that it was usual to provide a small hut specially for them.

The labour of equipping and dismantling at important events was very considerable. With the several different systems of working and the many individual pieces of apparatus to be wired for a variety of sets ranging from the simple morse key and sounder circuits to the long distance quadruplex sets, some joined up for decrement and other for increment working, with the further complication of Wheatstone transmitters on the "A" side, the critical adjustment of many relays with the added excitement of knife-edge balancing and "B" side kicks often made the work of the engineering and instrument room staff animated.

TELEPRINTER WORKING

Until 1928 Wheatstone and quadruplex working were the mainstay of special event arrangements, and it was about this time the introduction of teleprinter working into the inland service began to revolutionise the methods of instrument operating.

Early Trials

In 1929, teleprinter No. 3A working on an experimental basis was tried out at a number of race meetings in the London south-eastern area with every success. At this stage Wheatstone working was retained for omnibus (YQ) circuits. A feature at the trials was the use of a wired baseboard, which really consisted of a complete set of terminal apparatus for simplex/duplex teleprinter working, mounted on a board and permanently wired. This avoided the need for re-wiring and dismantling on each occasion with the consequent saving of much time and labour. The boards, however, were somewhat heavy and bulky.

Throughout the busy season of 1930 the trials were extended and teleprinter YQ working also proved itself satisfactory for this class of work, and in 1931 teleprinter working was adopted generally for special events.

Pool Centres.

The recurrent event commitments throughout the country were grouped into areas so that they could be served conveniently from some centralised pool of apparatus, thereby effecting an economy in the stocks of apparatus to be held and its transport to the various offices. Depots holding a pool of teleprinters, units (see later), rectifiers and subsidiary apparatus are now located at London, Birmingham, Leeds, Manchester, and Glasgow and, with the exception of Manchester, each pool has a mobile petrol-generator unit. The pool centres have the responsibility of providing and maintaining the telegraph requirements for all special event arrangements in their respective areas. The apparatus is in the custody of the mechanics' workshop at these centres and is main-

tained in good working order for dispatch at the shortest notice, if required. Excepting demands in the nature of emergency calls, the provisions to be made from time to time are known well in advance of the date of any special event. Before dispatching the apparatus, it is tested by one of a rota of mechanics who later takes charge of its installation at the event office. He remains in attendance for the period of the event and at the closure is responsible for the safe return of the apparatus. The mechanics employed on these rotas are familiar with all the line and apparatus arrangements of the event offices at which they are required to attend, and are men selected specially because of their ability and experience in the maintenance of teleprinters.

By transporting the apparatus in pneumatic tyred motor vehicles packing is reduced to a minimum, and loading-up at the mechanics' workshop and unloading at the door of the Event Office with the minimum of labour is facilitated.

Where the apparatus is required for providing additional circuits at a permanent office at which testing and maintenance staff are present it is not accompanied by a mechanic from the pool centre.

Power Supply.

Whereas only line and local battery supplies were necessary with earlier methods of working, the adoption of teleprinter working at race-course offices necessitated a power supply for driving the motors. Only at a few courses was a suitable supply already available. Where electric power could be made available at a reasonable cost this was done, but the direct costs for providing mains supply cables varied between such wide extremes as 30s. and £700. The latter figure was obviously prohibitive and where the cost for installing power mains was too great it was realised that the requirements could be met by a portable battery of large secondary cells or alternatively a petrol-generator unit. The fact that the most important of racing centres, namely Newmarket, did not lend itself to economical provision of mains supply at the grand stand office and the use of a secondary battery of sufficient capacity was impracticable, decided the question regarding a petrol-generator unit. A mobile unit was therefore designed specially for use at any race-course office. The use of metal rectifiers solved the problem where A.C. power supply was already available or could be made so.

Mobile Petrol-Generators.

These portable power units comprise a water-cooled, single-cylinder, two-stroke petrol engine fitted with a centrifugal-type governor which reduces speed hunting to a tolerable minimum. It is also fitted with an efficient silencer. Two D.C. generators, designed to give a flat voltage characteristic under the different loads as imposed by starting and running from one to eight teleprinter motors, are direct-coupled to the engine. The normal voltage of each generator is 55 volts and joined in series, they provide the 110 volts motor supply and, as the centre point between the generators is earthed, also a ± 55 V. battery supply for universal working. A portable secondary battery of 52 cells, 26 Ah capacity is

floated across the two generators and in addition to tying the bus bar voltage to 110-112 volts, provides a reserve supply in cases of failure and covers such contingencies as temporary stoppages from a choked jet or sooted plug. Normally the battery is trickle-charging, but at the moment of failure of the petrol unit a circuit breaker disconnects the unit and the load is taken by the battery without interruption to the working telegraph sets. A bell alarm sounds in the instrument room when the circuit breaker operates.

The whole unit is mounted on a rubber-tyred bogie truck and is suitably protected from the weather. When in use it is situated at a convenient place in the open, due regard being paid to avoid annoyance from engine noise or exhaust fumes. A panel on one side of the unit carries the usual instruments and switch gear together with resistances for adjusting the ratios of the series/compound generator windings. Heavy cabtyre cables connect the unit to a separate control panel, which with the floating battery, is located in or adjacent to the instrument room. A kit of tools and spare parts to deal with any ordinary failure of the unit are carried with it.

Auxiliary Apparatus.

A portable universal terminal unit (Unit Auxiliary Apparatus No. 72) has been designed to meet all the circuit conditions for teleprinter No. 3A. By the simple manipulation of a few telephone keys it provides for single wire simplex, two-line simplex, two pair simplex, duplex on single wire or loop, YQ and voice-frequency extension working.

The apparatus is mounted on a panel fitted in a Plimax case (sheet metal covered plywood). The panel is hinged at the front and when raised is supported on collapsible arms, giving easy access to the internal parts and wiring. A detachable cover of Plimax protects the panel when not in use. Diagrams of the internal connections and the schematic arrangements of the various terminations obtainable are fixed inside the cover. The stout construction of the unit avoids the need for any packing when transported by motor vehicle and two folding handles facilitate carrying by hand. It is proposed to describe the article fully in a forthcoming article in this JOURNAL.

Present-day Practice.

The establishment of a temporary office nowadays, so far as apparatus is concerned, is a fairly simple matter. The lines incoming to the event office are extended from the permanent terminations to the tables or benches on which the units and teleprinters are placed. Power leads from the D.C. mains supply, rectifiers if the supply is A.C. or the control board of the mobile power unit, are wired up to the cut-outs on the unit. The lines are connected as required to the terminals at the rear of the panel and the line and local battery supplies to their respective terminals. With the teleprinter plugged into the sockets at the front of the unit, and the keys thrown for the particular method of working, the set is ready for operating.

For duplex working, line balancing is necessary and for this, a morse key and sounder, mounted on a small baseboard, is plugged into circuit in place of the teleprinter. When working as an extension to a



FIG. 4.—INSTRUMENT TABLES AT A MODERN RACING EVENT OFFICE.

voice-frequency channel with battery supply from the V.F. terminal, the relay on the panel is withdrawn from its socket and by throwing the required keys the connections are changed suitably.

A photograph, typical of the instrument tables at modern racing event offices, is shown in Fig. 4.

VOICE FREQUENCY WORKING

With the teleprinter as the standard method of instrument working for the inland service, the apparatus side of special event equipment is uniform and only the number of complete sets to be provided varies; furthermore, the working of these sets being uniform with that in ordinary instrument rooms, a specialised operating staff is no longer necessary.

In 1933 a change in the method of operating the main lines of telegraph communication, from direct current to alternating current working, has so facilitated the general arrangements for these temporary offices that the provisions for all recurrent events are now an ordinary routine matter.

Between 1900 and 1933 additional circuits between important centres were provided principally by laying underground cables, some solely for telegraphic work and others for combined use by the telegraph and telephone services. The primary use of this underground telegraph network was to provide permanent inland service circuits, and the aerial lines remaining were used largely for setting up the temporary circuits for special event work. Because of their electrical

characteristics, working over these underground circuits was confined to direct-current methods. A multi-channel, voice-frequency system, however, requires a line which is suitable for a telephone circuit and therefore this system of working could not be operated satisfactorily over the existing long-distance telegraph cables. The greater part of the old telegraph network was therefore released to be modernised by suitable loading, in exchange for a corresponding network of 4-wire and 2-wire telephone circuits.

In Fig. 5, which shows the network of V.F. telegraph lines, it will be seen that direct communication is provided between London and all large centres, and there are many cross-country connections between provincial centres. The number of channels between any two places is indicated by the small figures.

So far as message transmission is



FIG. 5.—THE V.F. TELEGRAPH NETWORK.

concerned, all the V.F. channels in the separate systems are identical and operate in a similar way ; therefore, the effects of distance, so material in the earlier days, are eliminated, and moreover, there are means of inter-connecting channels of adjacent systems to give any desired routing over the V.F. network.

The voice-frequency terminal equipment to which the telephone trunk line is connected may be located in a telegraph office, telephone exchange or a telephone repeater station. The individual channels of the system are controlled by direct-current working over local lines which, irrespective of the location of the V.F. equipment, are terminated on a control board in the relative telegraph instrument room. This board provides the instrument-room staff with facilities for testing, making up and crossing any of the channels. The send and receive sides of each channel terminate in a jack field arranged so that with double plug, double-ended cords, the required connections or changes can be made by plugging into the appropriate jack. Adjacent to the control board is a concentrator board on which the teleprinter sets and physical lines are terminated. Transfer circuits between these two boards give complete facilities for connecting any voice-frequency channel terminated on the control board to (i) any teleprinter in the instrument room, (ii) the physical lines permanently connected to the teleprinter sets at out-offices, and (iii) the physical lines used for event offices, which may be, and often are, some considerable distance away. In the last case appropriate panel-mounted apparatus is included in the local circuit, giving facilities for balancing the line if this is necessary.

The extreme flexibility of the V.F.-operated network due to its facility for interconnection between systems enables circuits to be set up over long distances without difficulty. That any of the channels can be connected without previous preparation is a great advantage, but perhaps the most outstanding advantage in the application of V.F. working for special event arrangements is the ease with which long-distance YQ circuits can be provided. The working requirements of an omnibus or YQ circuit as it more usually is called, are that signals from the sending office can be sent simultaneously to two, three or more offices situated at distant places ; and further, that each distant office separately is able to give acknowledgment of good reception, or otherwise, and to check any part of the message if necessary. Extensive provision of this type of circuit has to be made for most of the important events, and in this respect certain meetings at Doncaster and York race-courses call for as many as seven YQ circuits.

Circuit Provision.

The telegraphic codes of the two centres are used to identify the complete voice-frequency system operating between them, and the separate channels are numbered 1-4, 1-12 or 1-18 as the case may be.

Where more than one system is in operation, the separate systems are identified by a letter ; for example, A indicates the first system, B the second and so on ; thus every channel of the network has an individual identification by which it is easily recognised, for example, TS-MR (C) 15 is channel No. 15 in the C (or third) system of 18 channels connecting London (TS) and Manchester (MR), and in a similar way LS-GW (B) 6 is channel 6 in the second system between Leeds (LS) and Glasgow (GW).

In each system, a certain number of channels have been earmarked for use when required as special event reserves. With few exceptions the circuit requirements for any recurrent event are the same each time, and only the actual dates and perhaps the duration alter from year to year ; therefore it has been possible to schedule the special event reserve channels and the associated local physical lines which will be used for these events during the course of the year. With non-recurrent events it is usual to have ample margin of notice of the date and requirements, and it becomes a matter of reviewing the schedule to ascertain what channels are available for that period. Particulars of those selected, together with the local lines to be used, are advised on a standard form to those concerned. When practicable the complete circuits are set up and tested out under working conditions from the event office the day before the commencement of the event. At its cessation, the V.F. channels and physical lines are restored to normal as soon as possible.

YQ Working.

The matter of providing YQ circuits is simplified by the use of a combiner unit which is associated with the V.F. control board in the instrument-room. This unit gives facilities for coupling four separate circuits, one of which may be the event (or local office) circuit. The unit consists essentially of a relay having six

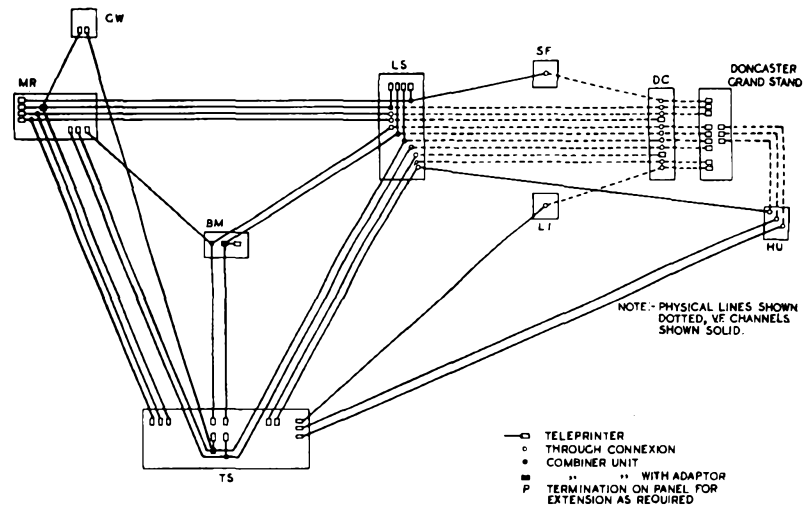

FIG. 6.—CIRCUITS FOR DONCASTER RACES.

similar windings. The sending side of the extension or event office teleprinter is connected to one of these windings and three other windings are connected individually to the receiving side of the V.F. channels radiating to three distant offices. The remaining two

windings are used for producing the necessary bias, electrically. The sending relays of the V.F. equipment and the receiving side of the extension teleprinter are bunched and connected to the tongue of the relay on the combiner unit. The performance of the relay is such that reversals of current in any of the four line windings moves its tongue, with the result that, in addition to a local record of the message transmitted, the signals from any one of the four teleprinters on the YQ circuit are received on the remaining three. When it is required to group only three teleprinters—the local or event office being one of them—correct operation of the combiner unit relay is arranged by passing through the spare winding a steady current of the same value as would flow if an idle V.F. channel were connected to the winding. On the other hand, when more than four teleprinters require to be grouped on a YQ circuit the conditions are met by using an adaptor with the distant combiner unit, and this enables extension to three more V.F. channels, and if necessary even further extension can be provided by using another unit with an adaptor introduced at the further control board.

Identification of Special Event Circuits.

The schedule referred to earlier contains a list of approximately 400 circuits allocated for recurrent events. When advices are circulated regarding any of the events as listed in this schedule, it is necessary to quote only the identification numbers of the circuits which will be used. Additional to these specified circuits is a series of over 200 circuit identification numbers allotted in groups to Regional Directors and Surveyors for use in connection with events of a non-recurring nature or recurring at irregular intervals.

Just how these circuits are routed under conditions of modern telegraph practice will be seen from Fig. 6, which shows schematically the circuit arrangements for Doncaster race meeting, and may be taken as typical of those for an important racing event. The particular routing and make-up of the fourteen additional circuits required for the Doncaster event is shown in Table I.

Eight of the circuits are YQ's and two of these are extended to include four offices on each circuit, and combiner units with special adaptors fitted are introduced at the places shown. It is perhaps of interest to compare the present-day arrangements with those of pre-teleprinter V.F. days, and Fig. 7 shows

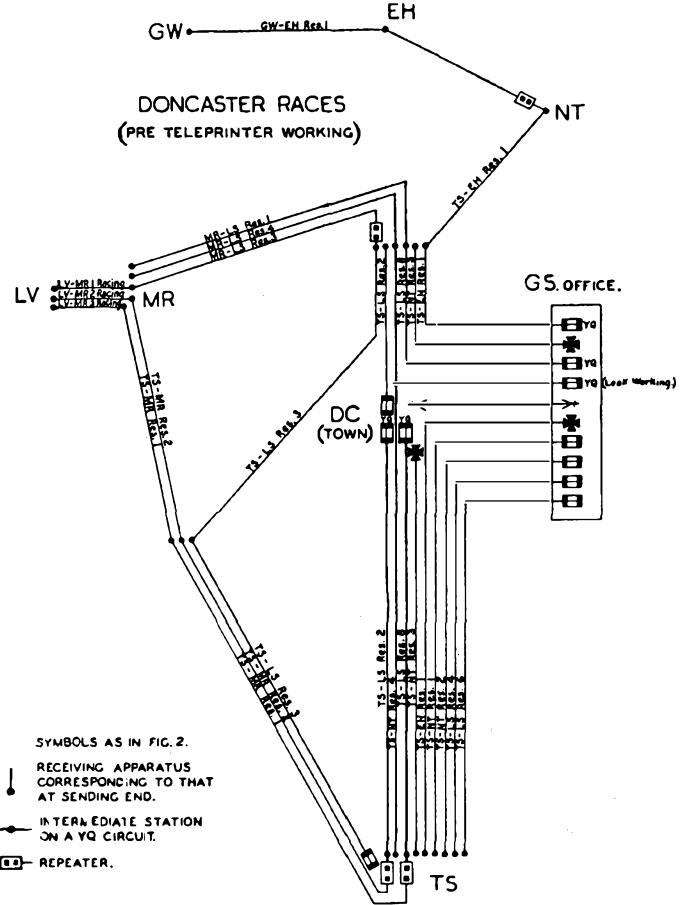
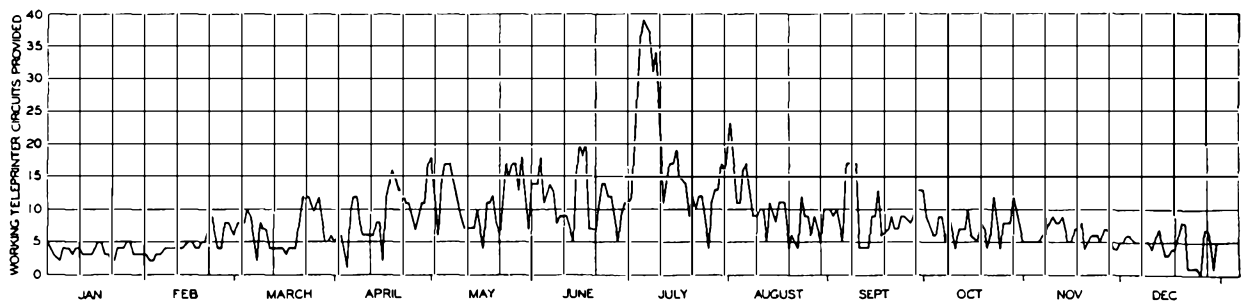

FIG. 7.—CIRCUITS FOR DONCASTER RACES, PRE-TELEPRINTER WORKING.

TABLE I.

Special Event	Identification number of circuit	Particulars of Circuit	Method of Provision		Combiner Unit at	Special Adaptor in use at
			Physical lines	Voice-frequency Channels		
Doncaster	178	HO-TS-MR	LS-DC4	LS-MR A13 + MR-TS A12	MR	MR TS BM
	179	HO-TS	LS-DC10	LS-TS A17	—	
	180	GS-TS	HU-DC1	HU-TS A5 from 12.30 p.m.	—	
	181	GS-TS	HU-DC2	HU-LS B1 + LS-TS B6 from 2 p.m.	—	
	182	GS-TS	HU-DC3	HU-TS A4 from 2 p.m.	—	
	183	GS-LS-TS-MR-GW	LS-DC3	LS-MR A14 + MR-TS B7 + MR-GW A17	LS	
	184	GS-LS-TS-MR-GW	LS-DC5	LS-TS A2 + TS-MR B11 + TS-GW B10	LS	
	185	GS-LS-BM-TS	LS-DC6	LS-BM A17 + BM-TS A17	LS	
	186	GS-LS-MR	SF-DC1	SF-LS A17 + LS-MR A16	LS	
	187	GS-TS-MR	LS-DC7	LS-TS B17 + TS-MR A7	TS	
	188	GS-TS-MR	LS-DC8	LS-BM A16 + BM-TS A16 + BM-MR A16	BM	
	189	GS-TS-MR	LS-DC9	LS-MR A15 + MR-TS A17	MR	
	190	GS-TS	LS-LI3 (DC & LI)	LI-TS A8	—	
	191	GS-LS	LS-LI3 (LS & DC)	(Extension as required)	—	



1938

FIG. 8.—NUMBER OF TELEPRINTER CIRCUITS PROVIDED.

schematically the line and apparatus provision for Doncaster in earlier times.

Mobile Post Offices.

When used at racing events the mobile office is located in the part of the field open to the public, and a noted spot where it has provided a very useful service is at Tattenham Corner of the Epsom racecourse. A full description of a mobile office is contained in Vol. 29, Part 3 (October, 1936) of this JOURNAL.

Conclusion.

It is, perhaps, fortunate that the dates and periods of the more important items occasioning these temporary provisions mostly follow on one another. For, were it otherwise, much larger reserves of teleprinters and associated apparatus would need to be held in readiness to meet them. As it is, requirements can be met with a relatively small stock of apparatus located at the five pool centres. There are times, however, when because of coincident events a particular centre

may be hard pressed in meeting its commitments; but usually, the position is eased by a loan from one of the other centres.

No mention has been made of any temporary office equipment other than the circuit apparatus, but of course there are many other items which have to be provided for special event offices, and included in these are clocks, numbering machines, timing stamps and the usual telegraph stationery items and counter equipment.

This article would be incomplete without giving some brief idea of the extent of present-day special event provision; it is not proposed to give statistics, but it may suffice to show graphically (Fig. 8) the number of circuits in connection with approximately 300 such arrangements made during 1938. This figure includes the events of importance for which teleprinter provision was made from pool centres, but takes no account of the many minor events where messages were disposed of by other means.

Book Review

British Association, Mathematical Tables. Vol. 7, "The Probability Integral." W. F. Sheppard. Cambridge University Press, 1939. 8s. 6d.

It can hardly be denied, in view of the wide application of the probability integral to design and sampling problems, that the publication of this volume of tables is an event of some importance. It can be confidently predicted that these tables will find a large sphere of usefulness, not only to engineers applying probability theory to their problems, but to all workers using statistical theory. For many years the late Dr. W. F. Sheppard (1863-1936) worked on the preparation of these tables, and their completion and publication by the British Association constitutes a memorial to his unsurpassed labours in the field of mathematical statistics.

The integral under discussion is $\frac{1}{\sqrt{2\pi}} \int_x^\infty \exp\left(-\frac{1}{2}t^2\right) dt$,

and the tables, which go up to ten times the standard

deviation are computed to as many decimal places as would ever be required. Although Gauss made such noteworthy contributions to probability theory by the use of this integral that his name is commonly attached to the function, it is well known that Laplace made use of the integral at least thirty years before Gauss. It would thus appear that the name of Laplace might more appropriately be attached to the probability integral than that of Gauss. In a recent historical research, however, Karl Pearson found that De Moivre as early as 1733 gave a treatment of the probability integral and its associated functions. The work of De Moivre antedates the discussion of Laplace by more than half a century. Moreover, De Moivre's treatment is essentially our modern treatment. Hence it appears that the discovery of the probability integral should be attributed to De Moivre. De Moivre was an English mathematician with a phlegmatic personality. It is recorded that he used to sleep twenty hours a day, leaving only four hours for probability theory—and everything else.

H. J. J.

The Supply of Power for Telephone Exchanges

G. M. MEW,
B.Sc. (Eng.), A.M.I.E.E.

U.D.C. 621.311.1 : 621.395.722 621.316.34 621.317.8

It has been the intention in preparing this article to give a brief description, so far as the larger telephone exchanges are concerned, of some of the considerations involved in obtaining a supply of electricity. Its subsequent distribution and conversion for the purpose of providing power for the operation of the telephone equipment will form the subject of a further article.

Electricity Supply.

IN the larger telephone exchanges, it is nowadays always possible to obtain electricity from a public electricity supply undertaking, but not always at low tension. Quite frequently, owing either to the heavy load which has to be catered for or to the comparative remoteness of the site selected, only a supply at high tension can be offered. In this event, accommodation on the exchange site or inside the building is usually needed for the necessary transformers and high tension switchgear.

As soon as possible, therefore, after the site for a new exchange has been decided upon, enquiries are made of the electricity authority concerned as to the type of supply available so that suitable accommodation for the low tension switchgear and any high tension plant can be incorporated in the building plans at a sufficiently early stage.

Before such enquiries can be made it is necessary to arrive at a fairly accurate estimate of the maximum load which is likely to be placed on the service cables and of the amount of electricity which will be consumed initially and ultimately. The first item affects the size of the plant to be provided by the supply authority and therefore has a direct bearing on the capital costs involved, a proportion of such costs usually being met by the Post Office. It may also be a deciding factor in determining whether the service is offered at high or low tension. The second item is important in selecting the most economic method to be adopted in paying for the electricity used. In addition, it enables the supply authority to estimate the revenue which they may expect from the consumer and this, in turn, gives them an indication of the initial costs which they themselves may reasonably bear in providing the service. In some instances, where the supply authority will be involved in exceptionally heavy expenditure, they often insist that the Post Office shall enter into an agreement to guarantee a specified minimum payment per annum for electricity over a number of years whether electricity to such a value is consumed or not, and the economics then have to be very carefully considered.

As, at this early stage, the proposals for the batteries and charging plant have not been drawn up, the estimates of maximum load and consumption, so far as such plant is concerned, are obtained by calculation from the available figures for the Day Calling Rate (CR) and the number of Direct Exchange Lines (L). A figure of 0.075 Ah consumption of energy per call is assumed.

Thus the 24-hour consumption for the exchange = $L \times CR \times 0.075$ Ah. An allowance for the energy consumed by the operators' positions should also be included, but generally this is so small that it may be neglected.

Having obtained the figure for the 24-hour exchange

consumption it is possible to select one of a number of standardised arrangements for batteries and charging plant, and hence the outputs and number of the motor generator sets or rectifiers to be installed is ascertained. A figure for the overall efficiency of the motor generator sets of 70 per cent. to 80 per cent., depending on the size of the machines, is used to determine the input to the motors and, when required, the power factor is taken at 0.8.

The consumption of power by the motor generators will vary during the life of the exchange, and for 50V equipment is calculated as follows:—

$$\begin{aligned} & \text{Daily consumption in watt hours} \\ &= \frac{L \times CR \times 0.075 \times 57 V}{\text{overall efficiency}} \end{aligned}$$

Where the divided battery float system is to be used the overall efficiency of the power plant and batteries may be taken at a rough figure of 65 per cent.

The figure for the number of direct exchange lines (L) will depend on whether the initial or ultimate consumption is being determined.

$$\begin{aligned} & \text{Annual consumption in B.o.T. units} \\ &= \frac{L \times CR \times 0.075 \times 57 \times 365}{0.65 \times 1,000} \\ &= 2.4 \times L \times CR \end{aligned}$$

In practice this figure has been found to be on the high side and a figure of $2 \times L \times CR$ is usually used at the stage when electricity supply is being considered.

The Post Office always prefers a low tension supply as this avoids the necessity for extra accommodation, is usually accompanied by lower capital charges, does not require the provision for the supply authority of special access facilities to its high tension equipment and, above all, it removes the extra fire risk, however slight it may be said to be, which is involved when high tension transformers are located in a building.

As a general rule, for large exchanges, there is little to choose between high tension and low tension supplies from the point of view of reliability, but efforts are always made to obtain a standby or duplicate supply which can be used in the event of a failure of the normal supply. The best possible standby supply is one obtained from the network of another independent supply authority, but this is only possible in special circumstances, and generally the standby supply is obtained from a separate sub-station of the same supply authority or from a separate portion of their network.

Where supplies are given at high tension, the transformers and associated control gear are usually installed and maintained by the supply authority and remain their property, in spite of the fact that the Post Office may have contributed towards the capital costs involved. There are occasions, however, when, influenced by an offer of specially low rates for energy consumed for so doing or for other economic reasons,

it is found preferable for the Post Office to purchase, install and subsequently maintain this plant.

Electricity Tariffs.

There is an almost endless variety of tariffs under which the Post Office may pay for electricity consumed, but they may be classified under broad headings as follows :—

- (1) A flat rate involving a constant price per unit consumed.
- (2) A sliding scale whereby the price per unit decreases according to an agreed schedule as the total consumption increases.
- (3) A two-part tariff with a constant price per unit and a fixed periodical additional charge based on the size of the machines installed.
- (4) A maximum demand tariff with a constant price per unit and a varying periodical additional charge depending upon the maximum demand recorded in any specified time interval over a certain period.
- (5) A two-rate scale whereby the price per unit varies according to the time of the day or night during which the electricity is consumed.

- (6) A limited hour rate under which electricity can be used only during a certain period each day, the supply being disconnected automatically for the remainder of the 24 hours.

Certain tariffs are sometimes further complicated by the inclusion of what is termed a "Coal Clause" by which the supply authority varies the nominal price per unit by an agreed percentage "up" or "down" in accordance with the rise or fall of the price of coal as delivered to their bunkers.

The terms offered under a tariff such as No. 6 are usually very favourable, but the supply is only available during the night period, and therefore advantage can be taken of such a tariff only where staff are already available at the exchange to carry out all the battery charging during this period. There are occasions, however, when the savings in the cost of electricity by adopting the tariff are capable of justifying a night shift on these grounds alone. The limited hour tariff can never, of course, be used where a battery float system is in use, as a supply must then be available throughout the 24 hours. In such circumstances, the increased costs involved by the

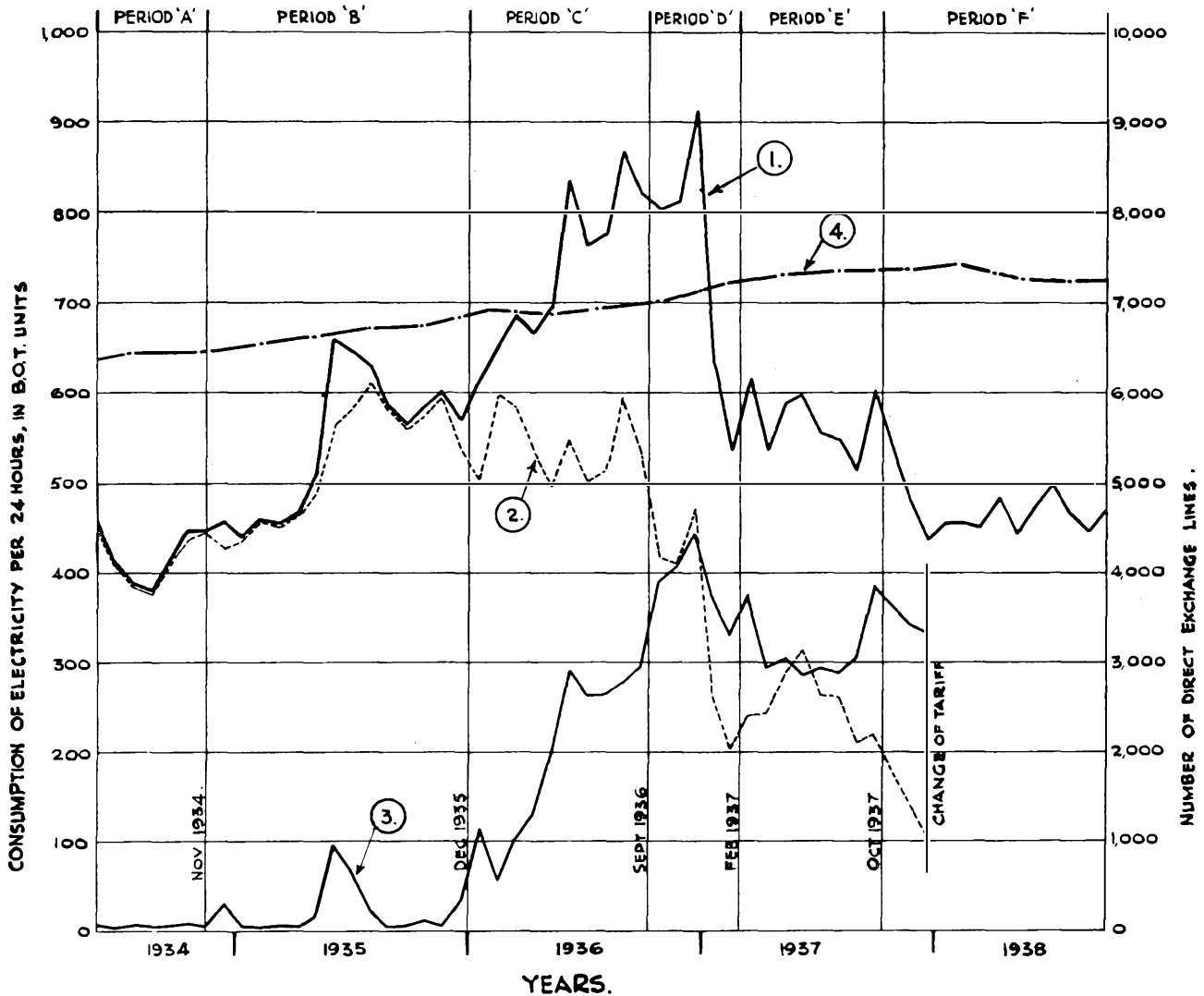

FIG. 1.—CURVES OF ELECTRICITY CONSUMPTION, TEMPLE BAR TELEPHONE EXCHANGE, LONDON.

adoption of some other tariff have a tendency to minimise the other financial advantages of the system.

A battery float system is also at a slight disadvantage as compared with the charge-discharge system, so far as electricity costs are concerned, when a maximum demand tariff is adopted because with the latter system the period of peak demand can be adjusted in relation to the demand of other apparatus in the building so as to reduce the combined maximum demand from the supply cables. These disadvantages, however, are almost invariably outweighed by the increased overall efficiency and other economic advantages of the battery float system.

Each individual exchange supply has, therefore, to be treated on its merits to determine the most favourable tariff to adopt.

In this connection the curves shown in Fig. 1 are interesting. They show the consumption of electricity from the supply mains at Temple Bar telephone exchange, London, under varying conditions as explained below:—

Curve (1).—Total units consumed per 24 hours.

Curve (2).—Units consumed during the night-time (8 p.m. to 9 a.m.).

Curve (3).—Units consumed during the day-time (9 a.m. to 8 p.m.).

Curve (4).—Number of direct exchange lines, which, of course, is the chief factor influencing the power consumed by the telephone equipment from the batteries.

Period A.—Normal charge - discharge battery working.

Period B.—Charge-discharge battery working, but the batteries are steadily deteriorating and it is therefore necessary to use the motor-generator sets to assist the discharge during the busy periods of the day.

Period C.—Charge-discharge battery working. The batteries are now in bad condition and the motor-generator sets are assisting the discharge for long periods each day.

Period D.—The batteries are being replated to a reduced capacity and the exchange is working on one battery, using assisted discharge and counter E.M.F. cells during charging.

Period E.—The batteries are now replated to a reduced capacity. Charge-discharge working with assisted discharge during busy periods of the day.

Period F.—The power plant is now converted for divided battery float working.

Prior to December, 1937, a two-rate electricity tariff was in force at the above exchange with current at 2d. per unit during the day-time and $\frac{3}{4}$ d. per unit at night, with no fixed charge. With the introduction of the divided battery float system, it was found advisable to change on to a two-part tariff with a fixed charge of £210 per annum and electricity at $\frac{3}{4}$ d. per unit. A few months afterwards the supply

authority reduced their charges and the price per unit became $\frac{1}{2}$ d.

The curves show clearly the improved overall efficiency obtained by the divided battery float system and also the disastrous effect which batteries in bad condition can have on electricity costs.

High Tension Chambers.

Where the electricity supply is given at high tension, accommodation has to be found for the transformers and associated gear. In many respects, it is preferable for these to be housed in a separate building or hut on the exchange site remote from the main building. Where this is not practicable a room in the building is provided for the purpose and should be on the ground floor as near as possible to the point where the supply cables enter the site. More often than not, however, a room on the basement floor has to be accepted and then complications in the way of lowering the heavy plant into position are introduced.

The room has frequently no means of communication with the rest of the building, the only means of access being via an external door on the face of the building.

The transformers are as a rule of the oil-immersed type in a steel tank fitted with cooling tubes. The tubes may be arranged to be detachable where the means of access to the high tension chamber are restricted, thus facilitating handling. They are extremely efficient appliances and efficiencies of 97 per cent. and above are not uncommon. Even so, a considerable amount of heat is dissipated under working conditions and to prevent undue temperature rise adequate natural ventilation must be provided for the room. This is usually done by vermin proof grids of adequate area disposed at high and low levels in the outer walls, such that a flow of cooling air through the room will be induced. In exceptional circumstances, mechanical ventilating plant may have to be installed for the purpose, but this is avoided, whenever possible, as a failure of the fan and motor might set up a dangerous condition.

The presence of the oil-filled transformers constitutes a fire-risk in the event of a major fault occurring and various precautions are taken to limit the spread of fire. The walls of the room are always made of brickwork and the doors are fireproof. A concrete sill or low wall is sometimes built around each transformer to prevent burning oil from spreading across the room and outside.

In certain exchanges CO₂ apparatus is now installed. A bank of cylinders containing compressed CO₂ is fitted permanently in the room and the outlets are connected to pipes which terminate in nozzles located over the apparatus. A steel cable is run round or across the room on pulleys, one end being fixed and the other terminating on a heavy weight which keeps the system under tension. At selected points in the cables fusible links are inserted so that in the event of an outbreak of fire these are melted and the weight is allowed to fall. In so doing, it operates a device which punctures the seals of the CO₂ cylinders, and the gas is released rapidly into the room where it displaces the air and extinguishes the fire as it will not support combustion.

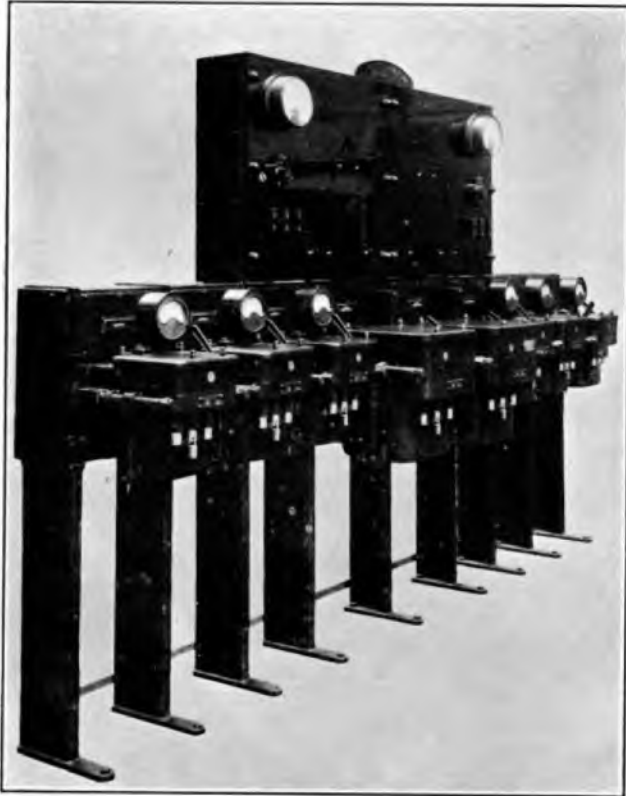

FIG. 2.—MAIN LOW TENSION SWITCHBOARD,
GRANGEWOOD TELEPHONE EXCHANGE.

Low Tension Switchboards.

A main low tension switchboard of one form or another is required in every telephone exchange and its main functions are as follows:—

- (1) to provide a suitable point of termination for the main electricity supply cables.
- (2) to segregate the various internal electricity supplies required so that suitable distributing cables may be fed from it and portions of wiring isolated when necessary.
- (3) to give complete protection to all the distribution cables in the building in the event of a serious fault occurring.
- (4) to provide safe and suitable accommodation for the electricity meters, and any other apparatus such as time-switches, current transformers, etc., which may have to be fitted.

The switchboard is normally installed in a separate room provided for this purpose alone. The room should be as near as possible to the route taken by the incoming supply cables or adjacent to or immediately above the high tension chamber where such is provided.

In very small exchanges the low tension switchboard may be composed of a number of ordinary combined switch-and-fuse units in cast-iron cases mounted, together with a sheet steel bus-bar box and meters, on an angle iron framework. This type of gear is, however, unsuitable for the larger exchanges,



FIG. 3.—MAIN LOW TENSION SWITCHBOARD,
EUSTON TELEPHONE EXCHANGE.

where it is now the usual practice to install a pedestal mounted switchboard with iron-clad oil-immersed circuit breakers and a built-in bus-bar chamber.

The circuit breakers are usually of the draw-out type with horizontal isolation, but quite a number of switchboards have been installed with circuit breakers of the non-draw-out type and having separate enclosed isolating switches. The main advantages of the former type are that spare circuit breaker units can, if required, be held in readiness, enabling a circuit breaker to be replaced in a few minutes in the event of a breakdown, and also it is possible to isolate any circuit breaker and draw it out well clear of other apparatus so that any necessary work on it may be carried out without any access difficulties. A disadvantage of the draw-out type of circuit breaker is that the isolating contacts are concealed when "made" and are perhaps more liable to contact trouble than are isolating switches. It is believed, however, that so far as the Post Office is concerned no troubles have been experienced in this way, and with modern designs

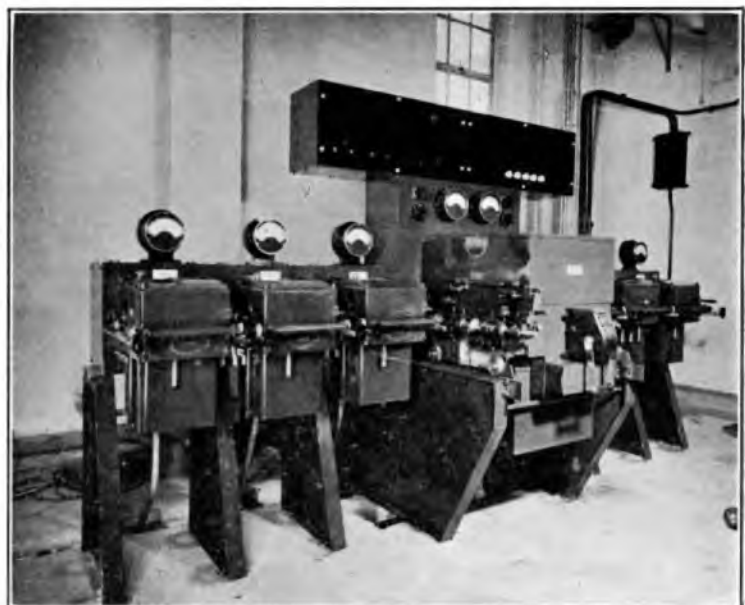

FIG. 4.—MAIN LOW TENSION SWITCHBOARD, VICTORIA TELEPHONE EXCHANGE.

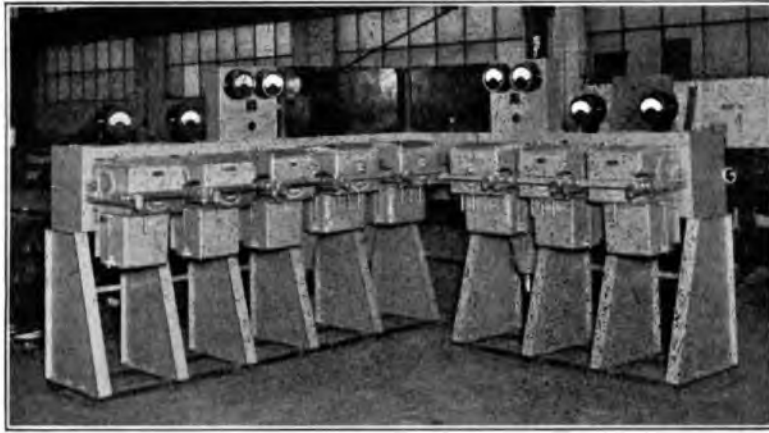

FIG. 5.—MAIN LOW TENSION SWITCHBOARD, WOOLWICH TELEPHONE EXCHANGE.

using high pressure line contacts there is every reason to hope for reliability in use. As regards the relative costs of the two types of gear, this varies with the manufacturer, but as a rule there is little to choose between one or the other.

The circuit breakers are equipped with all necessary interlocks and safeguards. They are of the free-handle type, so that in the event of closing on a fault there is no possibility of injury to the hand of the operator by the handle flying back, and it is impossible to hold the switch in the "on" position. The circuit breakers cannot be drawn out or reconnected until they are in the "off" position and means are provided to prevent the unit being pulled off the slide rails prematurely and injuring the operator. It is impossible to remove the top covers or lower the oil tanks unless the circuit breakers are isolated.

If it is desired to remove a circuit breaker for a long period a hinged cover can be swung over the exposed sockets in the bus-bar chamber and padlocked

in position, thus rendering the installation completely safe. Where units of large size are installed rack and pinion gearing may be provided for drawing-out purposes and mechanical assistance is also provided for tank lowering. In very large sizes motor-driven gear may become necessary.

The circuit-breaker contacts are nowadays nearly always of the high pressure line contact type which appears to have superseded the laminated large area type of contact. The contacts are usually of copper, readily replaceable and are sometimes silver plated to reduce contact resistance. Arcing contacts are fitted to reduce wear on the main contacts and are often reversible to give double life.

Overload coils are fitted to all the circuit breakers but no-volt coils have been found undesirable and are not provided unless needed in connection with the tripping of circuit breakers by time switches. The coils are sometimes immersed in oil in the main oil tank and this prevents them from being affected by dampness but renders them rather difficult of access for adjustment purposes.

From the latter point of view external coils are to be preferred but both types are accepted by the Post Office.

The bus-bar chamber runs at the back of the switchboard throughout the full length and is of unit construction so that additional panels can be added or panels removed without dismantling the whole of the board. The service and feeder cables usually enter at the bottom of the bus-bar chamber which is provided with conduit entries, hardwood bushes, metal spouts or sealing-off glands according to the type of cable to be dealt with. Accommodation is provided inside the bus-bar chamber for cable

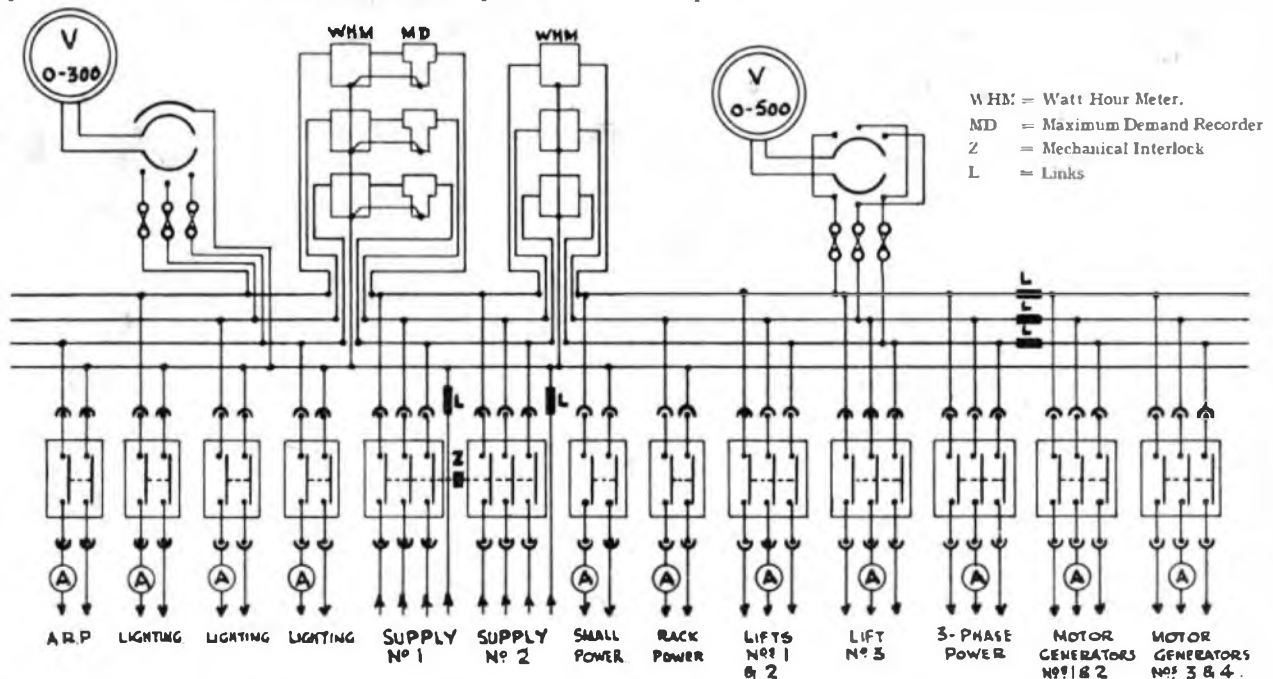

FIG. 6.—LOW TENSION SWITCHBOARD, LANGHAM TELEPHONE EXCHANGE.

terminations and any current transformers or shunts which are to be fitted.

The ammeters, voltmeters and watt-hour meters are accommodated in a sheet-steel chamber on top of the bus-bar chamber and are mounted in front on a Sindanyo panel. Alternatively, the bus-bar chamber may be increased in size to serve the same purpose.

When the switchboard is being designed, careful attention has to be paid to the metering arrangements and these are dependent on the various electricity tariffs which will be adopted. Frequently, it is necessary to effect a change of tariff during the early stages of the life of the exchange and these requirements must be foreseen and anticipated so that the necessary interception points may be catered for in the bus-bars. If this is not done, considerable alterations and consequent expense and inconvenience may be involved later on.

In the past, it has been the usual practice to provide one large circuit breaker to feed all the motor generator sets and a splitting box has been needed to connect the various machines to the one feeder cable. There is now a tendency, where circumstances warrant, to provide a separate circuit breaker for each machine as this provides greater reliability in the event of cable breakdowns and permits of more effective isolation for maintenance purposes.

Where duplicate or standby electricity supplies are available, some form of switching device must be installed to enable the supply to be taken from one or other of the services as required. It is usually undesirable for the services to be paralleled at the time of change-

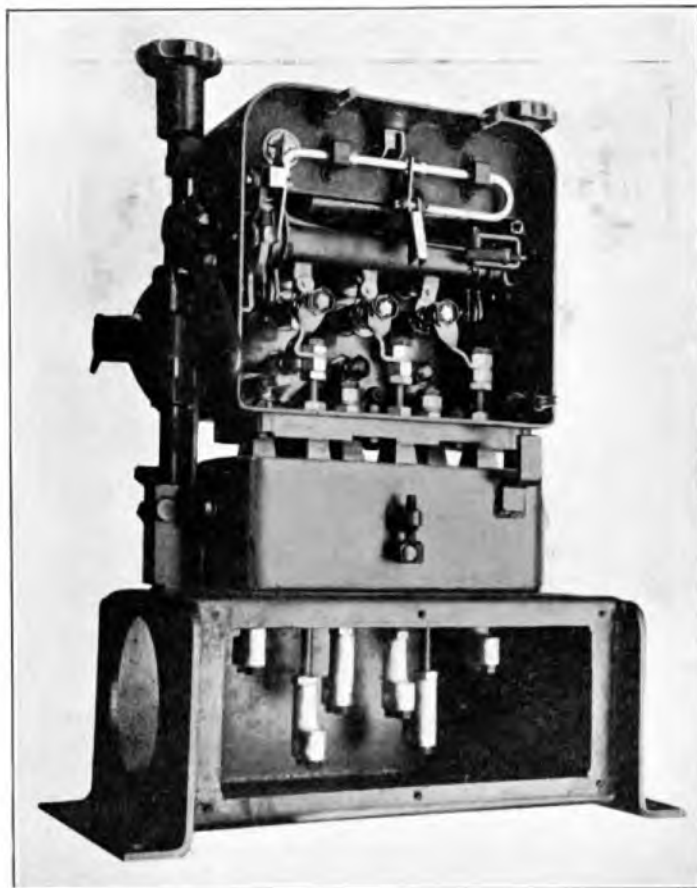

FIG. 8.—TOP VIEW OF 150 A, 3-POLE OIL CIRCUIT BREAKER WITH COVER REMOVED.

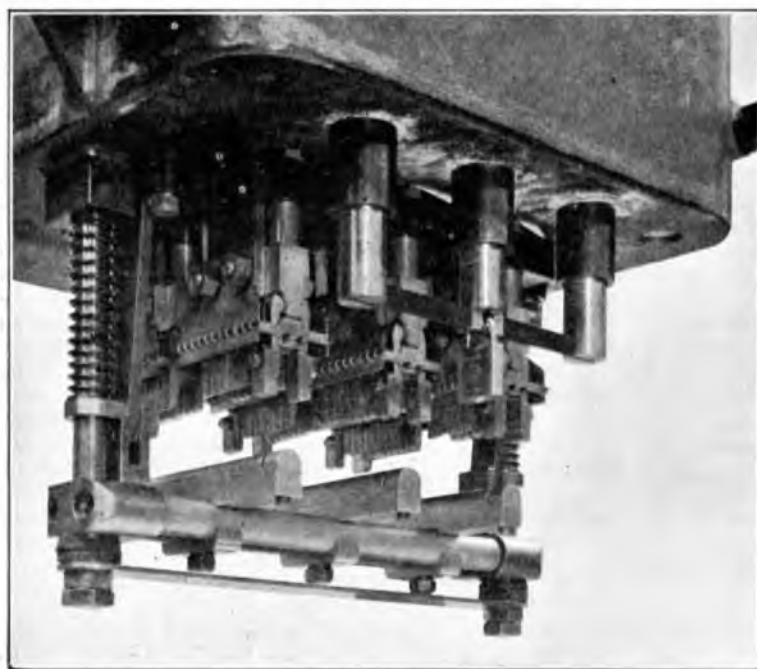

FIG. 7.—UNDER-CARRIAGE VIEW OF 800 A, 3-POLE, OIL CIRCUIT BREAKER WITH TANK REMOVED.

over and the switching is designed accordingly. A change-over switch, iron-clad, may be used for the purpose and is followed by the main incoming circuit breaker with which it is mechanically interlocked so that the change-over switch cannot be operated until the circuit breaker is in the "off" position. This ensures that the circuit may be connected or interrupted only by the circuit breaker contacts which are designed for the purpose, and not by the slow moving contacts of the change-over switch which might be damaged or cause a flash-over under such conditions.

An alternative method of providing the change-over facilities is to install two main circuit breakers, one for each supply, which are mechanically interlocked in such a way that only one circuit breaker may be in the "on" position at any time. This method has many advantages over the former arrangement and is now more or less standard.

Figs. 2, 3, 4 and 5 are general views of typical modern low tension switchboards which have been installed at various telephone exchanges in London. In each case the photographs were taken before the



FIG. 9.—SIDE VIEW OF 150 A, 3-POLE OIL CIRCUIT BREAKER WITH TANK LOWERED.

meters were fitted but the panels provided for the purpose can be seen. A typical diagram of connections for this class of switchboard is shown in Fig. 6.

Various close up views of oil circuit breakers are given in Figs. 7, 8 and 9 and the type of contacts and

other parts of the mechanism can be seen clearly.

Future Developments.

In view of the fact that practically all public electricity supplies are now derived from the "grid" system it often happens that an interruption will cause a total failure of the electricity supply to a telephone exchange, although a standby supply has been provided. It may be, therefore, that in the future there will be a tendency to dispense with a standby supply and provide, in its place, a diesel or petrol engine coupled to a generator for use when the normal supply has failed.

So far as main low tension switchboards are concerned, the comparatively recent development of high rupturing capacity fuses may lead to these replacing oil circuit breakers to a considerable extent, although, at present, opinions regarding the relative merits of these two types of apparatus are very divided.

There are also possibilities in the way of combining the main L.T. switchboard and the exchange power switchboard so as to form one complete unit. The motor generator sets usually constitute the largest load on the L.T. switchboard and this is an argument in favour of the scheme. It would then also be practicable to include the starting equipment for the motors on the same switchboard.

In conclusion, the author wishes to express thanks to Messrs. M. & C. Switchgear, Limited, Kirkintilloch, Glasgow; Messrs. Ferguson Pailin Limited, Higher Openshaw, Manchester; and Messrs. Drake & Gorham, Limited, Acton, London, who supplied the photographs.

Book Review

"Faults and Failures in Electrical Plant." Robt. Spieser, translated by Elaine Hunking of M.V. Electrical. 400 pp. 218 ill. Pitman, 30s.

This is the first English edition of the book written in 1932 by Professor Spieser, of Winterthur Technical Institute, in collaboration with engineers of Messrs. Brown Boveri Co., Ltd.

Practical experience in putting into commission and maintaining plant is necessary in the application of theory to the design and construction of engineering apparatus, and this book strikes a new note in engineering literature in putting into print some aspects of faults and failures which have been experienced in the operation of electrical plant. The book is adequately described in the preface as a "Treatise on Troubles." Heavy current machines, plant and associated apparatus only are dealt with, the book being divided into four sections: Electrical Machines, Transformers, Auxiliary Apparatus

and Materials, with an appendix containing notes on British and Continental practice. Knowledge of fundamental principles of electrical engineering and general theory of design is assumed as being readily available in numerous textbooks of the more orthodox kind. The methods described for testing and removal of faults and repair of apparatus after breakdown are essentially those which can be applied on site, and this enhances their value to the maintenance engineer. The chapters dealing with motors are particularly useful in view of the innumerable applications of the electric drive in modern industries. The engineers concerned have given freely of their experience of troubles which they have met, and the matter has been so arranged and illustrated with photographs and diagrams to make a very readable textbook. It is to be hoped that this book will prove to be the forerunner of other books on the same lines.

W. T. G.

The Swanwick Convention

U.D.C. 061.32 : 621.39 : 654

THE third Post Office Telecommunications Convention was held from June 24 to July 1st at the Hayes Conference Centre, Swanwick, Derbyshire, where the first and second conventions had been held in 1935 and 1937 respectively.



FIG. 1.—SIR RAYMOND BIRCHALL, K.B.E., C.B.

The popularity of this biennial event is well emphasised by the fact that the larger proportion of those present this year had attended previous meetings. Sir Raymond and Lady Birchall were present at the opening and remained for the first few days. The committee were particularly gratified that Sir Raymond, in spite of his many responsibilities and the numerous calls on his time, was willing to spend a few days with so many of his junior colleagues. In the course of a speech at the opening dinner Sir Raymond suggested that the Telecommunications Conference had passed through the experimental stage and was now part of standard Post Office machinery. In the course of the same speech, in dealing with the many activities of the Department, Sir Raymond mentioned that it had been decided to inaugurate a weather forecast service somewhat on the lines of the present speaking clock service.

Although the convention is primarily an occasion for social intercourse and recreation the serious side was not neglected and during the meeting five papers or lectures were given as follows:—

“Materials,” by Dr. W. G. Radley of the Research Branch, dealing with new materials and new ideas regarding the structure of materials.

“Regionalisation,” by Mr. W. H. Weightman. (In Mr. Weightman's absence the paper was read by B. L. Barnett who contributed a forceful addendum from the point of view of one who has helped to set up and work a region.)

“Film Production in the Post Office,” by Mr. H. Watt of the Film Unit. This was a fascinating address on the difficulties both financial and practical in making the film “North Sea” and how they were overcome.

“Empire Telegraph Communications,” by Mr. H. V. Higgett of Cable & Wireless, Ltd. This was a lantern lecture on deep sea cable technique, new systems of cable transmission and the beam telegraph services by an engineer largely concerned with the developments.

“Long Distance Telephony,” by Mr. G. J. S. Little, Chief Regional Engineer, N.W. Region. Mr. Little described the latest developments in long distance telephony, particularly new types of carrier systems such as the 12-circuit and coaxial. The lecture was interspersed with many demonstrations on equipment kindly loaned by Messrs. Standard Telephones and Cables, Ltd.

During the whole period of the meeting there was the usual exhibition and demonstrations of apparatus and equipment illustrating new developments in Post Office telecommunications practice, as well as items of general scientific interest provided by the Dollis Hill Research Station.

The visits and excursions which had been arranged were so numerous, and on each day there was such a wide choice, that it was frequently a matter of



FIG. 2.—IN THE GROUNDS.

difficulty to decide between the manifold attractions. Visits were arranged not only to the works of P.O. contractors such as Messrs. Ericssons, the Stanton Iron Works and the D. P. Battery Company, but also to places of more general interest, such as Boots factory at Nottingham, collieries, the Co-operative



FIG. 3.—MAJOR L. H. HARRIS THROWS A DART.

Wholesale Society's Nurseries, a lace mill, an agricultural college and a Borstal Institution. Excursions comprised a whole day trip to the dales and Derwent reservoir, trips to Welbeck Abbey, to Lincoln and Southwell cathedrals and a motor treasure-hunt. For assistance in arranging the excursions the Committee owe a debt of gratitude to Mr. W. Tomlinson of the Engineering Dept. and Chairman of the Nottingham group of the C.S.M.A. whose intimate knowledge of the whole district was at the disposal of the committee.

There were ample facilities for swimming, tennis, bowls, golf, and cricket, and in addition to local tournaments in tennis, bowls, golf and darts, a cricket match was arranged with Nottingham Post Office. In the evenings the same wide variety of choice prevailed such as dancing, a cinema provided by the film unit, darts, whist, and chess. In addition there was usually some feature of special interest; on one evening Messrs. Ericssons Dramatic Society presented "The Whole Town's Talking"—a most delightful performance. On other evenings there was a fancy headdress competition, a concert party from Manchester Post Office, a cabaret

show, the "Decibelles" from Bradford, and last but not least a conjuring and ventriloquial entertainment by Mr. G. F. Archer.

Once again the visitors were privileged to hear an address by telephone from the P.M.G. speaking from London. In the course of his speech Major Tryon said "This seems to be an occasion when I might appropriately pay tribute to the work done by all ranks of the Post Office during recent months. The Post Office staff, in common with the staffs of other Government Departments are passing through a very strenuous period. There has been little enough relief since the late summer of last year and prospects still of continued pressure. Judging by the programme that has been arranged I should not imagine that Swanwick provides much opportunity for rest, so that it must be all the more gratifying this year, especially to the Committee, that so many officials of the Post Office are yet willing to take leave to meet together and co-operate in the matter of recreation with the same obvious spirit of friendliness which has always marked their official relationships"

The success of the meeting was undoubtedly due in a large measure to the indefatigable energy of the secretary, Mr C. W. Gerrard, and his assistant Miss E. Richmond. Mr. Gerrard distinguished himself not only as an organiser but also as an announcer and his broadcasts at meal times of new arrangements and other matters of topical interest were masterly performances and thoroughly appreciated. Due acknowledgement should also be made to Mr. W. C. Griffith for his work in organising the entertainments and excursions and to Dr. W. G. Radley for his part in arranging the lectures and exhibits. Thanks are due to Mr. H. J. Mobbs for the photographs illustrating this article.

A. J. G.



FIG. 4.—IN THE DINING HALL.

The Effect of Noise and Interfering Signals on Television Transmission

U.D.C. 621.397.8

By R. F. J. JARVIS, Ph.D., and
E. C. H. SEAMAN, B.Sc.

This article indicates the effects of various types of electrical "noise" on television reproduction, and describes tests to determine the minimum satisfactory signal/noise ratio for television transmission.

Introduction.

A STATIONARY flat picture, or scene projected on a flat surface, may be regarded as a variation of brightness in two dimensions. If the picture is scanned by a spot of light moving in such a manner as to cover all points in the picture at regular intervals, the light reflected or transmitted by the picture being scanned can be converted into an electrical current proportional to the instantaneous magnitude of the reflected or transmitted light. Then if a spot of light at the receiving end is moved in synchronism with the transmitting spot, and the intensity of this light at any instant is varied proportionally to the value of the transmitted current at that instant, the picture will be reproduced at the receiving end, providing the rate of scanning is fast enough to enable the eye to see the receiving spot at all positions simultaneously by reason of the effect of persistence of vision. The picture is usually scanned in horizontal lines and it is more usual now to scan an electrical image of the transmitted picture with an electron beam, rather than scan the actual picture with a light beam, but the connection between the brightness in the picture and the electrical current transmitted remains the same. It is necessary to keep the scanning spot at the receiver in synchronism with that at the transmitter by suitable synchronising signals transmitted on the same path as the vision signal or on an independent path.

It is necessary to appreciate this fundamental connection between the brightness in the different parts of the transmitted and received pictures and the variation of transmitted current with time, in order to understand the effects of interfering signals on the received picture. Such interfering signals may be produced in the transmission path, or be picked up from outside. The instantaneous value of the total interfering current adds to the instantaneous value of the television signal current so that the brightness of the receiver spot at this instant is modified in accordance with this addition. The interfering current by itself, if of sufficient magnitude, produces a variation of brightness over the area of the received picture which appears as a series of spots or pattern, as described later, and when the television signal is added the desired picture is seen with this interference superimposed.

With sound transmission the disturbing signals are termed "noise," and the same term is generally used for disturbances present in television signals, although their effect is, of course, visual. The most important types of noise are:

- (a) Random noise, having a uniform energy frequency spectrum. This is produced by thermal agitation and valve noise.

- (b) Noise consisting of sharp transients produced at regular or irregular intervals. The most important type of this noise is that due to ignition systems.
- (c) Single frequency noise produced by interference from outside transmitters or set up in frequency translation processes.

It is proposed only to deal with the first and third types in this article, although the general conclusions will apply also to the second.

Effects of Noise on Television Reproduction.

As explained above, noise superimposed on a television signal causes an unwanted variation in brightness of the light-spot in the receiver, and if the noise level is sufficiently high the reproduced picture is marred by an irregular background, random white spots, or a superimposed pattern, the effect depending on the nature of the noise. The presence of noise also alters the shape of the synchronising pulses, so that relative displacement of successive lines in the picture occurs and the picture detail is distorted; interlacing is also impaired. If the noise level is very high the receiver may lose synchronism entirely, but noise which is just sufficient to produce an objectionable effect on the appearance of the picture is not generally sufficient to cause complete loss of synchronism.

The effects of different types of noise are more fully described below, and are illustrated by photographs of the screen of a television receiver taken during the reception of a B.B.C. programme, with noise superimposed on the received signal.

Effect of Random Noise.—When random noise is present at such a level that it is just visible on the picture, its effect is to produce a fine irregularity of the background illumination (Fig. 1 (g)). At higher levels it results in the appearance of numerous white spots, occurring irregularly in position and time, which may entirely obscure the picture detail (Fig. 1 (h)).

Effect of Single-frequency Noise.—When single-frequency noise is present, a sinusoidal voltage variation is superimposed on the signal which controls the brightness of the light-spot in the receiver. The brightness of the spot is increased during the positive half-cycles of the noise and decreased during the negative half-cycles, and a pattern appears superimposed on the reproduced picture. The nature of this pattern depends on the relation of the noise frequency to the line, frame, and picture scanning frequencies, i.e., the number of lines, frames, and complete pictures respectively scanned per second. It is convenient to consider two cases:

- (a) Noise frequency lower than line frequency.
- (b) Noise frequency higher than line frequency.

If the noise frequency is much lower than the line frequency, so that a number of lines are scanned in



(a) Without added noise.



(b) Single-frequency noise, 200 c/s.

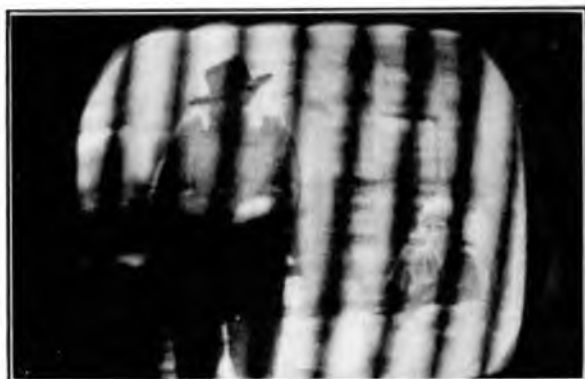

(c) Single-frequency noise, 101.3 kc/s.



(d) Single-frequency noise, 103.5 kc/s.



(e) Single-frequency noise, 500 kc/s approximately, bar pattern.



(f) Single-frequency noise, 500 kc/s approximately, mesh pattern.



(g) Random noise, low level.



(h) Random noise, high level.

FIG. 1.—PHOTOGRAPHS OF SCREEN OF TELEVISION RECEIVER, SHOWING EFFECTS OF NOISE.

the duration of one cycle of noise, there is no appreciable variation of brightness in the horizontal direction. The noise causes a variation of brightness in the vertical direction, and if the noise frequency is an integral multiple of the frame frequency, a stationary pattern consisting of horizontal bars alternately dark and light is produced, the number of pairs of bars being equal to the ratio of noise frequency to the frame frequency (Fig. 1 (b)). If the noise frequency is not an integral multiple of the frame frequency, there is a horizontal bar pattern which appears to move vertically, or a general flicker effect.

If the noise frequency is lower than the line frequency but not very low compared with the latter, the patterns are more complicated on account of variation of brightness across individual lines; the effect is generally one of sloping dark and light bars. When the noise frequency is higher than the line frequency, if the noise frequency is an integral multiple of the line frequency, a stationary pattern consisting of vertical bars alternately dark and light is produced, the number of pairs of bars being equal to the ratio of noise frequency to line frequency (Figs. 1 (c) and 1 (e)). If this relation does not hold, but the noise frequency is an integral multiple of the frame frequency, a stationary pattern consisting of sloping bars is produced (Fig. 1 (d)). With a noise frequency not an integral multiple of the frame frequency, there is a bar pattern which appears to move across the picture, or a general flicker or mesh effect (Fig. 1 (f)).

Signal/Noise Ratios.

In the reception of the B.B.C. television transmissions from the studio at Alexandra Palace, even under conditions of freedom from interference, the picture has a slight irregularity of background illumination. This is due to random noise which arises in the cameras and circuits at the transmitting station and in the receiver. For the design of a complete television system it is necessary to consider how far noise from these sources reduces the picture quality obtainable with a given number of scanning lines and frequency band-width; this question is, however, outside the scope of the present article, in which such noise will be regarded as "inherent" in the television signals.

Further noise is added by any cable or radio link used to convey to the broadcast transmitter a television signal developed at a distance, and by interference due to electrical plant in the vicinity of the receiver. In connection with circuits for television transmission, it is of primary importance to decide the highest permissible level, relative to the signal, of such additional noise; to this end, the series of tests described in the following paragraphs has been carried out in the Post Office Television Laboratory. The tests consisted in mixing additional noise with a vision signal having a normal amount of inherent noise, and determining by observation of the picture:

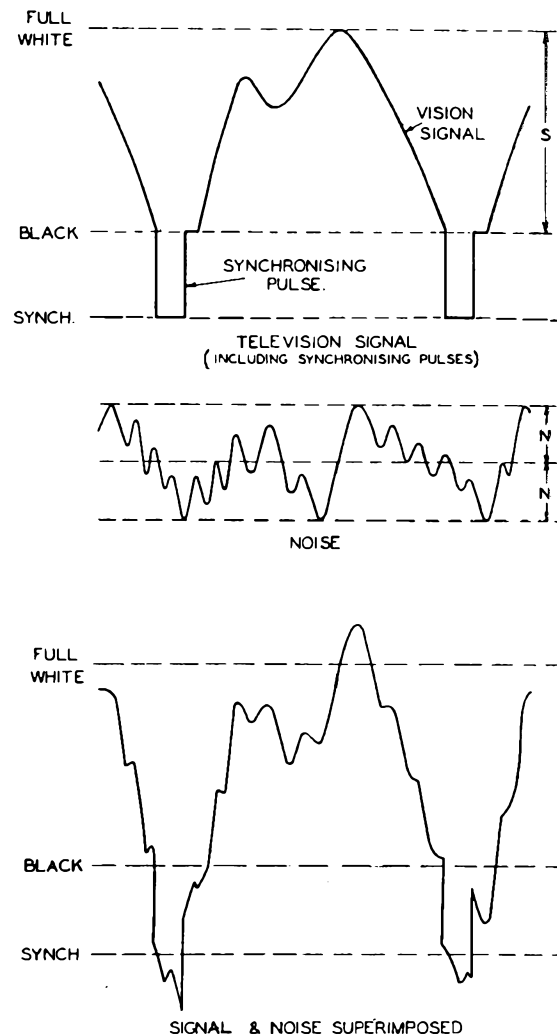

FIG. 2.—TYPICAL SIGNAL AND NOISE WAVEFORMS.

(a) the level relative to the signal at which the added noise just became visible against the background of inherent noise, giving the "Visible Signal/Noise Ratio";

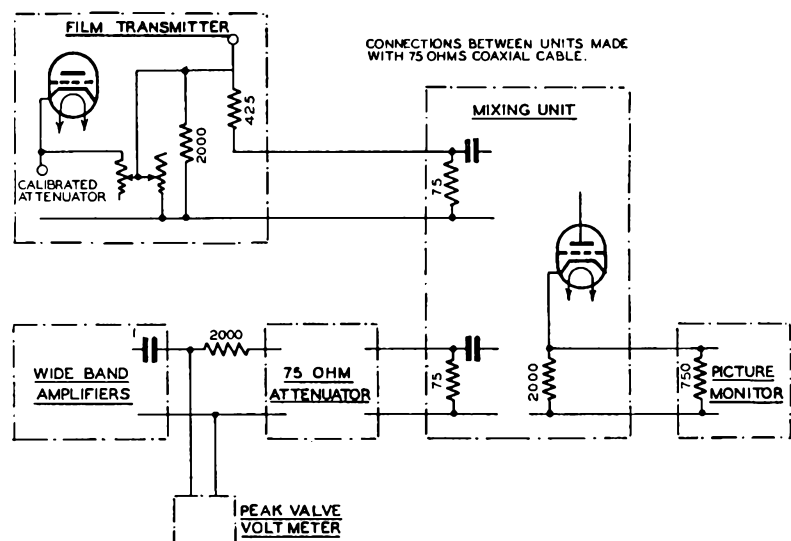

FIG. 3.—ARRANGEMENT FOR MIXING RANDOM NOISE WITH TELEVISION SIGNAL

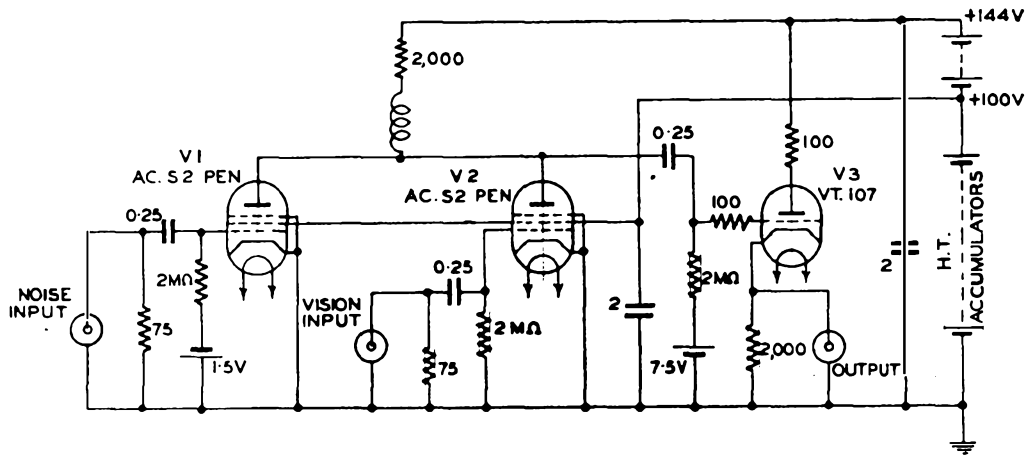

FIG. 4.—MIXING UNIT.

- (b) the highest level of noise relative to signal that could be tolerated without serious deterioration of the quality of the received picture, or undue irritation to the observer, giving the "Tolerable Signal/Noise Ratio";

As these relations are subjective, readings were taken by a number of different observers, and the average calculated. The "range" of the observations (difference between highest and lowest readings) is indicated in the Tables.

The signal/noise ratio is expressed as the ratio of the double amplitude peak (D.A.P.) vision signal voltage to the peak noise voltage. Referring to Fig. 2, the D.A.P. vision signal voltage is the magnitude *S* of the vision signal between black and full white, synchronising pulses being excluded. The peak noise voltage is the single amplitude peak value *N*.

Tests with Random Noise on Signals from Film-scanning Transmitter.

The experimental circuit for determining the effect of various amounts of random noise on pictures obtained from a film-scanning transmitter is shown in schematic form in Fig. 3. The vision signal was developed by 405-line interlaced scanning of stationary film in a cathode-ray film-scanning television transmitter. Random noise due to thermal agitation over a wide frequency range was produced by the use in series of two wide-band amplifiers, of which the frequency response was flat to within $\pm \frac{1}{2}$ db. from 10 kc/s to 2 Mc/s. These were followed by a variable attenuator for adjustment of the noise level.

Vision and noise were combined in a mixing unit of which Fig. 4 shows the circuit diagram. The two signals were applied to the grids of valves V1 and V2, which had a common anode load, and the combined signal was passed to the cathode follower output stage V3. The response of the unit, measured from either the vision or the noise input to the output, was flat to within $\pm \frac{1}{4}$ db. from 100 c/s to 2 Mc/s; in calculating the results allowance was made for difference in gain between V1 and V2. A picture approximately 10 in. by 8 in. in size was reproduced on a television picture monitor, and viewed from a distance of five feet.

The vision signal was measured by a cathode-ray oscillograph at the transmitter, and the peak noise by a peak valve voltmeter at the output of the wide-band amplifiers. From these measurements and the

TABLE I
EFFECT OF RANDOM NOISE ON PICTURES OBTAINED FROM FILM-SCANNING TRANSMITTER
V = Visible signal/noise ratio in decibels.
T = Tolerable signal/noise ratio in decibels.

Observer No.	Picture A		Picture B		Picture C		Picture D		Average	
	V	T	V	T	V	T	V	T	V	T
1	—	—	35	30	32	27	32	28		
2	36	31	—	—	—	—	—	—		
3	—	—	—	—	30	27	—	—		
4	—	—	—	—	—	—	31	21		
5	34	30	35	28	—	—	—	—		
6	37	33	38	33	37	25	38	34		
7	—	—	31	25	—	—	—	—		
8	42	26	31	21	32	21	33	26		
9	39	29	34	24	31	19	35	27		
11	—	—	—	—	—	—	29	19		
12	—	—	35	26	33	23	34	29		
Range	8	7	7	12	7	8	9	15		
Average	38	30	34	27	33	24	33	26	35	27

known gains and losses in the circuits, the signal/noise ratio at the cathode-ray tube of the picture monitor was deduced. As a check, the signal and noise amplitudes were also compared directly by a cathode-ray oscillograph at the anode of the vision output valve in the picture monitor. The results of the two methods agreed to $\frac{1}{2}$ db.

The following pictures were employed :

- (A) Close-up view of part of speaking clock.
- (B) View of men working on telegraph pole, giving effect of silhouette against clear sky.
- (C) View of sea-shore with trees in distance.
- (D) Close-up view of potter at work.

The results of the observations are given in Table No. 1.

Tests with Random Noise on B.B.C. Signals.

The B.B.C. transmissions were received at Dollis Hill on an experimental television receiver. To enable noise to be mixed with the vision signal, the receiver was modified by the addition of a valve in parallel with one of the existing vision-frequency amplifying valves. Random noise was obtained from wide-band amplifiers as previously described, a variable attenuator being interposed between the amplifiers and the noise input to the receiver for adjustment of the noise level. The signal/noise ratio was measured at the modulating electrode of the cathode-ray tube by means of a cathode-ray oscillograph with amplifier. The results of the observations are given in Table No. 2.

TABLE 2
EFFECT OF RANDOM NOISE ON PICTURES OBTAINED FROM B.B.C. TRANSMISSIONS

Type of Programme	Observer No.	Signal/Noise Ratio (db.)	
		Visible	Tolerable
Various ..	6	35	27
Various ..	12	33	28
Various ..	12	34	29
Film ..	7	31	—
Film ..	10	37	—
Film ..	12	34	—
Studio..	7	—	24
Studio..	10	—	29
Studio..	12	—	32
Studio..	7	37	27
Studio..	10	32	30
Studio..	12	32	30
Range..	..	6	8
Average	34	28

Tests with Random Noise Alone.

In these tests the same arrangement of apparatus as described in the preceding paragraph was employed, but there was no signal input to the receiver. In the absence of noise input, the picture field on the cathode-ray tube was uniformly illuminated, and its brightness could be varied by the control provided on the receiver. The level at which noise from the wide-band amplifiers just became visible was determined for three different brightness conditions, as follows :

- (a) *Low brightness.*—Picture field just visible.
- (b) *Medium brightness.*—Intermediate value.
- (c) *High brightness.*—Maximum brightness obtainable without defocussing.

The noise levels were recorded in terms of signal/noise ratio related to the signal level used in the tests described in the preceding paragraph, which was sufficient fully to load the cathode-ray tube. The results therefore indicate the signal/noise ratio at which random noise would be just visible on a picture free from inherent noise. The observations are recorded in Table No. 3.

TABLE 3
EFFECT OF RANDOM NOISE ON UNIFORM PICTURE FIELD
Signal/noise ratio in decibels at which noise was just visible.

Observer No.	Brightness		
	Low	Medium	High
7	41	42	37
10	40	42	40
12	41	43	39
Average ..	41	42	39

Tests with Single-frequency Noise on Signals from Film-scanning Transmitter.

The effect of single-frequency noise at a number of frequencies in the range 20 kc/s to 2 Mc/s was investigated experimentally. The film transmitter and mixing unit were employed as previously described,

TABLE 4
EFFECT OF SINGLE-FREQUENCY NOISE

Frequency (approx.) kc/s	Effect on Picture
20.25	Vertical bar pattern—2 pairs of dark and light bars in picture width. Bars drifting slowly across picture. Picture flickering sideways in step with movement of bars across its edge. Little loss of picture detail, but irritating flicker effect due to movement of bars and picture.
22.9	Pattern consisting of bars nearly horizontal—about 50 pairs in picture height. Slight rapid up-and-down movement of pattern, giving shimmer effect. Vertical lines in picture serrated and detail coarsened.
101.3	Effect similar to that at 20.25 kc/s, but bars narrower and more numerous.
103.5	Bar pattern similar to that at 22.9 kc/s, but bars sloping upwards from left to right. Also vertical bar pattern (probably due to a harmonic in the noise) superimposed.
500 1,000 1,500 2,000	In each of these cases the frequency was critically adjusted to give two different patterns as follows: <i>Bar Pattern</i> , consisting of vertical bars, slightly wavy and fluctuating sideways in position, giving impression of moving grating in front of picture. <i>Mesh Pattern</i> of vertical and diagonal lines, having finer structure than the bar pattern and without irritating fluctuation. Both types of pattern became finer in structure as the frequency was raised.

and single-frequency noise was superimposed on the vision signal by connecting the output of a standard signal generator to the "noise input" of the mixing unit. The noise frequencies at which tests were made, and the corresponding effects on the picture, are detailed in Table No. 4.

Readings of visible and tolerable signal/noise ratios were taken by five observers on the pictures (A) and (C) mentioned on page 197; the results are given in Table No. 5.

With signal/noise ratios lower than about 15 db., the presence of the noise caused a noticeable increase in the general brightness of the picture; the brightness control of the monitor was not readjusted to compensate for this effect. The "visible" level was taken as that at which a pattern became visible, any increase in brightness being ignored. In certain

instances, marked (X) in the Table, the observer was unable to detect any pattern from the normal viewing distance.

In assessing the "tolerable" level, the increase in brightness was taken as part of the interfering effect of the noise, and at the highest frequencies over-modulation of the tube from this cause had a more serious effect than the presence of the noise pattern.

Conclusions.

As was to be anticipated from the nature of the observations, there was a large variation between the signal/noise ratios assessed by different observers, but the averages for all observers did not vary greatly on different pictures, and there was good agreement between the average results of tests on pictures obtained from the film-scanning transmitter and from the B.B.C. transmissions.

TABLE 5

EFFECT OF SINGLE-FREQUENCY NOISE ON PICTURES OBTAINED FROM FILM-SCANNING TRANSMITTER

V = Visible signal/noise ratio in decibels.

(X) Observer unable to detect any pattern

T = Tolerable signal/noise ratio in decibels.

from normal viewing distance.

Picture	Observer No.	Frequency (Approx.) kc/s																								
		20-25		22.9		101.3		103.5		500		1,000		1,500		2,000										
		V	T	V	T	V	T	V	T	Bar	Mesh	Bar	Mesh	Bar	Mesh	Bar	Mesh									
		V	T	V	T	V	T	V	T	V	T	V	T	V	T	V	T									
(A)	4	50		33		47		35		40		21		34		18		30		16		18		16		
				32		30		29		32		27		15		26		9		15		12		9		9
	8	48		33		50		40		43		25		38		26		32		20		18		19		
				40		26		40		31		37		20		31		16		22		14		12		12
	9	49		30		46		39		40		24		37		20		30		16		15		(X)		
				32		24		34		30		31		15		26		9		16		11		9		8
	12	45		30		43		40		37		27		36		20		28		17		14		(X)		
				28		23		29		31		27		20		26		10		17		12		11		12
	13	51		35		44		41		34		28		32		19		33		20		17		18		
				33		27		33		33		26		22		26		16		20		16		12		8
Range	6		5		7		6		9		7		6		8		5		4		4		—			
			12		7		11		3		11		7		5		7		7		5		3		4	
Average	49		32		46		39		39		25		35		21		31		18		16		—			
			33		26		33		31		30		18		27		12		18		13		11		10	
(C)	6	47		43		49		40		40		28		36		25		33		18		16		18		
				39		34		40		33		33		17		25		12		14		10		7		7
	8	50		40		50		40		41		26		40		31		35		19		19		15		
				36		28		44		34		34		17		28		18		20		14		12		10
	9	47		30		46		37		42		26		38		22		29		21		16		(X)		
				32		20		35		30		32		16		24		10		15		10		7		8
	12	47		29		46		35		40		25		32		21		25		20		12		(X)		
				27		23		32		24		26		16		25		11		14		11		12		11
	13	52		31		54		35		42		25		37		23		34		20		20		15		
				40		27		43		25		38		19		29		15		18		14		12		8
Range	5		14		8		5		2		3		8		10		10		3		8		—			
			13		14		12		10		12		3		5		8		6		4		5		4	
Average	49		35		49		37		41		26		37		24		31		20		17		—			
			35		26		39		29		33		17		26		13		16		12		10		9	
(A) and (C)	Average	49		34		48		38		40		26		36		23		31		19		17		—		
				34		26		36		30		32		18		27		13		17		13		11		10

On the basis of the average results, it is concluded that added random noise is just visible on the picture at a signal/noise ratio of the order of 35 db., and that a signal/noise ratio lower than about 28 db. cannot be tolerated. It appears that, on a picture having no inherent noise, random noise would be just visible at a signal/noise ratio of about 40 db.; further investigation of this aspect would, however, be desirable before definite conclusions were drawn.

The effect of single-frequency noise was found to vary considerably according to the type of pattern produced, and for frequencies of the same order was much more serious when the frequency was an exact multiple of the line frequency, so that a stationary vertical bar pattern was produced. With a given type of pattern, the interfering effect decreased as the noise frequency was raised; the very low values of signal/noise ratio obtained at the highest frequencies may, however, have been partly due to lack of definition in the monitor employed. It is concluded that, for single-frequency noise in the range 20 kc/s to 2 Mc/s, the interfering effect is greatest when the noise frequency is a small integral multiple of the line frequency. For such noise frequencies, added single-frequency noise is just visible on the picture at a signal/noise ratio of the order of 50 db., and a signal/noise ratio lower than about 35 db. cannot be tolerated. No tests were made at frequencies lower than 20 kc/s, but as the visual effects would be similar, it appears reasonable to assume that the same figures would

apply with lower frequencies such as to give distinct bar patterns.

It will be appreciated from these results that single-frequency interference is, in general, more objectionable than random interference, as the bar pattern produced by the former is more noticeable than the moving spots produced by the latter, for a given intensity.

The level at which interfering signals first become visible is clearly directly related to the minimum perceptible percentage difference of brightness. It has previously been found that this is nearly independent of brightness over a wide range of brightness, and is of the order of 1–2 per cent. For a figure of 1 per cent. the interfering signal would just become visible at a signal/noise ratio, as measured in the experiments described in this article, of 46 db., which corresponds approximately with the level at which single-frequency interference just became visible in these tests.

Another important feature which these results indicate is the comparatively small difference of only about 12–14 db. in the level of noise which is just visible in the absence of all other noise, and the level of noise which is intolerable. Although this is, in some respects, a useful feature, the importance of it must not be overlooked when connecting a number of links of a television circuit in tandem, for while the noise in each individual link may just be invisible, the noise on the overall circuit may become intolerable.

Book Review

“Cathode Ray Tubes.” Manfred Von Ardenne. Translated from the German by G. S. McGregor and R. C. Walker. 530 pp. 465 Ill. Pitman. 42s.

This book is a revised English translation of a work originally published in German in 1933. The author has been associated with the development of cathode ray tubes and their application to television technique for many years, and the work is therefore authoritative. The subject is divided into four main chapters dealing with the construction of the cathode ray tube, the accessory circuits, the application to measurements, and the application to sound film recording and television.

The first chapter is illustrated with some particularly interesting photographs of ray paths to demonstrate focusing, etc. Practical information is given regarding the design and manufacture of gas-filled and high vacuum tubes. The information regarding after-glow in screens is interesting in connection with the application to television transmission. The section on the application of electron optics to focusing could, with advantage, have been amplified in view of the progress in this connection in recent years.

The second chapter gives useful information regarding power supplies and pre-amplifiers. Although the frequency ranges dealt with in connection with the latter have been far surpassed in television development, the general principles remain unaltered. Considerable space is devoted to time-base circuits, particularly for measurement work.

The wide field of usefulness of the cathode ray tube as a measuring instrument is well illustrated in the third chapter, and a careful study of this chapter will no doubt suggest to readers other applications to their particular problems.

In the fourth chapter the author's pioneer work on the application of the cathode ray tube to film scanning is of considerable interest, but no attempt is made to deal with the latest development in cathode ray television receiver technique, the author referring the reader to his later book on television reception.

The book is well illustrated with diagrams and photographs, and an extensive bibliography is given at the end of each chapter.

R.F.J.J.

Local Line Development Plant

U.D.C. 621.315.213 621.315.67 621.395.74

F. GUEST

This article is an endeavour to give a brief resumé of the basis of provision of local line plant, the methods adopted for cable design and the measures adopted for securing flexibility and relief.

Introduction.

THE subject concerned is a wide and varied one and although knowledge may be acquired from reading the relative Engineering Instructions, no definite rules can be laid down for any particular area.

Plant provision must therefore be based on :

- (1) The forecast of direct exchange lines and miscellaneous circuits supplied by the Sales Branch with suitable additions for power circuits and ringing leads, supplied by the Engineering Branch.
- (2) The existing plant and
- (3) The adoption of common sense principles in plant design, due regard being paid to the relative instructions and the conditions and amenities of the localities concerned.

Forecasts.

This particular feature of plant provision is a very vexed and difficult one. What may appear to be the right thing to-day may be the wrong thing to-morrow, due to unforeseen circumstances.

It may be that an estate company will conceive the idea of developing a certain area and then, for some reason or other, something happens to veto the scheme and the company decide to operate in an entirely different locality; or it may be that a scheme is set on foot to convert a number of houses into residential blocks of flats. Such alterations which cannot always be foreseen, often necessitate considerable amendments to the forecast figures, and if an underground development scheme has been prepared on these figures, then the particular area concerned has either a surplus or deficit of plant. Similar difficulties have been experienced owing to unforeseen air-raid precaution and defence requirements. It will therefore be appreciated that cable layouts become somewhat involved if the best use is to be made of the plant.

Figures are supplied by the Sales Branch giving the existing lines and forecast developments for the 1945, 1950, 1955, and 1960 periods. These are based on detailed surveys and intensive enquiries as to likely building development, etc., due allowance being made for the rateable values of various properties which are given weighting factors. From these facts and figures the forecasts are prepared. Upon the figures given, some thousands of pounds may be spent on engineering plant which may lie idle and therefore be non-revenue earning if the figures given are too optimistic. On the other hand, plant may not be in position by the time it is required, which results in orders for telephones either being refused or work being carried out which may be wasted, if the figures are too pessimistic.

It is considered that forecasts for exchange areas as a whole are remarkably accurate. Any difficulties that are experienced in this respect are usually to be

found in individual localities, especially those which are served by separate cable tracks.

Since the new forecasting procedure, instituted in 1936, has been in practice, it is felt that this has indeed been a step in the right direction towards more accurate forecasts.

Existing Plant.

It frequently happens that the layout of existing cables is not conducive towards a really satisfactory layout of both the old and the new plant, provided under a new development scheme.

The aim should be to avoid bottle necks, i.e., arrangements which prevent the continuation of cable pairs from the distribution poles to points of flexibility (auxiliary joints) or between points of flexibility and the exchange.

So far as the old plant is concerned, due regard should be paid to its future life. In certain areas it is more economical to scrap the old plant, if the future life is limited, to provide a clean layout and at the same time afford a proper basis for relief when necessary at a later date.

It should also be ensured that the existing jointing chambers and manholes are of suitable size and design so that they will provide a reasonable space and conditions for working operations to be carried out satisfactorily.

Plant Design.

Ducts, Manholes and Jointing Chambers.—These are normally provided on a 20-year basis except for :

- (1) " Leads-in " to exchanges where usually the period of the life of the building is used.
- (2) Throughfares congested with other undertakers' plant where no room exists for a subsequent instalment of conduits.

In instances where the standard manholes are unsuitable, special non-standard manholes should be provided.

These, if of the large type, should be designed not only to give adequate room from a cabling and layout aspect, but to afford ample space for jointers to work simultaneously without congestion, especially if transfer and diversion operations on a large scale are likely to be involved.



FIG. 1.—MODEL OF NON-STANDARD MANHOLE.

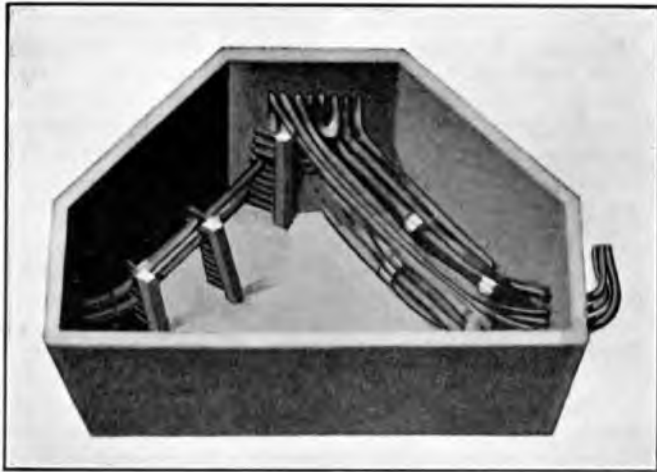

FIG. 2.—TYPICAL MODEL OF NON-STANDARD MANHOLE.

To facilitate cabling and lay-out operations, models should be prepared of which typical examples are shown in Figs. 1 and 2.

Plans should be prepared showing the types of cable entering and leaving the individual ducts in the exchange manhole and the positions which the cables occupy on :

- (a) the tiers of the cable chamber rack or supports,
- (b) the ducts between the cable chamber and the apparatus room, and
- (c) the M.D.F. verticals. This will ensure that no unsightly crosses will arise during cabling operations.

Special care should also be taken so far as jointing chambers are concerned at points of flexibility. Where



FIG. 3.—AUXILIARY JOINT IN FOOTWAY JOINTING CHAMBER.

an auxiliary joint is to be installed the jointing chamber should afford adequate working space, and if there are a number of cables on the route it may be necessary to use a manhole. Fig. 3 shows a mechanical type auxiliary joint situated in a footway jointing chamber (Type JRF4) from which it will be seen that the space available for the jointer is extremely limited.

Cables.—The importance of design cannot be over-emphasized on account of the high costs involved.

Planning periods for cables are 8 and 20 years and cables are provided to cover the first mentioned period where the growth exceeds 8 per annum over the 20-year period. Where the growth is less than this figure then the last mentioned period applies. These periods for large schemes commence from the year it is anticipated that the plant will be ready for use and this is usually the year following the design of the scheme, but may, on occasions, vary slightly.

The rules in the relative Engineering Instructions regarding cable provision are laid down as a guide only, and where the resultant cable sizes cause "bottle necks" then these rules are waived and the next larger suitable size is provided. Where, however, the forecasts justify a cable size which cannot be economically used, then similarly the next smaller size is used; the idea being to provide a sound, economical and flexible scheme.

Flexibility should be the key-note of cable design, as no matter what precautions are taken with forecasts, discrepancies are bound to arise from time to time. To meet these difficulties auxiliary joints, teed joints, and local loops are introduced.

An auxiliary joint provides an easy means of transferring wires from one distribution pole (D.P.) to another where the actual growth as compared with the forecast growths is greater in one area than another, whereas a teed joint makes one pair of exchange wires available at two D.P.'s and thus it is possible to use the wires at one or other of the D.P.'s, depending of course where the subscriber matures.

Under the local loop scheme pairs of wires are available between 2 D.P.s only. These are used for subscribers' external extensions circuits and private wires, and obviate the necessity for routing the circuits via the exchange M.D.F. Such pairs have been used where exchange pairs were not available at one D.P. but an exchange pair could be strapped through on the terminal block of another D.P. and thus made available at the first D.P. Fig 4 shows a typical example.

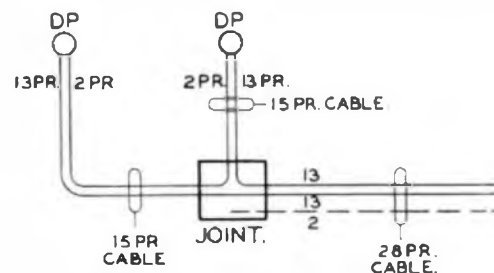

FIG. 4.—USE OF LOCAL LOOPS.

Auxiliary joints are made on from 100 pairs up to 250 pairs of wires on the exchange side of the joint and are usually situated at the junction of networks for the 8 and 20-year planning periods as shown in Fig. 5. It is generally undesirable to install an auxiliary joint at a point less than a $\frac{1}{4}$ -of-a-mile from the exchange. At points less than this distance it is generally cheaper to carry the cable for the 20-year period back to the exchange. It should be mentioned, however, that discretion should be used in deciding the position of these joints and there should be no

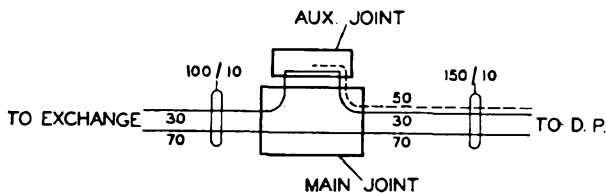

FIG. 5.—PRINCIPLE OF AUXILIARY JOINT.

hesitation in placing them at points adjacent to the junctions of the 8 and 20-year planning point if conditions warrant the procedure. This means either extending the 8-year into the 20-year area or vice versa.

Generally mechanical joints (Nos. 1, 2 and 3) may be used on cables having 100, 200 and 300 pairs respectively on the exchange side of the auxiliary joint. Cables totalling more than 350 pairs should not be used on account of the danger of damage to the insulation of the wires and possible displacement of the paper sleeves when the tube is removed. The number of pairs which are led into an auxiliary joint from D.P.'s in excess of those from the exchange varies considerably and of course depends chiefly on the forecast. Approximately 33 per cent. of the pairs on the exchange side are taken into the auxiliary joint.

Teed Joints.—These joints are generally provided at suitable junction points within the 20-year area. These points are usually to be found at the junction for several D.P.'s where the forecast figures do not permit of all the total available pairs being carried forward in the main track towards the exchange. In Fig. 6 twenty-six pairs are shown connected direct and the remaining twelve are teed to twenty-four

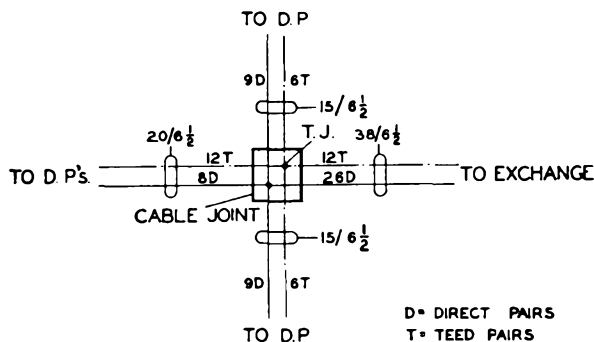

FIG. 6.—EXAMPLE OF TEED JOINTS.

pairs from D.P.'s. Such joints should not be made on pairs passing through an auxiliary joint as such an arrangement tends to complicate the records.

Local Loops (Link Pairs).—As previously explained, these provide a certain amount of flexibility between D.P.'s and also have the advantage of absorbing dead pairs in the main track which, on account of cable sizes, cannot be carried back to points of flexibility or the exchange.

A cable scheme should be planned so that relief can be provided, when necessary, by one or more of the following methods:—

- (1) By the extension of the plant at the extremities of the area beyond the points of flexibility.
- (2) By re-arranging auxiliary joints.
- (3) By drawing-in additional cables between the exchange and points of flexibility.

The practice of cutting into a large size cable for single D.P. spurs should be avoided where possible and the spur cables brought to the nearest joint providing the distance is not more than, say, approximately 100 yards.

In planning development schemes for large areas, it may be found very convenient to lay out the proposals for the whole area, and then sub-divide into smaller areas for estimating purposes, e.g., north, south, east and west localities.

Aerial Cables.

These cables are usually designed to cater for the 20-year requirements and used in rural and urban areas where the forecast figures do not warrant the provision of a duct. Unless expensive reinstatement conditions exist, aerial cables of types larger than 54 pairs are, as a general rule, not provided, but the question of providing cables of larger size is under review. Aerial cables up to this size are usually employed unless footway grass reinstatement is concerned, when underground may be found to be more economical, but nowadays with the many road-widening schemes that are either in progress or contemplated, this type of reinstatement is met with only on rare occasions. Before aerial cable construction is embarked upon, due consideration should be given to:—

(a) *Road Conditions.*—It is not advisable to erect an aerial cable route over a road which has numerous twists and turns with large trees on either side, as such conditions tend towards difficult and expensive maintenance. Where acute bends exist in a long length of route, it is good practice to lay duct at the bend for such a length that is sufficient to provide staying facilities for the two end aerial cable poles.

(b) *Stays.*—The strains and stresses on an aerial cable route are considerable and unless suitable conditions exist and the wayleaves are forthcoming for the necessary stays and struts, it is impossible to make an engineering job.

(c) *Junction Cables.*—Invariably if a junction cable is required along the same route, it is preferable for a duct route to be provided unless both subscribers and junction ultimate requirements are small, when one or two cables may be provided aerially.

(d) *Road Alterations.*—Aerial cable routes would not be provided where road alterations are contemplated as this would involve costly shifting operations. It is desirable, if possible, to wait until road operations

are in progress, lay a duct and avoid reinstatement charges.

(e) *Amenities.*—This type of construction, which cannot be considered sightly, is not recommended in built-up localities and should be restricted in the main to outlying areas.

Cable Design.

Aerial cable routes generally serve sparsely populated areas, included in which are isolated farms. It has been the practice in one District to meet the requirements of such farms by taking the back end pairs, as well as the exchange side pairs, into intermediate terminal blocks on the route, to avoid running wires for long distances on the overhead route. Should the subscriber cease service, then the cable pair can be strapped through on the block and used in another locality. This arrangement is similar to the method of "local looping" as described earlier in the article.

Subscribers' Underground Distribution.

This method of providing subscribers' service is adopted only where economical or where other methods are impracticable. Where semi-detached houses are concerned, one W.I. pipe is provided between the public thoroughfare and the premises and two 1-pr. 10 P.C.T. cables are provided for the two houses. Couplings can generally be used where the pipe joins the main cable run. Depending upon the number of houses and the forecast, 7, 10 and 15 pair cables are used for direct distribution.

A general planning policy to be adopted on future schemes on new estates is now under review by the Engineer-in-Chief's Office.

Distribution Poles.

The introduction of the ring type D.P. when used with open wires has done much to improve the appearance of overhead services and it is felt that less objection will be offered to this type of overhead construction than to the old cross arm covered wire type of D.P.

Dependent upon the type of property and of course the forecast, the ring type D.P. is frequently the most suitable for urban type areas. These D.P.'s may be provided to accommodate from 7 to 20 pair cables and are situated approximately 90 yards apart.

From a general appearance aspect it may be preferable to break out from a duct track and open a D.P. rather than run a number of open wires for several spans. This method is less subject to interruption and therefore less costly from a maintenance standpoint.

The æsthetic appearance of the ring type D.P. may be considerably enhanced by fitting additional insulators in positions diametrically opposite to the existing insulators where one-sided distribution predominates.

Block Wiring Points.

Every opportunity should be taken to install these points where suitable conditions exist.

Where large D.P.'s are situated in the inner localities of a busy town, the position should be reviewed from a block wiring aspect, as it will be appreciated that to provide new and maintain old services from such a D.P. is comparatively costly.

"Leads-in" to Large Buildings.

Where a number of floors in one building have to be served telephonically it may be advisable to serve each floor by a separate cable from an M.D.F. in the basement rather than by diminishing cables to each floor. This arrangements affords flexibility and when congestion arises on any particular floor it can be relieved by a redistribution of the main cable pairs on the M.D.F.

Conclusion.

To deal with a subject of this magnitude it will be appreciated that an outline of the broad principles only can be attempted but it is felt that if the ideas included in this article are put into practice many of the difficulties experienced with local line plant will be eliminated.

Constant Impedance Equalisers : Simplified Method of Design and Standardisation

F. PYRAH

U.D.C. 621.391.312.

In this article the author gives details of a method whereby constant impedance equalisers can be designed in a simple non-mathematical manner. Details are also given of a variable equaliser, together with a suggested scheme of standardisation of constant impedance equalisers for audio circuits.

Introduction.

FOR many years equalisation of attenuation distortion on cables has been done by the "grid-tuning" type of resonant equaliser. This type is quite suitable for coil-loaded lines of comparatively low cut-off frequency, but is totally unsuited for large amounts of equalisation or for the equalisation of unloaded cables. The growth of multi-channel carrier telephony and the consequent use of either very lightly loaded or unloaded cables has resulted in a more extended use of constant impedance equalisers for the correction of attenuation distortion. Apart from the use of such equalisers on carrier schemes, the number of audio circuits for which it has been necessary to provide them has increased until at the present time there is a considerable number of repeater stations at which constant impedance equalisers are fitted. They are generally fitted on special circuits, such as music circuits, where the ordinary method of equalisation is unsuitable owing to the use of unloaded cable or where the repeaters are not equipped with attenuation equalisers. Apart from the fact that such uses will continue to occur, it is possible that unloaded cables and flat gain amplifiers will become of general use in the provision of short repeated circuits, when constant impedance equalisers will become part of the normal equipment at all repeater stations.

The first equalisers to be fitted as permanent equipment on Post Office lines were those for the Port Kail-Donaghadee telegraph cables when they were released for use as telephone and V.F. telegraph circuits in 1933. Since then the design of equalisers has been undertaken by the Engineer-in-Chief's Office, from theoretical considerations or from transmission measurements. Experience in this connection has shown that considerable mathematical labour can be avoided by the use of curves which are of more or less general application. Further experience in the use of these curves has led to the development of a variable equaliser for use on audio (or voice) circuits, and as a result of this work it has been found possible to formulate proposals for standardisation of constant impedance equalisers for such circuits. As will be explained later the general curves are applicable not only to the voice range of frequencies but to carrier frequencies also.

Method of Design from Simple Mathematical Considerations.

A previous article on constant impedance equalisers¹, to which reference should be made for general information, has been published in this JOURNAL. The article gives methods of design, but it is desirable in

¹ P.O.E.E.J., Vol. 29, p. 302

the present article to outline in brief another method. It is as a result of attempts to simplify this latter method that the standardisation of equalisers becomes practicable.

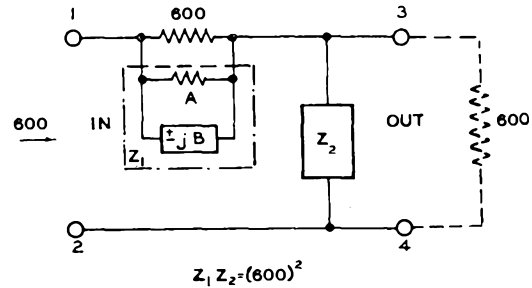

FIG. 1.—GENERAL LADDER TYPE OF CONSTANT IMPEDANCE EQUALISER. $Z_0 = 600\Omega$.

The type of equaliser which is to be considered is the ladder type having a characteristic impedance of 600Ω shown in generalised form in Fig. 1. Figs. 2 and 3 show the two particular forms of the equaliser with which this article is concerned. The form shown in Fig. 2 is generally used for unloaded lines of com-

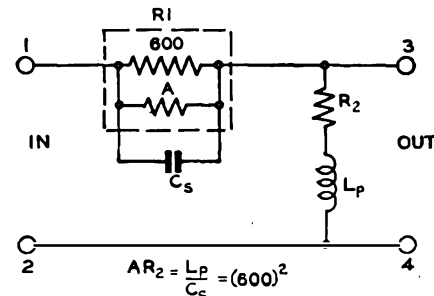

FIG. 2.—NON-RESONANT TYPE EQUALISER.

paratively short length, and the equaliser shown in Fig. 3 is used for loaded cables and also on long lengths of unloaded line—often in association with an equaliser of the form shown in Fig. 2.

Referring to Fig. 1, the ratio, n , of the voltage across the input terminals 1, 2, to that across the output terminals 3, 4, is given by

$$n = \left(1 + \frac{r}{600}\right) \pm j \frac{x}{600} \dots\dots\dots 1 (a)$$

where r and x are the effective resistance and reactance respectively of A and jB in parallel.

Squaring 1 (a)

$$n^2 = \left(1 + \frac{r}{600}\right)^2 + \left(\frac{x}{600}\right)^2 \dots\dots\dots 1 (b)$$

The transmission loss N of the equaliser is given by $N \text{ db.} = 20 \log n = 10 \log n^2 \dots\dots\dots (2)$

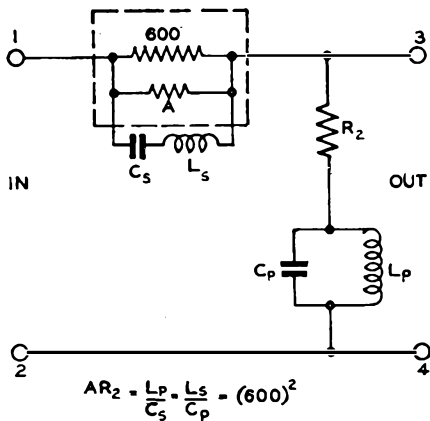

FIG. 3.—RESONANT TYPE EQUALISER.

Now assume it is necessary to design an equaliser to produce a specified loss/frequency characteristic. A typical characteristic plotted to a linear frequency scale is given in Fig. 4. It can be seen that an extension of the curve at the low frequency end indicates that the loss at zero frequency (D.C.) should be

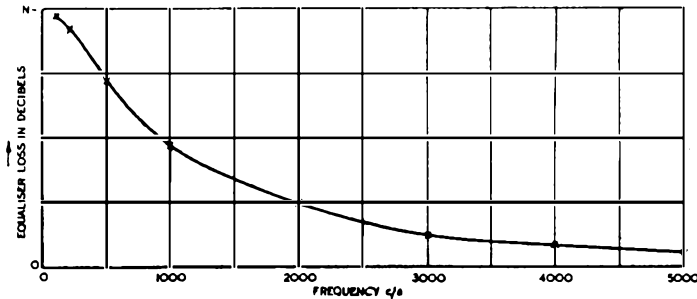

FIG. 4.—GENERAL SHAPE OF EQUALISER CHARACTERISTIC FOR UNLOADED CABLE.

approximately N db. This loss will be referred to as the basic loss of the equaliser. At zero frequency assume the effect of the reactance across the resistance A of Fig. 1 is nil. The value of x in Equation 1 (a) is therefore zero and the value of r becomes equal to A. Equation 1 (a) therefore reduces to

$$n = 1 + \frac{A}{600}$$

$$\text{or as } n = \text{antilog } N/20$$

$$A = 600 \left[(\text{antilog } N/20 - 1) \right] \dots (3)$$

Having thus found the value of the resistance A, it is now possible to use arbitrary values of shunt reactance B and to find their joint impedance in terms of effective resistance and reactance. These values can then be substituted in Equation 1 (b) and the transmission loss evaluated from (2). Thus, for each arbitrary value of B it is possible to find the loss which will result. Reference to the desired loss curve (Fig. 4) will enable the frequencies to be read off at which these losses are to occur. It then remains to plot a curve of reactance/frequency which is to be simulated in order to produce the required loss characteristic. By taking values of B which are in a geometrical progression, it is possible to avoid a fair amount of arithmetical labour. Sometimes it will be

found that if this is done the values of frequencies so determined will also be in a geometrical progression. This indicates that the loss characteristic will be obtained by making use of a condenser as the only reactive element in the series arm (see Fig. 2). It is also possible to simplify the calculations by taking fixed values of a ratio of B to A, and then it is possible to have a table whereby conversion from a parallel arrangement of resistance and reactance to its equivalent series resistance and reactance can be effected quickly.

Design Curves of General Application and Non-resonant Equaliser "Masks."

A more useful aid to the evaluation of equalisers is to plot on logarithmic paper a series of curves for fixed values of A (and therefore basic loss) and varying values of reactance B marked on a logarithmic scale. Such a set of curves is shown in Fig. 5, the vertical scale being marked in decibels. It will be seen that although only three curves have been plotted, it is quite possible to insert estimated additional curves, such as the one shown dotted, for any basic loss without actually carrying out any calculation. Such estimated curves are sufficiently accurate for ordinary purposes. The set of curves shown in Fig. 5 can be used for the design of either of the equalisers shown in Figs. 2 and 3, and this is done as follows:

First of all a basic loss is decided upon and the value of A evaluated, using Equation 3; if necessary the estimated curve for this basic loss is inserted on Fig. 5. It is then possible to write down the values of reactance B required to give the desired loss characteristic of the equaliser by reading off the values of frequency and reactance for a common loss from the two curves, i.e. equaliser loss curves of Fig. 5 and curve of transmission loss of the line to be equalised, or as it will be termed, "line plot."

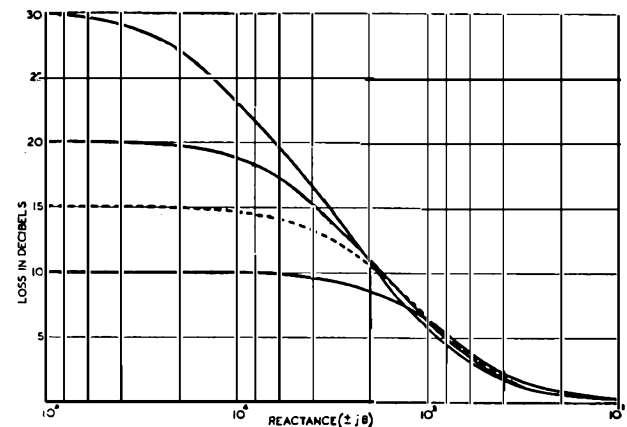

FIG. 5.—GENERAL DESIGN CURVES FOR CONSTANT IMPEDANCE EQUALISERS.

For the type of curve in Fig. 4, however, which can be closely simulated by an equaliser of the type given in Fig. 2, it will be found that if the curve of required equaliser loss is plotted on logarithmic paper the curve is of exactly the same shape as those

given in Fig. 5. This will be evident if it is remembered that the reactance of a simple condenser is inversely proportional to frequency. Thus if the reactance loss curves of Fig. 5 are printed on a transparent medium and this mask, as it will be termed, is then placed over the required equaliser loss frequency curve in such a manner that the latter curve becomes, in effect, an extra curve in the set of three shown, then the required equaliser curve can be considered as being common to the two sheets. This being so, there must be a common relationship between the scales of frequency and reactance. This is clearly so if they have both been plotted to the same scale. It is only a matter, therefore, of reading off the value of reactance B at any frequency, and from the relationship $B = 1/\omega C$ the value of C can be determined. The value of L in the shunt arm follows from the relationship $L = C \times 600^2$, which is fundamental for constant impedance equalisers. Even the evaluation of the condenser may be eliminated by inserting condenser values instead of reactance values in Fig. 5. Thus, having placed the

value of resistances A and R_2 can, where necessary, be evaluated from Equation 3 and the relationship $AR_2 = 600^2$. The joint resistance of A in parallel with 600Ω gives the value of R_1 .

A better method of calculation, however, is to evaluate R_1 and R_2 directly from the following :

$$R_1 = \frac{600(n-1)}{n} \dots\dots\dots(4)$$

$$R_2 = \frac{600}{n-1} \dots\dots\dots(5)$$

where R_1 is the combined resistance of A in parallel with 600Ω and where n is the voltage ratio corresponding to the basic loss.

It will be clear that when using a transparent mask it is not necessary to plot the curve of required equaliser loss as such. Provided the decibel scales of the line plot and mask are inverse a direct comparison can be made between the curves on the mask and the line-loss curve.

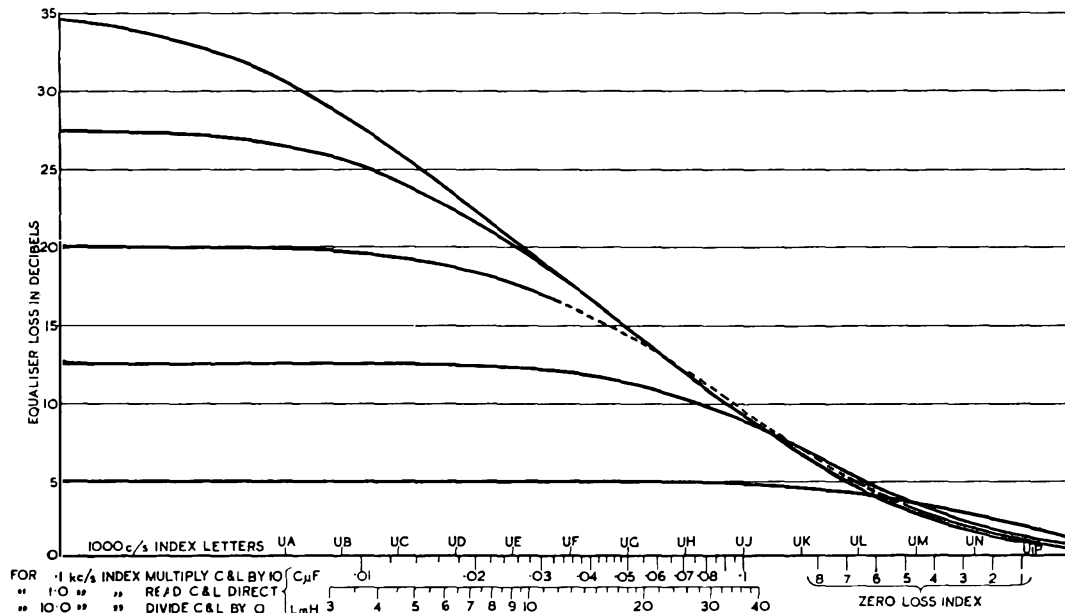

FIG. 6.—DESIGN CURVES FOR NON-LOADED CABLE EQUALISERS.

two sheets so that the required equaliser loss curve and mask curve fit in with each other, suppose that the value of reactance on the mask, which is coincident with the 1,000 c/s index of the line plot is replaced by the value of the condenser which will give that value of reactance at 1,000 c/s. As the other values of reactance are inversely proportional to frequency, then all other reactance values may be similarly treated. Thus the reactance scale now becomes a scale marked off in capacitance values.

Fig. 6 shows a complete mask. Values of inductance in the shunt arm of the equaliser are also shown, as these are related directly to the capacitance in the series arm. Such masks enable the type of equaliser shown in Fig. 2 to be determined by comparing the required equaliser loss characteristic with the mask characteristic and reading off the basic loss together with values of capacitance and inductance. The

Extension of Methods for Resonant Equalisers.

The equaliser given in Fig. 2 is of a non-resonant type, and its loss approaches zero as the frequency approaches infinity. Such an equaliser is not suitable for loaded lines and for certain unloaded lines. For such lines it is usually necessary for the equaliser to take the form shown in Fig. 3. The loss/frequency characteristic of this type of equaliser is shown in Fig. 7 (full curve), and it will be seen that, assuming perfect coils and condensers, the loss is zero at a finite frequency due to the resonance which occurs between L_s and C_s and between L_p and C_p . The slope of the curve, that is the rate at which the loss reaches zero, is dependent upon the relationship between L_s and C_s (or L_p and C_p); thus, if the product $L_s C_s$ is varied, then the resonant frequency is also varied, and if the ratio is varied, then the slope of the curve only is varied. It would appear at first

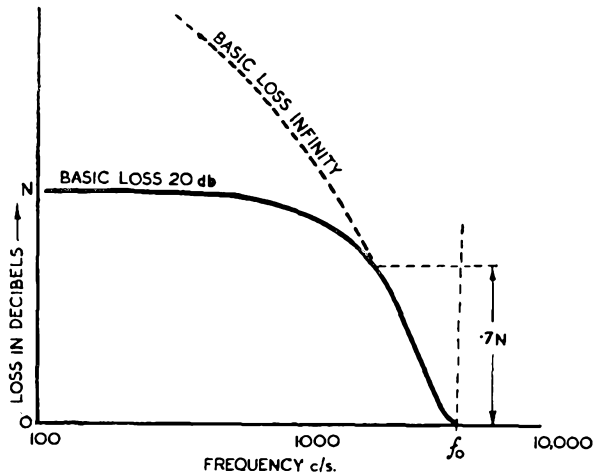

FIG. 7.—TYPICAL LOSS/FREQUENCY CHARACTERISTIC OF RESONANT EQUALISER.

sight that to obtain a set of curves from which an equaliser of this type can be designed easily will present some difficulty. This, however, is not so.

It will be realised that the basic loss is determined by the value of A in Equation 3, and that the rate at which this basic loss approaches zero is a function of the reactive elements. From a consideration of the curves for non-resonant equalisers (Fig. 5), it is evident that a single curve for a basic loss of infinity (i.e. A = infinity) could have been used with a fair amount of accuracy, and it is reasonable to suppose that this can be done for resonant type equalisers. As the curve for such equalisers will require to show both resonant frequency and variable slope, it is evident that the omission of the resistance A will effect considerable simplification in the plotting of curves of general application. The dotted curve of Fig. 7 shows the loss characteristic of an equaliser when the basic loss is assumed to be infinity.

Assume the resistance A in Fig. 3 is omitted. The equation connecting the loss of the equaliser with the impedance of the series arm therefore reduces to :

$$\text{Loss} = N = 10 \log_{10} \left(1 + \frac{B^2}{600^2} \right) \dots \dots \dots (6)$$

Having omitted A from the network, it is left to calculate values of reactance B for various values of C₃ and L₃ in Fig. 3. The reactance B₁ of any capacitance C in series with an inductance L at a frequency f₁ such that 2 π f₁ = ω₁ is given by :

$$B_1 = \omega_1 L - \frac{1}{\omega_1 C} \dots \dots \dots (7)$$

At the resonant frequency f₀

$$2 \pi f_0 = \omega_0 = \frac{1}{\sqrt{LC}}$$

from which

$$L = \frac{1}{\omega_0^2 C}$$

Therefore substituting in (7)

$$B_1 = \frac{\omega_1}{\omega_0^2 C} - \frac{1}{\omega_1 C}$$

Rearranging,

$$B_1 = \frac{1}{\omega_0 C} \left(\frac{\omega_1}{\omega_0} - \frac{\omega_0}{\omega_1} \right) \dots \dots \dots (8)$$

At frequencies below resonance this value will be negative, indicating capacitive reactance. Substituting this expression for B in equation (6).

$$\text{loss} = N \text{ db.} = 10 \log_{10} 1 + \left[\frac{1}{\omega_0 C} \left(\frac{\omega_1}{\omega_0} - \frac{\omega_0}{\omega_1} \right) \right]^2 \dots (9a)$$

or, alternatively, as

$$\frac{1}{\omega_0 C} = \omega_0 L$$

$$N \text{ db.} = 10 \log_{10} 1 + \left[\omega_0 L \left(\frac{\omega_1}{\omega_0} - \frac{\omega_0}{\omega_1} \right) \right]^2 \dots (9b)$$

These two formulæ are of interest, because of the ease with which the loss/frequency characteristic of the type of equaliser under review can be determined. Also, it can be seen that if a curve is calculated for a particular value of ω₀C (or ω₀L), this curve is applicable for an infinite number of values of either ω or C provided the same values of ω₁/ω₀ are used and provided the product ω₀C remains constant. Assume one such curve is calculated for say a capacitance of .05 μF and plotted on a transparent medium such as celluloid, using logarithmic paper underneath for scale purposes. The scale of the logarithmic paper should be marked off from 100 to 10,000 c/s and the decibel scale marked to a convenient size. Let the value f₀ (i.e. ω₀/2π) be taken as 1,000 c/s. Draw a vertical line coincident with this point. Now, if the transparent medium, or as it is termed, mask, is moved horizontally along until the vertical line coincides with, say, 5,000 on the logarithmic paper, the points through which the curve passes indicate the losses of the equaliser when its resonance is altered to 5,000 c/s and the value of the condenser has been reduced to one-fifth of its 1,000 c/s resonance value. If a point is now placed on the horizontal axis of the mask coincident with the 1,000 c/s point on the logarithmic paper, this point can be marked off with the value of √LC which gives resonance at 5,000 c/s.

The curve calculated is only one of an infinite number which can be made to resonate at 5,000 c/s. It can, however, be defined because the curve was calculated using particular values of ω₀, C and L. Thus, the slope of the curve applies to a particular value of L/C (or C/L), and this value can be marked off alongside the curve. That this is valid can be seen if we consider the mask to be moved further along horizontally until the vertical line indicating resonance frequency is coincident with 10,000 c/s. The value of the resonant frequency has been doubled. From Equation 9(a) in order to keep the same curve, C must have been reduced to half of its 5,000 c/s value; also from Equation 9(b) L must also have been reduced to half of its 5,000 c/s value, that is, the ratio of L/C has remained constant but the values of C and L have been changed. From this it will be seen that a family of curves can be calculated and plotted from Equations 9(a) or 9(b). Having done this, each curve can be marked off with its value of L/C and a

sufficient number of resonance points indicated by marking off the value of \sqrt{LC} at points coincident with the relative 1,000 c/s index to enable a considerable number of equalisers of the type shown in Fig. 3 to be designed quickly. In actual fact, if it is remembered that the values of \sqrt{LC} are marked off to the same scale as the logarithmic paper, then a logarithmic scale can be placed on the mask from which any value of \sqrt{LC} may be used in the design of an equaliser. Fig. 8 shows the curves of a mask constructed to be of use over the frequency ranges

·1 kc/s to 10 kc/s and
1 kc/s to 100 kc/s

It will be observed that the curves have been marked with the values of $\sqrt{L/C}$, as this value is more easily used than L/C .

From such a mask it is possible to design an equaliser of the type given in Fig. 3 for either audio or carrier frequencies in a matter of a few minutes by the solution of a few simple simultaneous equations. This is done in the following manner.

First the loss/frequency characteristic of the line to be equalised is plotted on the same type of logarithmic paper as was used in the construction of the mask, using the same scale of decibels on the vertical axis. The mask is then placed over this with its vertical and horizontal axes parallel to those of the line plot and in such a position that one of the curves on the mask is coincident with the line plot from a point as near as possible equal to f_0 , to the frequency at which the correction is .7 of the total amount of correction required, as indicated in Fig. 7. After this the line plot flattens out and will cut the decibel scale of the mask. The value read off on this latter scale is the basic loss. Having thus placed the mask in the correct position, the following values are read off:—

Basic loss in db.

$\sqrt{C_s L_s}$ (value coincident with 1 kc/s or 10 kc/s index).

$\sqrt{L_s/C_s}$ (value given alongside particular curve used).

The resistance components R_1 and R_2 of the equaliser can be obtained from Equations 4 and 5. The values of C_s and L_s are obtained from the following two equations:

$$C_s = \frac{\sqrt{C_s L_s}}{\sqrt{\frac{L_s}{C_s}}} \dots \dots \dots (10)$$

$$L_s = \sqrt{C_s L_s} \times \sqrt{\frac{L_s}{C_s}} \dots \dots \dots (11)$$

The shunt arm components are obtained from the relationship

$$L_p = C_s 600^2 \dots \dots \dots (12)$$

$$C_p = \frac{L_s}{600^2} \dots \dots \dots (13)$$

If a balanced equaliser is required, then the impedances in the series arm must be divided by two and each of the impedances so obtained inserted one in each leg.

Where it is necessary to use equalisers having a characteristic impedance Z_0 different from 600Ω , the conversion is effected by multiplying all impedances by the ratio of $Z_0/600$. Calling this ratio r ,

Resistances are multiplied by r .
Inductances are multiplied by r .
Capacitances are divided by r .

Loss/Frequency Curves Requiring Two Equalisers.

Difficulties in obtaining satisfactory equalisation with a single equaliser arise when the amount of equalisation is large or when the frequency band to be equalised is very wide. As an example, music circuits often require as much as 30 db. equalisation over the range 50 c/s to 6,000 c/s—a frequency ratio of 1 : 120. For such circuits, when the limits of accuracy cannot be obtained on one equaliser of either of the types under discussion, satisfactory equalisation can be obtained by using two equalisers, usually one to equalise the lower frequencies and the other to equalise the higher frequencies. Equalisation of lines used for Carrier System No. 4 affords a good example of the method of treatment.

Design of Equalisers for Carrier Circuits.

The masks shown in Figs. 6 and 8 are intended mainly for use on audio circuits, but they can also be used equally well for any frequency range, as, for example, the range of frequencies covered by Carrier Systems No. 4 or No. 5 (P.O. 1 + 4 and 12-circuit carrier systems respectively).

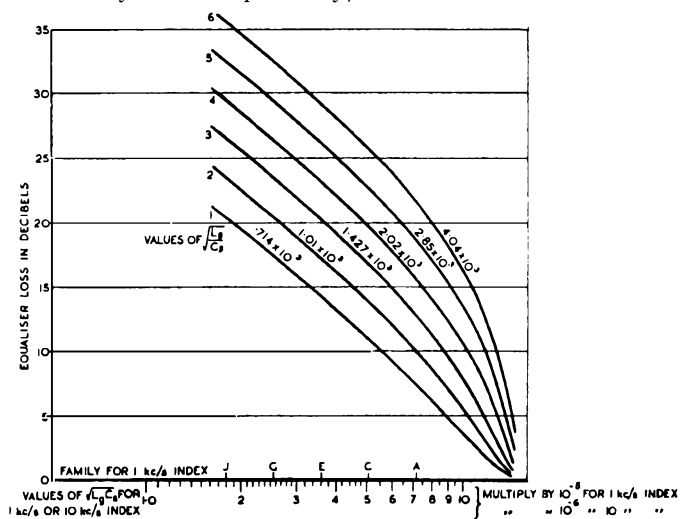

FIG. 8.—DESIGN CURVES FOR RESONANT EQUALISERS.

A typical transmission loss/frequency characteristic of a section of 25-lb. conductor loaded with 6 mH coils at 1,000 yards for Carrier System No. 4 is shown in Fig. 9. The frequency range covered is 200 c/s to 16,000 c/s, and it is clear that two equalisers will be necessary. The characteristic is therefore split up into two separate curves, one conforming to the shape which is obtained by using a simple non-resonant type equaliser, and the other curve to the shape obtained by using a resonant equaliser. Referring to the non-resonant equaliser, the required curve would be obtained when the 100 c/s of the line plot is coincident with the values $C = 0.45 \mu\text{F}$, $L = 162 \text{ mH}$ of the mask. Extension of the line curve to a value approaching zero frequency indicates a basic loss of 12 db. The evaluation of the resistances R_1 and R_2 from Equations 4 and 5 completes the design of this equaliser.

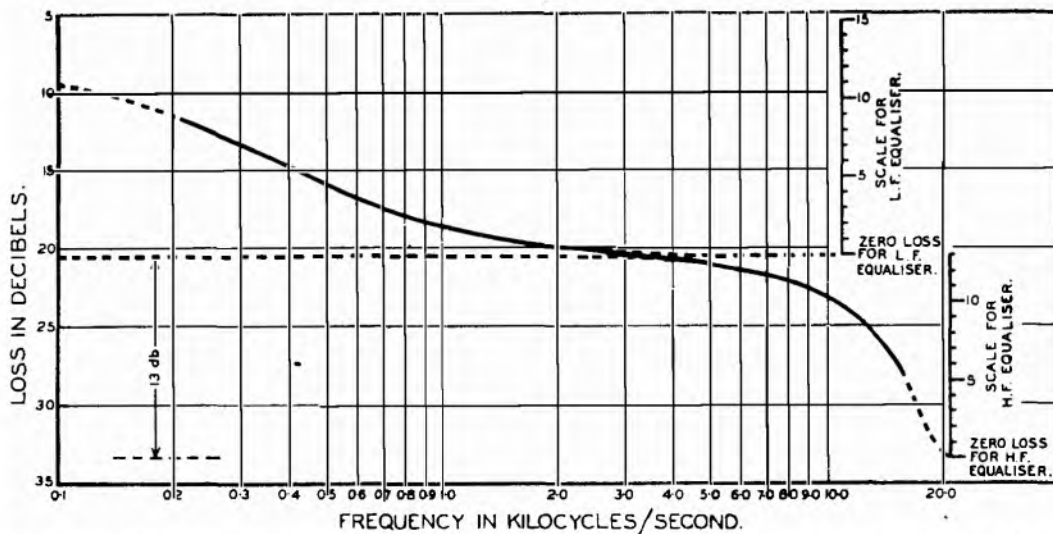

FIG. 9.—TRANSMISSION LOSS CHARACTERISTIC OF 30 MILES OF 25 LB. CONDUCTOR LOADED WITH 6 MH COILS AT 1,000 YDS.

For the resonant equaliser (to correct the higher frequencies) correct placing of the mask is obtained when the value of $\sqrt{L_s C_s}$ of the mask coincident with the 10 kc/s of the line-loss curve is 7.5×10^{-6} , and the line-loss curve falls on the mask curve whose $\sqrt{L_s/C_s}$ value is 1.43×10^3 . Under these conditions the low frequency end of the equaliser curve cuts the decibel scale of the mask at 13 db. Insertion of the three values so obtained in equations 4, 5 and 10 to 13 will give the values of the equaliser components. The full equaliser would be made up to the schematic diagram given in Fig. 10.

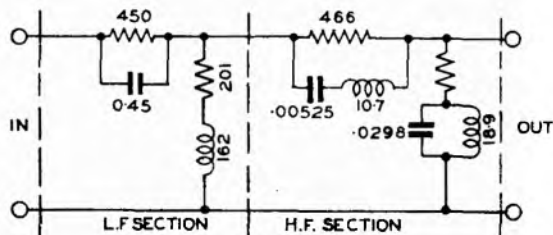

FIG. 10.—EQUALISER FOR 30 MILES OF 25 LB. CONDUCTOR LOADED WITH 6 MH COILS AT 1,000 YDS.

Design of Variable Equaliser.

The curves given in Fig. 8 are well suited as a basis for the design of a variable equaliser. If, in addition to marking condenser values or $\sqrt{C_s L_s}$ values along the bottom of the mask, fixed points are decided upon, then it becomes possible to design a variable equaliser to give curves corresponding to those in Fig. 8. In order to cover a wide range of frequencies it is necessary to select condenser (and inductance) values which are related to one another in a fixed ratio. This avoids the need for a large number of components in the variable equaliser. A ratio of $\sqrt{2}$ has been decided upon, this ratio giving families of curves whose resonant frequencies are related in the ratio $\sqrt[4]{2}$, i.e. 1.2 very nearly. The choice of $\sqrt{2}$ as the ratio of component values is also quite satisfactory for non-resonant equalisers.

A variable equaliser using this principle of com-

ponent variation has been made to the schematic diagram given in Fig. 11. By selection of condenser and inductance values and the inclusion of "U"

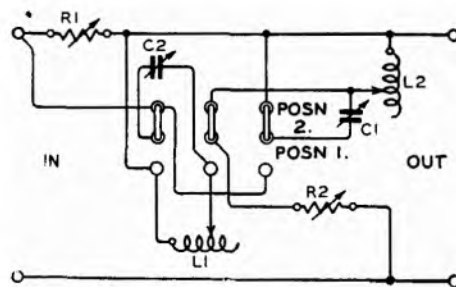

FIG. 11.—VARIABLE EQUALISER SCHEMATIC.

link switches it has been found possible to use the equaliser for both types of curve given in Figs. 6 and 8. Also in the case of Fig. 6 it has been possible to obtain additional curves (not shown) which, instead of approaching zero as the frequency approaches infinity, give zero loss (very nearly) at a finite but variable frequency. In other words the high frequency end of the curves may be turned downwards either slightly or more and more quickly until the curve actually turns over in a similar manner to the curves given in Fig. 8. The points at which the curves can be made to touch zero loss are indicated by the points marked "zero loss index," and this facility results in being able to produce an equaliser loss curve which can be changed from the shape given in Fig. 4 to that given in Fig. 7 in steps which are sufficiently close as to almost merit the description "continuously variable."

The equaliser has three controls. One is marked "Basis loss," and this controls the values of the series and shunt resistances simultaneously. The settings of this control are marked in decibels. The other two controls are marked CL1 and CL2, the former controlling C1 and L1 and the latter giving control of C2 and L2 (see Fig. 11). In this way the property of constant impedance is maintained independent of the equaliser setting. Table I gives the values of con-

TABLE 1.
VALUES OF CONDENSERS AND INDUCTANCES OF VARIABLE EQUALISER.

Position of Switch Arms CL1 and CL2	Values of			
	C1 μ F	L1 mH	C2 μ F	L2 mH
0	0	0	0	0
1	-025	9	-0707	25.5
2	-0353	12.7	-05	18.0
3	-05	18.0	-0353	12.7
4	-0707	25.5	-025	9.0
5	-100	36.0	-0177	6.4
6	-141	51.0	-0125	4.5
7	-200	72.0	-0089	3.2
8	-283	102.0	-0063	2.25
9	-400	144.0		
10	-565	204.0		

TABLE 2.
VALUES OF RESISTANCES IN VARIABLE EQUALISER.

Basic Loss Decibels	R1 Ω	R2 Ω	Basic Loss Decibels	R1 Ω	R2 Ω
5	263	770	20.0	540	66.7
6.5	317	538	21.5	550	55.0
8.0	361	397	23.0	558	45.6
9.5	400	302	24.5	564	38.0
11.0	431	235	26.0	570	31.6
12.5	458	187	27.5	574	26.4
14.0	480	150	29.0	579	22.1
15.5	500	121	30.5	582	18.5
17.0	515	98.8	32.0	585	15.5
18.5	529	80.9	33.5	588	12.9
20.0	540	66.7	35.0	590	10.8

TABLE 3.
VARIABLE EQUALISER SETTINGS—UNLOADED CABLE TYPE EQUALISERS.

1,000 c/s. INDEX																										Zero Loss Index		
UA		UB		UC		UD		UE		UF		UG		UH		UJ		UK		UL		UM		UN			UP	
CL 1	CL 2	CL 1	CL 2	CL 1	CL 2	CL 1	CL 2	CL 1	CL 2	CL 1	CL 2	CL 1	CL 2	CL 1	CL 2	CL 1	CL 2	CL 1	CL 2	CL 1	CL 2	CL 1	CL 2	CL 1	CL 2	CL 1	CL 2	
← LINKS IN POSN. 2 →										← LINKS IN POSN. 1 →																		
0	8	0	7	0	6	0	5	1	0	2	0	3	0	4	0	5	0	6	0	7	0	8	0	9	0	10	0	—
								1	8	2	7	3	6	4	5	5	4	6	3	7	2	8	1	—	—	—	—	1
								1	7	2	6	3	5	4	4	5	3	6	2	7	1	—	—	—	—	—	—	2
								1	6	2	5	3	4	4	3	5	2	6	1	—	—	—	—	—	—	—	—	3
								1	5	2	4	3	3	4	2	5	1	—	—	—	—	—	—	—	—	—	—	4
								1	4	2	3	3	2	4	1	—	—	—	—	—	—	—	—	—	—	—	—	5
								1	3	2	2	3	1	—	—	—	—	—	—	—	—	—	—	—	—	—	—	6
								1	2	2	1	—	—	—	—	—	—	—	—	—	—	—	—	—	—	—	—	7
								1	1	—	—	—	—	—	—	—	—	—	—	—	—	—	—	—	—	—	—	8

TABLE 4.
VARIABLE EQUALISER SETTINGS—LOADED CABLE TYPE EQUALISERS.
LINKS IN POSITION 2.

Family	Curve Number												Resonant Freq. f_0
	1		2		3		4		5		6		
	CL1	CL2	CL1	CL2	CL1	CL2	CL1	CL2	CL1	CL2	CL1	CL2	
A	—	—	7	1	8	2	9	3	10	4	—	—	2,200
B	6	1	7	2	8	3	9	4	10	5	—	—	2,650
C	5	1	6	2	7	3	8	4	9	5	10	6	3,150
D	5	2	6	3	7	4	8	5	9	6	10	7	3,750
E	4	2	5	3	6	4	7	5	8	6	9	7	4,450
F	4	3	5	4	6	5	7	6	8	7	9	8	5,300
G	3	3	4	4	5	5	6	6	7	7	8	8	6,300
H	3	4	4	5	5	6	6	7	7	8	—	—	7,500
J	2	4	3	5	4	6	5	7	6	8	—	—	8,900
K	2	5	3	6	4	7	5	8	—	—	—	—	10,600

condensers and inductances used and Table 2 gives the resistance values.

The masks for use with this variable equaliser are printed on celluloid and are similar to Figs. 6 and 8. A third mask is also available; this mask is similar to Fig. 8 but gives intermediate curves and index points. It will be observed that the masks have a "family" letter which (referring to voice circuits) when coincident with the 1,000 c/s of a line characteristic plotted to the correct logarithmic scale enables the loss/frequency characteristic of that particular family of curves to be read off. The curves themselves are also marked with a number, and to set up an equaliser to give a particular loss characteristic it is necessary to refer to Tables 3 or 4, from which the setting for any curve of the families given can be obtained. The equaliser has the following settings on the three controls.

Basic loss: 20 steps. This covers the range 5 db.-35 db. in steps of $1\frac{1}{2}$ db.

CL1: 10 steps. CL2: 8 steps.

By a combination of these settings it is possible to obtain a total of over 2,500 curves, although the settings given in the tables do not enable more than 2,000 of these curves to be specified; the remaining curves are considered to be of no value. The range given by these curves is intended to cover the frequency band 35 c/s to 11,000 c/s on both unloaded and loaded cables.

Use of Variable Equalisers.

The main use of variable equalisers will be to enable correction of attenuation distortion on circuits to be made without recourse to the Engineer-in-Chief's Office. This can be done by employing a variable equaliser for trial and then, having proved the suitability of the equaliser, a fixed one made up of components similar to those used in the variable equaliser can be substituted where desired. Another use for variable equalisers is to be found where temporary music circuits are to be set up for a matter of a few hours for broadcast purposes. These circuits are usually referred to as OB—outside broadcast—circuits to distinguish them from SB (simultaneous broadcast) circuits which are permanently rented by the B.B.C.

The method of use of the masks has been given earlier. Instead of having to perform calculations to determine the equaliser components, the required setting of the equaliser is obtained by noting the basic loss, family letter coincident with the 1,000 c/s index, and curve number. The required basic loss on the equaliser can be set up directly from the dial setting and the setting of the controls CL1 and CL2 can be obtained from Tables 3 or 4.

For unloaded cables equalisers of the form given in Fig. 2 are usually satisfactory. Sometimes, however, the line curve, instead of flattening out at the high frequencies, continues as a more or less straight line and cuts the horizontal scale of the mask. These curves can be satisfactorily treated by noting at which of the points marked "zero loss index" the line plot cuts the horizontal scale of the mask. The setting required to obtain the desired curve is obtainable as before by reference to Tables 3 and 4.

If a permanent equaliser is required then after checking the suitability of the variable equaliser setting the values of the components required can be obtained from Tables 1 and 2.

It will be seen therefore that all settings on the equaliser can be specified in the form of a simple three-element code of which the following are examples:

15.G.3, and

20.UF.2.

The first number in the code indicates the basic loss in decibels. Where this is followed by a single letter this letter indicates the family of curves used on the loaded cable equaliser masks. If, however, the letter is prefixed by the letter "U" then the equaliser curve is of the unloaded type. The final figure of loaded cable type equalisers gives the particular curve number whereas for the unloaded type equalisers it indicates the frequency at which the equaliser loss is zero.

Standardisation of Equalisers.

It is desirable to standardise any type of equipment as far as possible. With constant impedance equalisers this has not been possible up to the present, but it is thought that sufficient progress has now been made on the practical side of equaliser design to warrant future standardisation of all equalisers used for audio circuits.

The chief advantages to be gained are:

- (a) A standard specification can be drawn up to cover all equalisers.
- (b) Equaliser units can be stocked, so enabling equalisers to be made up at short notice or replacements to be effected with little delay.
- (c) Full design data and performance within close limits can be specified in the form of a simple code, thus simplifying records and eliminating the need for a large number of equaliser diagrams.

The equaliser units referred to in (b) above will each consist of a two-section inductance and two-section condenser in the same case. The inductances will be inverse to the condensers so that in an equaliser to Fig. 2 it will be necessary to use only one unit. The necessary resistors will be made up as required and will be screwed on the top of the case. It will be possible to mount six of the proposed units on a standard 10-in. by $3\frac{1}{2}$ -in. mounting together with a connection strip.

Conclusion.

The subject of attenuation equalisers is at the present time of considerable moment and it is hoped that this article has shown that, by the use of suitable "masks," the design of constant impedance equalisers of the types discussed has been simplified to a considerable extent. At the present time the long-distance backbone cables are all being designed for 12-circuit carrier systems. Attenuation equalisation is an absolute essential for this scheme. The future of the shorter distance, i.e. zone to group, cables is under consideration, and it is more than likely that attenuation will be catered for by feedback amplifiers, and all attenuation correction will be done on the line. The importance of the subject is consequently obvious.

A New Power Plant for P.M.B.X's.

W. S. ATHERTON

U.D.C. 621.311.8 : 621.395.23

Up to the present, double battery schemes (charge-discharge working) have been standard for the power supply at P.M.B.X'S. The author describes the single battery float scheme which will be provided on future installations.

Introduction.

THE various methods of supplying power to P.M.B.X's. may be summarised as follows:—

- (a) Primary Cells.
- (b) Power Lead.
- (c) Secondary Cells.

Where more than one of the above methods is possible, the choice is determined from economic considerations. Excluding the smaller switchboards, the choice usually lies between methods (b) and (c), and generally, supply by means of a power lead proves the cheaper.

Where secondary cells are installed it has been the practice to install duplicate batteries worked on a charge-discharge basis. With very few exceptions the cells are charged on the subscriber's premises from the public supply mains or the subscriber's private

New Type of Plant.

In the new plant only one battery is used and it will usually be of lower capacity than either battery of the superseded power plant, so that the actual cost of the cells has been more than halved. There is no control equipment corresponding to the existing charging panels, (Panels, Charging No. 7, 9, etc.), i.e. the switchgear and associated apparatus for changing the batteries from charge to discharge and vice-versa, and disconnecting the mains supply automatically at the completion of a charge. The need for periodic visits has also been eliminated as the battery is continuously floated.

The schematic diagram of the new plant is shown in Fig. 1, from which it will be seen that the load is in parallel with a 12-cell battery floated across the mains via a metal rectifier (Rectifier, No. 38).

Three sizes of rectifier, capable of supplying maximum loads of 15, 30, and 60 Ah per day (denoted by

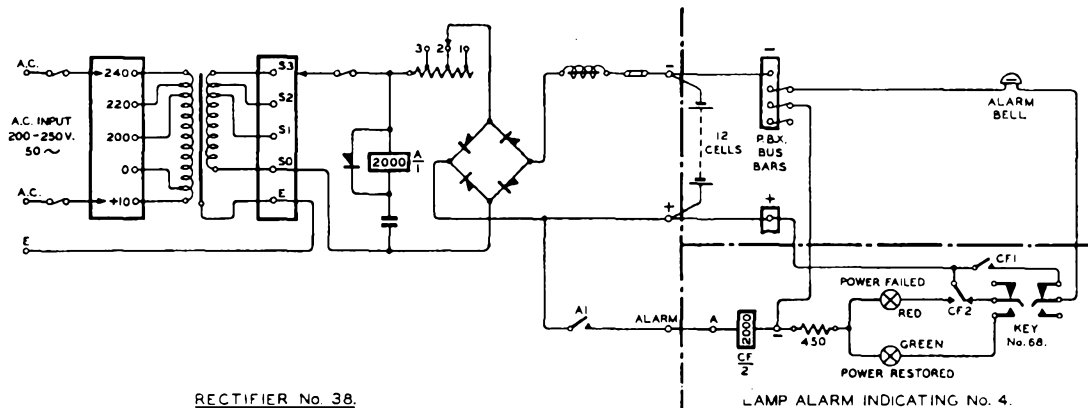

FIG. 1.—CIRCUIT CONNECTIONS.

supply. Economic considerations apart, secondary cell power plants have two important advantages over power leads:—

- (1) Continuity of service is practically ensured.
- (2) Improved transmission due to a steady, higher mean voltage at the P.M.B.X. bus bars.

The relatively high cost of secondary cell installations arises partly from the capital and installation cost of the cells and the associated control and charging equipment, and partly from the high maintenance charge. The bulk of the latter charge is caused by the necessity for periodic visits at short intervals to change over the batteries.

It was realised that a considerable reduction in these costs might be effected by a properly designed float system. Such a system has now been standardised for the power supply to P.M.B.X's. equipped for more than five exchange lines (switchboard AT3796, etc.), where an A.C. mains supply is available.

suffix letters A, B and C respectively), have been standardised. For larger loads rectifiers may be connected in parallel.

The rectifiers, which have been designed in collaboration with Messrs. Westinghouse Brake & Signal Co. Ltd., consist essentially of a mains transformer and bridge connected rectifier. A choke in the D.C. negative lead provides sufficient smoothing for P.B.X. work. The mains transformer secondary taps and the resistance in the secondary circuit allow for adjustment of output during manufacture. In the smallest size (Rectifier No. 38A) this resistance is also used to provide three different outputs by taps, thus effectively combining three sets in one, viz., a capacity of 5, 10 or 15 Ah per day. The function of the relay connected across the secondary of the mains transformer is to give immediate notification of a failure of the mains supply. The circuit arrangements are described later. Figs. 2 and 3 are photographs of the smallest and largest sizes respectively.

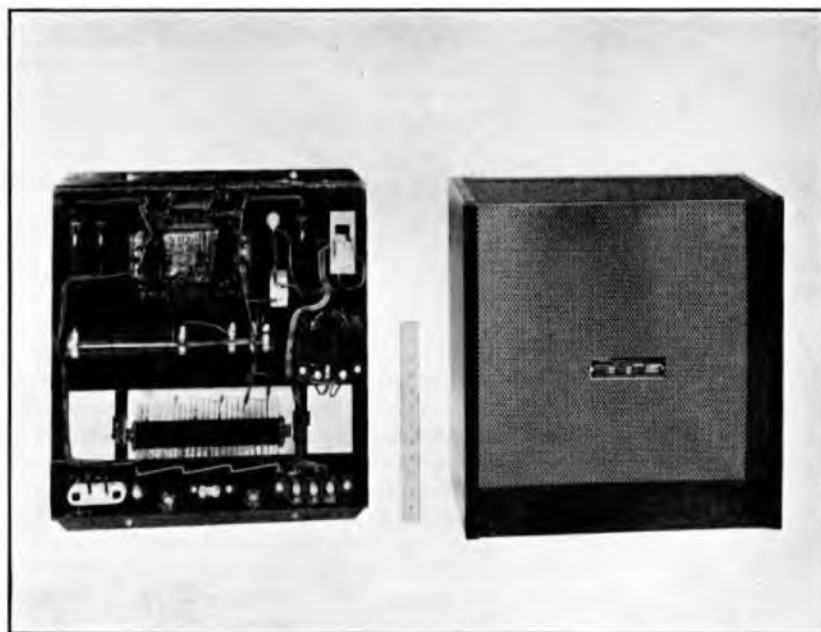

FIG. 2.—RECTIFIER No. 38A.

Operation of the Rectifier.

The action of the rectifier can best be studied by reference to the regulation curves, Fig. 4. The coordinates are the D.C. output voltage, in volts, at the terminals of the set (that is effectively the battery voltage under working conditions) and the rectified current in amperes. Three curves are given, for three different values of mains input voltage. This is necessary as mains supplies are only reckoned to be within ± 6 per cent. of their nominal value. Thus these three curves give the relationship between battery voltage and rectified current. For example, at an installation using Rectifier, No. 38B, when the battery voltage is 24 volts the rectified current will lie between 1.8 and 4.65 A, the extremes being the values with the applied mains voltage 6 per cent. low and 6 per cent. high, respectively.

Once installed the operation of the system is entirely automatic. It is evident from the regulation curves of the rectifier that the magnitude of the rectified current depends on the applied mains voltage and the battery voltage, that is to say, one or the other must vary if the rectified current is to vary. Now although the load current will often vary considerably from minute to minute as the number of circuits in use at the P.M.B.X. varies, these rapid variations of load current may take place without any appreciable change in the battery voltage. Thus the rectified current and the load current may, and usually will, differ considerably in value at any particular instant. When the load current is greater than the rectified current the difference is supplied by the battery, which is thus discharging. When the conditions are reversed the excess current delivered from the rectifier is taken up by the battery as a charging current. If the average value of the load current remains consistently greater than the rectified current for a sufficient length of time the resultant discharge from

the battery will lower the battery voltage, and this voltage change will increase the rectified current. In the reverse case the rectified current will decrease as the battery voltage rises due to charge. In other words whenever the average value of the load current remains consistently different from the value of the rectified current the battery voltage will vary in such a manner as will tend to equalise them.

It will now be apparent that the basis of the system is that the battery acts as a reservoir of power which may be drawn upon during periods of heavy load, the power so borrowed being replaced from the mains supply during periods of light load, and that the battery voltage is the controlling factor. It is thus to be distinguished from the usual arrangement adopted for large single-battery power plants, in which the power required by the load, apart from peak loads of short duration, is

supplied from the mains as it is required, the battery being maintained at an approximately constant voltage of 2.16 volts per cell.

The system here described is so designed that the battery voltage will vary, under normal working

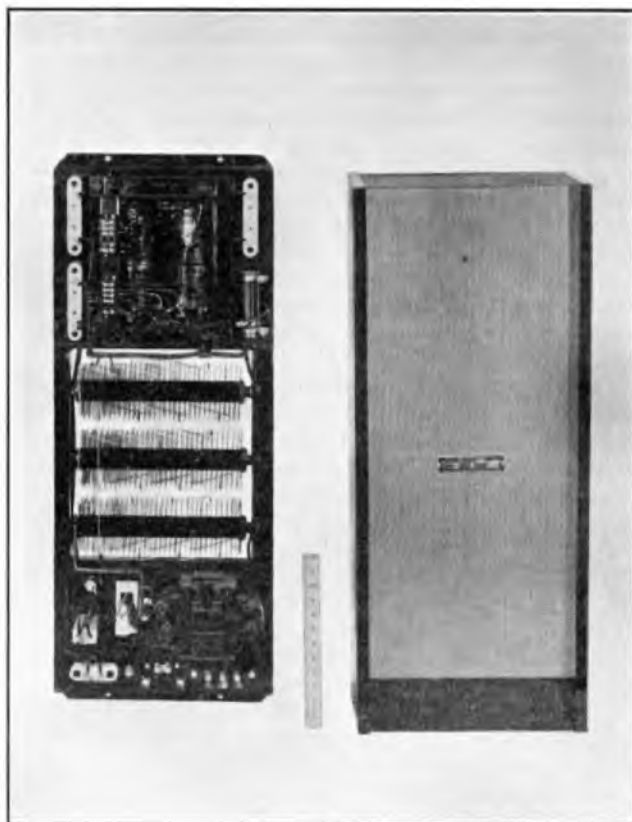

FIG. 3.—RECTIFIER No. 38C.

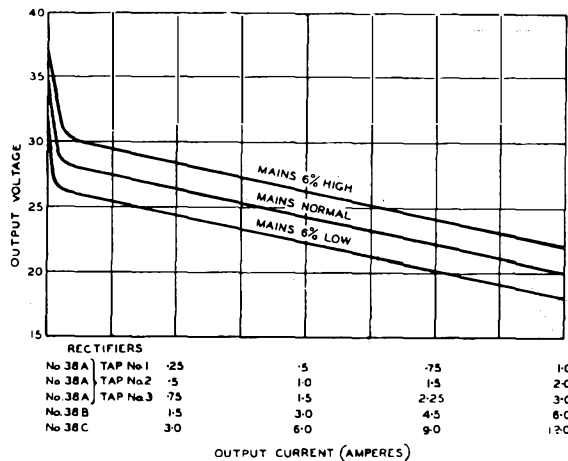

FIG. 4.—REGULATION CURVES.

conditions, from 24 to 30 volts maximum. How these limits are maintained will, perhaps, best be made clear by considering a practical example. Suppose that a switchboard with a day load of 30 Ah (calculated at 26 volts) is served by a Rectifier, No. 38B. In such an installation the battery capacity would not be less than 50 Ah. Experience shows that normally 40 per cent. of the day load is concentrated in the two busy hours. It will be assumed that the other 60 per cent. is totally absorbed in six hours. The actual load delivered during the busy hours, therefore, will be 40 per cent. of 30, that is 12 Ah at an average current of 6 A. The remaining 18 Ah will be delivered in six hours at an average current of 3 A. During the busy hours the battery will be discharging and the battery voltage will consequently not be greater than 24 V. With nominal mains voltage the output from Rectifier No. 38B at 24 V is approximately 3 A, as will be seen from the regulation curves, Fig. 4, so that the battery must supply $2(6-3) = 6$ Ah. For the remaining six hours the load current and the rectified current will both approximate to 3 A and hence it is not likely that there will be any further appreciable drain from the battery. The total drain from the battery during a normal day is thus 6 Ah, which will not lower the voltage of a 50 Ah battery below 24 V.

At the end of the working day in this assumed installation the rectified current will be equal to 3 A, and the load current will be zero. The battery is now on charge and the battery voltage will rise more or less gradually and, as a consequence, the charging current will be progressively reduced. The battery will continue charging with a rising voltage and a falling charging current until a point is reached at which the rectified current has fallen to a value incapable of causing any further voltage rise. The system will remain stable at this point until either the mains voltage changes or a load is applied.

The actual battery voltage at which the system will stabilise under no load conditions is determined by the final charge rate, that is the ratio of the battery capacity to the rectifier output. The maximum current the rectifier can deliver at 30 volts may be read off the regulation curve for mains 6 per cent. high, Fig. 4,

and is seen to be approximately 0.3 A, and thus the maximum charge rate at 30 V would be $50/0.3$ that is 167. The following typical figures, obtained by test on the Post Office enclosed type cells, show how final battery voltage is related to charge rate:—

Charge rate	Final volts per cell	Final voltage of fully charged 12-cell battery
30 hour	2.6	31.2
50 hour	2.57	30.8
100 hour	2.52	30.2
133 hour	2.5	30
200 hour	2.46	29.5
500 hour	2.33	27.9

As 167 lies between 200 and 133 in the above table the maximum voltage that will be reached in the assumed installation will lie between 29.5 and 30, and will be reached only when the input mains are 6 per cent. high—quite a likely condition during the night. At these rates gassing is inappreciable and the battery may be left on charge indefinitely.

Curves showing the actual rise in battery voltage and decline of charging current with a Rectifier, No. 38B connected to a completely discharged 12-cell, 50 Ah battery on no load are given in Fig. 5.

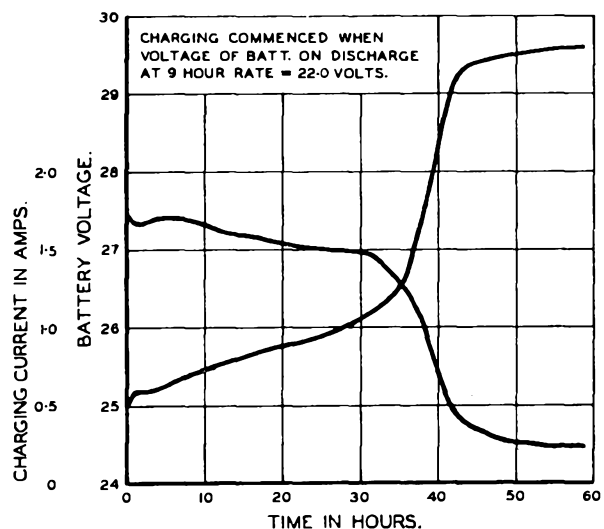

FIG. 5.—RISE IN BATTERY VOLTAGE AND DECLINE IN CHARGING CURRENT.

When the mains supply fails the load will be served solely by the battery. Even if the failure takes place at the end of the working day the example just considered shows that a large fraction of the rated battery capacity will be available. It has been assumed, rather arbitrarily, that the average discharge during the busy hour, under mains failure conditions, should not exceed the 8-hour rate. As already stated it is a good working rule that 20 per cent. of the day load is absorbed during the busy hour, hence, if L is the day load in ampere-hours, the average load current during the busy hour is numerically equal to $L/5$. If this is not to exceed the 8-hour rate the minimum capacity of the battery must be $L/5 \times 8$, that is $1.6L$. Thus at whatever time of the day failure of the mains supply occurs there will be

at the very least 24 hours reserve of power available in the battery. In the majority of installations there will be more as the capacity of the battery is normally based on the estimated load at the ultimate development period ten or even twenty years ahead.

Mains Failure Alarm.

Immediate notification of mains failure is given to the P.B.X. operator. For this purpose alarm lamps are fitted in a wood case on top of a non-multiple switchboard, or fitted flush in the cable turning section of a multiple switchboard. There are two lamps, one with a red opal marked "power failed," and one with a green opal marked "power restored." There is also a lever type key and an instruction label for the operator. On a failure of the mains supply the relay connected across the secondary of the mains transformer releases and extends an earth to operate a second relay in the alarm lamp unit. The operation of the second relay causes the "power failed" lamp to glow and the alarm bell to ring. The operation of the key will disconnect the bell but leave the "power failed" lamp glowing. On reconnection of the mains supply the relay in the rectifier will operate and release the second relay, the "power failed" lamp will go out and the "power restored" lamp will glow. The restoration of the key restores the alarm circuit to normal.

Accommodation.

The provision of space for power plant in subscribers' premises, particularly if a small switchboard is concerned, is often a matter of some difficulty. A special cabinet, developed from an earlier model, for accommodating the whole of the power plant where the capacity of the cells does not exceed 20 Ah, has therefore been introduced. In addition it includes fuse testing equipment and provides accommodation

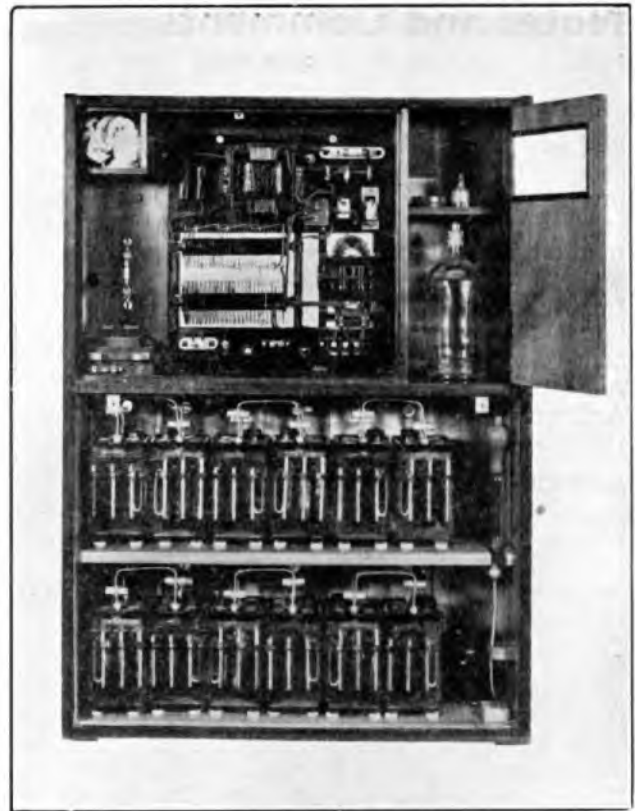

FIG. 6.—CABINET INCORPORATING RECTIFIER NO. 38B, WITH BATTERIES, ETC.

for the hydrometer, spare fuses and first aid equipment. It is finished in the standard P.B.X. colour and is suitable for fitting in switchrooms, passages, etc. A photograph of the cabinet is reproduced in Fig. 6.

Notes and Comments

Publication under War Conditions

Time has not been sufficient since the outbreak of war for the Board of Editors to consider fully the long term policy of the JOURNAL in the present emergency. It can be stated, however, that the Board proposes to make every endeavour to continue publication and trusts that it will receive full support from contributors, subscribers and advertisers.

Certain of the editorial staff have been decentralised from London but communications, other than those in reply to specific enquiries, should continue to be addressed to the Managing Editor, P.O.E.E. JOURNAL, Alder House, Aldersgate Street, London, E.C.1. Arrangements will be made for these communications to be forwarded to the official concerned.

Staff Changes

The Board of Editors regrets that it has not been possible to obtain details of the staff changes which have taken place during the past three months. It is hoped that it will be possible to resume this feature in the January, 1940, issue.

Mr. C. W. Green

In the last issue of this Journal, reference was made to the appointment of Mr. C. W. Green as

Technical Representative in Europe of the American Telephone & Telegraph Company and Bell Telephone Laboratories in succession to Dr. L. F. Morehouse. Mr. Green was instructor in electrical engineering at the Massachusetts Institute of Technology from 1907 to 1914, and assistant professor from 1914 to 1917. He subsequently joined the Western Electric Company and was there engaged on repeater development. In 1922 he was appointed Carrier Telephone Engineer in the Bell Telephone Laboratories. Mr. Green is a member of the American Institute of Electrical Engineers.

There is no need to remind our readers of the value which the Post Office place on the direct representation of the American Telephone & Telegraph Company and Bell Telephone Laboratories in this country. The representatives appointed have not only been engineers of wide knowledge and experience but they have had the gift of co-operating whole-heartedly with the British Post Office and with other European administrations. In offering a very sincere welcome to Mr. Green, the Board feel sure that relations with him will be as friendly as with his predecessors and hope that he will enjoy his stay on this side of the Atlantic.

The Institution of Post Office Electrical Engineers

RECENT ADDITIONS TO THE LIBRARY

New Books.

- 1458 Nomogram.: the theory and practical construction of computation charts.—H. J. Allcock and J. R. Jones (Brit., 1938).
- 1459 Introduction to electrical engineering.—E. W. Marchant. (Brit., 1939.)
- 1460 Spontaneous Fluctuations of voltage due to Brownian motions of electricity, shot effect and kindred phenomena — E. B. Moullin (Brit., 1938.)
- 1461 Foundations of Technical Drawing.—A. C. Parkinson. (Brit., 1938.)
- 1462 Grid System: A Paper pub. by The Association of Engineering and Shipbuilding Draughtsmen.—R. Gabel. (Brit., 1938.)
- 1463 Aluminium Bronze.—Copper Development Association. (Brit., 1938.)
- 1464 Tensor Analysis of Networks.—G. Kron. (Amer., 1939.)
- 1465 Classified Examples in Electrical Engineering: Vol. II. Alternating Current.—S. G. Monk. (Brit., 1937.)
- 1466 Foundations and Earth Pressures. — C. H. Wollaston. (Brit., 1939.)
- 1467 Introduction to Vector Analysis for Physicists and Engineers.—B. Hague. (Brit., 1939.)
- 1468 Text-book of Heat.—R. W. Stewart and J. Satterby. Revd. by C. T. Archer. (Brit., 1939.)
- 1469 Purposes of Examinations: A Symposium.—Various. (Brit., 1939.)
- 1470 Great Men of Science: A History of Scientific Progress.—P. Lenard, trans. by H. S. Hatfield. (Cont., 1938.)
- 1471 Introductory College Physics.—O. Blackwood. (Amer., 1939.)

New Books.

- 1472 Conjugate Functions for Engineers: A Simple Exposition of the Schwartz-Christoffel Transformation Applied to the Solution of Problems Involving Two-dimensional Fields of Force and Flux.—Miles Walker. (Brit., 1933.)
- 1473 Electricity Meters and Meter Testing.—G. W. Stubbings. (Brit., 1939.)
- 1474 Introduction to the Calculus: Part I.—S. Beatty and J. T. Jenkins. (Can., 1938.)
- 1476 Introduction to Modern Statistical Methods.—P. J. Rider. (Amer., 1939.)
- 1477 Cathode Ray Tubes.—M. von Ardenne, trans. by G. S. McGregor and R. C. Walker. (Cont. 1939.)
- 1478 Carburation and Carburettors.—C. H. Fisher. (Brit., 1939.)

New Editions.

- 932 Handbook of Technical Instruction for Wireless Telegraphists.—H. M. Dowsett. (Brit., 1939.)
- 942 High-frequency Alternating Currents. — K. McIlwain and J. G. Brainerd. (Amer., 1939.)
- 1031 Motor Vehicle: A Descriptive Text-book of Chassis Construction for Students, Draughtsmen and the Owner-Driver.—K. Newton and W. Steeds. (Brit., 1939.)
- 1168 Meter Engineering: A Practical Book on the Installation, Testing and Maintenance of Electricity Meters.—J. L. Ferns. (Brit., 1938.)
- 1274 Accumulator Charging: Maintenance and Repair —Covering Charging and Upkeep of Accumulators for Wireless Work, Electrical Vehicles, Motor Cars and Cycles, Country House Lighting and Emergency Plants.—W. S. Ibbetson. (Brit., 1938.)

District Notes

Eastern District

A.R.P. DRIVING EXERCISES

During the black-out exercises of August 11th and 12th, the opportunity was taken at Cambridge to test the drivers of decontamination squads under practical conditions. Full protective clothing, including hoods, was worn, and the vehicles used were 30-cwt. W.D. Morris's; a supervising officer travelled on each vehicle as an observer.

Tests were made in backing vehicles in a narrow lane, emerging on to main roads, overtaking, and being overtaken, and finally, on return, parking in a crowded garage under full black-out conditions. Actual driving time in full equipment was 1½ hours, and the men showed no undue discomfort. Sidelights only were used and they were diffused with orange-coloured paper; the same method of diffusing applied to rear lights was found very effective.

The opinion of the drivers is that it is far easier to drive in the country areas than in the towns, no doubt due to the fact that in towns many different surfaces are encountered which show up very clearly, especially where a surface may have been recently repaired, such as a restated trench across a roadway. This sudden change of surface causes the driver to imagine an obstruction across the roadway.

No undue difficulty was experienced, and should occasion arise when it is necessary to drive under such conditions the men will approach the task with full confidence.

North Western Region

METROPOLITAN-VICKERS NEW SWITCHBOARD INSTALLATION AT MANCHESTER

The largest P.B.K. installation in Manchester was opened at the above factory, Trafford Park, on June 21st, 1939.

The work covers many hundreds of acres, with a consequent large number of external extensions, and the transfer was effected in approximately 30 seconds without any faults occurring. By 8.30 p.m. the same evening, a number of the recovered sections were dismantled and ready for shipment to other urgent works.

The old exchange consisted of 11 CB No. 9 sections, with 37 exchange lines, and 794 extensions.

Due to extensive development, and the high calling



rate (3.7 neglecting call valuations) it was necessary to provide 14 new CB No. 10 sections.

A feature of the work which makes it unique is the fact that, although operations could not commence before the last week in March, the new board was in service by June.

In the photograph the old switchboard is shown in service, and above it is situated the cable runway for the new sections. Cables are seen leaving the main runway for the "special apparatus rack." This rack was constructed locally by Departmental labour. The work involved the provision of a standard "main and intermediate" distribution frame consisting of 18 verticals.

The lead-in cables were tied on to the new frame with breakjacks let into the circuits on the old frame and "wedges locking" were used on the new protectors to isolate the equipment prior to transfer.

T. J. N. H.

North Wales District

DOUGLAS ULTRA-SHORT-WAVE RADIO LINK

Early this year negotiations were completed for a site for a new radio station at Holyhead. The building work was commenced in February and completed in May by H.M.O.W. The station is designed to provide an additional link between the mainland and the Isle of Man (Douglas) and will initially provide six ultra-short-wave, both way radio circuits, and later it is hoped to superimpose one carrier channel on each radio circuit.

The work of the District staff has been to provide two 24pr/20 P.C.Q.T. balanced carrier cables from Holyhead exchange to the site and between the buildings, to provide the receiving and transmitting aeriels, to provide heating and lighting and to give general assistance to the Radio Branch specialist staff during the erection of the wireless plant.

Duct work for the carrier cables was carried out by contract and a considerable amount of blasting was required. As the end of the track was carried over rough rock and moorland, and up a very steep incline, this portion was laid in steel pipe. The two 24pr/20 P.C.Q.T. carrier cables were drawn into one duct by Departmental labour during July and the three locating coil sections concerned were tested for capacitance unbalance and every joint made a scheduled joint during August. The cable is not loaded. It is intended ultimately to continue this carrier cable through to Liverpool on a 12-channel carrier cable.

The erection of the aeriels was a novel construction job. There are two arrays, one set for the seven transmitters and one for the seven receivers. The aeriels are in one straight line and each separate aerial consists of two Koomans type horizontal half-dipoles connected in parallel, with similarly constructed reflectors mounted vertically immediately behind. The seventh aerial is provided for monitoring with the spare transmitter and receiver. The aerial entailed the erection of sixteen 55-ft. medium poles for the masts and 64 light poles were used for spreaders and leading in, and there are also 68 stays. The aerial wire is mainly 150-lb. and 200-lb. copper wire. The masts are fixed at 45 and 48-ft. spacings and the aeriels are suspended on tension springs. Each of the 14 separate aeriels consists of a double network of 15 wire panels which are separately insulated. These panels had to be constructed to an accuracy of half an inch and represented a very skilled piece of wiring. This work was done by local non-

specialist wiremen and the construction work is a credit to the men concerned.

Power was brought to a point near the site by the North Wales Power Company on an 11 kV 3-phase overhead line, and this is continued underground to the transformer house where it is terminated on a 25 kVA H.T. transformer. The radio station is mains operated at 240 V, but a standby Diesel charging set of 25 h.p. is installed for emergency purposes and an automatic switch brings this into operation within nine seconds of a mains failure. The station will be unattended and it is anticipated that two maintenance visits will be required weekly.

South Western District

DEATH OF MR. H. G. SMITH

The sudden death at the age of 57 of Mr. H. G. Smith, Area Engineer, Bournemouth, while playing tennis, on July 22, 1939, came as a shock to his many friends and colleagues throughout the Service. Up to the time of his death he had enjoyed perfect health, and this made the suddenness of his passing the more noticeable.

Mr. Smith was an ex-National Telephone Co. servant and transferred to the Post Office in 1912, when he took up an appointment as Inspector at St. Albans. During the Great War he was stationed at Watford and was subsequently promoted to Chief Inspector at St. Albans in 1924, where he remained until his promotion to Asst. Engineer in the Norwich Section in 1930.

When the post of Efficiency Engineer became vacant in the Eastern District in 1933, Mr. Smith was transferred to Cambridge to fill it, and during his period as Efficiency Engineer he carried out valuable investigations in the Eastern District for the Committee on Unit Construction Costs (Internal), which materially assisted in the determination of suitable internal items and rates. Mr. Smith was at the time of his death a member of a Headquarters Committee which was reviewing the Internal Unit Construction Costs scheme, and his work in this connection will be greatly missed.

BOARD OF EDITORS

A. J. GILL, B.Sc., M.I.E.E., M.Inst.R.E., Chairman.
F. E. NANCARROW, A.R.C.Sc., M.I.E.E., M.Inst.R.E.
P. B. FROST, B.Sc., M.I.E.E.
A. H. MUMFORD, B.Sc.(ENG.), A.M.I.E.E.
C. W. BROWN, A.M.I.E.E.
R. E. JONES, M.Sc., A.M.I.E.E.
J. READING, B.Sc.(ENG.), M.I.E.E., Managing Editor.
H. LEIGH, B.Sc.(ENG.), A.M.I.E.E., Assistant Editor.

Copyright

The entire contents of this JOURNAL are covered by general copyright, and special permission is necessary for reprinting long extracts, but Editors are welcome to use not more than one-third of any article, provided credit is given at the beginning or end thus: "From the *Post Office Electrical Engineers' Journal*."

The Board of Editors is not responsible for the statements made or the opinions expressed in any of the articles in this JOURNAL, unless such statement is made specifically by the Board.

Communications

All Communications should be addressed to the Managing Editor, *P.O.E.E. Journal*, Engineer-in-Chief's Office, Alder House, Aldersgate Street, London, E.C.1. Telephone: HEADquarters 1234. Remittances should be made payable to "*The P.O.E.E. Journal*" and should be crossed "& Co."

In 1936 he was promoted to Executive Engineer at Bournemouth, where he remained until his death, which took place only three weeks after the opening of the Bournemouth Telephone Area.

"H.G." will be remembered for his enthusiasm and abundant confidence which never failed to act as a tonic on his colleagues.

South Eastern District

INAUGURATION OF THE CANTERBURY TELEPHONE AREA

An inauguration ceremony in connection with the Canterbury Telephone Area took place at 3.45 p.m. on August 21st, 1939, at Telephone House, Canterbury. In this new and commodious building will be housed the headquarters staff of the new Area, formerly housed in a number of different buildings under the control of the District Manager and Sectional Engineer.

The gathering took place on the fourth floor of the building when Mr. McIntyre, Surveyor of the South-Eastern District introduced the Telephone Manager, Mr. B. R. Mead, to the assembled company of about 250. Mr. Mead then took the chair and welcomed the staff of the new organisation. Further speeches followed by Mr. A. B. Morice (Acting Superintending Engineer, South-Eastern District), Mr. B. Lister (Area Engineer), Mr. B. Knowlden (Chief Clerk), Mr. T. R. Thompson (Local Whitley Committee, Staff Side), Mr. T. S. Stigger (Post Office Engineering Union), and Mr. C. T. Burrows (Engineering Whitley Committee).

After greetings telegrams of good wishes which had been received by Mr. Mead had been read, the pleasant proceedings were brought to a close by a tea, and a staff dance followed in the new building in the evening. An excellent opportunity was thus afforded for the commercial and engineering staffs to become acquainted with each other and with the work of the various sections of the new organisation.

A.B.M.

Binding Cases

Cases for binding are available, and may be obtained from the Local Agents for 1s. 9d. Subscribers can have their copies of Volumes bound, at a cost of 3s., by sending the complete sets of parts to the Local Agents or to the *P.O.E.E. Journal*, Engineer-in-Chief's Office, Alder House, Aldersgate Street, London, E.C.1. Orders for binding for Vols. 1-19 should indicate whether the original binding case with black lettering, or the later pattern with gold, is required. Cases with gold lettering are the only type stocked from Vol. 20 onwards.

Back Numbers

The price of the JOURNAL, which is published quarterly, is 1s. (1s. 3d. post free) per copy, or 5s. per annum post free. Back numbers can be supplied, subject to availability of stocks, at 1s. each (1s. 3d. post free). Orders for back numbers may be sent to the Local Agents or to the Publishers.

Advertisements

All communications relating to space reservations should be addressed to the Advertisement Editor, *P.O.E.E. Journal*, Alder House, Aldersgate Street, London, E.C.1. Communications regarding advertisement copy, proofs, etc., should be addressed to the Publishers, Messrs. Birch & Whittington (Prop. Dorling & Co. [Epsom], Ltd.), 49 Upper High Street, Epsom, Surrey.

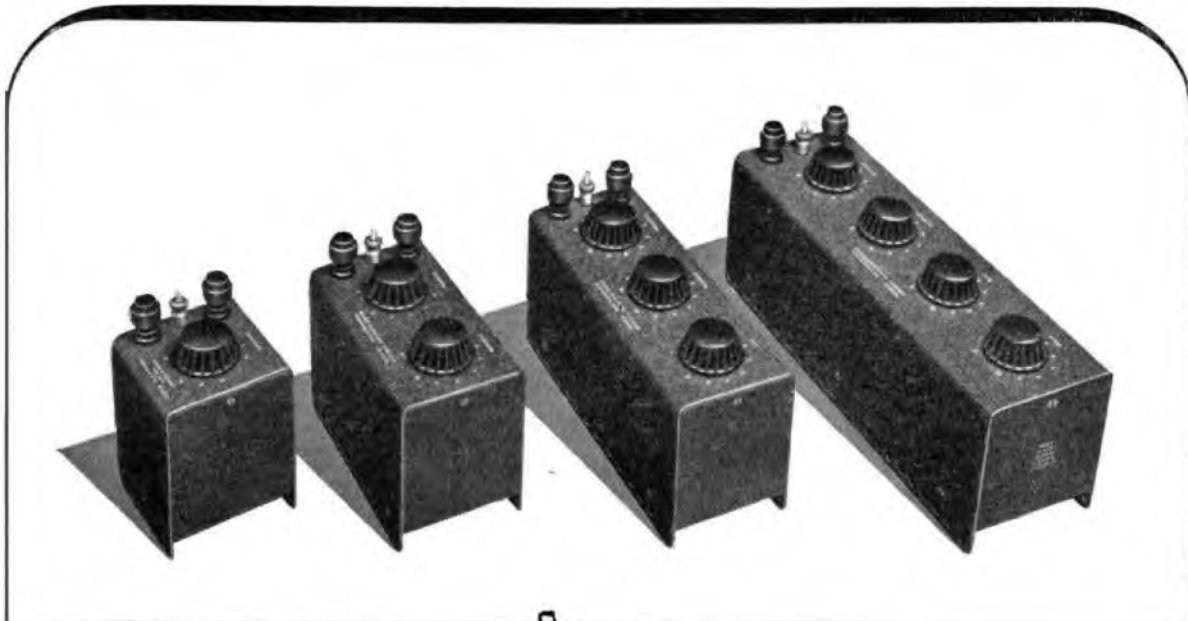

Good enough for



ITS PURPOSE

... a patronising sort of phrase, suggesting usually that the article in question is not good enough for the speaker! Well, it is the phrase we are going to use to describe our **MUNIT RESISTANCES** and nobody has to be patronising about them. These resistances are only adjusted to 1% accuracy—though, of course, the user can calibrate them to any desired limit. They are eminently suitable for educational use. All they have lost is a degree of accuracy that is quite unnecessary for many purposes. What they have gained is a tremendous saving in price. We most strongly recommend these excellent components to you. Their design is based on that very sound scientific principle—"fitness for purpose," which to most minds is an object for wholehearted admiration and certainly not for condescension.

**"MUNIT"
RESISTANCE BOXES TYPE 36**

These resistance boxes retain their D.C. accuracy at carrier and in some cases radio frequencies. The resistance elements are non-reactively wound and adjusted to 1%. The **MUNIT** construction possesses the following advantages: All metal construction; good electrical screening; mechanical strength; interchangeability; boxes of all sizes may be bolted together in either direction or may be fixed to a base board or panel. The price is given for a box with N Dials by the expression £N.15.0 where N is an integer between 1 and 5.

May we send you copies of bulletins B-500-A and B-501-A.

MUIRHEAD

MUIRHEAD AND COMPANY LIMITED · ELMERS END, BECKENHAM, KENT · TELEPHONE: BECKENHAM 0041-0042
FOR OVER 60 YEARS DESIGNERS & MAKERS OF PRECISION INSTRUMENTS

C.R.C. 16

Stowger Works.
Liverpool 7.
England.
October 10th 1939.

The Manager,
Colonia Telephones.

Dear Sir,

Re: Vacancy for Telephone Operator.

I beg to apply for the position. I have testimonials to swift, efficient operation from both Telephone Administrations and subscribers in some 70 different countries. My experience covers the provision of service for a few persons, or for several thousands, and in either case I connect subscribers in a second or so without an error.

I speak every language. I am prepared to work all day and all night, and do not require any holidays.

I do not need any salary, nor does my engagement raise any problems with regard to living accommodation.

From the foregoing I feel sure you will realise that if my services are accepted you will be able to provide the highest standard of service at the lowest possible cost to subscribers.

Yours faithfully,
Stowger A.T. Switch.

THE STOWGER AUTOMATIC TELEPHONE SWITCH.

Encl: Photograph and notes.

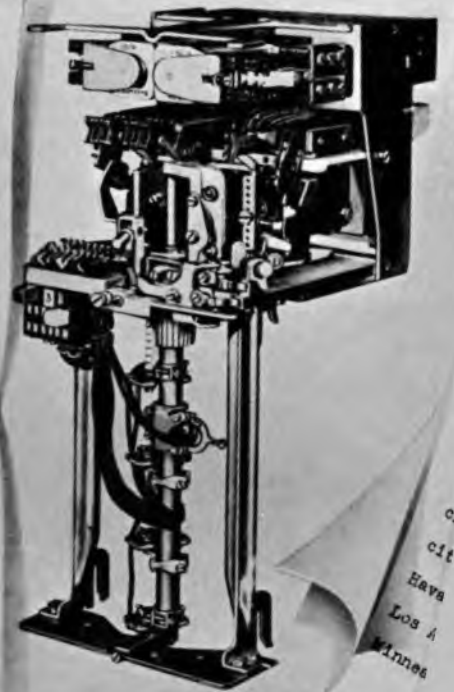

ci
cit
Eava
Los A
Winnes

Circuit
with Tru
contacts,
or power driv
consequently r
adjustment resul
service without ap

Some notes on
OPERATING EXPERIENCE & TECHNICAL QUALIFICATIONS.

Varying periods from 1892 to date with the world's largest state and private telephone administrations in public exchanges and with many thousands of commercial and industrial organisations - hospitals, schools, etc., in private exchanges.

Testimony as to efficiency under normal and extreme climatic conditions can be obtained from subscribers of such cities as London, Buenos Aires, Philadelphia, Sydney, Lisbon, Havana, Manchester, Tokio, Glasgow, Johannesburg, Toronto, Angeles, Leeds, Winnipeg, Houston, Dallas, Bombay, Birmingham,neapolis, Melbourne, etc.

Served as Group and Final Selector, Line Finder, "Demand" Finder and Cord Circuit Finder for associating Repeater trunk Lines.

Selected in only 100 milli-seconds, any one of 2,200

Contact capacity far greater than any known uni-selector even selector.

Compactness effects economy in floor space and reduces building costs.

Precision manufacture and assembly secures permanence of setting in lowered maintenance costs.

Proved laboratory life equivalent to 75 years' actual apparent deterioration.



AUTOMATIC TELEPHONE & ELECTRIC CO. LTD.
MELBOURNE HOUSE, ALDWYCH, LONDON, W.C.2
NORFOLK HOUSE, NORFOLK ST., STRAND, W.C.2
STROWGER WORKS, LIVERPOOL, 7

Phone Temple Bar 4506 Grams 'Strowger. Estrand London'
Phone Temple Bar 9262 Grams 'Autelco. Estrand London'
Phone Old Swan 4830 Grams 'Strowger. Liverpool'



STANDARD WITH THE BRITISH POST OFFICE



'Megger'
Reg^d Trade Mark.

THE BRIDGE-MEG TESTING SET used by the British Post Office is a portable, self-contained instrument combining the functions of an Insulation Tester and a Wheatstone Bridge; it can be used for fault location by the Varley Loop method. Facilities can also be provided whereby, with the use of an external galvanometer and resistance box, the instrument may be used for making Murray Loop tests. Insulation range 100 megohms at 500 volts. Bridge range 0.01 to 999,900 ohms. Size $7 \times 8\frac{3}{4} \times 12$ ins. Weight $12\frac{3}{4}$ lbs. Mains operated instruments are also supplied to the British Post Office. Ask for list X 267.

EVERSHED & VIGNOLES LTD., CHISWICK, LONDON, W.4
TELEPHONE: CHISWICK 1370 * TELEGRAMS: "MEGGER" CHISK, LONDON

G.E.C.



Automatic Exchanges



Manual Exchanges
Local and Trunk



Rural Automatic Exchanges

TELEPHONE EQUIPMENT

for
PROVED RELIABILITY
in
TEMPERATE and TROPICAL CLIMATES



Carrier Equipment



V.F. Repeater Equipment



Subscribers' Instruments

G.E.C. Telephone Works, Coventry



THE GENERAL ELECTRIC CO. LTD. OF ENGLAND
TELEPHONE WORKS COVENTRY ENGLAND

Coventry 4111. (10 lines), "Springjack, Coventry." New Standard; A.B.C. (5th Edition); Western Union; G.E.C. Private
Head Office: Magnet House, Kingsway, London, W.C.2. Branches and Agencies throughout the World.
Temple Bar 8000 (90 lines), "Electricity, Westcent. London," "Polyphase, London" (Cables).

Fit
"TripleX"
Royal
and be safe
 THE
G.P.O.
 DO

THE "TRIPLEX" SAFETY GLASS CO. LTD.,
 1 ALBEHARLE STREET · LONDON · W.1

For All the Latest News and
 Technical Data about the
 Telephone Field—READ

TELEPHONY

The best investment a telephone man can make is TO INVEST IN HIMSELF. Whether you are new in the business or an old-timer, TELEPHONY will give you practical and up-to-the-minute ideas for doing your work better. There is no other magazine covering every department of the telephone business as comprehensively. Know all the latest approved telephone practices and all the current telephone news. Read TELEPHONY. Subscription price \$5.00 per year. Published since 1901.

TELEPHONY

Address : Odhams Press, Ltd., Technical Book Dept., 85 Long Acre, London, W.C.2 (Telephone : Temple Bar 2468) for a sample copy of TELEPHONY, or write direct to :

TELEPHONY PUBLISHING CORPN.
 406 S. Dearborn Street, Chicago, Ill., U.S.A.

**TURNER DIFFERENTIAL
 MILLIAMMETERS
 G.P.O. No. 17
 & No. 18**

Meet the most exacting demands for balancing currents in multiplex telegraph circuits.

—A quality product of outstanding merit—

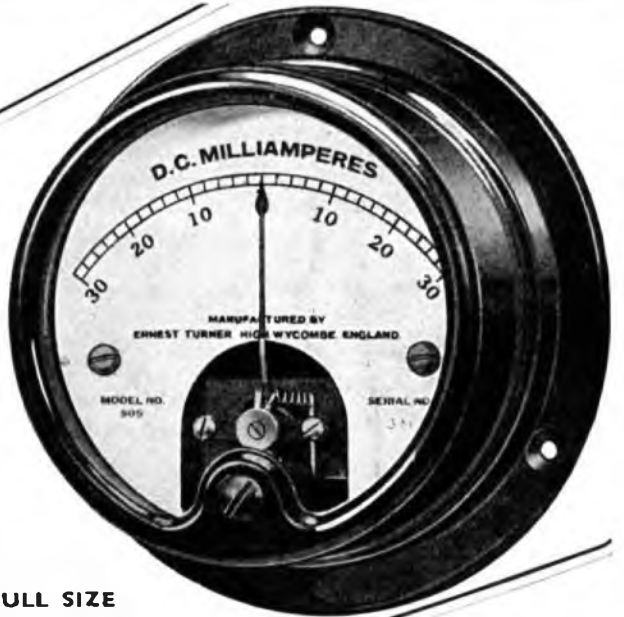

FULL SIZE

Also manufacturers of G.P.O. Detector No. 4, and a comprehensive line of instruments for precision electrical measurements.

ERNEST TURNER ELECTRICAL INSTRUMENTS, Ltd.

**CHILTERN WORKS,
 49-73 TOTTERIDGE AVENUE,
 HIGH WYCOMBE,**

BUCKS, ENGLAND

Telephone : High Wycombe 1301, 1302.
 Telegrams : Gorgeous, High Wycombe.

AUTHORITATIVE CORRESPONDENCE TRAINING for ENGINEERING QUALIFICATIONS

- POST OFFICE EXAMINATIONS —
Probationary Inspectors
Assistant Superintendents
Assistant Engineers

A.M.Inst.C.E., A.M.I.E.E., A.F.R.Ae.S.,
B.Sc.(Eng.), C. & G., etc.

22 FIRST PLACES

and HUNDREDS of PASSES have been gained by T.I.G.B. students in the above examinations. The T.I.G.B. Guarantees training until Successful for the one fee.

Write to-day for "The Engineer's Guide to Success" — Free — which alone gives the Regulations for Engineering Qualifications and contains the world's widest choice of engineering courses — over 200 — including Electrical Engineering, Telephony, Telephonic Transmission, Telegraphy, Radio Engineering, Wireless and High Frequency Engineering, Sound Reproduction, Television, etc. Mention branch, post or qualification that interests you.



THE TECHNOLOGICAL INSTITUTE OF GREAT BRITAIN

115 Temple Bar House, London, E.C.4
FOUNDED 1917 20,000 SUCCESSES

... off Test —



... and recently completed are Standby Plants ranging in size from a 200 k.w. Automatic Plant for a large Municipal Power Station to a 2½ k.w. Plant for an A.R.P. Shelter. Whatever its size or purpose, the same stringent test conditions are applied to every

Austinlite AUTOMATIC STANDBY PLANT

AUSTINLITE LTD

Proprietors: CHANCE BROTHERS and CO., LIMITED.

LIGHTHOUSE WORKS, SMETHWICK

The New Star of the Telephone World

THE new Ericsson Automatic Telephone No. 1002 shown here has a casework of black moulded bakelite in a modern, distinctive and pleasing design. It incorporates a form of cradle or micro-telephone rest which is not readily damaged should the instrument get violently knocked or fall to the ground.

The whole of the interior apparatus which is mounted on a frame can be removed as a unit, the base plate which incorporates a useful sliding tray fitment being first removed. Dimensions, 6 by $9\frac{1}{2}$ by $8\frac{1}{2}$ inches ; weight, 6 lbs.

NOW AVAILABLE TO P.O. SUBSCRIBERS

Full particulars from makers :

ERICSSON TELEPHONES LTD.

HEAD OFFICE : 22 LINCOLN'S INN FIELDS, LONDON, W.C.2.

Works : Beeston, Notts.

(Telephone : HOLborn 6936)



CREATED BY

Ericsson

TELEPHONES LTD.



INDEX TO ADVERTISERS

Austinlite, Ltd.	xvii
Automatic Telephone & Electric Co., Ltd.	xii & xiii
Bennett College	ix
Blackie & Son, Ltd.	xx
British Institute of Engineering Technology	xxi
Caplin Engineering Co., Ltd.	v
Creed & Co., Ltd.	viii
Edison Swan Electric Co., Ltd., The	iv
Elliott Bros. (London), Ltd.	xxiii
Ericsson Telephones, Ltd.	xviii & xix
Evershed & Vignoles, Ltd.	xiv
Ferranti, Ltd.	xxi
General Electric Co., Ltd., The	ii & xv
Hall Telephone Accessories (1928), Ltd.	xx
International Correspondence Schools, Ltd.	xx
Muirhead & Co., Ltd.	xi
Prelli-General Cable Works, Ltd.	xxiv
Rawplug Co., Ltd., The	viii
Siemens Brothers & Co., Ltd.	vi & vii
Smith, Frederick, & Co.	xxiii
Standard Telephones & Cables, Ltd.	x
Sullivan, H. W., Ltd.	iv
Technological Institute of Great Britain, The	xvii
Telephony Publishing Corporation	xvi
"Triplex" Safety Glass Co., Ltd., The	xvi
Turner, Ernest	xvii
Turners Asbestos Cement Co.	iii

Hall Telephone Accessories (1928) Limited

Suppliers to the British Post Office, Air Ministry,
Admiralty & Foreign Government Departments.

Manufacturers of prepayment telephone
multi-coin collectors, precision instru-
ments, automatic stamp selling and
ticket selling machines, automatic slot
machines and fire alarm apparatus.

Registered
Office & Works: **70, DUDDEN HILL LANE,**
WILLESDEN,

LONDON, N.W.10
Tel. WILLESDEN 5141/2/3.
Also GUEST WORKS, DOWLAIS, STH. WALES



The largest and most successful
Institution in the world devoted
to spare-time training by post,
offers thoroughly sound Courses of
Instruction to cover the following
Examinations :

G.P.O. Probationary Assistant Engineer (Limited).
G.P.O. Probationary Inspector (Engineering Dept.).
Assistant Traffic Superintendent, Telephone Service.
P.M.G. Certificate for Wireless Operators.
Provisional Certificate in Radio Telephony and
Telegraphy for Aircraft.
Graduateship, I.E.E.
City and Guilds Electrical Engineering Practice.
Electric Installation and Telecommunications.
Institute of Wireless Technology.

Other Courses meet the requirements of all who desire to
qualify for responsible positions in Electric Power, Light and
Traction Stations. Equally successful is our instruction for
Telegraph and Telephone Engineers, Telegraphists and Tele-
phonists, Radio Engineers, Radio Servicemen, and those who
wish to study Television.

Instruction is by correspondence from textbooks specially
prepared by many experts in tuition by post.

WRITE FOR OUR SPECIAL BOOKLET and state the
particular subject or Examination in which you are interested.

INTERNATIONAL CORRESPONDENCESCHOOLS,LTD.,
Dept. 108, International Buildings, Kingsway, London, W.C.2

WHO INVENTED THE TELEPHONE?

William Aitken, M.I.E.E.

"The author has gone to a very great deal
of trouble in his research work in the field of
patents and publications in order to establish
the historical developments in the invention of
the telephone . . . full of material for those
interested in the history of the telephone."—
The Electrician.

"A comprehensive and authoritative survey
of the work of those who contributed to the
invention of the instrument."—*The Scotsman.*

5/- net

A BLACKIE BOOK

Ferranti

CLIP-ON AMMETER

Just turn
the switch
to change
the range.



THE CLIP-ON AMMETER has become established as an indispensable instrument for the rapid measurement of currents in busbars, fuses and cables.

You simply take the instrument in one hand, clip round the conductor and observe the reading!

Don't worry if the conductor is bare--the core is completely insulated and the frame is of moulded bakelite.

COMPREHENSIVE RANGES AVAILABLE :

0 - 100 - 500	0 - 7.5 - 75	0 - 20 - 100
0 - 100 - 1000	0 - 10 - 50	0 - 25 - 150
0 - 200 - 1000	0 - 15 - 75	0 - 50 - 250
0 - 300 - 1500		

Write for List IN 11.

FERRANTI LTD., HOLLINWOOD, LANCs.
London Office, BUSH HOUSE, ALDWYCH, W.C.2.

Fl 33a

PROMOTION

COMMENCE YOUR PREPARATION IMMEDIATELY.

Since the B.I.E.T. was founded twelve years ago, we have specialised in preparing candidates for leading Technical Examinations, and our success may be gauged from the following remarkable results :

FIVE 1st PLACES

In the Probationary Inspectors and Assistant Superintendents of Traffic Examinations held in 1932-1938, B.I.E.T. candidates obtained Five First Places.

FIRST THREE PLACES

In the 1937 Competitions for Probationary Inspectors, B.I.E.T. candidates secured First, Second and Third Places.

239 SUCCESSES

In the Probationary Inspectors and Assistant Superintendents of Traffic Examinations held in 1934-1938, 239 B.I.E.T. candidates passed the Examinations.

We teach successfully by correspondence and definitely guarantee---

"NO PASS—NO FEE"

You are advised to send for a copy of our General Prospectus "ENGINEERING OPPORTUNITIES." This Handbook contains 268 pages of most useful information. It also contains particulars of all leading Engineering Examinations, including

Probationary Inspectors (Open and Limited Competitions).

Probationary Assistant Engineers (Limited Competition).

Assistant Superintendent of Traffic (Open and Limited Competitions).

City and Guilds, I.E.E., B.Sc., A.M.I.C.E., A.M.I.Mech.E., London Matric., etc., etc.

The Handbook also outlines "up-to-the-minute" courses of Home-Study in *all branches* of Engineering.

Special Courses are offered in Telegraphy, Manual Telephony, Automatic Telephony, Telephone Transmission, Electrical Technology, Wireless and High Frequency, Radio Communication, Alternating Currents, etc., etc.

Our 268 pages Handbook should be on your Book-shelf. It will be gladly sent on request, FREE and without obligation. (Please state subject or Examination of most interest.)

British Institute of Engineering Technology

369 Shakespeare House,

17, 18 & 19 Stratford Place, Oxford Street,

London, W.1

THE INSTITUTION OF POST OFFICE ELECTRICAL ENGINEERS

PRINTED PAPERS

The following papers contributed to the proceedings of the Institution have been printed by authority of the Council and may be obtained, if still in print, from

"THE LIBRARIAN, The Institution of Post Office Electrical Engineers, G.P.O. (ALDER HOUSE), LONDON, E.C.1."

The prices do *not* include postage, and in every case, Members, Associate Members and Associates have the privilege of purchasing copies at two-thirds the stated price.

No. 147	"DESIGN AND CONSTRUCTION OF ELECTRIC WAVE FILTERS."—R. J. HALSEY, B.Sc., etc. 1932.	1s. 3d.
No. 148	"STORES SPECIFICATIONS AND ACCEPTANCE TESTING."—Capt. J. LEGG, B.Sc., A.M.I.E.E. 1933	9d.
No. 149	"RECENT DEVELOPMENTS IN UNDERGROUND CONSTRUCTION, LAYING AND LOADING ARMOURED CABLES."—J. E. Z. BRYDEN, B.Sc.(Eng.), A.M.I.E.E., and T. HARGREAVES, A.M.I.E.E. 1933	1s.
No. 150	"TELEPRINTERS."—E. S. RITTER, M.I.E.E. 1933	1s.
No. 151	"RECENT REPEATER STATION INSTALLATIONS."—Major F. E. A. MANNING, M.C., B.Sc.(Eng.), M.I.E.E., A.M.I.Mech.E. 1933	1s.
No. 152	"SOME NOTES ON EXCHANGE EQUIPMENT FACTORY COSTING AND THE ECONOMICS OF PRODUCTION."—S. J. HUSBAND, Assoc.I.E.E. 1933	1s. 3d.
No. 153	"MODERN DEVELOPMENTS IN TELEPHONE TRANSMISSION OVER LINES."—J. STRATTON, A.C.G.F.C., and W. G. LUXTON. 1933	1s. 3d.
No. 154	"THE TELEGRAPH POLE."—W. H. BRENT, B.Sc., A.M.I.E.E. 1933	1s.
No. 156	"MODERN TENDENCIES IN THE SUPPLY OF POWER TO TELEPHONE EXCHANGES."—H. C. JONES, B.Sc.(Eng.). 1935	9d.
No. 158	"ULTRA SHORT WAVE RADIO TELEPHONE CIRCUITS."—D. A. THORN, B.Sc.(Eng.), A.M.I.E.E., and H. T. MITCHELL, A.M.I.E.E. 1935	1s.
No. 159	"MODERN ELECTRIC PASSENGER LIFTS."—R. S. PHILLIPS, A.M.I.E.E. 1935	9d.
No. 161	"MODERN TELEPHONE REPEATER STATION POWER PLANT."—F. W. G. DYE. 1936	6d.
No. 162	"VOICE FREQUENCY SIGNALLING ON TRUNK CIRCUITS."—T. H. FLOWERS, B.Sc., A.M.I.E.E., and B. M. HADFIELD, B.Sc., A.M.I.E.E. 1937	1s.
No. 163	"AUTOMATIC EXCHANGE DESIGN."—H. E. FRANCIS. 1936	1s. 3d.
No. 164	"THE LONDON-BIRMINGHAM COAXIAL CABLE SYSTEM."—A. H. MUMFORD, B.Sc.(Eng.), A.M.I.E.E. 1937	1s. 3d.
No. 165	"PROPERTIES AND TESTING OF DI-ELECTRIC MATERIALS."—J. F. DOUST and W. J. SULSTON, M.Sc., A.Inst.P. 1938	1s.
No. 166	"CHEMISTRY AND COMMUNICATIONS."—D. W. GLOVER, M.Sc., A.I.C. 1937	6d.
No. 167	"TWELVE-CIRCUIT CARRIER TELEPHONE SYSTEMS."—G. J. S. LITTLE, B.Sc., A.M.I.E.E. 1938	6d.
No. 168	"THE DEVELOPMENT OF MAGNETIC MATERIALS."—C. E. MORGAN, A.M.I.E.E. 1938	6d.

The Board of Editors wishes to inform readers that it will make every endeavour to produce this Journal regularly, and with as little change as possible, during the present emergency.



ANACOS

REGD.

WIRES

in

BRONZE AND CADMIUM-COPPER

AS SUPPLIED TO H.M. POST OFFICE
FOR TELEPHONE LINES

SEND US PARTICULARS OF YOUR JOB
AND OUR TECHNICAL ENGINEERS WILL
PROVIDE YOU WITH THE DATA YOU NEED

TELEPHONE
BLACKFRIARS
8701 (8 lines)

FREDERICK SMITH & COMPANY
(INCORPORATED IN THE LONDON ELECTRIC WIRE COMPANY AND SMITHS, LIMITED)
ANACONDA WORKS, SALFORD, 3, LANCS.

TELEGRAMS
ANACONDA
MANCHESTER

Differential Moving Coil **MILLIAMMETERS** For Telegraph Circuits



British
Instruments
for
British
Industries

T. 1098. WALL MOUNTING TYPE.

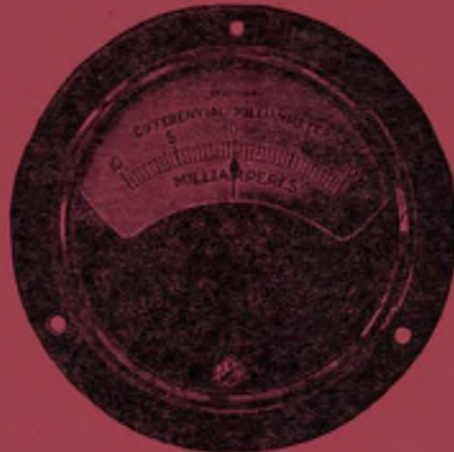

T. 1089. PANEL MOUNTING TYPE.

Particulars will be sent on request.



T. 1097. TABLE MOUNTING TYPE.

TABLE, WALL AND PANEL MOUNTING TYPES

INVALUABLE as line Milliammeters
on Differential Duplex, Sub-Audio
Frequency and many other Telegraph Systems, also for testing
purposes in connection with Land Lines and Radio Communication.

ELLIOTT BROTHERS (London) LTD., Century Works, Lewisham, S.E.13

Telephone :
Tideway 3232

In association with

SIEMENS BROTHERS & COMPANY, LIMITED, Woolwich, London, S.E.18

Telephone :
Woolwich 2020

OVER **2½ MILLION** YARDS

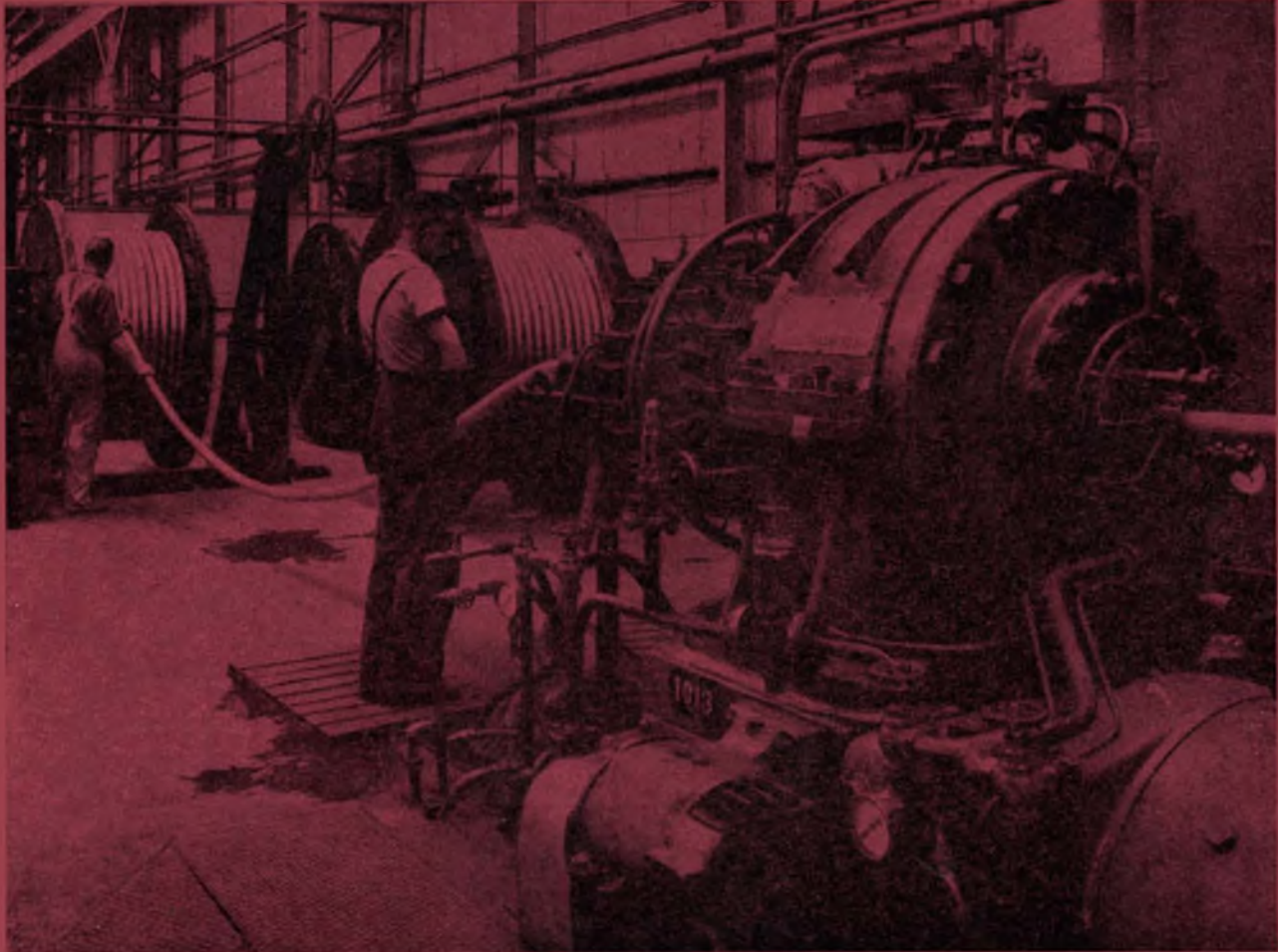

OF AIR SPACE TELEPHONE AND
SUPERTENSION CABLES HAVE
NOW BEEN SHEATHED ON THE
PIRELLI-GENERAL CONTINUOUS
LEAD EXTRUDING MACHINES.

TELEPHONE:
SOUTHAMPTON
2141 (5 lines).

PIRELLI-GENERAL
CABLE WORKS, Ltd., SOUTHAMPTON.

TELEGRAMS
"PIGEKAYBEL"
SOUTHAMPTON."

Proprietors: PIRELLI, Ltd., and THE GENERAL ELECTRIC CO., LTD.