

THE POST OFFICE ELECTRICAL ENGINEERS' JOURNAL



VOL. 25
PART 3

OCT:
1932

Price 1/- net.

ADVERTISEMENT INDEX
see page xii.

ACCURACY

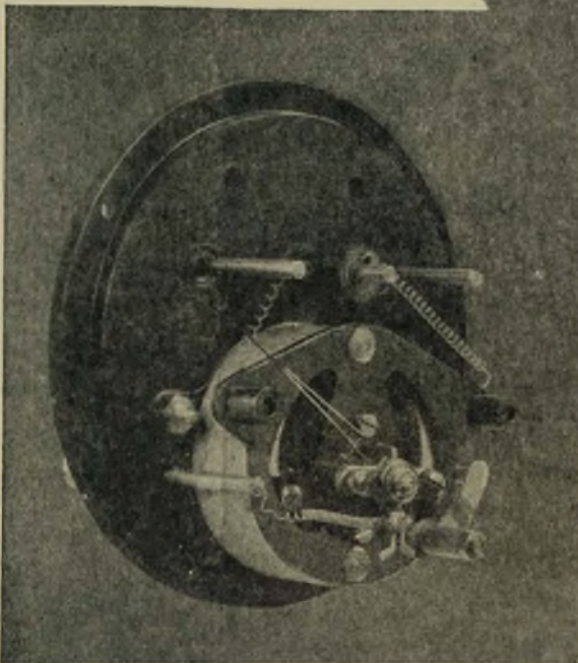
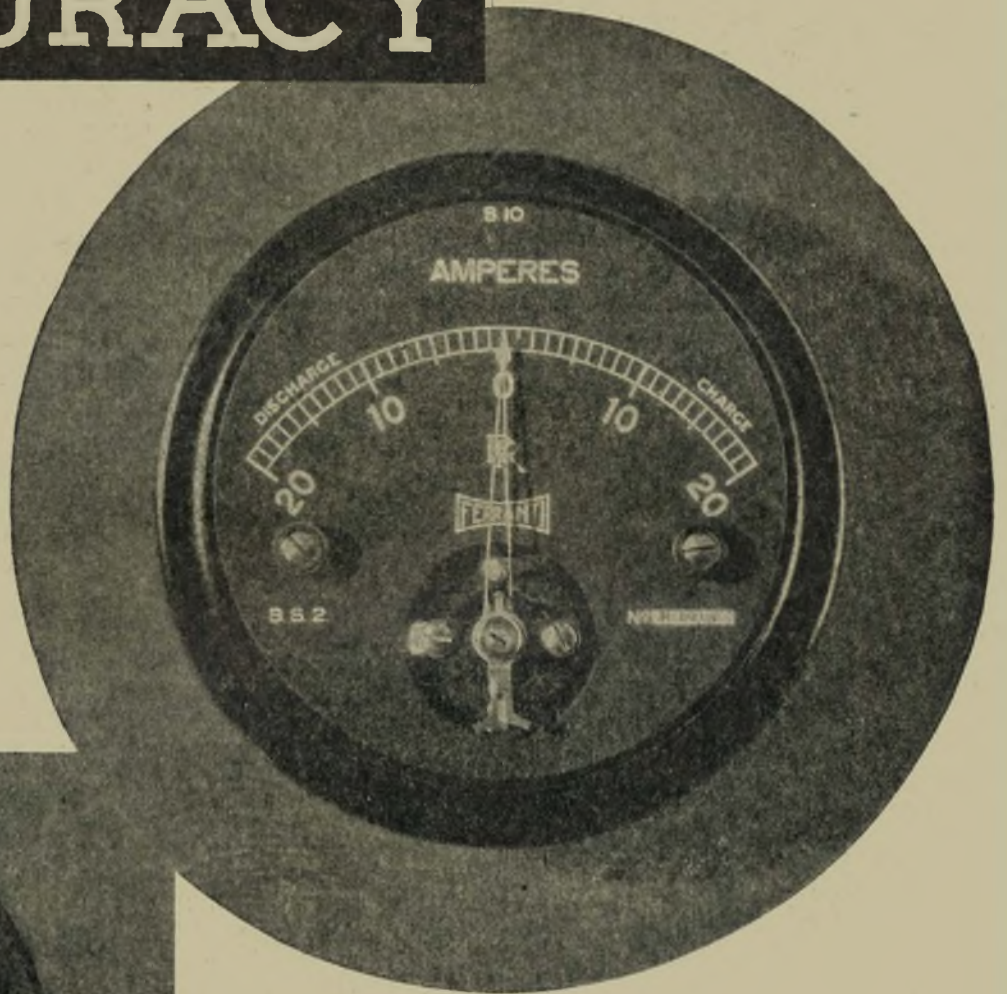

Ferranti Instruments stand supreme. They are the product of technical genius, embodying unusual precision and durability.

The finish and appearance of Ferranti Instruments is as perfect as their technical precision.

Specify Ferranti Instruments.

Write for illustrated lists. The Ferranti Range covers your complete requirements.

**FERRANTI
HOLLINWOOD
ENGLAND**

FERRANTI

PRECISION INSTRUMENTS

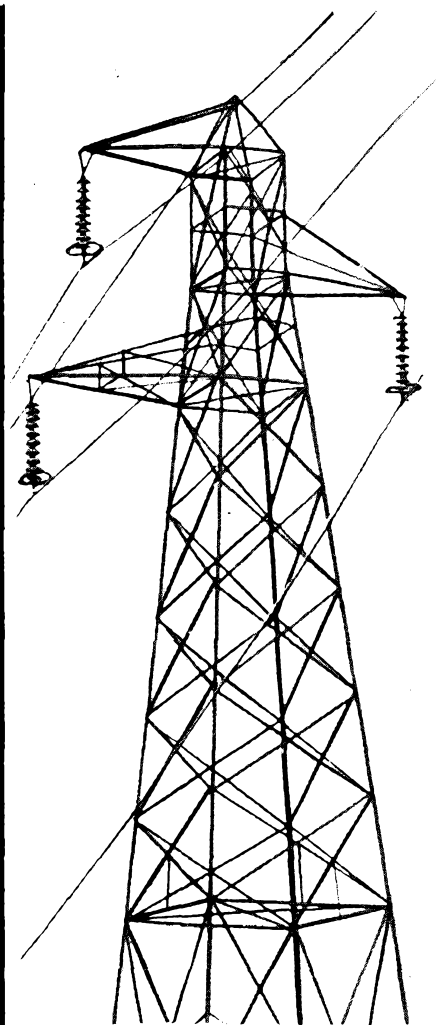

**STROWGER
SUPERVISORY
EQUIPMENT**
on the
GRID

**S-W ENGLAND • N-W ENGLAND
CENTRAL SCOTLAND**

The successful operation of the "Grid" is dependent upon efficient centralised control. A.T.M. Strowger supervisory equipment has been selected by the Central Electricity Board to provide the necessary centralised indications and telephone facilities for efficient control in these three areas.

Our engineering resources are particularly suitable for dealing with centralised indication and supervisory control problems of any nature. Literature is available on request.

Automatic Electric Co. Ltd.

Formerly: Automatic Telephone Manufacturing Co. Ltd.

Strowger Works, Liverpool. Melbourne House, Aldwych, W.C.2
Telephone: Old Swan 830. Telephone: Temple Bar 4506.

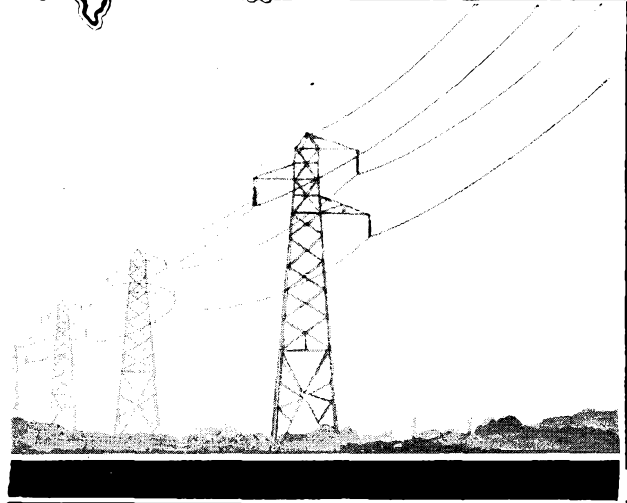

The Post Office Electrical Engineers' Journal.

A QUARTERLY JOURNAL.

COPYRIGHT.—The entire contents of this Journal are covered by general copyright, and special permission is necessary for reprinting long extracts, but Editors are welcome to use not more than one third of any article, provided credit is given at the beginning or end thus: "From the 'Post Office Electrical Engineers' Journal.'"

The Board of Editors is not responsible for the statements made nor the opinions expressed in any of the articles in this Journal, unless such statement is made specifically by the Board.

CONTENTS FOR OCTOBER, 1932.

	PAGE
TELEX—R. G. DE WARDT, A.M.I.E.E., M.I.R.E.	177
AN ALL-MAINS, VOICE FREQUENCY SINGLE-CHANNEL HIGH SPEED DUPLEX TELE- GRAPH SYSTEM—J. M. OWEN, A.M.I.E.E., and W. F. BEVIS	182
RECTIFIED REACTION—L. H. HARRIS, M.Sc., M.I.E.E.	190
TELEGRAPH AND TELEPHONE PLANT IN THE UNITED KINGDOM	194
A NEW TELEPHONE SYSTEM IN HOLLAND—A. H. DE VOOGT	195
THE EFFECT OF SIDE TONE ON THE EFFICIENCY OF TELEPHONE SYSTEMS, AND THE PRINCIPLES GOVERNING SIDE TONE CONTROL—E. R. WIGAN, B.Sc. (Eng.).	197
IMPEDANCE OF LINES CONNECTED TO SUBSCRIBERS' INSTRUMENTS	204
SOME EXPERIENCES IN THE LONDON C.C.I. SERVICE—J. E. YOUNG	208
MISCELLANEOUS FACILITIES AT AUTOMATIC AND MANUAL TELEPHONE EXCHANGES —A. HOGBIN and H. O. ELLIS	212
LONDON CENTRAL DIRECTORY ENQUIRY BUREAU—L. E. MAGNUSSON	220
ACCOMMODATION FOR CABLES IN MANHOLES AND SUBWAYS—F. G. C. BALDWIN, M.I.E.E.	225
SOME CONSIDERATIONS IN THE DESIGN OF TELEPHONE CABLES—CHARLES F. STREET, M.I.E.E., Assoc.M.Inst.C.E.	231
THE POST OFFICE EXHIBIT AT THE NATIONAL RADIO EXHIBITION—A. MORRIS, M.I.E.E., Assoc.I.R.E.	235
RESEARCH	238
NOTES AND COMMENTS	240
DISTRICT NOTES	243
INSTITUTION OF POST OFFICE ELECTRICAL ENGINEERS	248
JUNIOR SECTION NOTES	249
BOOK REVIEWS	251
STAFF CHANGES	254
COMMUNICATIONS	256

All communications with regard to Advertisements to be addressed to:

The Advertisement Manager,

Post Office Electrical Engineers' Journal,

4, Ludgate Hill, London, E.C.4.

PUBLISHERS:

THE ELECTRICAL REVIEW, 4, LUDGATE HILL, E.C.4.

Single copy 1/- net, post free, 1/3.

Annual Subscription, postage
inclusive, 5/-, payable in advance.



INSTANT CONNECTION!

Through to your man AT ONCE no waiting, no "cross-talk." That's the job of the Ericsson Intercommunication System —and it does it well.

An Ericsson Telephone on your desk places your organisation at your finger tips —directors, secretary, accounts, warehouse. Clear-speaking, efficient, foolproof, a really faithful servant earning its keep all the time.

Our new instrument is handier itself—a wonderful improvement on the older "candlestick." It looks well on the orderly desk too.

We are supplying this system to progressive firms everywhere. Can be supplied in delightful colours to match your interiors. May we quote for installation? *Write for quotations and particulars of our moderate rental and maintenance service terms.*

ERICSSON TELEPHONES LTD.
67/73, KINGSWAY - - - - LONDON, W.C. 2

Telephone—HOLBORN 3271 3.

Ericsson



ENTIRELY BRITISH MADE

" THE WORLD'S MOST E , ALL THE UNIQUE

NOW INCORPORATED IN TELEPHONE



"NEOPHONES" of the following type
are now available :

AUTOMATIC
CENTRAL BATTERY
MAGNETO
BATTERY CALL
INTERCOMMUNICATION

STANDARDIZED by the
Union of South Africa
important overseas tele-
Siemens "Neophone" has
knowledge as "The World"
Now . . . the exclusive "Neophone"
been embodied in a wide variety of
instruments. These new instruments
designed to serve a greatly increased
illustrations demonstrate that each
each instrument is first a masterpiece
which means that it gives an articulation
articulation unequalled in

" SIEMENS NEOPHONES

SIEMENS BROTHERS & CO., LTD.

Telephone :

REPRESENTATION ABROAD : Winnipeg, Rio de Janeiro, Buenos Aires, Cairo, Cape Town, Johannes-
burg, Port Elizabeth, Durban, Melbourne, Sydney, Brisbane, Adelaide, Newcastle (N.S.W.), Perth,

THE ADVANTAGES OF EFFICIENT TELEPHONE

INSTRUMENTS OF EVERY TYPE



British Post Office and the
and adopted by many other
phone administrations, the
come to be universally ac-
s most efficient telephone."
eophone" principles have
range of special-purpose
Neophones" have been
ended field of use, and the
character and variety. Yet
d foremost a "Neophone"
quality of transmission and
the sphere of telephony.

SIEMENS "NEOPHONE"

WOOLWICH. LONDON. S.E.18

Woolwich 1161



Full particulars
of any type
of instrument will
be sent on request.

Wellington, Auckland, Tokyo, Shanghai, Tientsin, Mukden, Harbin, Calcutta, Bombay, Madras,
Colombo, Ipoh (Perak F. M. S.), Kuala Lumpur, Singapore, Penang, The Hague, Malta.

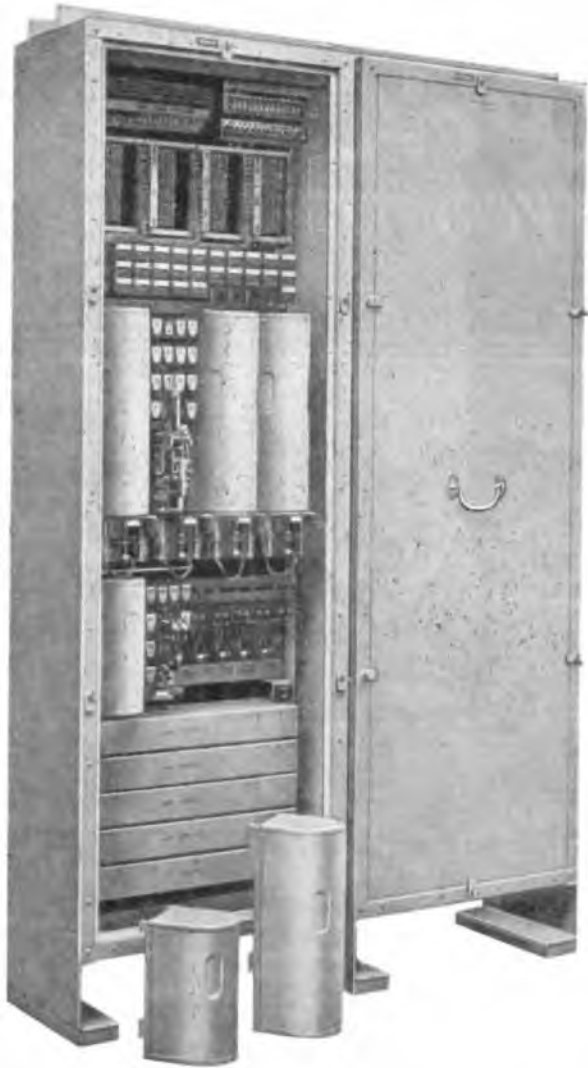

G.E.C.

AUTOMATIC AND SEMI-AUTOMATIC TELEPHONE EXCHANGES FOR RURAL DISTRICTS

The General Electric Company specialises in the design and manufacture of modern rural telephone exchanges of all sizes and for every class of service. The above illustrates two Units Auto No. 5 as supplied in large numbers to the British Post Office. In addition to this and other standard types, the Company manufactures a complete range of rural automatic and semi-automatic exchanges of special design for use in tropical countries.

THE GENERAL ELECTRIC CO. LTD. TELEPHONE WORKS - COVENTRY

TELEPHONE: COVENTRY 4111

TELEGRAMS: "SPRINGJACK, COVENTRY"

London Office: MAGNET HOUSE, KINGSWAY, W.C. 2

BRANCHES AND AGENCIES THROUGHOUT THE WORLD



For rural schemes

Henley Class P.B.J. Cables are supplied finished in Green and Chocolate Brown in addition to the usual Red finish. These colours blend with foliage and harmonise with rural surroundings.

The Green and Chocolate Brown finishes will often help to solve your problems, and from the point of view of insulation and lasting properties the cables are unique.

As we are on the Post Office List of Approved Manufacturers of P.B.J. Cables, we are able to despatch supplies to you without the delay of having to submit samples to the G.P.O.

Send us your enquiries for Class P.B.J. Cables finished Red, Green or Chocolate Brown.

HENLEY P. B. J. CABLES

W. T. HENLEY'S TELEGRAPH WORKS, CO., LTD.,
Holborn Viaduct London, E.C. 1

17 Telephone: CITY 2271 Telegrams: "Henotel, Cent, London"

G.P.O. Detector No. 4.

D.C. Voltammeter
Model 55



This instrument was designed by us for the British Post Office, and is now a standard instrument in that service and the majority of the Dominion and Colonial P. & T. Services, with the Post Office designation "Detector" No. 4.

*Sole Manufacturers under
Patents 217738 and 299247.*

With Set of Shunts and Resistances, Tests from 200 Microamps to 50 Amps, and from 2 Millivolts to 500 volts can be made.



EXT. RESISTOR



EXT. SHUNT

ERNEST TURNER ELECTRICAL INSTRUMENTS, Ltd.

**CHILTERN WORKS,
55-73, TOTTERIDGE AVENUE,
HIGH WYCOMBE,**

BUCKS. ENGLAND

Telephone: High Wycombe 301.
Telegrams: Gorgeous, High Wycombe.



THIS TELEPHONE EXCHANGE
NAMED AFTER THE POET BYRON
IS THE ONE THOUSANDTH
AUTOMATIC EXCHANGE INSTALLED
BY THE BRITISH POST OFFICE
OPENED 2ND JUNE 1952

A landmark in telephone development

BYRON EXCHANGE, HARROW, is the latest STANDARD exchange to be cut-over in this country. It is the one thousandth automatic exchange to be installed by the British Post Office, and has been named after the famous poet, who was educated at Harrow School.

We welcome enquiries for Automatic or Manual Exchanges of any capacity.

Standard Telephones and Cables Limited

Sales Dept., THE HYDE LONDON, N.W. 9

Telephone: Colindale 6533

HOME BRANCHES: BIRMINGHAM, GLASGOW, LEEDS, MANCHESTER.

OVERSEAS BRANCHES: CAIRO, CALCUTTA, DUBLIN, JOHANNESBURG, SINGAPORE.

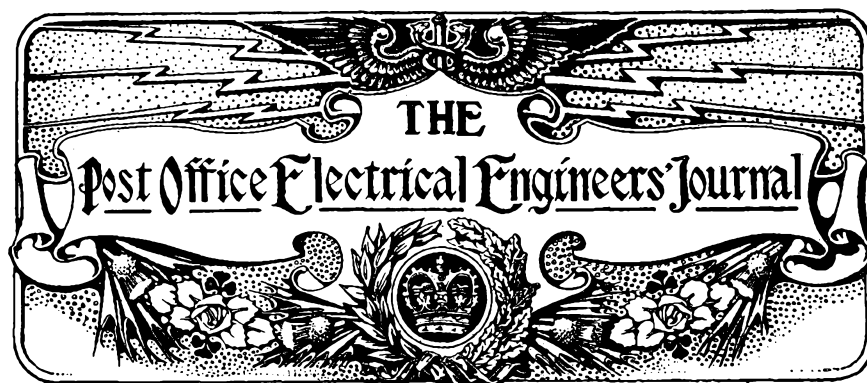

Telex

R. G. DE WARDT, A.M.I.E.E., M.I.R.E.

FOR many years past Engineers have visualized the introduction of a system of working which would permit of any one telegraph instrument connected to a network being put in direct communication with any other instrument on that network.

While it has not yet been possible to develop the public telegraph system on these lines, the introduction of Teleprinters, which require only type-writing skill for their operation, has led to such a service being placed at the disposal of renters of telephone exchange lines who are also prepared to pay for the rental of a teleprinter.

In America and other countries a service is being developed on special networks associated with the telegraph networks by means of special switching centres. The great economic advantage which would accrue if the existing telephone network and switching facilities could be utilized has led the British Post Office to develop a system which utilizes the public telephone line network in place of a special network. The use of the ordinary telephone circuits and trunk and local switching facilities prohibited the adoption of the direct current methods used in ordinary land line telegraphy for the service and necessitated the employment of alternating currents of a frequency and magnitude comparable with those used in the transmission of telephone speech. With this requirement as a basis, a system has been developed and an official service was opened in London in June last and subsequently extended to Manchester, Birmingham, Liverpool and Leeds. A public service was made available in London on August 15th and is now in process of extension to provincial centres. This Teleprinter exchange service is known as the "Telex" service and will ultimately provide teleprinter communication facilities between renters wherever telephone communication is possible.

It will be appreciated that the difficulties to be overcome in the development of this system and the methods of operating were very different to those which would have been experienced in developing a system using a separate network. The Telex system had to be grafted on to an existing system, using operating procedure developed solely from the telephone viewpoint, with the basic difference between telephone and teleprinter requirements, that while telephone intelligibility is not interfered with by momentary disconnexions or interruptions, such as the throwing of monitoring keys, the effect of such operations on the Telex system would be that extra letters, failure of letters and misprinting would occur on the teleprinter, depending on the time of occurrence and the length of the interruption.

The technical problems involved in the production of a suitable voice frequency transmitter and receiver having been solved, the operating procedure to be adopted in handling Telex calls was studied and tried out experimentally on both the trunk and local systems. The results of these experiments have been carefully examined and the causes of the teleprinter errors followed up and eliminated.

As now installed, each equipment comprises a Teleprinter 7A, a voice frequency converter together with auxiliary apparatus (described later) and with a change over switch which in one position connects the telephone to the line, disconnects the power supply to the teleprinter and the converter, and in the other connects the teleprinter to the line, disconnects the telephone and connects power to the teleprinter and converter.

A subscriber making a Telex local call turns the switch to "Telephone" and proceeds to dial the required number, if automatic, or to pass the call in the usual way if manual. When connexion is established both subscribers turn their switches to "Teleprinter" and the two stations are then con-

ected by a line which provides a simplex teleprinter service in alternate directions without further operations of switches. A local record of the message being transmitted to the distant end is automatically provided.

The Teleprinter (7A) used on this service is fitted with an automatic "answer back" device which permits the subscriber confirming the correctness of the connexion. As soon as the change-over switch is thrown, the calling subscriber depresses the upper case of the letter D key labelled "Who are you" which sends a combination of signals to line and the distant teleprinter. The reception of this signal brings into action a series of cams which automatically transmits the first three letters of the name of the exchange and the subscriber's number from the called teleprinter. This is recorded at both ends. The called subscriber depresses the "Who are you" key on his teleprinter and receives the exchange and number of the calling subscriber.

When teleprinter communication is finished both subscribers return their switches to "Telephone." The line is thus cleared in the normal manner; the telephones having been replaced on their cradles when the switches were turned to "Teleprinter."

Telex trunk service is being given as far as practicable on a demand basis and is being gradually extended to all parts of the country. Trunk calls will pass through a Telex position in the trunk exchange and where telephone demand working is available the ordinary demand circuits will be used for the Telex service to give the demand facilities required by that service, although, of course, such circuits will be absorbed into the telephone network as and when telephone demand working becomes available between the centres concerned.

The use of a separate Telex position has been rendered necessary to provide, for the special handling of Telex calls. Monitoring and time announcements, such as are used on telephone trunk circuits, would cause interference to a teleprinter circuit, and it was therefore considered desirable that all trunk Telex work should be handled on a special position by an operator specially trained for the work.

A subscriber in a director automatic area desiring a trunk connexion will dial "TLX" and the call

will be routed *via* a direct high grade circuit to the Telex position. Where there are difficulties in providing direct circuits, or where traffic conditions do not warrant their provision, a call will be routed *via* a mechanical tandem exchange or the appropriate switching centre to the Telex operator, who will immediately reverse the call.

In non-director areas level 98 will be used for the Telex service reversing of calls, except those from main exchanges, this being necessary until such time as the transmission efficiency of the circuits is made suitable for ordinary telephone demand working. When such circuits are available Telex calls from



FIG. 1.—SUBSCRIBER'S TELEX INSTALLATION.

all automatic exchanges in non-director areas will be dealt with on a recording and completion basis.

Traffic from manual exchanges will reach the Telex position *via* the keysending positions, or manual positions, as the case may be, and the Telex operator will reverse the call.

Subscribers to the service are required to rent a Telex equipment which, for convenience in installation, is mounted on a steel table supplied by the Department. Each table is completely wired before

issue to the fitting staff, leaving only the connexion of the telephone lines and power supplies to be made on the subscriber's premises.

A complete Telex installation is shown in Fig. 1.

The table equipment consists of a Teleprinter 7A, (a rectifier being provided if the power supply is A.C.), a converter voice frequency Telegraph No. 1 or No. 2 for A.C. or D.C. supply respectively, a change-over switch, a telephone and auxiliary equipment.

The teleprinter is the standard "Teleprinter 7A" using the international alphabet No. 2 and standard keyboard; the bell signal on the upper case of the J key being provided by an electric bell operated by a pair of contacts.

The voice frequency converter is of Departmental design and, operating at a frequency of 300 cycles, permits of teleprinter working over circuits having an attenuation up to 30 db. at that frequency.

The converter consists of two parts mounted in a metal case, the power panel (No. 1 for A.C. and No. 2 for D.C.) supplying the necessary filament and anode power to the converter panel, which forms the second portion of the voice frequency converter.

The panel power No. 1, Fig. 2, is employed when

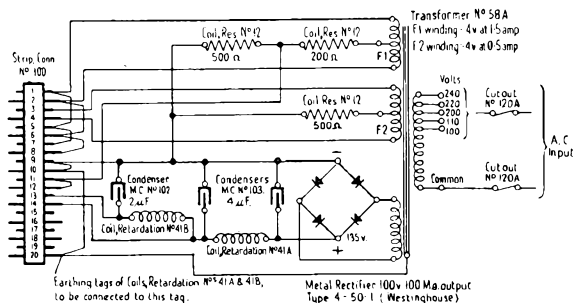

FIG. 2.—PANEL, POWER, NO. 1.

the power supply is A.C. The power supply is fed to the primary transformer 58A which has three secondary windings. The first of these windings F1 provides filament heating current for the rectifier and push pull valves of the converter, and the second winding F2 provides filament heating for the oscillator valve. The output of the third of the secondary windings is rectified by a copper oxide rectifier and smoothed to provide the high tension supply to the anodes of all the valves in the converter.

The grid return of the oscillator valve on the converter panel is connected to the negative terminal of the high tension supply and the centre point of the filament heating winding via the biasing resistance of 500 ohms.

The grid return of the detector valve is connected to the centre point of the appropriate filament heating winding via the resistances of 500 and 200 ohms, the latter being common to the grid returns of the push pull valves.

Panel Power No. 2, Fig. 3, is used when the power supply is D.C. In this case the valve filaments are connected in series and the heating current adjusted by a 200 ohm resistance. A biasing resistance of 9 ohms is also connected in series with this circuit.

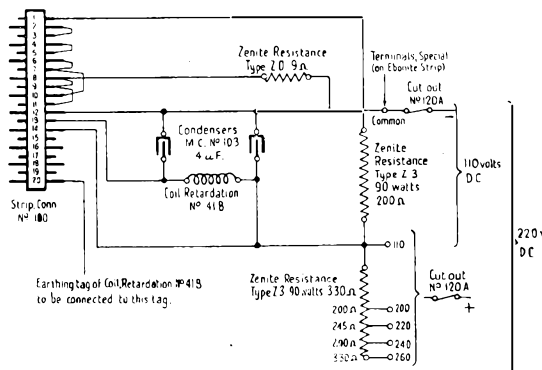

FIG. 3.—PANEL, POWER, NO. 2.

The grid return of the oscillator valve is connected to the positive side of the filament of the last valve of the series; that of the detector valve to the negative high tension terminal through the common 9 ohm biasing resistance. The grid return of one of the push pull valves is taken direct to the negative of the high tension supply and that of the other to the common 9 ohm resistance.

Tappings are provided on both types of power panels to enable the standard type of power panel to be employed for any supply voltages.

Fig. 4 shows diagrammatically the connexions of the converter with A.C. supply and Fig. 5 that with D.C. supply.

The converter consists of transmitting and receiving portions. The transmitting portion comprises a valve oscillator having one coil of a transformer 55A in its anode circuit, the coil being tuned to 300 cycles by a 0.5 microfarad condenser. The coupling between grid and anode is provided by the second coil of this transformer: the third winding of this transformer coupling the oscillator output via transformer 48H to the line when the transmitter tongue moves to spacing. A 300 ohm non-reactive resistance is inserted in series with the output winding of the transformer 55A to prevent overloading of the valve and the output to line is adjusted by a variable resistance in the anode circuit to give three volts across a line having a resistance of 600 ohms.

A portion of the output is bypassed to the receiving portion of the converter via transformer 56A and the 0.5 microfarad condenser to give a local record on the teleprinter of the signals being sent to line.

The receiving portion of the converter consists of a rectifier valve and two push pull amplifiers.

The rectifier is coupled to line by the transformer No. 48H, the 0.5 microfarad condenser being short-circuited by the transmitting tongue of the teleprinter resting

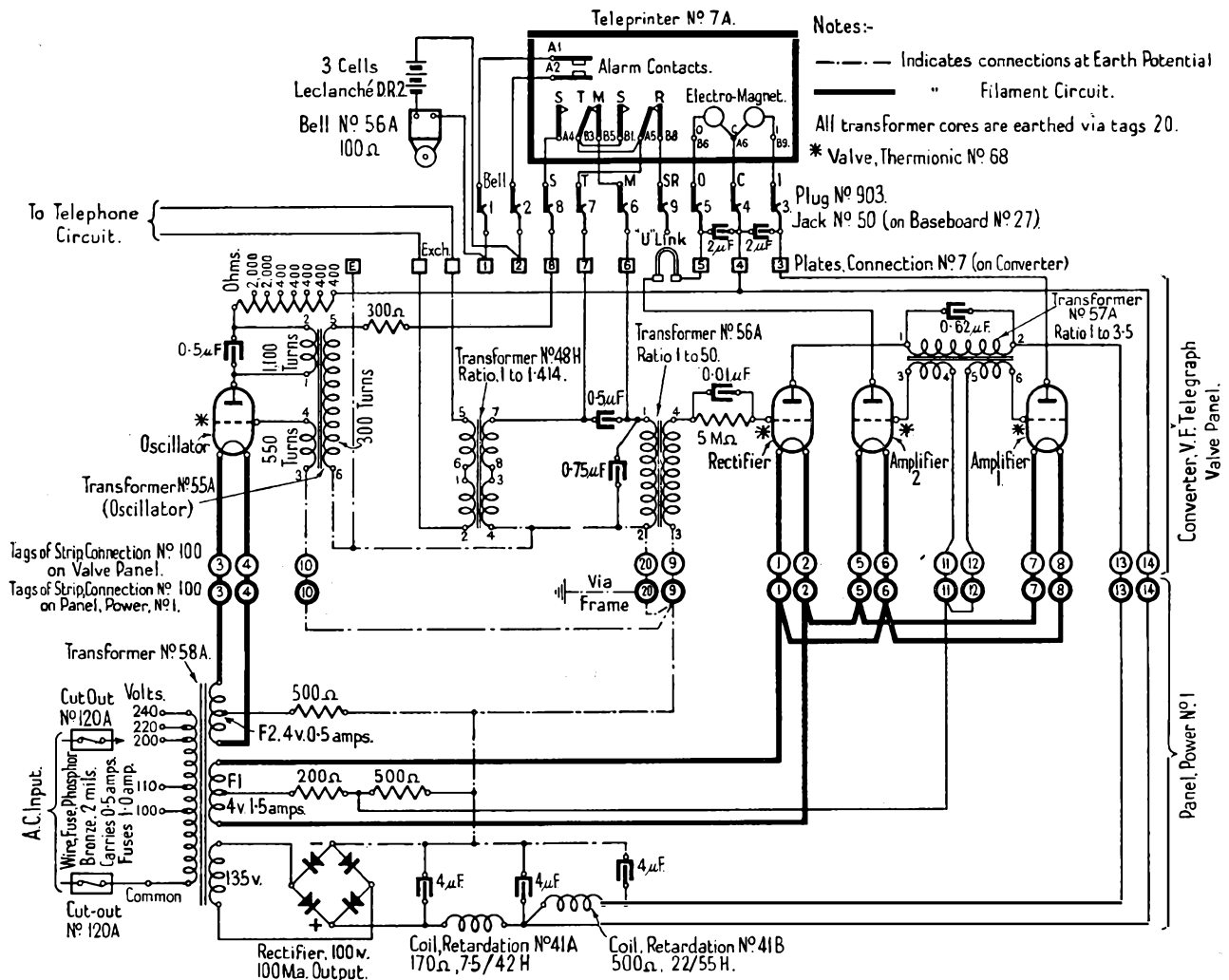

FIG. 4.—CONVERTER WITH A.C. SUPPLY.

on the marking stop. The grid of the rectifying valve is normally biased to a point at the bottom of its operating curve when a minimum current flows in its anode circuit. An incoming signal produces a rise in current in the anode circuit comprising the primary winding of the transformer 57A. This transformer has two secondary windings, one end of each being connected to the grids of the push pull valves and the other to the respective grid returns. The anodes of these valves are each connected through one coil of the teleprinter electromagnet to the positive of the high tension supply.

The increase in the current flowing in the rectifier anode circuit due to the incoming 300 cycle signals causes a momentary current in the secondary windings of transformer 57A. The grid of one of the push pull valves becomes momentarily positive and an increased current flows in the anode circuit of that valve and the coil of the electromagnet associated

with it, moving the relay armature to the spacing stop.

The grid of the other push pull valve is made more negative by the same anode current and its current is in consequence slightly reduced. On cessation of the signal the reduction in detector anode current produces pulses in the opposite direction in the secondaries of transformer 57A. The potentials of the grids of the push pull valves are thus reversed with the result that a momentarily increased current flows through the other coil of the teleprinter electromagnet, moving the relay armature to the marking stop. Thus a double current effect is obtained.

A monitoring and test set for use with the Telex service is provided in each centre. The facilities provided are as follows (see diagram of connexions shown in Fig. 6):—

1. Measurement of the voltage given by the subscriber's set under test.

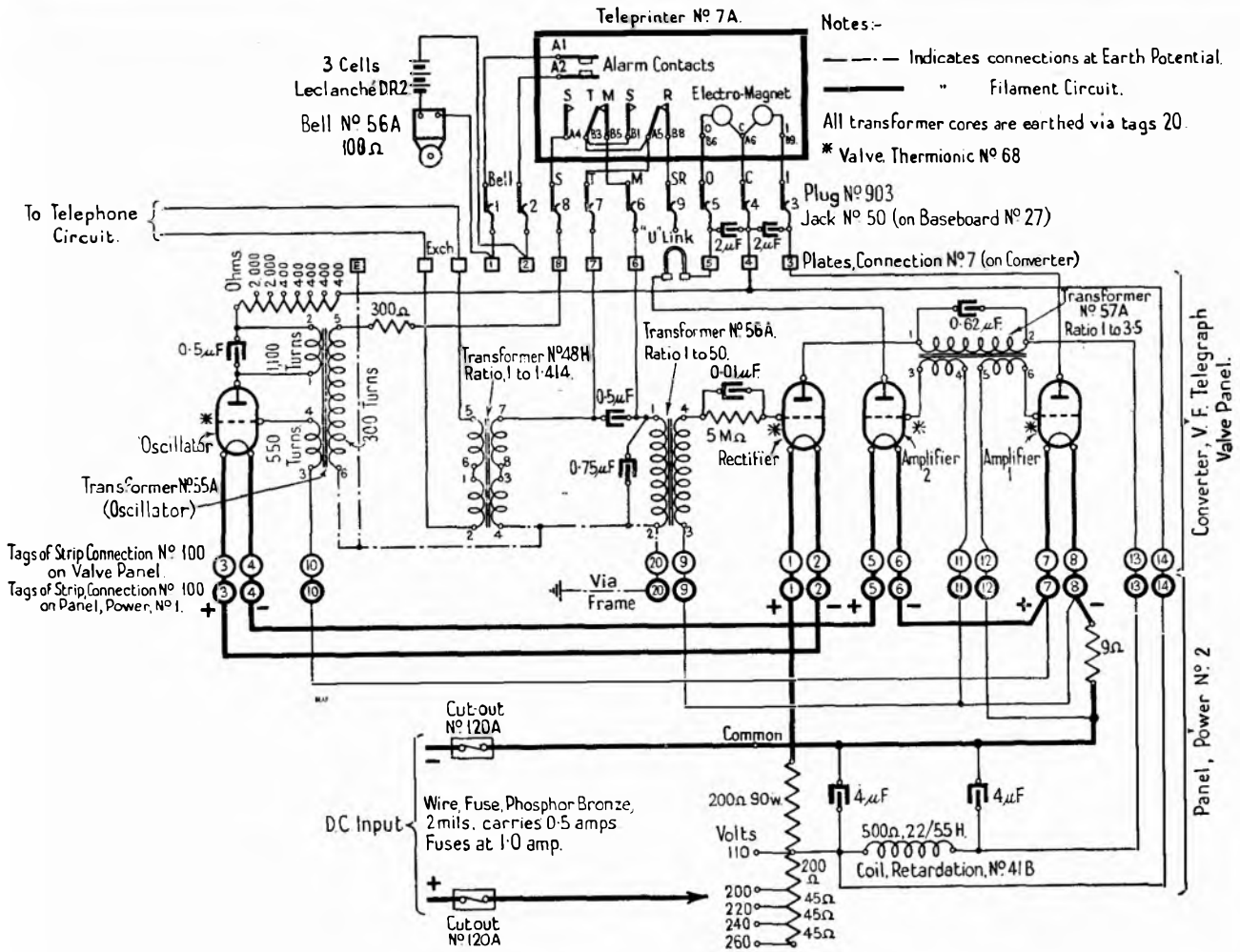

FIG. 5.—CONVERTER WITH D.C. SUPPLY.

2. Test of teleprinter working to the subscriber's set from the test set through an attenuator, enabling the satisfactory working of the subscriber's teleprinter and converter to be tested.

3. Facilities for placing the teleprinter test set in leak across two subscribers' lines connected together at the Telex test desk. An amplifier is thrown into the test teleprinter circuit in this case, the leak impedance being kept high in order to interfere as little as possible with the operation of the two sets under test. (This facility will only be used in special cases where it is necessary to take steps to watch the operation of a circuit in order to trace obscure difficulties in working).

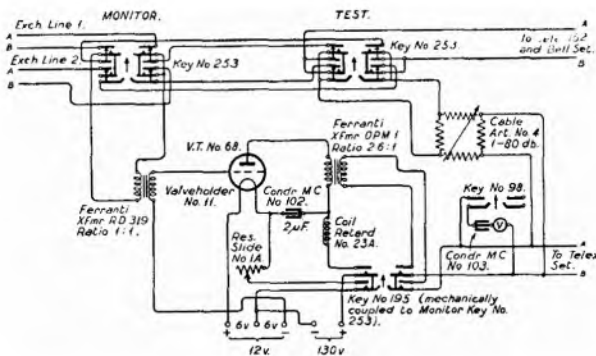

FIG. 6.—MONITORING AND TEST SET.

A service similar to the phonogram service for telephone subscribers is being provided for Telex subscribers. This is known as the "Printergram" service.

A novel feature provided in this service is that the subscriber calling the printergram service starts teleprinting as soon as ringing tone ceases without calling in the printergram operator. As soon as transmission of the telegram is finished,

depression of the J bell key calls in the printergram operator who confirms the subscriber's number by depression of the "Who are you" key on the printergram instrument and acknowledges the receipt of the message.

The circuit arrangements used in this case are shown in Fig. 7. Ringing currents at the position

from the telephone. The distant subscriber then transmits the message, the teleprinter at the printergram position being unattended during this period. The operator, who supervises several instruments, is called into circuit by the glowing of a red lamp, illuminated by the distant subscriber depressing the J bell contacts on his machine. When the message is acknowledged the printergram operator throws the change over switch and clears the connexion.

Should the operator fail to throw the change over switch the motor of the teleprinter will continue to run for about 90 seconds after the receipt of the last signal and will then have its power cut off by the operation of the auto start-stop switch on the teleprinter. When power is cut off in this manner relay P in the power circuit falls back and lights a green lamp through the closed contacts K₁, thus giving a warning that the switch has not been returned to "telephone." K₁ is broken by the switch being returned to telephone.

This automatic feature of this service will ultimately be carried a further stage by means of a device now being developed to switch on the teleprinter power and change over the telephone line to the teleprinter after three ringing pulses have been received. The printergram operator will, therefore, only be required to attend to the circuit when the lighting of the red lamp indicates that the transmission of the message has been completed by the subscriber.

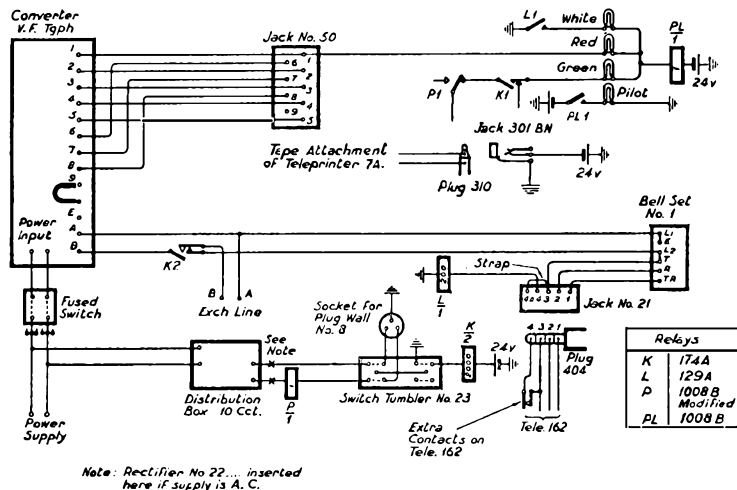

FIG. 7.—PRINTERGRAM SERVICE.

cause the white calling lamp to glow and this lamp is extinguished by the throwing of the teleprinter switch by the operator. This switch, in addition to starting the teleprinter, trips the ringing, causes a cessation of ringing tone to the calling subscriber and changes the exchange line over to the converter

An All-Mains, Voice Frequency Single-Channel High Speed Duplex Telegraph System

J. M. OWEN, A.M.I.E.E., and W. F. BEVIS.

Introduction.

IN modern telegraphy increasing use is being made of voice frequency systems. Several articles have appeared from time to time dealing with multi-channel circuits, but so far little has been written with regard to single-channel working. The present article describes a high speed voice frequency single-channel system which is capable of operating at 200 words per minute duplex, over a transmission range of 0.30 db., the sets being operated from A.C. or D.C. mains.

The speed of working on a multi-channel voice frequency system is dependent upon the frequency band width of the filters used. In the latest apparatus this figure is 120 p.p.s., in accordance with C.C.I.T. recommendations, which, of course, provides sufficient margin for teleprinter working. It will be appreciated, however, that, whilst the teleprinter has been adopted as the standard instrument in the British Post Office, several systems of working still remain which operate at speeds considerably in excess of this type of apparatus. This is

particularly true with regard to newspaper offices, where Creed, Wheatstone, Murray Multiplex, etc., are still extensively used. The filter band widths of multi-channel systems using standard frequency separation are too narrow for high speed circuits, and one solution of the problem is to use a single-channel system.

The design of a single-channel voice frequency telegraph unit is a comparatively simple matter, provided that one adheres to the general principles of normal telephone transmission, and at simplex the possible speed of working obtainable is in excess of that at which the normal telegraph receiving apparatus will function satisfactorily. This was proved several years ago on the Australian and Indian Beam services when speeds of 300 to 500 w.p.m. were easily obtained. In the present case, however, the

The general scheme of working can be briefly stated as follows:—Two carrier frequencies are used, 800 p.p.s. and 1,300 p.p.s., and the voltage output to line is 1 volt. At one end of the circuit the transmitting frequency is 800 p.p.s., and the receiver is operated with 1,300 p.p.s., whilst at the other end of the circuit the frequencies are 1,300 p.p.s. sending, and 800 p.p.s. receiving. In order to ensure satisfactory duplex working, high and low pass filters are used. The units are operated entirely from the A.C. or D.C. mains, and no batteries whatever are required. The system may be considered as being divided into the following units:—(1) Oscillator, (2) Receiver, (3) Transmitting and Receiving Filters, and (4) Power unit. A schematic diagram of the arrangement is shown in Fig. 1, and the units themselves will be described later.

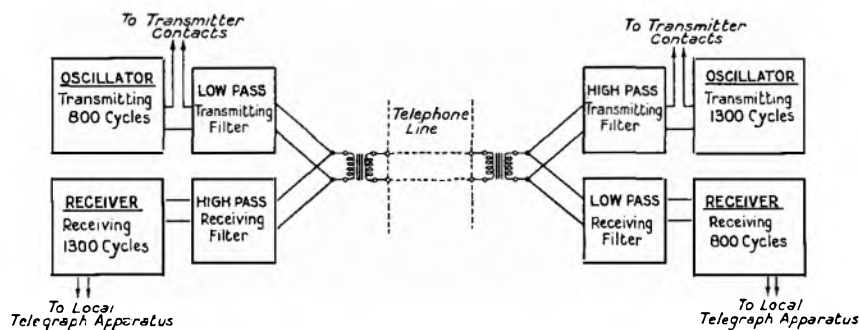

FIG. 1.—SCHEMATIC LAY-OUT.

design of a unit is considerably complicated by the following conditions:—

- (a) The unit must be capable of operating at speeds up to 200 w.p.m. duplex (*i.e.*, 80 p.p.s. or 160 bauds).
- (b) It must operate from either the A.C. or D.C. mains.
- (c) It must operate without manual adjustment if possible over the speed range mentioned, and in addition be capable of working over telephone lines when the overall transmission equivalent varies from 0 to 30 db.

After considerable research and experimental work, A.C. and D.C. units which satisfy the above conditions have now been completed. The present units have been designed to operate with any two-element duplex telegraph system at speeds up to 200 w.p.m. duplex. They will operate on any telephone line alternately with telephone working if required, provided that the overall transmission equivalent of the circuit used, including terminations and local ends, does not exceed 30 db. at the highest frequency (*i.e.*, $\omega = 8,150$ radians per second). In practice, these figures have been exceeded and speeds up to 250 w.p.m. duplex from 0 to 35 db. have been obtained during several tests. As the system operates on a voice frequency basis, a two-wire or four-wire telephone circuit must be used.

Essential Data.

(1) Choice of frequencies.

The frequencies used are 800 p.p.s. and 1,300 p.p.s. respectively, and the reasons for their selection are as follows:—

- (a) The frequencies selected must be reasonably far apart. This condition is, of course, an obvious one when it is considered that high-speed duplex working is required.
- (b) The lower frequency must be some distance on the frequency range from the 500 p.p.s. used for ringing on repeated telephone circuits.
- (c) For high-speed working, frequencies below 500 p.p.s. are not considered suitable because, firstly, there is a definite lack of margin due to insufficient cycles per dot character, and, secondly, the increased distortion encountered at the lower end of the frequency range does not lend itself to the conditions necessary in a high-grade circuit.
- (d) At the other end of the frequency range, too high a frequency is not suitable owing to the increased attenuation and phase distortion on normal circuits. This point is all the more important when it is considered that the present set is required to

work over a comparatively large attenuation range, and obviously the transmission loss in the line itself should be a reasonable figure in order to allow for the maximum loss in the local ends.

(2) *Power Level.*

The output voltage to line should not exceed 1 volt on a line whose $Z_0 = 600\Omega$. This condition, whilst meeting existing requirements, was more or less necessitated by the present ringing arrangements on telephone repeater circuits. Early trials proved that frequencies other than 500 p.p.s. operated the ringing relays when the voltage output was increased above 1.5 volts. The question of improving the operating characteristics of the ringing relays is believed to be under consideration, but at the time of the original trials it was desired to use the voice frequency telegraph system without in any way interfering with the existing telephone arrangements. It was therefore necessary to maintain the output voltage at a figure not exceeding the lowest operating value of the 500 p.p.s. ringing relays at 800 p.p.s.

(3) *Echo Suppressors.*

In order to permit of duplex working, the telephone circuit used must not be fitted with echo suppressors, or, alternatively, arrangements should be made to nullify their action.

(4) *Range of working.*

It was desirable that the unit should function over as wide a transmission range as possible. The figure provisionally decided upon was 0.30 db. As the output was restricted to 1 volt, it was therefore necessary to increase the sensitivity of the receiver in order to obtain the required result. The sensitivity of the receiver must thus be within certain defined limits.

(a) Expressed as a transmission level, it must be less than the combined attenuation loss in the sending and receiving filters at one end. In other words, the sensitivity of the receiver must be such that it will not operate when the sending frequency at the same end is transmitted. (For example, if 800 p.p.s. is the sending frequency, it will first pass through the low-pass filter and so to line, but a certain proportion, at a very low level, will pass through the high-pass filter into the home receiver. Signals at this level must not operate the receiver). Alternatively, if increased sensitivity is required then the combined attenuation loss in both filters must be increased by adding one or more filter sections.

(b) This alternative cannot be carried on indefinitely, however, because whilst filters can be designed to meet most requirements of attenuation loss, and the sensitivity of the receiver can be increased, this sensi-

tivity must be such that at a maximum it is still insensitive to the maximum possible cross-talk in the cable or circuit used. That is to say, the minimum sensitivity must be above the noise level. The figure of 30 to 35 db. is therefore considered to be a reasonable working maximum under normal conditions.

(5) *Power Supply.*

The use of either A.C. or D.C. mains for operating voice frequency telegraph units, whilst introducing the usual problems associated with mains-operated sets, gives rise to a further cause of disturbance. In single-channel voice frequency telegraphy, the speed of working may be said to vary roughly from 0 to 100 p.p.s. (*i.e.*, 250 w.p.m. or 200 bauds). It may be considered that this frequency is modulated on a carrier frequency and transmitted as such over a telephone line. The important point to note is that the telegraph signalling frequency is comparatively low, and therefore interference arising in, or at, the transmitting or receiving ends of the order of 50 p.p.s. or 100 p.p.s. will be a serious hindrance to successful working. This point is emphasised more in the case of A.C. mains, where, if the supply frequency is 50 p.p.s., the ripple frequency of the rectified supply is 100 p.p.s. The smoothing arrangements must therefore be efficient in order to reduce the ripple to an absolute minimum consistent with the economics of the work in hand.

Whilst this point is not so serious in the D.C. mains case, it is nevertheless very important to reduce mains hum to a minimum.

(6) *Adjustment.*

With all the previous conditions in mind, it was necessary, as far as possible, to produce a unit which would be self-adjusting over the working speed range (0 to 200 w.p.m.), and also over the transmission range (0 to 30 db.). This ideal has almost been obtained and, as will be seen later, one adjustment only is provided, and but for the necessity of some small safeguarding measure, this could be removed.

(7) *Valves.*

The valves used in the set are of the type known as V.T.68. These valves were chosen (a) because of the comparatively low filament consumption and (b) the same valves could be used in all parts of the circuit. Further, valves of this type are in use on several voice frequency telegraph schemes.

The different units and their operation are described in the following paragraphs:—

Oscillator.

The fundamental consideration in the design of an oscillator for this particular purpose is that the generated frequency must be comparatively free from harmonics. This is a very necessary condition, as

harmonics will tend to interfere with the receiver and render duplex working impossible.

Many trials have been carried out and it has been found that the generation of a pure frequency, consistent with a reasonably uniform output from a single valve circuit is not a practical proposition. A two-valve arrangement has therefore been adopted. The circuit used is based on the well known "Resistance Feed Back" design with one stage amplification. In this circuit, a comparatively pure frequency is generated in the first valve, the feed back resistance from the anode circuit being adjusted until the valve is only just oscillating. At this level the output is low, and an amplifier is therefore added to the circuit. This provides an adequate output and, in addition, ensures a constant load on the oscillator valve.

Figs. 2 and 4 show the connexions of the oscillator

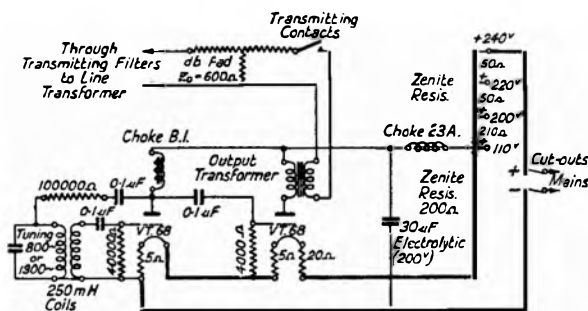

FIG. 2.—OSCILLATOR AND POWER ARRANGEMENT. (D.C.).

for the D.C. and A.C. mains cases, respectively. It will be seen that, with the exception of the power supply, these two diagrams are identical.

The oscillations generated are passed through the output transformer to the transmitting network, sending filter, and line. This network, which comprises a single T section, regulates the output to line, and, at the same time, ensures that the sending filter is terminated with its characteristic impedance at any condition of signalling. The values of the resistance are fixed so that the output to line is normally 1 volt. It will be seen from Fig. 2 that the transmitting contacts are placed in series with one leg of the loop between the T network and the oscillator output transformer. Other arrangements are of course possible, and several have in fact been given extensive trials. The scheme of short-circuiting the output was put to prolonged test, but under working conditions contact resistance of as low as 3 ohms in the transmitter switches and contacts gave unsatisfactory "shorting" periods, and lead to serious distortion. The arrangement adopted has, however, a certain disadvantage because, if there is any appreciable wire-to-wire capacity in the leads from the voice frequency equipment to the key contacts, a clean break in the signals is not possible. It was considered, however, that the disadvantages of the former completely outweighed those of the

latter, and that, with reasonable precaution, the arrangement used would present no serious difficulty in practice. Under normal working conditions a frequency is sent to line when the transmitting apparatus is at rest. This method gives the best results, as a constant load is maintained on the limiting amplifying valve of the receiver. The power supply to the filament, anode and grid priming circuits will be dealt with later when the power unit is considered.

Valves V.T.68 have been used throughout and are proving very satisfactory. The filament consumption is comparatively low (0.415 amp.) and at zero grid volts with 100 volts on the plate, an anode current of 20 milliamps is obtained.

The anode and grid coils, which are each 250 mH, have been wound on dust cores, and specified not to vary from their rated values by more than 1% when tested with 1 mA at 1,000 p.p.s. The feed back resistance, grid resistances, and tuning condensers differ at the two ends of the circuit, since one oscillator generates a frequency of 1,300 p.p.s. and the other a frequency of 800 p.p.s.

Receiver.

With due regard to what has been previously stated, it will be seen that the function of the receiver is threefold.

- (a) Rectified signals must be produced in order to operate the telegraph relay.
- (b) An arrangement must be used by means of which the input to the rectifying valve is constant over a specified range. This gives rise to the limiting valve.
- (c) In order that the set shall operate over the range 0-30 db. an amplifying valve must precede the limiting valve.

In the present unit, three V.T.68 valves are used; the first as an amplifier; the second as a limiting amplifying valve; and the third as an anode bend detector. Figs. 3 and 5 show the connexions of the receiver for the D.C. and A.C. mains cases respec-

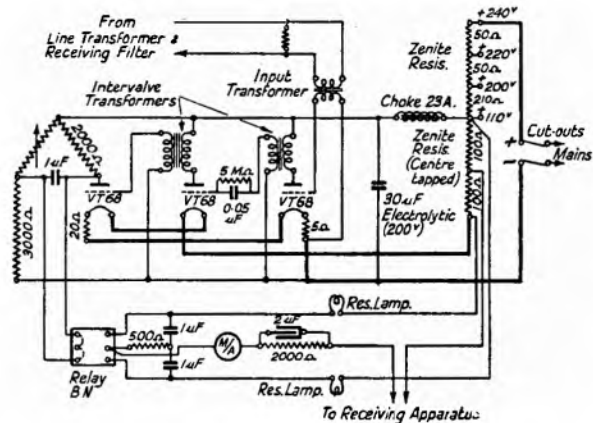

FIG. 3.—RECEIVER AND POWER ARRANGEMENT. (D.C.).

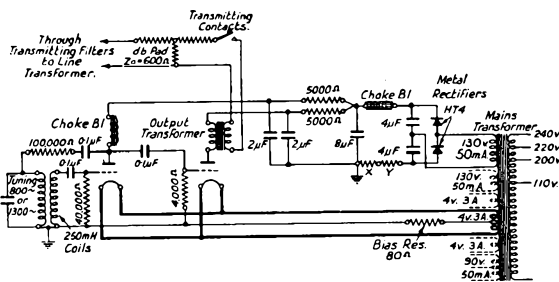

FIG. 4.—OSCILLATOR AND POWER ARRANGEMENT. (A.C.).

tively. It will be seen that, with the exception of the power supply, these two diagrams are identical.

A study of Figs. 3 and 5 will show that a condenser of $0.05 \mu\text{F}$, shunted by a resistance of 5 megohms, is placed in the grid circuit of the second valve in a somewhat similar manner to that of the usual grid leak detector. The present circuit, however, differs fundamentally inasmuch as the grid is

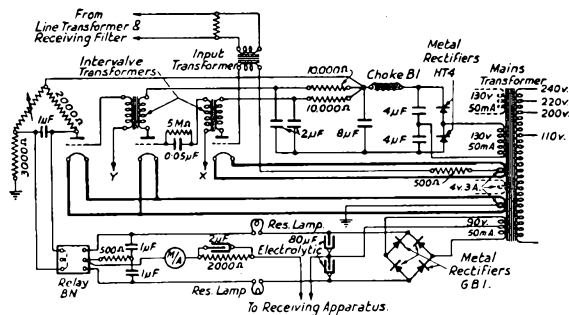

FIG. 5.—RECEIVER AND POWER ARRANGEMENT. (A.C.).

biased back to approximately the mid-point of its working characteristic. Incoming signals which just load the grid circuit will produce an anode output corresponding to the full grid swing; that is to say, from the negative grid voltage where emission is suppressed, to zero grid volts where grid current is about to flow. If, however, a signal is applied to the grid circuit, and the amplitude is such that overloading of the grid occurs, then the resulting swing will be from below the point of suppression to a positive grid voltage (*i.e.*, where grid current has commenced). Thus, under these conditions grid current will flow for every positive half cycle of the input, and accordingly a charge will be built up in the condenser, the amount of the charge depending upon the overload. Further, this charge puts additional negative voltage on the grid of the valve, which, in turn, suppresses the anode output proportionally. Thus it will be seen that, as soon as grid current flows, the condenser is charged and forthwith biases back the incoming signal to the point where grid current is just about to commence. This is, in effect, the original condition, and there-

fore an anode output corresponding to a full grid swing is obtained even if the grid circuit is overloaded. Grid swings which are more negative than the suppression point will of course be ineffective. Therefore if this valve is just fully loaded or overloaded, a constant anode output will be obtained. If the amplitude of the input voltage is insufficient to load the valve, a decreased output will result and as this does not meet the requirements of the circuit it is a condition which must be avoided. In practice, this condition exists when the limit of the set is reached. The $5 \text{ M}\Omega$ leak provides a path for the condenser to discharge after the passage of a train of signals. It is interesting to note that the combination of the condenser and leak resistance has a time constant which plays an important part in the production of distortionless signals for high-speed working. The output wave shape is not quite sinusoidal, but with due regard to the other necessary circuit conditions the amount of distortion is negligible. In order to facilitate identification, this part of the unit has been termed the limiting amplifying valve circuit.

The working range of this valve following a high ratio input transformer is approximately 0-10 db. At levels in excess of this, the grid of the valve is not sufficiently loaded and the output will not be constant. In order, therefore, to ensure reliable working over the range 0-30 db., it is necessary to add an amplifying valve which, of course, precedes the limiting valve.

The third and last stage comprises an anode bend detector circuit. In this case, the receiving relay is inserted in the anode circuit, but the arrangement and operation differs from the systems normally used in voice frequency telegraph working. A network scheme¹ suggested by the Authors has been adopted, whereby a Wheatstone Bridge combination brings about the operation of the relay, and produces what are, in effect, double current conditions. It is considered that this is a distinct improvement on differential or impulse methods for high-speed working. From Fig. 3, it will be seen that the last valve anode circuit completes a Wheatstone Bridge network. The resistances are arranged to balance at a point between the extremes of the D.C. anode resistance variation. For example, suppose the anode current is varying from 20 milliamperes on load (Space) to 1 milliamperes or less on suppression (Mark), then simultaneously the D.C. anode resistance of the valve varies from say 5,000 ohms to 100,000 ohms or more, for the respective currents. Thus, if the condition of balance lies between these values, then when the valve is normal the bridge is unbalanced; the resulting current through the relay being in one direction when the anode resistance is

¹ Since writing this article the authors have ascertained that a similar scheme was used by the Research Section in a unit for testing the efficiency of subscribers' instruments. It should be noted, however, that this is a balanced bridge arrangement, whereas the present scheme is an unbalanced bridge.

in the 5,000-ohm condition, and in the reverse direction for the 100,000-ohm condition. By choosing a suitable arrangement of bridge resistance values, these resulting currents can be made equal in each direction for both working conditions. Consequently, since the anode of the valve is either loaded or suppressed for a "Space" or a "Mark," it follows that a current is flowing through the relay coils in a positive or negative direction at any instant. This is, in effect, double current operation, and in no small measure contributes to the efficiency of the circuit as a whole.

It will be observed that one arm of the bridge has been made adjustable. This has been done to ensure that neutral signals are passed through the relay coils. In practice it has been found that once an adjustment has been made, further variations do not materially affect the working of the system. The adjustable resistance is mounted on the front of the panel together with the centre zero millimeter. The former is the only adjustment provided in the set, and the latter, which is joined in series with the tongue of the BN relay, serves to give an indication as to the signals which are passing from the voice frequency equipment into the receiving telegraph apparatus. When at rest, the millimeter will be deflected to the left thus indicating that a frequency is being received, and when no tone is incoming the deflection will be to the right. That is to say, the left corresponds to a space and the right to a mark. Figs. 7, 8 and 9 show different views of the unit, and the items mentioned above can be clearly seen on the front of the panel.

For the purpose of the reception and in order to retransmit the signals to any telegraph apparatus, a Post Office standard relay BN is used in conjunction with a baseboard No. 26. The relay should be removed from the set when it is required to adjust or clean the contacts, and the gap should be set at about 1 mil but not exceeding 2 mils. It should, of course, be adjusted to neutral. Closeness of the contacts is necessary if high-speed working is required. As already mentioned, the tongue of this relay is joined to the millimeter and then *via* the receiving telegraph apparatus—Wheatstone, Creed, Murray Multiple, etc., as the case may be,—the bias control resistance being adjusted until neutral signals are obtained in the local circuit.

Transmitting and Receiving Filters.

In order to establish duplex working and to separate the transmitting and receiving frequencies, high and low pass filters are used. The high-pass filter has been arranged to have minimum attenuation at 1,300 p.p.s., the cut-off frequency being 1,050 p.p.s., whilst the low-pass filter has minimum attenuation at 800 p.p.s., the cut-off frequency being 1,050 p.p.s. These filters are of the unbalanced type, and have been arranged to have an impedance of 600 Ω . A typical attenuation-frequency curve for the filters at one end of the circuit is given in Fig. 6.

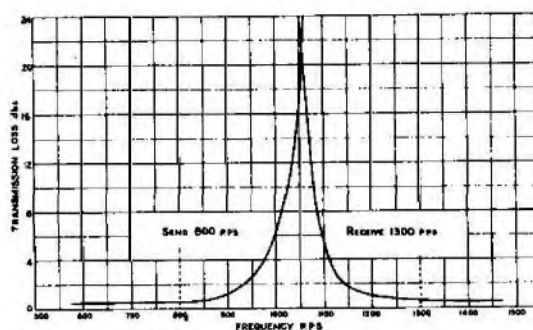

FIG. 6.—FILTER ATTENUATION-FREQUENCY CURVE.

The calculation and make up of the filter units followed conventional lines so it is not considered necessary to go into this matter in detail.

Power Supply.

D.C. Mains Case.

All the power necessary for filament, grid, anode, and local voltages is obtained from the D.C. mains. Figs. 2 and 3 show the arrangement. It will be seen that the oscillator and receiver have separate power feeds. This is a necessary precaution in



FIG. 7.—VIEW OF UNIT.

duplex working in order to prevent variations of load in the one circuit from affecting the other. In order to derive the necessary voltages, Zenite resistances type Z3 dissipating 90 watts were used. Further, in order to provide points at the required voltages for grid priming, coils resistance No. 9 were inserted at different points in the filament circuits. Considering the oscillator circuit first (Fig. 2), it will be seen that power is supplied to the two Zenite resistances which are joined in series, then *via* the resist-

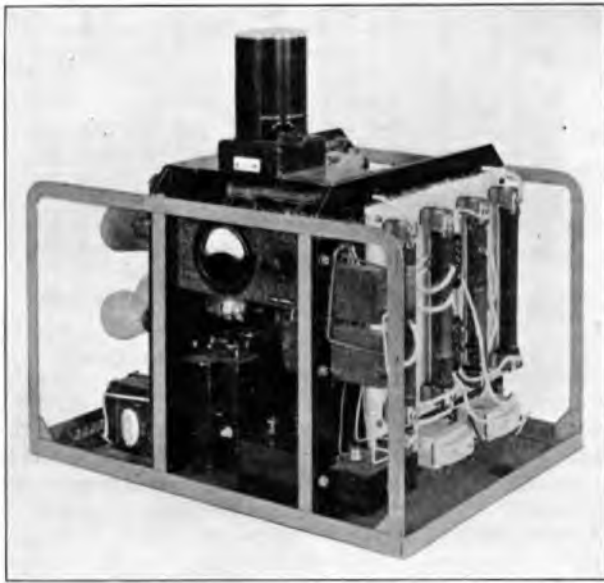

FIG. 8.—POWER PORTION OF UNIT.

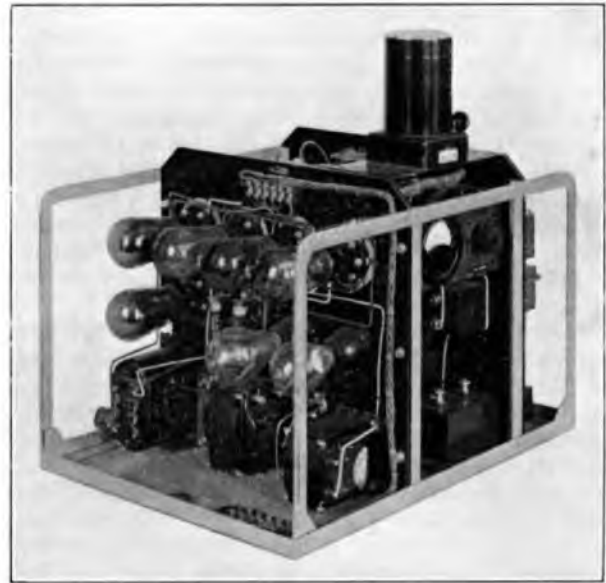

FIG. 9.—SENDING AND RECEIVING PORTION OF UNIT.

ance No. 9, 20Ω , second oscillator filament, 5Ω , first oscillator filament, 5Ω and then back to the common point which is, in most cases, the neutral wire of the supply. The first Zenite resistance is 310Ω , and has tapplings at 260Ω and 210Ω , these three points providing respectively for 240, 220 and 200 volts. The junction of the two Zenite resistances provides the tapping for the 110 volts, and, in addition, is the point from which the anode voltage is supplied. There is no tapping from the second Zenite resistance which is 200Ω . Anode voltage is supplied from the 110-volt tapping *via* a plate retard 23A to the anode circuits of the valves, an electrolytic condenser $30\ \mu\text{F}$ (tested to 200V) being joined from one end of the plate retard 23A to the common point. The grid circuits are so arranged that the priming on each oscillator valve is approximately 1.5 volts. Valves V.T.68 are of the 4-volt type, the current consumption being 0.415 amps, and, as will be seen, the filaments of the two oscillator valves are joined in series. The normal anode current in both cases is 10 mA.

In the case of the receiver (Fig. 3), the arrangement is almost the same with the exception that the second Zenite resistance is centre tapped. This centre tap in conjunction with the two ends of the resistance provides the battery supply for the locals of the telegraph relay. A study of the diagram will show that the tongue of the relay is joined *via* the milliammeter, shunted condenser, and receiving equipment to the centre point of the Zenite resistance, whilst the marking and spacing contacts are joined *via* lamps resistance $100\text{V } 16\ \text{CP}$ to the two ends of the same resistance. There is thus approximately an 80 volt drop between marking and spacing contacts and this is more or less equivalent to a 40 volt positive and negative telegraph battery. A spark

quench circuit is provided to eliminate sparking at the relay contacts. In connexion with the adjustment of the relay, due care should be taken to ensure that the locals do not short circuit. This momentary short circuit produces an excess voltage across the filaments and is therefore detrimental to the life and characteristics of the valves. The relay should not be adjusted therefore whilst the power is connected to the set.

A switch tumbler No. 9 is situated outside the unit and the power will enter the sets *via* the Cut-outs 120A . The fuse wire used in the cut-outs is of nickel silver 5.5 mils and rated at 1.2 amps. It should be noted that irrespective of the power supply, or its polarity, 100 volts approximately will be available between the common point and the anode of any valve. As before the filament current is 0.415 amps. and the filaments are joined in series. The power supply can be varied approximately 10% before the working of the set is affected.

A.C. Case.

This unit works entirely from the A.C. mains. The schematic diagrams of the receiver are given in Figs. 4 and 5 and except for the power arrangements these units are the same as for the D.C. case. Fig. 4 is a diagram of the oscillator and Fig. 5 shows the receiver. The mains transformer is provided with primary tapplings for 110V, 200V, 220V and 240V supplies, and there are six secondary windings which are made up as follows:—

- (a) Two 135 volts 50 mA windings, one each for the oscillator and receiver H.T. supplies respectively.
- (b) Three 4 volts 3 amps. centre tapped windings for the filament supply circuits, the

first being for the two oscillator valves (in parallel), the second for the last two valves of the receiver (in parallel), and the third winding for the receiver amplifying valve.

- (c) One 90 volts 50 mA centre tapped winding for the local telegraph supply.

Metal rectifiers type HT₄ are used to form a voltage doubler network for the rectified anode supplies for both the oscillator and the receiver. The rectified current is passed through a smoother circuit comprising a Ferranti B₁ choke and an 8 μ F condenser to the decoupling resistances, and thence to the anodes of the respective valves. The values of the decoupling resistances have been fixed so that the drop across each valve is approximately 110 volts, the condensers used in the decoupling circuits being each 2 μ F.

In the return lead of the oscillator smoothing circuit, a resistance with two taps has been inserted. These points are marked "X" and "Y" in Fig. 4. This is a means of providing grid bias for the second and third receiver valves. The first receiver valve and the oscillator valves are auto primed by placing a resistance in the filament return leads, but this method cannot be used for the second and third valves as the anode current in both these cases varies when signals are passing. As the oscillator load is constant, the resistance in the oscillator smoothing circuit provides a steady negative potential to earth and thus meets the requirements. This method slightly reduces the anode potential available for the oscillator valves, but as the voltage doubler method of rectification provides ample voltage at the output, it has only been necessary to reduce the values of the decoupling resistances in the oscillator valves, in order to maintain the anode voltage. The filaments are all fed with unrectified A.C., the anode return lead being taken to a centre tap in the respective windings. With regard to the current provision of the filament windings, the value shown in the diagram is slightly overrated, and a rating of half an ampere per valve should prove adequate in practice.

The local telegraph supply of ± 40 volts is obtained from a bridge rectifying network used in conjunction with the centre tapped 90 volts 50 mAs winding. Each arm of the bridge comprises one Westinghouse metal rectifier type GB₁. This unit is rated to give an output of 20 mAs at 45 volts and for small power supplies appears to be ideal. Smoothing is effected by connecting two 80 μ F electrolytic condensers between the extremities of the rectified supply and the centre point as shown in Fig. 5.

Construction of Units.

At the time of writing properly constructed A.C. mains units have not been completed, but Figs. 7, 8 and 9, which show the completed D.C. mains units, give a good idea of the arrangement for both schemes. Fig. 7 shows a general view of the unit, whilst Figs. 8 and 9 shows views with the cover

removed, the first looking towards the power unit and the second towards the sending and receiving unit.

All the apparatus with the exception of one or two items is mounted on two main panels, both sides of which are used. The left hand panel carries all the apparatus for the oscillator and receiver circuits. In the case of the right hand panel, one side carries the filter units, and the power unit is mounted on the other side. The relay BN is mounted on the top of the case, and both the differential milliammeter and biasing resistance are carried on a small panel which faces to the front, and is accessible for observation and adjustment. The Zenite resistances are mounted in a vertical position in order to dissipate heat in the most efficient manner. All the metal work in the unit is earthed and for this purpose a special earth terminal has been provided at the foot of the power panel. The two panels in the unit are interconnected by means of two strips connexion.

Experimental Trials.

The list of the tests given below were carried out not only on the completed D.C. mains units, but also on the experimental A.C. mains units where possible.

(1) Non-Reactive Attenuator.

Speeds of 0-250 words per minute duplex were obtained over a range 0 to 35 db. The adjustment required during these changes on the bias control resistance was very small. Power used (a) 110V D.C. positive and negative, (b) 220V A.C. 50 p.p.s.

(2) London-Manchester-London-Harrow.

One set was installed at London, and the other at Harrow. The particulars of the circuit are as follows:—

(a) London-Manchester-London.

This was a four-wire circuit, between London-Birmingham 25 lb. conductor (loaded 120/1.136), and between Birmingham and Manchester 40 lb. conductor (loaded 176/1.136). Repeaters were inserted at Fenny Stratford, Birmingham and Manchester, the circuit being complete with voice frequency ringing equipment, and four-wire/two-wire terminations. The overall transmission equivalent was 8 db., the length of the circuit being 375 miles approximately.

(b) London-Harrow.

This was a straight-through junction circuit, unloaded; mixed 40 lb. and 20 lb.; loop resistance 874 ohms; attenuation loss at 800 p.p.s., 16.5 db.; and length 13.185 miles.

The power at Harrow was 220 volts D.C. outer positive neutral negative, and at London as in (1) 110 volts D.C. outer positive, negative neutral, and also neutral positive outer negative. It will be seen

therefore that a four-wire circuit was obtained TS-MR-TS, one end of which was joined to the junction circuit to Harrow. The overall transmission equivalent of the circuit was approximately 25 db. Perfect Wheatstone duplex working was obtained on this circuit throughout a two weeks' trial. The power supply at London was changed from positive 110V D.C. to negative 110V D.C. without impairing the working efficiency of the circuit.

Trials on the A.C. units over the London-Manchester-London portion of the circuit were carried out with perfect results.

(3) *London-Derby-London.*

This trial was similar to the previous one and will not be described in detail. A four-wire circuit was used, complete with voice frequency ringers and terminations. The length is approximately 250 miles and the overall transmission equivalent was 6 db.

Trials at 200 w.p.m. duplex on the D.C. mains and A.C. mains sets were perfect.

(4) *London-Liverpool-London.*

For the purpose of this experiment, use was made of two existing London-Liverpool two-wire circuits. Both of these circuits had two-wire repeaters inserted at Fenny Stratford, Derby and Manchester, and the overall transmission equivalent of each was about 10 db. In addition, the circuits were fitted with 500 p.p.s. ringing equipment. This test was considered in the nature of a breakdown trial for the units, so that in the first place the two circuits were joined together at Liverpool, thus giving a two-wire

circuit of approximately 400 miles. Further, there were six two-wire repeaters in circuit. The operation of the circuit was perfect one way (800 p.p.s. receive) at 200 words per minute duplex, but the working of the unit which received the 1,300 p.p.s. was not so satisfactory. A test was taken on the line and it was found that the overall transmission equivalent was approximately 27 db. at 800 p.p.s., whilst at 1,300 p.p.s. it was 35 db. This, of course, accounted for the considerable reduction in efficiency of the 1,300 p.p.s. receiver. To sum up, however, even over this length of two-wire circuit and with conditions as stated above, the working of the 800 p.p.s. receiver was perfect at 200 w.p.m. duplex, and the 1,300 p.p.s. receiver was good at 100 w.p.m. duplex. The circuit was later looped back at Derby, thus giving a two-wire circuit of approximately 250 miles with three two-wire repeaters inserted, and working was perfect all round at 230 w.p.m. duplex.

Conclusion.

Voice frequency telegraphy is more or less still in its infancy in this country and it is not improbable that considerable changes, even in recent equipments, may occur in the near future. It is felt, however, that a statement of the problems, and a review of the conditions tends to a greater understanding and appreciation of the difficulties encountered in the change-over from the older to the newer method of telegraph working.

Finally, the Authors take this opportunity of thanking their colleagues in the Telegraph Group, Research Section, for the many useful discussions of the problems, and suggestions offered, during the progress of the experiments.

Rectified Reaction

L. H. HARRIS, M.Sc., M.I.E.E.

IN telegraph and telephone engineering the use of alternating current for signalling is gradually becoming more common as technical developments are made and their commercial value realised. The desirability of signalling with currents suited to the cable network, which in the main is designed for the transmission of alternating currents within the speech frequency range, is obvious. The provision of a number of channels by subdividing the speech frequency range is a further immense advantage and it is certain on these grounds that transmission of signals, whether for telegraph, telephone or other purposes, will ultimately be carried out to a very great extent by alternating currents. No considerable technical difficulties arise in the generation of the necessary frequencies, but at the receiving

end it is usually necessary to provide special arrangements to meet the direct current requirements of local apparatus. The conditions are not unlike those of electrical power supply in which case the ease and economy of generation and transmission far outweigh the disadvantage of providing special apparatus to deal with the D.C. demands.

The cable network is designed for speech power levels, and tone frequency signalling apparatus must in many cases work at the very low level of attenuated speech. Sensitivity and reliability are the first considerations for such apparatus and any apparent gain on first cost or local power consumption may be easily swamped by the less tangible cost of maintenance of unstable apparatus or of degraded service.

The A.C. valve relay described in this article originated in the Exchange Signalling Group of the Research Section and has proved, under both practical and laboratory conditions, to meet to a remarkable extent the above requirements of sensitivity, reliability and cheapness. It has therefore provided an advantageous basis for the solution of all the problems to which it has so far been applied.

The usual way of operating a D.C. relay by tone frequency signals is to apply amplified signals to the grid of a thermionic valve primed as an anode bend rectifier and having the relay in series with the anode. This is an inefficient method since, in the first place, only half periods are effective in producing the change in the anode current and, secondly, no use is made of the alternating component of the anode current which must be large in this case.

For efficiency, a change in the D.C. component of the anode current is best produced by applying a direct potential to the grid. Very little power is necessary to produce this direct potential and it is one purpose of rectified reaction to provide it from the usually wasted alternating energy of the anode circuit which may in this case, however, be extremely small.

In one of its more simple forms the arrangement is shown in Fig. 1(a). In this case the tone fre-

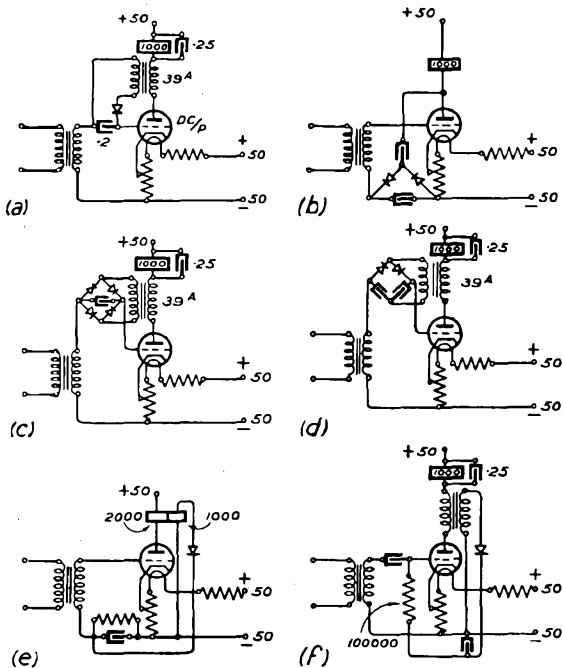

FIG. 1.—VALVE RELAY CIRCUITS USING RECTIFIED REACTION.

quency signal is applied to a step-up input transformer and applied *via* the grid condenser to the grid which is primed to give a very small or zero anode current. The magnitude of the input may be much too small to produce any appreciable change in the

anode current itself, but the amplified signal is fed back *via* the coupling transformer, is rectified and charges the grid condenser to render the grid positive. This process is limited by the flow of grid current from the condenser, the result being that the receipt of a signal of any magnitude produces the same effect; that is, a change in the anode current from zero to approximately the value corresponding to zero grid volts.

A typical characteristic of the device in this form is shown in Fig. 2, where also the curve for anode

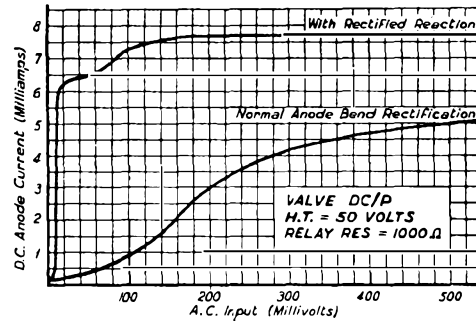

FIG. 2.—EFFECT OF RECTIFIED REACTION ON SENSITIVITY.

bend rectification is given. The two curves were taken under exactly the same conditions except that in the one case the grid condenser, rectifier and coupling transformer were omitted from the circuit. Comparison of the curves shows the extraordinary gain in sensitivity resulting from the arrangement for the important small values of input.

Fig. 1(b) shows a second arrangement with electrical coupling which is even more sensitive than the transformer coupled circuit. In this case half the alternating component of the anode current charges the grid condenser *via* one rectifier and the other half is passed direct to the cathode *via* the second rectifier.

In Fig. 1(a) half wave rectification of the energy from the anode is shown but, if required, full wave or voltage doubling circuits can be used as shown in Figs. 1(c) and (d).

Fig. 1(e) shows the circuit as it originated, a second winding on the anode relay being used for coupling. Connexion of the condenser in the position shown in this figure and in Fig. 1(b) prohibits the use of a common point on the input where it is desired to use a number of valve relays in parallel and some method of connexion such as shown in Figs. 1(a) or Fig. 1(f) must be used. In the latter case, the potential is applied to the grid through a leak resistance and a little efficiency is lost.

In the initial stages of development some doubt was felt as to the stability of the device, since circuits employing reaction are commonly lacking in this respect.

The feed back in this case is, however, primarily

D.C., the alternating component after rectification being comparatively small and appearing only as a ripple on the grid condenser voltage due to incomplete smoothing. Early tests showed that with exceptional values of the circuit components, oscillatory conditions can be obtained and that the chief determining factors are, the grid condenser value, the ratio of the coupling transformer and, in certain cases, the sense of the connexions of the latter. The value of the anode voltage used has little effect.

No difficulty has been experienced by numerous experimenters in avoiding the oscillatory conditions and in obtaining complete stability without critical selection of the component values.

If the rectifier is reversed and the valve is primed to zero grid volts so that the anode current is a maximum in the absence of a signal, then, on the application of a small value of input, a reduction in the anode current occurs. The latter does not drop completely to zero, due to the amplification falling off as the grid becomes negative, but otherwise, for small values of input, the effect is similar to that shown in Fig. 2 but inverted. In this case, however, the effects of rectified reaction and normal anode bend rectification are opposing instead of assisting and, as the input is increased, the latter begins to have some effect and the reduction in the anode current on the receipt of a signal decreases. Large values of input give still less reduction and so an interesting condition is simply obtained in which, for example, a relay will respond only if the input is limited in magnitude.

With all the above arrangements it will be seen that on the cessation of the signal the grid condenser discharges *via* the back resistance of the rectifier. By suitable choice of rectifiers and by the use of shunts on the condenser it has been found possible to vary the operating and release lags to meet particular requirements, whilst further independent variation of the lags has been obtained by using the relay contacts to change the conditions after operation. Even with an exchange battery as low as 46 volts, providing both bias and anode, and with appreciable build-up time of tuned circuits involved, the timing is such that the requirements of key sending are covered. With higher voltages, teleprinter speeds are easily obtained; for example, Fig. 3 shows a one-valve circuit which with 1 volt transmitted gives perfect operation of the 3A Teleprinter without adjustment of circuit or machines with any line from 0 to 35 db.

When operated by attenuated speech potentials from a microphone, the anode relay normally tends to chatter in unison with the spoken syllables and a second relay must be used to cover the gaps if continuous operation is required. A novel use of the device in this form was provided by the Research Section at the Varley Centenary Lec-

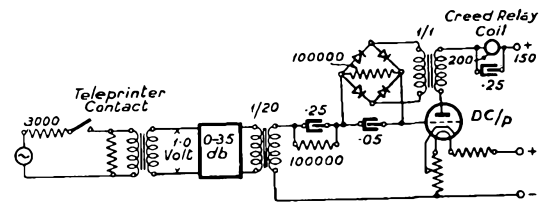

FIG. 3.—SINGLE-VALVE RECEIVER.

ture, 1932, given by Lt.-Col. A. G. Lee, O.B.E., M.C. This was a speech level indicator arranged to give a visual signal if the speech volume fell below that of an initial generally audible level to which the set was adjusted.

Another of the earlier experimental applications was to the provision of a single-valve set for the routine testing of tones in automatic exchanges, and extension to voice-operated supervisory signals, voice switching or to tone frequency telegraph supervision should be simple and economic. Ability to operate on the 50 volt exchange battery and independently of the strength of the tone makes it readily adaptable to these purposes.

The best known embodiment of "rectified reaction" is the four-frequency valve receiving set for key sending from A-positions over the junctions to automatic exchanges. It was in the search for a means of obtaining increased sensitivity as an aid to the economic solution of this problem that the device originated. It immediately provided a solution which had previously been difficult to obtain reliably without the use of expensive filters. As the receiving sets are required to operate over junction lines of any length, the main problem in this case is that of obtaining quick and reliable operation of the anode relays on a long line and at the same time avoiding interference between the frequencies on zero line. The circuit is shown in Fig. 4, while Figs. 5 and 6 show the arrangement in its final form as developed from the Research Section's bench lay-out by the Automatic Electric Company of Liverpool. The advantages of this form of valve relay are well demonstrated by this circuit and a description of its operation therefore follows. Referring to Fig. 4,

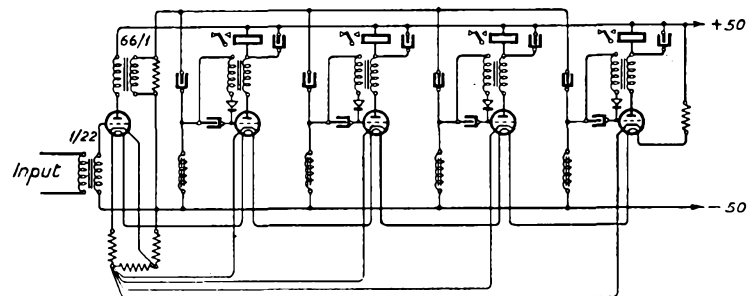

FIG. 4.—FOUR-FREQUENCY VALVE RECEIVING SET FOR KEYSENDING FROM A-POSITIONS.

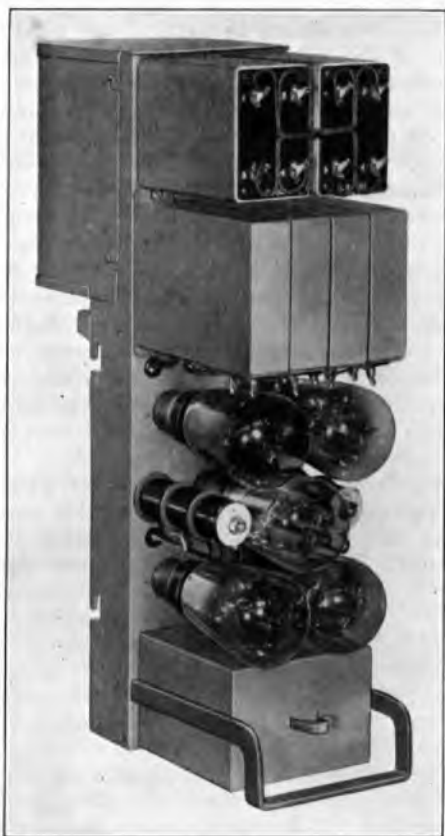

FIG. 5.—FOUR-FREQUENCY VALVE RECEIVING SET. (FRONT).

the incoming junction line is terminated on the primary of a high ratio step up transformer, the secondary of which is connected to the grid of an amplifying valve common to the four frequencies. The frequencies are the standard ones of 900, 750, 600 and 500 cycles per second, which are applied to the line at an approximately uniform level of one volt. The output of the common amplifying valve is passed to a high ratio (66 to 1) step down transformer, the secondary of which is shunted by a low resistance (of the order of 5 ohms) and connected to four low resistance tuned series resonance circuits connected in parallel.

The input voltage to the four tuned circuits is therefore very small—of the order of 0.25 volt—but is to a considerable extent independent of line length and also of the load of the tuned circuits. This is important as the latter is heavy at the resonant frequencies and the full step up effect of resonance would not otherwise be obtained. To the four tuning inductances are connected, *via* grid condensers, the four rectifying valves, having four telephone-type relays connected in series with their anodes and the 50-volt exchange battery. The valves are normally biased to give zero, *i.e.*, less than 0.1 mA, anode current which incidentally reduces the effective anode voltage by 6 volts. On the receipt

of a signal comprising some combination of the frequencies, the voltage on the relative resonant condensers and inductances builds up and, after amplification, the corresponding energy from the anode circuit is fed back and charges up the grid condenser with consequent operation of the anode relays and of the sender of the automatic equipment. On the cessation of the signal the relays release, as the resonant energy decays and the condenser discharges through the back resistance of the rectifier. As regards performance, operation on lines having attenuation of from zero to 20 db., with margin to cover variations in the exchange battery and in the speed of the four-frequency generator, can readily be obtained. No marginal adjustment of the relays or grid bias is required nor any other special adjustments. The level of the set can, however, be changed by altering the value of the shunt resistance on the output of the step down transformer; thus the range of operation can be changed to 20 to 40 db. or adjustment made for different voice frequency supply voltages. Tests of a set similar to that shown in Figs. 4, 5 and 6 have been carried out over a period of four months between Clerkenwell and National Exchanges and gave completely satisfactory results from both the engineering and traffic points of view.

Selective ringing schemes which have been

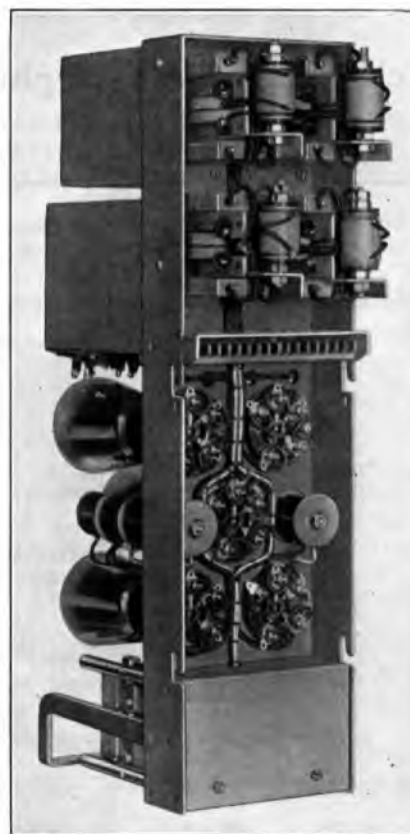

FIG. 6.—FOUR-FREQUENCY VALVE RECEIVING SET. (REAR).

designed by the Automatic Electric Coy. for more onerous service make use of a voice frequency receiving circuit which embodies a double rectified reaction arrangement as shown in Fig. 7. This receiver is required to respond to dialled interruptions in a 3,200-cycle tone which is otherwise continuously on the line. Undistorted impulsing of telephone-type relays on 50 volts H.T. and over a very wide

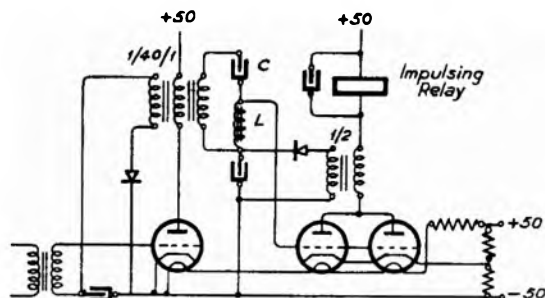

FIG. 7.—VOICE FREQUENCY RECEIVER FOR SELECTIVE RINGING SCHEME.

range of line attenuation is required. It will be noticed that two valves in parallel are used for the operation of the relay, whilst automatic control of the amplification of the first valve is provided by means of rectified reaction from a low impedance winding on the anode transformer, acting as a limiting device. With an input to line of 10 mW, the relay current is within the range of $12 \text{ mA} \pm 1 \text{ mA}$ for line attenuation of from 0 to 35 db., and small impulse distortion is present over this range. Furthermore, the double rectified reaction arrangement, by preventing grid current, ensures that the impedance of the relay-receiver is very high, hence securing minimum loss of speech currents. This is of some importance since on these particular schemes a relay-receiver is permanently connected across the line at each station for the purpose of controlling the stepping mechanisms.

It seems from the experience so far gained and the developments made that a wide field of usefulness exists for this device, the characteristics of which are so well suited to voice frequency signalling circuits.

Telegraph and Telephone Plant in the United Kingdom.

TELEPHONES AND WIRE MILEAGES. THE PROPERTY OF AND MAINTAINED BY THE POST OFFICE IN EACH ENGINEERING DISTRICT AS AT 30TH JUNE, 1932.

No. of Telephones owned and maintained by the Post Office.	Overhead Wire Mileages.				Engineering District.	Underground Wire Mileages.			
	Telegraph.	Trunk.	Exchange.	Spare.		Telegraph.	Trunk.	Exchange.	Spare.
775,659	692	8,955	42,668	2,861	London	43,218	177,363	3,387,335	141,919
92,539	1,976	17,554	41,025	3,296	S. Eastern	3,982	49,390	341,270	41,620
106,846	4,330	36,664	63,502	3,679	S. Western	23,823	28,264	267,114	60,189
72,548	4,699	39,399	61,012	8,246	Eastern	20,068	51,428	150,280	48,605
118,094	7,257	52,346	49,774	5,299	N. Mid.	32,971	123,543	320,990	77,302
93,522	3,965	32,472	61,205	2,598	S. Mid.	15,867	41,918	274,629	81,603
66,850	3,394	32,145	50,760	3,964	S. Wales	6,808	39,975	162,424	53,928
129,364	6,758	29,958	52,836	5,208	N. Wales	16,502	56,613	397,868	121,822
179,761	923	13,149	24,544	4,716	S. Lancs.	13,126	109,846	599,576	81,499
109,564	5,113	31,132	36,417	6,422	N. Eastern	20,959	69,315	312,734	50,939
73,796	3,329	24,722	25,128	3,878	N. Western	8,866	44,077	231,558	54,645
56,620	2,261	17,349	20,617	3,640	Northern	11,207	35,505	174,472	36,893
27,128	3,616	10,922	11,017	616	Ireland N.	224	4,092	61,027	6,462
79,549	4,660	32,832	37,777	1,765	Scotland E.	9,238	30,431	175,018	45,123
101,839	4,477	24,101	29,384	2,845	Scotland W.	8,560	38,685	253,596	38,186
2,083,679	57,450	403,700	607,666	59,033	Total	235,419	899,545	7,109,891	940,735
2,063,128	57,779	406,936	595,164	53,846	Figures as at 31 Mar., 1932	238,008	867,954	6,975,359	952,913

A New Telephone System in Holland

A. H. DE VOOGT

(of the Dutch Telegraph Service).

THE construction of pupin cable and repeater systems for telephonic traffic has reached a very high degree of perfection. Singing point and cross-talk values of 3.5 and 10 Nepers, respectively, are very often attained. The price of these cables and the high cost of installation, however, are such that one may ask if this system is really the only way of providing an efficient telephone system capable of handling national and international traffic.

The one-way amplification of a two-wire repeater in normal working conditions is not more than 1.5 to 1.8 Nepers, whereas the maximum gain of the valve, including input and output transformers, is as high as 2.8 to 3.0 Nepers. In order to obtain the full benefit of this valve amplification, it is obvious that it is necessary to apply the four-wire system to all circuits, and the purpose of this article is to show that the universal application of this system is not so uneconomical as it has hitherto been considered.

In Fig. 1, the result is given from a simple calculation of the gain, cable attenuation, stability, etc., of a two-wire and a comparable four-wire system. It is interesting to note that, assuming equal end-to-end conditions for the circuits, the allowable attenuation for the cable section is 2.8 Nepers for the four-wire system against 1.18 Nepers in the two-wire case, which means that the amount of copper required for the four-wire system is not twice that required for the two-wire system. For circuits with more repeater sections, the figures are still more in favour of the four-wire system, because, for a given stability, it is necessary to reduce the gain of successive two-wire repeaters.

It is well known that, in four-wire systems, it is necessary to separate the go and return circuits. For a large number of circuits, the best way of doing this is to provide two cables, one for the go circuits and the other for the return circuits. Having done this, it is clear that the cross-talk conditions for the four-wire systems are 1 Neper in advantage to the two-wire system of the same cable quality, this figure being found by taking twice the loss in the terminations. Hence, for equal cross-talk conditions, a cable of lower cross-talk—*i.e.*, a cable of lower quality and price—will satisfy the end-to-end conditions specified. Further, the balancing and installation of such a cable is simpler than the installation of high-quality pupin cables and can be carried out by the Administration itself.

Singing point conditions are of much less importance in four-wire systems, and for this reason, also, the cables are cheaper in price and installation. It is indeed possible to use a good subscriber-type cable and, for this reason, after careful examination of the economic aspects of the project, the Dutch Adminis-

tration decided to introduce the four-wire system universally for all the trunk circuits in Holland. The costs take into account the fact that the amount of repeater material required in the case of Fig. 1 is

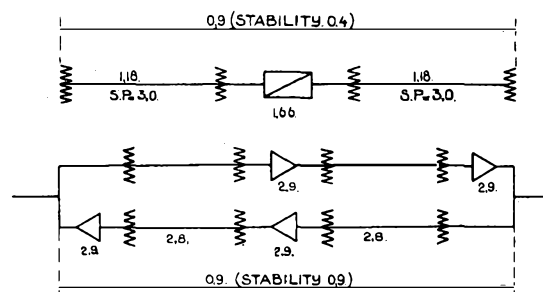

FIG. 1.—COMPARISON OF 2-WIRE AND 4-WIRE SYSTEMS.

twice as much for the four-wire system as for two-wire working; for more repeater sections, this difference decreases, as the extra is that due to the terminal repeater only. Furthermore, it is obvious that the construction of the one-way, one-valve repeater is very simple; no networks are required and the output transformer may be connected either as a simple output transformer (for through circuits) or as a balancing transformer (for terminated circuits). In this way, great uniformity and flexibility in the design of repeater stations is possible. For reasons given below, no anti-distortion devices are inserted in the repeaters; condensers are inserted in the midst of the line transformers for the correction of the low frequencies. It will be evident that all these modifications have resulted in the cost of one half-repeater being far below the price of a normal two-wire repeater. Finally, in comparing the repeater material for both systems of Fig. 1, one must bear in mind the fact that in the four-wire system cord circuit repeaters are not required when two circuits are switched together, whereas for the two-wire circuits, a certain amount of cord circuit repeater material will have to be installed.

As regards the pupin loading of the cable, it was considered that the loading in general ought *not* to be applied for attenuation reduction only, but also for improving what are now regarded as very important circuit transmission qualities, *viz.*, bandwidth, transients, non-linear distortion, etc. A system of 65 mH coils spaced at distances of 3.68 km. was therefore introduced. As the normal spacing of loading coils previously adopted in Holland is 1.634 km., the total number of loading coils required is nearly the same for both the two-wire and the four-wire systems.

This system of loading is installed in the now completed Amsterdam-Utrecht double cables, each cable consisting of 105 star quads having 0.8 mm. (approx. 16 lb. per mile) conductors and one screened music pair. The distance is 48 km., and Fig. 2 gives

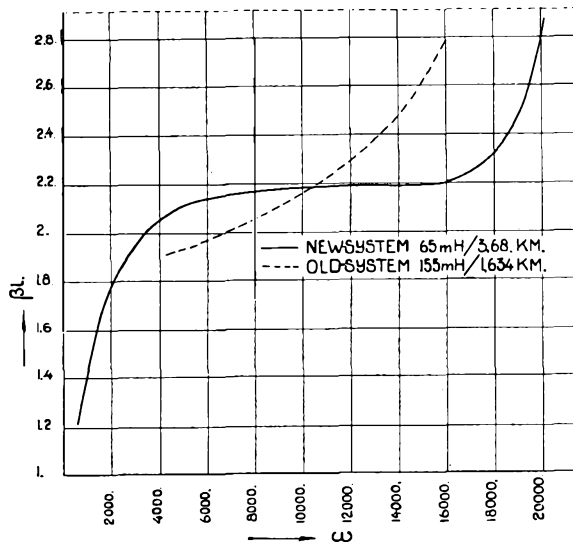

FIG. 2.—ATTENUATION CURVE.

the measured attenuation curve. This curve compares in a very favourable way with the dotted-line curve, representing the attenuation curve of a normal two-wire circuit (1.24 mm. conductors, loaded with 155 mH coils spaced at 1.634 km.). It is now clear that no anti-distortion devices are necessary while the curve is practically flat above 6,000 radians. Below this figure, a series condenser gives the necessary correction.

The band-width available for transmission goes up as high as 18,000 radians, which is 84 per cent. of the natural frequency of the cable. For two-wire systems, this value is not more than 75 per cent.

In Fig. 3 are given the velocity conditions of the new circuits and also of the old system.

It is very clear that the new system provides circuits of a very high quality and, though the experiments on this new cable system are not yet finished, it may be stated that very good transmission could be given over 2,500 km. of this circuit.

The critical value for long distance transmission, the difference of the quotient $\frac{d_a}{d_w}$ for 1,000 km. and a band-width of 2,000-15,000 radians, is 22 milliseconds for the old system of heavy loading and 9.5 milliseconds for the new loading system. For long distance purposes, the new system equals the special light-loaded circuits in the old pupin cables.

The Amsterdam-Utrecht circuits will be brought to an overall equivalent of 0.35 Neper and this will be the standard value in the future for all the lines

between the telephonic centres of the country. There will be 22 telephonic (automatic) centres in Holland and these centres will be connected by four-wire cable systems providing from 150 to 288 circuits.

In 1931, the following cables were completed: Utrecht-'s-Hertogenbosch (56 km.), 's-Hertogenbosch-Eindhoven (36 km., 0.7 mm. conductors), Rotterdam-Utrecht (58 km.), Eindhoven-Venlo (65 km.) and Utrecht-Zwolle (96 km., 1.0 mm. conductors).

The new system will greatly facilitate the construction and extension of the telephone system in Holland; indeed, it will not be necessary in the future to divide a cable into certain groups of thick and thin circuits, which is a very troublesome and unpractical method, and avoids the necessity of determining the best number of circuits of each kind. There will be only one type of circuit using, for 60 km. or less 0.8 mm. conductors, and for greater distances, 0.9 or 1.0 mm. conductors.

Finally, there are two points which ought to be mentioned. The quality of the cable used is slightly better than the normal subscriber-type cable used in Holland; the difference in price is reduced to 10 to 15 per cent. whereas the former pupin cables were as much as 50 per cent. higher in price than subscriber-type cables. As it is necessary to have a good quality subscriber-type cable in the automatic telephone centres, the modern subscriber-type cables have improved considerably in quality in recent years. Because, as stated above, the cables for the new system have been lowered in quality from the high standard of the pupin cables, there seems to be a tendency towards arriving in the future at one *universal* type of telephone cable, which certainly will have advantages.

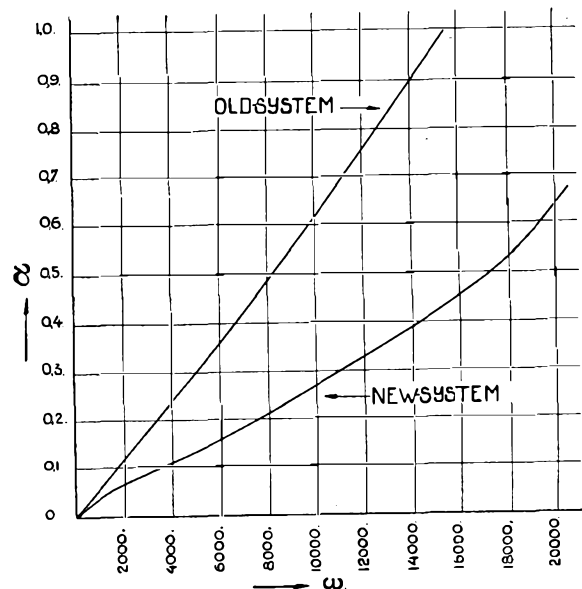

FIG. 3.—VELOCITY CONDITIONS.

Secondly, the loading with 65 mH coils at distances of 3 to 4 km. opens up the possibility of the application of cheaper coils. In fact, compared with the kilometric resistance of the rather thin line wires, an increase in resistance of the coils is not very serious. Furthermore, the hysteresis conditions necessary for long distance service are easily obtained by these

coils, there being only half the number of coils per repeater section.

In concluding, the author would like to mention that the system described may be applied in countries other than Holland, and surely there, as well as in our country, it will prove to be an economical and practical system.

The Effect of Side Tone on the Efficiency of Telephone Systems, and the Principles Governing Side Tone Control

E. R. WIGAN, B.Sc. (Eng.).
(of Messrs. Siemens, Bros. and Co., Ltd.)

Introduction.

THE principles involved in the design of telephone instrument circuits have been stated very fully from time to time. The theoretically ideal proportions of sidetone and anti-sidetone circuits are well known. In spite of this another discussion of this subject is not out of place.

The theoretical treatment so often adopted does not keep close enough to the facts. For example, it is obvious that the electrical output from a transmission circuit is dependent ultimately on the acoustic input. This is under the control of the speaker and is related in an obscure manner to the conditions under which the voice is produced. Because of this the calculated equality in efficiency between sidetone and anti-sidetone circuits is upset by a psychological factor which the presence of side tone induces.

Again, the efficiency with which a message is received through a telephone system ultimately depends on the listener. He is strongly influenced by the presence of room noise if it is permitted to enter the ear which is attending to the message. In sidetone circuits this masking effect may be very large, and consequently the operating efficiency of these circuits may bear no relation to the calculated value.

In the action now being taken by Telephone Administrations throughout the World there is evidence that the effects of side tone are being appreciated. The exact measurement of these effects is being undertaken by various investigators and is a matter of some difficulty. The opinion seems to be growing that side tone is not only unnecessary but definitely damaging. In this article this opinion is supported and an analysis is made of the cause and cure of side tone.

Two Definitions.

Side tone in telephone instrument circuits is produced by the microphone energizing the local

receiver. It consists of a distorted version of either the speech sounds or the room-noise which is entering the microphone. The distortion is in most cases quite considerable, and adds to the annoyance which the existence of side tone generally induces. Side tone may be reduced to a conveniently low level by the proper use of "anti-sidetone" circuits.

Between "anti-sidetone" circuits and the normal circuits, which will be described as "sidetone," there is no clear distinction, but in general they may be differentiated as follows: in "anti-sidetone" circuits under practical conditions the side tone is almost always audible, but is controlled so as to vary in a desired manner; while in "sidetone" circuits the level and variation of side tone is not considered when the circuit is designed. The two types of circuit may be recognized by the number of electrical elements involved: the anti-sidetone circuit requires at least one more element than the sidetone circuit.

Side Tone as a Factor Controlling Operating Efficiency.

The standard efficiency tests for substitution instrument circuits have not involved, until comparatively recently, any allowance for the loudness of the side tone. In the past, transmission tests were made without the local receiver being applied to the speaker's ear, and reception efficiency was measured in surroundings which were as quiet as could be obtained. While these methods are ideal for the measurement of the electro-acoustic factor of microphones and telephone receivers, they do not represent the conditions under which the instruments with which they are associated are normally used.

The discrepancy is due to two factors, one psychological and one more nearly physical. Firstly, the speaker who hears his own voice in a distorted and amplified form as side tone is bound to react to the mental impression it produces; and, secondly, the listener who is endeavouring to receive a message in a noisy situation is further embarrassed by the

presence of the noise introduced by side tone. The first effect is difficult to measure with accuracy and depends on the normal tone of voice and the frame of mind of the individual concerned. It is, in fact, dependent entirely on choice, whereas the second effect is due to a physiological phenomenon the operation of which is outside the control of the listener, and which may be measured with some accuracy.

The Influence of Side Tone on the Speaker.

It is common knowledge that the energy with which one speaks in conversation depends on the apparent loudness of the speech produced. Covering the ears entirely induces a greater output of speech energy in a subconscious attempt to reproduce the normal loudness in the ear. Experiments show that the reverse effect is produced if the ear is provided with more than the normal proportion of the speech energy, the voice dropping by degrees under the influence of the illusion and very considerably when the loudness of sound in the ear becomes painful.

It is clear that a conversation carried on over the telephone must be influenced by this effect. The side tone, although entering but one ear is, in certain cases, so loud that the voice level is unconsciously dropped by as much as 8 db. There are wide variations in the magnitude of this reaction, but the curves shown in Fig. 1 cover the range normally encountered.

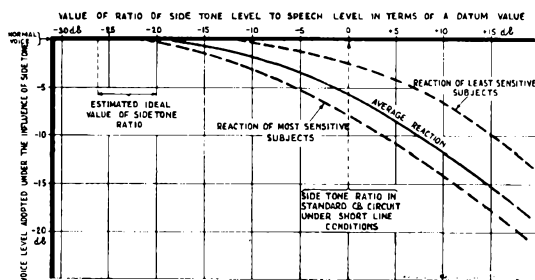

FIG. 1.—ILLUSTRATING THE REDUCTION OF SPEECH LEVEL WHICH IS INDUCED BY STRONG SIDE TONE.

The horizontal scale in this figure refers to the ratio between the loudness of the side tone and the loudness of the speech input to the microphone. This quantity depends on the circuit arrangement and the efficiencies of the receiver and microphone concerned. The datum point has been chosen to represent the conditions in the standard Post Office No. 1 C.B. circuit employing a Solid Back transmitter and a Bell Receiver of average efficiency, the feeding current to the microphone being assumed as 150 mA on the 22V. System, the exchange circuit being followed by a long, 20 lb., junction cable.

The side tone level in this circuit is very high indeed. When the new high-efficiency micro-telephone was first introduced attention was drawn

to this fact, the resulting 5 db. rise in transmitter efficiency causing such painful side tone effects that some measure of side tone reduction was demanded. The figures to the left of the datum show the values of the side tone ratio after a large reduction is made either by degrading the transmitter or by altering the circuit. In the present form of the microtelephone instrument adopted by the Department, the side tone control little more than neutralizes the increases in the microphone efficiency, leaving the side tone ratio in the neighbourhood of the datum value.

The part of the curve to the right of the datum was derived in order to complete the evidence. It will be seen that, so far as operating efficiency is concerned, an increase in microphone efficiency is cancelled by the fall in voice level after a certain point is reached. On the other hand, reduction of the side tone ratio cannot usefully be carried beyond -20 db. or so. Very low levels of side tone ratio (less than -25 db.) affect the telephone user adversely: there is a feeling that the transmission efficiency of the circuit is inadequate. At the ideal level, the side tone in the speaker's ear should have the same loudness as his own voice as he hears it by the air path in normal conversation. For economic reasons the ideal level of side tone is not aimed at in the design of anti-sidetone circuits: a value of -15 to -20 db. is chosen as a compromise.

The Influence of Side Tone on the Reception Efficiency of Telephone Instruments.

It is well known that room-noise affects the receiving efficiency of a telephone instrument. The incoming speech is masked by the noise which is introduced into the receiver by the side tone. On muffling the transmitter the interference is eliminated, and the message is received with comparative ease in spite of the noise which enters the listener's free ear.

An efficient anti-sidetone circuit has the same effect. In Fig. 2 the characteristics of a side tone and a "zero-sidetone" circuit are compared, the latter representing a perfect anti-sidetone circuit.

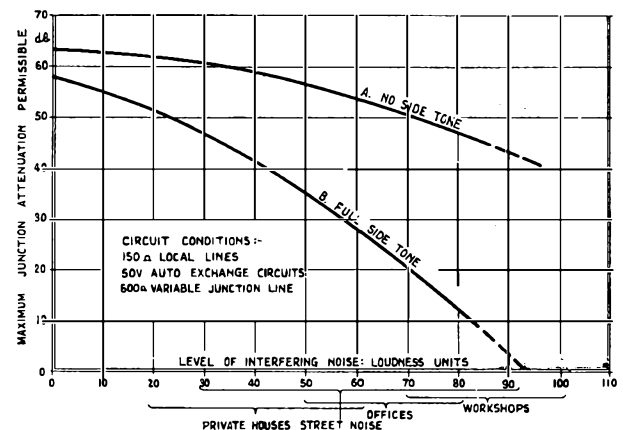

FIG. 2.—SHOWING THE PRACTICAL VALUE OF ELIMINATING SIDE TONE COMPLETELY IN A TYPICAL ANTI-SIDETONE CIRCUIT,

The zero-sidetone curve, A, was obtained with a pair of sidetone circuits in which the microphone at the receiving station was replaced by a 50Ω resistance : it serves as a datum against which the other may be compared. For the "sidetone" curve, B, the circuits were of the standard No. 1 C.B. type fitted with Solid Back transmitters and Bell Receivers of average efficiency. The ordinates of the graph are the limiting values of junction attenuation through which conversation could be conducted in the presence of artificially controlled room-noise at the receiving station. The loudness of the noise in the room is given by the abscissæ.¹ The curvature of the graph A indicates that the noise received by the free ear of the listener is beginning to take effect. (The very high values of junction attenuation are due to the tests being made at the limit of intelligibility and are not to be taken as feasible for "commercial" speech.)

The vertical intercept between the two curves gives a measure of the degradation of the reception efficiency of the system which the presence of the full side tone level involves.

In practice, it is not possible to attain to the performance shown in curve A, since practical anti-sidetone circuits inevitably produce some residual sidetone. However, a large part of the loss of 30 db. or so may be recovered by a carefully designed circuit.

It will be noticed that the losses introduced by side tone both at the transmitting station and at the receiving station are of a different order altogether from those considered important in the testing of microphones and receivers. We are dealing in 10's of db's. instead of units. It appears, therefore, that a well designed anti-sidetone circuit will add very largely to the efficiency and also to the amenities of a telephone system.

Factors Influencing Side Tone Level.

The level of side tone in any two-way transmission circuit employing only two line wires depends on the following quantities :—

1. The microphone output, which is proportional to the speech or noise level, the electro-acoustic factor, and the direct current p.d. across the microphone.
2. The acoustic-electric efficiency of the receiver.
3. The composition of the instrument circuit.
4. The impedance connected to the line terminals.

Factors 1 and 2 have the same influence in all types of circuit. The difference between the side tone characteristics of anti-sidetone and sidetone circuits lies in the factors 3 and 4.

¹ The loudness scale shows the "masking" value of the artificially-controlled noise, measured by Davis' method. The zero on this scale does not, however, indicate complete silence, although it is probably within 5 or 10 db. of the true zero.

In anti-sidetone circuits, the side tone level is more closely related to the line impedance than in sidetone circuits.

The difference is best illustrated by considering the transmission circuit as a form of "bridge" network. The microphone takes the place of the generator, the receiver represents the indicator, and the instrument circuit itself provides the bridge-network which is to be "balanced" by the fourth arm of the bridge. This arm is represented by the impedance of the line to which the circuit is connected.

In anti-sidetone circuits, balance is obtained (*i.e.*, side tone is extinguished) by line impedances of the same order as those of the lines to which the instrument may be connected. In use, therefore, the circuit is never very far from balance. In sidetone circuits, the line impedances which provide zero side tone are either infinite resistances (normal L.B. circuits) or large negative reactances (No. 1 C.B. circuit) or zero ("parallel" type circuits). In this list, the circuits stand in order of merit. The last is particularly unsuited for general use, the side tone level varying very considerably with the line impedance.

The side tone level is always high in sidetone circuits since the design theory requires that the power dissipated in the receiver shall be equal to the power transmitted to the line. This holds for only one value of line impedance. Depending on the circuit, the actual value of the side tone in practice may exceed that required by this theory.

The Control of Side Tone.

Since the side tone level in anti-sidetone circuits depends so closely on line impedance, it is clear that under normal conditions of use the level will vary considerably. The loudness and the frequency-spectrum of the side tone will have a different value for each type of call made. In designing an instrument-circuit for general use on a telephone system, it must be the aim of the designer to maintain the level of side tone within specified limits in spite of the wide variation of line impedances met with in practice.

In attacking this problem, the following equation² may be used to determine the relationship between the degree of "unbalance" and the resulting side tone current.

$$\frac{i_r}{e_A} = - \frac{P/a \ K/c \ \Delta_L}{(Z_C + Z_L)(Z_C + Z_L + \Delta_L)} \dots\dots\dots(1)$$

where i_r is the side tone current produced by the impedance unbalance Δ_L :

e_A is the microphone e.m.f.,

P/a is the ratio of the O.C. volts at the line terminals to the microphone e.m.f.,

K/c is the ratio of the receiver current during reception to the incoming line-current,

² The derivation of this equation is explained in Appendix I.

were measured on local connexions in a private automatic exchange; group *b* were measured on a connexion involving short exchange lines and two auto-exchanges separated by short lengths of 20 lb. unloaded cable; group *c* were measured on circuits of some length involving loaded as well as unloaded junctions. A telephone instrument on a P.B.X. or P.A.B.X. will meet all these conditions from time to time, and although one type of connexion may be more common than another, it is reasonable to expect adequate side tone control in every case.

It should be noted that comparatively short lengths of local line were used in the circuits analysed. The addition of relatively non-reactive local line (such as overhead wire) has the effect of shifting the impedance locus to the right. The addition of reactive line (such as 10 lb. cable) tends to convert loci of group *a* to group *b* or *c*. In all these cases, however, the attenuation of the feeding-current reduces microphone efficiency and consequently the side tone levels are lowered. Hence an anti-sidetone circuit which will control side tone when the local line is short will in general be adequate when the line is longer.

The best Distribution of Energy in the Side Tone Spectrum.

It is evident that no single anti-sidetone circuit can be designed to reduce the side tone to a very low level under each of the line conditions to which Fig. 4(A) refers. By the exercise of careful compromise, however, the average side tone level can be kept low. To achieve this, attention must be directed to the composition of the side tone "spectrum." It is essential that side tone due to noise shall cause as little interference as possible, whereas side tone due to speech must not be completely eliminated. These requirements are satisfied as follows. The circuit is arranged so that the side tone consists of relatively small quantities of the low and middle speech-frequency currents, but has a large proportion of high-frequency in the neighbourhood of 2000 Hertz. The greater part of the loudness of side tone due to speech is wiped out by suppressing the side tone currents of frequency 200 to 1000. The unsuppressed high frequency sounds carry little energy and serve the purpose of reassuring the speaker without overloading his ear. When such a circuit is influenced by room-noise, in which the distribution of energy in the spectrum is in general very wide, the high frequency components again form the largest proportion of the side tone current. Interfering sounds at this frequency (near 2000 Hertz) are known to have less disturbance value than sounds of, say, 1000 Hertz. For equal disturbance the currents at 2000 Hertz may be 12 db. higher than the currents at 1000 Hertz in the case of an average telephone receiver. Consequently, side tone containing a large proportion of high frequency has the minimum loudness combined with the minimum interference value. A circuit adjusted to give this proportion will have a high operating

efficiency. The "Q" locus, W, is taken from a circuit which has this property.

Behaviour of Anti-Sidetone Circuits under Practical Conditions.

A circuit designed on the principles which have been outlined fulfills the foregoing requirements very well. Fig. 4 illustrates this point.

The small circles in Figs. 4(B), 4(C), 4(D) represent impedances taken from the typical line impedance loci of Fig. 4(A). The three diagrams show the relationship between the side tone diagrams and the line impedances at three single frequencies. For the particular circuit under consideration, it is estimated that at 500 and 1000 Hertz the side tone current should not exceed 0.4 mA./V, while at 2000 Hertz 1.6 mA. may be permitted for the reasons just discussed. The fact that the majority of the impedance points lie within the limiting side tone circles, indicates that side tone level has in these cases been reduced to a level approximately 15 db. below that existing in the No. 1 C.B. circuit under similar conditions.

The behaviour of circuits having such characteristics is most satisfactory from the user's point of view. The side tone level during transmission approaches the ideal value shown in Fig. 1, while, during reception, the reduction in the interference value of room-noise is very remarkable. Fig. 5

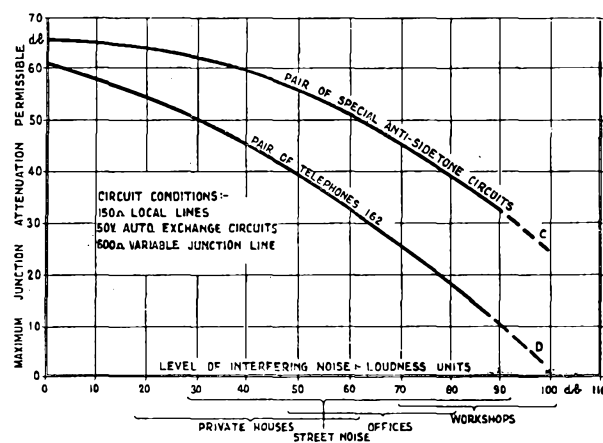

FIG. 5.—A COMPARISON OF THE PRACTICAL VALUES OF TWO TELEPHONES OF EQUAL ELECTRICAL EFFICIENCY, BUT DESIGNED WITH DIFFERENT DEGREES OF SIDE TONE CONTROL.

illustrates this point. The two curves refer to two pairs of circuits employing similar microphones and receivers and working through similar junction circuits. The difference in the performance of the two pairs of circuits is therefore entirely due to the degree of side tone suppression. The behaviour of the more efficient pair is illustrated by curve C; these are the anti-sidetone circuits under discussion. Curve D refers to a pair of Telephones No. 162, an instrument in which no attempt has been made

to carry side tone control to the limits advocated here. The diagram shows that the residual side tone in the Telephone No. 162 is responsible for considerable loss of efficiency.

It will be noticed that the two circuits are not quite equal in efficiency even in a quiet place. The greater efficiency of the pair of anti-sidetone circuits is due to the greater speech input permitted by side tone control. As the noise level increases, the degree of interference at the receiving end of the circuit becomes the controlling factor, and the anti-sidetone circuit shows a steadily increasing advantage over the other.

It is interesting to note that the two types of circuit to which Fig. 5 refers show very little difference in efficiency when tested in the standard manner. The Transmission Reference Equivalent of the anti-sidetone circuit is slightly higher than that of the Telephone No. 162 and the Receiving Equivalent slightly lower. The differences are difficult to assess accurately as there is a difference in tone, the anti-sidetone circuit transmitting a larger proportion of both high- and low-frequency currents. The overall difference is not greater than 1 db. As Fig. 5 shows, the operating efficiencies of the two circuits differ by far more than this.

Telephone Instruments for use in excessively noisy situations.

When the level of room-noise exceeds 100-110 loudness units at the receiving station, special arrangements must be made. For instance, the efficiency of the microphone can be reduced with advantage to the listener. The loudness of the incoming speech is unaffected, whereas the loudness of the side tone is reduced by the fall in microphone output.

It is a common practice to effect the required reduction of transmitter efficiency by plugging the transmitter mouthpiece so as to degrade it acoustically. While such a plug may be desirable in reducing horn-resonance and consequently susceptibility to acoustic shock, serious damage may be done to the quality of the speech transmitted. A far better way is to reduce the current to the microphone. This may be done either by a shunt, or, better, by a series resistance. The preference for the latter is that it increases Z_c in equation (1) with resulting advantages. The introduction of a series resistance in the microphone leads will not seriously affect the output/frequency characteristic so long as the impedance of the circuit at this point is not highly reactive.

A second receiver will sometimes improve the receiving conditions, but the effect is usually small compared with the gains obtained by other methods. This appears to be due to the effect illustrated in Fig. 2 by curve A. The mind is so constituted that messages received by one ear are not greatly disturbed by noise entering the other, unless the loudness is very great.

If side tone is still excessive when every precaution has been taken to ensure that the best electrical conditions have been obtained at the station suffering from room-noise, the acoustic problems at this station must be considered. The ratio of noise to speech picked up by the microphone will depend on the distance between the mouthpiece and the speaker's lips. It also depends upon the design of the mouthpiece. A mouthpiece which gives the maximum discrimination between room-noise and speech must, in effect, transfer the microphone diaphragm to the horn aperture. Under these conditions the speech energy is attenuated as little as possible before reaching the diaphragm. The design of the horn appears to have little effect in reducing the amount of room-noise picked up. Any horn-resonance must, of course, be avoided as it will be excited by acoustic shock.

A two-way conversation may be limited either by one party being overwhelmed by the surrounding noise, or by the other party being unable to distinguish between the speech and noise transmitted. When the special precautions just mentioned have been taken, the limit is probably set by the first effect, but if no special precautions are taken to raise the transmitted speech-noise ratio, the limit will be set by the second effect when the noise level exceeds 100-110 loudness units.

Conclusion.

In an article of this length it is not possible to cover the ground completely and all that can be done is to put forward the evidence and discuss the cure of the ill effects produced by side tone.

As regards the evidence: too much stress must not be laid on the numerical accuracy of the curves which have been referred to. They must be taken as evidence of the existence of psychological reactions in the mind of the individual. Their existence is already generally recognized although their magnitude is still under discussion. Only experience will demonstrate the full importance of the difference between sidetone and anti-sidetone instrument circuits.

As regards the cure: only the most difficult case has been considered, in which the line has a wide variety of impedances. This is the practical problem which the telephone engineer must face, once the importance of side tone control has been appreciated. The heavy emphasis which is laid on the importance of controlling side tone, even though it may be at the expense of transmission and reception efficiency, is justified by the relative magnitude of the effects involved; side tone does damage to the extent of 10's of db's while electrical efficiency is with difficulty raised by units.

There may be some doubt as to the economic application of side tone control where room-noise is negligible, but there is little doubt that by its application the field of usefulness of the telephone instrument may be widened so as to include the noisiest

situations. So designed, the instrument becomes a tool the efficiency of which is largely independent of its mode of use.

APPENDIX I.

Derivation of the fundamental side tone equation.

In order to arrive at the equation relating side tone current to line impedance, it is necessary, first, to prove that, in every transmission circuit employing two line-wires, side tone can be eliminated by adjusting the impedance of the line to which the circuit is connected.

It is then justifiable to consider the relationship between this impedance and the side tone current.

Consider a substation circuit, the essential characteristics of which are, (1), that two line-wires are employed; (2), that the system is capable of transmitting power to, and receiving power from, the line; (3), that the circuit is "invariable," *i.e.*, it is used without modification for both transmission and reception. (It will be noticed that all sidetone and anti-sidetone circuits fall into this category).

Suppose that the microphone generates an e.m.f. e_A . Then, if a finite impedance, Z , is connected to the line terminals of the circuit, a current i_L will flow through it. At the same time, either a side tone current i_r will flow in the receiver circuit, or there will be no current; there is no alternative.

Taking the first case, suppose the impedance Z be altered to Z' , so that i_L becomes i'_L . Then, if Z' is finite, the change of impedance is analytically identical with the injection of an e.m.f. e' in series with the unaltered impedance Z , e' being equal to $i'_L(Z - Z')$. And, since the circuit is designed to be sensitive to an e.m.f. injected into the line, e' produces a current in the receiver. It is clear that, by a proper choice of Z' , the current due to e' may be made to neutralize the current due to the microphone e.m.f. Side tone may thus be eliminated by the choice of Z' . (In the special case in which Z' is made infinite, e' has the value $-i_L Z_C$; Z_C being the impedance of the transmission circuit as measured from the line terminals, and e' being applied directly to the line terminals).

Taking the second case, in which i_r is initially zero, the same argument applies, any change in the initial value of Z inevitably producing some side tone current. Moreover, analysis of the first case shows that there must be a balance point, while the second case on analysis shows that there can be only one balance point. This follows from the assumption that all the circuit elements employed, with the exception of the microphone, are "linear."

The side tone equation will now be derived.

Let Z_L be that impedance which, when connected to the line terminals of the circuit under consideration, reduces side tone to zero. The current in Z_L will be i_L ,

$$\text{where } i_L = e_A \cdot \frac{P/a}{(Z_C + Z_L)} \dots\dots\dots(a)$$

Here P/a is a circuit parameter and is equal to the ratio between the open-circuit p.d. at the line terminals and the microphone e.m.f. e_A . The receiver current i_r is initially zero by hypothesis.

Now let Z_L be altered by an amount Δ_L . The line current alters to:—

$$i'_L = e_A \cdot \frac{P/a}{(Z_C + Z_L + \Delta_L)} \dots\dots\dots(b)$$

Identically the same electrical effects would have been obtained by the appearance of an e.m.f. e' in place of the additional impedance Δ_L ; the e.m.f. would be

$$e' = -i'_L \Delta_L$$

which, from equation (b),

$$= -e_A \cdot \frac{P/a \cdot \Delta_L}{(Z_C + Z_L + \Delta_L)} \dots\dots\dots(c)$$

It is to this e.m.f. that side tone is due.

The line current produced by e' is equal to

$$\frac{e'}{(Z_C + Z_L)}$$

The resulting current in the receiver is a certain fraction of this, K/c , a parameter decided by the design of the circuit.

$$\text{So } i_r = e' \cdot \frac{K/c}{(Z_C + Z_L)} \dots\dots\dots(d)$$

Hence, finally,

$$\frac{i_r}{e_A} = -\frac{P/a \cdot K/c \cdot \Delta_L}{(Z_C + Z_L)(Z_C + Z_L + \Delta_L)} \dots\dots\dots(e)$$

where i_r is the side tone current due to an impedance unbalance Δ_L . (The negative sign indicates a phase reversal.)

APPENDIX II.

Measurement of Circuit Parameters.

The parameters of an anti-sidetone circuit may be experimentally determined very rapidly as follows:

The side tone current is measured at the required frequency with the line terminals of the instrument open-circuited. This is equivalent to making Δ_L in equation (1) equal to infinity. The ratio i_r/e_A is therefore numerically equal to $\frac{P/a K/c}{(Z_C + Z_L)}$. The side

tone locus diagram can then be drawn when Z_C and Z_L have been measured. The latter measurement may have to be performed as follows or it may be obtained by the use of known standards to represent the line impedance.

APPENDIX III.

Measurement of Z_L in special cases.

Cases arise in which a circuit has values of Z_L

which cannot be realised by physical standards; for instance, Z_L may contain negative resistance. For these cases and for others when standard apparatus is not available, an A.C. potentiometer may be used.

The potentiometer is connected in series or parallel with the source connected to the microphone terminals of the circuit under test. Current from the same source is injected in series with a resistance across the line terminals of the instrument circuit. This current is adjusted in phase and magnitude until side tone vanishes. The A.C. potentiometer is then

used to measure the p.d. across the line terminals (E_1) and the p.d. across the resistance connected to them (E_2). Then, if R is the value of the resistance, $\frac{R \cdot E_1}{E_2}$ is the value of Z_L at the frequency used.

Obviously Z_L may be very great or very small or contain negative resistance and still be within the scope of this method of measurement. This method has the additional advantage that direct current may be allowed to flow through the circuit, thus exactly simulating working conditions.

Impedance of Lines Connected to Subscribers' Instruments

IN view of the development of subscribers' instruments of improved efficiency, the question of the reduction of side tone has become a matter of great importance. (An associated article on Side Tone, by Messrs. Siemens Bros., appears in this issue).

To effect a reduction in side tone the provision of anti-sidetone circuits must necessarily follow and in connexion with the development of such circuits some information was considered essential as to the impedance variation of lines likely to be met with in practice. The information was also desired in connexion with the problem of the prevention of "howling" on lines connected to subscribers' instruments provided with loudspeaker facilities as there is an increasing demand for this type of instrument.

Tests were therefore carried out on typical lines at various London Exchanges, the apparatus and exchange wiring involved in a call being in circuit during the tests.

Impedance/frequency measurements were made over a frequency range of 500 to 2,500 p.p.s. at intervals of 100 p.p.s., and in some cases where necessary at smaller intervals.

The lines were terminated in all possible cases with a Telephone No. 162 and Bell Set No. 1. The receiver of the instrument was placed face down on a thick felt pad, and the transmitter replaced by a 50-ohm non-inductive resistance.

In cases where a 50-ohm local line was required, it was not possible to obtain actual cable local lines of this resistance; for the purpose of these tests therefore, a network of resistance and capacity was made up to simulate this condition.

Curves were plotted of effective resistance against reactance and Figs. 1—12 show the results obtained.

The various circuit conditions for these curves are given in Fig. 13.

In all of the conditions, with the exception of Fig.

5, the transmission bridges at the exchanges were of the 50V type with $200\Omega + 200\Omega$ relays bridged across the line and $2 \mu\text{F}$ condensers in each side of the line.

The conditions for Figs. 5 and 12, curve D are the same with the exception that in Fig. 5 the transmission bridges were replaced by repeating coil cord circuits with $2 \mu\text{F}$ condensers in the centres of the coils.

It will be seen in Fig. 13 that in several cases where two exchanges were required one exchange name only appears. For the convenience of testing, it was arranged that all apparatus involved in a call between two exchanges could be set up at one exchange. The junction and local line were selected and looped back to the testing end and inserted between the apparatus as required.

Condition 11, curve A, is given as an example.

The local lines nearest to 300 ohms from Gladstone Exchange were found to be pairs from Gladstone to Willesden looped at Willesden Main Frame back to Gladstone, giving a resistance of 303 ohms. For the junction nearest to 5 db. it was found that a pair out to Hampstead gave 2.3 db. Two pairs were taken and looped at Hampstead Main Frame giving a 4.6 db. junction.

It will be seen from the curves that it is impossible to obtain a balance to satisfy even approximately all of the impedances. As an example, Fig. 1, which is a short local condition, is entirely different at all frequencies from the other curves.

These curves indicate the difficulties of the problem involved in preventing interaction between the transmitter and receiver in telephones where, by amplifier or otherwise, their overall efficiency is raised above the normal level, but they give the data required by those attempting to overcome these difficulties.

E. D. L.
W. C. S. P.

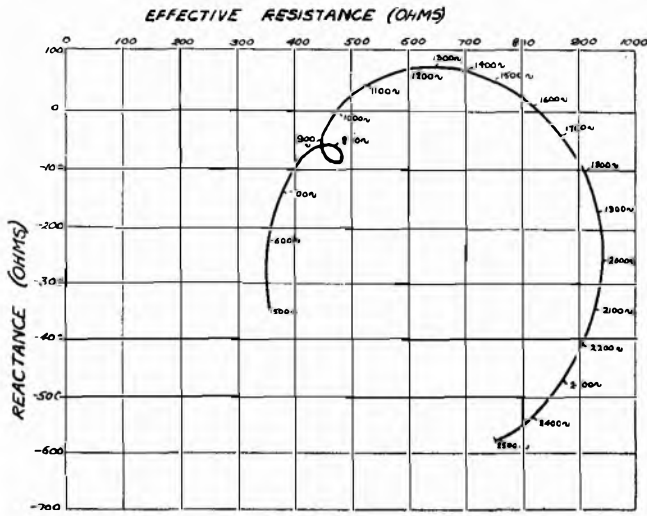

Fig 1

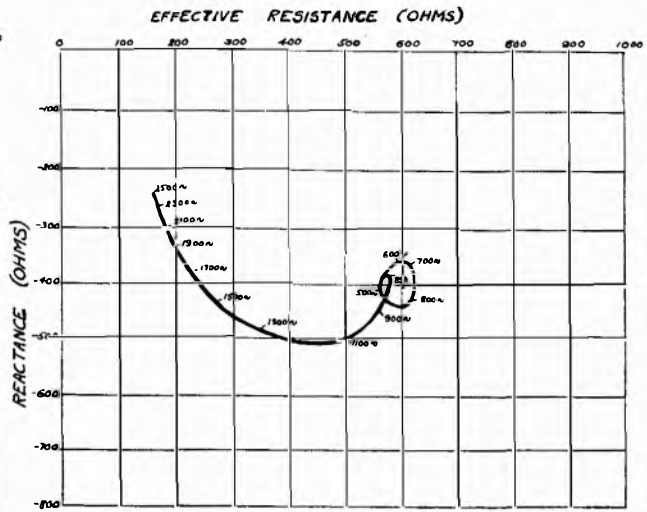

Fig 2

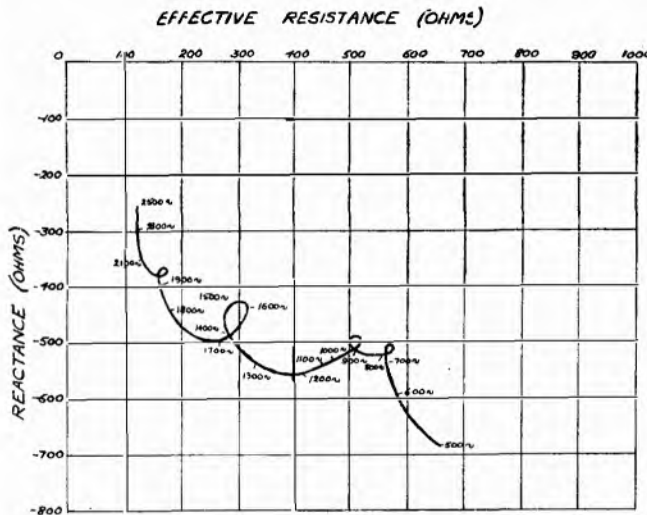

Fig 3

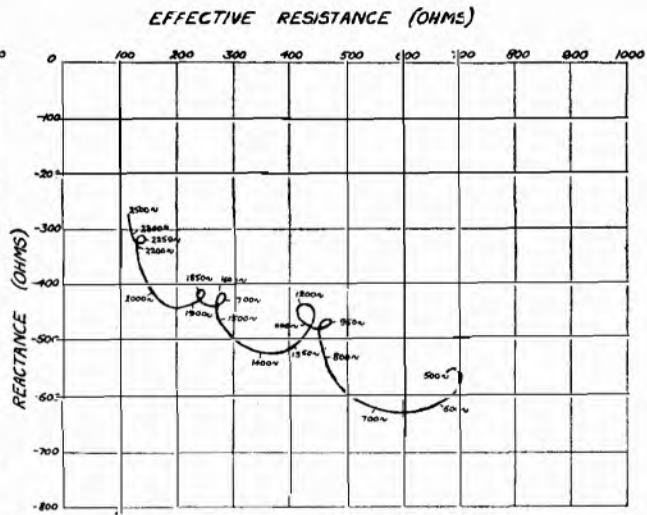

Fig 4

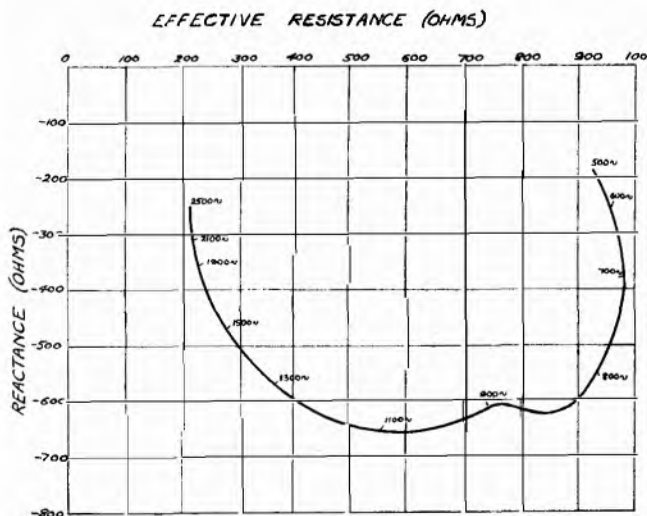

Fig 5

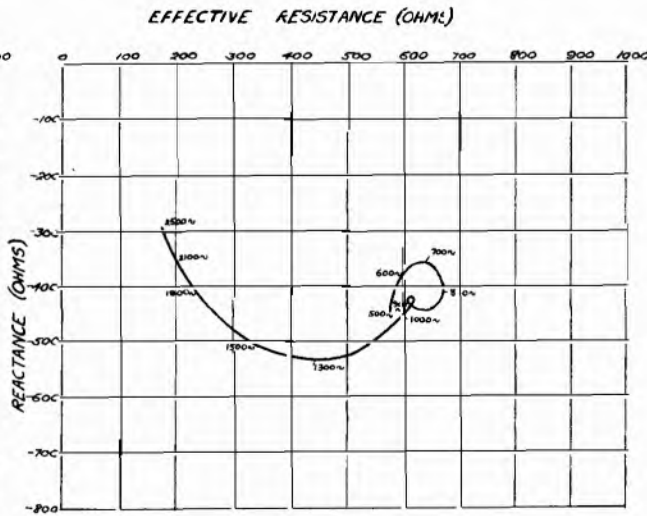

Fig 6

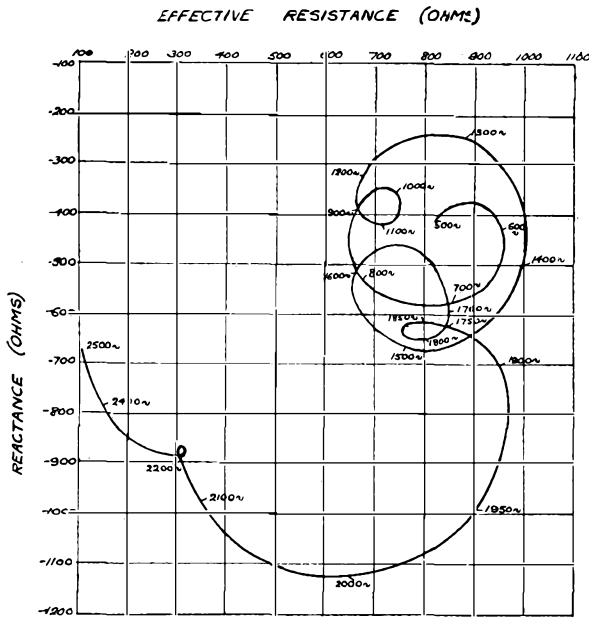

Fig 7

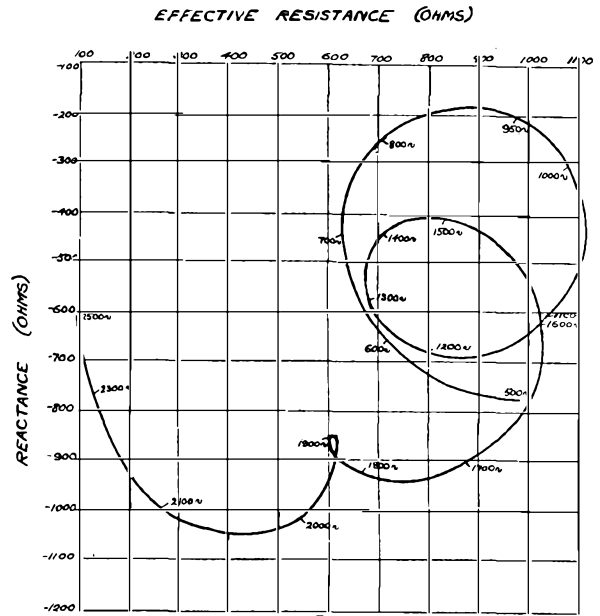

Fig 8

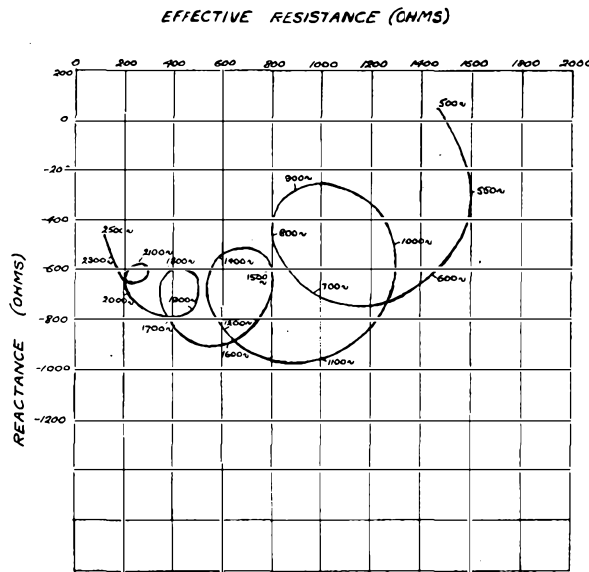

Fig 9

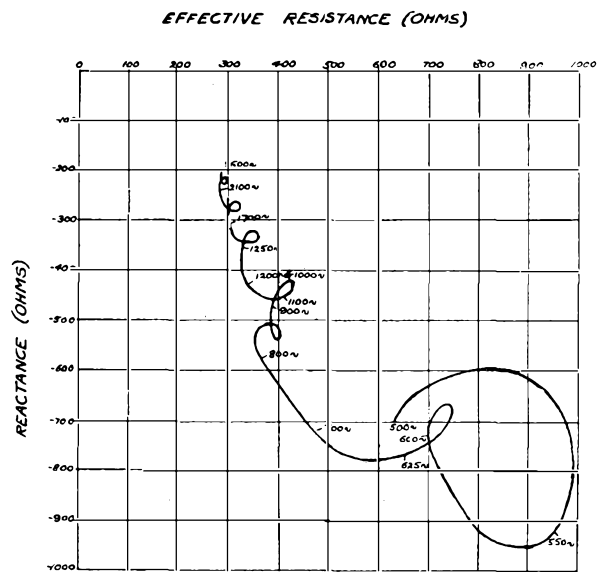

Fig 10

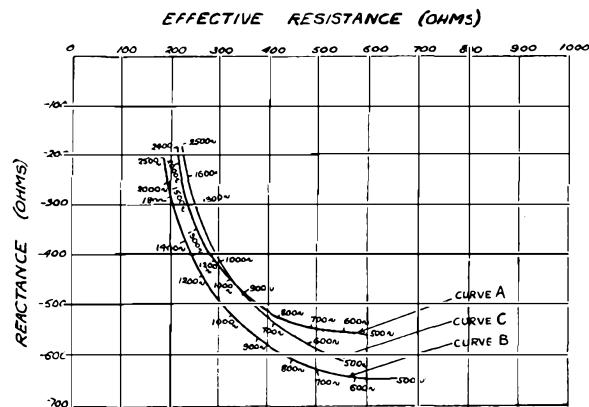

Fig 11

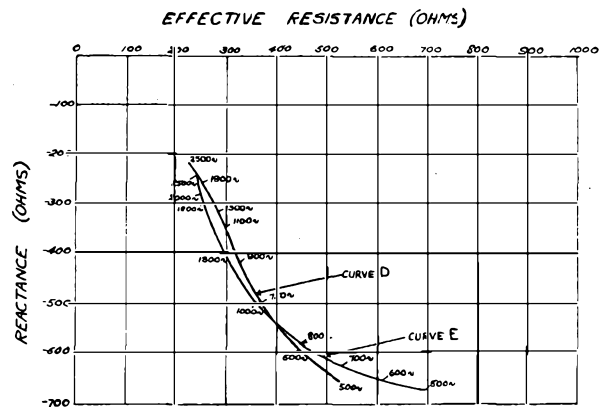
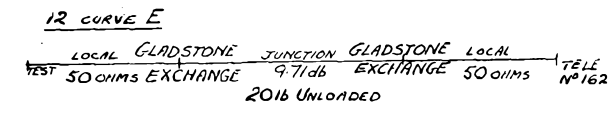
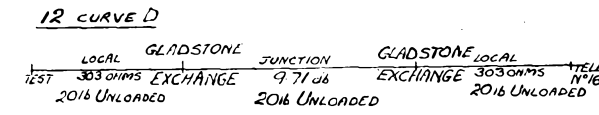
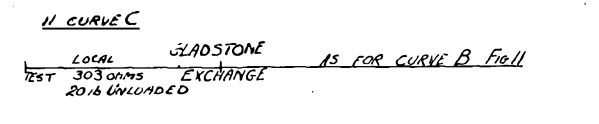
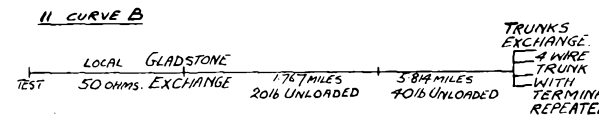
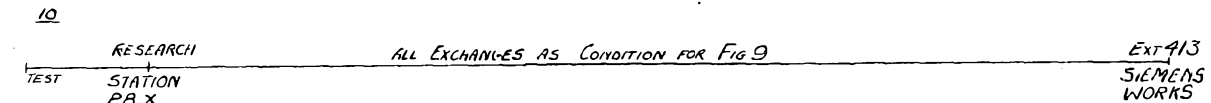
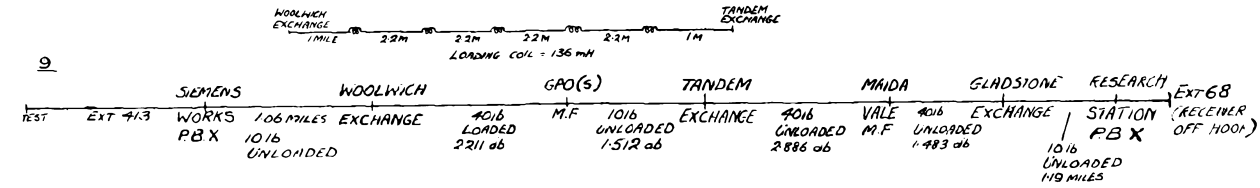
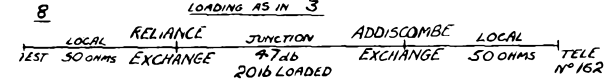
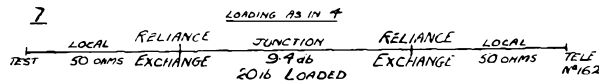
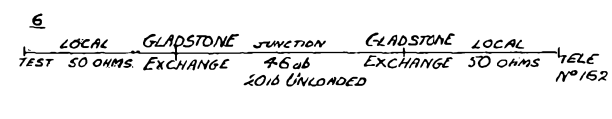
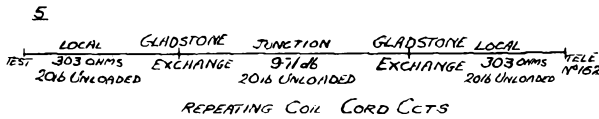
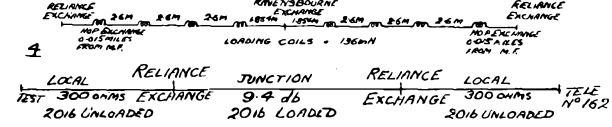
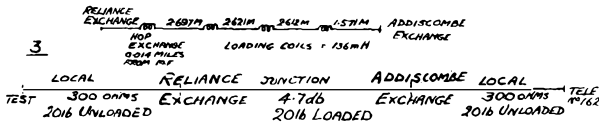

Fig 12

FIG 13 CIRCUIT CONDITIONS FOR FIGS 1-12.



Some Experiences in the London C.C.I. Service

J. E. YOUNG.

THE Coded Call Indicator equipment at the manual exchanges in London has been the subject of several articles in the Journal. The maintenance of this apparatus has not to date, however, formed the basis of any of the articles and it is thought that readers may be interested in some of the problems encountered in normal day to day maintenance.

Despite the development of the London Automatic Scheme and increase in the number of automatic exchanges, only 12 manual exchanges have been closed owing to rapid growth of the London Telephone Service. This expansion has resulted in the provision of additional Coded Call Indicator (C.C.I.) equipment at a number of existing manual exchanges, although it was originally anticipated that the opening of automatic exchanges would lead to a corresponding reduction in Coded Call Indicator equipment owing to closing down of manual exchanges.

Efficient working of C.C.I. equipment is, therefore, essential in view of the volume of traffic flowing between automatic and manual exchanges, and a high standard of maintenance must exist in order to afford trouble-free service to automatic exchange subscribers when passing calls to manual exchanges. That such a standard does exist and is ever improving is evident from the following extracts from the "London Day Service Observations, Automatic Exchanges—Distant Manual Calls," published by the London Telephone Service :—

6 months January to June, 1930.

Wrong Exchange or number obtained... 2%

6 months July to December, 1931.

Wrong Exchange or number obtained... 1.3%

These figures include lost calls due to C.C.I. plant defects, operating errors on the part of C.C.I. Operators, junction calls misrouted or wrong numbers set up owing to plant defects at the automatic exchanges. It will be appreciated from these low percentage figures and the many miscellaneous causes contributing to wrong number difficulties, that irregularities on the part of C.C.I. equipment causing the connexion of wrong numbers must be extremely small in number.

The main function of the C.C.I. equipment is to receive and decode four-digit numbers transmitted from the automatic exchange in the form of battery pulses. These pulses are defined in Table I, and the pulse composition of each digit 1 to 0 is shown in a schedule on Fig. 1.

The pulses are received at the manual end by three series relays, LN, HN and LP, forming a loop across the junction as shown in Fig. 1. Of these three relays, LN and LP are polarized in such a manner as to respond only to negative and positive pulses respectively, whilst relay HN is a marginal

relay which operates only on the current received when a heavy negative pulse is applied. The current received from light positive and light negative pulses is not sufficient to operate the marginal relay.

TABLE I.

Pulse.	Definition.	Denoted by Symbol.
Heavy Negative (HN)	Earth applied to the negative line of the junction and 50 volt. battery via 100 ohms resistance applied to the positive line.	—
Light Negative (LN)	The same conditions apply as for the heavy negative pulse except that the 50 v. battery is applied via 5100 ohms to the positive line.	—
Light Positive (LP)	Earth applied to the positive line of the junction and 50 volt. battery via 5100 ohms resistance to the negative line. This pulse gives a reverse condition to the LN pulse.	+

These relays, which are known as decoding relays, were regarded with considerable suspicion by local maintenance officers when the equipment was in process of installation, and it was thought that the construction of the relays was somewhat crude in view of the meagre current flowing in the line when light positive or negative pulses are received. Experience has shown, however, that the performance of decoding relays is beyond reproach, being such that the Emergency Manual Equipment, whereby C.C.I. positions can be temporarily worked on a manual basis, has rarely, if ever, been used, and on the later equipments has only been provided where there are three or less C.C.I. positions fitted.

A semi-automatic routiner is provided at the manual exchanges and a daily check is made to ensure the satisfactory operation of each C.C.I. position. Each cord circuit and position trunk relay-set is tested, and the decoding relays can be subjected to extremely critical tests by the use of special keys associated with the routiner.

In addition to these daily tests, it is the custom of the traffic staff at each London C.C.I. Exchange to intercept daily a number of calls at the C.C.I. positions. Any case where the displayed number differs from the number actually required by the calling subscriber is tabulated on a form, and this is

afterwards handed to the maintenance staff for investigation.

An extract from a typical return is shown in Table II.

TABLE II.

Date.	Posn. No.	No. Displayed.	No. Required.
16-4-32	4	5662 3215 7020	5662 3316 8120

It is the duty of the C.C.I. Maintenance Officer to analyse cases such as those scheduled on the specimen form, and the pulses comprising each number are set out for comparison on the following lines :—

No required, 8120 + --- + ---
 No. displayed, 7020 --- ---

Scrutiny of the pulse trains in the above case reveals that a light positive pulse is being missed on each of two digits, and subsequent tests of the decoding relays will invariably indicate that the LP relay requires slight adjustment.

telephone, whilst the number actually required may be a busy private branch exchange and the occasional misrouting of a call to the quiet subscriber due to intermittent receipt of additional positive or negative pulses in the C.C.I. display, is a source of irritation when few, if any, incoming calls are received by the complainant.

If comparison is made, as in the former cases, between the coded pulses of the number required and those of the number actually received, there appears to be no relationship between the digits incorrectly displayed and the digits sent until oblique strokes are drawn as shown :

No. required, 1745 + --- --- + --- ---
 No. displayed, 1701 + --- --- --- + --- ---

It will now be seen that the portions enclosed by the strokes are identical, but the pulses in the second number have been displaced by the interposition of an additional light negative pulse after the last heavy negative pulse of the preceding digit.

In the very early days of C.C.I. Service it was thought that the production of an additional light negative pulse was not within the bounds of possibility at the C.C.I. end and investigation was directed towards the sending equipment at the automatic and Tandem exchanges. It was subsequently found, however, that the trouble was due to

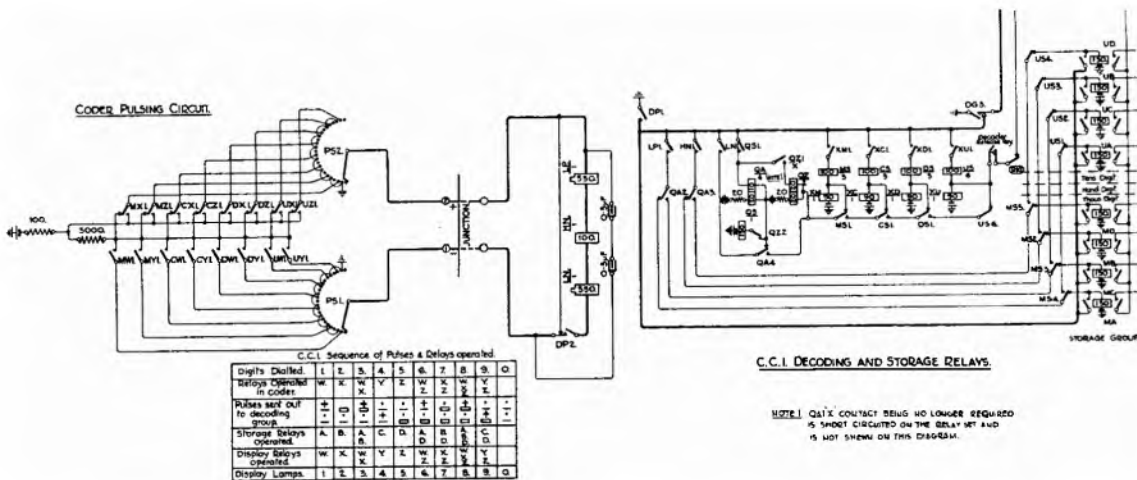

FIG. 1.—ELEMENTS OF C.C.I. EQUIPMENT.

Such cases in which pulses are missed are comparatively simple in treatment, but a more difficult problem is to account for those wrong numbers where *additional* light positive or negative pulses are received. Intermittent receipt of additional light positive or negative pulses is rarely brought to light by use of the semi-automatic routiner and the first intimation is usually received from an irate subscriber called in error for another number. The called subscriber is often an infrequent user of the

relay adjustment in the decoding group of the C.C.I. equipment and the following explanation may be of interest :—

Fig. 1 shows the pulsing out circuit of the automatic exchange coder associated with the decoding and storage relays at the C.C.I. end. Taking the sending of digit 7, comprising two heavy negative pulses, the circuit operation of the decoding relay group is as follows: On receipt of the first HN pulse, relays HN and LN operate. QS relay

operates *via* QA4 normal and LN1 operated, and storage relay MB operates *via* HN1 operated. QA relay is now X-operated and fully operates when LN1 is released at the termination of the first negative pulse. The second negative pulse of the digit 7 re-operates relays HN and LN, relay QZ X-operates and relay XM operates *via* QA4 and LN1 operated. Storage relay MD is operated *via* QA3 and HN1 operated and at the termination of the second negative pulse, relay QZ fully operates as the shunting earth at LN1 is removed. Relays QS and QA are now released and the removal of the shunting earth at LN1 allows relay MS to operate *via* XM1 operated and the leads are connected to the 2nd digit storing group.

The operation and locking of relays MB and MD cause the digit 7 to be held in the storage group ready for display when the remaining digits comprising the number have been received in the decoding group.

The above sequence of operations provides for the correct receipt and storage of a digit, but the addition of a false negative pulse is set up in the following manner. Relay QZ is actually too lightly adjusted and on receipt of the second negative pulse of the digit seven, this relay fully operates when it should only X-operate until the termination of the pulse.

It will be seen from a scrutiny of Fig. 1 that relays QS and QA will immediately release by the operation of QZ2 contact.

Relay MS will operate and connect the leads to the second digit storage group as shunting earth is removed by the release of QA4 contact. Before the termination of the negative pulse relay QS re-operates and relay QA X-operates. On the release of relay LN, relay QA fully operates and relay MS having already operated, the thousands digit 7 is followed by an additional light negative pulse which causes the remaining pulses of the number to be moved up in position.

The existence of the above fault partly depends on the length of time that the LN1 contact is operated as it is necessary for relay QZ to operate, relays QS and QA to release, QS to re-operate and QA to X-operate before the termination of the negative pulse. It will thus be readily appreciated that the fault is likely to be extremely intermittent and may only occur on junction routes of low resistance, when relay LN will have a slightly longer time of operation due to the transmission of heavier pulse currents.

Wrong numbers due to intermittent receipt of an additional light positive pulse have provided a different problem and in this case the

first intimation came from a distinguished doctor who received numerous enquiry calls intended for a large railway station. The fact that the trouble was experienced at the height of the excursion season rendered it necessary to take speedy action, and it was subsequently found that the addition of a false positive pulse to each digit of the railway number was caused by a contact between the negative wires of two junctions from Tandem Exchange to the C.C.I. equipment.

It will be seen from Fig. 1 that light positive pulses are normally transmitted from the automatic exchange coder over the negative wire of a junction. The existence of a contact between the negative wires of two junctions causes a current to be sent through the decoding relays in a positive direction when these relays are connected to one of the junctions during the pulsing out of a call from the automatic exchange. The current from the contact is sufficient to cause false operation of relay LP and the transmission of any of the digits 2, 4, 5, 7, 9 or 0 from the coder, together with the false positive current, result in the display of digits 3, 1, 6, 8, 6 or 1 respectively at the C.C.I. position.

A further trouble was experienced at some exchanges, however, due to the intermittent receipt of digit 9 when 5 was transmitted. This was at first dismissed from mind as being due to phonetic similarity between the two digits and was thought to be mainly connected with calls routed from manual to manual exchanges *via* Tandem Keysender B-positions.

Fig. 2 illustrates the routing of calls from manual and automatic exchanges to C.C.I. positions and it will be seen that operating errors may affect the passage of a call between the manual exchange "A" operator and the Tandem "B" operator.

Subsequent investigation proved this conclusion to be incorrect, as similar trouble was detected on occasional calls from automatic exchanges in which case operators cannot be called upon to shoulder the blame for errors due to phonetic similarity of digits. Another interesting feature was the fact that at any

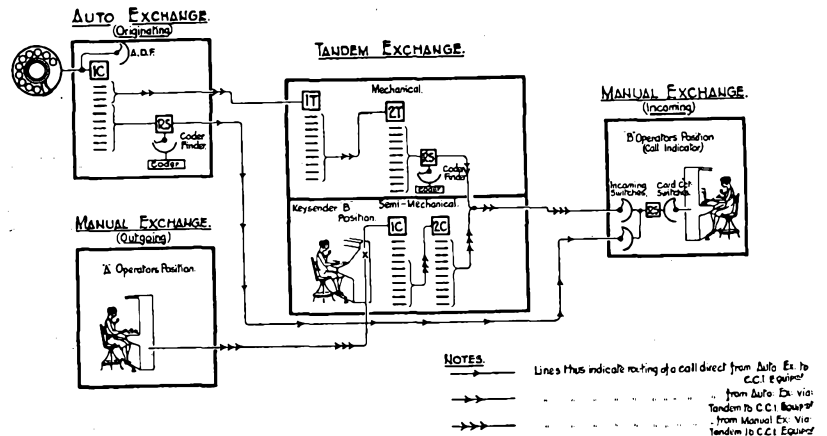

FIG. 2.—CODED CALL INDICATOR SERVICE. GENERAL SCHEMATIC DIAGRAM.

one exchange only one digit would usually be affected. For instance, the transmission of calls for 5555 to one C.C.I. equipment would result in the display of 9555, but when the trouble was experienced at another exchange the change might only take place on the tens digit, so, 5555 to 5595.

This change of digit only occurred on one C.C.I. position at each of the exchanges concerned, so it was undoubtedly a trouble at the C.C.I. end as calls for 5555 routed over the same junctions, but to other positions were correctly displayed.

Routiner tests of the faulty position failed to reveal any trouble in the decoding relay group and tests for satisfactory operation of the polarized and marginal relays at scheduled current values were also carried out without failure.

A contact between the negative wire of two junctions results in the digit 5 — — being displayed as 6 + — — as previously explained. In order to change 5 to 9, however, the false positive pulse must appear not before the first negative pulse but between this pulse and the second negative pulse, so — + —.

In view of difficulty experienced in London with the false positive pulse trouble, special investigations were carried out in the Circuit Laboratory of the Engineer-in-Chief's Office and it was definitely established, by the use of an oscillograph, that a positive surge occurs in the junction line after the transmission of a heavy negative pulse. This surge was observed to be of sufficient magnitude to cause the polarized relay LP to operate momentarily, but the operation was not of sufficient duration to affect the storage relays.

Applying this knowledge to the problem of the digit 5 being displayed as 9, scrutiny of Table III. and Fig. 3 will show that this digit change is the only one which can take place if the positive surge after the transmission of a heavy negative pulse *should* cause relay LP to operate for a sufficient period to permit a storage relay to be energized.

It will be seen that the circuit arrangement in Fig. 3 is such that operation of storage relay MC by a false positive pulse in the case of, say, digit 3

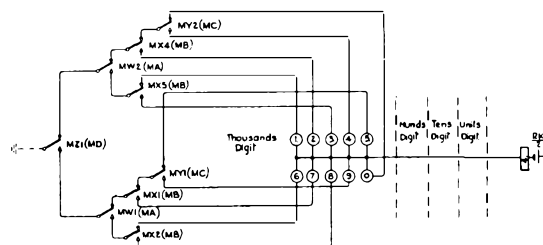

FIG. 3.—C.C.I. DISPLAY LAMP'S AND ASSOCIATED RELAY CONTACTS.

Letters enclosed in brackets () indicate Storage Relays concerned.

does not cause any change in number as the display lamp circuit is completed *via* operated contacts MX5 (MB), MW2 (MA), and its continuity cannot be affected by operation of contacts MY1 or MY2 (MC). This also applies to other digits that contain heavy negative pulses, viz. : 2, 6, 7, 8 and 9, but in the case of digit 5 false operation of contact MY1 (MC) causes the continuity of the digit 5 display lamp circuit to be broken and a circuit for digit 9 display lamp is completed by the change over of this contact. It will also be seen that the digit 9 is stored and displayed whether pulses are received in the order — + —, or — — +.

In view of this singular peculiarity in connexion with the digit 5, investigation was directed towards the possibility of the known positive line surge after the transmission of a heavy negative pulse actually affecting the LP relay. When the trouble was found to occur on any C.C.I. position, the LP relay was subjected to special tests and it was established that, whilst the relay was satisfactorily adjusted as to

spring gauging and operate and non-operate current conditions, the stroke, *i.e.*, amount of armature travel, was actually one or more mils shorter than that specified in the relevant adjustment schedule.

This slight difference in stroke was rectified and the trouble was immediately removed, thus showing that too close proximity of the LP relay armature and core by only one thousandth of an inch will permit operation of the LP relay by the positive line surge for a sufficient period to energize the storage relays.

The condition of the storage relays was also examined and

TABLE III.

Digit Transmitted.	C.C.I. pulses and storage relays operated.	C.C.I. Pulses with additional positive pulses following heavy negative pulses, and storage relays operated.	Digit stored and displayed.
1	+ — — A	+ — — A	1
2	— — B	— + — BC	2
3	+ — — AB	+ — + — ABC	3
4	— + — C	— + — C	4
5	— — D	— — + DC	⊙
6	+ — — AD	+ — — + ADC	6
7	— — BD	— + — + BCD	7
8	+ — — ABD	+ — + — + ABCD	8
9	— + — CD	— + — + CD	9
0	— — NIL	— — NIL	0

in several cases it was found that the relays concerned in the storage of positive pulses were too lightly adjusted. It will readily be seen that such light adjustment would render these relays susceptible to operation when the LP relay was energized for the short duration of a positive line surge.

The investigation and satisfactory solution of the difficulties mentioned in this article has provided the London C.C.I. staff with many interesting moments, and it is hoped that this explanation of the troubles will be equally entertaining to the many readers of this Journal.

Miscellaneous Facilities at Automatic and Manual Telephone Exchanges. II.

A. HOGBIN and H. O. ELLIS.

Interception Equipment at Automatic Exchanges.

(1) *General.*

At each automatic exchange special equipment is provided so that calls normally completed by automatic switching plant can be intercepted by an operator on a monitorial position. By means of plugs and cords and multiplied jacks on the Main Distribution Frame and cross-connexions on the Intermediate Distribution Frame any subscriber's line can be associated with the equipment so that calls on that line are received by a monitor.

The circumstances in which it is necessary to intercept calls incoming to a subscriber's line are as follows:—

(a) *For "ceased" numbers.*

When a number in an exchange is no longer required by a particular subscriber due, for example, to his removal from the exchange area, it is not practicable to re-allot the number immediately to a new subscriber. Until a new Directory is issued, the "ceased" number is connected to interception equipment so that callers can be advised of the cessation.

(b) *Changed numbers.*

In certain circumstances, for example, when a single exchange line becomes a P.B.X. group with two or more lines, subscribers' numbers must be changed and it is therefore necessary to intercept all calls incoming to the old number so that callers can be advised of the change.

(c) *Directory errors.*

Misprints, duplicate entries, transposition of numbers, etc., in Telephone Directories render it desirable that calls incoming to certain lines be intercepted. In this way the subscribers concerned are saved the trouble of answering calls intended for other subscribers and callers can be advised of the correct number to be dialled in the future.

Interception in such cases is, of course, only necessary until a new Directory is issued.

(d) *Service complaints by subscribers.*

For instance, a subscriber may complain of being called in error by people wishing to establish connexion with an entirely different number or he may make a general complaint of unsatisfactory service. Interception equipment allows of calls on that subscriber's line being supervised. The number required by each caller can be checked and the connexion only completed if the calling subscriber really desires to speak to the intercepted subscriber.

The four conditions outlined above can be handled by means of one type of interception equipment. At a number of large exchanges, however, there are so many changed numbers that special changed number equipment is fitted. This equipment is simpler and cheaper than "Full Facility" Interception Equipment and is used solely for dealing with calls incoming to changed numbers.

The number of interception equipments fitted at an exchange is, at the present time, dependent on the number of subscribers' lines on that exchange. They are provided on the following basis:—

(a) "Full Facility" Interception Equipment:—
1 equipment for each 500 working Exchange lines or part thereof.

(b) "Changed Number" Interception Equipment:—
1 equipment for each 200 working Exchange lines or part thereof.

Information regarding the number of equipments required at a particular exchange is supplied to the Engineering Department by the Traffic Staff who also allot the subscribers' lines to the interception circuits.

(2) *Earlier Equipment.*

In the early days of Automatic Telephony, if a dial on a subscriber's telephone became faulty so that

numbers could not be dialled although the instrument itself and the external plant were quite in order, it was considered that the line should be worked on a manual basis temporarily. Under these conditions the line should be associated with interception equipment so that outgoing calls could be completed by a monitor.

Provision was therefore made on the earlier types of this equipment for the interception of calls outgoing or incoming to a subscriber's line, or where necessary, for the interception of both outgoing and incoming calls. Such factors as increased reliability of dials and more speedy replacement of faulty dials, however, have rendered it unnecessary to intercept outgoing calls, and the only calls now intercepted are those incoming to subscribers.

The arrangement of the most widely used type of pre-standard equipment is shown in Fig. 1, and a brief description of the equipment follows:—

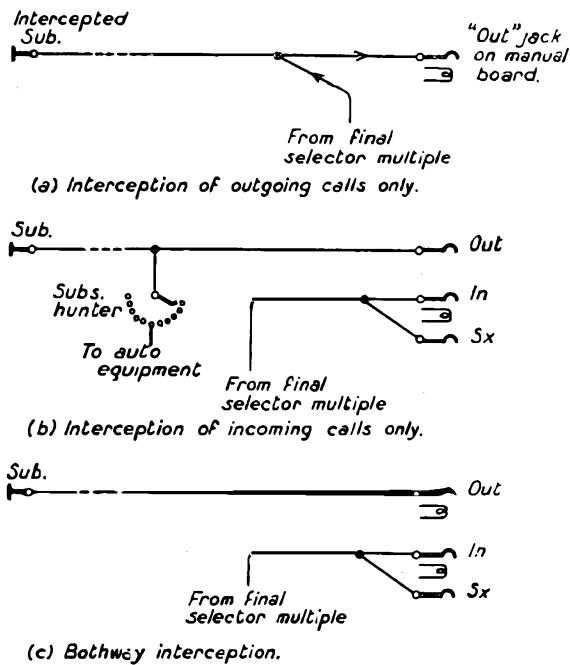

FIG. 1.—PRE-STANDARD INTERCEPTION EQUIPMENT.

(a) *Interception of Outgoing calls only.*

It will be seen from Fig. 1(a) that the subscriber's line is terminated on a jack marked "OUT" on the manual board, but the connexion from the final selector multiple remains unaltered. When the subscriber lifts his receiver, the calling lamp glows, the operator answers, prepares a ticket and completes the call over the normal circuits from the manual board to the automatic equipment.

(b) *Interception of Incoming calls only.*

In this case outgoing calls are completed *via* the subs hunter as usual, but calls incom-

ing to the subscriber from the final selector multiple are received on the "IN" jack on the manual board. The operator who answers ascertains the number of the calling subscriber and the number he requires, and, after referring to information cards, gives him any necessary information regarding change of number, etc. She also prepares a ticket, and if the call has come from an operator at a dialling-in exchange, she withdraws the plug from the "IN" jack and inserts it in the "SX" jack, so as to give the correct supervisory condition at the distant manual exchange. If necessary the call to the intercepted subscriber is completed *via* the "OUT" jack.

(c) *Bothway Interception.*

From Fig. 1(c) it will be seen that for bothway interception the outgoing and incoming equipments are combined. The operating procedure is therefore similar to that outlined in the two foregoing paragraphs.

This type of equipment was very satisfactory for exchanges where the manual board is in the same building as the automatic equipment, but where the automatic exchange is several miles from a manual board as in the case of satellite exchanges or exchanges in Director areas with centralised manual boards, it has definite disadvantages. Some of these are:—

- (a) Two junction pairs are required for *each* subscriber for incoming or bothway interception.
- (b) Considerable transmission loss is introduced by the three junction circuits required between the main exchange and a distant exchange. (One circuit is required to reach the final selector multiple at the distant exchange, and there are then the circuits to the "IN" jack and from the "OUT" jack.)

In addition to these two considerations, the equipment suffers from the drawback that all connexions are completed *via* a cord circuit on the manual board. Apart from the operating time involved in setting up and clearing each connexion, the cord circuit introduces further transmission loss.

(3) *Present Standard Equipment.*

In view of the disadvantages of the earlier equipment, a line finder scheme was designed. From Fig. 2 it will be seen that instead of the intercepted subscriber's lines being permanently extended to the manual board, they are terminated on the banks of line finders, the wiper connexions of which are connected to a manual board circuit. The number of manual board circuits is therefore much smaller than the number of subscribers under interception. As described later, arrangements are made for the circuits to be used during only a very small portion of

each call, thus further reducing the number of circuits required.

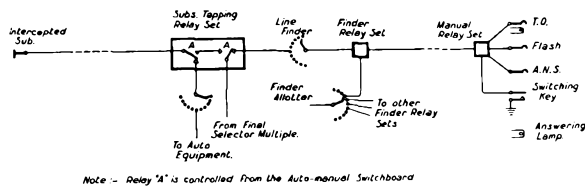

Note - Relay 'A' is controlled from the Auto-manual Switchboard

(a) " Full Facility " Equipment.

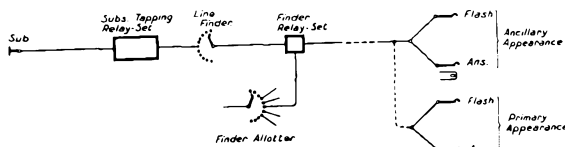

(b) " Changed Number " Equipment.

FIG. 2.—STANDARD INTERCEPTION EQUIPMENT.

Details of the circuit operation are appended, but the following is a brief general description of full facility and changed number equipment :—

(a) " Full Facility " equipment.

As stated in the opening paragraphs of (2), nowadays only calls *incoming* to subscribers are intercepted, so that no provision has been made on the standard equipment for the interception of outgoing calls. Fig. 2(a) shows the general lay-out of the apparatus. The subscriber's line to be intercepted is connected to a " subs. tapping relay-set " by means of plugs and cords (Fig. 3) on the Main Distribution Frame. (Horse-shoe type clips were formerly used on the M.D.F. protectors, but, owing to the possibility that they might be knocked out of position, they have been superseded by the smaller plugs shown in the figure.) Details of the cross connexions and circuit arrangements of the sub-

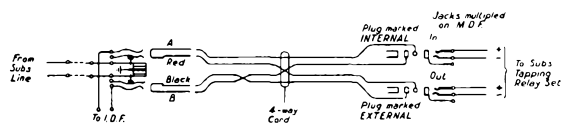

(a) Method of Connecting Subs' Lines.

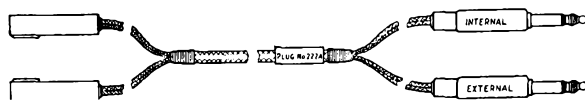

(b) Connecting Plugs and Cords.

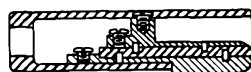

(c) Section through Arrestor Plug.

FIG. 3.—M.D. FRAME INTERCEPTION CONNEXIONS.

scribers' tapping relay-set and line finder are shown in Fig. 6, from which it will be seen that the normal jumper on the I.D.F. is removed, with the exception of the meter wires, and the negative, positive and private wires are jumpered to the subscribers' tapping relay-set.

Each subscriber's tapping relay-set is cabled to the bank of a 24-point line finder, and the wipers of the line finder are associated with a two-wire circuit to the manual relay-set, and thence to the Manual Board. It follows, therefore, that one line finder and circuit to the Manual Board may serve a maximum of 24 subscribers. Traffic requirements, however, rarely allow of all the calls to 24 lines being concentrated in this way and it becomes necessary to have several line finders and associated manual board circuits, over which calls are distributed by an " allotter " uniselector.

Subscribers tapping relay-sets, etc., are fitted on a rack as shown in Fig. 4, while Fig. 5 shows the lay-out of the lamp jacks and keys on the monitorial

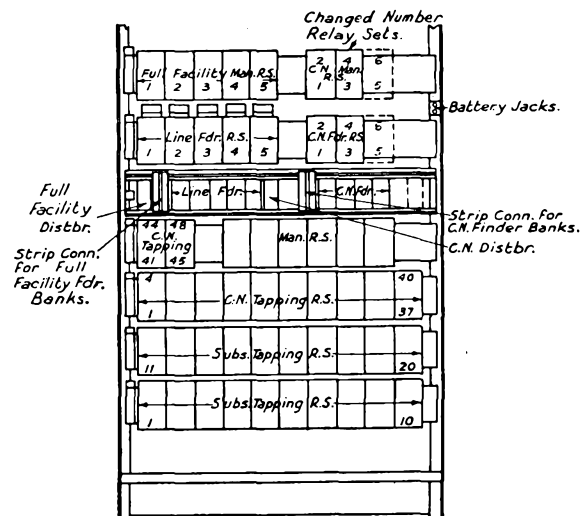

FIG. 4.—APPARATUS RACK LAY-OUT.

positions. There is only one appearance of these circuits on these positions, although arrangements are made for calling signals to be given on a concentration position at night-time. The concentration keys by means of which this is effected are fitted at the top of the panel concerned while the switching keys, jacks and lamps are fitted at the bottom of the panel.

The facilities provided by this equipment are as follows :—

- (a) Interception of calls incoming to subscribers.
- (b) Ringing tone returned to the caller until operator answers.
- (c) " Flashing " of the distant operator on dialled-in calls.

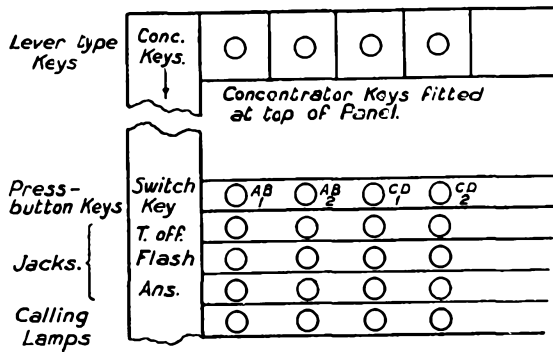

FIG. 5.—LAY-OUT OF MANUAL SWITCHBOARD EQUIPMENT.

- (d) Switching of a call through to the intercepted subscriber under control of the manual board operator.
- (e) Observation of a call by the interception operator after a call has been switched through and until the plug is withdrawn from the circuit.
- (f) Busy tone returned to the caller if the intercepted subscriber is engaged when a call is switched through.
- (g) Non-metering of a call until the intercepted subscriber answers a call.
- (h) Trunk offering by the Interception operator.
- (i) Concentration keys provide for calling signals to be diverted to a concentration position at night-time.

As soon as the wipers of a final selector reach an intercepted subscriber's line, the subs. tapping relay-set is seized and ringing tone is returned to the caller from the final selector in the usual way. A line-finder, previously allotted by the allotter uniselector, then rotates in search of the calling relay-set and as soon as this is found

- (a) the allotter steps to the next free line-finder,
- (b) ringing on the final selector is tripped,
- (c) ringing tone is returned to the caller from the line-finder relay set,
- (d) the calling lamp lights on the manual board.

The insertion of a plug in the "Answer" jack disconnects the ringing tone, but does not meter the call against the calling subscriber. "What number do you want, please?" queries the monitor and then, "What is your number, please?" If the call has been dialled-in, that is originated from a manual exchange, the proper supervisory conditions must be returned to the manual exchange, and to do this the plug is withdrawn from the "Answer" jack and placed in the "Flashing" jack. After reference to her information cards, the monitor gives the caller appropriate advice, and if the call has been dialled-in, she attracts the attention of the distant operator by operating her cord circuit flashing key.

If the intercepted subscriber is actually the one required by the calling subscriber, the plug is returned to the "Answer" jack and the "Switch" key is depressed. Busy tone is returned to the caller from the subs. tapping relay-set if the intercepted subscriber is engaged on an outgoing call, but if he is free ringing current is connected to his line and the calling subscriber hears ringing tone. When the intercepted subscriber answers, metering conditions are established, and the call proceeds and terminates in the usual way.

Although she has switched the call through, the interception operator can still listen-in on the connexion, but as soon as she hears that the call is completed satisfactorily, she "clears" the manual board connexion and so releases the line-finder for use by a subsequent call.

A trunk operator wishing to call an intercepted subscriber reaches the interception operator in the usual way via the final selector multiple and line-finder. Having checked-up the name and the number of the subscriber required, the interception operator transfers the answering plug to the "T.K.O." jack to ascertain whether the intercepted subscriber is engaged. If no conversation is heard on the line and there is no reply to a challenge, the plug is transferred to the answering jack and the switching key is depressed to switch the trunk operator through. On the other hand, if the subscriber is engaged when the plug is put in the trunk offering jack, the interception operator offers the trunk call. Assuming that the call is accepted, the subscriber is asked to replace his receiver and, after a short interval has been allowed for him to do this, the trunk operator is switched through to the subscriber.

Some of the calls received by interception operators are, of course, originated from call offices. Failing to get a reply to her challenge the interception operator says "If you are speaking from a call office please press button A." The usual checking-up of numbers follows and, if necessary, the call is completed—after the operator has made sure by means of the trunk offering jack that the subscriber is free. If the number required is different from the intercepted number, the caller is asked to replace his receiver and the operator dials the required number over the normal automatic selectors and then the number of the call office. Should it not be possible for a call from a call office to be completed, the name and address of the caller is noted and the money refunded by post.

(b) *Changed number equipment.* Fig. 2(b).

This is a simplified form of the "full facility" equipment as there are no subscribers concerned, but only final selector numbers. These are extended via line-finders (50-point, if necessary) to the manual board and, owing to the uniform nature and large number of calls concerned, the manual board circuits are usually terminated on A or enquiry positions and

have an ancillary appearance in addition to the normal calling equipment.

The main facilities given on this equipment are the same as (a), (b), (c) and (i) for full facility equipment. In addition, the interception operator receives an indication on her supervisory lamp when the calling subscriber replaces his receiver and there is also the ancillary appearance of the manual board circuits mentioned above.

The operation of the equipment, too, is the same as for full facility equipment while the operating procedure is very similar. Instead of a call being completed, however, a caller is advised that "the number has been changed to . . . (exchange and number). Will you please make a note of it and call that number."

Calls from call offices are, in most cases, reverted by the interception operator so that there is no need for the caller to deposit any more money to obtain the correct number.

Area transfers and area corrections often result in large blocks of subscribers' numbers being changed and for a short time there is a considerable amount of changed number traffic to be handled at a particular exchange. To meet this condition in the most economical manner portable changed number equipments have been constructed and are now

transported from place to place throughout the country.

(c) *Combination of full facility and changed number equipments.*

When the amount of interception traffic is small, separate groups of full facility and changed number circuits to the manual board are not justified. In such cases the two types of tapping relay-set, shown in Figs. 6 and 8 respectively, can be connected to the same group of line-finders.

Only one line-finder and associated circuit to the manual board is justified for very small exchanges (e.g., between a satellite exchange and the automatic switch board at the main exchange in a Non-Director area) and the allotter uniselector is not fitted. Provision is made, however, for it to be connected at a later date if necessary.

(4) *Use of interception equipment for filter purposes.*

It is sometimes desirable to ascertain whether a subscriber has enough circuits to carry the calls incoming to him. This can only be accomplished when his line is already connected to a P.B.X.-type final selector and when the number or numbers after the one concerned are spare. It is then possible to

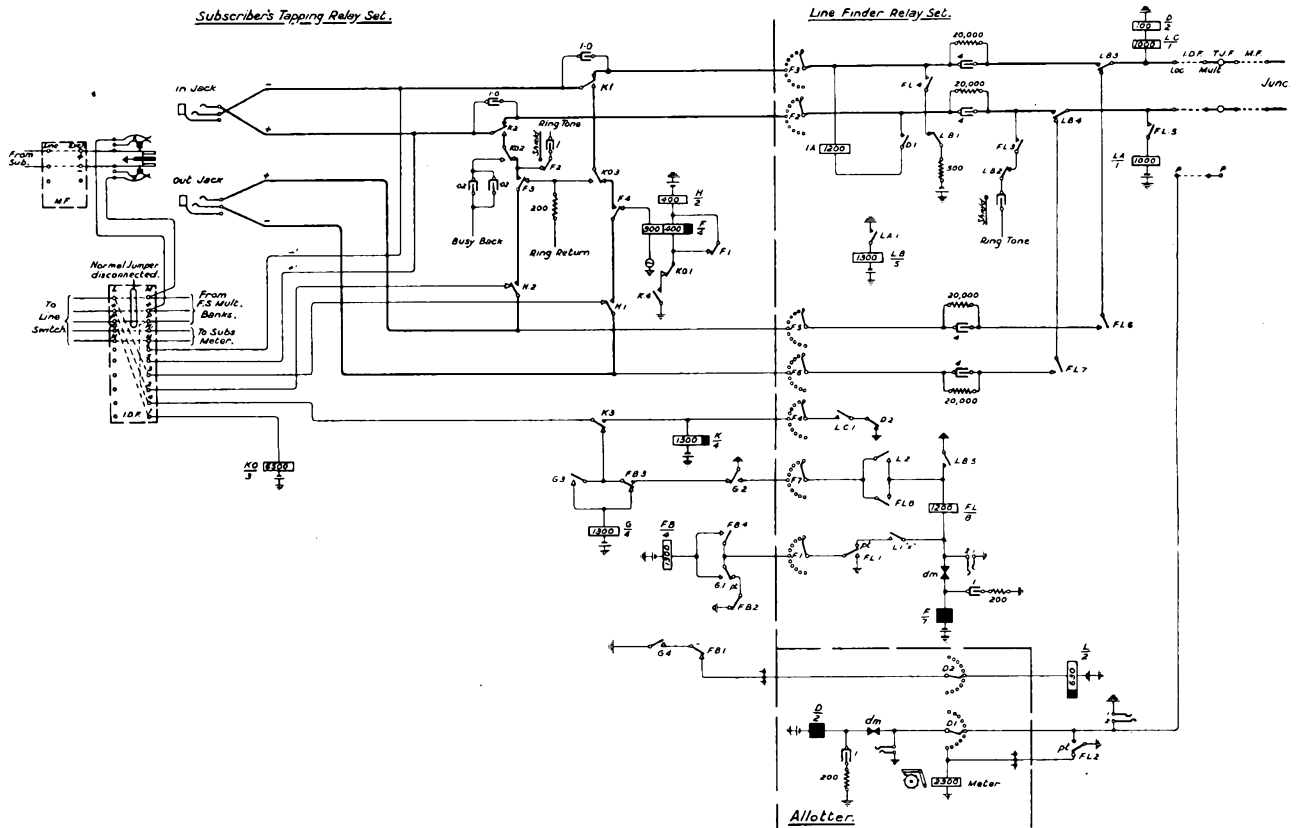

FIG. 6.—" FULL FACILITY " INTERCEPTION EQUIPMENT,

connect the spare numbers to interception equipment, so that a record can be kept of the calls received while all the lines to the subscriber are engaged.

Even this method is not entirely satisfactory as it is possible for callers to receive the busy tone during periods when the subscribers' lines and the interception circuits are engaged.

APPENDIX.

Full Facility Equipment.

A final selector "tests in" to relay G (Fig. 6) which operates, and at contact 4 operates the L relay in the line-finder relay-set. Contact G1 disconnects the busying earth from the F1 bank of the finder and thus "marks" the calling contact, and also prepares a circuit for the operation of relay FB, while G2 applies earth to operate relay FL when the finder reaches the marked contact. G3 provides a locking circuit for relay G under control of contact K3.

Contact L1 provides the operating circuit for the rotary magnet and the finder therefore drives round until wiper F1 reaches the marked contact. Wiper F7 is thus connected to earth via the bank contact, and relay FL operates. Contact FL1 operates relay FB in the subscriber's tapping relay-set, and FL2 provides a circuit for the allotter driving magnet,

thus causing the wipers to rotate to the next free line-finder. The 500-ohm battery via FL4 trips the ringing from the final selector and FL3 connects ringing tone to the calling line. Relay FL holds at FL8 and contact FL5 operates relay LL in the manual relay-set (Fig. 7) to light the calling lamp. Owing to the high resistance of LL, relay LA remains unoperated.

When the operator answers, relay S operates relay SS at S2, and SS1 disconnects relay LL, thus extinguishing the calling lamp. Contact S3 connects the retard IC to the incoming positive line and sufficient current now flows through relay LA (Fig. 6) to cause it to operate. LA1 operates LB to switch the lines through to the manual relay-set. Contacts LB1 and LB2 disconnect the ring trip battery and ring tone from the negative and positive lines respectively.

If the call is from a subscriber at an Automatic Exchange and is proper to the subscriber on interception, the interception operator depresses the "switch" key (Fig. 7). This operates relay SW which, at contact SW1, completes a high resistance circuit for relays LC and D (Fig. 6). Relay D does not operate, but LC operates and completes a circuit for relay K via LC1. At K3, relay K locks itself to the earth on the P-wire of the final selector multiple,

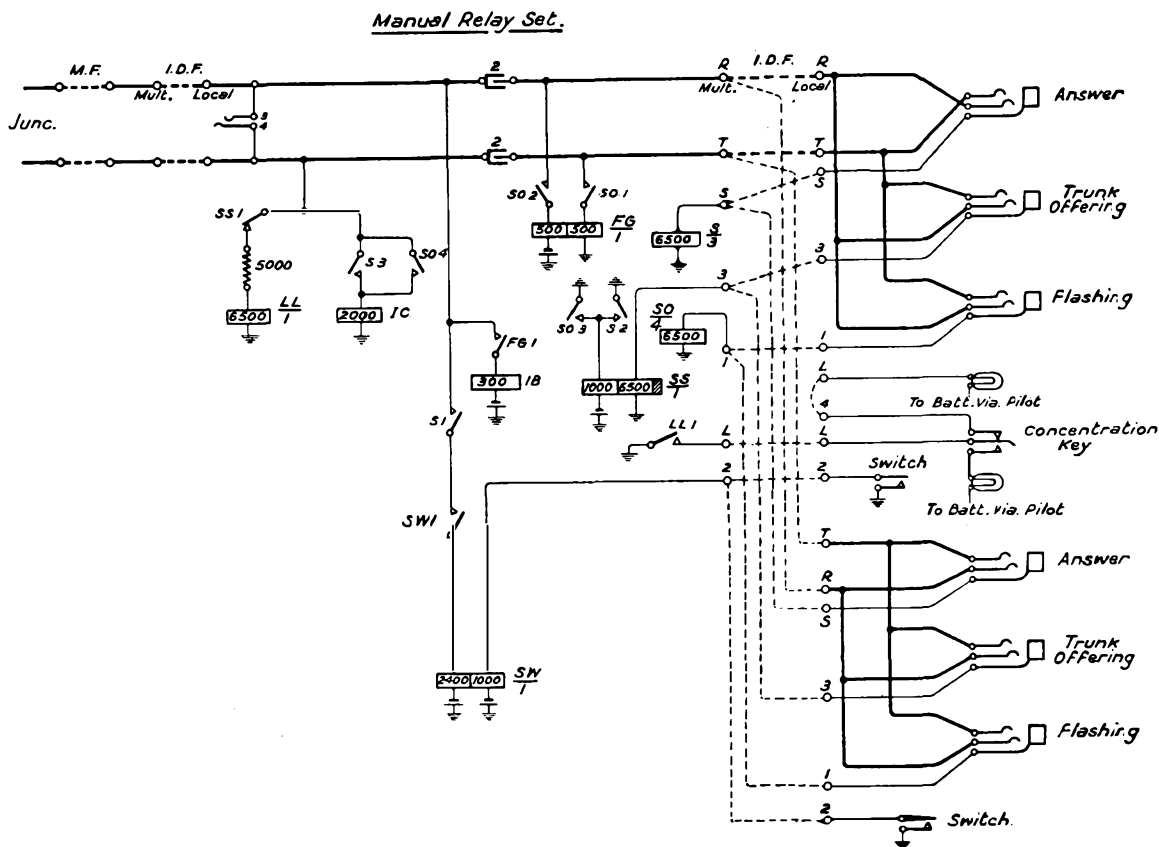

FIG. 7.—MANUAL SWITCHBOARD TERMINATION FOR "FULL FACILITY" EQUIPMENT.

and K1 and K2 switch the incoming lines away from the manual board circuit.

If an outgoing call is in progress, KO has operated from the P-wire, and, when K operates, busy tone is returned to the calling subscriber *via* KO2 and K2. If the intercepted subscriber's line is free, KO is normal and contact K4 operates relay H, which at H1 and H2 connects ringing and ringing return to the negative and positive lines. The answering of the call causes relay F to operate and complete the connexion at F3 and F4. The operator can listen *via* the 1 μ F condensers which bridge contacts K1 and K2, and, when she is satisfied that the connexion is established satisfactorily, she withdraws the plug from the answering jack. The disconnexion of relay S releases relay LA, which in turn releases I.B. Contact LB5 disconnects relay FL which, at FL2 removes the "finder busy" condition from the allotter.

call, the interception operator replaces the plug in the answering jack and depresses the "switch" key.

For trunk-offering purposes, the interception operator plugs into the trunk offering jack, thus releasing relay S, but retaining SS. Relays IA and LB (Fig. 6) release, and a speaking circuit is completed *via* LB3 and LB4 and wipers F5 and F6 to the intercepted subscriber's line. The operator challenges and, if the subscriber is engaged, "offers" the trunk call. She can then listen until she hears that the line is clear, when, by returning to the answering jack and depressing the switch key, the call is completed.

Changed Number Equipment.

Each final selector multiple number which is changed is jumpered across to a "changed number tapping relay-set" (Fig. 8). These relay-sets are connected to the banks of a uniselector which is

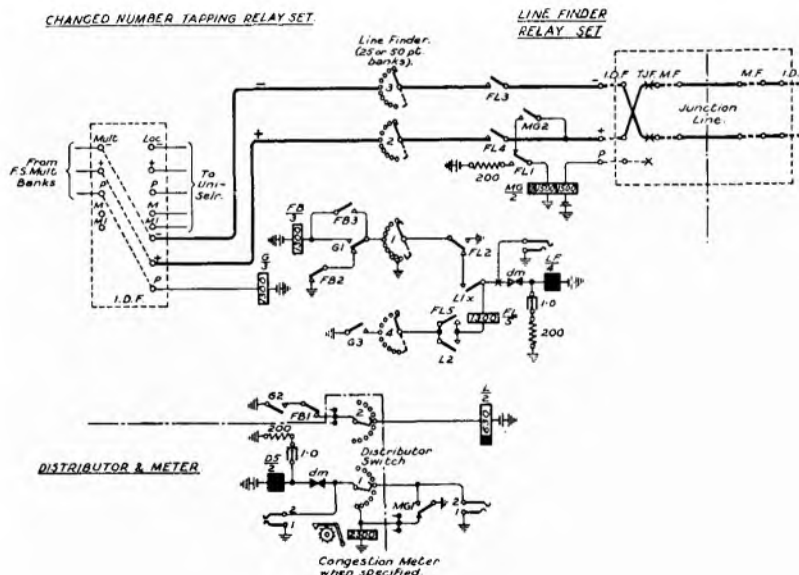

FIG. 8.—" CHANGED NUMBER " INTERCEPTION EQUIPMENT.

If the call has been originated by a subscriber on a Manual Exchange, the interception operator transfers the plug from the answering to the "flashing" jack, thereby releasing relay S and operating relay SO. Contacts SO1 and SO2 connect relay FG to the cord circuit, the operation of FG applying battery *via* the retard IB to the negative line. This low resistance battery operates both relays LC and D, and D connects retard IA across the supervisory at the Manual Exchange. By alternate operation of the flashing key, the distant supervisory lamp can be "flashed" to attract the attention of the operator. The coincidence of operation of contacts LC1 and D2 together with the slug on relay K prevents this relay from operating. In order to switch the

associated with a finder relay-set, the latter in turn being connected *via* a manual relay-set (Fig. 9) to the manual board calling equipment.

The line-finder uniselector may be of the 25 or 50-point type, and, where traffic requirements necessitates more than one such finder, an allotter is provided to route the calls in succession to the idle finders.

When a call is routed to a particular tapping relay-set, relay G is operated and at contact 2 operates relay L over the bank contact of the allotter, while contacts G1 and G3 complete the circuits for the line-finder to hunt for and "cut in" on the contacts with which the tapping relay-set is associated. It will be seen that the circuit conditions are similar to

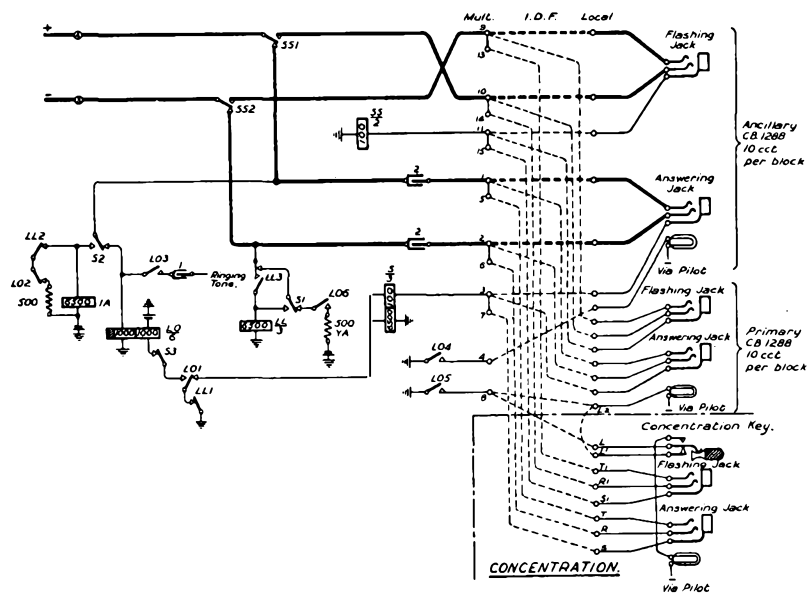

FIG. 9.—MANUAL SWITCHBOARD TERMINATION FOR "CHANGED NUMBER" EQUIPMENT.

those obtaining on the full facility line-finder equipment.

The operation of relay FL switches the negative and the positive lines through to the manual relay-set which may, or may not, be in the same building as the finder relay-set.

The ringing return battery, which is applied to the positive leg of the final selector, operates relay LO which at LO1 locks in. Contacts LO4 and LO5 complete circuits for calling lamps on primary and ancillary positions on the manual board, LO3 supplies ringing tone to the calling subscriber, whilst ringing is tripped by LO6.

The operator plugs into the answering jack and enquires the number being called and that of the calling party. If the call originates at an automatic exchange, all the operating is done from the answering jack, but if a manual exchange is involved the plug is transferred to the flashing jack.

Dealing with the automatic case first, it will be noticed that, owing to the high resistance of retard IC and relay LL and to the condensers in the lines, metering does not take place when the operator answers.

Relay S operates over its two coils in series, thus preventing the supervisory lamp from glowing. Contact S disconnects the ringing trip battery and connects the high impedance clearing relay LL to line; S2 takes the operating coil of relay LO from the positive line and connects the retard IA in its place. Relay LL operates to battery from the final selector D relay and locks in over LL3. Contact

LL2 disconnects the 500-ohm shunt from the IA retard before LO2 has released.

When the call clears, relay LL is released and thus at LL1 short circuits the 6,500 ohm coil of relay S. This decreases the sleeve resistance and causes the supervisory lamp in the cord circuit to light, thus giving the operator a visual signal.

The circuit is arranged so that the removal of the plug from the answering jack does not result in the calling signal operating again—on the release of S—LO cannot re-operate since, after the F relay in the final selector has once operated, the positive line is connected to earth *via* the D relay. When a plug is inserted in the flashing jack, relay SS operates and switches the lines through to the flashing jack and cord circuit, thus providing ordinary C.B. conditions.

On completion of the call, the subscriber replaces the receiver and releases all the selectors, thus releasing relay G (Fig. 8) and hence relay FL. Before the line-finder is marked "free" on the allotter (by the release of contact MG1) however, it is necessary to ensure that the operator has withdrawn the plug. For this purpose, the 500-ohm shunt across retard IA is provided, so that while relay S is still operated after LL has released, a comparatively low resistance battery is applied to the positive line to retain relay MG (relay FL having released). When the operator does withdraw the plug, S releases and releases relay MG, thus, at MG1, taking the "line-finder busy" condition off the allotter bank.

London Central Directory Enquiry Bureau

L. E. MAGNUSSON.

THE Directory Enquiry Bureau, as its name implies, is a Bureau where all enquiries in respect of the Directory are dealt with. Prior to the opening of the Central Bureau, enquiries were dealt with at five different centres and the operators at these centres were required to perform the somewhat laborious task of referring to the Directory, with its small type, and consulting numerous supplementary lists of changes which had occurred since the last issue of the Directory. A considerable amount of work was necessary in keeping these Directory Centres informed of the changes which occur hourly in every part of the London Telephone area. Advices of changed numbers, changes of name and address, new numbers, etc., had to be telephoned to a central office and from there the information had to be distributed to each Directory Enquiry Centre. The accuracy of the information given to a person making an enquiry depends, mainly, upon the rapidity with which particulars of changes are incorporated in the records

of the Enquiry Bureau, and some delay was inevitable when the records of five different offices were required to be kept up-to-date. The growth in the number of subscribers in the London Telephone Area and the consequent large number of enquiries made, justified the centralization of the Directory Enquiry work on the grounds of improved service and more economical working. The general lay-out of the Bureau is shown in Fig. 1.

Outline of Scheme.

The Directory at the new central bureau has been sectionalized in compact loose-leaf booklets and various sections have been allocated to different operators. Automatic subscribers dialling DIR or Manual subscribers asking for Directory Enquiry will, in each case, be routed *via* Tandem to the Central Bureau where an operator, known as the Distribution operator, will take particulars of the enquiry and route the call to the operator dealing with the particular section of the Directory. The



FIG. 1.—GENERAL VIEW OF SWITCHROOM.

sections of the Directory are arranged in tiers of pigeon holes in front of the Directory operator (see Fig. 2) and she is able to select the particular booklet and give the required information.

Special operating and equipment features.

The Distribution Positions are regular C.B.10 sections of the Auto-Manual switchboard type and the key-board lay-out has been arranged to meet the special needs of Directory Enquiry work (see Fig. 3). The incoming jack-ended equipments, which are multiplied every six panels, terminate on the Distribution Positions. The jack-ended equipments serving automatic exchanges provide standard non-registration conditions when the Distribution

operator answers, whilst those serving manual exchanges provide standard supervisory conditions at the manual exchanges.

The Distribution operator answers a calling signal by inserting an answering plug into the relative jack and, in doing so, extinguishes the calling lamp and the lamp associated with the answering cord. The Distribution operator, with the cord circuit "Speak" key normal, then proceeds to question the caller as to the name and address of the subscriber required. Having obtained this, she throws the "Speak" key into the "Speak DIR and Hold" position, inserts the calling plug into the jack associated with the head set of the appropriate street index operator and repeats the particulars of the enquiry. If the



FIG. 2.—DIRECTORY POSITION.

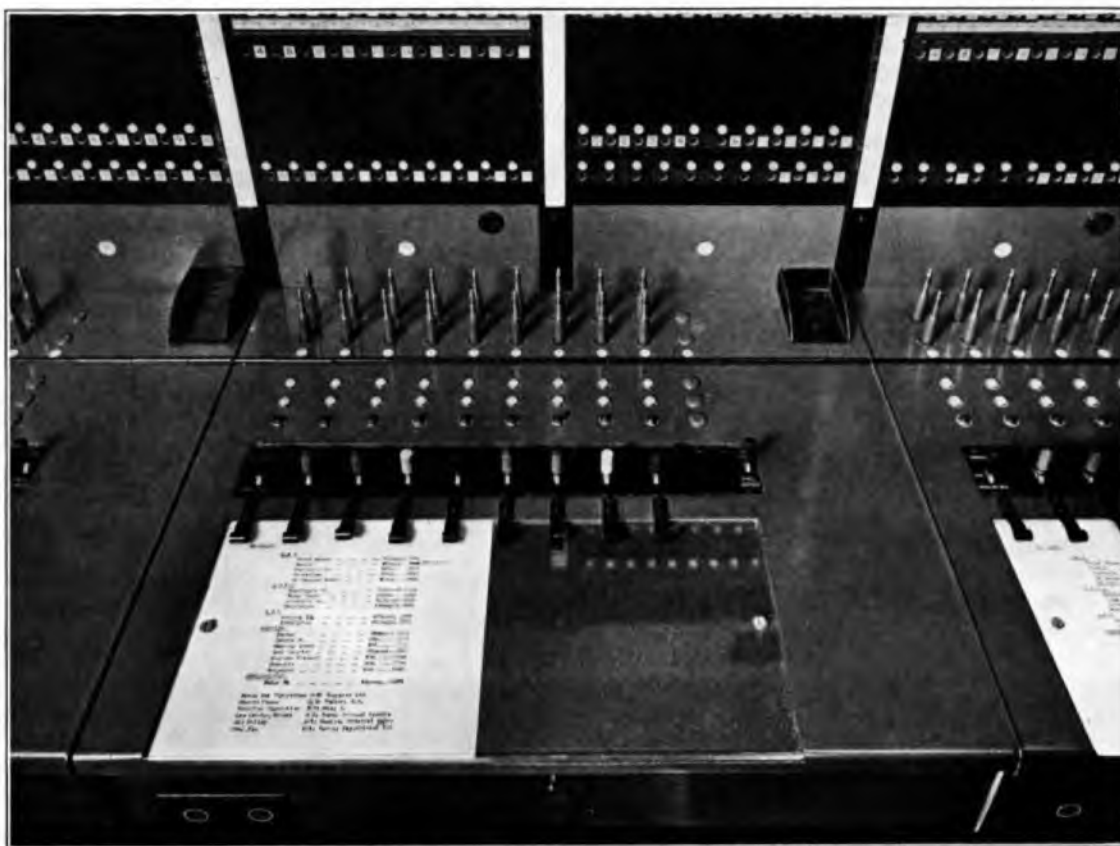

FIG. 3.—DISTRIBUTION POSITION KEYBOARD.

caller is unable to state the name of the street in which the required subscriber resides, connexion is made to the name index operator. In order that the caller shall not hear the demand being passed to the Directory operator, the cord circuit "Speak" key has been arranged to disconnect the answering cord when placed in the "Speak DIR and Hold" position. In the event of the Distribution operator not being able to dispose of the call immediately, she will leave the "Speak" key in the "Speak DIR and Hold" position and the red lamp, associated with this position of the key, will glow to remind her that the connexion must be completed when a circuit to the Directory position is available. After having passed forward the particulars of the enquiry to the Directory operator, the Distribution operator throws the "Speak" key to the "Through" position, when the caller will be switched through and the cord circuit prepared for a subsequent clearing signal from either side of the circuit.

The outgoing lines to the Directory positions are worked on the Visual Idle Indicating scheme, the signals of which are multiplied over both the Distribution and Directory positions.

The insertion of the calling plug into a Directory circuit extinguishes the visual idle indicating signal

associated with each repetition of the particular Directory circuit. The signal is also extinguished when a Directory position becomes vacant, thus ensuring that no calls are connected to a busy or unstaffed position. A call-count meter associated with the Directory position will operate when a call is connected to the position. After the Directory operator has supplied the necessary information she throws the "clear-down" key and a pulse is thereby transmitted to the cord circuit clear-down relay, the operation of which causes—

- (a) Both the calling and answering supervisory lamps on the Distribution position to glow.
- (b) A clearing signal to be given to a manual exchange.
- (c) Disconnexion of the operator-hold in the case of automatic calls.
- (d) Disconnexion of the cord circuit from the operators head set, thus making her immediately available for another call.
- (e) The visual idle indicating signals associated with the particular Directory circuit to glow.
- (f) The incoming junction circuit is freed for the reception of a following-on call irrespective of the cord being cleared from the jack.

As a safeguard against slow clearing on the part of the Directory operator, the incoming junction relay-set has been designed to transmit a pulse to operate the clear-down relay in the cord circuit 6 to 12 secs. after the originating subscriber clears. The Distribution operator takes down the cords upon the receipt of double clearing signals and restores the "Speak" key to the normal position, when the calling and answering supervisory lamps are extinguished. In the event of a following-on calling signal being received before the cord has been withdrawn from the incoming circuit, the Distribution operator is able to answer the call by simply restoring the "Speak" key to the normal position; the calling cord, of course, has to be withdrawn from the Directory circuit.

In a number of the more common enquiries, such as for the telephone numbers of railway stations, etc.—these are entered in the Directory under the name of the company running the service and not under the name of the station—the Distribution operator is able to answer the enquiry by referring to the position bulletin which is fitted under a glass panel in the front of the keys (see Fig. 3).

Transfer Circuits.

It is often necessary for a Directory operator to be able to communicate with another Directory operator for the purpose of referring to another part of the Directory. For this reason, Transfer keys have been provided and each Directory operator has access to any other Directory operator by simply throwing the appropriate key. Associated with each transfer key is a visual idle indicating signal. The operator is thereby able to ascertain whether or not the particular Directory operator is busy before throwing the key. The throwing of a "transfer" key performs the following functions:—

- (a) Places the calling operator into direct communication with the operator called, and, at the same time, disconnects the incoming circuit from the calling operator's headset. The incoming circuit, however, remains held.
- (b) Extinguishes the visual idle indicating signals associated with the called Directory operator's circuit on both the Distribution

and Directory Positions. The visual idle indicating signal associated with the calling operator's circuit remains extinguished, but should the person making an enquiry clear while the operator is using a transfer circuit the signal will glow. A following-on call will light the position pilot lamp, if this occurs when a "transfer" key is thrown. The pilot lamp is also lit if a call is connected to an unstaffed Directory position.

Directory Positions.

The Directory Positions, which have been arranged as a double row with the Directory pigeon holes between and accessible from either side, will permit co-operation between six Directory operators. Referring to Fig. 2, it will be seen that the booklets are arranged so that the covers in one half face the opposite side. By this means the particular section of the Directory allotted to an operator is indicated. Calls for this section of the Directory will normally be connected to her, but, in the event of her being engaged, the Distribution operator can effect a connexion to any of the other five Directory positions abutting the primary choice position. To facilitate team working between six operators, the circuits to the Directory Positions, with their visual idle indicating signals, appear in the outgoing multiple on the Distribution Positions as an actual lay-out plan of the Directory Positions (see Fig. 4). The same also applies to the "transfer" keys on the Directory Positions. With this scheme the staff can gradually be withdrawn from the Directory Positions and the traffic is directed to an idle operator who has easy access to the particular records. When a Directory operator is required to cover more than six adjoining positions, the actual number of positions covered are indicated by means of coupling indicating spot signals which are placed over the relative jacks in the outgoing junction multiple. These spot signals are controlled by means of keys fitted on the cable turning section. Referring to Fig. 4, and assuming an operator is required to control the first eight Directory Positions, the "coupling indication" key marked "7 & 8" is thrown, and this lights the spot signal over the jacks and thus indicates that only one operator is staffing positions one to eight.

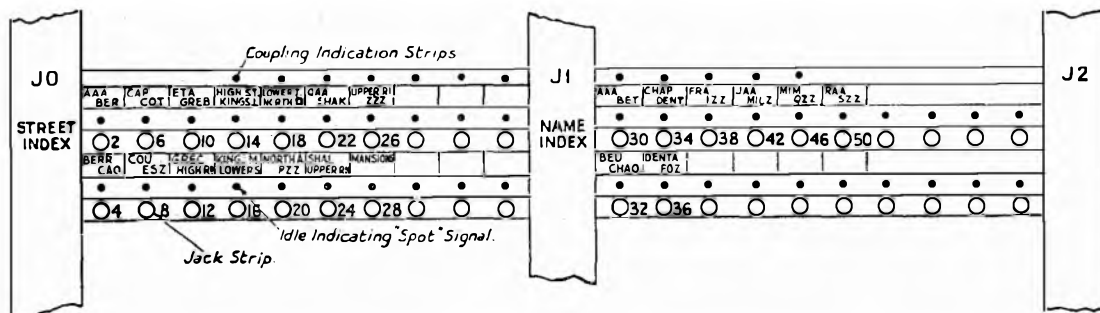

FIG. 4.—ARRANGEMENT OF OUTGOING MULTIPLE.

Clerical Positions.

In order to keep the Directory up to date, exchanges have instructions, immediately upon the completion of any work (under advice note authority) affecting the telephone number, name or address of a subscriber, to report the details to the clerical staff at the Central Directory Enquiry Bureau. The incoming circuits, which are at present accommodated on spare Directory Positions, are answered by a telephonist who records the particulars in triplicate, or in the case of a changed number or new line, in duplicate. The forms are immediately handed to a messenger who delivers them to the appropriate Directory Positions. Thus in the case of a removal, one copy is delivered to the name index, one to the street index of the old address and one to the street index of the new address. The typed amended slips for incorporation in the actual booklets are prepared from the Daily Report which is compiled from the completed advice notes.

Circuit Design.

The chief points of interest, from a circuit design point of view, are the methods adopted to meet the special operating facilities which are required to ensure complete flexibility of switching from one point to another and for the rapid clear-down of the connexion once the information has been provided. Fig. 5 shows, schematically, the signalling arrange-

away and contact L2 short circuits the high resistance winding of relay CO. The lamp, which does not light when connected *via* the high resistance winding of relay CO, will glow when connected to earth *via* the low resistance winding. Similar signalling conditions apply when the calling cord is connected, except, in this case, flashing of the calling cord supervisory lamp is effected by the "Flashing" key on the Directory Position.

The clearing down of the connexion by the Directory operator is effected in the following manner. As previously described, the Distribution operator connects the calling subscriber to the Directory operator by throwing the "Speak" key to the "Through" position. This connects relay CD across the talking conductors. When the Directory operator throws the "clear-down" key, battery is transmitted *via* the tip of the cord to operate relay CD. This relay locks up *via* its own contact CD₁, and disconnects the talking and sleeve conductors. At the same time both supervisory lamps are made to glow. This complete disconnexion of the calling and answering cords from their respective circuits is, in effect, the same as taking down the cords. The Incoming Junction circuit and the Directory circuit are thereby made available for a following-on call irrespective of the cords being cleared from the circuits. In the event of slow clearing on the part of the Directory operator, the incoming junction

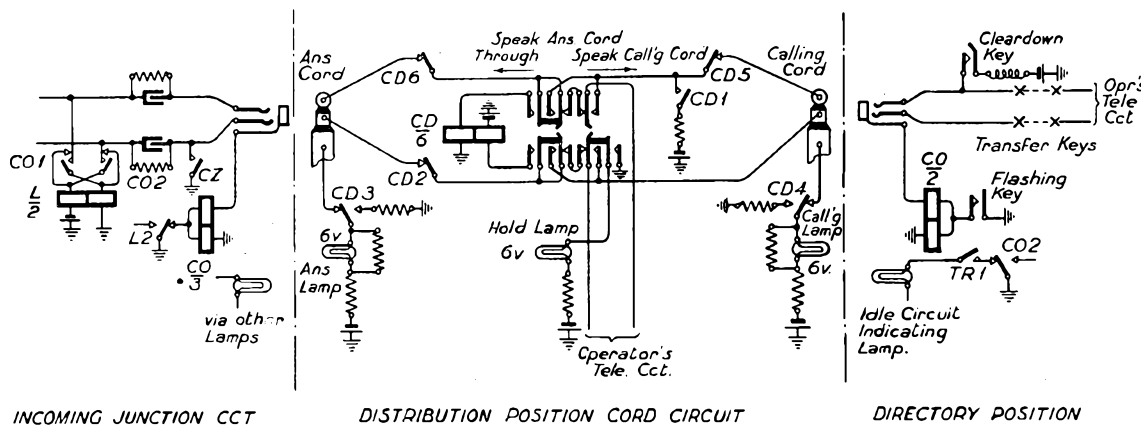

FIG. 5.—SCHEMATIC DIAGRAM OF CONNEXIONS.

ments involved when a caller is connected to a Directory Position. When the operator answers a call, relay CO in the incoming junction circuit is operated from battery *via* the cord circuit answering lamp. The contacts of CO control the disconnexion of the ringing tone, the extinguishing of the calling lamps, and the application of operator-hold condition in the case of calls from automatic exchanges, or the operation of the supervisory signals in the case of calls from manual exchanges. Flashing signals from the caller are transmitted to the cord answering lamp in the following manner. Relay L falls

circuit is made to transmit a pulse over the B-wire within 6 to 12 seconds of the caller clearing; this pulse operates relay CD and results in the disconnexion of the cord circuit, as previously described. The locking circuit of relay CD is broken when the speak key is restored to the normal position.

The idle indicating lamps associated with the Directory circuits are controlled normally by relay CO; when the latter relay operates, contact CO₂ disconnects the lamp circuit, thus indicating that the position is not available for a call. The lamp is also extinguished when the operator pulls her "head-

set " plug out of the instrument jack. This is effected by inserting a relay (TR) in series with the battery feed to the transmitter circuit. The contact of this relay (TR₁) is inserted in series with the idle indicating lamp circuit and thus controls the signal.

The " Transfer " keys, by which a Directory operator may obtain communication with any other

Directory operator, are designed, when operated, to disconnect the incoming talking conductors and to connect the caller direct to the called operator's telephone circuit. The action of throwing the " Transfer " key also transmits a battery to operate the CO relay of the called circuit, thus busying the position by extinguishing the visual idle indicating signal.

Accommodation for Cables in Manholes and Subways

F. G. C. BALDWIN, M.I.E.E.

THE complexity of the problems encountered in the design, construction, and upkeep of telephone exchange systems increases enormously with the number of telephone circuits to be provided for, and perhaps it is not an exaggeration to say that the telephone constructional engineer of the present day is largely occupied with the problems associated with accommodation.

One of the problems of this nature which, from time to time, has been given much consideration is that of the arrangement and disposition of cables and cable joints in underground manholes and subways, and of the provision of suitable accommodation for cables and their terminations between the street and the main frames at telephone exchanges. The problem has assumed greater importance in recent years owing to the increasing congestion of service mains of all classes accommodated below ground and the increasing number of circuits to be accommodated.

The question of cable accommodation is of much importance and it is necessary that the provisions made should not only conform to the essential technical requirements, but, should also secure the utmost economy in initial expenditure and subsequent maintenance.

A good deal of valuable work has been done in standardization of design in underground construction, but varying local conditions, which must be taken into consideration, frequently intervene, and consequently it is necessary to depart from such standards in many cases.

This short article is the result of a suggestion made to the author that readers of *The Post Office Electrical Engineers' Journal* would be interested in particulars of some works executed in Newcastle-on-Tyne a short time ago, in which it is considered that certain desirable improvements upon standard practice were introduced.

For convenience the subject will be briefly dealt with under two heads as follows:—

- (1) The design of manholes and arrangements for the accommodation and support of cables and joints therein.

- (II) Accommodation for line cables and their essential joints in telephone exchanges.

(I) Manholes.

In the past manholes have usually been designed, and conduits have been laid in such a way, as to necessitate the bank of cables passing directly through the middle of the manhole in conformity with standard practice.

When the number of cables exceeds about eight or where the number of cables abreast exceeds three, difficulty arises in jointing the innermost cables after the outer ones have been installed, and access thereto at a later date is rendered almost impracticable. Further, the provision of satisfactory supports for cables and their joints, when installed in this manner, is both difficult and costly, with the result that in some cases it is omitted altogether.

Unless manholes are made unduly large the available space for jointing is also restricted. The considerable use now made of the streets for underground services of all descriptions demands that space should be conserved as much as possible, and manholes made no larger than is essential for the satisfactory execution of the work to be done within them.

In order to remove some of the disabilities of the practice referred to, the method of dividing the bank of cables vertically into two approximately equal portions, and supporting them and their joints upon suitable bearers affixed to the two side walls of the manhole has been adopted with highly satisfactory results.

A typical and simple case is shown in Fig. 1. The manhole entrance is directly over the centre, and a removable iron ladder, affixed as shown, provides a means of access instead of steps let into the walls. The ducts on either side are " splayed " where the number of ducts justifies such a measure, so that they may enter the manhole somewhat nearer the side walls, in order to reduce the bend of cables between the mouth of the duct and the first support.

The cable bearers are in the form of cantilevers supported upon vertical steel channels affixed to the

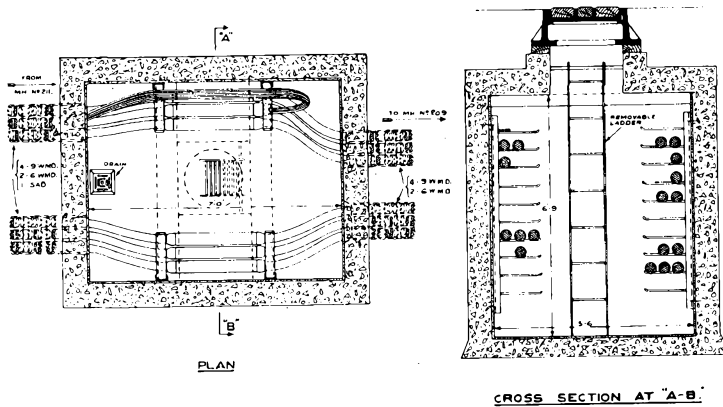

FIG. 1.—SIMPLE MANHOLE ACCOMMODATING 49 DUCTS, WITH ENTRANCE IN CENTRE AND CABLE JOINTS SUPPORTED UPON SIDE WALLS, CORNER OF CARLIOL SQUARE AND WORSWICK STREET, NEWCASTLE-ON-TYNE.

walls, as shown, and the supports are so arranged that the cables, and not the joints, rest upon them. Where practicable, not more than two cables are accommodated abreast on one bearer. The bends in the cables at each end of the manhole give flexibility which permits a certain amount of movement if required at a later date. Advantages derived from the method described are:—

- (a) Cables and joints are more accessible.
- (b) Satisfactory support of the cables is facilitated.
- (c) Working space for jointers is improved.
- (d) Total cubical contents of manhole for a given number of cables is reduced, with consequent saving in cost of construction.

A plan and elevation of a further manhole, with cables arranged in a similar manner, are given in Fig. 2. In this case the manhole is situated at a right-angle turn in the duct line and its particular shape has been derived from a square as indicated by the dotted lines.

Importance is attached to the desirability of designing each manhole in relation to the cables (and their branches, if any) ultimately to be accommodated, together with their supports. The construction of large manholes on more or less arbitrary and standard lines, without respect to the subsequent arrangement of cables and joints within them, is to be deprecated.

Photographs representing a manhole with cables arranged in the manner referred to appear in Figs. 3, 4 and 5.

The manholes illustrated, which are typical of all large manholes included in the same scheme, were designed in 1927 and constructed in the following year.

(II). Leading cables into telephone exchanges.

A great deal of thought and consideration has been given for many years to the accommodation to be

afforded for cables entering telephone exchanges. The difficulties are by no means inconsiderable and much ingenuity is called for in evolving suitable schemes which shall be satisfactory from all points of view. The conditions to be fulfilled may be stated briefly as follows:—

- (a) Provision must be made to accommodate the ultimate number of cables.
- (b) Satisfactory accommodation for cables and their terminating joints, and means for their support must be provided.
- (c) The general arrangements must be such as will permit of extension of the M.D.F. in successive stages, section by section, from the commencing end as occasion may arise—in other words, they must be sufficiently flexible to permit of any cable being terminated at any position on the M.D.F.
- (d) The cables and joints must be readily accessible and adequate room for cabling and jointing operations must be available.
- (e) Regard must be paid to architectural features.
- (f) The length of the relatively expensive termin-

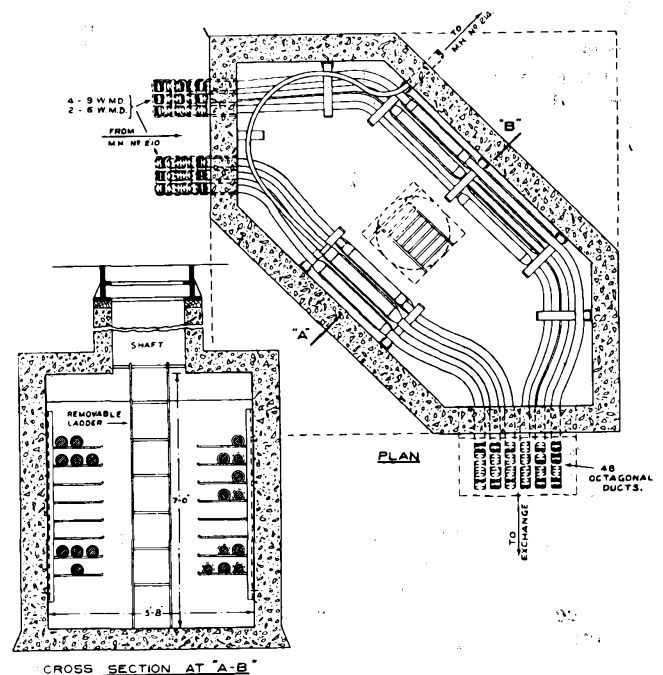

FIG. 2.—MANHOLE AT RIGHT ANGLE TURN IN DUCT LINE ACCOMMODATING 48 DUCTS, ENTRANCE IN CENTRE AND CABLES SUPPORTED UPON SIDE WALLS, N.E. CORNER OF CARLIOL SQUARE, NEWCASTLE-ON-TYNE.



FIG. 3.—PHOTOGRAPH OF PORTION OF A MODEL MANHOLE WITH CABLES AND JOINTS SUPPORTED ON SIDE WALLS.

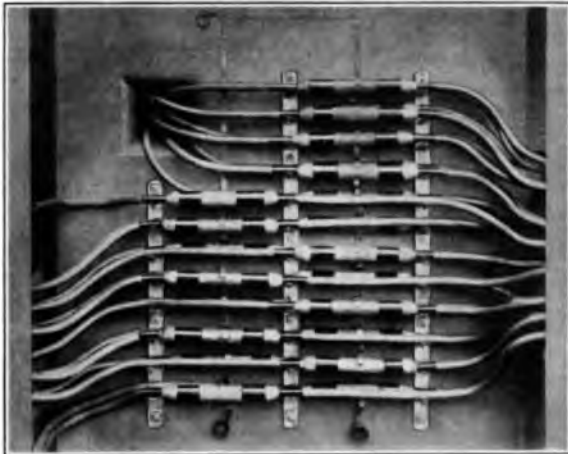

FIG. 4.—PHOTOGRAPH OF PORTION OF A MODEL MANHOLE WITH CABLES AND JOINTS SUPPORTED ON SIDE WALLS.



FIG. 5.—PHOTOGRAPH OF PORTION OF A MODEL MANHOLE WITH CABLES AND JOINTS SUPPORTED ON SIDE WALLS.

ating cable should be as short as practicable.

- (g) The cabling and building costs should be so balanced that the overall cost is a minimum.

The above is a formidable list of requirements which can only be satisfied by the application of skilled attention in the early stages of the design of the building.

Cases to be dealt with may conveniently be divided into two classes as follows :—

- (1) Where the main frame upon which all cables are to be terminated is situated upon the ground floor.
- (2) Where the main frame is upon a floor above the ground floor.

Location of the M.D.F. upon the ground floor removes many of the difficulties associated with the provision of satisfactory leading-in facilities and is an ideal arrangement. An essential requirement is, however, that the method of leading in to be adopted should be determined when the architectural features are in the initial stages, and that the details should be worked out to scale before final approval of the architect's drawings. Otherwise, the provision made may be found inadequate or seriously inconvenient, and accompanied by added cost to the cable equipment out of all proportion to the additional building costs, if any, which might have been incurred.

Whatever system of leading-in is adopted, it is important to bear in mind the condition that the M.D.F. is normally extensible in one direction only, and in successive steps starting from the first fuse vertical. Consequently, line cables must follow one another in similar steps. As future development is unknown, the order in which cables will be led into the building and the particular ducts which they will occupy, is problematical, and therefore the cable supports, bearers or racks, must allow of a cable in any position being taken to the M.D.F. from any point of the rack without fouling a neighbouring cable either initially or subsequently. Fig. 6 shows the leading in arrangements as originally designed and as actually carried out in 1930 at the Low Fell, (Newcastle) Exchange. This is considered to be one of the best and most economical arrangements for an exchange approximately of the ultimate capacity in question, viz., 5,000 lines. All cables are carried upon inexpensive supports affixed as shown in the drawing. This vertical arrangement of joints was first used systematically at the Victoria (London) Exchange in 1913 and fulfils all the conditions cited above. The height of the basement chamber must be such that sufficient headroom is allowed for vertical joints of the maximum length and cables branching therefrom to the M.D.F. above, for the bend of the main cable above the uppermost cable bearer and for the requisite number of cable bearers. Clearance between bearers must permit of one cable

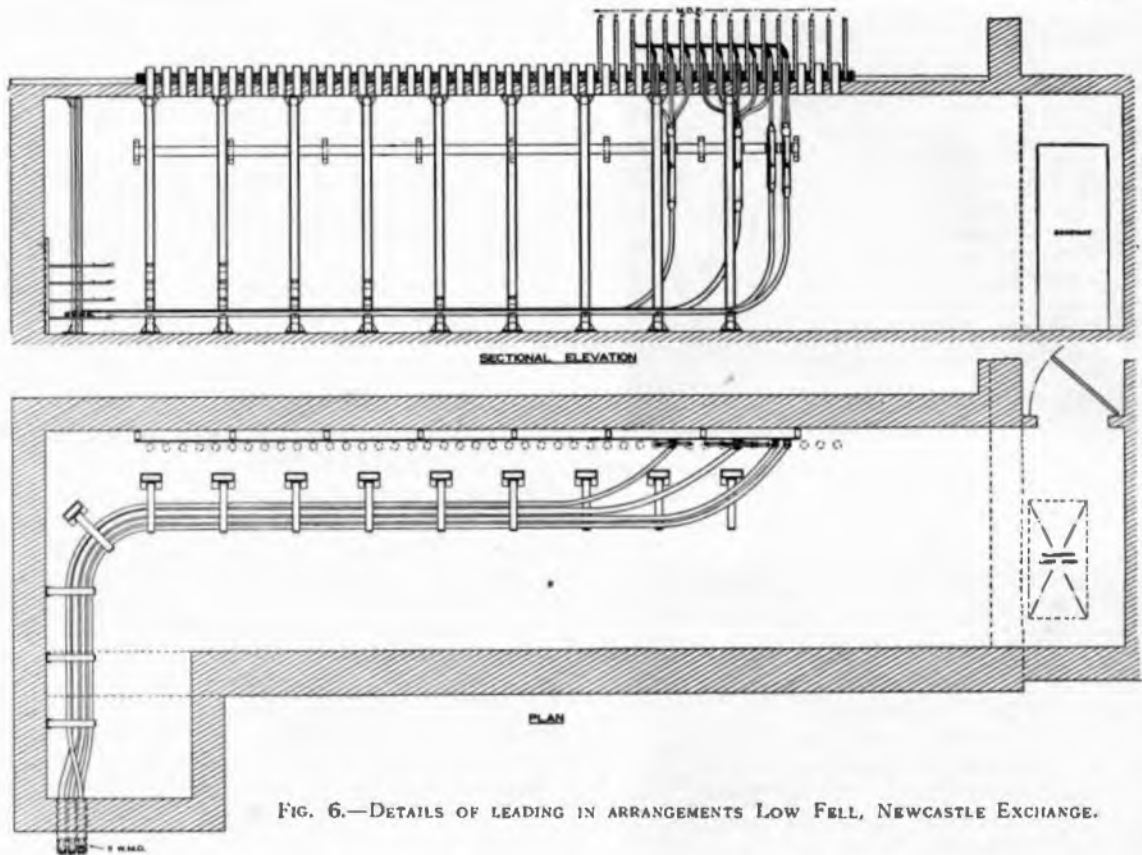

FIG. 6.—DETAILS OF LEADING IN ARRANGEMENTS LOW FELL, NEWCASTLE EXCHANGE.



FIG. 7.—PHOTOGRAPH OF LEADING IN ARRANGEMENTS, NEWCASTLE EAST EXCHANGE.

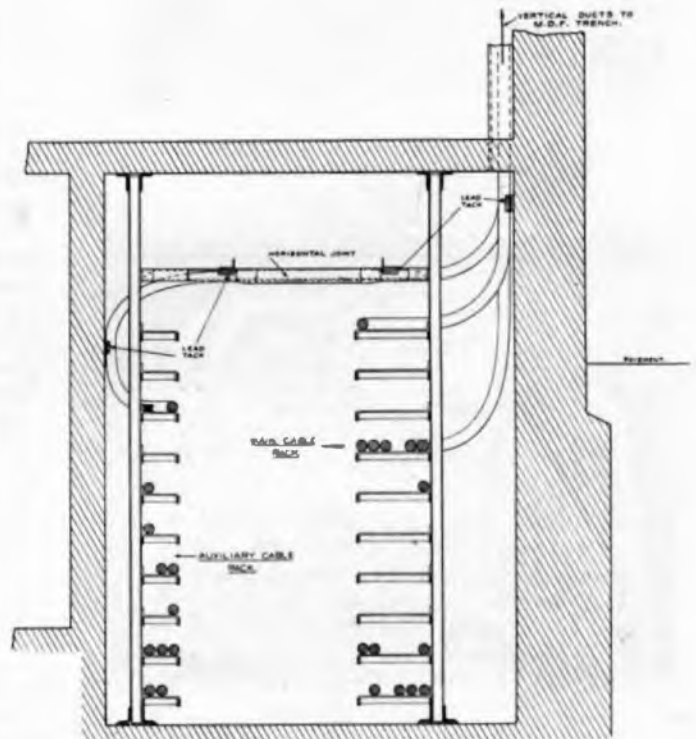

FIG. 8.—CROSS SECTIONAL ELEVATION OF NEWCASTLE CENTRAL AUTO EXCHANGE CABLE SUBWAY, SHOWING RACKS AND CABLES.

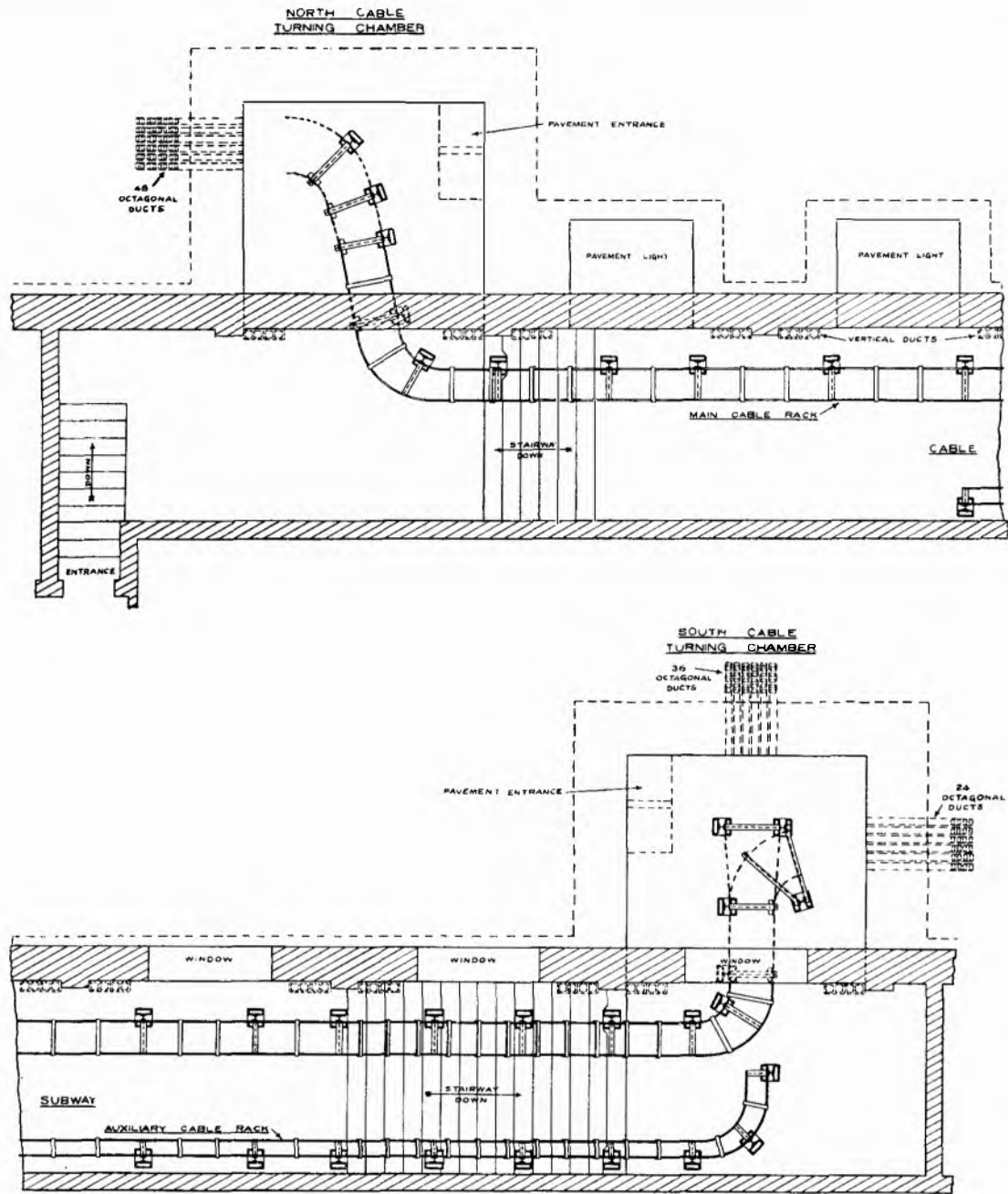

FIG. 9.—PLAN OF NEWCASTLE CENTRAL AUTOMATIC EXCHANGE CABLE SUBWAY, SHOWING CABLE RACK.

crossing over another in order that a cable from any position may be led out at any point desired.

The vertical height of the cable chamber is therefore a dimension of much importance and obviously must be settled before the construction of the building is commenced. The necessity for settling the details of the leading in arrangements in the initial plan stages will no doubt be apparent.

A photograph of the leading in arrangements at

the Newcastle East Exchange is reproduced in Fig. 7.

The present standard method of leading cables to an M.D.F. on a higher floor than the ground floor has been in force for many years, and is generally satisfactory. The chief difficulty is the architectural one of providing the requisite number of vertical ducts between the basement and the floor on which the M.D.F. is situated. In this connexion, the

adoption of a vertical duct of smaller cross section than the present standard of four inches square is worth consideration.

The largest cables employed can be accommodated in $3\frac{1}{4}$ " ducts and by using these a desirable increase in the vertical accommodation could be secured. There are many cases where the vertical provision is deficient, owing to the limited space available.

A case presenting some interesting features and many complications was that of the Newcastle Central Exchange, equipped in 1930. The M.D.F. is situated on the second floor, and provision is made for a further M.D.F. on the first floor immediately below, if, and when, required. There are, in all, 88 vertical ducts built into the front wall of the building from the cable subway to the second floor. 48 underground ducts enter the subway at the north end and 60 ducts, in two separate groups and directions, at the southern end—in all 108 ducts. The difficulties were increased by the necessity for bringing in cables at each end of the subway, and several alternatives were considered.

Decision was made finally to provide one rack from end to end of the subway and, in order to avoid the possibility of overlapping between two cables entering one from each end, a contingency which could not be overlooked owing to exigencies of space and to other considerations, an auxiliary rack was provided for the requisite distance. The auxiliary rack is used to carry only those cables entering at the south end which, if put upon the main rack, would block positions eventually required for cables entering at the north end, these positions meanwhile being vacant.

The main rack has 10 shelves, each providing accommodation for six cables abreast; the auxiliary rack will carry two cables abreast and has a similar number of shelves. No special provision is made in the subway for jointing cables upon the main rack and all such cables are run through without jointing. All cables carried on the auxiliary rack are jointed at the point where they cross the subway overhead. Fig. 8 is a cross section and Fig. 9 is a plan of the subway; both racks are shown and some of the cables and joints are shown in position in the first mentioned illustration. Figs. 10 and 11 are photographs of the same subway viewed from the north end. Both main and auxiliary racks are visible in the photographs, as well as some of the cables in position on the two racks. Provision is made for crossing on both racks. In this way all possible contingencies were provided for and a thoroughly flexible arrangement was achieved.

In view of the carefully designed method of formation of runs for cables it would be unfortunate if, in later years, new cables were drawn into such cable chambers in any haphazard manner. Drawings have, therefore, been prepared showing allotted positions for new cables, and a framed instruction is exhibited in the chambers indicating to foremen that no additional cables are to be laid on the racks without reference to these drawings.



FIG. 10.—PHOTOGRAPH OF LEADING IN ARRANGEMENTS, NEWCASTLE CENTRAL AUTOMATIC EXCHANGE.



FIG. 11.—PHOTOGRAPH OF LEADING IN ARRANGEMENTS, NEWCASTLE CENTRAL AUTOMATIC EXCHANGE.

Some Considerations in the Design of Telephone Cables

CHARLES F. STREET, M.I.E.E., Assoc.M.Inst.C.E.
(late Engineer-in-Chief's Office, G.P.O.).

DEVELOPMENTS in the design of telephone cables in recent years have been directed mainly towards the improvement of the "Star Quad" cable which is superseding the "Twin" and "Multiple Twin" types for all purposes.

In the Star Quad cable each "quad" consists of four insulated wires associated together to form, in section, a square. The four-wire square formation is then twisted about its own axis and the diagonals of the square are used to form a pair.

This type of cable owes its success very largely to its small space factor and consequent cheapness. The area occupied per pair for the same mutual capacity is less than for any other type of cable.

Star Quad cable can now be made with high class characteristics and is used for trunk purposes, whilst the same type of cable made with less precision is superseding the ordinary twin cable for subscribers' distribution.

For these reasons, this type of cable is generally dealt with in the following article:—

ELECTRICAL CONSIDERATIONS.

The necessary characteristics of a length of cable depend to some extent upon the class of circuit for which it is to be used.

No appreciable difficulties are encountered in obtaining the necessary qualities with regard to Conductor Resistance, Insulation Resistance or Leakage with modern design and methods of manufacture.

The features which require most attention are—

- (1) The actual value and the variations of the mutual capacity per mile of each of the pairs of wires, and
- (2) The immunity of interference between all the circuits in the cable.

Mutual Capacity.

When a pair of wires AB is twisted together there is a definite direct capacity "m" between them. When, however, the wires of a pair are associated with another pair to form a quad, and the quad is placed in a cable with other quads, the whole condition is changed and the mutual capacity between the wires AB is entirely different. The changed condition is shown in Fig. 1. Instead of the total capacity between the wires AB being "m" there are now additional capacities existing.

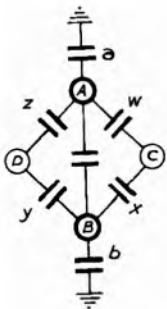

FIG. 1. — THE COMPONENT CAPACITIES OF A STAR QUAD.

If, for the sake of simplicity, a degree of uniformity is assumed, namely, $w = x = y = z$ and $a = b$, then the total capacity between the wires AB is now

$$M = m + w \frac{a}{2}$$

Investigation shows that "m" is now only a fraction of the total capacity between the pair of wires AB.

The relative value of these quantities varies according to the layer in which the quad is situated, as shown in the following Table I. :—

TABLE I.

RELATIVE VALUE OF COMPONENT CAPACITIES OF A PAIR. (ALL OTHER WIRES FREE).

Layer.	m.	w	a/2.	M.
Centre	19.1	50.3	30.6	100
1st	15.2	47.5	37.3	100
2nd (Outer) ...	12.8	41.7	45.5	100

In each case it will be seen that "m," the direct capacity between the wires in question, is only from 12.8% to 19.1% of the total capacity M. It is, of course, the quantity M which is of importance for telephone transmission problems.

The usual specified requirements of the Post Office Engineering Department for cables of 20 lb. wires and over are, that the mean value of M shall be $.066 \pm 5\% \mu\text{F}$ per mile.

The variations of individual pairs is governed by stating that the mean of all the deviations shall not exceed 4% and that the value of any pairs shall not differ from the mean of the cable by more than 12.5%.

The circumstances which affect these variations are discussed later on.

Interference.

The interference between one pair and another in the same cable may be due to either electromagnetic or electrostatic causes associated with dissymmetry of electrical characteristics and generally known as unbalances. It is convenient to classify the conditions under which interference occurs under three different headings and to consider each separately.

- (a) Interference between the two pairs in the same quad.
- (b) Interference between pairs in different quads in the same layer.

(c) Interference between pairs in quads in different layers.

(a) *Interference between pairs in the same quad.*

To minimise this it is necessary that the dielectric shall be uniform throughout its length and that special steps be taken to ensure that the four wires are placed and maintained in the position assigned to them. The use of diagonal wires to constitute a pair gives a symmetrical arrangement and the interference between the pairs in the same quad is probably a measure of the dissymmetry of the quad.

An indication of the magnitude of the interference expressed as unbalance on a 176-yard length is given by the following extract from P.O. Specification No. 448F :—

Capacity unbalances Within quad.

90% of cables. Mean/max = 33/125 $\mu\mu\text{F}$.

10% „ „ „ „ = 50/200 „

(b) *Interference between pairs in different quads in the same layer.*

In this case it is only necessary to consider quads which are next to one another, *i.e.*, adjacent in the same layer. With modern cables interference between quads in the same layer, which are separated by one or more intervening quads, is negligible. With a certain type of construction referred to later, this interference is however not negligible.

In the case under consideration the interfering pairs being adjacent in the same layer are parallel to one another and the method most generally adopted to prevent interference due to both electrostatic and electromagnetic causes is to twist the four wires of each quad about its own axis. The process of twisting together the wires of a pair or a quad is not only a very useful means of keeping particular wires associated, but its action presents each wire in turn in the same way to the source of disturbance and consequently, it is claimed, the net resulting disturbance in the circuit is nil.

In some conditions these claims are true. For example, if the disturbing source be a single conductor at a constant distance from the axis of the disturbed pair then the twisting process is effective.

In a telephone cable, however, the source of disturbance is seldom, if ever, a single conductor as assumed and in the case under consideration the interference is between two twisted pairs, and examination of these conditions reveals that the process of twisting now partly fails.

Fig. 2 shows the section of two pairs of wires Nos. 1 and 2 in four positions *a*, *b*, *c* and *d* occupied in one complete twist. The same pitch of twinning or quadding has been assumed for both pair 1 and pair 2. In order that A_1 shall not be interfered with by pair 2 it is necessary that A_2 and B_2 shall both operate on A_1 electro-magnetically and electrostatically in the same way. The twisting of pair 2 would accomplish this result if the wire A_1 were

placed and remained at the centre O. The twisting process fails because A_1 also moves. Reference to Figs. *a*, *b*, *c* and *d* shows that the distance between A_1 and A_2 is constant throughout the cycle, being equal to "*d*," but the distance between A_1 and B_2 varies from zero to $2d$.

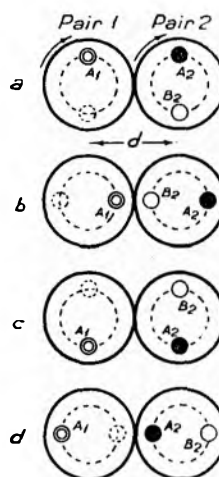

FIG. 2.—THE GEOMETRY OF WIRES IN ADJACENT QUADS HAVING EQUAL PITCHES (PAIRS PARALLEL).

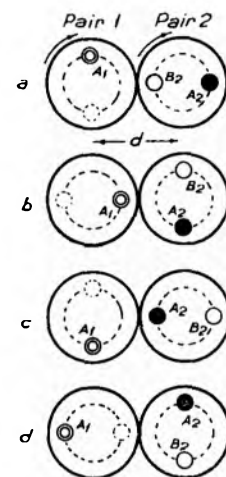

FIG. 3.—THE GEOMETRY OF WIRES IN ADJACENT QUADS HAVING EQUAL PITCHES (PAIRS AT RIGHT ANGLES).

As the capacity between the two wires A_1B_2 varies inversely as the distance between them, a few calculations will show that the capacity A_1 to B_2 can be very different to the capacity A_1 to A_2 when taken over the cycle of a complete twist.

In Fig. 3 the same pairs are indicated as in Fig. 2, but the lines joining the two wires of a pair are now at right angles instead of being parallel. Examination of this figure shows that the conditions are totally different to those shown in Fig. 2. In fact, not one of the positions which the pairs occupy in Fig. 2 ever occur in the arrangement shown in Fig. 3. It will be appreciated that this difference in geometric relationship of the conductors in separate pairs depends upon their relative positions at the commencement of the cycle of the twist.

In general it can be taken as impossible in practice to ensure that conductors in adjacent quads will occupy any specific position and that their relative positions are practically haphazard.

Unfortunately, no figures are available for a Star Quad cable showing the interference between adjacent quads with the same quadding pitch. The following figures for an M.T. cable will, however, answer the purpose. To demonstrate the point with this type of cable, it is necessary to consider interference between Phantom and Phantom of adjacent quads. In the cable in question the quadding pitches were 7" and 9" and in some instances the 7" quads were next to one another.

TABLE II.

Adjacent quads.	Ph.—Ph. ($p-q$).		
	Min.	Mean.	Max.
7" pitch to 7" pitch	30 $\mu\mu\text{F}$	131 $\mu\mu\text{F}$	305 $\mu\mu\text{F}$

These figures demonstrate that the unbalances between identical quads vary between very wide limits (30-305), and it is suggested that these variations are due to the geometrical conditions already referred to.

In practice the same quadding pitch is never employed for quads which lie alongside one another in the same layer. Nevertheless, even when different pitches are employed, it will be found that the interference between two adjacent quads having different pitches varies very considerably. That is to say, if a layer be made up of adjacent quads of say 5" and 7" pitches, the interference between some adjacent quads will be of a totally different magnitude to that between other adjacent quads although the quads under consideration are identical in construction. The author advances the opinion that these apparent inconsistencies are due, possibly among other causes, to the fact that the geometrical relationship of the pairs in question may be entirely different for the reasons shown in Figs. 2 and 3.

In a modern Star Quad cable the specified capacity unbalance limit for 176 yards of cable between pair and pair in adjacent quads is $\text{meant}/\text{max } 20/100 \mu\mu\text{F}$. A commercial figure which is fairly readily obtained is $11/50 \mu\mu\text{F}$.

Pursuing the geometrical difficulties referred to in Figs. 2 and 3 a solution is shown in Fig. 4. With this arrangement each wire of a pair is operated upon by the other pair in the adjacent quad in

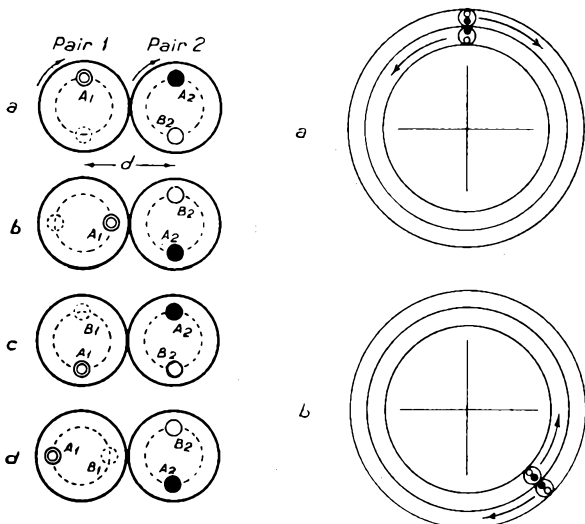

FIG. 4.—THE GEOMETRY OF WIRES IN ADJACENT QUADS, THE PITCH OF ONE BEING TWICE THAT OF THE OTHER.

FIG. 5.—THE GEOMETRY OF WIRES IN QUADS IN ADJACENT LAYERS.

exactly the same way irrespective of the position of the wires at the starting point of a cycle. The arrangement provides that the pitch of pair 2 is one-half that of pair 1. So that pair 2 makes two complete turns while pair 1 makes one turn.

Thus while A_1 makes one-half of a revolution (Figs. a and b and c) A_2B_2 makes a complete revolution. At the end of this period B_1 now occupies exactly the same position occupied by A_1 in Fig. a. During the next half revolution of B_1 , A_2B_2 again make a complete revolution and operate on B_1 in exactly the same way as they operated on A_1 in the first revolution. The chief objection to the adoption of such an arrangement is that it involves such a wide range of quadding pitches which introduce rather wide differences in mutual capacity.

(c) Interference between pairs in adjacent layers.

The conditions in this case are quite different to either of the cases previously considered.

When a cable is "laid up" or "stranded" it is desirable that the sense of stranding shall be left and right for successive layers. This is done largely for mechanical reasons for if successive layers were stranded with the same sense the quads in a layer would be liable to sink in between those of the layer beneath and the circular cross section of the cable would be very difficult to retain. Quads in adjacent layers therefore do not run alongside one another like quads in the same layer, but merely cross one another at points along the length of the cable.

In Fig. 5(a) two quads in adjacent layers are shown crossing one another. As longer stranding pitches are generally used for the outer layers, these two quads will not meet at a point diametrically opposite, but will meet again in some such position as 5(b). Since these quads only meet one another at those intervals and the distance apart of the pairs between these crossing points is relatively great it will be appreciated that the whole of the interference occurs at crossing points. Unlike the condition of adjacent quads in the same layer the number of times that the wires revolve on their own axis has nothing to do with the matter. It is the relative position of the wires in the quads when they cross that matters. Clearly if, say, the A wire of the outer quad is innermost and the A wire of the inner quad is outermost persistently every time these quads meet, then interference will occur.

The condition which it is desired to produce is that the same wires shall not persistently meet, but that the position at the crossing points shall be such that a succession of them shall produce a condition of compensation between one circuit and another. This matter is dealt with and is the subject of Patent Specification No. 321,947 (Kaempff and Dalzell).

Considering the nature of this interference it might be thought to be very improbable that interference of any magnitude between quads in adjacent layers is likely to occur. The author has, however, had several instances of abnormal interference of this kind, of which the following is an example.

The average interlayer unbalance experienced at the time in question was about mean/max $4/17 \mu\mu\text{F}$ per 176-yard length. On a certain length of cable (131 yards $24/40$ P.C.Q.) some exceedingly high interlayer unbalances were experienced and it was subsequently found to be due to an error in manufacture whereby two quads were placed in the wrong layer, *i.e.*, R.W. centre crossed with R.W.1 first and B.W. centre crossed with B.W.1 first. The test results are shown in Table III.

TABLE III.
CAPACITY UNBALANCES BETWEEN CENTRE AND FIRST LAYER. $24/40$ P.C.Q.

First Layer.		Centre Layer.			All values in $\mu\mu\text{F}$.
Colour.	Pitch.	R.W. 10.82" Pitch.	B.W. 13.14" Pitch.	R.B. 15.07" Pitch.	
R.W.	11.98 inc.	2.5	4.0	1.0	}
B.W.1	13.91 "	3.0	4.0	5.0	
R.G.1	10.82 "	32.0	1.0	2.0	
B.W.2	13.14 "	2.5	76.0	3.0	
R.G.2	10.82 "	85.0	4.0	2.0	
B.W.3	13.14 "	2.0	43.0	2.0	
R.G.3	10.82 "	68.0	2.0	1.0	
B.W.4	13.14 "	2.0	26.0	2.0	
R.B.	10.05 "	2.0	1.0	6.0	

The above is a striking example of the interference which can occur between similar quads in different layers. Note how the 10.82" quad in the centre interferes with the 10.82" quads in the first layer. Similarly the 13.14" B.W. The R.W. and B.W. centre quads should have been 11.98 inc. and 13.9 inc. respectively.

Screens.

It will be seen from the foregoing that the only process described for the prevention of interference between the several circuits in a cable is to twist the wires forming a pair or quad about an imaginary axis. The degree of immunity from interference obtained by this means even if the cable be balanced on site is insufficient for some classes of circuits. For this reason an electrostatic screen of metal or metallised paper has been employed. The objection to the screened quads is the abnormal space which they occupy in a cable. The defect is not due to the space occupied by the material used for the screen itself, but due to the fact that when the screen is placed round a pair or quad of conductors the component capacity " $a/2$ " as shown in Fig. 1 increases greatly with the result that the mutual capacity of the circuit is increased.

In order to keep the mutual capacity to its normal value it is necessary to employ a spacer of cellulose twine or other material in order to keep the screen away from the conductors and thus keep the component $a/2$ to its normal value. Moreover the

placing of a screen round a four-wire quad offers no protection against interference between the two pairs of the quad and a screened pair occupies nearly as much space as a screened quad.

Attempts to overcome the defect of the large space occupied by screened pairs led to a suggested improvement as follows. If interference between pairs is being prevented by the use of screens, is there any necessity to twist the wires of a pair? Clearly there is a large amount of space wasted in a cable by pair twisting because the effective cross section monopolised by a twisted pair is a circle having a diameter equal to twice the diameter of each wire. This gave rise to the idea of pairs of conductors being laid side by side with a screen placed round them. This form of construction (known as Flat Screened Pair) enables a pair of screened conductors to occupy a much smaller space than a twisted pair and pairs made in this way make a very neat and compact cable.

The advantages of a successful cable of this construction would be enormous. Such a cable could be jointed up "straight" during construction without any balancing and in the event of a fault occurring during the life of the cable the defective piece could be withdrawn and replaced without incurring the tedious process of rebalancing.

The following show the relative spaces occupied per pair of various types of cable for 40 lb. conductors:—

	μF per mile.	Pair.	Sq. inc. per pair.
<i>Twin</i>	10	.0318
		150	.0294
<i>M.Twin</i>	8	.0316
		160	.0296
<i>Star Quad</i>066	8	.0215
		254	.0175
<i>Twisted Screened Pair</i>	4	.0723
		(DE-AB)	
<i>Flat Screened Pair</i> .063		7	.0404

The following is a summary of some test results on Flat Screened pair cable:—

TABLE IV.

Cross-talk in millionths.	Condition of far end.	
	Short circuit.	Open.
(1) Between adjacent pairs in same layer. 88 yds. ...	300-400	Nil.
(2) Between pairs in same layer, but separated by one pair. 88 yds. ...	70-100	—
(3) Adjacent pairs in same layer. 168 yds. ...	1400	—
(4) As above, but one pair crossed in middle ...	< 10	—

The failure of the scheme lies in the fact that although the screen prevents interference due to electrostatic causes, considerable interference occurs not only between adjacent pairs, but between pairs separated by an intervening pair due to electromagnetic causes.

When the scheme was first suggested it was anticipated that interference between adjacent pairs due to electromagnetic causes could be disposed of by merely crossing alternate pairs at joints. This crossing has indeed proved to be most effective as shown in items (3) and (4) in the Table IV., but seeing that interference is not confined to adjacent pairs only but extends to pairs separated by an intervening pair the process becomes much more complicated than originally anticipated.

In spite of the great improvements which have

been effected in telephone cable design and manufacture there is a demand for still further improvement.

It is not possible even with the highest grade of cable which can be made to-day to join up more than a few lengths of cable before the capacity unbalances and consequently the interference becomes abnormal and the expensive and tedious process of balancing one length against another has to be resorted to.

This process of "balancing" consists substantially of measuring the unbalances of all the pairs in the two lengths of cable to be jointed together and joining pairs together in such a way that the unbalances compensate one another.

For these reasons it is of great importance that the cable manufacture should be still further improved so as to minimise the amount of work to be done in this balancing process.

The Post Office Exhibit at the National Radio Exhibition

A. MORRIS, M.I.E.E., Assoc.I.R.E.

RADIOLYMPIA (1932) was formally opened on August 19th, at 15.30 B.S.T., by the Rt. Hon. J. H. Thomas, P.C., M.P., Secretary for the Dominions, in a speech from Ottawa transmitted over the Post Office Canadian radio circuit and broadcast in this country over the British Broadcasting Corporation's system, and to the public at the exhibition by means of a public address system.

By the courtesy of the Radio Manufacturers' Association, the Post Office exhibit, with a frontage of 90 feet and a depth of 20 feet, was located in a commanding position in the National Hall. The engineers entrusted with the production of the exhibit conceived the idea of demonstrating to the public in bold outline the main features of the radio services of the Post Office. With this object in view, the total space was divided into three sections and allotted as follows:—

In Section 1 was exhibited typical commercial plant as manufactured by leading British contractors for use by the Post Office in its communication services. In addition, a few distinctive pieces of measuring apparatus as designed and constructed at the Post Office Radio Laboratories, Dollis Hill, for use in investigation work and in the development and operation of the services were shown.

Section 2 was given over to an exhibition of representative industrial and domestic electrical items arranged to give intense interference to modern broadcast receivers located in their neighbourhood, the whole being housed in a sound-proof room fitted with screened aerial lead-in. The cure of such disturbance was demonstrated by switching appropriate

interference eliminating units into the circuit of each of these items, the wiring of which was carried out in conduit, lead-covered cabling being prohibited by L.C.C. regulations. Lectures and demonstrations were given in this section twice per hour throughout the day during the run of the exhibition.

The third section consisted of a Bureau arranged as a lounge and fitted with two enquiries counters. Models of one of the 820-foot Rugby masts and of a short wave array of the T.W. type, as well as samples of the Department's anti-interference units, a trolley bus stopper coil, and a low frequency smoothing unit were suitably arranged as the main furnishing, whilst a radio-route map of the world, framed photographs of a number of items of radio engineering plant, and a number of Post Office advertising posters, decorated the walls. In addition, copies of recent technical papers and pamphlets, as well as a variety of mimeographed instructional forms, were available for the use of the public.

The general lay-out of the exhibit is shown in Fig. 1.

Sixteen thousand pounds worth of plant was exhibited, much of which was loaned and installed

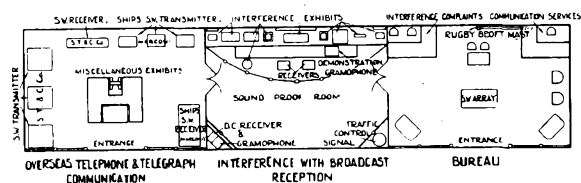

FIG. 1.—LAY-OUT OF EXHIBIT.

P.O. EXHIBIT AT THE RADIO EXHIBITION

ll known manufacturers, the remainder being ed from the Dollis Hill laboratories. The used, together with the names of the manu- ers are listed below, all loans being hereby ully acknowledged.

List of Exhibits.

Wave transmitter with control desk as used Rugby.
 Standard Telephones and Cables, Ltd.
 Wave receiver as used at Baldock.
 Standard Telephones and Cables, Ltd.
 Wave receiver as used at Burnham.
 Standard Telephones and Cables, Ltd.
 Wave transmitter as used on liners.
 Marconi's Wireless Telegraph Co., Ltd.
 Wave receiver as used on liners.
 Marconi's Wireless Telegraph Co., Ltd.
 ion Finder as used at Coast Stations.
 Marconi's Wireless Telegraph Co., Ltd.
 Aerial for use with Direction Finder.
 Marconi's Wireless Telegraph Co., Ltd.
 nitting Valve, 100 kW.
 Marconi's Wireless Telegraph Co., Ltd.
 electric crystal wave meter.
 Dollis Hill Radio Laboratories.
 le field strength measuring set, with oscillator.
 Dollis Hill Radio Laboratories.
 le screened oscillator-amplifier.
 Dollis Hill Radio Laboratories.
 ed high frequency bridge.
 Dollis Hill Radio Laboratories.
 riginal " broadcast receiver.
 Radio Instruments, Ltd.
 nival " and " Nomad " broadcast receivers.
 General Electric Co., Ltd.
 m cleaner.
 Vac-tric, Ltd.
 y chargers.
 Lancashire and Crypto Dynamo Co., Ltd.
 mill.
 Hobart Manufacturing Co., Ltd.
 ic fan.
 Edison Swan Electric Co.
 ng Sign.
 Franco Signs, Ltd.
 Sign.
 Buckley Brothers.
 g machine.
 Frister and Rossmann.
 erator.
 Frigidaire, Ltd.
 er and ultra-violet ray lamp.
 Hewitt Electric Co., Ltd.
 : signal.
 Chance Bros. & Co., Ltd.
 -gram with audio filters.
 Dollis Hill Research Laboratories.
 requency mains hum eliminator.
 General Electric Co., Ltd.
 of 820-foot Rugby mast.
 Head, Wrightson & Co., Ltd.

Model of short wave array, T.W. type.
 Dollis Hill Radio Laboratories.

Photographs of the exhibits are shown in Figs. 2 and 3.



FIG. 2.—INTERFERENCE WITH BROADCAST RECEPTION EXHIBIT.



FIG. 3.—OVERSEAS TELEPHONE AND TELEGRAPH COMMUNICATIONS EXHIBIT.

In addition to the loan of plant, Messrs. Standard Telephones & Cables, Ltd., and Marconi's Wireless Telegraph Company, Ltd., respectively provided engineering staff for attendance on the items loaned for Section 1, during the whole period of the exhibition.

The exhibits in Section 2 were serviced by staff of the respective Manufacturers, the lectures and demonstrations being given by Post Office engineering staff normally engaged on radio interference work, assisted by operating staff drawn from the London Telephone Service.

The attendance at the Bureau consisted of engineering and contract officers dealing respectively with radio interference complaints and communications services enquiries. All complaints were dealt with as far as possible on the spot, but in those

cases where investigation was obviously necessary a complaint form was used and passed at the end of the day to the Radio Section for attention. More than 500 complaints were dealt with in this manner.

Judging by the attendances and by the interest displayed by the public, the exhibit was an overwhelming success. Located quite apart from the main exhibits in an advantageous position close to the Hammersmith Road entrance of the National Hall, the situation was one which attracted the public in large numbers, a continuous and steady stream of visitors passing through the exhibit from 11 o'clock in the morning until 10 o'clock at night. Of the total visitors to the stand about 30,000 attended the radio interference demonstrations.

By conveying to the public, in a simple yet strikingly practical manner, a general knowledge of the various facilities offered by the radio services of the Post Office, particularly those relating to the interference troubles of the broadcast listener, sound propaganda work was performed, devoid of all suggestion of exaggeration or of "stunt" advertising. The actual items of plant as used for Trans-Atlantic, ship to shore and other overseas telephone calls, as well as the effective elimination of noise from radio receivers, subjected on the spot to interference from the operation of electrical machines, were matters of absorbing interest. Added to this, however, clear technical explanations of the plant were volunteered at all times and brief lectures

accompanied each interference demonstration. These latter features constituted by far the greatest source of value and popularity of the exhibit and contributed mainly to its success. Such success was only possible by reason of the sustained efforts of the expert staff provided by the Manufacturers and the Post Office and employed on the work. By reason of their familiarity with radio principles and practice, they obtained the confidence of the public as individuals who not only knew their subject thoroughly, but who were willing and able, either personally or through the Post Office organization, to assist them with their problems. The scope of the enquiries was extremely wide and ranged from that of the man who came up to London determined to ventilate his radio dispute with his neighbours, to that of the design engineer who desired technical data as to the effect of receiver and external interfering noises on the programme value in Blankshire of the transmission from a particular foreign station.

The Postmaster-General visited the Exhibition on August 26th and spoke from the Post Office stand over the public address system, in reply to a speech of welcome from Mr. Leslie McMichael, the Chairman of the Radio Manufacturers' Association. After his inspection of the Department's exhibit, and before making a tour of the main hall, Sir Kingsley Wood very kindly expressed his pleasure and appreciation to each member of the staff engaged upon the stand.

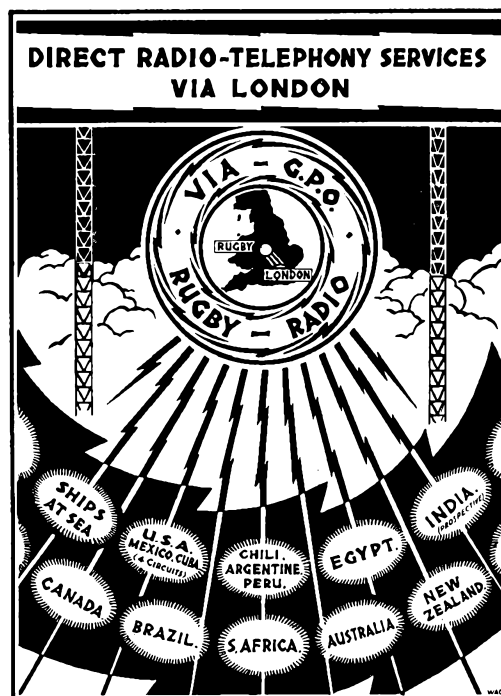

Research

FOLLOWING the precedent of the July issue of the Journal notes are given below on some of the investigations completed or in progress in the Research Section that are likely to be of general interest to readers.

TELEGRAPH SERVICES.

Delayed clearing signal for Teleprinter Switchboard. To meet the requirement of the provision of a clearing signal for teleprinter circuits terminating on P.B.Xs, a scheme has been developed based on the use of a small metal rectifier and a condenser in series with a telephone-type relay in leak on the line. On the application of a positive potential for a period of 0.5 to 1.5 seconds, a current builds up in the relay closing the contacts to light a local lamp at the switchboard. The arrangement will not function with the normal telegraph signals and it does not degrade the working signals.

The use of the Thyatron as a Telegraph Valve Relay. As is well known, the Thyatron possesses triggering properties within a threshold range of grid potential. The anode current is triggered "on" under the control of the grid potential, but to trigger "off" it is necessary momentarily to disconnect the anode voltage or to reduce it to a very low value. Some preliminary work has been done using the Thyatron as a Trigger telegraph valve repeater. Using A.C. anode voltage supply, it has been possible to work over 350 miles of artificial line representing a double phantom circuit on 40 lb. side circuits. Further work is proceeding on these lines and also using a D.C. anode voltage.

TELEPHONE LINES TRANSMISSION.

Single-Stage Repeater for main lines. This repeater, which embodies regeneration and was mentioned in the previous issue of the Journal, is now in a satisfactory stage of development. It is considered that the design, which is based on a maximum gain of 32 db. without reaction, but in which the latter is employed for gain frequency equalization on the trunk lines, should meet the Department's normal requirements, exceptional cases being met by the existing two-stage repeaters.

Improvement of Liverpool-Dublin and other trunks. Experiments that have been carried out confirm that the trunks to Bangor and Carnarvon can, by utilizing a 4-wire system to Colwyn Bay, be worked with an overall of approximately zero. Using 2-wire repeaters at Liverpool and Colwyn Bay, the circuits could be made practically zero by employing the 600-ohm termination scheme; with regard to the Dublin trunks, the submarine cable is the deciding factor. An investigation on the use of stabilisers on the land portion indicates that they would enable a zero Liverpool-Dublin or zero London-Dublin trunk *via* Liverpool to be made up, providing that the noise on the aerial cable is main-

tained at its present low level. In the event of this noise becoming troublesome, the simplified "all mains" carrier equipment can be used between Nevin and Colwyn Bay. Being mainly in the audible range, the noise will not affect the carrier circuits, and the radio disturbances from Carnarvon should cause no trouble at the low carrier frequency used.

Carrier working on underground circuits. Tests on the light loaded (22 mh) circuits, London-Derby route, of lengths 250 and 500 miles using existing 4-wire repeaters have shown that the scheme is practicable. Using the suppressed carrier system, the cross modulation between these channels was negligible. The cross modulation arises practically exclusively in the repeaters. It therefore appears that, given satisfactory cable conditions as regards cross-talk and using, if necessary, broadcast-type repeaters in conjunction with very lightly-loaded lines, the scheme should be an economic success.

All-mains carrier equipment. A convincing example of the utility of this equipment has occurred in which the single channel demonstration set was in service for a month as an emergency private wire between Helensburgh and Luss R.A.X. in connexion with Kay Don's water speed record on Loch Lomond. The circuit was extended to Glasgow trunk switchboard, the transmission equivalent of the carrier link being 3 db. better than zero. Satisfactory service was given and several minor improvements suggested by the trial in the field have been incorporated in the design. The circuit was actually superposed on the R.A.X. junction and one of the old-type carrier sets was worked on the same pair.

TRANSMISSION TESTING, APPARATUS.

Effect of Room noise and Side Tone on reception. A prolonged series of tests have been carried out to determine the relation between articulation, room noise and side tone. The tests were made on a No. 1 C.B. circuit with variable junction side tone and room noise, and it was found that room noise of less than 40 units has very little effect. Also if the side tone is 20 db. or more below that on a No. 1 C.B. circuit with a 300-ohm local line, it does not contribute to the loss in reception due to room noise. With a noise of 70 units, the side tone on a No. 1 C.B. circuit with 300-ohm local line covers the same loss in reception as an increase in the junction by 29 db. Curves have been obtained by which the loss in any particular case can be readily computed.

Transmission Measuring Set for local circuits. To meet the requirement of a general method of measuring the transmission losses in local plant, it has been proposed that the whole apparatus necessary should consist of three units, (1) Oscillator, (2) Receiving meter, (3) Noise generator. It has been found that a metal rectifier type meter can be used in conjunction with an oscillator to measure

losses up to 20 db. with sufficient accuracy and can be made direct reading. The oscillator can be made to operate from any of the usual exchange batteries (or from dry cells in exceptional cases) and to give three frequencies at a constant voltage through 600 ohms. In conjunction with a noise generator, the meter can be used to measure the efficiency of subscribers' transmitters and lines.

Apparatus for producing delays in speech transmission over telephone circuits. Trials have been made of a steel band recorder which enables an adjustable delay to be introduced in one direction of transmission over a telephone circuit. The speech is recorded magnetically on a travelling steel tape and picked up after a time interval has elapsed. The record is obliterated before the loop of steel tape completes its revolution. The distortion is negligible over the ordinary Telephone Speech range.

Meter for the measurement of line noise. A new meter has been designed and constructed in the Research Section for the measurement of line noise and has been used very successfully in some tests for the C.M.I. in the South of France in which comparisons were made with other meters of American and German origin. The British meter was found to give results more nearly in accordance with the auditive effect and to have a better balance to earth, which makes the meter less liable to false readings in the presence of large longitudinal voltages.

At the request of the C.M.I. it has been arranged for the British Meter to be loaned to the S.F.E.R.T. laboratory in Paris for the series of tests on the effect of noise which is shortly to be carried out.

SIGNALLING EQUIPMENT.

Key Sending from A-positions using A.C. signals on a straightforward junction basis over-two-wire junctions. With this method of working, an A-operator at a manual exchange can operate, by means of a digit key, the storage relays of the key sender equipment at a distant automatic exchange and thus set up the connexion without the intervention of a B-operator. A final report has now been issued giving the results of an extended investigation in which the merits of six 4-frequency valve receiving sets, which were designed during the development of this method of working, are fully discussed. In the preferred design the principle of Rectified reaction is used in the receiving set employing indirectly heated valves and simple tuned circuits for selecting the four signal frequencies.

Voice Frequency signalling system for On demand Trunk Working. Traffic requirements have reached the stage where some method of signalling over trunk lines which will give similar operating facilities to those at present in use over junction lines is necessary. A two-frequency V.F. system is therefore being developed which will give full automatic signalling for manual to manual calls and also facilities for dialling-in and key sending on direct

trunk routes terminating at the distant end in an automatic network. A successful preliminary demonstration has been given to a committee of members of the Secretary's and Engineer-in-Chief's offices. At this demonstration the method of setting up a connexion for a manual to manual call and the application of the method to key sending into multi-office areas were shown, calls being set up between two subscribers sets over a 300-mile loaded and repeated trunk line having a transmission loss of about 5 db. The development of the methods employed from the experimental to the conditions of practical service is being energetically pursued.

CHEMICAL AND PHYSICAL INVESTIGATIONS.

Corrosion. A considerable number of corrosion cases are referred to the Research Section for investigation and from the microscopical and chemical methods now employed it is usually possible to diagnose with some certainty the cause of the trouble, i.e., whether electrolytic or chemical. Investigations have been in progress on the effects of protective films on lead and practical trials are being made of a method of impregnating the petroleum jelly lubricant, for drawing in cables, with sodium silicate which possesses the property of forming a protective film on lead.

Galvanizing tests. A large number of tests have been carried out on specimens of galvanized wire from various sources in order to assist a Committee of the British Standards Association to frame a modified and more suitable specification for testing the quality of galvanizing on iron and steel wires.

The action of different kinds of Cement Concrete on lead. In view of the conflicting opinions as to the effects of Portland and Aluminous cement concrete on lead, a series of quantitative experiments are being carried out to obtain definite data on the question.

The Quantitative determination of Antimony, Tin and Cadmium in lead Cable Sheaths by means of the Quartz Spectrograph. The experimental work that had already been carried out to evolve a quick spectrographic method for estimating tin has now been extended to antimony and cadmium, and after satisfactory practical trials the technique has been described in a final report, giving full details for the quantitative analysis of cable sheath alloys containing each of these alloys.

Improvements in the methods of testing enamelled wires. Owing to the introduction of the modern "red" enamels, it has been necessary to reconsider the existing specifications for enamelled wire which were originally drawn up to cover the older black enamels. A detailed investigation has therefore been made of the various methods of testing enamelled wires, as a result of which it has become evident that some modifications of the testing methods could be made with advantage.

Notes and Comments

Laying Cables by means of a Moledrainer

CONSIDERABLE interest has been expressed regarding the article appearing in the July issue on the above subject, and numerous enquiries have been received at Headquarters for more detailed particulars. There have been a

number of developments in regard to the methods employed since the article was published, and the illustrations on these pages will be of assistance to readers in regard to the details of the equipment and the improvements effected.



Fig. 1.—Front view of Fordson-Automower Tractor and winch, showing winding drum and one of the anchors.



Fig. 4.—Mole Drainer, showing make off of cable, mechanical fuse and cylindrical cover for fuse with torpedo end.



Fig. 2.—Rear view, showing steel Hawsers and Guide Rollers.



Fig. 5.—Cylindrical cover slipped over fuse.



Fig. 3.—Ransome Mole Drainer.



Fig. 6.—Tractor, Mole Drainer and Cable Bogey. Notice anchor and winding drum.



Fig. 7.—Portable anchor and pulley block used where steel hawser turns a sharp corner.



Fig. 10.—“Little Wonder” Mole Drainer (with special leading wheels and modified mole), used on narrow margins.



Fig. 8.—Ransome deep digging plough.



Fig. 11.—Small Mole Drainer in action in ploughed furrow. Note cable entering joint hole.



Fig. 9.—Plough drawn by winch with Furrow 10"—12" deep.



Fig. 12.—Rushton Tractor, Cable Bogey and Ransome Ridging Plough.

Efficiency Engineers

During recent years increasing attention has been given to the problems of improving the efficiency of the Department's methods of organisation, the output of working parties and the revision of linemen's maintenance loads. The initial investigations were carried out from Headquarters with the co-operation of the accounting staff. The successful results obtained from these efforts demonstrated that an extension of the scheme was likely to produce further improvement by intensive work in each District. To this end a post of Efficiency Engineer has been created in each District.

The new organisation was inaugurated by a course of lectures and instruction to each of the officers appointed to the new posts, preparatory to their taking up the new duties. The series of lectures dealt with—

- (a) The Organisation and Control of Work.
- (b) The Department's statistical system for the Control of Works.
- (c) Examination of records from an accounting point of view.
- (d) Internal Plant maintenance.
- (e) Special features of Underground works.
- (f) Use and development of Motor Transport.
- (g) Prompt completion of Subscribers' services.
- (h) Engineering supervising duties.

Addresses were given to the officers by Col. Sir T. F. Purves, Col. A. G. Lee, Major H. Brown and Mr. H. Buckland, of the Accountant General's Department. Reference was made by these gentlemen to the high standard of efficiency which had already been reached in the Department's methods of construction and maintenance, and that the primary object of the course of instruction was to widen the field of enquiry and action in order that even better results might be attained. Stress was laid on the necessity for regarding the service as a highly specialised commercial undertaking and that the co-operation of every member of the staff should be aimed at in order that the best possible service should be given to subscribers at the cheapest cost. From this point of view it would be an essential part of the Efficiency Engineers' duty not only to educate workmen and foremen, but also to act as a willing helper to supervisors in order that the active co-operation and goodwill of everyone might be directed towards obtaining maximum output at a minimum cost. The financial difficulties in the country as a whole, indicated the conditions which existed and demonstrated the need for special efforts being made to effect an improvement. Dealing with certain phases in more detail, it was brought out that there was a definite need for a real measure of the time necessary for various labour operations, and the investigations already made showed the necessity for determining a standard figure. Costs as compared with present standards had been reduced for all classes of external work from 135% in 1928 to 97% at the present time, but it was certain that even

better results were obtainable without demanding a greater output from the workmen than the Department had a reasonable right to expect. Plausible explanations of high costs could be expected, but these should be reduced to their true value by investigation and observation. Alternative and better methods including the use of new appliances should be suggested and studied and Foremen should be encouraged tactfully in such matters so that friction and irritation were avoided.

The officers attending the course expressed their appreciation of the invaluable instruction given to them.

F.H.H.

An Unsolicited Testimonial

The following paragraphs are reprinted from the *Dundee Evening Telegraph and Post* for September 12th, 1932 :—

"The new telephone exchange in Seymour Street, Dundee, was opened on Saturday without any flourish of trumpets or any ceremonial whatever. The Post Office have no time for opening ceremonies and the presentation of gold keys. Had this been a municipal affair there would have been many speeches followed by a cake and ginger ale banquet, and somebody would have been certain to get a gold or silver key.

All that happened at the Post Office was that someone turned a switch and the new automatic exchange began to function. The Post Office way has a lot to commend it."

International Electrical Congress, 1932

During the early part of July, the 50th anniversary meeting of the International Electrical Congress took place in Paris. It was at the meeting held in 1881 that agreement was reached upon the more important of the units of electrical measurement, and the meeting held this year was in celebration of this. In the Communication Engineering section of the Congress, papers were contributed by Messrs. B. O. Anson and B. S. Cohen, of the Engineer-in-Chief's Office, who were members of the British Government Delegation appointed by the Prime Minister to attend the Conference.

Errata

Dr. Rosen has called our attention to the following errors which occur in the article which he contributed to the April issue :—

Page 70, Col. 1, Lines 21 and 22 should read :—

$$\text{When } \phi \text{ is small and } \theta \text{ is large, } \tan \frac{\theta + \phi}{2} = \tan \frac{\theta}{2}$$

$$\therefore \beta = ak_1^2 = k_1 \sqrt{\frac{\omega CR}{2}} \dots \dots \dots (16)$$

Page 71, Col. 2, penultimate line should read :—

$$k_2 = \sqrt{\operatorname{cosec} \theta}$$

District Notes

Scotland West

SPECIAL ARRANGEMENTS FOR MISS ENGLAND III. RECORD RUNS ON LOCH LOMOND.

One of the most beautiful districts in Scotland is the Loch Lomond Area. The beauty and grandeur of the scenery, the entrancing loveliness of colour in spring and autumn, the magic and wonder of the reflections in the mirror of the loch's surface of the green slopes, trees, rocks and crags of the majestic Ben Lomond, leave an unforgettable impression on appreciative minds. The district is very sparsely populated although visited by many thousands annually. The telephone requirements and possibilities of this region are very limited, and the plant has, therefore, been provided on the light scale usual for such localities. The little village of Luss, with its R.A.X. and eight subscribers, even in its busy visitors' season, is amply served by a single junction to Helensburgh, about 7 miles away, and for the greater part of the year this circuit carries very little traffic.



MISS ENGLAND III. ON LOCH LOMOND.

Owing to the keen and widespread interest in high speed records, and the international rivalry for supremacy, tremendous publicity is inevitable when records are being attacked. Press and broadcasting facilities are demanded, usually on short notice, which may be given in more thickly populated areas, but are almost impossible to supply in a district such as the Loch Lomond Area. Under these conditions, the news that Miss England III. was to attempt to break the water speed record on Loch Lomond awakened some trepidation in case the special demands could not be met in the short time available. Little more than a week's notice was received and special circuits were demanded by the Press Association, two Glasgow newspapers (the Glasgow Evening News and the Glasgow Evening Times), and the B.B.C. Five loops had, therefore, to be provided on a light line which could not carry them,

even temporarily. Rebuilding was out of the question for several reasons. After a careful review of the possibilities, it seemed that interruption cable was the only solution, and nine miles of cable would be required. This great length could not be obtained and it was decided at Headquarters that the three newspaper lines could be provided by carrier wave working between Luss and Helensburgh, the ordinary junction and an appropriated section of an omnibus circuit being used as physical circuits. Between Luss and the newspaper camps, about two miles farther north, interruption cable was to be used, and from Helensburgh to Glasgow, 21 miles, wires were to be picked up in the main cable.

The method having been decided upon, no time was lost in putting it into operation. Less than five days were available by this time, and apparatus in large cases, cables, transport, and men were assembled together as if by magic. Panels and apparatus were unpacked, erected, wired, and tested, with surprising expedition. Cable was erected and jointed under great difficulty owing to the narrowness of the road, the amount of traffic, and adverse weather conditions. At 11 p.m. on Sunday night, the day before Miss England III. was to make her debut on Loch Lomond, in a storm of wind and rain, the last length of cable was jointed through and tested, with a sigh of relief from all engaged in the work.

Three sets of carrier equipment were used to provide three of the trunks. Two sets were of old pattern and had been previously used on the Glasgow-Aberdeen route. These sets worked at frequencies as follows:—

- Circuit (A) 23.7 KC Helensburgh to Luss
16.1 — in the reverse direction.
- (B) 16.1 — Helensburgh to Luss
10.5 — in the reverse direction.

The third set was new apparatus in process of design by the Research Section. This set is mainly driven and very simple in detail so as to be rapidly installed and operated to provide service in remote areas where extra circuits are required for seasonal traffic or other purposes. The set embodies new features and had never been tested away from the Laboratory before. It fully justified its existence, however, and the occasion gave an excellent opportunity for the set to be tried under working conditions. The apparatus will, no doubt, be described later when its final form is reached. The carrier frequency used in this case was 6.5 KC, the upper side band transmitting in one direction and the lower side band in the other direction.

In the Glasgow newspaper offices the circuits were terminated on loud-speakers, the only means available for signalling. When the reporter's voice was heard in the loud-speaker the circuit was switched over to an ordinary telephone. In one case the line was led through the P.B.X. so that it could be

switched through to an associated paper when desired, thus making the arrangement more flexible. The P.A. line was terminated on a London position in Glasgow Trunk Exchange so that while the reporter was speaking the roar of Miss England's engines might have been actually heard in the London Office, when the line was extended during one of the trials.

After things had got into working order the three newspapers asked for additional telephones to be fitted on their respective circuits in the immediate vicinity of Luss Hotel. The reason for this was that the result of the attempt on the record was to be announced at the Hotel whereas the camp telephones were two miles away. This modification of the original scheme was a great advantage to the reporters as the Hotel was a kind of Staff centre for the dissemination of news.

The B.B.C. sent down a motor van fitted with the necessary plant. Although technically the broadcasting conditions were perfect, the actual events commented upon were not what was hoped for. It was intended that the record run should be broadcast and it was thought that this would be done in the afternoon, but the series of mishaps and defects to the boat prevented this intention from being realised, to everyone's disappointment.

The period of trial was noteworthy for the atmosphere of continuous anticipation and the repeated spasms of excitement. The fact that something exciting might happen at any moment between dawn and dusk, on any day, made the maintenance of good conditions on the special circuits very much of a strain. The circuits worked very well with a few minor interruptions, although a main cable breakdown once rendered it necessary to appropriate a trunk line to make good the only special wire affected and the local newspapers concerned recognised the efforts of the Post Office to provide service under the exceptional conditions by printing very well written and appreciative special articles. This recognition is more than gratifying when one remembers the adverse criticism so frequently presented to us.

J. MCINTYRE.

South Western District

BRISTOL-YEOVIL-DORCHESTER CABLING BY DIRECT LABOUR.

Further to the short notice in the January issue of the Journal it is now possible to give some further details of the above work.

Route.—The road from Bristol runs across the Mendips and through some of the age-old towns and picturesque villages of Somerset. Wells, noted for its splendid Cathedral and Glastonbury with its glorious ruins, which mark the site of the first Christian place of worship to be built in England, are both on the direct route. From Glastonbury the route runs through King Arthur's country to Yeovil

and along the old Roman Road to Dorchester in Dorset.

Cable.—The cable, which is P.C.S.Q. Trunk type of 20 lb. conductors, provides for 160 pairs between Bristol and Wells, with a spur cable of 74 pairs to Shepton Mallet, and 122 pairs between Wells and Yeovil, tapering to a 74-pair cable between Yeovil and Dorchester. Loading will be carried out with 44 and 88 millihenries coils at a nominal spacing of 1.136 miles.

Double standard lengths of cable (*i.e.*, 350 yds.) are drawn in by motor winches, to reduce jointing costs, and with an organization of five men and a foreman opening holes, pulling in ropes and setting up drums, and a cabling gang of eight men and a foreman—a total of 15 men—an average rate of 2,000 yds. per day is being maintained. Under favourable conditions, the maximum progress for one day's work was 2,660 yds. of cable.

The cable is balanced to the requirements of Specification W. in C. 323 with two systematic joints and three test-selected joints per loading coil section.

For the first few loading coil sections, four systematic joints were laid down with a test-selected joint at the centre point, but the arrangement resulted in residual unbalances somewhat in excess of those required by the Specification and further test-selected joints were introduced. All other loading coil sections on this work will have three test-selected joints spaced as indicated below, the length to be balanced for capacity by means of a quadruple selection.

In order to avoid cutting the cable at "pull through" points, the systematic and test-selected joints are being arranged as follows:—

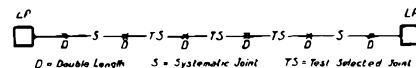

Consequent upon the high rate of cabling progress obtained and the additional test-selected joints which are now necessary, it is found that one testing group is unable to keep pace with the cabling work and a second group of test officers is being employed on shift duties to make the best use of the only available test van and to overtake arrears of balancing and acceptance tests.

Many difficulties have been encountered including flooded boxes in water-logged subsoil, silted duct lines, cable drums being delivered out of sequence and, above all, typically English "Summer" conditions, but all these in turn have been overcome and the very satisfactory progress which has been obtained reflects credit on all concerned.

Northern District

RETIREMENT OF MR. J. T. BRAMWELL.

When Mr. J. T. Bramwell, Asst. Superintending Engineer, Northern District, retired on the 31st

August, 1932, after 46 years' service, he left with the general and genuine regret of the staff.

At a gathering of the Staff on the 31st August, 1932, Mr. F. G. C. Baldwin, Superintending Engineer, on behalf of the members, presented Mr. Bramwell with a first grade camera as a token of their affection and esteem and wished him happiness in his retirement.

Mr. Bramwell was a man of great charm and lofty ideals. He was deeply religious, conscientious, and capable.

One never heard him condemn an officer who erred or strayed and one never appealed to him for advice or assistance in vain. He reached great heights in the organisation and work in connection with the Newcastle Automatic Transfer and spared absolutely no efforts to make the scheme a success. Its smooth working to-day is all the reward he would desire.

The Engineering Department has lost the services of a Christian gentleman whose name and conduct will be remembered and respected in the Northern District in days to come.

J. L.

SUNDERLAND AUTO EXCHANGE.

The Sunderland Automatic Exchange was opened on July 9th, 1932. An announcement of this nature is commonplace nowadays, and there is no need to give any detailed technical description in this instance.

There are, however, several features which are of interest and a short article on the subject may not be unacceptable.

Sunderland has—at the moment of writing—the most up-to-date non-director automatic exchange in the Kingdom, with equipment for 4,500 subscribers' lines. In 1880 Sunderland had the honour of housing the first telephone exchange in the North of England. The equipment was for 25 lines in the form of intersecting bars which could be joined together at the junctions by means of solid metal plugs to connect any two lines together—a similar principle to that of the old Umschalter Switch.

In 1901 Sunderland again was in the forefront in that the Common Battery Exchange then opened was the third only of its type in the Kingdom. It followed closely on the Bristol C. B. Exchange which, as stated in the April 1932 issue of this Journal, was opened in 1900. The Sunderland switchboard with recurring additions and modifications has served its purpose and has been closed down. The last call was interesting in two respects. It was a fire alarm call which was completed without delay at the new exchange—a tribute to the efficiency of the traffic arrangements. Further, the Engineer who had installed the original suite in 1901, is now, after varied experiences in different localities, in charge of the adjacent Newcastle area. It was opportune for him to be present in the old switchroom at this transfer. He therefore has had the uncommon experience of

seeing the first call put through, and 31 years later of seeing the last call made.



FIG. 1.—SUNDERLAND AUTOMATIC EXCHANGE.

A few days after the new exchange was brought into use a civic visit was made by the Mayor of Sunderland and other influential business men who were keenly interested in the method of working of the new system. Amusement was caused when the Superintending Engineer—Mr. Baldwin—asked the Mayor to accept as a memento of the visit the actual cause of the first fault reported on the day of opening. This was a bent penny which had stuck in a coin box.



FIG. 2.—SUNDERLAND EXCHANGE BUILDING.

The opening of this exchange brings the number of auto telephone stations in the Northern District to 56% of the total number, as against 27% for the United Kingdom.

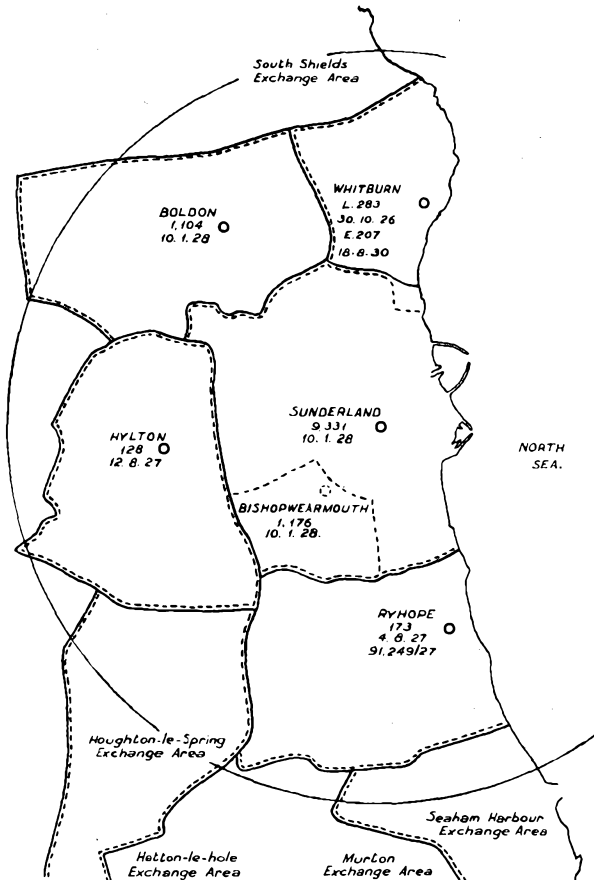

FIG. 3.—LAY-OUT OF SUNDERLAND AREA.

The exchange installation was carried out by Messrs. Ericsson Telephones Ltd. and has equipment for 4,500 subscribers' lines with ultimate capacity of 14,500.

The Selector racks are of the open single-sided pattern which have been described in earlier issues of this Journal, and the group selectors are of the 200 outlet type.

The general lay-out of the apparatus room is excellent, giving a sense of freedom from congestion which is so often felt in some auto exchanges. Fig. 1 illustrates this. It has been possible to apportion a separate room to accommodate the subscribers' meter racks. This is a most desirable feature.

The power plant consists of 1,800 Ah batteries with ultimate capacity of 4,500 Ah. One 56 H.P. Motor Generator for normal use,—one 3 cylinder, 67 H.P. Ruston & Hornsby Oil Engine Generator set in reserve, together with the usual Mains Supply

and battery driven Ringing machines and associated apparatus.

The building itself is a notable addition to the town. Fig. 2 shows the front elevation.

The lay-out of the multi office area is shown in Fig. 3. Six Satellite exchanges are catered for. Boldon, and Bishopwearmouth were opened for automatic working simultaneously with the main exchange—Ryhope new auto exchange will be brought into use shortly, and Whitburn and Hylton will be converted at a later date.

W.A.

Scotland East District

EDINBURGH MULTI-EXCHANGE AREA.

The conversion of the Central Exchange and three Satellite Exchanges (Morningside, Murrayfield and Newington) was effected on 2nd October, 1926. This transfer was the largest simultaneous transfer undertaken by the Department, and, though the number of exchanges concerned has since been exceeded by Newcastle-on-Tyne and Bristol, Edinburgh still holds pride of place in the number of lines transferred at one time.

Detailed arrangements for the work completed in October, 1926, are described in a paper read before the Scotland East Centre of the Institution by Mr. J. Innes, B.Sc., on 19th April, 1927. A full description of the Siemens No. 16 Automatic Equipment with particular reference to the Edinburgh installation was read before the same Centre on 27th January, 1925, by Mr. C. W. Brown.

A brief reference to developments which have taken place since the initial equipment will probably be of interest. Residential building developments have necessitated the provision of two exchanges additional to those originally contemplated, viz., Abbeyhill and Liberton. This entailed a modification of the numbering scheme for the area from that recorded in the two papers quoted above, and the numbers now allotted are given in the table below. Five-figure numbers have been retained throughout the area. Satellite exchanges were opened in 1929, 1930, 1931 and 1932; the Corstorphine Exchange conversion will be completed when the next Directory issue is made in July, 1932. With the exception of Leith (C.B.) and Lothianburn (C.B.S.) this completes the conversion of the Edinburgh Multi-Office Scheme. The Leith Exchange serving an industrial area has been affected by the prevailing trading conditions, and its conversion date depends mainly on the effective life of the present equipment which was originally installed in 1902. A site for the new exchange has been secured and provision is being made on the assumption that the existing equipment will be made to meet service requirements up to 1938 or 1939. The manual board has been relieved of 29 A and 14 enquiry positions since 1926.

The original testing facility provided for centralized testing, but this was found to have serious dis-



COLINTON EXCHANGE.

advantages during periods of breakdown—cables or storms—and decentralized testing with a central fault and record control has been introduced and the exchanges equipped with test desks as shown in the schedule. With these exceptions the installation is, in the main, in accordance with standard practice.

The architectural details of some of the buildings will probably be of some interest. Edinburgh has claims to beauty in many ways peculiar to its situation, its traditions and as the Capital City of Scotland; its amenities are the special care of certain National and local Associations and Societies which keep a watchful eye on any departure from the standard they consider should be maintained, whilst a certain measure of freedom from English control is claimed and recognised by a Local Board of Architects of H.M. Office of Works. The Scottish system of land tenure—feuing building sites—and Dean of Guild Courts have also the effect of imposing the wishes of the owners of estates or policies, or of the City Guilds on any premises erected on such sites, to a much greater extent than is the case in the majority of places South of the Border. This has resulted in the production of external effects



DAVIDSON'S MAINS EXCHANGE.

which blend with the surrounding private properties. The photographs show that utility has not been the sole consideration, and that the Architects have succeeded in introducing a local character to the buildings. The photographs illustrate:—

(a) A building of the single storey type, Colinton.

Colinton Exchange has been erected in a good class residential area. The exchange has been built of brick covered with light cement harling, and with light stone facings; the door and trellis screen are of unstained, polished oak.

(b) Two storey buildings—Granton and Davidson's Mains.

Granton is of brick with cement and gravel rough-cast, red Dumfries sandstone facings and stone urn ornaments. The adjacent building estate is of similar stone construction, which forms a distinct contrast from the Craigleith stone of which the majority of Edinburgh public buildings and "New

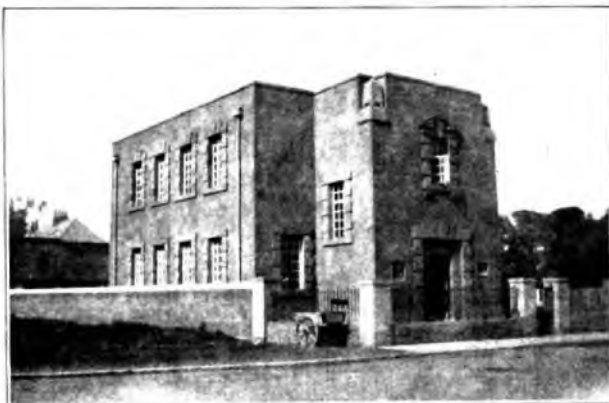

GRANTON EXCHANGE.



PORTOBELLO EXCHANGE.

Town " have been constructed during the last 150 years.

Davidson's Mains is of castellated appearance, with Craigeleith stone facings and cement roughcast walls.

(c) Portobello is a single storey building designed

for conversion to two storeys, when development justifies extension. It is built between a Church and Post Office of different elevations, and the stone building is designed to maintain a suitable building line and elevation with the adjacent premises.

Exchange.	Date of Opening or Conversion.	Numbering Scheme *	Number of Subscribers' Lines at cut-over.	Testing Positions.
Edinburgh Central ...	2-10-26	20,000--39,999	6,831	8
Abbey Hill	12-12-31	75,000--76,199	349	—
Colinton	23-1-32	87,000--88,399	409	—
Corstorphine	† 7-32	85,000--86,599	† 490	—
Davidson Mains	30-11-29	77,000--78,599	316	†
Granton	9-8-30	83,000--84,599	879	†
Leith (C.B.)	1902	71,000--74,999	—	†
Liberton	23-1-32	79,000--79,999 & 89,000--89,299	293	—
Lothianburn (C.B.S.) ‡	16-10-25	—	—	—
Morningside	2-10-26	51,000--57,799	1,832	†
Murrayfield	2-10-26	61,000--65,899	1,248	†
Newington	2-10-26	41,000--46,599	1,724	†
Portobello	9-8-30	81,000--82,599	613	†

* Based upon anticipated development at 1956.

† Provisional and Estimated.

‡ Remains C.B.S. at present; may be converted to R.A.X. later.

Institution of Post Office Electrical Engineers

Retention of Membership on Retirement

The following particulars regarding retention of membership of the Institution by members retiring from the Engineering Department following the normal operation of the Service regulations will be of interest to many readers of the Journal:—

- (1) Under Rule 11 membership may be retained at a commuted fee of £2 2s. od.
- (2) Retired members may continue to borrow books from the Central Library, and also attend the Centre meetings.
- (3) Retired members have the option of receiving copies of the P.O.E.E. Journal instead of the Printed Papers.

Those desirous of retaining membership should apply to the Secretary of the Local Centre.

Corresponding Membership

It is believed that the facilities for corresponding membership are not fully known to many officers who are eligible. The rule governing such membership is as follows:—

The admission of corresponding members shall be controlled by the Council in accordance with the principles laid down in this rule.

Application for corresponding membership may be made by the following:

- (1) By former corporate members of the Institution who have left the service of the Post Office Engineering Department and are engaged on any responsible work connected with electrical communications.
- (2) By officers engaged in electrical engineering work of a responsible character, either in connexion with a telegraph or telephone service in the British Dominions or Colonies or Dependencies or in India, or in connexion with electrical communications which are controlled by any British Government Department other than the Post Office.
- (3) By officers engaged in electrical engineering work of a responsible character in connexion with a foreign telegraph or telephone service.

Individual admissions shall be subject to the approval of the Chairman of Council. The Council

or Chairman of Council can terminate the membership of any corresponding member at any time.

The following grades of officials of Colonial Government administrations are considered eligible under the rule :—

Australia.

- Chief Engineer.
- Superintending Engineer.
- Deputy Superintending Engineer.
- Supervising Engineer.
- Metropolitan Engineer.
- Transmission Engineer.
- Divisional Engineer.
- Engineer.
- Cadet Engineer.

New Zealand.

- District Telegraph Engineers.
- Telegraph Engineers.
- Asst. Telegraph Engineers.
- (Min. 988, 14-10-30).
- Technical Clerks.
- Engineering Cadets.

India.

- Chief Engineer, Telegraphs.
- Deputy Chief Engineer, Telegraphs.
- Deputy Chief Engineer, Telephones.
- Directors, Telegraph Engineering.
- Divisional Engineers, Telegraphs.
- Electrical Engineer-in-Chief.

- Asst. Divisional Engineers, Telegraphs.
- Asst. Engineers, General.
- Asst. Engineers, Telephone.
- Asst. Electricians.
- Deputy Asst. Engineers, General.
- Deputy Asst. Engineers, Telephone.
- Deputy Asst. Electricians.
- Director of Wireless.
- Divisional Engineers, Wireless.
- Asst. Divisional Engineers, Wireless.
- Asst. Engineers, Wireless.
- Deputy Engineers, Wireless.

S. Africa.

- Engineers (Headquarters).
- Asst. Engineers (Headquarters).
- Divisional Engineers in charge of Provinces.
- Asst. Engineers.
- Engineering Assistants.

S. Rhodesia.

- Engineers.
- Sub-Engineers and Technical Clerks.
- Auto Superintendents.
- Engineering Assistants Grade A.

Ceylon.

- Chief Engineer.
- Asst. Engineers.
- Divisional Engineers.
- Engineers.

Junior Section Notes

The establishment of Junior Centres of the Institution is proceeding rapidly. There are 37 such Centres to date and details of the various officers of

the Centres have been given in the following statement in continuation of the table which appeared in the July issue.

Reg. No.	Name of Centre.	Number of Members.	Chairman.	Vice-Chairman.	Hon. Secretary.	Hon. Treasurer.
24.	Oxford	32	E. C. Harris.	W. J. Strange.	H. Bett.	H. J. Lieberman.
25.	Macclesfield	15	A. Hargrave.	B. Garner.	A. M. Hanna.	S. Lawton.
26.	Liverpool	40	H. M. Turner.	F. C. Wright.	L. H. Whitmore.	H. Utting.
27.	Brighton	92	C. T. Wright.	H. W. Jarvis.	W. J. Dawes.	E. S. Osborne.
28.	Bradford	45	J. Hardy.	*	J. H. Neill.	H. Brook.
29.	Grimby	23	J. W. Lee.	*	J. P. Loftus.	J. P. Loftus.
30.	Lincoln	25	P. Sheldrake.	Z. Clark.	H. C. Harvey.	H. C. Harvey.
31.	Doncaster	20	C. J. Search.	*	S. W. Chipp.	S. W. Chipp.
32.	Halifax	26	A. E. Lancaster.	*	M. Rushworth.	F. W. Allan.
33.	Leeds	35	A. R. Wormald.	*	G. Crosby.	H. Gerrard.
34.	York	16	E. Townshend.	*	R. E. Wood.	G. E. Winterburn.
35.	Southend	20	H. Y. Starkey.	R. C. Such.	E. E. Butcher.	A. Saberton.
36.	Nottingham	30	L. C. Topham.	A. L. Mantle.	T. A. Bish.	W. Parker.
37.	Aldershot	25	S. H. Allen.	*	R. Smith.	F. S. Padgham.

* Not yet appointed.

Essay Competition

The Council of the Institution announces the offer of Five Prizes of Two Guineas each for the five most meritorious essays submitted to it by employees of the Engineering Department of the Post Office *below the ranks of Inspector and Draughtsmen Class II.* and, in addition, to award a limited number of Certificates of Merit.

Details of the competition have been circulated widely and include a wide list of suggested subjects. Competitors are not restricted to the list however, but essays must be relevant to current telegraph or telephone practice.

Essays must not exceed 5000 words and must be written on foolscap on one side of the paper only.

A certificate is required from each competitor in the following terms:

"In forwarding the foregoing essay of — words, I certify that the work is my own unaided effort both as regards composition and drawing."

Essays must reach The Secretary, The Institution of Post Office Electrical Engineers, G.P.O. (Alder House), E.C.1, *before the 31st December, 1932.*

Competition

At the formation of the Junior Section, the Council of the Institution announced that five prizes of £2 2s. od. would be awarded annually for the five best papers written and read by members of, and before the Junior Section. The Council is at present considering the rules to be followed by Junior Centres in regard to the competition and a notification will be sent to each registered Junior Centre in due course. It is hoped that these awards may stimulate members of the Junior Section to demonstrate the talent which is known to exist among the junior ranks and we look forward to hearing of keen competition for the prizes. Space will not permit of our publishing the full list of programmes of all Junior Centres, but there is abundant evidence of keen interest in the new venture.

Nottingham Centre

The inaugural meeting of the Junior Centre was held at Nottingham on the 6th July. Mr. A. W. Blower gave an account of the inception of the Junior Section and of the progress so far attained. He outlined the proposed constitution and activities of the Junior Section and on behalf of Mr. A. B. Gilbert, Chairman of the North Midland Centre of the I.P.O.E.E., promised the full support and co-operation of the parent Institution. Mr. J. R. Milnes, who occupied the chair, expressed the keen interest of the Section officers in the welfare of the proposed Centre and offered the active support and

interest on his own and Mr. Watson Weatherburn's behalf in its formation and working.

Brighton Centre

The practicability of forming a Local Centre at Brighton having been assured, a preliminary meeting took place on the evening of July 20th.

There was a good attendance and the proceedings were marked by the enthusiasm of the staff.

The objects and scope of the scheme having been explained by Mr. W. McCormack and Mr. W. Vickery, Sectional Engineers, it was unanimously resolved to form a Local Centre, membership to be open to the staff of the Brighton South and Brighton North Sections.

It was explained to the meeting that it was desirable to elect a member of the Local Centre to the important post of Chairman and that the Junior Section was intended to be self-governed and self-supporting.

It was unanimously agreed, however, that the first Chairman should be a member of the Parent Institution and Mr. C. T. Wright, Inspector, was elected. Great interest was taken in the filling of the various offices, there being no lack of nominations and a gratifying willingness to serve.

The Library facilities were specially appreciated.

The membership is already over 100 and it is confidently expected to increase when officers now on loan to other Districts return to their Headquarters.

Aldershot Centre

A preliminary meeting in connexion with the above was held at Aldershot Telephone Exchange on the evening of the 5th instant for the purpose of electing officers for the ensuing session.

The Sectional Engineer (Mr. F. Lock) presided, and explained the aims and object of forming the Junior Section and mentioned the facilities and advantages offered.

He pointed out that the new entrants into the Service usually had had the advantage of a much higher standard of education than hitherto, and that the complicated work carried out by the Department called for some medium through which the workmen and youths could be encouraged to give expression to latent ideas. He thought that the formation of the Junior Section would undoubtedly lead to greater efficiency, and he hoped they would enter into the spirit of the movement and support it wholeheartedly.

Mr. Lock also said he was glad to see such a representative gathering, and that they could depend on him to do everything possible to make the Aldershot centre a success. He also mentioned that they were expected to be self-governing, and that it would be fitting if they could find a Chairman from among the junior section grades.

Book Reviews

"Telephony," Volume I. By T. E. Herbert, M.I.E.E., and W. S. Procter, A.M.I.E.E. Sir Isaac Pitman & Sons, Ltd., Parker Street, Kingsway, London, W.C.2. Second Edition. 1218 pages. Price 20/-.

The second edition of Volume I. of this standard work on Telephony deals with Manual Switching Systems and Line Plant. Volume II., dealing with Automatic Systems, is in an advanced stage of preparation. In general the work is an exposition of the Telephone System of the British Post Office and the descriptive titles used are those in current use in that Department.

The subject matter dealt with covers the syllabuses of the Preliminary and Intermediate examinations of the City and Guilds of London Institute together with much of the material required for the Final Grade. The volume is necessarily large on this account and a number of chapters dealing with Physics and External Plant construction, etc., could, with advantage, be placed in separate volumes.

In their treatment of the subject the authors have outlined the general principles of each particular branch, followed by detailed descriptions of the apparatus and equipment employed. The student is thus able to obtain readily a thorough grasp of both the theoretical and practical sides of speech transmission and signalling. Subscribers' apparatus, Magneto, C.B.S., and C.B. exchanges are described in complete detail together with descriptions of the latest practice in Junction and Demand Trunk working and the miscellaneous services associated with telephone service generally. Several chapters have also been devoted to such matters as Carrier working, Telephone Repeaters, and Cable Balancing. The chapter dealing with the Economics of Plant Provision forms a useful introduction to this most important phase of communication engineering.

Numerous illustrations have been given of items of apparatus and of the parts in detail, and a useful bibliography has been given at the end of each chapter. The authors are to be congratulated on the diagrams and circuit descriptions. Detached contact methods have been used extensively and the circuit descriptions are concise and complete. The work is well indexed and can be thoroughly recommended to students in telephony and to communication engineers generally. J.I.

"Outline Notes on Telephone Transmission Theory." By W. T. Palmer, B.Sc., Wh.Ex., A.M.I.E.E. The Electrical Review, 4, Ludgate Hill, London, E.C.4. Price 5/-.

These excellent Notes, which have already appeared in the *P.O.E.E. Journal*, are here collected, with a few additions, in attractive book form at a price easily within the reach of any student. The matter is set up in clear type with sub-headings and main formulæ boldly picked out, and is set to the

inside of each page, leaving ample marginal space for notes, in addition to a few blank pages at the end of the volume.

The book consists of full Notes on Telephone Transmission primarily intended for candidates for the C. and G. examinations or the Final B.Sc. (Eng.) of the University of London, but it fills a much needed want in presenting in a single volume the fundamental points to which a Telephone Engineer wishes ready access but which have, hitherto, been spread over many volumes. In case of more detailed reference being required to any particular branch of the subject, a very comprehensive series of references has been included in each of the XVII Sections into which the book is divided. It is pleasing to be able to draw attention to the inclusion of an index, which is so often exasperatingly absent from a book of this nature.

The first Section summarizes the principal mathematical formulæ, so essential if much progress is to be made in transmission theory. From this the sections proceed steadily to cover the main subject, and then to deal with branches such as the European Master Reference System, Repeaters, Measurements, and Localisation of Irregularities. Finally, a short Section draws attention to the major transmission features of Telegraph Cables.

A Foreword contributed by W. Cruickshank, M.I.E.E., well known as the late Editor of the *P.O.E.E. Journal*, adds greatly to the value of the

THE NEW AND REVISED EDITION IS NOW
READY

TELEPHONY

(SECOND EDITION)

VOLUME I.

MANUAL SWITCHING SYSTEMS & LINE PLANT

By T. E. HERBERT, M.I.E.E., *Superintending Engineer, Post Office Engineering Department, and*

W. S. PROCTER, A.M.I.E.E., *Engineer-in-Chief's Office, Post Office Engineering Department.*

This important standard Work is now published in Two Volumes. Volume I is now ready and should be ordered immediately from a bookseller, or direct from the Publishers. Volume II, dealing with Automatic Telephony, is in preparation.

This Work presents a detailed exposition of the telephone system of the British Post Office, and all who are concerned with the manufacture, uses and repair of telephone apparatus should have it for reference. It covers the syllabuses of the City and Guilds of London Institute for the Preliminary and Intermediate Examinations and much of that for the Final Grades, and is strongly recommended to students of the subject.

1210 pp. **20/- net.** Illustrated.

A descriptive Leaflet will be sent post free on request.

SIR ISAAC PITMAN & SONS, LIMITED
PARKER STREET, KINGSWAY, LONDON, W.C.2

book by giving some brief considerations of the electrical transmission of speech from the physical point of view. This Foreword will help many students to get an initial grasp of the fundamentals of transmission theory before proceeding to Mr. Palmer's more mathematical development.

F.E.A.M.

"Acoustical Engineering." By W. West, B.A., A.M.I.E.E. Sir Isaac Pitman & Sons, Parker Street, Kingsway, London, W.C.2. 331 p. 15/- net.

The science of acoustics has been receiving a great deal of attention of late and several books, and many articles, have recently appeared dealing with the various sides of the question. The present volume is a valuable addition to these.

Exception may perhaps be taken to the title which rather suggests a more exclusive consideration of the direct application of acoustical knowledge than is here dealt with. The book actually is primarily concerned with the theory of acoustics as applied to the various problems arising, but the author always keeps the practical application before the reader. There is a natural division occurring between Chapters VII. and VIII., the first portion being concerned with the theoretical basis, and the second dealing with the practical application. Any reader not wishing to study the first portion will find the second quite self-contained.

In developing the theory the author has abandoned the usual method of employing the velocity potential and uses instead the idea of acoustical impedance. This method of treatment, from its analogy with the electrical case, is of obvious advantage from the engineering standpoint. The author has done much original work in this direction with valuable results. For example, the first scientifically based artificial ear was constructed by him from measurements of the acoustical impedance of human ears.

The book covers a wide ground. The theoretical treatment is necessarily mathematical, but those who have been unable to tackle the "Sound" of Rayleigh and Lamb will find the present volume a much more digestible matter.

A résumé of the contents will perhaps best indicate the scope of the work.

After an introductory chapter on notation and units, followed by a discussion of plane waves, the properties of mechanical vibrating systems are dealt with, numerical examples of the effects of various types of control being given. The reader is then introduced to the idea of acoustical impedance, and the conventions required to bring it into line with mechanical and electrical impedance.

Divergent radiation is then dealt with followed by a full treatment of resonance considered from the impedance standpoint. A chapter on distortion completes the more general portion of the work.

Three chapters are devoted to telephone transmitters, receivers, loud-speakers and acoustical instruments generally. Considerable attention is

given to the methods used for the measurement of sound in calibrating microphones, a matter in which the author is a specialist. Two chapters are devoted to sound absorption and architectural acoustics, followed by one on physiological acoustics. This latter contains much useful information and is necessary since all matters relating to sound must ultimately be referred to their effect upon the human ear.

The final chapter on noise and articulation testing might usefully be expanded.

Three mathematical appendices are given dealing with plane waves, divergent waves and the effect upon impedance of dissipation at an orifice.

A very useful feature is a number of numerical examples, with suggestions for their solution, together with the correct answer.

The book can be thoroughly recommended as containing a wealth of useful information, lucidly presented in a form suitable both for the seeker after theoretical information, and also for the so-called practical man.

A.J.A.

"Communication Engineering." By W. L. Everitt. McGraw Hill Publishing Co., Ltd. Pp. 567. 30/-.

The tendency in modern books on communication engineering is to cover a very wide range. The present book is no exception to this as it deals with line and radio transmission, telephonic transmitters and receivers, amplifiers, oscillators and measurements at high and medium frequencies. The general treatment is fundamental, no attempt being made to deal with specific applications such as telephone switching systems. The book is intended for those having a knowledge of the principles of direct and alternating currents and of the calculus. At the end of each chapter there are given problems illustrating the principles discussed and also a bibliography.

Chapters 1 to 11 deal with telephonic transmission.

Chapter 1 explains the fundamental problems of electrical communication and introduces the ideas of equivalent networks, linear and non-linear components, wave form, range of audibility, distortion, modulation, etc. Stress is laid on the necessity for faithfulness of reproduction rather than volume.

Subsequent chapters in this section deal with the theory of complex quantities; network theorems; resonance; transmission over an infinite line; reflections; filters; interference from power circuits; coupled circuits and applications of the Wheatstone Bridge principle.

All expressions for line constants such as attenuation and impedance are derived from the equivalent network. This method of treatment has the advantage of simplicity and of facilitating the realisation of the practical meaning of the mathematical expressions. Hyperbolic functions are first introduced in connexion with reflections, as they represent in a convenient manner waves travelling in opposite directions.

Throughout the book numerical examples are

given which are a great help to the theoretical expressions.

Among the applications of the Wheatstone Bridge principle are included A.C. measuring bridges; harmonic analysers; anti-sidetone devices; phantom circuits and telephone repeater systems.

There is very little to criticise in this section of the book.

The consideration of line-distortion might with advantage have been fuller especially as regards non-linear and phase-distortion, as these are at present the chief limiting factors of long-distance transmission.

The proof of the Reciprocity Theorem on page 40 is somewhat misleading as the generator and receiver impedances are included in the series network impedances. When the generator and receiver are transposed, as stated, these impedances will be modified and the proof is not strictly correct.

More details of alternating current bridge measurements would have been useful. Such necessary devices as screening and the Wagner earth balance are omitted.

Chapters 12 to 15 deal with microphonic transmitters, audio and radio amplifiers under the general heading "Networks using Unilateral Impedances." As examples of such devices there are mentioned "Relays, switching mechanisms, steam valves, rifles and mouse-traps"; but the scope of the book does not cover these. The design and functions of

different types of thermionic valve, including the screened grid and pentode types, are described.

Chapters 16 and 17 deal with the application of valves to modulation, de-modulation and detection under the general heading "Networks using non-linear impedances." The theory of modulation is described and its application to systems such as suppressed carrier and radio secrecy systems. The different methods of detection described include grid, anode and heterodyne detection.

Oscillators are dealt with in Chapter 18. After giving the theory of thermionic valve oscillators, different types are described, including audio, heterodyne, negative resistance, dynatron and Barkhausen oscillators. Chapter 19 deals with electro-mechanical devices and includes telephone receivers and loudspeakers of different types such as Piezo-electric; moving coil, magneto-strictive and condenser types, as well as the normal Bell receiver.

Chapter 20 deals with Radiation and includes an account of the action of the Heaviside layer.

Chapter 21 describe instruments for the measurement of current and voltages at high and medium frequencies. The instruments include hot-wire, thermo-couple, copper-oxide rectifier and vacuum tube types, and methods of measuring field strengths and frequency are described.

The book is well produced and the figures are clear. It can confidently be recommended for the use of communication engineers. C.R.

PITMAN'S BOOKS

JUST PUBLISHED.

ACOUSTICAL ENGINEERING

By W. WEST, B.A., A.M.I.E.E., of the Research Staff of the Post Office.

This book explains simply and directly the theory of sound and its practical applications to telephone engineering, etc., as well as to acoustical measurements and research. Fundamental principles are stressed, particularly in the section on Distortion of Sound, a chapter which provides a useful basis for the discussion of the transformation from acoustical to electrical vibrations, and vice versa. A scholarly and practical work. 350 pp. 15/- net.

SUBMARINE TELEGRAPHY

By ING. ITALO DE GIULI. Translated into English by J. J. McKichan, O.B.E.

With a Foreword by T. E. Herbert, M.I.E.E. Deals with the operation of modern telegraph apparatus and provides sound fundamental knowledge from a practical standpoint. Students and engineers of all branches of electrical communication work will benefit from its authoritative guidance. 250 pp. 18/- net.

STANDARD WORKS.

ALTERNATING CURRENT BRIDGE METHODS.

By B. HAGUE, D.Sc., Ph.D., A.C.G.I., M.I.E.E.

A theoretical and practical handbook for the use of research workers, students, and engineers, describing up-to-date methods for the measurement of inductance, capacitance and effective resistance at low and telephonic frequencies. Third Edition. 15/- net.

RELAYS IN AUTOMATIC TELEPHONY.

By R. W. PALMER, M.I.E.E. Crown 8vo, cloth gilt, 190 pp., illustrated. 10/6 net.

THE DIRECTOR SYSTEM OF AUTOMATIC TELEPHONY.

By W. E. HUDSON, B.Sc., (Hons.) (Lond.), Whit. Sch., A.C.G.I., *Engineer-in-Chief's Department, G.P.O.* Crown 8vo., cloth gilt, 166 pp., with 174 illustrations. 5/- net.

THE CALL INDICATOR SYSTEM IN AUTOMATIC TELEPHONY.

By A. G. FREESTONE, of the Automatic Training School, G.P.O., London. Crown 8vo., cloth gilt, 124 pp., illustrated. 6/- net.

THE PRACTICAL TELEPHONE HANDBOOK AND GUIDE TO THE TELEPHONIC EXCHANGE.

By JOSEPH POOLE, A.M.I.E.E., Wh.Sc., in collaboration with other specialists in telephone engineering. Crown 8vo., with 685 illustrations. Seventh Edition. 18/- net.

Full particulars of these books will be sent, post free, on request.

SIR ISAAC PITMAN & SONS, LTD., Parker Street, Kingsway, London, W.C.2

Staff Changes.

POST OFFICE ENGINEERING DEPARTMENT.

PROMOTIONS.

Name.	From	To	Date.
Cornfoot, T.	Assistant Suptg. Engineer in Charge, N. Ireland District.	Suptg. Engineer, S. Mid. District.	9-11-32
Partridge, T. T.	Assistant Suptg. Engineer, S. Lcs. District.	Assistant Suptg. Engineer in Charge, N. Ire. District.	9-11-32
Smith, H. A.	Executive Engineer, London District.	Assistant Suptg. Engineer, Scot. W. District.	1-10-32
Hudson, W. E.	Acting Executive Engineer, E.-in-C.O.	Executive Engineer, E.-in-C.O.	1-9-32
Martin, P. C.	Assistant Engineer, N. Wa. District.	Acting Executive Engineer, N.E. District.	To be fixed later.
Saunders, F. J.	Assistant Engineer, London District.	Executive Engineer, London District.	1-9-32
Phillips, C. H.	Assistant Engineer, London District.	Executive Engineer, London District.	1-10-32
Starkey, Major H. Y.	Assistant Engineer, E.-in-C.O.	Executive Engineer, E. District.	17-7-32
Pate, C. H. V.	Assistant Engineer, E.-in-C.O.	Executive Engineer, E.-in-C.O.	1-7-32
Taylor, H. M.	Chief Inspector, London District.	Assistant Engineer, Scot. W. District.	31-8-32
Akester, A.	Chief Inspector, E.-in-C.O.	Assistant Engineer, E.-in-C.O.	31-8-32
Bryant, G. H.	Chief Inspector, S. E. District.	Assistant Engineer, N. Mid. District.	31-8-32
Bolton, G. F.	Chief Inspector, S. Mid. District.	Assistant Engineer, N. Wa. District.	31-8-32
Lowe, J.	Chief Inspector, N. Wa. District.	Assistant Engineer, N. Wa. District.	31-8-32
Bothwell, A. D.	Chief Inspector, E.-in-C.O.	Assistant Engineer, E.-in-C.O.	} To be fixed later.
Sims, A. E.	Chief Inspector, E.-in-C.O.	Assistant Engineer, E.-in-C.O.	
Scarborough, W. H.	Chief Inspector, E.-in-C.O.	Assistant Engineer, London District.	} To be fixed later.
Kilburn, G. A. N.	Chief Inspector, London District.	Assistant Engineer, Scot. E. District.	
Clyma, H. P.	Inspector, S. Les. District.	Chief Inspector, N. Wa. District.	} To be fixed later.
Taylor, W. L.	Inspector, S. Mid. District.	Chief Inspector, S. Wa. District.	
Elliott, G.	Inspector, London District.	Chief Inspector, London District.	2-8-32
Worthington, C. E.	Inspector, N. District.	Chief Inspector, N. Ire. District	To be fixed later.
Brown, W. J.	Inspector, London District.	Chief Inspector, London District.	22-8-32
South, E. A.	Skilled Workman, Class I., E. District.	Inspector, E. District.	5-5-31
Berrill, W. G.	Skilled Workman, Class I., E. District.	Inspector, E. District.	29-5-32
Thorne, E.	Skilled Workman, Class I., E. District.	Inspector, E. District.	20-12-31
Usher, C. W. G.	Skilled Workman, Class I., N. Mid. District.	Inspector, N. Mid. District.	1-1-31
Johnston, A. N.	Skilled Workman, Class I., Scot. W. District.	Inspector, Scot. W. District.	8-6-32
Clinch, F. A.	Skilled Workman, Class I., Scot. W. District.	Inspector, Scot. W. District.	13-8-32
Sadler, A. T.	Skilled Workman, Class I., London District.	Inspector, London District.	1-1-30
Hornsby, G.	Skilled Workman, Class I., London District.	Inspector, London District.	14-10-30
Gray, H.	Skilled Workman, Class I., London District.	Inspector, London District.	7-11-31
Holliday, R. F.	Skilled Workman, Class I., London District.	Inspector, London District.	13-6-31
Legood, F. J.	Skilled Workman, Class I., London District.	Inspector, London District.	29-11-31
Judd, F. W.	Skilled Workman, Class I., London District.	Inspector, London District.	5-7-31
Blakeman, W. W.	Skilled Workman, Class I., London District.	Inspector, London District.	1-1-32
Linsell, W.	Skilled Workman, Class I., London District.	Inspector, London District.	12-9-31
Nokes, H. R.	Skilled Workman, Class I., London District.	Inspector, London District.	25-6-31
Morgan, L. O.	Skilled Workman, Class I., London District.	Inspector, London District.	1-1-32
Ricketts, N. W. J.	Skilled Workman, Class I., London District.	Inspector, London District.	1-1-32
Burdick, C. A. R.	Skilled Workman, Class I., London District.	Inspector, London District.	11-7-31
Freshwater, R. A. A.	Skilled Workman, Class II., London District.	Inspector, London District.	16-12-31
Loveland, F. F.	Skilled Workman, Class II., London District.	Inspector, London District.	8-12-31

STAFF CHANGES

255

TRANSFERS.

Name.	Grade.	From	To	Date.
Manning, G.	Assistant Engineer.	E.-in-C.O.	South Wales.	10-7-32
Smith, W. F.	Assistant Engineer.	E.-in-C.O.	Northern.	11-8-32
Affleck, D. B.	Assistant Engineer.	N. Wales.	E.-in-C.O.	1-6-32
Norfolk, E. W.	Inspector.	London District.	E.-in-C.O.	1-8-32
Willmot, A. J.	Chief Inspector.	T. Branch.	E.-in-C.O.	1-9-32
Allison, A. J.	Inspector.	London District.	Inland Rev. Dept.	

RETIREMENTS.

Name.	Rank.	District.	Date.
Cameron, Major J.	Assistant Suptg. Engineer.	Scot. West.	30-9-32
Bramwell, J. T.	Assistant Suptg. Engineer.	Northern.	31-8-32
Tobbits, J.	Executive Engineer.	N. Wales.	31-8-32
Bolton, W.	Executive Engineer.	London.	31-8-32
Hardie, J. J.	Executive Engineer.	E.-in-C.O.	31-7-32
Couch, J. M.	Assistant Engineer.	Scot. E.	9-7-32
Wiggins, F.	Assistant Engineer.	N. Mid.	30-6-32
Bolton, J. H.	Chief Inspector.	S. East.	31-8-32
Holder, F. W. W.	Chief Inspector.	London.	31-8-32
Hunt, R. W.	Chief Inspector.	S. Lcs.	31-8-32
Wigg, H. H.	Chief Inspector.	Eastern.	31-8-32
Nunn, R. J.	Chief Inspector.	Eastern.	31-8-32
Benney, C. F.	Chief Inspector.	Eastern.	30-8-32
Hannah, W.	Inspector.	Scot. E.	31-8-32
Bayard, J.	Inspector.	London.	30-6-32
Scott, T. A.	Inspector.	S. Wales.	27-6-32
Morgan, C.	Inspector.	London.	30-7-32
Brown, A.	Inspector.	Scot. W.	12-8-32
Smithson, W.	Inspector.	N.E.	31-7-32
Lock, A.	Inspector.	S. Mid.	3-7-32
Brown, J. M.	Inspector.	Scot. E.	1-8-32
Haycock, W. A.	Inspector.	N. West.	10-6-32
Bouquet, B. C.	Inspector.	London.	31-5-32
Boniface, G. E.	Inspector.	London.	31-5-32
Smith, J. W.	Inspector.	Scot. E.	10-9-32

DEATH.

Name.	Rank.	District.	Date.
Siddall, H.	Proby. Inspector.	Training School, E.-in-C.O.	20-6-32

CLERICAL GRADES.

PROMOTIONS.

Name.	At Present.	To Be	Date.
Carrier, G. H.	C.O., N. Wa. District.	H.C.O., N. Wa. District.	1-9-32
Thompson, H.	C.O., S. Lcs. District.	H.C.O., N. Ireland.	29-7-32
Dodgson, P. J.	C.O., S. East District.	H.C.O., S. Mid. District.	26-9-32

RETIREMENTS.

Name.	Rank.	Location.	Date.
Storey, S.	H.C.O.	N. West District.	10-7-32
Palk, E.	H.C.O.	S. Mid. District.	1-9-32
Smith, C. J.	H.C.O.	S. Mid. District.	26-9-32
Lock, F. J.	H.C.O.	I.dn. District.	30-9-32

TRANSFERS.

Name.	Rank.	From	To	Date.
Austin, R. B.	H.C.O.	N. Ireland.	N. West District.	30-7-32
Donaldson, J. G. K.	H.C.O.	N. Wa. District.	S. Mid. District.	1-9-32

BOARD OF EDITORS.

B. O. ANSON, M.I.E.E., Chairman.
 P. J. RIDD, M.I.E.E.
 C. J. MERCER, M.I.E.E., M.I.R.E.
 A. J. GILL, B.Sc., M.I.E.E., M.I.R.E.
 J. PRESCOTT.
 J. T. KELLY.
 J. INNES, B.Sc., A.M.I.E.E., Managing Editor.
 W. S. PROCTER, A.M.I.E.E., Assistant Editor.

COMMUNICATIONS.

All Remittances and Communications should be addressed to the MANAGING EDITOR, P.O.E.E. JOURNAL, Engineer-in-Chief's Office, Alder House, London, E.C.1.

Binding covers and copies of the Contents for Vol. 3 to 25 are available, and may be obtained from the local agents for 1s. 6d. and 3d. respectively. Subscribers can have their copies of Vol. 25 bound, with index included, at a cost of 3s., by sending the JOURNALS to the local agents. Orders for bindings, Vols. 1-19, should indicate whether the original binding with black lettering, or the latter pattern in gold, is required. Covers with gold lettering will be the only type stocked from Vol. 20 onwards.

The price of the JOURNAL is 1s. (1s. 3d. post free) per copy, or 5s. per annum, post free. All back numbers 2s. each.

THE

NEW TYPE LOADING COIL POT

MADE IN ENGLAND

FOR BURYING DIRECT in the GROUND WITHOUT MANHOLES



Supplied recently to
THE BRITISH POST OFFICE
for loading minor trunk
circuits

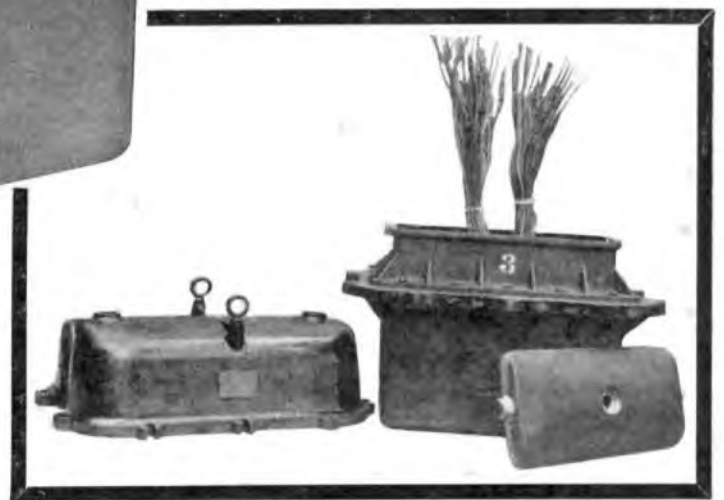

THE BURIED POTS CONTAIN

G.E.C.

LOADING COILS
WOUND ON
GECALLOY CORES

Famous for the outstanding characteristics:
**LOW LOSSES AND
HIGH STABILITY**

The loading coils and containers were designed,
developed and manufactured at THE SALFORD
ELECTRICAL INSTRUMENT WORKS of

THE GENERAL ELECTRIC CO., LTD.

Head Office: MAGNET HOUSE, KINGSWAY, LONDON, W.C. 2

Branches throughout Great Britain and in all the principal markets of the World

G.E.C. BURIED LOADING POT
FOR USE IN CONJUNCTION
WITH PIRELLI - GENERAL
ARMOURED TELEPHONE CABLE
FOR THE CAMBRIDGE-KINGS
LYNN CIRCUIT

INDEX TO ADVERTISERS.

	PAGE		PAGE
Automatic Telephone Mfg. Co., Ltd.	iii	Henley's, W. T., Telegraph Works, Co., Ltd.	ix
British Institute of Eng. Technology	xiv	Pirelli-General Cable Works, Ltd.	xvi
Creed & Co., Ltd.	xiii	Pitman & Sons, Ltd.	253
Ebonestos Insulators, Ltd.	xii	Standard Telephones and Cables, Ltd.	x
Elliott Brothers, Ltd.	xv	Siemens Bros. & Co., Ltd.	vi and vii
Ericsson Telephones, Ltd.	v	Smith, Frederick & Co.	xv
Ernest T. Turner	ix	Telephony Publishing Corp.	xii
Ferranti	ii	The Electrical Review	iv
Hall Telephone Accessories (1928), Ltd.	xii	The General Electric Co., Ltd.	viii and xi

Hall Telephone Accessories (1928) Limited.

Suppliers to the British Post Office and
- Foreign Government Departments.

Manufacturers of prepayment telephone
multi-coin collectors, automatic stamp
selling and ticket selling machines,
automatic slot machines and fire alarm
apparatus.

Registered
Office & Works : 70, DUDDEN HILL LANE,
WILLESDEN,
LONDON, N.W. 10

Tel.: WILLESDEN 5141/2.

Moulders to the Trade

*Established
30 Years*

MOULDINGS
IN WHITE OR
COLOURS.
BAKELITE —
BEETLE —
CELLULOSE
AND OTHER
SYNTHETICS.

PLASTIC MOULDINGS HAVING
HEAT — ACID — OIL — ALKALI —
WATER RESISTING QUALITIES.

EBONESTOS INSULATORS LTD
Excelsior Works,
Rollins Street,
Canterbury Road,

Telephone
NEW CROSS 1913 (5 lines) **LONDON, S.E.15.**



THIRTY-ONE YEARS—

is the span of time during which TELEPHONY has been the telephone industry's leading journal. This high standing has been earned because each issue contains a host of valuable information on engineering, construction, commercial and maintenance subjects. TELEPHONY is read by progressive telephone people all over the world. Subscription price £1 5s. for 52 interesting and instructive issues.

Address: Electrical Trading and Electricity Technical Book Dept., 85,
Long Acre, London, W.C. 2, for a sample copy of TELEPHONY.
TELEPHONY PUBLISHING CORP., 608, S. Dearborn St. Chicago, ILL, U.S.A.

Teleprinters revolutionise telegraph practices



THE supplanting of Morse and Baudot sets by Teleprinters has considerably increased the speed of telegraph traffic.

Creed Teleprinters can be continuously operated at speeds up to 66 words per minute, and are thus more than twice as fast as hand-operated Morse. Further, in Teleprinter working, an operator is required only at the sending end of the circuit, so that only one operator per channel is necessary in place of two per channel for hand Morse working.

The British Post Office who are extensive users of Creed Teleprinters, have now over 2,500 installed throughout Great Britain, carrying a large percentage of the total inland telegraph traffic.

Teleprinters for either page or tape printing can be supplied. Write for full particulars.

The **CREED** **TELEPRINTER**

Advertisement of Creed & Co. Ltd., Telegraph House, Croydon. Telephone: Croydon 2121.

The Institution of Post Office Electrical
Engineers.

PRINTED PAPERS.

The following papers contributed to the proceedings of the Institution have been printed by authority of the Council and may be obtained from:

The Librarian,
The Institution of Post Office Electrical
Engineers,
G.P.O., Alder House, London, E.C. 4

The prices do *not* include postage.

- | | | |
|----------|---|-----|
| No. 128. | " CRITICAL METHODS OF INVESTIGATION AS APPLIED TO THE STUDY OF TELEPHONE AREAS AND PLANT LAY-OUT."—J. N. HILL. 1930 | 1/3 |
| No. 129. | " PICTURE TELEGRAPHY."—E. S. RITTER, D.F.H., M.I.E.E. 1929 | 9d. |
| No. 130. | " COMPOSITE TELEGRAPH AND TELEPHONE WORKING."—J. M. OWEN, A.M.I.E.E., and J. A. S. MARTIN. 1930 | 1/3 |
| No. 131. | " CARRIER CURRENT TELEPHONY."—Capt. A. C. TIMMIS, B.Sc., A.M.I.E.E. 1930 | 1s. |
| No. 132. | " THE HEATING AND VENTILATING OF POST OFFICES AND TELEPHONE EXCHANGES."—W. T. GEMMELL, B.Sc. (Hons.), A.M.I.E.E. 1930 | 9d. |
| No. 133. | " RURAL AUTOMATIC EXCHANGES."—J. C. DALLOW. 1929 | 9d. |
| No. 134. | " SOUND AND HEARING."—N. F. CAVE-BROWNE-CAVE, B.Sc., M.I.E.E. 1930 | 1s. |
| No. 135. | " THE ELECTRICAL CONTROL OF TIME SERVICES IN THE BRITISH POST OFFICE."—A. O. GIBBON, M.I.E.E. 1931 | 1s. |
| No. 136. | " SOME DEVELOPMENTS IN TELEGRAPH TECHNIQUE AS APPLIED TO RADIO CIRCUITS."—H. FAULKNER, B.Sc. (Hons.), A.M.I.E.E., and G. T. EVANS. 1931 | 1s. |
| No. 137. | " INTERFERENCE WITH WIRELESS RECEPTION ARISING FROM THE RECEPTION OF ELECTRICAL PLANT."—Col. A. S. ANGWIN, D.S.O., M.C., T.D., B.Sc., M.I.E.E. 1932 | 6d. |
| No. 138. | " TELEPHONE CABLE TESTING (INCLUDING FAULT LOCALISATION)." — W. T. PALMER, B.Sc., Wm. Ex., A.M.I.E.E., and E. H. JOLLEY, A.M.I.E.E. 1931 | 1/3 |

GUARANTEED EXAMINATION COACHING

Since the B.I.E.T. was founded several years ago, we have specialised in preparing candidates for leading Technical Examinations, and our success may be gauged from the fact that over all this period of time, our candidates have returned the remarkable average pass record of

OVER 90% SUCCESSES.

Here are three recent results:—

In the Probationary Inspectors' Examination held in December, 1931, 7 out of our 8 candidates were selected for interview.

In the I.E.E. Examination held in May, 1932, 18 out of our 18 candidates passed successfully. Not one failed.

In the Assistant Superintendent of Traffic (Limited Competition) Examination held in April, the candidate who was placed 1st was trained by this Institute.

We teach successfully by correspondence, and definitely guarantee—

"NO PASS—NO FEE"

You are advised to send for a copy of our General Prospectus "ENGINEERING OPPORTUNITIES." This Hand-book contains 250 pages of most useful information. It also contains particulars of all leading Engineering Examinations, including

Probationary Inspectors (*Open and Limited Competition*)

Probationary Assistant Engineers (*Open and Limited Competition*)

Assistant Superintendent of Traffic (*Open and Limited Competition*)

City and Guilds, Special G.P.O. Examination, I.E.E., B.Sc., A.M.I.C.E., London Matric., etc., etc.

The Hand-book also outlines "up to the minute" courses of Home Study in *all branches* of Engineering.

Special Courses are offered in **Telegraphy, General Telephony, Automatic Telephony, Telephone Transmission, Electrical Technology, Wireless and High Frequency Radio Communication, Alternating Currents, Talking-Picture Engineering, etc., etc.**

Our 250 page Hand-book should be on your Bookshelf. It will be gladly sent on request, FREE and without obligation. (*Please state subject or Examination of most interest*).

British Institute of Engineering Technology

369, Shakespeare House,
29/31, Oxford Street, London, W. 1

Differential Moving Coil MILLIAMMETERS FOR TELEGRAPH CIRCUITS

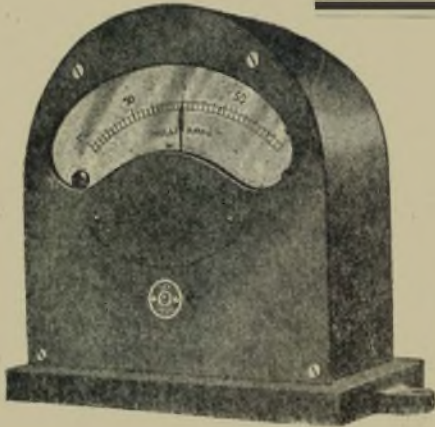

T. 1097. TABLE MOUNTING TYPE.

TABLE, WALL AND PANEL MOUNTING TYPES.

INVALUABLE as line Milliammeters on Differential Duplex, Sub-Audio Frequency and many other Telegraph Systems, also for testing purposes in connexion with Land Line and Radio Communication.

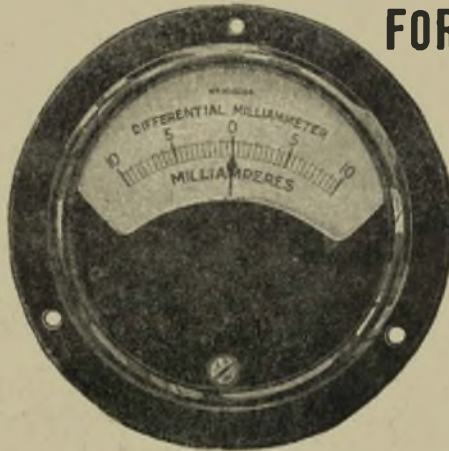

T. 1089. PANEL MOUNTING TYPE.

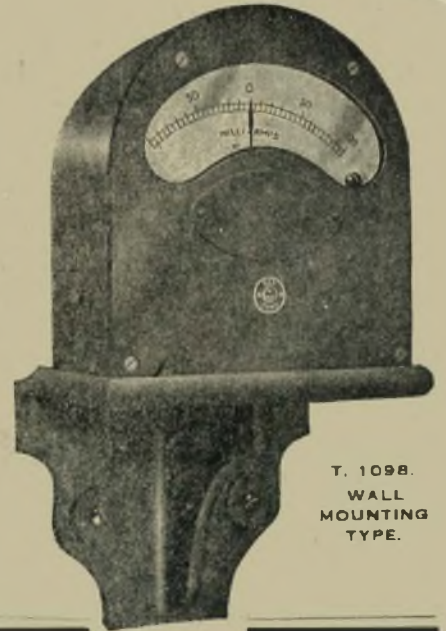

T. 1098. WALL MOUNTING TYPE.

Particulars will be sent on request.

ELLIOTT BROTHERS (London) Ltd., Century Works, Lewisham, S.E.13

Telephone:
Lee Green 4656

in association with

SIEMENS BROTHERS & Co., Ltd., Woolwich, London, S.E. 18

Telephone:
Woolwich 1161

FREDERICK SMITH & COMPANY

(INCORPORATED IN THE LONDON ELECTRIC WIRE COMPANY AND SMITHS, LIMITED)



BRONZE AND CADMIUM COPPER WIRES

As Supplied to H.M. Post Office for
TELEPHONE LINES

SILICIUM-BRONZE,
COPPER.

SEND US PARTICULARS OF YOUR JOB, AND OUR TECHNICAL ENGINEERS WILL PROVIDE YOU WITH THE DATA YOU NEED.

COPPER-CADMIUM
TAPES & BINDERS.

Anaconda Works

Telephone:
Blackfriars 8701 (8 lines)

Salford, Manchester

Telegrams:
"Anaconda, Manchester"

Land Lines

PIRELLI-GENERAL are at present supplying the land lines for connecting Belfast to Glasgow. These cables contain circuits for Four-Wire Repeaters, Two-Wire Repeaters and Broadcasting;

whilst circuits are specially loaded for Carrier Current Telephony. Complete immunity from cross-talk between four-wire "Go" circuits and four-wire "Return" circuits is obtained by the insertion of screening fillets. Pirelli-General were the first to install a cable with this screening device some while ago and it is noteworthy that it is again being used on the important contract mentioned above.

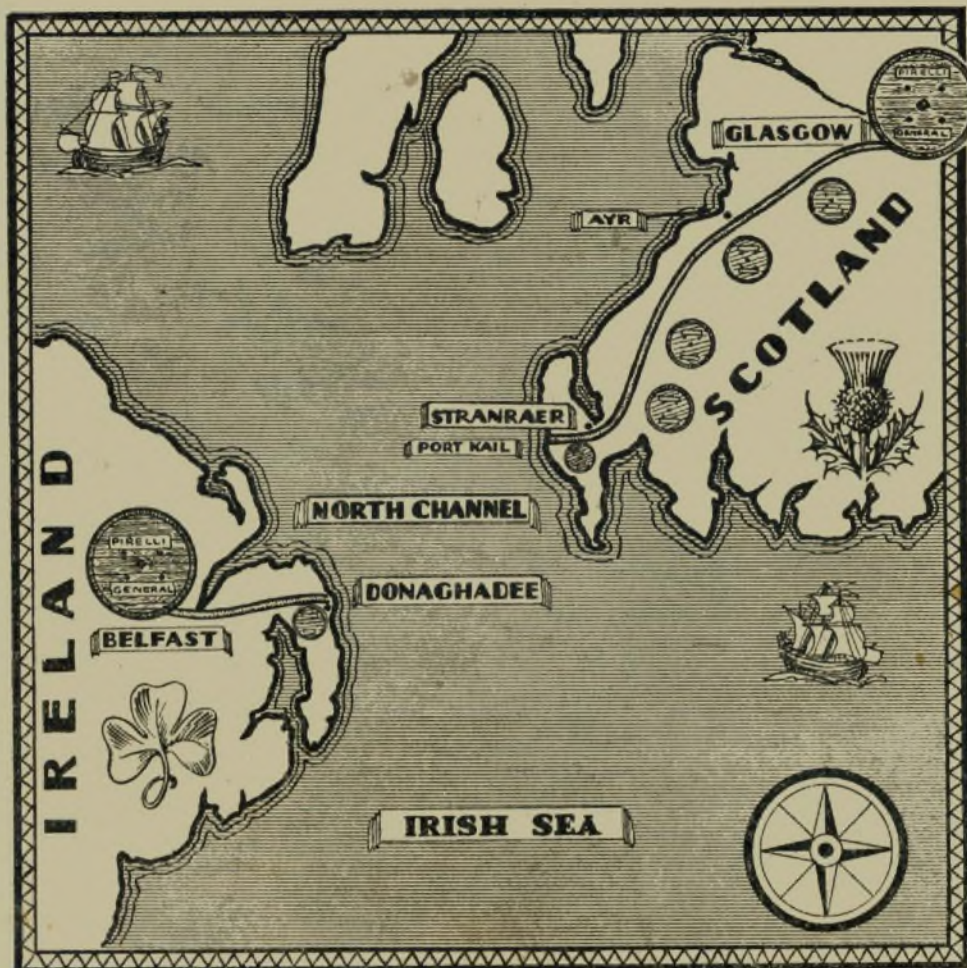

**ANOTHER
EXAMPLE OF
THE EFFICIENCY
OF PIRELLI-
GENERAL TELE-
PHONE CABLES**

TELEPHONE
SOUTHAMPTON
2141 (3 LINES).

PIRELLI-GENERAL

CABLE WORKS, Ltd., SOUTHAMPTON.

Proprietors: PIRELLI, LTD., and THE GENERAL ELECTRIC CO., LTD.

TELEGRAMS:
"PIGEKAYBEL,
SOUTHAMPTON."