

SPECIAL ARTICLE: WINSTON CHURCHILL AND THE B.B.C.

MODERN WIRELESS

1/-

VOL: XVIII. N° 68

AUGUST 1932

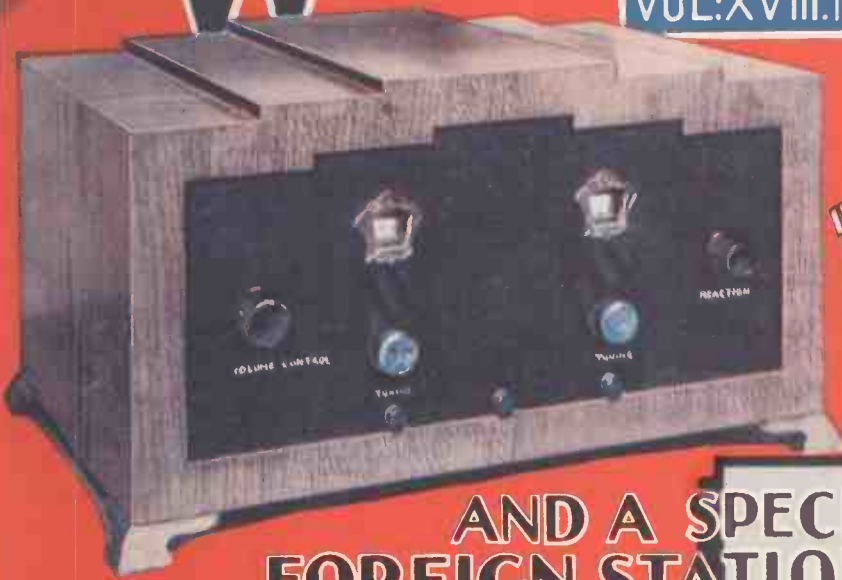

This Month
**THE
"FIVE-GRID"
FOUR**

AND A SPECIAL
FOREIGN STATION SECTION

The WORLD'S PROGRAMMES

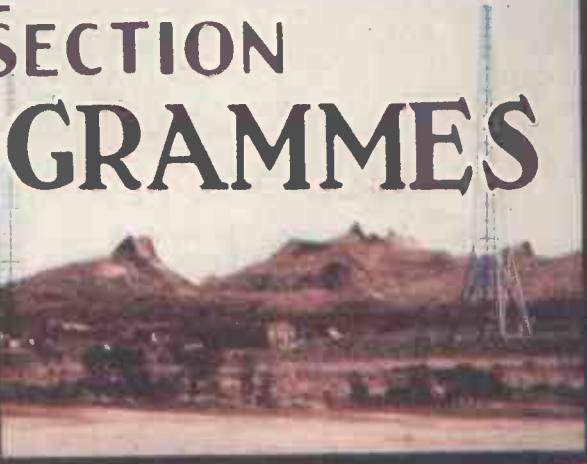

ALSO INSIDE:
MODERN RADIO-GRAMS
EQUALISING DIAL READINGS
THOSE VARIABLE-MU VALVES
TROUBLE TRACKING
etc., etc., etc

**BRITISH
MADE**

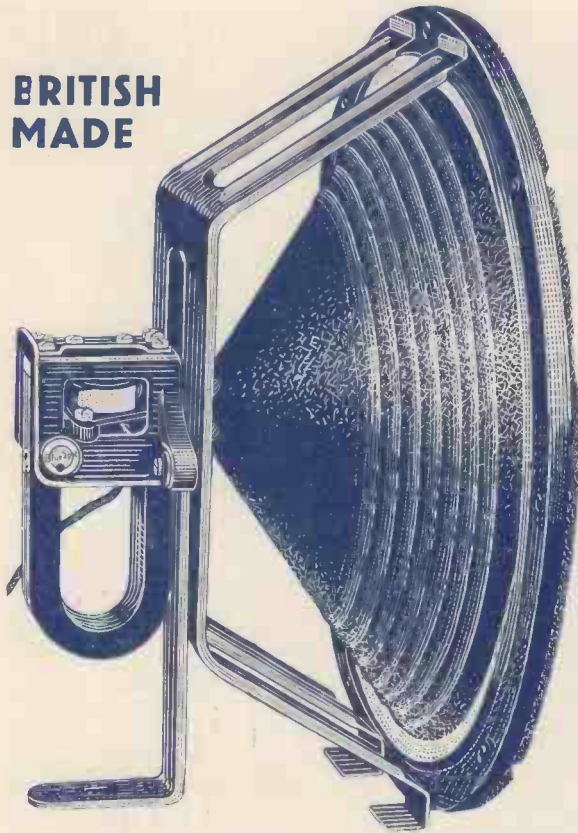

**MOVING
COIL
PERFORMANCE**
for the
**SMALL
RECEIVER**

BLUE SPOT
100U-39'6
Gives Moving Coil Performance

BLUE SPOT PICK-UP

You simply can't believe that music so beautiful can be had from gramophone records until you hear them played through a Blue Spot Pick-up.

Price complete with self contained volume control



63/-

IF you are running a small set with a dry battery H.T. supply here is your chance to get Moving Coil performance with very little outlay and no structural alteration.

Blue Spot 100U is designed to work satisfactorily on very small inputs. In consequence it may be used with battery-operated receivers with every confidence as well as all mains sets.

Its performance is remarkable. It has all the sensitivity and richness of tone that distinguishes the *good* (and expensive) Moving Coil speaker. It gives the finest rendering of the difficult bass notes without detracting from the clear high notes of the treble.

For the man who wants a really good top notch speaker 100U provides good Moving Coil quality at economy price.

Send for Catalogue No. M.W.19U



ALL BLUE SPOT PRODUCTS ARE NOW OBTAINABLE BY INSTALMENTS.

THE BRITISH BLUE SPOT COMPANY LTD
BLUE SPOT HOUSE · 94/96 ROSOMAN STREET · ROSEBERY AVENUE · LONDON · E C I
Telephone: Clerkenwell 3570.
Distributors for Northern England, Scotland and Wales: H. C. RAWSON (Sheffield and London), Ltd., 100, London Road, Sheffield: 22, St. Mary's Parsonage, Manchester; 44-46, High Bridge, Newcastle; 37, 38, 39, Clyde Place, Glasgow.
Telegrams: "Bluspot, Isling, London."

CONTENTS

Vol. XVIII. No. 68. MODERN WIRELESS AUGUST, 1932.

	Page		Page
Editorial	95	Recent Record Releases	148
Democracy and the B.B.C.	96	These Modern Radio-Grams	149
Round the Turntable	98	A Radio Reckoner	151
The Amateur Transmitter	99	Questions Answered	154
The "M.W." "Gramo-Tone"	101	Cinema versus Church-Organs	155
Trouble Tracking	104	In Passing	157
My Broadcasting Diary	121	The "Lotus Bud" A.C. Two	159
Using the New Pentodes	123	Those Variable-Mu Valves	161
The "Diodion"	124	Spotlights on the Programmes	165
Missing Notes	128	Equalising Dial Readings	168
At Your Service	129	Wave Research in Germany	169
Choosing an Output Valve	131	Autodyne Adaptors for Short Waves	173
Winston Churchill and the B.B.C.	132	The "Micro-Cell"	176
About Those Mains	134	The "M.W." Charger-Changer	177
That Penetrating Wave	135	For the Constructor	181
The "Five-Grid" Four	136	Behind the Scenes of Broadcasting	182
On the Short Waves	143	Radio Notes and News	186
On the Test Bench	146		

SPECIAL SUPPLEMENT, "THE WORLD'S PROGRAMMES," PAGES 105-120.
(See page 105 for contents of this section.)

As some of the arrangements and specialities described in this Journal may be the subject of Letters Patent the amateur and trader would be well advised to obtain permission of the patentee to use the patents before doing so.

Edited by NORMAN EDWARDS.

Technical Editor: G. V. DOWDING, Associate I.E.E.

Radio Consultant-in-Chief: Capt. P. P. ECKERSLEY, M.I.E.E.

Scientific Adviser: J. H. T. ROBERTS, D.Sc., F.Inst.P.

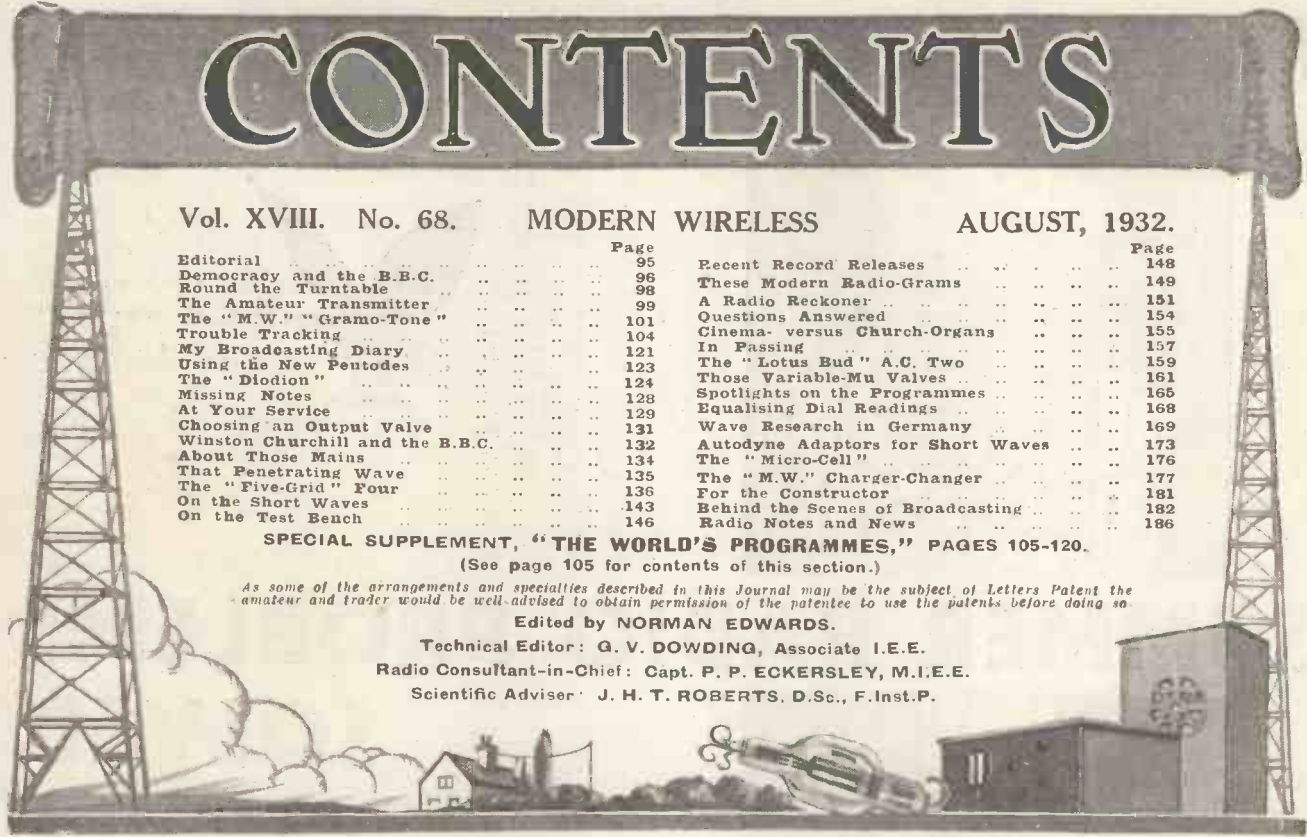

You must go to the Radio Show

You'll be going to the Radio Show, of course! This is an event that claims the attention of all modern-minded people. See all these sensational new sets for yourselves and hear, examine and discuss them with the experts on the spot. Last year's Radiolympia broke all records. The 1932 Radio Show must be seen to be believed. It's bigger — more spectacular — an absolute wonderland.

COME TO **RADIOLYMPIA** WHERE BRITISH IS BEST!

AUGUST 19 - 27

ADMISSION 1/6. DANCING Free.

11 a.m. to 10 p.m. Daily.

ORGANISED BY THE RADIO MANUFACTURERS' ASSOCIATION

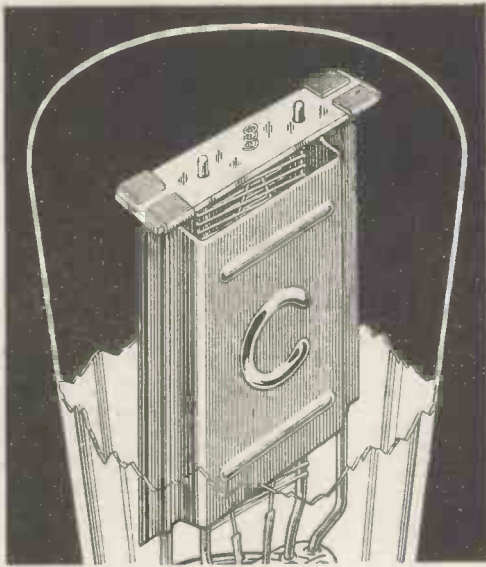

SUMMER RADIO PROBLEMS SOLVED



A copy of the 40 page Cossor Valve and Wireless Book B17 will be sent you free on application to A. C. Cossor Ltd., Melody Dept., Highbury Grove, London, N.5.

Get one of the new Cossor Station Charts price 2d. Ask your dealer for a copy of this useful novelty or write to us enclosing 2d. stamp.

SUMMER Radio conditions are difficult. Distant stations are harder to bring in. To ensure enjoyable Radio your Receiver must work at its maximum efficiency. And its efficiency depends largely on the valves you use. Due to the use of the famous Mica Bridge, Multi-point Filament Suspension, and other important constructional features, the efficiency of Cossor Valves is so high that their use ensures a marked improvement in the performance of any well designed Receiver.

WITH

COSSOR

ALL-BRITISH

VALVES

FITTED WITH THE FAMOUS MICA BRIDGE CONSTRUCTION

A. C. Cossor Ltd., Highbury Grove, London, N.5.

Depots at Birmingham, Bristol, Glasgow, Leeds, Liverpool, Manchester, Newcastle, Sheffield and Dublin.

79 ♡ 801

MODERN WIRELESS



Vol. XVIII. No. 68.

BRITAIN'S LEADING RADIO MAGAZINE.

AUGUST, 1932.

The "Five-Grid" Four—The "Diodion"—Mr. Churchill—The "U"-Boat Commander's Broadcast.

THE main features of the "Five-Grid" Four, which is described in this issue of MODERN WIRELESS, may be very briefly summarised: controllable selectivity; input volume control that does not affect the tuning, but yet obviates detector overloading; easy-to-build; and a particularly straightforward circuit.

The latter comprises an S.G., Det. and 2 L.F. stages, and readers will note that provision for a pick-up is made by a jack on the terminal strip at the back of the set.

Our Special Exhibition Set

PRELIMINARY details of our special Exhibition set, the "Diodion," are given in this issue, and in next month's MODERN WIRELESS—our special Exhibition Number—full constructional details will be given.

The "Diodion" is a set we are very proud of, and it is the result of several months of intensive research work. The advantages of the set are extremely fine selectivity, with easy control, and a high degree of sensitivity. The detector circuit makes use of a method of diode rectification that is largely the result of research work carried out by the B.B.C., and is recommended by their engineering staff as particularly suitable for distortionless detection.

Thus the "Diodion" is a set which is distortionless, and the use of carefully chosen output valves enables this distortionless rectification to be utilised to the fullest possible extent. For instance, the output valve can be fully loaded, a feature that is not often the case in ordinary receivers, due to detector distortion and because of the leakage of H.F. into the L.F. side of the set.

A point to note is that no grid-bias battery is required, for in the "Diodion" G.B. is automatically applied to both the L.F. valves. In short, the set is ideal for pure reproduction of local and distant stations, and will, we feel sure, inspire every reader of next month's issue of MODERN WIRELESS to build it.

Mr. Churchill and the B.B.C.

IN this issue we include a provocative article dealing with a subject which has attracted a good deal of attention in the Press during the last few weeks, namely, the B.B.C.'s attitude to Mr. Winston Churchill's suggestion that he should broadcast.

Mr. Churchill has always been ready to broadcast a talk giving his views on India, and the recent B.B.C. ban

on his appearance before the microphone when he proposed dealing with the world financial crisis seems to have annoyed him considerably.

We have heard Mr. Churchill's views, but still the B.B.C. refrains from issuing an official statement on the matter. Which is a pity. A controversy of this nature is always interesting, and it doesn't do the B.B.C. any good for one side of the case only to reach the public.

It was previously stated by the B.B.C. that in view of the Lausanne Conference it was considered unwise to allow a controversial talk of the nature suggested by Mr. Churchill to be broadcast; but nobody, we feel sure, takes that explanation seriously.

Mr. Churchill is such a well-known and interesting figure that it really is rather a pity the B.B.C. should refuse him an opportunity to broadcast his views. After all, people are not such fools these days that they can be swayed by the individualistic opinions even of Mr. Churchill, or any other broadcaster who has pet views of his own to impart to the public.

Putting the Blame on Lausanne

THE same criticism may apply to the B.B.C. for cancelling the talk of the German "U"-boat commander. But, on second thoughts, we must be fair and admit that the B.B.C. was quite willing for this latter talk to be broadcast, and, we learn, it was only on direct representations from certain members of the Cabinet that the chiefs at Portland Place were persuaded to cancel the talk.

Admittedly, the German "U"-boat commander who was to have given the talk was responsible during the war for the sinking of a great many British merchant ships, but in his particular case there is ample evidence that he conducted his duties with chivalry and humanity, and, in fact, in accordance with the proper usages of war.

Sir Kingsley Wood, the Postmaster-General, stated in the House after the discussion had been cancelled that "In view of the international discussions proceeding at Geneva, I am informed that it has been decided not to proceed with the talk."

Many M.P.'s cheered this announcement. But why should the ban be placed on the "U"-boat commander when no objection was raised against the talk by the Zeppelin commander who recently broadcast an account of his experiences in bombing London?



Democracy and the B.B.C.



A well-known writer and traveller urges the B.B.C. and to provide for the representation of listeners on its provoke much

I WONDER when all this nonsense about democracy and the B.B.C. is going to cease.

We have heard so much about it, especially since the B.B.C. ceased as a private company and was reborn as a national corporation. Personally, I have come to the conclusion there is not a single honest-minded democrat in all Broadcasting House.

I know all about the ubiquity of the wireless set. I know that a king and a coal-miner may listen to the wireless programmes with the same ease, and, within limits, with the same degree of comfort. I know, too, that attempts are made to cater for every degree of musical and entertainment taste. But that, to me, is not democracy.

Nothing But Dictatorship

Look at it in this light.

The British Broadcasting Corporation exists on the money it obtains from wireless licences. Without wireless listeners there would be no such thing as a National Broadcasting Corporation, no Broadcasting House, no Board of Governors. The B.B.C. is an institution run for public benefit with public money, and beyond the need of subsidy.

Yet the public which provides the wherewithal has no say in the policy governing their wireless entertainment.

Below you see a party of street entertainers at a recent broadcast of "busker" turns—part of the B.B.C.'s policy of "democracy" which Lord Strathpey (see above) decries in his article.



by
**The Right Hon.
 LORD STRATHSPEY**

to give up the Dictatorship which it now enjoys board. Lord Strathspey's thoughtful suggestions will discussion.

As I see it, the B.B.C. is a dictatorship, pure and simple—and one that in future years may be uncomfortably allied with political partisanship.

It is begging the question to assert that the Governors and the programme builders attempt to give the public what it wants. I say that the public have no representation in the B.B.C.; that they have to take what the B.B.C. thinks fit to give them.

Out of Touch with Listeners

From the programmes, one sometimes wonders how much the B.B.C. is in touch with its public. For the thousands of people who take the trouble to write to Broadcasting House there must be hundreds of thousands who do not. There has been no attempt at practical representation, either from the public on the one side or the broadcasting authorities on the other.

As I see it, the B.B.C. attempts to justify its position by spoon-feeding its listeners. Somebody or other once coined two most expressive phrases—"high-brow" and "low-brow"—and the B.B.C. Governors seem obsessed with the high-brow and low-brow complex. They pander to and fawn upon what they believe to be the high-brow and low-brow taste.

Yet, how are they to tell exactly what those tastes are unless the public itself is there to tell them? To my way of thinking, the B.B.C. ridiculously over-estimates the taste of the high-brows and sadly under-estimates that of the low-brows. And they will go on doing so until some new method of deciding policy is employed.

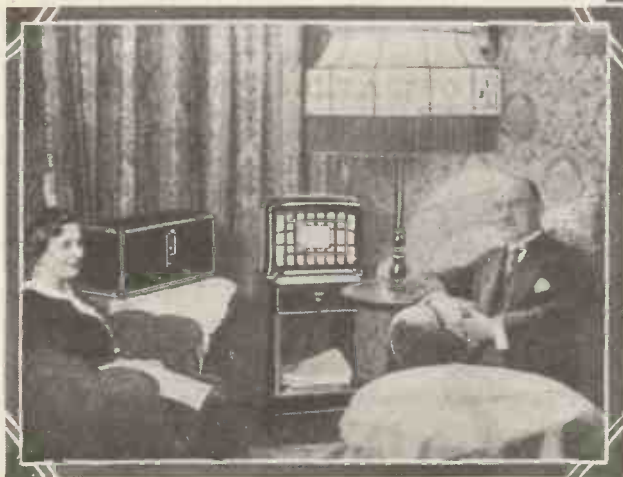

These two entirely different pictures of people listening in serve to emphasise the wide diversity of personality and mood for which the B.B.C. has to cater every day.

Consider, for a moment, that curious cacophony which has been given us under the title of "Contemporary Music." Perhaps it is very clever, and perhaps I lack the education to appreciate it. There is that possibility. But I am convinced that the percentage of wireless licence holders who actually enjoy it, who seek it as a form of entertainment, is very small indeed.

At the other end of the scale we have dance music and revue. Dance music I must pass. It is undoubtedly very popular (but whether the public demand as much as three hours per day—which, roughly, is the dose prescribed by the Broadcasting House doctors—is a moot point).

A number of revues are extremely amusing. A still greater number are so puerile that they would discredit an average end-of-term school concert. I cannot believe that low-brow taste is as low as the B.B.C. would have us believe.

(Continued on page 180.)



ROUND *the* TURNTABLE

By "TONE-ARM."

Battery and Mains Radio-Gramophones—An Interesting and Efficient New "Pick-up"—The Loudspeaker Question.

MOST people who go in for radio-gram receivers have amplifiers (incorporated in their sets as a rule) which are capable of providing quite good results. Where they fall down is generally in the power supply and the choice of pick-up and loudspeaker.

Insufficient Power

Much of the trouble that makes itself evident in distorted reproduction is due to insufficient power supplied to the anodes of the valves. It is impossible to get really satisfactory results with record reproduction with valves smaller than the 350-milliwatt types. This entails need for H.T. of 120 to 150 volts and current of from 15 to 30 milliamps.

It may be argued that the reception of radio can, and is, carried out very satisfactorily with smaller valves, and I agree. But if electric reproduction is to beat the acoustic gramophone, it is, in my opinion, necessary to have a moderate volume, and this is only possible without distortion when the power-handling capability of the output valve is 350 milliwatts or more.

Bass Balance

Naturally the strength of the reproduction will depend also upon the sensitivity of the loudspeaker, but even if this is sensitive I do not like to hear a pick-up in use with a set that is starved of power. Radio heard with purity but little volume does not sound out of place (though it is difficult to get a good bass balance under such circumstances), but the gramophone record played with the volume control hard over to the left seems very wrong.

It seems unnecessarily thin and un-

lifelike, so my first words to those contemplating the use of battery radio-gramophones is to be prepared to supply at least 16 milliamps at 120 volts if you are to get anything but a faint imitation of electrical reproduction.

The choice of a pick-up I have often discussed, but if you are not sure enough about matters to choose it from the maker's curve (when given), I should like again to emphasise the importance of hearing the component under the conditions in which it will be used; that is, on your own set.

No Corrective Devices

The alternative is to hear it on a radio-gramophone that gives results like yours on radio, and then listen to the pick-up being used without any corrective devices in circuit.

And talking about pick-ups, here are a few details of one that I can recommend to your attention. It is the Bowyer-Lowe A.E.D. Mark III model, and it is really very good.

THE BOWYER-LOWE A.E.D. PICK-UP



The Mark III shown above is the latest pick-up to be placed on the market. The arm is adjustable for height and the instrument gives excellent results.

I cannot give you the curve here, because I have not yet taken one, but on a preliminary try-out and on careful tests the pick-up has shown that it ranks in the front rank of those instruments. The impedance has been kept low to avoid the cutting

off of the high notes by volume control, and at 50, 500, 1,000, 3,000, 4,500, and 6,000 cycles the impedance figures are approximately 2,320, 8,670, 14,900, 27,000, 43,800, and 56,600 ohms respectively.

Makers Are Modest

Thus quite a low value resistance volume control can be used, and though the makers state that the figure is best round about 150,000 ohms, I have used as low as 20,000 ohms without any noticeable high-note loss.

The Mark III pick-up is completely metal-enclosed, and is adjustable for height from the motor-board. This is accomplished by means of a screw thread that runs into the pillar supporting the arm, and it can be raised or lowered quite a useful amount to take up the variation in height of the various gramophone motors and to ensure that the tone-arm runs horizontally.

Brilliant Response

The response is pleasingly brilliant and the whole range seems to be free from any pronounced peaks. The bass response is good, though whether the increase in bass response to compensate for the falling off in the recording is sufficient is open to argument.

The results, however, are very good indeed and the sensitivity of the pick-up is ample. It is well designed, and at 30s. it forms excellent value.

Price Governs the Choice

The last point that I raised, that of the loudspeaker, is as important as the pick-up, for without a good speaker it is hopeless to expect true reproduction or anything like it. Naturally the choice of the speaker must depend to a large extent on the price that one is ready to pay for it. If price is no object, and the expenditure of something over £5 or so is not too much, then one of the finest loudspeaker chassis is the Epoch 99k, of which more will be said in a later issue.

It is a speaker that is not so sensitive as some other makes (it is of the permanent-magnet type), but it has been designed specifically to give as perfect reproduction as it is possible to obtain with the science of speaker making at its present stage.

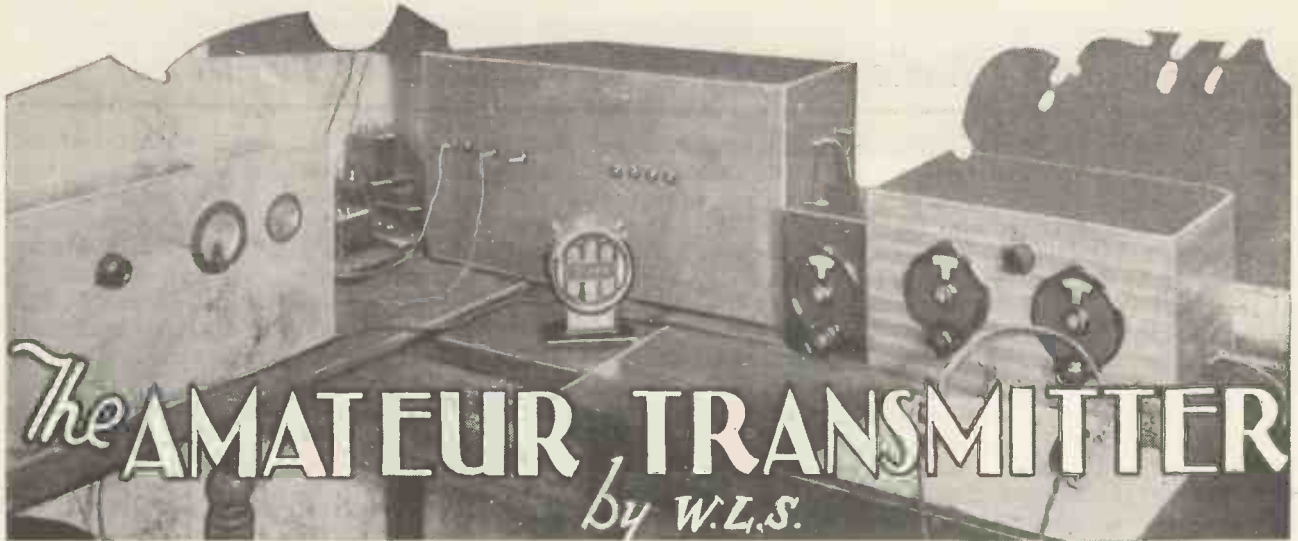

EVERYONE knows that a "ham" is an amateur transmitter. Some know the amateur transmitter as "that chap who grinds out gramophone records on Sundays," and others as "the source of all the crashes and bangs that upset the broadcast programmes." But, in my experience, very few really know him for what he is worth.

For the Defence

There are black sheep, unfortunately, who come in the two categories above, but for every one of them there must be a thousand hard-working "hams" who are never heard, or even heard of, by the broadcast listener.

Perhaps, having been a "ham" myself for nearly ten years, I may be allowed to say one or two words in defence of this much maligned and much misunderstood body of radio enthusiasts.

The "ham" game started before the war, when the authorities found that some of the keen radio amateurs knew almost as much about spark transmission as themselves. But the business of amateur transmission had hardly got on to a sound footing before the war changed everything—gear was confiscated, operators joined up, and all was forgotten for a while.

Begun in Earnest

Soon after the war the magic word "valve" began to attract attention; and then the "ham" business may be said to have begun in earnest. In the two years before broadcasting started the only telephony that receiving amateurs could hear from this country emanated from Croydon aerodrome, "Two-emma-toc-Wr-r-rittle" (under P.P.E.) and from the amateurs. Call-signs that will immediately come to the minds of old-

There are few people who do not know that a "Ham" is an amateur transmitter, but there must be many who know nothing of the valuable work he does for the advancement of radio. In this account W. L. S. gives readers an outline of the work of the indefatigable band of enthusiasts who, for the sheer love of the game, chat with all corners of the earth using no more power than is consumed by an ordinary electric light bulb.

stagers are 2 F Q (Mr. Burnham, at Blackheath), 2 O M (Mr. Walker, at Brentford), 2 O N (Major Parker, at Walthamstow), and others like 2 N M, 2 O D, 2 J Z (at Aberdeen), and so on.

Broadcasting, of course, changed things considerably. The "hams," instead of having large slices of ether to do what they liked with, had to keep to narrow bands and to avoid, if possible, interference with the huge

body of broadcast listeners that was springing up.

The story of the rapid move "downwards" is now ancient history. The amateurs shifted (voluntarily, by the way) from 1,000 metres to 440, from 440 to 150, and then to 115, 90, 45, 23 metres, and so on. The last three bands, under the new regulations, are now styled "80, 40 and 20," and these are the three in most frequent use nowadays, although the 150-175-metre band is used quite a lot for "local" work and, incidentally, for the nefarious purposes of the "gramophone-grinders."

Colossal Numbers

The present state of affairs is this. There are, in this country, about 1,600 licensed amateur transmitters. In the States there are upwards of 20,000, and some ninety-five different countries of the world can claim to have a

ALL THE WAY FROM AUSTRALIA

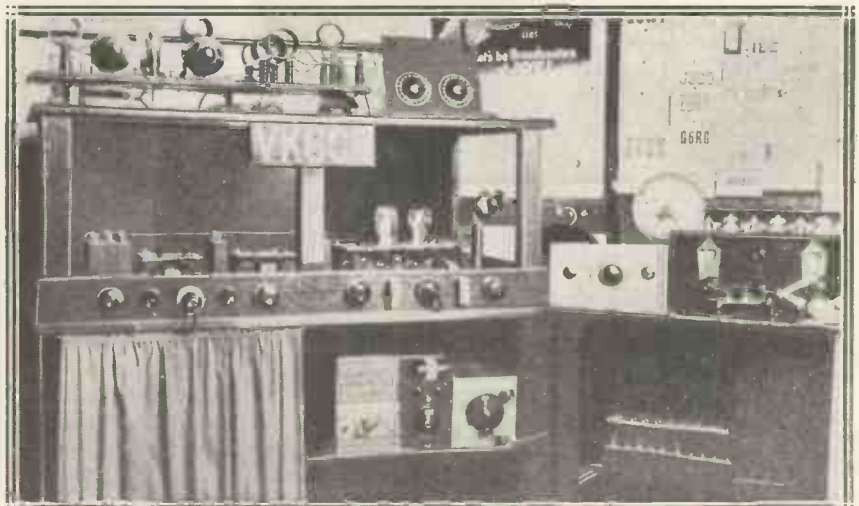

This neat amateur station, V K 6 G F, is located at Mount Lawley, West Australia, and is often heard in this country. It is owned and operated by Mr. George Milner, an enthusiastic experimenter with many years' experience of radio. The apparatus to the left is the transmitting gear, while the various receivers are located to the right.

A Friendly Radio Link Between Countries of the World

colony (however small) of active "hams." From such places as Martinique, Johore, Sumatra, Jamaica, Fiji Islands and Iceland, amateur signals can be heard almost daily—chiefly on the 20-metre wave, which is the accepted "DX" band." It is safe to assume that there are some 15,000 really active amateurs in the world at the present time.

At this point the reader may be pardoned for asking: "What do they all do?" To answer that in full would be an impossible task, since the R.S.G.B. in this country alone has groups of amateurs carrying out research on some twenty different branches of short-wave radio.

natural, since amateurs in all countries of the world are, after all, interested in the same kind of work. The problems that beset the Londoner probably worry the man in Kenya or Java just as much!

"English As She Is Spoke"

Another queer thing is that English has been accepted throughout the world as the "ham language." English, plus American slang and queer abbreviations, is used by practically every amateur transmitter in the world. So the language difficulty is non-existent—thanks to the perseverance of foreigners in learning one of the most difficult of them all.

Sixty countries can be heard regularly.

Britishers are allowed to handle messages only if they refer—directly or indirectly—to the experimental work in hand. Thus if I wanted to try out a new aerial and see how my signals were in South Africa with it, I should be within my rights in forwarding a message to any transmitter that I knew there, asking him to "meet me" at a certain time and on a certain wavelength for the purpose of making some tests.

A Private Message!

But to send a message to a friend on the continent, asking him to come home as the cat has had kittens, would be violating the terms of the British transmitting licence.

In cases of emergency this rule would probably be relaxed, for, under certain circumstances, the amateur transmitter would be in a position to render very considerable assistance to the community.

As an actual instance, when New Zealand was shattered by the big earthquake some time ago, all means of communication failed, and if it had not been for the quick action of certain experimenters in rigging up their transmitters, calling for assistance and keeping in touch with the outside world, things would certainly have been much worse than they were.

One last point—amateur transmitters are allowed to work on their allotted wavelengths at any time. They are supposed to take all reasonable precautions against causing local interference, and the Londoners in particular are very careful about this. Unfortunately, the inselective broadcast receiver is not a thing of the past yet; and this is often the cause of friction and bad feeling.

If you are ever placed in the predicament of being interfered with by a local "ham" working on 20 or 40 metres, try approaching him—don't write to the B.B.C. or the G.P.O. about it. The usual result of the latter course is the reception of a polite letter stating that the trouble is probably caused by "inselective and unsuitable receiving apparatus."

Call and Have a Chat

Finally, if this short article has awakened your interest in the "ham" species, just call on the nearest one and have a chat with him. You will find him only too glad to tell you all about it.

TURNING SOUND INTO LIGHT

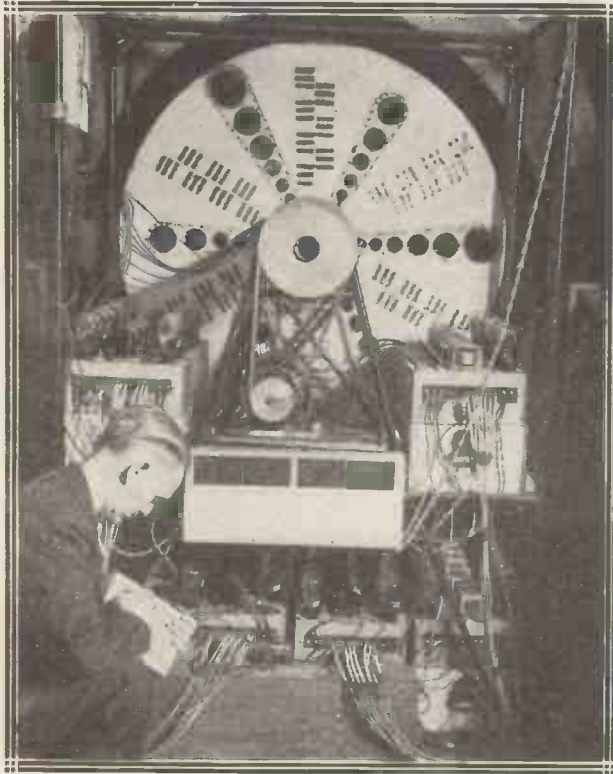

A new piece of apparatus, called the Colourphone, invented by an American, and intended for turning various musical tones into different coloured light. It is claimed that it will be invaluable for testing artistes' voices to see if their tone varies. It employs no fewer than 44 valves, and can differentiate between 88 tones, so they say! It will be interesting to see how the tone colours shown on this apparatus agree with the colours often associated with high and low notes by music critics. Will the bass of an organ give a red light, and the high notes of a violin a blue shade?

In America the "hams" are allowed to relay private messages, and many of them make full use of this privilege—rather to the exclusion of real experimental work, I am afraid.

Feeling of Fellowship

The outstanding feature of this "ham" business, all over the world, is the wonderful spirit of fellowship and friendship that binds them all together. The ham is "old man" or "old chap," whether he be talking to Germany, Sweden, French Morocco, or the Solomon Islands. This is only

If there were two million "hams" instead of 20,000, just think of the tremendous influence that the movement would have towards the goal of world-friendship! I, personally, can say quite truthfully that I have real friends in some sixty different countries. I have never met most of them, but I do chat regularly with them and exchange notes and news. I have had brief chats with "hams" in another thirty countries, but these come under the heading of "hams that pass in the night"—they appear on the air for a week and then are heard no more.

The M.W. GRAMO-TONE™



It's true that any old pick-up hitched on to a small loudspeaker receiver will give electrical reproduction of records—of a sort. One may even be so lucky as to get quite good results if various factors happen to fit in with one another.

But in most cases there are a number of items that require careful consideration if really worth-while and pleasing-to-listen-to results are to be obtained. (Naturally, I am not referring to sets on which special provision is made for a pick-up and which are therefore designed with pick-up work in mind.)

Full Control Essential

The sort of things that are so often overlooked are whether sufficient amplification is available and whether a suitable control of volume is present that will prevent valves from being overloaded. Then there is the matter of tone control—in most cases quite important, because the input from the pick-up usually has quite different frequency characteristics from the radio input.

Another point, and one which is so often neglected when an ordinary adaptor plug is inserted in the detector valve holder, is the provision of grid bias to the detector valve, for under these circumstances it is working as an amplifier.

One of the most practical little units ever described. It enables a pick-up to be applied to any receiver, and at the same time provides a perfect control of both volume and tone in the most convenient and effective manner.

By A. S. CLARK.

The purpose of the "Gramo-Tone" unit is to ensure that all these items are taken care of, and that the best results are obtained when a pick-up is used on sets that are not originally designed for the purpose. It is, in fact, a very complete input device.

To start with, it provides a volume control immediately across the pick-

up itself, the best position for such a control. Following this is a tone adjuster of an unusual type, for it is entirely made up of a variable resistance, and provides a very useful and effective means of varying the high notes.

Any loss of volume that it might entail is made up by the extra amplifier valve that is another feature of the unit. Even with an insensitive pick-up this extra valve ensures that sufficient input to give maximum volume will be applied to the set.

An Ideal Unit

The adaptor plug, by means of which the unit is joined up to the receiver, should have four sockets on top to take a valve, and three valve legs below to fit into a valve holder. The grid pin is the missing one.

If you obtain an adaptor that has four pins it is as well to remove the grid one in case it allows radio to break through. The two filament and the plate sockets should be wired up inside the adaptor plug to the three corresponding pins.

WHAT TO COLLECT—AND HOW TO CONNECT

PANEL

3½ × 5½ (Peto-Scott, Lissen, Permcot, Becol, Ready Radio, Wearite).

VOLUME CONTROL

1 ½-megohm (Varley, Colvern, Wearite, Lissen, Ready Radio, Magnum, Tunewell, Watmel, Igranic, Graham Farish).

POTENTIOMETER

1 50,000-ohm (Lissen, etc.).

CONDENSER

1 .01-mfd. (T.C.C., Dubiller, Lissen, Telsen, Graham Farish, Sovereign).

VALVE HOLDER

1 (Lissen, W.B., Bulgin, Clix, Wearite, Telsen, Igranic, Graham Farish).

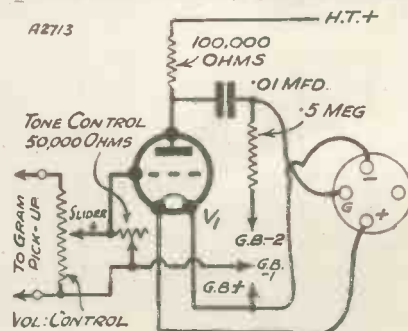

The circuit is as simple as the list of parts given here, which includes all the components you need.

GRID LEAK

1 ½-megohm and holder (Graham Farish, Dubiller, Lissen, Ready Radio, Telsen, Varley).

RESISTANCE

1 100,000-ohm and holder (Graham Farish, etc.).

MISCELLANEOUS

- 1 G.B. clip (Bulgin).
- 2 sockets and plugs (Clix, Eelcx).
- 4 battery plugs (Belling Lee, Bulgin, Eelcx, Clix).
- 1 pick-up adaptor (Bulgin G.R.1).
- 5-ply wood, flex, wire, etc.

Usually this adaptor will be plugged into the detector valve holder, but it will work just the same when placed into a low-frequency position. Actually this is advisable in the case of sets with two low-frequency stages, when the plug should be inserted into the first low-frequency valve holder.

You should note from the wiring diagram that there are only three wires running to the adaptor plug, and that the unconnected socket and pin are the plate ones. Another important point concerning the adaptor plug is the method of connecting the filament pins.

L.T. Wiring

There is a certain way round that these must be wired, and it is dependent upon which side of the valve holder that takes the adaptor, is connected to low-tension negative. The wires from the filament pins should be so arranged that the lead from the negative one is connected in the unit to the filament terminal that goes to G.B. positive.

Easily Changed

With this in mind you will appreciate that the connections as shown in the wiring diagram may not fit in with *your* set. But this simply means that the filament connections to the adaptor plug have to be reversed.

The next item that requires explanation is the presence of two G.B. negative plugs in the unit, when it contains only one valve. One of these, No. 1, is for the valve in the unit, while the other is for the valve into whose holder the adaptor is plugged.

Even if this happens to be the first L.F. stage, with G.B. already applied in the set, it will nevertheless get its bias via this plug when the adaptor

is in use. It is also this plug (G.B.—2) that biases the detector when it is used as an amplifier.

Valves to Use

And that brings us to the types of valves to use, and in which positions to insert them. First we will consider the case in which a detector and one L.F. stage set is to be used.

THERE IS NOT A SINGLE EXTERNAL ITEM

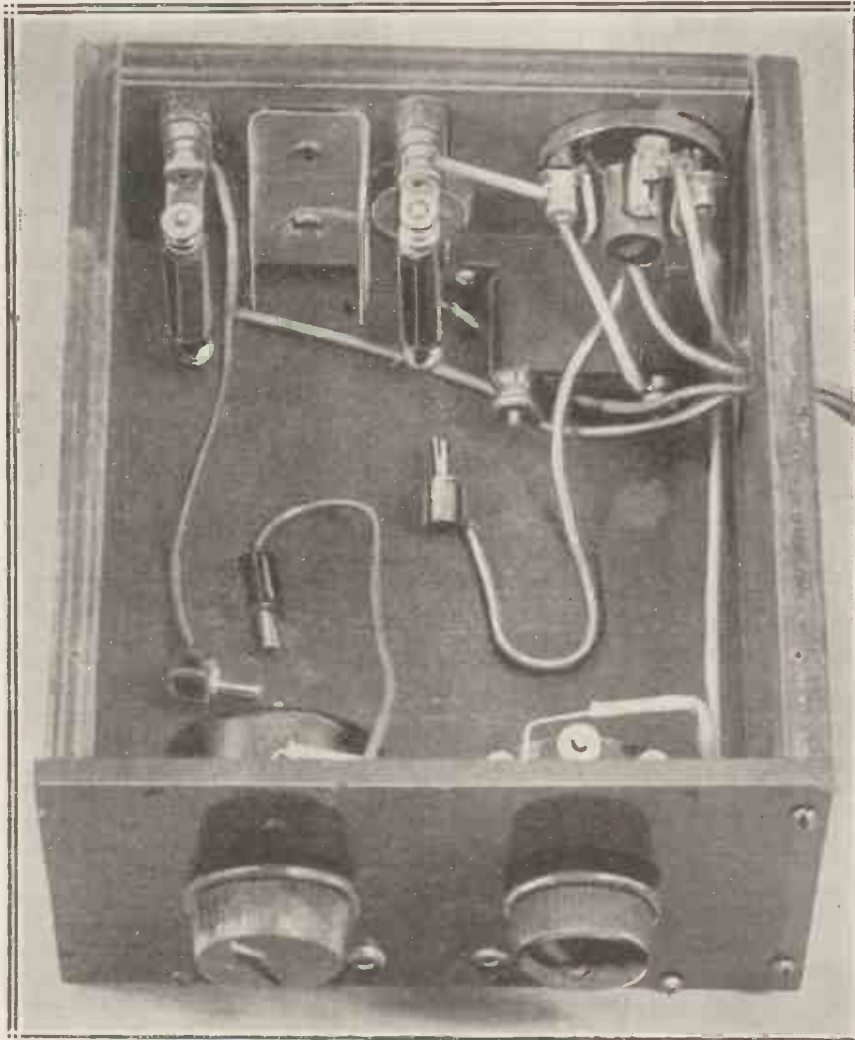

The valve is mounted horizontally inside the unit, and the grid-bias battery is also fitted away out of sight. The clip for the latter can be seen between the two resistances screwed to the same piece of wood as the valve holder.

In this instance you will need an extra valve beyond the two at present in the set. The best kind to get will be one of the L. or L.F. types.

Very Important

Don't put this straight into the unit, which you might at first think was the correct thing to do. The valve in the *unit* is the first amplifier; then comes the detector in the set, and after that the power valve.

Consequently, as the valve used as detector is almost certain to be one

of the H.L. or similar type, it is best for this to come first in the sequence, with the new L.F. valve second. The reason for this is because the L.F. valve will handle a larger grid swing than the other.

Apply 1½ volts G.B. to the No. 1 negative plug, and 3 or 4½ to the second one. The H.T. positive plug from the unit should be plugged into a fairly high tapping point on the battery, such as 100 or 150 volts.

Two L.F.'s

Now we will take the case of sets that have two low-frequency stages, in which the plug is placed in the first L.F. holder, as already intimated. There is no need for a new valve here, because we already have a third valve in the detector position of the receiver.

This should be taken out of the set and placed in the holder of the unit, and grid-bias voltages applied similar to those mentioned for the two-valve set. About the same voltage should also be given to the H.T. plug.

Pentodes

In the case of receivers that employ a pentode valve, it will usually be found best to plug into the pentode's holder. But this cannot be done

if the pentode is of the five-pin type, because there is not provision on the adaptor for making contact with the fifth pin.

When using a pentode, remember that much more grid bias must be applied to G.B. negative 2. Actually, the correct value will be the same as that applied to the pentode valve when the set is used in the normal manner.

When plugging in the adaptor, remember that there is a valve to be fitted in on the top of the adaptor

A Unit That Gets the Best From Any Pick-Up

plug, or you will not get any results at all. Often the valve to put in the top will be the one that has been removed from the holder to make room for the plug.

Besides the ebonite panel on which are mounted the controls, there are three other pieces of wood screwed to the baseboard. The sizes for these pieces of wood are given in the wiring diagram, and you will see that several components are mounted on the piece opposite the panel.

The other two pieces help to form a cabinet for the unit, the cabinet being completed by a piece of wood for the top.

Operating Details

You will see that the two side and the back pieces of wood are on top of the baseboard, the screws passing up into them through the latter. The top fits over the sides and back.

Finally, about the operation, which is as follows: Turn the right-hand

knob until the tone of reproduction is to your liking, and adjust the left-hand control until volume is at a suitable level. A movement of the right-hand knob will make it necessary to shift the left-hand one also, if the same level of volume is desired.

Thus this little box with its two knobs will give you just the right volume, just the right tone, and will ensure that your pick-up is working at its very best.

*
FOLLOW THE
BLACK LINES FOR
GOOD RESULTS
*

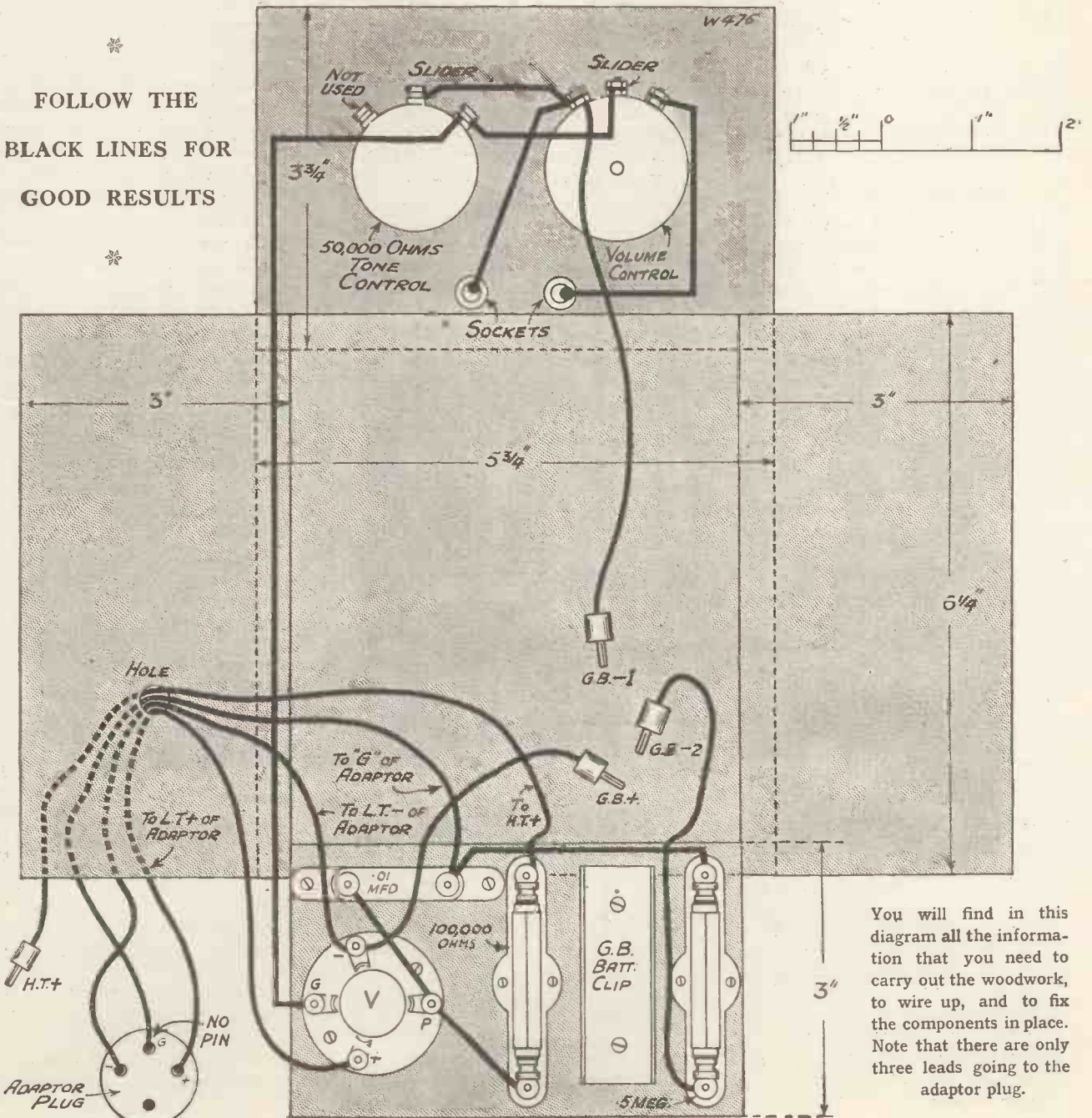

Trouble Tracking



On this page the Chief of the "M.W." Query Dept. discusses, month by month, some of the common difficulties and troubles which can be so perplexing. This month he gives some useful information concerning summer-time complaints.

THE main complaint at this time of the year is weak reception of distant transmissions. The beginner in the science of radio immediately says: "Why should it be more difficult to receive a distant broadcast transmission in the summer than in the winter?"

The Indirect Ray

There are various reasons. For instance, the hours of daylight are longer during the summer period, so that most of the reception is due to the direct ray from the transmitter, since the indirect ray only comes into being after dark. It is upon the indirect ray that we have to rely so largely for our programmes from abroad, and thus transmissions which in the winter months came in so strongly are now inaudible until late in the evening.

Then, again, it is a well-known fact that sunshine has a detrimental effect upon the strength of the received waves. On a bright day when the sun is shining the volume frequently shows a definite decrease. This is even noticeable on the local transmission.

Loss of Efficiency

Also there is the fact that when the ground is dry our earthing system, if we use an earth tube or buried earth plate, may lose a certain amount of its efficiency. Fortunately, we can overcome this trouble by saturating the surrounding soil with copious supplies of water, so keeping it in a damp condition. Water-pipe earths usually retain their efficiency because they do not have to rely on a small area of contact for their connection with the surrounding soil. In spite of this, the summer time is the period when the earthing clip should be given the "once over" to see that the inside of the clip and the corresponding surface of the lead pipe are not corroded or oxidised

Another trouble at this time of the year is atmospherics, sometimes called "X's." This latter term owes its origin to the fact that in the days of coherers and Morse inkers used in early commercial wireless the effect of a lightning flash or other electrical disturbance in the atmosphere was to make a Morse sign equivalent to the letter "X" on the tape.

Atmospherics caused by distant thunderstorms are often troublesome during the hot weather, especially when one is endeavouring to receive a

picked up by the aerial, the removal of the aerial lead from the aerial terminal on the receiver will immediately cause them to cease.

There is no known method of cutting out the crackling due to electrical disturbances in the ether, so the only thing to do is to "grin and bear it." If the crackling becomes bad enough seriously to interfere with the reception of the local programme, it is probable that a nearby thunderstorm is the cause.

In these circumstances the safest plan is to earth the aerial, either by means of a special earthing switch, preferably outside the house, or by disconnecting the aerial lead-in and joining it direct to the earthing terminal.

A USEFUL HINT



During the dry weather the contact between the earth tube and surrounding soil sometimes offers a high resistance to the currents flowing in the earth circuit. Copious supplies of water will overcome this trouble.

foreign transmission. They can be recognised by the crackling noises which occur either continuously or at intervals in the loudspeaker.

Easy to Test

Unfortunately, an atmospheric noise is identical with that of a faulty dry H.T. battery or a bad connection somewhere in the set.

It is, however, always easy to differentiate between atmospheric and internal troubles in the set, because if the noises are due to disturbances

Don't Blame the Set

The receiver is often blamed for interference due to extraneous effects, and whenever violent crackling or "spitting" sounds are heard during the summer months it is advisable to apply the simple test of removing the aerial wire from the set.

Internal troubles such as those produced by faulty windings, spaghetti resistances, batteries, loose wires, etc., are unaffected by this test, and the crackles they cause will still continue even when both the aerial and earth leads have been disconnected.

No Need to Worry

Don't get worried when a thunderstorm is approaching. A wireless aerial is not a danger, and the chances of the house being struck by lightning are no greater with an aerial than without it.

But a lightning switch or some other means of earthing the aerial does protect the set from the "backwash" of a lightning discharge, and it is therefore always advisable to take this simple precaution.

THE WORLD'S PROGRAMMES HOW WHEN AND WHERE TO HEAR THOSE FOREIGNERS



BAD FOR BURGLARS! The venerable profession of burglary is heading straight for disaster. This U.S. genius has just perfected an invisible ray which, when it sees a burglar, takes his photograph, gasses him and sends an alarm. In fact, it does everything but put him behind the bars!

CONTENTS OF THIS SPECIAL SUPPLEMENT

- "Gingering-up" a Short-Waver.
- New International Prefixes.
- Budapest's Radio Toy-Time.
- The Panel that Tinged!
- Medium Waves.
- Broadcasting with a Chirp!
- Below 550 Metres.
- News from the Stations.
- Items of Interest from Overseas.
- A 16-metre Broadcaster.
- Station Information.
- Above 1,000 Metres.
- What the Distant Stations are Doing.

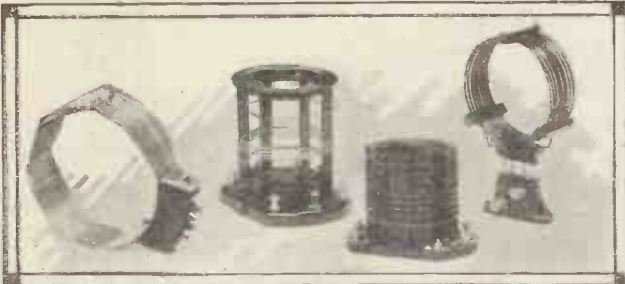

THE purpose of this short article is to show how the owner of an ordinary small short-wave receiver which may be inclined to be old-fashioned can make a few adjustments or slight alterations in order to make the very most of the minute currents energising the aerial of the receiver.

Assuming that such important points as layout, spacing of parts, etc., have been taken care of, it is often surprising what a difference a little "tuning-up" can make to results on wavelengths below about 50 metres.

Importance of Detector

In the writer's opinion, easily the most important part of a short-wave receiver is the detector circuit. If this is really doing its work, the rows of L.F. amplifying valves so often seen will be found quite unnecessary.

There are now several very efficient special detector valves on the market which give infinitely superior results to any old type of general-purpose valve. This may be hard to believe, but one has only to try one, operating under the correct conditions, in a short-waver, to be convinced.

Using a modern valve of this type there should be no need either to employ a potentiometer to adjust the potential on the grid, or to use a very low H.T. voltage. To obtain the very smooth reaction which is essential for telephony reception. Using a leak of from 5 to 8 megohms, it is possible to put between 60 and 90, or even more, volts on the plate of the detector, and still retain perfect reaction control.

The valve will then be working far more efficiently than with about 20 volts or with the grid made negative by means of a potentiometer, both of which expedients invariably result in loss of sensitivity. Also, a 20,000-ohm spaghetti resistance can be used in the place of the H.F. choke, and helps to prevent any tendency towards threshold howling.

The tuning arrangements are also very important. If the coils are of the plug-in variety and any doubt exists as to their efficiency, or to that of the coil holders, it will pay to substitute a set of modern six-pin coils, which are apparently very low-loss.

To Simplify Tuning

A very small variable, equipped with a slow-motion dial and connected in parallel with the main tuning condenser, will make the tuning much easier, as it can then be taken in steps of a few metres at a time, while a good slow-motion dial on the reaction condenser will help astonishingly in bringing up weak telephony to good strength. Another point which is often neglected is the size of the tuning condenser.

Using a large coil and a small condenser improves the sensitivity of the set on the higher frequencies considerably and is well worth while, although it makes coil-changing necessary rather more often than if a large condenser is used.

Turning to the L.F. amplifier, if one is used, the writer feels very strongly that a high-mag. three-electrode valve is superior to a pentode if headphones are to be

R. C. FROST gives some valuable hints on—

"GINGERING-UP" A SHORT-WAVER

used. Really good quality is rarely obtainable in a small short-waver, never if 'phones are used, and the three-electrode valve does not bring up the background and mush, in proportion, to anything like the extent that a pentode does.

Use a Volume Control

It is also far more economical than a pentode. In any case, a volume control should be used, as it is far easier to read a weak signal through a very weak background than a louder one through an equally louder background of atmospherics, mush, etc. A 1-meg. variable resistance across the 'phones is ideal for this purpose.

An output filter, and decoupling by means of a resistance and a large by-pass condenser, are always worth while, and small H.F. chokes in the 'phone leads will get rid of any hand capacity due to H.F. in the 'phone cords.

A screened-grid H.F. amplifier is an advantage in any short-wave receiver, especially where the reception of telephony is the main object, but *only* if it is properly adjusted. If it is not, all sorts of troubles crop up and, instead of its being a great help right down to below 10 metres, it will be worse than useless below 100 metres.

If the S.G. valve is coupled too tightly to the detector, tuning will be extremely difficult, as the two circuits will interlock. The condenser between the two valves must be slackened off until the H.F. tuning condenser acts merely as a kind of coarse volume control, and a C.W. signal is audible throughout the range of the dial.

Similarly, the coupling between the aerial and the S.G. valve must not be too tight.

The H.F. choke in the anode circuit of the amplifier may also be the source of much trouble, unless specially designed for work in this position. If it is suspected, a 100,000-ohm resistance can be used to advantage in its place, and is very unlikely to give any trouble.

In the course of an untuned H.F. stage, the H.F. choke coupling the aerial to the S.G. valve may be replaced by a resistance, not higher than 15,000 ohms, which will probably be found much better than a choke.

In conclusion the receiver should be supported a short distance above the bench on some sort of legs, the batteries kept well up to scratch and all switch contacts very clean. Then, if the above points have been observed, and if conditions in the ether are moderately good, no one should have any difficulty in picking up a lot of stations heard below 100 metres.

A Test Receiver

The writer has had a receiver in use for the last nine months, as a standard by which to compare other experimental models. On it signals from over 100 countries, and broadcasting stations in 20 or more, have been identified, and it oscillates smoothly down to below 7 metres.

NEW INTERNATIONAL PREFIXES

Listen for these calls on the short waves.

A FEW months ago there appeared in one of the wireless papers a very useful list of Nationality Prefixes used by amateur transmitters all over the world.

Since this was published I have heard several new prefixes in use on the 40- and 20-metre amateur bands and, having definitely ascertained the countries from which they originate, perhaps a list of these will be useful to readers.

One is therefore given below :

- A R Syria.
- E U Russia in Europe.
- F M 4 Tunisia. (Algerian stations use F M 8.)
- H I Dominican Republic.
- K 5 Canal Zone.
- Z C 6 Palestine. (Trans-Jordanias uses Z C 1.)
- Z D Nigeria.

In addition, there is a station in

Sarawak using the call-sign O B-S K 2, one using V P 2 P A in Jamaica, and another in Barbados using V P 2 M R.

I have also heard, from what should be very reliable sources, that there are stations in Ethiopia and Albania using E T and Z A respectively to prefix their calls, but have not yet quite satisfied myself that these are genuinely on the air.

All the rest are undoubtedly correct.

R. C. F.

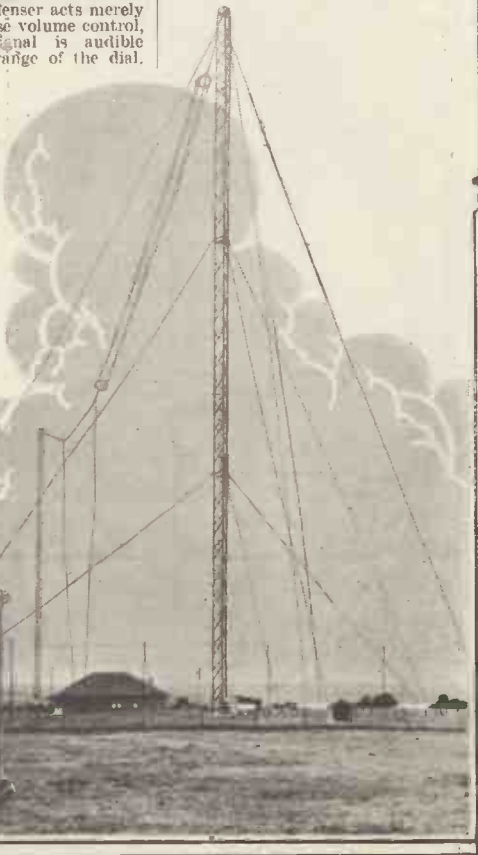
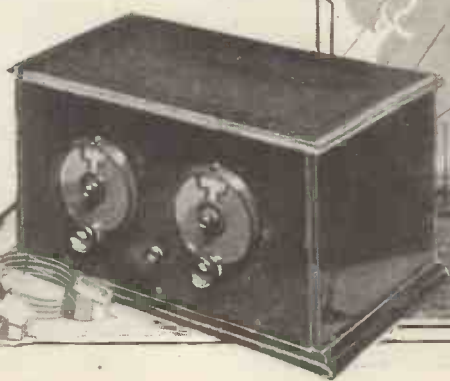
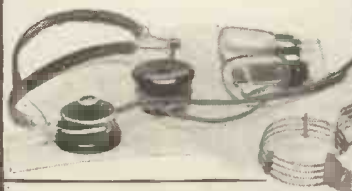

Budapest's Radio Toy-Time



Have you ever tuned in to hear delighted childish voices from Budapest, on 550 metres? They make a special feature there of interesting the youngsters in easy-to-make toys, some examples of which are shown in all their beauty on this page.

THE celebrated aunts and uncles of wireless fame are by no means wholly a British institution. Their counterparts are to be found in nearly all the other European countries. Among the most famous is Aunt Gizy of Budapest, or to give her the name by which she is known to grown-ups, Miss Giza Harsanyi,



Here is "Aunt Gizy," with two of her pupils, at the microphone.

a municipal kindergarten teacher.

Aunt Gizy has lately had the splendid idea of using two of her weekly hours for giving little Hungarians instruction in the art of making simple and ingenious toys out of chestnuts,

Corks and matchboxes are the most important materials used, while wonders can be done with pins and ordinary cardboard. The very realistic horseman at the top of the page, and the seaplane below, show that a wonderful variety of subjects is ready to hand.

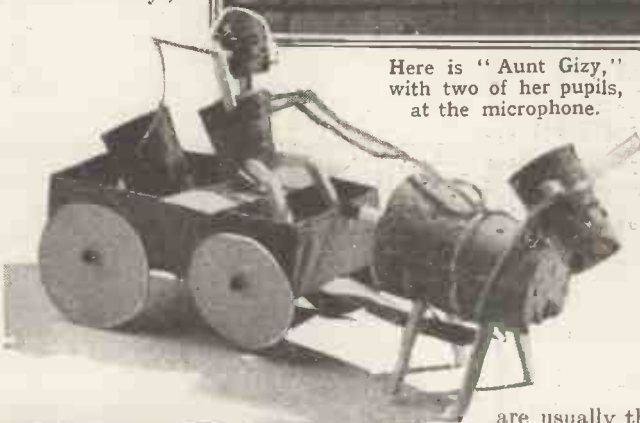

matches, corks, tissue paper, and other similar treasures.

To make her instructions entirely practical, and to assure herself that they can be carried out by an ordinary child of the age they are intended for, Miss Harsanyi takes a couple of children to the studio with her and bids them make the objects that she is reading about, then and there. If any difficulty arises, the children ask questions—and they

are usually the same questions that thousands of other children, listening to Aunt Gizy's instructions and with fingers busy while ears are riveted to the loudspeaker, would ask at the very same minute.

A Competition Arranged

When Aunt Gizy's lessons had been going on for some weeks, an increasing number of the letters she received from little listeners-in said: "How I wish I could show you the cork aeroplane, or the chestnut regiment, I made as you told us!"

So Aunt Gizy arranged a competition. The toys made by children all over the country were sent to the broadcasting studio, and the most successful replicas of Aunt Gizy's designs were awarded prizes.

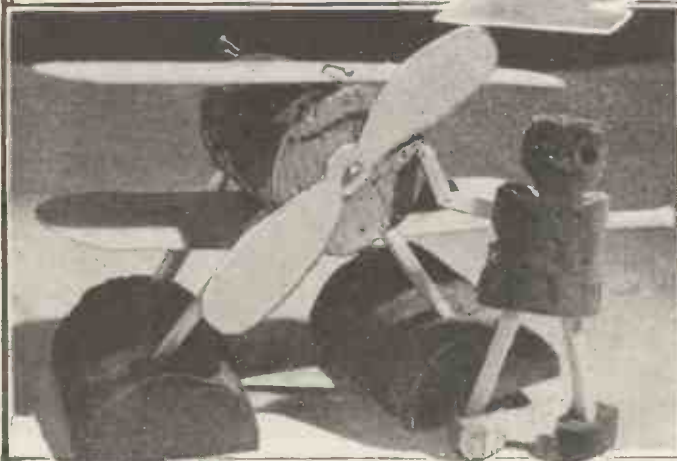

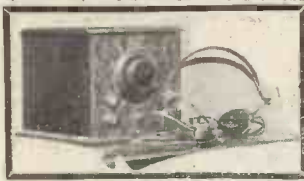

THE PANEL THAT TINGLED!

A most unusual fault is here described by a Nigerian reader of "M.W."

THE following unusual occurrence happened while at an out-station in Nigeria. It is quite true and can be vouched for.

I had taken my short-wave receiver with me and, as tables were scarce, I built a platform of sticks and dried mud on which to place the receiver and batteries.

I ought to mention that the receiver had an aluminium panel, and was fed by four 45-volt H.T. batteries.

A Surprising Switch

For a week I got good results, until one Sunday morning I went to switch on the set and got an

electric shock from the aluminium panel as I did so.

It was not a bad shock, but enough to tingle the fingers. At first I thought that I might have made a mistake or have been touching something connected to the positive high-tension, so I again touched the panel, ensuring as I did so that I was not touching anything else with my other hand. Again I got a shock.

This was definitely wrong. The panel was at earth potential, and the negative H.T. was connected to it. I also was standing on earth (the floor being dried mud), so how could I get a shock?

Signs of Madness

I switched on the set and it worked all right, as I got two or three C.W. stations on the loud-speaker.

As long as I only touched the bakelite dials of the condensers everything seemed all right, but if one of my fingers touched the panel I got that shock again.

I began to wonder whether I or the set had gone mad, or whether I had suddenly come across some new electric phenomenon. I switched the set off and sat down to reason it out.

Everything Disconnected

I considered the matter and came to the conclusion that if I got a shock when I touched the negative H.T. terminal then I must in some way be connected to the positive end of the battery.

I therefore disconnected every terminal from the accumulator, grid bias, and H.T. batteries, except for the negative H.T. terminal. Once more I touched the panel

and again got a shock. This proved that I was correct in my reasoning, but how on earth was it happening?

I lifted up my fourth battery (the one to which the positive plug went) and all was explained. WHITE ANTS!

Damp Clay

To make this clear I ought to state that the white ant, which is one of the most voracious and destructive of insects, covers everything on which it is working with a fine clay which it makes itself. This clay is damp at first, but dries in a few hours.

If the ant moves above ground it also builds a tunnel of this material through which it moves. This is because the ant soon dies if exposed to the sun or open air, as it cannot stand a change of temperature of more than a few degrees.

A Substantial Meal

White ants, then, had worked up the side of the platform on which the set was standing and had attacked and eaten the cardboard side and base of my fourth H.T. battery (a Pertrix) and exposed the positive electrodes.

The clay substance which the white ants had made was still damp and was touching these electrodes, thus causing a short-circuit through the earth, earth tube and metal panel of the set to negative high-tension.

I also (wearing thin slippers) caused a short-circuit from negative H.T. through myself and the earth to the positive when I touched the panel.

I apparently must have discovered the fault shortly after the ants had bared the electrodes, otherwise my batteries would soon have run down and I probably would never have discovered the reason.

Paraffin Cure

There is little more to say. A little paraffin was poured down the white ants' channel to kill them, the battery cleaned and replaced, resting on a piece of ebonite this time, and the fault was cured.

G. C. W.



NO MORE SWINGING THE LEAD!

Not the least useful of electrical navigating devices is the newly invented "Echometer." This apparatus (you can see it in the right-hand picture) has been fitted to a number of British vessels for the purpose of taking depth-soundings by electricity—a great improvement on the old lead-and-measured-line method!

Above, the navigating officer of the P. & O. liner "Strathnaver" is seen reading the soundings which are automatically recorded on a dial as soon as a switch is pulled out.

The Marconiphone Sounding Device Co., the inventors of the apparatus, are sending an expedition to the Arctic Circle to record sea levels. This information will add much to scientific knowledge.



MEDIUM WAVES

Topical notes on the reception conditions now prevailing on the 250-550-metre waveband, with hints on the best stations to listen for during the daylight hours.

THOSE searchers for foreign entertainment who remember reception conditions last summer will have by now made some interesting comparisons in their minds between 1932 and 1931. And the probability is that even the glamour of the far-off will not disguise the fact that last summer, compared to this one, was a washout.

Daylight Reception

The hardest test of summer conditions, no matter what kind of valve set you use, is to concentrate on daylight reception for comparison purposes. And the common experience seems to be that, judged on this basis, 1932 wins all along the line.

It is not a matter of Mother Nature favouring us this year—not nature, but art, the art of the radio engineer, is responsible. For this year we have an ether that is far richer in high-power transmissions than last year's.

A Good Goer

One of the best of the new stations is Poste Parisien, on 328.2

metres. Except on Sundays he is rarely heard before noon, but from that hour he does his high-spirited best to promote joy and gladness in the hearts of listeners who tune to the 328.2 wavelength.

Continuous Performance!

Hilversum is another of the good fellows on this part of the dial. From early morn till dewy eve he delights both "dames en heeren" with his lively music. And although his clock chimes appear to be always

NEXT MONTH

The September "M.W.," which will be
THE
SPECIAL EXHIBITION NUMBER
IS TO BE ON SALE AUG. 19th.
USUAL PRICE : : ORDER NOW

twenty minutes wrong to the ears of the British listener, he has the good opinion of many a London business man, who relies on the 7.40 a.m. time signal to check the overnight performance of the household clocks.

Brussels is yet another great favourite in the South of England—especially, perhaps, Brussels No. 1, on 509 metres. And there are many other good stations who win golden opinions by their performance under the stringent test of summer daylight conditions.

LJUBLJANA'S DIRECTOR

This is the Abbé Zor, who has the arranging of the programmes of the Ljubljana station, which works on 574.7 metres.

Next year, however, promises to show 1932 a very clean pair of heels in this respect; for quite a number of new medium-wave programme-providers should be in full swing by then. There is a whole nest of projected and powerful stations in South-eastern Europe (Budapest, Vienna and Co.), but apart from these there are some much nearer-home improvements to be effected.

Germany's Regional scheme will have reached full fruition by 1933, and there is a probability that France's success with Poste Parisien will be repeated by the other stations that are now merely names on the famous "Ferrie Plan" of French radio revision.

Europe's New Punch Merchant

Spain has high hopes of high power soon, and Luxembourg is another that is likely to provide plenty of daylight punch for British listeners.

Already Fécamp has shown that there is plenty of diversion to be obtained from programmes that are avowedly advertising.

Just what the new Athlone station, which is to replace Dublin, will do for the enrichment of British radio entertainment is not yet known. But it should prove very interesting.



BROADCASTING WITH A CHIRP!

Some views from Vienna of an interesting attempt to broadcast a sound picture from a poultry farm.



FEEDING TIME!

The microphone was held over one of the feeding-pens so that listeners could hear the determined attack on the corn made by the hens!



IN THE INCUBATOR

In the circle below, the trays of eggs are depicted, with the microphone held close to hear the crack of an opening shell. The picture above shows the young chicks making a start on the feeding-box.



CHIRP! CHIRP! CHIRP!

After one horrified look at the microphone, this chick let out a chirp which astonished Austria, and then went on to tell the listeners of Vienna and the other cities all about his first impressions of life. He was still chirping when they took the mike away!



THIS month our "tour" is to take place at the top of the dial. On most wireless sets, when the wave-change switch is thrown over to "medium waves," the top wavelength reached when the tuning condenser is turned all in is about 550 metres.

Some sets will tune to a wavelength rather higher than this, but generally speaking such a gain at the top of the dial is counterbalanced by a loss of stations when the condenser is "all out."

One of Europe's Favourite Stations

It is a moot point whether it is better to have the lower wavelengths at the expense of those above 550 metres, or vice versa. But there is a fairly general agreement that the 550-metre wavelength should be included if possible, for on it works Budapest, one of Europe's favourite stations.

This month we commence our "tour" at Budapest, and work downwards to the North Regional programme, which is to be found on 480 metres. And although this is not a very large segment of the tuning scale, it will be found to include a number of very interesting stations well worth investigation.

Budapest, our starting-point, is situated almost exactly nine hundred miles from London. It is therefore not a particularly easy station to pick up, unless you are using a super-het. or a similar powerful receiver, but after dark many a three-valver and plenty of well-handled "two's" think nothing much of bringing in the Budapest programmes.

Easily Spotted

They are fairly easy to recognise. For one thing the announcements of the name are frequent; and they are also clearly given, and agree closely with our own pronunciation of the city's name—which is more than can be said of many foreign stations!

"Hallo! Hier Boodapest" or "Radio Boodapest" is the usual statement, but sometimes the phrase "Voici le poste radio-phonique Budapest" is employed. (It is sometimes useful to know, also, that the Budapest programmes are repeated on about 210 metres by the new Hungarian station Csepel.)

Another useful identification mark is the harmonious little musical phrase used as an interval signal. There are nine notes in this—G sharp, B A B G sharp, B A B G sharp.

Usually the Budapest station gives a news bulletin

and time signal at 10 p.m., followed by music of the Tzigany type. And it closes down with the announcement repeated in Magyar, German and French.

A Dodge You Can Try

It has been said above that some sets do not "tune up" as high as Budapest's 550 metres. On some of those that do there is, nevertheless, a failure of reaction right at the top of the waveband, and it might perhaps be of use to indicate one very simple trick for overcoming this particular trouble, before going farther—

All that is necessary is a small condenser, fixed or variable, of up to about 0001-mfd. capacity. It should be fitted with two flexible leads and then carefully joined in parallel with your reaction condenser.

"In parallel" simply means one side of the new condenser goes to one side of the old one, and the other side to its other side. The fixing takes only a few minutes, but it often gingers up reaction sufficiently to give the extra amount necessary for top-of-the-dial stations.

One or two degrees below the Budapest dial reading we come to 542 metres, a wavelength shared by Palermo and Sundsvall. Palermo has not been up to form just lately, but to make up for that Sundsvall has had bouts of great vigour, and can often be heard from about 9.30 p.m. onwards relaying the Stockholm programmes.

Comes Over Well

Scotland and the North of England find Sundsvall a fairly easy station to pick up, and when he happens to be in form he is easily received in the South of England, and in the western counties, notwithstanding the fact that he is situated on Sweden's eastern seaboard, on the shores of the Gulf of Bothnia, which is the northern extension of the Baltic.

On the dial-reading immediately below Sundsvall's is to be found one of

Germany's regional stations, Munich.

At present Munich uses a power of only 1.5 kilowatts, but in conformity with modern demands it will be raised to the status of a high-power station soon—probably in October.

A point to remember in identifying the Munich transmissions is that the name is not pronounced as spelt, but sounds like "Munchen." Three other stations relay the Munich programmes, namely, Augsburg, Kaiserslautern and Nurnberg. The respective wave-

Another "M.W." Conducted Tour.

BELOW 550 METRES

Budapest is our starting point for this month's radio "tour"—North Regional the finish. 550 to 480 metres doesn't take in much of your dial, but there are plenty of stations there worth hearing. Vienna, Munich, Brussels and Prague are some of the stations we "visit" in the tour.

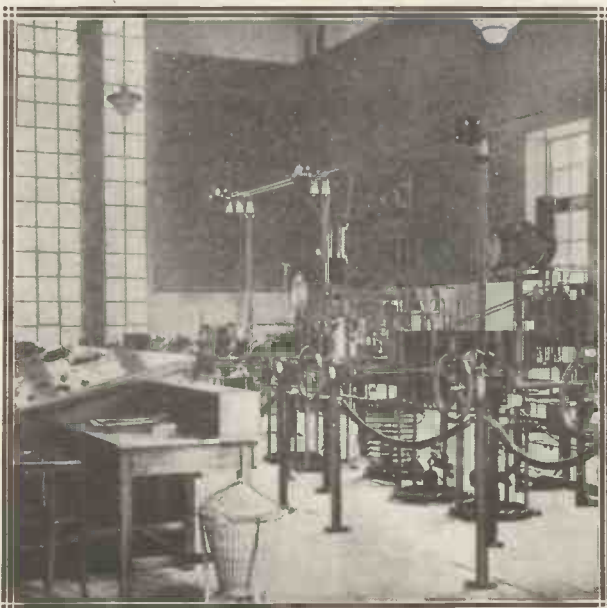

Here you see the transmitter hall at the Budapest station. It is interesting to compare it with some of the new British broadcasters such as Moorside Edge and Falkirk.

STRAYING ROUND EUROPE

You will find European "travel" a simple matter if you follow the black arrows from Budapest, through Sundsvall, Munich, Vienna, Brussels, Florence, and Prague, to our North Regional.



J T RANKIN CARTOGRAPHER

Making a Feature of Pigeon Flying!

lengths of these relays are 560, 560 and 239 metres. As sometimes happens in Germany, one of the "relays" has higher power than the "main" station. In this instance Nürnberg is a two-kilowatt, and its programme may often be heard some three degrees or so below Belfast.

Farther Down the Dial

A degree or so farther down the dial we find, just below Munich, another prime favourite, Vienna. Or, as the announcers there call it, "Radio-Wien."

Sometimes the actual site of the station is mentioned, namely, "Rosenhugel"; and another useful marker is the Vienna metronome, which ticks away in the intervals at the rate of 270 ticks to the minute.

Vienna is well over 750 miles from London and yet its programmes have attained a great reputation in this country for consistency, as well as for quality. And as a new station of 100 kw. is eventually to replace the present 15-kilowatt, the popularity of these tuneful

The one we are now considering, Brussels No. 1, always announces in French, and the call is "Ici Radio Belgique." Incidentally, it is situated almost exactly two hundred miles from London.

Being a 15-kilowatt station, like Vienna (which is nearly four times as far away), Brussels is easily received in this country. Readers who are interested in pigeon-flying will like to know that on Sundays Brussels No. 1 comes on at 5 a.m. with flying-pigeon reports and it gives these hourly during the day.

Built by British Engineers

Continuing our progress down the dial, we leave Brussels and turn to the station located a degree or so lower on the scale. Actually there are two stations which work on 500.8 metres—the Russian Nijni Novgorod, and the Italian Florence.

Nijni Novgorod is almost an unknown quantity in this country, but Florence has been well received, it



BROADCASTING OPERA TO THE WORLD

By an arrangement between the manager of the Vienna opera and a well-known radio concern, British listeners will have an opportunity of hearing relays from the magnificent State Opera House (which you see here). This relay arrangement will also cover South Africa, Australia, North and South America, India, etc., and constitutes practically a world-wide service. The many complicated technical problems which confronted the engineers responsible have already been satisfactorily overcome, and it should not be long before the B.B.C. relays are announced.

programmes as an alternative to B.B.C. fare is likely to increase still further.

Little need be said of Vienna's identification marks, for its transmissions can always be located easily by remembering that they are immediately above those of the Brussels No. 1 station, our next stopping place on this tour. Vienna's wavelength is 517 metres, while that of Brussels is only eight metres lower, on the 509-allocation.

Solving the Language Problem

We have already "visited" Brussels on these tours, and it will be remembered that as a great proportion of Belgians speak Flemish and another large proportion French, the two Brussels stations use different languages.

being one of the new Italian Regionals, with a power of 20 kilowatts.

This station was built recently in England—at the Chelmsford works of the Marconi Co.—and has made quite a name for itself in the few months since it was inaugurated. The Italians call Florence "Firenze," and the lady-announcer is easily recognised, the programme usually covering Florence, Genoa, Milan and Turin, which are respectively announced as "Firenze," "Genova," "Milano" and "Torino."

It is delightful to linger in imagination for awhile in Florence, which has been called the art capital of Italy. Here the poet Dante was born, and here lived Galileo and Michael-Angelo.

At one time Florence was the capital of United Italy, and within its ancient walls the reformer Savonarola was

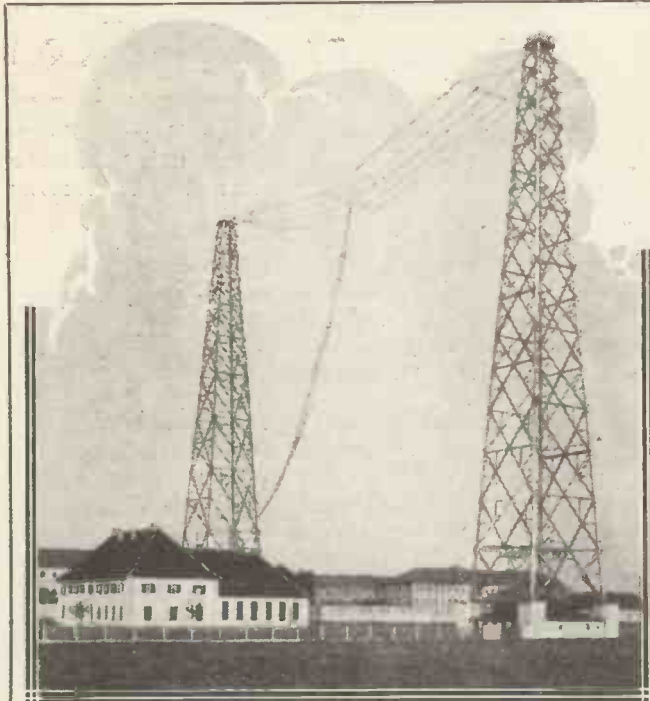

THE WOODEN MASTS OF MUNICH

The broadcasting station at Munich, which you see here, is renowned for its wooden masts, which were installed owing to their low absorption co-efficient. It is claimed by some engineers that steel masts introduce considerable losses because of their "shadowing" effect.

hanged and burned in 1498. Its cathedral with a unique dome is a marvel of engineering, and architects from all over the world go to Florence to inspect it.

One very interesting point about the apparatus at the Florence broadcasting station is that it is of the same type as the gear installed at several other well-known broadcasters, including Reykjavik, Bratislava and Bucharest.

Good Design Responsible

Perhaps it is the similarity in design that accounts for the fact that Florence and these other stations come over so well in this country. Later on in the year it is fairly common to receive him at almost any time of the day if one has a sufficiently sensitive receiver.

From the great Italian centre of art we turn to visit the capital of one of Europe's newest states—Prague, in Czechoslovakia. It is easily found on the tuning dial, for Prague is by far the most powerful medium-wave station in Europe.

Listeners who live fairly close to the North Regional will probably have difficulty in receiving Prague unless their sets are really selective, for the separation between them is only 9 kilocycles. (It is when two powerful stations such as these start working on adjacent channels that we realise that 9-kc. spacing is not enough, at least not for the ordinary type of set.)

Europe's Largest Medium-Waver

Prague's wavelength is 488.6 metres, and the power 120 kilowatts. There is only one other station (the long-wave Warsaw) with a power of this magnitude, and the clash of nationalities in this south-eastern section of Europe has resulted in the demand for such high-power

transmitters, which is all to the gain of the keen long-distance listener.

The Prague transmissions are almost too well known to need introduction, but for the benefit of the uninitiated it may be said, in passing, that Prague is called "Praha" in the announcements.

There are both male and female announcers, and they frequently mention the other Czechoslovakian stations, namely Brno, Bratislava, Kosice, and Moravska-Ostrava. The words "Dobrou Noc" are used for "Good-night," and the opening call is the very appropriate one of a lusty cockcrow, at 6.15 a.m.!

North Regional—Our Last Call

The next place we "visit" on this tour is our "home" station, the North Regional at Moorside Edge. Its wavelength is 480 metres, and it is thus only about one degree on the dial below Prague's position.

From an engineer's point of view, Moorside Edge is probably the best station in Britain.

It is situated, as its name suggests, in high, open country, and its 500-ft. masts give it a far better "get-away" than the London programmes, which go out on similar power, but from masts of less than half the height.

At Moorside Edge our "tour" ends this month, and in working down from Budapest to the North Regional it is worth noting that we have covered only seventy metres of wavelength range.

Well Worth Remembering

But we have "visited" some stations well worth remembering, and when the darker days come in the next few months these at present rather coy and elusive foreigners will appear to close in and become more and more familiar to the listener for overseas programmes.

There is often a tendency to neglect the top-of-the-dial stations in favour of those of lower wavelengths; but as our tour has indicated, there is really much of interest attaching to the upper end of the waveband, in the region immediately below 550 metres.



"DOBROU NOC"

Prague's "Good-night" is well known to listeners on the 488.6-metre wavelength. Here are two of the station engineers at work in the control-room, from which they deal with relays to Brno and the other Czechoslovakian stations.



NEWS FROM THE STATIONS

Short items of broadcasting news from here, there and everywhere.

STUHLY EI SE IBURG. The wavelength of 21.92 metres is used in daylight, and 43.83 metres during darkness, by the new Hungarian short-waver when transmitting to the U.S.A.

MONTE CENERE. The Swiss Regional station to be erected near Tessin, on Monte Cenero, is expected to be in operation within the next five months.

KALUNDBORG. The new transmitter will be capable of straight-line modulation up to 95 per cent, thus ensuring practically perfect quality.

RASIN. The aerial of the long-wave Warsaw station (1,411 metres) is situated at Rasin. It is of the half-wave type with a feeder house under the centre of the aerial.

MADRID. The Madrid Town Council meetings are broadcast every Friday, and are, strangely enough, regarded with great favour by listeners.

BISAMBERG. The preliminary work on the site for the new Vienna transmitter has now been completed, and it is hoped that the aerials and masts will be finished by September.

ABERDEEN. The 288.5-metre Aberdeen transmitter was withdrawn on July 10th to be modified for its work on the new wavelength of 214.3 metres. (The alterations should be completed before these words appear in print.)

EDINBURGH. The new control room recently installed was rendered necessary by the dual programme extensions at Westerglen.

NEWCASTLE. As at Aberdeen, the main Newcastle transmitter is being withdrawn from service for about a week whilst it is being modified for its new wavelength of 211.3 metres.

WESTERGLEN. Test transmissions from the Scottish National station are due at the beginning of August. Wavelength, 288.5 metres.

for the provinces of British Columbia, Manitoba, Ontario and Quebec.

LEIPZIG. The new high-power station should be on the air regularly by the time these words are in print. (390 metres.)

FRANKFURT. By the beginning of August, Frankfurt is due to have increased

BISAMBERG. The cost of Vienna's new high-power station now under construction at Bisamberg will be about £150,000.

STUTTGART. With the idea of economy, Stuttgart, Munich, Frankfurt and Cologne now regularly share concerts with one another

DAVENTRY. The following wavelengths have been reserved for the new Empire short-wave station now under construction:

- 49.58 metres
- 31.54 "
- 31.29 "
- 25.53 "
- 25.28 "
- 19.81 "
- 16.88 "
- 13.97 "

BROADCASTING HOUSE. The ultra-short-wave transmitter installed on the seventh floor of Broadcasting House, London, is a Marconi S.W.B.4 type, with an aerial output of about 300 watts. The wavelength is about 7.75 metres.

KALUNDBORG. In the new station now under construction the last amplifying stage will employ two water-cooled valves, each rated at 120 kilowatts, and with an anode voltage of 20,000.

RADIO NORMANDIE. This popular French station recently surprised its audience by broadcasting an S.O.S. to a ship, asking it to look out for a balloon that was making a forced descent off the Normandy coast.

The September "M.W."

Our next issue of "Modern Wireless" will tell you all about

THE RADIO EXHIBITION

IN A

SPECIAL ENLARGED NUMBER

USUAL ORDER YOUR OUT ON
PRICE COPY NOW AUG. 19th.

MADRID. At the Wireless Conference to be held in Madrid this autumn it is expected that arrangements will be completed for a similar international conference to be connected with broadcasting only. (All wireless services are to be represented at the Madrid Conference.)

BILBAO. A 10-kw. station to work on 229 metres, at Bilbao, is one of the proposals in the Spanish Regional scheme.

MONTREAL. The report of the Committee on Canadian Broadcasting recommends a 50-kw. station for Montreal, and stations of similar power

and changed wavelength to 259 metres.

MUNICH. October is now given as the month when the new high-power Munich station is likely to be ready.

M N G. The direction-finding station transmitting the call M N G in Morse on 1,050 metres is situated at Ronaldshay.

BRESLAU. At the beginning of the day's programme the names of the announcers to be on duty that day are stated with times.

The rest of the German stations may follow suit.

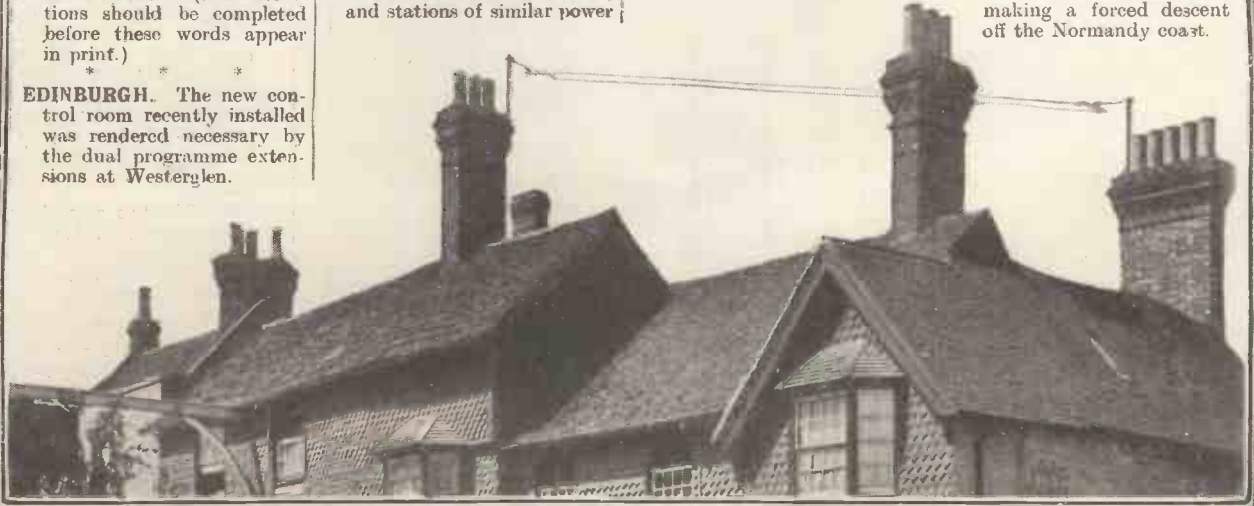



ITEMS OF INTEREST FROM OVERSEAS

Palermo's Radio Link—Hilversum's Electric Organ—New Spanish Stations—Berlin's 7-metre Transmitter—Switched on by an Airship!

ROME. Rome's new Broadcasting House has thick walls, and doors and windows trebled to exclude unwanted sounds.

PALERMO. When this station relays Rome it employs radio as a link, there being no suitable landline connection between the two cities.

BARI. The work on this station has been badly delayed.

MILAN. The new station at Milan which was supposed to be working by mid-summer is to be ready "shortly," according to a statement from Rome.

ASMARA. A 200-watt transmitter has been installed by the Italians at Asmara, Eritrea.

HILVERSUM. The new electric-power organ now on order is to have church bells, carillon, harp, and various orchestral instruments, besides 50 organ stops.

WARSAW. The recent sensational interruption of the dance programmes and the superimposed political message was accomplished by "tapping" the line from the studio to the transmitter in some woods near the station building.

MADRID. The Spanish Government's conditions for allowing a new broadcasting system to work in Spain include the provision of a super-power (120 kw.) long-wave station for Madrid.

SEVILLE. A 20-kw. station working on 263 metres is proposed for Seville under Spain's latest broadcasting scheme.

CORUNNA. 251 metres is the wavelength allotted provisionally to the proposed 20-kw. Corunna station.

BERLIN. The ultra-short-wave transmitter testing on waves between 6 and 8 metres is located at the foot of the Funkturm—Berlin's Broadcasting Tower.

SCHENECTADY. The new 50-kw. transmitter recently opened was switched on by a beam of light from an airship flying high over the town.

PRANGINS. American listeners report excellent reception of the League of Nations station at Prangins, on 19 and 35 metres.

KONIGSBERG. Breslau, Leipzig and Berlin all take concerts regularly from Konigsberg, which in turn relays musical programmes from the stations named.

CHICAGO. The "People's Church" recently celebrated its eighth year "on the air," a record equalled by only one other church in America.

BRESLAU. The completion of the new high-power transmitter has advanced Germany's regional scheme another step towards completion.

COLOGNE. The transmitter recently removed from Cologne is being re-erected in place of the Hanover relay station.

HANOVER. Like other German stations, Hanover pins

its faith on wooden masts, the one employed being 195 ft. high.

NEW YORK. The television tests from the station on the top of the Empire State Building resulted in "fairly clear" pictures. The size of picture was only 4 in. by 5 in.

WEA F. This American station heads one of the two N.B.C. broadcasting networks; the network rate-charge to advertisers, etc., is said to be £2,572 per hour.

MONTREUX. An interesting fact which emerged at the recent Montreux conference on broadcasting was that between March, 1931, and March, 1932, the number of Europe's licensed listeners rose by over two millions.

POSTE PARISIEN. An organ without pipes has been installed in the Poste Parisien station—oscillating valves are used instead.

WASHINGTON. The American broadcasting systems are delighted with Presidential campaigns. In the 1928 political battle the Republicans spent £97,300 and the Democrats £118,436 for the privilege of microphone publicity.

U.S.A. The two great broadcasting chains of America—Columbia and National—each control about one hundred stations.

SOTTENS. The 5 p.m. time-signal comes from the Neuchatel Observatory.

OSLO. The short melody played in the intervals is the motif from Grieg's "Sigurd Jorsalfar."

A RADIO-EQUIPPED 'PLANE



This Marconi aircraft transmitter and receiver is installed on board Prince Bibescu's new air-yacht. It can be used for either telegraphy or telephony, and has a range of several hundred miles.

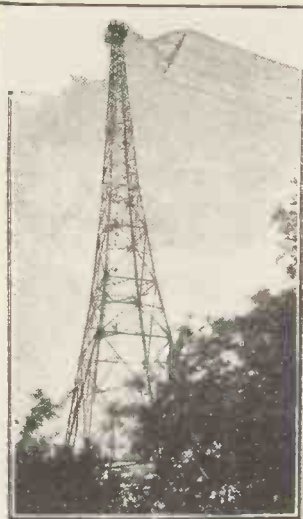

COME ON A VISIT TO A 16-METRE BROADCASTER

A Correspondent talks about Bangkok, the station which keeps Siam in touch with the rest of the world.

As it is extremely difficult to work a set here, I have been out of touch with radio for nearly eighteen months, but my enthusiasm was aroused when I was allowed to go over the short-wave station.

A new member of a local tennis club turned out to be one of the station officials, and naturally after a little while we couldn't keep radio out of the conversation! And my visit to the station was the result.

Nothing Experimental

It is one of those few stations keeping company with Kootwijk and the Indo-Chinese station Saigon, which work down on the 16-metre band.

Knowing that when an amateur makes up gear for working below 20 metres it is generally of a makeshift nature, with home-wound coils and valves suspended on efficient but amateurish-looking rubber supports, I naturally expected to find some signs of what the Americans call "experimentation" in even a professional ultra-short-waver.

Well, a visit to the Bangkok station disproved this in a startling way. All the gear there has been built by the well-known German Telefunken concern and it looks like part of Heilsberg, "Mühlacker" or any other German medium-wave broadcaster.

Well Laid-Out

As the transmitter is run by cable and commercial interests, there is no sign of amateurishness about it. One whole single-storey building at the station centre is devoted to the ultra-short-wave transmissions. As not one of these is above 40 metres, what I saw was of outstanding interest.

A large field has been taken over by the station authorities, and a broad drive up from the road to the station is now in course of construction. There is also a tiny lake into which a fresh spring runs, and this is used for cooling water at the station so that the plant will not run dry even after extensive draught.

Apart from the two lattice masts which carry the short-wave aerials, the station is also the terminal point for cable land-lines, and I should have supposed that the large number of wires on the telegraph posts below the aerials

would have some effect on the transmissions, but the engineers told me that on 16 metres one has to contend with different wave-reflection problems from those encountered at higher-wave broadcasting stations.

Twenty-Four-Hour Service

The entrance hall of the building leads into an office and also the quarters for the night staff. Most of Bangkok's work is done in the early hours of the morning, and shifts are arranged for the engineers so that there is a 24-hour service.

There are six ultra-short wavelengths for Bangkok, each wave-band being granted a separate call-sign, so that if they want to have two or three transmitters going at once there is an individual call.

The 49-32-metre transmitter is H S P. This can tune down to 37-76, but at this lower limit uses the call-sign H S P 1 to prevent confusion. H S I O K works on 37-6 metres, and H S J on 16-9 metres up to 18-7. A new transmitter, H S G, has just been installed and this works on 29-5 metres.

There is also an emergency 300-metre broadcaster for working with ships and passing on messages

that the heating troubles in ordinary valves when working on 16 metres cause far more difficulty than the slight loss brought in by water cooling.

As a matter of fact, the ultra-short Bangkok valves are not quite "ordinary" valves. They are picked valves with a special electrode spacing, and are connected in a novel type of neutralised circuit to cut out the stray capacity from filament to anode.

The valves are costly, and after one or two initial "burn-outs" the engineers installed an ingenious water-controlled relay so that immediately the water pumps stop working, or the flow slows down for any reason at all, the relay operates a main switch which cuts off the high-tension.

Automatic Switching

This safety relay is fixed up on a concrete block to prevent vibration affecting it, and every week or so the water supply is deliberately throttled while the station is working to see that the relay acts properly.

The oscillators and following H.F. amplifiers for the 16-metre transmitter are enclosed in screening

engineers, though, have a primary check on the frequency, even at the early stages.

On the white switchboard is an ingenious frequency meter, carrying, instead of a needle, a number of tuned reeds with a white blob on the end of each. The A.C. supply causes these reeds to vibrate. As the reeds are tuned, only those nearest to the supply will flicker, and thus make the frequency of this obvious by the flickerings of the graduated white ends.

Special Checking-Room

The checking room is fitted up with a large teak work-bench on which the wavemeters and two check receivers are mounted. One of these sets can be used on the broadcast band, and is the receiving point in connection with the 3-kilowatt broadcast-band transmitter, which incidentally has its main control panel right outside the door of the checking room.

I was taken out into the grounds and shown the two aerials. These are vertical, the long cable between the masts, holding the down leads, being insulated to make it electrically "dead."

Both these aerials can be used at once for semi-beam transmission, in the Hertz fashion, while they can both be switched in parallel and a counterpoise earth brought into play for the broadcast-band transmitter.

Isolated Position

As readers will remember, Bangkok is situated midway between Rangoon and Saigon, not so very far from the Equator. It is for this latter reason that short waves are so popular, for only those who have experienced tropical atmospherics on the higher waves can appreciate their significance.

Even on the short waves they are sometimes very troublesome, but nothing compared to what they are on the ordinary broadcast band. Sometimes when using the 300-metre transmitter the engineers told me that it is almost impossible to hear a ship at all, unless it is "almost under the receiving aerial." And all this because of the strength of these atmospheric disturbances. It is certainly a blessing that the short waves are comparatively free from this type of interference.

Strangely enough, a very well heard station at Bangkok is the W 2 X A D 19-metre station at Schenectady, which British listeners can hear in the evening. Some atmospheric freak enables these 19-metre signals to be heard more clearly than any of the other transmitters, and so the Bangkok engineers are experts on American sponsored programmes via the ultra-short waves!

THE NEVER-SILENT STATION



Here you see the modern station house at Bangkok, which not only houses the transmitting gear, but also provides sleeping accommodation for the staff who provide a 24-hour service.

received on the ultra-short waves.

This broadcast-band job is a standard three-kilowatt Telefunken "sender," as is in several relay stations of the Berlin broadcast programmes. A familiar sight in strange surroundings!

Plenty of Power

The transmitter H S J, the 16-metre job, can handle 20 kilowatts if necessary, and it takes up about a quarter of the space of the whole station. A surprising thing is that water-cooled valves can be used satisfactorily at these extremely high frequencies, but I was told

boxes with removable fronts. There are six of these boxes and all that can be seen from the front are four meters on each, big handles for the quick detachable panels and a main high-tension control.

Facing these screening boxes is a large white board running the length of the room and carrying all the generator controls and the switches for the valve cooling pumps.

Valve wavemeters in an adjoining room are used to check up the ultra-short wavelengths, and this is a whole-time job for one engineer. The transmitter en-



BRUSSELS. The check on wavelength wanderers revealed that recently from 300 to 400 metres has been the "cleanest" part of the medium waveband. The only bad offender being Radio Vitus, who is supposed to stick to 312.8 metres.

ZEESEN. At present overhead feeder lines run to the aerial from the transmitter, but these will shortly be replaced by underground lines.

HEREDIA. The famous Costa Rican station (T 1 4 N R H), which works on 29.3 metres, made most of its long-distance records when using the apparently ridiculously low power of 7½ watts.

PRONTO. The word "Pronto," sometimes heard from Italian stations, means "Ready," and is employed as we use "Hallo."

KONIGSWUSTERHAUSEN. An eight-fold increase in energy at the receiver is claimed for the new Zeesen short-wave "bird-cage" aerial.

KALUNDBORG. An act of great courtesy is reported in connection with Kalundborg's new station. Before the order was finally given the Danish Government told their neighbours—Norway and Sweden—of the project to ascertain how they regarded its effect on their own broadcasting. A fine example of radio good manners.

STRATOSPHERE. Professor Piccard's balloon is fitted with a compact receiver and short-wave transmitter.

BEROMUNSTER. The Swiss authorities are instituting broadcasts to schools from the above station, on 459 metres.

WASHINGTON. A proposal to collect revenue by granting short-wave transmitting licences has caused great indignation in the U.S.A., where amateur organisations

STATION INFORMATION

News of the world's broadcasting stations, the increases in power, and particulars of altered services, and so forth, chronicled for the benefit of long-distance listeners.

are very strong, and cooperate with the Government services in national emergencies such as the Mississippi floods.

FÉCAMP. The "Radio Normandie" "transmission" on about 55 metres is not a short-wave relay, but is the station's fourth harmonic.

G 5 S W. When the Chelmsford short-wave station started regular relays of B.B.C. programmes, five years ago, there were less than thirty short-wave telephony programmes to listen for. There are now over one hundred.

receiving end of the Anglo-Egyptian radio-telephone service.

ABU ZABAL. This is the full name of S U Z station, which works with Rugby on 21.7 metres.

ÉCOLE SUPÉRIEURE. Television programmes have recently been broadcast by this popular Paris station on 447.1 metres.

RADIO VITUS, PARIS. This station, which has been working on 307 metres, broadcasts the speech and music accompaniment of the



down temporarily to enable the work of construction proper to be completed.

BERLIN. The lady announcer who has recently been heard is on a three-months' probation, at the end of which period it will be decided whether a male or female announcer is more popular with the Berlin listeners.

BUENOS AIRES. The "Radio Nacional" station is increasing its power from 7½ to 10 kw.

RADIO EXCELSIOR. This station, situated at Buenos Aires, claims the highest aerial masts in the world devoted solely to broadcasting. (Both the Eiffel Tower and the Berlin Radio-Tower are higher, but neither was built exclusively for radio uses.) Radio Excelsior's masts are 700 ft. in height.

ITALY. The E.I.A.R.—Italy's B.B.C.—intends to install a large organ, specially designed for broadcasting, in the Rome Broadcasting House.

BRITISH EMPIRE S.W. STATION. The new station at Daventry will at first have two transmitters, with powers of 15 or 20 kw.

YOUR FRIEND ABROAD

Why not send him "Modern Wireless" every month to keep him in touch with all the latest radio news and developments? Post his name and address with 17s. to the Subscription Department, Amalgamated Press, Ltd., The Fleetway House, Farringdon Street, E.C.4, and "M.W." will be sent every month for a year.

ZEESEN. The German short-waver is acquiring a name as a high-quality-music stand-by station. It usually works till about midnight. Wavelength, 31.38 metres; also 19.73 metres.

DAVENTRY. The building for the Empire short-wave station is virtually finished, and it is expected that the station will be completed by Christmas or thereabouts.

BALDOCK. This Hertfordshire G.P.O. station is the

École Supérieure television programmes.

RADIO SPLENDID. The new 15-kw. transmitter at the above-named Buenos Aires station is now in action.

ATHLONE. After its successful broadcasting under test conditions of the Pontifical Mass at the close of the Dublin Eucharistic Congress, the Athlone station closed



ABOVE 1,000 METRES

A rapid review of the long-wavers which have been giving a particularly good account of themselves during the past few weeks, when conditions for foreign reception are supposed to be at their worse!

DURING the past month reception of the long-distance stations is supposed to reach its lowest level of strength and reliability. And yet, in spite of the calendar, how amazingly good it has been!

The expected bout of severe atmospherics was not of the continuously troublesome kind that midsummer conditions are supposed to bring. In fact, on some days there was very, very little sign of atmospherics, and the volume control could be put on the "all out" position to give maximum sensitivity without any of the nerve-shattering scratches and bangs that are so often supposed to be inevitable in summer.

Keeping Up Phenomenally Well

So far as strength goes, the majority of the favourite stations are keeping up phenomenally well. Certainly the summer weather does seem to take toll over the very long distances, and a rather careful search on one particularly sunny Sunday evening, chosen as typical, failed to reveal anything at all of the Leningrad or Moscow programmes.

This was not so surprising, however, as the case of Warsaw. The high power of this remarkably good station has kept it going as a good possible alternative long after Moscow and Co. had been given up as unlikely. But on this particular occasion Warsaw was so weak as to be not worth listening to. Summer conditions with a vengeance!

Plenty to Choose From

And yet some of those other long-wave stations sounded as cheery as though the Yule Log were on and the Christmas dinner just eaten! At the top of the dial, Huizen, always religiously inclined, was conducting a service with such clarity of response and clearness of hymn-singing that one might easily have been in church.

A few degrees lower Radio-Paris was coming in with truly remarkable strength. His advertisements in English of worldly pleasures to come effectively dispelled the ecclesiastical air of the Huizen transmission; and the gramophone records which followed clearly indicated that gaiety has not yet gone from the face of the earth. The strength and clarity of this transmission were all that could be demanded.

A Splendid Transmission

The B.B.C. stations being off, the next transmission encountered in descending the dial was Eiffel Tower. Strength here, too, was remarkably good, though not up to the local-just-round-the-corner effect secured by Radio-Paris. And the programme was a talk of some kind—nothing to linger over.

A little lower down the dial there was another strong transmission—Motala, this time. Considering the station is about 900 miles away one might have expected it to be necessary to "find" and "nurse" Motala. But, no! It was a strong, easily-heard programme, as loud as the B.B.C. provides in some districts.

It has been said that the above-named stations were all found easily in the course of a casual Sunday evening run round the waveband. And having obtained so many good-strength transmissions in an idle twenty minutes, one could hardly have expected more in the way of free entertainment. But just below Motala another real punch-merchant was tuned in—Kalundborg.

Farther Down the Dial

The Danish long-waver has so often been commended for the way in which his low power gets over to this country that one hesitates to say once again that it is surprising. And yet even while one recalls the many fine performances in the past it is undoubtedly astonishing to find this far-away transmitter capable of the performance he gives.

Clear announcements and high-quality musical transmissions, combined with a steady and completely satisfactory level of strength, make this one of the outstanding stations of Europe in the opinion of many a keen long-distance enthusiast.

One other station of interest is Oslo. He is one of the most temperamental transmitters on the long waves, but why this should be is an absolute mystery. At times his strength in this country is really remarkable, and if you can catch him in one of these moods he can be very entertaining. D.X.

THE STATION OF STAMBOUL

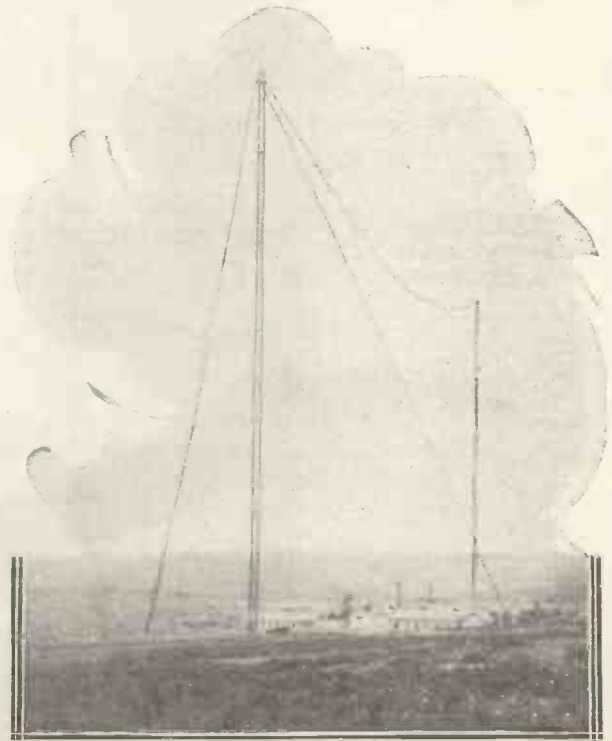

A general view of the Constantinople station. The Turks call their capital "Stamboul," or "Istanbul," the latter being the spelling usually adopted for the name of the wireless station. It works on a wavelength of 1,200 metres, using a power of about five kilowatts.

WHAT THE DISTANT STATIONS ARE DOING

Some comments on the more interesting features of a keen listener's reception log, with notes on a few of the outstanding stations and out-of-the-ordinary programmes picked up.

THE weather recently has been so excellent that I have to admit that it resulted in my missing at least one interesting event—from a long-distance enthusiast's point of view—the special broadcasts from the Rio de Janeiro station P R X A.

Although, as I remarked, I did not hear these transmissions, I have a number of reports from people who did. From these it would appear that the station did not commence transmission at the time given owing to a technical hitch.

When everything was put "to rights," and the station got on the air, signal strength was poor, although announcements, which were made in English of sorts, were clear enough to be understood. The result was that it was more a case of receiving a distant station than enjoying its programmes.

However, as this is what we enthusiastic distant-listeners are after, that did not matter.

The station was, I understand, employing a power of 15 kw., and a wavelength of 31.52 metres.

Chile in Mid-Summer

Brazilian short-wave stations have been very prominent during the month, and P P U, Rio de Janeiro, has been heard broadcasting on about 32 metres as well as on 38.56 metres. The latter wavelength provided the stronger signals.

There are sixteen broadcasting stations in Venezuela and only one employs a wavelength above 100 metres. This is Y V - 1 B C, Caracas, which works upon 312.3 metres. The remainder employ wavelengths between 24 and 75 metres.

Speaking of Venezuela reminds me that Y V - 11 B M O, at Maracaibo, Venezuela, is broadcasting special concerts for the benefit of English-speaking nations. A wavelength of 48.95 metres is employed.

So far as I have heard, this station has not been received in England, although it has been heard at good strength in the United States and even Canada.

Transatlantic Traffic

The re-broadcasting of programmes across the Atlantic has been continued with seemingly unabated enthusiasm. Three "new" Rocky Point stations have added their voice to those already at the "game." These are W I Y on 21 metres, W E N on 40 metres, and W M A on 22.3 metres.

Europe has also supplied plenty of re-broadcasts, but these have not been heard at much strength, owing to the beam effect that naturally accompanies these stations.

Did you hear the unusual Derby-Day "broadcast" from the traffic-directing auto-gyro—G A - B U D, which broadcast the traffic conditions leading to the Downs? These broadcasts were to a land station, G T E.

I understand that by amalgamating radio and aircraft the controlling of traffic was rendered much easier than it would have been were the more usual "land" methods employed.

Royal Air Force stations and aircraft—in the region of 100 metres—are extremely interesting, for it frequently occurs that you can hear an aeroplane attempting to communicate with the land station which cannot hear it. Noms-de-plume are used by the land and aircraft stations in these instances.

Farther up the waveband, upon the medium waves, conditions are excellent.

America Quite Audible

One might imagine that American stations would be inaudible by now, but such is by no means the case. Although they are received far less frequently than even a month ago, and although the strength with which they are received is of a lower level than then, moderate reception has been experienced on several occasions.

There have been several phenomenal days, or, perhaps I should say nights, when reception of American stations has been astoundingly good. On these occasions I have heard W T I - C, at Hartford, Connecticut; W - P - G, Atlantic City; and W J Z, Boundbrook, at worth-while strength.

These three stations appear to be the only ones that put over any strength at this time of year.

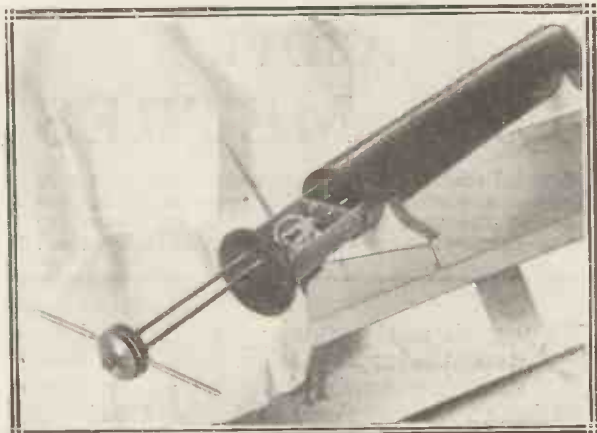

HALF A METRE! This is a complete receiver for a 50-centimetre wavelength. Instead of coils straight wires are used—which explains the length of the instrument.

W G Y, K D K A, and W A B C have, despite their power, been unheard.

From South America there is, so far as I am concerned, only one station audible at the present time. It is the well-known station L R 3, Radio Nacional, Buenos Aires. This station, which is remarkable for the "getting over" power it possesses, has been heard at moderate strength on several occasions.

So far as conditions for the reception of European stations are concerned, there is not much to choose between the number of stations and the volume at which they are received now than during the winter months. Conditions have been positively astounding and many distant stations have come in at "local" strength.

Among these is Katowice, over 900 miles away, which has been quite as powerful as the Midland Regional station, about 80 miles distant.

Fécamp Louder

Readers have doubtless observed a considerable increase in the volume of the well-known Fécamp station, Radio Normandie. The reason for this is that this station has recently increased its power.

PRINCE MICHAEL AND THE MIKE



Seated before this microphone are King Carol and Prince Michael, with ministers and others, during a "hospital" broadcast from Bucharest.

I should very much have liked to see Mr. Leonard Henry's face recently when a certain artiste, whose name I forget, was announced at Fécamp. The resemblance between this artiste's voice laugh, etc., and that of Leonard Henry was so marked that—well, I repeat, I should have liked to have seen Leonard's face!

"Percy the Piano"

I thoroughly enjoy broadcasts from Radio Normandie, because the announcers have that friendly American way of announcing, and are also wonderful at creating "atmosphere." Take the instance of the announcements—frequently made—that the Syncopated Players (not forgetting "Percy the piano"!) have just walked on to the stage in their flawless evening dress.

If the announcer has nothing much other than a "mike," gramophone and records before him, that's marvellous!

One might imagine that the sunny weather would have brought portable receivers out in "flocks." Such has not been the case, however, and I have not seen a portable receiver outdoors for a long time.

Having carried one of these so-called "portable" receivers several miles, I can readily understand why they are left indoors. They are, for me at least, far too unpleasant and tiring to take about.

A Hint to Manufacturers

It seems to me that British radio manufacturers would do well to consider the manufacture of receivers especially for motor-cars. "Auto-radios," as they are termed in America.

An "auto-radio" is a receiver constructed in the automobile, and it cannot readily be removed. These receivers generally employ six or nine valves, and they are either super-heterodynes or multi-screened-grid receivers. The tuning controls are either on the dashboard of the car or upon the steering column.

A frame-aerial is incorporated in the roof of the car. This is fixed edge-wise so as to avoid directional effect. Moving-coil speakers are employed in almost all instances. These are either fixed in the back of a seat, on the dashboard or even in the floor.

It is a revelation to hear one of these receivers. They are extremely sensitive and stations over a thousand miles can fairly readily be tuned-in on the loudspeaker when the car is travelling along at fifty miles an hour.

Despite their great sensitivity, everything is arranged so that there is a silent background.

L. W. O.

MY BROADCASTING DIARY



Our own Broadcasting Correspondent records the progress of the British Broadcasting Corporation, and comments frankly on the policies in force at B.B.C. headquarters.

B.B.C. Finance

B.B.C. finance is still to the fore. The May Economy Committee of last year recommended a straight cut of half a million; but the B.B.C. got in first with an offer of £150,000 a year "during the crisis."

Many people still hanker after the May cut, and there is restiveness on this score in the House of Commons. I think the B.B.C. would be well advised to give more information about its expenditure. Public opinion is ready to be helpful, but hardly on the present sketchy outline.

The Future of "Mechanised" Broadcast Music

There is renewed talk about the introduction of a larger proportion of "mechanised" music into broadcasting programmes. By this is meant more recorded music both by Blattnerphone and gramophone.

The idea is, of course, one of economy. It is also argued that programmes will be actually improved; that, in fact, the "tinned article" is better than the fresh fruit of direct performance.

I cannot say whether there is anything in the latter point; but this I will say, that I hardly see how the former point justifies such an extension. For one thing, the first-hand performance is psychologically much more convincing and comforting. For another thing, there comes the point where the discouragement of "executant" music will dry up the sources of artistic achievement.

There is much more in all this than superficial figures.

Broadcast Humour Reserve

The problem of new material for broadcast humorists is one that causes much anxiety at Broadcasting House.

Now that there is virtually in existence a corps of microphone humorists, there is more need than ever for the regular provision of suitable material. So it is proposed to set up a small staff of qualified writers who will contribute on a part-time basis.

I think the idea an excellent one, provided the writers keep in personal touch with the microphone people, and keep envisaged continually the personality and peculiarities of those who will put over the stuff.

Mr. Percy Edgar's Health

Much sympathy is expressed in broadcasting circles for Mr. Percy Edgar, Midland Regional Director, who is slowly recovering from a painful illness and operation on his throat.

Mr. Edgar is the senior Regional chief and Chairman of the Committee. His work at Birmingham during the past nine years or so has been remarkably successful. Undoubtedly, Mr. Edgar has got nearer to the public taste than any other B.B.C. programme builder. Even haughty London has stooped to adopt one of Mr. Edgar's most-liked programme creations—I mean the musical features of Mr. Joseph Lewis.

ANOTHER MEDAL FOR MARCONI



Marchese Marconi has received yet another honour. He has been awarded the Kelvin medal, and this photograph shows Lord Rutherford handing over the prize at the Institute of Civil Engineers.

Latest News Items for the Listener

This, I understand, was due to the personal suggestion of Sir John Reith. Anyway, it has been a wonderful success.

Future of Opera

The future of opera is still obscure. There have been endless futile negotiations. But one thing seems clear, and that is that there will not be a repeat this year of last year's English autumn season.

Also, there is no sign as yet of a permanent healing of the breach between Sir Thomas Beecham and Covent Garden. It should be noted, however, that relations between Sir Thomas and the B.B.C. have been miraculously cordial for some months longer than ever before.

In this resides the last shred of hope of accommodation. Meanwhile, time slips away, and the lease of Covent Garden falls in at the end of next January.

GETTING A MOVE ON AT WEST REGIONAL

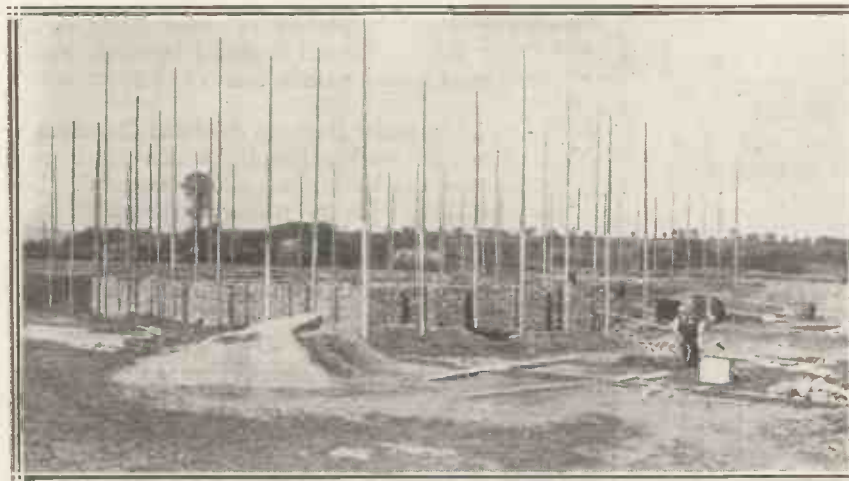

Work in progress on the site of the B.B.C. West Regional station. Building is going ahead by leaps and bounds, and it should not be long now before the work is completed.

My own view is that if the situation is to be resolved at all it will be by Lady Snowden, who has kept well aloof from recent negotiations. Whatever happens, no doubt the B.B.C. will make arrangements for the continuance of the right proportion of opera in the programmes.

Governors of the B.B.C.

This year, with Broadcasting House established and inspected by two of the Three Estates of the Realm, the B.B.C. is taken much more seriously. It is in definite danger of being regarded as a permanently respectable and solidly sound British institution. Hence the rush for the Board will be on a wider scale than before.

There is this difference, however. Previously the outside entertainment industry has always had several active candidates; this year there is no sign of attempts from that quarter, the view being that the B.B.C. is now much too deeply entrenched in Whitehall to be a reasonable hunting ground for a theatre manager.

On the other hand, there are far more names from the

ranks of the nobility, young and old. Then, of course, there are the supporters of some of our old friends once again pressing the claims of their champions.

Sir Harry Brittain's stock went well up with the publication of his book, "The A.B.C. of the B.B.C."; but suffered a little on the realisation of the almost intemperate praise which was meted out to the B.B.C. Sir Robert Donald is still mentioned with confidence in places where such subjects are discussed with authority.

More "Informal" Talks

The Talks Branch of the B.B.C. used to complain that they did not have more broadcast discussions because at Savoy Hill there were no facilities; that is, there were no suitable studios. This deficiency has now been fully repaired.

There are several specially prepared "Talks" studios at Portland Place, and I am glad to learn that advantage is to be taken of them this autumn. The development of the informal manner of presentation by question and answer round a table will add tremendously to the value and acceptability of talks.

The National Chorus

By the beginning of the next Symphony Season in October, the reorganisation of the National Chorus should be complete.

The National Chorus has done splendid work; more, indeed, than could be expected in view of its predominantly amateur character. But the time has arrived when the B.B.C. cannot afford to take any risks with its choral work, and I anticipate the early formation of a strong professional nucleus, which will be developed, as finances permit, to become exclusively professional.

Not only will the work be done better, but there will be a much-needed opportunity of employment for some of the numerous capable and deserving artistes out of work through no fault of their own.

The Danger of Ruts

Perhaps it is inevitable that the B.B.C. programmes should be accused annually at this season as lacking a "summery" atmosphere. Although special efforts are made to apply a seasonable touch to the transmissions the serious fundamentals of B.B.C. policy preclude the abandonment of everything except light entertainment.

I see more substance in the line of criticism that suggests that B.B.C. programmes tend to fall more and more into hard and fast categories apparently incapable of modification—a sort of unending repetition of Military Band, Light Orchestral, Symphony, Chamber Music, Vaudeville.

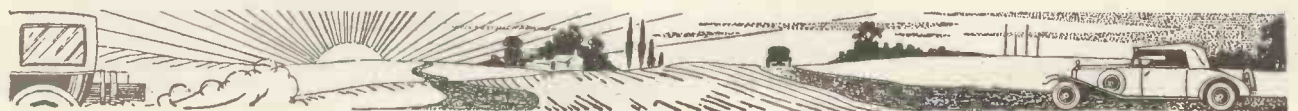

USING THE NEW PENTODES



Some useful hints on getting the best from the latest steep-slope types.

By N. E. B. LOMAX.

THE ultra-sensitive pentode valves recently introduced, of which the Osram P.T.2 and Mazda Pen.220 and Pen.220A. are typical examples, form a valuable addition to the output valves available for the 2-volt battery user.

For an anode current of only 5 m.a.

important, and it is interesting to note that moving-iron speakers specially wound to suit the P.T.2 and Pen.220 have been marketed by the Ormond and Celestion firms. As the anode current is small, these speakers may be inserted directly in the anode circuit, and all that is necessary to secure a good quality output is a compensating device.

This consists of a 75,000-ohm resistance and a .002 fixed condenser in series, connected between the anode and filament of the pentode (see Fig. 1).

The use of moving-coil speakers must next be considered, and here the vital point in matching is the correct ratio of output transformer. This can be calculated by taking the figure for the optimum load of the pentode concerned, dividing by the

TONE CORRECTION

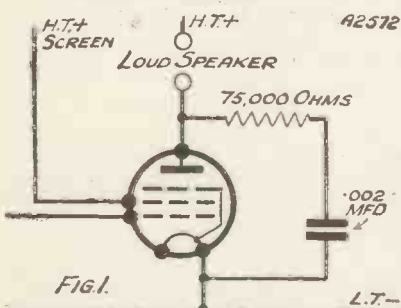

FIG. 1.

The tendency of a pentode to over-emphasise the high notes can be counteracted by connecting a resistance and condenser of suitable value as shown in this diagram.

at 150 volts, an undistorted output of 370 milliwatts, sufficient volume for any average-sized room, is attainable with either of the first two valves mentioned. Over 500 milliwatts may be obtained by using the maximum voltage of 150 on screen and plate, involving an anode current of 9 m.a.

Moving Coil with Small H. T.

The Pen.220A. gives an even bigger output, and will develop 1,000 milliwatts with 150 volts H.T. and an anode current of 18 m.a. If the current is limited to 12 m.a., 600 milliwatts is still obtainable, which means that a moving-coil speaker is now a feasible proposition with a 2-volt receiver and quite a modest H.T. supply.

It must be emphasised that no pentode can be regarded as being interchangeable with a triode output valve unless the necessary circuit modifications are made.

The problem of matching is all-

TRANSFORMER MATCHING

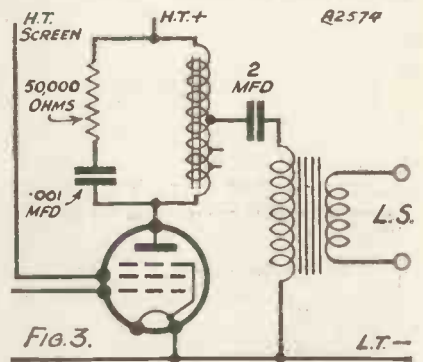

FIG. 3.

An alternative method of matching the impedance of a pentode to the loudspeaker is to employ an output transformer. This scheme is generally adopted where high ratios are required, as in the case of a moving-coil loudspeaker.

number of ohms impedance of the moving coil, and calculating the square root of the resultant figure.

For example, if the optimum load is 12,000 ohms, and the moving-coil impedance 12 ohms, the correct ratio would be the square root of (12,000 ÷ 12) or roughly 32 to 1. The optimum load of the P.T.2 and Pen.220 is 17,000 ohms, and the Pen.220A., 7,500 ohms, for the maximum undistorted output.

A Useful Tone Control

The tone-correcting device already described should be connected across the choke, rather than across the transformer, the values of resistance and condenser given being suitable.

Individual taste varies considerably in the matter of tone, and it is worth while fitting a variable resistance, which will form a useful tone control.

Try Several Tappings

In the case of ordinary moving-iron speakers an auto-transformer output should be adopted, using a choke with a centre and several other tappings, all of which should be tried until the best position is found.

The tone-correcting device is connected across the choke, as shown in Fig. 2, and the values of resistance and condenser respectively may be 50,000 ohms and .001 mfd. when using the P.T.2 or Pen.220. For the Pen.220A. the values of resistance and condenser are considerably different, 20,000 ohms and .01 mfd. being recommended.

CHOKE OUTPUT

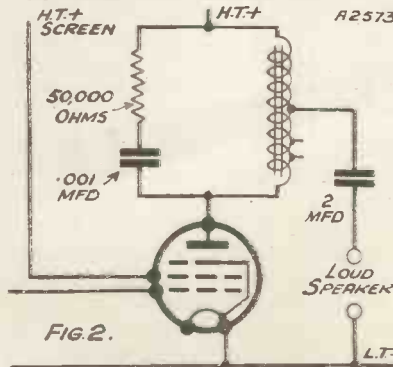

FIG. 2.

If maximum power is to be obtained from a pentode it is important that it should work into the correct impedance. This can be attained by using a tapped output choke arrangement.

THE "DIODION"



A TEST IN THE "SCREENED-ROOM"

An "M.W." engineer putting the "Diodion" through important sensitivity tests in the special listening cabinet, which is lined with copper to avoid all possibility of direct pick-up. So complete is the screening in this soundproof room that it is possible to work for only a few minutes at a time in this "electrical cage!"

DISTORTIONLESS reception, a high degree of selectivity and sensitivity, and, above all, economy of running. Those are the main features that we set ourselves in the design of our special exhibition receiver, the full details of which will be published next month, and a model of which will be on view at our stand at Olympia during the National Radio Exhibition.

Other refinements, such as the complete scrapping of the grid-bias

battery (although the set contains two L.F. valves, and is battery operated), and the reduction of the total anode current to 10 milliamps, were comparatively minor considerations in the design, though we must admit that they are eminently worth having. With the points outlined above they make a truly amazing array of strong features that rightly place the set in the forefront of modern radio receiver construction.

The full story of how the set was

The use of a special form of diode detector — a scheme for which the B.B.C. is mainly responsible — ensures a quality of reproduction which is unsurpassed. It provides a degree of selectivity capable of dealing with the worst of present-day ether-crowding difficulties which puts the "Diodion" in a class by itself.

designed and what are the minute secrets of its construction must be left till next month, but we want here to give a brief outline of the history of the set, and what it will do, and wherein its advantages will benefit the listener.

Real Economy

The great need to-day is economy, and in the design of a battery-operated receiver this must be one of the foremost considerations. But it must be real economy, not the sort that entails cutting down the performance of a set in order to keep the list of parts within a certain figure.

It must incorporate not necessarily economy of parts, though these must not be lavishly employed, but it must enable cheap operation in terms of anode wattage, and to do this it is necessary that the set be more than usually carefully designed. No latitude for variation of key components is possible, and the various stages must be so arranged that they give of their utmost, without any chance of "slacking," when the set is in the hands of the home constructor.

High Efficiency

Thus the utmost must be obtained out of the output valve, and though it is impossible in any set (without using a valve far larger than is really necessary) to arrange the output so that it can never distort even on the

AN INTRODUCTION TO "M.W.'s" MARVELLOUS NEW RECEIVER

Before the final model of this magnificent set was reached many versions were built up, then scrapped, altered, or retained for further experimentation. And, after all that, the completed instrument had to go through every possible test that could be thought of. No wonder it's such a winner!

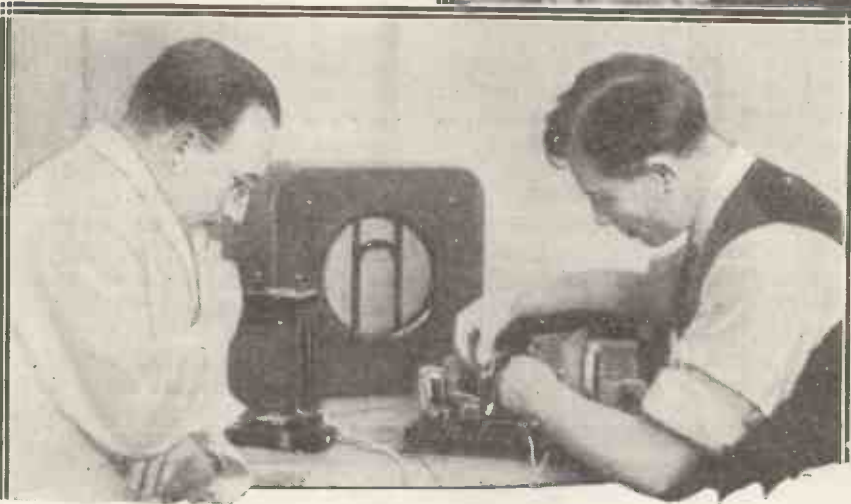

EVERY POSSIBLE LAYOUT HAS BEEN TRIED

A final critical survey of the component arrangement to see if there remains any small point where improvement can be made by moving or re-arranging components. No pains have been spared to get the most advantageous layout from every point of view.

loudest passages, it is not only possible, but in a set of this description imperative, that the output stage will be giving its fullest power output before distortion takes place. In other words, the distortion that does occur must be due purely to overloading, and not to any amplitude, or frequency distortion occurring because there is something wrong somewhere in the set itself.

So in order to get the full punch from the set, and therefore to obtain true economy, every effort had to be made to see that there was no chance

of distortion occurring prior to the output stage; and then only that due to overloading of the output valve.

But economy even of this type is not enough these days unless it is accompanied by another form of economy. This time we refer to economy in sensitivity. In other words, the set must be capable of getting a reasonable number of stations, and to do this it must perforce be sensitive, easy to operate, and selective.

So it will be seen that we set ourselves no easy task when we decided

THE CRITICS

This group is of special interest, as it includes an expert musician—who is trying to find something wrong with the tonal balance of the new "M.W." receiver. We need hardly add that he was entirely unsuccessful.

that the set for the September number of MODERN WIRELESS had to live up to all those points. It has to be a real economy set.

In undertaking a task such as this it is impossible to take one or other of the points and work from that towards the finished whole.

We could not, for instance, take the selectivity part of the set without considering the output question, for it is well known that high selectivity is liable to necessitate high H.F. amplification, and that usually results in troubles due to the difficulty of stopping some of the H.F. getting past the detector, and so upsetting the L.F. side of the set; and also it necessitates very careful detector design.

Providing the Power

Power grid detection immediately comes to mind, but the next thought banishes this as being out of the question on the grounds of economy. We have first got to decide one thing definitely, and that is the output

valve we will use. How "big" shall it be?

Obviously it cannot be very large, otherwise the drain on the H.T. battery will be large and the wattage economy correspondingly low. What size is necessary for comfortable reception on the average loudspeaker? One of 300 milliwatts? Or will 150

So we started with two facts, one that selectivity was necessary, and that therefore it was essential to use at least one stage of S.G. amplification, and also that the small output valve was essential for low anode wattage consumption.

The two ends of the set are roughly decided. What of the middle? This

experimentation, it was decided to try some form of diode detector.

Visions of insensitivity and wasted valves immediately float across one's imagination when the word "diode" is mentioned, but, as will be seen from the details of this set next month, there is no need for waste and no need for insensitivity.

Obviously the diode with the highly positive grid would not do, as this would mean a grid-bias battery, and one that would have to provide quite a considerable grid current at that. No, the rectifier must be "self-supporting," and it was decided to try out the method of rectification propounded by one of the B.B.C. engineers, Mr. L. Kirke.

IT WILL SUIT YOUR LOUDSPEAKER

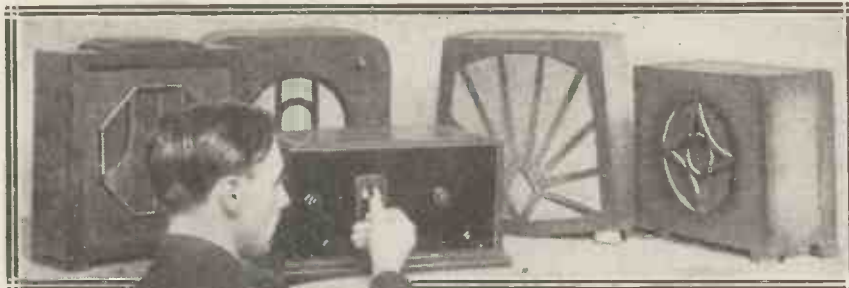

Balanced-armature, moving-coil and ordinary-magnet type speakers of all shapes and sizes have been tried with the "Diodion"—and it works well with all of them! It is not one of those fastidious receivers that won't be pleasant unless they are humoured by one particular type of loudspeaker!

milliwatts do? There is a large difference in the anode consumption of the two types of valve.

Ample Output

After some thought it was decided that the latter valve, if a really efficient one, used so that the full output wattage was obtained, would do the trick for all purposes where ordinary room strength was required.

It would not be sufficient for "loud moving-coil" strength, of course, and for those who want big punch with the same purity that this set will give (and it is of the highest order) a larger receiver will be needed, and will be described after the one we are now discussing.

Auto G.B.

The small valve, then, was decided on, and the decision carried with it a very definite advantage that we have not yet brought forward in any detail. The advantage that there need be no grid-bias battery; the valve could be auto-biased.

must work in perfect harmony with both ends. It must take the highly amplified impulses from the S.G. stage without difficulty, and it must pass on undistorted L.F. to the output valve.

Diode Detection

Power grid detection was cast aside as being too costly from the H.T. consumption point of view; ordinary leaky-grid rectification was tried with varying types of coupling circuits, but without completely satisfying the requirements. Finally, after much

Improving Selectivity

This we thought could, with suitable coils and careful choice of components, be made to operate in a very efficient manner, to give a high degree of selectivity with one stage of screened-grid amplification, and it would pass on to the L.F. side undistorted voltage variations over sensibly the whole of the required audio-frequency range.

There are very great advantages in using a diode of the description mentioned, as will be explained fully next month. Briefly, they include very low damping on the tuned grid coil (enabling very high selectivity and sensitivity to be obtained), and the rectifier carries out the task of rectification only, thus making it easier to stop any H.F. getting past into the L.F. end of the set, with the usual results fatal to purity of reproduction.

Exactly how the valve is used, and how many valves there are in the set,

we will leave till next month. This time we want to give but a brief outline of the set and what it will do.

SMALL HIGH-TENSION CURRENT

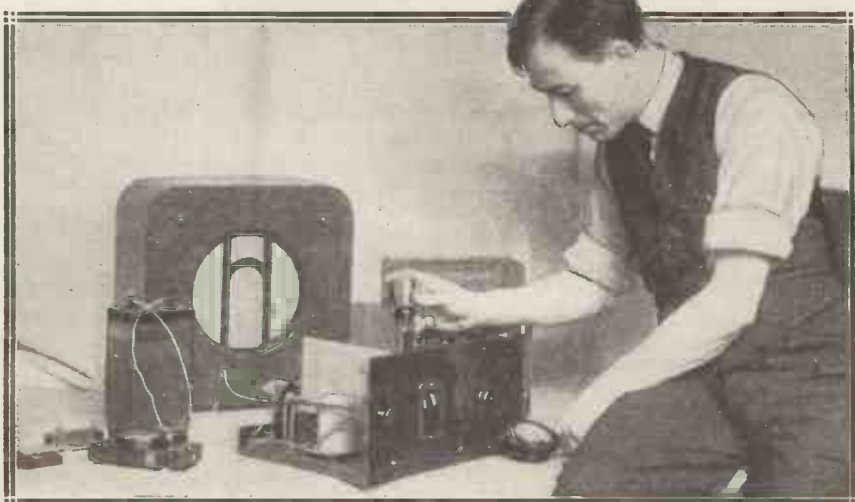

Normally, the bugbear of a powerful non-mains set is its voracious appetite for milliamps, that necessitates frequent visits to the radio shop for a battery renewal unless a mains unit is employed. Not so this set! As you see here, special trials to ensure economical H.T. consumption were an important part of the set's thorough testing.

Good Range

The frequency range covered (audio frequency) is, as said before, sensibly the whole range necessary for really high quality reproduction. The bass notes come through with a clarity and crispness that is astonishing, while the attack on the high notes is very

An Ode to the Diode!

noteworthy. In fact, the set is limited in its output quality only by the loudspeaker with which it is used.

A strong assertion, but a true one. It is a set that can justly be boasted about. It will give distorted results, but only when mishandled by reason of its being overloaded.

Its sensitivity is amazing. A matter of ten or a dozen stations can be picked up with the same amazing purity, and at a volume that needs reducing to prevent the output valve being overloaded, can be picked up any evening, while a large number of other transmissions are available at varying strengths, but all on the loudspeaker.

Easy Separation

The selectivity enables such stations as the Northern Regional and Langenberg to be separated (provided the set is not in the swamp area of the Northern), while at a distance of ten to twelve miles S.E. of the London stations, the spread of these stations is only a matter of a few degrees on the tuning dials (of which there are two).

And mentioning the controls, we must emphasise the fact that the operation of the set is extremely easy;

occasional adjustment, especially the input volume control.

A long series of experiments was undertaken (such is the thoroughness with which the set has been designed)

NO G.B. BATTERY



By a special circuit arrangement a negative voltage is automatically applied to the output valve, thus doing away with the necessity for a grid-bias battery. This is but one of the super refinements of this ultra-modern set.

to make absolutely sure that the leakage of H.F. from the rectifier to the L.F. stages was a minimum. And the minimum was below the limit of detection, as will be explained when

the constructional details of the set are given.

Follow the Layout

Layout plays a very big part in this, as does the choice of components, and it is strongly urged that those who build the set later on do not depart in any way from the layout shown in the wiring diagram and the photographs, nor from the list of components and their alternatives.

With regard to the layout, as many as five different sets were completely built after the "rough" hook-up stage had been passed, and experimented with before we felt assured that not only was the layout the best that could be achieved from a practical and theoretical point of view, but that it was such that it could be reasonably easily copied, by those who decided to make the set.

The layout is a most important point, and it must be correctly copied if the full success of which the set is capable is to be obtained in future models. But more of this next month.

On View at Olympia

The set, as you have read, is to be on view on the MODERN WIRELESS stand at Olympia from August 19th to 27th, and there will be experts in attendance all the time, who will be only too willing to explain any points of theory or practice that arise concerning the set.

The "Diodion" is a receiver that will surprise all who make it. We have absolutely no hesitation in recommending it to every battery set owner

(Continued on page 184.)

THE FINAL SURVEY

DETECTOR DISTORTION NON-EXISTENT



Everything is doubly checked—aurally and technically. Here is a vital test in process, a meter being included in the anode circuit of each valve, so that verification of the correct working of each in relation to the others may be carried out.

On the right is the final scrutinisation of the set as a whole, just to make sure it really is as near perfection as is humanly possible.

there are only the two drum controls for tuning (and these can be moved together), wave-change and on-off switches, and the input and output volume controls to be handled.

Naturally these latter only need



Missing Notes!

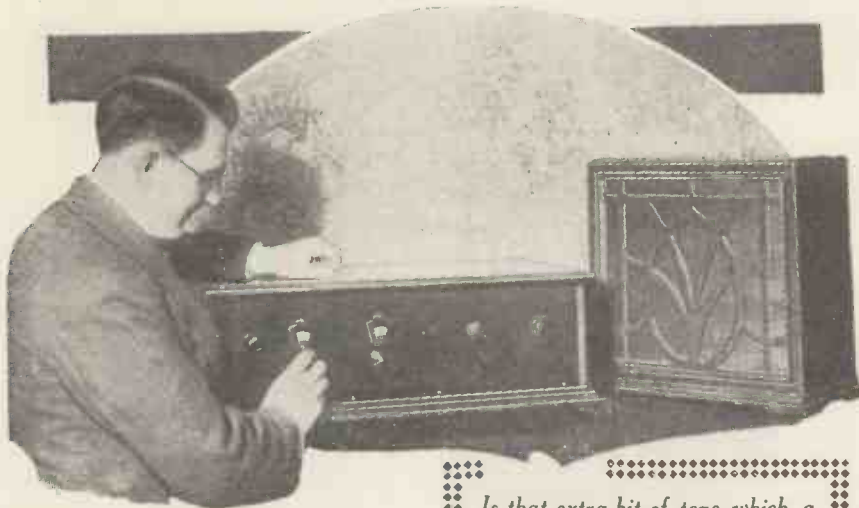

NOT so very long ago I had the opportunity of comparing the real thing in the way of an orchestral item with the received version as heard on two kinds of radio receiver.

I happened to possess the full orchestral score of a piece of music and had the knowledge that this would be used, note for note, by the broadcasting orchestra concerned.

An Elaborate Experiment

But previously, I must mention, I had followed the score through with a similar orchestra while sitting in the actual concert hall. Therefore, I knew exactly how it should sound, always remembering that slight differences occur in the individual performances of instrumentalists and the direction of different conductors.

I conducted the experiment on fairly elaborate lines, and had the two sets arranged with a change-over switch so that I could at once go from one to the other.

The first set was a straightforward three-valver built up with inexpensive components. It had an electro-magnetic speaker of the cheap cone type, and some 100 volts H.T. was employed in conjunction with ordinary two-volt valves.

A "Big" Set

The second set comprised an all-mains outfit using super-power valves capable of developing some two watts of "undistorted" power to feed a "senior" model moving-coil loud-speaker. But though you can style this a "big" set, it was by no means exceptional in its qualities. It has

Is that extra bit of tone which a big set gives to musical items really worth while? Or are listeners content so long as speech is clear and undistorted? This is the question interestingly discussed.

By H. A. R. BAXTER

its equal in almost any of those rather ambitious all-mains radio-grams to be found in many suburban homes.

Well, the item was announced and I switched over to set number one—the smaller and battery-driven outfit.

At first I listened critically for a few seconds without referring to the printed parts which I had laid out before me like a giant hand of cards.

It sounded quite good, but there was an absence of "depth," as though a medley of only four or five instruments was trying to do the work of the whole orchestra of about sixteen.

The Missing Piccolo

In the following passage I noted that a piccolo should have been active, but however intently I listened I could not detect it.

Some rhythmic work on the part of a double bass was audible only through the harmonics of the instrument, and these sounded thin and scratchy.

I then switched quickly over to the second and more powerful outfit, and at once noticed a marked difference.

The double-bass came into prominence and I could at times follow the various instruments operating on the treble with fair ease, though I must admit that it was difficult to separate them from the middle register.

I could take a single instrument

and follow it with no trouble at all by constant reference to its printed music, but to distinguish successively and quickly a whole series was not always so easy. But the volume level was up—mark that!

After this attempt at an analysis of the sounds coming through the moving-coil speaker, I again listened to both sets and asked myself this question: "Does the ordinary listener care two hoots about the individual instruments of an orchestra?"

He Doesn't Care!

I was forced to admit to myself that I did not think he did. So I asked myself this second question: "Does the ordinary listener usually worry about the finer shades of orchestration or care a hang who the conductor is?" I answered this, too, in the negative—still listening to my test piece.

My final question was: "What is the ordinary listener's criterion of quality in radio reproduction?"

I was sure about the answer to that, too. It is speech. He will judge a set's quality mainly by the intelligibility of the speech which it reproduces. As a secondary criterion he will take the loudness of the music the set can develop without running into strident harshnesses. He will very seldom feel the need of working his set to this limit.

Not Much In It

As a matter of fact, he will generally cut the volume down to a comparatively low level out of consideration for his neighbours! (In any case, who wants big volume in the house?)

I turned the volume control of the big set until its volume was approximately that of set number one. The bass dipped, and the "shallowness" of set number one was in some measure duplicated!

I compared the two sets at this similar volume level, and, frankly, I do not consider there was now much in it!

Running Too Loud

You see, one naturally expects more volume from a bigger set, and in a test one inevitably runs a set louder than one would for ordinary listening.

Judged purely on this basis, I feel sure the average listener would obtain as much satisfaction from set number one as he would from set number two, apart from the pride of possessing a larger and more handsome-looking instrument.

AT YOUR SERVICE

by

OUR TRADE COMMISSIONER



A Blue Spot Reduction

READERS will be glad to know that the famous Blue Spot loudspeaker unit, the 66K, has been authorised for sale at 15s.; a reduction of 10s.

Clarion Valves

Some little time ago, it may be remembered, a disastrous fire laid low the valve factory of the Clarion Valve Company, and since then strenuous efforts have been made by that concern to get going again. At last, after a great deal of perseverance, they have practically completed the re-equipment of the works, and by the time this appears on the bookstalls the Clarion valve will again be available on a full scale.

Battery-operated valves will be placed on the market first, followed by A.C. and then D.C. types.

National Radio Service Co.

Under the very highly trained and suspicious eye of Capt. P. P. Eckersley (late of the B.B.C., and the popular and well-known Radio Consultant-in-Chief of MODERN WIRELESS a company known as National Radio Services, Ltd., has been formed, with P.P.E. as chairman, to deal with the ever-increasing demand for some technical organisation capable of doing repair work on radio receivers.

Whether it be a straight repair or one of the worst type, the N.R.S. aim to have the plant, the men and the organisation to cope with it efficiently, economically and speedily.

The factory layout comprises what is said to be the only test panel of its type capable of finding any fault, and the cause of the fault, in a matter of minutes, and the only set of twenty-six benches so equipped that the repair can be carried out in the minimum time consistent with guaranteed work.

Here is some varied news of the trade that should interest all readers, whether or not they are connected with the radio industry. Manufacturers, dealers, home constructors and general readers are invited to send items of interest to be included under this heading.

The work can be carried out with the utmost dispatch because the organisation explained above, coupled with an extremely well-organised direct road transport system, makes safe re-delivery to any place in the British Isles a matter of only a day or so.

There are many readers who own expensive sets which are out of date and utterly incapable of coping with the demands of modern broadcasting. By slight reconstruction and the

addition of perhaps an S.G. circuit these can be brought up to date.

Similarly, the home constructor can have any set of components assembled for him if he will send a small sum to N.R.S., and the receiver returned to him in a guaranteed working order. A technical advice bureau is at the disposal of those requiring diagrams and explanatory notes on any radio query whatever.

For repairs a small charge of 5s. is made for the fault-finding test, an estimate then being sent to the owner of the set so no exorbitant charges can arise, and this figure is taken into consideration in the time charge for the repair on acceptance of the estimate.

Every set is cleaned well inside, the dials and knobs and cabinet polished and returned like new.

A SCENE IN "SCOTLAND YARD"

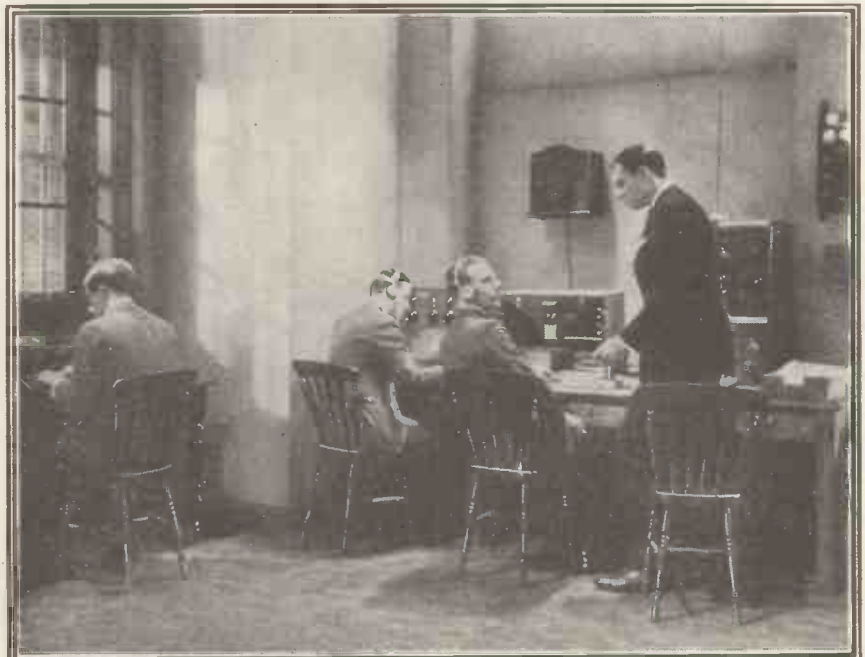

A reconstruction at the Beaconsfield Film Studios of the Radio Room at Scotland Yard. The scene is taken from the film "The Flying Squad," yet to be released, and readers will note the Marconiphone Model 64 speaker on the wall.

CHOOSING AN OUTPUT VALVE

By JEREMY GREY

Our contributor, who is an expert on all matters connected with valves, has some good advice to give readers on the choice of an output valve for their sets. He claims that much of the trouble experienced in obtaining good reproduction is due to the selection of a wrong type of valve for this important position, and his article should prove invaluable to many listeners.

THE more I come into contact with listeners' problems, the more I realise that nearly half the cases of poor reproduction are the result of incorrect selection of valves, and that of these the output stage is the one which most usually suffers.

Only Half a Truth

To a very great extent this is due to the loose nomenclature which has been built up in the radio industry. For example, we talk of three-electrode output valves as of either the "power" or "super-power" type, and jump to the conclusion, which seems obvious on the face of it, that a "power" valve will merely give small volume, and the "super-power" valve will of necessity give large volume.

This, however, is only a half-truth, and so appalling are the results which sometimes accompany the application of this erroneous rule that a little explanation seems worth while.

It must be remembered that several factors govern the output obtained from a valve.

Types Differ

In the first place, the output is limited by the signal voltage applied to the grid. Other things being equal, and provided the maximum signal input is not larger than the valve can handle without distortion, any increase in grid input will give a corresponding increase in output.

On the other hand, different types of valves differ in the strength of signal which they can handle without distortion.

The maximum *peak* value of grid

input signal may be taken as the maximum value of grid bias recommended by the maker.

HOW MUCH GRID-SWING?

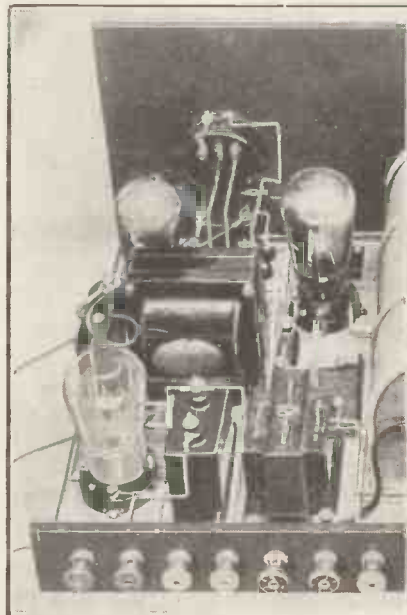

When deciding on the type of power valve to buy, consideration should be given to the valves preceding it, and the amount of grid-swing it will have to handle. The peak grid-swing that a certain valve will take without overloading can generally be taken as equal to the grid bias it requires under normal working conditions.

The second factor which affects the output is the amplification factor of the valve. Again, other things being equal, a valve with a high magnification factor will give a larger output for a given grid input than a valve with a smaller amplification factor.

High Amplification Factor

In general, output valves are designed to have lower amplification factors than early-stage valves, because sufficient *voltage* amplification usually takes place in earlier stages of a set. But, still, valves in the small output classes have fairly high mag. factors. For example, the P.M.2A. 2-volt valve is a 2-volt "power" valve with an amplification factor of 12.5, and the indirectly-heated A.C. valve type 104V., which originally had a mag. factor of 10, has now gone up to 12.

Such valves are designed to make the most of comparatively weak inputs of the order of 6 to 10 volts, and are the most suitable triode output valves for use in two-valve sets on account of their comparatively high sensitivity.

Internal Impedance

There is another property of a valve, however, which plays a big part in deciding its output; namely, the internal impedance.

Of two valves having equal mag. factors, and given equal grid inputs, the valve with the lower impedance will give the larger output. Now, in designing valves the requirements for high amplification factor are diametrically opposed to those for low impedance; the one calling for a close grid, and the other for an open-spaced grid. A high-mag. valve,

(Continued on page 181.)

Winston Churchill



..... "It is entirely contrary to the traditions of British political life to deny a reasonable measure of free speech to public men, even if they do not hold an official position" is the claim of Mr. Churchill in this outspoken interview with
OUR SPECIAL CORRESPONDENT.

consider this decision unreasonable. My broadcast to the United States on the same subject did nothing but good, and both His Majesty's Government and the Government of the United States subsequently adopted the proposal which I urged for a monetary conference in London.

"It is entirely contrary to the traditions of British political life to deny a reasonable measure of free speech to public men, even if they do not hold an official position.

"I have given thirty years of service to the House



Mr. Ramsay Macdonald's first radio broadcasts were not at all successful, but since then he has become so friendly with the microphone that his speeches are now looked forward to as being among the very best ever heard by radio.

PEOPLE with a grievance against the B.B.C. are not uncommon. But when the complaint comes from so prominent and august a personage as the Right Honourable Winston Churchill, ex-Chancellor of the Exchequer, and ex-goodness-knows-what-else, one wonders whether the B.B.C. attitude is unjustified.

I have just been down to Mr. Churchill's beautiful home in the folds of the hills of Kent, an ancient manor house, a beautiful place of unstained oak and varnished walls and rich Persian carpets, with no wireless set to disturb the tranquillity.

This is what he says about his controversy with the B.B.C. :

There's Always "Some Excuse"

"Whenever I have asked to be allowed to broadcast, some excuse has always been made to prevent me !"

Mr. Churchill is angry because the B.B.C. refused to allow him to broadcast his views on the world's monetary problem, which he offered to give without a fee.

"I stated that what I said would not in my opinion raise any party issue, nor would I say anything which might not be said without offence at a public dinner where representatives of all parties were assembled.

"I was informed in reply that in view of the imminence of the Lausanne Conference my offer was refused. I

of Commons and to the State, and it is very wrong that a persistent attempt should be made to prevent me from giving my counsel on great questions by means of the broadcast. Last year when I asked to speak about India the pretext of the approaching second Round Table Conference was put forward."

But the idea that the Government is afraid of any expression of opinion apart from that which it controls is really great nonsense.

Brought up a Barrage of Rhetoric

I have just been reading the correspondence that passed between Mr. Whitley, chairman of the B.B.C., and Mr. Churchill, when the latter offered to give an address about India—and this in spite of the fact that three other

—and the B.B.C.

speakers had already utilised the microphone to deal with aspects of the self-same question. Mr. Whitley refused Mr. Churchill's offer with perfect politeness, but Winston immediately brought up his barrage of rhetoric.

"The B.B.C. is trying to lull . . . the B.B.C. is trying to chloroform . . . the British people into a state of apathy . . ." and much more in the same vein.

Yet Mr. Churchill is not unknown to the microphone. Apart from that brief appeal in aid of a blind fund three years ago, he has frequently addressed listeners during outside broadcasts. There was that occasion when he gave a Rectorial address to the students of Edinburgh University.

"The Soul of British Life"

"Broadcasting seems a wonderful facility for public discussions exactly adapted to fill, or help to fill, the void—but were I to seek to use that instrument to discuss any of the great questions concerning the endurance of our



Empire, or the welfare of our people, I should be banned . . ." and so on.

Now Mr. Churchill is a very clever and notable man. There can be no doubt of that. But I suggest that about one thing he has a definite prejudice. Hear him a little further on the B.B.C. :

"It seems absolutely idiotic that political controversy should be kept off the wireless. Controversy is the soul of British life. We have grown great by it. We have arrived at a higher unity by controversy than has ever been arrived at in any country through a rigid and compulsory uniformity.

Competing with the Children's Hour

"I have a very practical suggestion to make. It is that one hour a night should be given to political and party controversy on the broadcasting, and that this hour



MASTERS OF THE MICROPHONE

Above is the Rt. Hon. J. H. Whitley, former Speaker of the House of Commons, now Chairman of the B.B.C. Board.

To the left is a characteristic portrait of Mr. Winston Churchill, facing the microphone, while below are three other political speakers, including the Postmaster-General, Sir Kingsley Wood (centre).



should be divided according to the strength of the parties in any given House of Commons. After all, we should only be in competition with the Children's Hour, and surely we have a right to that!"

There you have Winston Churchill's attitude to broadcasting. Meantime, the B.B.C. declares that it has nothing to say. Which is a pity. We have heard one side—now it is up to Sir John Reith to see that Mr. Churchill gets a definite answer.

About those Mains

THERE are a number of excellent gramophone drives on the market now. Some of the latest models are simplicity itself—they consist merely of a turntable, and can be fitted in a few minutes by the veriest novice.

Apart from the "universal" type of motor suitable for both A.C. and D.C. mains, there are two types of A.C. machines to choose from.

One is the purely *synchronous* type. It is so called because it must first be run into synchronism with the supply frequency. The usual procedure is to run the motor a little above normal speed, and, with the supply "on," let it fall into synchronism as the speed falls through normal.

A synchronous motor can run only at one speed—should the load become too heavy, say, by touching the turntable, it falls out of "step" and stops.

FOR RECTIFYING

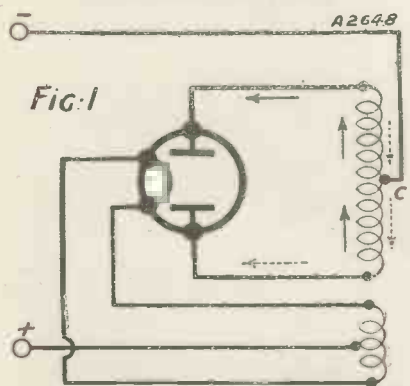

For full-wave valve rectification a centre-tapped transformer is necessary, it being connected up as shown in this diagram. The filament of the rectifying valve becomes H.T. positive, and the centre-tap of the high-voltage winding H.T. negative.

The second type is the *induction* motor. Its outstanding advantages are simplicity, and the fact that it is self-starting. There is no commutator or brushes to give trouble. The rotating part can even be of solid

By HANDEL REES, A.M.Inst.B.E.
Here are some useful hints concerning mains-driven radio receivers, and details of the advantages and disadvantages of the A.C. and D.C. types. Our contributor also gives a useful tip for telling whether a supply is alternating or direct current.

steel, since it is driven by currents induced by a rotating field.

Both these motors can be obtained either as separate units or in the form of a "disc drive"—a system of A.C. magnets acting on a turntable. Any of them can be relied upon to provide more than sufficient torque to play the heaviest recording without appreciable speed variation.

Mains Fluctuations

Trouble is experienced in many districts by heavy fluctuation in D.C. mains voltages. This is a point deserving of careful consideration by anyone contemplating an "all-mains" D.C. set.

On some 250-volt systems which are heavily overloaded, the pressure can be down to even less than 220 volts during hours of heavy load, and rise considerably beyond normal voltage during the "light" hours.

Such conditions are obviously serious where D.C. is used for filament heating. Various types of "thermal" resistances can be made to cope with small fluctuations, but where the pressure varies over wide limits it is advisable to defer purchasing a D.C. receiver until the supply companies can be induced to move in the matter of regularising pressure.

The Centre Tapping

When using a full-wave rectifying valve, a transformer with a centre-tapped secondary is required. The anodes are coupled to the "free" ends of the winding, while the centre tap forms the negative output terminal. (See Fig. 1.)

It is not essential to buy a new transformer if one with two secondaries of the correct voltage is available. The centre connection can be formed by joining the windings together. Care must, however, be taken to join the proper ends.

The voltages in the two windings must act in the *same* direction. Thus during opposite half-cycles the directions will be as indicated by the full and dotted lines in Fig. 1.

Fig. 2 (a) and (b) makes this clearer. If at a given instant the voltages are acting in the direction of the arrows, they will evidently be "additive" when the centre connection joins the *end* (e) of one winding to the *start* (s) of the other as in (a). Should two "ends" or "starts" be looped, as in (b), the voltages would be in direct opposition, i.e. the resultant voltages across the free ends would be in opposition.

A.C. or D.C. ?

The other day I came across the unusual case of a D.C. eliminator having been bought for A.C. mains.

USING TWO TRANSFORMERS

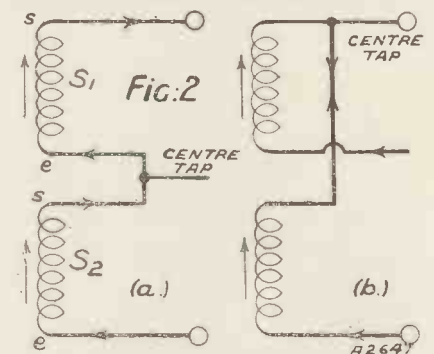

If a centre-tapped transformer is not available, and it is desired to obtain full-wave rectification, two separate single-wave transformers may be used. Care should be taken, however, to see that they are connected in the right sense, as at (a), and not as shown at (b).

Half the street was on D.C., while the rest had been changed over to A.C.

A call on the supply company would, of course, settle the matter at once, but a very simple test at the lamp switch will even save that trouble should anyone be in a similar position. Generally the meter has the letters "A.C." or "D.C." on the name plate, but, in any case, all that is necessary is to hold a 2-mfd. condenser across the terminals of one of the switches which is "off," taking care not to touch live parts, of course.

A.C. will flow through a condenser, so that the lamp will glow dimly. On a D.C. supply only a momentary current will flow on putting the condenser on, the lamp remaining "dark."

THAT PENETRATING WAVE

By G. H. DALY.

Canadian scientists, who have been conducting experiments, have proved conclusively that, while ordinary waves have no effect at all on the body, ultra-short waves may be used shortly for the curing of disease.

IN its time wireless has been blamed for wet weather, dry weather, mysterious explosions, coal-mine disasters, bad crops and most of the other misfortunes to which man is heir. It is quite natural, therefore, that some prominence should be given to the remark of a doctor that wireless is bad for the health. It was the sort of thing that was bound to be said sooner or later.

Making Investigations

As it happens, two Canadian scientists have just been investigating the effect of short wireless waves on living tissues, and in view of this it is interesting to see exactly how wireless waves might be expected to affect our health.

When wireless waves come in contact with ordinary matter they act according to the structure of the matter. For example, if they strike against a sheet of copper a certain percentage of the waves are reflected back in the same way that a lamp reflects light waves.

Another portion of the waves is transformed into minute currents on the surface of the copper, while yet another fraction is lost as heat. The waves do not penetrate through the copper.

No Opposition

This also applies to almost any metal conductor to a varying extent; it has the effect of stopping the waves.

Other materials, such as wood, glass, brick and plain stone, let the waves pass through them with but little hindrance. Thus on one hand we have matter which absolutely stops the waves, and, on the other, objects which let them pass freely.



Now, the body is a fairly good conductor of the ordinary electric current, as we know only too well should we touch a live wire. Hence, when the wireless waves strike the body the effect is probably half-way between the effect of the waves on striking a conductor like copper and an insulator like glass.

It Depends on Frequency

The lower-frequency waves will pass right through us, while the high-frequency vibrations will tend to be reflected or absorbed. That, at least, appears to be what happens.

However, owing to the fact that we are usually well earthed by having our feet on the ground, any currents which tend to hang around our person immediately pass away to earth.

In the case of a body which is in-

sulated from the earth by rubber boots, the rubber tyres of a car and so forth, a minute static charge of electricity is induced in the body, but this is due to the natural electricity in the atmosphere and has been with us since the world began.

Then, of course, it does not hurt us if we hold on to an object having a charge of ten thousand volts and hundreds of amps. provided we do not make a connection to earth. It is when we provide a path to earth for the current that the trouble starts.

Static Charges

A static charge does not affect us at all, and, as a matter of fact, the body can be charged to quite an appreciable extent, in the same way as the plate of a condenser, and no sensation whatsoever is experienced. Also, when a tram runs off the rails or develops a fault, as trams sometimes do, you are advised to keep your seat and not leave the tram.

This is because you may form part of the electrical circuit of the tram and your body is at high potential to the earth; when you step off the tram you would be likely to form a circuit between the high potential of the tram and earth, but you come to no harm so long as you remain on the tram, no matter how highly charged is your body.

Nothing to Fear

As far as the ordinary wireless waves which we meet in the street are concerned, we have nothing to fear whatsoever. It is different, however, in the laboratory, where it is possible to create ultra-short waves of great intensity.

From recent investigation it would appear that ultra-short wireless waves may have surgical and medical possibilities in the same direction as X or radium rays.

HIS IS A LIGHT TASK!



Mr. John Bellamy Taylor, of Schenectady, doesn't think much of wireless. He has just perfected the apparatus seen here which will send human speech on a beam of light. His invention opens up great possibilities for secret communication between aeroplanes and the ground, or ships and the shore.

A Triumph of Modern Wireless—

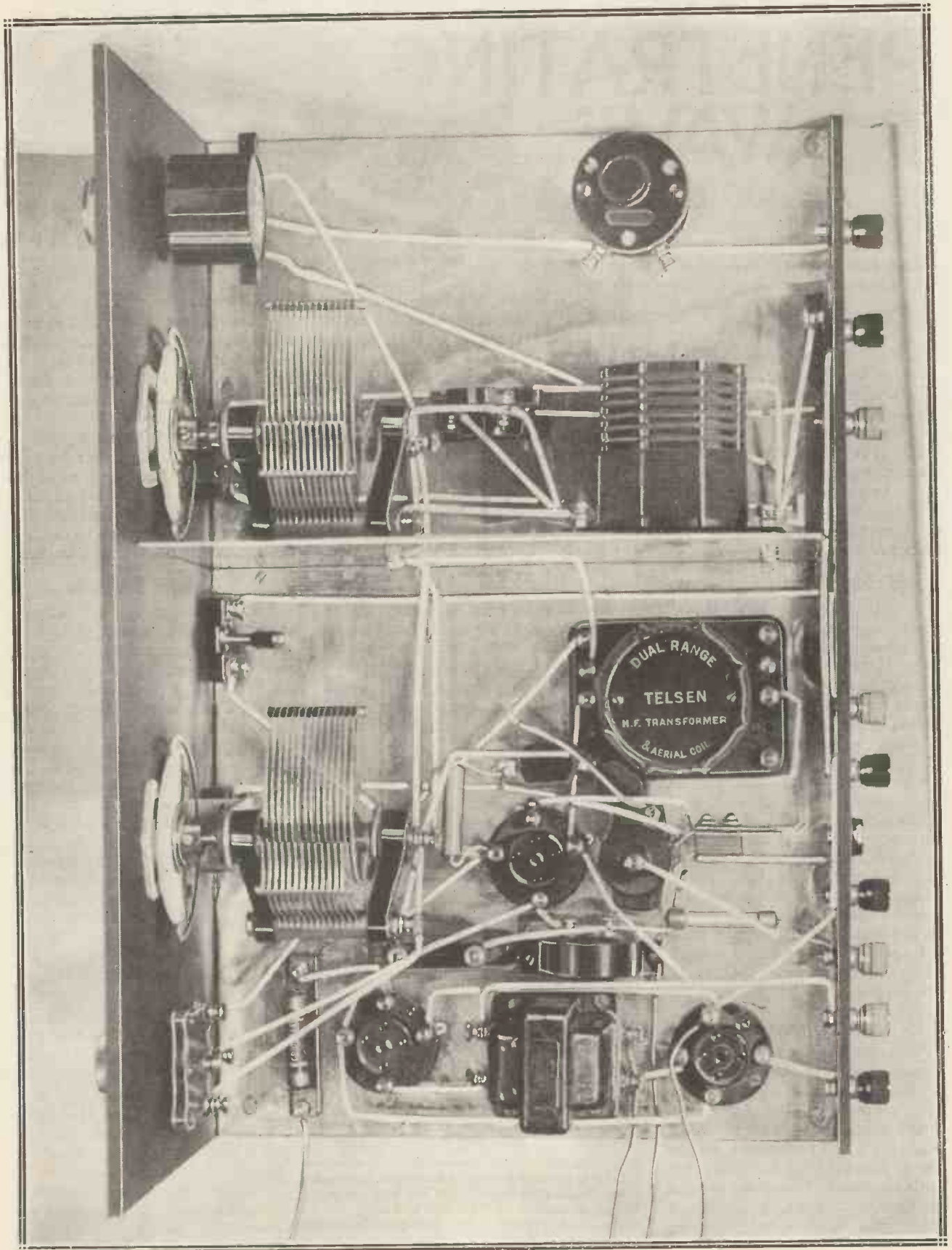

THE "FIVE-GRID" FOUR

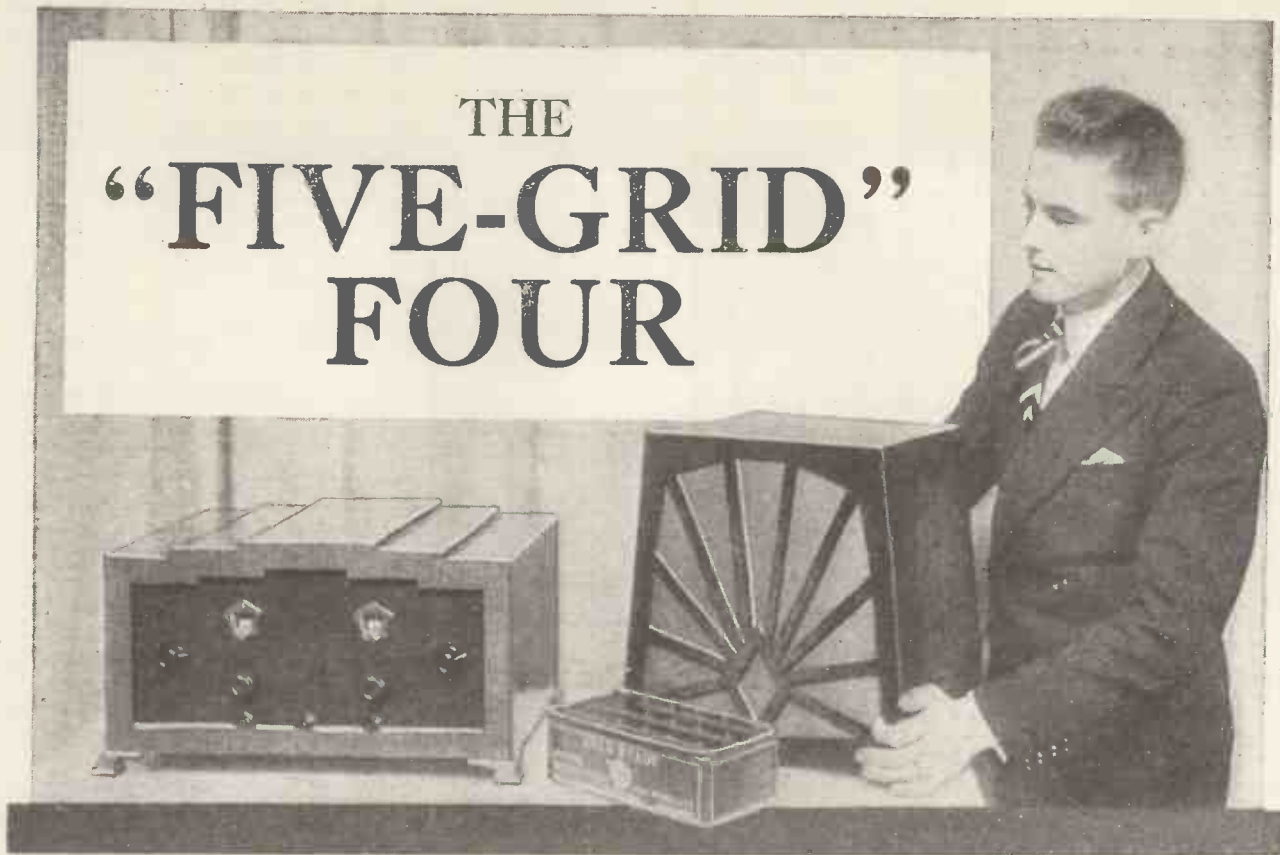

Designed and Described by the "M.W." Research Dept.

FIVE Grids! But what a difference the extra one makes to results when it is the screening-grid of an S.G. valve! Distant stations which would otherwise whisper attain real entertainment value; and the local station, even if you live a long way from it, comes through with such pep that one hurries to adjust the volume control before the loudspeaker "goes up in smoke."

"... adjust the volume control!" What difficulties that necessary process can produce if the design of the circuit is not just as it should be? Take the following case—which is quite a typical one.

Avoiding Distortion

There is not a single flick of the milliammeter needle, and yet the quality is—well, to say the least, it just *isn't* quality! And cutting down volume by means of the potentiometer across the secondary of the L.F. transformer doesn't seem to make matters any better either.

These are symptoms that continually puzzle set users, and the cause of all the trouble is placing just a little too much importance on the absence of kicks from the milliammeter needle. (We are assuming, of

course, that the meter is connected in the anode circuit of the last valve.)

While showing very definitely whether the output valve is being overloaded or not, such a meter will not necessarily indicate when a "spot too much" is getting on to the grids of preceding valves. It is

A LOGICAL RECEIVER

Every point in the design of this four-valve set—an S.G., Det. and 2 L.F.—has been chosen only after careful reasoning and the weighing-up of all the pros and cons of the various schemes available. It is a set in which every confidence may be placed, because the circuit is the logical outcome of scientific consideration of the end in view.

a question of the type of circuit in use, and the sensitivity of the particular meter.

But there is one thing that all this does indicate very clearly. That with a powerful multi-valve set, controlling the volume applied to the last valve only is not always the best of schemes.

Pre-detector volume control is wanted. And, while one is about it,

it may as well be pre-H.F. control, because it is quite a common occurrence for a powerful local to overload an S.G. H.F. stage.

And that brings us to the question of the best method of controlling volume to apply to the screened-grid valve. This matter at the same time raises the point of valve noises.

Controlling Volume

It is often put forward that the best way to provide pre-detector volume control is to make the S.G. valve less sensitive, and thus control the power it is able to pass on to the detector. It is claimed that this decrease in efficiency has the effect of decreasing at the same time what is known as valve noise.

"Valve noise" is supposed to be the "hissy" background noise heard in the loudspeaker when much amplification is in use. But too much importance is often given to this so-called valve noise.

It is stated to be due to microscopic variations in a valve while it is working, but if the aerial and earth are removed from a powerful set that is reckoned to be producing valve noise, in most cases quite a lot of this "red herring" will go! Extraneous noises picked up from the

ether are too often confused with valve noises.

Because of this, and because the reduction of sensitivity in most cases leaves the S.G. valve open to being

it is applied, and this enables the two stations to be received clear of one another.

Such reasoning led up to the method of controlling volume that is

If it were it would not be capable of giving the fine results that it does, either where quality or distance is concerned. We should like to go into the reasons that lie behind everything else, but unfortunately space will not permit of that, for simple though the diagrams by themselves make the construction, we should like to make it even simpler by a few hints.

SYMMETRICAL LAYOUT—EASY OPERATION

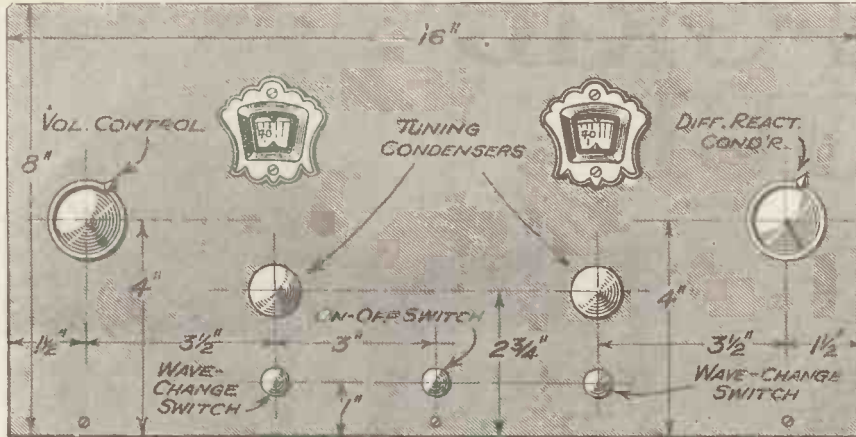

Artistically balanced front-of-panel layouts are often obtained only at the expense of efficiency behind them. Not so here! In fact, the very simplicity greatly assists in obtaining the effective baseboard arrangement.

more easily overloaded, the reduced sensitivity method of volume-controlling is by no means always desirable as an input control.

One Exception

There is one exception to be mentioned, and that is the case of the variable- μ valve. But here there is a different drawback altogether: that of the need for an extra and high-voltage grid-bias battery, as well as other smaller drawbacks.

So the most effective, simple and convenient method to control the input immediately after the aerial connection is to use a high-resistance potentiometer. The aerial is taken to the slider and the ends of the resistance of the potentiometer are joined across the aerial winding of the first coil.

As the slider is moved along the resistance, so the volume is varied; it being at its maximum when the slider is at the "top" or high-potential end of the winding. The resistance value chosen must be such as not to occasion any appreciable damping so far as the aerial winding is concerned.

Improved Selectivity

There is another important advantage also. When two strong stations interfere with one another they can often be separated by reducing the volume with the volume control, and then bringing it up again by means of the reaction condenser.

The use of reaction sharpens up the tuning of the circuit to which

utilised in the "Five-Grid" Four, and serves as a good illustration of the amount of thought that has been lavished on the design of the set. Similar thought lies behind all other points of the design, so although the circuit may look straightforward, the set is decidedly *not* "just another 'four.'"

Choice of Components

You will find that there are quite a large number of alternatives given in the list of components. As the set is not at all cramped there is room for most makes of good components, enabling us to give these alternatives.

Note that the two wave-change switches are of different types. One (that which is mounted on the panel under the H.F. tuning condenser) is of the three-spring type. The other is an ordinary two-spring "on-off" switch similar to that used for switching the set on and off.

When drilling the panel you will have to cut two "odd" shaped holes for the escutcheons through which the dials of the condensers are viewed. In spite of all that has been written about drilling a row of small holes, etc., for such a job, the

REPRODUCES RECORDS REALISTICALLY

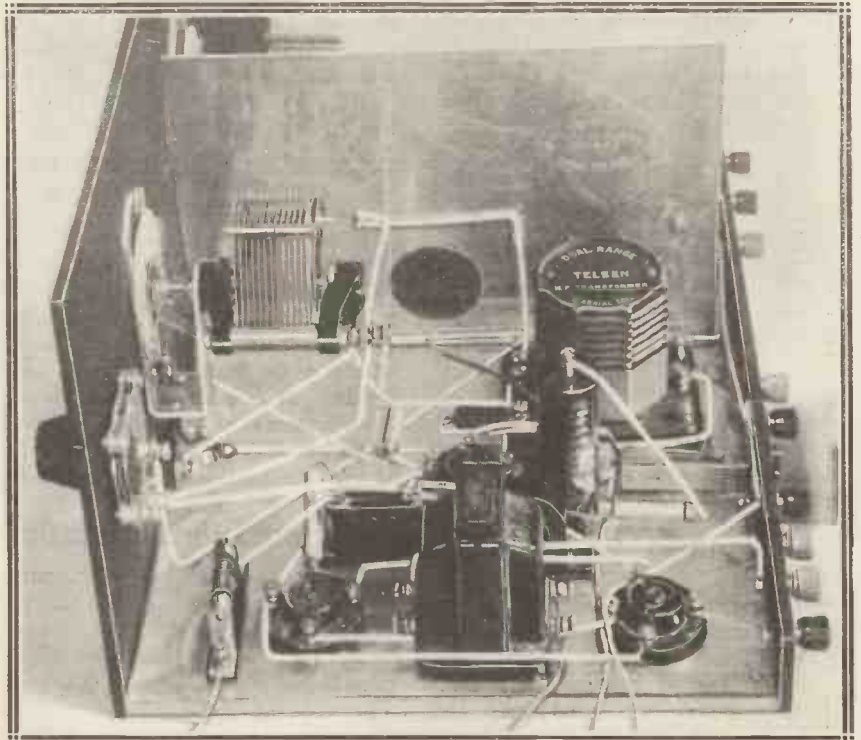

Not the least of the set's achievements is its ability to reproduce your gramophone records electrically, thus bringing out their finer points in a manner never to be heard on ordinary acoustic gramophones. The jack into which the pick-up plug is inserted can be seen on the terminal strip.

An S.G. Valve to Ensure H.F. Efficiency

best thing with which to tackle it is a fretsaw.

If you haven't got one, it is worth buying. They are cheap and one will save you no end of trouble before you have had it very long.

Previous to mounting any of the components that go on the baseboard, the latter must be covered with the copper foil. A small brad or tack at each corner will be sufficient anchorage, as the components themselves help to hold it in place when they are screwed down.

This copper foil is earthed via the vertical screen. For this reason it is necessary to see that the bottom of

the vertical screen and the part of the copper foil with which it makes contact are quite bright before the vertical screen is fixed in place.

Mounted Horizontally

The position of the hole for the S.G. valve to pass through the vertical screen can be gauged from the wiring diagram by means of the scale printed thereon. About 1½ in. in diameter will be O.K., and the height up from the baseboard is naturally dependent upon the make of valve holder employed.

The cutting of this hole will present no difficulties if you once

again make use of that fretsaw. You may perhaps break a blade or two in the process, but, then, blades are very cheap! On the other hand, if you order the screen specifically for this receiver the hole should already have been cut for you.

If you are quite sure you will not want to use a gramophone pick-up with the set you can quite easily omit the jack on the terminal strip. The alterations necessary in the wiring are very simple, but will be given later.

Note how three of the small fixed condensers are mounted. Those in question are the .0003-mfd. one that is attached to the earth terminal, and

FROM COMPONENT LIST TO COMPLETED SET

PANEL

16 x 8 in. (Peto-Scott, Permeol, Becol, Wearite, Ready Radio).

CABINET

To fit above, with baseboard 16 x 10 in. (Camco, Peto-Scott, Pickett, Osborn, Gilbert, Ready Radio).

VARIABLE CONDENSERS

2 .0005-mfd. (Ormond type No. 4 log, Polar, J.B.).

2 Disc drives for same (Ormond, etc.).

1 .0003-mfd. max. compression (Lewcos, Goltone, Polar, Telsen, Sovereign, Formo).

1 .0003-mfd. differential reaction (Ready Radio, Telsen, Lissen, Polar, Lotus, J.B., C y l d o n, G r a h a m Farish).

COILS AND CHOKES

2 Cosmic dual-range coils (Telsen H.F. transformers, Wearite, Lewcos, Ready Radio, Sovereign, Peto-Scott).

1 Flat-type H.F. choke, to be mounted vertically (Lissen, Telsen, Igranic).

1 Vertical-type H.F. choke (Peto-Scott Standard, Lewcos, Lissen, Ready Radio, Sovereign, R.L., Tunewell, Varley).

L.F. TRANSFORMER

1 Medium ratio (Lissen Hypernik, R.I. Hyperlite or Hypermu, Varley Niclet or Ncoore, Ferranti A.F.10, Telsen Ace, Lotus, Tunewell).

RESISTANCES

1 2-meg. grid leak with terminals or with tags (Lissen, Dubilier, Graham Farish, Igranic).

1 .25-meg. leak (Telsen, Ready Radio, etc.).

1 Grid-leak holder (Ready Radio, etc.).

1 .5-meg. grid leak, with terminals or tags

(Lissen, etc.).

1 100,000-ohm resistance (Dubilier 1-watt, Graham Farish Ohmite).

1 10,000-ohm potentiometer (Wearite, Colvern, Watmel, Lissen, Varley).

FIXED CONDENSERS

1 .01-mfd. (T.C.C., Lissen, Telsen, Magnum, Ferranti, Dubilier, Igranic, Sovereign, Graham Farish).

1 .0001-mfd. (Dubilier type 670, T.C.C. type M).

2 .0003-mfd. (Dubilier type 670, T.C.C. type M).

SWITCHES

1 3-point push-pull (Ready Radio, Telsen, Bulgin, Goltone, Wearite, Lissen).

2 2-point push-pull (Ready Radio, etc.).

VALVE HOLDERS

1 Horizontal type for S.G. valve (W.B., Telsen, Lissen).

3 Ordinary 4-pin type (W.B., Lissen, Telsen, Graham Farish, Wearite, Igranic, Clix, Bulgin).

MISCELLANEOUS

9 Indicating terminals (Bulgin, Belling-Lee, Clix, Igranic).

1 Pick-up jack (Igranic type P.62).

1 Screen, 10 x 6 in.

Sheet of copper foil, 16 x 10 in.

Terminal strip, 16 x 1½ in.

Battery plugs, etc. (Belling-Lee, Clix, Bulgin, Igranic).

18-gauge copper wire and sleeving (Wearite).

ATTRACTIVELY FUTURISTIC IN APPEARANCE

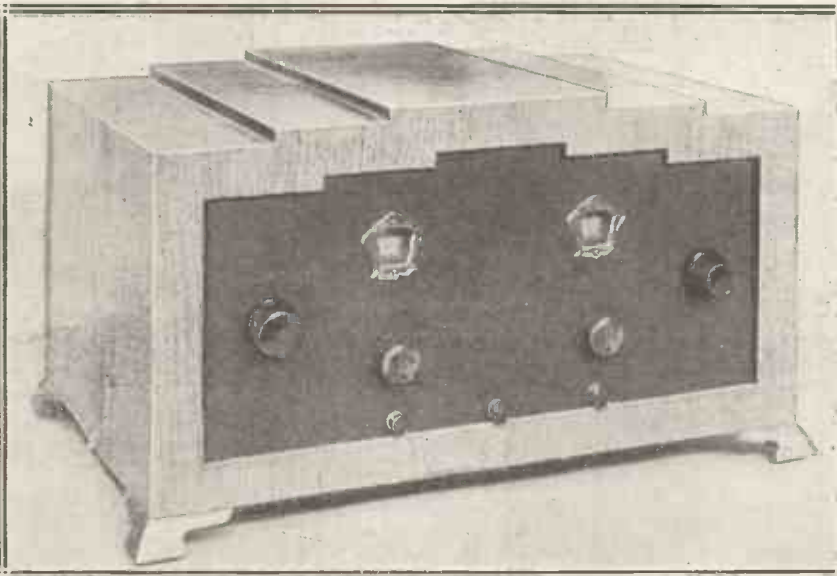

While it greatly enhances the appearance of the receiver, it is not imperative that this style of cabinet-work be employed. If you prefer, an ordinary style of case can be used to house the set.

ACCESSORIES:

Loudspeakers. Epoch, Celestion, R. & A., B.T.H., H.M.V., Marconiphone, Blue Spot.

Valves. S.G.: Marconi S.21, Mullard P.M.12A., Cossor 220S.G., Osram S.21, Mazda S.215B., Six-Sixty 215S.G., Tungram S.210, Lissen S.G.215, Eta B.Y.6.

Det.: Cossor 210Det., Mullard P.M.1H.L., Mazda H.L.2, Osram H.L.2,

Marconi H.L.2, Six-Sixty 210H.L., Tungram H.210, Eta B.Y.1814.

L.F.: Marconi L.2B., Mullard P.M.1L.F., Mazda L.210, Six-Sixty 210L.F., Cossor 210L.F., Tungram L.210, Lissen L.210.

Output: Mazda 220A., Mullard P.M.202, Marconi P.2, Osram P.2, Cossor 230X.P., Six-Sixty S.P.220, Tungram S.P.230, Lissen P.X.240, Eta B.W.303. (Smaller output valves

may be used to reduce H.T. current.) Batteries. H.T. (Super power, 120 to 150 volts; with dry batteries it is best to use the smaller type of output valve): Lissen, Ever Ready, Drydex, Oldham, Pertrix.

G.B. (to suit output valve): Ever Ready, Lissen, Drydex, Oldham, Pertrix.

L.T.: Exide, Oldham, Pertrix, Lissen. Mains Units. To give .30 milliamps. at 120 volts, (Hayberd, R.I.).

THE WIRING WON'T WORRY YOU

On this page you will find all the necessary details for wiring up the receiver. Just follow the diagram carefully, point by point, and you will have the wiring finished before you realise it. In the circle, to the right, is a close-up picture of the pick-up jack, to which there are only three connections, so you will have no difficulty in getting this correctly wired up at the first shot.

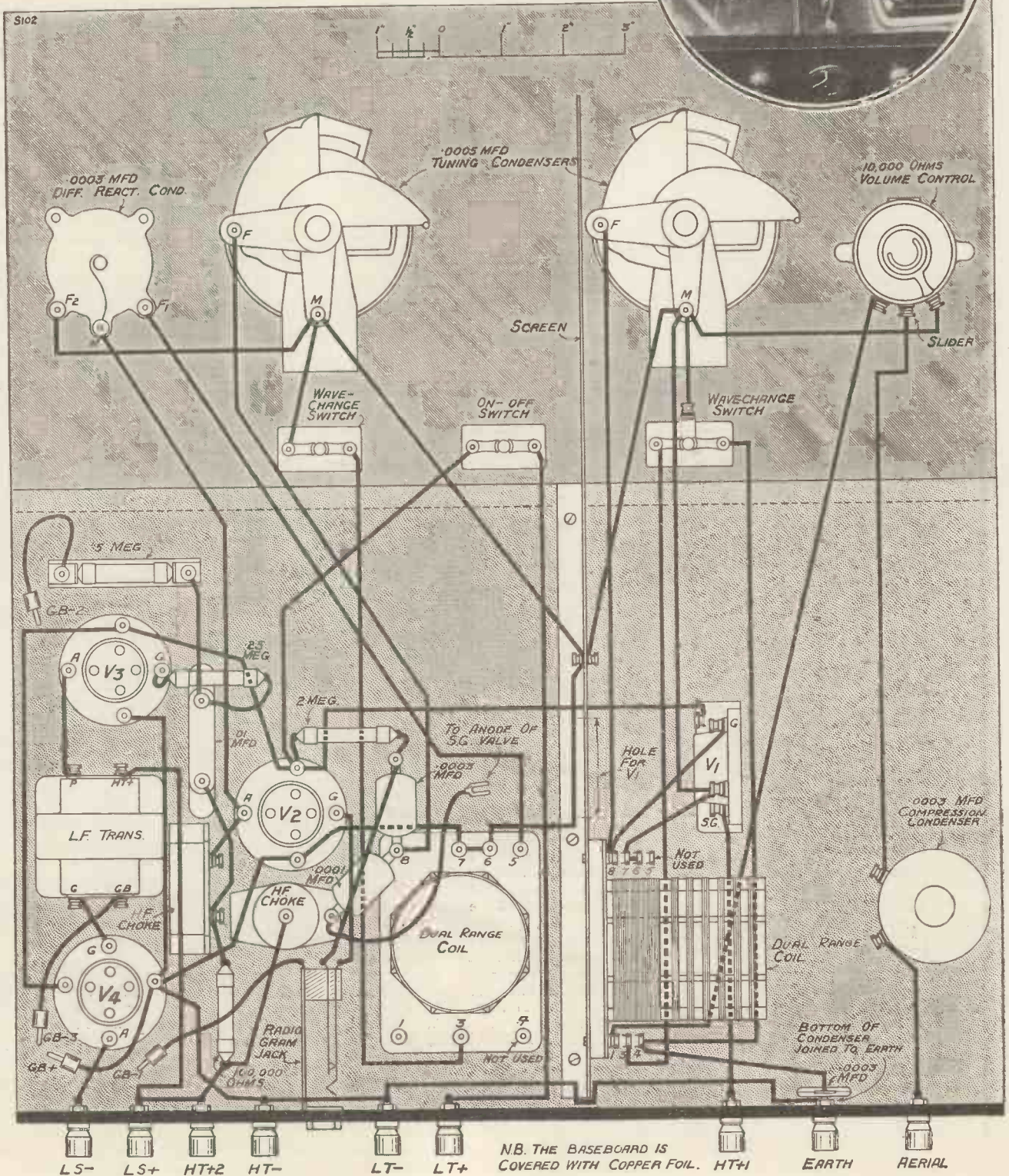
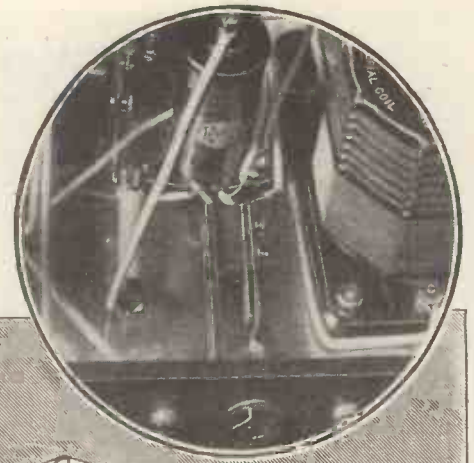

It Will Stand the Closest Criticism

the two that are secured to terminal No. 8 on the second dual-range coil, one of these is a .0001-mfd. and the other another .0003-mfd.

These condensers are provided with soldering lugs with a hole in them so that the lug may be fixed under a terminal screw just like an ordinary connection. This does away with the necessity for a wire to connect up one end of these condensers.

Efficient Lay-out

Actually, in the case of the .0001 joined to terminal No. 8 on the second coil, both ends are thus connected. The other end goes to one side of the H.F. choke.

Incidentally, this method has the advantage of greatly assisting the avoidance of losses due to long connecting leads.

Don't try, by crowding up the L.F. end of the set, to make room for the

grid-bias battery to stand on the baseboard. This battery should be fixed on the side of the cabinet, where it will be more convenient to get at than if it were down on the baseboard. Naturally, "the side of the cabinet" means on the inside of the side.

And now for the wiring. Due to the presence of the copper foil that has been placed over the baseboard, it is not advisable to make use of bare wire. Use some form of insulated connecting material.

Run the various connections from the same points as those to which they go in the wiring diagram. Don't make variations in this connection, even when the points chosen are joined by metal to the points used in the original.

The reason for this warning is because the wires have been carefully arranged so that the screening is not

common to two of the oscillatory circuits—a condition which might lead to trouble from instability.

Mention has already been made of the fixed condensers that are connected direct to terminal screws, but you may be a little puzzled as to the use of the .0003-mfd. one that is joined on the one side to the earth terminal and connected on the other side to terminal No. 4 on the first dual-range coil. Its object is to prevent break-through from a medium-wave station while the set is in operation on the long waves.

Preventing Break-Through

You will see from the circuit diagram that it is connected across the long-wave section of the primary of the first coil. The effect of so tuning this section of the coil is to make it reject the interference of the medium-wave station.

Six Signs of Scientific Selectivity

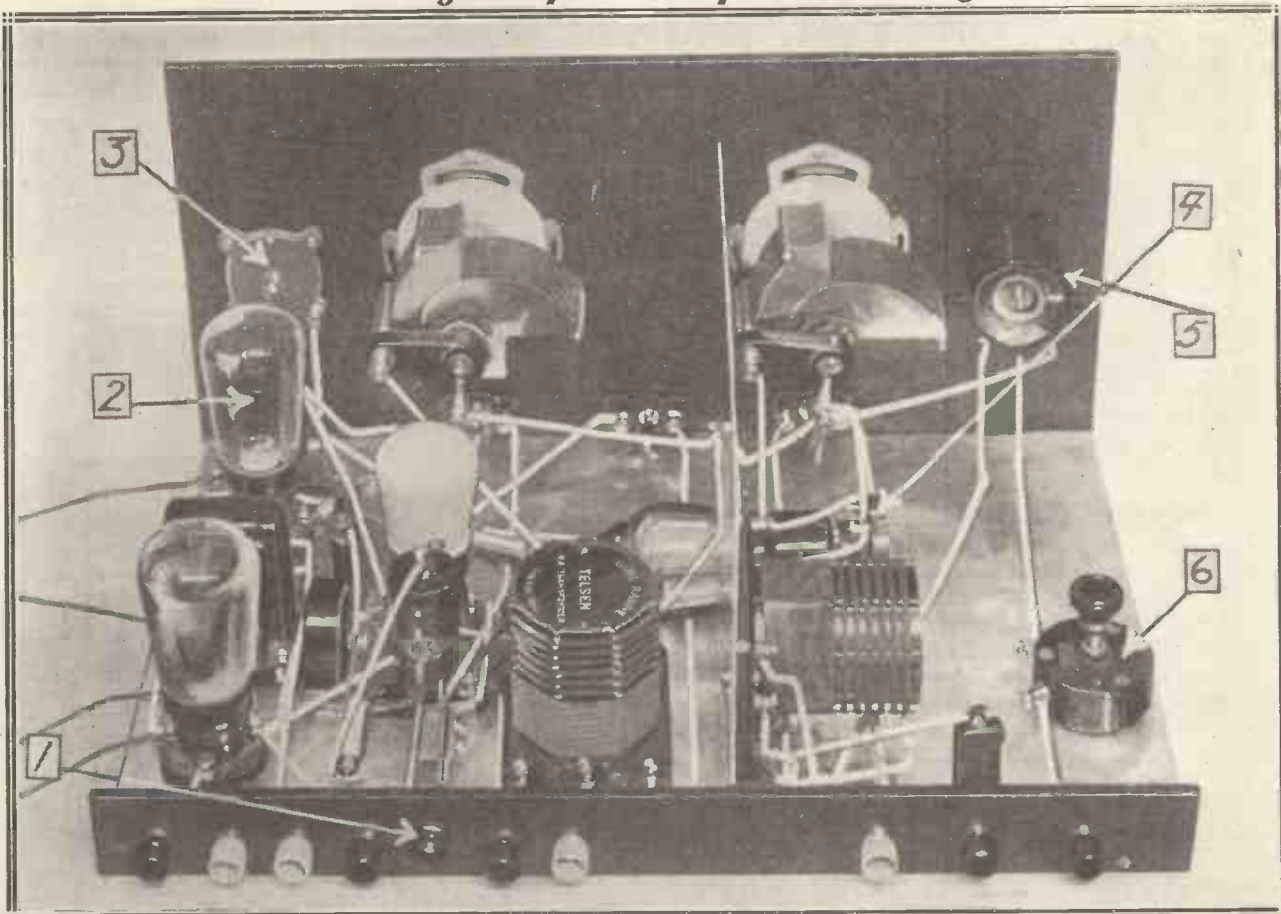

With the "Five-Grid" Four you can always select a programme to suit your tastes. Even if there seems to be nothing suitable in the ether, you can play records by simply connecting a pick-up to the jack marked (1). The first L.F. valve (2), by ensuring ample mag., enables selectivity to be increased when desired by increasing reaction with the condenser (3) and reducing volume on the potentiometer (5); (4) indicates the S.G. valve and holder, which, like (6), the series aerial condenser, is largely responsible for the overall selectivity of the receiver.

Uses a Well-Tried and Successful Tuning Scheme

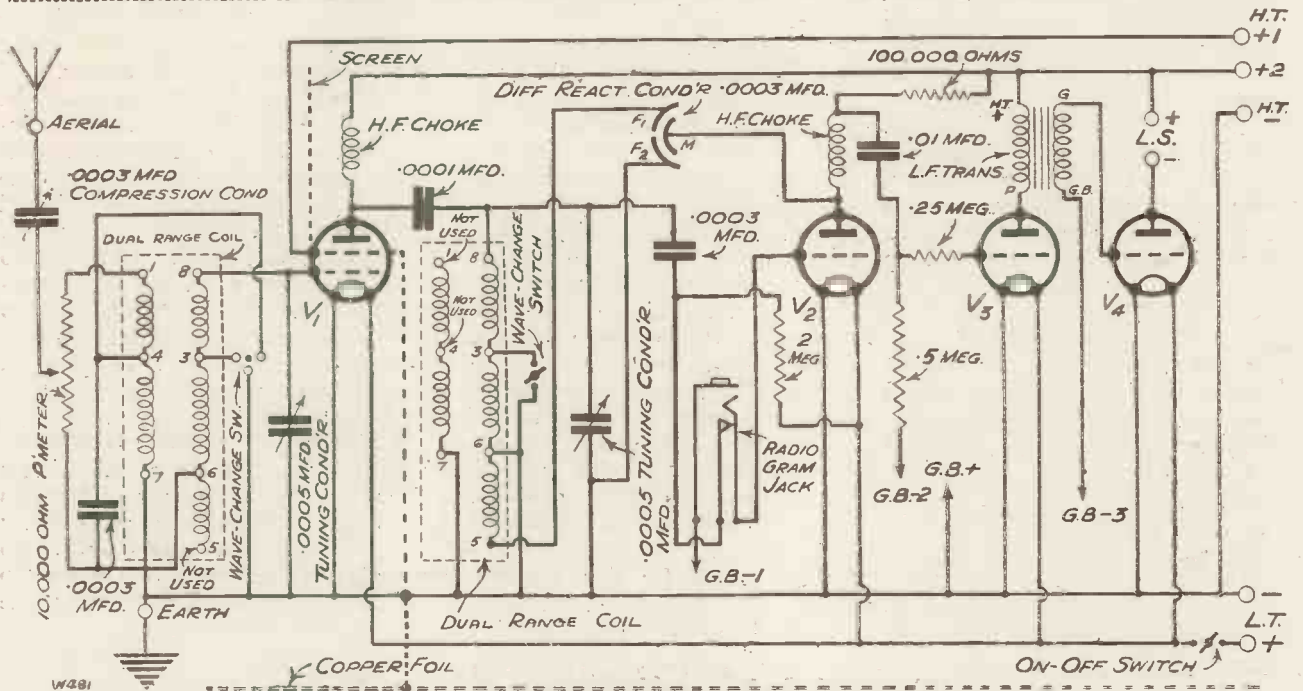

DUAL-RANGE COILS—DIFFERENTIAL REACTION—INPUT VOLUME CONTROL

The circuit is designed for sheer reliability and efficiency, and is consequently largely composed of schemes that have proved again and again to be worthy of the trust placed in them. There is not a single point where any doubts about the efficiency of the method employed could be raised.

We have already mentioned that the gramophone jack can be omitted if desired. The difference in the wiring necessary is as follows:

Omit the three leads that go to the three springs on the jack. Then connect the grid terminal of the detector valve holder to the side of the 0.0003-mfd. grid condenser that goes to one side of the grid leak. That is all; but don't leave out this component unless you are absolutely positive you will never, never want to use it.

Saving Shorts

See that none of the soldering tags on the components come into contact with the copper foil. Also take care to keep the connections to the reaction condenser and volume control the right way round so far as the outside terminals are concerned.

Otherwise you will find these components working backwards when you come to tune the set. A final point in connection with the wiring is to warn you to keep the wires on the ends of the 2-megohm grid leak and 100,000 detector decoupling resistance clear of the baseboard as they are not insulated in any way.

And now for the operation. Those of you who have had multi-valve sets previously will find it all plain

sailing. But don't forget the use of the volume control in conjunction with the reaction condenser to improve selectivity, in the manner described at the beginning of the article.

For the benefit of those who are not used to handling elaborate receivers, we will go over the use of the controls. As a start there is the
(Continued on page 180.)

BISECTED BY A SCREEN

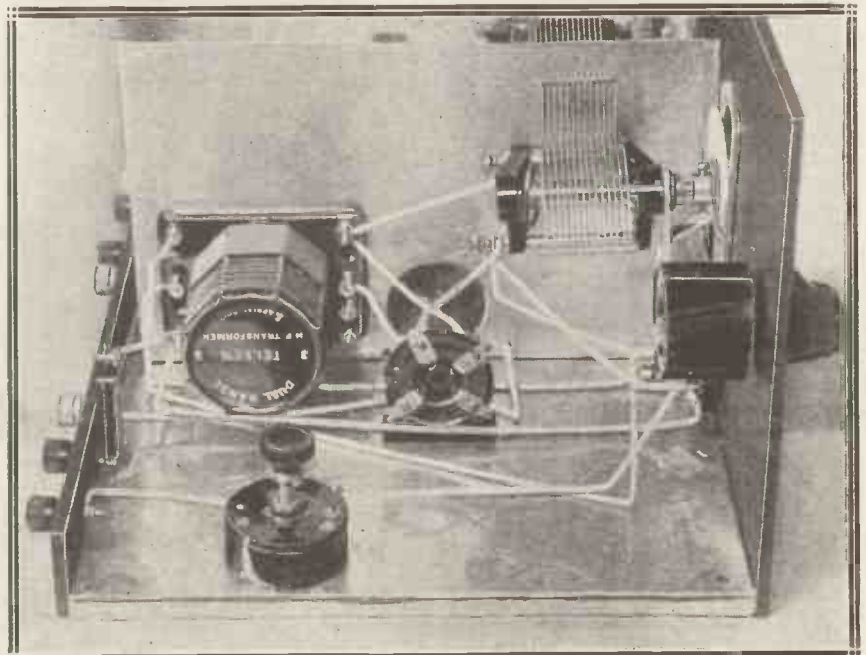

The vertical screen literally cuts the high-frequency part of the set in two. On the one side are to be found the aerial circuit and grid circuit of the H.F. valve, while on the other is the anode tuning and the S.G.-to-detector coupling.

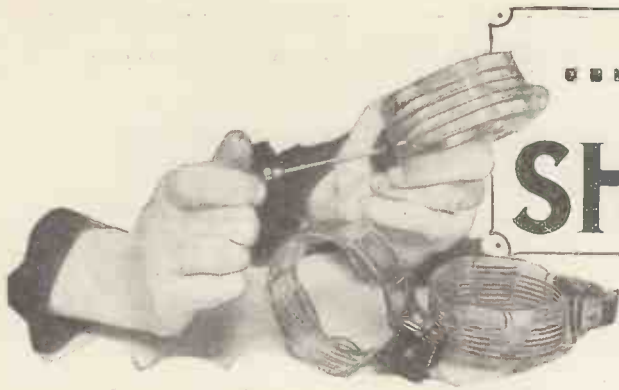

... ON THE ... SHORT WAVES

By W.L.S.

This month our contributor talks about the fascination of short-wave listening, and the vast amount of pleasure to be obtained from "Towing the World" on the higher frequencies. He also relates his experiences while carrying out experiments on the newly-popular 5-metre waveband.

ENTHUSIASM about short-wave work is running so high just now, in spite of the endless spell of poor conditions, that I am beginning to wonder just what it is that makes the short-wave "fan" so desperately keen. Of course, there *may* be cases of people who take up short-wave work for a while and then give it up in disgust, but I never hear of them.

Most of the folk I know who have turned from rather mildly interested broadcast listeners into wildly enthusiastic short-wave DX-hunters just seem to have been "bitten by the short-wave bug," the effects of which are severe and generally permanent.

I should like to circulate a questionnaire to all the regular readers of these notes, worded on the following lines: "Do you continue to be a keen short-wave experimenter because of (a) the additional difficulties attendant upon short-wave work, or (b) the fact that there is more scope for experimenting with receivers than on the broadcast bands, or (c) because the mere thrill of receiving really long-distance stuff attracts you?"

The reason, in most cases, is surely one of these three.

"Short-Wave Dog-Fight"

Under this "snappy" title the "dailies" have been making much of the case of the retired clergyman in South Africa who has been broadcasting his teaching from a high-powered station. All the amateurs of the world, says the scare press, are combining to suppress these transmissions!

The facts of the matter are, of course, that the gentleman concerned, doubtless with the highest ideals in view, has been mistaken enough to appropriate the narrow amateur 40-metre band for a service that is not "amateur" in any sense of the word. Legitimate amateurs—quite rightly—have been voicing their objections to the presence of a 500-watt broadcast-

ing station in their midst, and in no uncertain terms.

The South African "hams" apparently delivered an ultimatum to the effect that unless the talks are limited to two minutes they will *all* tune their 50-watt transmitters to the gentleman's wavelength, and by a combined effort compel him to shift to a cooler spot than the amateur's own property—the 40-metre band.

Some Real "DX"

A letter from a regular reader in New Zealand makes me wonder whether we have any right to boast

about our feats of reception over here. This man, "A.A.H.," who lives, rather appropriately, in "Bay of Plenty," receives regularly all the European broadcast stations that we receive ourselves, as well as pretty nearly everything else that is going.

For instance, does it strike you as good to receive, out in N.Z., two-way 'phone contacts between the airports and three 'planes bound from New York to Chicago, Seattle and San Francisco?

"A.A.H." also mentions two locals that we never seem to hear of over here, namely, Wellington (ZL2AX)

on 49.54 metres, and Melbourne (VK3LR) on 51.72 metres. Personally, I don't feel like looking "A.A.H." in the face again until I have heard both of them! He would like to correspond with home readers, if they will write to A. A. Hassan, Oatkiri, Bay of Plenty, N.Z.

On the 5-Metre Band

Amateur 5-metre work is now becoming really interesting. Crowds of "hams" who are sickening of the interference and dull conditions on the other bands are turning their attention to "five," and find that they get as much of a thrill from it as if they had started radio all over again. I am one of them, so that I speak from experience.

A FAIR RADIO OPERATOR



This young lady is a radio operator at one of the ground stations that are used for communicating with regular airliners in the United States. She is the only woman to be employed for this class of work. In this photograph she is shown instructing students from one of the big radio schools.

Receivers, transmitters, and general operating technique are so completely different on "five" from any of the other bands that one feels that radio is becoming interesting again. If any amateurs who find themselves becoming blasé about DX work happen to read this, let them get busy on this newest band of all.

Up to the present I have not succeeded in pushing my telephony signals farther than four miles on this band, but that is partly because the only other active stations near me are over the top of a hill. When

24 and 32 metres on Tuesdays and Thursdays from 9 till 11.30 p.m., and on Sundays from 3.30 till 5 p.m.

VE9GW, Bowmanville, Canada (rather an old favourite of mine), will be on with increased power and improved gear on 49.22 metres by the time these notes appear. TGX, Guatemala City, will be on irregularly on 33.5 metres, probably from 2 till 5 a.m. Here's a chance for the "night owls," particularly as the station does not yet seem to have been heard over here.

CE3AC, an amateur in Santiago,

a wide sweep with your condenser that the 200-500-metre band occupied the bottom five degrees, the 900-2,000-metre band filled a few degrees in the middle, and the rest of the dial was full of commercial stations.

Crowded Bands

That, in effect, is just what we have to do on short waves. All the genuine short-wave broadcast stations are crowded into narrow bands centring round 14, 16, 19, 24, 31 and 48 metres, and the vast spaces in between these bands are filled with every kind of commercial user of the short waves.

One of these days I am going to make a short-wave receiver with a very small tuning condenser, arranging the coils very carefully so that

RIGOROUS TESTS FOR RADIO RECEIVERS

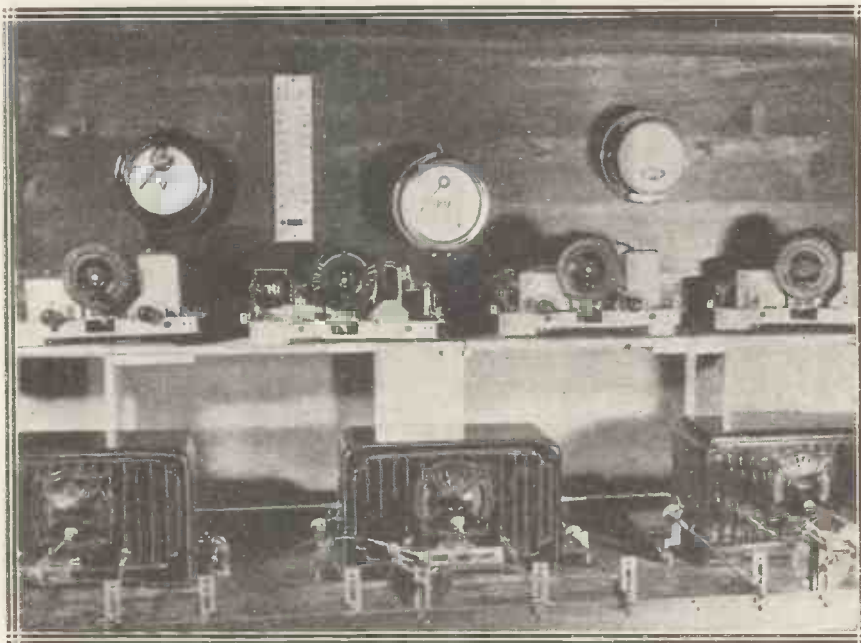

Before radio receivers are sold to the public in Germany they have to pass a very strict test. At intervals a number of sets are taken from stock and subjected to all manner of ill-treatment; some are packed up and left to knock about in vans for weeks, while others have their knobs turned round and round many thousands of times. If they emerge from this torture "alive," the designers consider them O.K. This photograph shows some sets undergoing test.

there is one for each broadcast band, which will cover the whole sweep of the dial. Then, and not before, short-wave tuning will be comparable with broadcast tuning.

A Weak Carrier

Another difference is that the carrier-waves will not be extremely strong, like those of some of the European broadcasters. The distant short-wave broadcast station often has quite a weak carrier-wave, but makes up for it by employing very full modulation. Careful tuning will bring him up to a fine strength, but a ham-handed operator at the dials will probably be able to do very little with him.

The experienced short-wave man turns his controls very slowly and steadily, and listens to every mortal thing that he hears. Only in this way is it possible to break DX records, or to be the first to receive some new station on the air. If you only bother to listen to the stations that you can tune in easily, your log will be one of the usual "Rabat-Rome - 5SW - Moscow - Zeesen" variety.

The set itself is just as important as the operator, but I would hesitate

someone starts up in the other direction, which is more or less flat, I may get farther afield.

The "vest-pocket" gear used for this wavelength makes all visitors laugh heartily, and it certainly does look rather grotesque to see two transmitting valves in a push-pull circuit with a single turn of wire between their two anodes for the main tuning inductance!

New Stations Still Arrive!

New stations are still appearing on the air, with the result that there are at least eighty genuine broadcasting stations now putting out regular programmes below 70 metres. When our own Empire station gets going, I understand that it will probably make use of the broadcast bands available round 16, 18, 24 and 32 metres, with a possibility of a transmission on 48 metres as well.

Meanwhile, here are some newcomers to look out for. Radio Funchal, Madeira (CT3AQ), is working on

Chile, broadcasts music on the 42-metre band and has been reported in England round about midnight. CMCI, Havana, Cuba, is working on 24.5 and 31.38 metres, and is difficult to receive, though it can be done—and with my single-valver at that!

For the Novice

In response to some appeals to me not always to assume that my reader is an experienced short-wave listener, I must say a few sage words for the benefit of the newcomer.

The first thing you will find out is that short-wave listening is an entirely different matter from tuning in European broadcast stations on 400 metres. Don't expect to switch on your receiver, twiddle the dial quickly round, and hear carrier-wave after carrier-wave.

The novice's first complaint about short waves is that "it seems to be all Morse"! It does, but so would the longer band if you had to cover such

Don't Put Up With a Set That Hoots

before saying that it was more so. It is no good putting up for five minutes with a set that hoots at you when you take your hands off the dials, or with one on which hand-capacity troubles are present.

I am not going into technical details now, but if you look back

RINGING-UP THE EARTH



New Scotland Yard now has a radio-equipped aeroplane for assisting in traffic control work. It is used on special occasions when an abnormal amount of traffic is probable, and has already proved of great value. The observer in the 'plane is able to fly over the congested areas, and report by radio-telephone to headquarters so that those in charge can act quickly. The Marconi transmitter and receiver are shown in the other picture.

through these notes for the past twelve months you will find hints on the curing of every short-wave trouble that I have come across—and I think I've met most of them.

Given a set that "handles" nicely, the only other requirement is a little patience, and, if you are a "super-fan," the ability to listen to nothing at all for hours on end with the idea of catching those elusive stations when they begin to come up in strength sufficiently well to be received here.

The Four Big Noises!

Don't let these remarks damp your ardour; there are always plenty of distant stations to be received without this kind of waiting. The four "big noises" on the 48-metre band—W 8 X A L, W 3 X A L, W 8 X K and W 3 X L—can generally be found before midnight, for instance.

It is, of course, on the weak stations that one can do most experi-

mental work. Try out other aerials, other valves, different battery voltages, different grid-leaks, and so on, until you have them coming in really well.

But, when all is said and done in the way of "hints," the fact remains that the best way to learn is to do things for oneself, so go ahead with your own receiver.

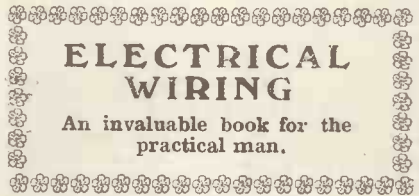
ELECTRICAL WIRING
 An invaluable book for the practical man.

We have recently received a copy of the latest edition of "Practical Wiring Systems" for review. The book is published for the benefit of all those interested in the installation and management of electric light and power circuits, and it should be invaluable to persons engaged in this class of work.

The book is written by Laurence M. Waterhouse, A.M.Inst.C.E., M.I.E.E., and published by the well-known

firm of Gee & Co., Ltd., 41, Moorgate, E.C.2, at the modest price of five shillings net, or five shillings and fourpence post free. There is also a smaller pocket edition at three shillings and sixpence net, or three shillings and ninepence post free.

In the first chapter there is a brief summary of the development of electricity for domestic use, and the descriptions of some of the older systems make very interesting reading. The other sections of the book deal very fully with the various up-to-date systems now in use, and all the advantages and disadvantages of the different arrangements are dealt with.

Every aspect of the subject seems to have been covered, and there is even a small section devoted to private generating plants. Only two individual plants are described, but this should be ample to give the reader an idea of the capabilities of this form of supply.

The book contains many useful tables and data sheets, and it is thoroughly recommended to all those interested in electric wiring.

F. B.

IN THE OBSERVER'S COCKPIT



This photograph shows the Marconi radio equipment in the cockpit of the special traffic control aeroplane. The receiver, which has two stages of S.G. amplification, can be seen to the right and slightly below the air-speed indicator, while the short-wave transmitter is standing on the floor. The aerial consists of a single wire trailing behind the machine, and it can be wound in or out with the small hand reel seen to the right of the receiver.

By the
Technical
Editor

On the

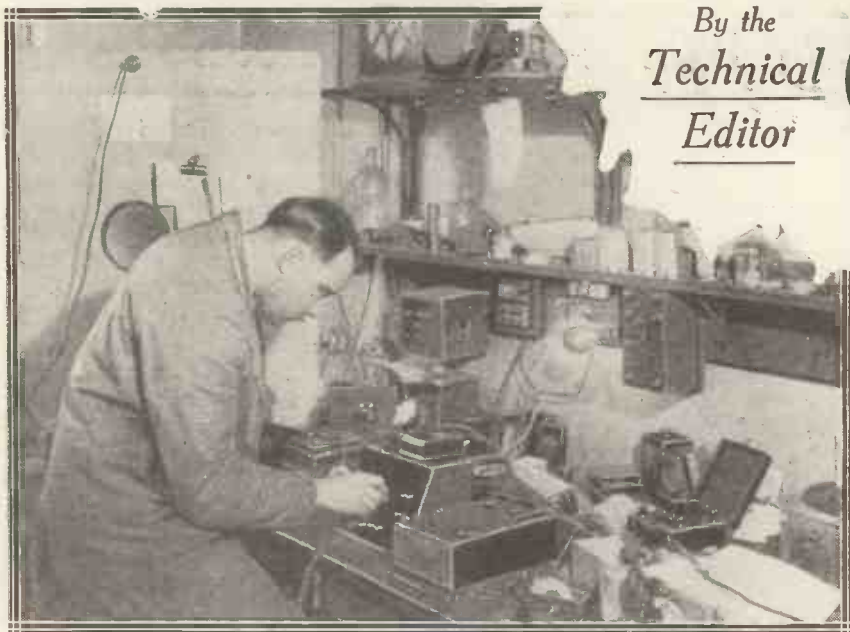

New Wearite Components

MESSRS. WRIGHT AND WEAIRE are now in production with many entirely new components, and thus face the coming season with an enlarged range of radio products which, we predict, will command considerable interest among constructors.

There is a most compact screened H.F. choke, retailing at 3s. 6d., which covers from 15 to 2,500 metres with perfect effectiveness—no small feat of design that!

And then there are various types of push-pull switches which operate on what we believe is an entirely new principle. A metal disc snaps cleanly in and out of recessed contact pieces, and the efficient action is aided by a spring.

The contacts are firm and self-cleaning, and make and break with that staccato effect which is tangible evidence of high-class switch construction. These switches range in

price from 1s. the on-off type, to 1s. 6d. for a four-pole model.

The R.D. resistance is another excellent production. It is a neat baseboard-mounting, wire-wound resistance available in numerous values from 50 ohms at 1s. 0d. to 25,000 ohms at 2s. The current-carrying capacities range from 280 to 9 milliamperes.

A fourth Wearite component of note is the Q.V.C. volume control. This is of the wire contact-track variety, and by means of a small roller an exceptionally velvety action is obtained. Indeed, it is hard to visualise a more satisfactory movement.

And yet it costs only 4s. 6d. in values up to 50,000 ohms, and 5s. 6d. for those above that and up to 100,000 ohms, which, in the circumstances, is, we consider, very reasonable.

Protecting Your Set

We have received a range of "Microfuses" for test, these being a product

of Microfuses, Ltd. They are all-British, which is rather surprising, for there are not many gadgets of a like effective nature that do not originate in either American or German factories!

The fusible element is a thin gold film which cannot depreciate, and it is sufficiently robust to withstand any ordinary mechanical ill-treatment without suffering damage.

The outstanding feature, however, is the speed at which the "Microfuse" "blows." It is so rapid in its action that whatever the circumstances it provides complete protection for the valve filament or other object it is its duty to guard.

No less than seventeen stock ratings are available, and these range from

STOPPING RESONANCE

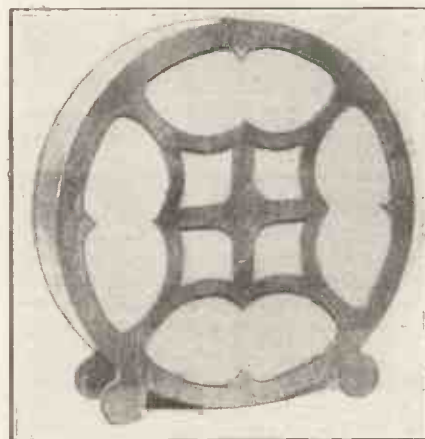

The distinctive cabinet of the Donophone Speaker is designed so as to reduce box resonance.

3 to 750 milliamperes current-carrying capacities. We would certainly advise all radio enthusiasts to acquire full particulars of these novel and eminently practical fuses.

The Donophone Speaker

We have had the opportunity of testing a Donophone loudspeaker. It employs an electro-magnetic unit, and the special feature of its construction is that the cabinet has large apertures at both sides.

The object of this is to reduce "box resonance," and we must say this has been accomplished with considerable success, though, naturally, there must be some loss of bass. But in view of the character of the

ORIGINAL, USEFUL, AND INEXPENSIVE PRODUCTS



An R.D. Resistance, Push-pull Switch, Q.V.C. Volume Control, and Screened H.F. Choke, made by Messrs. Wright and Weaire.

Test Bench

This month we deal with Wearite, Donophone, True Tone, R. & A., and Magnum products.

unit this is not serious, and the procedure is fully justified by the results.

The speaker is sensitive, and the general level of its performance is such that it deserves the serious attention of all desirous of purchasing an inexpensive instrument.

Tone Control

One of the most interesting developments of the year is the Multitone Tone-Control L.F. transformer. This

CORRECTION AT EITHER END



With a Multitone L.F. Transformer and a potentiometer either a bass or treble lift or straight-line amplification can be obtained.

is essentially a first-class L.F. transformer. But it is of special construction, and when used in conjunction with a potentiometer it gives a most striking tone control at both ends of the frequency scale.

Merely by rotating the potentiometer knob the characteristic of the transformer is continuously and smoothly altered from one that sharply falls (for bass emphasis), through a straight line and so on to a rising characteristic (for high-note emphasis).

Any good potentiometer of not less than 0.5 meg. can be used, but Multitone Electric make a special potentiometer for the purpose. The Multitone transformer does what is claimed for it, as our tests clearly prove, and the component will almost inevitably find its way into an "M.W." set.

As a matter of fact, it could be fitted to practically any existing receiver, especially a radio-gram, with real advantage. It retails at 17s. 6d.

A New R. & A. Speaker

Nineteen thirty-two is undoubtedly a vintage year for loudspeakers, and those who have hitherto been holding on to early models in anticipation of a moving-coil millennium need do so no longer, for it would appear most definitely that this condition is with us now.

Consider the new R. & A. Challenger. This is a moving-coil loudspeaker of the permanent-magnet type which is sold in chassis form, complete with a 3-ratio transformer built on it, at 35s.

And yet it is able to "challenge" comparison with any other moving-coil speaker and need not be considered only in relation to instruments of a similar price.

In our tests we found it to have a sensitivity above the average, while

it is able to reproduce frequencies down to 50 cycles in a manner which would prove creditable to a much more expensive production.

The higher notes are reproduced cleanly, and there is a brightness of response throughout the whole scale indicative of first-class design.

We were able to test this speaker with the new gear which has been installed in the "M.W." Research Dept., and with this the wide response of the instrument was very definitely shown. Compared with those of some earlier moving-coil speakers it is a



The R. & A. "Challenger."

revelation. It is a loudspeaker which all radio enthusiasts should make a point of hearing.

An Excellent Adaptor

The "Magnum" short-wave adaptor made by Burne-Jones is sold complete and ready for use at 39s. 6d.

The wave-range covered is 40-80 metres, and, if required, an extra coil for 18-40 metres is available at 3s.

The outstanding feature of the adaptor is that it can be used with any type of set from a two-valver to a super-het., irrespective of whether the set is battery or D.C. mains or A.C. mains driven.

We carried out tests with a number of receivers, and even with an all-A.C. set exceptionally good results were given with smooth reaction and a freedom from hum. Mains set owners should be particularly interested in the unit, and, of course, those who have battery sets, too, will find it an efficient and easy-to-use adaptor.

FOR ALL TYPES OF SETS

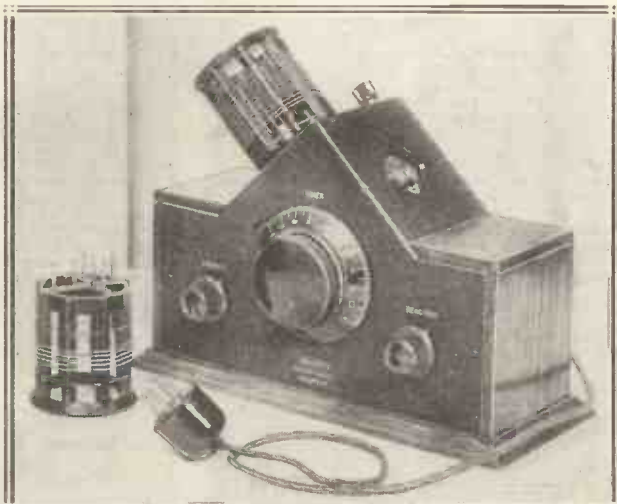

The Magnum Short-Wave Adaptor can be used with battery and mains sets of all types.



RECENT RECORD RELEASES

BROADCAST

THERE seems to be no abating in the flood of records that are placed on the market each month, or half-month, by the various gramophone concerns. The struggle for supremacy in the mind of the radio and gramophone public is a fierce one, and though it is a fact that a great choice of not only subject but also artists and type of rendering is attractive, one cannot help thinking that the wastage of discs must be rather high.

It would be surprising if it were computed how many different discs there were containing renderings of, say, such numbers as "Auf Wiedersehen" and "Good Evening." But do we need so many different renderings?

The old Vocalion Co., now merged into the Crystalline Co., are keeping their end up with a large bi-monthly issue of the famous Broadcast records. This month, as usual, contains an almost bewildering variety of numbers and artists.

A new dance band has made its appearance in the form of the Rhythm Rascals, who have recorded Paradise (another number that bids fair to sweep the board in public fancy) and Strangers. (868.) The record is one of the smaller Broadcasts, and it is well worth hearing.

Monte Hunter is better than usual, in our opinion, this month, with Minnie the Moocher, the number that Roy Fox has made so famous, and It Ain't No Fault of Mine. Minnie seems to suit Monte more than the items he has been portraying lately, and this disc (865) is one that should be placed among your list of "to be heard."

Sandy Powell is a little tiring if you hear all his records, and they are legion, but taken on their individual merits each one must be acknowledged to be quite a gem in its way. This month we have a Broadcast of him acting as a Grocer, selling sausages and aniseed balls. Not the usual type of grocer perhaps, but, then, Sandy is not a usual type of man. He has rather a rough time. (864.)

The Western Brothers, well-known on the stage and by radio, have also entered the "canned" music world. They have chosen Old King Cole and It Was Bound to Happen in the End, and their breezy style makes it a most attractive disc (8209.)

One of the most tuneful and attractive musical comedy records is the Telling Tunes from "Tell Her the Truth." In it are Wynne Ajello, Dan Donovan, and The Three Ginx, with dance band accompaniment. It introduces the favourite numbers of that hilarious musical play, such as "Hoch, Caroline," "Happy the Day," "Sing, Brothers, Sing," and "That's Fine." (3217.)

Vocal Gems from "The Dubarry" are also available on Broadcast record 3216, and in this case we have Thea Phillips and Trefor Jones with chorus and orchestra. We do not particularly like the chorus work, it is a bit harsh at times, but on the whole the record is a good one.

The Three Ginx are to be heard "solo" on 871 in You Didn't Care About Me and When Work is Through, while a second Rhythm Rascals disc worth hearing is Let Me Be Your Carmen For To-night and Let That Be a Lesson to You. (873.)

COLUMBIA

Band records do not as a rule conjure up any great enthusiasm in us, due perhaps to the usual failure of the discs to produce quite the balance between high brass and low brass notes, and to the often lacking of the drums. This month, however, we must say we were most agreeably surprised at the quality of reproduction that was put up in the Grenadier Guards' Band recording of Marche Slav on DX59. It is not a new record, but we have recently been going over some of the later band recordings and must place this one before your notice as a good example of brass recording.

Another excellent record is Stanford's Te Deum recorded at St. George's Chapel, and conducted by Sir Walford Davies. It is, of course, quite a different disc from the last-named. It is a really fine recording. (DX357.)

Auf Wiedersehen is dishd up again, this time on the cinema organ by Terance Casey. It is not a success, the playing being very monotonous and badly lacking in character. (DB848.) The melody of "A.W." is certainly haunting, but surely we have had enough of it now!

The Open Road, by Debroy Somers' Band, a hiking medley, on DX356, is a good idea, and it is well carried out. The melodies cover the British Isles in an ingenious fashion by bringing in tunes associated with various places. The vocal choruses add to the realism and give the disc the hiking atmosphere.

The Treasures From Schubert (DB838), by Manuella and his Orchestra, should be heard by all music lovers. It contains excerpts from the famous "Unfinished Symphony," "Promise of Spring," "Erl King," "Serenade," and several other noted works. The result is a really delightful record.

A brief selection from some of the records released during the month. Only a few are discussed, but they are representative of the many brought out by the various gramophone record companies.

A novelty is provided by Flotsam and Jetsam, whom we have not heard for some time, with The Pussy Cat News and Little Chap. Both these are excellent conceptions, the former being a particularly humorous and original idea. "Little Chap" is a song with a "human interest" appeal, and a neat twist at the end that gives it extra freshness and attraction. (DB843.)

Clapham and Dwyer, on It Isn't Cricket, are funny, but somehow the humour seems a little laboured. (DB845.)

A humorous sketch built round Jack's proverbial resting-place in the Bay of Biscay forms a capital 10-in. Columbia record in the new list. Entitled In Davy Jones' Locker, it introduces a goodly helping of rousing sea shanties from such lusty throats as those of Captain Kidd, Ned Morgan, Barnacle Bill and the skipper of the "Hesperus" whose wreck lies in this very spot. Into this illustrious company comes a bewildered Cockney sailor, and after being "initiated" with rum (the real stuff), he reaches the state when he wants to fight everybody. He is soon cured of this and, voicing his hunger, he meets the "Hesperus" skipper's daughter, now in the guise of a sizzling mermaid, who acts as waitress to "the boys" and serves such delectable dishes as filleted dolphin on plates of coral. Her charms win him over, and he kisses her. They then indulge in a duet, "We'll go no more a-roving," joined by the rest of the maritime crowd in a hearty finale. (DB842.)

H.M.V.

The big noise, in more senses than one, this month in the H.M.V. list is the recording of the Aldershot Tattoo. It is a gigantic effort, which is the result of concentrated recording over the entire period of the Tattoo week. Practically the entire Tattoo was recorded, and then the best

excerpts were re-recorded in the H.M.V. studios, so that perhaps out of a full recording of a band item only forty-five seconds have been used in the final record, while a "running commentary" has been added to weld the whole together.

The atmosphere of the Tattoo has been captured to a remarkable degree, and it is safe to say that it is one of the finest recordings of open-air happenings that has ever been made. The 1,000 bandmen playing Handel's opera, "Berenice," was no easy matter to record, but the H.M.V. engineers have succeeded in amazing fashion. You should hear these records (there are two of them), whether or not you are interested in the subject itself. (C2437-8.)

Maurice Chevalier is always a good seller, and his disc this month will be no exception to the rule. He has a saucy manner of presentation and intimacy of vocalisation that places him in a class all his own. H.M.V. have made two discs this month from the film "One Hour With You," in which Maurice stars with Jeanette Macdonald. They have both contributed, making one record each, their items being One Hour With You and We Will Always Be Sweethearts (B4210) (Jeanette), and What Would You Do?, which has been very popular as a dance number, and Oh! That Mitz (B4153) by Maurice Chevalier.

Once again we have Auf Wiedersehen, this time as a piano solo by Raie da Costa, coupled with Sing, Brothers from "Tell Her the Truth." (B4209.)

Of the dance numbers here are a selection that will make the mouths of all dance enthusiasts water, or should we say, feet twinkle? For the real hot fad we have Duke Ellington and his Cotton Club Orchestra playing Bugle Call Rag, and, on the other side, Gene Kardos supplies Mean Music. (B6188.)

Victor Arden-Phil Ohman and Co. are to be heard on B6189, with Coon Sanders' Orchestra playing I've Got Five Dollars and Sing a New Song respectively.

Ambrose, however, in our opinion, is the best this time with When Yuba Plays the Rumba on His Tuba (B6190), which is a truly excellent piece of work. It does not, in our opinion, need any more hot playing than this, though we have heard dance combinations that make the number just an excuse for going completely "gaga." Though we are fond of hot music, we shudder to think what Duke Ellington would do with Yuba, though Duke is supposed to be the greatest exponent of eccentric orchestration of the day.

ZONOPHONE

The talkies are a great source of lively and melodious tunes, and the various record companies are not slow to take advantage of them. Recordings of talkie hits are sure of popular acclaim, and the revival of Broadway Melody and You Were Meant For Me, from the talkie of the first-named, on 5353, is bound to be successful. The numbers are sung by Maurice Elwin, who has attained great popularity as a crooner, while a further hit from the same film—which it will be remembered was the first musical talkie—is recorded by the Salon Orchestra. This is Wedding of the Painted Doll, a number that set all the country humming some years ago. (5446.)

The London Orchestra, one of the most tuneful combinations in the recording world, have turned their attention to "On With the Show," from which they have recorded a selection introducing most of the star numbers. These include "Kiss By Kiss," "Lovely Little Silhouette," "Sailin' on the Robert E. Lee," "On With the Show." It will be remembered, is the famous entertainment at the North Pier, Blackpool. The disc is 6142, and it is excellent.

Paradise and Keeping Out of Mischief (6140) are sung by the famous duettists, Jack and Jill, the former number being all that one can wish in neatness; the tune itself is too well known for us to have to say anything about its melody.

It Ain't No Fault of Mine is one of the latest catch numbers, and it is sung on Zonophone 6149 by the Grant Trio, with good effect. We rather prefer it as a dance item played by a band; Maurice Winnick, for example, and his band has somewhat specialised in this particular number and made it all their own. By the way, when are we going to get some of this excellent orchestra's numbers on records? They are sadly needed. Here's a chance for Zono., or their allied companies!

Another fine dance band combination is the Blue Lyres who have this month recorded two more discs on Zono.: 6137 contains Round the Marble Arch and Snap Your Fingers, and 6138 holds Whistle and Blow Your Blues Away with Five Minutes to Twelve. We prefer the latter number, though the rendition of the others is very good. We should like to hear their recording of When Yuba Plays the Rumba, for their broadcast version of this is second to none.

We have said before that we like the accordion in its proper sphere—the tango orchestra, but we do not like it as applied to such recordings as The Gay 'Nineties (6147). This is a disc containing excerpts from the various shows of the period, melodies that never will be forgotten, thanks to the gramophone. But they deserve better treatment, and should have been played by an orchestra.



These Modern Radio-Grams

by
JOHN MARSDEN

“I CONSIDER it’s disgraceful ; I paid thirty-two guineas for this machine a month ago, and I’ve had to have the service men here twice already. I have had two gramophones during the last ten years made by the same firm, and they never went wrong. I never paid more than twenty pounds for those, but when I pay thirty-two guineas the radio-gramophone is not as reliable as the ordinary machines.”

A Frequent Complaint

One frequently hears this type of complaint now that radio-gramophones are so popular, and it is interesting to examine the reasons why so many purchasers of expensive instruments are inclined to bemoan their lot after a few weeks of proud ownership.

It is an extraordinary fact that the non-technical radio-gramophone user does not appreciate the difference between the acoustic gramophone and the combined instrument, and the chief reason for this would appear to be the fact that both instruments are, at first sight, very similar in appearance.

Amazing Ignorance !

The cabinet of the average radio-gramophone is identical in form with that of the gramophone, and unless the owner is a technician he rarely appreciates that the reproduction of records in a radio-gramophone is made possible by an electrical pick-up used in conjunction with a valve amplifier and loud speaker. This ignorance may sound incredible, but

The present-day radio-gram is a robust piece of apparatus, but people are apt to regard it as they do the old acoustic gramophone, and expect it to stand any amount of rough treatment. This article will do much to clear the air, and to show the difference between the two instruments.

one has only to ask a non-technical friend how a radio-gramophone operates to realise that it is true.

The acoustic gramophone consists of six parts at the most: (1) cabinet; (2) spring motor; (3) sound-box; (4) tone-arm; (5) horn, and possibly (6) automatic brake. All these, with

the exception perhaps of the automatic brake, are foolproof.

A spring motor may require oiling every year or so, and a new spring at longer intervals. The automatic brakes are very simple and rarely require attention. It is this type of machine that the average “man-in-the-street” has been accustomed to use for years past.

Considerable Complication

The composition of the all-mains radio-gramophone is, however, vastly more complicated. It consists of (1) cabinet; (2) electric motor; (3) pick-up mounted on carrying arm; (4) radio receiver and amplifier; (5) automatic brake, and perhaps many additional “gadgets” such as panel lamps, etc.

CHECKING VOLUME

The apparatus shown here is used for measuring the volume level of an orchestra when broadcasting, or making gramophone records.

The volume level is registered on a long strip of paper, where it appears as a continuous wavy line.

Note the imposing array of switches, dynamos, meters, and other “gadgets” which are necessary for this apparently simple operation!

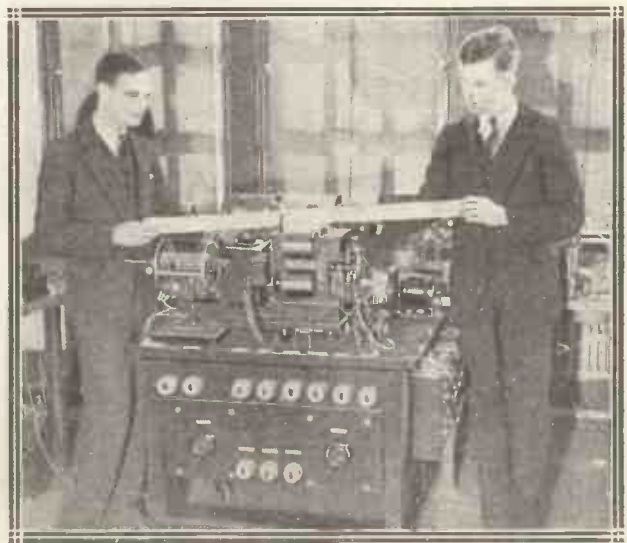

Mains Voltage Variation is a Punishable Offence

Now, although the modern induction disc electric motor is as reliable as a spring one, an electrical pick-up is more delicate than an acoustic sound-box. Furthermore, the construction of the modern all-mains radio receiver and amplifier, which forms the heart of the radio-gramophone, is very different from the horn of a gramophone.

A Good Comparison

In fact, an excellent analogy between a gramophone and a radio-gramophone is made when we consider the difference between a cart and a motor car. Each type of vehicle comprises primarily a box on wheels, but

It is, in fact, surprising how reliable the radio-gramophone is when we consider the many components that it incorporates. Although large manufacturers give all the components rigorous tests before passing them for assembly into the complete instruments, there is at the present time a weak link in the chain. Valves are admittedly the most unreliable part of a radio-gramophone.

Their life cannot be guaranteed, and although valve manufacturers accept no liability they are often prepared to replace a valve if, after it has been used for a short time, it ceases to function and it appears that this is due to a fault in manufacture.

etc., in the receiver. Although the components of the more expensive radio-gramophones are tested at higher voltages than they are used at in practice, it is not always possible to provide for heavy surges.

Another factor that is outside the control of the radio-gramophone manufacturer is the electricity mains, which in England are on an average considerably better than those of other European countries.

Alternative Tappings

To obtain the maximum efficiency of performance from the mains transformers of radio-gramophones, they are usually provided with alternative tappings for every ten volts between 100-120 volts, 200 and 260 volts.

Electricity supply companies in many provincial areas are prone to allow the voltages of their supplies to vary; in some cases a considerable rise in voltage is experienced, and very often the voltage varies during the course of the day.

Although any supply company can be penalised if it can be proved that its voltage has altered beyond its stated figure more than 4 per cent either way, there are many occasions when a voltage of 200 may rise to as much as 224 volts.

These variations in supply naturally hinder satisfactory operation of a radio-gramophone; a fall in voltage may slow down the speed of the turntable motor, whilst a serious increase in voltage might damage the mains transformer, valves, chokes and resistances, besides affecting the motor speed.

Report Any Trouble

It will thus be realised that it is the duty of any radio experimenter who finds that his supply voltage is varying considerably to report the matter to the supply company or the Electricity Commission, Savoy Court, W.C.2.

It will be realised from what we have said that radio-gramophones are all the technician would expect them to be, but the general public unjustly believe that they should operate as free from trouble as acoustic gramophones. It is most unlikely that this will ever be possible!

Nevertheless, there is so very little for the non-technical radio-gram owner to learn about the essentials of his set that it is certainly worth his while to make the effort, which will result in increased efficiency.



YOU'LL FIND HIM AT TUSSAUD'S!

Nearly everybody must have heard broadcasts of the organ at Madame Tussaud's. Well, here you see Mr. Edward O'Henry, the organist, who has made a considerable number of very popular gramophone records.

Incidentally, Mr. O'Henry is one of the staunchest defenders of the cinema organ against those who say that this modern instrument is a travesty of musical art.

whereas the former is propelled by an animal, the latter has complicated machinery to provide the motive power.

The car owner expects to have frequent adjustments and replacements made to his machine, but the average radio-gramophone purchaser believes that his instrument should be as trouble-free as an acoustic gramophone.

Thousand Separate Parts

However carefully radio components are manufactured, it is obvious that the factor of foolproofness is decreased by the increase in the number of separate parts that go to make up the complete instrument.

The radio receiver and amplifier chassis of a well-known commercial three-valve radio-gramophone is comprised of 1,083 separate parts! Compare this with the acoustic horn, which is made by soldering sheets of zinc together.

Although a replacement is made, it appears to the non-technical radio-gramophone owner that his instrument is unreliable, it also means that the time for a service man to replace the valve has to be paid for by somebody.

If a fault develops in a valve during the first few months that a new radio-gramophone owner has taken delivery of his machine, he feels that he should not be liable, and therefore either the dealer or the manufacturer of the instrument has to bear the cost of the service-man's time.

Valves May Be Harmful

It is unfortunate that besides developing a fault a valve can at the same time cause harm to components of the instrument. The grid bias can be altered by a valve having a reduced emission, and consequently a higher high-tension voltage is developed, thus putting an additional strain on the transformers, chokes,

A RADIO RECKONER

By W.A. Barclay M.A.



This month our contributor deals with the amplifying properties of a valve. He gives a set of his famous "N" diagrams, and with their aid the experimenter can carry out many calculations with a minimum of trouble.

THIS month it is proposed to continue our discussion of the valve, and to consider how it is that by means of this device we are able to magnify radio signals.

First of all, let us be quite clear as to what exactly the valve does. We saw in the last article that the three principal things which have to be taken into account in a triode valve are (1) the anode voltage, or P.D. between the anode and filament; (2) the grid voltage, or P.D. between grid and filament; and (3) the anode current.

Definite Mean Values

This last consists of the stream of electrons which "evaporate," so to speak, from the hot filament and are attracted to the positive anode. Each of these three things consists normally of a steady component or "mean value," on top of which is superimposed an oscillating or alternating component, which is due to the passage of the particular signal in which we are interested.

It is quite evident that the amplitudes of the oscillating components depend on the magnitude of the signal, while the mean or steady components have no direct concern with the actual process of reception.

Now, when our triode valve is connected up as an amplifier, let us say, and is receiving a signal of a certain fixed strength, there will be certain definite mean values of anode voltage, grid voltage and anode current around which the actual values

at any instant fluctuate. But it is the amounts of the fluctuations in which we are interested, and it is these fluctuations, and not the mean values, which we have to study. Let us now look into the matter somewhat more closely.

In what follows we shall consider the valve arranged to function as a L.F. resistance-coupled amplifier as shown in Fig. 1. The L.F. voltage impulses from the preceding stage are impressed between the grid and filament in addition to the steady P.D.

between them which is provided by the grid-bias battery.

This causes a corresponding variation in the electron current in the valve, and this variable current has to pass through the external loading resistance, R. Let us examine carefully the two-fold function of this resistance.

Voltage Drop

As we know, the steady component of the anode current must pass through it all the time, in order to complete its circuit through the valve to the H.T. battery. A potential difference or "voltage drop" is thus maintained between the two ends of the resistance, so that the anode, at one end of it, is kept at a steady fixed potential.

The amount of this anode potential will, of course, be less than that of the positive terminal of the battery at the other end by the "voltage drop" across the resistance.

When signal current passes, however, a variable P.D. is developed in addition across the resistance, but since the battery end of it is connected (via the battery) to earth, we may regard this end as anchored to a fixed potential.

Oscillating Potential

A variation in voltage must, therefore, show itself at the other, or anode, end. We may thus say that the anode potential now varies about its former mean value by the amount of the oscillating potential developed in the resistance.

THE BASIC CIRCUIT

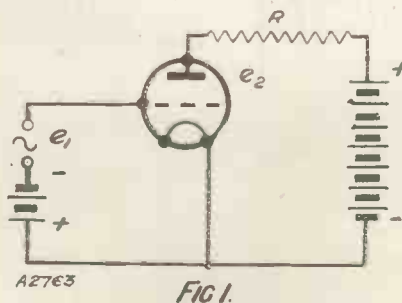

Here you see a valve connected up as a resistance-coupled amplifier, in the manner referred to by Mr. Barclay on this page.

An Ideal Aid to Rapid Calculation

Owing to the peculiar nature and properties of the valve, it will generally be found that the voltage variation resulting at the anode is considerably greater than the variation of grid voltage which gave rise to it; and so we have an explanation of "voltage magnification," which is one of the

voltage variation, since, after all, it is the variation in the voltage, and not the voltage itself, that is magnified.

Still, as everyone uses the words "voltage magnification" to mean this, no great harm is likely to result provided the meaning is really clear!

It may help towards an under-

be 3 milliamps. This is the steady current flowing in the absence of any signal, and it is easy to see that it will cause an IR "drop" of 60 volts across the anode resistance.

Accordingly, the pre-signal steady voltage on the anode will be 160 less 60, or 100 volts.

Now let us imagine that a small signal of amplitude 0.2 volt arrives at the grid. Since the mean or steady potential is held at 6 volts negative, by the grid-bias battery, this means that the actual potential of the grid is now continuously varying about this value—it will, in fact, alternate between the limits -5.8 and -6.2 volts.

Sympathetic Fluctuation

The result is to vary the amount of the anode current above and below its former steady value of 3 m.a., and this, in turn, causes the anode voltage to fluctuate in sympathy with the current oscillations. We may suppose that in this case the anode voltage is thus made to fluctuate between the values 95 to 105 volts; that is to say, the amplitude of the voltage variation at the anode is 5 volts.

Then we see that the "voltage magnification" attained by the stage is the quotient of 5 divided by 0.2, which is the same as 50, or 25. In other words, the voltage variation at the anode is exactly 25 times the voltage variation at the grid.

Using the Diagrams

The two "N" diagrams given this month are useful in enabling us to ascertain rapidly the magnification obtained by such a stage of resistance amplification when the grid and anode variations in voltage are known. Alternatively, knowing the amount of the signal input at the grid, we can read off the corresponding amount of anode voltage variation for any given amount of overall stage magnification.

The Resistance Value

In what has been said above we have assumed the valve to be connected up as a practical resistance-coupled amplifier. Naturally, the amplification to be obtained in this way will depend by some extent on the particular value of the external resistance, R, which is selected, as well as upon the valve used.

It is convenient, however, to be able to separate the amplifying

FINDING THE AMPLIFICATION FACTOR

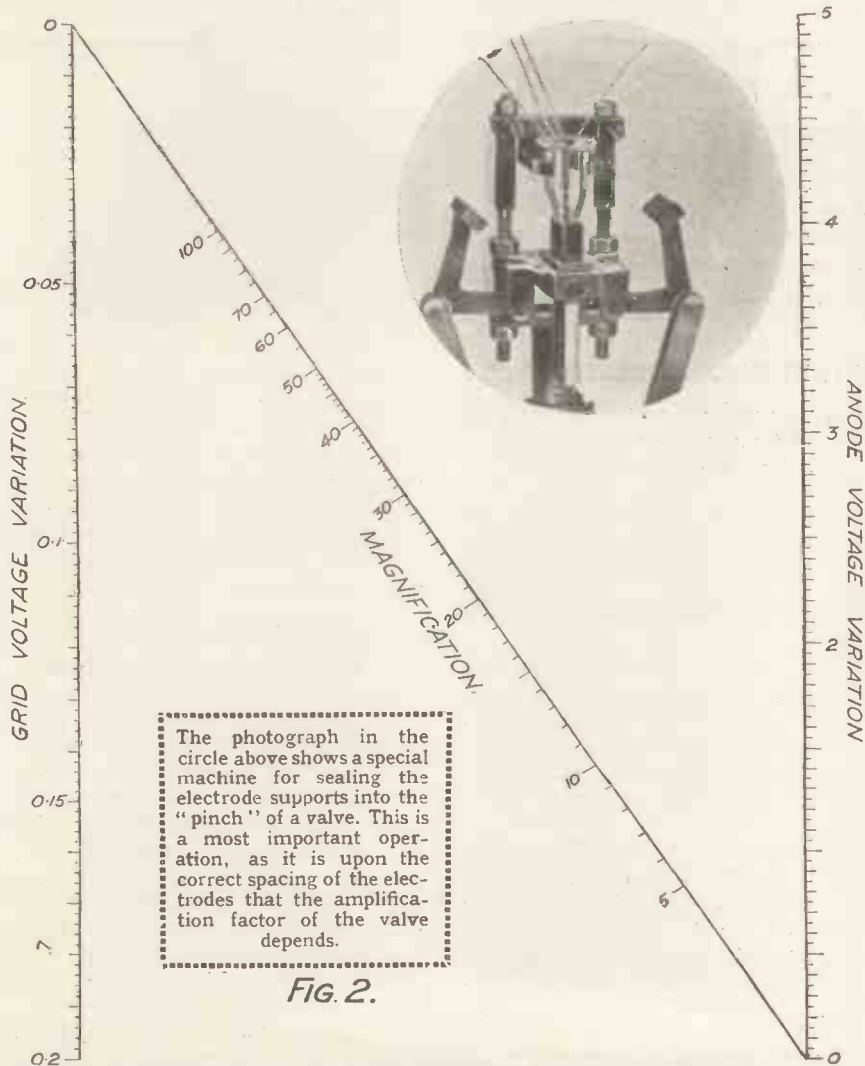

With the help of this "N" diagram you can find out several useful things about a valve. Given the anode voltage variation produced by a certain change in grid potential, you find its amplification factor. In fact, provided you know any two of the foregoing quantities, you can quickly discover the third.

most useful and important functions of the valve.

Voltage Magnification

It is worth while to notice that the phrase "voltage magnification" as commonly used is not strictly correct. If we want to be pedantically accurate and highbrow, we should really speak of the magnification of a

standing of the processes we have been trying to describe if we consider an actual numerical case. Suppose, then, that in the circuit illustrated, in Fig. 1 the H.T. supply is 160 volts, the grid-bias battery is one of 6 volts, and the anode external resistance is 20,000 ohms.

Under these conditions we shall suppose the anode current flowing to

You Won't Need More Than a Ruler

properties of the valves from the modifying effects of the circuits in which they are connected; in other words, to be able to compare one valve with another in this respect without reference to some particular amplifying circuit. For this purpose we use what is called the "amplification factor," or "magnification factor," of the valve, denoted by the

But if the anode voltage be now somewhat decreased, the current will again be diminished. If we find, then, that it takes a decrease of e_2 anode volts to restore the anode current to its former value, we take the ratio of e_2 to e_1 , or $\frac{e_2}{e_1}$ as the valve magnification factor, or μ .

It may be pointed out here that the

Fig. 1 is always less than the μ of the valve; that is to say, that in practice with such a stage it is never possible to utilise the full magnification of which the valve is theoretically capable. There is, however, a very simple relation which will show us exactly how much of the amplification provided by the valve we may hope to realise in a resistance coupled amplifier.

This will be considered in a subsequent article.

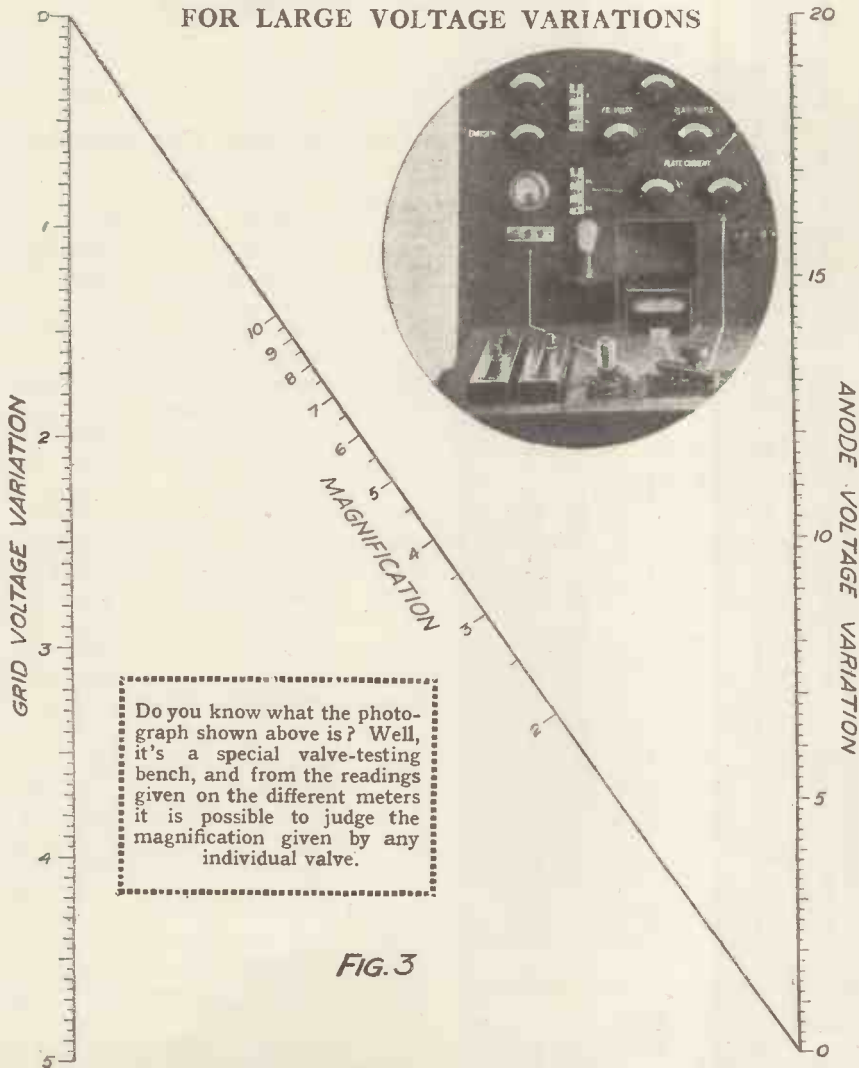

This diagram is very much like Fig. 2, but it is intended for use when larger voltage variations are being dealt with. A ruler is all you require to make full use of the diagram, it being necessary only to place the straight-edge so that it cuts the two known quantities, and the third one can be read off on the remaining ordinate.

symbol μ . This quantity is arrived at in the following way.

Suppose that, with certain fixed values of negative grid and positive anode voltages, a certain anode current passes. If, now the grid voltages be made less negative by a small amount, e_1 volts, the anode voltage being kept constant, the anode current will increase by a certain amount.

two "N" diagrams here reproduced are equally serviceable in illustrating the numerical relations between the quantities e_1 and e_2 (on the upright scales) and values of μ (on the diagonals).

It will be found that the actual "voltage magnification" obtainable from a stage of resistance-capacity-coupled amplification such as that of

 * "THE W.L.S. 1932" *
 * SHORT-WAVER *
 * "Nothing to touch it!" *

To the Editor, MODERN WIRELESS.

Sir,—A short time ago I constructed the short-wave set as described by you in the January edition of MODERN WIRELESS, and I think that perhaps it may interest you to hear my report on this set.

I have previously built a number of short-wave receivers, both two and three valves, but have never found one to touch your set either in ease of control or in sensitivity. I am using an Osram S.G. valve as detector, with a Lissen pentode in the output stage.

An Imposing List

Since building the set I have heard the following stations all at excellent 'phone strength: W 8 X K, W 3 X A L, Rome, Zeesen, G 5 S W, Moscow, Vatican City, Radio-Maroc, Pontoise, P L V, P L E, V K 2 M E, W 2 X A F, W 2 X A D, W 1 X A Z, V E 9 D R, 7 L O, Skamlebaek, P R B A, Rio de Janeiro, together with a large number of American commercial transmitters.

For the last two nights conditions here have been exceptionally good as regards transatlantic reception. All the American stations mentioned above have been coming in at R5-R8.

A Pleasure to Handle

In conclusion, let me congratulate you upon this fine set. It is a pleasure to handle, and renders short-wave listening quite as easy as reception on higher wavelengths.

Yours truly,
 NORMAN G. TARBOLTON.
 Edgbaston.

QUESTIONS ANSWERED

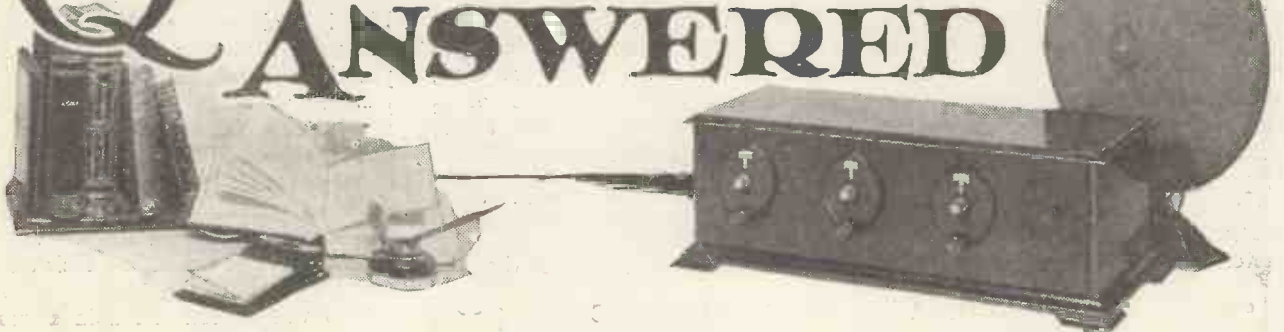

L.F. Instability

M. R. C. (Bognor Regis).—"For the last six months I have been using a balanced-armature cone-type loud-speaker in conjunction with a detector and 2 L.F. receiver. My output circuit included a filter choke and 2-mfd. condenser. Recently I decided to invest in a permanent-magnet moving-coil speaker, and in the place of the filter choke and condenser I inserted an output transformer of the correct ratio. To my surprise the set started to howl. Can you suggest any reason for this, because I cannot understand why such a simple alteration should produce this trouble?"

This trouble is fairly common, and boils down to the question of decoupling. The filter choke and condenser assisted in the stability of the circuit by separating the L.F. impulses from the external circuit through the H.T. supply.

All the while this condition of affairs existed the set remained stable. Directly you removed your decoupling, L.F. howling occurred.

Easily Cured

The remedies are either to increase the present decoupling arrangements in the detector anode circuit, such as by using a larger by-pass condenser and a higher value of decoupling resistance, or by replacing the output filter, utilising the output transformer by joining its primary winding to the output-feed terminals to which you previously connected your speaker.

In this way you will still retain the advantages of the choke filter scheme. The output transformer is, of course, essential, otherwise your moving-coil will not work satisfactorily.

In addition, make sure that in carrying out these alterations you are not cramping the layout, and be careful to space all wires so that those near the output valve do not come close to the wiring of the first L.F. stage.

Corroded Aerial Wire

A. C. (Yarmouth).—"I live near the sea and I notice that my aerial wire rapidly becomes corroded. It has occurred to me that this may result in a loss of efficiency and thus have a detrimental effect upon the volume and range of my set.

"I am told that the corrosion is caused by the sea air. Will you please say whether my assumption that the volume will suffer is correct?"

TECHNICAL QUERIES DEPARTMENT

Are You in Trouble With Your Set?

The MODERN WIRELESS Technical Queries Department is in a position to give an unrivalled service. The aim of the department is to furnish really helpful advice in connection with any radio problem, theoretical or practical.

Full details, including the revised scale of charges, can be obtained direct from the Technical Queries Department, MODERN WIRELESS, Fleetway House, Farringdon Street, London, E.C.4.

A postcard will do. On receipt of this all the necessary literature will be sent to you, free and post free, immediately. This application will place you under no obligation whatever. Every reader of MODERN WIRELESS should have these details by him. An application form is included which will enable you to ask your questions so that we can deal with them expeditiously and with the minimum of delay. Having this form you will know exactly what information we require to have before us in order to solve your problem.

London Readers, Please Note: Inquiries should not be made in person at Fleetway House or Tallis House.

Provided the joints in the aerial system—if there are any joints—are properly soldered it is unlikely that the corrosion will produce any loss of efficiency.

But it will reduce the life of the aerial wire, and for this reason those who live near the sea should always use enamelled wire in preference to the ordinary uncovered variety. Any soldered joints should be painted over as a protection from the effects of the atmosphere.

In erecting an aerial it is advisable to arrange for the horizontal portion and the lead-in to form one con-

tinuous wire. There is then no possibility of a troublesome joint.

Anode Current Consumption

L. R. (Hammersmith).—"I am thinking of replacing my existing power valve with one of the super-power type, but I am doubtful whether I shall be able to supply the additional anode current required, since I am using a dry battery for H.T. I don't wish to buy new batteries every few weeks, and if the purchase of a super-power valve entails the use of a mains unit I shall abandon the idea for the present and continue to employ the power valve."

There is no need to worry if you employ H.T. batteries made up from cells of the larger type. Such batteries are usually designated by the term "triple" or "super" capacity, which means that they are designed to supply a heavier output than those batteries comprising small-sized cells.

Requires Servicing

G. N. N. (Sittingbourne).—"My L.T. battery is now two years old, and although I have it charged at regular intervals, I do not get the full number of hours from it between charges.

When I first bought the battery I could use it constantly for a fortnight before it ran down, but now after a week's use I have to put it aside for re-charging. Does this mean that I shall have to purchase a new accumulator?"

Not necessarily. Take the battery to a good service station—or preferably the makers—and have it examined. The acid may need renewing, especially if water has been used to replace spilt acid.

Look at the plates and see whether you can detect any whitish-grey patches on them. These indicate sulphation and their presence does mean that the accumulator may have to be scrapped.

CINEMA- VERSUS CHURCH- ORGANS



Cinema Organ—or Church Organ? Both are broadcast, both have their supporters. Which do you prefer?

Let us see what the men who play them have to say about it.

Below, three "straight" organists and three equally famous cinema organists air their views on the matter.

G. D. CUNNINGHAM, M.A., F.R.A.M., F.R.C.O., Birmingham City Organist.

"The cinema organ and the 'organ,' as we have always known it, are entirely distinct instruments. Any comparison between them is futile."

EDWARD O'HENRY, the popular Tussaud's Cinema Organist.

"The gist of the whole matter, as I see it, is that the cinema organ, well played, is really a superstructure erected over and above straight organ work. The two types of player—those who specialise in church and recital work, and those who prefer the cinema organ—have much in common from a musical point of view, but choose different media to express their views.

Quite Ridiculous

"To look upon cinema organ playing as the inferior branch is manifestly ridiculous. Two things are necessary to make a successful cinema organist: fundamental musicianly experience, and a personality. Without these it is useless to attempt it.

"I go further than this. I venture to suggest that the average cinema organ player could easily handle a church organ, although the church organist would be at sea in a cinema!

"It is true that the two instruments differ widely in construction and components, but are alike in that they each have several manuals (keyboards) and pedal-board. In either

case, the technique consists in mastering the synchronisation of hands and feet.

"The cinema organ is ideal for broadcasting provided it is of a reputable make, and the fact that every reasonably-sized theatre possesses one indicates the public demand in no uncertain fashion.

"Verb. sap.!"

A BIRMINGHAM BROADCASTER



Frank Newman, F.R.C.O., the first cinema organist to broadcast. He can be heard in the London Regional programme on Fridays, when his organ music is relayed from Lozell's Picture House, Birmingham.

REGINALD GOSS CUSTARD, the popular broadcaster, and Alexandra Palace Organist.

"Is there any basis at all for comparison between the cinema and church or concert organ? I suggest that no such basis exists. They are as far apart as a jazz band and a full orchestra.

"It has been suggested in certain quarters that the concert organ is waning in popularity. Such a state of affairs may very well arise if certain highbrow critics (self-styled) continue to insist upon music being played on the organ which is impossible of comprehension by the ordinary listener.

He Does Not Like Them

"I admire cinema organists. But I must confess that I do not like the organs! However—what is the old tag?—'A place for everything, and everything in its place.'

"As far as I can gather, the broadcasting of organ music is popular up to a point, and, to a certain extent, educational. It serves a useful purpose, at any rate, as a medium for testing the capacity of one's set!"

FRANK NEWMAN, of Lozell's Picture House, Birmingham.

"Almost every day abuse is hurled at the cinema organ and its players by persons who more often than not know little of the construction and purpose of that maligned instrument. These critics often forget that the functions of the church organ and the cinema organ differ very widely.

"The two types of organ are quite distinct as regards their tonal make-up, but as the cinema organ is played

Pity the Poor, Maligned Cinema Organist!



Young in years, but not in experience, Mr. Reginald New (who also comes from Birmingham) is not the least popular of the cinema broadcasters.

by means of keyboards and pedals, and possesses stops—similar to its church counterpart—why deny it the name of organ? The attitude of many of the cathedral and church organists towards their cinema brethren is, to say the least, often unkind, snobbish, and ignorant.

“On the other hand, I know personally of several notable exceptions, prominent amongst them being three well-known cathedral organists who, far from being politely sarcastic when I showed them over my own organ and demonstrated it to them, were very appreciative, complimentary, and intensely interested.

“I happened to mention to one of these gentlemen, when first introduced to him as ‘an organist,’ that I was a *cinema* organist, expecting him to be rather distant in demeanour. His reply was: ‘Well! What’s the matter with that?’—in a breezy, ‘jolly-good-luck-to-you’ sort of voice!

Not Comparable

“The cinema-going public expects to be entertained at the cinema. For a lover of the organ music of Bach and Rheinberger to cavil because he does not hear such music in a cinema, or to compare a recital at a cathedral with one given in a cinema, is absurd. As well compare Tom Webster with Velasquez—both good men in their own department!

“Speaking as one of the first cinema organists to broadcast in this country—I commenced in February, 1927—the fact that I have received many hundreds of letters from appreciative listeners living all over the British Isles and the Continent testifies to the popularity of cinema organ broadcasts.

Many Requests

“As regards the music, I receive many more requests for really good light music than for what is known as ‘tripe.’ It is one of the real pleasures of my work to be able to include in my broadcast programmes works of really good musical taste.”

WALTER S. VALE, F.R.A.M., whose broadcasts from All Saints’, Margaret Street, W., are familiar to listeners.

“The cinema organ, with its tricks and effects—to say nothing of the abuse of its tremulant—can, for the most part, only appeal to those who would of necessity be bored by true organ music, well played, on a well-designed church organ. It is just a question of taste, and on such questions of taste it is difficult, if not impossible, to look at the matter from the other fellow’s point of view.

“But I think it can be said with some degree of certainty that there could not well be a greater artistic crime than to play noble music, written and intended for church use, on an instrument constructed to interpret an entirely different type of music—a type of music suited mainly to the kind of entertainment which it accompanies.

An Air of Solemnity

“In my opinion, the church organ should be designed to produce an effect of solemnity, mystery, majesty, and awe. The music written for and played on it should have something of these characteristics. As to the broadcasting of organ music, I think this principle should apply.

“Serious and classical music from the church organ—from the cinema organ, anything suitable for that instrument. Each is different in function, and should be different in design.

“Any comparison is really futile.”

REGINALD H. DIXON, of The Tower Ballroom Organ, Blackpool.

“Certainly the time seems ripe for some action to end the duel between

the partisans of church and cinema organs. For inasmuch as the two organs are entirely different instruments, the duel seems a little unnecessary.

“The cinema organ, which is wider in scope and has almost unlimited possibilities, is built for light music and orchestral compositions. My own instrument was built for dance work.

“The church organ is largely limited to its own ponderous tone, but is suitable for its surroundings. I enjoy playing a church organ for a change, or hearing a recital clearly played from a church.

“The whole trouble is that people will insist on confusing the two instruments in their minds. Here is a striking example of one listener who was guilty of this.

They Are Poles Apart

“We should appreciate your talent more,” he wrote, “if you treated the organ as the solemn instrument it is, i.e. give us long, sustained chords.”

“It is often forgotten that most cinema organists have been, and may still be, church organists. Any

NOTES FROM THE NORTH!



Holiday crowds in the Tower Ballroom at Blackpool are delighted by the playing of Mr. Reginald Dixon, whom you see here ready for action.

musician who, like them, plays both instruments with any degree of success, knows perfectly well that they are poles apart.

“But each must be judged on its merits.”



The Story of Pamela and the Portable

IF you meet your small son emerging from the pantry with jam on his face and fingers you imagine that the *obvious* explanation of that apparition is the *only* one possible. The case for the prosecution, so you fondly think, is cast-iron, water-tight, and a "walk-over."

Don't Judge by Appearances

Well, you might be right in this instance, but do not apply the same principles to every set of circumstances which may look so eloquent as to need no argument. For instance—

When William Clipper's chief told him to run down to Folkestone to clear up the mess made by the firm's new agent, William was annoyed, because he had been married only six months, and still had the glamour of it all in his head and veins. To be parted from Pamela for a week would be tough and hardly to be borne.

But William knew better than to refuse or even to show unwilling. Besides—Folkestone was a nice place. He might have been sent to East Ham or Bilston!

And—think of the thrill of the homecoming! What a "kick" he would get out of that! Why, it was almost worth going for that alone.

So William trotted home, bursting with the news of the singular honour which had been conferred upon him.

Wifely Composure

Pamela, knitting herself a *beret*, received his news with a composure that nearly stunned William. She swung her dainty foot as she knitted, and said—Hear, O ye heavens!—

that they had picked the right man for the job, and she hoped he would give the naughty agent hip-hip-hurrah and collar lashings of kudos.

Now, poor old Bill had thought that she would weep several fluid ounces, and cling to him with her well-known pre-marriage convulsive grasp. So he was not only nearly stunned, but slightly disappointed.

Dash it—she seemed positively pleased! Was he nothing in her life?

He certainly was—to this extent. He held up two skeins of wool for her to wind into balls; he put the cat out and set the mousetrap; he locked up all the doors and "french"

Pamela the long, weary hours of his absence, William deceived himself again and clocked up for himself an exceedingly *mauvais* quarter of an hour, as will be understood hereafter.

Kissing the Bald Spot

Pamela's ecstasies over the portable sent a warm glow up and down, and from front to back, of William's frame. That was because he did not know that Mrs. Glarcher, the next-door "cat," had been piling it on about Mr. Glarcher's portable only that very morning. To Pamela, the arrival of a portable that night must have looked like the work of a beneficent providence.

However, being a wise woman, she made nice little pleased noises and kissed William on his bald spot. Of course, she loved the fellow as much as one could love a fellow like him, with a bald spot like that and a snore like the cry of a cow five fields away!

Where Ignorance is Bliss

And so, on the morrow, he embraced her long and lingeringly in the "hall," beside the barometer—and rode away with a heart of lead in which was enshrined, like a bit of radium in its capsule, the memory of her fair visage and gracious movements. Not having television gear in the back of his head, he did not observe that Pamela, having waved him farewell, poured herself another cup of tea, put her feet up on his chair and gave herself up to a voluptuous perusal of "Corisande's Column" in the "Daily Bunk."

At 3 p.m. she began to fiddle with the portable set. Women have no

NOT ALL JAM!



"—emerging from the pantry with jam on his face and fingers."

windows, and subsided on to a perplexed pillow. Why—was—she—so—infinitely—pleased?

Anybody but Bill Clipper would have known that she was glad because her Bill had been picked on for special duty. But he had been married six months only, and had not awakened. Women never really sleep, of course!

In buying a portable radio set, thinking that it would while away for

"Pamela Had Been Injured, Probably Murdered—"

radio sense. She fiddled and fiddled, ignoring William's careful lessons in manipulation. She fiddled.

I know that she turned the volume control through about nine complete clockwise circles. She put the reaction hard over and thought she had got the Pangbourne nightingale. We will leave her to her fiddling, and see how William is getting on.

William is doing exceedingly well, thank you. He has won a whisky too many at that nice little place near the fish market, and is walking along the Leas with his head singing like a kettle.

The Morning After—

His feet seem to be slightly independent of his steering-wheel, and his tie has slipped round to the back of his neck. He tells the lift attendant at his hotel a fairly long story about his mother's early struggles and then remembers no more until he wakes and sees his boots, one on each bed-knob, at his feet. There is also the suspicion of a "tongue."

Luck favours fools! William found the cause of the agent's troubles in something under one hour. Her name was Henrietta. Financially, the bother reduced itself to a mere £10 deficit, which the agent paid—and left his motor-bike in the hands of another.

"BADLY HETERODYNED!"



"His feet seemed to be slightly independent of his steering-wheel."

But Henrietta still loomed on the horizon like a cloud. William perpended, the agent weeping generously from sheer relief.

Would the agent flee from temptation and go to Paris—where there is no such thing? He would, forthwith, if required. A telegram to London. Reply, "Approved." Agent caught next boat. Henrietta diddled!

William balanced the books and walked the Leas like a young god. He would be home two days earlier than he expected. What a delightful sur-

prise for Pam. Possibly! Possibly!

Now we come to the horrible tragedy of William Clipper. Oiled, scented, groomed and brushed, our William alighted from his taxi at the corner of Laburnum Terrace, generously tipped the driver with his firm's

SHOCK EXCITATION



"On the floor, between the fireplace and the bed, stood the portable receiver."

money, and almost tip-toed down to his own front door. Turned his latch-key in the lock. Entered his house.

The Mystery Increases

A dead, fusty sort of smell, like the house when you get back after the holidays! Bills and circulars on the mat. Three bottles of milk on the doorstep.

In the dining-room—gosh!—the remains of a meal. The teapot nearly full; dried-up bread and butter; a shrivelled and musty kipper; the "Daily Mail" two days old, propped up against a stone-hard loaf. Talk about the *Marie Celeste*. This was it, all right!

Coo-ee! No answer. William dashed upstairs, burst into the bedroom, and saw the evidence of what appeared to be a perfectly water-tight case for the prosecution.

On the floor, between the fireplace and the bed, stood the portable receiver in company with two wine-glasses. One of these glasses was broken and the other contained two cigarette ends.

Bloodstains on the Sheets

There was a sherry decanter on the table. The bed was in a state of wild disarray; there were bloodstains on the sheets and a hole had been burnt in the coverlet. The window was wide open. A ladder leaned against the sill and rested its feet in William's best rose bed!

Gentlemen of the jury, that is my case. Pamela had been injured, probably murdered, by two burglars who

had been much too anxious to get away, or to bury the body, to trouble further about loot.

Mental Purgatory

Having ascertained the facts as I have stated them, William passed rapidly through a series of mental purgatories. Sounds were then audible—indicating movements in the lower part of the house.

This is the point at which my case begins to crack, for Pamela was seated on the dining-room table, taking a meal of biscuits and milk, as peacefully as though she had never been murdered at all.

More noises were audible, and when William arrived at the foot of the stairs, armed with a mashie, he had a strange vision of his dead (or injured) darling. She was finishing a mouthful of biscuit and making sounds of welcome to a young and handsome man who had apparently just been admitted through the front door.

As William knew that Pamela was not expecting her husband to return that day the tragedy assumed a yet more terrible aspect.

Torn with Sharp Swords

The noise of William's hurried arrival on the scene caused Pamela to turn with a cry of alarm, which was succeeded by a squeal of joy translatable into "Billy! How lovely!" The

A STRANGE MAN!



"She was finishing a mouthful of biscuit and making sounds of welcome to a young and handsome man."

beautiful creature then cast herself upon William's bosom, torn though it was with sharp swords, uttering words of endearment. Meanwhile the young man on the mat twirled his hat and looked sheepish.

My case, gentlemen, still looks fairly water-tight in spite of the elimination of the murder. The defendants then made their statements.

(Continued on page 182.)



The "LOTUS BUD" A.C. TWO

Are you on A.C. mains?—If so, you will be interested to read about this new all-electric two-valver, the subject of the "M.W." tests described below.

ONE does not have to go back very far to remember the time when by far the greater majority of the "mains-on-the-premises" community used battery-operated sets.

A Radio Myth!

Either the household were scared of the possibility of a mains-operated set "blowing up" (though nobody knew quite why it should!) or else—and this was probably the real reason—the cost of such an outfit was out of all proportion to the entertainment service provided.

The "blowing up" idea is—and, for that matter, always has been—something of a radio myth, for with any well-designed mains set, and particularly for A.C., the chances of anything untoward happening are remote in the extreme. It's like the one in nearly four and a half million people who claims to have been struck by lightning, and who is instantly afforded such prominence in the daily press that a potential market for at least a million lightning arresters is immediately assured!

Tremendous Reductions

But it's safe to assume that it isn't the "blowing up" idea that has appreciably retarded the sales of all-electric sets—the greatest militating factor in the past has undoubtedly been that of high cost.

You will notice that the foregoing paragraph is in the past tense. It needs to be, and very much so, when an enterprising firm can present us with an all-electric two-valver—a two-valver as good as anyone could wish for—for the extremely reasonable price of ten guineas.

The set alone might not be considered expensive at that price, especially when one remembers the

extra equipment that is necessary to dispense with batteries entirely, but when a good moving-coil speaker and a handsome cabinet are thrown in with it, well, it is getting things down to a fine art, isn't it?

Yet that is the creditable achievement of the Lotus people, and all this is by way of introduction—justifiable introduction—to their new "Lotus Bud" A.C. two-valve receiver.

There appears to be a general move towards appreciable cuts in the prices of all-electric instruments at the present time, and even on that score alone the forthcoming exhibition at Olympia should be one of unusual

have any doubts, it is as safe and as foolproof as an electric bulb!

Before we give details of our practical tests with this new all-electric receiver there are one or two attractive features of the design that are well worthy of mention.

The Wavelength Range

First of all, have a look at the pictures accompanying this article, and particularly the one in the heading. They will give you an excellent idea of the general appearance of the instrument.

As you will see, there are four controls on the front, although from

YOU COULD MANAGE THESE WITH EASE!

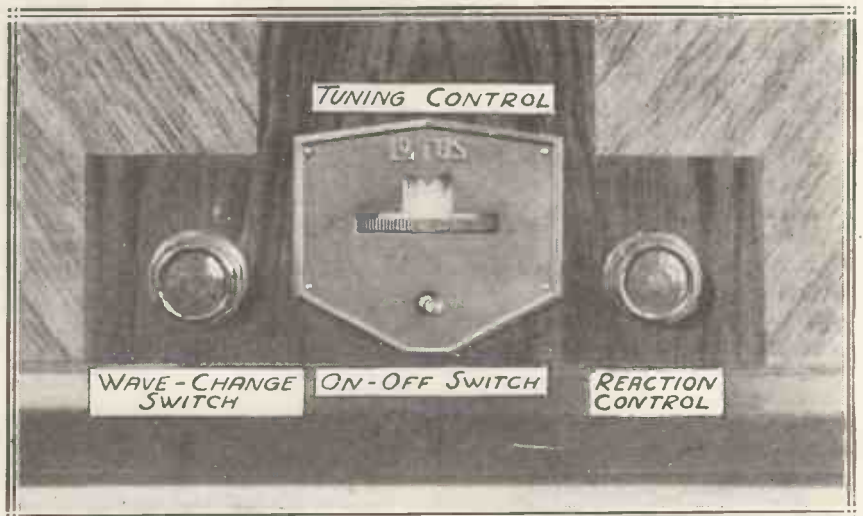

The new "Lotus Bud" is in every sense of the word a "family" set. It is remarkably simple to operate, and for a two-valver it is capable of excellent results.

interest. But the Lotus people have undoubtedly set the pace for two-valvers, and at the all-in price of ten guineas we have no hesitation in saying that we feel that this new Lotus production will want a lot of beating.

Really Efficient

It is neat in appearance, simple to operate, efficient as any two-valver could be, and, for those who may

the operating point of view it is perhaps hardly correct to refer to the on-off switch as a control.

The central control is the main tuning dial. Although it is mounted as unobtrusively as possible, it is easily accessible for tuning purposes, and in our tests we found it possible to make quite delicate adjustments without any tedious "finger twiddling." Immediately below the tuning

The "Lotus Bud" A.C. Two—continued

dial is the main on-off switch, which has a good positive action.

The control for wavelength range is the knob to the left of the tuning dial, and the change from medium to long is effected by rotating the knob in a clockwise direction. The only other knob on the front of the set—the one to the right of the tuning dial—is the reaction control, which works in the orthodox manner.

That is all very simple, isn't it?

Built to Last

Now, supposing we have a look at the set from behind before we go into the all-important questions of operation and results.

Immediately below the mains transformer, which is situated to the left of the loudspeaker, is a strip with three holes in it by which the set can be adjusted for use with A.C. mains voltages of from 200 to 250 volts.

It is perhaps hardly necessary to add that the receiver should be entirely disconnected from the mains while any adjustments are being made to these sockets.

Apart from this adjustment there is never any need to remove the back of the set except possibly for the purpose of changing a valve, but that is looking a bit too far ahead!

Now a word or two about the strip which runs right along the back of the set. The mains leads and earthing connection points are straightforward enough, but some guidance upon the use of the two aerial sockets would probably not be amiss.

The No. 1 socket, which goes direct to the coil, is the one which gives maximum volume regardless of selectivity. For that reason it will not often be possible to use it in cases where the set is being operated within 15 or 20 miles of a powerful regional transmitter.

Variable Selectivity

For those who are so situated the No. 2 aerial socket is the one which will be found to be the most suitable, for it brings a small variable condenser in series with the aerial, by means of which the selectivity can be adjusted to suit your own local requirements.

That explains the purpose of the knob on the terminal strip at the back. It controls the setting of the small series selectivity condenser.

For those listeners who are situated reasonably close to a powerful transmitter—by close we mean up to about

20 miles—the "Lotus Bud" A.C. two-valve receiver can be worked very satisfactorily in conjunction with a mains aerial, provision for which is made on the strip at the back.

The mains aerial plug when not in use is plugged into a special socket, but when it is desired to use it, it should be transferred to the socket marked "Aerial No. 1." Incidentally, when using a mains aerial in conjunction with an A.C. set of this description it is always a good scheme to try the effect of reversing the mains plug.

While on the subject of the design of the set it seems opportune to

in order to obtain adequate selectivity for the particular conditions under which the set was tested. But even with this selectivity control approximately half-way out there was still more than adequate volume from the locals for all normal domestic requirements, and the performance on the more powerful of the distant stations was very satisfactory for a two-valver.

An Excellent Proposition

After all, it would be unreasonable to expect a "fifty-stations-on-the-loudspeaker performance" from *any* two-valver except under freak conditions, but with the careful use of

A DETECTOR AND ONE L.F.

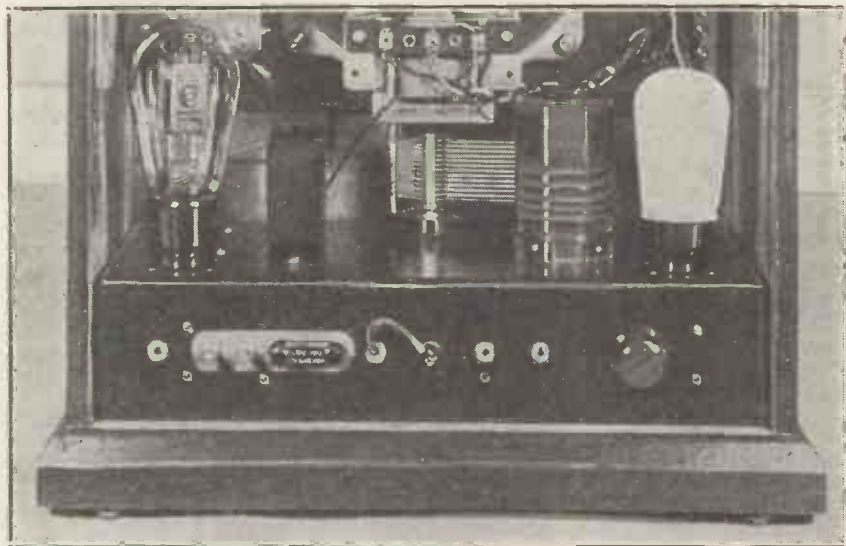

The "Lotus Bud" is a highly efficient two-valver employing a grid-leak and condenser detector, followed by a large power valve having remarkable characteristics and an undistorted output of over 1,000 milliwatts.

mention that the circuit—which is a detector and one note-magnifier—does not employ pentode output. The valve in the output stage is a Cossor 41 M.P., which, in addition to giving an output adequate in all respects for the moving-coil speaker, has a fairly high magnification factor.

The suitability of this particular valve in the output position of a set of this type is very well illustrated in the present case. For instance, in our tests with the "Lotus Bud" at a distance of approximately 15 miles from the London stations the volume and quality of the local transmitters were remarkably good.

On the Locals

We found it necessary to use the No. 2 aerial socket (the one that brings the series aerial condenser into circuit)

reaction it is definitely possible to get several alternative programmes at really excellent strength with this new Lotus model. And we regard that as a very creditable performance.

On the long waves, the first thing that impressed us was the complete absence of "break-through" troubles.

The set's performance on this wave-band was every bit as good as on the medium broadcast waves. 5 X X at a distance of approximately seventy-five miles was almost up to the standard of the local stations; while Radio-Paris and one or two of the other powerful long-wavers were quite comfortable to listen to.

For all those who are fortunate enough to be wired with an A.C. mains supply, the "Lotus Bud" A.C. two-valve receiver is undoubtedly an excellent proposition.

THOSE VARIABLE-MU VALVES

Practical details concerning the operation of the latest types of screened-grid valves.

By K. D. ROGERS.

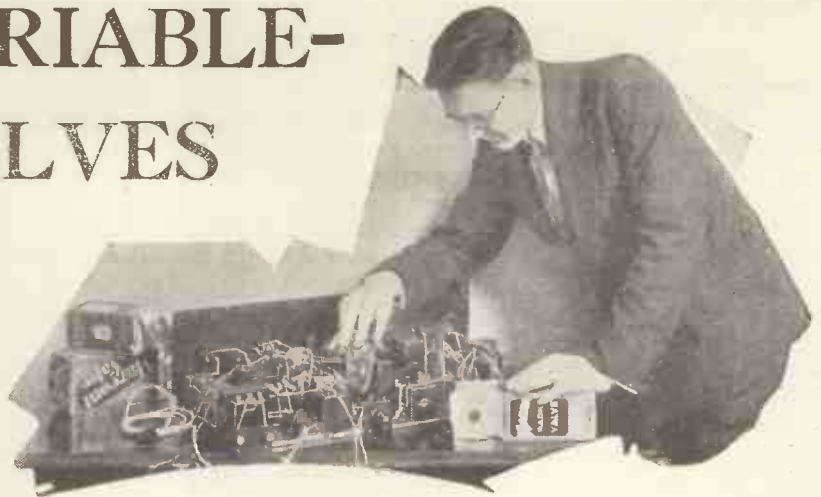

CROWDING of the stations in the ether, and the high degree of amplification available with the screened-grid valve, have combined to make the problem of volume control in a radio receiver no easy one to solve.

There are few instances where, with one or more stages of S.G. amplification, some form of pre-detector volume control is unnecessary. In most instances it is a vital

affect the tuning of the side of the band-pass unit to which it is attached.

In such a case it is often useful to use a resistance potentiometer across aerial and earth, though if the set is fairly powerful this may not be sufficient to enable the volume to be cut down to a whisper when tuned to the local station.

Differential Feed

Where a separately tuned aerial circuit is employed it is sometimes advantageous to employ a differential aerial condenser, but here again the cut-down of input is often not sufficient.

The old method of controlling the screening-grid potential is one that has been used with success, but it is not a really satisfactory method, for it upsets the characteristics of the screened-grid valve, and it will cause rectification to take place if carried too far.

There are snags in all the types of controls we have mentioned, for if the control does not affect the operation of the S.G. valve it will be likely to cause either flattened tuning, a throw-out of the tuning, or, at the most satisfactory case, a diminution of the input at the aerial which will necessitate the full amplification of the S.G. valve being applied to a faint input, thus making the valve noise that is so far inseparable with the S.G. valve, of large proportion compared with the required reception.

Background Noises

The result is that on the local station, when it would be assumed that the reception would be free from background noises, the received programme would tend to be comparable in quality with that of a distant transmission, due to the background hiss.

In the case of battery sets these disadvantages are inevitable at the

moment unless one particular make of S.G. valve is employed, but where A.C. is available and a mains set is constructed the problem can be solved by the use of the new variable-mu S.G. valves.

These enable the best form of volume control yet devised (of the pre-detector type, that is) to be carried out. It is a control that in no way upsets the tuning of the circuits, and it has no deleterious effect upon the operation of the S.G. valve, provided the correct adjustment is utilised.

Varying the Grid-Bias

In the case of the variable-mu valve the control is carried out by varying the bias on the main grid of the valve. This bias variation has the effect of varying the mutual conductance of the valve, from maximum (as the negative bias is increased) until it reaches a point where the

THE BATTERY TYPE



The first battery "V.M." valves were these Cossors.



FOR A.C. RECEIVERS

Since its recent introduction the variable-mu S.G. valve has done a great deal to assist designers of modern radio receivers, and has enormously simplified the problem of providing adequate pre-detector volume control. One of the earliest mains-operated types was placed on the market by Mullard. Here is a typical example of it.

necessity, and many modern receiver designs incorporate some such device.

The actual form the volume control takes is dependent upon the type of set, its power of H.F. amplification, and the sort of tuning circuits that it employs. Where the band-pass type of tuning is used care has to be taken that the pre-detector control, which is as often as not some form of aerial input control, does not seriously

The Constant Voltage Potentiometer Scheme

valve ceases to amplify, and, in fact, actually reduces the received energy, enabling on the local station the set to be fully tuned in without any fear that the detector will be overloaded.

The variable bias is obtained by a variable resistance (the value depending upon the type of valve) in series between the cathode and H.T. — In other words, it is in the normal position for auto bias.

It is not so simple as that statement would lead one to expect, however, as one thing has to be guarded against when the variation of bias is undertaken. This is the effect upon the characteristic of the valve of the necessarily accompanying change in anode and screened-grid current, and therefore of the voltages applied to the anode and screening grid.

Saving the Characteristic

Obviously, if the bias is increased (in a normal S.G. valve) the anode and S.G. currents will drop, and the

rectification (and consequent cross-modulation) would be defeated.

In order that the voltage on the screening grid shall remain constant, a rather ingeniously arranged resistance feed for the screening grid is arranged.

The values of these resistances, which are arranged as shown in the diagram, depend upon the type of valve used, and it is essential that they be correct.

The Practical Aspect

It will perhaps be easier to understand if we discuss the practical aspect of the resistances in relation to one specific valve, though it must be realised that this is only typical, and is not an exception to the main features of all the A.C. variable-mu valves now on the market.

We will take the Mazda A.C./S1. V.M. as our example, remembering that variable-mu's can be obtained from several of the other valve manufacturers, notably Mullard,

it is advisable to get the maker's recommendation as to values in every case where variable-mu valves are to be employed.

ENSURING A STEADY S.G. POTENTIAL

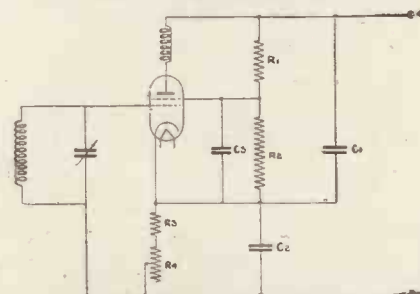

A typical potentiometer resistance system for controlling the new S.G. valves. The values corresponding to the various resistances, as they concern the Mazda valve, are given in the text.

Here are the characteristics, as far as it is possible to give them, of the Mazda valve :

Screen voltage ..	75	90
Anode voltage ..	200	200
Grid voltage ..	-1.5	-1.5
Mutual A.C. conductance ..	1.1	1.28
Amplification factor ..	600	440
Anode A.C. resistance (ohms) ..	545,000	345,000
Anode current ..	8.8	8.0
Screen current (approx.) ..	1.6	1.9
Mutual conductance at -35 volts bias, approx. ..	.005	—
Mutual conductance at -45 volts bias, approx. ..	—	.005
Inter-electrode capacities:		
Anode to control grid, effective ..	0.001	$\mu\mu\text{F}$
Anode to cathode ..	11.0	$\mu\mu\text{F}$
Grid to cathode ..	6.5	$\mu\mu\text{F}$

How It Works

The action of the valve in general is this. As the grid bias is made more negative by means of the cathode series resistance, the space current from those areas of the cathode covered by the closely wound portion of the grid is gradually cut off, so that only the portion of the cathode under the more open section of the grid is operative. The valve has been so designed that during the increase of negative grid voltage the anode current and mutual conductance characteristics follow a shape

WATCHING WHERE THEY GO

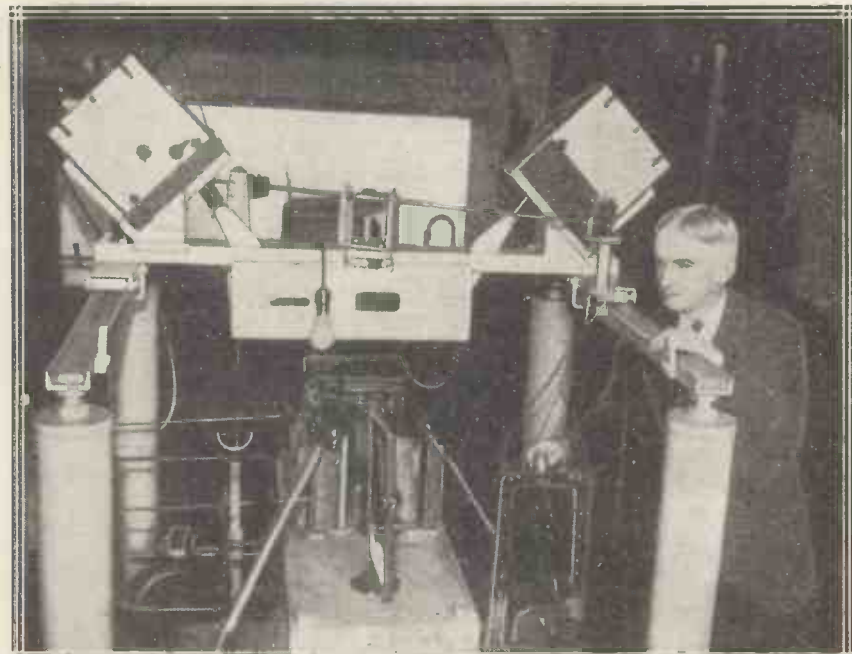

Some of the intricate apparatus used by an American Professor to photograph the tracks of atoms. Atoms travel, or rather bounce, at a tremendous speed, and so it is impossible to photograph them, but their tracks can be made visible and recorded.

voltage applied to these electrodes will rise. If this were to occur unchecked in the case of the variable-mu valve the characteristic would be upset, and its object of providing volume control without introducing

Marconi, Osram, Cossor and Lissen.

The table of values for the operation of the valves is that given by the makers, and, as the working out of the resistance network value is not easy,

"ATLAS"
WON "W.W."
OLYMPIA
BALLOTS
1930 & 1931

"ATLAS" AGAIN GO ONE BETTER!

*Wonderful New Model
for H.T., L.T., and G.B.*

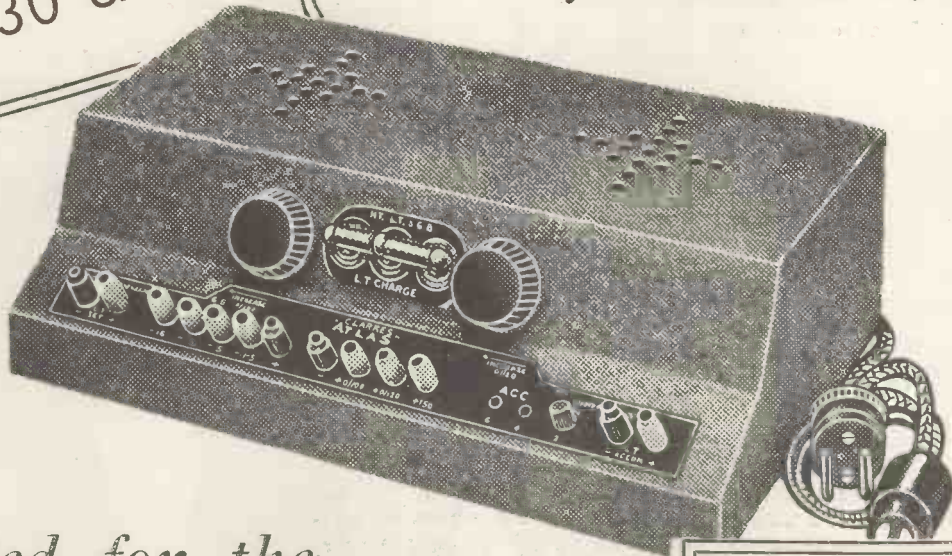

**OLYMPIA
STAND
91**

Specified for the "FIVE-GRID" FOUR

Only "ATLAS" can improve on "ATLAS." The outstanding features of last year's Olympia Ballot winner, hitherto acknowledged as the world's finest value, are now enhanced by the addition of alternative output tappings. This refinement ensures a constant and correct output voltage for all current consumptions up to 25 milliamps.

The new "ATLAS" A.C.300 is emphatically the last word in design and is ideal for the "Five-Grid" Four described in this number.

Ask your dealer to arrange for a demonstration and send coupon for full details of the "ATLAS" range of Mains Units and Components.

**"CLARKE'S
ATLAS"
MAINS UNITS**

H. CLARKE & CO. (M/cr.) LTD.
George Street, Patricroft, Manchester.
SOUTHERN OFFICES: Bush House, W.G.2.

MODEL A.C.300

For A.C. Mains 100/125 and 200/250v., 40/120 cycles. One Variable Tapping, 0/100v.; One Variable Tapping, 0/120v.; One Fixed Tapping, 150v. Three Alternative Outputs, 12, 18 and 25 m/A. at 150v. L.T. Trickle Charger, 2, 4 and 6v. Charging rate, 0.5 A. 4 G.B. Tappings, 1½, 3, 9, 16v. Safety Switching. Tapped Input. Double Adaptor. Size, 10½ x 6 x 3½., Westinghouse Rectifiers.

12 months' Guarantee.
CASH PRICE

£6 : 10 : 0

or 10/- DOWN and 9 monthly payments of 15/- each.

Regd. Design No. 765,640.

POST THIS COUPON NOW!

Messrs. H. CLARKE & Co. (M/cr.) Ltd., George Street, Patricroft, Manchester.

Please send me the "ATLAS" Folder giving full details of "ATLAS" Mains Units and Components.

Name.....
Address.....
M.W.8

Biasing the Mains-Type Variable-Mu

which minimises the factors responsible for cross-modulation and amplitude distortion.

As a result, as is the object of variable-mu valves, the amplification of the valve may be reduced to a very low value, and at high values of grid bias the valve can handle a large input signal without amplitude distortion or cross-modulation.

To achieve the necessary control the grid bias should be capable of being increased to -40 volts when a screen voltage of 75 is employed, or -50 volts if the screen potential is 90 volts.

The Screen Voltage

In use care must be taken to see that the screen voltage cannot rise above, say, 90 volts; otherwise, if the grid bias available is limited to 40-50 volts it may not be possible to reduce the gain of the valve to the desired value.

To achieve this limitation the screen voltage supply should be obtained from a potentiometer system, as already indicated. The screen current of individual valves is liable to variation; consequently, as the use of a fixed resistance in series with a high-voltage source causes the screen voltage to be uncertain, this method should not be used. For the same reason, any radio-frequency decouplers, if used in individual screen circuits, should have a moderately low D.C. resistance.

The recommended method of obtaining the screen and grid-bias potentials is shown in the figure. The values of the various resistances should be chosen so as to ensure that the screen voltage at the maximum bias is at least 75 volts, and the screen voltage with the minimum bias about the same.

Cross-Modulation

In the majority of variable-mu screened-grid valves the portion of the characteristic where the cross-modulation becomes appreciable is in the region of -4 to -10 volts bias. The maximum amount of cross-modulation obtainable in this region varies inversely with the value of the screen voltage, i.e. the larger the screen voltage in this region, the smaller will be the percentage of cross-modulation. In the screen potentiometer recommended for Mazda V.M. valves the screen voltage is

deliberately made to rise to a maximum in this region, so as to obtain a minimum amount of cross-modulation.

Amplitude Distortion

As the control grid bias is still further increased so as to obtain a low mutual A.C. conductance, amplitude distortion may become evident with excessively large signal inputs. This amplitude distortion is also decreased with any increase in the screen voltage, and the screen

for one and two H.F. stages, for a screen voltage $E_s = 75$ volts :

	R_1	R_2	R_3	R_4
1 H.F. stage	27,000	25,000	145	15,000
2 H.F. stages	13,500	12,500	72	7,500

In the receivers of the super-heterodyne types the valve may be used in both the radio-frequency and intermediate-frequency stages. It will also serve satisfactorily as the

TAKING THE TEMPERATURE OF STARS

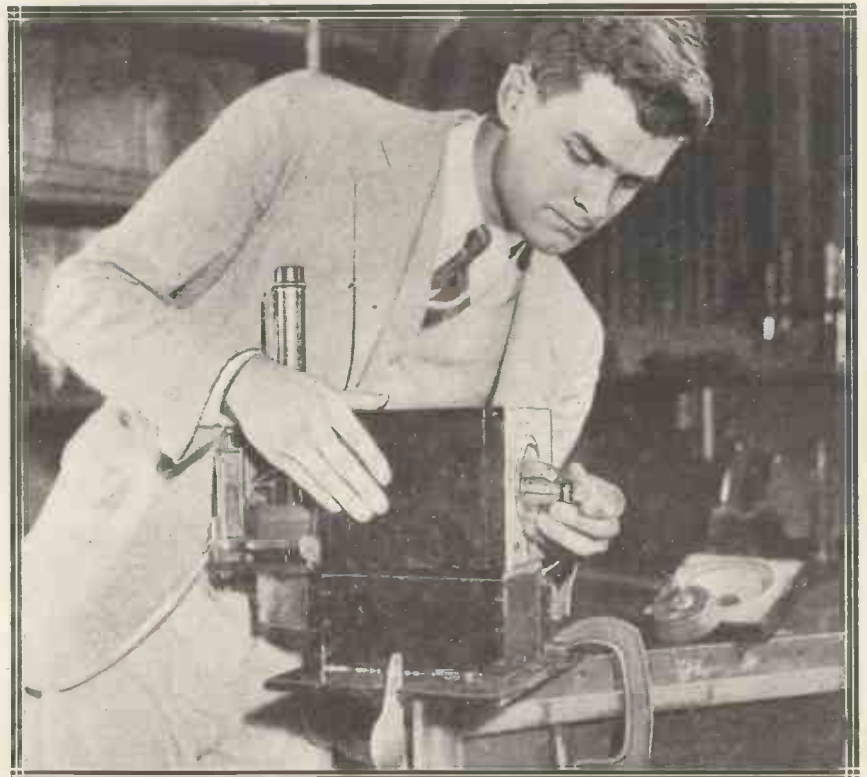

The photo-electric cell plays a great part in the modern methods of computing the temperature of the stars, for which it is necessary that their brightness shall be accurately determined. Here is a small ice-cooled cell unit that is used for the purpose.

voltage must therefore be maintained at a high value for the maximum bias.

As the bias required to reduce the mutual A.C. conductance to 5 microamps. per volt increases with increase in the screen voltage, the design of a potentiometer to give a minimum amount of amplitude distortion becomes a compromise under practical conditions. In the potentiometer recommended the screen voltage at maximum bias is about 65 volts, and this will prove satisfactory in the majority of practical conditions.

The table below gives the required values of R_1 , R_2 , R_3 and R_4 in ohms

first detector, where it will also assist in controlling the overall amplification. The valve is not suitable for use as a second detector or frequency changer.

It can be safely operated with a high difference of potential between heater and cathode, since the insulation is exceptionally high between these electrodes. When a high value of auto-bias resistance is connected between the heater and cathode, it is essential, in order to avoid interference, that a non-inductive condenser of at least 4 μF be connected across the resistance.

SPOTLIGHTS



PROGRAMMES

New Use for Broadcasting—A "Star" Overnight—Even Announcers are Human!—The Mystery Man of the B.B.C.—Where are the Radio Dramatists?

WHATEVER you may think of the programme policy of the B.B.C., its officials have one great virtue—they do know how to laugh at themselves.

It creates a friendly feeling at once when listeners realise that Broadcasting House can, for once in a while, come out of its shell and see the "funny side" of its more serious moments.

Which is why we should like to see many more programmes of the recent "General Post" or "Victoria" type. There will be fewer complaints about the programmes when it is realised that the B.B.C. is not going to be too serious about itself.

Really Amusing

A new use has been found for broadcasting in Spain. I hear that a councillor in Madrid, after making a very official radio speech, casually remarked, for the benefit of his cook, who was listening, that he would not be home for lunch!

I trust that the habit will not spread to this country, although it would be fun to hear Christopher Stone quietly informing his household that he would be kept late at the B.B.C. Knowing Mr. Stone, he would probably conclude his programme with a record of "I Shan't Be Home 'Till Morning!"

* * *

John Tilley (whom you see here) is definitely the Vaudeville department's "discovery" for this year. It did not take the powers-that-be long to capture this bright raconteur from the Windmill Theatre and turn him into a "star" overnight.

In this connection, incidentally, I claim a little personal credit for the discovery! After Tilley's first theatre performance in February of this year, I informed a very sceptical body of critics that he would be doing great things within six months.

The broadcast was in June, so I ran things rather close—but, then, I have discovered since that Tilley, though he has done most things in an exciting life, had not been on the stage before. Still, anyone who can lose a fortune running into five

WORTH DISCOVERING!



This is John Tilley, a new comedian, who has been the B.B.C.'s vaudeville "discovery" of the year. Until last February Tilley had never done any stage or microphone work!

figures and then become a comedian is cut out for success!

Times Have Changed

I have often sighed for the old days of broadcasting, when P. P. Eckersley and his colleagues treated us all as though we were each one of us helping with some very jolly new experiment. How we loved the breakdowns, the apologies, the impromptu songs and talks!

Broadcasting in 1932 is a much more serious business. But even so exalted a personage as an official announcer can become human on occasion.

Reading the results of the lawn tennis championships at Wimbledon one evening recently, our friend the chief announcer found himself faced with the name of Mlle. Jedrzejowska. Having with much difficulty achieved the correct pronunciation (as probably set forth in "Recommendations to Announcers regarding Certain Words of Doubtful Pronunciation"), the announcer heaved a deep sigh of thankfulness and murmured: "Got it!"

I hope that the Director of Programmes realised how much listeners appreciated this lapse from grace.

One Good "Turn" Deserves Another

Like John Tilley, Greta Keller, the Austrian singer, became famous via the microphone; and now she, in her turn, has introduced a young French singer to the B.B.C. The name of the new "discovery" is Colette Betty, she is twenty-six, and she has a deep voice like Fraulein Keller.

In fact, one good "turn" deserves another!

Wireless as an "Aid" to Domino Playing!

There is probably no better librettist for light shows than John Watt. Yet the programme officials are content to use him as a compère and occasional producer, while the writing of musical shows is entrusted to much less capable men outside Broadcasting House.

We had a glimpse recently of what Watt can do. "Postman's Knock," which he wrote in conjunction with



CLAUDE—AND MIKE!

Here you see Claude Hulbert making notes for the musical comedy "Postman's Knock," which he wrote in conjunction with John Watt.

Claude Hulbert, was undoubtedly the best musical comedy ever presented for broadcasting.

I hope that John Watt will see to it that he is not allowed to relapse into comparative obscurity again.

* * *

Can you tell a story? It has always been a mystery to me why so many men can get up after dinner and bring forth anecdote and wit of the most sparkling order, while the B.B.C. has to depend entirely upon A. J. Alan for its stories.

The "Hazard" Series

The series of "Hazard" talks has produced some individuals with charm of manner and exciting matter, but the B.B.C. seems to be doing nothing about it for the future.

A. J. Alan is the perfect story-teller. But half his success depends upon the complete mystery which surrounds his identity and upon the fact that his broadcasts are limited to three or four a year.

Probably the strain of keeping half a dozen speakers under such conditions would prove too much for the authorities.

But we should like more than two hours a year of this kind of entertainment.

Incidentally, I have been trying for several years to pierce A. J. Alan's anonymity. Vague rumours float around as to his occupation. He is a high Civil servant one moment and one of the engineers of the B.B.C. the next.

Very Mysterious!

However, I can disclose the exclusive information that A. J. Alan writes with purple ink, has a passion for picture postcards, and makes the B.B.C. his permanent address.

So much mystery surrounds this delightful man that I should be quite prepared to state, like the little boy who saw a giraffe for the first time, that "there ain't no sich person"!

* * *

Which brings me to a pet subject. Why, with so many plays written for broadcasting, are the radio plays so very mediocre?

"Squirrel's Cage," written in 1929, still remains the model for the new radio technique, and it has never yet been surpassed.

Young geniuses have been very slow to seize the opportunity which an entirely new art form has offered them.

John Drinkwater, with "Midsummer Eve," has led the way. Who will follow?

* * *

I am told that a number of seaside boarding-houses have now been provided with plugs at intervals round their walls so that visitors (I almost wrote inmates) may listen on headphones.

Justifying Those "Extras"

While this may be a trifle better than an antiquated speaker, I feel that it will not do much to brighten the boarding-house atmosphere, which is not conspicuous for its gaiety. Headphone listening may go well with knitting, but it will not improve bridge or even dominoes.

Still, it will allow the landlady to justify some of the charges for "extras," so somebody will be happy.

* * *

The studio audience is definitely becoming a nuisance. During a recent "music-hall" programme I had to switch off my set in the middle of an item because of the complete lack of discrimination shown by the audience.

They laughed and cheered every remark made by the comedians, apparently on principle, since the jokes themselves were of a very inferior order.

Studio artistes who play entirely to the visible audience are becoming more frequent, and their "acts" are consequently quite unintelligible as far as listeners are concerned.

A Definite Danger

The indiscriminating studio audience is a very definite danger to the success of B.B.C. vaudeville; and apparently the atmosphere of the studio is such that an audience loses its head and its sense of humour as soon as it takes its seats.

* * *

Do you remember a play by Philip Wade called "Oranges and Lemons"? It was broadcast not so very long ago and won a great deal of well-merited applause.

The author tells me that the B.B.C. has made arrangements for a repeat performance of this play at a not-too-distant date; while his latest effort,



DRAMATIST AND ACTOR

Philip Wade (whom you see on the left) is to have another play produced by the B.B.C. He is also a talented radio actor and took part in the production of his first play, "Oranges and Lemons."

a play called "Family Tree," has also been accepted for performance in the London studios.

Philip Wade was one of the best of the permanent theatre company which used to be a feature of Savoy Hill.

P. C.

**TECHNICAL
MEN ARE
ENTHUSIASTIC
ABOUT
THIS NEW
SET**

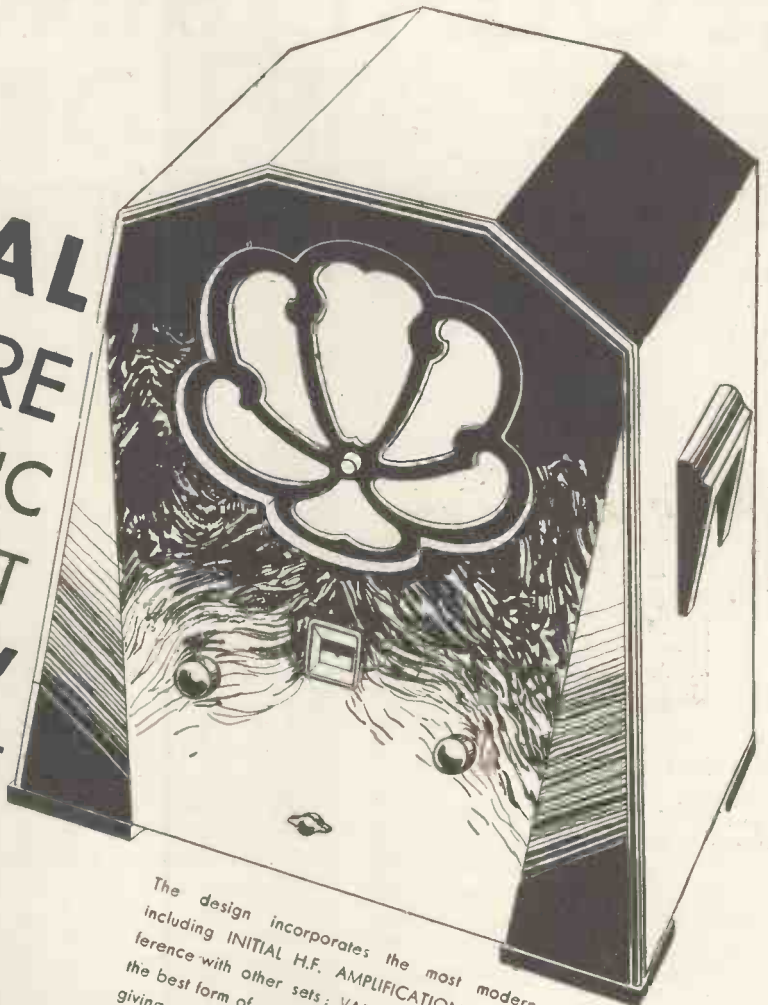

Widespread interest has been aroused by the introduction of the FERRANTI 7-Valve Super-Heterodyne. Knowing the high quality of FERRANTI components, technical men looked for an altogether outstanding performance from the new FERRANTI Receiver. The definite opinion of these practical-minded listeners is that the FERRANTI Super-Heterodyne is exactly what is wanted for modern radio conditions—an instrument built to standards of precision in every detail, and able to exploit the full possibilities of every kind of broadcast.

The design incorporates the most modern features, including INITIAL H.F. AMPLIFICATION, preventing interference with other sets; VARIABLE MU VALVES, providing the best form of volume control; GANGED CONDENSERS, giving one knob tuning; BAND PASS COUPLING, ensuring high selectivity without loss of high notes; MOVING COIL SPEAKER, for high quality reproduction; TONE CONTROL, to provide sharp or mellow tone at will; ILLUMINATED WAVELENGTH SCALE, giving instant station identification; AUTOMATIC MAINS AERIAL DEVICE, enabling the Receiver to be easily moved from room to room and used wherever an A.C. light or power socket is available, and GRAMOPHONE PICK-UP.

FERRANTI
7-VALVE SUPER-HETERODYNE CONSOLETTA

SEE AND HEAR IT AT STAND **78**
RADIO EXHIBITION, OLYMPIA. AUG. 19th-27th

RETAIL PRICE
22 GNS

Or by Deferred Payments -42/- down and 12 monthly payments of 38/6.

FOR ILLUSTRATED LITERATURE, WRITE TO:
FERRANTI LTD., HOLLINWOOD, LANCS., or BUSH HOUSE, LONDON, W.C.2

EQUALISING DIAL READINGS



An article dealing with the many advantages to be gained by arranging for equalised dial readings in a multi-dial receiver.

By D. GLOVER.

WHEN two tuning condensers figure in a radio set station-searching is much easier if their dials give similar readings.

Set designers choose their coils and condensers carefully in order to preserve as close a matching as possible, and if the constructor mixes his makes he is likely to upset matters very badly in this regard.

Not a Good Remedy

It is possible to get the readings in line over a part of the dials by loosening the dial of one condenser and twisting it round until it gives the same reading as on the other for the particular station which is tuned in at that moment.

But it is highly probable that this will result in either or both of two things: (1) A divergence of readings at other parts of the dials; (2) a restriction of the tuning range so far as readings are concerned at one or other of the ends of the dial. Let me explain this second fault in detail.

Supposing you tuned in the London Regional station and found that the readings on the two dials were 70 and 60.

Without changing the vane position of condenser number one you would loosen its dial and turn it round so that this, too, reads 60, and fix it permanently in this position.

But by altering the dial 10 points from its correct positioning relative to the vanes, your minimum capacities will carry no readings at all!

The End of the Scale

This, you might argue, won't matter a scrap, because the mere fact that you have had to retard the readings ten points means that you have the equivalent of that in extra and

unwanted capacity as inductance in the circuit controlled by the second condenser.

Quite so, but how about those stations which ought to be coming in over the uncontrollable and irrecoverable 10 points at the end of the scale?

The fact is you have lost a proportion of the wave-range on the one control. Stations falling within this band may still be heard, but not at their full strength unless the one circuit is so flat that a 10-degree mistuning doesn't matter!

GANGED CONDENSERS

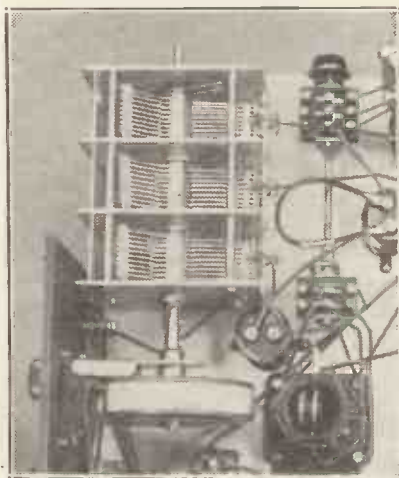

If a ganged condenser is used in a set it is most important to have the various circuits properly matched, otherwise difficulty will be experienced in balancing up the different sections of the condenser.

It is not advisable to bring the 70-degree reading into line with the 60-degree one by adding capacity to its circuit, for that is only rubbing-in the tuning restriction, as it were. Seldom or ever is any advantage gained by putting up a minimum;

more often it is desirable to reduce the minimum in order to cope successfully with such stations as Newcastle on 211 metres.

A Definite Fault

A wide discrepancy in readings is a definite fault. It should not happen in a properly designed and constructed receiver. If the correct coils and condensers have been employed the fault should be looked for in the wiring, and after that the components themselves must be suspected.

In some circuits, though not many modern ones, the aerial and earth may directly affect the readings of the first tuning circuit.

In such a case it is often possible to provide compensation in the form of a compression type condenser.

It is doubtful, however, that absolute symmetry will prove possible over the whole of the range. But, then, such a condition is most difficult to obtain even with specially designed apparatus, including specially matched coils.

One Will Be Flat

Fortunately, it nearly always happens that one or other of the tuning circuits is fairly flat. This is, indeed, something of an advantage, for a set with two extremely sharp tuning circuits would be difficult to handle.

In the usual way, then, calibration should be carried out on the one dial, and the operator can consider himself fortunate if the other dial lines up with moderate closeness all through the medium- and long-wave bands.

But more than a mere three or four stations should be used as a basis of the calibration, for a "curve" taken under such conditions is liable to be misleading.



"This Institute is particularly suited to give expression to the intimate connection between pure science and engineering. For the man by whose name those entering this house are greeted, the man who discovered wireless waves, Heinrich Hertz, who opened up to engineering new realms of vast extent, was, though an excellent experimenter, no engineer, but an investigator of pure science, who, when viewing his tiny sparks through the magnifying glass, was very far from suspecting that his discovery some day might prove of importance even to the engineer."

THESE words are quoted from the address delivered in Berlin by the celebrated physicist, Dr. M. Planck, at the opening of the Heinrich Hertz Institute of Wave Research (*Heinrich Hertz—Institut für Schwingungsforschung*). More than a year has gone in the meantime, and the new Institute has been taking an ever-growing importance in science and industry.

Several Sections

During one of his recent visits to its laboratories the writer was authorised to take a series of photographs, which it is hoped, along with a short account of the many-sided activities of the Institute, will interest the readers of this magazine.

The Institute, which is situated in Berlin-Charlottenburg, at a short distance from the Engineering College, comprises the following five sections:

1. General Electrical Engineering;
2. Telegraph and Telephone Engineering;
3. High Frequency Engineering;
4. Acoustics;
5. Mechanics.

Solving Their Problems

The following are some of the more important problems at present investigated at this unique Institute:

In the field of *Wireless Engineering*, any problems connected with the spreading of waves and atmospheric disturbances, the problems of acoustic broadcasting and television, the choice of proper standards for the gauging of radio receivers, etc.

An account of the work undertaken by one of Germany's premier scientific institutes, the Heinrich Hertz Institute of Wave Research, named after the great German scientist who first demonstrated radio waves. It is written from first-hand information obtained by our contributor during a recent visit to the Institute, and some of the photographs which he took are reproduced below.

In *Acoustic Engineering*, a systematic investigation of sound components contained both in human speech and the sounds of musical instruments, all general problems of physiological acoustics, the testing of acoustic apparatus—telephones, microphones, loudspeakers—an investigation of

proper conditions for satisfactory reproduction in a talking film, in architectural acoustics, the fundamental problems of sound transmission and the fighting of noise; the acoustic insulation of rooms, the testing of sound insulators and of conditions on which the acoustic efficiency of halls is dependent, and the gauging of resonance.

Up-to-Date Equipment

The ground floor and first floor of the Institute are mainly given up to laboratories for electric and acoustic tests. All of these have been equipped with water, gas, electricity and special high-tension supplies.

An optical signalling system enables any persons happening not to be in their rooms to be called

TESTING OUT AN EXPERIMENTAL SHORT-WAVER

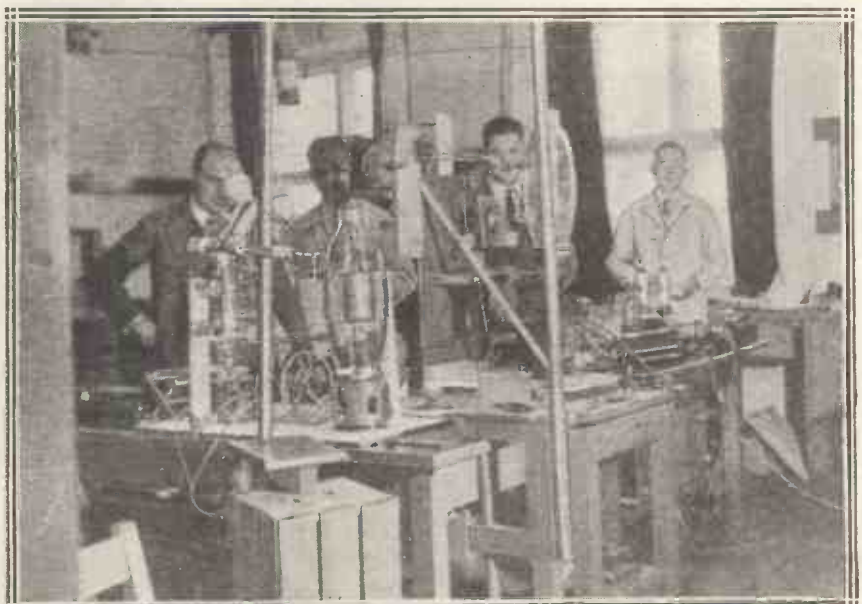

Here you see an experimental short-wave transmitter undergoing test in the laboratories of the Institute. Prof. G. Leithauser, who is in charge of this section, is seen on the extreme left.

One Hundred Million Cycles a Second!

to the nearest telephone from the telephone switchboard, buzzer alarms drawing their attention to the optical signs.

Provision has been made for darkening each of the laboratories belonging to the electric and acoustic sections by fitting the windows with light-proof blinds. In addition to the usual laboratory equipment there are instruments and apparatus for gauging the properties of telephone cables and a huge induction coil for generating extremely high voltages, which are used in connection with insulation tests.

Sound Absorption Tests

One of the acoustic laboratories comprises walls with a very smooth surface, raising the time of resonance to about eight seconds. The specific sound absorption of various materials is tabulated by ascertaining the times of resonance before and after the installation of the material. Moreover, there is an arrangement for putting up several walls between this and the adjoining room, and thus ascertaining the sound penetration of these walls.

Again, another room is highly damped, the time of resonance being reduced to about 1/10 second. This is insured by coating the walls with two intensely absorbent materials—Celotex and Insulite—which are applied above one another, five centimetres apart. The upper coat-

ing has been perforated, so as to reinforce the damping effect with the lower frequencies. Loud speakers and microphones are mainly tested here.

A special experimental outfit enables any sounds to be analysed

A WEIGHTY WAVEMETER!



This huge instrument is a standard wavemeter specially designed for measuring high frequencies. It employs a quartz crystal, and is capable of extreme accuracy.

as to their composition, the amplitude and frequency of component harmonics being recorded photographically.

The Radio Laboratories have been accommodated on the second floor, where conditions for reception with

emergency (room) antennæ are most satisfactory and connections with the roof antenna systems shortest.

Particular attention is, of course, given to short and ultra-short waves, the laboratory destined for these tests comprising below the floor an insulated coating of copper sheets which can be either earthed or used as electric counterpoise. Two high-tension laboratories and a music studio have been provided on the uppermost storey, below the roof.

An Experimental Transmitter

One of our pictures shows the experimental design of a short-wave transmitter for ascertaining the distribution of field intensities in the case of ultra-short waves intermediary between 8 and 10 metres. A high-power ultra-short-wave transmitter for a wavelength of 3 metres, or 100,000,000 cycles per second, serves for physiological investigations.

In another room there is found an outfit for accurately measuring the frequency of short waves: a standard quartz crystal having been excited in one of its upper harmonics, a very high harmonic vibration, as obtained by a special method, is made to interfere with the frequency to be gauged.

One interesting piece of apparatus I recently saw at the Heinrich Hertz Institute is a high-frequency-point-discharge loudspeaker. A high-frequency vibration having been stepped up to high tension, there are produced point discharges. The low-frequency, and, accordingly, the point discharge, is modulated, thus causing the air to vibrate in the rhythm of low-frequency modulation.

Television Section

Much attention is given in the short-wave section to television tests, there being several transmitters and receivers, special glow lamps for reproducing television images and apparatus for cathode television.

The Heinrich-Hertz Institute of Wave Research is placed under the general directorship of Professor K. W. Wagner, one of the highest authorities on telephone and radio engineering, while the short-wave section is directed by another renowned physicist specialised in wireless, Professor G. Leithäuser, who also conducts the television tests.

HOW MANY HARMONICS HERE?

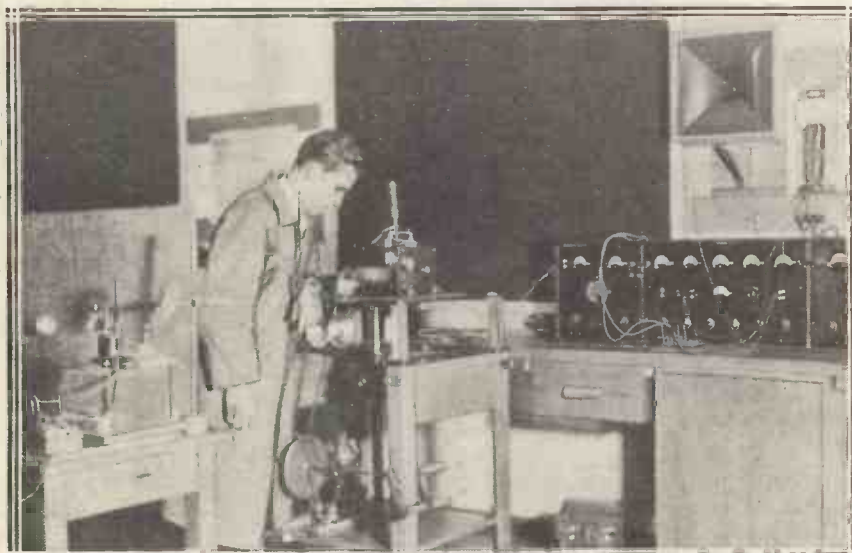

The apparatus shown in this photograph is also part of the laboratory equipment. It is used for gauging the composition of musical notes, and will register photographically all the harmonics.

B.I. ENAMEL COVERED WIRES

B.I. Enamelled wires are unequalled for the field windings of small motors, measuring instruments, radio transformers, and other pieces of electrical apparatus where space is all-important. They are produced throughout in our own works, from the raw material to the finished wire, and every phase of manufacture is under the strictest control as regards quality of material and accuracy of gauge. B.I. Enamelled Wire is unexcelled for its high insulation, dielectric strength, flexibility of enamel, and general dependability. We regularly manufacture Enamelled wire as fine as .002" dia.



BRITISH INSULATED CABLES
LIMITED
PRESCOT-LANCS

Makers of B.I. Cables

Telephone No.: PRESCOT 6371.

London Office: Surrey House, Embankment, W.C.2

Telephone No.: Temple Bar 4793, 4, 5 & 6

CHALLENGER"



35/-
COMPLETE

The R. & A. "Challenger" P.M.M.C. Reproducer is beyond question an outstanding achievement. The WIRELESS WORLD states:—

"Performance is such that it merits discussion from an absolute standpoint . . . overall sensitivity slightly better than average . . . reproduction of bass below 100 cycles quite definitely above average . . . full-bodied bass without boom . . . speech natural . . . balance in music exceptionally good."

The "Challenger" will operate perfectly with any set, from a 2-valve to a power amplifier, and will accept up to 3 watts undistorted A.C.

Your dealer can supply.
Refuse a substitute.

**REPRODUCERS &
AMPLIFIERS, Ltd.,**
Wolverhampton.



Permanent Magnet MOVING COIL REPRODUCERS

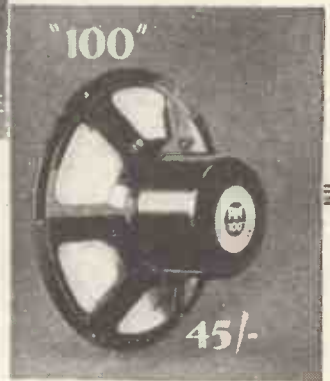

"100"

45/-

Of the R. & A. "100" P.M.M.C. Reproducer, the WIRELESS TRADER states:—

"In power-handling capabilities above the average . . . will deal with 5 watts undistorted A.C. . . . reproduction is very good . . . response rich and full-bodied. Tone will appeal to a wide public . . . plenty of bass . . . excellent value for money . . . will work well with quite a modest output valve."

A 3-ratio transformer for use with the R. & A. "100" is supplied at 12/6 extra.

YOUR COPY OF

"CAMCO'S" NEW CATALOGUE

is ready—send the coupon now and secure a copy. It contains the complete range of "Camco" cabinets with full particulars and specifications. The "Camco Popular" Radio-Gram Cabinet (rgd. design) illustrated is the finest value offered, with motor board shelf, baffleboard and automatic stay, shaded walnut finish, 75/- complete!

OLYMPIA STAND 123
CARRINGTON
MFG. CO., LTD.

Showrooms: 24, Hatton Garden, London, E.C.1.
Phone: HOLborn 8202.
Works: South Croydon.

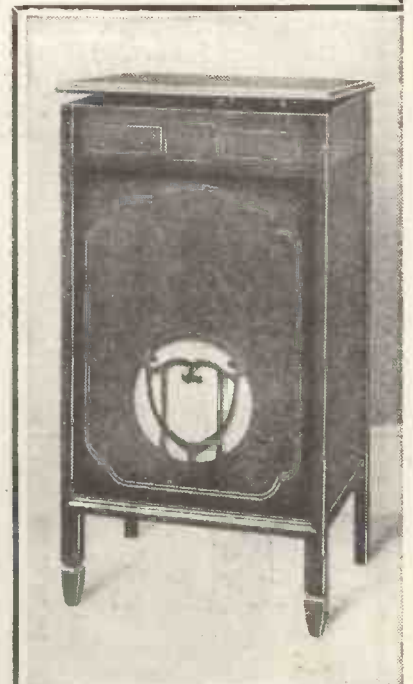

COUPON

Name.....
Address.....



M.W.12 CABINETS



FREE To-day!

Real Working Model—Fast Scout

BI-PLANE

The "CHUMS" CONDOR 1
Complete and Ready for Assembling

This single-seater Scout Bi-Plane is designed on the lines of the fastest R.A.F. machines. It is produced in full military colours, has a steel propeller; fitted with a modern undercarriage and metal tail skid, and will fly 75 yards.

CHUMS has been famous for many, many years—and is now more popular than ever. Every month it is crammed with splendid yarns—the sort that boys really like. Here you can revel in the daring exploits of well-known explorers, and unravel sea mysteries, and be thrilled with exciting tales of adventure, school and sport. Its regular features include two magnificent serials, a book-length story and short stories by the most popular writers of boys' fiction. There are also entertaining articles on hobbies, a special film feature, copious illustrations and

**8 Pages in
PHOTOGRAVURE**

CHUMS is a regular book for a regular fellow—buy it every month.

This is the finest working Model Bi-Plane any boy could have. It is given complete and ready for assembling with the August CHUMS—the premier magazine for boys. A second gift is also included in this issue—a magnificent

COLOUR PLATE

Entitled "At Grips with the Buccaneers," by CECIL GLOSSOP.

Then comes a wonderful budget of exhilarating stories and entertaining articles including:—

GALLEONS O' DEATH

A thrilling serial of Buccaneer adventure on the Spanish Main, by Rear-Admiral E. R. G. R. EVANS, C.B., D.S.O., R.N.

ALL THE SCHOOL WONDERED

A rattling fine school serial by the famous CHUMS author—ST. JOHN PEARCE.

NOT CRICKET

A magnificent long complete story by ROWLAND YORKE.

GHOST SHIP OF THE CLOUDS

by GEORGE E. ROCHESTER—a fine book-length complete story of daring adventure and peril in the air.

Splendid STAMP FEATURE

by FRED J. MELVILLE.

MODEL GLIDERS

An up-to-date article featuring details of The CHUMS Model Glider.

SPECIAL FILM SUPPLEMENT

A boy's guide to the pictures by HORACE RICHARDS.

CHUMS

The Most Up-to-date Magazine for Boys
Buy the AUGUST issue TO-DAY—with FREE GIFTS

1/-

AUTODYNE ADAPTORS FOR SHORT-WAVES

by J. ENGLISH

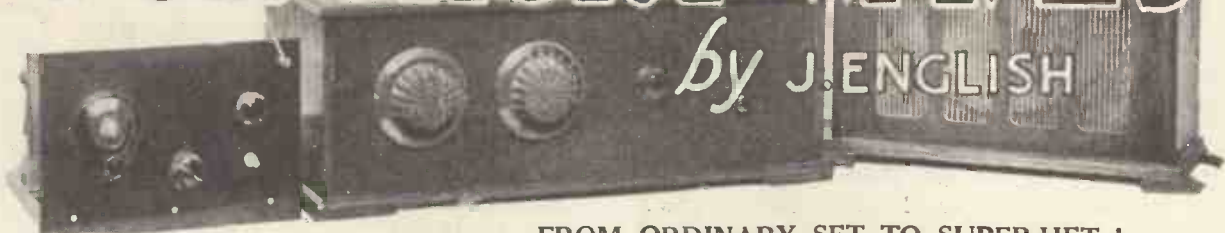

FROM ORDINARY SET TO SUPER-HET.!

FOR the man who is diving below the 100-metre mark for the first time there is probably no better receiver than the straightforward regenerative detector plus an L.F. stage.

Superior in Power

Of course, more experienced short-wave workers realise the limitations of this "straight" type of receiver. Consequently they are more able to appreciate the manifest advantages of the S.W. super-het., which is definitely superior both in range and power.

QUITE STRAIGHTFORWARD

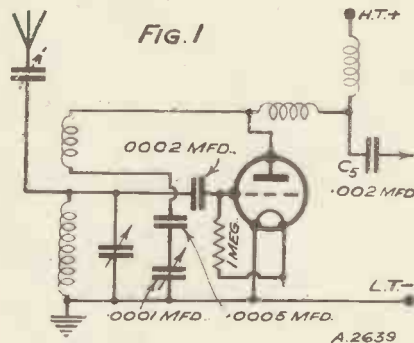

This is the circuit for a simple, single-valve autodyne adaptor. Its likeness to an ordinary short-wave adaptor is apparent at a glance.

Now in these times of economy few people can afford to construct a separate S.W. super-het. of four or more valves when there is the inexpensive alternative of making a one-valve adaptor. In conjunction with a modern broadcast receiver the latter will give you all the superiority of the S.W. super-het. at quite a small cost.

If you have been interested in the broadcast super-hets. described in MODERN WIRELESS you will remember that a separate oscillator is often used

The higher frequencies are attracting more and more interest as the months go by, and the old question of "super" or "straight" receiver keeps cropping up. This convincing and informative article shows the advantages of the autodyne system of reception on the short waves.—

SENSITIVITY. EASE OF CONTROL. SIMPLICITY.

to supply the local frequency that, mixing with the signal frequency in the first detector, produces the long-wave (I.F.) signal which is then passed for H.F. amplification to the I.F. stage.

In the S.W. super-het. adaptor we normally use a similar first detector and separate oscillator, the H.F. stage of the broadcast receiver then functioning as the I.F. amplifier. Although this type of two-valve adaptor is quite satisfactory, there is no reason why simplification and economy should not be carried a step farther by reducing the adaptor to just one valve. This can be done without loss of efficiency if we use an autodyne adaptor, in which one valve operates simultaneously as first detector and oscillator.

Nothing Complicated

There is nothing complicated about the autodyne adaptor; just a simple S.W. detector, oscillating under control, with a straightforward coupling to the first H.F. valve of the broadcast receiver. The autodyne detector takes up the S.W. signal and delivers a long-wave signal to the H.F. stage.

The latter is tuned near its maximum range to a wavelength free from long-wave interference and all tuning is then done with the adaptor. In operation the latter approximates to one-dial control, there being no critical adjustment of reaction, while

threshold howl and "dead spots" are extremely unlikely snags.

One of the simplest autodyne circuit arrangements is that of Fig. 1, which is so much like a normal S.W. receiver that with very little trouble the possibility of converting an existing one-valver or an old-type adaptor becomes an accomplished fact.

Two Chokes Employed

You will notice two H.F. chokes connected in series in the anode circuit. The first of these, a short-wave choke, merely deflects sufficient H.F. energy of signal frequency to secure oscillation without, however, impeding the flow of H.F. current at intermediate frequency. This latter, the long-wave signal, is then by-passed by the second choke, a standard type, to the broadcast receiver input circuit via the condenser C₅.

USING "ANODE-BEND"

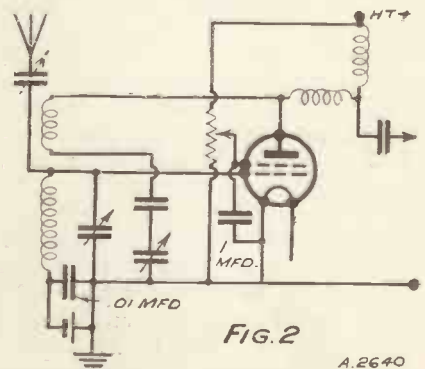

With a one-valve adaptor greater sensitivity can be obtained by making use of an S.G. valve. With this type of valve anode-bend detection gives maximum sensitivity.

Now although this adaptor has much in its favour as regards easy construction and operation, it is not the last word in efficiency.

Some Simple "Super" Circuits for the Short Waves

There is no doubt that the S.G. valve makes a more sensitive first detector in a S.W. super-het., especially when used as an anode-bend detector. Probably you have already experienced the better performance of the S.G. in the detector stage of your own S.W. receiver. Merely replacing an S.G. for the triode of Fig. 1 is not enough, however, as the fullest efficiency is only obtainable by careful adjustment of anode and screen volts, particularly the latter. But no very drastic alteration in the circuit of the adaptor is necessary, as you will see from Fig. 2.

THE HARTLEY SCHEME

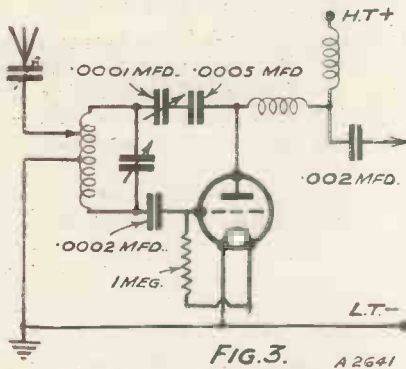

Here is a Hartley circuit that gives very good results. The old disadvantage of this circuit—that the variable condensers are "up in the air"—can be surmounted by employing extension handles.

Grid bias should not exceed 3 volts negative, usually 1½ volts is a more workable value.

If for any reason you prefer to use a triode detector, then another autodyne circuit, by no means original but well worth a trial, is that of Fig. 3.

The obvious objection to this circuit, which I know will occur to you, is that both tuning and reaction condensers are "up in the air." Thanks to modern developments in S.W. tuning condensers and screening, this argument no longer holds water. I find the circuit of Fig. 3 just as manageable as that of Fig. 1, and, with suitable layout and tuning arrangements, it has no hand-capacity worth bothering about.

A Valve Substitution

A very interesting modification of Fig. 3 can be obtained by substituting a screened-grid valve for the triode with suitable circuit adjustments. This comes out like Fig. 4, with the S.G. as an anode-bend detector and potentiometer control of screen volts.

The obvious advantages of this S.G. autodyne are simple tuning arrangements, free oscillation and, of major importance, high sensitivity.

For Sets Without H.F.

Now there is another type of two-valve adaptor which will appeal strongly to the very large number of listeners who use broadcast receivers of the det. and L.F. class. With the latter it is impracticable to use any of the adaptors so far described, as the essential I.F. stage is missing. In this case a decidedly attractive proposition is an adaptor combining autodyne detector and I.F. stage in one complete unit.

For this type of adaptor, a circuit which I find eminently suitable is that of Fig. 5. S.G. valves are used in both autodyne and I.F. stages, while a marked increase in efficiency results from the tuned-anode circuit adopted for the I.F. coupling. As you will see from the diagram, this coupling follows the series reaction choke, and is fixed-tuned to a suitable wavelength in the region of 1,800 metres.

The coupling between adaptor and broadcast receiver takes the usual form of standard H.F. choke and fixed condenser, and considerably simplifies the actual connections between the two sets. Incidentally, this connection should give a moderately tight coupling into the grid circuit of the second detector.

Long-Range Loudspeakers

With a dual-range receiver of just two valves, high-efficiency detector and power output, preceded by the adaptor of Fig. 5, I have received numbers of long-range transmissions, including well-known Americans, at

full loudspeaker volume. So powerful is this 4-valve super-het. combination that some commercial code stations make a really deafening din on the speaker.

INCORPORATING AN S.G.

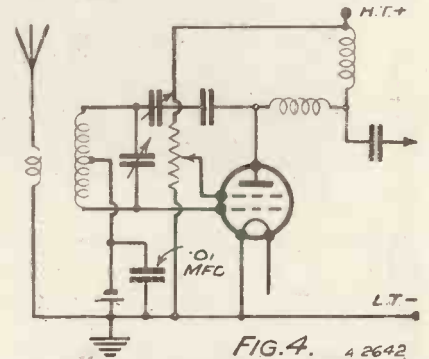

This is another Hartley circuit, only this time it has been "hotted up" by incorporating a screened-grid detector—a great improvement.

I am rather partial to the tuning scheme shown in Fig. 5. Here a special short-wave condenser (rating 0.0015 mfd.) is used, a fixed condenser of 0.002 mfd. being switched in parallel for the upper wave-range.

Plenty of Reaction

It is always important to see that the autodyne detector oscillates freely at all wavelengths. This is most easily tested with a milliammeter in series with the H.T.+ lead, current decreasing when the grid detector oscillates, increasing in the case of the S.G. anode-bend detector. Experiment will decide the best adjustments of screen volts and reaction-condenser setting. Maximum volume is only obtainable with the reaction control advanced some little way beyond the threshold of oscillation.

IT EMBODIES AN INTERMEDIATE STAGE

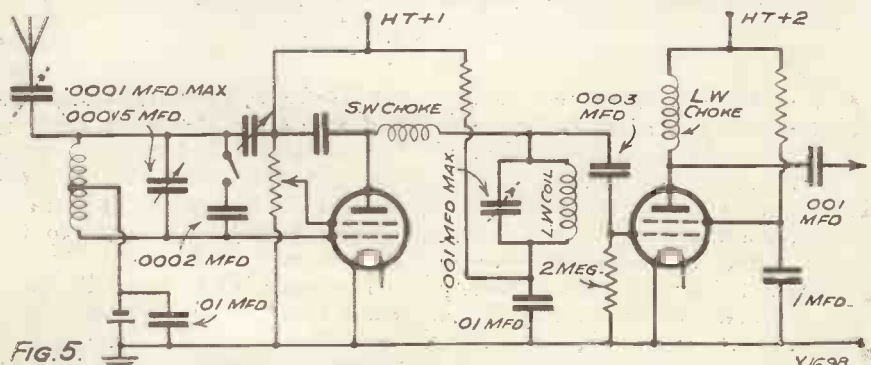

All the adaptor circuits shown previously are suitable only for sets in which there is a stage of H.F. amplification. This two-valve arrangement, however, has its own intermediate-frequency amplifier, and is particularly recommended for use with det. and L.F. sets. of all types.

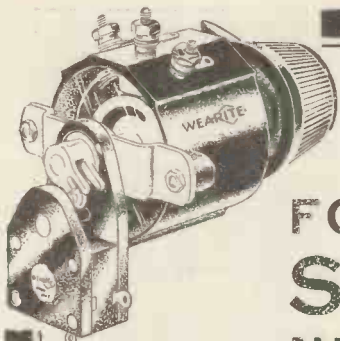

FOR EVERY SPECIAL NEED

Here is a standard Q.V.C. Volume Control and a standard G.40 Mains On-Off Switch mounted together - Price **6/6**

These Volume Controls are available in all values from 600 to 100,000 ohms.

HERE ARE THE WEARITE PARTS FOR THE "FIVE-GRID" FOUR
 Paxolin Panel, 16" x 8" - Price 7/6d.
 Two Cosmic Dual- each Range Coils. Price 5/6d.
 The Wearite Q.V.C. Volume Control (10,000 ohms) - Price 4/6d.
 One Wearite 3-pt. Push-Pull Switch (G23) - Price 1/6d.
 Three 4-pin Valve- each holders - Price 1/3d.

Write for special leaflets—and, if you have a technical problem, if it's components, write our Test Lab.—

WRIGHT & WEARE LTD. - 740, HIGH ROAD, TOTTENHAM, N.17 - Tel.: Tottenham 3847/8,9.

814

WEARITE COMPONENTS

Whenever a problem is presented for the simplification of construction or wiring, if that problem involves a component it is certain that the answer is in the "Wearite" laboratories. For over twelve years Wearite have laboured to produce components—not just those of everyday use, but components with a special function—a typical example of which is shown here. Whatever the component you need—follow the lead of the set designers—consult the "Wearite" Range first.



MAGNUM SHORT-WAVE ADAPTOR

MODEL T for British A.C. or Battery Sets.
 MODEL T.A. for American Sets.

PRICE - - - - **39/6**

Extra Coil, 18/40 metres, 3/-
 Full particulars and list of leading short-wave stations Free on request.

Particulars of the latest Burne-Jones "STENODE" are now available—free on request.

"MAGNUM HOUSE," 296, BOROUGH HIGH ST., LONDON, S.E.1.

Telephone: Hop 6257 & 6258.

Scottish Agent: Mr. ROSS WALLACE, 54, Gordon Street, Glasgow, C.1.

MODERN WIRELESS

REVISED ADVERTISEMENT RATES (Commencing August Issue)

SINGLE Insertion - - - -	£40 0 0
per page and pro rata to eighth page	
6 CONSECUTIVE Insertions	37 10 0
per page and pro rata to eighth page	
12 CONSECUTIVE Insertions	35 0 0
per page and pro rata to eighth page	
ONE INCH single col. (2½ in. wide)	1 10 0
Minimum Space (half inch single col.)	15 0

All communications respecting advertising must be made to

JOHN H. LILE, Ltd., 4, Ludgate Circus, London, E.C.4
 and NOT to Editorial or Publishing Offices. Phone: City 7261.

Proof!



of their AMAZING STRENGTH



These Dubilier Metallized Resistances are astoundingly sturdy. They have withstood a weight of 64 lbs. on a knife-edge across their circumference, and weights of 45 lbs. each have been suspended from their connecting leads.

Their performance in every way matches their phenomenal strength. Dubilier Metallized Resistances are made under a patent process and their range embraces a Resistance for every need.

Like all Dubilier products, these Metallized Resistances are as dependable as daylight. Whenever you need a Resistance . . . be sure it is Dubilier.

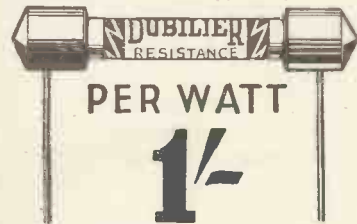

D.4

1 watt 1/-, 2 watt 2/-, 3 watt 3/-.

DUBILIER

Metallized

RESISTANCES

DUBILIER CONDENSER CO. (1925) LTD.
 Ducon Works, Victoria Road, North Acton, W.9

The "MICRO-CELL"

By a Correspondent.

Up to the present the use of the photo-electric cell has been more or less confined to television and talking films, but in this article a Correspondent describes a new use for this interesting device in recording microscopic processes.



IT occurred to Mr. Winckelmann, of Berlin-Friedenau, a well-known radio pioneer, a short time ago, that photo-electric cells might be used to investigate microscopic processes. Many difficulties were, of course, met with in this endeavour, which had to be overcome by the development of special apparatus. Two methods were mainly developed, both of which are discussed here.

Method I is the simpler of the two, though with instruments of precision it will lead to extremely accurate results. Its only drawback, as compared with Method II, is the necessity of reading the measuring instrument from time to time, whereas in the case of Method II, phenomena are recorded automatically.

The Apparatus

In the case of tests continued for some length of time, when phenomena have to be watched day and night, without any interruption, this would, of course, be the preferable alternative.

The microscopic outfit is made up of a lamp, a glass bulb holding about 1 litre, which is acting as concentrating lens, and the microscope itself. Above the latter, the photo-electric cell is arranged in a light-tight box, so as to be struck only by beams passing through the microscope.

Variouly coloured liquids are in-

duced into the bulb, in order, whenever required, to filter out of the spectrum any light-bands desired and to produce more or less monochromatic light. Photo-electric cells are, of course, of variable sensitiveness to the various colours of the spectrum, according to their actual construction.

Whenever the test is at the same time to be observed visually and recorded by photographic means, the bulb should be filled with a liquid closely agreeing with the colour of daylight.

Using a Neon Tube

In the case of Method II, the fluctuating current of the photo-electric cell is not transmitted to a simple amplifier system direct, as in Method I, but is used to control the discharges of a condenser through a glow tube. The underlying principle is as follows:

A neon tube is so connected up with a condenser and resistance scheme that it will glow periodically. The frequency of the periods of glow can be varied by altering the values of the

circuit components. In fact, any frequency desired can be obtained by suitable values.

This amplifier arrangement can be connected up to a loudspeaker direct, for listening to the oscillations. Whenever these have to be registered, a Morse recorder will do very well.

Possibilities of Application

Either of the two methods above described affords a ready means of recording any kind of Microscopic Process.

A particularly interesting example is illustrated at F in the figure, there being seen on the object-holder of a microscope a thin sheet of water containing a number of minute organisms of vivid coloration and great mobility. A brush either containing some trace of a chemical substance or applying an electric charge is dipping into the water, thus stimulating the small organisms, and attracting or repelling them. This play can be either gauged with the ammeter or listened to in the loudspeaker, or finally, recorded by the Morse recorder.

SOME SECRETS OF THE MICROSCOPE

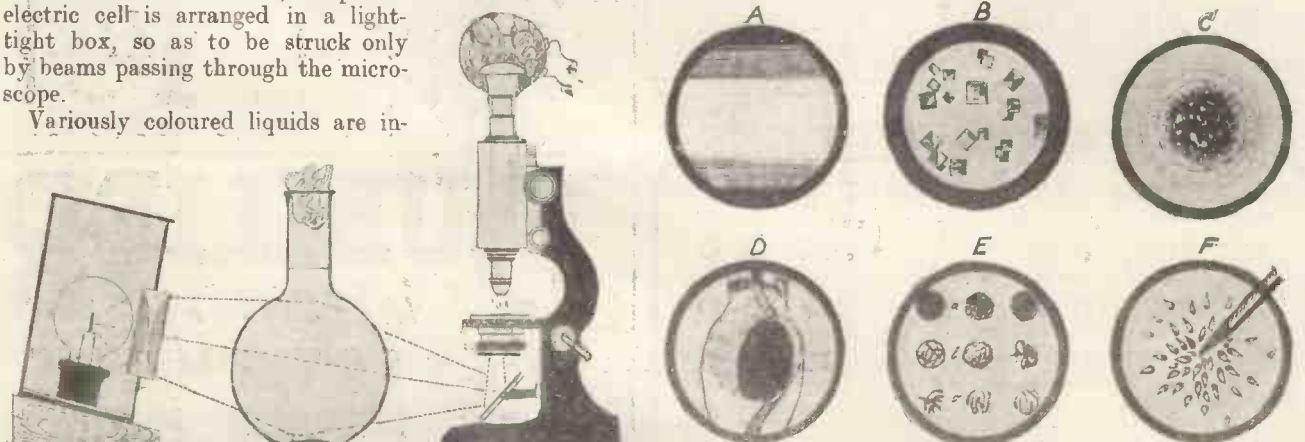

On the left you see the apparatus necessary for the experiments. It consists of a lamp shining through a spherical glass container filled with liquid which acts as a concentrating lens, directing the light on to the microscope mirror. The photo-electric cell is located in a light-proof compartment, so that the only rays it receives are those that come through the microscope. To the right are several microscopic views of different processes which the apparatus can be used to observe, as explained in the article.

The 'M.W.' CHARGER-CHANGER



Do you make the most use of your A.C. mains? You may not run your whole set directly from them, using A.C. valves, but with your battery set do you make the most of the advantages you have of being on the electric light supply?

No matter how small or large your receiver—unless, of course, it be of the crystal type—you will want H.T., and you will need L.T. Now H.T. can quite easily come from the mains via an H.T. mains unit, thus avoiding all bother of batteries and the troubles which accompany them. The L.T. can either be direct A.C. or can come from an accumulator.

VERY FEW PARTS REQUIRED

- 1 metal base-piece, approx. 7 x 3½ x 2 in. (see text) (Magnum, etc.).
 - 2 battery type lamp holders.
 - 1 lamp adaptor or two-pin plug.
 - 1 double-pole change-over (mains type) switch (Bulgin).
 - 6 insulated terminals with insulating washers (or ebonite plate to fit one side of metal base) (Belling & Lee, or Clix, etc.).
- Wire, flex, screws, etc.

If you are using A.C. valves, then we are afraid this article will not interest you, but if you are using an accumulator you will like the little idea we are about to unfold.

Done While You Sleep

The best way to solve the accumulator charging problem is to use a trickle-charger. But this, to be fully effective, must be arranged properly.

If you have a separate charger and a separate H.T. unit you are rather inclined to forget the necessity of switching on the charger when you close down the set for the night.

How easy it is (we have all done it) to switch off the set by means of the filament and the mains switches, and close down for the night. The filaments are out, the H.T. is off, there is nothing to worry about.

Here is an ingenious but simple device that makes trickle-charging from A.C. mains a quite automatic operation. It is a solution to the power problem that will appeal to a large number of set users.

Designed and Described by the "M.W." Research Department.

But there is something to worry about really. That accumulator ought to be recharged, and if you miss one or two nights with your trickle-charger it is ten to one that it will be weeks and weeks before you "catch up" again, and replace the whole of the charge you have taken from your accumulator.

The average trickle-charger charges at about a quarter of an amp., which means that it is not too much for the battery if after four or five hours?

service the trickle-charger is placed in action all night and left going until the set is used again on the following evening.

Thus in order to keep the battery in tip-top condition it is possible to have the charger going the whole time that the battery is not in use, assuming, of course, that you use the set fairly regularly every day.

Impossible to Forget It

What can be done then? It's no good tying knots in your handkerchief or winding thread round your little finger in order to make you remember to switch on that wretched charger.

The obvious thing to do is to make a little unit so that by one switch action you will switch off the set completely (both L.T. and H.T.) and switch on the charger all in one.

And this is what you get in the

A POWER PROBLEM SOLVED

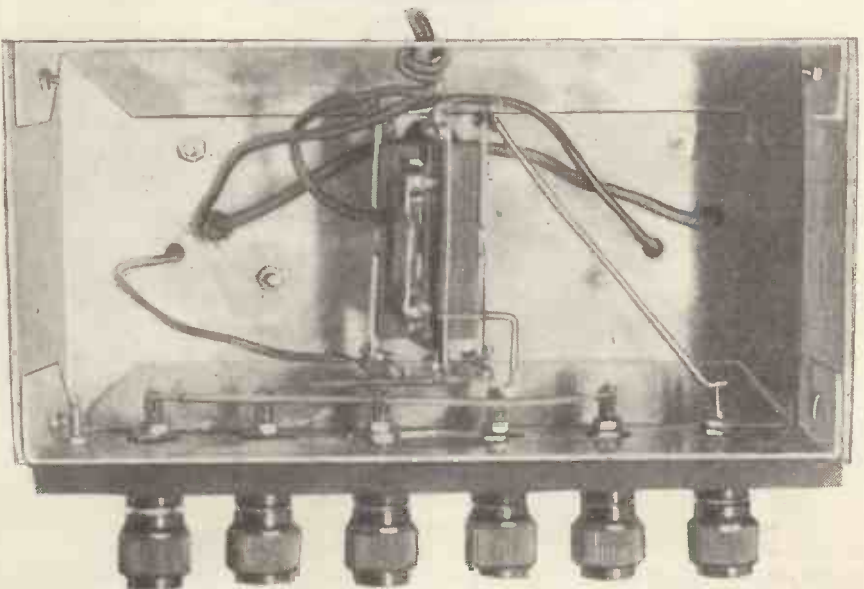

The switch and the wiring are protected by a metal case which makes the device safe for use by anyone.

There is Absolutely Nothing to Go Wrong

little unit which we have named the "Charger-Changer."

As you will see by the photographs, it consists of a small metal base about 3½ in. wide, and 7 in. long, and about 2 in. deep. On the top of either side are two ordinary batten-type lamp holders, and in the centre is a switch.

Permanently Connected

A row of terminals along the face of the unit and a flex lead coming out at the back completes the whole thing. It is simple to make, but invaluable in use, and it enables you at one flick of the switch to cut off your set and to switch on the charger, or, at the commencement of the evening's entertainment, to stop the charger and turn on the set.

You will see from the theoretical diagram that the unit consists merely of a double-pole change-over switch to which is attached a plug which goes into your mains. When the switch is in one position the mains are taken to one batten holder, into which is plugged the plug from your H.T. mains unit.

At the same time the switch allows the accumulator positive to make circuit with the L.T. terminal on your set, so that in one flick both the L.T. and the H.T. are turned on. When the programme is over you switch over and immediately the L.T. is cut off from the set, the H.T. unit is cut off from the mains, and the mains are taken over to the input side of the trickle-charger, the accumulator being switched over to the output of the charger as well.

Nothing could be simpler, and nothing could be more effective. You leave the L.T. switch on your set permanently "on," and you leave the H.T. mains unit plugged into the batten holder on the right of the unit.

The accumulator is permanently connected up to the centre pair of terminals, the L.T. charger output to the

left-hand pair, and the L.T. terminals on the set to the right-hand couple on the unit. Finally, the L.T. charger input is plugged into the batten holder on the left, the plug coming out of the unit at the back being placed in the mains electric light socket.

AN AUTOMATIC CHANGE-OVER

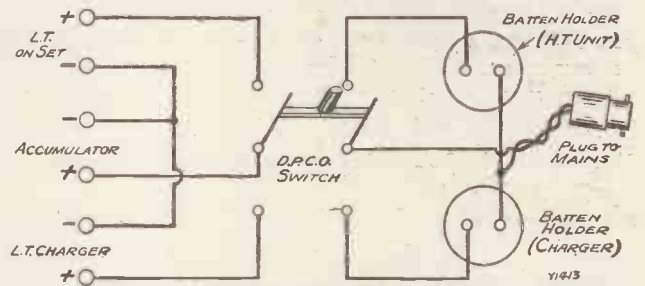

There is only one switch to operate, so you cannot possibly go wrong in the operation of the device.

The construction of the "Charger-Changer" is simplicity itself. The metal case can be obtained ready-made for a few shillings, and the parts additional to this are the two batten holders, the switch, and half a dozen terminals, with a length of flex and plug-in adaptor and a few odd bits of wire.

It will be noticed in the photographs that we used a terminal strip, cutting holes in the metal box to give clearance for the terminals, but it is possible to get special Belling & Lee insulated washers so that they can be mounted straight away in the metal box, thereby saving a considerable amount of work.

Don't Overcharge

The switch is well insulated, and is very simple to mount; this, of course, being fixed in the centre of the top of the box. The batten holders are arranged on either side, while the wiring, which is simplicity itself, can be clearly seen from the wiring diagram.

There are no snags in this little unit, and there is absolutely nothing to go wrong. But by its use the complicated arrangements of charging and mains running and on-off switches that so many home constructors use with their sets are done away with. The set becomes a real "household" proposition—one simple switch action turning it on or off at will.

By the way, just because you have the "Charger-Changer," don't regularly overcharge your battery; sometimes ten hours or so will be enough, and the charger should then be switched off at the mains.

CONNECTIONS BENEATH THE BASEBOARD

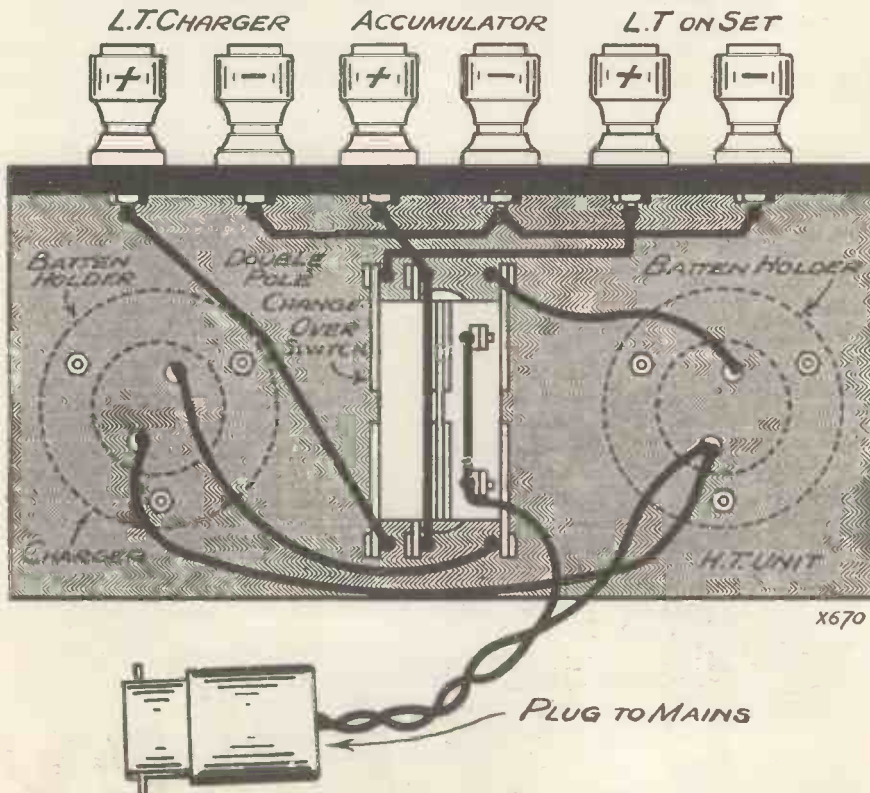

It is a simple enough job, but, as with any mains device, the wiring must be carried out very carefully indeed. Once made the "Charger-Changer" is perfectly safe to operate, but a wrong connection in the first place should be carefully avoided

You'll be proud to display your sound judgment of quality



if you build a Garrard Spring or Electric Motor into your Radio-Gramophone. Recognised throughout the world as the standard of quality. Garrard Motors are used by the majority of British Manufacturers, also by the B.B.C.

The Garrard No. 202a Induction Motor illustrated herewith is an ideal Motor for the All-Electric Radio-Gramophone Builder served with A.C. current.



Write to-day for complete illustrated catalogue of all Garrard Spring and Electric Motors. Free and post free on application.

THE GARRARD ENGINEERING & MANUFACTURING CO. LTD.
NEWCASTLE STREET, SWINDON, WILTS.



The GREATEST Kit & Component Suppliers in the WORLD!
Ready Radio

Head Offices: Eastnor House, Blackheath, S.E.3. Lee Green 5678.
Showrooms: 159, Borough High St., London, S.E.1.

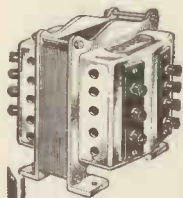

Above is an illustration of a new Mains Transformer, described below.

MAINS POWER

You can't miss this year's Radio Exhibition at Olympia—where all that is latest in Mains Equipment will be displayed on Stand 13. New Transformers and Chokes—of the proved "Heyberd" quality, Chargers—even better than before, and various items of Mains Equipment. But! . . . the feature of the Heyberd show is the latest design Mains Unit. Sturdy and compact construction—incorporating the tested Heyberd Transformer, two constant-inductance air-gap Chokes, Block Condenser, Westinghouse Rectifier, Resistances and Fuses. Modern clear-cut, aluminium-finished case—with recessed panel on top carrying the control knobs and terminals.

Secondary Tappings.	Cap.	Rectifier.	Rectified Output.
W.33 { 240 v.	200 ma.	H.T.g	300 v.,
{ 4 v.	5 amps.	A.C. valves	60 ma.
{ 4 v.	1 amp.	Power valve	35/.

Don't forget to visit our Stand

13
OLYMPIA.

F. C. HEYBERD & CO.,
10, FINSBURY ST., LONDON, E.C.2.
(One minute from Moorgate Und. Stn.)

FIRST

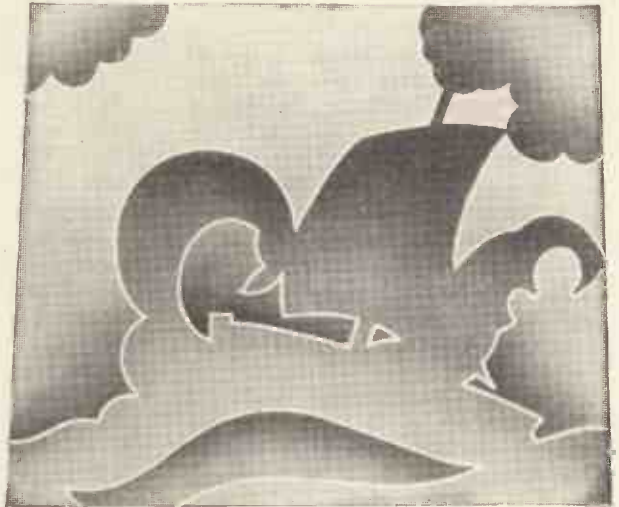

WITH WIRE-WOUND RESISTANCES

BI-DUPLEX
POPULAR
POWER
SPAGHETTI
TAG

A good anode resistance must be accurately rated and remain accurate in use. It must be robust, silent in operation and free from overheating or liability to break down. It must have a low self-capacity. *In short, it must be VARLEY, who first introduced wire-wound resistances for radio.*

WRITE FOR SECTION BC OF THE VARLEY CATALOGUE

Varley
Props.: Oliver Pell Control, Ltd.

Adv. of Oliver Pell Control Ltd., 103, Kingsway, London, W.C.2.

THE "FIVE-GRID" FOUR

—continued from page 142

compression-type condenser connected in the aerial lead and fixed to the baseboard behind the panel.

The very fact that it is behind the panel indicates that it does not often require adjustment. As a matter of fact, once set for your particular conditions it does not have to be touched again, either on the long or the medium waveband.

Its object is to provide a variation of the degree of selectivity appertaining in the set. All situations are not the same so far as interference is concerned, nor are all aerials the same size.

So the compression condenser should be set so that you get just enough selectivity for *your* locality and for *your* aerial. Keep it as near maximum capacity as selectivity requirements will permit.

Striking a Balance

It is quite possible, though, that you may have to compromise between the best position for it on the medium waves and the best position on long waves. It is at maximum capacity when the knob is screwed as far as it will go in a clockwise direction.

The pick-up jack we can neglect for the time being, because so long as the plug is not in position the receiver is set for radio reception.

Of the three switches along the bottom of the panel, the middle one turns the set on when it is pulled out and switches it off when pushed in.

The two other switches should be either in or out at the same time. They control the waveband for which the receiver is set, this being medium waves when they are out and long when in.

When tuning always keep the two tuning dials "in step." Since they are on condensers which tune similar coils, their readings will be very close to one another, if not equal, throughout their whole tuning range on both bands.

Controlling Reaction

The reaction knob increases reaction when it is turned in a clockwise direction, and decreases it when rotated in the opposite direction.

Similarly, the volume control knob increases volume when turned in a clockwise direction and decreases it when turned in an anti-clockwise direction.

Reference to volume control brings to mind the fact that this control is inoperative when a pick-up is in use. When the pick-up plug, to which the leads from the pick-up are joined, is put in the jack, the circuit prior to the detector's grid is put out of operation—the volume control with it.

Across the Pick-Up

So a separate volume control is needed for the pick-up, and it should preferably be fitted to the motor-board. After all, this is really its proper position. (Many pick-up arms are now fitted with an incorporated volume control.)

A potentiometer with a resistance of around 100,000 ohms should be used. The ends of the resistance element are joined to the two wires coming from the pick-up.

The two wires that come from the pick-up plug are then taken, one to the slider of the potentiometer, and the other to one end of the potentiometer's resistance. It does not matter which, either being just as effective.

There are only two H.T. positive taps, so you should have no difficulty with joining up to the H.T. supply. H.T. +2 should have 120 to 150 volts, and H.T. +1 from 60 to 80 volts. Find the best value for the latter by trial.

There are three grid-bias taps, and the first (-1) supplies the detector valve when it is working as an amplifier for pick-up purposes. Apply 1½ volts to it.

Grid-Bias Voltages

The same voltage, or perhaps 3 volts instead, will be needed on -2, which serves the first L.F. stage. G.B. -3 feeds the last valve, and its value is dependent on the output valve employed and varies greatly from one type to another. Follow the maker's recommendations where this valve is concerned.

A word about the S.G. valve will be our final note. As the circuit employs a parallel-fed tuned-anode arrangement to couple the S.G. valve to the detector, and to give the set plenty of punch, you must stick to the valve recommended in the list of accessories.

If you don't the receiver *may* oscillate. If it does, everything—quality, distance-getting, and ease of control—will be upset.

Just follow our advice throughout, and you will not have any difficulty with the set, or any snags to overcome.

DEMOCRACY AND THE B.B.C.

—continued from page 97

The present attitude of the B.B.C. is splendidly exemplified in the vocal characteristics of its announcers. I am aware that a certain quality of voice is required to make a good wireless speaker; but the "microphone voice," as it is called, seems strangely allied to the Oxford accent. I can imagine the B.B.C. Governors grouped round a large table, speaking in Oxford tones, and attempting to cater for a proletariat which it never meets.

Public Entertainment

Let me make it clear that I do not accuse the B.B.C. of utterly failing in its attempts to provide public entertainment. Were that the case, wireless broadcasting would be as dead to-day as the proverbial doornail. I would go further and say that during the novitiate stage of wireless in this country, a dictatorial policy of sorts was absolutely essential. You could not expect an uninitiated public to subscribe worth-while opinions on its own welfare.

But in 1932 the public is no longer uninitiated, and the present method of wireless government has outlived its usefulness. There is no justification for dictatorship. Sooner or later a change in policy must come. The public must have representation.

What, I wonder, are the qualifications for a seat on the present Board of Governors? Granted the Governors are persons of proper integrity and responsibility, but what is there to prove them in touch with public opinion?

Not Representative

Certainly they are not representative of every class of society, which is what a truly democratic board should be. Their number, too, seems totally inadequate. Who is there to represent the Toms, the Dicks, and the Harrys, amongst wireless licence holders? Where do the housewives have their say? What safeguard is there that personal bias does not, or will not, direct the nation's broadcasting policy?

It is to the future we must attend. The B.B.C. claims it is not a government department, but it is sufficiently closely allied to the State to be considered such from all but the theoretical point of view.

FOR THE CONSTRUCTOR

Details for making a dual-range coil switch, and some hints on adapting terminals.

I THINK that Dr. Roberts was originally responsible for the design of this switch, which, in its modified form, I have found very useful for earthing various points of a

A CONVERTED RHEOSTAT

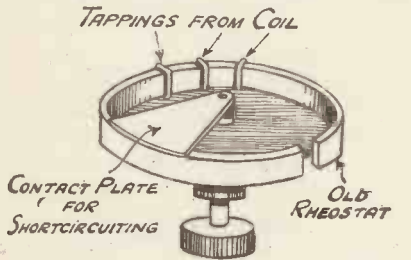

A.2684

By means of slight alterations an old variable resistance can be made into a really efficient wave-change switch.

dual-range coil. It is adapted from a discarded rheostat.

The winding has been removed, and two or three slots cut in the former so that tappings from the coil can be

attached and left standing rather above the edge. The original narrow wiper has been replaced by a wide plate, which, as the knob is revolved, will connect the various tappings.

As the centre spindle is earthed, it is possible to short-circuit the various parts of the long-wave section when it is desired to work on the medium band. The usual thin wire used for winding coils will not stand up to much friction, so it is better to make the connections to the switch with wire of much stouter gauge.

* * *

The absolutely perfect terminal has not yet been invented, and whenever the telephone type or the W.D. model is used for the purpose for which it is not designed there are grounds for much dissatisfaction. The sketch illustrates the best plan for adapting such terminals for other purposes.

The telephone type can be made to give quite good service if a thick

washer, such as was employed as a spacing washer in an old condenser, is placed beneath the screwed top and the post of the terminal. A spade-end or a twisted piece of wire can then be held securely beneath the washer and the top of the terminal.

The W.D. type can be used for telephone tags and the like if it is

DONE IN A MOMENT

A.2680

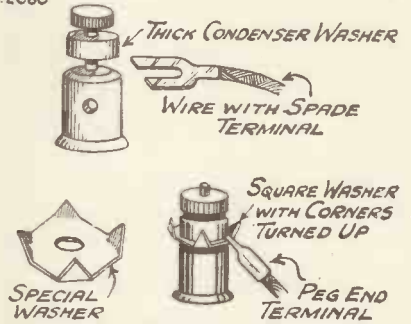

Showing how varying types of wire tags may be employed with different terminals.

equipped with a square washer, cut from a piece of soft brass or copper. The head is screwed down tight, and the four corners are then knocked up with a hammer. When a telephone peg is then inserted above the washer there is no longer experienced that disconcerting tendency to "squirt" out.

therefore, such as the "power" types already mentioned, must of necessity have an impedance of the order of 3,500 to 4,000 ohms, and can only be expected to give a moderate output.

If a valve capable of a bigger output is required, a valve of the "super-power" class, such as the P.M.202, must be used. But such valves have lower mag. factors, and therefore need larger grid inputs—which, indeed, they are designed to handle.

Doomed to Failure

To substitute a "super-power" for a "power" valve in the hope of getting bigger volume from the same input must result in disappointment, for the super-power valve, owing to its lower mag. factor, will actually give a smaller output.

Another point to be borne in mind also is that the larger valve consumes a greater anode current, and should not be used unless ample H.T. battery capacity is available.

If, however, you have a three-valve or four-valve set capable of providing a hefty voltage to the grid of the

CHOOSING AN OUTPUT VALVE

—continued from page 131

output valve, a "super-power" will give you all the volume you need—at any rate, for the more powerful transmissions.

But here, again, comes a difficulty. The amplification factor of a large output valve is not great, and there are certain to be some foreign stations which, while heard at fairly good volume when using a "power" valve, will be too weak to give good strength when the super-power is used.

Two courses may be suggested for overcoming this difficulty. If you are really anxious to listen to the weaker foreign stations, you can use a "power" valve for the sake of the greater amplification, and employ a volume control to limit the signal, and thus prevent overloading the output valve when listening to the locals. In this case you must content yourself with medium volume all round.

Alternately you may employ a pentode (which combines the larger output of a "super-power" valve with even greater sensitivity than a "power" valve), also with some form of volume control, in which case you may expect great volume on the local stations and every worth-while foreigner which your set is capable of receiving.

THE RADIO EXHIBITION

AUG. 19th to 27th.

COME AND SEE US AT

STAND No. 8

THE SEPTEMBER

"MODERN WIRELESS"

WILL BE A SPECIAL ENLARGED NUMBER TELLING YOU ALL ABOUT THIS GREAT NATIONAL SHOW AT OLYMPIA.

On Sale AUG. 19th. Price One Shilling

BEHIND THE SCENES OF BROADCASTING

This month our contributor raises the question of realism in broadcast noises, and illustrates his ideas on the matter in a singularly interesting way.

WHAT is the value of realism in broadcasting? Has it any value at all? As I have already shown, it at one time appeared to be the object of our broadcasters to achieve realism at all costs.

I can give you a further striking illustration of this. Some six or seven years ago the Manchester station transmitted a broadcast version of one of W. W. Jacob's stories.

The Real Thing

Now, in those days the studios were located in a gaunt building in the Parsonage. At their back flowed the sluggish, dirty River Irwell, which threads its refuse-contaminated way through the very heart of the city.

They turned this fact to account by hiring barges which they had brought up to a point near the studios in order to provide realistic effects.

But I do not think listeners were informed of this arrangement, and if barge noises could have been produced as effectively in a "synthetic" manner, I cannot see why that should not have been done. It would have been both easier and cheaper.

And as with those Bournemouth sea sounds, it is quite possible that even greater realism could have been produced by skilfully manufactured imitations.

On the other hand, great skill in noise production is necessary in order to make these, and carefully rehearsed effects often fail badly. A case in point is the broadcast of the radio play "Waterloo." The sounds which were supposed to represent gun-fire were obvious "fakes," and could have been equalled by any drummer of any cinema orchestra.

A Poor Imitation

We heard them as a beating of drums and not as we should imagine gun-fire to sound. But that was purely a technical and not an artistic fault; anyway, the B.B.C. was hardly likely to consider hiring a battery of real guns as an alternative!

As a matter of fact, though, more of the effects sounds are "real" than is perhaps realised; the B.B.C. has a

wonderful collection of gramophone records of different kinds of car, bird, train and other noises.

That early enthusiastic search for realistic radio effects must not be thought of as being entirely waste of time. Indeed, it now stands as a glowing symptom of the enthusiasm with which our broadcasters worked in earlier days.

No Pains Spared

They are still good servants of the public, but whereas they are now doing scheduled daily tasks keenly, eight years ago it seemed to me that most of them were convinced that they had an entertainment mission to fulfil and that they spared no pains to "get over" with the greatest possible punch.

Mistakes were made, but there was an adventurous spirit abroad in the ether and plenty of evidence of the truth of that saying "nothing risked, nothing gained."

However, there is no going back, and, on balance, it is doubtful whether many of us would turn back the clock of broadcasting even if we had the power to do so. We have lost most

DON'T FORGET
THE
SEPTEMBER "M.W."
ON SALE AUG. 19th
IT IS A
SPECIALLY ENLARGED
EXHIBITION NUMBER
Price 1/- Order Now

of those intimately personal touches and microphone mannerisms with which the B.B.C. men once delighted us listeners, and there is to-day a depressing absence of novelties in the programmes mainly because so much material has been used that there are few if any novelties left!

But we have gained a comparative freedom from programme irregularities and from technical breakdowns.

I was speaking to Mr. Bishop, the assistant chief engineer, one day, and I asked him whether he ever sighed for the "good old days" when British broadcasting was in its earliest experimental stages of development.

He shook his head, and indicated Broadcasting House opposite.

"That," he said simply, "is very much better."

G. V. D.

IN PASSING

—continued from page 158

Pamela said: "When you had gone, Billy, I tried to work the wireless, just like you showed me, but I couldn't hear anything except a lot of whistles which weren't in the programme.

"So I did the washing and had lunch. I took the set up to the bedroom after lunch, had forty winks and then tried again, but it was no good, so I gave it up and 'phoned to Mr. Wonderby, asking him to pop in the next morning and put the set right.

"Well, next morning I got a card from father saying that mother had one of her bad turns, and could I go along right away and look after mother till Dorothy came back.

Breakfast Uneaten

"So I flew off, not even finishing breakfast. Then I remembered that Mr. Wonderby was coming, so I popped over the way and asked Mrs. Wonderby to ask him to get in the back window and mend the set and have a glass of sherry.

"Then I just flew off to mother's, and when Dorothy came home I rushed back. And here I am."

Next witness, Mr. Wonderby.

"It's like this, Bill. I felt a bit queer about climbing in like a burglar, but Pamela was frightfully keen on having that set put O.K. before you came back. Nothing much wrong with it and I got it going in half an hour.

"Then I had a cigarette and a glass of sherry. Unfortunately I broke the glass. As I had only taken a couple of sips I went downstairs, got another glass and went upstairs again.

Blood—and Whatnot

"Then I found that in breaking the glass (during which process I gave myself a nasty gash in the thumb) I had dropped the cigarette on the bed. I rolled the bedclothes up and stifled the smouldering part. Golly, what a mess! Blood—and whatnot.

"While I was listening to the set I heard an S.O.S. about a man I knew. I legged it down the ladder and went off to Evesham Cottage Hospital in the car. I had to leave all the mess in your bedroom, so I came round now to apologise."

We will leave William to recover, but I submit, gentlemen, that the unanswerable case for the prosecution has collapsed like a pricked bubble.

Whilst it moves —

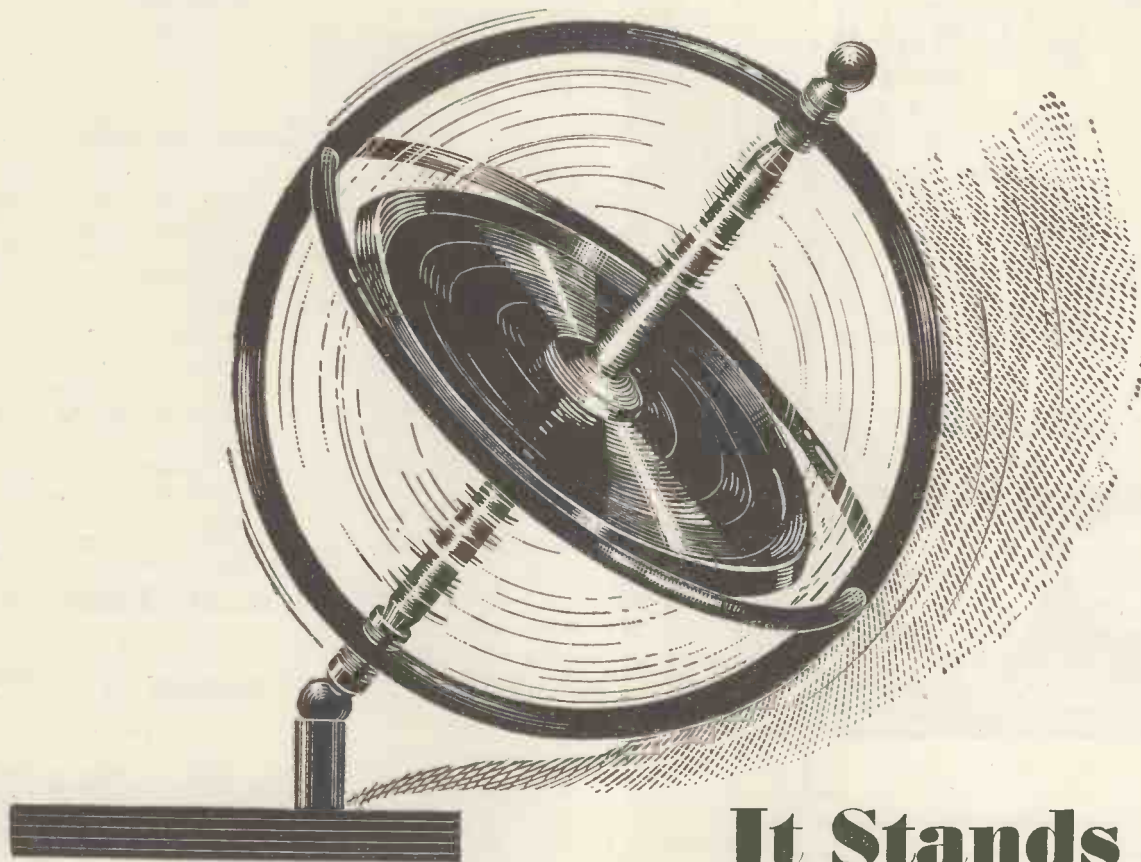

It Stands

THE stability of the gyroscope, which has been utilized for the steadying of planes, ships, trains, comes from the movement of its fast revolving wheel. It is stable only whilst the wheel revolves. The movement steadies it.

Business is like the gyroscope. Its greatest stabilising force is movement—forward movement—progress. And the progressive business to-day is the business that advertises.

Many an advertised product has continued to increase its sales throughout the recent lean years. Its goodwill has proved a bulwark against the storm. Carefully planned advertising has kept it forging ahead.

Many another advertised product has faced a sudden change in the market—produced a completely new line—and triumphed. The goodwill was inextinguishable. It descended at once from the old product to the new.

In the company reports of the firms that advertise and in their advertising itself, you can hear the smooth re-assuring hum of the gyroscope. You can see them going ahead, expanding, building goodwill and consolidating it.

*"It Pays
to Advertise!"*

Issued by the Institute of Incorporated Practitioners in Advertising in conjunction with the Federations of Master Process Engravers and Master Printers, etc.

A 30-2

HINTS TO BETTER RECEPTION. 3.

SIMPLIFY CONTROL

WITH THIS NEW DOUBLE POLE ROTARY SWITCH



Easy and simple to wire in any receiver, this switch controls your Radio, Gramophone and L.T. by the easy rotation of one knob only. Dustproof Bakelite construction, self-cleaning contacts. Indicating plate as shown.

Send 2d. postage for 75pp. Catalogue and special S110 Leaflet.

BULGIN

NO S110 **26** NO S110 **26**



Advt. of A. F. BULGIN & Co., Ltd.
Abbey Rd., Barking, Essex.

MOVING-COILS FOR THE MILLION



PM 4

42! PERMANENT MAGNET Moving Coil Speaker.

Complete with special output transformer mounted on top.

Glorious and true moving-coil reproduction from ANY 2-, 3-, or multi-valve set. No mains needed. Sheffield-made cobalt steel magnet guaranteed for 5 years.

Write for leaflets.

WHITELEY ELECTRICAL RADIO CO., LTD.
Nottingham Road, Mansfield, Notts.



Irish Free State Distributors: **KELLY & SHIEL, LTD.**, 47, Fleet Street Dublin.

THE "DIODION"
—continued from page 127

who wants to have the last word in purity of reproduction.

As regards this feature of the receiver, upon which we feel it is impossible to lay too much stress, you will be interested in one of the photographs in these pages.

Stringent Tests

It shows once again the thoroughness with which the set was designed. After having passed stringent sensitivity and selectivity tests, both on the ordinary aerial and in the sound-proof, induction and electro-static proof cabinet (a photograph of which is seen at the commencement of this article), the set was placed before a number of prominent musicians.

They were asked for opinions as to its merits or demerits on the quality side of broadcast reception. Not until there was unanimous decision in favour of the set was the design finally passed on to the last stage of its tests.

This was the hearing of the "Diodion" on a very large number of different makes and types of loud-speakers, so that we should know exactly how the set would sound in the various circumstances under which it would be used in readers' homes.

Tests under varying aerial conditions naturally followed, the receiver being taken to a number of districts round London and down to the coast so that its operation and performance under as many kinds of conditions as possible could be determined.

We have mentioned the sound-proof, interference-proof cabinet. This is a part of the test that is essential. It enables a close standard of performance for sensitivity and selectivity to be set up.

The Screened Cabinet

The cabinet is covered with metal sheet, which is earthed. Into it run either the main aerial or, with this completely removed, a screened dummy aerial feed from a local screened modulated oscillator.

In the first case only the pick-up from the aerial can reach the set, and so we can determine the receiver's actual sensitivity and selectivity on the aerial (apart from any direct pick-up on the wiring of the receiver), while the second case is even more valuable.

With the aerial removed entirely and the screened feed from the oscillator substituted, valve volt-meter readings can be made to determine the sensitivity and selectivity of the receiver when operated from a standard constant radio input.

Excluding Interference

No outside interference or pick-up can possibly be present, and the result of this test shows conclusively the degree of sensitivity and selectivity possessed by the receiver under examination.

It is useless to try to get an accurate indication of these factors by testing on the outdoor aerial alone. The field strength of the local or a distant station can be measured, but it is constantly varying; while local interference plays a large part in upsetting one's measurements.

The SEPTEMBER Issue
of
"MODERN WIRELESS"
is our
SPECIAL ENLARGED EXHIBITION NUMBER

ON SALE PRICE 1/-
AUG. 19th. ORDER NOW.

especially with a set of the description of the "Diodion."

Thus we use as a final test of all models of our sets the fixed input from the calibrated oscillator (really a miniature broadcast station) whose feed is taken via a screened lead direct into the screened cabinet. The whole tuning range, for medium and long waves, can be accurately covered by this means, and sensitive meter movements show at once how the set is behaving.

The "Diodion" is a compact receiver, and in appearance it gives no indication of the vast amount of work that has been done on it before it was deemed good enough to place before you as the star set of the year.

"HINTS ON HOME RECORDING"

Owing to a misunderstanding, the article titled as above, in the July "Modern Wireless," appeared under the wrong name, the author being Mr. H.E.J. Orton and not as given on page 83.

SENSITIVE LOUDSPEAKERS

Some Notes on Their Use.

WITH only a small maximum output it is very important to use a sensitive loudspeaker. Otherwise the volume output at the safe limit of the power valve will be inadequate. The temptation will then be to overload the power valve to get more volume, and thus distortion will be introduced.

The effect of the power valve impedance on quality is often most marked, and it is possible to exercise quite an appreciable tone control by changing the power valve. But there is a snag in matching the impedances.

For while it is true that the maximum undistorted power output is obtained when the impedance of the loudspeaker is about twice that of the power valve, this loudspeaker impedance increases as the frequency increases. Matching is, therefore, only right at one particular frequency.

A NEW VALVE DEVELOPMENT

Less Than Half-an-inch Across!

A NEW valve development which promises to introduce valves measuring only $\frac{3}{8}$ of an inch in diameter, and less than two inches in length, is covered by patent specifications of a prominent valve company.

From the specifications it appears that in the new valve the anode forms part of the envelope, just as in the large water-cooled valves used in transmitting installations, and thereby it has been made possible to design the valve to have much smaller overall dimensions than those in common use to-day. Instead of having the comparatively large surrounding glass envelope there is nothing outside the anode except two glass extensions of the same diameter.

The difficulty that seems at present to be troubling the inventors most is that of correctly spacing the grid and cathode from the anode, with the limited means at their disposal, so as to avoid microphonic trouble.

If this invention is put into commercial use some means will have to be found of insulating the exterior of the anode, otherwise there will be considerable risk of short-circuiting the high-tension supply.

SMOOTH AND ACCURATE SLOW-MOTION

J.B. ILLUMINATED VERNIER DIAL
Takes panels up to $\frac{1}{4}$ in. Fitted easily — only one round hole to cut. Scale mounted neatly behind panel. Smooth action. Price 5/—, complete with lamp-holder.

J.B. BASEBOARD DRUM DIAL
Exceedingly powerful, reliable and simple to fit. Mounts on baseboard independent of panel. Height to match J.B. Gang Condensers. Ratio 16/1. Oxidized silver or bronze panel plates. 7/6

J.B. PRECISION INSTRUMENTS

Advertisement of Jackson Bros., 72, St. Thomas' Street, London, S.E.1. Telephone: Hob 1837.

YOU, TOO, CAN BUILD SELECTIVE FAMILY 3

An amazing 60-Station Set described by "Maxamp" in "Tit-Bits," May, 1932.

AN AMAZING 60 STATION SET

The Selective Family 3

YOU CAN BUILD THIS SET IN AN EVENING

with this **PILOT RADIO ENVELOPE**

CONTAINING FULL SIZE BLUE PRINT 5 PHOTOGRAMS COMPLETE LIST OF PARTS AND FULL ASSEMBLING AND WIRING INSTRUCTIONS.

complete

PELO-KOTT CO. LTD. 77 CITY RD. LONDON, E.C.1. PIONEERS OF CONSTRUCTOR KITS IN 1919

EASILY BUILT IN ONE EVENING

PILOT ENVELOPE

Contains Full-size Blue Print, 5 Photograms, List of Parts with newly invented, Simplified System of Home Construction and easy-to-follow operating notes. Get your copy of the **PILOT RADIO ENVELOPE TO-DAY** and build this wonderfully simple family Receiver.

Obtainable from Book-stalls and shops of Messrs. W. H. Smith & Son, Newsagents and Radio Dealers.

1/-

Advt. of Peo-Scott Co. Ltd. 77 City Rd., London, E.C.1.

Famous Makers Offer! **£5** Radio-Gram CABINET for **65/-**

7 DAYS' FREE TRIAL (OR 10- MONTHLY.)

Polished Oak! and Piano built! The acoustic Tone brings a fine thrill. Makers to (Radio-Press, E.B.C. 3,000 clientele). Other Models 35/- to £15. Photographs and List FREE.

PICKETTS Piano-Tone Cabinets. (M.W.) Albion Road, Bexleyheath

MICROFU GOLD FILM FUSES

THE MICROFU is the fastest-blowing fuse known. The gold film blows under overload before the wire has time even to get warm. Put one in your set to protect valves.

NEW FLAT TYPE from 50 m/a upwards. Fuses 6d. Holders 6d. Complete 1/-.

Absolutely Reliable. 100% British.

MICROFUSES, Ltd. Telephone: 36, Clerkenwell Rd., E.C.1. Clerk 4049.

FREE A Luxury Wireless Set

or components of equivalent value.

Wonderful offer to introduce the Radialaddin Club. Write (enclosing 1d. stamp) for particulars.

RADIALADDIN CLUB (Dept. M.W.), 47/48, Berners Street, London, W.1. Museum 1821.

The ACME of CRAFTSMANSHIP High Grade RADIO GRAMOPHONE CABINET

of exclusive modern design, with record wells hand-made and polished, on Queen Anne legs. Figured Oak . . . £7 13 6 Figured Walnut or Mahogany £9 9 0 (Carriage Paid.)

Illustrated Catalogue Free. Cabinets made to order a speciality.

GILBERT Cabinet Maker, SWINDON

Estimates Free. Estd. 1866.

RADIO NOTES and NEWS of the MONTH

By G.B.



HARD words were used against the B.B.C. early in July, at the conference of the Museums Association, when Mr. J. A. Charlton Dees said the B.B.C. should not only think about the listeners' responsibility, but its own responsibility. Addressing the B.B.C. delegates, he said: "You people sit up all night devising ways and means and suggestions for the use of time, but if you give Britain the time as well as broadcasting you will have solved the problem."

He went on to say that the B.B.C. might act more usefully if it reduced the amount of jazz music which was broadcast. The B.B.C. was responsible for the production and encouragement of the most abominable jingle and bad English that had ever been scattered, and he was surprised that the B.B.C. could let pass some of the songs one had to listen to.

The music was bad enough, but when some feeble individual commenced to bleat the words it was a disgrace to British broadcasting. Tut, tut!

New Radio Boom

There are certainly definite signs of a new radio boom. For example, the G.E.C. has recently carried out further extension of its works at Coventry. Wholesalers who attended the G.E.C. Convention recently were greatly impressed by the new receivers which had been designed. A new departure in sets for the home assembler is the G.E.C. Osram 33 Music Magnet, which incorporates a built-in loudspeaker.

It is also reported that Ready Radio have a £30,000 advertising campaign in readiness. This campaign will be devoted to announcing that Ready Radio have abandoned their scheme of trading direct with the public, and will make use of the normal methods of distribution.

Preparing for a Million More Listeners

In fact, the radio industry is reported to be preparing for a million new listeners within the next few months, and factories all over the country are putting down new plant and increasing production facilities. Last year the radio industry sold £25,000,000 worth of sets and apparatus. In ten years the industry has come to the front rank; indeed, there is possibly only one other competitor—the motor trade—which can rank with the radio industry.

A Matter of Dress

According to the "News-Chronicle," dress reformers will find little to encourage them at Broadcasting House, where the clothes of 800 men and women officials are being subjected to a fairly close "censorship." It appears that office boys, messengers, and others of that ilk, have to dress to a standard of style—navy blue suit, blue or black tie, stiff white collar and black shoes. Senior members of the staff may use their own discretion in dress matters, except that at night time in the studios it is *de rigueur* to appear in evening dress.

The National Radio Exhibition

As most readers know by now, the National Radio Exhibition will be held at Olympia this year during the latter part of August. Incidentally, the Exhibition will serve to celebrate the tenth anniversary of the B.B.C.

At the Exhibition, visitors will see a model of the new British headquarters of broadcasting, and many other novelties.

Staggering Progress

During the last twelve months the wireless industry has increased its turnover by 50 per cent, and the Exhibition this year will certainly provide staggering proof of the amazing progress made by this ten-years'-old industry.

To begin with, the Exhibition will be about twice the size of last year's, and will for the first time occupy the main hall at Olympia. Two special

(Continued on page 187.)

No cutting of flex..No stripping of thread

Grips every battery socket and stays put even in portables under vibration—the resilient hard-drawn spring wire prongs (not soft brass) ensure exceptional self-adjustment and strength of contact. Side entry, with patent loading device—no tools required. 12 permanent indications.

(Patent)

The *whole* flex gripped—copper, rubber and braiding. No sharp cutting edges; no loose, straggling ends.

No jagged saw-cuts or cross holes to strip the thread inside the cap.

BELLING-LEE

FOR EVERY RADIO CONNECTION

Advt. of Belling & Lee, Ltd., Cambridge Arterial Road, Enfield, Middlesex.

RADIO NOTES AND NEWS OF THE MONTH
—continued from page 186

terraces are to be built inside the Grand Hall, and fifty miniature theatres, all soundproof, will be specially built for loudspeaker demonstration purposes.

Many Interesting Exhibits

One of the most interesting novelties for visitors to inspect will be a radio set which has no tuning dial. Visitors will be able to speak a code word in the direction of the receiver, which will, on hearing the voice, immediately tune itself. A list of code words is provided for this set in connection with the sixteen leading European stations.

To Attract Your Attention

Sets will also be on view provided with double loudspeakers. New Baird television receivers will be shown, and sets with all-metal cabinets and panels will undoubtedly attract wide attention.

Visit Broadcasting House

By the time this issue of MODERN WIRELESS is on sale, the B.B.C. will probably have announced details of a series of conducted tours of Broadcasting House for members of the public. Listeners who want to see the sights of Broadcasting House will have to apply for tickets in the same way as at present in force for getting permission to be present during one of the vaudeville broadcasts.

Peace Declared

It was reported in the Press that the so-called war between the gramophone companies and broadcasting concerns has ended. It has been a silly sort of war, in any case.

For a long time past now the gramophone companies have been quite keen on getting their records broadcast, but some companies held old-fashioned views that regular transmissions of records offered no inducement to the public to buy them. The peace proposals which have been satisfactorily concluded, were brought about by the Council of the International Union, and so from now on gramophone companies will be able to arrange for the broadcasting of their best records.

Most Likely, Too!

Although the National Radio Exhibition will be held in August this

year, it has been estimated in the Press that over a quarter of a million listeners will visit Olympia, and it is thought that before the Exhibition closes its doors the five-millionth wireless licence will have been issued.

A SIMPLE METHOD OF RESISTANCE MEASUREMENT

THE use of comparatively simple apparatus can be extended to the measuring of quite high resistances.

A milliammeter is the measuring instrument used, and the more sensitive the meter the higher is the resistance it is possible to measure. A multi-range milliammeter is particularly useful.

All we have to do is the measure the current passing through our unknown resistance when a given voltage is applied, then, by Ohm's law find the resistance, and from this deduct the resistance of the milliammeter if it is large enough to worry about.

To simplify calculation, a good plan is to make a graph. This we can make on graph paper, or preferably on logarithmic graph paper. If we use log. paper we are able to take readings of consistent accuracy over the whole resistance scale.

The right type of log. paper for us to use is that which is logarithmic in both directions—such as is frequently used for plotting sound intensity against frequency. This paper generally has numbers marked on it, starting from "1" in the lower

AN ORDINARY GRAPH

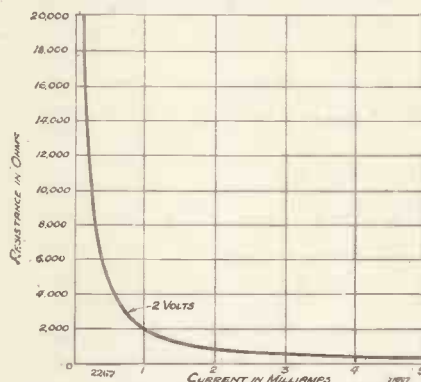

Fig. 1. Ordinary graph paper gives unsatisfactory low-value readings.

(Continued on page 188.)

TUNEWELL VOLUME CONTROL
Increases power of reception. Losses much less than with ordinary types. Logarithmically wound with double-silk-covered wire. Paper laid between windings.
Type V. All sizes up to 50,000 ohms. 5/6. Sizes from 50,000 to 100,000 ohms. 7/6.
Type P. Variable Resistance or Potentiometer. Equal resistance between studs. Max. Dissipation 3 watts. 5/6.



The NEW
TUNEWELL COMPONENTS
give you
SUPER-RADIO
at Lower Cost!

TUNEWELL WIRE-WOUND ANODE RESISTANCES
All values from 10,000 to 100,000 ohms.
3/6 each.
Bakelite Holder (for vertical or horizontal mounting) 1/6.

The standard of quality achieved by the new TUNEWELL Components has hitherto been approached only by the highest-priced products, but by careful design and lowering our profits, TUNEWELL have removed the old price-bar to Quality Radio. Send the coupon now for the TUNEWELL "Guide to Super-Radio"—an interesting folder you will keep for reference. It includes 8 Blue Prints (Band-Pass All-Mains 3, Kit Eliminator, etc.) and details of the new range of TUNEWELL Components.

TUNEWELL ALL-PURPOSE H.F. CHOKE
Wound on hollow-cored moulding. Capacity reduced to absolute minimum. Results unequalled by any other. Range 20-2,000 metres. 3/6.

TUNEWELL RADIO, LTD.
54, Station Rd., New Southgate, London, N.11

8 FREE Blue Prints

To Tunewell Radio Ltd., 54, Station Rd., London, N.11.

Name.....

Address.....

My nearest dealer is..... M.3.

Post this Now!

A SIMPLE METHOD OF RESISTANCE MEASUREMENT

—continued from page 187.

left-hand corner and going in two directions from the corner. We use both sets of numbers. Now we have to make our ohms and milliamps. correspond with the numbering on the paper, although where necessary we may add noughts on either side of the numerator. Obviously, therefore, we cannot start from zero, but must start from the lowest power of 1 we are able to use when measuring with our particular meter. Starting from this power we must mark the other numbers accordingly. If our meter reads up to, say, 5 milliamps., we start from .1 milliamp., mark up to 1 milliamp, and then in whole numbers mark to 5.

Filling in the Values

Following on this we must calculate the resistance that corresponds to the minimum current scaled and 1 volt, and place it at the top of the resistance scale. We must next mark all the other numbers accordingly. If we use a multi-range meter, extra scales can be marked alongside the first.

We must next draw a line diagonally across the paper from one high reading corner to the other as indicated by line "A" in Fig. 2. As we are unlikely to use 1 volt for measuring

with, we should draw other lines. parallel to the first for various voltages. If we use 10 volts we only need to add a nought on the right-hand side of our resistance numbers, so that, for instance, 10,000 ohms becomes 100,000

ohms. We use the graph in the ordinary way, as shown by the dotted line in Fig. 2. With regard to the resistance of the meter, this is better dealt with afterwards than allowed for on the graph. H.E.J.O.

USE "LOG. PAPER" FOR ACCURATE READINGS

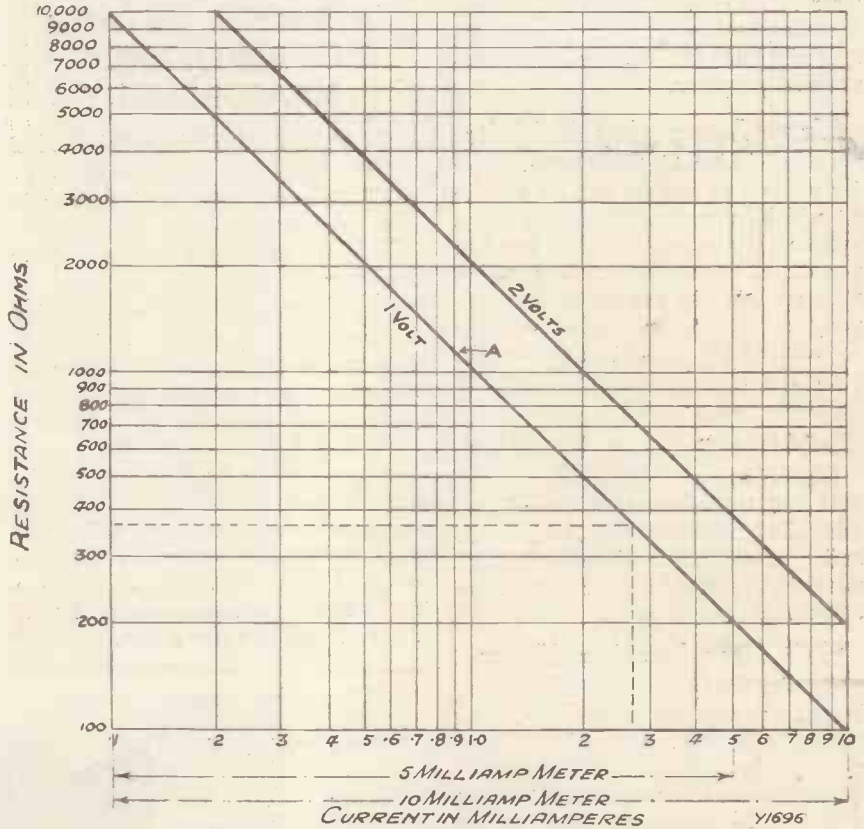

This easily-read scale is much better than that of Fig 1.

"OHMITE" RESISTANCE

Better than Wirewound
All values from 300 ohms to 5 megohms. Accurate and Constant 1/6 each. Holder 6d.

Made by **GRAHAM FARISH** Bromley Kent.

INDEX TO ADVERTISERS

	PAGE
Belling & Lee, Ltd.	186
British Blue Spot Co., Ltd.	Cover ii
British Insulated Cables, Ltd.	171
Bulgin, A. F., & Co., Ltd.	184
Burne-Jones & Co., Ltd.	175
Carrington Manfg. Co., Ltd.	171
Clarke, H., & Co. (M/cr.), Ltd.	163
Cossor, A. C., Ltd.	94
"Chums"	172
Dubilier Condenser Co. (1925), Ltd.	175
Edison Swan Electric Co., Ltd.	Cover iv

	PAGE
Ferranti, Ltd.	167
Garrard Eng. & Manfg. Co., Ltd.	179
General Electric Co., Ltd. (Osram Valves)	Cover iii
Gilbert, J. C. (Cabinets)	185
Graham Farish, Ltd.	188
Heyberd, F. C., & Co.	179
Institute of Incorporated Practitioners in Advertising	183
Jackson Bros.	185
Microfuses, Ltd.	185
"M.W." Revised Advertisement Rates	175
Peto-Scott Co., Ltd.	185

	PAGE
Pickett's Cabinet Works	185
Radialaddin Club	185
Radio Exhibition	93
Ready Radio, Ltd.	179
Reproducers & Amplifiers, Ltd.	171
Tunewell Radio, Ltd.	187
Varley Products	179
Whiteley Electrical Radio Co., Ltd.	184
Wright & Weaire, Ltd.	175

All communications concerning advertising in "Modern Wireless" must be made to John H. Lile, Ltd., 4, Ludgate Circus, London, E.C.4. Telephone: City 7261. REVISED ADVT. RATES—PAGE 175.

EVERYTHING **The G.E.C.** your guarantee ELECTRICAL

OSRAM
new automatic cushion
filament springing
ensures
ABSOLUTE CONSISTENCY



CONSISTENCY IN OPERATION

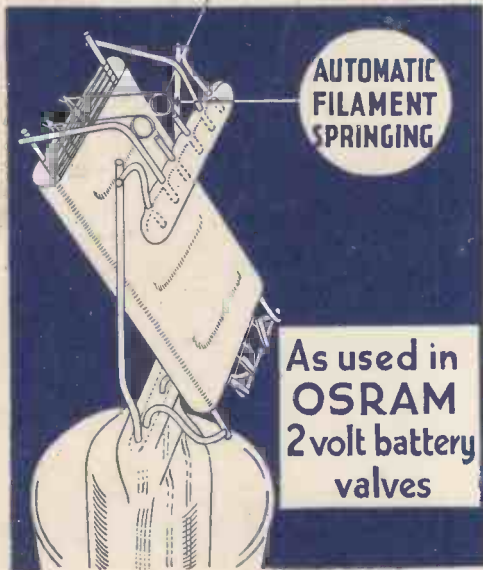

is as vital in a radio valve as in a ship's compass.

To ensure consistency, the position of the electrodes in any valve must *not vary*. Now, OSRAM, by momentous advance in valve design, remove all dangers resulting from filament expansion due to heat. More, the effects of internal and external vibration are *eliminated*. OSRAM filament-springing means consistent performance *always*—an end to microphonics, a dead silent background, longer and more useful valve life.

Osram
2 VOLT BATTERY
Valves
MADE IN ENGLAND
SOLD BY ALL WIRELESS DEALERS

WITH THE WEMBLEY FILAMENT

Advt. of The General Electric Co., Ltd., Magnet House, Kingsway, London, W.C.2

DESIGNED BY BRITISH ENGINEERS

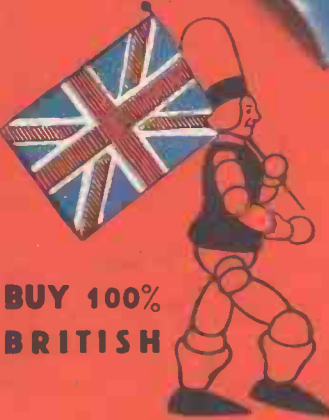

**BUY 100%
BRITISH**

LOOK
FOR "EDDY"
IN YOUR
DEALER'S
WINDOW

The amazing

MAZDA THE BRITISH VALVES

**See our
Stand at
RADIOLYMPI**

(Aug. 19 - 27)

Mazda valves are standardised by most leading British receiving set manufacturers. They are designed by British engineers and manufactured throughout in our British factory devoted entirely to Mazda valve production. You can buy with confidence!

Always ask for Mazda valves—your dealer has them.

The Edison Swan Electric Co. Ltd.

Incorporating the Radio Valve Business of



155 Charing Cross Rd. London. W.C.2

The British Thomson-Houston Co. Ltd.

V.