

EVERY LOUDSPEAKER CRITICISED AND CLASSIFIED

MODERN 1/- WIRELESS

VOL. XVII · N° 65

MAY 1932

LOUDSPEAKERS OF TODAY

SEE SPECIAL
SECTION INSIDE



This month we present the most comprehensive survey of Loudspeakers that has ever been attempted. It will prove of interest and value to every listener desirous of acquiring the latest and most authoritative information regarding the selection and use of radio Loudspeakers.

RADIO CONSULTANT IN CHIEF CAPT P. PECKERSLEY

BELIEVE IT

YOU may think us guilty of exaggeration in saying that BLUE SPOT 100U is the equal of the most expensive Moving-Coil Speakers. Yet, far from being an exaggeration, this is actually an under-statement.

Ask your dealer to let you hear this wonderful inductor type speaker and compare it with Moving-Coil Speakers. You will find that it is every bit as sensitive, that it reproduces bass notes to perfection and *yet gives full value to the remainder of the musical scale.*

100U gives to voices their real personality and to music the fresh crispness and distinctive individuality of the original.

Unlike Moving-Coil Speakers 100U reproduces perfectly even from very small inputs and is free from distortion. Hear this amazing speaker to-day. Send for illustrated Catalogue No. M.W.16U.

100D, an attractively designed Cabinet Speaker in fine quality oak, 63/-.

OR NOT

100U 39%

COMPLETE MOUNTED TO CHASSIS

REDUCED PRICES OF BLUE SPOT RECEIVERS

- W.400 now reduced to 15 gns.
- W.S.400 now reduced to 17 gns.
- Table Grand now reduced to 20 gns.
- Upright Grand now reduced to 22 gns.

For A.C. mains, 100-240 volts. Complete with 5 valves and royalties paid.

HIRE PURCHASE TERMS ARE NOW AVAILABLE FOR ALL BLUE SPOT RECEIVERS.

BRITISH MADE



THE BRITISH BLUE SPOT COMPANY LTD

BLUE SPOT HOUSE · 94/96 ROSOMAN STREET · ROSEBERY AVENUE · LONDON · E C1

Telephone: Clerkenwell 3570.

Grams: "Bluospot, Isling, London."

Distributors for Northern England, Scotland and North Wales:—H. C. RAWSON (Sheffield and London), LTD., 100 London Road, Sheffield; 22 St. Mary's Parsonage, Manchester; 183 George Street, Glasgow.

Hutchinson

CONTENTS

Vol. XVII. No. 65. MODERN WIRELESS. MAY, 1932.

	Page		Page
Editorial	399	At Your Service	463
Meet Stravinsky	400	On the Short Waves	465
Round the Turntable	402	Behind the Scenes of Broadcasting	467
Short Waves for Mains Sets	403	On the Test Bench	468
Questions Answered	408	In Passing	470
My Broadcasting Diary	431	How to Cure "Break-Through"	473
Trouble Tracking	433	Recent Record Releases	474
The "Timepiece" Three	434	More Evenings in the Studio	475
A New All-Wave Scheme	442	Radio-Grams in Old Furniture	480
A Radio Beckoner	459	The S.G. for R.C.C.	483
A De-Luxe Radio-Gramophone	462	Radio Notes and News	486

SPECIAL SECTION, "THE WORLD'S PROGRAMMES," PAGES 443-458
 (See page 443 for contents of this supplement).

"LOUDSPEAKERS OF TO-DAY—A COMPREHENSIVE SURVEY," PAGES 409-430
 (The contents of this valuable section are detailed on page 409.)

As some of the arrangements and specialties described in this Journal may be the subject of Letters Patent the amateur and trader would be well advised to obtain permission of the patentee to use the patents before using so.

Edited by **NORMAN EDWARDS.**

Technical Editor: **G. V. DOWDING, Associate I.E.E.**

Radio Consultant-in-Chief: **Capt. P. P. ECKERSLEY, M.I.E.E.**

Scientific Adviser: **J. H. T. ROBERTS, D.Sc., F.Inst.P.**

The Clock for the "Timepiece Three"

AND FOR CERTAIN,
 ACCURATE TIME IN YOUR HOME

How comfortable always to know just what time it is. Here is a clock that is always right. It has no main spring, no escapement, no intricate wheels and cogs. It is silent. It costs less than 6d. a year to run. It will last a lifetime.

Connect your Ferranti Electric Clock to the mains. Set it and start it. From that minute you will have the correct time brought to you from the power station and checked frequently throughout the day against Greenwich time. Your clock can never be more than a few seconds out. It is automatically corrected. You can use a Ferranti Electric Clock wherever there is controlled frequency of alternating current (200/250 volts, 50 cycles)—which is the case in about 80% of the wired homes in Great Britain. You will find a wide selection of beautiful Ferranti models at Jewellers, Radio and Electrical Dealers and principal Stores—ranging from as little as 30/- in price. Behind every clock stands the name and reputation of Ferranti.

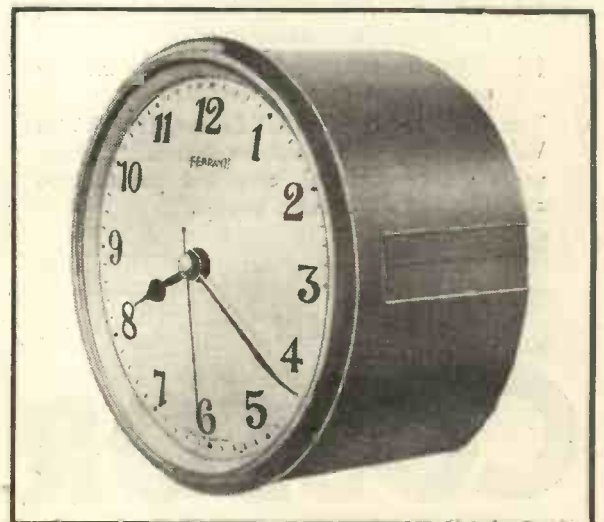

For the "Timepiece Three." The Ferranti Electric movement only, particularly suitable for incorporation in the "Modern Wireless" Receiver described in this issue. Enclosed in a neat moulded bakelite case. Send for booklet (post free) to Ferranti Ltd., Hollinwood, Lancs, or Bush House, Aldwych, London, W.C.2.

★ **FERRANTI** ★

ELECTRIC ★ CLOCK

made entirely in England

THE RIGHT TIME FOR A LIFETIME

EFFICIENCY— CONSISTENCY— LONG LIFE

—all ensured by the
MICA BRIDGE

THE system of Mica Bridge construction employed in all Cossor A.C. Mains Valves has the following important advantages:

- (1) It permits microscopic accuracy in the assembly of the electrode system thus ensuring the highest possible efficiency.
- (2) It prevents variation of the electrode spacing and therefore of variation of characteristics.
- (3) It imparts great mechanical strength thereby ensuring exceptionally long life.

You will see, therefore, that Cossor A. C. Mains Valves possess all the features demanded by the valve user—efficiency, consistent performance and long and dependable service.



A copy of the 72-page Cossor Wireless Book B11 will be sent you free on application to A. C. Cossor Ltd., Melody Dept., Highbury Grove, London, N.5.

IN

COSSOR

ALL-BRITISH
A.C. MAINS VALVES

COSSOR VALVES FOR THE "M.W." SETS DESCRIBED IN THIS ISSUE

May.	The "Timepiece" Three	*M.S.G./L.A. 19/-	*41M.H. 13/6	41M.P. 15/-
April.	"Varmu" Three	*220V.S.G. 16/6	*210H.F. 7/-	230P.T. 17/6
April.	"Tri-Band" Three	*210H.L. 7/-	210L.F. 7/-	230X.P. 12/-
April.	"Cabinet" Two (Model "B")	*210H.L. 7/-	230H.P.T. 17/6	
March.	"Bi-Band" Three	*215S.G. 16/6	*210H.L. 7/-	230P.T. 17/6
March.	"M.W." "Cabinet" Two	*210H.L. 7/-	230H.P.T. 17/6	
	"Eckersley" Adaptor	210H.L. 7/-		

* Metallised.

MODERN WIRELESS

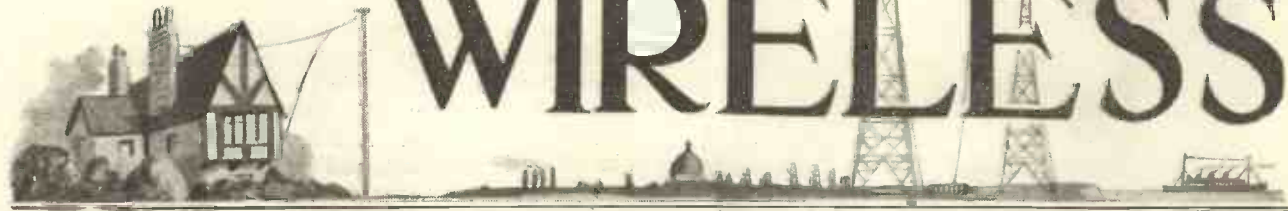

Vol. XVII. No. 65.

BRITAIN'S LEADING RADIO MAGAZINE.

MAY, 1932.

Loudspeakers of To-day: An Important and Comprehensive Review—Two Special Sets—Accurate Time from a Mains-Driven Clock—The B.B.C.'s Experiment in Economics—Marconi's Researches.

WE publish a special feature in this May issue of MODERN WIRELESS entitled "Loudspeakers of To-day." Readers will observe that this is not merely a catalogue or a series of generalisations on loudspeakers, but that it comprises an attempt thoroughly to analyse and classify the dozens of different types and makes of speakers which are offered to the public to-day.

We have made every endeavour to bring this section quite up to date, and we feel confident that our readers will find all there is to be known about commercial loudspeakers in this special supplement.

Two Special Sets

THERE are two special sets in this issue which we would like to bring to the attention of our readers.

The "Timepiece" "Three" is an all-mains receiver incorporating a built-in electric clock. The latter is driven and kept in accurate time by the mains, so that it never needs any attention. The radio side of this receiver consists of an S.G., det., pentode circuit, and provision is made, of course, for gramophone pick-up working. The set contains a built-in loudspeaker, so that the outfit is of a complete and attractive type.

But we would like to point out also that this is not a set specially designed for millionaires! Actually it costs barely as much as a simple commercial set of ordinary design.

We also publish a full description of a simple unit with which any mains set can be immediately converted for short-wave reception. Alternatively, the unit can be used as a single-valve short-wave receiver for headphone reception.

We are continually receiving letters asking us to enlarge our "World's Programmes" section. There is no doubt that readers find it packed with useful information, and in this issue we have retained the recent space-expansion of this special feature. Readers will see that it does not contain old data, but new and vital facts of considerable interest to those who concentrate on listening to foreign stations.

The B.B.C.'s Experiment

IN a recent issue of MODERN WIRELESS we waxed rather sarcastic concerning the B.B.C.'s collaboration with the London School of Economics in organising a family census. Well, as we forecast, the scheme has by no means set the Thames on fire. In fact out of the

millions of listeners in this country, 48,340 requested the B.B.C. to send forms. We now understand that only approximately 5,000 listeners completed the forms and sent them in to the B.B.C.

It will be remembered that this Questionnaire was prepared in collaboration with Sir William Beveridge, the Director of the London School of Economics. Listeners were asked innumerable questions relating to the most intimate details of their family life, such as "Where did you first meet your wife?" "Has your grandfather got grey eyes," etc.; etc.

It would certainly seem that this scheme has not justified the considerable expense to which the B.B.C. has been put in printing and sending out the forms, together with stamped, addressed envelopes. In fact, it is a clear case where listeners' money has been wasted, for there can be no doubt that 5,000 replies are not sufficient to make the experiment worth while to the London School of Economics.

We should also like very much to see some of these 5,000 completed forms. No doubt many people sent for them out of sheer curiosity, but, if we know anything of the British character, a good many of them were sent back to the B.B.C. with the questions very waggishly answered. In fact, we should very much like to know how many of those 5,000 replies received at Savoy Hill are really worth the paper they are written on.

Anyway, perhaps this will be a lesson to the B.B.C. in future not to indulge in experiments of this nature at the expense of the listening public.

Marconi's Researches

THE Marchese Marconi's latest ultra-short-wave experiments in Italy indicate that he is now able to communicate over a distance of 100 miles, and as the Marchese is using waves that were previously considered to be limited to a distance of 10 miles (for practical purposes), whatever the initial power used, his success will certainly have important influence on present theories about short-wave radio transmission. It has even been suggested that Marconi has made a discovery that might mean an alteration to the wireless valve as we know it to-day, but until the Marchese sees fit to disclose technical details concerning his latest success with ultra-short-waves, it would be best to refrain from imaginative flights of fancy.





A BRILLIANT MUSICIAN
who, although a comparatively young man, is already remarkably successful.

I WAS a musical ignoramus when I first met Stravinsky in Paris about twelve years ago.

It was at an orchestral concert of modern music, which I had been pressed to attend although loathing all such noises at the time! After some trivial overture the hall was all agog with excitement because the great "Stravinsky" was, himself, coming to conduct one of his own works.

When the Orchestra Played

Stravinsky. I expected a typical Russian of the Moussorgsky variety, with fiery antics and a flowing beard, military and madly musical. Stravinsky appeared. I thought he was the man to turn over the music!

A frail figure walked on to the platform. A lithe man with thin, straight, fair hair, wearing tiny spectacles and appearing to be enormously self-conscious and a trifle short-sighted. Picture what a disappointment for a poor listener who vaguely appreciated Russian music and who hoped to find the composers as bizarre and impressive as the crashing chords of their music.

When the orchestra played my disappointment was dispelled. Perhaps you have seen him at the Queen's Hall when he broadcast in the B.B.C. Symphony Concerts.

MEET

Last season, when my musical education had widened to the extent of appreciating modern Russian music in general, and Stravinsky's in particular (bear with me if Stravinsky bores you stiff), I met him in the old Number Ten "wharf" studio. A B.B.C. friend and I talked to him after his broadcast, and for the first time I realised how unlike the average composer Stravinsky really is. He is a broadcasting enthusiast.

A Talk with the Great Man

My last occasion of meeting him was at the Queen's Hall, when the famous Swiss conductor Ansermet, a personal friend of Stravinsky, came over to conduct two broadcast concerts in which Stravinsky items featured, and in one of which Stravinsky played the piano part.

I cannot truthfully say that we chatted! My knowledge of Russian goes only so far as understanding the chorus of the Volga Boat Song when given in its original form! Stravinsky speaks French, volubly and with gesticulations, but it is not my English-French. He knows a little English, but not the words I wanted to use!

Ansermet, with his charming pronunciation of English, came to our assistance. During the evening there had been a short out-of-tune passage in the wind section of the orchestra, and I ventured to ask Stravinsky's opinion of our B.B.C. Orchestra.

Stravinsky gesticulated. Ansermet translated.

"Yes," he said. "That was a leetle out of tune. But Strrrravinsky 'e like eet! Eet give ze colour to ze music!"

But I don't really think that's typical of Stravinsky, or fair to him!

Writing Special Music for Radio

Perhaps it's because he's a young man, and not full of conservative ideas, that he is keen on broadcasting and wants to write special music for radio performance. He is what I suppose the average non-musical person would call a "crank," and yet he himself is very much a man of the world.

He did not intend to be a musician. He is just forty; surprisingly young for a man who is known internationally.

Of course, he came of a musical family. His father was an opera singer in Leningrad (then St. Petersburg), and little Igor was born in a suburb of the great city.

That was before the Revolution. Opera singers made money in Russia in those days. The family had enough money to send Igor to the St. Petersburg University.

They wanted him to be a lawyer, and although he could play the piano very well he was quite content. He passed legal exams. at St. Petersburg with flying colours, and went to Heidelberg to "finish off"—a fortunate accident for modern music!

His First Important Work

One of his fellow-students was the musician Rimsky-Korsakov, who wrote *Le Coq d'Or*, and the time which the two used to spend together composing and studying music completely prevented Stravinsky from taking what we should call the "Bar Final."

Korsakov begged him to turn to music instead, and with

STRAVINSKY..!

Our Special Correspondent gives here an intimate character sketch of this famous Russian composer—one of the romantic futurist musicians who are destined to play a big part in the development of music for broadcasting.

the same mental ease with which Stravinsky turns now to the production of music for broadcasting he turned then from legal studies to writing a symphony.

His first big work, this symphony, was finished in 1907.

Unlike most musicians, Stravinsky had a stroke of luck in his early days. He wrote two orchestral pieces called *Fireworks* and *Scherzo Fantastique*. I suppose nowadays we shouldn't regard these as ultra-modern music.

Music for a Russian Ballet

But just before the war they created a sensation. Serge Diaghilev, of the famous Diaghilev Russian Ballet, heard the *Scherzo*, and, realising that Stravinsky was a budding genius, asked him to write some music for the ballet. That is how *The Fire Bird* came to be written. Probably you have heard it broadcast from Number Ten Studio.

His studio experience goes back a long way. One of
(Continued on page 490.)

AT THE QUEEN'S HALL



(Above) Dr. Adrian Boult, who is Musical Director of the B.B.C.

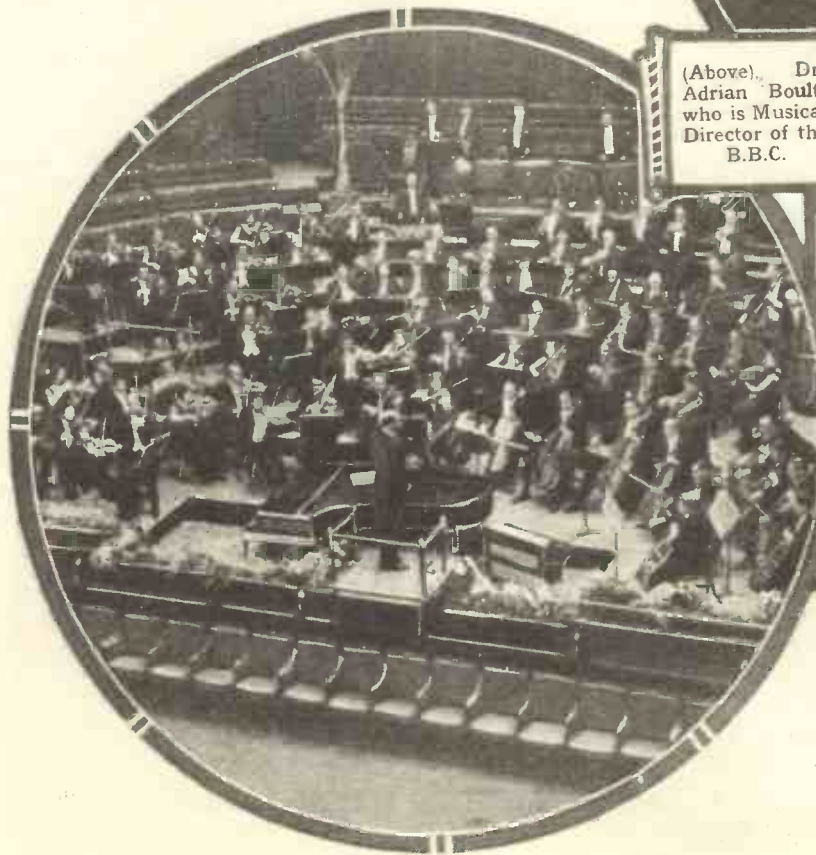

(Left) The B.B.C. Orchestra performing at the Queen's Hall. Stravinsky has conducted this orchestra on several occasions, and is himself a very enthusiastic broadcaster. (Right) Mr. Jack Hylton is well known to listeners as leader of the famous dance band.



By "TONE ARM."

A silent-running gramophone motor is essential for successful pick-up operation, whether it be of the clockwork or electric variety. Below is a description of two of the latest electric types.

I HAVE just received for trial a couple of the latest Garrard electric gramophone motors. This firm is too well known in the clockwork motor line to need any introduction, but possibly not so many readers are familiar with their electric motors.

The models that have been sent to me are the new 202a induction type, and the universal motor. The 202a is an A.C.-only motor, which has been brought on the market as a follow up of the successful senior motor, the 201.

Perfectly Silent

It runs on the induction principle, and is perfectly silent in operation, a feature that will immediately place it among the very finest, in spite of the fact that the price is only 58s. 6d., with automatic stopping and starting switch.

I have had the motor running continuously for many hours, and cannot find the slightest trace of heating, while the power is quite sufficient for the playing of records having the heaviest of recording passages.

The cost of running, too, is extremely small, being a matter of only one unit for 75 hours or so, while the motor is self-starting, and the whole instrument is mounted on one chassis integral with the plate under the turntable.

For D.C. or A.C. Mains

In my opinion, the other motor, the universal model, is an even finer piece of engineering than the one we have just been considering. It is

suitable for either D.C. or A.C. mains, and is as smooth running as the induction type.

No Vibration

This is largely due to the fact that the motor is a very slow-running one, and therefore there is no vibration due to speed, while the floating spring tension under which the motor drive is kept ensures a smooth transfer of energy from the motor to the turntable.

It is as easily fitted as the other motor, and is supplied with one of two forms of mains resistances that makes it perfectly easy to install. The price is higher than in the case

of the A.C. motor, but there is, of course, more work in the instrument, and £5 15s. complete with resistance is not too much to pay for a high-class job such as this is.

The insulation resistance is carefully tested to a voltage of 1,000 volts, while the power of the motor is really surprising—it takes quite a lot of stopping with the hand.

The cost of running is negligible, for about 300 12-in. record sides can be played for one unit of power. Here, again, on very long running I could trace no sign of heating, while placing the ear close to the turntable detected no suspicion of vibration noise.

Non-Interfering

The great test of an electric motor is not the mechanical vibration, though this is important, but the degree of electrical interference that is set up in the gramophone amplifier while the motor is in use. Most motors that I have tested have been guilty of either one or other of two faults, sometimes both.

These are vibration transferred mechanically to the pick-up armature through the turntable, and electrical interference due to sparking at the commutator of the D.C. type, or the A.C. field in the case of the A.C. variety of motor.

In the case of the Garrard motors I could trace no sign of either interference. The turntable ran perfectly smoothly in each instance, and the eye could not detect any sway or indication of the spindle being slack or out of truth. Truly a very fine piece of work.

TWO OUTSTANDING ELECTRIC MOTORS

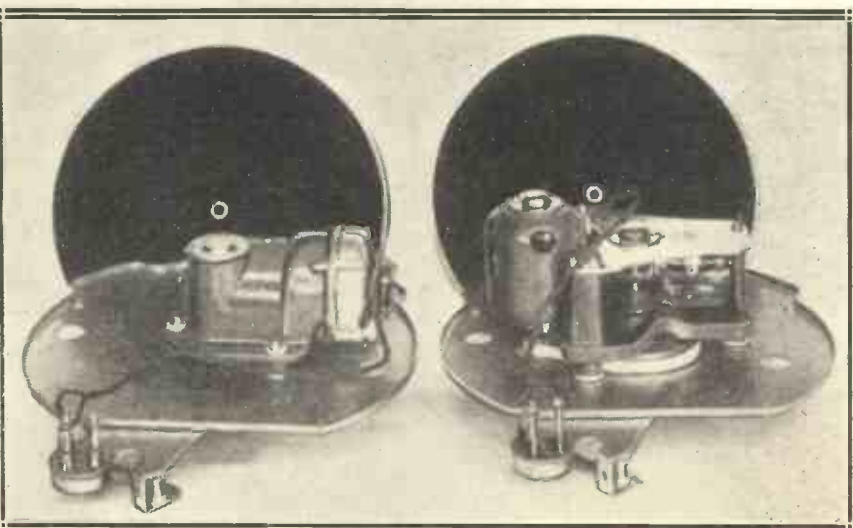

In the above illustration are shown the Garrard A.C. induction motor type 202a (left), and the universal type that is suitable for either A.C. or D.C. mains operation.

SHORT WAVES FOR MAINS SETS



The user of an all-mains set generally finds that, no matter how interested he is in short waves, he cannot listen to them without building another complete receiver. But if there is provision on your set for a pick-up, then the practical details in this article will enable you to use it for listening to the short waves.

By A. S. CLARK.

It is generally appreciated that there are difficulties connected with mains short-wave working that are not encountered on ordinary broadcast wave-lengths, whether it be just a matter of using an H.T. mains unit, or whether all-mains work is attempted. But the reason for this is not at all obvious.

Undoubtedly there are several factors concerning mains interference in relation to wave-length which are in the nature of mysteries; but the reason why the use of A.C. for heating the detector valve is not always successful is clear enough; it is simply a matter of the "noise"/signal strength ratio.

A.C. Hum

Slight mains irregularities do not worry us when working on broadcast waves and fairly strong stations. But with short waves the set generally has to be "pushed" a little more, and signals are generally much weaker; the result being that a given amount of ripple is made louder by greater amplification and at the same time is more noticeable because the stations are not so strong.

All of which is liable to make the possessor of a mains receiver, whether home-built or commercial, arrive at the conclusion that he must give short waves a miss, unless he is prepared to build another complete receiver, which is both a bother and an expense.

Separate Supply Advisable

Obviously the use of an adaptor is

its current from the set to which it is attached.)

With D.C. the trouble is more or less similar, as there is naturally a large fluctuation in the heating current, since it is unusual to arrange any smoothing for the L.T. But there is a simple and inexpensive way out.

As a matter of fact, it is a way out that would be useful even if the difficulties mentioned did not exist.

For with a large number of commercial receivers the valves are so tucked away that it is not possible to get at the detector valve socket to insert the necessary plug for an adaptor.

A Way Out

Indeed, it so happens that this difficulty is met with in many of the commercial battery sets on the market. And in many cases where it is possible to get at the detector's socket considerable trouble is involved, so that the changing over to short waves becomes "too much of a good thing."

The simple unit which I am going to describe in this article enables a change-over to short waves to be made in about half a minute. And so

A UNIT WITH WORLD-WIDE RANGE

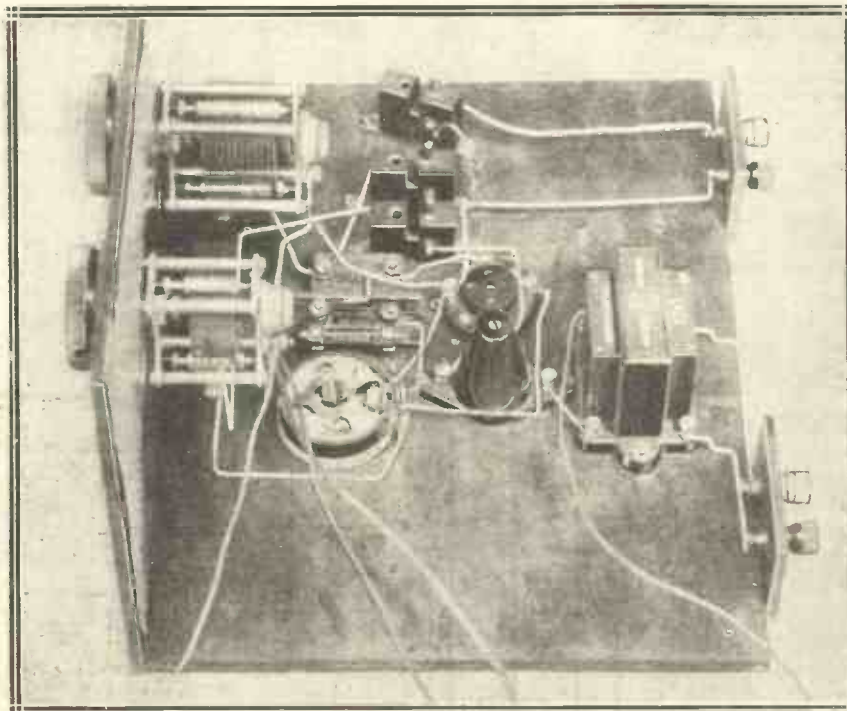

It won't take long to assemble, but it will give added pleasure in the use of your mains receiver, whether A.C. or D.C.; and it will also work with any ordinary battery receiver that is capable of playing gramophone records.

generally impractical, because, as already explained, in nearly all cases A.C. for heating the detector militates against success. (An adaptor obtains

ong as the set has provision for the use of a pick-up—and few mains sets have not nowadays—the unit is suitable, whether the receiver is run from A.C. mains, D.C. mains or batteries.

frequency currents from the short-wave station being received. The amplifier part works from the mains in the usual way, while the separate batteries supply the detector valve

chased their sets ready made, and therefore have never tackled constructional work before, I intend to deal very fully with the practical work.

VARIABLE AERIAL COUPLING IS PROVIDED

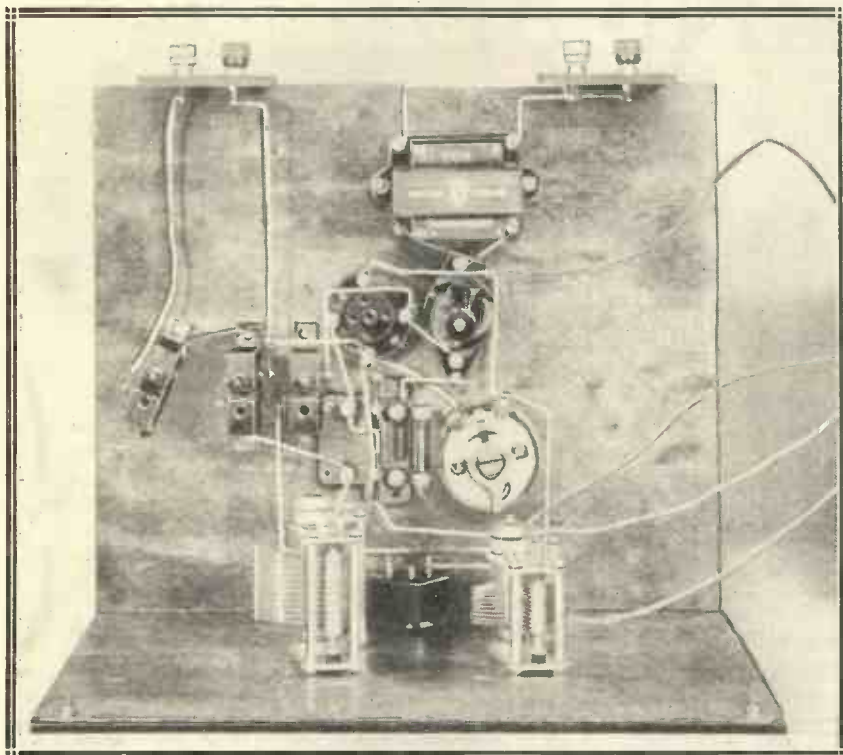

The three plug-in coil holders for the short-wave inductances can be seen to the left of this "aerial" view of the receiver. The one on the outside is held by only one screw so that it can be swivelled away from the next one, thus providing a simple and convenient method of altering the aerial coupling to the grid coil.

It is, of course, intended for loud-speaker reception of short-wave broadcasting stations, but if 'phone reception is desired for very weak stations this may be carried out. True, 'phone reception would be on one valve, but has not W. L. S. often explained that one valve is often all that is wanted where 'phones are concerned?

Easily Adapted

Anyway, you can search around on the 'phones until a good station is found, and then, in a moment, bring the receiver and speaker into service. This is another way in which the unit can sometimes be preferable to an adaptor.

I expect that by this time, having read as far as this and had a look at the photographs and diagrams, you have got a pretty good idea of exactly what the unit is. It is a complete one-valve short-wave set with batteries incorporated, which can be plugged on to the pick-up input of the receiver.

Thus the gramo. amplifier is used as an amplifier of the rectified low-

with humless H.T. and L.T., and since they have to give only a small amount of current they last a very considerable time.

RELIABLE TRANS-OCEAN RECEPTION

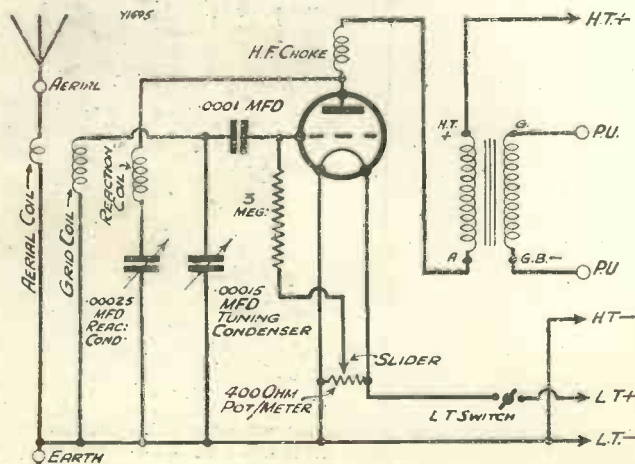

The circuit, seen here, is arranged on well-ried lines, and the method of aerial coupling keeps background noises down to a minimum, thus providing the clearest possible reception.

The unit is particularly easy to assemble, and as it will no doubt have an appeal to many who pur-

Concerning the Circuit

But first of all let me indicate one or two items of interest in the circuit. It is arranged along accepted lines, but the use of a separate coil for the aerial circuit is of interest.

It is found that this greatly helps to keep down the background-noise level, a fact worth bearing in mind, as in many cases a good bit of amplification will be in use. The holder for this coil is arranged to swivel so that the coupling can be adjusted and reaction dead-spots overcome.

The use of a potentiometer for the grid-leak return is also bound up with the reaction. It enables a smooth control to be obtained, a vital necessity for long-distance short-wave reception.

What is termed "throttle control" of reaction is used, and the anode feeds into the primary of an L.F. transformer via the short-wave H.F. choke. The secondary of this transformer is connected to the amplifier via the pick-up terminals, thus taking the place of the pick-up winding.

Constructional Hints

Some form of volume control is needed, but as this will quite often be incorporated in the receiver itself, there is not one in the unit. However, farther on you will find details for connecting up one in case your set is not provided with such a component.

And so to the construction. With the aid of the list of components you will see that there is a wide choice of makes.

While you may choose any of the makes, you must keep to the values, although a hundred ohms or so more for the potentiometer would not matter. Be sure that you get variable condensers with slow-motion dials.

On the last page of this article you will find a diagram labelled "panel layout." On this the dimensions for the positions

You Will Hear America on Your Loudspeakers!

of the holes in the panel are marked, and from them you must mark up the points to be drilled on your panel.

Incidentally, the panel can be of wood instead of ebonite, or, again, it can be of metal, in which case the

the baseboard. This is particularly simple and consists of putting in a few wood screws.

Spacing Out the Parts

Arrange the parts in a similar manner to the wiring diagram,

What you must remember is to allow plenty of room for the batteries, and it is as well to stand these in place to ensure that they will be O.K.

See that the coils will be well clear of the valve and tuning condenser when they are inserted in their holders. To ensure this, put them and the valve in their holders when arranging the components.

Having done this you are ready for the final job in the construction, that of wiring. This should be carried out with some form of insulated wire. It is not essential that you should make a neat-looking job of it and keep all the wires dead straight, but if you can so much the better. What you must avoid is bunching several of the wires together.

Very Little Wiring

Follow the wiring diagram carefully. The majority of the connections are permanently anchored wires, but there are six flex connections. Two for L.T., two for H.T., and two for the aerial coil holder, which has to be fixed in place with one screw only, so that it can be swivelled.

HERE ARE THE COMPONENTS THAT ARE NEEDED

PANEL.

12 x 8 in. (Permeol, Becol, Wearite, Ready Radio, Peto-Scott).

CABINET.

To suit above, with baseboard 10 in. deep (Camco, Pickett, Gilbert, Peto-Scott, Ready Radio, Osborn, Morco).

VARIABLE CONDENSERS.

- 1 .0015-mfd. tuning condenser with slow-motion control (Polar type C, Cydon, J.B., Lotus, Formo, Ormond).
- 1 .0025- or .003-mfd. do. (Polar type QJ, Ormond, J.B., Ready Radio, Cydon, Utilly, Lotus, Telsen, Lissen).

FIXED CONDENSER.

- 1 .0001-mfd. (Telsen, Lissen, Ready Radio, Dubilier, T.C.C., Goltone, Sovereign, Formo, Ferranti).

CHOKE AND COILS.

- 1 Short-wave H.F. choke (Magnum, Bulgin, Polar, Tunewell, Melbourne).
- 1 Set plug-in short-wave coils (Atlas, Igranic, Melbourne).

VALVE HOLDER.

- 1 Four-pin sprung type (Lotus, W.B., Magnum, Igranic, Graham Farish).

MISCELLANEOUS.

- 1 Filament on-off switch (Ready Radio rotary snap type, Claude Lyons B.A.T., Bulgin, Telsen, Lissen, Peto-Scott, Wearite, Goltone, Graham Farish).
- 3 Plug-in coil holders (Wearite, Lotus, Lissen, Igranic).
- 1 400-ohm baseboard-mounting potentiometer (Igranic, Sovereign, Ready Radio, Lissen).
- 1 3-meg. grid leak and holder (Dubilier, Graham Farish, Lissen, Telsen, Ready Radio, Ferranti).
- 1 L.F. transformer, medium ratio (R.I. Dux, Telsen, Ferranti, Graham Farish, Climax, Formo, Goltone, British General, Varley).
- 2 Terminal strips, 2½ x 2 in.
- 4 Indicating terminals (Bulgin, Eclax, Igranic, Belling-Lee, Clix).
- Battery plugs, etc. (Clix, Igranic, Eclax, Belling-Lee).
- 1 Sheet of copper foil, 12 x 8 in.
- Glazite, Jiffilix, Quickwyre, Soldawyre, Lacoline.
- Flex, screws, etc.

copper foil can be omitted. This foil is secured at the top of the panel by two small nuts and bolts.

At the bottom it is held by being pressed against the baseboard when the panel is screwed in place. When you have finished drilling, fix the foil in position and pierce the necessary holes in it with some sharp instrument.

Incidentally, this foil has to be connected to earth, and this is achieved by letting it make contact with the metal frames of the variable condensers, which are in turn connected to L.T. negative. When you have fixed the three panel components in place, screw the panel to the baseboard with three wood screws.

The Terminal Mounts

Your next job is to prepare the two small terminal strips that are screwed to the back of the baseboard. These are pieces of ebonite 2 in. by 2½ in., with two holes in each for terminals, and two for fixing screws.

If you prefer, this strip could run the whole length of the baseboard. Also, instead of pieces of ebonite you could use two of the terminal blocks that are available.

With these in place we come to the mounting of the components on

although slight deviations due to different parts may have to be made.

HAND-CAPACITY WILL NOT TROUBLE YOU

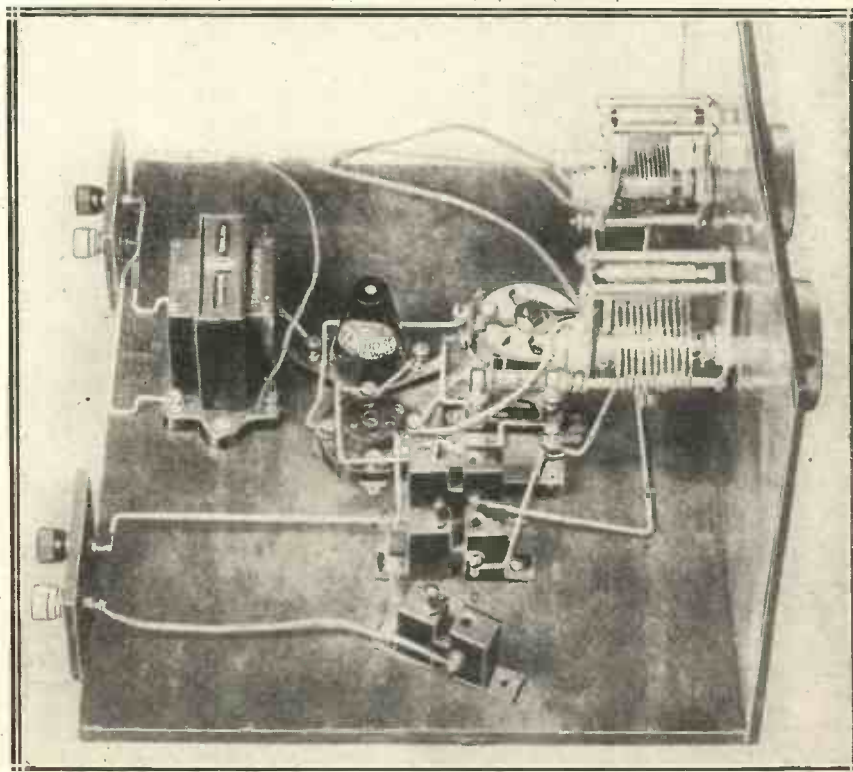

You will find tuning delightfully easy, due to the careful design, which gives extremely smooth-reaction control and an absence of hand-capacity effects—stations will not vanish as you remove your hands from the dials.

It is not necessary to solder the connections, but be sure to tighten all the terminal screws and nuts with pliers to ensure that they are really tight. You will see that there are two soldered connections between wires, but these leads can be taken to terminals on the components instead.

For instance, the wire from the filament of the valve to the lead joining the two moving vanes terminals of the variables can go instead direct to the moving vanes of the tuning condenser. In the

case of the other junction the wires can all be taken to the terminal on the grid-coil holder.

Adding a Volume Control

Before going on to the operating details there is the volume control, if you want to connect one up. It should have a value of about 100,000 ohms, and be of the three-terminal or potentiometer type.

One end terminal of its resistance should be connected to one output terminal marked P.U. and the other

end terminal to the other P.U. terminal. The two wires for connecting up to the pick-up terminals or plug of the set will then come, one from the slider of the volume control and the other from one of the two P.U. terminals; it does not matter which.

If your set has a plug for joining up the pick-up you will need to get another one like it for the unit. Then you simply plug in either the pick-up plug or unit plug, according to which you desire to use.

So far as accessories are concerned there is little to say. Almost any valve of the detector, H.L. or H.F. types will be suitable for the unit.

IT LOOKS SIMPLE—AND IT IS SIMPLE

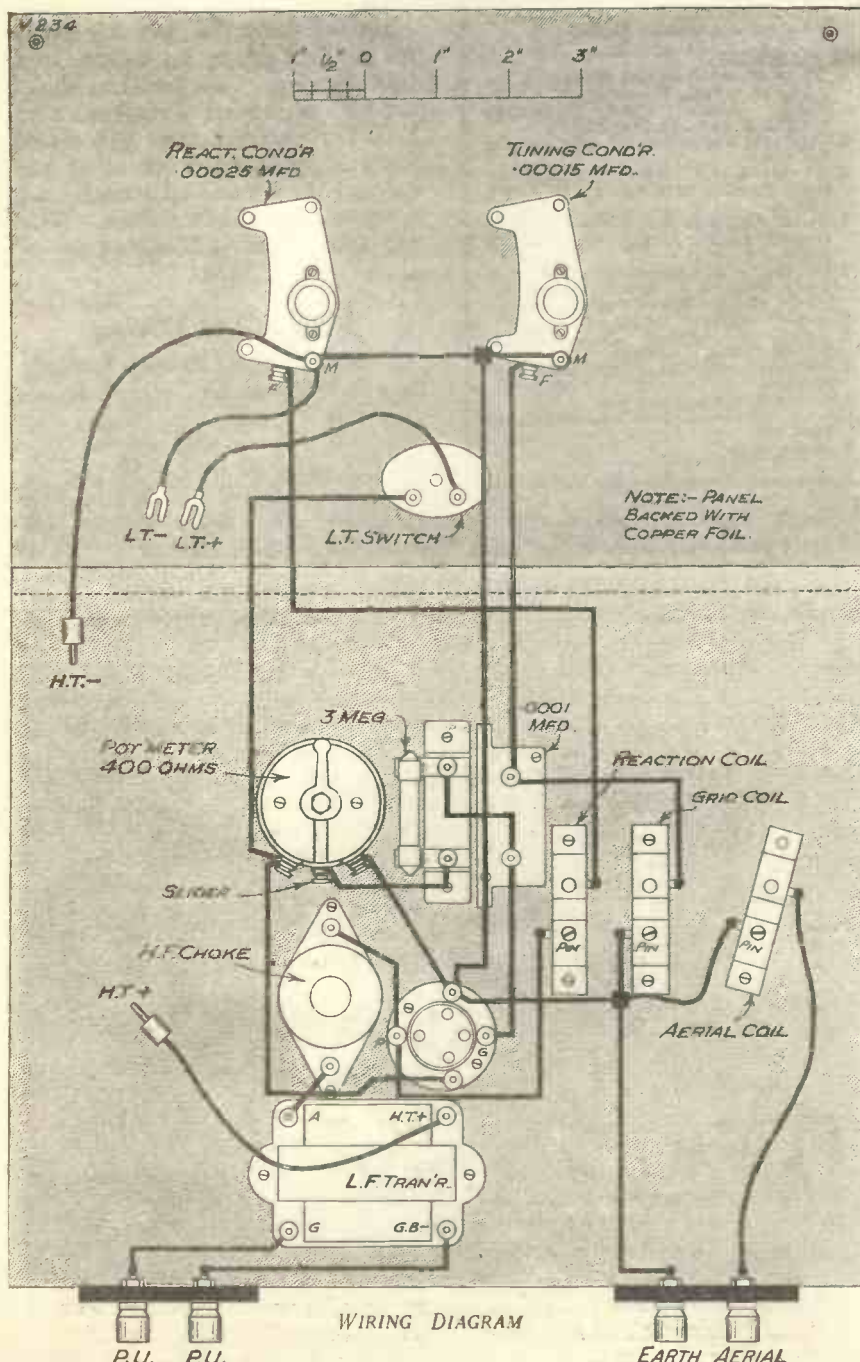

WIRING DIAGRAM

No one could possibly have any doubts about being able to make a success of the unit after seeing this plan of it, with every component in place and every connection made. There is not a single difficult point in the construction.

Special Coils

The accumulator seen in the photograph on the last page of the article is of the portable "jelly" type, but there is no reason why a small ordinary one should not be used, as there is ample room for it.

In the set of coils you will find four with turn numbers something like this—2, 4, 6 and 8. You will be able at some time or other to hear stations with any one of the three larger ones in the grid socket.

Use a size smaller in the aerial socket, except in the case of the 8-turn one, when the 4 may be used for the aerial position, the 6 going in the reaction holder. Otherwise, a size larger can be used for reaction.

The 4-turn and the 6-turn coils will

RECOMMENDED ACCESSORIES

- Valve.—(Mazda H.L.2, Cossor, Mullard, Marconi, Osram, Tungstram Eta, Lissen, Fotos, Six Sixty.)
- Battery.—H.T. 60-volt ordinary capacity (Drydex, Pertrix, Ever Ready, Lissen, Magnet).
- Accumulator.—Small 2-volt (Exide, Ever Ready, Pertrix, Ediswan, Oldham, Lissen).

be the most useful, and, to give you an idea of the wave-lengths, the 4-turn will go up to somewhere around 45 metres at the top of the tuning dial. This, of course, is a very rough estimate.

Ready for Test

You will find that quite a low H.T. voltage is best for smooth reaction control. Before connecting the unit up to your receiver, give it a try out on a pair of telephones, connecting these across the P.U. terminals. You may lose a little in the transformer, but results will still be quite good.

When you have got the hang of the tuning you can connect the unit up to

Connected Up In Half a Minute

TWO DIALS THAT CAN COVER MILES

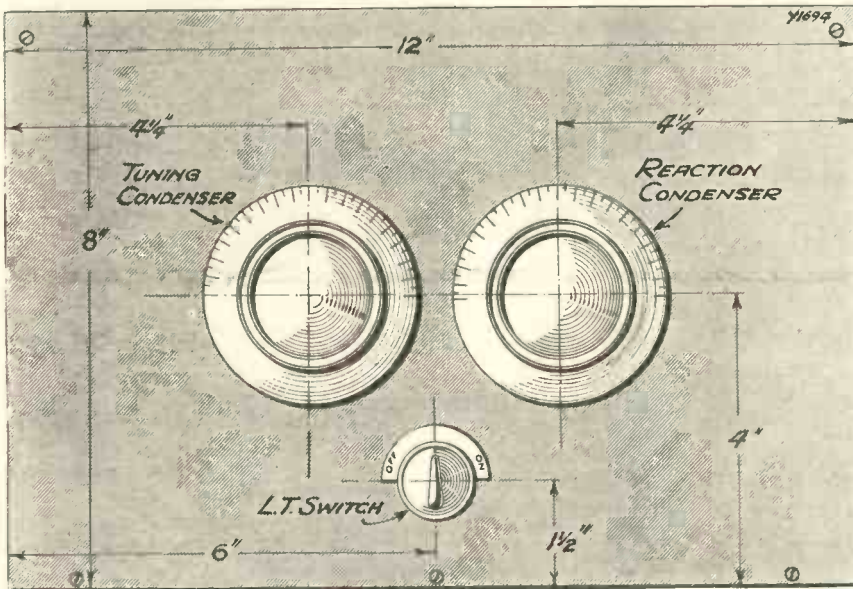

PANEL LAYOUT

These two dials on the panel are the only ones that have to be manipulated for searching over the short waves. All the tuning controls on the main receiver are temporarily out-of-action and standing-by.

the receiver. There is just one point here that must be mentioned. It concerns the earth connection.

It is desirable to have an earth connection to both the unit and the set, and the same earth will answer quite well. In the case of a D.C. set that has a fixed condenser connected in the earth lead for safety purposes, the earth for the unit should be taken from the earth side of this condenser, and not straight from the earth terminal of the mains set.

Separate Earth Advisable

If this is not done you will be almost certain to experience an increase in hum when the unit is used instead of the pick-up. If the hum is worse with the unit than with the pick-up, it would be worth while trying a completely separate earth connection for the unit.

Also, in case it is due to the inductance or resistance of the transformer secondary being very much more than that of the pick-up, you could experiment with a resistance across the secondary of the transformer. Its value would depend on circumstances and might vary from 250,000 ohms to as low as 25,000 ohms. But it is highly improbable that such schemes will prove necessary.

Adjust the slider of the potentiometer so that it is as near the positive end as possible consistent with

smooth reaction. In the wiring diagram the positive end is that nearer to the end of the baseboard on

which the batteries are accommodated.

Should you find one or more spots on the tuning dial where the set goes out of oscillation for a degree or so (what is termed a dead spot), try reducing the coupling of the aerial coil to the grid coil by swivelling the aerial coil more towards a position at right angles to the grid coil. This should overcome the trouble, but if it does not, increase the H.T. a little, making the potentiometer a little more negative to maintain smooth reaction control if necessary.

A Fascinating Wave-Band

Finally, read all you can about short-wave reception and stations, particularly under "On the Short Waves" each month in MODERN WIRELESS. You will then get a good idea of what times to listen, and on what wave-lengths to expect stations to come through. Do not be disappointed if you choose the wrong time and wave-length at your first shot; and turn the dials very slowly, investigating every sign of a station.

You'll soon get into it!

IT IS COMPLETELY SELF-CONTAINED

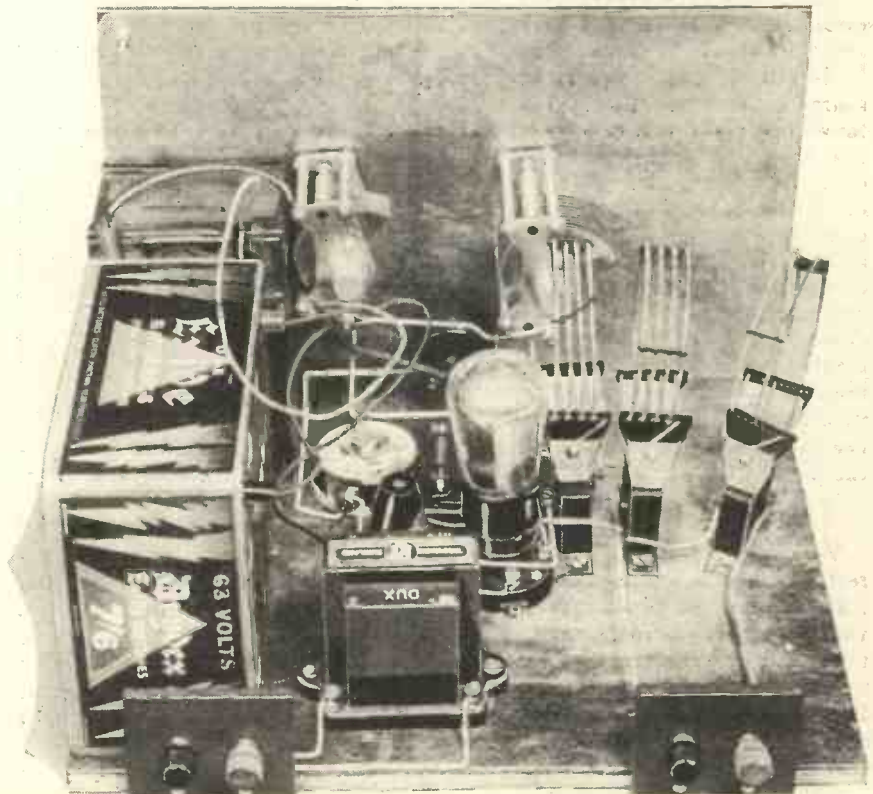

The small batteries which supply the short-wave detector valve are kept inside the cabinet, on the baseboard. The only external connections are to aerial, earth, and pick-up input of main receiver.

QUESTIONS ANSWERED

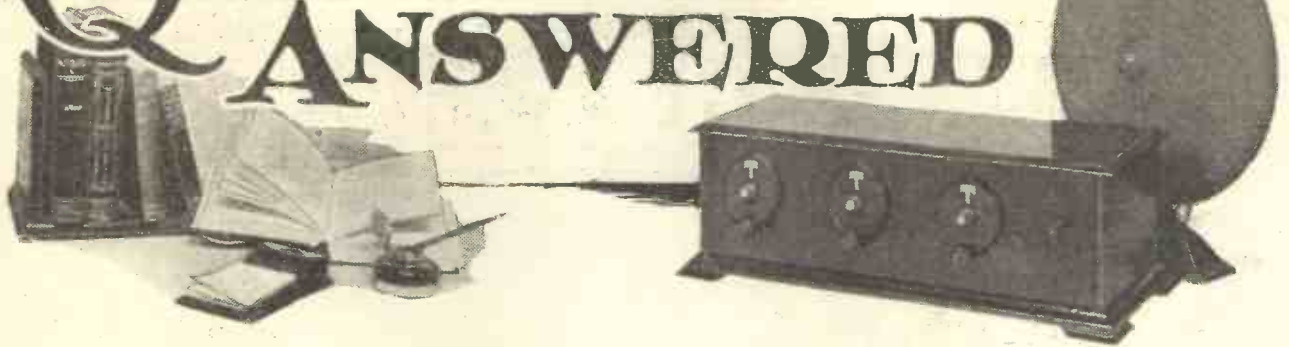

The Aerial Lead-In

L.C. (Berkhamsted).—"I have often heard that it is undesirable to run the lead-in from the aerial close to a wall for any distance. My lead-in is an insulated wire which I have secured to the house with small staples to hold it in position. Would this account for the poor results I am getting on my two-valve set? I also find that the selectivity is bad."

In considering the effect of an aerial it must be remembered that the energy picked up is minute, particularly when the station is a distant one. It is therefore essential that no loss of this precious energy should take place on the way to the set.

In the ordinary course of events direct leakage to earth is prevented by the aerial insulators and the lead-in tube. *But* there is another source of leakage. The lead-in wire forms one plate of a condenser, and the neighbouring brickwork, pipes, etc., the other plate. The capacity of this condenser is increased by decreasing the space between the wire and the earth bodies (i.e. the wall, drain-pipes and guttering). Energy may leak away through this condenser, particularly if the lead-in is secured to the wall at intervals. The use of insulated wire does not prevent this, and it is therefore advisable to keep the leading-in wire well clear of the walls of the house.

Increases Capacity

We often hear of cases where readers have taken a lead-in wire from a back-room window, round the wainscoting of a room, and then through a dividing wall to a set in a front room. This, of course, is a fertile source of inefficiency and should be avoided. Moreover, since this procedure increases the total capacity of the aerial system it also makes the question of obtaining good selectivity more difficult.

A Loud Whistle

M. K. C. (Barnehurst).—"My set is a detector and two transformer-coupled low-frequency stages. The receiver worked perfectly until I made up a D.C. mains unit, since when I have been troubled with a high-pitched whistle and a hum which I cannot eliminate. In addition my reception is now distorted, and although I have tried alterations in the

(the detector tapping) and the terminal marked H.T. on the first L.F. transformer.

This entails the removal of the H.T. + lead which is at present joined to H.T. on the transformer. One end of the spaghetti is then connected to this H.T. + wire and the other end of the spaghetti is joined to the H.T. terminal of the transformer.

Then you will also need a 2-mfd. fixed condenser. Connect one terminal of the condenser to H.T. on the transformer, and join the other condenser terminal to L.T. negative.

It is always worth while to try the effect of reversing the connections to the secondary terminals of one of the transformers. But you must make quite sure that your H.T. mains unit is up to standard.

TECHNICAL QUERIES DEPARTMENT

Are You In Trouble With Your Set?

The MODERN WIRELESS Technical Queries Department is in a position to give an unrivalled service. The aim of the department is to furnish really helpful advice in connection with any radio problem, theoretical or practical.

Full details, including the revised scale of charges, can be obtained direct from the Technical Queries Department, MODERN WIRELESS, Fleetway House, Farringdon Street, London, E.C.1.

A postcard will do. On receipt of this all the necessary literature will be sent to you, free and post free, immediately. This application will place you under no obligation whatever. Every reader of MODERN WIRELESS should have these details by him. An application form is included which will enable you to ask your questions so that we can deal with them expeditiously and with the minimum of delay. Having this form you will know exactly what information we require to have before us in order to solve your problem.

London Readers, Please Note: Inquiries should not be made in person at Fleetway House or Tallis House.

grid bias, the whistle, hum and distortion still persist. Is there anything I can do to remedy this?"

Unfortunately you do not give any particulars of your mains unit. Since it is home-made there is the possibility that the current output is not sufficient for your valves. The use of the incorrect types of smoothing chokes would account for this, and inadequate smoothing would also produce a background "hum."

The first procedure is to decouple the detector stage, and this is carried out as follows: Insert a 15,000-ohm spaghetti resistance between H.T. +

Coupling Condensers

A. C. (Liverpool).—"I have heard that one of the essential features of an R.C. coupling condenser is high insulation. Surely this also applies to all other condensers in the set. Why should the point be stressed so much in the case of the coupling condenser used in a resistance-capacity-coupled L.F. stage?"

You are perfectly correct in your statement, A. C. All the condensers in a set should possess high insulation, especially those connected to high-tension positive.

The R.C. coupling condenser is usually singled out because if there is a very small leak through the dielectric material between the plates serious distortion may occur.

The reason is this. The coupling condenser is joined between the anode of one valve and the grid of the next.

Since the anode of the valve is at high-tension potential, a leakage through the dielectric material of the condenser will cause a positive potential to be applied to the grid of the following valve.



LOUDSPEAKERS OF TODAY

A Comprehensive Survey

CONTENTS

- PART 1. TECHNICAL CONSIDERATIONS.
- PART 2. LOUDSPEAKERS OF TO-DAY.
—ALL MODERN TYPES RE-
VIEWED.
- PART 3. THE LINK BETWEEN.—CON-
CERNING THE IMPORTANCE
OF THE OUTPUT CIRCUIT.

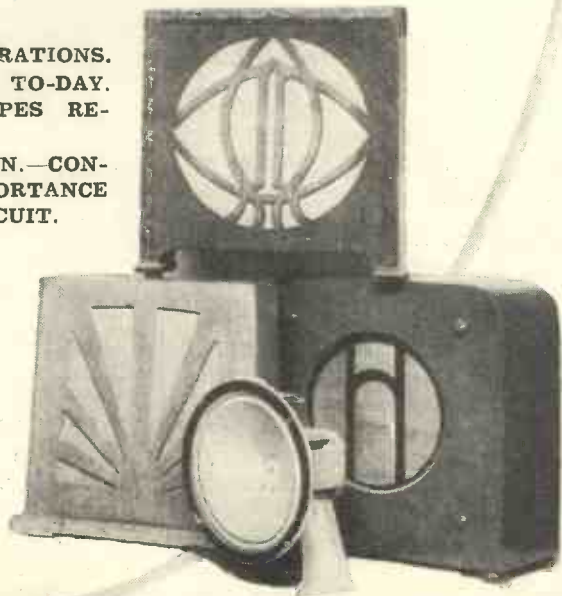



TECHNICAL CONSIDERATIONS

By G. V. DOWDING, Associate I.E.E.

One of the best articles our Technical Editor has ever written
—no more than which need be said!

FOUR years ago the loud speaker was regarded as the black sheep in the radio family; one spoke of it apologetically, even despairingly. It was known that a moderately high loudspeaker efficiency could be achieved, but only by elaborate instruments of expensive construction.

In the Early Days

Those were the days when the possessor of a "moving coil" had the undisputed right to air a superiority complex. Lesser men were happy with mere intelligibility; he had bass!

And it did seem that in this department of the radio art we had reached something approaching finality. Only the most daring prophet had the temerity to suggest the possibility of anything much more than the slightest of slight progress.

Meanwhile, owners of 1922 horn-type speakers cynically smiled at their friends' excursions into "cones," and if they deigned to listen to these novelties they merely shrugged their shoulders, said something about "squeakiness" or "harshness," and settled down again to their throaty little tin trumpets.

Spurred into Activity

Then, all of a sudden, the industry woke up. "Better and cheaper loud speakers" became a war cry instead of a pious hope. All over the world frenzied technicians, spurred into activity by harsh-voiced managing directors, focussed their microscopes and slide-rules on the "black sheep," and realised that it was black mainly because it had not been subjected to the cleansing rays of intensive research?

You see, "loud talking" had been taken for granted by the radio expert.

Telephone receivers were there when broadcasting began. You merely had to stick a horn or a large diaphragm on one telephone earpiece so as to amplify the sound and, hey presto, the loud speaker was a *fait accompli*! Now, they said triumphantly, let us tackle this valve business; what about high-frequency amplification, neutralisation—and so on?

It is true that in a restricted way there was development, but the fruits of this limited research could

A PATENT ARMATURE

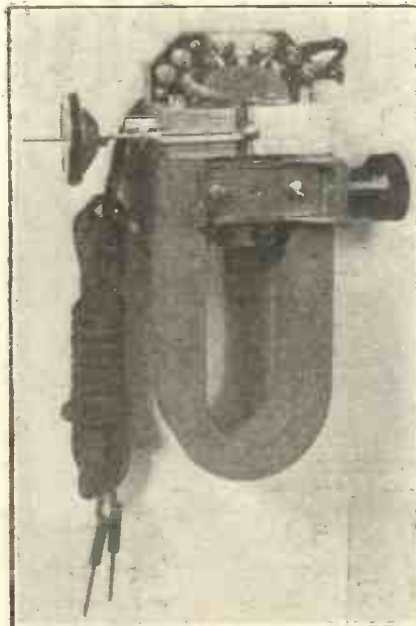

The new Motor type S.40 unit, which has a patent compensating armature.

obviously be enjoyed by the comparatively few.

And exactly why did big business turn its hungry eyes in the direction of the loud speaker, and set the wheels of intensive loudspeaker research turning?

Well, the credit must be given to the public, for the public is the master of big business, for that exists for no other reason but to give the public what it wants.

The Demand for Quality

Broadcasting had lost its novelty appeal, and instead of marvelling at the miracle that sounds could be transmitted through the ether, listeners grew more critical of the actual results.

They began to ask themselves whether the thin pipings of their 1924-5-6-and-7 loudspeakers really were quite as pleasing as they had once thought them. Letters appeared in the Daily Press on the subject of "those horrible wireless loudspeakers"; eminent musicians refused to do their stuff before the microphone.

But the industry, having solved the problem of mass-production of pretty good sets, was able to turn a fair proportion of its energies into the direction of "better and cheaper loud speakers"—with surprising results.

And that brings me to the reason-to-be (*raison d'être*—if you prefer French) of this special "M.W." section.

It is presented in the hope that we can convince radio enthusiasts that inexpensive modern loudspeakers are as good as their three- and four-year-old predecessors were bad.

Give Them a Chance

In addition we shall have plenty to say to those of you who have 1932 instruments, for we shall show how these should be used in order that they can have a fair chance to "speak for themselves."

I think 1931 will always be remembered as the "loudspeaker" year

Are You "Drugged" by Distortion?

because it was during that twelve months that the moving-coil principle became available to the masses. And coincident with falling prices for "M.C.'s," the balanced-armature rose in quality (but not in cost), and the inductor appeared on the scene as a popular commodity.

For make no mistake about it, the moving coil has not killed these other types; rather has it set a standard which these other types have risen towards.

But, of course, it is not every 1932 loudspeaker which can give a performance equal to that indicated by one of those really good response curves which you see as representing what is possible with a modern speaker.

Those "Museum Pieces"!

On the other hand, it is quite safe to say that a loudspeaker which could not eject a curve better than almost any 1922 instrument would be thrown into a 1932 dustbin!

But between the two extremes lies a whole museum of distortion, and the pity of it is so many people harbour museum pieces without realising it. Their ears have become adapted to distortion and their aural nerves are blunted against "peaks" and tolerant of frequency deficiencies.

I know the *riposte* to this is: "So long as they are satisfied—what you don't know about you can't miss."

But this is most negative argument, as is proved by the intense new enjoyment the man who changes from a "puddeny" speaker to an even-response modern type gets—once he has got used to the change-over.

Making a Change

For you have got to get used to such a drastic change. Realism in loud-speaker reproduction can actually be heard as fearful distortion if one's

ears have had a long training in accommodating themselves to distortion!

I have had personal evidence of the truth of this, and I expect there are also many "M.W." readers who could quote striking instances.

However, just as one's ears can adapt themselves to distortion, so also can they "unadapt" themselves. During the Great War I spent many hundreds of hours with my ears within a few feet of roaring aeroplane engines, not to mention screaming flying-wires and tearing artificial gales caused by the passage of big "birds" through the air. I got "used" to it. Then, after the war, I got "unused" to it again, and found such noises as intolerable as when I first had to hear them!

Higher Efficiency

But it sometimes happens that a further factor impeding a quick appreciation of the potentialities of a new loudspeaker creeps in. And this is incidental to the greater efficiency of the instrument.

In brief, a new loudspeaker may show up faults in the output of a radio set which were smothered by the original loudspeaker.

Supposing there had been valve overloading. Now this generally evinces itself in the higher register, and is heard as a harsh cracking and grating. A speaker which is "mellow" (which means it can't handle "top")

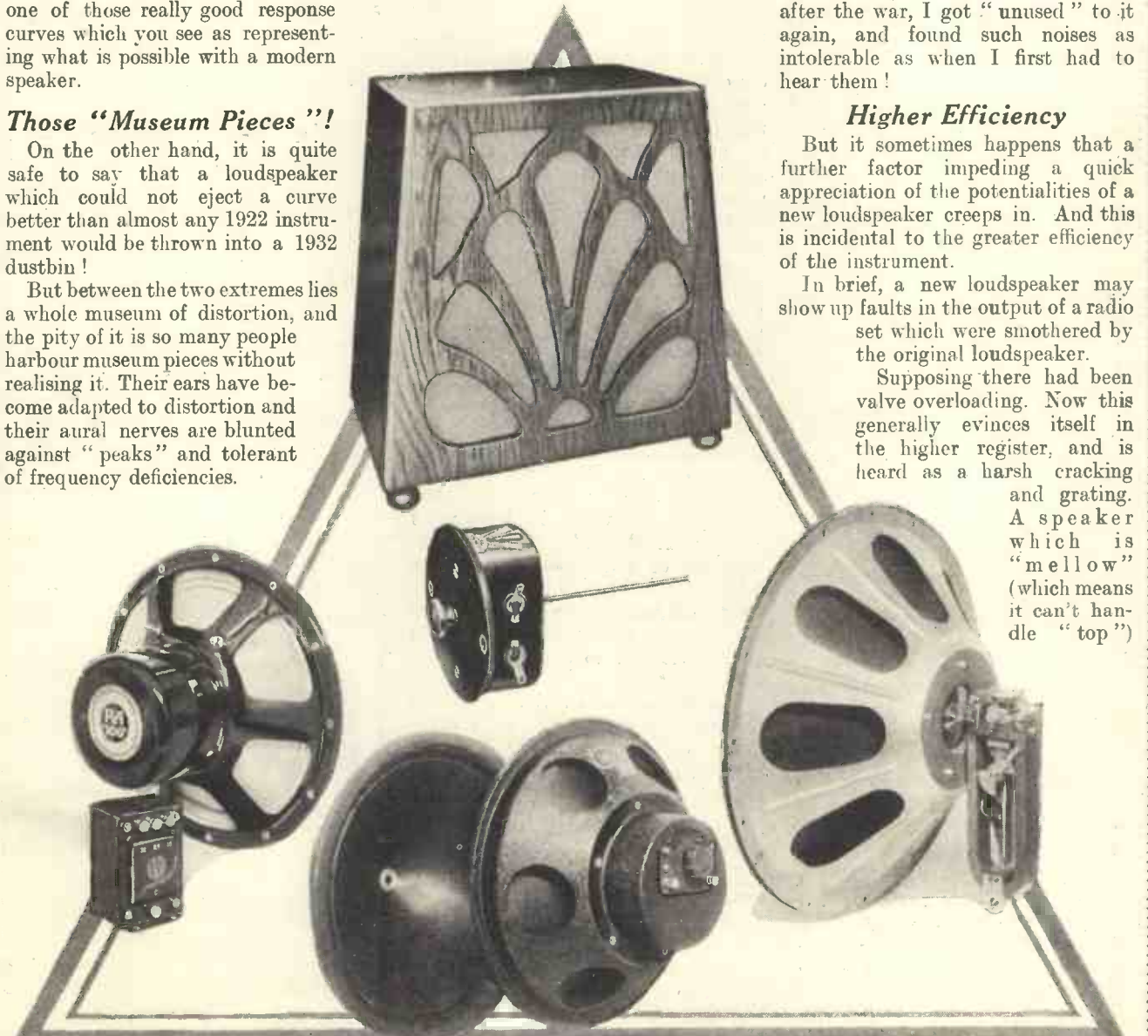

Here are grouped the Kolster-Brandes K.B.287 cabinet cone speaker (top), the R. and A. "100" moving-coil chassis and output transformer (left), the Graham Farish model A.C.4 cone chassis (bottom), the Wufa 60-pole unit and chassis (right), and the Six-Sixty Junior loud-speaker unit.



This pleasingly handsome cabinet houses the MoToR "Windsor" loud speaker

may need a lot of this overloading distortion before it reveals its presence. But on the efficient 1932 speaker it is plainly heard, and the listener says: "Why, that loud speaker is worse than my old one."

Of course, he is visiting the sins of his set on the new loud speaker!

Not All Perfect

Nevertheless, I must hasten to add that every 1932 loudspeaker will not be so perfect that the speaker can now be dismissed from our minds as a source of distortion. But if mechanical and other troubles can develop, or even if serious inherent faults still exist in some products of 1932 factories, the plain fact remains that, providing you choose your make with discrimination, modern loudspeakers are very well worth while buying as replacements for two or-more-year-old models.

Indeed, no better investment can be made than one such as this.

And now let us examine in detail some of the changes in technique which have been made to bring about such a revolution.

Diaphragm Design

I think one of the most striking is to be seen in the diaphragm. At one time it seemed to be almost universally believed that a large diaphragm was essential for the proper treatment of bass frequencies.

This idea was probably due to the fact that more energy is needed for the development of bass than for the higher notes at proportional loudness. (A large diaphragm displaces more air than a smaller one; ergo, a big diaphragm is needed for the bass!)

Now it is commonly known, especially with the moving-coil principle, that the smaller you make the diaphragm the more uniform is the

distribution of the sound waves in space at all frequencies, although with a decrease in diaphragm size there may be a loss in low-note power owing to an increasing disparity in the relative size of the coil.

Which all goes to show that there is a "best size," and that that size isn't the huge one that designers at one time appeared to think it should be.

Construction of Cones

Then there is the question of cone angle—for nearly all modern diaphragms are cone-shaped in order to achieve both stiffness and lightness.

The more acute the angle, the more directionally are the high notes radiated, and the nearer to flatness it is the thicker a given material has to be to achieve the required stiffness. Special constructions and special materials are used in modern diaphragms in order to affect the best possible compromise.

"This special 'M.W.' section is presented in the hope that we can convince radio enthusiasts that inexpensive modern loudspeakers are as good as their three- and four-year-old predecessors were bad."

Then there has been great concentration of what is known as "paper break-up." This is the tendency of a diaphragm to vibrate sectionally instead of moving backwards and forwards as a whole in the air. It occurs at the higher frequencies and, obviously, to a greater extent with larger diaphragms.

The upshot of all this is that a modest-sized diaphragm and a baffle board, or a scientifically designed cabinet, are nowadays in the make-up of most speakers.

Avoiding Box Resonance

And no longer is a speaker unit encased in a box of haphazard design. More scientific thought is given to the cabinet of a speaker than was directed at the very unit itself five years ago.

And as for the unit, well, here progress has been phenomenal. All three types—balanced armature, inductor and moving coil—have advanced. In

the last the use of special cobalt-steel permanent magnets and skilful engineering have given us inexpensive instruments of high quality and great sensitivity.

If the ordinary listener desired great volume, the choice between the three types would be much easier, but modest volume eliminates most of the bass anyway—you cannot have bass without loudness. The moving coil scores in the bass because of the greater motional freedom of its driving element—the moving coil itself. But it also tends to score in that its impedance remains moderately constant at all frequencies and does not rise steeply at the higher frequencies and thus give these poorer treatment.

An Equal Response

Also, it does not deal with strong inputs more favourably than with the weaker ones. But at the "quieter" levels such amplitude distortion does not show itself markedly in a balanced-armature type, and is absent in the inductor.

So you see, that from the average radio enthusiast's point of view there are no sharp divisions to be drawn. It is a foolish vanity to make a fetish of a principle—it's the results which matter.

Fortunately, the price scale is fairly well representative of the relative qualities of the various types and makes.

You will see exactly what I mean if you carefully note the products of a

Throw Out Your Duds!—



The W.B. "P.M.3" permanent-magnet moving-coil speaker can be obtained in this attractive oak cabinet

—and Begin to Enjoy the Real Thing

firm which specialises in loudspeakers and which has a wide range of models on offer. Of course, this constitutes only a rough guide as to the individual merits of speakers of different makes.

The prices and qualities of all the models of all the manufacturers do not run parallel. Nevertheless, there is something of a standardisation among the leading concerns.

This is not arrived at by mutual

senior moving-coil effectiveness at junior model prices!

At the same time, radio enthusiasts can take heart at the fact that the technical gap between the speakers at opposite ends of a price range is by no means as wide as it was a few years ago.

"Parlour Listening"

And it is very debatable as to whether the listener with the average size of set who requires only a modest

high time I handed my pen over to Mr. Kelsey so that he can particularise to good purpose on the subject of speaker selection.

I have endeavoured to show you that the time has come when you can buy loudspeakers fearlessly, knowing that hard-and-fast standards of performance have been aimed at and achieved, and that there is not so far to go on the road to perfection that your 1932 loudspeaker can

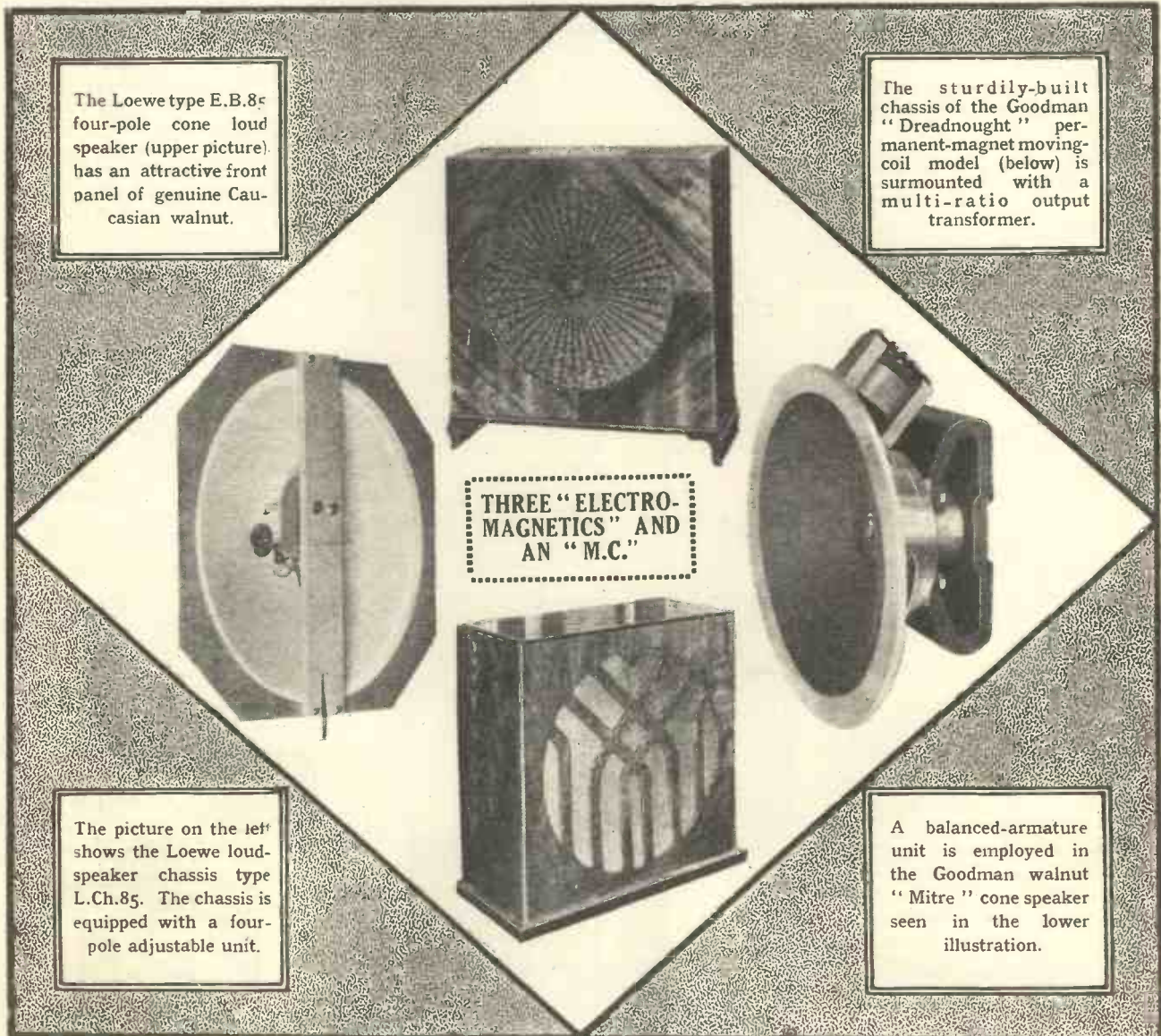

The Loewe type E.B.8c four-pole cone loud speaker (upper picture) has an attractive front panel of genuine Caucasian walnut.

The sturdily-built chassis of the Goodman "Dreadnought" permanent-magnet moving-coil model (below) is surmounted with a multi-ratio output transformer.

The picture on the left shows the Loewe loudspeaker chassis type L.Ch.85. The chassis is equipped with a four-pole adjustable unit.

A balanced-armature unit is employed in the Goodman walnut "Mitre" cone speaker seen in the lower illustration.

THREE "ELECTRO-MAGNETICS" AND AN "M.C."

arrangement, but by a mutual and general endeavour to give the best value for money.

Economics are a strongly deciding factor in speaker design, and it is not practical to give, for instance,

volume for "parlour listening," as technicians say, will be losing much if by force of financial circumstances he cannot purchase one of the more expensive models.

But enough of generalities; it is

be "dated" before the year is out.

Mr. Kelsey will marshal all the important models in review for you, and Mr. Rogers will conclude by telling you exactly how to use them to the best effect.

LOUDSPEAKERS



The fine array of cabinet speakers in this picture are (left to right) the H.M.V. S.7, the B.T.-H. Minor R.K. (top row), the Marconiphone Model 131, the W.B. P.M.3, the Graham Farish "Snap" speaker, the Rotor Midget Dynamic, the Celestion J.12, and the Ormond R/452.

IF only we were conscious of sound through the medium of our eyes, what a glorious bonfire of obsolete loudspeakers there would be! Out would come all the old tin horns in one concerted rush to be dumped on the nearest rubbish heap, yes, and not a few of the old cones would quickly be committed to the flames, too!

But perhaps you do not see the connection. Well, let us consider the matter from another point of view.

Supposing you went to the cinema and you saw a full-size picture projected on to a screen only half the normal depth. It isn't difficult to imagine what would happen, is it?

High Quality Reproduction

The centre portion of the projected image would be clear and in focus. It would, in fact, be exactly as it was intended to be—a replica of the original scene. But at the top and bottom, where the projection overlapped the curtains and drappings, the reproduction would be thin and unintelligible. In other words, the picture would be incomplete—it would be lacking in detail at the top and bottom, and if such a thing did happen you would probably think that the management were "not so well," and would get up and walk out!

The possibility is almost too absurd to bear thinking about, and yet how many thousands of people are content, even at the present day, to put up with an exactly similar state of radio "half projection"?

To enjoy the almost perfect reproduction that it is possible under modern conditions to obtain, it is obviously vitally necessary for the "voice" of the set to be able to take in the "full-width" of the frequency "projection." It must not be lacking in detail at the lower frequencies—or, equally as important, at the upper register. It must have an even response—may I call it a full-width projection?—over the whole of the frequency range employed in broadcasting.

That brings us to the question of loudspeakers of to-day, and it is no idle statement to say that almost without exception the present-day types—due to the tremendous advances that have been made during the last year or so in the technique of reproduction—can truthfully be claimed to give that full-width and even-frequency response which is not only desirable but necessary to obtain faithful reproduction.

Tremendous Advances

With the older types you simply cannot obtain this condition of absolute fidelity. However much "hotting up" you may do to your actual set you cannot alter the characteristics of the loud speaker itself—at least, not to the extent of obtaining an even frequency response over the whole of the scale.

But I mustn't harp on technicalities any longer, for Mr. Dowding has already covered the ground very thoroughly, and if any of you are content to put up with "cacophonous noises" after reading the Technical Editor's article, I shall be very surprised!

What I am going to do is to give you a review of as many types as possible of the modern loudspeakers, and although every effort will be made to give complete details in each case, you must not expect me to say that the so-and-so model is better than somebody else's, because that would

be an extremely dangerous—possibly, even, an unreliable—procedure!

I purposely say unreliable because it is a fact that no two people hold quite the same views when it comes to matters of reproduction. And, since all modern loudspeakers are of a high standard, it is absolutely a matter of personal opinion as to which one you choose.

The main thing to remember is that you must interest yourself particularly in those types which are most suitable for your set, and your final choice will be governed very largely by the type of output circuit you are using. But here again I must not digress, for the question of output arrangements is fully covered by Mr. Rogers in a later article.

So numerous are the various types and makes of modern loudspeakers that in marshalling them for review it will be best to adopt some sort of grading scheme, whereby it will be possible to refer in an instant to any particular type.

In this connection, perhaps the best scheme will be to start with the smallest cones and to work up to the super moving coils, dealing with the various makes in alphabetical order. So here goes!

Starting With Cones

B.T.-H.—The B.T.-H. people strike rather an original note in the design of their cone loud speaker. A distinctive circular moulding having an ornamental grille and backed by gold gauze takes the place of the more conventional cabinet, and at the reasonable price of £2 10s. 0d. it represents an attractive proposition. This particular model is especially suitable for pentode output.

BLUE SPOT.—In the Blue Spot range there are three handsome cabinet cone speakers. The model 44R, the price of which is £2 12s. 6d., incorporates the well-known Blue Spot 66R unit, and it is housed in an attractive oak cabinet. It has a "twin brother," in so far as the movement is concerned, known as the 45R, which retails at

SOME EXCELLENT EXAMPLES

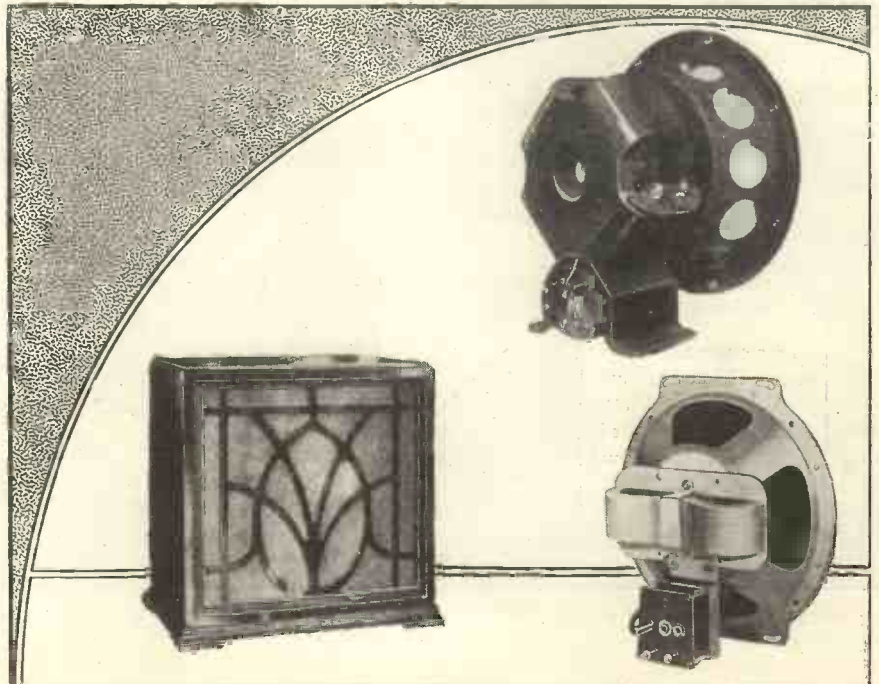

Some more modern loudspeakers. The cabinet model on the left is the Marconiphone Model 131 permanent-magnet moving-coil speaker, while on the right (above) is shown the Type 91 permanent-magnet moving-coil chassis produced by this company. The lower illustration on the right shows the Magnavox C.M.130 chassis.

OF TODAY

A COMPREHENSIVE SURVEY

OF MODERN TYPES

By G. T. KELSEY.

Cabinet cone loudspeakers—energised and permanent-magnet moving-coil types—units—chassis equipments, etc.—all are dealt with in this informative review of loudspeakers of to-day. This is the most comprehensive guide to that all-important, but often-neglected accessory—the loudspeaker—that has ever been produced, and it shows in rather a striking way the tremendous advances that have been made during the last year or so in the technique of reproduction.

the same price, but the cabinet in this case—although handsome—is of more orthodox design. The next step higher in this particular range brings us to a really handsome speaker, the 70R. The cabinet, which is of walnut, is pleasingly out-of-the-ordinary, and the complete speaker into which is built the 66R unit retails at £3 15s. 0d.

A Well-known Firm

CELESTION.—The name of Celestion requires no introduction into the field of cone loudspeaker manufacturers, and altogether there are five models in this range, varying in price from £1 18s. 6d. to £5 7s. 6d. The J.12, which is the cheapest one, is built into a highly polished and artistic oak cabinet, and it has the appearance of being extraordinarily good value for money. Next in price comes the D.10 at £3 10s., and the M.12 at £3 12s. 6d. The M.12 and the M.14 (the latter retails at £4 10s. 0d. in an attractive oak cabinet) incorporate the Celestion super "M" movement and the

reinforced diaphragm principle of construction, which is an exclusive feature of all Celestion cone models. At the top end of the price scale in this particular range is the model D.12. It is obtainable in an oak or mahogany cabinet at £5 and £5 7s. 6d. respectively, and it can rightly be classified as among the best of the super cone speakers.

COSSOR.—The reputation which Messrs. Cosso: have built up in the valve world render it unnecessary to say anything by way of introduction to what are perhaps their lesser-known products. Yes, they make loudspeakers as well, and altogether there are two in the Cosso: range which fall into the cone class.

The model 295 at £1 5s. 0d. is extremely modest in price in view of the fact that it is built into an oak cabinet. The other one, which can be obtained in an oak cabinet (model 500) or a walnut cabinet (model 550), is priced at £2 10s. for either model, and it is, if anything, slightly modernistic in appearance, but none the less attractive. It is, as a matter of fact, a very nice-looking job, and every bit up to the standard that one would expect from Messrs. Cosso:.

FALK, STADELMANN.—There are plenty of types at various prices in the "Puravox" range of cabinet cones, because Messrs. Falk, Stadelmann confine their activities in the loudspeaker field to the production of cone types only.

The open cone model at £1 1s. 0d.—styled the W.91549—is the cheapest of the lot, and next to this in price comes the W.91550, a neat, polished oak cabinet model selling at £1 10s. 0d. Then, in order of cost, comes the W.91551 and W.91552—both handsome cabinet models at £1 17s. 6d.—and, finally, the W.91763 and the W.91553, both at £2 15s. 0d.

Original in Design

The "Puravox" W.91763 sets an entirely new standard in the design of cabinet cone loudspeakers. The entire cabinet is a mahogany finished bakelite moulding, and it has a particularly artistic Peter Pan fret design. It strikes one as being a worthy exterior for the excellent loudspeaker contained in it.

G.E.C.—The famous Gecophone "Stork" cone loud speakers employing the "Stork" adjustable armature unit are available in two different designs. The Plaque model, the price of which has recently been reduced to £1 17s. 5d., is eminently suitable for wall suspension, but it is also provided with a stand, so that it can, if desired, be placed on a flat surface.

The "Stork" cabinet model at £3 5s. 0d. represents the last word in high-grade workmanship. It is "the sort of thing that would look "at home" even in the most elaborately furnished room, super-added to which is the fact that the G.E.C. people claim it to have an excellent audible efficiency over a very wide frequency range. Included in the Gecophone range is a medium-priced bakelite model which retails at £2 10s. 0d.

GOODMAN.—One of the cheapest of the cabinet cone loudspeakers is the one produced by Messrs. Goodmans under the name of the "Cabinet-cone." The speaker itself is built around the Goodman adjustable differential unit, and, bearing in mind that it is housed in a hand-polished oak cabinet, it is remarkable value for 19s. 6d. The walnut "Mitre" cone speaker, the only other cone speaker in the Goodman range, incorporates the Goodman four-pole balanced-armature unit, and sells at £1 9s. 6d. The speaker is housed in a real walnut cabinet of distinctive design, and at such a low price it seems a very attractive proposition.

An Attractive Cabinet

GRAHAM FARISH.—There is something distinctly pleasing about the appearance of the Graham Farish "Amazing" A.C.4 loudspeaker. Whether it is the fact that the cabinet is bakelite, or whether it is something to do with the suggestion of futurism in the design, I am not quite sure. But or those who are concerned with cone speakers the "Amazing" A.C.4 at £2 2s. 0d. is one that is well worthy of consideration. Messrs. Graham Farish also manufacture a guinea loudspeaker known as the "Snap" model.

KOISTER-BRANDES.—Although quite a number of Koister-Brandes loudspeakers are included in their well-known sets, there is only one that is definitely available to the public. This is the K.B.287, which is offered at the "reachable" price of £1 17s. 6d. It is an adjustable armature cone speaker, built into a pleasing-looking cabinet

OF MODERN "MOVING COILS"

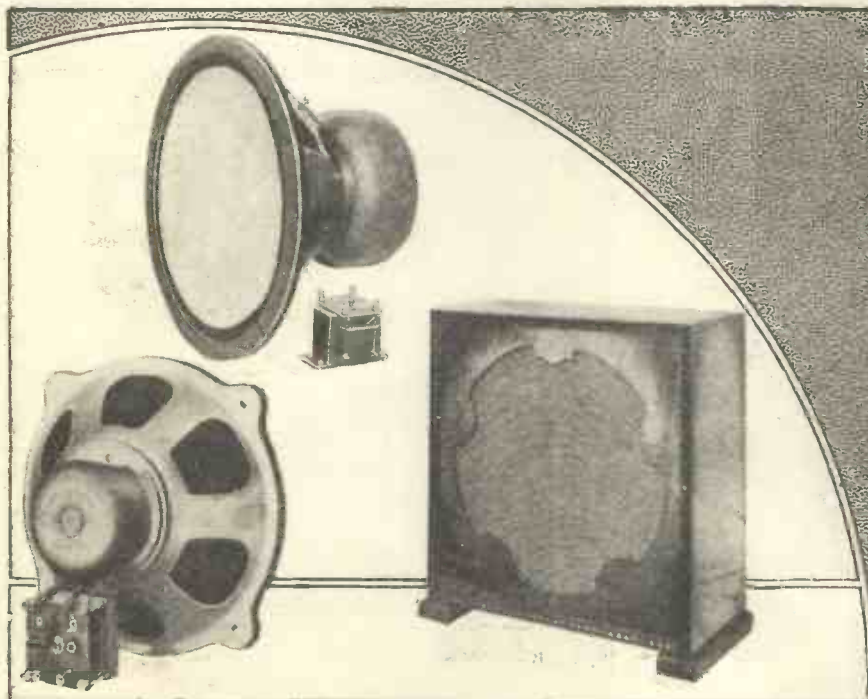

Have you heard these? The chassis on the left is the Magnavox D.C.144—an energised model for D.C. mains—while immediately above it is the Amplion permanent-magnet chassis and transformer. The right-hand picture is of the Amplion Two-Guinea cone.

ANOTHER FINE SELECTION OF UP-TO-DATE SPEAKERS

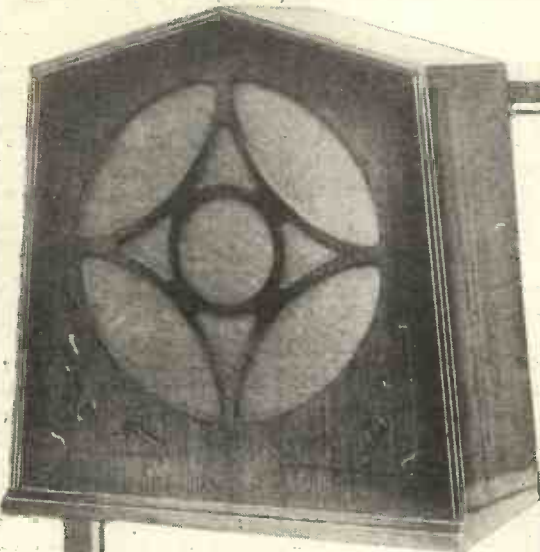

(Left) The Blue Spot model 44 R, and (right) the new and ingenious Donotone speaker.

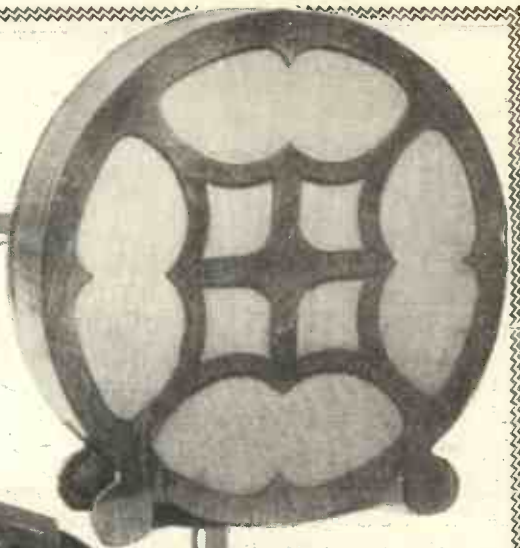

(Below) The Ormond R/452 cabinet cone and the Ultra "Imp" chassis.

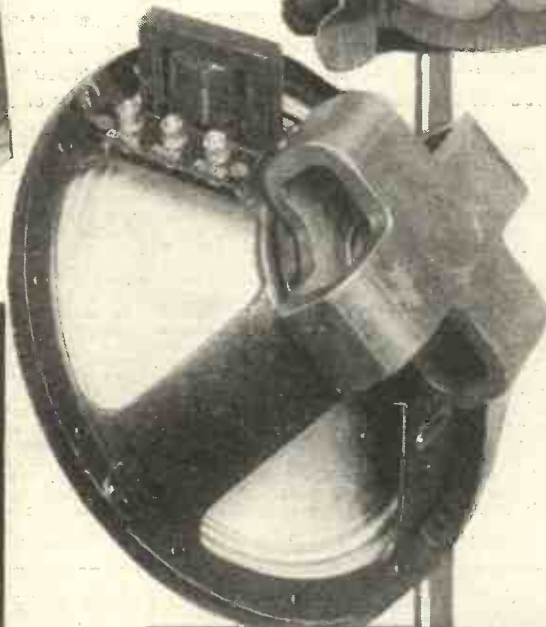
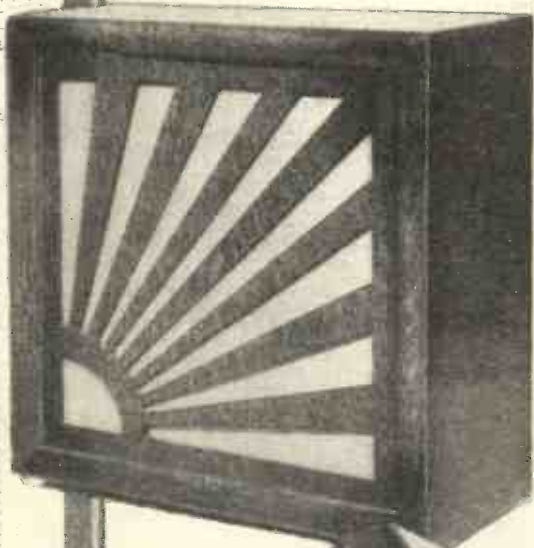

The solidly-built chassis on the left is the new Igranic permanent-magnet moving-coil model. Below is seen the chassis and cone assembly of the Undy 8-pole dynamic speaker.

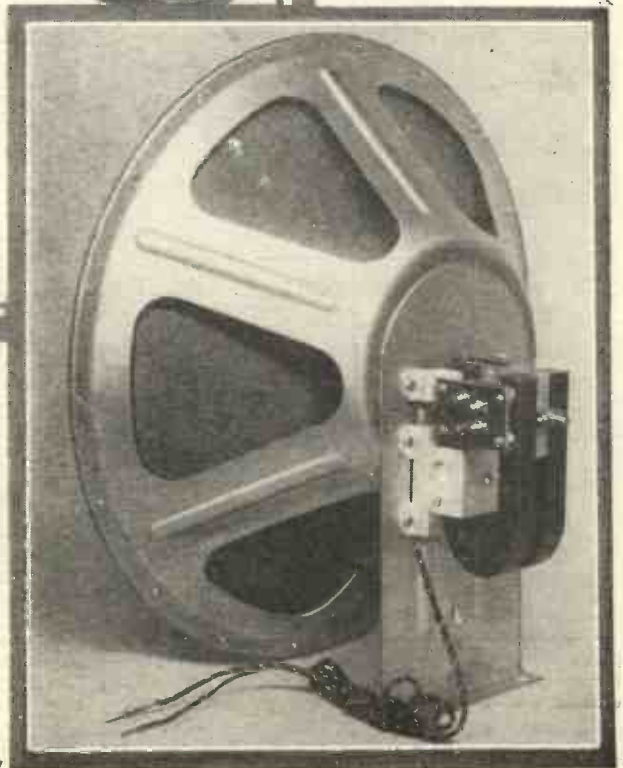
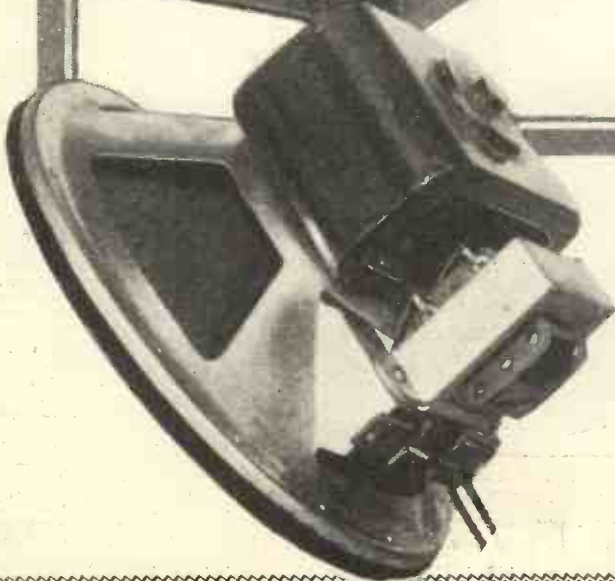

Say Good-Bye to Half-Truths!

and all that need be said about it is that it is quite up to the high standard that one associates with K.B.

LISSEN.—There are two cabinet loudspeakers in the Lissen range which fall into the cone class. The first is the type L.N.5078 at £1 2s. 6d.—a very good proposition indeed for the money—and the other is the type L.N.5099, which retails at £2 15s. 0d. The higher-priced model incorporates a four-pole balanced-armature unit of special design, and the oak cabinet is in keeping with the high standard of results given by this model.

An Inexpensive Instrument

LOEWE.—The Loewe type E.B.85, which is the only cabinet cone loudspeaker produced by this company, has established its reputation not only on the grounds of low price for high performance, but also on account of its particularly attractive appearance. The cabinet has a quartered front of genuine Caucasian walnut, and the actual cone opening is covered with pleated silk. The cone is actuated by a four-pole power unit, and the complete speaker sells for the extremely moderate price of £2 2s. 0d.

MARCONIPHONE.—Mention of the name of Marconiphone immediately conjures up visions of something good in the realm of cone loudspeaker manufacture. The vision in this case is something more than a mere phantasy—it is a very definite reality, and the Marconiphone model 64 at £2 15s. 0d. leaves nothing to be desired. It employs a special balanced-armature movement, and the speaker is housed in a polished oak cabinet of truly artistic appearance.

ORMOND.—Originality of design is the keynote of most of the cabinet cone models produced by Messrs. Ormond. They are the manufacturers of what, I believe, is the only cabinet pedestal model designed to fit into a corner, and a very fine-looking job it is, too. The actual speaker part of it is built around the famous Ormond four-pole adjustable unit, and at the price of £3 19s. 6d. it is a model that will appeal to many.

In addition to this model, the Ormond people contribute three good table models, the R/470 in a polished oak cabinet and employing the No. 3 unit at £1 2s. 6d. (£1 5s. 0d. in mahogany), the R/452 incorporating the No. 1 unit and with the choice of an oak or mahogany cabinet at £1 9s. 6d., and a super model designated the R/455 at £2 10s. 0d., again with the choice of an oak or mahogany exterior.

Special Floating Armature

ROTOR ELECTRIC.—The three cabinet cone speakers marketed by Rotor Electric, Ltd., are known as the Super-Dynamic, the Junior-Dynamic, and the Midget-Dynamic, and the prices are £4 17s. 6d., £3 3s. 0d., and £2 12s. 6d. respectively. In the case of each of these speakers the finish is of a very high class.

The Grassmann floating unit is employed in the Midget and the Junior, but in the case of the Super model the unit is of special design. The actuating mechanism in the Super model is a double unit built up on the Grassmann floating-armature principle, and it is capable of very fine results indeed.

STANDARD BATTERY COMPANY.—The famous Wates loudspeakers, of which there are

two that fall into the cone class, are built up on a very ingenious principle. Instead of having just one cone, each of the Wates models is provided with two cones, one specially designed for the lower frequencies, and the other to bring out the high notes. As a result of this combination scheme the Wates models give a very pleasing performance.

The "Star" 14" model, which is supplied in an oak cabinet complete for £3, can be had in a mahogany cabinet for an extra 5s. The larger model, which is known as the "Star" 20" model, sells for £4 in an oak cabinet, but as in the case of the "Star" 14" it can be had in mahogany for an extra charge of 5s.



Who could want anything more artistic than this? It is the new H.M.V. model S.7, and the cabinet is of solid walnut.



A masterpiece—the new H.M.V. S.5 moving-coil instrument.

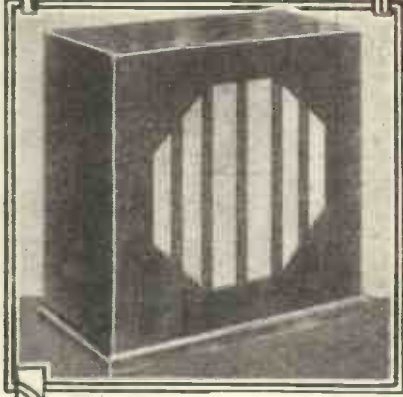

These two cone models represent the Coscor contribution to the loudspeakers of to-day, and very excellent instruments they are, too, in their respective classes. The model shown above is known as the "500," while the left-hand picture gives an excellent idea of the model 295. Model "500" is the designation of the oak cabinet version of the Coscor Super speaker, but this particular instrument is also available in mahogany and it is styled the "550."

TEKADE (MoToR).—In the case of both of the cabinet cone speakers produced by Tekade Radio & Electric, Ltd., the cone is driven by the new "MoToR" balanced-armature loudspeaker unit designated as the type S.40. This is one of the most recent units to make its appearance on the market, and it is claimed to have an extremely good frequency response. Certainly the results given from it are very realistic.

This new unit is featured in the MoToR model "York" loudspeaker—a figured-walnut speaker of pleasing appearance, which sells complete for £2 15s. 0d., and it is also incorporated in the MoToR model "Windsor," a very fine-looking job indeed, which, for what it is, is very reasonable at the price of £3 15s. 0d.

Famous for their "Moving Coils"

W.B.—Messrs. The Whiteley Electrical Radio Co., Ltd., have built up their reputation as a loudspeaker manufacturing concern on the merits of their famous moving-coil models, and perhaps not all are familiar with the fact that they also make two cabinet cone models.

As a matter of fact, they are very nice-looking jobs, and at the price of £1 2s. 6d. and £1 19s. 6d. they would be difficult to better in their respective classes. The cheaper model, known as the "Popular," is housed in a polished oak cabinet; while in the case of the senior model, the cabinet is again of polished oak, but the unit is a specially sensitive four-pole balanced-armature movement capable of handling large volume.

That brings us to the end of the cabinet cone models, but before passing on to inductors and moving coils I want to bring this section to a close with just a brief review of cone chassis equipments and loudspeaker units. Again it will be best to deal with them in alphabetical order.

BLUE SPOT.—The chassis equipment produced by the British Blue Spot Company is very solidly constructed, and is available in two different styles. The Major Chassis costs 15s., and the Special Chassis retails at 7s. 6d. These prices do not, of course, include the units, which can be obtained separately and fitted. The Blue Spot range of units is a very famous trio, and includes the original but improved 66K at £1 5s. 0d., the 66P at £1 7s. 6d., and the 66R at £1 15s. 0d. The last-named unit, fitted to a well-designed cone, is capable of handling very large volume without the slightest distress.

Cone Chassis and Units

BRITISH RADIOPHONE, LTD.—British Radiophone, Ltd., specialise in the production of loudspeaker units, and although they produce several, the ones which are of particular interest to the home constructor are the No. 196 at 7s. 3d. and the No. 275a at 10s. 6d. They are both well-made units of the adjustable type, and in the case of the 275a a choice of three different impedances is possible.

CELESTION.—It is only comparatively recently that the Celestion people have produced a loudspeaker chassis, but the type M.12, as it is called, at £1 15s. 0d., is quite up to the high standard of their older-established productions. It incorporates a very sensitive unit, and the frequency response is remarkably good.

GRAHAM FARISH.—The one-guinea A.C.4 chassis and unit manufactured by Messrs. Graham Farish is similar to the chassis assembly employed in their "Amazing" A.C.4 loud speaker. In other words, it is very good. This company also produce two efficient units—the "Snap" at 5s. 6d. and the "Audion" at 12s. 6d.

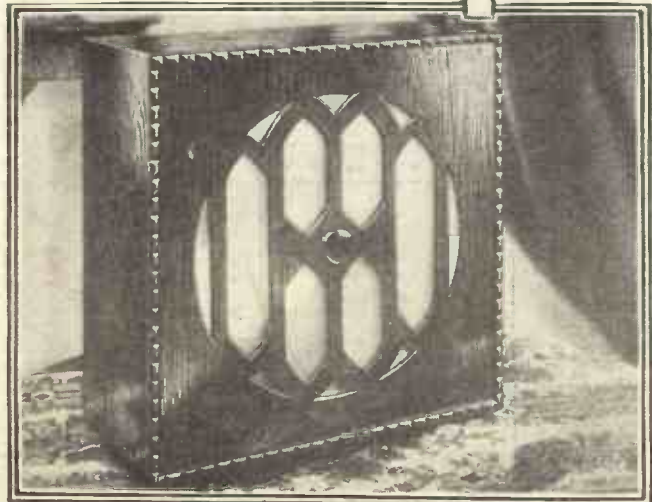

ALL RANGES AND PRICES OF "MOVING COILS"

Make	Permanent-Magnet M.C. Chassis	Permanent-Magnet Cabinet M.C.s.	Moving-Coil Chassis Mains Type	Mains Type Cabinet Moving Coils	Make	Permanent Magnet M.C. Chassis	Permanent Magnet Cabinet M.C.s.	Moving-Coil Chassis Mains Type	Mains Type Cabinet Moving Coils	
BAKER'S (All the models produced by this company will be found in this section only, because they do not manufacture anything but moving-coil types. In the case of certain other firms, however, their products are divided up into the appropriate sections.)	Model S.P.P.M. £6 0 0 (including trans.) Model S.P.M. £4 10 0 (including trans.) Model P.P.M. £3 15 0 (including trans.)	"Klock" Model (P.M. speaker and electrically controlled clock in handsome cabinet) £12 0 0 "Permag" £2 7 0 (with trans.)	Super-Power Moving Coils Model S.P.6 (6-v. battery) £6 0 0 Model S.P.D. (D.C. model) £6 0 0 Model S.P.A.C. (A.C. model) £9 0 0 Standard Models S.8 (6-v.) £4 15 0 S.D. (D.C. mains) £4 15 0 S.A.C. (A.C. mains) £7 10 0 Popular Model P.D. (D.C. mains) £2 15 0	"Elomag" £1 14 0 (with trans.)	FERRANTI Type M.1 £7 10 0 Type M.2 £5 0 0 Type M.3 £2 15 0			Type D.2 (D.C. model) £2 5 0		
						GENERAL ELECTRIC COMPANY --- --- ---		D.C. Model £7 0 0 A.C. Model (with rect.) £10 10 0	D.C. Model £10 10 0 A.C. Model (with rect.) £14 0 0 (Cabinet or decorative baffle)	
BLUE SPOT	Blue Spot P.M. £3 15 0	"Goliath" Model 30 P.M. £5 10 0	Model 72 (D.C. mains) £2 7 6		GOODMANS "Dreadnought" £1 19 6 (with multi-ratio output trans.) --- --- ---		"Dreadnought" £2 19 6 (with multi-ratio output trans.) --- --- ---			
B.T.-H. (An output transformer is not included in the prices of reproducers listed by this firm, but it is obtainable for a small extra charge.)	Minor R.K. Reproducer £2 10 0 Senior R.K. Reproducer £5 12 6	Minor R.K. Reproducer. In artistic cabinet. Fumed oak £3 17 6 Walnut £4 4 0	Minor R.K. Reproducer (D.C. model) £1 11 6 Senior R.K. Reproducer (D.C. model) £5 5 0 (A.C. model with rect.) £7 15 0		H.M.V. --- --- ---		H.M.V. S.5 (walnut) £13 10 0 H.M.V. S.7 £5 5 0			
BRITISH ROLA	Model P.M. (available with single, push-pull, or pentode transformer) £2 9 6 (without trans.) £2 2 0		Model F. (available in various ranges for D.C.) (including output trans.) £1 15 0 (without trans.) £1 7 6		IGRANIC Igranic P.M. (with trans. for power or pentode output) £3 7 6 (without trans.) £3 0 0					
CELESTION	P.P.M. £2 7 6 (including trans.) R.P.M.8 £3 10 0 R.P.M.12 £6 0 0	R.P.M.8B. £5 10 0 R.P.M.12B. £10 10 0			LAMPLUGH M.C.P.M. (with output trans.) £2 2 0		Lamplugh Mains Type £1 14 0 (with trans.)			
COSSOR			Cossor "Utah" Models 825 and 850 £1 15 0		LANCHESTER Junior £1 10 0 Monitor £2 8 0 Senior £2 18 0 Special Senior £3 3 0	Junior £2 10 0 Monitor £3 10 0 Senior £4 0 0 Special Senior £4 5 0				
EDISON BELL	"Premier" (Models for both power and pentode output) £3 7 6 "De Luxe" (in two types, as above) £2 10 0	"De Luxe" In oak cabinet (both power and pentode models) £3 15 0			LISSEN Types L.N.963 and L.N.964 £7 10 0	Types L.N.965 and L.N.966 £9 10 0	Types L.N.5001 and L.N.5002 (D.C. mains) £3 15 0	Types L.N.5115 and L.N.5118 (D.C. mains) £5 15 0 Types L.N.750 and L.N.751 (A.C. mains) £8 0 0		
EPOCH (Limitations of space preclude a reference to every one of the speakers in this range, but the only ones that have been omitted are those not directly of interest to the home listener, i.e. cinema models etc.)	New Model £1 15 0 (including 3-ratio transformer) Type J.1 £2 5 0 (including output trans.) Type A.2 £3 3 0 (including output trans.) Type 99K. £7 7 0 (including output trans.) Type 99X. (extra sensitive) £6 15 0 (without trans.)	Type J.1C. (polished walnut) £3 12 6 Type A.2C. (polished walnut) £4 10 6 Type A.2C1. (superior cabinet in oak, walnut or mahogany) £5 5 0 Type 99K. £9 9 0 or £11 11 0 Type 99X. £8 17 0 or £10 19 0 Type C.17 £2 17 6 Type C.18 £4 7 6	Type 101F. (D.C. model) £7 15 0 Type 101H. (A.C. model) £11 5 0 (with rectifier equipment) A model for accumulators is also available, i.e. Type 101E. £6 15 0 Type 99F. (D.C. mains) £4 15 0 Type 99G. (A.C. mains, 9 watts) £7 0 0 Type 99H. (A.C., 18 watts) £8 5 0 Type 99E. (accum. or rect.) £4 15 0	Type 101F.C. (D.C. model) £13 4 0 Type 101H.C. (A.C. model) £16 14 0 Type 101E.C. (accum. model) £12 4 0		MAGNAVOX Model C.M.130 (with trans.) £3 3 0	Model C.M.130 In walnut £5 15 0 In oak. £5 5 0	Model D.C.144. Type L. (110-190 v.) £2 10 0 Type H. (190-300 v.) £2 12 6 Model D.C.142. Type L. (110-190 v.) £2 15 0 Type H. (190-300 v.) £2 17 6		
					MARCONI-PHONE Model 91 £6 6 0	Model 131 (mah. cab.) £10 10 0 (with trans.) Model 132 £4 19 6 (inc. trans.)				
					ORMOND (inc. trans.) Model R/464 £3 5 0	Model R/466 £4 19 6				
					ROTOR ELECTRIC --- --- ---		Models D.C.110 and D.C.220 (for D.C. mains) £4 17 6 Model D.C.6 (4-6 volts) £4 17 6 Model A.C.6 £8 5 0 Model "Red" A.C. £5 5 0 D.C. £3 7 6 Model "Golden" A.C. £3 19 6 D.C. £2 9 6 Smaller models (for D.C.) £1 0 6 £1 19 6 £2 9 6			

ALL RANGES AND PRICES OF "MOVING COILS" (Continued)

Make	Permanent-Magnet M.C. Chassis	Permanent-Magnet Cabinet M.C.s.	Moving-Coil Chassis - Mains Type	Mains Type Cabinet Moving Coils
R. & A.	R. & A. "100" £2 5 0 "Challenger" (incl'g trans.) £1 15 0	—	—	—
STANDARD BATTERY COMPANY	Wates Permanent Magnet (with multi-ratio output trans.) £2 4 0	—	Wates Mains Energised (with multi-ratio output trans.) £1 17 6	—
TEKADE (Motor)	Motor P.M. £3 10 0 (including trans.)	"Chester" £4 19 6	—	—
ULTRA	Model 95 £4 15 0 (including trans.) Ultra "Imp" £2 15 0 (including trans.)	Model 95 In walnut cabinet £6 6 0 "Imp" In walnut cabinet £4 0 0	D.C. Type (acc. or mains) £2 19 6 (including trans.) A.C. Model £4 12 6 (including trans.) Ultra Minor (D.C. mains) £1 10 0	D.C. Type In walnut cabinet £4 17 6 (including trans.) A.C. Model In cabinet with trans. £6 6 0 Ultra Minor (D.C. mains) £2 17 6
WHITELEY ELECTRICAL RADIO CO. (W.B.)	P.M.1 £6 0 0 (including trans.) P.M.2 £4 5 0 (including trans.) P.M.3 £2 12 6 (including trans.) P.M.4 £2 2 0 (including trans.)	P.M.1 (in quartered walnut cabinet) £3 5 0 (includ'g trans.) P.M.2 (polished walnut cabinet) £6 10 0 (includ'g trans.) P.M.3 (oak cabinet) £4 2 6 (includ'g trans.) P.M.4 £3 12 0 (includ'g trans.)	—	—

LOUDSPEAKER UNITS

Make	Inductor Chassis	Cabinet Inductors
BLUE SPOT	Type 66R. £1 15 0 Type 66K. £1 5 0 Type 66P. £1 7 6	Model R/463 No. 3 unit 8/6 Model R/450 No. 1 unit 12/6
BRITISH RADIOPHONE	No. 196 - 7/3 No. 275a - 10/6	Adjustable unit £1 1 0 Non-adjustable 19/6
GRAHAM FARISH	"Snap" unit 5/6 "Audion" unit 12/6	Standard model 10/- Junior model 6/9
LISSEN	"Super" - 15/- "Cone" - 15/- "Standard" - 13/6 "Solenoid" - 5/6	"Star" Unit £1 5 0
LOEWE	Type L.S.85 Adjustable unit 15/6	Type S.40 £1 14 6 No. W.54 Unit 5/6

INDUCTOR DYNAMIC TYPES

Make	Inductor Chassis	Cabinet Inductors
BLUE SPOT	Type 100U. £1 19 6	Type 100D. £3 3 0
FERRANTI	Ferranti Chassis Inductor £3 10 0	Ferranti Cabinet Inductor £5 10 0
GENERAL ELECTRIC COMPANY	Inductor Dynamic £3 10 0	Inductor Dynamic In walnut, oak, or black and gold cabinet £5 10 0
LAMPLUGH	Model C.10 £3 10 0	—

ALL RANGES AND PRICES OF CONES AND CONE CHASSIS

Make	Cone Chassis	Cabinet Cones	Make	Cone Chassis	Cabinet Cones	Make	Cone Chassis	Cabinet Cones
BLUE SPOT	Chassis only. Major - 15/- Special - 7/6	Model 70R. £3 15 0 Model 44R. £2 12 6 Model 45R. £2 12 6	GRAHAM FARISH	A.C.4 Chassis £1 1 0	"Amazing" A.C.4 £2 2 0 "Snap" £1 1 0	ROTOR ELECTRIC	Super-Dynamic £2 19 6 Junior Dynamic £1 15 0 Midget Dynamic £1 9 6	Super-Dynamic £4 17 6 Junior Dynamic £3 3 0 Midget Dynamic £2 12 6
B.T.H.	—	Bakelite Moulded Cabinet Model £2 10 0	KOLSTER BRANDES	—	K.B.287 £1 17 6	SIX-SIXTY	Cone speaker assembly (excluding chassis, which is not required for fixing purposes) 15/-	—
CELESTION	Type M.12 £1 15 0	Types D.10 £3 0 0 D.12 £5 0 0 J.12 £1 18 6 M.12 £3 12 6 M.14 £4 10 0	LISSEN	Type L.N.632 £1 2 6 Plaque model 13/6 Bakelite model in black & silver 15/-	Type L.N.5078 In solid figured oak £1 2 6 Type L.N.5099 In oak cabinet £2 15 0	STANDARD BATTERY COMPANY	Wates Star Chassis 12-in. cone £1 13 0 14-in. cone £1 14 0 20-in. cone £1 14 0	Star Speaker 14-in. Oak - £3 0 0 Mahog. £3 5 0 Star Speaker 20-in. Oak - £4 0 0 Mahog. £4 5 0
COSSOR	—	Model 295 £1 5 0 Models 500 & 550 £2 10 0	LOEWE	Type L.Ch.85 19/-	Type E.B.85 (walnut front) £2 2 0	TEKADE (MOTOR)	—	Model "York" £2 15 0 Model "Windsor" £3 15 0
FALK, STADELMANN	"Puravox" Open cone model, with cast stand finished bronze colour £1 1 0	"Puravox" Model W.91552 £1 17 6 Model W.91783 (bakelite cabinet with Peter Pan fret) £2 15 0 Model W.91553 (polished mahog.) £2 15 0 Model W.91550 £1 10 0 Model W.91551 £1 17 6	MARCONI-PHONE	—	Model 64 Balanced-armature speaker in polished oak cabinet £2 15 0	TELSEN	Major Chassis (excluding unit) 10/6 Popular Chassis (excluding unit) 5/6	—
GENERAL ELECTRIC COMPANY	Stork Plaque Model £1 17 6	Stork Cabinet £3 5 0 Bakelite Cabinet £2 10 0	ORMOND	Model R/454 Small chassis cone and L.S. unit 17/6 Model R/451 Small chassis and cone only 5/- Model R/458 Large chassis and cone only 9/- Model R/460 No. 1 board chassis £1 5 Model R/461 No. 3 board chassis 17/-	Model R/470 (oak cabinet) £1 2 6 Model R/471 (mahog. cabinet) £1 5 0 Models R/452 and R/453 (oak or mahog.) £1 9 6 Models R/455 and R/456 (oak or mahog.) £2 10 0 Model R/459 (corner cabinet speaker) £3 19 6	WHITELEY ELECTRICAL RADIO CO. (W.B.)	"Popular" £1 2 0 4-pole balanced-armature model (in oak cabinet) £1 19 6	
GOODMANS	—	Cabinet Cone - 19/6 Walnut "Mitre" £1 9 6	—	—	—	—	—	—

Modern and Realistic Reproducers

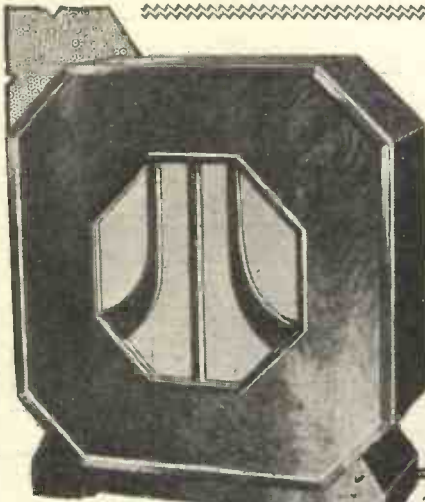

LISSEN—An interesting feature of the Lissen loudspeaker units is that each one is made in two different types, one for ordinary power valve output, and the other for use with pentodes. The Lissen "Solenoid" unit at 5s. 6d. is, without a doubt, an excellent value-for-money proposition; and even in the case of the four-pole balanced-armature models, the prices strike one as being extremely reasonable for what they are.

The Lissen chassis equipment, which includes a cast aluminium frame and a specially treated fabric cone, can be obtained for £1 2s. 6d., including their special four-pole balanced-armature unit. Without the unit the chassis and cone retail at 10s.

Two Handy Plaque Models

Although far from being a chassis assembly—at least, in so far as appearance is concerned—there are two speakers in the Lissen range to which I want to refer under this heading, and they are their well-known plaque models. The Lissen-Plaque models are, of course, complete loudspeakers, and they are provided with a stand so that they can be placed on a flat surface or suspended of a wall.

There are two models, the L.N.5077, which has a metal frame and costs 13s. 6d.; and the L.N.5076, which is surrounded with a black and silver bakelite frame, and retails at 15s. They are both good speakers at the price, and they are very pleasing in appearance.

LOEWE—The Loewe loudspeaker chassis type L.Ch.85 is especially suitable for use in portable receivers, because the framework is of wood, and it is therefore light in weight. The price of 19s. includes a special cone and unit.

In addition to this special chassis, Messrs. The Loewe Radio Company also produce a solidly-built four-pole adjustable power unit which is a good proposition at 15s. 6d.

ORMOND—The chassis equipment included in the Ormond range consists of a small ribbed aluminium frame with specially prepared cone, a large ribbed aluminium chassis incorporating the Ormond "Wonder" cone, and, finally, a special board chassis arrangement designed for use in portable receivers.

The small chassis and cone, designated as the R/451, has every appearance of being excellent value for the remarkably low price of 5s.; and even in the case of its larger brother, known as the R/458, the price of 9s. which is charged for it is very low considering the high finish and excellent workmanship that is obviously put into it.

Designed for Portables

The Ormond loudspeaker equipment for portables can be had fitted either with the No. 1 or the No. 3 Ormond unit. The No. 1 unit portable assembly retails at £1 5s. 0d., while the No. 3 outfit sells for 8s. less.

While on the subject of units, I must not forget to mention the No. 3 and the No. 1 four-pole adjustable models in the Ormond range. At the prices of 8s. 6d. and 12s. 6d. respectively they are an excellent investment for all those who are interested in the home construction of loudspeakers.

ROTOR ELECTRIC—Three chassis-type dynamic cone speakers are available in the Rotor range, and they are known as the "Midget," the "Junior," and the "Super." In each of these cases, although the prices are quite modest, the workmanship is of a very high standard indeed.

The Rotor dynamic series sell at £1 9s. 6d. for the "Midget," £1 15s. 0d. for the "Junior," and £2 19s. 6d. for the "Super," which prices, of course, include the unit.

Two balanced-armature units are also manufactured by Messrs. Rotor Electric: an adjustable one at £1 1s. 0d., and a non-adjustable model at 19s. 6d.

SIX-SIXTY—It is hardly correct to refer to the Six-Sixty equipment as a chassis, because, in point of fact, it is not! But the one-hole-fixing scheme employed in the Six-Sixty cone speaker assembly renders a chassis unnecessary, so that at the price of 15s., which includes quite a good unit, it represents an excellent proposition.

In view of the fact that the Six-Sixty people manufacture two really excellent units—the "Standard" at 10s. and the "Junior" at 6s. 9d.—

manufacture a loudspeaker unit which at 5s. 6d., the price at which it sells, is excellent value for money.

In passing from the cone section to the review of moving-coil models, there is another class of speaker—the Inductor Dynamic—which can logically be classified as between the two. As a matter of fact, although there are only a few models available, the modern inductor dynamic speakers are of such a high standard that in operation it is not at all an easy matter to distinguish them from moving coil types.

Four well-known firms have tackled the production of inductor dynamic models, and, alphabetically, they are as follow:

BLUE SPOT—Although it is only comparatively recently that the Blue Spot people have entered the inductor dynamic market, with the reputation that they have established in other branches of speaker production, it is only to be expected that their latest model is something really good.

As a matter of fact, their 100U, as the chassis is designated, is good—very good—and it ranks among the best of the inductor dynamic types at present available. The price of the chassis assembly is £1 19s. 6d., but it can also be obtained mounted in a dignified oak cabinet for £3 3s. 0d.

Pioneers in Faithful Reproduction

FERRANTI—Who among all the firms in the radio trade could claim to have spent more time over matters of perfect reproduction than have Messrs. Ferranti? It is true that their efforts have mostly been directed towards the perfection of L.F. intervalve couplings, but it is obvious that their entry into the inductor dynamic speaker field would not have been made with anything but a speaker of the highest class.

The Ferranti Inductor Dynamic Speaker is available in chassis or cabinet form, and the prices are £3 10s. 0d. and £5 10s. 0d. respectively.

GENERAL ELECTRIC COMPANY—The G.E.C. were, I believe, among the first people in this country to introduce an inductor speaker, and their "E.C.1850"—the chassis model—which is manufactured under the Ferranti Inductor Patent, is unquestionably a very fine job.

It is claimed to have an even response over a very wide range of frequencies, and tapings are provided so that the impedance can be rendered suitable for almost any type of output valve.

The chassis version sells at £3 10s. 0d., but it can also be obtained in a cabinet—a particularly artistic cabinet—in walnut, oak, or black and gold—for £5 10s. 0d.

The truly artistic cabinet in the top left-hand corner houses the famous Celestion R.P.M. 12 B permanent-magnet moving-coil speaker. Below is the new Celestion "P.P.M." chassis.

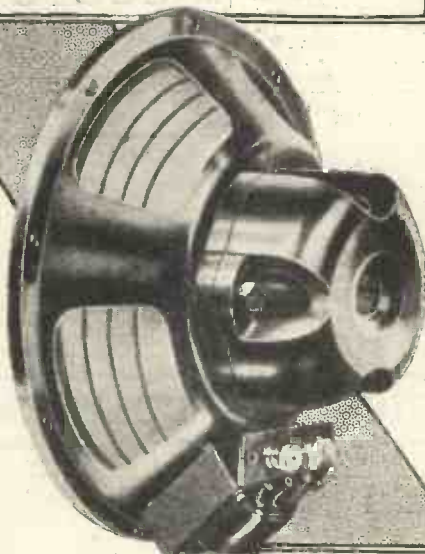

All sorts of ingenious cabinet designs have been adopted by manufacturers, and in the model below—the M.12—the Celestion people have endeavoured to create the impression of "sound in perspective."

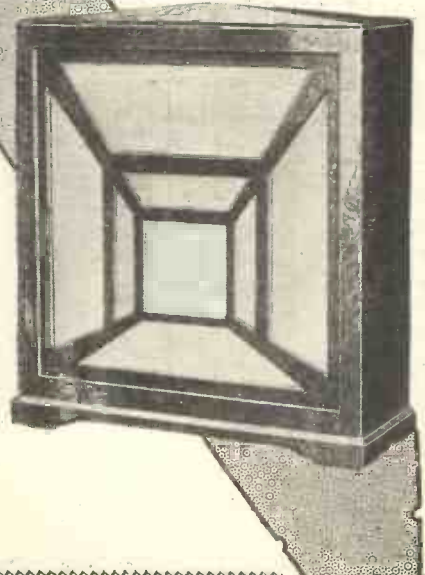

it is a pity that their appeal must necessarily be limited to the home constructor. But for those who are interested in home construction the two units available in the Six-Sixty range would be difficult to better in their respective classes.

STANDARD BATTERY COMPANY—For those who are interested in the home construction of loudspeakers, the Wates double-cone scheme, to which reference was made in the review of their standard cone speakers, is also available in chassis form.

The Wates special double-cone chassis is available in three different sizes, costing for a twelve-inch cone £1 13s. 0d., for a fourteen-inch cone £1 14s. 0d., and for a twenty-inch cone £1 18s. 0d.

Especially suitable for this double-cone equipment, although, of course, adaptable to any other chassis, is the Wates "Star" speaker unit at £1 5s. 0d. The construction of this particular unit is most ingenious, being built up from two separate horse-shoe magnets.

Radio at Popular Prices

TELSEN—The Telsen chassis, known as the "Major" and the "Popular," are available at prices which will be within the reach of all. They are both very well made jobs, and the retail prices are 10s. 6d. for the "Major" and 5s. 6d. for the "Popular."

To go with either of these models—or, of course, for use in conjunction with any other standard chassis—Messrs. The Telsen Electric Co. also

LAMPLUGH.—The Lamplugh model C.10 inductor chassis has recently been improved both in regard to sensitivity and frequency response, and it now represents an excellent example of the almost perfect reproduction that can be obtained from this type of speaker. So far it is available only in chassis form, but for what it gives in the way of reproduction it is very reasonable in price at £3 10s. 0d.

By the way, before we leave the question of inductor dynamic speakers, it is rather important to mention that this type of reproducer requires some sort of baffle board or baffle cabinet in order to obtain the best results that it is capable of giving.

included in the price of each of these); the S.P.6 (6-volt battery) and the S.P.D. (D.C. mains), both at £6; the S.P.A.C., a model for 200/250 A.C., the price of which (£3) includes rectifier and smoothing equipment; the S.6 (6-volt battery) and the S.D. (D.C. mains) both of which retail at £1 15s. 0d.; the S.A.C., another mains model for 200/250 A.C., at £7 10s. 0d., including rectifier and smoothing equipment; and, finally, the P.D. for D.C. mains of all voltages from 50 to 250, at £2 15s. 0d. All these models can be obtained suitable for pentode or power output.

The Baker's cabinet models include an excellent permanent-magnet model called the "Permag," at £2 7s. 0d., including transformer; the "Elomag,"

assembly for D.C. mains at £2 7s. 6d.), the British Blue Spot Company have made two worthy contributions to the modern quest for perfect reproduction.

They also do a really beautiful cabinet permanent-magnet model. The cabinet of the "Goliath" 30 P.M., as it is called, is of walnut, and considering that it could hold its own even in the most elaborately furnished room, I regard the price of £5 10s. 0d. as very reasonable.

B.T.-H.—The famous B.T.-H. R.K. Reproducers rank among the finest of the moving-coil speakers of to-day. In the chassis range there are two minor R.K. models, the P.M. model at £2 10s. 0d.; a D.C. version (200/250-volt D.C.) at £1 11s. 6d., both

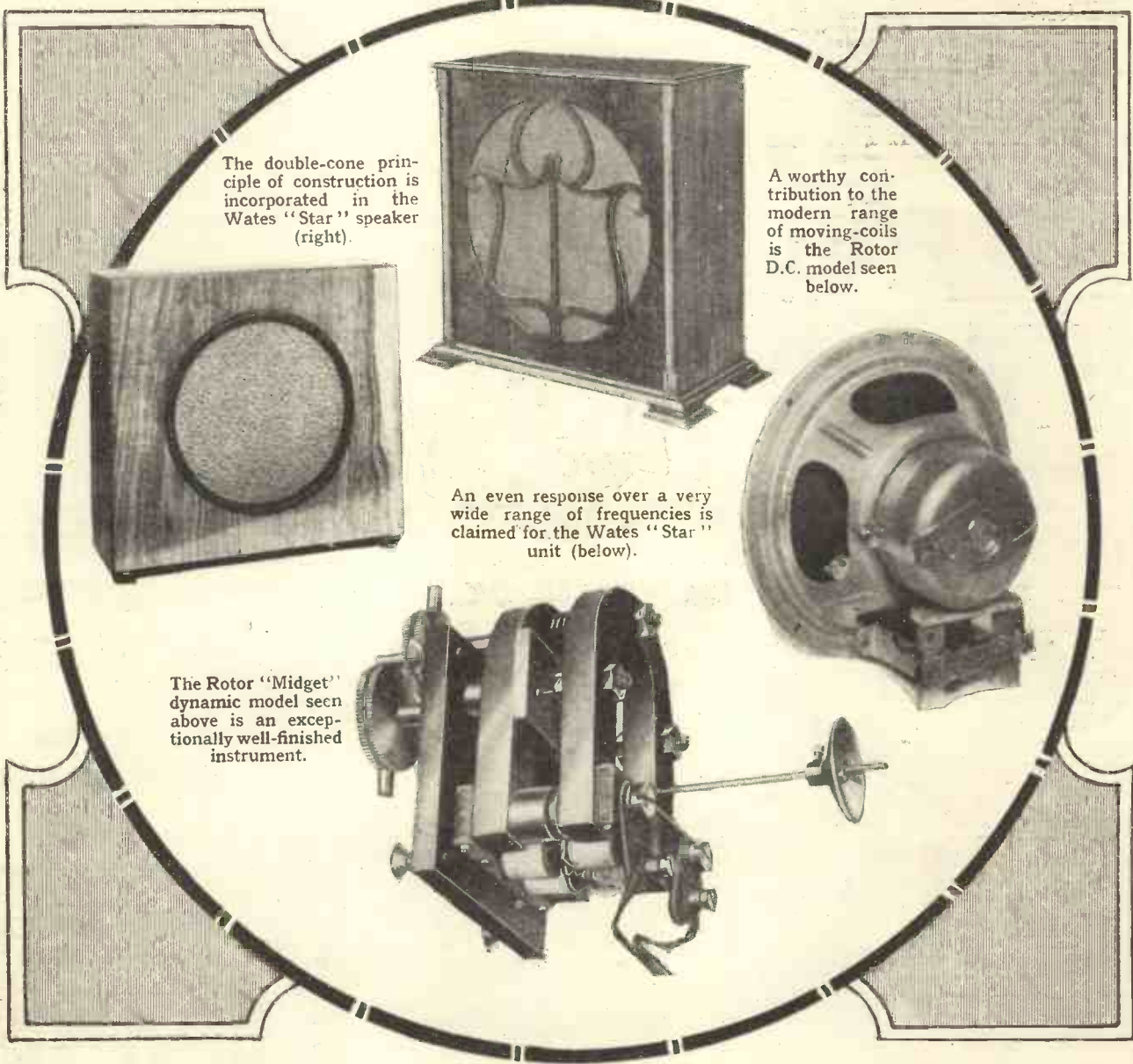

The double-cone principle of construction is incorporated in the Wates "Star" speaker (right).

A worthy contribution to the modern range of moving-coils is the Rotor D.C. model seen below.

An even response over a very wide range of frequencies is claimed for the Wates "Star" unit (below).

The Rotor "Midget" dynamic model seen above is an exceptionally well-finished instrument.

Now, concerning moving-coil speakers, when I break into this section with the news that there are well over a hundred different types to be reviewed it will be obvious that there will only be room for just a brief reference for each particular model. So without any further preliminaries, here are the moving-coil loud-speakers of to-day.

BAKER'S.—Almost every conceivable type is included in the Baker's range of M.C. speakers. They specialise in nothing but moving-coil reproducers, and they are responsible for over a dozen different models.

Dealing with the chassis models first, there is the S.P.P.M., a super-power permanent magnet speaker at £6 6s. 0d.; the S.P.M., another permanent-magnet model, at £4 10s. 0d.; the P.P.M., also a permanent magnet, at £3 15s. 0d.; (a transformer is

for D.C. mains, at £1 14s. 0d. (which price also includes transformer), and, finally, something really outstanding in the design of modern speakers—the combination of a battery-driven clock and a remarkably good P.M. speaker in one really handsome-looking cabinet. I consider the Baker's "Klock" speaker, as it is called, to be cheap at the price of £12!

Moving-Coil Types

BLUE SPOT.—The Blue Spot reputation for high-quality cone speakers and units has been fully maintained in their more recently produced moving-coil types. In producing the Blue Spot P.M. (a permanent-magnet chassis at £3 15s. 0d., including transformer), and the model 72 (a chassis

of which are particularly sensitive and can therefore be used in conjunction with quite small sets—and three senior models.

The Senior R.K. Reproducers include an A.C. model at £7 15s. 0d., including rectifier equipment, a D.C. version at £5 5s. 0d., and a super-permanent-magnet chassis which costs £5 12s. 6d.

The permanent-magnet Minor R.K. is also available in a handsome-looking cabinet. There is a choice of two finishes—fumed oak at £3 17s. 6d. complete, or walnut at £4 4s. 0d. An idea of the artistic lines of the cabinet can be obtained from the illustration which will be found elsewhere in this review.

BRITISH ROLA.—Although, ostensibly, there are only two moving-coil chassis in the Rola range, these two speakers are listed in twenty different

The Right Route to Radio Realism

varieties. The model F, for instance, which is an excellent mains-energised chassis at £1 15s. 0d., is available in four different voltage ranges, and in each separate range there is a model for power, pentode or push-pull output. The average power required to energise the field in this D.C. chassis is from 5 to 9 watts.

The Rola permanent-magnet chassis, as in the case of the D.C. version, can be obtained for power, pentode or push-pull output, and at the price of £2 9s. 6d. (£2 2s. 0d. without transformer) it has the appearance of being a very well-finished instrument.

CELESTION.—Several of the leading firms have recently endeavoured to produce high-class moving-coil instruments at prices within the reach of all, and the Celestion P.P.M. permanent-magnet chassis at £2 7s. 6d.—which includes an output transformer—

not surprising that their activities in the manufacture of a mains-energised moving-coil chassis has resulted in the production of a very high-class instrument.

The Cossor "Utah" D.C. mains-energised chassis is at present available for two different voltages, the model 825 works at its best with a voltage of approximately 160 across the field coil, and at this voltage the field current is approximately 65 milliamperes. The other version, known as the 850, requires a field voltage of 230 or thereabouts, and the current taken at this figure is roughly 45 milliamperes. The price of £1 15s. 0d.

In addition to the "De Luxe" chassis, which sells complete with transformer for power or pentode output, for £2 10s. 0d., the Edison Bell people also market a "super-permanent-magnet" model at £3 7s. 6d. As in the case of the "De Luxe" chassis, the price of the "Premier," as it is called, includes a transformer which can be supplied for power or pentode output.

For those who are interested in "drawing-room" models, the Edison Bell "De Luxe" speaker is available in a solidly constructed and well-finished oak cabinet for an extra cost of £1 5s. 0d.

EPOCH.—In reviewing the Epoch range of moving-coil speakers one is tempted to think that the easiest course would be to tell you of the types which Messrs. Epoch do not make! That would mean that I could pass straight on to the next review, for I do not believe that there is a single set

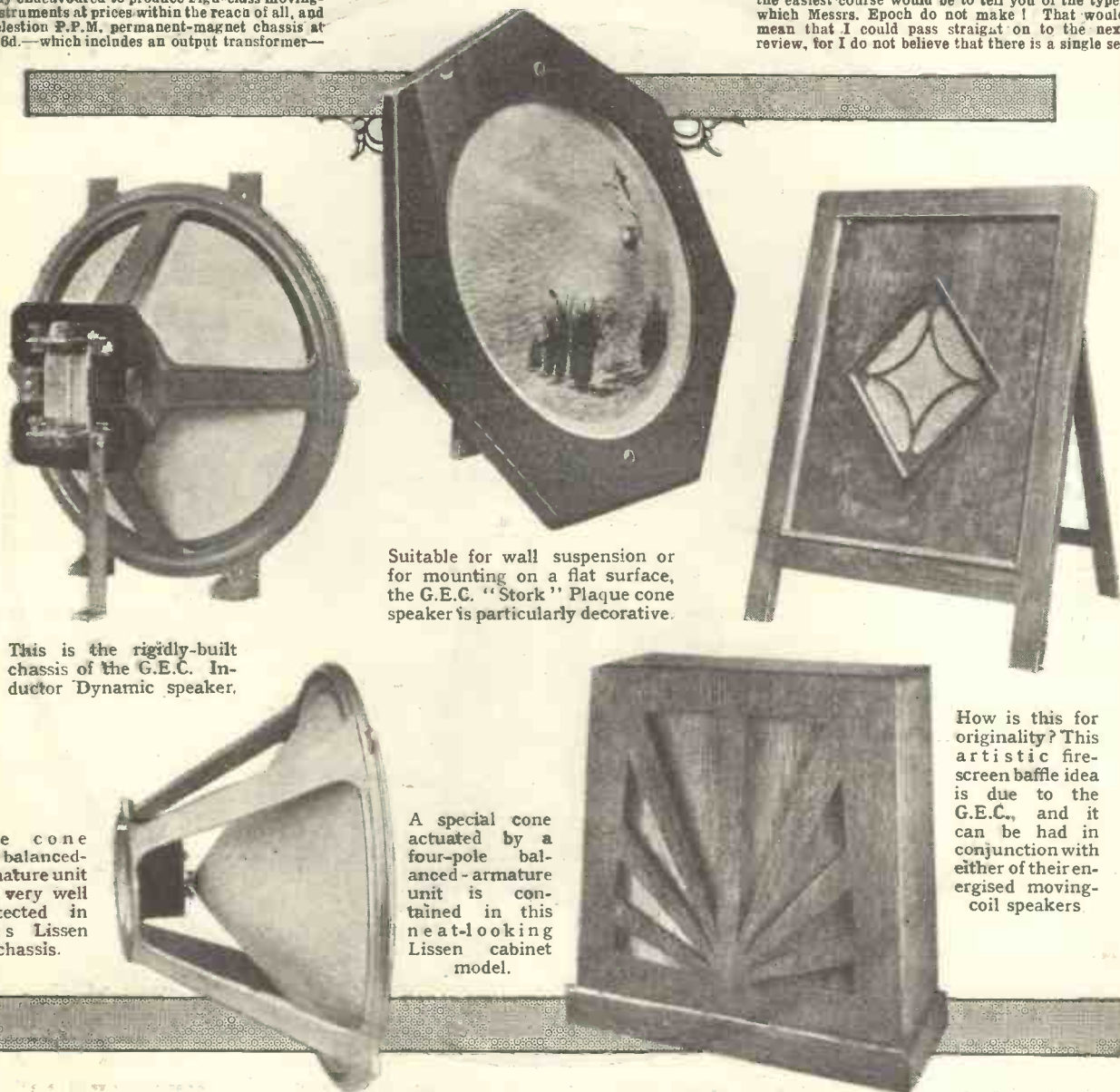

This is the rigidly-built chassis of the G.E.C. Inductor Dynamic speaker.

Suitable for wall suspension or for mounting on a flat surface, the G.E.C. "Stork" Plaque cone speaker is particularly decorative.

The cone and balanced-armature unit are very well protected in this Lissen chassis.

A special cone actuated by a four-pole balanced-armature unit is contained in this neat-looking Lissen cabinet model.

How is this for originality? This artistic fire-screen baffle idea is due to the G.E.C., and it can be had in conjunction with either of their energised moving-coil speakers

is an excellent example. The reproduction given by this latest Celestion production leaves nothing to be desired, and the sensitivity is such that it can be used satisfactorily in conjunction with quite small sets.

The more ambitious listener is also adequately catered for in the Celestion range with the R.P.M. 8 permanent-magnet chassis at £3 10s. 0d., and the R.P.M. 12 chassis (also permanent magnet) at £6. They are both very good speakers, and they can be obtained in cabinet form for £5 10s. 0d. and £10 10s. 0d. respectively. The R.P.M. 12 is capable of handling very large volumes without the slightest distress.

COSSOR.—With the reputation which Messrs. Cossor have established in the valve world, it is

for either of these models includes the necessary transformer.

EDISON BELL.—The specifications of the Edison Bell permanent-magnet moving-coil speakers are prepared in a way which many of the other loudspeaker manufacturing firms would do well to copy. In the case of the new "De Luxe" model, for instance, we learn from their specification that it is capable of excellent results with an input as low as 150 milliwatts, and that it will stand up to 5 watts without the slightest distress.

When you have read Mr. Rogers' informative article which appears elsewhere in this supplement you will realise how very helpful this information is when making your choice of a speaker.

or purpose for which Messrs. Epoch do not make a suitable model!

It is unfortunate that space must necessarily preclude a reference to all the various Epoch speakers, for they are responsible for some very fine models indeed. That is one of the advantages of specialising in the production of moving-coil loud speakers only.

But for those who are interested, you will find a complete guide to the Epoch domestic range in the special tables accompanying this article, and may I just add that of all the numerous versions that are available in this range I do not know of a single model that does not come up to the very high standard for which the name of Epoch is justly renowned.



Another fine array of 1932 instruments. From left to right they are the cabinet and chassis models of the Lanchester "Senior" permanent-magnet speaker, and two famous chassis models in the W.B. range—the P.M.3 and the P.M.1 permanent-magnet "moving-coils."

FERRANTI.—In the Ferranti descriptive matter concerning their moving-coil loudspeakers there is a very apt remark to the effect that a receiver can be only as good as its speaker. I would go a stage farther than that, and add that if the reproducer is a Ferranti it will not be the speaker that is at fault if you get anything but the very best reproduction.

Messrs. Ferranti are specialists in all matters connected with reproduction, and it is not therefore surprising to find that their moving-coil speakers are every bit up to the reputation which one associates with this firm.

They are responsible for three permanent-magnet moving-coil chassis models, the M.1 at £7 10s. 0d., the M.2 at £5, and the M.3 at £2 15s. 0d. In addition, they also produce a D.C. energised chassis which sells for £2 5s. 0d. All these models can be obtained in a walnut or a blue or brown Rexine cabinet for an extra charge of £2 and £3 respectively.

GENERAL ELECTRIC COMPANY.—Up to the present the G.E.C. have confined their activities to the production of mains-energised moving-coil speakers, but those models that they do produce—one for A.C. and one for D.C.—are capable of remarkably life-like reproduction.

The A.C. chassis, into which is built the rectifying equipment, is one of the most massively-built chassis on the market, and the whole of the mains equipment is totally enclosed. The price of this chassis, which is obtainable for 100/130- or 200/260-volt mains, 40/80 cycles, is £10 10s. 0d. complete. The chassis for D.C., available in the same voltage ranges, retails at £7.

Either of these models can be obtained mounted in a walnut cabinet of artistic appearance, or on an ingenious solidly-built decorative baffle, which is provided with a back support.

The A.C. chassis in the cabinet or on the baffle costs £14, and the D.C. version sells complete for £10 10s. 0d.

Some Really Inexpensive Models

GOODMANS.—Messrs. Goodmans are responsible for one of the cheapest permanent-magnet moving-coil speakers on the market, and credit must be given to them for the production of what is unquestionably a good instrument at the low price of £1 19s. 6d. The price of the "Dreadnought,"

as it is called, includes a multi-ratio output transformer, and it is also available in cabinet form for an extra charge of £1.

H.M.V.—It is obvious that the Gramophone Company had their high reputation in mind when they set about the design of their moving-coil loudspeakers; for I do not think it would be possible to better them at any price.

Both from the point of view of appearance and reproduction, the two models produced by H.M.V.—both of which are of the permanent-magnet type—take a place among the finest loudspeakers of the day.

The model S.7, at £5 5s. 0d., is housed in a beautifully-grained walnut cabinet, and it has a remarkably even frequency response over a very wide range. A transformer is included by which the speaker can be adjusted for use with any type of output circuit.

High-Class Workmanship

The other model, the S.5, is rather more expensive, costing £13 10s. 0d. for the complete instrument. But when you have seen the delightful cabinet in which it is housed, and have heard the astonishingly good reproduction that it gives, it is quite easy to appreciate that even at this price it is far from being expensive. As in the case of the first-mentioned instrument, the S.5 is provided with a universal transformer that enables it to be used satisfactorily in conjunction with pentode, power, or push-pull output.

IGRANIC.—Messrs. Igranic have limited their activities to the production of only one permanent-magnet moving-coil chassis, but the model that they do produce is a worthy addition to their range of high-quality radio devices.

The Igranic permanent-magnet chassis is particularly good on speech, and the results on music tend to indicate an absence of peaks and an even response over a wide range of frequencies. The chassis retails at £3, and it can be supplied complete with transformer for power or pentode output for an extra charge of 7s. 6d.

LAMPLUGH.—Insensitivity, to a large extent, was one of the principal drawbacks to the earlier types of moving-coils. That, of course, is far from being the case with the present-day models, and in the Lamplugh P.M. model the designers have

made every effort to bring moving-coil reproduction within the reach of all.

This particular model is sufficiently sensitive for use with simple detector-L.F. sets, and the performance is good. The price of the Lamplugh P.M. chassis is £2 2s. 0d., complete with multi-ratio output transformer. A mains-energised chassis is also included in the Lamplugh range, and at the price of £1 14s. 0d., in which is included the transformer, it is a creditable achievement.

LANCHESTER.—The series of permanent-magnet moving-coil speakers manufactured by Messrs. Lanchester's Laboratories are characterised by an exceptionally good response in the upper registers, and the reproduction of speech and music given by these instruments is faultless.

There are four of them altogether, and they can be obtained either in chassis form or mounted in a cabinet. The prices of the chassis models are: "Junior" £1 10s. 0d., "Monitor" £2 8s. 0d., "Senior" £2 18s. 0d., and "Special Senior" £3 3s. 0d. The cabinet equivalents retail at £2 10s. 0d. for the "Junior," £3 10s. 0d. for the "Monitor," £4 for the "Senior" and £4 5s. 0d. for the "Special Senior." The cabinets, incidentally, are covered with an attractive blue leather cloth, but polished mahogany can be supplied for 10s. extra.

Remarkable Degree of Perfection

LISSEN.—The degree of perfection to which modern moving-coil speakers have advanced is exemplified in the range that Messrs. Lissen are producing. There are two electro-magnetic types, and one permanent-magnet model, and in each case the reproduction is of a standard which would not have been thought possible a matter of eighteen months or two years ago.

The D.C. model (for 200/250 mains) and the permanent-magnet type are available in chassis form at prices of £3 15s. 0d. and £7 10s. 0d. respectively. These two models are also available in cabinet form, the price being £2 more in each case.

The Lissen electro-magnetic type for 200/250-volt A.C. mains is not available in chassis form, but it is sold in an artistic-looking cabinet for £8 complete. It is a very fine speaker, as are the other two models in the Lissen range.

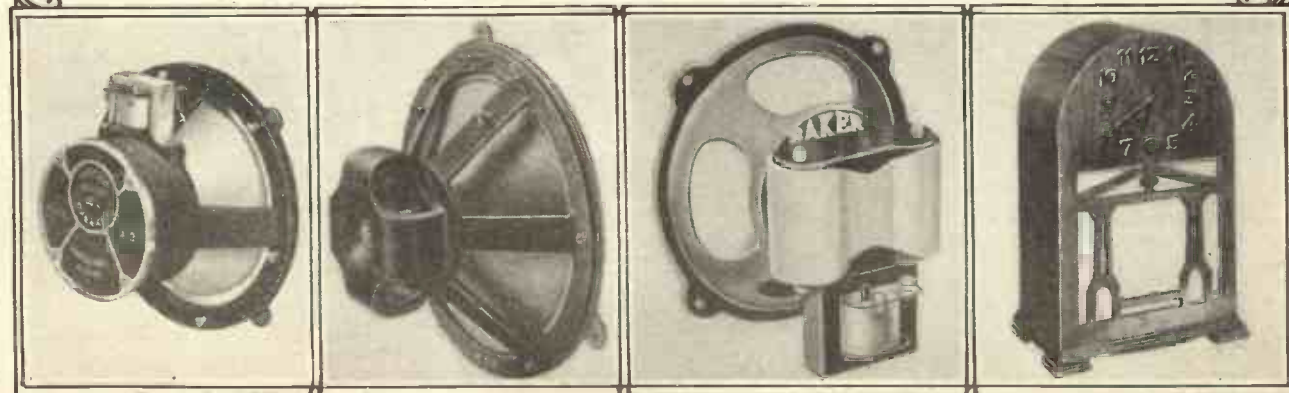

Here we have, reading from left to right, the Epoch A.2—a permanent-magnet moving-coil model for normal domestic use; the Epoch D.25—a super-power P.M. speaker; the Baker's "Permag" M.C. type; and something really novel—the Baker's "Klock" speaker.

"An Inefficient Speaker Can Make a Good Set Bad!"

MAGNAVOX.—The Magnavox people certainly ought to know all that there is to be known about moving-coil speakers, for they first produced a model over twenty years ago! And it is obvious from the high standard of their present-day products that the twenty years' experience has been put to good account.

Their present list includes a permanent-magnet chassis, the C.M.130, at £3 3s. 0d. (including transformer), two electro-magnetic chassis models for D.C. mains voltages 110/190 and 190/300, the D.C.144 at £2 10s. 0d. for the lower voltage range, or £2 12s. 6d. for the higher range, and the D.C.142 at £2 15s. 0d. and £2 17s. 6d. (depending upon field voltage), and two handsome cabinet versions of the C.M.130 at £5 15s. 0d. for walnut and £5 5s. 0d. for oak.

An Old-Established Firm

MARCONIPHONE.—In marshalling for review the permanent-magnet moving-coil speakers manufactured by the Marconiphone Company, perhaps the most apt description I can give you is to mention that their qualities from the musical point of view have been acclaimed by such celebrities as Sir Edward Elgar, Chaliapine, Albert Coates, Dr. Malcolm Sargent, and quite a number of others.

And it is not really surprising, for apart from the old-established reputation of the firm in question, their moving-coil speaker productions are of a very high order indeed.

The model 132 at £4 19s. 6d. is housed in an elegant dark oak cabinet, and the reproduction it gives is faultless. Their more expensive model—the model 131 at £10 10s. 0d.—represents the last word in up-to-date loudspeaker design.

For those who are interested in chassis assemblies, the Marconiphone model 91 at £6 6s. 0d.—which is a permanent-magnet speaker—is all that could be desired from the point of view of reproduction.

ORMOND.—I suppose we all have our own ideas as to what constitutes an artistic cabinet, but there is something about the design of the Ormond cabinet that appeals to me tremendously. It is a really elegant-looking job, and the speaker which it houses—a permanent-magnet moving-coil—every bit in keeping with the handsome exterior. The price of the complete instrument is £4 19s. 6d., but the Ormond permanent-magnet moving-coil speaker is also available in chassis form, and the price of £3 5s. 0d. includes a multi-ratio output transformer.

REPRODUCERS AND AMPLIFIERS.—The reputation of Messrs. R. & A. as manufacturers of high-class permanent-magnet moving-coil reproducers was established when they introduced the R. & A. "100." Unquestionably, the R. & A. "100" is a first-rate instrument, and the success that they have achieved with this model has prompted them to follow it up with another permanent-magnet-chassis model at the popular price of £1 15s. 0d., complete with three-ratio output transformer.

This new R. & A. "Challenger," as it is called, has the appearance of being very rigidly built, and it will handle A.C. inputs of up to 2½-3 watts.

Mains-Driven Models Only

ROTOR ELECTRIC.—All of the moving-coil speakers manufactured by Rotor Electric, Ltd., are of the mains-driven type, but their range is very comprehensive, and it includes a model for almost every purpose. There are, for instance, three chassis models for A.C., the "Red" A.C. 5-watt type at £5 5s. 0d., the "Golden" model 3-watt version at £3 19s. 6d. (a very reasonable price for what is unquestionably a good speaker), and the Universal "A.C.6" at £8 5s. 0d.

For those who are interested in D.C. energised models, there are eight in all in the Rotor range

from which to choose. There is the 7-watt Senior range, which includes the D.C.6 (field voltage of from 4 to 6 volts), the D.C.110 and the D.C.220, all of which are priced at £4 17s. 6d. Then there is a D.C. version of the "Red" 5-watt chassis at £3 7s. 6d., a D.C. model of the "Golden" 3-watt speaker at £2 9s. 6d., and three smaller types of D.C. chassis varying in price from £1 9s. 6d. to £2 9s. 6d. Altogether, a fine collection of high-quality speakers!

Interesting Instruments

STANDARD BATTERY COMPANY.—The moving-coil chassis models in the Bates range, of which there are two, are among the most recent to make their appearance. There is a permanent-magnet model at £2 4s. 0d., with multi-ratio output transformer and an electro-magnetic chassis, also with multi-ratio transformer, which retails at £1 17s. 6d. These speakers may have been among the last to make their appearance, but they are certainly far from being among the last from the point of view of results. They are, in fact, both excellent speakers, and would no doubt be difficult to better in their respective classes.

TEKADE (MoToR).—A degree of sensitivity equal to a good balanced-armature unit, and an even response over the whole of the effective frequency range, is claimed for the MoToR permanent-magnet moving-coil speaker, one of the latest additions to the modern range of moving-coil models.

W.B.—Messrs. The Whiteley Electrical Radio Co. have concentrated their activities on the production of permanent-magnet moving-coil speakers, and as a result the famous "quartette" of W.B. "P.M." models has reached a very high standard. There is the "P.M.1" at £6, the "P.M.2" at £4 5s. 0d., the "P.M.3" at £2 12s. 6d., and the "P.M.4"—the most recently introduced one—at £2 2s. 0d. In each case an output transformer is included. The cabinet versions work out at £8 5s. 0d., £6 10s. 0d., £4 2s. 6d., and £3 12s. 0d. respectively, and they are worthy exteriors for the excellent speakers which they contain.

That brings us to the end of the moving-coil speaker review, in fact, to the end of the complete survey, but a comprehensive feature supplement such as this can hardly be considered absolutely complete without just a reference to cabinets.

So for the benefit of all those readers who are interested in the home-construction side of this question, I propose to bring this article to a conclusion with a short review of loudspeaker cabinets.

Loudspeaker Cabinets

CAMCO.—There are, altogether, six high-quality cabinets in the Camco range, ranging in price from 12s. 6d. for an attractive-looking oak-finished model, to £7 10s. 0d. for a magnificent pedestal cabinet.

The Camco list includes the "Triumph," which is the cheapest one; the "Truetone" at £1 10s. 0d.; the "Beltone" at £1 18s. 0d.; in two different sizes and varying in price according to finish, from £1 2s. 0d. to £1 13s. 0d.; the "Regent" (another handsome pedestal model) at £3; and, finally, the famous Camco "Mayfair" pedestal cabinet at £5 10s. 0d. for a mahogany veneered finish, or £7 10s. 0d. for burr walnut.

All these cabinets are of a very high finish, and special attention has been paid in the design to the avoidance of box-resonance effects.

LOCK.—Most of the cabinets manufactured by Messrs. W. T. Lock are slightly futuristic in appearance, but without exception they are particularly artistic, and the finish is of a high standard.

The cheapest one is the "Clarionette" in oak at £1 4s. 0d., or in mahogany or walnut at £1 8s. 0d. Then, in order of price, comes the "Mellotone" at £1 14s. 6d. in oak, £2 2s. 0d. in mahogany, or £2 5s. 0d. in walnut; the "Clari-belle" in the same finish at £1 15s. 6d., £2 3s. 6d., and £2 6s. 6d. respectively, and, finally, a handsome-looking pedestal model with a fabric-covered back, to avoid box resonance, at £3 7s. 0d. in oak, £4 4s. 0d. in mahogany, or £4 7s. 0d. in walnut.

Kits of Parts

OSBORN.—One of the features of particular interest to the home constructor in the Osborn range of cabinets is that they can be obtained as a kit of parts, as well as in the assembled form either polished or unpolished.

The Osborn cabinet kits are extremely reasonable in price. For instance, it is possible to obtain the parts for a beautiful Queen Anne pedestal cabinet for a cost of only £1 10s. 0d., and in the case of almost all the table models the prices range between about 10s. 6d. and 13s., which seems to be remarkably good value for money.

Altogether there are twelve speaker cabinets in the Osborn range, of which no less than three are beautifully finished pedestal models. The prices of the pedestal models, ready assembled and polished, range between £2 15s. 0d. and £4, depending upon whether you choose oak, mahogany or walnut.

The table model speaker cabinets can also be obtained ready assembled and polished. And in the case of several of these table versions a choice of size is possible.

TWO FINE MODERN REPRODUCERS

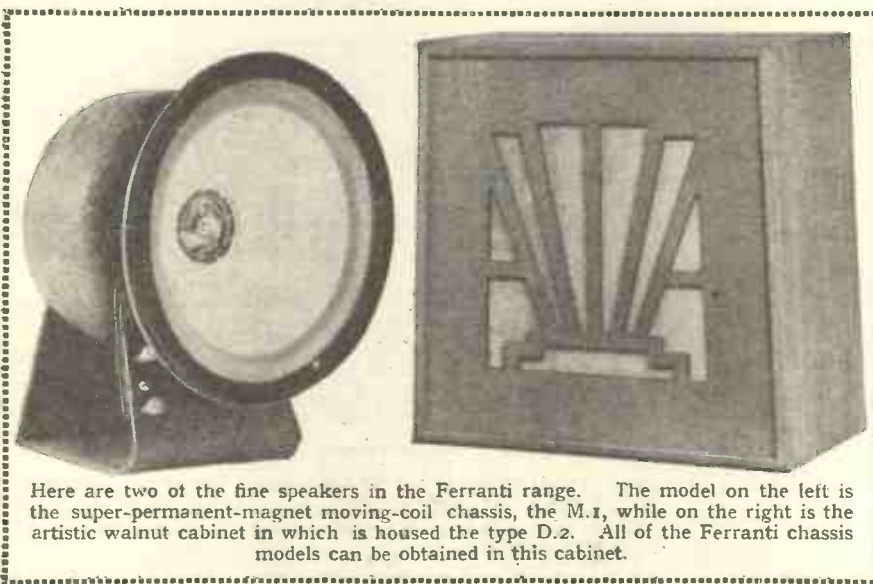

Here are two of the fine speakers in the Ferranti range. The model on the left is the super-permanent-magnet moving-coil chassis, the M.I., while on the right is the artistic walnut cabinet in which is housed the type D.z. All of the Ferranti chassis models can be obtained in this cabinet.

We have not yet had an opportunity of testing it out, but it certainly has every appearance of being well made. The price of the chassis is £2 5s. 0d., including transformer, and it can also be obtained in cabinet form for £3 15s. 0d. The MoToR Senior chassis is £3 10s. 0d.

Specialists in Speakers

ULTRA.—Messrs. Ultra is another one of the firms who justifiably earned a reputation with one-type loud speakers, and the same high standard is fully maintained in their more recent moving-coil types.

They are responsible for two permanent-magnet models, the model 95 at £4 15s. 0d. (£6 6s. 0d. in walnut cabinet), and the famous Ultra "Imp" at £2 15s. 0d. (£4 in walnut cabinet), and three electro-magnetic versions. The standard D.C. type for accumulator or mains costs £2 19s. 6d. for the chassis, with which is included the transformer, or £4 17s. 6d. complete in a walnut cabinet.

There is also another model for D.C. mains known as the "Ultra Minor," and it represents extraordinarily good value at the low price of £1 10s. 0d. The cabinet version of the "Minor" retails at £2 17s. 6d.

The Ultra A.C. speaker equipment consists of a well-built chassis with output transformer for £4 12s. 6d., and a cabinet version of the same speaker for £6 6s. 0d.

THE LINK BETWEEN PROVIDING POWER AND PURITY

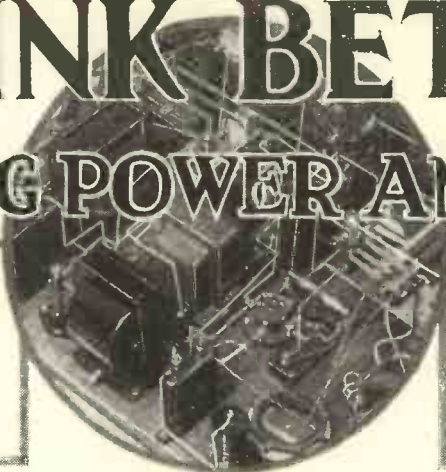

In the foregoing pages the various types of loudspeakers have been discussed, but it is of no avail to be the owner of even the "most perfect" of speakers unless it is used properly. This section, therefore, is included with the express purpose of

assisting all set users to obtain the very best from their loudspeakers. This is impossible unless the output circuit of each receiver is properly designed; a simple procedure, as is shown in the following article. By K. D. ROGERS.

THIS is not a discourse on primeval man, of apes and their relation to the human race, but an article on a most important radio subject—the link between the set and the loud speaker.

The Output Stage

There are pitfalls for the unwary in every stage of a set's design, but although most constructors seem to get away with it pretty well in the H.F., detector, and the first L.F. stages, when it comes to the output they fail lamentably.

Not that there are not plenty of good excuses, for this particular section of the set is one of the trickiest, and at the same time the one with the most external limitations.

Let me explain. We can get along all right in the design and operation of the S.G., det. and voltage amplification L.F. stages, valves for these are pretty much of a muchness as regards their requirements, but when it comes to the conversion of the voltage step-up into power so that the loudspeaker may be successfully operated, it's another matter.

Power Operated

For the loudspeaker is a power-operated device, and seldom is there much more undistorted power available than is required. Without casting any reflections on any loudspeaker manufacturer, we can honestly say that it is a most difficult job to design a good loudspeaker that will make full use of more than a small portion of the power supplied to it by the last valve.

Taking into consideration the fact that with the ordinary triode valve something like $\frac{1}{3}$ th to $\frac{1}{4}$ th only of the energy supplied to it from the H.T.

batteries or mains unit is converted into undistorted "electrical sound" for the use of the loudspeaker, we see how very necessary it is that we make the utmost of the potential sound energy at our disposal in the last stage. Let us be sure that the link between is a true and efficient one (within the limits that are set us).

A FINE CHASSIS

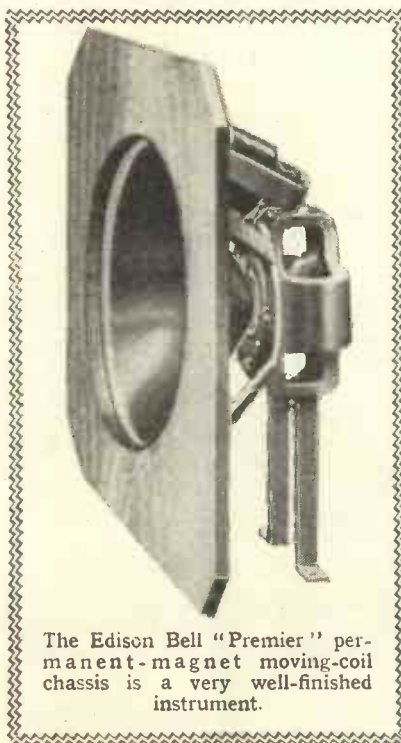

The Edison Bell "Premier" permanent-magnet moving-coil chassis is a very well-finished instrument.

We have not taken into consideration the fact that of the tiny proportion of energy that does get transformed into sound by the speaker only a very minute part acts upon any particular individual ear; this loss is one common to all diffusion

systems, whether of sound or of radio, and so we mention it in passing so that our readers may get a little of the correct perspective of the position.

Now let us get down to practicalities as they affect the average set designer and constructor. To do this we must realise the limitations placed upon us by the need for quite considerable energy supply by the power valve.

Anode Wattage

This very necessary part of the outfit can be classified in many ways, but the most useful is that of output power, either D.C. or A.C. The former gives the anode wattage consumption of the valve from the power supply, and the other the amount of that power that is turned into useful account.

Power valves can be divided into six groups, as they are grouped by the B.V.M.A. specifications. These are: (1) valves with a power dissipation of 1-2 watts (anode volts 150, anode current 8 m.a.) or less; (2) those that take the same voltage, but up to 16 m.a. in current (2-4 watts); (3) valves of 6-watt rating (200 volts and 30 m.a., or 250 volts 24 m.a.); (4) 10-watt valves (200 volts 50 m.a.); (5) 15-watters; and (6) above 15 watts.

Some Instances

Typical valves that come under these headings respectively are the P.215, P.240, P.625A. and B., P.X.4, L.S.5A., and L.S.6A. types.

Here at once we see that the undistorted output will be limited as follows, assuming that in practice about $\frac{1}{3}$ th of the D.C. dissipation is usually obtained, with a maximum

that never exceeds $\frac{1}{8}$ th. For safety we will take it that $\frac{1}{8}$ th is the more likely figure, and then we see that, on the average, class (1) gives only $\frac{1.2}{8}$ watts, i.e. 150 milliwatts; (2) 300 milliwatts; (3) 750 milliwatts; (4) 1,250 milliwatts; (5) 1,875 milliwatts; and (6) 1,875 milliwatts or more.

These figures are on the conservative side, but in the design of radio receivers it is advisable to keep well within the maximum limits. The undistorted output powers and the other details we shall refer to later are given in the valve tables published in last month's "M.W."

Economy Considerations

Now, for very best reproduction on a moderately sensitive loudspeaker we really need more than 150 milliwatts output, though if we are to run the set off dry H.T. supply we are economically limited to output valves of classes (1) or (2). Batteries to run class (3) can be obtained, but here we are running into rather high upkeep costs.

For moving-coil speakers 300 milliwatts is about the minimum that is

likely to be any use at all, so that those who cannot use valves of the 2.4-watt dissipation type will do well to keep to armature-driven speakers.

If an attempt is made to make the valve do more than it should in the way of A.C. output, the result is only a sort of "rattle" in the speaker due to the harmonics introduced by the overloading of the valve.

Safety Factor

We have said that you need at least 300 milliwatts for anything like satisfactory operation of a moving-coil speaker, but this does not mean that 300 or more milliwatts are too much for the moving-iron type. It should be remembered that the greater the maximum wattage of the valve used in the output circuit of a set the greater the possible volume, and the greater the factor of safety from overloading.

Thus if we consider classes 3 and 5, we see that 5 gives more than twice the output of 3; but we may never want to use that output as a mean or average level. To do that we should need a larger valve still, but we may occasionally get somewhere near it on a peak passage of music, and the factor of safety lets us run up, say, from a mean of round about 600 or 700 to a peak of well over 1,000 milliwatts.

As a matter of fact, it has been stated that though the average sound level of a broadcast programme received on a moderately-sized set may

be quite small, yet the loud passages may represent a surprising number of times the energy of the mean. So a good factor of safety is well worth having, is it not?

So much for a generalisation of the power valve, and its possibilities. We have shown that the larger the valve (within sensible limits) the better, not necessarily because you often need its full power, but because you need a full factor of safety.

The use of a set with a 150-milliwatt valve cannot have any factor of safety on local reception, and the 300-milliwatt man is hard put to it to keep his set from overloading before he has "got enough" from it.

Other Troubles

But true overloading is not the only trouble that besets the set owner. Just as serious is the fact that not infrequently the output valve does not get a chance of delivering the full



Two elegant-looking cabinet models in the Blue Spot range; (above) the 70R and (below) the type 45R.

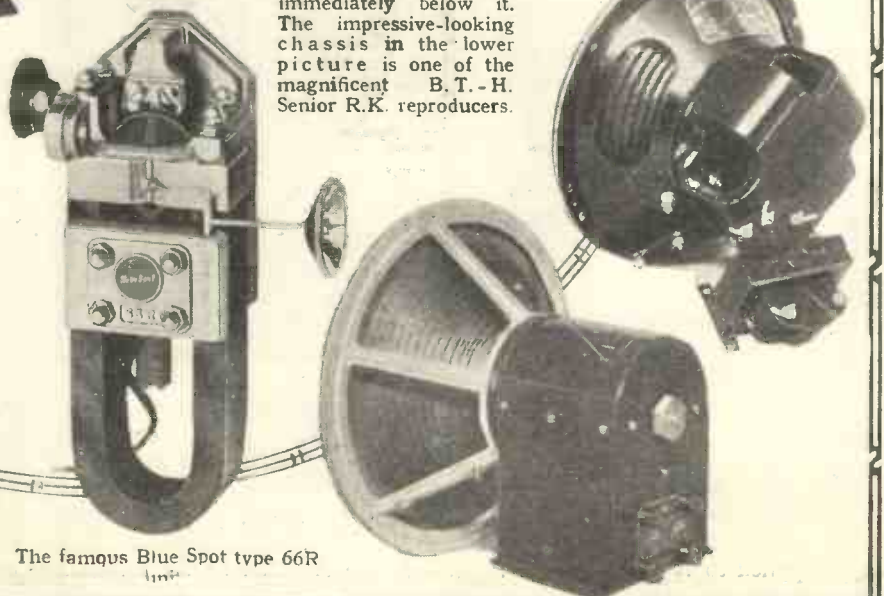

The cabinet of the B.T.-H. permanent-magnet Minor R.K. reproducer (right) has an ornamental fountain grille with an old gold corded background of original design. The chassis model of this particular speaker is seen immediately below it. The impressive-looking chassis in the lower picture is one of the magnificent B.T.-H. Senior R.K. reproducers.

The famous Blue Spot type 66R

Match Your Output Circuits for Best Results

power of which it is capable because it is (1) not matched to the loudspeaker; (2) starved of H.T., and (3) incorrectly biased.

Taking 2 and 3 first, we find they are naturally interlinked, and if set owners would only remember (especially those who use no filter output circuit) that the voltage that "reaches" the anode of the last valve may be



Valves of this category of this Mazda D.C./Pen. give an undistorted output approaching 2.5 watts. This represents volume much in excess of what is normally required for domestic purpose.

the output from the power valve into the loudspeaker. One is to have the loudspeaker direct in the anode circuit of the valve, another is to use an ordinary filter output scheme with a low-frequency choke (either tapped or untapped), a third is the use of a transformer link between valve and speaker, and a fourth is a development of No. 3, the use of a push-pull output. Let us deal with them in order.

The Filter Output

The first method necessitates the use of a high-resistance loudspeaker and simultaneously includes the great disadvantage of causing a serious drop in the anode voltage of the valve, as we have seen. Where long speaker leads are used, or a mains unit is employed, it is not a good scheme, as the loudspeaker leads carry the anode voltage and current, and so risk of shock and leakage is run.

The choke filter is better, but as in the case above the impedance of the

approaches the advantages of the transformer output.

This third method (transformer) enables exact "matching" to be obtained, while the fourth method (push-pull) has the same advantages, and allows more power to be provided for the speaker with less anode voltage than would be required when only one valve (instead of two in push-pull) was used.

Now let us consider the practical details. Briefly, the rule for the obtaining of maximum *undistorted* power out of the valve is that the anode circuit impedance shall be twice that of the rated A.C. resistance of the valve.

Empirical Value

Naturally, as the valve impedance is to all intents and purposes unaffected by frequency, and as the anode circuit impedance varies with frequency, this value must be taken at some empirical figure. That usually chosen is 500 or 1,000 cycles.

Obviously, above that figure the impedance will increase, and below we shall have a decrease. But with a well-designed circuit these variations will not be serious in their effect on the reproduction. It is essential, of course, that a good choke, or output transformer, be employed, and that no chance of core saturation shall be possible.

Now, taking it as granted (it can easily be proved) that an impedance ratio between anode circuit (not necessarily speaker) and valve of roughly 2:1 is required, let us re-examine the positions of the various forms of coupling.

Two to One

Where the direct method is used obviously the impedance of the speaker must be twice that of the valve, as the speaker is the only impedance in the external anode circuit. This means that with a power valve

of class No. 1, which has an average impedance of 4,000 ohms, the speaker impedance must be round about 8,000 ohms. (Last month's valve lists will show the optimum loads for the various power and super-power valves.)

Again, if the valve is a 2,000-ohm,

very much less than that applied, over-biasing of the valve and starving of H.T. would be far less frequent.

The average moving-iron loudspeaker has a D.C. resistance of 2,000 ohms or so. Now place that in series with a valve that should have 150 volts on its anode, and, properly biased, should take 15 milliamps. To get that 150 on the plate you should be applying about 180 volts.

Voltage Drop

Obviously you are starving the valve and over-biasing it at the same time.

That voltage drop in the external anode circuit occurs whatever output system you employ, but it is less serious if choke-filter or transformer output is used, for the well-made choke, or transformer primary will have a D.C. resistance of a mere few hundred ohms.

The most important factor in the power output and quality of the reproduction is the so-called "matching" of the valve to the loudspeaker.

It is essential that the right relationship of valve A.C. resistance to speaker impedance (at average musical frequencies) be obtained, otherwise the full output of the valve will not be obtained without distortion.

There are several ways of feeding

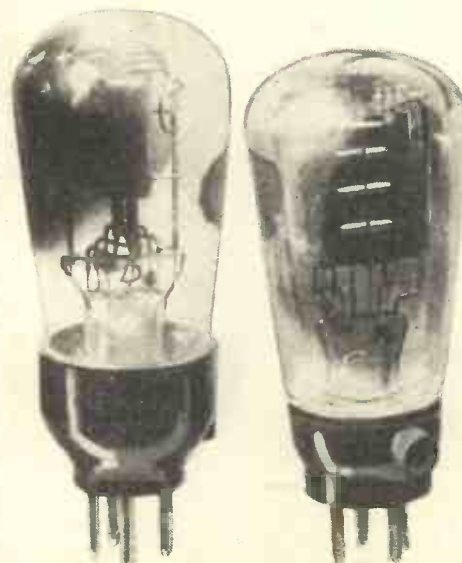

Two of the good modern battery pentodes which give adequate outputs for reasonably sensitive moving-coil speakers. On the left is a Marconi, while the valve on the right is from the Osram range.

speaker must be directly "matched" with that of the valve if best results are to be obtained. Of this so-called "matching" we will say more farther on.

The tapped choke allows a ratio link between valve and speaker impedance to be obtained, and

How to Get the Greatest Possible Power

the speaker impedance of 8,000 will be too high, and you will require a speaker having an impedance of about 4,000 ohms. Awkward, is it not? For it means you are tied hand and foot to the use of a certain valve with a certain speaker.

The choke output filter has the advantage of isolating the speaker from the direct anode current, but as the speaker and choke are in parallel across the valve the same "matching" trouble exists.

Choke Design

The choke should have as high an impedance as is practicable with reasonably low D.C. resistance, and then the speaker and valve are balanced as before.

The tapped choke gives some latitude in that definite ratios can be obtained, but the transformer (either fed via a choke output, or direct in the anode circuit of the valve) is the most satisfactory way of matching the two impedances.

It allows two things to be arranged with complete independence of each other. The valve anode circuit impedance can be chosen, and at the same time this same impedance (which will be the optimum load for the valve you are using) can be suited to any particular loudspeaker by means of the ratio between the primary and secondary windings of the transformer.

"Moving-Coils"

Thus if you have, as is the case when dealing with low-resistance moving-coil speakers, a valve with an impedance of 800 ohms (P.X.4) and a speaker with a coil impedance of 16 ohms, you can "match" the valve and the speaker via the transformer ratio.

Thus you require a primary impedance of 1,600 ohms and a secondary that will transfer the maximum energy to the speaker—i.e. of the same impedance, 16 ohms.

Here, perhaps, it is necessary to explain that although with a valve, as in the case of any other "generator" of energy, the maximum power developed is when the external im-

pedance equals the internal impedance, this is not the maximum *undistorted* output, which is obtained when the impedances bear a ratio of approximately 2 : 1.

Equal Impedances

In the case of the transformer, however, the same phenomenon does not exist, and so we have the secondary winding of the same impedance as the speaker winding we are feeding.

Now, then, how shall we go about matching our valve and speaker? Practically, the best thing is to get the makers of the speaker to supply the requisite transformer for that particular valve. They may do it by means of a tapped secondary or primary, or in one unalterable instrument. But they will work out the requirements something like this:

If N is the ratio required, the formula is:

$$N^2 = \frac{\text{Twice impedance of valve } 1,600}{\text{Impedance of speaker } 16} = 100. \text{ Therefore the ratio is } \sqrt{100} = 10/1.$$

This is quite simple, is it not? And it allows practically perfect "matching" or balancing of the speaker and valve impedances.

Transformer coupling between the valve and the loudspeaker is the most straightforward method of coupling,

and it can be employed whether or not the use of a filter output circuit is contemplated. We say this because many set designs are published with a filter output, and if it is desired to use a transformer this can be done without disconnecting the output choke scheme, the primary of the transformer being connected to the loudspeaker terminals as if it were a high-resistance loudspeaker.



This is the Mazda A.C. equivalent of the D.C./Pen. shown on another page. It is one of the "big fellows," giving an undistorted output of approximately 2½ watts.

It must be remembered in this case that the ordinary output-filter arrangement is a 1 : 1 ratio affair, and apart from keeping the D.C. component out of the loudspeaker or the transformer it does nothing towards matching the valve and loudspeaker together.

For Pentode Valves

The tapped choke is different unless the taps are ignored and the output is taken right across the choke. This choke is usually only used when it is intended that a pentode valve is to be employed, when the loudspeaker impedance is likely to be less than that of the valve, and a step-down ratio between the two is required.

The output choke system is excellent for purposes where speaker and valves are likely to be pretty near each other as regards matching, as in the case of the small power valve and many of the ordinary loudspeakers; but when it comes to the larger valves, with their lower A.C. resistances, the need for more careful matching becomes very apparent.

In connection with this it should be mentioned that the ordinary reed-driven loudspeaker varies a great deal in impedance, according to the make, and a study of the details given in the preceding sections of this



Here are two more high-efficiency battery pentodes. The Mazda Pen.220A. on the left, and the Cossor 230P.T.

"Push-Pull" Output Has Many Advantages

supplement will show how very difficult it is to be at all dogmatic about the values of the components that are likely to be needed in the average output circuit.

Treatment of Pentodes

We have said nothing about pentode valves because they are subject to just the same treatment as the ordinary power types, except they need very careful matching.

We have not yet touched upon the push-pull type of output circuit, so we will pass on to that interesting device.

The whole idea of push-pull, as you probably remember, is to allow the owner of a set that cannot be provided with much anode voltage to get extra punch (punch that can otherwise be obtained only by using more voltage) by using two output valves of low voltage instead of one.

There are two limiting factors to the amount of power that an output valve will provide, assuming that the input to it is not limited; one to the amount of H.T. voltage (assuming that the H.T. current is not also limited), and the other is the grid swing of the valve.

Limiting Factors

They are mixed up with each other, for if the valve is starved of H.T. the grid swing will be limited, and if the valve has only a small grid swing it is probably due to the fact that it is a small valve, one that does not need and will not take much H.T.

You will be able to see from the foregoing classification of the power valves that if you want a big output power you must use a valve that will supply that power, and that valve will need a lot of H.T.

Thus if you have a limited voltage, such as is the case with a 200-volt D.C. set, you can use, say, two 8-10-watt dissipation valves in push-pull and get an undistorted output of about 2 watts, a state of affairs that would otherwise necessitate the use of a larger valve, which would demand well over 200 volts H.T.

In the smaller classes it is sometimes advantageous to use two 2-4-watt valves on a large-capacity H.T. battery of 150 volts, or a D.C. mains unit giving that voltage, rather than to increase the voltage to 200 or 250 volts and employ the 6-watt type. The two push-pull 2-4-watters would not give quite the output that you would get from the 6-watter, but they would go a long way towards it.

Separate Grid Bias Advisable

In using push-pull it is advantageous to use an input transformer to the push-pull stage with a double secondary so that separate grid bias for the two valves can be applied. This obviates the necessity of exact matching of the valves, a most important

In push-pull it is often said that the valves can be biased down to their anode-bend points, so that the anode current is saved, and the rectified part of the output is automatically cancelled out in the output transformer. In theory this is all very well, but very exact matching of valves and the exact transformer impedances are required, so that in practice it is usually somewhat disappointing.

It is better to bias the valves as if they were being used in the ordinary way, though this does not constitute any special economy in anode current.

Parallel output valves in the average set are not worth while, as owing to the anode voltage drop in the output circuit, due to the greater anode current when two valves are used instead of one, nothing like the power output that one might expect is actually obtained.

High-Note Loss

There is one snag in push-pull that we ought to mention for the sake of the quality man. It is that this system of amplification does a great deal to check the generation of harmonics by the output valve; and though this is a laudable object in itself, it often results in a slight loss of high notes that would otherwise be present due to slight harmonic generation.

Thus in a set that is particularly selective, and consequently cutting off some of the side-bands from the received transmission, the use of push-pull may give the reproduction a somewhat dead quality; and in such a case it is useful to have some sort of high-note lift in the previous stages of the L.F. amplifier.

Not Always a Disadvantage

A good band-pass set, on the other hand, can often be improved by the slight loss of some of the highest notes, that are usually accompanied by heterodynes.

We have said that the reduction of harmonics by the use of push-pull is sometimes a disadvantage, but we should not like it to be thought that



In consequence of the greatly improved sensitivity of the modern moving-coil loudspeaker it is possible with many of the types to get really excellent results when using quite a modest size of battery output valve. Those shown here are (left) the Lissen P.T.240 and the Mullard P.M.252.



consideration if the valves have to be worked off the same bias point.

Impedances in Series

As regards the output side of the push-pull arrangement, the matching with the speaker is done in the same way as with the single valve, except that it has to be remembered that the valve impedances are in series, and so the impedance figure is twice that of one of the valves. Otherwise the matching process is exactly the same, it being borne in mind that the output system is usually of the transformer variety. Choke output, the choke having a centre tap as well as other taps for matching, can be used, but, as a rule, the transformer method gives the more satisfactory results.

"A Good Speaker Cannot Make a Bad Set Good"

this is a real fault in the system. It is, in fact, the opposite, provided that the previous part of the set is properly treating the high notes.

Gives it Extra "Life"

Harmonics are not in themselves desirable except in such cases where high-note reduction has already occurred, when slight harmonic distortion, though technically wrong, gives some welcome "life" to the reproduction. The pentode valve is prone to produce harmonics, and this is the cause of its shrill reproduction in cases where it is not properly used, and its welcome brightness in cases where a little harmonic distortion is the lesser of two evils.

But whatever type of output circuit you favour, please bear in mind the vital necessity of properly "matching" your output valve to the loudspeaker.

This matching business is not just the cry of some technical faddists, it is a most important part of the design of a radio receiver or electric gramophone. And it can easily be carried out satisfactorily if set owners will only take the trouble to get in touch with either the manufacturers

of their loudspeakers, or with the makers of the valves they want to use in the output stage.

Match up the Output

The best way to go to work is to decide which valve will best suit your requirements as to its power output and its anode power consumption, and then get into touch with the speaker people, telling them the speaker you want and the valve you will use with it, and asking for the correct transformer to link the two together. That link between is most important. See that yours is a strong, well-designed one, and you will benefit by it in increased power and better

quality more than you can possibly imagine.

In conclusion, perhaps it will not be out of place to discuss briefly another point that concerns the output valve, though somewhat indirectly. This is the provision of anode power from mains units, or in all-electric receivers.

Mains Unit Problems

The mains H.T. supply is ideal from the point of view of economy and power, but it is also the forerunner of certain troubles that do not beset the battery user, troubles that are often the result of careless design, or employment of the power unit.

For instance, to attempt to use a mains unit that will not comfortably

Many constructors consider that the fact that the L.T. winding of the transformer has a centre-tap on it is sufficient to guarantee proper balance between the two ends. But such a tap is no criterion of an electrical centre, and as often as not it is far from being that desirable fact.

Consequently we in our set designs usually neglect the centre-tap of the L.T. winding and place a potentiometer across the L.T. circuit, taking the grid returns and cathodes of the valves to the centre of the potentiometer. This is adjustable by means of a slider and so by trial and error the exact electrical centre of the transformer can be found.

This may seem to be a lot about little, but if you want to get rid of

the last trace of A.C. hum you will usually find that the use of a potentiometer of some sort (and it should have a low resistance) will be necessary.

In mains sets, too, it is of advantage to decouple the automatic grid-bias resistances, otherwise a certain loss of bass-note amplification will be likely to result.

A Price Alteration

Since the preceding pages of this special supplement

went to press we have been advised of a slight alteration in the prices of MoToR loudspeakers and units. The MoToR "Chester," which is the cabinet version of their Minor moving-coil loudspeaker, is now £3 15s., and the chassis alone, with output transformer, is £2 5s. The new MoToR type S.40 cone speaker unit is 2s. less than the price given in our table, i.e. it is £1 12s. 6d., and not £1 14s. 6d. as stated.

We also learn that Messrs. Tekade Radio & Electric, Ltd., are now producing a cone chassis assembly designated as the MoToR C.400, which is £2 5s. complete with the new S.40 unit, or 12s. 6d. without the unit.

WHAT ABOUT THESE TWO?

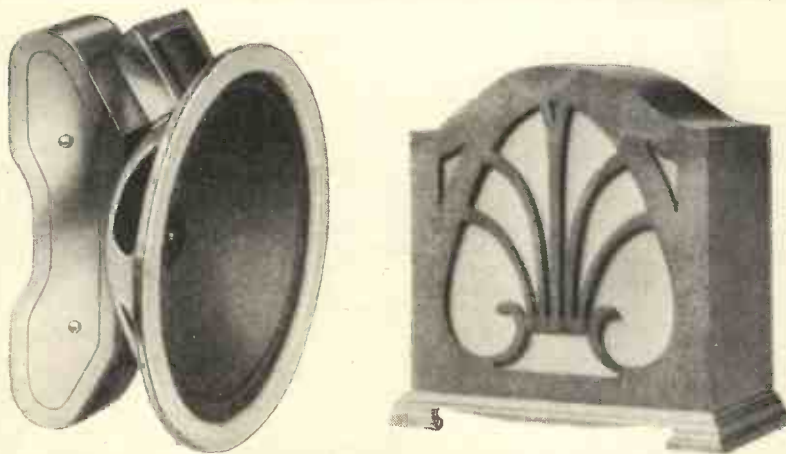

The Lamplugh "Silver Ghost" permanent-magnet moving-coil chassis, on the left, gives an even response over a wide range of frequencies. The cabinet model on the right is the Falk, Stadelmann "Puravox," type W.91551, one of the good modern cone speakers.

supply the anode current required will usually result in hum and possibly motor-boating.

Hum is also caused by insufficient smoothing in the unit, and, in an all-electric receiver, by unsuitable return between the heaters of the valves (or the filament if a directly-heated output valve is used) and the L.T. winding of the mains transformer.

This is a most important point to watch in the design of a mains set, and readers will notice that in the three-valve all-A.C. set described in this month's "M.W." special precautions regarding the "earth" return have been taken.

MY BROADCASTING DIARY



Our own Broadcasting Correspondent records the progress of the British Broadcasting Corporation, and frankly comments on the policies in force at B.B.C. Headquarters.

Midday Transmissions

I FIND that the B.B.C. still does not attach to midday transmissions the importance they deserve. These concerts have an enormous public. It was, of course, an excellent plan to regularise the arrangements so that there would be uniform and general timing.

But it is a mistake to put on organ recitals at midday. These are much too lugubrious. Concerts of light music should be the invariable rule. And what about Sunday? Is there ever anything to be done about lunch-time entertainment on the Sabbath?

P.M.G. and Television

Col. L'Estrange Malone, M.P., arranged the other day for the Postmaster-General, Sir Kingsley Wood, to go and have a look at Baird Television in the Long Acre studios. They were accompanied by Mr. Noel Ashbridge, Chief Engineer of the B.B.C. I hear the P.M.G. was interested, but unimpressed.

"Rungs of the Ladder"

The forthcoming "Rungs of the Ladder" series of talks promises to be specially interesting. The idea is to induce representative successful men to come to the microphone and "enthuse" others to go and do likewise.

Some of the speakers will talk about themselves; others will talk about others. Lord Beaverbrook is one of those who will talk about themselves; likewise Mr. J. H. Thomas and Lord Ashfield. I hear Mr. Gordon Selfridge declined in the face of great pressure.

Programme Recording

The recording of British programmes for use abroad is likely to become an important business before long. The B.B.C. has interested itself in a scheme for merging the various companies involved into a sort of concessionaire combine.

As it gets more generally recognised that reception of the new Empire station will be variable, listeners in the Dominions and Colonies will be increasingly glad to hear an admixture of recorded British programmes on their own stations.

Regional Directors

The status of Regional Directors of the B.B.C. is again under review. True, not for the first time; the subject

coming up whenever there is a move at headquarters for greater centralisation, which happens about twice a year.

But this time the Regional Directors themselves are taking the initiative in establishing their status. Their idea is that as they are responsible not to branch heads at Savoy Hill, but to the Director-General, they should be put on the Control Board, thereby exercising more influence on policy.

THE RETURN OF WILL ROGERS



Will Rogers, the great American humorist, and his wife, being interviewed for the talkies on their return to the States, after an extended tour of Europe

Latest News Items for the Listener

At the same time as this move, Mr. Siepmann and Mr. Roger Eckersley, the programme and talks chiefs for London, have put their heads together to bring about a much more stringent measure of centralisation. So this time the issue is well joined, and will be fought to a finish. I am not a prophet, but I am inclined to back the "Regionals."

Those Wireless Exchanges

The number of subscribers to wireless exchanges is increasing steadily all over the country, and this is well on the way to becoming a big industry. The B.B.C. and the Post Office do not agree about wireless exchanges, the former wishing to control them much more extensively than the latter will accept.

There is a good deal of bother over the Sunday pro-

the reception on the exchange receiver to such effect that the exchange had to ask the B.B.C. to let them have a land-line link with a control room.

Wave-length Changes

The next change in wave-length will probably be at Newcastle. The suggestion is that Newcastle take on the 200-metre spare wave. This allotment, of course, confers the advantage that Newcastle could resume the origination of programmes, which it has not been able to do since being put on 288.5 metres—the National common wave.

On the other hand, there is the disadvantage that listeners would have to make adjustments to their receivers, most of which at present would hardly go down as low as 200 metres. Yet, if the B.B.C. would give a guarantee that the new arrangement would be permanent, it probably would be welcomed by local opinion.

The evolution of the Regional Scheme makes certain periodical re-shuffles inevitable, but listeners are none the less impatient of changes which make a difference to receiving sets. Once Newcastle is straightened out, something is to be done about Aberdeen, but I don't know what.

HENRY GIVES THEM THE "ONCE OVER"



Here is a close-up of some of the individual members of the new B.B.C. dance orchestra being rehearsed by their leader, Henry Hall.

The Ultra-Short Waves

If only the ultra-short waves would come along serviceably, the B.B.C. would surmount most of its troubles readily enough. A number of local stations would be set up, probably at Inverness, Wrexham, and Sheffield and Londonderry. But this appears to be some years distant.

The Governors Quiet

The B.B.C. Board of Governors seem to have settled down. I hear much less criticism of them by the staff than was the case a year or even six months ago. Then there was irritation at their alleged interference with programme arrangements.

Now, however, this feeling has definitely subsided. Sir John Reith, of course, is on excellent terms with his Board, which appears to be giving him as free a hand as he had in the days of the Company, when the wireless manufacturers were responsible for broadcasting in Britain.

Holt Marvel at Hollywood

Holt Marvel, the brilliant dramatic producer, known otherwise as Eric Maschwitz, the editor of "The Radio Times," is taking his holidays this year in a visit to Hollywood, where he is exploring film possibilities. I would not be surprised at all to see him kidnapped by American interests, which would be a signal loss to the B.B.C.

Threatening the Trade?

The Radio Manufacturers' Association look with some concern at the growth of wireless exchanges, which threaten to cut into the wireless trade. Indeed, the feeling in the trade is so strong that in one North Country town a local trader is said to have purposely interfered with



Trouble Tracking



On this page the Chief of the "M. W." Query Dept. discusses, month by month, some of the common difficulties and troubles which can be so perplexing. This month he deals with the effects of a poor earth.

THE importance of a good earth is sometimes overlooked, but many cases of instability; both H.F. and L.F., are due to a poor earth.

A really stable circuit ought not to be seriously affected by the efficiency of the earthing system. That is to say, the removal of the earth lead from the set should not cause the H.F. or L.F. stages to go into oscillation.

A Dry-Weather Tip

There are, however, designs which emit startling howls and moans immediately something goes wrong with the earth. Some sets with two transformer-coupled L.F. stages are particularly sensitive to variations in this portion of the circuit, and rely upon a good earth to hold them down.

With the approach of summer and the possibility of dry weather those who use buried earth plates or earthing tubes should keep a close watch on the soil surrounding the plate or tube.

In order to ensure good electrical contact the soil should be damp, and the best way of achieving this is to soak the ground in the vicinity of the earth connection with plentiful supplies of water at regular intervals.

When the Foreigners Fall Off

Apart from the question of stability which, of course, does not apply to every set, it is surprising how the efficiency of the earth affects sensitivity.

I frequently get letters from puzzled readers who tell me that for some mysterious reason the "reaching out" properties of their sets seem to have been reduced by umpteen per cent.

There are many factors which can account for this, such as run-down H.T. batteries, valves which have partly lost their emission, dirty or

defective contacts in the wiring, or a faulty component.

But I find that these points all come under suspicion directly the symptoms of vanishing power are noticed, whereas the earth system is rarely suspected.

It is well worth while to have a look at this first of all. Water-pipe earths can give just as much trouble as the buried variety.

Connection to the water pipe is usually made via a copper or brass clip, and unless the connection is very

out that aerial joints also require attention once or twice a year.

I receive a certain amount of correspondence relating to interference by tramways. Sets situated close by an overhead trolley system suffer from crackling noises produced by sparking between the trolley wheel and overhead conductor wire.

Tramway Interference

There is practically nothing one can do to the receiver itself to remedy the trouble. By cutting down the

A SIMPLE AND STABLE LAYOUT

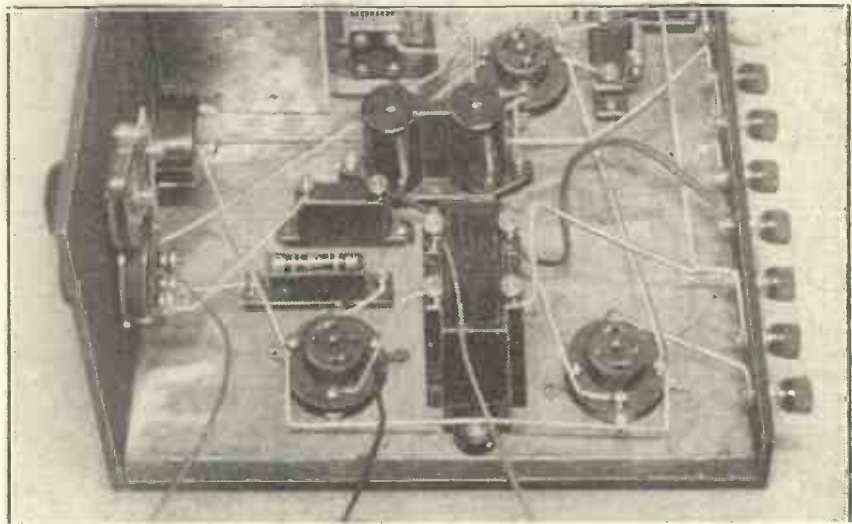

Some types of L.F. coupling are affected more than others by the efficiency of the earth connection. - A well-designed resistance-transformer combination usually remains stable even when the earth lead is removed from the set.

carefully carried out at the beginning there is a tendency for the surface of the lead pipe to oxidise. This coating of oxide has a comparatively high resistance, but can easily be removed with a piece of fine glasspaper or emery cloth.

In the absence of these the surface can be scraped with a knife.

While dealing with the subject of earths I feel that I ought to point

aerial length and improving the selectivity of the set some measure of relief may be obtained. A re-arrangement of the position of the aerial may help, but this is not always a practical proposition.

Removing the earth lead, providing the receiver remains stable, may also assist matters, but generally speaking the remedy lies at the source or the interference.

The "Timepiece" Three

DESIGNED and DESCRIBED
By K. D. ROGERS

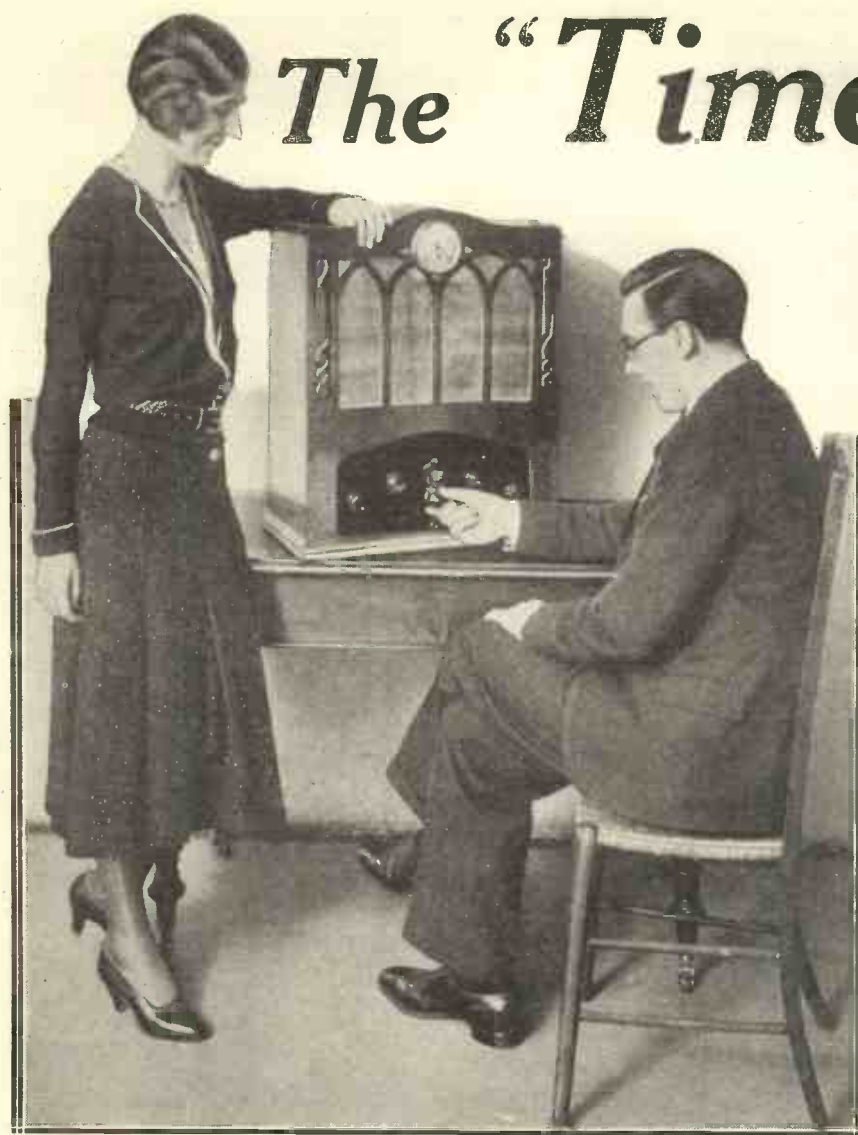

There should be no more complaints about not knowing the exact time, at least not from those readers who build this novel receiver. It is a highly efficient three-valver, working completely from the A.C. mains, and having an electric clock let in the front of the cabinet.

There is ample room inside for a large moving-coil loudspeaker, and it is a set that is very easy to build.

The combination of the two is quite an easy matter, as you will see when you have read this article. It is quite simple to construct an average 3-valver and include in the design both speaker and clock so that the table type of cabinet shall house the whole lot.

ONE of the most interesting and at the same time valuable consequences of the development of A.C. electricity supply in this country, especially where the grid system is employed, is the fact that all-electric synchronous clocks can be used in every home that has such a mains supply.

The benefits are obvious, for with the electricity main time controlled there is no possibility of the clocks going more than a few seconds out at any time, while the exact checking at the station so corrects the mains frequency that the plus and minus errors cancel out in a very short period.

Correct Time Always

Therefore, those who are lucky enough to be on time-controlled electricity mains can be assured, at a mere nominal cost, of the correct time all the year round. For the synchronous clock is very inexpensive to buy,

and it takes a mere 1 or 2 watts, or even less, from the power supply.

Another advantage accruing from A.C. mains is the fact that it is particularly easy to run all-electric radio receivers from them. That is a fact that is already well known, and we mention it here not because of its particular value in itself, but because we are going to suggest the use of an all-electric receiver and that of an electric synchronous clock combined in the one instrument.

Table Model

Why not, indeed, combine the clock with the radio receiver, and have an instrument that is at once right up to date, and of practical use the whole day long? The clock does not interfere in any way with the operation of the set, and the latter in no way affects the timepiece. The clock goes merrily on, providing the correct time, regardless of whether the set is in operation or not.

Easy Operation

That is what we have done in the set to be described, and illustrated in the photographs. It is an easy set to build, and has absolutely nothing tricky in the construction, though as the set is fairly compact care has to be taken that no mistakes in layout or wiring are made.

The theoretical circuit shows at a glance that there is nothing out of the ordinary about the circuit, and indeed, we claim no more than ordinary 3-valve results with it. It is powerful and moderately selective, while its ease of operation makes it ideally suited for home use.

One stage of screened-grid H.F. amplification is employed, followed by a detector and pentode. External power supply is arranged for, the power unit fitting inside the cabinet, so that the whole thing is self-contained.

Two of the lately introduced Lissen screened coils are employed as aerial and tuned-anode tuning, the desired degree of selectivity being obtained by means of that simple but effective device the series aerial condenser.

As the set is fairly powerful, a pre-detector volume control is included, and also an L.F. volume control that can be used either in conjunction with the H.F. control, or only when the set is used with a gramophone pick-up. This latter is provided for by the jack situated under the Extenser control.

No Wave-Change Switches

No wave-change switching has to be carried out when you want to go from long to medium, or vice versa, the whole of the wave-band control being done by the Extenser, which is of the dual-gang type.

The most important part of the set is naturally the H.F. end, and so in considering the construction of the receiver we will deal with that part first.

An Electric Clock and Moving-Coil Speaker are Incorporated in the Design

As an A.C. S.G. valve is employed, it is essential that the screening be of the best possible, consistent with reasonable ease of construction of the set. We have, therefore, kept the screening down as far as possible, but a certain amount has to be done to make the set properly stable.

The Screening

In the first place, the ganged Extenser is not of the enclosed type, so that a certain amount of screening has to be done here. This consists of

cutting a metal screen so that, besides allowing the S.G. valve to protrude through in the usual manner, it is also carried on to fit in line with the front screen of the back section of the Extenser.

Baseboard Covering

A thin strip (about 1 in. wide) is continued along above this screen belonging to the Extenser, and allows the new screen to be bolted to the Extenser screen at each end. This makes the job perfectly rigid, and also provides excellent screening. A further screen along the L.F. side of the back portion of the Extenser, as shown in the photographs, completes the screening with the exception of the copper foil that is used to cover the whole of the baseboard.

And having mentioned the screens, we can go ahead with the actual construction and assembly of the set. Having covered the baseboard with foil, the next thing to do is to drill the panel to the dimensions given in the

Some Points of Interest in This Novel All-Mains Set

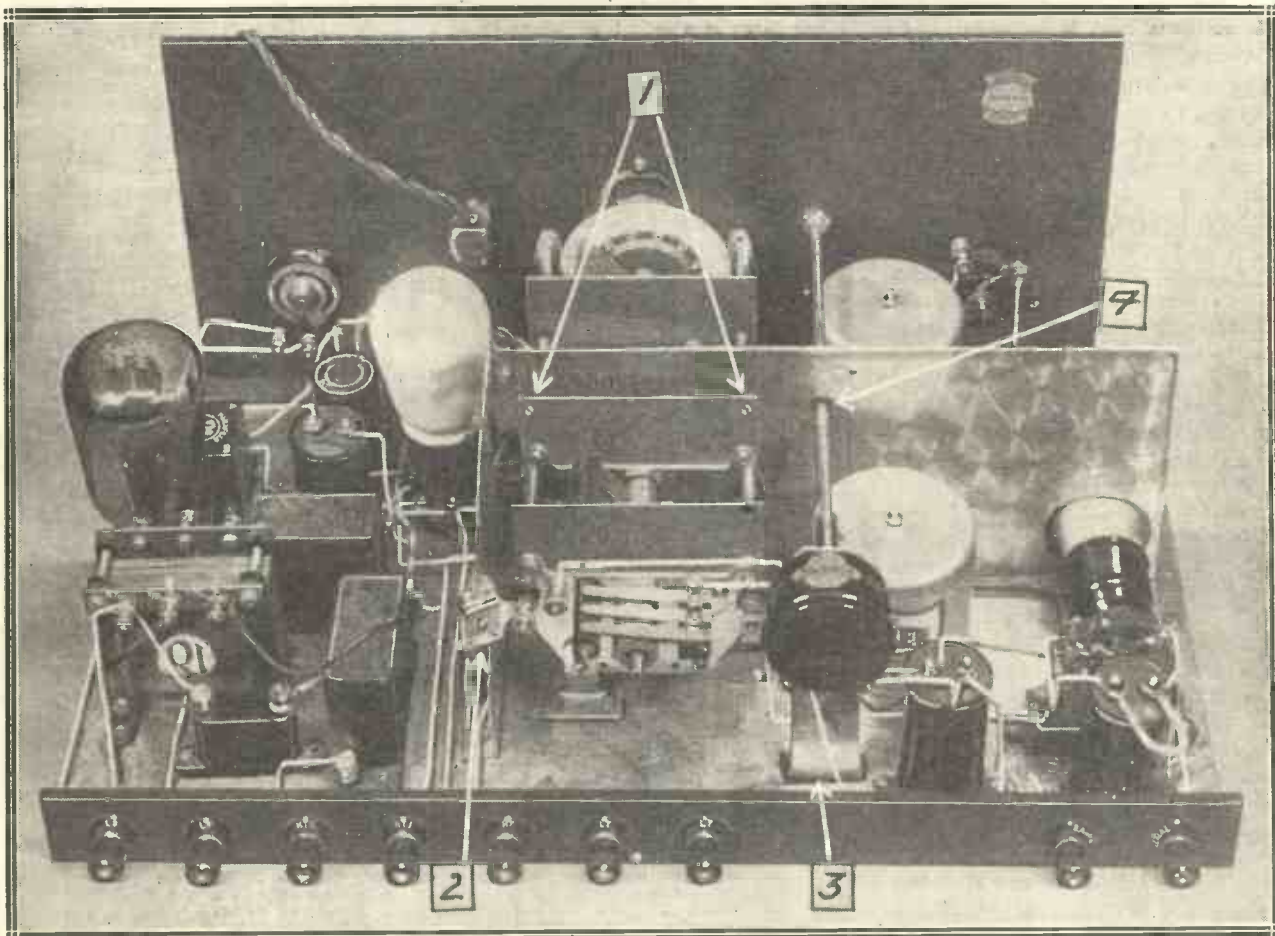

(1) The two screws at which the arrows are pointing secure the main screen to the smaller piece of metal that is part and parcel of the dual Extenser; (2) indicates the small trimming condenser which is connected across the aerial section of the ganged Extenser; (3) when screwing this bracket to the baseboard, care should be taken that the metal foil does not touch the bracket, because it is at high potential; (4) this is the control rod of the volume control and is also at high potential, it is therefore necessary to make sure that the hole in the main screen is sufficiently large for ample clearance.

diagram. Then mount the panel components and temporarily fix the panel to the baseboard.

This will show how the land lies as regards the mounting of the baseboard components, which must be done with the panel in position, though it will be an advantage to remove it when the wiring is commenced.

is removed and the Extenser taken off, and the wiring to the pick-up jack is carried out.

This is the only wiring to be done with the Extenser out of position, the rest being quite easily carried out with everything *in situ*.

But before we go any farther into the building of the set let us utter a word of warning—test the com-

but it is really advisable to check up the health of the fixed condensers, the valve holders, and H.F. and L.F. chokes before going right ahead with the receiver.

Most of the present-day parts can be relied upon to be pretty sound, but we have come across such things as faulty valve holders, chokes that will not pass even D.C., let alone do any choking, and leaky fixed condensers, quite recently, so that the day of one-hundred-per-cent perfection has not yet arrived.

THERE IS ONLY ONE TUNING KNOB

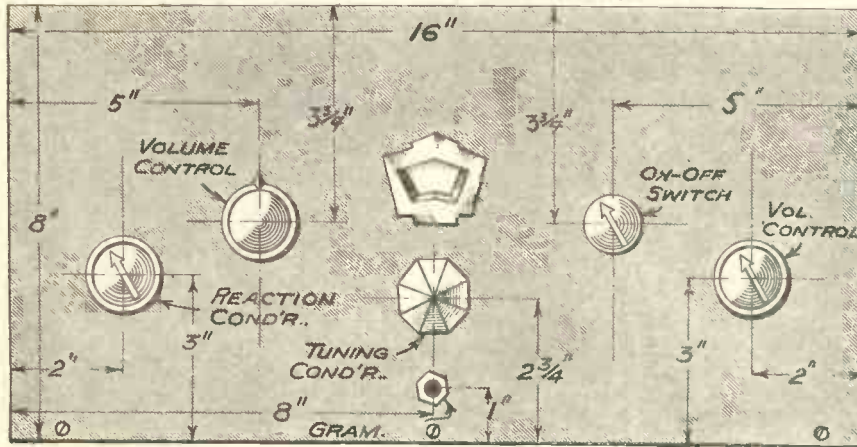

PANEL LAYOUT.

Although there are several controls on panel, one only is used for tuning purposes. This is the octagonal knob in the centre, and just below there is a socket for plugging in a pick-up.

The pre-detector volume control will have to be mounted on a metal bracket, control from the panel being arranged by an extension rod about 8 in. long, and fitted with a short collar. And here, as with the mounting of the small 30-ohm potentiometer known as a humdinger, a special precaution must be taken. This consists in so arranging things that the mounting bracket supporting the H.F. volume control and the humdinger do not come into contact with the metal foil covering the baseboard.

Alternative Methods

This is essential, because the spindle of the volume control is not insulated from the slider, while the metal ends of the humdinger would be shorted if they came into contact with the foil. There are two ways of carrying out this insulation. One is to cut away the foil round the components in question, and the other is to mount them on blocks of wood, taking care that they do not come into contact with the screws used to fix the blocks on the foil.

The other components are mounted in the usual way, though it is not advisable to fix the Extenser in place permanently until the pick-up jack has been mounted and wired up. So after mounting the various components on the baseboard the panel

ponents before you finally fix them on the baseboard and connect them up.

This does not mean that such parts as the Extenser and the L.F. transformer need testing if they are new,

A Reason for Everything

It is easy, however, to check up the few parts in the set, and then, with the sure knowledge that the condensers will not leak, and that the valve holders will make good contact with the valves, and the chokes will really be likely to choke, one can go full-steam ahead and get on with the building of the set.

In the wiring diagram you will probably notice that some of the leads in the two tuning circuits are apparently unnecessary; they could have been replaced by short connections to the earthed metal covering on the baseboard.

This use of wire connections where apparently the foil could have been employed is done deliberately, however, for it is not a healthy practice to return the tuning coils to the earthed sides of the Extenser

A COMPLETE LIST OF THE PARTS REQUIRED

- PANEL**
 - 1 16 in. x 8 in. (Permacol, Becol, Ready Radio, Peto-Scott, Wearite).
- CABINET**
 - 1 Moreco "Gothic" No. 1069, with baseboard 18 in. x 10 in.
- EXTENSER**
 - 1 Double-gang disc-drive (Cyclon, Wave-master).
- SWITCH**
 - 1 On-off rotary snap (Claude Lyons, Ready Radio).
- VARIABLE CONDENSER**
 - 1 .00075-mfd. solid-dielectric (Telsen, Ready Radio, Polar).
- RESISTANCES**
 - 1 5-meg. volume-control potentiometer (Igranic, Ready Radio, Sovereign, Colvern, Wearite, Clarostat, Magnum).
 - 1 50,000-ohm potentiometer (Igranic, etc.).
 - 1 2-meg. grid leak, with holder if required (Graham Farish Ohmite, Telsen, Ready Radio, Igranic, Sovereign, Watmel, Ferranti, Lissen).
 - 1 40,000-ohm Spaghetti (Telsen, Graham Farish, Bulgin, Tunewell, Ready Radio, Varley, Lissen, Leweos).
 - 1 20,000-ohm do. (Bulgin, etc.).
 - 1 25,000-ohm strip resistance (Colvern, Dubilier 2-watt type, Varley, Sovereign wire-wound, etc.).
 - 1 30-ohm Humdinger (Claude Lyons).
- FIXED CONDENSERS**
 - 1 .0003-mfd. (Formo type 42c, Dubilier, Telsen, Ready Radio, Lissen, T.C.C., Sovereign, Ferranti, Graham Farish, Goltone).
- 1 5-mfd. (Dubilier type 9200, etc.).
- 1 .01-mfd. (T.C.C., etc.).
- 2 .0001-mfd. (Ready Radio, etc.).
- 1 1-mfd. (Dubilier type 9200, etc.).
- 5 2-mfd. (Dubilier type 9200, Telsen, etc.).
- COMPRESSION CONDENSERS**
 - 1 .0003-mfd. max. (Formo, Leweos, Sovereign, Goltone, Polar).
 - 2 Trimming condensers (Cyclon type B.T.50).
- VALVE HOLDERS**
 - 1 Horizontal 5-pin type (W.B.).
 - 2 Ordinary 5-pin type (W.B., Igranic, Graham Farish, Telsen, Clix, Wearite, Magnum, Lissen, Bulgin).
- CHOKES AND COILS**
 - 2 H.F. chokes (Polar, R.I., Leweos, Telsen, Varley, Ready Radio, Wearite, Tunewell, Peto-Scott, Dubilier, Sovereign).
 - 1 Pentode output choke (R.I. Pentamite, Tunewell, Atlas).
 - 2 Screened coils (Lissen).
- L.F. TRANSFORMER**
 - 1 "Shunt-feed" transformer of medium ratio (R.I. "Parafed," Igranic "Parvo").
- MISCELLANEOUS**
 - 1 Sheet copper foil, 18 in. x 10 in.
 - 1 Ferranti electric clock chassis.
 - 1 Screen 5 in. x 11 in.
 - 1 Screen, 5 in. x 4 in.
 - 1 Bracket and 8-in. $\frac{3}{16}$ in. rod for 50,000 volume control, also panel bush and collar for same (Wearite).
 - 1 Terminal strip, 18 in. x 2 in.
 - 9 Indicating terminals (Bulgin, Igranic, Belling-Lee, Eclex, Clix).
 - 1 Radio-gram jack and plug (Igranic type P.62).
 - Glazite, Lacoline, Soldawyre, Quickwyr, Jifflix.
 - 18 in. Twin metallised wire (Leweos).
 - Flex, screws, etc.

The Tuned Circuits are Accurately Ganged

by way of the foil, for that is likely to set up instability, due to the fact that the foil is common to both of the tuned circuits.

It must also be remembered that the moving vanes of the Extenser and the framework of it are common, and are therefore at earth potential. With the tiny screws on the cams screwed down, these cams are also electrically connected to the moving vanes, and so only one contact on each section of the Extenser is required, and there is no need to insulate the Extenser from the foil.

In replacing the lids of the canned coils after wiring has been carried out, care should be taken that the edges of the lids do not cut into the wire as it comes out through the slots provided in the lids. It is regrettably easy to cut into the wires in this manner, and a fault developed in this way very often takes a lot of finding, and it is not unlikely that it might prove detrimental to the life of the mains unit.

The Clock Wiring

At this point perhaps we should say a little about the arrangements made for the inclusion of the electric clock and the wiring controlling it. Obviously, the control switch on the panel of the set must not switch off the clock every time the set is "closed down."

So that switch is completely independent of the action of the clock, and controls merely the input to the set via the mains unit. What happens is this. The mains unit, which is a separate part of the outfit, is supplied by the makers with a plug and flex for plugging into the electric-light socket. This plug is still used for operating the set, but one of the leads is broken and the switch on the panel of the set is inserted in series with it. It obviously does not matter in the slightest which of the two leads is broken.

Independent Switching

So far we have arranged for the set to be switched on or off without the need to touch either the plug in the electric-light socket or the switch controlling that socket. The clock must, however, be so wired that although the whole outfit could be switched off by removing the plug from the socket, the clock must not be affected by the control switch on the panel.

This is easily arranged by tapping the clock connections on to those from the plug to the set. So one side of the clock is connected to one of the flex leads, say the one that goes to the panel switch, but on the side of the switch that goes to the plug. The other connection of the clock is connected into the lead from the plug that is unbroken and goes to the mains unit direct.

Moving-Coil Speaker

These connections are easily made by just baring the flex and twisting round and soldering to the bare portion the ends of the flex from the clock. The joins afterwards must be carefully covered with insulating tape.

The loudspeaker we have chosen for use with the set is the Ultra moving-coil, but obviously any other

make of suitable size, and of the permanent-magnet type, can be employed if it is desired to change.

Mains-Unit Rating

The mains unit must be capable of supplying 3 amps. at 4 volts for the heaters of the valves, and an anode current of 30 to 40 milliamps. at a voltage of not less than 200. We have shown in one photograph the Heyberd M.W.1 unit, which will give over 50 m.a. and up to 5 amps. for L.T.

As the load on the unit will not be approaching its maximum, the voltage will rise above 200, and so we must apply an additional load across the maximum H.T. and H.T. negative terminals. This can conveniently take the form of a resistance of about 7,000 ohms, which will load

SHOWING THE COILS WITH "CANS" REMOVED

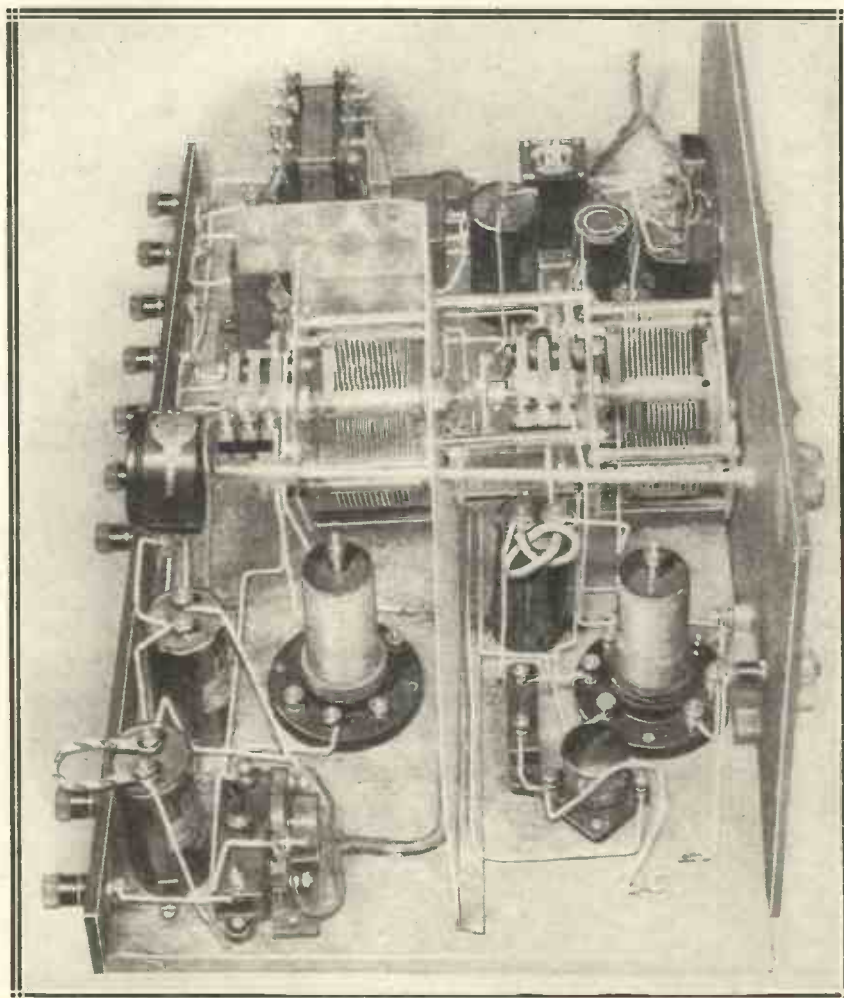

This photograph was taken from the aerial end of the receiver. The two coils can be seen in the foreground with their "cans" removed. That nearer the panel is the intermediate coil, while the other is the aerial tuning inductance.

Here is the Receiver in Its Finished State

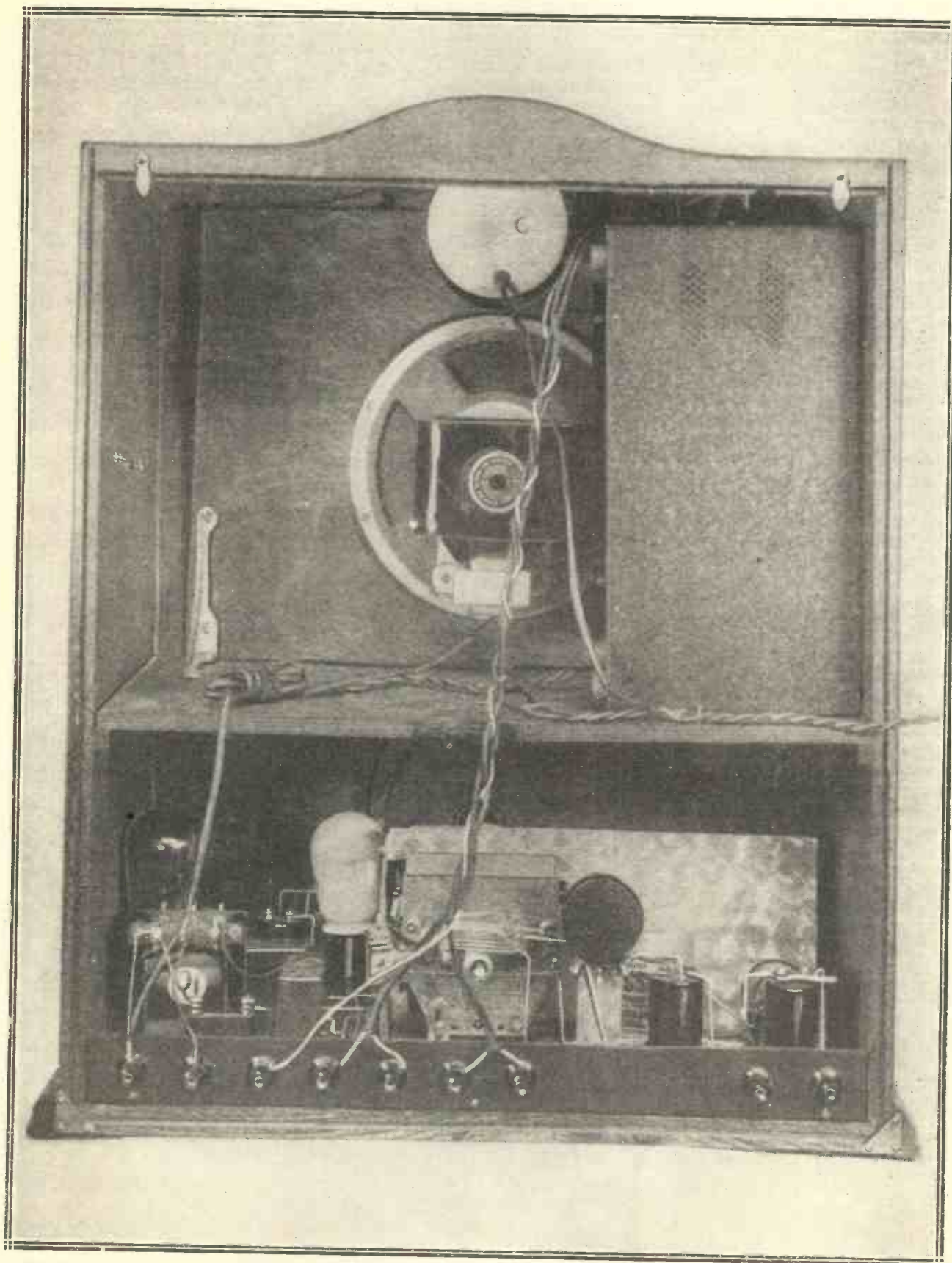

This photograph, with the back of the cabinet removed, shows very clearly the disposition of the various items. At the bottom is the set itself; above is the loudspeaker, with the mains unit to its right, and immediately above the speaker can be seen the case of the electric clock.

It Employs an S.G.-Det.-and-Pentode Combination

the unit sufficiently to keep the voltage down to a safe limit. This resistance must be capable of carrying 30 milliamps., such as the Colvern Colverstat.

There is no need to place any extra load on the L.T. side of the unit, but you will probably think that to use so ambitious a unit is unnecessary.

receiver the unit has to be scrapped and a complete new outfit obtained.

Remember that if you use a metalised S.G. valve the bulb must not come into contact with the screen through which it passes, or the grid-bias resistance will be short-circuited.

the values in the manner described above.

When the set has been constructed, the first test should be carried out with the set out of its cabinet, so that the ganging can be checked up and any adjustments that are required can readily be made.

A Highly Efficient Three-Valve Circuit Arrangement

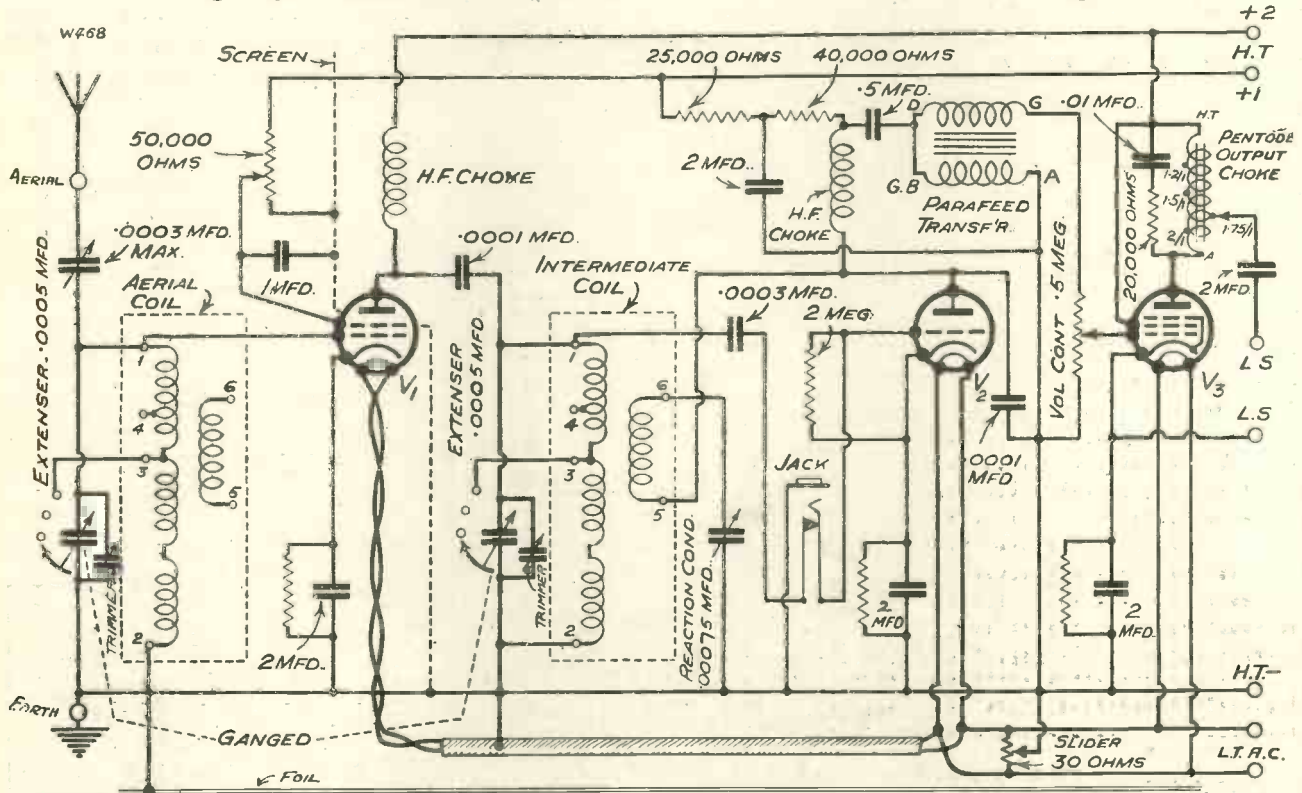

The circuit which is shown in its theoretical form above, aims at getting the maximum possible out of three valves. The first valve is one of the screened-grid type, and works as a high-frequency amplifier. Then follows the detector, and, finally, the output valve, which in this case is a pentode. The set is designed for operation from A.C. mains, the power being supplied by a separate unit.

Actually this is far from the case, because this particular unit is so designed that H.T.— is not permanently connected to the L.T. winding of the transformer, as it should not be for this receiver.

As a matter of fact, ordinary units that just provide the necessary output will not be found to be appreciably cheaper, while there is an added advantage in purchasing the M.W.1 in that one becomes the possessor of a thoroughly reliable unit that has an output capable of supplying practically any type of set that one may construct in the future.

For Future Use

Nothing is more annoying than to find, after buying a unit for a particular set, that on the construction of a larger

So when cutting the hole in the screen bear this point in mind.

G.B. Resistances

We have purposely left out the bias resistance values of the three valves, because they will depend upon the particular types of valves employed. The value can be obtained either from the makers of the valves, or by the simple formula, $R = \frac{E}{C}$; where R is the required value, E is the voltage of bias required, and C is the anode current of the valve.

In our list of accessories the correct bias figures for the various valves mentioned for the three positions are given, so that those who use these types of valves need not work out

With the valves in position, connect up the mains unit with the variable tapping to H.T.+1. In the M.W.1 Heayberd unit there are two other fixed taps besides the maximum, but these are neglected, and H.T.+2 is taken to the full voltage of the unit.

The H.F. volume control will allow easy voltage variation of the screen voltage of the S.G. valve, and the voltage on the detector is not at all critical.

Trimming Tuning

After switching on, tune in a low-wave station (preferably not the local) and trim the two sections of the Extenser by means of the trimmers that have been mounted as shown in the diagram on the fixed vane terminals of the two sections. These are

adjusted to maximum results, and then the set is tuned (still on the medium wave-band) to a station near the top of the scale.

Probably it will be necessary to re-trim here, but this cannot be done with the trimmers, and must be carried out by very carefully adjusting the setting of the two sections of the Extenser.

This sounds a terrible thing to do, but the setting will only have to be altered a minute amount, probably

an almost unnoticeable fraction of the rotation, for the coils are sent out by the makers ready matched, and we have only the stray capacity and inductance of the circuits to account for.

Coupling Adjustments

This adjustment is done by slacking off the screws in the universal coupling between the two sections of the Extenser and slightly rotating one of the sections (preferably the rear one)

while the set is in operation and tuned to a distant transmission.

The tuning is not so sharp that this task is critical, and you need have no fear that the series aerial condenser will upset things, for it has yet to be set. This, in fact, is the next task, and the series condenser should be adjusted to provide the requisite degree of selectivity, and its setting will depend upon the local conditions under which the set is to be used.

Once set the condenser will not

Here Is Your Guide For Wiring Up

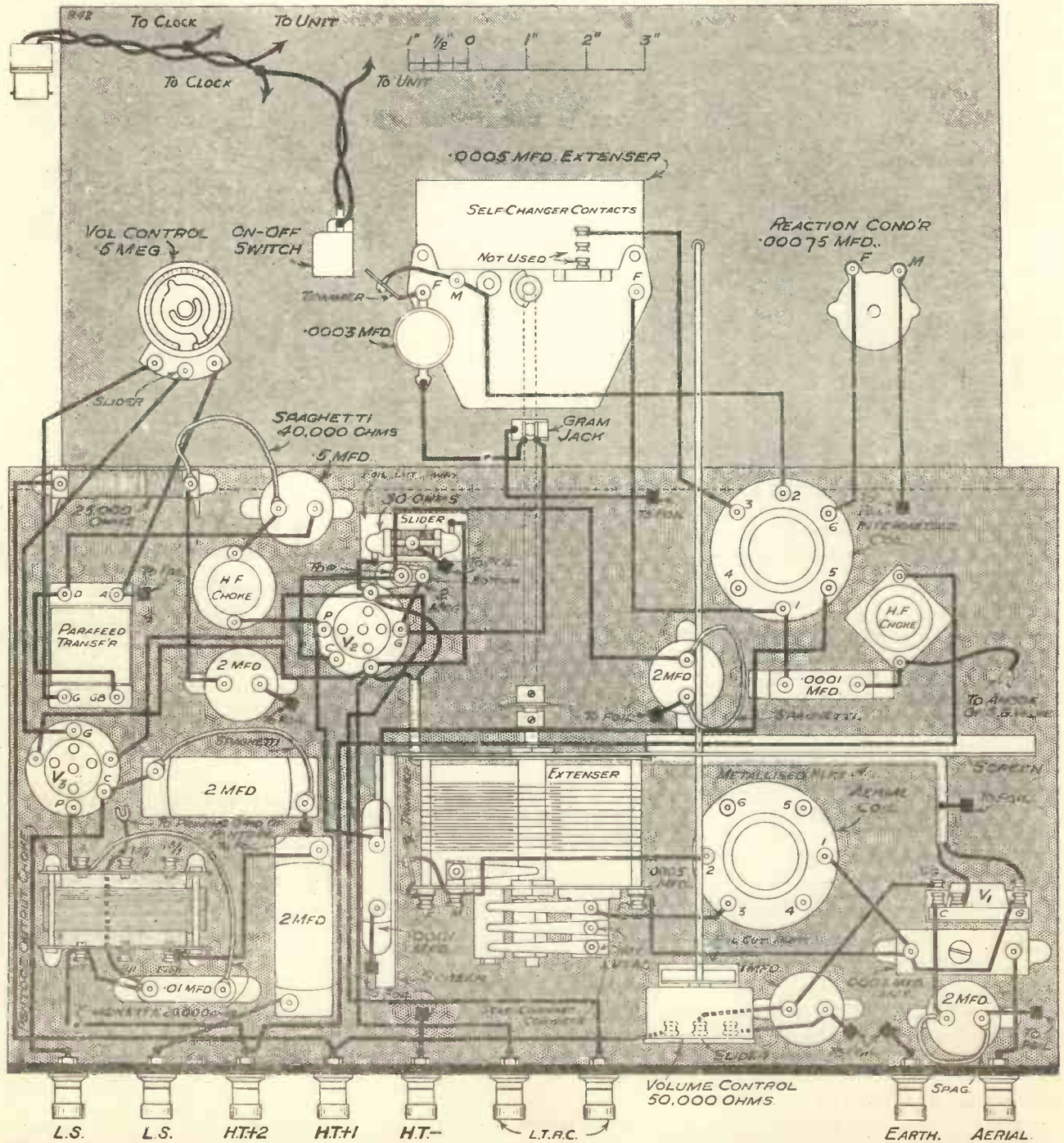

This plan of the receiver is intended as a guide to the layout of the various components, and to the connections for the job of wiring-up. It shows both the panel and baseboard arrangements, the former appearing as though it were bent down level with the baseboard.

There is Provision for a Pick-Up in This Set

have to be altered, and we can finally adjust both the trimmers.

The ganging should now hold reasonably well for both medium and long wave-bands, and the set will be found to be a very easy one to handle, with selectivity quite adequate for all general purposes, and a high degree of sensitivity. It is intended as a household set rather than as an ether-scourer, and so the design is such that maximum ease of operation has been given primary consideration.

As a Radio-Gram

The pick-up is added if required by means of a plug inserted in the jack below the Extenser on the panel, and this simple operation at once converts the receiver into a radio-gramophone.

One word about the loudspeaker. A moving-coil type of speaker is employed, and the mains unit and the speaker all pack into the top part of the cabinet. To avoid boxiness it is advisable to keep the back of the cabinet out, or else to cut a large piece of it away and fill in with gauze to leave the back fairly open.

And now to start the clock, which is fitted just as a tight fit at the top of the speaker fret. This is "on" all the time the set is plugged into the electric light mains (provided the switch to the electric light socket is on) and operates independently the receiver. So with the set off, but the plug in the mains socket and the mains on, remove the metal cover at the back of the clock and give the little spindle without the knob a twist to the left.

Starting the Clock

The hands are set by means of the other spindle in the same way as with an ordinary clock, and thereafter the correct time will be available as long as the mains supply is switched on. Operating the set has absolutely no effect on the clock and the latter has no effect on the receiver.

One word more about the set. In order that the correct electrical centre of the L.T. supply may be found it is necessary that the mains unit be such that the filament winding of the transformer is not centre-tapped, or if it is that this tap be free and not connected to the H.T. negative of the unit. In the "M.W.1" this tap is brought out to a separate terminal, marked E, and in this set that terminal is not used.

Instead, to find the electrical centre

RECOMMENDED ACCESSORIES

Loudspeaker. — Marconiphone, Blue Spot, Celestion, H.M.V., B.T.H., Epoch, Graham Farish, W.B., R. & A., Undy, Cossor.

VALVES AND BIAS RESISTANCES

The following are the required bias resistances for use with a suitable selection of valves.

S.G.: Mazda A.C./S.G., 1,000 ohms; Marconi and Osram M.S.4B., 750 ohms; Mullard S.4V.B., 200 ohms; S.S. 4Y.S.G.A.C., 200 ohms; Cossor 41M.S.G./L.A., 250 ohms; Eta D.W.2, 1,000 ohms; Tungram A.S.4100, 750 ohms; Triotron 124A.C., 750 ohms.

Det.: Mazda A.C./H.L., 600 ohms; Marconi and Osram M.H.4, 750 ohms; Mullard 354V., 1,000 ohms; S.S. 4G.P.A.C., 1,000 ohms; Cossor 41M.H., 1,000 ohms; Eta D.W.4023, 1,000 ohms; Tungram A.R.4100, 1,000 ohms;

Pen.: Mazda A.C./Pen., 350 ohms; Marconi and Osram M.P.T.4, 350 ohms; Mullard Pen.4V., 300 ohms; S.S. 4Pen.A.C., 300 ohms; Cossor M.P./Pen., 400 ohms.

Mains Unit. — See text (Heayberd M.W.1).

the screw on the humdinger is adjusted to the position of minimum hum while the set is in operation, before it is

set where it is intended to be employed on the electric power circuit instead of the lighting supply.

Normally the lighting supply has in its circuit fuses of 5-amp. current-carrying capacity, but the power or heating supply has anything from 5 to 15-amp. fuses. Such fuses are not sufficiently delicate to safeguard the clock mechanism, and so where the set is to be used on the power or heat mains different fuses should be employed.

Plugs with Fuses

This is not as difficult as it sounds, for to use the receiver on such a supply it is obviously necessary only to change the adaptor provided with the mains unit for a two-pin power plug. In this change-over it is simple to use, instead of the usual power plug, the special plug provided by Ferranti for use with their clock, and containing in it two 5-amp. fuses. This at once carries out the required alteration of the unit connection and the safeguarding of the clock. It is not yet certain whether the Ferranti plug will be available in a size to fit 10-15 amp. power sockets;

THE PENTODE OUTPUT STAGE

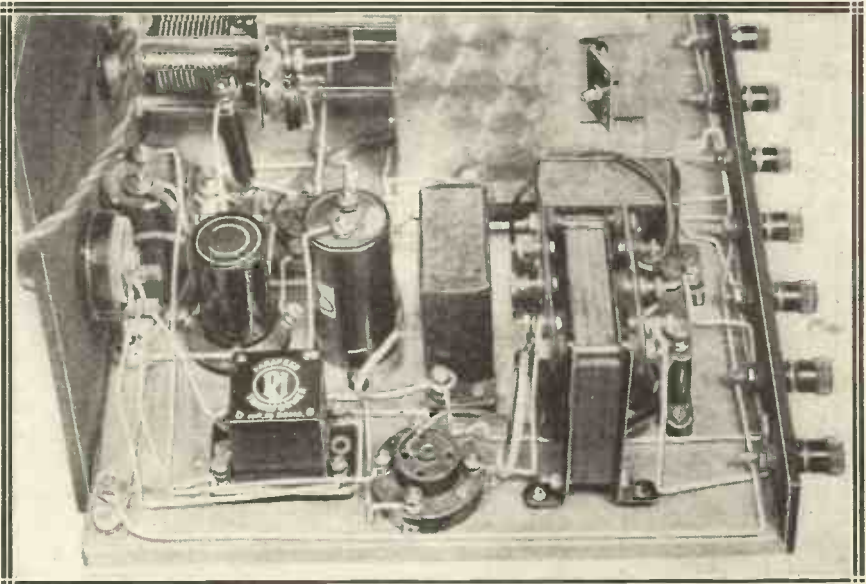

Here you see the L.F. end of the set, with the parallel-fed transformer, last valve holder and pentode output choke all clearly illustrated. The choke, by the way, has several tapings so that the loudspeaker can be properly matched up to the pentode.

finally housed in the cabinet. If you should desire to try a unit that has no such free transformer centre, the humdinger should be omitted.

In conclusion, we would like to say a few words about the use of the

the standard plug is for the 5-amp. size, which has smaller pins and closer spacing, but if not it is a simple matter to use a power-plug adaptor, which can be obtained from any electrician for a few shillings.

A NEW ALL-WAVE SCHEME



How obvious, you may remark WHEN you have read this article, but that in no way detracts from the usefulness and ingenuity of the idea, which makes possible easy tuning on both broadcast and short waves with the same receiver.

Designed and described by W.L.S.

THERE has always been a certain amount of difficulty about producing a set that is really efficient both on the broadcast wavelengths and on the ultra-short waves.

Simplicity Essential

By the words "really efficient" I include the desirable factor of simple operation, for the most effective of sets is not very useful if only an expert can handle it!

The whole trouble has, of course, arisen from the fact that the whole business of tuning nowadays is a compromise. An ideal set would be tuned with a condenser of about .0015 capacity on the long waves, .0005 or perhaps .00075 on the broadcast (medium) band, and .0001, or something even smaller, on the short waves.

This would give reasonably equal spacing between stations on all waves,

TUNING TWO TURNS

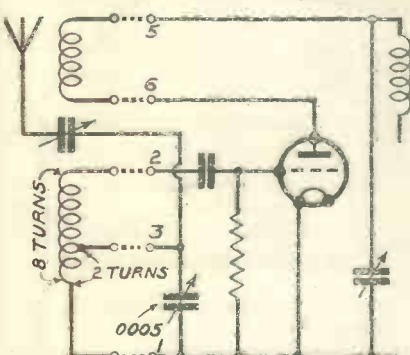

A2609 FIG. 1. SHORT WAVES

On short waves the variable condenser is across only part of the coil, so that its effect is similar to a smaller one across the whole coil.

except for a certain crowding as one got down really low. Everyone knows that we have had to make a compromise, and to standardise .0005 as

the conventional size for a tuning condenser.

Unfortunately, this compromise does not hold good for short-wave work—about which very little was known when the suggestion was first made! Thus a .0005 tuning condenser, which, across our broadcast coil, will cover about 1,000 kc., giving us one station per degree (or something of that order), will cover the full range of 20 to 60 metres (10,000 kc.) when we use it with a short-waver.

"Ironing Out" the Tuning

The most optimistic of us will not admit that it is a nice thing to make our short-wave tuning exactly ten times as difficult as our broadcast-wave tuning, and this has brought us up against a choice between another compromise and a complete breaking-away.

Obviously, we don't want to reduce our .0005 to something smaller unless we are going to use our set for short waves only. If we decide on the latter solution we can, of course, come down to .0001, and our difficulties are almost over. But anything smaller than .0005 is very undesirable if we intend to use the set for broadcast as well.

Various schemes have been propounded from time to time for "ironing out the tuning-range," as the Americans call it. One of the best-known is the use of a small fixed condenser in series with the variable, provision being made to short out the fixed condenser when the set is used for the broadcast waves.

Using Two Condensers

Another arrangement, preferable to the above, but seldom used, is to arrange two variable condensers in parallel. One is the usual .0005 and the other almost as small as you like to make it. Then, for short waves, one sets the .0005 to zero and tunes on the other.

For broadcast the small condenser serves as a useful vernier control. The

chief disadvantage is, of course, the unnecessary expense of installing two separate tuning condensers in the one set, together with the fact that valuable space is also taken up.

The third scheme, of which my own is a modification, was used in one of my sets as far back as 1927, and used

FOR BROADCAST BANDS

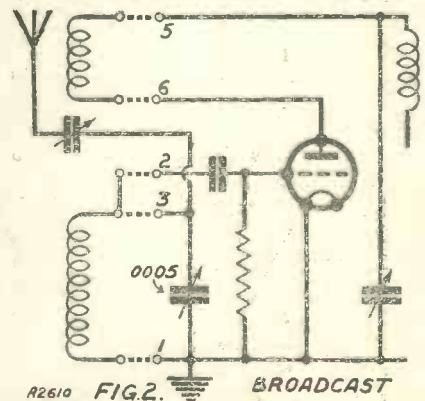

A2610 FIG. 2. BROADCAST

Here you see how the tuning condenser is automatically joined across the whole of the grid coil when the broadcast-band coils are inserted.

the principle of tuning only a small portion of the coil by means of the conventional .0005 capacity. Similar tuning ranges are, of course, given by a .0001 across the whole coil and a .0005 across one-fifth of the coil.

Automatic Change-Over

The only disadvantage to this, in the way in which it was then arranged, was the necessity for "crocodile clips" and the provision for tappings on the coils.

The method by which I am now arranging this does away with switching, and brings the set down to the very simplest form. The condenser automatically goes across the whole coil when the broadcast coil is plugged in, and roughly a quarter of the coil when the short-wave coil is used; the wiring of the coil and base looks after this, and there is no switching whatever to worry about.

(Continued on page 488.)

THE WORLD'S PROGRAMMES

HOW, WHEN AND WHERE TO HEAR THOSE FOREIGNERS



HE DOESN'T LOOK AT THEM! Paul Whiteman, the "King of Jazz," conducting an audition in an American broadcasting studio. He is blindfolded so that the beauty of some of the candidates cannot prejudice him!

CONTENTS OF THIS SPECIAL SUPPLEMENT

- | | |
|--|--------------------------------------|
| Broadcasting a Volcano! | At Sunny Salzburg—Mozart's Home Town |
| Conducted Tours—Some Seaboard Stations | Those Short-Waves |
| The First Radio City | "British Empire Calling" |
| Long-Wave Listening | The Medium Wave-lengths |
| Countries to Listen For—Poland | Station Information |
| Radio for Airmen | What the Distant Stations Are Doing |
| Station Alterations | |

BROADCASTING A VOLCANO!

Some striking photographs of an amazing "O.B." conducted by American radio engineers on the island of Hawaii.

The picture below shows one of the broadcasting engineers engaged in the tricky task of lowering the microphone over the rumbling and boiling pit of lava, so that listeners should hear the big noise.

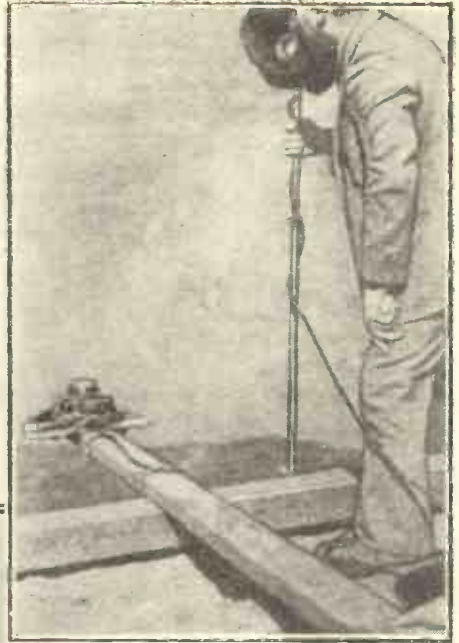

Above is a close-up of the microphone with the commentator describing the scene to listeners.



The spectacular photograph below shows the lake of boiling lava on the summit of the volcano, as seen from the air.

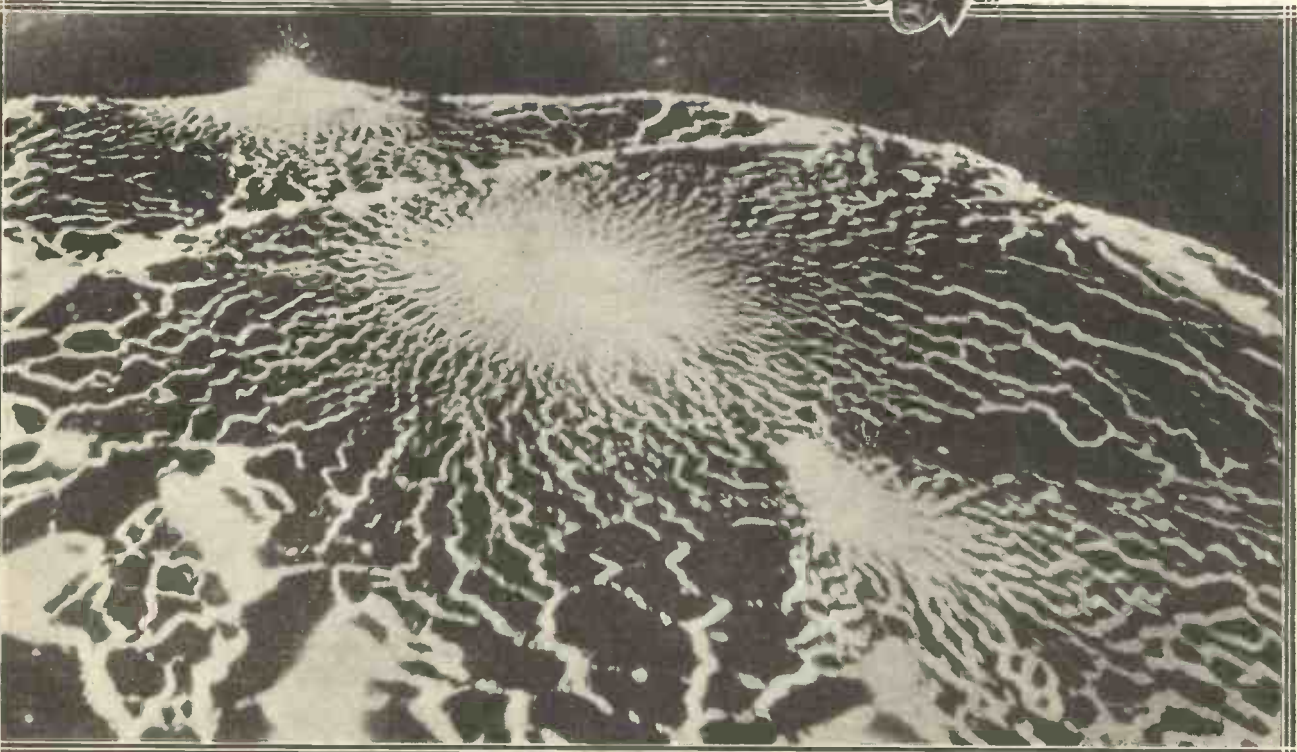
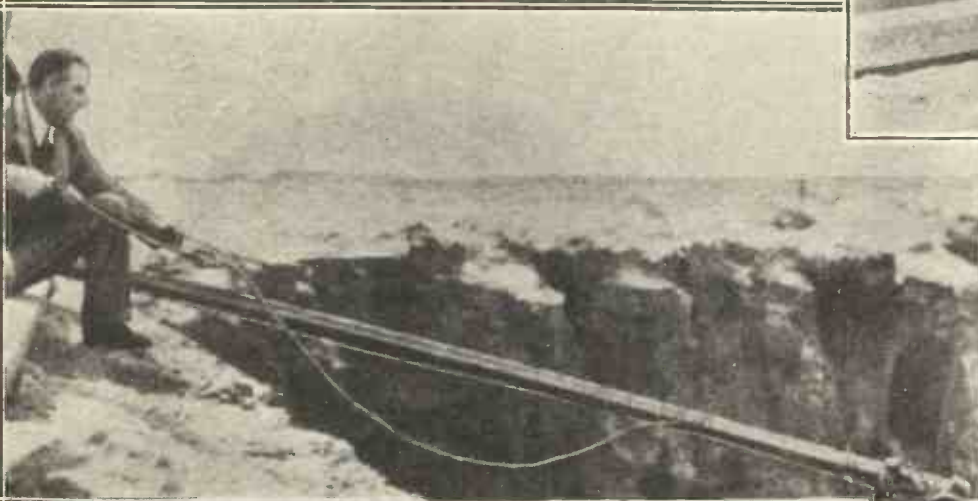

**"MODERN WIRELESS"
CONDUCTED TOURS, No. 2**

**A VISIT TO
SOME SEABOARD STATIONS**

WHEN you tune in some far-off foreign station do you ever visualise its background? When your set takes you over to a place like Barcelona do you ever get a geographical kick out of your journeying?

It is surprising how much more interesting the stations seem if some kind of mental picture is painted in whilst you are tuning in. And as all the Continent is on your doorstep, so to speak, you can visit any part of it in which you are especially interested, jumping the boundaries and ignoring the traditional barriers, paying your calls just when and where you will to the countries of Europe.

As an example, let us suppose you are interested in harbours and coasts, and would like to visit some of the seaboard stations of Europe. Let us try a trip over the Bristol Channel, then over part of the Atlantic and the Bay of Biscay, across to the Mediterranean, over the Adriatic, then through the Dardanelles to the Black Sea. Returning northwards to the Baltic, and finally home by the North Sea.

Our Starting Point

Such a circuit will lead us across England, to Ireland, across France, Spain, and Italy, through the Balkans to Turkey, and right across Central Europe to Northern Germany, whence we return home via Scandinavia. And a convenient starting-point is Cardiff, the great port of Wales.

Cardiff, look you, dates from Roman days, and near where their early fortress stood there is now a great city of over 200,000 inhabitants, with some 200 acres of docks and many magnificent buildings and streets. Just how the Romans found Cardiff we do not know; but listeners will agree that it is not a very easy place to find on a wireless set, unless one happens to live in the West of England.

The reason for this is, of course, that the power is low, being only 1 kw. Cardiff's nearest powerful neighbours are the North Regional and Bordeaux-Lafayette, which are just over 300 metres, and about three or four degrees lower on the dial than the Welsh station, which has a wavelength of 309.9 metres.

**CARDIFF—CORK—BORDEAUX—BARCELONA
—PALERMO—BARI—ISTANBUL—HEILSBERG
—COPENHAGEN.**

The most powerful station just above it, and one which is well received in this country, is Genoa, on 312.8 metres. This wavelength is immediately above Cardiff's, and as there are a Swedish and a Yugoslavian station on the next wavelength below Cardiff, the disentangling of the Cardiff programme from these others is quite a feat for most listeners.

That is one thing that makes these radio tours so interesting—you often find difficulty with the

stations near at hand and get the distant ones quite easily!

If your set is sensitive enough to give you Cardiff from the crowd all around him you will then be able to pass on to Cork, which is the next step. Cork uses a wavelength of 224.4 metres, and comes in right at the bottom of the dial; in fact, some sets will not tune as low as this, in which case the owner will have to do what the Atlantic liners have to do in bad weather—give the Irish port a miss!

But call at Cork if you can; the lady announcer has a charming little brogue of her own, and appears to be losing the extraordinary language complex which led her to announce in incomprehensibilities instead of in English.

Cork, by the way, is a city of some 77,000 souls (mostly cheery), with a dream of a harbour. Both Cromwell and Marlborough had to capture it, at odd times, and it still dreams of the strenuous days of old when there was always plenty of trouble without the trouble of looking for it!

Now just a twist of the dials to a couple of degrees or so below Cardiff and we find Bordeaux, the great French port of the Bay of Biscay. The wavelength is 304 metres, and the station is on more or less continuously from just before noon till 9 p.m. or after.

The full name of the station is "Bordeaux-Lafayette," and this is announced frequently and clearly. Announcements of its Paris relays can also be heard frequently.

A Picturesque Port

With a population of well over a quarter of a million, Bordeaux is the fourth port of France. When the German invasion threatened Paris in 1914 it was to Bordeaux that the French Government migrated—they had had to do exactly the same in the war of 1870!

As the centre of the wine trade, Bordeaux is a picturesque port with a homely air, due to its situation sixty miles up the River Gironde. In the 13th, 14th, and 15th centuries it belonged to England!

All but the latest ships can lie at the magnificent modern docks of this great Atlantic port, and on one of its main squares are two tall towers that serve as lighthouses. Bordeaux is nothing if not picturesque!

The next step of our radio journey is the short one across the Pyrenees to Barcelona. The wavelength is 340 metres; so listeners do well to wait until the neighbouring Regional has closed down, as the dial reading will be only one degree or so lower.

The second largest city and the chief port of Spain, Barcelona has

ONE OF THE NEW ITALIANS

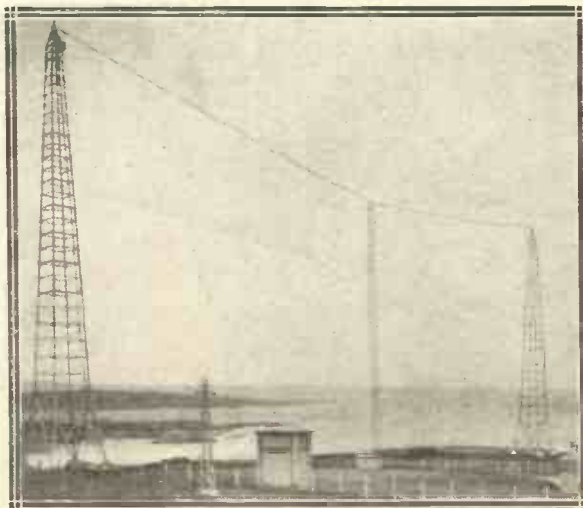

Italy is reorganising her broadcasting service, and our 'tour' this month includes the very latest station, Bari, on the Adriatic. This photograph shows the station at Trieste, also on the Adriatic, and in the heading is a typical scene taken on the shores of this famous sea.

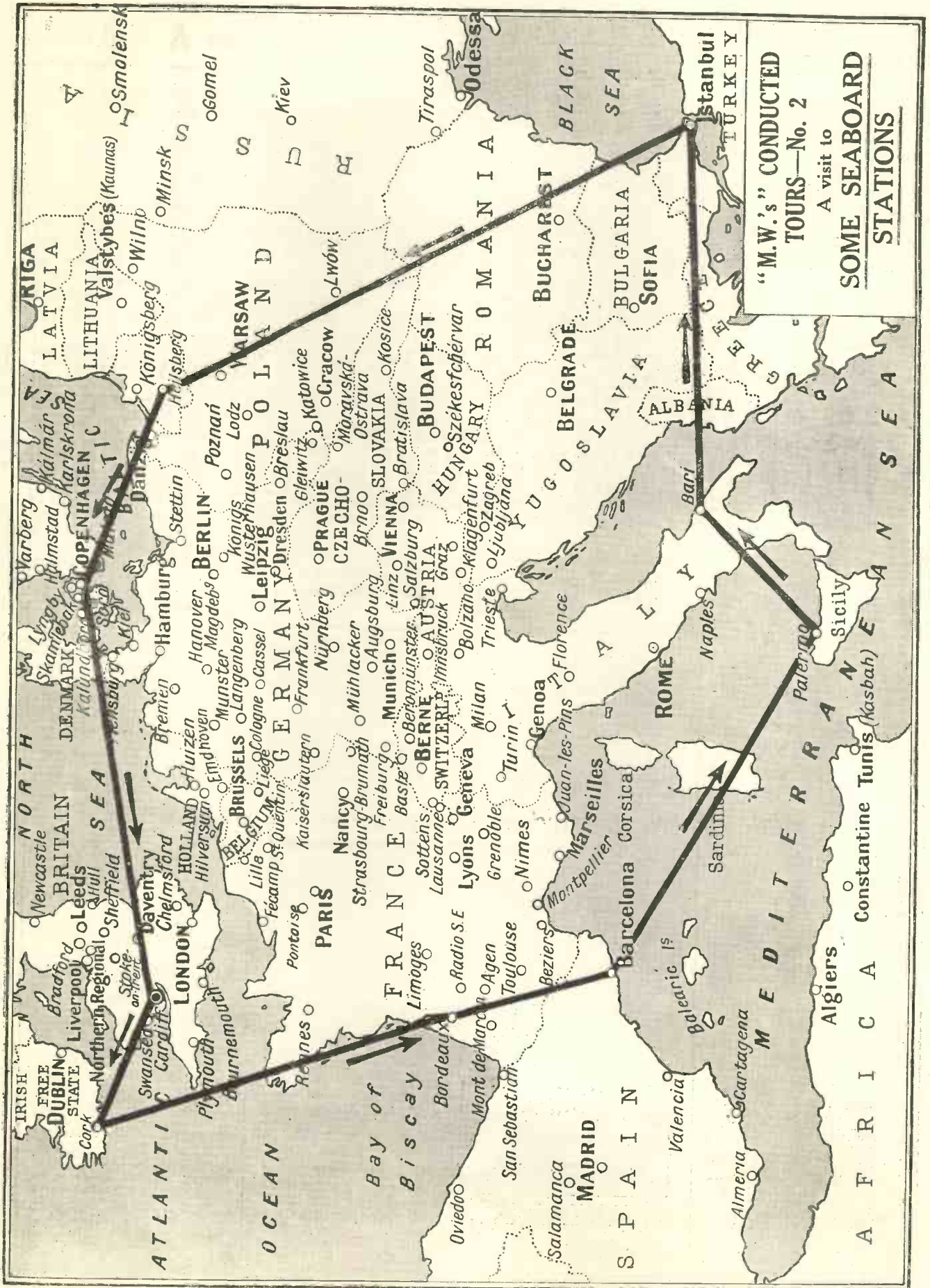

**"M.W.'s" CONDUCTED
TOURS—No. 2**
A visit to
**SOME SEABOARD
STATIONS**

Cities That Were Old Before Britain Was Known!

a population of about 622,000. In its sheltered and picturesque situation on the Mediterranean, it enjoys a fine climate and the reputation of being the pleasantest city of Spain.

It is a port of call for about forty important shipping lines, and its average annual commerce is valued at some £35,000,000. There are large manufactories of silk, cotton and wool, and many other important industries.

Like the surrounding city, the Barcelona radio station is not indolent; and, in fact, it is generally on the air by about 8 a.m., continuing at intervals till about midnight. Lessons in English are regularly featured on Thursdays at 7.30 p.m.

Another Port

We must push on to another attractive Mediterranean port in our next move by tuning to 525.6 metres for Palermo. This is the new Italian station that works on a wave-length between Budapest and Brussels No. 1. (Incidentally, its proper wave-length is 542 metres, but it has—at the time of writing—bagged 525.6 instead!)

The town is gloriously situated on the Bay of Palermo, backed by an amphitheatre of mountains surrounding its fertile plain. It is almost incredibly old, having been founded by the Phœnicians.

The Greeks knew it well, and it became a Carthaginian stronghold that was seized by the Romans about 250 years before Christ was born. The Saracens owned it once, and so once did the Normans.

The Palermo of to-day has a population of about 310,000. Its radio programmes go out more or less continuously from about noon till approximately 10 p.m. A clear-voiced lady announcer pronounces "Radio-Palermo" very distinctly, so when you hear her you can picture yourself as being in about mid-Mediterranean. And our next hop is north-eastwards, to Bari, on the Adriatic.

As a matter of fact, this is going to be an adventurous hop, for, at the time of writing, Bari, the newest Italian Regional, is not on

the air! However, it is due by the beginning of May, if it has not started at the end of April, and thus it has all the lure of the unknown.

Like Palermo, Bari is one of the new Italian broadcasting stations called for by the progressive radio policy of Mussolini.

Linked with Rome

Its wave-length will be in the neighbourhood of 281 metres—between the dial-readings of Hellsberg and Hilversum—and the power will be the very respectable one of twenty kilowatts.

As Palermo, with a mere three kilowatts, has been getting over quite well, Bari should be a comparatively big noise. Remember that for programmes it will be linked with Rome and Naples, and thus "Radio-Roma-Napoli," the frequently heard announcement from these stations, will be heard as "Radio-Roma-Napoli-Bari" instead.

Although Bari is not a name familiar to English ears, the town is of considerable size with a population of about 110,000. It was an important place in Greek and Roman times, when it was known as Barium.

Really Distant

The Normans, those inveterate investigators of other people's property, captured Bari in 1071, and the Norman castle is now used, appropriately perhaps, as a prison. Among the mixed exports of the city are pianofortes, organs, olive oil, almonds, furniture, and playing cards!

In case Bari should prove to be an easy capture by radio, another rather problematical and picturesque stage has been planned for the next "jump"—to Constantinople; the city which the Turks themselves call "Stambul," or "Istanbul."

To get there by radio needs a good set, and a change to long waves. For the wave-length of Istanbul is 1,200 metres, and its power is much lower than that of Reykjavik, the Iclander with whom it shares a wave-length.

For most people the easiest way of searching for Istanbul is to remember that it is about 1 degree higher than Kulundborg's wave-length. And that it can be identified by its bi-lingual announcements—Turkish and French—and by a quick-ringing gong, striking 77 times to the minute.

The announcer calls "Ici Radio-Stamboul"; and as the local time is two hours ahead of Greenwich the station closes down rather early. It is, moreover, not at all strong, because the distance from London is well over 1,500 miles, and the power is of the order of a mere 5 kw.

Thus only a powerful set is likely to pick up Istanbul, although the writer remembers getting it strongly on one occasion with a battery-run S.G., Det. and L.F. in daylight. This was certainly something of a fluke!

Delightful Situation

The city itself is situated in a truly delightful position on the famous Golden Horn, one of the finest natural harbours in the world, leading from the Bosphorus and Sea of Marmora. With easy access to the Black Sea and to the Mediterranean, there is no wonder that Constantinople is a flourishing cosmopolitan centre of unusually varied and colourful aspect.

It is easily the biggest city we have touched so far—the population is certainly over a million, and probably nearer 1,250,000. And, as there are about 800 mosques, the minarets and towers give the old city a graceful and often beautiful outline.

Historically, Constantinople is of the greatest interest, but our space is limited, and we must leave the Eastern capital for a journey northwards to the Baltic.

What is the best way to visit the Baltic shores by radio?

A Good Relay

Some sets will be able to tune in one of the Swedish stations, such as Malmo, or Karlskrona, which are actually on the Baltic, while others

will more easily pick up Konigsberg, the German Baltic station on 217 metres. But the nearest that most receivers will be able to do is to receive the high-powered relay of Konigsberg, namely Hellsberg, on 276.5 metres.

This is one of Europe's best-known stations, located a little above the London National, and below the British relays. Hellsberg itself is a small and unimportant place, but Konigsberg, its broadcasting "father," is the capital of East Prussia, with a population of nearly a quarter of a million.

It is a town of great historical interest, and as recently as the Great War it was in ferment, for the Russians almost reached it in 1914. Kant, the great philosopher, died and was buried here in 1804.

From East Prussia we can return home via Scandinavia—either by Copenhagen itself, or by its long-wave relay, Kalundborg. Copenhagen works on 281 metres, and is thus only three stations above Hellsberg on the tuning dial, the intervening stations being Bratislava, and Radio-Liege, a small Belgian station.

Popular Station

On nearly all sets Kalundborg, the long-wave relay of Copenhagen, will be easier, this station being well known and situated a few degrees above the Oslo wave-length. The announcements are common to both the Danish stations, and are usually given as "Kalundborg-Copenhagen."

When Kalundborg gets its promised increase in power it will certainly be a highly popular station, for even now it is singularly well received in this country, probably on account of the fact that it has a fine aerial system situated right at the water's edge.

It is thus particularly appropriate to act as our last port of call in a visit to some of Europe's seaboard stations—a visit that has shown what an amazing diversity of life lies behind those clustering programmes.

One of the Broadcasting Stations on the Baltic

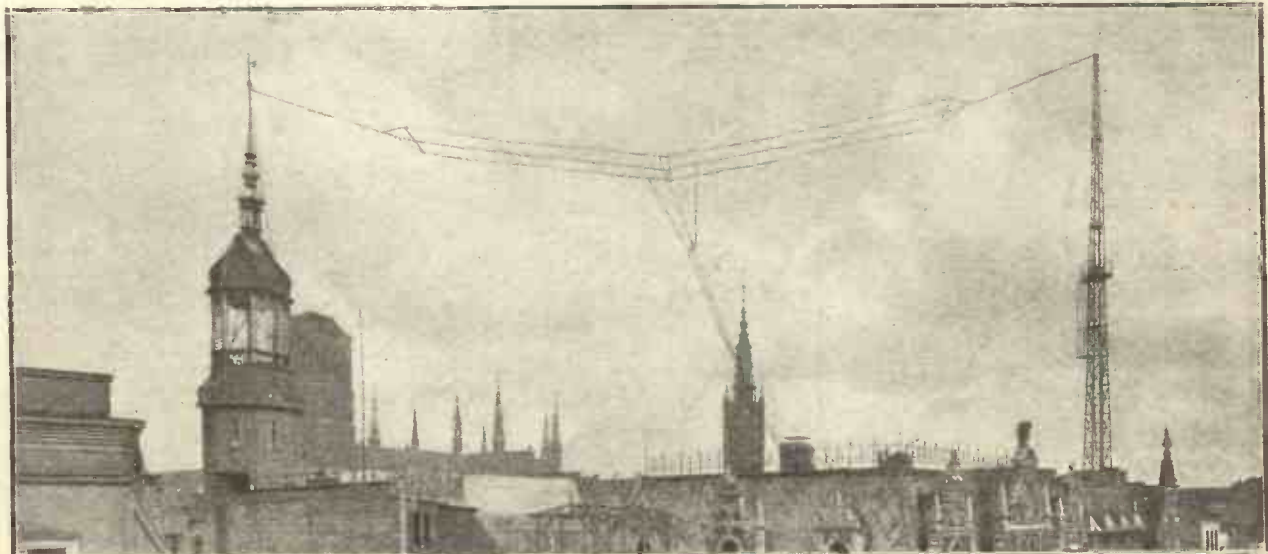

This picture shows the broadcasting aerial of the Free Town of Danzig, which acts as a relay of the Konigsberg programmes, mentioned above. Danzig works on rather low power on a wave-length of 453.2 metres.

MORE VIEWS OF THE FIRST RADIO CITY

*The great home of New
York's Radio and Tele-
vision interests*

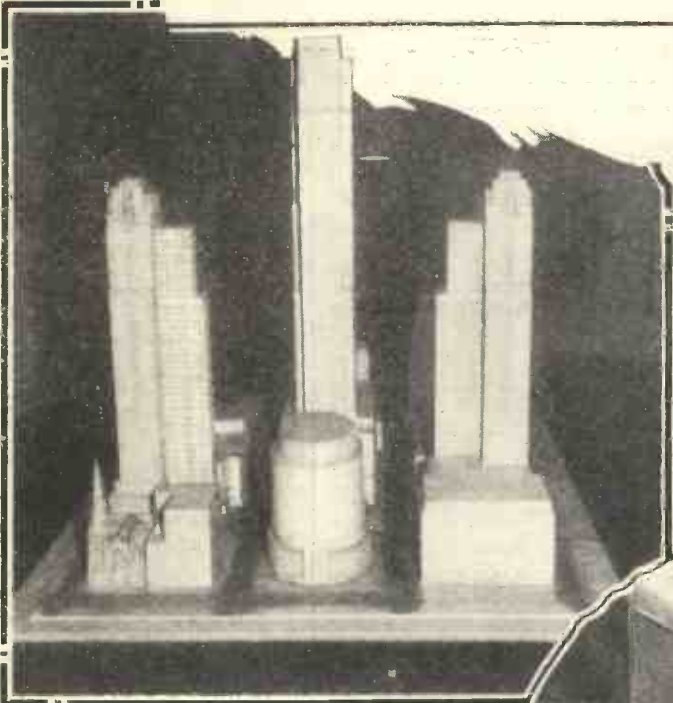

HOW IT WILL LOOK

The picture above is a plaster model of the architect's conception of the completed Radio City as it will appear when the \$50,000,000 contracts are completed. Some idea of the towering and impressive height of the skyscrapers can be obtained by noting the "tall" church spire, which will be left in position on the left-hand corner of the site.

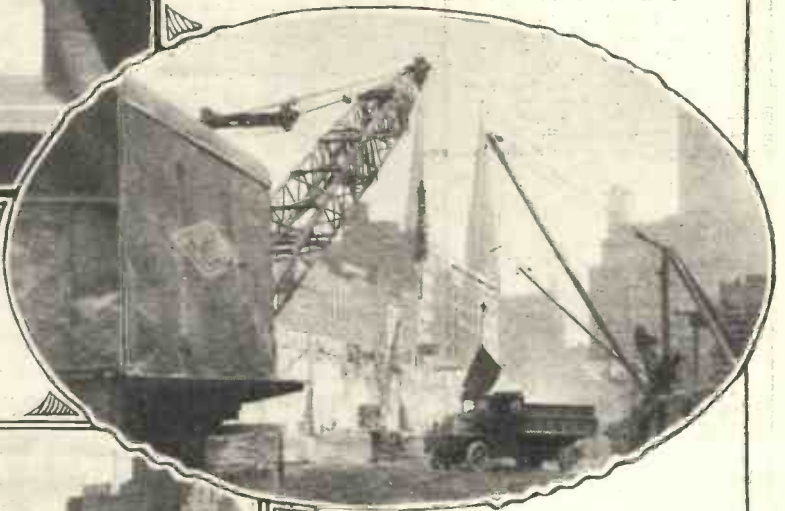

BELOW THE STREET LEVEL

As one of the skyscrapers is going to rise to 68 storeys the foundations have got to go down to solid rock!

Above are seen some of the steam shovels and cranes, working many feet below the street level.



EXCAVATION EXTRA-ORDINARY!

Above and to the right are more views of the great excavations now in full swing for the foundations of the world's largest amusement centre. Located between Fifth and Sixth Avenues, and Forty-eight and Fifty-first Streets, the group of buildings will include three giant skyscrapers, and embody several theatres, as well as the broadcasting headquarters. They will take three years to complete—even at New York speed!





LONG-WAVE LISTENING

Some practical details of recent reception from stations working on wave-lengths above 1,000 metres.

for those who wish to hear their pro-

grammes in Morse. easy to receive, works longer hours, and gives better programmes than ever before.

DURING the past few weeks reception on the long waves has been of the all-quiet-and-humdrum variety, and if there has been nothing very pleasing to brag about there has certainly been nothing very displeasing to grumble at. Apart from a few bursts of atmospherics, especially noticeable during the stormy period following Easter, the long-wave band is standing up to the encroachment of spring very well.

grammes in Morse.

The reports received from different parts of the country indicate that Radio-Paris is now putting out a very satisfactory transmission, and has settled down with the new transmitter to give consistent service. It is probable that more listeners tune to 1,725 metres than to any other foreign wave-

Variable Reception

The Scandinavian stations have been interesting, and have introduced an air of unexpectedness into the search on long waves. On some nights Motala would come over like the local, while a couple of nights later hardly a trace of it could be heard. Oslo, too, has been switch-backing in strength, with surprisingly rapid ups and downs.

One curious feature which has been commented upon is that if you tune to, say, Motala, and find he is coming over well, it is most improbable that he will let you down in listening to him for an hour or so. And yet on the next night it may be almost impossible to get good reception.

DESIGNED FOR D.X.

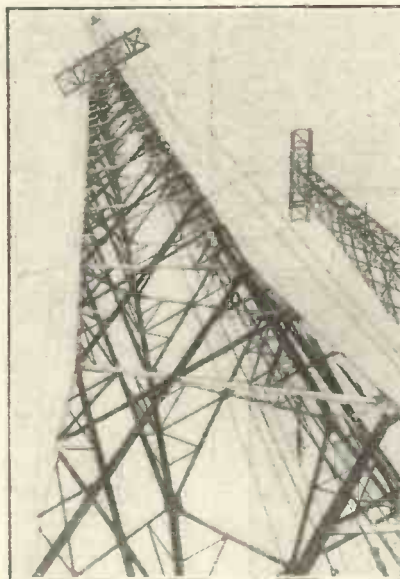

This rather unusual picture shows two of the special type masts used at Nauen, Germany, to support the aerials for work with America.

In connection with the Soviet radio plan, mention has already been made in these columns of the new Russian broadcasting stations, and for the listener on long waves there has been evidence of increasing activities here. Both the Moscow Trades Union and the Leningrad transmissions have been unusually powerful or unusually lucky—the effect being far better reception in England than was to be expected from past performances of these stations.

Several New Russians

In addition, a number of new heterodynes and strange carrier-waves suggest that the Soviet radio campaign is going forward in good style.

Right at the top of the wave-band, near Huizen, a total stranger has been butting in, which is presumably one of the new Russians. And in addition to the actual broadcasting stations I understand a number of telegraphics are in contemplation, so there should be plenty of links with Russia very soon

length on the long waves, and it is certain that ever since the old days, when this station was known as "Radiola," its programmes have been very high in the regard of the British listener to foreign stations.

Under the new conditions it is

It is expected that before the improvements are effected to our own Daventry long-waver, the Danes will have increased the power of Kalundborg. When this happens there should be a great increase of interest in this station, which already is greatly favoured on account of its lively and good musical programmes.

A Disappointing Station

Of the other long-wavers, Warsaw maintains its remarkably good degree of strength and quality, coming next to Eiffel Tower as an excellent alternative. The most disappointing station has been Königswusterhausen, which now seems completely overshadowed by Daventry, and far, far more difficult to get than the equivalent-power Germans on the medium wave-lengths.

Countries to Listen For— POLAND

Some details of the great country that lies on the east side of Germany, and of the excellent broadcasting service which it has installed.

THE great country of Poland, over 240,000 sq. miles in extent, is a republic that was created by the Peace Conference at the close of the Great War. It has a population of about 30 millions.

Poland is almost entirely an inland state, though a short strip of it extends northwards to terminate on the coast of the Baltic Sea—the famous "Danzig Corridor." To the west of it lies Germany, and to the east, East Prussia, which is thus cut off from the rest of Germany by the Corridor.

Nearby Countries

On the north, Poland is bordered by Lithuania (as well as by East Prussia), to the east by the Soviet Republics, while to the south are Roumania, and Czechoslovakia, with Germany in the south-west and west. Prior to 1914, Poland had been partitioned up amongst some of these powerful neighbours, and did not exist as a separate country; but it had had a long and glorious history as a separate entity before that took place.

The Polish language is of Slavonic origin, and although it looks difficult on paper, being full of sz's, rz's, ps's and similar difficult-looking consonants, it is really a distinctly pleasing language, as anyone may judge by listening to the Polish stations.

A Romantic City

The chief town and present capital is Warsaw. It lies in the heart of the country that has always been Poland, but from the 14th to the 16th centuries the capital was Cracow, in Little Poland.

The language, literature and music of Poland has survived conquest and partition, and to-day they are knitted together more closely than ever before by radio.

For Poland has a first-class broadcasting system.

This is distributed from six points, namely, Wilno, Poznan, Warsaw, Katowice, Cracow and Lwow. Of these stations, Wilno and Lwow are well over 1,000 miles from London. Warsaw is a little less than this.

Katowice, placed roughly centrally between the others, is some 835 miles, and on its wave-length of 408 metres, a little above the Midland Regional, it stands out as one of Europe's best-known medium-wave stations.

From a broadcasting point of view, the easiest way to get to Poland is to tune to the long waves and adjust for 1,411 metres, which is immediately below Eiffel Tower and a little above Motala, Sweden. Here you will find Europe's most powerful long-wave broadcasting station, Warsaw No. 1.

British Built

The Warsaw transmitter which was built at the Marconi works at Chelmsford, England, put out its first programmes in the second week of January, 1931, and in the short time which has elapsed since then it has become one of the most famous and well-liked stations in Europe.

Its power, five times as great as Daventry, 5 X X, was at that time in excess of any other broadcasting station in the world. The fact that Warsaw No. 1 gives crystal reception over the whole of Poland—which, with its great forest areas, is not a particularly easy country for broadcasting—will indicate the high efficiency of Poland's central broadcasting station.

On a sensitive set this station is powerful enough to come over quite well in daylight, and a good time to tune for it is just before 11 a.m., which, incidentally, is mid-day in Warsaw. At this hour



The towns having broadcasting stations are shown in the heavier type.

Warsaw sends out a time signal, followed by the letter W in Morse (---) and by the famous bugle call from Cracow.

This bugle call—which suddenly breaks off in the middle—commemorates the death of a bugler who was killed by the enemy while giving the alarm, and it is one of the most interesting interval signals in the whole of Europe.

Another interesting feature of the 11 a.m. transmission from Warsaw is the fact that a part of the signal is repeated at intervals on a rising scale, and as the notes get higher and higher they afford a very good test for high-note response of your receiver. The Polish musical programmes are first-rate in quality, and the Saturday evening concerts by the Philharmonic Orchestra, generally about 7 p.m., are of special interest.

The piano music, especially that composed by Chopin and commemorating the troubled history of Poland, is another noteworthy feature of the transmissions.

With its chequered history, its beautiful music, its triumphant return to the map of Europe, its ambitious and successful broadcasting network, Poland is certainly one of the most interesting countries in the whole of Europe.

on an aerodrome which is unknown to him, or if (as happens fairly frequently in a heavy fog) it be a forced landing on an open field, there are obvious and ugly possibilities in such a tremendous landing speed.

Broadcast Warnings

The radio services from meteorological stations and from airports have greatly mitigated the fog danger by warning the pilot of fog banks, thus enabling him to avoid them in many cases, either by circumventing them or by rising above them. But this service does not enable the aviator to dispel the dangers of fog when he is actually in the midst of it.

The present invention attempts to eliminate the dangers by means of an ultra-short-wave apparatus. Preliminary tests have proved successful, and the Luftansa is only waiting for the final report of the German experimental station for aviation before adapting the system to its planes on the various air routes.

"POLSKIE RADIO"



When you hear a man's voice announcing the above from Warsaw you can be fairly sure you are listening to Mr. Tadensz Bochenski.

THE VOICE FROM POLAND

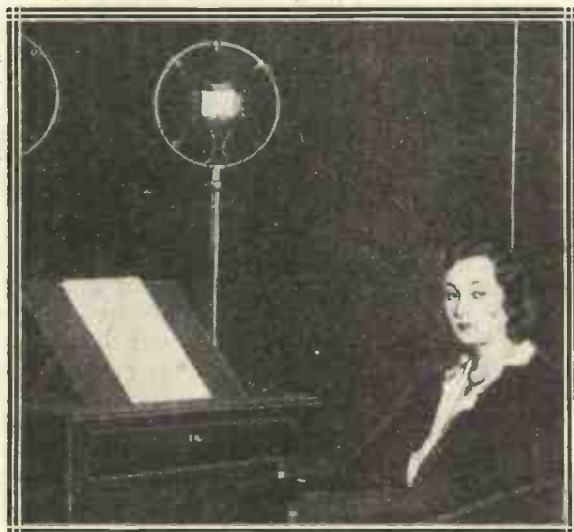

You can hear this charming young lady on 1,411 metres, where she announces the Warsaw programmes with great clearness, introducing her station to listeners as "Varshova." At home she is Mrs. Janina Sztompka-Grabowska.

RADIO AID FOR ARMEN

Simplifying Landing in Fog.

THE German experimental aviation station is now testing a new radio apparatus by means of which it is hoped to avert the dangers now attendant upon every aeroplane which attempts to land in a fog. The device is based upon an ultra-short-wave transmitter with an automatic recording instrument attached.

Fog is notoriously the airman's most dangerous and insidious foe, particularly during the process of landing. It must be remembered that the landing speed of the average plane is from 50 to 60 miles per hour.

If the landing takes place in an aerodrome familiar to the pilot, the position is not so bad. But if it be



NEWCASTLE. It is probable that Newcastle will take a wave-length of about 210 metres before or when the Scottish National service is inaugurated.

W 3 X A U recently attempted an O.B. from a train travelling at over sixty miles per hour.

BEROMUNSTER is arranging a May broadcast to commemorate the opening of the famous St. Gothard Tunnel fifty years ago.

INDIA. The Government has made an official announcement that it will itself carry on the broadcasting service, which had been threatened with extinction.

HAMBURG purchased a short-wave transmitter last December, and is using it for relaying running commentaries in connection with sporting events, etc.

RADIO SCHAERBEEK, the Belgian station which appealed against a fine and confiscation imposed upon it by the courts, has now withdrawn the appeal.

BRESLAU. This station, which has been coming through well on its present 1.5 kilowatts, is eventually to increase its power to 60 kw.

LONDON. Experiments are now being conducted with a new type of microphone, called the Edison microphone.

LENINGRAD. The State Opera Theatre is to broadcast more opera. Certain of the German stations have already picked up Leningrad and relayed the programmes to German listeners.

BROADCASTING HOUSE. The big change-over from Savoy Hill to Portland Place, which started officially during the last week in March, will continue this month.

STATION ALTERATIONS

Items of interest about the world's broadcasting stations, the increases in power, and particulars of new services, and so forth, chronicled for the benefit of long-distance listeners.

LEIPZIG. The new high-power station is scheduled to be on the air for first tests by next June.

LILLE (France) is to follow the example of Poste Parisien, and install a high-power transmitter.

MADRID. The great Conference on Radio is to be held from September to December, 1932.

VIENNA. The proposed increase of power to 100 kw. will not raise Vienna to the same status as Prague and Warsaw, which each employ 120 kw.

RABAT. The Moroccan station recently increased its power from 2.5 to 6 kw.

POSTE PARISIEN recently enlarged its announcing staff by engaging M. Laporte, who was one of "Radiola's" original announcers.

RADIO VATICAN. The opening call of this station is "Laudatur Jesu Christus."

TOULOUSE has engaged several professors for a new series of language talks, including English.

AMSTERDAM is holding an International "Sound and



FALKIRK. Tests from the new Regional on 376.4 metres will probably be radiated about the time these words appear in print.

CSEPEL. The powerful new Hungarian station is now due on the air (on 211 metres), and should shortly be using its full power.

THE SCOTTISH NATIONAL, which will be "faded-in" for service when the new Scottish Regional has properly settled down, will at first use a wave-length of 288.5 metres.

PLYMOUTH. Like Bournemouth, this station relies on the wireless link from Davenport 5 X X for all its "morning" transmissions, i.e. those up to 2.30 p.m.

RADIO NATIONS. The new League of Nations equipment at Prangins includes two powerful short-wave transmitters—one French and one British, the latter having a power of 20 kw.

LJUBLJANA. Listeners in South America have recently been amazed to tune in this famous Yugo-Slavian on 574.7 metres.

REYKJAVIK. Iceland's long-waver has been getting over better of late. Its time is one hour behind Greenwich.

THE JUNE "M.W."

Don't forget to order your next month's "M.W." It will be on sale June 1st, and will contain another "World's Programmes" supplement specially compiled for the long-distance listener.

MILAN'S new station will be of the same rating as the B.B.C. Regionals—50 kw.

MOSCOW can often be heard in the small hours, sending a programme out for the benefit of its night-workers.

BAKU. A new Soviet station has been opened at Baku, on 1,715 metres.

LISBON. Portugal is contemplating a Government-owned broadcasting station to work with a power of about 20 kw.

Picture" exhibition from May 6th to May 16th, representative of radio and allied interests.

(Particulars can be obtained from Heerengracht 581, Amsterdam.)

ABERDEEN. There is no intention of withdrawing this transmitter when Falkirk's two services are in operation, as the area it serves is outside the service range of the latter.



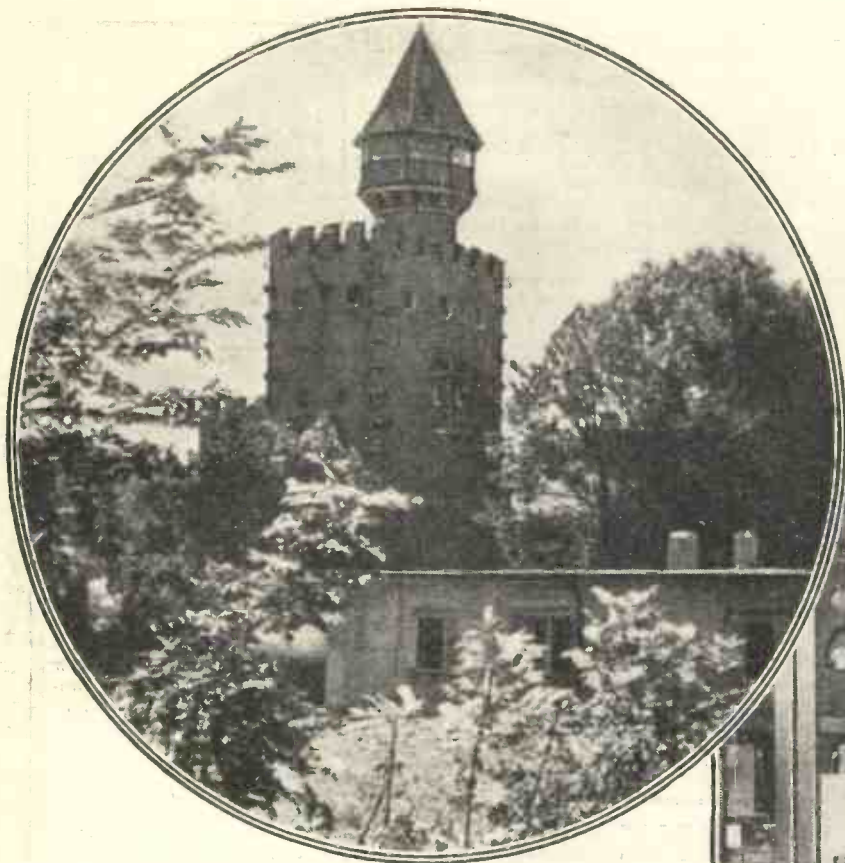

AT SUNNY SALZBURG

Surely there are few broadcasting stations situated so picturesquely as Salzburg, part of which is shown in the foreground of the picture above. Another view of the station is given below, and to the right is a close-up of one of the transmitting panels.

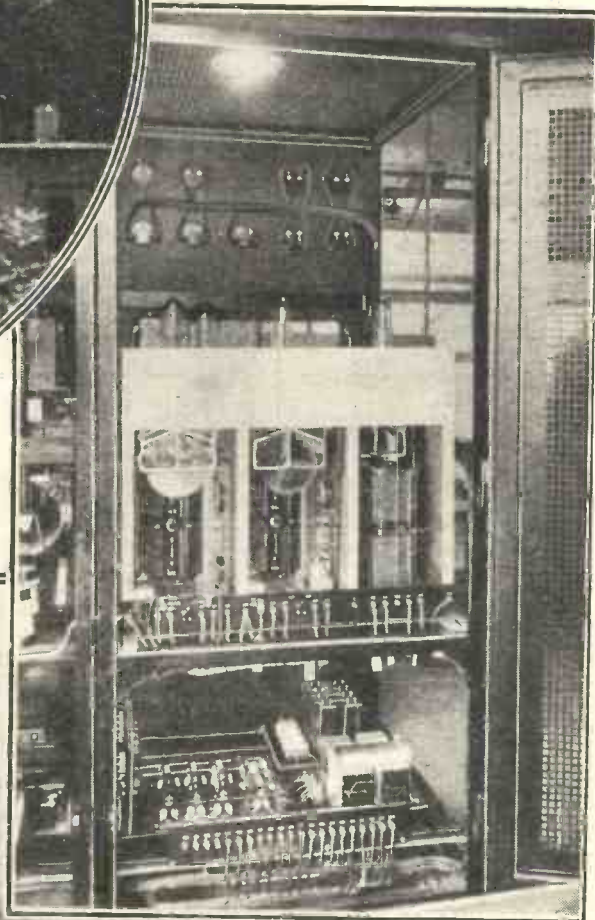



IN MOZART'S HOME TOWN

BUSINESS in Vienna prevented me from seeing the broadcasting station there. But, from a radio point of view, the visit was not entirely unfruitful. I managed to get a promise from a "Radio Wien" official that when in Salzburg I should be allowed over the transmitter.

"That's a relay station?" I inquired.

"Yes," said the Vienna man, "the Salzburg station is connected by telephone cable with the studio here. When you get to Salzburg you will be able to see what our relay arrangements are."

After a week's delay I did manage to get to Salzburg, and lost no time in getting over to the west side to see the station.

Relays Vienna

Salzburg is only one of the five stations which take the Vienna programme, and to me, as a British listener, it is hard to see why, considering the fact that Vienna's power at the moment is 20 kilowatts, so many relay stations should be needed to put out the same programme. The other relays are at Graz, Linz, Innsbruck, and Klagenfurt.

There was difficulty in getting a wave-length for Salzburg when it opened on December 21st, over two years ago. The Vienna man had told me that.

The relay works on 218 metres, and it is a common wave-length with Flensburg. Graz, of course, has a

A visit to Salzburg by Our Special Correspondent, who describes Vienna's way of relaying its programmes over the country.

wave-length of its own, 352 metres, and adheres to it remarkably well. The average error over a month's working is only 0.3 kilocycle.

Dodging Interference

Salzburg's error is much greater than this, and the reason is that the engineers have had difficulty in getting a free transmission space in the ether.

In the previous month, for instance, Salzburg remained dead on its wave-length for seven days, but afterwards had to shift up and down, always keeping slightly above the common wave-length of 218 metres in order to be free of interference.

The station is in most picturesque surroundings, being under the shadow of one of the many old towers which are a feature of Mozart's birthplace. It is a little one-storey affair of reinforced concrete and is even smaller than the B.B.C. Tatsfield listening station.

Almost Amateurish

Inside most of the space is taken up by the transmitter panels, which look for all the world like those of an American amateur's transmitting station. The apparatus is on rather

more ambitious lines than is owned by the average British amateur transmitter, but as the output power is only just over half a kilowatt it does not make a very big show.

The panels are enclosed in a metal framework with safety locks at the back so that as the gates are opened the power is switched off. All the power comes from the local supply lines, and is rectified by a separate bank of valves.

For a small relay station the gear is unusually compact. Each panel carries five separate racks, the valves being at the top and the coupling and smoothing condensers below.

The master oscillator drive is enclosed in a separate metal box at the extreme left-hand side of one of the panels, so that there is no chance of any feedback from one of the earlier valves.

Crystal Control

The wave-length is kept constant by a quartz crystal, and this, too, is enclosed in the metal box. I was shown the crystal stage, and the engineer made a great point of the fact that one of the reasons why Salzburg always keeps on its wave-length is that the crystal and valve of the master control are connected through a special trap circuit to the first valve of the actual transmitter.

The idea of this is, that if the frequency of the last valve of the transmitter changes at all—if the aerial sways, or if there is any variation

Salzburg's Wave-length is Controlled by a Crystal

in the power lines—it cannot react back on to the drive valve.

All the valves are lit from the A.C. supply and special precautions are taken to prevent the H.T. supply of the first valve after the crystal varying.

There is one complete panel devoted to the modulating gear, and this is coupled up at an early stage in the transmitter — almost immediately after the crystal drive. The other valves in the transmitter are ordinary high-frequency amplifiers.

Air-Cooled Valves

Not one of them is water-cooled, for the power is too low. The coils are about 6 in. in diameter, and are wound on light ebonite supports with little tapings, so that it is a matter of only about five minutes to choose new tapings, put in a new crystal, retune the drive, and alter Salzburg's wave-length.

There is, of course, a long land-line back to the Vienna studios. There is no studio at Salzburg. Ordinary telephone lines are used, and I saw the filter circuit at the Salzburg end, which is used to make up for a loss of bass over the long lines.

A permanent-magnet speaker is connected to the first stage of the amplifier which deals with the studio programme on the incoming line, and on the automatic telephone the station operator has a private line through to the studio so that he can give the signals on the indicator board.

I saw the station started up for a late afternoon programme. It had been in use all day, and the Vienna programme on that particular day had started at 8.20 in the morning.

An Easy Starter!

It took only three minutes to get the whole station going; a big difference from the B.B.C. Regional station, where they have to get in readiness

bourhood. The aerial is quite a short one, and there is a vertical lead-in from the flat roof of the station building.

Mental comparison with the Newcastle relay station, which I saw a year ago, is in favour of the B.B.C. gear, at least as far as constancy of wave-length goes. Crystal control is all very well in a big commercial station, but an ordinary master oscillator—as the B.B.C. uses for its relays—is more reliable and automatic for relays. At least, that is how it strikes me.

A RADIO ROOM AT CHARTERHOUSE SCHOOL

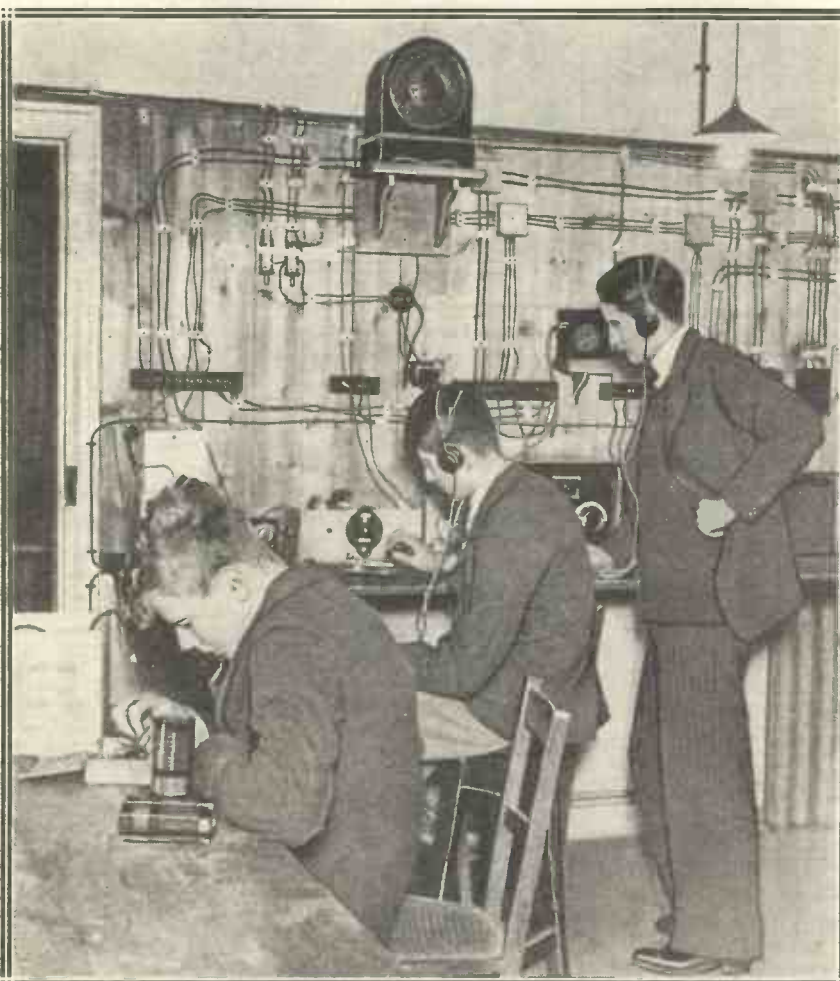

This is a scene in the famous public school near Godalming, where facilities for radio instruction are given in connection with the O.T.C. The boys also experiment with their own "unofficial" sets.

Patent Difficulties

I asked if they had tried tuning-fork drive, but there appear to be patent difficulties. The man at Salzburg had never been to England, but he had heard all about our fork-controlled relays, and from the Brussels wave-length he knew of, and marvelled at, their rigid adherence to our National common wave-length, 288.5 metres.

The reason why Graz, Linz and the rest don't share common wave-lengths is that they are too close. There would—at least, so they think—be "fringe" wave-length changes which would

about half an hour before the programme begins!

Badly Screened

Salzburg was chosen as the site for the station because of the huge population in and around the city. My private opinion is that it is not giving the relay a chance, because of the trees and big buildings in the neigh-

bourhood.

cause sideband distortion. If they could devise some scheme whereby a common wave could be used, other stations would benefit considerably. Our own relays have the advantage that their tuning-fork synchronising gear enables them to "keep station" with far greater accuracy than with any crystal-controlled arrangement.

THOSE SHORT-WAVES



Have you ever wondered just *why* short waves are able to cover such spectacular long distances? Here is an interesting and easy-to-understand account of their adventurous journeys, by W.L.S., "M.W.'s" famous short-wave expert.

PROBABLY 50 per cent of the readers who glance at this article know quite well that signals from untold distances may be received on the short waves with the help of quite a simple receiver, but are just content to accept it as some queer sort of magic and leave it at that. Certainly there is no reason why one should bother one's head about the technicalities, any more than one need know all about radio to be able to enjoy a symphony concert or a vaudeville programme.

But it is always interesting to know, for these waves (below, say, 100 metres) behave in quite a different manner from the longer broadcast waves.

The chief difference is that when they leave the transmitting aerial a great proportion of them are sent off upwards into the ether at an angle varying between 15 and 60 degrees to the horizontal.

Two Separate Radiations

If you imagine this state of affairs you will see at once that these waves are not going to be much use to anyone fairly close by; they will pass well over their heads. The remainder of the transmitted power spreads out in the same manner as it does on the longer wave-lengths, but owing to certain properties of short waves it is absorbed very quickly. It doesn't reach, very often, to a distance of more than 20 miles or so on wave-lengths of 20 or 30 metres.

It is this property that explains at once the long-distance reception that is possible, thanks to our good friend the Heaviside layer. We most of us believe this to exist—although there are some diehards that don't—in the form of a stratum in the upper atmosphere, at heights varying between 50 and 200 miles.

Our short waves that have been "lost" after leaving the transmitting aerial proceed straight

ahead until they meet this layer, when two things happen to them. Some of them penetrate into it, are refracted (or "bent") and come out again, while others are probably reflected from the surface. They then simply proceed in their new direction until they come down to earth again.

Reflected Back to Earth

As the "refracted" portion emerges in the form of a broad beam, it spreads still farther, with the result that it does not arrive back on the earth's surface at one isolated spot, but over a fairly wide region.

Thus between the place where the direct ray fades out—owing to the absorption mentioned—and the place where the reflected beam arrives back, there is a "dead" region in which that particular transmitter cannot be heard at all.

To complicate matters still further, the Heaviside layer is constantly changing. Its height varies with the time of day and the angle at which the sun shines on the particular part that is treating our signals; it also varies with the condition of the sun—sunspots cause a marked variation in short-wave reception conditions; and it probably changes constantly with the movement of the earth round its orbit.

Thus the distant spot at which our given signal produces the greatest effect may be shifting about from day to day, accounting for the strange "dull periods" that every short-wave man knows all about.

Comparison with Medium Waves

On the broadcast waves, of course, it is the direct ray that does most of the work, and we have the fairly safe rule that signals weaken off as one moves the receiver away from the transmitter. Even that, however, is not invariable, as we come across locations at which certain stations come in exceptionally well.

Generally speaking, however, reception conditions for powerful broadcasting stations on the short waves remain about the same for at least a hundred square miles or so, unless one is troubled with local absorption.

The same effect that wipes out the direct ray before it has travelled far from the transmitter may easily do similar things to the reflected ray after it has come back to earth. Steel-frame buildings, gasometers, overhead cables, all have undesirable effects upon short-wave signals.

One factor that has not yet been mentioned is the wave-length used. Waves of different length penetrate the Heaviside layer to different depths, just as the component parts of sunlight are separated by passing through a prism. Thus the region in which the transmitted wave appears again on the earth is governed by the wave-length used.

The general rule is that the shorter waves "skip" over a greater distance; 80-metre transmissions are

heard quite well at 200 miles, 40-metre at 500 miles, 20-metre at 2,000 miles, but 10-metre often do not "come down" again at all. The 10-metre transmissions probably penetrate right into the Heaviside layer, and may even emerge on the other side!

The Seven-Metre Band

Seven-metre transmissions have a particular interest for us just now, and these probably do the same, so that it is the fairly restricted direct ray that will be of use to us for 7-metre broadcast reception.

If we ever find out where these "lost" transmissions eventually do go, we may have to alter the title of this section of "M.W." to "The Universe's Programmes"!

"BRITISH EMPIRE CALLING"

How to find and recognise the far-flung stations of the Empire is the subject dealt with in this extremely practical article for the possessor of a short-wave set.

THE growth of short-wave broadcasting during the past year or so has resulted, in the year 1932, in a wonderfully comprehensive list of regular programmes from all parts of the world.

No one but the regular listener with plenty of time on his hands realises just how many different countries there are "on the air." The writer recently compiled a list—from his own receiver and other sources—of all the British Empire stations that the average short-wave listener can hope to tune in, and in the hope that it is of interest to readers most of the information is related herewith.

The best-known of all the Empire stations is Sydney (VK 2 ME), on 31.28 metres. He is on at all sorts of times, but he can, as a rule, be regularly counted on for the following: Saturday nights, 8 p.m. to 10 p.m.; Sunday mornings, midnight till 4 a.m.; and every morning from 4.30 to 7.30 a.m.

Australian Stations

Immediately above him is the lesser-known Melbourne (VK 3 ME), on 31.55 metres. He should be heard just after midnight on Wednesdays and Saturdays. Sydney, by the way, also works on 28.5 metres and 37.8 metres; he comes over well on the former wave, but is seldom heard on the latter.

Another Australian that appears in the lists, but one that is seldom heard, is Melbourne (VK 3 UZ), on 34 metres.

Turning now to Canada, we have quite a list of transmitters, most of which have been reported in this country at some time or another, and all of which are definitely "in action." The highest in wave-length is London (Canada), VE 9 BY, on 62.56 metres. Coming down a little we find Drummondville (VE 9 DR), on 49.96, and sometimes Winnipeg (VE 9 CL), on 48.5.

A little lower still there is London (VE 9 BY), again on 46.67 metres.

The same station works on yet a third wave, 34.68 metres.

On 25.6 metres—next door to G 5 SW, on the upper side—we have Winnipeg (VE 9 JR); and a little lower, on 25.43 metres, there is Bowmanville (VE 9 GW).

Africa is represented by Johannesburg and Nairobi (V Q 7 LO), both in the neighbourhood of 49 metres. Both stations have recently been coming over well during the evenings, starting as early as 7 p.m.

This completes the list of "legitimate" broadcasting stations, but there are, in addition, the following commercial telephony stations, which generally handle traffic but may occasionally be heard testing.

The Longest DX

Starting "at the top," we have V RT (Hamilton, Bermuda), on 59.42 metres. There is Rugby (G B S), on 42.9 and 32.5, and G A (Drummondville, Canada), on 32.1. Hamilton works again on 29.8, and Wellington, New Zealand (Z L W), on 27.3. The latter station is interesting, as representing the longest DX that you will ever tune in from this world!

Below 30 metres the Rugby stations (G B S, G B U, G B W, and G B X) may be heard on all sorts of different wave-lengths, working either with the States or some part of the Empire.

Finally, we must mention the British ships. Those most often heard are the Majestic (G F W V), the Olympic (G L S Q), the Homeric (G D L J), and the Belgenland (G M J Q). They work on 33.95 metres, 22.68 metres, and 17.05 metres.

If one includes the amateurs, they provide another 3,000 or so of "assorted Empire stations." Countries strongly represented are South Africa, Canada, Australia, New Zealand. There are also small groups in Malaya, Hong Kong, India, British West Indies, Iraq, and Egypt.

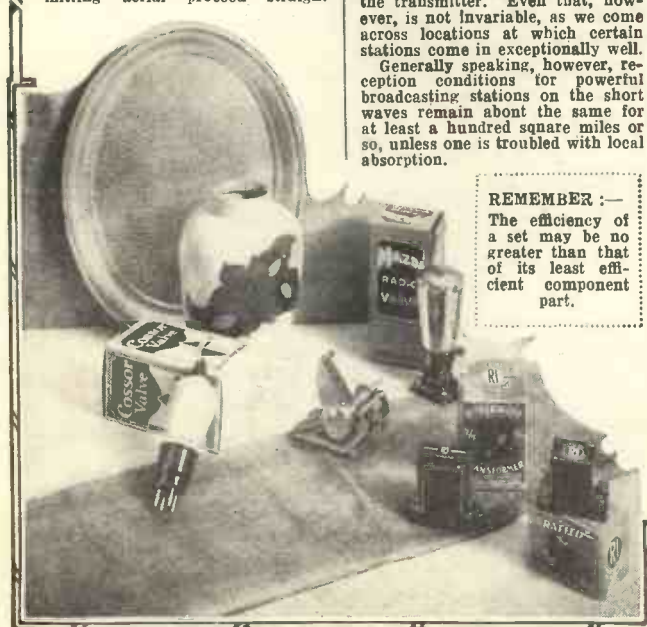

REMEMBER:—
The efficiency of a set may be no greater than that of its least efficient component part.



WORKING ON THE MEDIUM WAVE-LENGTHS

Some topical notes on reception conditions and on the outstanding stations between 250 and 550 metres.

Higher Power and Daylight Results—Rome's Decline—Fall-off of some of the Favourites—The new Poste-Parisien, etc.



IN spite of what the calendar says about the progress of 1932, good long-distance results on the medium waves are still easily obtained.

Good Results in Daylight

With a sensitive set there is still no need at all to wait for dark, and a careful combing of the dials will soon provide an alternative or alternatives, probably from as far afield as Toulouse, Heilsberg, Trieste or one of the other Italians. And it seems quite on the cards that such daylight reception of medium waves will be possible to some extent right through the summer.

There is no doubt that the general increase in power of the European broadcasting stations is going to be a great blessing in the summer, whatever it may have been in the winter. On the dark nights, when even low-powered stations come over well, there may have been a certain amount of resentment at the punch behind Prague or some such powerful South-East Europe transmitter. But in the brighter weather, when there is a constant muttering of atmospheric and only comparatively weak reception, a few extra kilowatts at the transmitter make all the difference to the foreign listener.

On the other side of the picture we have to record several stations who have distinctly fallen from grace, so far as British reception is concerned. One very noticeable example is Rome (441 metres), and, to a lesser degree,

Toulouse (385 metres) comes in the same category.

Beromunster, on 459 metres, is another foreigner which does not seem to be putting over anything like the programme strength that obtained several months ago. And several other stations might be mentioned, notably Sottens (403 metres), which has definitely deteriorated according to reports over large areas.

But the decline and fall of Rome, and of these other favourites, tends to emphasise the very high level attained and maintained by the majority of the popular foreign programme-providers.

"RADIO ZAGREB"



The Yugo-Slavian stations are well received in this country, and here is Dr. Stern, one of the "voices" of Radio Zagreb, which works on 307 metres.

A rather curious point raised by one reader is whether the stations tend to fall off singly or in groups? He has noticed that Rome and Beromunster, for instance, on wave-lengths not far apart, fell off at about the same time and failed to supply their usual standard of reliability. While a few weeks before his chart showed that higher up on the tuning dial, round Budapest and Vienna, similar groups of stations with wave-lengths close together began to get weak simultaneously.

Over another period, Berlin Witzleben (419.5 metres), and Katowice, Poland (408 metres), showed a noticeable decline within a few days of each other; and although in the case of Rome and Beromunster there is a rather wide wave-length separation, it does certainly seem as though not only single stations, but certain sections "on the dial," do seem to get weaker at certain times together.

More Power from Post-Parisien

The Post-Parisien station on 328.2 metres is putting up a great show during the test of its new transmitter.

Incidentally, this station is still listed officially as using 1.2 kw. at the time of writing, but judging by the thump with which it arrives, a great deal of power in excess of this is employed for the tests.

Reports in France indicate that the final power of Post-Parisien will be 60 kw., at the Copenhagen rating, which is the same as Stuttgart, Mühlacker, and Heilsberg, Germany, and is in excess of our own Regional stations, which use only 50 kw.

Incidentally, Rome is a 50-kw. station, Langenberg and Beromunster rejoice in 60 kw., while Prague is in a class right by itself with exactly double this amount. The British Regional stations by the way, use 50 k.w.

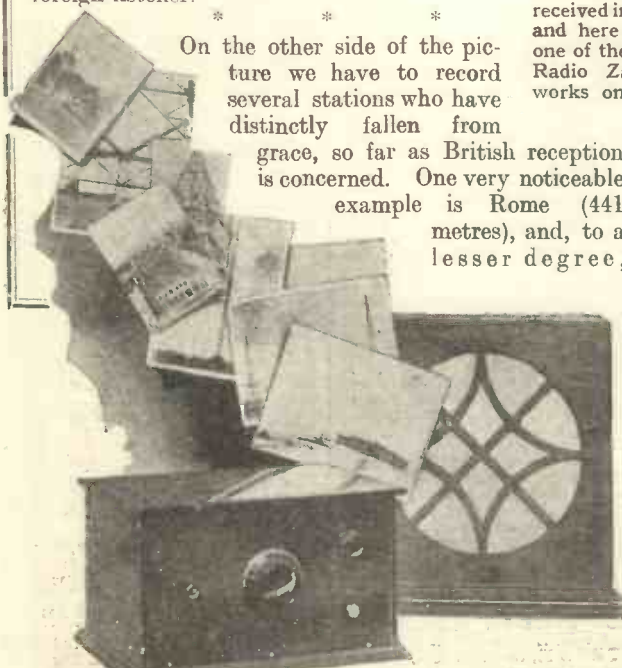



STATION INFORMATION

Items of broadcasting news of interest, from here, there and everywhere.



MOSCOW. There is a Moscow short-wave station on 43.58 metres, as well as the Trades Union relay on 50 metres.

BANGKOK. This station has been testing on 41 metres on Mondays, between 1 and 4 p.m.

KALUNDBORG. The Copenhagen town-hall chimes, formerly relayed at 11.30 p.m., are now usually sent out at 11 p.m., during an interval in the dance music.

FRANKFURT. The present Frankfurt wave-length (390 metres) has provisionally been allotted to the new Leipzig transmitter, soon to be completed.

DAVENTRY. It has been decided to move the whole of the Daventry station to a new site, farther west and closer to Birmingham. This will increase the efficiency of the transmitters and result in a better service to North Wales.

LONDON. The suggestion has been made that the Children's Hour should be dropped, and one advantage claimed for the plan is that the period before 6 p.m. might be a silent one to permit listeners to listen undisturbed to Continental programmes.

HUIZEN. The power of the Dutch long-waver is to be more than trebled in the near future.

HILVERSUM. The projected power-increase at Hilversum is to be a big one—from 8.5 to 50 kilowatts.

RADIO-PARIS. The power of the new Radio-Paris transmitter (Copenhagen rating) is 75 kilowatts.

FECAAMP. The popular Radio Normandie station has recently been using a television transmitter.

W 2 X A B. This famous American station broadcast a television portrait of the Lindbergh baby continuously for four hours and at 15-minute intervals during the main evening programme in the early efforts to trace the kidnapers.

CZECHOSLOVAKIA. Preparations are being made for the provision of a Czech-

closed German relays will be re-erected in Coblenz, owing to the rather poor results obtained there from Langenberg.

W B Z. This famous station at Springfield, Mass., which was lately well received in this country on medium waves, is employing a new transmitter and 100 per cent modulation.

TASHKENT is the name of the new Russian station that was causing interference with Kalundborg.

MIDLAND REGIONAL. The improvements to "5 G B" will bring this station up to the status of the other new Regionals—about 50 kw. to the aerial and a peak modulation of 80 per cent.

LEEDS. The new buried cable (for even frequency response between 50 and 6,500 cycles per second) is now in service to Edinburgh, via Newcastle.

CT 1 A A. The famous Lisbon station has been getting over extremely well on 42.9 metres since he improved his aerial system some weeks ago.

ST. PIERRE and MIQUELON. A broadcasting station is to be installed for the islands of St. Pierre and Miquelon, near Newfoundland, to relay the programmes from Pontoise, the French colonial station.

WESTERGLEN. The Scottish Regional station at Westerglen, near Falkirk, is due for its official public tests about the time that these words appear in print.

THE SCOTTISH REGIONAL. The 376.4-metre wave length is allotted to the Scottish Regional, and 288.5 metres to the Scottish National. The latter will be introduced in August or September, if the present arrangements materialise.

YOUR OVERSEAS FRIEND—

Why not send him "Modern Wireless" every month, to keep him in constant touch with all the latest radio news and developments?

Post his name and address with 17s. to the Subscription Dept., Amalgamated Press, Ltd., Fleetway House, Farringdon Street, E.C.4, and "M.W." will be sent every month for a year.

slovakian national short-wave station.

KALUNDBORG. When the new transmitter comes into operation the old station will be used as a standby for Copenhagen.

AACHEN, the German station which recently closed down, was the German name for what we call Aix-la-Chapelle.

COLOGNE and MUNSTER relay stations were closed on March 21st, in conformity with the German regional scheme.

COBLENZ. It is possible that one of the recently

VOLGA BOATMEN are receiving wireless navigation reports from a new station at Nijni Novgorod. Wave-length, 1,730 metres.

DROITWICH. At the time of writing, tests for a site for the new Daventry station are still proceeding in the Droitwich area.

"5 X X." The B.B.C. has stated officially that the power of the new "5 X X" will be about four times that of the present outfit, and approximately 100 kw. will be delivered to the aerial.

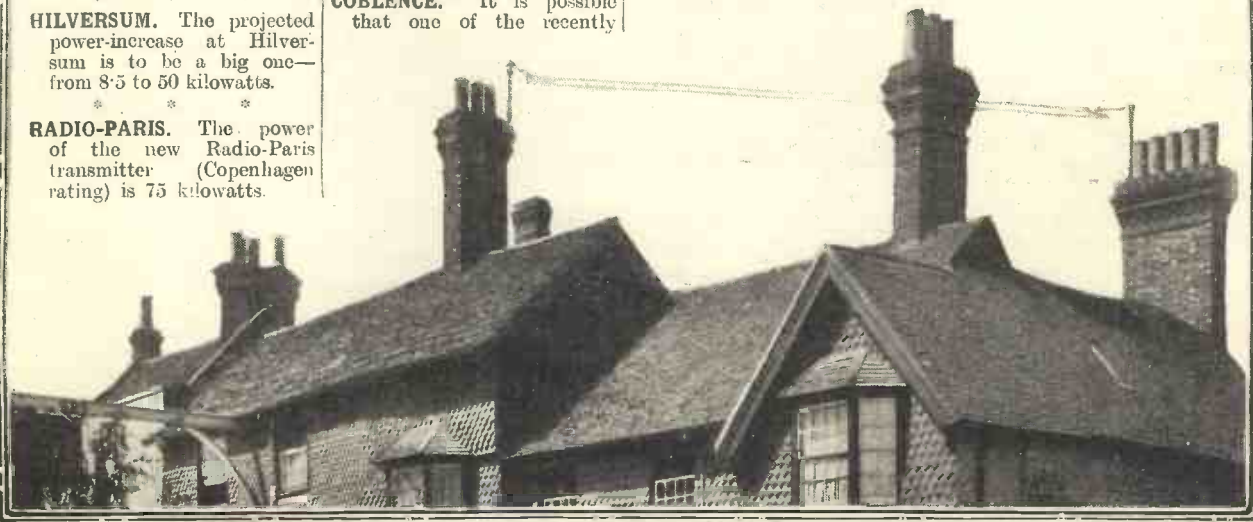

BESIDES logging a fair number of United States stations at reasonable strength, I recently had an experience which I think unusual enough to relate.

I had been working to complete a receiver, and was so absorbed in my work that I completely lost count of time, and consequently when I had completed the receiver and looked at the clock I was mildly startled, for the clock fingers pointed to after 1 a.m. The hour being late, I considered it an excellent opportunity to stay up a little longer and see what fate had in store for me as regards the reception of American stations.

Good Conditions

And so, just before 1.15 a.m., one might have seen me sitting facing my receiver with headphones clamped to my ears and, I expect, the renowned far-away look D.X. fans have when searching. Reception conditions were good.

Within a few moments I was listening to music originating from our old friend WTIC, at Hartford, Connecticut. Another favourite, just below WTIC, the well-known Atlantic City station, WPG, was also coming in extremely well.

Leaving these stations, I turned "up dial" until I came to "rest" upon an obvious American station that was unfortunately jammed by a "spark" transmission which appeared to be working on the exact frequency of the American broadcaster. It did not take me many moments to arrive at the conclusion that it was a sheer waste of time hoping to hear anything through the telegraph transmission.

A Surprise

I was just about to turn away when the code discontinued for a moment or so. Imagine my surprise when during that brief period I heard my own name, followed by the announcement, "... three thousand miles away may be listening to this station now..." emanating from the American station.

I was just able to hear someone exclaim, in true American style, "Geet!" before the telegraphic transmission recommenced. This time it did not discontinue, and so I was not able to discover where the station was located. However, wherever it was, there is no denying it gave me an unexpected thrill!

Tuning away from the now unintelligible jumble, I found several "fat" carriers, and so turned my attention upon resolving the "fat-test." This was easy, and in a few moments I was listening to still another old friend, WABC, New York.

Queer "Music"

There were a fairly large number of other stations coming in well on this occasion, but I was unable to hear the calls from the majority of them. However, WJZ, Boundbrook; WNAO, Boston; and WIOD, Florida were all identified.

LR3, Radio Nacional, Buenos Aires, was the only South American station audible, and strength was such that it had not the slightest entertainment value.

Another night worthy of note was at the end of March, when the D.X. "menu" was comprised almost entirely of Argentine Republic stations!

WHAT THE DISTANT STATIONS ARE DOING

Further notes and news from a long-distance listener's log.

On this occasion (March 28th) I received LR2, Radio Prieto; LR3, Radio Nacional; LR8, Radio Sarmiento (all of Buenos Aires); and LV2, Radio Central, Cardaba; besides other unidentified stations, at remarkable strength.

LR8 came in at the greatest strength, probably owing to the fact that this station employs a shorter wavelength than the others. Tango music, and what I took to be national "music"—I hesitate to call it "music" because it resem-

of reception reports of American stations broadcasting D.X. concerts to convince me that a few details about these concerts in general will be of interest, and probable help, to readers.

D.X. Concerts

These concerts are named "D.X. concerts" owing to the fact that they are broadcast with a view of ascertaining how far the station can be received. These concerts are frequently dedicated to one or

"WAY DOWN SOUTH" AT SLANGKOP



Situated on the Cape of Good Hope, about 50 miles from Cape Town, the famous Slangkop radio station keeps South Africa in touch with the great liners on the Atlantic and Indian Oceans. The towers shown have just been erected to replace the masts.

bled to a very marked degree the weird tunes of African Negroes—were heard at good "phone strength" from this station, a detector and pentode being employed, whilst using a six-valve receiver (2 S.G., det., 1 R.C.C., 1 P. and S.P.) all four stations came in at moderate loudspeaker strength.

Fading Starts

Signal strength was constant until shortly after 3 a.m., when fading set in. By 3.30 a.m. this had become so bad that only short snatches of music could be heard from these stations.

WTIC, Hartford, was the only North American station worth listening to, though there were numerous other U.S. stations audible.

During the recent broadcast, from station WPG, Atlantic City, for the benefit of British listeners, I was unable to use my receiver and, consequently, unable to hear the transmission. However, I have many reports of reception of this programme, which would show that it was received at good strength over almost the whole of the British Isles.

Besides reports of the above concert I have a sufficient number

of other radio society or club, or even a foreign country—an instance being the recent broadcast over WPG.

In the majority of instances stations taking part in these programmes are situated upon a wavelength also occupied by other stations. The obvious result is that the range of the station is seriously restricted. To ascertain how far their station can be heard—for advertisement and other reasons—the owner, or owners, of the station organise these concerts, which are broadcast in most instances after midnight, as by that time the other stations sharing the wavelength will most probably have closed down.

Listeners are invited to send in reports of reception, a verification card or stamp being promised to them, whilst in some instances the stations offer prizes to those receiving the broadcasts farthest from the transmitter. These broadcasts are heard in Great Britain around 5 to 6 a.m.

Low Power Data

As one may imagine, these broadcasts result in much interesting information being obtained as regards the range of low-powered

transmitters. It has, for instance, been ascertained that stations with the absurdly low power of 10 watts can be heard as far as one thousand miles from the transmitter.

One should, however, bear in mind that nine-valve receivers are the "order of the day" in America; 100-watt stations can be received fairly regularly across the American continent, whilst they are occasionally received in Great Britain, a fact that I can personally vouch for, as during the remarkable season of 1930 I received WGBB, Freeport, New York; WJAC, Johnstown, Pa.; WHBY, Green Bay, Wisc.; and WWRW, Woodside, at fair strength. (To the incredulous I would add that I have verifications!)

There are hundreds of stations broadcasting these D.X. concerts, and so I intend to content myself with a few details regarding a very small number of them which employ a power exceeding 100 watts.

At Glace Bay, Nova Scotia, we find the popular marine and fisheries station, VAS, broadcasts special programmes each week for an organisation known as the Radio Listeners' Club of New England. These transmissions are broadcast upon 437.8 metres, with a power of 10,000 watts.

Another Canadian station which also broadcasts special D.X. concerts is the 1,000-watt Hamilton (Ontario) station CKOC. This station works on 475.9 metres.

From U.S.A.

Turning southwards we enter the United States. Here we find, amidst the wheat lands of Dakota, a popular broadcaster, KSOC, in the important city of Sioux Falls. This station has been received in England from time to time, but not so frequently as its partner, WRVA, at Richmond, Va., which frequently "comes across." Both these stations work upon 270.1 metres, KSOC employing a power of 2,000 watts.

We next turn to a less-known station, WCAL, Northfield, Minn. This station is not so fortunate as KSOC, for whereas the latter shares its wavelength with only one station, WCAL has seven partners. WCAL employs 1,000 watts on 239.9 metres.

Leaving the 1,000-watt stations, we turn our attention to two 500-watt stations, KOH, Reno (which I need hardly mention is the city of quick divorces), Nevada, and KQV, Pittsburg, Pa. Both stations work upon 217.3 metres.

Zeesen—along with other German stations—has been providing some interesting relays from America recently. Those desirous of hearing these broadcasts direct will find a Sunday evening with the short-wave receiver extremely interesting.

American Relays

The transmissions are—in most instances—put out from station W-2XBJ, Deal Beach, and can be heard emanating from this station at remarkable strength. This station employs a wavelength round about 30 metres, besides that of 20.49 metres.

W-2XBJ can frequently be heard arranging for the broadcasts with DFC, Nauen, or DJB Zeesen. Both these stations also come in extremely well.

L. W. O.

A RADIO RECKONER

By
W. A. BARCLAY
M.A.



This article is the commencement of a new stage in this extremely fascinating series. In it our contributor discusses ammeters and milliammeters, and gives some very useful N-diagrams for finding shunt values.

U P till now we have been concerned with the "dry bones" of the subject of radio—the essential preliminaries which every wireless amateur must get acquainted with if he is to understand the "hows" and "whys" of his science. Such matters as the impedance of series and parallel circuits—however dry and uninteresting they may be in themselves—are seen to become of vital interest and importance when one thinks of the wide part they play in modern radio practice.

Varying Impedance

For instance, the well-known principle of varying impedance with frequency is universally employed on the H.F. side of receivers, where it appears under the guise of the "tuning system," be it straight, coupled, or even band-pass.

On the L.F. side the identical principle is finding no less important applications in the various methods of "tone-control" which are now being developed with such striking success to correct tonal distortion.

But it is time to leave such general studies, and consider some of the more elementary applications of theory to practical radio apparatus.

Current Measurement

We have dealt at length with Ohm's law, and shown the relation which the potential difference between any two points in a D.C. circuit has to the current flowing between them. The actual amount of current flowing in such a direct circuit may be

measured in many ways, but of these much the most convenient is the use of an ammeter—an instrument with which most readers will be quite familiar. For the benefit of those who are unacquainted with its properties, however, the following remarks may not come amiss.

Current is led to and from the ammeter by means of two main terminals, the amount of current flowing through the instrument being indicated by a movable pointer reading on a fixed scale on which the main current divisions are clearly marked. It is of the greatest importance that the maximum value of current indicated on the scale should never be

exceeded, or damage is likely to result.

To use an ammeter, i.e. to measure the amperes passing in any circuit, the instrument should be placed in series with the circuit. Thus if current is supplied to a resistance from a battery as shown in Fig. 1 (a), the ammeter would be connected as shown in Fig. 1 (b), since it is thus in series with the medium conveying the current.

"It's Not Done"

To connect it directly across the battery would be to court disaster, and a burnt-out ammeter. It is important to remember this, especially as, if the voltage of the battery is desired, the normal procedure is to place a voltmeter across its terminals.

Many a beginner has thought it strange that, although he can measure the voltage of an accumulator by applying a voltmeter to it directly, yet to measure its current-producing powers by the similar application of an ammeter is one of the things which, electrically speaking, is simply not done!

More Economical

In this case, however, it is more economical to consider why it should be so rather than make the test. The reason is to be sought in our old friend, Ohm's law. An ammeter, being intended for insertion in a circuit in which current is already passing, is constructed to offer as little resistance as possible to the current which passes through it.

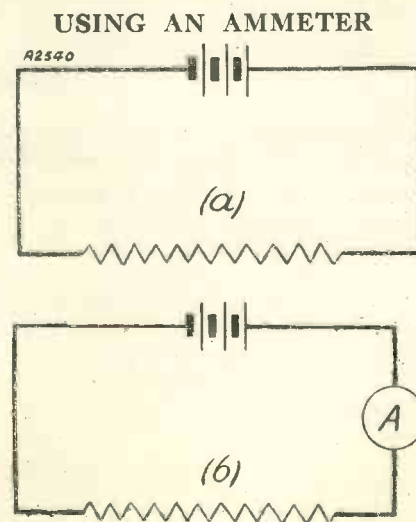

FIG. 1.
Showing method of connecting an ammeter in circuit to measure current flowing.

It is, as we say, of "low resistance." Hence, if such a low resistance element is placed directly between the terminals of an accumulator, the resulting current will be very large indeed, and will certainly burn out the coils of the instrument.

Different Ranges

Ammeters are made in various ranges. The largest used in ordinary wireless work will measure filament current up to five amperes, while others suitable for filament current work may have maximum readings of 1 amp. or 0.5 amp.

The very much smaller currents used in anode circuits are measured by means of a similar instrument called the milliammeter, whose scale is graduated in milliamperes, the milliampere being the one-thousandth part of an ampere.

HOW SHUNTS WORK

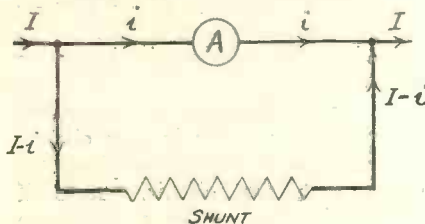

A2541 FIG. 2.

Here you see how the greater part of a large current (I) is deflected through a shunt, leaving only a small current (i) to pass through the ammeter.

A milliammeter reading up to 10 or 20 milliamperes is a very useful part of the radio experimenter's outfit. Many valves pass an anode current well within this margin, and the skilful use of such an instrument is wellnigh essential if any serious attempt is to be made to eliminate distortion or cure other ills to which the modern receiver is liable.

We have already seen that it is desirable that the resistance of an ammeter should be small, in order that its inclusion in a circuit may not appreciably affect the current flowing. A milliammeter suitable for use in the anode circuit of a receiving valve may have a resistance of anything up to a hundred ohms without causing the readings to depart substantially from the true current measures.

A Useful "Dodge"

The reason is, of course, that ordinarily the resistance in the anode circuit—including that of the valve itself—is of the order of many thousands of ohms, so that the addition of the odd hundred ohms due to the

meter resistance makes very little difference to the current flowing.

Although we may not use an ammeter directly to measure currents greater than the maximum value indicated on the scale, we may, nevertheless, use the instrument indirectly to measure such large currents by employing a very useful "dodge."

in Fig. 2, which shows how a comparatively large current, I, flowing along a conductor may be apportioned between meter and shunt so that only a small part of it, i, passes through the instrument, the remainder being deflected through the shunt.

The precise distribution of the current as between meter and shunt

MAKING MULTIPLIERS FOR MILLIAMMETERS

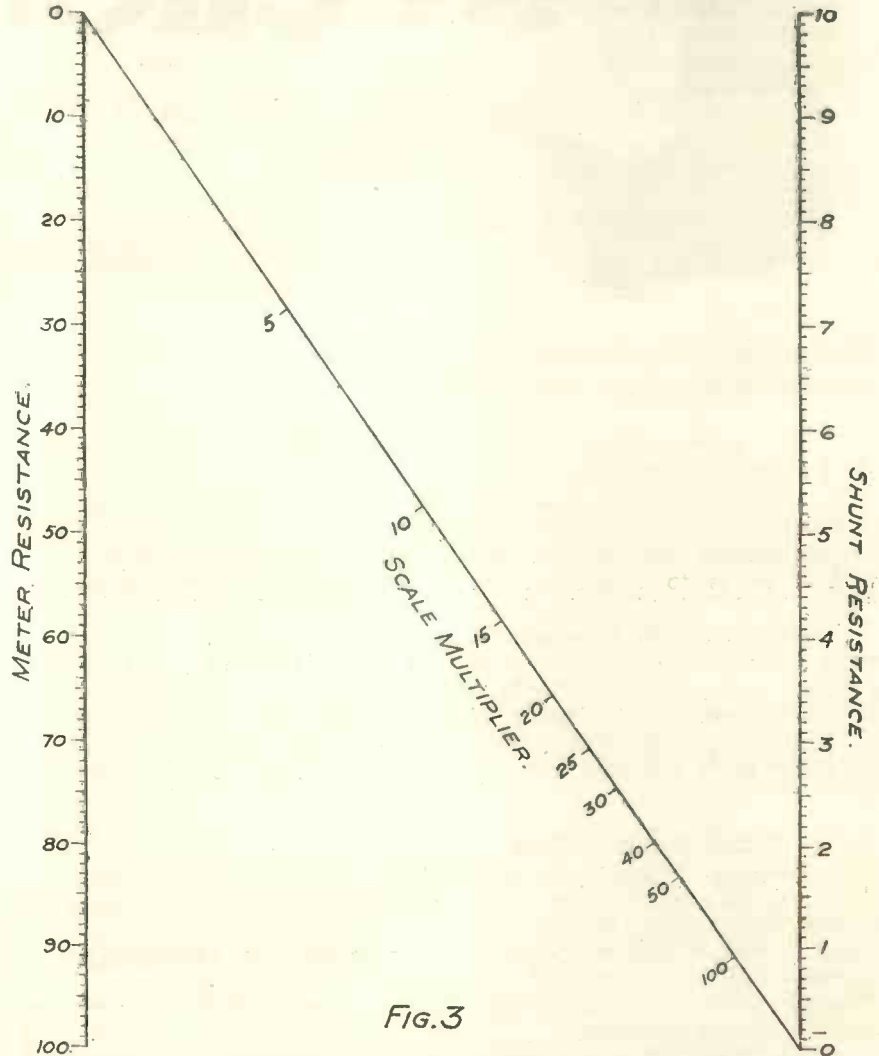

FIG. 3

This very useful N-diagram enables the experimenter, if he knows the resistance of his meter, to find the shunt resistance required to give various multiplying powers.

What we do is to connect a shunting resistance of small value across the terminals of the meter; if the value of this shunt is sufficiently small as compared with the meter resistance, most of the current will pass through the shunt, leaving only a small part to pass through the greater resistance of the meter, which is thus actuated in perfect safety.

Of course, the current shown by the meter is not the total current passing in the line circuit, but this total current is always proportional to the meter reading, and can easily be found from it. The principle is illustrated

will obviously depend on their relative resistances. For example, if the value of the ammeter resistance is 4 ohms, while that of the shunt is only 1 ohm, the current taken by the meter will be only one-fourth of that passing through the shunt, or one-fifth of the total line current.

Increased Five Times

In other words, when a shunt of 1 ohm is used with this meter, the total line current will be given by multiplying the reading on the meter by 5.

It is very convenient to be able thus to multiply the readings of an

All Those Complicated Calculations are Quite Unnecessary

ammeter by some nice, round number such as 5, 10, 20, 50, etc., but in order to do so we must know the precise value of the shunting resistance that will work the trick.

When we know the resistance of our meter—and if it is unmarked the makers should be able to help you—the necessary shunt values to obtain any desired multiplier may be readily ascertained from the two N-diagrams which are published this month. (See Figs. 3 and 4.)

is intended to work in conjunction with a shunt to measure currents up to a maximum of 40 milliamps. What value should the shunt have?

Reading Off the Value

It is evident that the scale values of the instrument must all be multiplied by 20 when the shunt is connected up; 20 is therefore the "multiplier" corresponding to the required shunt, and this figure is sought on the diagonal scale.

Fig. 4 is similar in principle, being intended for use with smaller resistance values.



THE PRINCIPLES OF TELEVISION

A new book on this vitally interesting subject.

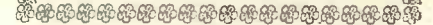

FOR LOW-RESISTANCE METERS

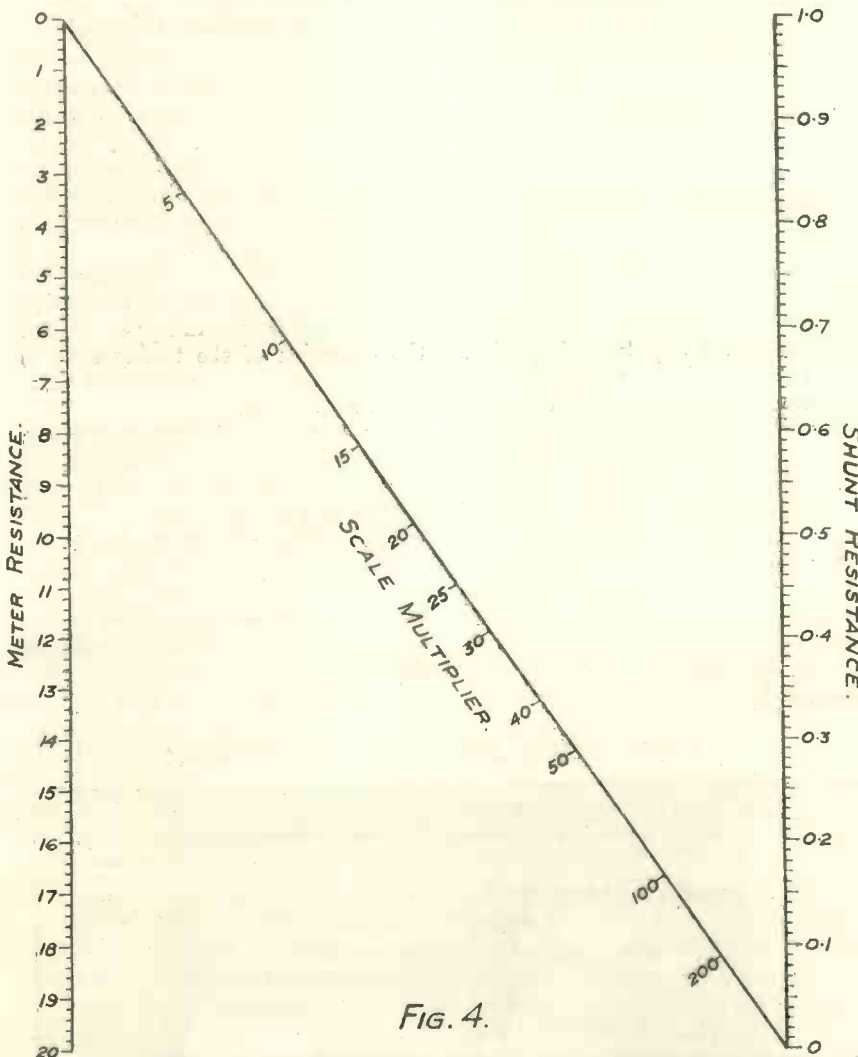

FIG. 4.

Here is another N-diagram which is very similar to the one shown on a previous page, but intended for meters having a lower internal resistance.

A Suitable Shunt

An example of their use will make the matter quite plain. Let us suppose that a milliammeter whose full-scale reading is 2 milliamps., and whose internal resistance is 57 ohms,

A straight line taken between this point and the value of 57 ohms on the left-hand scale of Fig. 3 will now be found to meet the right-hand scale of the diagram in the point marked 3 ohms, which is thus the required shunt value.

HOWEVER the progress of television proper may be regarded, there is no doubt about the progress of the literature of the subject. It grows and it improves.

The latest addition is "First Principles of Television," by A. Dinsdale, M.I.R.E. (Chapman and Hall, 12s. 6d.). A big book of nearly 250 pages, clearly printed and lavishly illustrated.

It is certainly a book of outstanding interest to the serious student of television, as the author sets out to expound the principles of the subject, rather than to describe individual efforts in what is admittedly a vast field.

Essentially Practical

Yet Mr. Dinsdale's treatment of the matter is essentially practical, and he is an adept at pointing out the vital and interesting points. His chapter on Elementary Considerations, for instance, leaves the reader with the feeling that the subject is going to be dealt with thoroughly, and the following chapters justify this confidence.

The illustrations are noteworthy, there being many excellent photographs of apparatus and of those responsible for the various systems; in addition there are the copious explanatory sketches and diagrams, which are unusually well adapted to illustrate the text.

Worthy of Study

In summing up, the author is quite frank about the deadlock which television seems to have reached, and yet he holds out a hope that some development of the cathode ray, or some entirely new system, may accomplish the desired end. Certainly this book shows the subject to be one full of interest, and worthy of study by the amateur as well as by the professional engineer.

P. R. B.



The appearance of the receiver leaves nothing to be desired.

"HIS MASTER'S VOICE" have done a great many noteworthy things in the way of set designs in the last two or three years, but we can confidently say that all pale in significance against the 531, the super-het. radio-gramophone introduced in their 1931-1932 range.

Not that the other receivers are unworthy of the highest praise, but the nine-valve super, with its single-knob control, is a technical achievement of which any firm might be proud. And the Gramophone Company rightly regard it as their ace set.

One Tuning Control

In designing this model the H.M.V. engineers have aimed at a de-luxe proposition from every point of view.

They have reduced the tuning controls to one, and produced a super-heterodyne which will operate satisfactorily on both long and short waves. Between 80 and 90 stations can be received regularly at any time on this instrument with really satisfactory quality, power and tone, using the mains or a few inches of wire as an indoor aerial. There is no need for an elaborate outside antenna.

Although the output is over 4 watts, the quality and range of reproduction is extremely fine.

A DE-LUXE RADIO-GRAMOPHONE

Some interesting details concerning the H.M.V. "Super-heterogram" Model 531.

The dial settings for the stations, once noted, are permanent, the illuminated scale reading directly in wavelengths. An extremely useful feature in the form of a "local-distance switch" is provided, the normal high-frequency amplification of the instrument being so terrific that any attempt to receive a powerful transmitter within 100 or so miles would swamp the low-frequency and detector stages. This switch makes it possible to reduce the high-frequency amplification for the reception of comparatively nearby stations.

Quality Compensations

Whenever the tuning of any control is likely to affect the quality, the control has been arranged in such a way that it will automatically compensate for any loss of quality.

The "local-distance switch," for instance, while introducing de-sensitising loads into the high-frequency stages, automatically compensates the quality of reproduction so that it is exactly the same as that received on an insensitive high-quality receiver.

The same automatic compensation occurs when tuning from long to medium waves, so that the woolliness characteristic of so many receivers on the long-wave band has been eliminated.

The cabinet is of a form which has received general approval, and, while being larger than the popular "His Master's Voice" Model 521, it is not by any means unwieldy or unsuitable for the average small home. At the same time it loses no dignity by the fact that it is not a large piece of furniture.

Ten Band-Pass Circuits

The single tuning knob, which operates on a horizontal illuminated scale countersunk at an angle in the motor-board, and extremely convenient to read, has been arranged to handle ten tuning circuits, either directly or indirectly, according to the circuit in question.

In spite of the fact that there are nine valves employed, and ten tuning circuits utilising band-pass tuning, the operation of the tuning scale is as simple as on the smallest two-valve instrument.

The cost of running the instrument is negligible in comparison with its performance—about 100 watts with gramophone in operation.

The instrument is available for alternating current on any voltage between 100 and 260, and any frequency between 50 and 100 cycles, and at the price of 70 guineas its popularity and success is assured.

(Continued on page 492.)

A REAL TIME- AND TROUBLE-SAVER!



Automatic record changing is incorporated, making the outfit the very last word in luxury listening.

AT YOUR SERVICE



by
**OUR TRADE
COMMISSIONER**



Plenty of Plugs

AN extremely wide variety of terminals, battery plugs and sockets is covered by the latest Ealex leaflet, recently sent to us for perusal.

Everything you are likely to desire in the way of "binding posts" and plugs of all descriptions are included among a galaxy of minor parts, such as switches, link connectors, and so on. The number of different switches is amazing, for we are introduced through the leaflet to practically every conceivable type of small power switch. Black tumblers abound among key switches and snap types of all descriptions, while in every instance the price is right.

But "small stuff" is not the only reason for the production of this interesting catalogue. Besides the terminals, switches and plugs, there are frame aerials, cabinets made on the well-known "Byldurone" method, and short-wave adaptors, and oscillator wave-meters. It is worth while getting a copy of this leaflet, which the makers will be pleased to supply to anybody who will write for it to Messrs. J. J. Eastick & Sons, Ealex House, 118, Bunhill Row, London, E.C.1.

A Watmel "Pot."

We have received details of the latest Watmel potentiometer, which has been designed for the requirements of those wanting a potentiometer of 50,000 ohms and upwards. It is of the wire-contact-element type, and is of special self-cleaning design. Retail at 4s. 6d., it should have a ready sale.

Comprehensive Cossor Collection

So well known have A. C. Cossor been for the manufacture of radio valves that few people probably are completely aware that those magic

Here is some varied news of the trade that should interest all readers, whether or not they are connected with the radio industry. Manufacturers, dealers, home constructors and general readers are invited to send items of interest to be included under this heading.

little "bottles" by no means complete the activities of the firm. The Cossor kit sets are also well known, but there are still some surprising things that emanate from the factory at Highbury or from their associated factories.

One of these is the Cossor pick-up and tone-arm, which sells for the moderate figure of 30s., while another is the 8s. 6d. volume control that is designed for use with the pick-up or elsewhere in an L.F. amplifier.

Another, as you will have seen from the special loudspeaker supplement, is the "Utah" series of loudspeakers. These are of the moving-coil type, and can be obtained in several models: Then there are L.F. transformers, H.T. batteries, and accumulators for supplying low tension; truly a remarkable set of adjuncts for a firm that is mainly interested in the production of valves.

A Polar Reduction

In this issue you will find a description of a special short-wave adaptor that is designed for use with mains sets. It employs one of the popular Polar type C condensers, the double-spaced vane short-wave variable that till recently cost 10s. 6d. In order to meet the requirements of our readers who are interested in short-wave

BEHIND THE SCENES AT EALING



H.R.H. The Prince of Wales, who always has the welfare of British trade at heart, inspecting the talkie studios belonging to Associated Radio Pictures at Ealing Green. Note the transportable type of control-board for the electrical apparatus.

British Radio Firms Still Forging Ahead

reception and want a really good condenser, Messrs. Wingrove & Rogers have reduced this price specially to assist those who intend making this adaptor. It is a wise move, and one that should have a considerable effect on the sales.

Changing Colour

I understand that for reasons of production the Ferranti A.F.10 transformer, recently introduced on the market, is to have a case of a different colour. At present it is brilliant vermilion, but I understand that there is a little difficulty in producing a case of this colour to the high standard of purity demanded by this critical firm, and so it is on the cards that the case will in the near future be considerably changed, though not in shape or dimensions.

More Price Reductions

We are rapidly reaching rock bottom in the prices of radio goods of all sorts, and the latest drop that has been recorded is in the series of dry batteries manufactured by Messrs. Ediswan. I understand that the

battery is being introduced with a voltage of 9 to sell at 1s. It will be known as the "Minor," being somewhat smaller in capacity than the standard 9-volt battery.

Down Below 100 Metres

An interesting folder has been prepared by Messrs. Burne-Jones & Co., Ltd., dealing with their latest design of short-wave adaptor, Model T. The adaptor is a rather curious-looking instrument, and is designed to operate on any kind of set, whether mains or battery energised. It is fully dealt with in the folder, and the latter is made doubly attractive by the very comprehensive list of short-wave stations given on the fourth page.

Forging Ahead

The Essex air seems to be agreeing with Messrs. E. K. Cole, for they are still rapidly extending their works. The latest activity is connected with the installation of some new and up-to-date moulding plant. Hundreds of new hands are being employed to work the three 1,000-ton

long and 63 ft. wide with a height of 50 ft. is required to house them.

Princess Elizabeth's H.M.V. Gramophone

One of the interesting features of Princess Elizabeth's miniature house, which was recently shown at the Ideal Home Exhibition, is a portable H.M.V. gramophone finished in royal

"SAVING TIME"

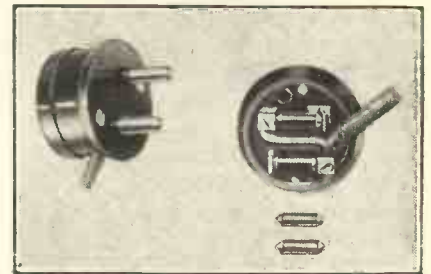

The special 1/2-amp. plug recommended by Ferranti for use with their electric clock, as used in the "Timepiece" Three.

blue and presented to the Princess by The Gramophone Company, Limited.

Accompanying the instrument is an album of H.M.V. records made by the little Princess's royal relatives. She will no doubt be interested to compare the human voices with the records of her father, H.R.H. the Duke of York; her grandparents, Their Majesties the King and Queen; and her uncle, H.R.H. the Prince of Wales.

A set of the records of Elgar's Nursery Suite, dedicated to the Princess, and recorded by "His Master's Voice" in the presence of T.R.H. the Duke and Duchess of York, will also entertain her in her little cottage.

The portable gramophone was made by Welsh workmen at The Gramophone Company's factories at Hayes.

Miniature Mullard Museum

Mullards are always well to the fore where there is any sign of a radio exhibition, and their latest activity in this respect was at the recent radio show at Bobbies, of Folkestone. An exhibit arranged by the famous valve firm depicted the history of radio valves, and included some two dozen specimens covering the period 1914 to 1932.

Another section of the display comprised examples of Mullard A.C. mains valves, and a case containing valves in various stages of manufacture.

SPEEDING UP PRODUCTION AT HAYES



A new simplified method of constructing the H.M.V. automatic record-changing mechanism has recently been introduced at one of the factories at Hayes. The chassis are mounted in jigs which can be tilted at any angle to facilitate adjustments, while overhead conveyors do a great deal to speed up production.

standard 60-volt battery is now down to 6s. 9d.—a shilling reduction; while the 99-volt unit has come down from 13s. to 11s.

These reductions are continued in the super class and in the series of grid-bias batteries. A new grid-bias

hydraulic presses, which are said to be the largest moulding presses in the country.

Some idea of the enormous size of these may be obtained from the knowledge that they are 100 tons in weight, and that a factory 180 ft.

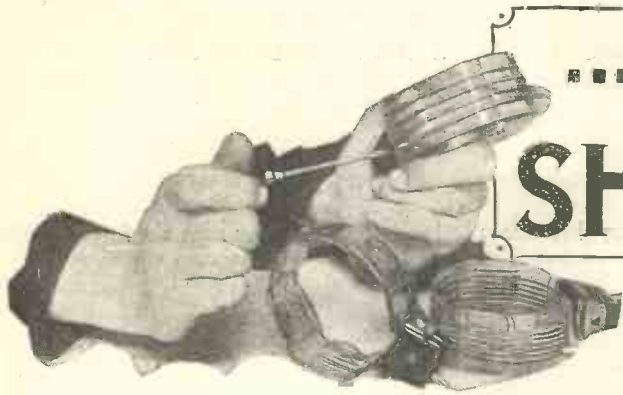

... ON THE ... SHORT WAVES

By W. L. S.

Who answers some questions of interest to all enthusiastic short-wave searchers, and deals with some interesting aspects of "mush" as a background noise.

I AM frequently asked by short-wave listeners, as well as would-be short-wave listeners, what the differences are that one has to consider when designing receivers for short-wave work and "ordinary" work.

This is a question that would take anyone a lot of time and space to answer fully; it certainly could not be done in two pages of "M.W." But there are one or two important points that beginners frequently forget, and I may as well deal with them here and now, since they are of importance to practically everyone with an interest in the short waves.

Covering the Bands

We need not go into the first very deeply. It is just the old, old question of "frequency-spread," and can be summed up quite shortly. Of course, you realise that we have, on a short-wave receiver, to do one of two things: either we have to cover a ridiculously large band of frequencies in one sweep of the tuning condenser, or we have to do an infernal amount of coil-changing. The former method involves difficult tuning, and the latter is just a nuisance.

Accordingly we arrive at a compromise between the two. We use a tuning condenser of about .0001, and we use three sets of coils to cover the band between 18 and 80 metres. This makes tuning about five times as critical as it is on the broadcast waves, which means that it is not too bad if we use a good slow-motion dial.

Special Coils

Another way of getting round the difficulty is to decide on the "bands" over which we want to listen, and to design coils that will enable us to cover those bands with small tuning condensers. Those of us who are interested in amateur work will elect to listen in the neighbourhood of 20, 40 and 80 metres, while those who want broadcast will listen in the regions

of 19, 25, 32, 49 and perhaps 80 metres.

It is impossible to give any "rules" for this game. It is up to you to decide on how many wavelengths you want to cover, and to plot a graph showing your skill in tuning against your hatred of coil-changing!

Background Noises

So much for that. The second basic difference that one meets when changing over from broadcast receiver design to short-wave design is rather more important. It is the whole question of "mush."

Unfortunately for us all, it is far more difficult to obtain a really silent background with a short-wave set than with any other. Some of the "mush" comes from outside, but not all of it. Furthermore, even the "outside" component of it can be dealt with to a certain extent.

Put in plain language the situation

is this—that the multi-valver is often at a definite disadvantage, and that the small set scores every time. Particularly is this the case when listening to weak amateur signals, which are, after all, the greatest test of the efficiency of one's gear.

We need so very small an aerial to give us the necessary "pick-up" on short waves that everything in the set can do its share. Without a semblance of an "intentional" aerial we can receive distant stations on the inductances only; very often we hear people boasting about their feats in this direction. It is, however, much better to use a decent aerial and to cut down the amplification in the set itself.

The Important Detector

This seems an opportune moment to preach my old sermon once more: *Look to your detector* to do the real work. Don't cover up the shortcomings of an inefficient detector by

WEE—THE VERY SMALLEST STATION IN THE WORLD!

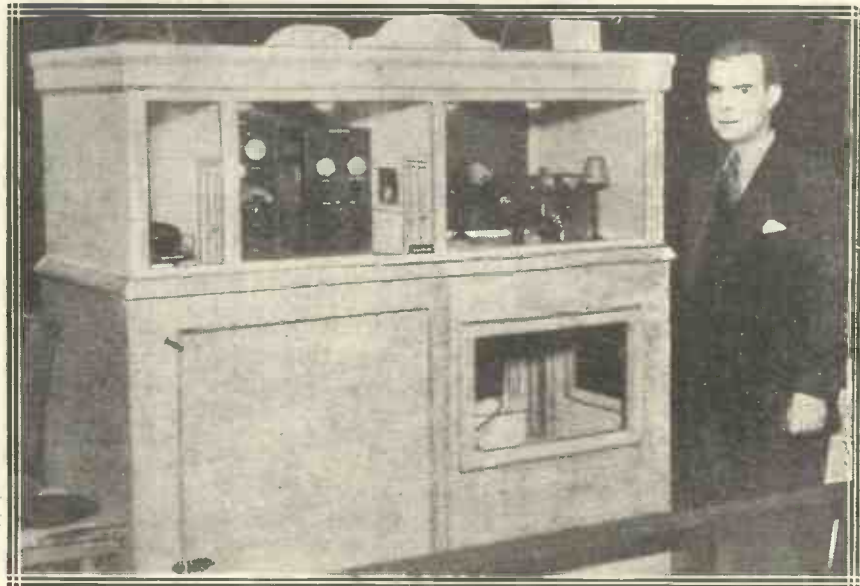

Here it is, complete with diminutive waiting room, miniature transmitting gear, and tiny studio. Beside it is the ingenious builder, John Boyle, of Philadelphia, who showed parties over it during a Boston Radio Show. When he applied for a call-sign for it the authorities entered into the joke and, learning that it was only 55 in. wide and 8 ft. high, they allotted to it the appropriate letters WEE!

W.L.S. Says You Should Look to Your Detector

Piling on L.F. amplification until you can't keep the 'phones on your head.

If you do you will probably have one of those terrible sets that gives an output with 60 per cent of mush and 40 per cent of signals. It is a real education to listen on your detector alone, and to see just what it brings in. You will find that when it is working well you will hear the outside "mush"—just a faint hiss—quite clearly, and that any signals that are stronger than this mush are likewise audible.

"signal-mush ratio" slightly worse, but one note-mag. doesn't do much harm in that way. Put on some more, though, and unless you are going to be content with strong broadcast signals I am afraid you will find that the single-valve man will beat you every time.

Valve Noise

The snag that is responsible for all this is "inside mush." I have not yet met a valve that operates without a very faint "hiss." It may be very

I could demonstrate to any of my readers a simple experiment which would probably make them think very hard. I could give them the headphones on my own single-valver and tell them to tune-in the weakest amateur Morse signal they could find.

I would then switch in two note-mags.—quite good note-mags, too—and I wager they would not be able to read that signal any longer. Not if it were really weak in the first place.

This seems all wrong, but it isn't really. The reason is simply that the battery of note-mags. has increased the signal by about 1,500 per cent and the mush by about 2,000 per cent, with the result that the signal has just about disappeared beneath the noise-level.

For Loud Stations

On strong signals, of course, this doesn't matter. If they are already signals in the category of W 3 X L—about five times as loud as the mush to start with—they will sound all the more impressive when the "heavy stuff" is switched in, and the increase in the proportion of mush will probably pass unnoticed.

It is a queer anomaly that one has to use a small set for weak signals and a big one for strong signals, but any experienced short-wave amateur will tell you that it is perfectly true.

Now for some hints about keeping this "mush" down to a reasonable level. First, use inductive aerial coupling rather than capacitive. Signals may be a little weaker, but the loss will be worth it. Next, if you want some amplification, use screened-grid H.F. rather than too much L.F.

If you are in a "noisy" location—troubled by car ignition, trolley-buses, vacuum-cleaners, or anything of that sort—use a fairly small indoor aerial and, if possible, dispense with an earth connection.

"Man-Made Static"

If you have an enormous amount of this kind of "man-made static" in your neighbourhood, build the receiver in a metal box and thus ensure that most of your signals are picked up on the aerial, and not by all the bits and pieces in the set.

Regarding "inside-mush," make sure that your grid-leak is not "hissy"; some of them are, unfortunately.

RADIO REPORTERS OF THE U.S.A.

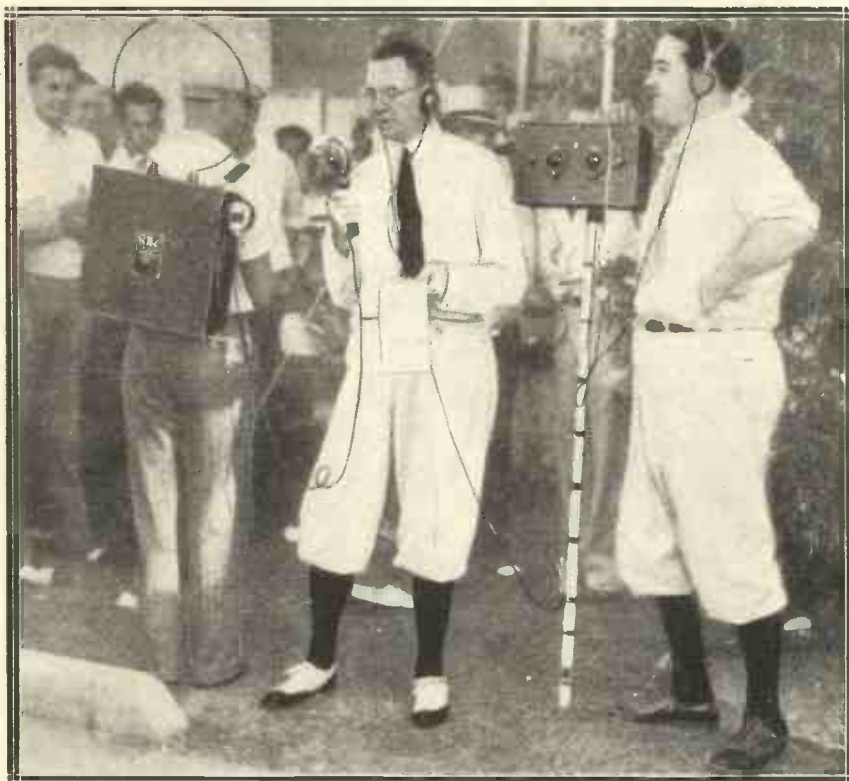

The two gentlemen in the baggy nether garments are conducting a running commentary, and you will note that a portable transmitter of the knapsack type is being used, with single-loop, short-wave aerial. Note also the pole for taking the weight of the receiving gear.

This being the case, I simply cannot see how that state of affairs can be improved in any way! Surely, if the signals are weaker than the "mush"—when, of course, the latter really is genuine outside interference—we shouldn't be able to make much out of them with the best "super-set" in the world!

With One "Note" Mag.

So, when you have reached that point, if you want louder signals, add one "note" mag. and review the situation again. I am afraid you will always find that you have made the

faint, but it is there, and when further amplification follows it becomes a serious matter.

One set that a friend demonstrated to me was so sensitive—and so noisy!—that I swear I could hear the electrons leaving the filaments!

So here, definitely, we have to split up into two parties. Those who want real good programme-value from the short-wave broadcast stations take the super-sets; those who derive their thrill from logging unbelievably faint signals from, say, Fiji Islands, take the more humble affairs, and generally get away with it.

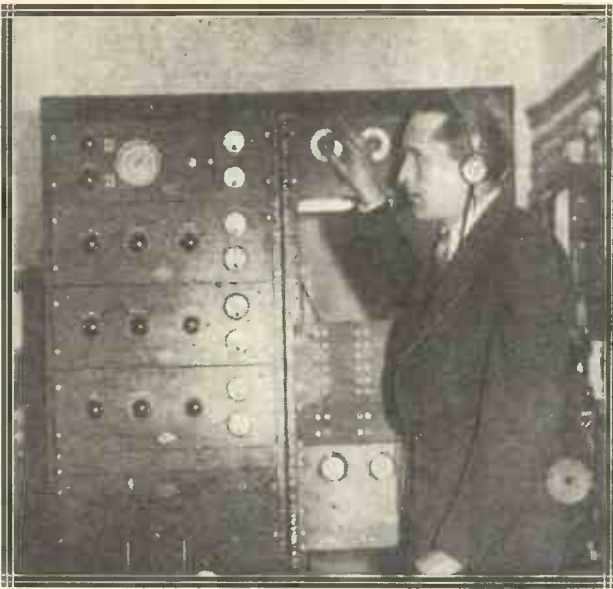

BEHIND THE SCENES OF BROADCASTING

An account of some interesting events, both humorous and dramatic, which have occurred in British Broadcasting Studios.

He smiled cheerily and walked over towards the door, and whispered something to a man who had been leaning against the wall interestedly

watching the proceedings.

Then the door was shut, and the red light above it flickered into evidence. Suddenly I felt panic-stricken. This was no joke; that wretched station director had called my bluff and thrown me on to the ether! Millions, perhaps, of people were going to hear my every word, my every articulated sound. If I coughed or rustled my papers, I would "deafen thousands of listeners."

My tongue seemed to grow in size and become awkwardly uncontrollable. I licked my dry lips and smiled feebly at the fiendishly cool and collected B.B.C. man, and anxiously watched his arm for the signal, vaguely wondering why we were waiting for such an interminable space of time. I didn't realise until afterwards that he was, on his part, studying the clock! Whether or not a time signal preceded that news bulletin I do not know to this day.

Frozen with Fright!

All I can remember of the next few minutes is that I moved my lips, and a thin, shaky voice appeared to hang round my teeth. I didn't seem able to get it "away," and I couldn't develop any resonance! (It must have been a horribly-damped studio!) In my attempt to make my voice sound like a voice, and not the reedy chirruping of an asthmatic old lady, I suppose I dropped it about an octave in tone, for the station director waved his hand upwards frantically.

I thought at first he meant I should lift my head higher, but as I did that I nearly choked with the constriction on my Adam's apple, caused by my efforts to develop bass!

FOUR or five years ago I was being shown over one of the British broadcasting stations by the director of it. We arrived at a small but pleasantly arranged little studio.

"This," said my guide, "is the studio we usually use for the news and talks."

"Very cosy," I observed. "Nothing to put the wind up anybody here."

"You don't think so?" He looked at me strangely, speculatively. Then suddenly he said: "Have you ever broadcast?"

I admitted that I hadn't.

An Alarming Experience

"Would you like to broadcast the news bulletin in ten minutes' time?"

He asked the question in quite a casual tone of voice.

"It would be an experience," I said, as casually.

"Right you are," he said; and, to my amazement, a sheet of typed news and microphone announcements was produced and thrust into my hands.

"Of course," said the station director apologetically, "we shall have to have a brief voice test first."

I entered into the spirit of what I thought was a joke and, placing myself in front of the microphone, which was fixed above a small table, I began to read the words.

"Fine!" announced the B.B.C. official, interrupting me before I had spoken more than two or three paragraphs.

"Now stand by, and when I wave my hand go ahead from the beginning. You can tell me afterwards, if you get the 'wind-up.'"

However, I am thankful to say I managed to overcome my "mike fright," and half-way through the bulletin I became almost lighthearted, and found myself putting more feeling into the news than has ever been done since, I am sure. For one thing, it wouldn't be allowed!

You see, I experienced a complete reaction, and from sheer fright swung right over to a super-hyper-over-confidence! I gracefully plucked my handkerchief out with a free hand and, with a grin at the B.B.C. man, mopped my streaming brow. I dramatised the remaining news atrociously. I was coy, cheery and affectingly resonant in turn as with different items of news.

The Finishing Touch

At the end I said gaily:

"Well, that is the end of the news. A rather interesting bulletin, wasn't it? Please stand by for a moment; your station director will now take charge of the microphone and make some further announcements regarding the radio fare he has to offer you."

I think I might have amplified these somewhat fatuous and most irregular remarks had not the worthy "S.D." borne down on me with a terrible frown and, politely but firmly, indicated that I should vacate my position. Brimming over with triumph at my "broadcasting debut," I waited until he had polished off the session. The red light went out, thus indicating that the microphone was out of circuit.

"And that is that," he observed, with what sounded like a sigh of relief.

"O.K.?" I queried.

"Not bad for a first show, but you shouldn't have been so frightfully conversational about it. Still, it was my responsibility."

He changed the subject with significant quickness, and nothing more was said.

And now for the sequel. Just before I left I had a few words with

(Continued on page 490.)

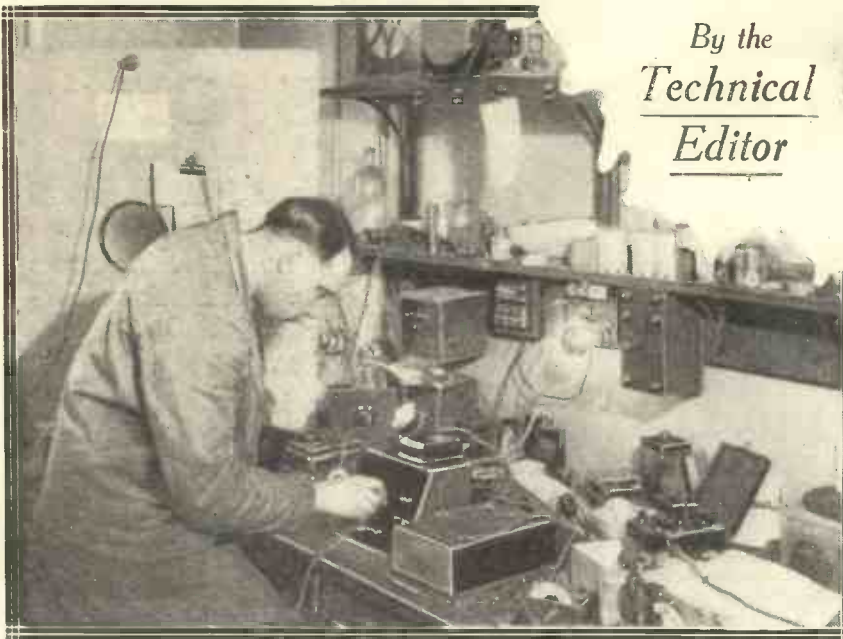

By the
Technical
Editor

On the

That is to say, there is a composition element, although the moving contact does not scrape round this, but along an intervening and protective wire track.

This method of construction appears to us to be an excellent compromise—when carried out efficiently as in the case of this Watmel component, in which we find a special system of clamping the contact strip and the actual resistance element.

The retail price is 4s. 6d. The movement is smooth, and on test we found the technical characteristics of this Watmel potentiometer to be perfectly satisfactory.

For the Short Waves

OF the many short-wave adaptors which have come our way we do not remember any one which appealed to us as strongly as the one due to Messrs. Hustler, Simpson and Webb, and known as the "Aerodyne."

It bears the stamp throughout of careful and knowledgeable design. For example, there is slow-motion reaction, a feature which is fast becoming to be regarded as indispensable for "hot" short-wave apparatus.

But such a control is of little real value if it is not in itself efficient, as in the "Aerodyne," where both the tuning and reaction slow-motions are a delight to handle.

The "Aerodyne" is not sold as a kit, but markets complete in a handsome cabinet and all ready for use. It can be employed with practically any set, and it takes only a matter of moments to bring it into commission.

We have carefully tested the instrument in conjunction with two or three sets of widely different characters, and in all cases excellent results were obtainable.

We recommend all listeners who are attracted by the idea of being able to venture on to the fascinating short-wave bands at little additional cost, and without the need for great operating skill, to obtain full details of the "Aerodyne."

New Watmel Potentiometer

The latest pattern Watmel potentiometer has been designed for values of 50,000 ohms upwards. It is of the wire-contact type.

Ohmites

One of the ostensibly simplest of all radio components is the fixed resistance. We can well imagine that many constructors think of these as merely pieces of material of graded lengths and thicknesses.

A WIRE TRACK

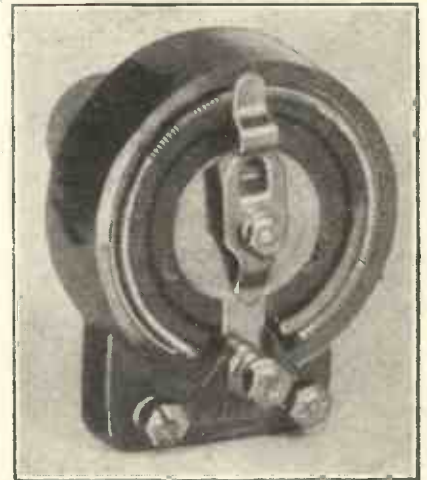

The moving contact of the new Watmel potentiometer runs round a wire track which is rigidly clamped to the resistance element.

And so they are if taken at their face value, but preceding the production of any satisfactory fixed resistance inevitably lies a wealth of research and experiment. This even applies to the wire-wound types, but there is vastly greater difficulty in producing the less expensive and more compact "composition" type.

There are two main requirements which have to be satisfied, and these are stability of resistance and current-carrying capacity; the one being, of

THE "AERODYNE" ADAPTOR

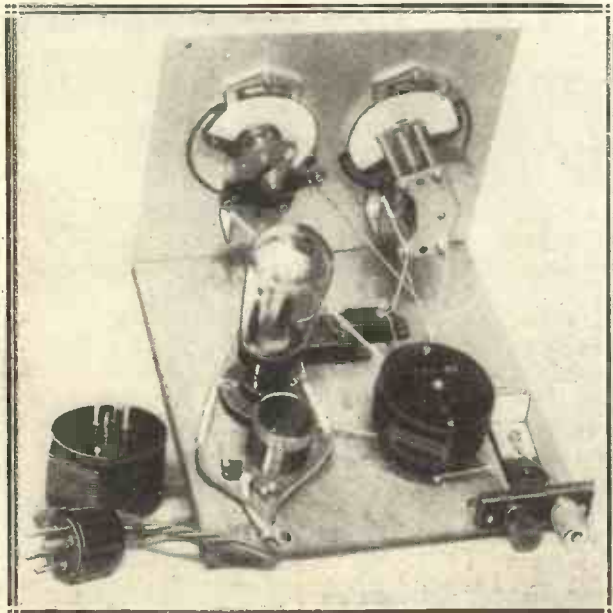

Two coil units are provided, and they cover 15-50 and 50-100 metres. The price of this efficient adaptor complete and ready for use is 35s.

Test Bench

This month we deal with the H.S.W. "Aerodyne," Graham Farish "Ohmites," and components due to Ferranti, Lissen, Watmel, and Lotus.

course, largely dependent on the other.

And even to-day there are all too few completely reliable fixed resistances available—probably the most frequent cause of set noises and breakdown are fixed resistances of an unsatisfactory kind.

The Graham Farish "Ohmite" is not, in our opinion, in this category,

selling at around about six shillings have very low reliability factors—the majority of those little Continentals give a distinctly poor showing in this respect.

But we need not look in vain to Hollinwood for reliability, as Ferranti's have a very high reputation for this.

After all, the noticeable audible

difference between the performance of two different transformers may be slight, even though their "curves" are widely divergent—when the receiver concerned uses an average loud speaker and average component parts.

Judged purely as an inexpensive transformer, the Ferranti A.F.10 gives good results, and we feel sure Ferranti's

will not regret their decision to bring their brand of radio goods within the reach of tens of thousands more radio enthusiasts.

The Lissen Shielded Coil

It is an interesting commentary

WITH ITS SHIELD REMOVED

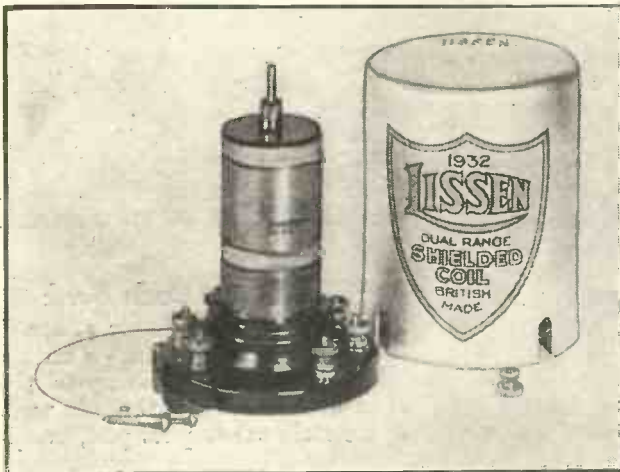

Showing how easy it is to remove the Lissen coil's "can."

for we have given "Ohmites" stringent tests and they have stood these with complete equanimity.

If Graham Farish did not produce anything else of a notable character they would deserve a place in the sun for their "Ohmites" alone. "Ohmites" are neat little components and their reliability earns them inclusion in any receiver.

Ferranti A.F.10 L.F. Transformer

The famous Hollinwood firm are now catering for the man who has to look twice at his every shilling before spending it. Of course, they are unable to give us a transformer having the qualities of the A.F.5 at 5s. 6d., that is an economic impossibility, but their new A.F.10 provides us with a good sixty-sixpenn'orth of Ferranti.

It should be remembered that two out of three L.F. transformers



The new Ferranti L.F. transformer.

on the article on "Power Curves for Coils," which appeared in "M.W." recently, that Messrs. Lissen publish dynamic resistance curves in connection with their new shielded-dual-range coil.

But they are one among a most select company, and it should be noted that their literature was published before our article appeared in print.

It goes without saying that the curves are good—in fact, they constitute something of a challenge to coil makers who do not venture into the open with their publicity matter!

However, Lissens maintain their reputation for good stuff at low prices, for the price of the new shielded coil is only 6s. 6d., complete with shielding. In construction it is compact and well finished, and in operation it reaches a high standard of performance.

It can be used for simple single-tuning circuit sets, or it can be employed in ganged formations.

Three Lotus Components

The new Lotus dual-wave aerial coil is available either unscreened at 5s. 6d. or with a "can" at 7s. 6d., and is a component which will

(Continued on page 489.)

THREE NEW LINES FROM LOTUS

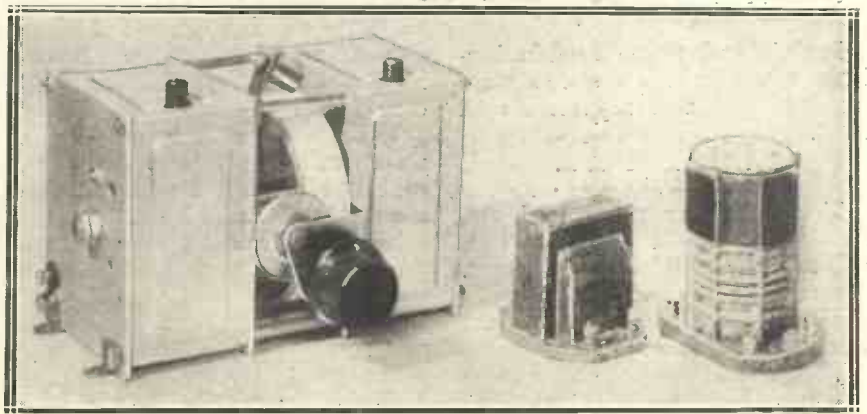

The Lotus ganged condenser, output choke, and dual-wave coil.



The Drama of Dead Man's Rock

OWING to an unusually virulent outbreak of "spring cleaning" in this house, I find myself relegated to a spare bedroom-cum-lumber-room. Those graceful ladies who, when the sickness of spring cleaning is not upon them, pay so much attention to the dressing of their hair and to the things called hats which they ram on it—these charmers now charge about the premises wearing dusters on their heads.

THE ANNUAL JUNK-HUNT



"What a collection! Enough to give a chance visitor the wobbling willies!"

In their hands are mops and feather-brooms, and on their lips are strange words of power. I suppose it's all right.

Like a Dud H.T.

Meanwhile, however, here I am, all amongst the old trunks and lino, without any inspiration whatever. My mind is as blank as Modred's shield. Not a bee in the bonnet, not one single bat per belfry!

What a collection of junk! Enough to give a chance visitor the wobbling willies! Two Gladstone bags, period

1897! Half a bicycle and a baby's "go-cart."

A large kite, four rolls of pre-war lino, the gas-fittings we brought with us ten years ago, and a mounted dog's head which we found here when we moved in; a polo stick, a doll's cradle made from an orange crate, a couple of iron fenders, two cornice-poles, and the ruins of some "Venetian" blinds; a large framed photograph of an unknown house, almost faded out; a frame-aerial used by me in 1919—and never since; sundry trunks and hat boxes—and my dear old solar topee!

By gum! How the sight of that topee brings back the old days, when I used to chuck some collars and things into a suit-case, take my stick in my hand and set out for the wilds just as though I were stepping round the corner to buy an ounce of tobacco.

A Thriller This Time

Two or three years later I would breeze back again, hurl the suit-case into a corner, bung the stick into the same old hall-stand—and there I was, at home. ("And is old Higgins still the verger at St. Mark's?" etc., etc.)

Well, well, you'll be wanting a radio yarn from old Jones, I suppose, so I had better tell you that one about "Dead Man's Rock."

It's a thriller, and it actually happened to me, though I had almost forgotten it till that old sun-helmet of mine brought it back as fresh as paint.

In August, 1916, a fellow called Buck and I were sent by a certain branch of H.M.'s Forces on a con-

fidential mission to a certain small island belonging to a certain Latin country.

We took with us, besides the impedimenta of a camp, certain very special radio apparatus with which we were to make certain measurements and signals.

The Secret Code Book

In addition we took—or rather, I took, being the senior man—a certain secret code book. Thus up to the moment when we landed on the mole at a certain sub-tropical port, every-

IN THE INN



"They flung themselves in one wriggling lump through the parlour door!"

thing was certain, as you have doubtless remarked; thereafter our ways were set about with uncertainty.

Our none-too-willing hosts, the islanders, were uncertain about our credentials, which they inspected about three times a day; they were uncertain whether they could supply us with food for our camp, and besieged us privily, after dark and at the back door of the inn, with special offers of food, "varey sheep, señores." They were uncertain, as a



**SPECIFIED FOR
THE MAINS SET
SHORT-WAVE UNIT**

described in this number

**IN FOUR SIZES
15-100 Metres**

Size 2 ..	2/6
" 4 ..	2/7
" 6 ..	2/8
" 9 ..	2/9

Set of 4

10/-

By carrying off the Olympia Ballots in both 1930 and 1931, "ATLAS" Mains Units are proved unapproachable in design, performance and value. There are models for every set. D.C. Models from 39/6. A.C. from 52/6, and a wonderful special Model, A.C.244/ST, at 59/6, for the "S.T.300." Write for free booklet, "Power from the Mains."

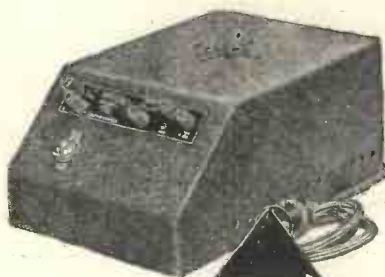

**10/-
DOWN
AND BALANCE
IN EASY
MONTHLY
PAYMENTS**

Westinghouse Rectifiers
Guaranteed 12 Months.

**"CLARKE'S
ATLAS"
COILS & MAINS UNITS**

H. CLARKE & CO. (M/cr) LIMITED,
Old Trafford, Manchester. 'Phones : Trafford Park 1744-5-6.
Southern Offices: Bush House, W.C.2. 'Phones : Temple Bar 3862 & 7130:
Glasgow Office: 24, Oswald Street. 'Phone : Central 5119.

**DUBILIER
IS THE NAME OF
THE CONDENSER
YOU CAN TRUST**

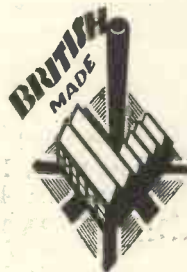

Illustration shows the
Dubilier
Special
NON-INDUCTIVE
Type Condenser.

Designed primarily for
use where lowest radio
frequency impedance is
required. Ideal for by-
pass purposes in H.F.
circuits.

Working voltage 250
D.C., tested 500 volts D.C.
Capacities from .01 mf to
2 mf. Prices from

2/-



B3

DUBILIER CONDENSER CO. (1925) LTD.
Ducon Works, Victoria Road, North Acton, W.3

A Radio Tale of the Secret Service

community, about the ownership of "Dead Man's Rock," whereon, we had decided, our camp should be pitched; but when they learned that we proposed to pay rental—and no questions asked—nine families were very certain that the rock belonged to their nine paternal grandsires.

Backing the Winner!

These islanders were uncertain who would win the war, and so they were very, very neutral, with that passionate sort of neutrality which is exhibited by the jackal when the tiger is fighting the buffalo. But they were certain that might is right and that money is money. I feel sorry for the Jews; their "genius for finance" is quite overshadowed by that of the French—and of these islanders.

By the third day after our arrival we had secured our stores and were ready to move to camp. Then my malaria paid its annual visit to my circulatory system, and I was shuddering and shivering in the good old way. But duty is duty, and there was no alternative but for me to order Buck to go on with the mules, set up the tents and apparatus, and get a move on with the job, which was scheduled down to split-minutes.

Bound with Brown Paper

I gave him the code book, carefully bound with brown paper, and warned him not to go lending it to girl friends, and so on. Then I collapsed on to a bench in what might be called the inn's saloon bar, and slept like the dead, having taken a huge dose of rum.

They let me alone, though I heard afterwards that I was inspected during the day by several policemen, a photographer, two priests, all the kids and most of the girls of the village. Old Mother Poüerat, the pub-lady, grew very sympathetic about nine of the evening, and threw a mouldy goatskin over me; this partially awoke me, and I lay in a kind of heavy doze, the rumble of the guests' voices sounding like the sea far off.

It must have been about a quarter to midnight when bits of conversation began to get through to my mind. The place was full of men, gambling and drinking as usual.

Presently I heard a deep voice say: "Pooh! I'd cut his throat for two ha'pennies." I do not know why I

jumped to the conclusion that this cheery butcher was alluding to my throat, but that is what I did, and with a big effort I sat up in order to have my say about the throat business.

The fever had left me, but I was as tipsy as a Highland tinker. Every-

A DAMSEL IN DISTRESS



"I'm Amurrican," she said, "and I've been putting over a bit of painting."

body present turned and blinked at me as I rose and hurled the goatskin over the counter, grunting like a pig. M. Poüerat began a lot of rubbish about "the poor young one," which I took to be the equivalent of pulling the wool over my eyes while the throat-chap got behind me. So I picked up a bottle, backed to the door, and threatened to brain every islander in that pub.

Dear me! Even now, after all these years, I can see them. They flung themselves in one wriggling lump through the parlour door and out amongst the goats and hens behind the house; it was like a conjurer's trick!

THE MISSING CODE



"Quick! Mister! Ze gal. She are espy."

They were uncertain about my sanity, but most emphatically undesirous of trying the matter out. A second-rate pack of yellow, jumping monkeys, without the nerve to grab the greasy coppers on the card tables! The throat-cutting person took the first and longest jump—and I heard later that he had been talking about the Mayor, not me.

This little interlude, plus another drink and a dip in the tub, sobered me sufficiently. I laughed for about five minutes, and then staggered off to Dead Man's Rock, about 800 feet above sea level, where I arrived at two o'clock in the morning and found the camp looking snug and trim. Buck was smoking his pipe and doing odds and ends to the apparatus.

"What's this Stink?"

"Good lad," I said. "Gimme a bottle of soda-water and a gnaw of ham. I've defeated the whole militia and taken no prisoners."

"Glad you've come," he answered. "I'm ready for a snooze. How do you feel? Hadn't you better get some sleep?"

"Sleep? I slept for twelve hours, and feel like a giant." Then I told him of the throat affair and the retreat of the ten thousand. "By the way," I added (*sniff sniff*), "what's this stink of scented soap on something? Have you pinched the bit from the inn, you Scotsman?"

He edged up to me, and jerking his thumb at the other tent, hissed:

"We've a visitor, a lady."

"You know perfectly well, Buck, that you can't do the garden party racket here—on this job. I don't care who she is, or where you picked her up. She's got to buzz off."

"But, Jonesy—she's straight stuff, and in a frightful state. Came tottering up here last evening, tongue hanging out, hat over one eye, panting fit to bust. Said the Mayor of this one-eyed hole was chasing her. You know what these dagoes are, Jonesy, over a real white girl. Take a *dekkio* yourself!"

Far from Distressed

I did take a look. Moreover, I took that look through a slit in the tent, and there was my lady, looking far from distressed, powdering her nose, and chewing gum. Somehow, though, she seemed to be an innocent enough little baggage. So I called to her to come out.

"Good-morning," I said. "Sorry to hear you've been molested, but I'm afraid you cannot stay here. Just who is it who has annoyed you?"

"Why—the—they said he was the Mayor. Such a beastly man."

"Hum! But what are you doing in this island these days, Miss—or —?"

(Continued on page 492).

HOW TO CURE "BREAK-THROUGH"

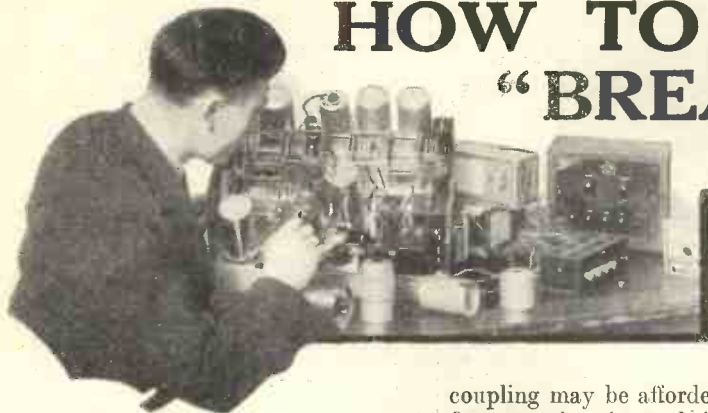

Some practical pointers on a troublesome form of interference.

By D. GLOVER.

BREAK-THROUGH" is probably the most commonly met fault of all in the earlier types of sets. It is, of course, the breaking through on to the medium-wave tuning adjustments of one or even two powerful medium-wave local stations.

And, in order to deal with it, you must first discover the reason why it occurs. But this is no mystery in the majority of cases. The primary circuit of the tuner is generally the culprit.

Tuned to the Local

Either the separate coil winding, or a part of the main winding lying between a tap and earth, have a "natural" wave-length near enough that of the powerful medium-wave local for this to be able to jam through the moderately-tight coupling with the secondary or grid winding.

And this effect can be duplicated in an H.F. transformer, so that "break-through" is possible in a two-tuned-circuit H.F. set, although it is not so frequently met with in such as it is in the simpler Det.-L.F. types.

But let us analyse an example. Take a dual-range tuner of the simple variety in which there are three windings in addition to reaction. The one comprises fifteen or so turns, and operates as the medium-wave aerial winding. This is coupled to a medium-wave grid or secondary winding.

Why It Occurs

By means of a switch the grid winding is loaded for long waves by the bringing in of the third winding in series with it, while the long-wave coupling is reinforced by the aerial winding being joined to a tap on this new long-wave section.

This tap may be twenty or thirty turns from the bottom of the coil. Now it is obvious that the aerial circuit includes about forty-five turns in all, and though an excellent long-wave

coupling may be afforded, that forty-five turns is going to bring the tuning of the aerial sufficiently close to the wave-length of the powerful medium-wave local to enable this to "break through." You see, an aerial circuit never is selective!

The cure is to push this natural wave-length well away from the region of the medium waves. One "M.W." method which has attained considerable popularity, and which is known as the "Contradyne," is to arrange the circuit so that the long-wave switching introduces a small 2½-in. diameter hank coil of about sixty turns into the aerial circuit, and so send up its inductance.

Another and not so well-known scheme is to join a .0005-mfd. compression condenser across the primary

with that of the potential "breaker-through."

A definite tuning for the "break-through" is often to be noticed when one of these selectivity condensers is in use, for at one particular setting the "break-through" is at a maximum.

Always Move Up

But never endeavour to tune down in an attempt to get away from "break-through." Always aim at pushing the wave-length of the long-wave primary circuit in an upward direction. Incidentally, this will also improve your long-wave volume.

But it should be mentioned that, in successfully dealing with "break-through," you may lower the long-wave selectivity, and you can deal with that only by reducing the degree

SCOTLAND'S REGIONAL PROGRESSES

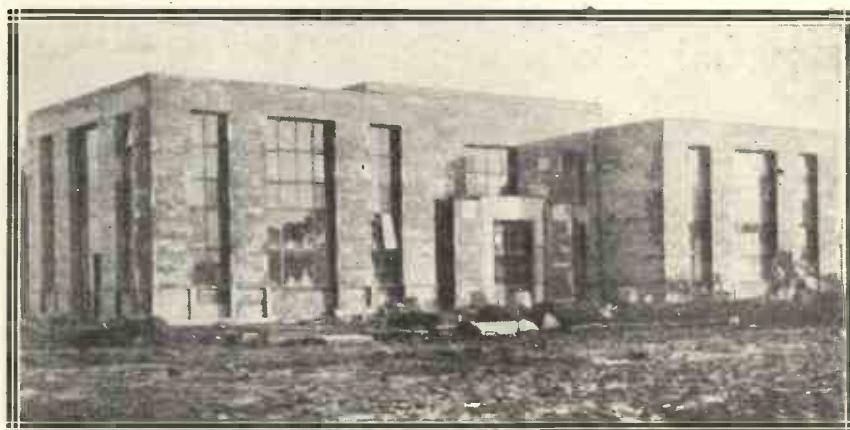

The building which is to house the transmitter for the Scottish Regional station at Falkirk is now rapidly nearing completion.

winding. You adjust this small condenser until you have turned out the interfering station, after which it can be left set.

It sometimes happens that "break-through" of a serious nature is introduced by the use of an aerial series selectivity condenser—an ironic commentary on the value of such a device!

The reason for this is easy to see. The capacity of the aerial circuit is reduced sufficiently to bring the wave-length of the system more into line

of coupling between primary and secondary circuits.

This can be done by lowering the long-wave tap.

It must not be forgotten that our old friend the wave-trap is able to deal with "break-through" quite successfully so long as there is a tendency for only one station to cause the interference.

Where two regional stations are offenders, then there is no real alternative to the "tuning" away scheme.



THIS month we are arranging our record review a little differently, so that it is easier to pick out the type of disc required from the necessarily large and mixed collection at one's disposal. Records will therefore be listed in no particular order, but with their titles well displayed, so that a glance will suffice to select one from another.

BROADCAST RECORDS

Everyone's Favourites From Grand Opera. (3166.) Played by the Grand Opera Company, this lively "Super-Twelve" includes half a dozen more of the most popular selections from well-known operas. It constitutes what are known as Parts 3 and 4 of the series, but it is, of course, complete in itself, and well worth hearing.

Trees and The Rosary. (3159.) Roma Johnson, with male quartet, orchestra, and organ. Miss Johnson's voice is admirably suited to the items she has chosen for this disc, and the tuneless, if rather hackneyed, first-named piece is excellently rendered.

Maire My Girl and I. I Might Only Come To You. (3167.) John Thorne, with chorus, orchestra and organ. Both these songs are so well known that it would be absurd to attempt to describe them. The singing is good, and altogether the record is worth adding to your collection.

One Little Quarrel and I've Got "It." (3161.) Gracie Howard. A couple of light items that are sung in pseudo-American style with good effect. The recording is a little harsh, but we enjoyed both sides of this lively disc.

More Scenes of Domestic Bliss. (3168.) Billy Caryl and Hilda Mundy. This is the second record made in the series by this clever variety duo. It is not quite up to the standard, in our opinion, of the first "bliss" disc, but it is nevertheless very amusing, especially the side entitled "Drunk Again." Billy Caryl's impersonation of a character somewhat "the worse" is masterly.

All Of Me and Sweetheart. (3162.) The Manhattan Melodymakers. This is a good dance record that should be found in the homes of many of the younger generation. The tempo is good, while the band never lets the first-mentioned number get monotonous; which cannot be said of a number of other orchestras we have heard.

My Bluebird's Back Again and I'll Have To Go On Without You. (3171.) Jack Harris and his Band. A good dance disc that will be popular, and so will the two recordings by The Blue Mountainers, entitled:

You Rascal You and Kiss By Kiss. (3176.) The former of these two numbers is a particularly popular one at the moment, though it has not much to recommend it except its naiveness. The sentiments expressed are not those we should like to become general, and, in order to get the number over, vocal gymnastics of an unusual order are required. The Blue Mountainers do the item justice, and it is sure to be among the best dance-sellers of the Broadcast range.

Jealousy and The Song of the Rose are two tangos that will appeal to all lovers of that particularly haunting dance. (3175.) Played by Stein's Tango Orchestra Tipica, the former tune is, in our opinion, the more attractive of the two, but both are excellently rendered and the disc is sure to be in demand.

COLUMBIA

Among the large selection sent to us this month by Columbia we have chosen the following varied programme.

Prelude and Fugue on B-A-C-H. (DX349.) An organ twelve-incher by G. D. Cunningham, of a famous Liszt composition. It is recorded in the Central Hall, Westminster, and is an excellent example of what may be accomplished in the "canned organ" line. It requires a good radio-gramophone (or electric reproducer) to do it justice, and while the type of composition will not appeal to people who are not fond of the fugue type of composition, it will be a favourite among many radio-gram enthusiasts who are on the look-out for a "deeply" recorded organ solo.

Rhapsodiana. (DX336.) By Debroy Somers Band. A pot-pourri of Liszt Hungarian Rhapsodies that is rather spoilt, in our opinion, by somewhat harsh rendering. There is too much

use of the brass and stringed upper register, giving the impression of bad balance.

Trees and Allah's Holiday. (DX345.) Two concert versions that are really well done by the Savoy Hotel Orpheans. As a rule, when a dance orchestra takes on the task of providing what is known as a concert version of a popular number, it proceeds to render the major part of that number almost unrecognisable.

In this case both the pieces are treated with due regard for the intentions of the composer, and "Trees" especially is excellently done. The vocal refrain is not one of those sickly draws, but it is clear-cut and sympathetic, and does a great deal to make the disc a success.

Another excellent rendering of Trees is given on DB780 by Turner Layton, of the inimitable Layton and Johnstone duo, who are combined on the other side to provide To Be Worthy of You.

A brief selection from some of the records released during the month. They have been chosen because of their special value to the pick-up user.

Layton has a fine voice, which we like better in semi-straight items than in the plain dance vocal duets, and "Trees" suits him down to the ground.

O, Who Will O'er the Downs So Free? and **O, Hush Thee, My Babe** (DB770) form a couple of choral gems that show up to perfection the talent of the B.B.C. Wireless Singers and their conductor, Stanford Robinson. The items are unaccompanied, and the rendering is always sympathetic without being thin anywhere. So many choirs accomplish light and shade by achieving thinness, but no such lack of body can be discerned in this record.

Gettin' Sentimental and By the Sycamore Tree (CB431) are two dance numbers that you are sure to have heard via the ether played by that much-discussed combination, the new B.B.C. Dance Orchestra. Here we have them on Columbia, among the first recordings they have made.

They and the accompanying numbers are worth getting both from the musical point of view and to compare the "canned" version with the "real" thing as heard by radio. Of the other Henry Hall recordings we will mention but one: **The Blue of the Night and Songs That Are Old Live For Ever**, a particular favourite of Henry's. (CB430.)

Less sweet, perhaps, but more like modern dance representation, are the several records of the Savoy Hotel Orpheans.

They are all excellently rendered, and have the same perfect dance rhythm that characterises the B.B.C. band, though they are of quite a different nature.

H.M.V.

Petite Suite de Concert. (C2372 and C2373.) London Symphony Orchestra. Samuel Coleridge Taylor is mainly famous for two of the many works that he composed, "Hiawatha" and the "Petit Suite de Concert," which is recorded in the records numbered above. Probably the Suite is even better known than the Cantata, and it is deservedly popular, for it ranks among some of the most tuneful music that has ever been written.

This recording of the work by the London Symphony Orchestra does it full justice, for although the Suite is usually played by small salon orchestras, with whom it is extremely popular, it is very refreshing to hear a full-bodied orchestra dealing with the four tuneful airs.

Legende and Thais, Meditation. (DB1537.) Mischa Elman (violin). This is a record that is superb from both the recording and the musical point of view. The violin reproduces with remarkable fidelity, and that necessary "edge" that

gives it its characteristic timbre is there despite the normal high-note limitations that encompass the recording engineers.

The Lost Chord and Good-bye. (DB1526.) Benjamin Gigli. This is a record that will meet with the approval of a very large section of the gramophone public. The airs are old, but their rendering is beautifully fresh. Incidentally, this record is the first that the world-famous tenor has made in English. You should hear it.

Gracie Fields Medley (C2378) is the title that is given to a remarkable twelve-inch disc that contains a wide selection of the hits of our most popular comedienne. Her infectious good humour, fine singing and delightful fooling have endeared her to everyone, and on this record we are reminded of a number of her greatest successes.

In the dance section there are some particularly interesting records this month. Of these probably the most unusual is in the "hot" rhythm series of modern dance music. It is on B6150, and is called **One Hour**, being played by the Mound City Blue-Blowers.

As this would lead one to suppose, it is a blues, and is recorded by some of the most renowned rhythmic artists. But perhaps it will be as well to explain what a blue-blower is.

Blue-blowing is a recent addition to the tricks of the dance band and "consists of humming a rhythmic transcription of the original melody. Originally variation of tone colour was obtained by the use of jugs, glasses, kazoes, etc., but to-day the voice is modulated merely by cupping the hands over the mouth.

"The art lies less in the tone colour obtained than in the rhythmic and melodious construction of the phrases, and the sense of rhythm and emotional appeal with which they are interpreted." So says an eminent authority on modern dance-band technique. So now you know!

But whatever they are doing in "One Hour," the effect is exceedingly intriguing, and both this record and the one on the other side of the disc should be heard. This latter is by Tiny Parham and his Orchestra, and is called **Sud Buster's Dream**.

She Didn't Say Yes and Try To Forget (B6153), from "The Cat and the Fiddle," and played by Ambrose and his Orchestra, are excellent numbers. The former is particularly well played, with phrasing that is a delight to hear.

Lastly, let us take Frank Crumit, singing on B4102. He is a cheery soul, and the two items are excellently rendered. The first is **Tangit Me How to Play the Second Fiddle**, and the other is **I'm a Specialist**. They are entertaining yarns, and the orchestral effects in both are well done. We do not consider the subject matter of the second number to be quite the sort of thing for a record, even though it may be based on a small book that has had very good reviews. As a matter of fact, unless one has read the book, or has the trend of the story related to one, it is probable that not very much sense will be made of the record until at least half a dozen runs have been made. It is undeniably funny when you know what it is about; but, even so, is it in sufficiently good taste?

ZONOPHONE

The Zonophone list always contains an unusual selection of records, and this month is certainly no exception to the rule. Not that being unusual is always a matter for congratulation, but it does at any rate create interest.

An example where the unusual is rather disconcerting is the harp recording of **Topical Favourites** (6109), which deals with such items as "I Don't Know Why," "By the Fireside," and so on. As the makers themselves say, we do not usually associate harps with dance numbers, and we would ask them in all seriousness whether the novelty imparted by that instrument is really worth while.

Sleep On, Helen, and I'll Whistle Under Your Window (6097), by the International Novelty Quartet, form another case where, in our opinion, the rendering of certainly one ("Sleep On") number is quite inadequate. The "novelty" does not compensate for the peculiar thinness imparted to their interpretation of a very fine and tuneful waltz.

The London Orchestra, playing medleys of **Congress Dances and Happy Ending**, is very much better. (6088.) We enjoyed this record, and advise gramophone users to hear it.

The Blue Lyres, an "Ambrose" combination from the Dorchester Hotel, are good in **You Rascal, You and Three Little Times** (6092); while their **Goopy Geer** is also very enjoyable (6091). The other side of this, **Open Up Dem Pearly Gates**, is rather monotonous, not solely due to the orchestration, but also to the composition itself; it requires very careful handling if it is not to become tedious.

His of the Moment, No. 2 (6108), would have been very much better if the medium chosen had not been an accordion band. But that is only what we think; to those who are fond of this peculiar instrument the record will have a large appeal, for it is well played.

Kiss by Kiss and I'll Have to Go on Without You (6104), Billie Lockwood, is nicely sung in the usual dance vocal refrain style, with a mezzo-soprano voice that is well modulated. The accompaniment is neat, especially in the second-named number.

MORE EVENINGS *in the* STUDIO



By the time these words appear in print the great trek from Savoy Hill to Broadcasting House may be completed. And this article is in the nature of a personal tribute to the interesting times I have spent at Savoy Hill. I trust "M.W." readers will enjoy my brief "look back" at the one-time headquarters of British Broadcasting. There were no less than ten studios at Savoy Hill.

The First "Double-Decker"

Manchester has a double-decker—the first studio with a gallery to be built by the B.B.C. It holds a hundred people and, when first constructed in 1929, it was the largest in Europe. There is also a smaller studio for soloists, and a third very small studio furnished only with a chair and reading desk. This is for the talks, of course.

But Savoy Hill was more elaborate. Studio Number Three was formerly Number One; it was in the old "No. 2, Savoy Hill" building, and was the first ever opened by the B.B.C., but having been redecorated all the old heavy drapings were scrapped. The later Number One was also in the old building.

Studio Number Two was down in the basement and was used for radio plays; next to it was the "effects" studio. Rooms Four and Eight were used for variety, the children's hour, and so forth. Number Eight was immediately above Number Four, and you passed the doors as you went up in the lift at the main Savoy Hill entrance.

Used by Jack Payne

The double-decker, Number Seven, was always used by Jack Payne; this had no balcony, however, as has Number One at Manchester.

Our B.B.C. Special Correspondent describes microphone mannerisms of Vernon Bartlett, Dean Inge, A. J. Alan, Philip Ridgeway and many other firm favourites.

The gramophone records were broadcast from Number Six—the "weather oak" studio—and this was also often used by Sir Walford Davies.

Number Five was the talks studio, which has been used by the Prince of Wales and from which the news was read every day. Number Nine, the last actually at Savoy Hill, was the Chinese studio in the basement, and Number Ten was the converted wharf on the south side of the Thames.

There is our total of thirteen studios, and when you think of the thousands

of artistes who passed through them for broadcasts and auditions it is not surprising that there were sometimes humorous and interesting happenings.

Most artistes have peculiarities, especially if they are regular broadcasters and are allowed to exhibit their particular fads. Vernon Bartlett, for instance, likes to speak from Talks Studio, and prefers not to have any audience—even the announcer. The Hon. Harold Nicolson has the same ideas about broadcasting.

An Ideal Broadcaster

A little while ago, John Barbirolli, the famous conductor, was appearing a great deal; he is an ideal broadcasting musician, for he never gets flustered. He always seems to be in evening dress, and in jolly good taste, too, which is more than can be said of many musicians!

TWO REAL FAVOURITES

It is not difficult to guess which is which out of Clapham and Dwyer, the two patter comedians whose turns are seemingly completely spontaneous.



**NOW, have it on approval,
in your own home FREE**
Test it for yourself without the
slightest obligation



The wireless technical experts have tested "His Master's Voice" Model 435—and are genuinely enthusiastic about it. Now the opportunity is yours to test this instrument for yourself—in your own home—without the slightest obligation.

This radio receiver will win your approval just as it has won the approval of the press experts who know all about wireless from A to Z.

Have it—test it at your convenience—in your own home. Compare its performance with that of other instruments of its price and type, and prove for yourself how truly this set deserves all the unstinted praise it has received.

Examine the fine cabinet, its neat and compact appearance. Entirely self-contained, this powerful three valve all-mains receiver has a built-in loudspeaker of the latest "His Master's Voice" permanent magnet moving-coil

SPECIFICATION 3-valve radio receiver and moving coil loudspeaker in walnut cabinet. Mains operated (A.C. or D.C.). Band-pass tuning. Marconi valves—One tuning knob. One volume control—new "His Master's Voice" frictionless pattern. One operating switch—new continuous action pattern. Unique illuminated control scales, showing only what is in operation—long waves, medium waves or the playing of gramophone records from a pick-up. Mains aerial (A.C.). Plugs for additional loudspeaker.

type. Switch on, and observe its extreme sensitivity, obtained through the scientific circuit design which incorporates band-pass tuning. Hear the quality of its reproduction, its clear-cut treble and rich bass, its freedom from resonance—amazingly faithful . . . true to life.

And it is one of the simplest sets to operate. There are only three controls—the wave changing switch, the tuning knob and the volume control.

But to appreciate Model 435 you must examine and hear it—at your leisure, in your own home. And this is what any "His Master's Voice" dealer will gladly arrange. Just say

you are interested—and an instrument will be installed in your home without obligation. If you do not know the address of your nearest "His Master's Voice" dealer—fill in this coupon.

His Master's Voice

"TRUE TO LIFE" RADIO

The Set
the Experts
Recommend



42/- DOWN and the remainder in 12
monthly instalments of 33/10

*Price does not apply in
Irish Free State.*

CASH PRICE 20 GNS.

COUPON:

The Gramophone Co., Ltd., 363, Oxford Street, London, W.1.

Send me full particulars and the name of a dealer who will arrange for me to try Model 435 in my own home, free, and without obligation.

NAME

ADDRESS

M.W. MAY, 1932

Some Broadcasters Like an Audience—Others Don't!

Dean Inge is a broadcaster who is utterly regardless of the "mike." Until recently there was the famous notice "*If you sneeze you will deafen millions*" at the side of one of the microphones, but the Dean disregards it and puts the engineers to confusion!

When he wants to cough, he coughs, and the microphone catches the full blast of the noise. He cannot be persuaded to be careful in turning over the pages of his manuscript when reading—always a difficult job—and that is the explanation of the crackling noises you may often hear!

Mysterious as His Yarns!

A. J. Alan is a mystery, even at Savoy Hill itself. When he is due to broadcast he is taken by the announcer to a vacant studio—no one knows which studio it will be. "Ladies and gentlemen—A. J. Alan," says the announcer, and then a mystery "thriller" yarn is spun.

Some say that A. J. Alan is a doctor, others that he is a high official in the Civil Service, and others that he is a member of the B.B.C. staff itself. Only the announcer on duty at the time knows.

Clapham and Dwyer like an audience in the studio; theirs is the kind of humour that goes down better with a laugh at the back of it. Studio

audiences, by the way, are not always chosen from the artistes' friends, and, contrary to the critics, the laughter is genuine and spontaneous!

HE KNOWS THE WORLD



Mr. Vernon Bartlett, whose talks on "The Way of the World" are probably the most popular of the talks series.

By the lucky chance I was once able to see the "behind-the-scenes" of a radio play. Studios Two, Four, Six, Seven, "Effects" and "Echo" were used, the artistes being in Two and Four, the orchestra in Seven, and the gramophone records in Six.

In the artistes' studio an electric bulb was hanging down near the microphone—I believe the B.B.C. name for this is a "flash"—and when this bulb flickered (each was switched on from the control room) the actors had to start. Each piece of acting seemed disjointed and nonsensical at times, and the orchestra appeared to play a few bars now and then when the light flashed: but, of course, the producer at the [D.C.P. (dramatic control panel) was linking each part up into the complete play.

Good Entertainment

On another occasion I saw a part of Tyrone Guthrie's *The Flowers Are Not For You To Pick* being broadcast, and although this is a very serious play so far as listeners are concerned, it was almost laughable to watch, in the studio, the disjointed pieces of acting; and some radio-play artistes do not care how they appear before the "mike"!

The Ridgeway broadcasts were usually given in Studio Four or Eight, and there is no greater fun to watch. Hermoine Gingold, Irene Vere, Hugh Dempster and all the others—not forgetting Ridgeway himself, who is "Mr. Ramsbottom"—are always as amusing to watch as they are to hear.

Yes, there are some very jolly evenings in the studio.

FULL-DRESS FOR RIDGEWAY PARADES



Here we see a rehearsal for one of those popular shows directed by Mr. Philip Ridgeway, who believes in dressing the part in order to get the right atmosphere.

AN UP-TO-DATE HOTEL
 Where guests are provided with a full radio and musical service.

THE Atlanta Hotel at Rotterdam has been wired and equipped to provide a complete radio and musical service. A central control room serves the various restaurants and dance floors, while each guest room has a loudspeaker and switch for choice of alternative programmes, gramophone music, or the hotel's own orchestras; microphone communication also serves to convey information and general announcements to guests.

WHY NOT PLACE A REGULAR ORDER FOR
 "MODERN WIRELESS"?
 AVOID DISAPPOINTMENT!



The
MIDGET
L.F.
TRANSFORMER

2 Components that turn
"amateur wireless into
"professional perfection!"

Constructors! Profit by
the experience of experts!

First—the MIDGET L.F. Transformer, the famous "miniature masterpiece" in which ultra-efficiency has been packed into convenient size. Reproduction reaches a brilliance never before possible at the price. Ratio 3 : 1 advised for valves of 10,000—20,000 ohms. Ratio 5 : 1 for valves from 5,000 to 10,000 ohms. Second—the Igranic Spaghetti Resistance—wire wound and protected by insulated sleeving. Made in 13 sizes. Igranic quality—at your price!

The
IGRANIC
SPAGETTI
Wire
Wound
RESISTANCE

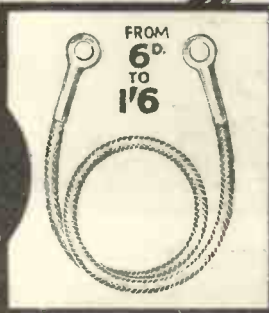

FROM
6^d.
TO
1'6



IGRANIC ELECTRIC CO., LTD.
149, Queen Victoria Street, London.

"If it's IGRANIC—it's BEST for your set!"

Write for
descriptive
leaflet
No. J.1178.

KIT-BITS FOR "M.W." SETS

Selected C.O.D. lines for this month's sets.
You Pay Postman — We pay post charges on orders over 10/-.

"TIMEPIECE" THREE

Cydon double-gang disc drive Extenser	£ s. d.
Telsen 00075 solid-dielectric condenser	1 16 0
8 Dubilier non-inductive condensers type 9200, as specified	2 6
R.I. Pentode output choke	1 6 9
2 Lissen screened coils	1 1 0
R.I. Parafeed transformer	13 0
	8 6

SHORT WAVES FOR MAINS SETS

Polar type C. 00015-mfd. condenser with slow-motion control	5. d.
Polar type Q.J. 00025-mfd. condenser with slow-motion control	10 6
Set of Atlas plug-in short-wave coils	9 0
R.I. Dux L.F. transformer	10 0
	6 9

We supply everything radio—let us quote for YOUR requirements.

PETO-SCOTT CO. LTD. 77, CITY ROAD, LONDON, E.C.1.
Telephone: Clerkenwell 9406-7-8.

For Crossword Enthusiasts—

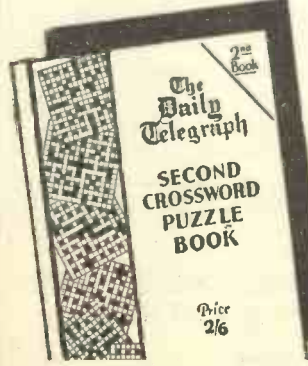

Fifty Puzzles are reproduced in the Daily Telegraph Second Crossword Puzzle Book. Neither too hard nor too easy, they possess that leavening of wit and humour that has brought a world-wide reputation to the Daily Telegraph Crossword.

At all Newsagents - - 2/6
or they can be sent to any address for 2/6 each (post paid), by the Publisher of the

Daily
Telegraph

FLEET ST., LONDON, E.C.4.

DOES YOUR RADIO GIVE TROUBLE ?



Whether your set is all-electric or battery-operated, buy a Pifco "All-in-One" Radiometer, the Sherlock Holmes of Radio. Tests every single thing, swiftly and surely. Simple to use, it is the most efficient instrument ever made. Patented all over the world. Obtainable from good-class radio dealers.



De Luxe Model, as illustrated. **£2.2.0**

Standard Model, only for Battery Sets. **12/6**

Patentees:
PIFCO LTD.,
HIGH STREET,
MANCHESTER.

PIFCO
ALL IN ONE
RADIOMETER



THERE are many people who, when choosing a radio-gramophone, are influenced by the exterior appearance of the instrument to such an extent that they will not have an instrument that does not harmonise or match their furniture to the utmost degree.

Manufacturers of present-day mass-produced radio-grams cannot make up their instruments in a wide variety of woods to suit everybody, at a moderate price, and this fact opens up very interesting work for the constructive amateur.

There are many pieces of old furniture whose very solidity and cumbersome nature lend themselves to the inclusion of radio-gramophone apparatus; sideboards, dinner wagons, writing desks and bookcases to mention a few.

As the writer has had some experience with this kind of work, a few practical suggestions may be of value if only to readers who themselves have a piece of furniture which, at present, is more ornamental than useful.

Points to Remember

Now when one is gazing thoughtfully at an odd-shaped piece of furniture, wondering how on earth a multi-valve receiver and electric gramophone motor, turntable and pick-up, not to mention the loudspeaker, are to be crammed into it, there are two or

By E. J. G. LEWIS.

An inexpensive way to acquire a radio-gram which will harmonise with your furniture is to assemble it yourself in, for instance, a sideboard. Our contributor has had some considerable experience in carrying out interesting constructional work of this character and is able to provide some practical hints on the subject which will afford help to "M.W." readers who have ideas in the same direction. On the following page is a photo of one of Mr. Lewis's conversions which illustrates the complete practicability of his admirable suggestions.

three things that we are apt to forget. Chiefly they are:

(1) That the modern valve will operate just as well whether it is working in a vertical or horizontal position.

(2) That the H.F. and detector stages may be yards away from the L.F. stages. The latter can be made up in one unit with a rectifying valve and mains transformer, the whole being technically termed a power pack.

(3) That with the aid of flexible shielded wire, pick-up leads, loudspeaker leads, H.T. and L.T. wiring, etc., may be bunched if necessary.

With these in mind we will run over the conversion of one of the most difficult pieces of furniture, a side-

board, into a radio-gram. There will probably be two cupboards with doors and two drawers over the cupboards, and we wish to preserve the outward appearance of the sideboard so that no one would guess that it was also a radio-gram.

We will assume that we have decided upon a four-valve all-mains circuit, with moving-coil speaker and an electric gramophone motor. The receiving circuit will comprise, say, screened-grid, detector and two L.F. stages, using M.S.4, M.H.L.4, M.H.4, P.X.4 class of valves. This will, of course, give good power, but we are not concerned with the circuit of any particular kind, but with the disposal of the components.

A Good Drawer-Full

Now the H.F. and detector stages, with their coils, long-wave-medium-wave switch, radio-gram switch and tuning condensers (the mica-dielectric type are very compact and nowadays quite reliable if of good make), may be accommodated in one of the drawers.

A panel of ebonite, half the area of the interior of the drawer, may be supported on fillets sunk sufficiently to give clearance for the control knobs when the drawer is shut. To the back of the drawer the valve holders may be placed, either horizontally or vertically, according to the depth.

Next, the power pack can be made

P.P.M.



**PERMANENT
MAGNET
MOVING COIL
SPEAKER**

The P.P.M. Speaker incorporates an impregnated diaphragm, and a patented twin suspension permitting large cone movements without undue distress. The new patented cobalt steel magnet produces a very high flux density. Housed in a strong metal chassis. Dual impedance output transformer included. (Pentode supplied only if specified.) Hear this amazing speaker demonstrated and write for fuller particulars.

CELESTION

The Very Soul of Music

LOUD-SPEAKERS

47/6 INCLUDING TRANSFORMER

Can also be obtained on Easy Payments. 10/- down and six monthly payments of 8/-.

CELESTION LTD., LONDON RD., KINGSTON-ON-THAMES, London Showrooms: 100, Victoria St., S.W. 1

POLAR best for Short Waves

therefore specified for the Short-Wave Unit described in this issue by A. S. Clark.

Type C Condenser

Double spacing of vanes, allow very gradual capacity variation and aids selectivity. Very low minimum capacity. Direct and Slow Motion drive are embodied and specially designed bearings give smooth and silent action. Rigidly built. One-hole fixing.

New reduced prices:

·00015 - 9/-
·00025 - 10/6

"Q.J." Condenser

A very compact model for reaction. Direct and Slow Motion drive as in the Type C.

·00025 - 9/-
·00015 - 8/9 ·0001 - 8/6

From all dealers.

Polar Catalogue "M" on request.

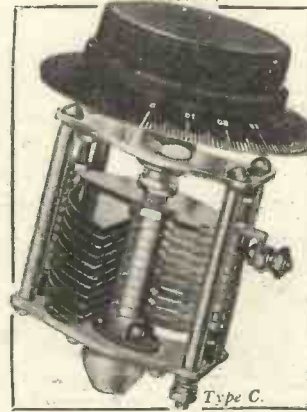

Wingrove & Rogers Ltd., 188-9, Strand, London, W.C.2.

POLAR CONTROL for BETTER RECEPTION

MAGNUM SHORT WAVE H.F. CHOKE

Specified for "Short-Wave Mains Unit" described in this issue by A. S. CLARK.

Price 7/6



SHORT WAVES ON A.C. MAINS or BATTERY SETS

An entirely new design of amazing efficiency.

This Short-Wave Adaptor can be used with any type of receiver (excluding D.C.), whether A.C. Mains, Battery-operated or Super-Het., irrespective of the circuit or the number of valves. It is supplied complete with one special Short-Wave Coil (40 to 80 metres), cord and plug. No extras whatsoever are required. Can be attached to your set in a few seconds. Write now for full particulars and free trial offer.

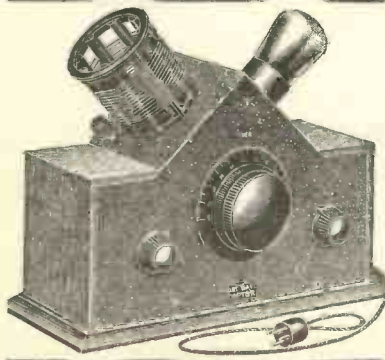

Price, complete 39/6

Extra coil if required, 18 to 40 metres . . . 3/-

All "Modern Wireless" sets are available ready wired and tested. A comprehensive range of lists, including particulars of the latest "Stenode" - free on application.

BURNE-JONES & CO., LTD. "MAGNUM" HOUSE, 296, BOROUG HIGH STREET, LONDON, S.E.1.

Telephone: HOP 6257 & 6258.

Scottish Agent: Mr. Ross Wallace, 54, Gordon Street, Glasgow, C.1.

CLICK!

YOU HEAR—FEEL and KNOW that contact has been made—good and hard.

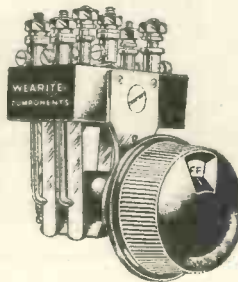

THERE is nothing half-hearted about these "Wearite" Switches—positive contact every time—clean make and break. That is because each type is a thoroughly scientific job—designed and built by switch specialists of unequalled experience. And that is why leading set designers and makers always specify "Wearite." Whatever the switching problem, there is a "Wearite" Switch to do the job—and do it perfectly.

★Note the Indicator window on knob

These switches are now fitted with terminals and are complete with window knob, dial and bracket—and are "one-hole" fixing.

No. 1.21 .. 1-way, 3/3	No. 1.23 .. 3-way, 4/-	No. 1.25 .. 5-way 5/3
No. 1.22 .. 2-way, 3/6	No. 1.24 .. 4-way, 4/6	No. 1.26 .. 6-way, 6/3

The following indicating discs are available—either black lettering on white, or white lettering on black. "Rad-off-Gram," "L-off-S," "Off-On," and also blank white for own marking.

If you have any difficulty in obtaining Wearite components, send to us direct—giving name of your usual dealer. We will post your requirement by return C.O.D.

WEARITE COMPONENTS

WRIGHT & WEAIRE, LTD., 740, High Road, Tottenham, N.17.

Phone: Tottenham 3847/8/9

Placing the Power Pack in Position

up and bolted down at the bottom of one of the cupboards, preferably the one you decide to have the speaker in. This will leave the other cupboard free for record storage.

H.T. and L.T. Leads

The power pack will consist of the two L.F. stages and the rectifying components. From this leads will convey H.T. and L.T. to the H.F. stages, the latter having their own voltage-dropping and biasing resistances incorporated, so that the H.T. leads are taken from the smoothed output of the rectifying unit and the twisted L.T. leads from the 4-volt winding of the mains transformer.

this may be objected to, a good plan is to take the door off its hinges and fix it with four pegs or plugs that engage firmly with four holes or sockets in the baffle board. The door can then be pulled out and stood behind the radio-gram when the latter is playing.

The gramophone motor and pick-up can be accommodated in the remaining drawer, if one of the latest induction disc type of motor is used. They are a little deeper than the ordinary turntable.

If you have to use a D.C. motor or spring-drive type, it could be mounted on a shelf in the empty cupboard with a pilot lamp to switch on when changing records, placing the motor

amplifier or power pack, the speaker being connected, of course, to the output of the power pack. These wires should be shielded flex.

The mains wiring would consist of a twin flex to the mains transformer and a twin flex to the motor. These flexes to be joined in parallel through a tumbler switch and fuses to a two-pin plug or bayonet socket.

A Motor Control

A separate small switch should be fitted beside the motor turntable to control the motor without disturbing the amplifiers. A potentiometer volume control can also be mounted on the motor board if desired, and wired across the pick-up leads.

Allow plenty of flex to connect with the drawers, and fix wooden blocks to the latter so that they cannot be completely withdrawn.

For battery operation the power pack will consist only of the first L.F. and power stages. The H.T. batteries and accumulators may be placed close by, while the grid-bias batteries may be included in the amplifiers.

An aperture may be cut in the back of the cabinet for access to the batteries and the piece cut out used as a door.

In choosing a spring-driven motor it should be remembered that compact ones can be obtained as used in portable gramophones, the winding handle being detachable, so that it is not difficult to find a place for the motor somewhere in the piece of furniture under conversion.

This article has not attempted to give complete constructional details of a radio-gramophone, but sufficient data has been given to enable the reader to put together a very fine instrument at the cost of the components.

THIS WAS ONCE AN ORDINARY SIDEBOARD!



... But now, as you can plainly see, it is a handsome all-mains radio-gram.

The loudspeaker is the next thing to be tackled. The position is, of course, undisputed. It will occupy a central location in the front of one of the cupboards. It is not wise to try to cut a circle through a couple of inches of solid oak door, besides which it is our intention to hide the true nature of the one-time sideboard.

The speaker may be fixed to a stout baffle board screwed just behind the door with a fret grill covering the cone aperture. The baffle should be stained to match the exterior wood.

The door must now be wide open when reproduction is required, and, as

as far forward as possible. This is done in some American instruments.

Finally, the wiring-up should present no difficulties.

Pick-Up Output

The output from the pick-up is taken to one side of the radio-gram switch. The leads should be in shielded flex and the shielding earthed. Also earth the motor casing and pick-up arm. These leads can all be joined and a single wire connected to the earth terminal at the back of the instrument.

The output from the switch is taken to the input terminals of the L.F.

* * * * *
DON'T FORGET—
Two items that it will repay you to remember.
 * * * * *

If the end of your aerial is stayed near a chimney, or in any position where it is particularly liable to pick up soot or smoke, remember that its insulators will frequently require cleaning.

A good method of protecting a panel's surface while it is being drilled is to place several thicknesses of paper underneath it.

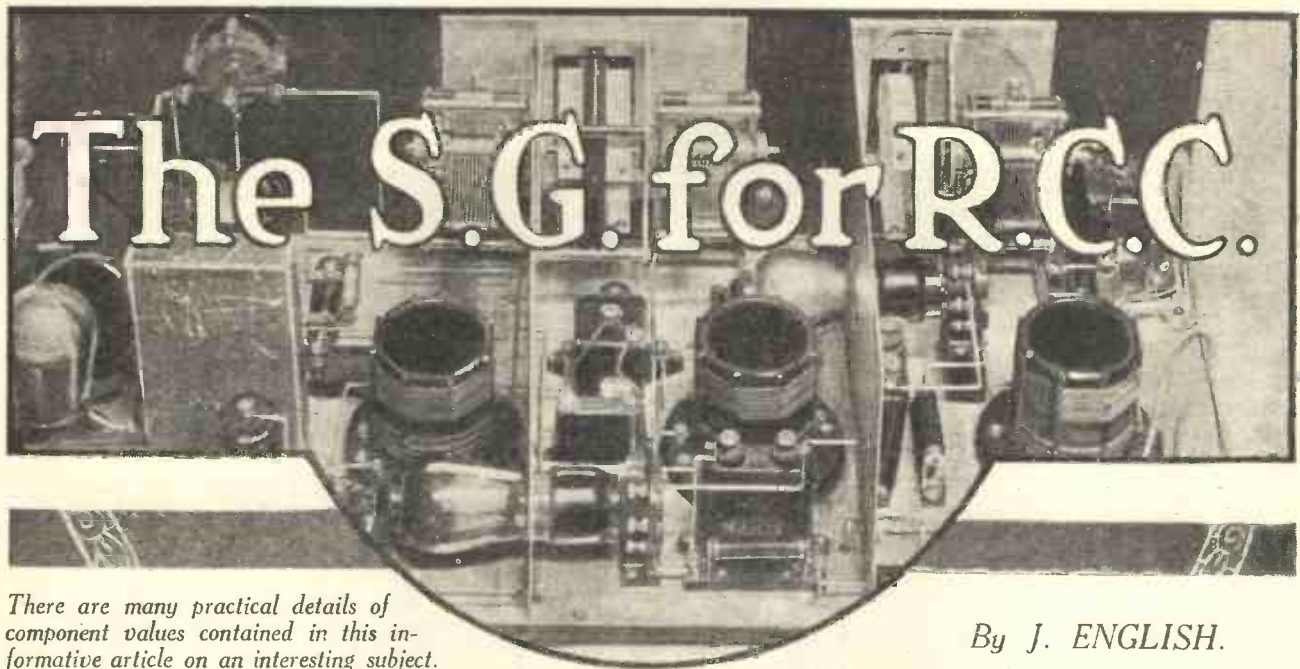

There are many practical details of component values contained in this informative article on an interesting subject.

By J. ENGLISH.

THE most notable features of a screened-grid-detector circuit is the large amplification and exceptionally good quality which are easily obtainable. A typical circuit is reproduced in Fig. 1. Having experienced consistently excellent reception of the two London stations with such a scheme, the project of extending the range of the receiver, by the addition of a high-efficiency H.F. stage, became increasingly attractive.

It was anticipated that with proper design it would be possible to secure a large overall amplification adequate for long-distance reception, with an output of better quality than that usually passed to the loudspeaker by the average three-valve H.F.-detector-L.F. receiver.

In this type of receiver, range and volume often depend very considerably upon the "boost" of reaction, and the skill with which this control is manipulated. When reaction is employed to increase the overall amplification of a receiver, the consequent sharpening of tuning may take much of the brilliance and some of the clarity from reproduction.

Many Experiments

Recently I have had the opportunity of laying out and testing an experimental circuit, and the performance expected of the trial receiver was more than realised. High spots of general interest, such as adequate selectivity, large output and excellent quality, were at length developed in the final receiver to a very satisfying degree. In consequence, I am summarising here the developments leading to the final design, with some notes on results and operation.

I should mention, in passing, that, as far as I can recall, only one receiver with an S.G. detector was to be seen at the 1931 Show, but this year quite a number of new designs made use of this method of detection in some form or other.

Adding an H.F. Stage

The first circuit drawn up for practical test is that shown in Fig. 2. This has quite a simple S.G. H.F.

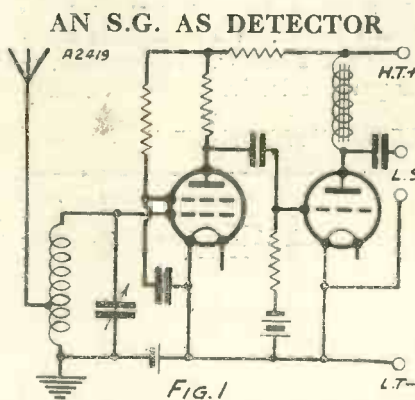

This is the basic circuit from which others were eventually evolved. It is a screened-grid detector followed by an R.C.C. L.F. stage.

stage preceding the detector, with our old friend the tuned-grid circuit as the H.F. intervalve coupling.

The H.F. valve is well de-coupled and screened from the detector stage by a metal sheet. Separate tuning condensers were used merely to save time in assembly and initial operation,

with 60-turn tapped solenoid coils, unscreened, in both grid circuits.

A preliminary test confirmed the expected large overall amplification. For example, the two London transmissions produced such enormous volume that the output valve was well-nigh paralysed! This, needless to say, without reaction, and a signal input from an indoor aerial.

The degree of selectivity, although rather better than usual for this class of receiver, was yet inadequate for really satisfactory long-range reception. The high magnification increases local station swamping, and selectivity consequently suffers. The selectivity of the S.G. stage, with single tuned input and output circuits, is notoriously poor, and without some form of input station-selector it is almost impossible to confine powerful local transmissions to a narrow tuning band.

Curing Instability

Some H.F. instability was also observed on the lower wave-lengths, resulting in oscillation unless screen volts were reduced considerably below the optimum value. This was later traced to H.F. leakage into the output stage. Apparently the S.G. detector functions rather well as an H.F. amplifier in addition.

Unless proper precautions are taken, therefore, the audio-frequency input to the power stage will carry a relatively larger H.F. component than that met with in the normal transformer-coupled detector. The cure for this will be discussed later.

In planning the next experimental receiver attention was first devoted to improving the overall selectivity. For this the now increasingly popular band-pass input tuner was selected as being most effective; the actual tuner used was a Varley Square Peak unit with the companion H.F. intervalve screened coil for the tuned-grid circuit. These two units proved to be both convenient and efficient.

The full theoretical circuit is given in Fig. 3. A ganged condenser was, of course, more or less essential for the band-pass coils, but the other was separately tuned for convenience of layout.

Simple Screening

No attempt was made to elaborate the intervalve screening, just a metal sheet between the input tuning circuit and the H.F. valve, shown in dotted lines in Fig. 3, with a very short grid lead to the latter valve. If a "canned" S.G. valve were used here it is probable that this metal screen would not be required, especially as the intervalve coil is also "canned."

The H.F. instability of the original layout, to which I have already referred, was effectively nailed down in this receiver by inserting a stopping resistance in the grid lead of the output valve, with an H.F. filter in its anode circuit. This arrangement is much to be preferred to the more usual detector H.F. filter specified for a transformer-coupled detector.

Here the presence of any appreciable capacity shunting the detector output, such as a by-pass condenser would provide, would largely impair the high-note response which is such a good feature of this S.G. detector.

The filter scheme of Fig. 3, however, should result, theoretically, in the minimum loss, and in practice the reduction of the upper audio-frequencies is imperceptible. The properties of the band-pass tuner itself tend to counteract any such distortion of the frequency balance by

been solved by adopting band-pass input tuning, both on the medium- and long-wave bands.

Once again the very small input damping of the S.G. detector was prominent. With the normal grid detector the tuning of the intervalve H.F. circuit is relatively flat, but here

THE FINAL SELECTIVE CIRCUIT

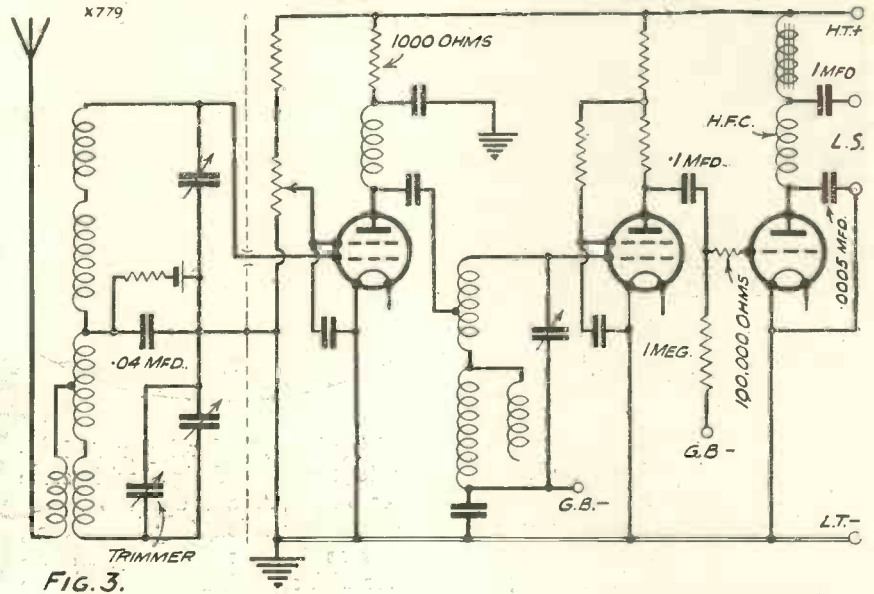

FIG. 3.

A band-pass tuner was finally included in the design. A special H.F. stopper and an H.F. output filter are incorporated in the grid and anode circuits respectively of the output valve.

passing to the H.F. valve a wave form with a full complement of the upper modulation frequencies.

Splendid Performance

The performance of the re-designed experimental receiver was now definitely better, both as regards selectivity and stability. The problem of adequate selectivity had virtually

more accurate tuning was found to be necessary for maximum response.

If anything, an even greater overall magnification was obtained with this receiver; a number of Continental stations were easily received after dark at the large volume associated with the "locals" on circuit of Fig. 1. In one or two cases some volume control was necessary.

Quality of reproduction was exceptionally good, speech crisp and remarkably clear, with a full frequency balance on musical items. Where no heterodyne note intruded, and unfortunately it often does when receiving foreigners under present ether conditions, stations were brought in against a quiet background.

Plenty of "Mag."

As the overall magnification of this receiver going all-out is far too great for local station reception, it is necessary to incorporate a severe form of volume control. An obvious method would be to cut out the first valve, switching the H.F. input straight through to the detector.

This could be done, but the necessary switching is complicated, and leads to instability unless carefully arranged. It is simpler to reduce

AN EXTREMELY SENSITIVE "HOOK-UP"

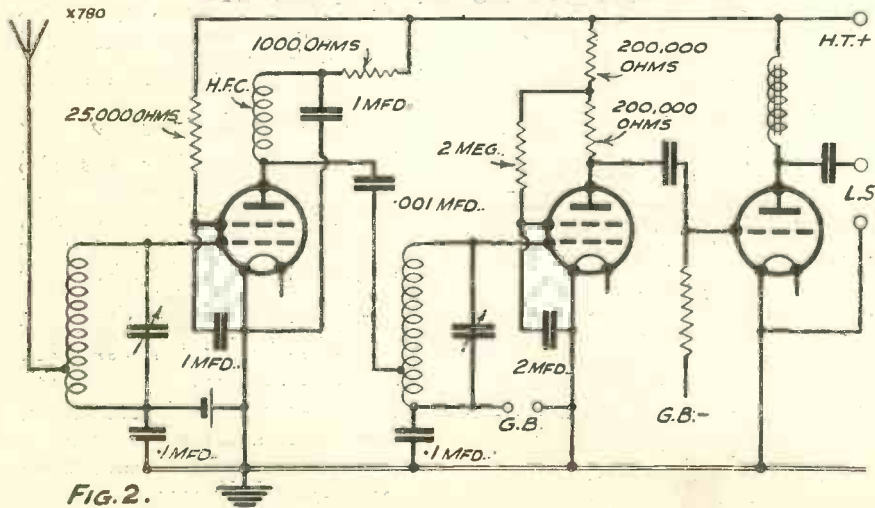

FIG. 2.

This is the first three-valve circuit tried. It is similar to the Fig. 1 circuit, but an H.F. stage has been added.

Making the Most of Modern "S.G.'s"

the amplification of the H.F. stage, which can be done in several ways in addition to the potentiometer control of screen volts.

The easiest method is to connect a small semi-variable condenser in the aerial lead, adjust this to give sufficient volume for local transmissions, with a switch to short-circuit it for distance reception. This is the simplest form of "local-distance" switch. It is certainly quite satisfactory in operation, provided the dual condenser tuning the band-pass coils is accurately ganged.

The Volume Control

Another easy scheme of volume control, which incidentally must come before the detector, is to arrange a fixed resistance of 50,000 ohms to be switched across grid and filament terminals of the intervalve coil for "local" reception. This does not impair selectivity, which is well cared for by the B.P. input tuning, while theoretically it should improve quality.

Although it is quite a practical plan to use a three-gang condenser for the tuning circuits, thus giving one-dial control, I have a preference for a separate condenser tuning the intervalve H.F. circuit, with the trimmer wired across one section of the B.P. unit, mounted on the panel. This enables you to get the last ounce out of the receiver on weak transmissions.

Just a touch on the trimmer very often makes all the difference in volume. Even if fully-ganged tuning condensers are used, the panel-mounted trimmer is an idea well worth adopting in any receiver.

Inter-Stage Screening

As regards layout, some screening is necessary between H.F. and detector stages. Usually a metal sheet is sufficient, unless coils and tuning condensers are all "canned," in which case no extra screening is necessary.

I also found it of advantage to use a metallised S.G. for the detector stage, as this further stabilises the H.F. stage and reduces the internal capacity of the detector itself. You can easily "metallise" an ordinary S.G. by wrapping it in the foil removed from a packet of tobacco! The foil is secured by a few turns of bare wire, the free end of this being taken to the negative filament pin.

The layout of the components forming the coupling between detector and output valves should be such that stray capacity and leakage paths are not excessive. A sound scheme is to use the new type fixed resistors with a length of wire at each end; no holders are then required, and a particularly compact assembly can be adopted.

In all the experimental tests described above a mains unit of generous output was used to supply H.T. current for all three valves. No trouble was experienced, at any time, from mains hum or other troubles often concurrent with mains operation.

in production of cones of truly symmetrical shape, may I suggest two variations from the methods you suggest.

First as regards attachment of the baffle ring. Instead of serrating the ring, cut the cone material one quarter of an inch larger than your specification, and serrate the edge back to the measurement you prescribe. Fold up (outwards) the serrations.

Constructional Details

Place a sheet of the cone paper on a flat surface—I use a piece of plate glass—and after gumming the turned-up serrations, place the cone on the

ANY STATION—ANY ITEM—ANY TIME!



The latest in American radio receiver stunts. It can be set in advance to pick out any 15-minute programme from any of six stations. When the time arrives it automatically switches on and delivers the "goods"!

CONCERNING CONES

An interesting letter from an enthusiastic home-constructor.

TO THE EDITOR.

Sir,—The article in a recent number on cone construction is very interesting to me as it confirms almost in detail a method which I have already tried out with excellent results, though employing a slightly different suspension.

For the benefit of those who perhaps have not had much experience

flat sheet of paper and, gently pressing the apex, let the cone take up its natural seating. Then press down the serrations. When dry, cut out the central circle from the mouth of the cone. A safety-razor blade is excellent for this. Also, cut round the perimeter of the cone mouth to leave, say, half an inch ring of flat flange. This method results in a perfectly flat flange, without distortion of the cone proper.

Yours faithfully,
J. S. MICHELMORE.

Streatham,
S.W.16.

RADIO NOTES and NEWS of the MONTH



seventeen aerials. Eleven of them will be of the reflector type and focussed for transmitting beam-like waves in specific directions. Six different wave-lengths will eventually be used: 14, 17, 20, 25.6, 32 and 48 metres.

A B.B.C. official stated recently that there was every likelihood of the station being completed before the end of the year, and that in all probability it would be possible to use it for broadcasting Christmas greetings to the Empire.

The Scottish Regional

THE B.B.C.'s new Scottish transmitter, which is being erected near Falkirk, has already reached an advanced stage of construction. The engineers' tests from the Regional have already started, but the National will not be introduced until August or September.

Something Revolutionary?

The B.B.C. is taking great pains to keep the secrets of the new transmitter closely guarded. Day and night watchmen are on duty at the site in quite surprising numbers, and they have instructions to exclude everyone from the station grounds until the station comes into operation.

The New Danish Transmitter

We learn that the Danish Government recently placed a large and important order in this country for

wireless gear for a new broadcasting station at Kalundborg. When this station is finished it will take its place among the ranks of the important high-power broadcasting stations of Europe.

The carrier power will be 60 kilowatts, increased by modulation to 100 kilowatts. We congratulate the Standard Telephones and Cables, Ltd., on securing this important contract. It is quite likely the station will be on the air early next year on a wave-length of 1,100 metres.

Our Empire Broadcaster

Small wooden masts, from 60 to 80 ft. high, will be used for the aerial circuit of the Empire wireless station at Daventry. In all there will be

The Radio Exhibition

The Radio Exhibition this year will be at Olympia as usual, but it will open a month earlier than last year, viz., on August 19th. Furthermore, the Grand Hall of Olympia will be used for the Exhibition for the first time. The idea of having the show earlier is that the trade will have a better opportunity of getting ready for the autumn season, and also that provincial listeners on holiday in London will have a better chance of seeing the Exhibition.

Naturally, MODERN WIRELESS, with its contemporaries, "Popular Wireless" and "The Wireless Constructor," will occupy a very conspicuous stand

(Continued on page 487.)

The newest thing in SHIELDED COILS



COMPLETELY SCREENED—LOW DAMPING LABORATORY MATCHED FOR GANGING

No longer is it necessary to buy new coils for practically every set you build. Here are coils which are almost universal in their utility. They are based on the research work of the Lissen laboratories and embody all the points which experience has proved to be necessary in coils for high efficiency. They can be used for band-pass tuning, or as ordinary

dual-range aerial coils, as tuned anode or tuned grid coils. Selectivity is of the very highest order, and long-wave "break-through" has been almost entirely eliminated. Shielding is particularly complete, with shielding cover and disc supplied. Full diagrams and instructions enclosed with each coil, price 6/6 each.

Obtainable from all good radio dealers.

6/6 LISSEN 6/6
DUAL RANGE SHIELDED COILS

YOUR SET DESERVES

THE BEST SPEAKER YOU CAN BUY

Made by the Pioneer Manufacturers of Moving Coil Speakers!

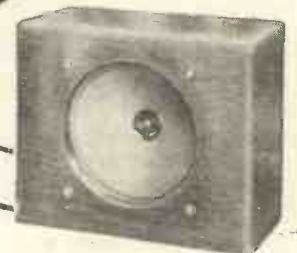

Every Music Lover

should hear these wonderful new models

"ELOMAG" & "PERMAG" MOVING COIL SPEAKERS

REALLY AMAZING PRICES

Complete with Cabinet from 25/-

BAKER'S 'Selhurst' RADIO

89, SELHURST RD S. NORWOOD S.E. 25.
Works and Demonstration Room:
42, CHERRY ORCHARD RD. E. CROYDON.
Phone: Croydon 1618.

Ask your dealer to demonstrate, he will be glad to do so. Also send for FREE LITERATURE—new issues just off the Press.

RADIO NOTES AND NEWS OF THE MONTH
—continued from page 486

at the Exhibition, and I understand that many surprises are in store for our friends who pay us a visit there.

Reciprocal Programmes

It will be interesting to see whether the reciprocal broadcasts between the B.B.C. and the Columbia broadcasting stations of America prove popular. By the time this issue is on sale, listeners on both sides of the Atlantic should have had an opportunity of judging.

Newcastle's New Wave-length

As we go to press we understand that 5 N O, Newcastle, is to have a new wave-length between 200 and 220 metres. At the time of writing no definite decision has been made, but there is no doubt that some alteration in the wave-length for Newcastle is necessary, for the new Scottish National transmitter will eventually operate on 288.5 metres—the common wave-length at present used by Newcastle.

Probably the change will not take place in 5 N O's wave-length until August or September, but it is just as well that listeners in that district should be fully informed in plenty of time beforehand.

Good Progress

Judging by the statistics recently published, the wireless trade advanced by 50 per cent during 1931, the sales figure of £20,000,000 for 1930 giving way to one of £29,750,000 last year. The Post Office state that 900,000 new licences were issued during 1931, and there must be at least one and a quarter million wireless sets in use in Great Britain to-day—and that is not taking into account pirate sets, if any. (We say "if any" because, to use a colloquialism, the G.P.O.'s vans have certainly "put the wind up" the pirate fraternity, and we should think that by now their ranks have been thinned very considerably.)

(Continued on page 488.)

POPULAR

For many reasons besides price

The J.B. "POPULAR" LOG CONDENSER—a typical J.B. product in its sound design, high electrical efficiency, and thorough finish.

Two models—plain or slow-motion—with rigid brass frames, vanes of extra heavy gauge brass, and end-plates highly finished in nickel-plate.

High-grade ebonite insulation. The slow-motion has a ratio of 35 to 1 and is smooth, silent, and sure in action.



PRECISION INSTRUMENTS

SLOW-MOTION type, as illustrated, with 3-in. dial and knob.

·0005, 8/6 ·0003, 8/3
·00025, 8/- ·00015, 8/-

PLAIN TYPE (without dials)

·0005, 6/- ·0003, 5/9
·00025, 5/6 ·00015, 5/6
4-in. dial, 1/6 extra.

Write for illustrated Catalogue.

Advertisement of Jackson Bros., 72 St. Thomas' Street, London, S.E.1. Telephone: Hop 1837.

SOLVE ALL H.T. TROUBLES

WET BATTERIES

TAYLEX

SELF GENERATING

Per doz.	No. 1	No. 2
	s.d.	s.d.
Jars (waxed)	1 3	1 6
Sacs	1 2	1 9
Zincs	10	11
Rubber Bands (24)	4	4
Terminals	8	10

Trade supplied.

LONG LIFE : SILENT : ECONOMICAL

Sample doz. (18 volts), complete with bands and electrolyte. No. 1, 4/1; No. 2, 5/-; post 9d.; terminals extra. No. 3, with terminals, 7/6 (10,000 milli-amp. sample unit 6d.). Orders 10/- carr. paid. New illustrated catalogue post free.

FREE Bargain List of Receivers, Amplifiers and Components.

M. TAYLOR, 57, Studley Road, Stockwell, London.

The ACME of CRAFTSMANSHIP

High-Grade RADIO-GRAMOPHONE CABINET

of exclusive modern design, hand made and polished, on Queen Anne legs.

Figured Oak £4 12 6
Figured Walnut or Mahogany £5 10 0
Carriage paid.

Illus. Catalogue Free. Cabinets made to order a speciality.

GILBERT
Cabinet Maker,
SWINDON
Estimates Free. Estd. 1866

Non-discolouring

SPECIFIED FOR THE "TIMEPIECE 3"

The only Ebonite guaranteed never to spoil your set by discolouring.

Black, Mahogany or Walnut finishes with an amazing mirror polish. Easy to cut and drill and costing only 4/6 for 7" x 18" panel (Black).

Ask your dealer or write to us for list. Any panel size cut. Cash or C.O.D. by return.

BRITISH HARD RUBBER Co., Ltd.,
PONDERS END, MIDDLESEX.

PERMCO

Make **The DAILY SKETCH**
YOUR Picture Paper.

"OHMITE" RESISTANCE

ALL values from 300 ohms to 5 megohms 1/6 Holder 6d.

"BETTER THAN WIREWOUND!"

GRAHAM-FARISH

Ohmite

Made by **GRAHAM FARISH**
Bromley Kent.



DENOTES
QUALITY



3-AMP.
250 V.

"B.A.T." No. 2728 DOUBLE POLE SWITCH

A new D.P. Switch of usual "B.A.T." general 'snappiness' and electrically perfect.

"INDICATING," as shown	3/9
No. 728. S.P. "ON-OFF"	2/-
No. 730. S.P. Terminals	2/3
No. 729. S.P. 2-Way	2/6
No. 161. SEMI-ROTARY (as in D.C. "W.W.-3")	2/9

12-page Booklet, numerous illustrations with exceptions by useful circuits, by return or from all good dealers. BEWARE OF IMITATIONS OF OUR SWITCHES—THERE ARE MANY.



TYPE H. D.-30 "HUMDINGER"
A.C. HUM SUPPRESSOR 3/-

This device is essential in all A.C.-operated apparatus, and is specified for the "Timepiece Three," Pamphlet (with circuit) free from:

CLAUDE LYONS LTD.
76, Oldhall Street, Liverpool, London: 40, Buckingham Gate.

RADIO NOTES AND NEWS OF THE MONTH

—continued from page 487

"It Is a Lie!"

A suggestion was made in the House of Commons recently that the Government's £17,500 a year Opera subsidy was being used not only for the presentation of new operas, but to pay off losses incurred by the syndicate before the subsidy was granted. Lady Snowden, who is a Governor of the B.B.C. and a Director of the Covent Garden Opera Syndicate, stated emphatically to a newspaper man in respect of this suggestion: "It is a lie!"

More Advertising!

Sponsored programmes from the Continent are becoming more frequent, and in a few weeks' time, when the Luxembourg station is completed, listeners in this country will have another example of the sort of fare sent out by a sponsored station.

The new Luxembourg transmitter has been testing lately on a small scale on 1,250 metres, but when the station is really ready to take its place in the ether it will use a power of 200 kilowatts—more than six times that of the present Daventry long-wave transmitter, and twice that of the proposed National transmitter to be erected on a site near Droitwich.

Seven-Metre Tests

At the time this issue is on sale the B.B.C.'s new 7-metre transmitter should be delivered at Broadcasting House. No transmissions may be expected, however, for about a month, and tests—when they begin—will be definitely of the experimental nature.

The B.B.C. admits that 7-metre transmission will be a distinct novelty in this country, but it attaches great importance to the possible technical results obtainable, and, should the experiment prove successful, it is quite likely that within a year or two we may have quite a number of 7-metre transmitters dotted about the country.

Of course, the object is to provide miniature relay stations, each one serving a restricted area, and using a wave-length of 7 metres, so as to avoid interfering with the other baby transmitters.

A NEW ALL-WAVE SCHEME

—continued from page 442

Fig. 1 shows you a straight detector circuit arranged in this way. The five numbered points represent five of the sockets of a six-pin coil-base. You will note that the .0005 condenser is tuning two turns of an eight-turn coil, and also that the aerial is tapped, through the usual small series condenser, down on to the bottom end of the coil.

Simplifies Tuning

In Fig. 2 you see the broadcast coil in action. The whole coil is now tuned, and the aerial is tapped, still through its condenser, on to the top of the coil.

Probably your only comment will be: "How very obvious!" It certainly is! So much so that I have frequently kicked myself for not having thought of it before; particularly as the first set in which I have incorporated the scheme is by far the best "all-wave" set I have ever used myself.

On short waves it is really easy to handle. The band covered is not more than about 4,000 kc. wide until one gets right down to the bottom of the "spectrum," and in those regions there are not many stations to bother about. But with almost any good slow-motion drive I guarantee that the rawest novice could tune in Nairobi or Sydney after five minutes' practice.

There is another distinct advantage that this arrangement can claim over those relying on complicated switching—that of short wiring. I have chosen the pins on the coil-base in such a way that they give a nice layout; you will not find parts of the tuned circuits straying all round the set.

Full Details Later

Later I hope to publish full details of the first set incorporating this system, together with dimensions for the full range of home-made coils. The latter will probably be obtainable from certain component manufacturers, and I believe there are still plenty of folk who enjoy the task of coil-winding! For their benefit the particulars will be given.

In the meantime, please don't write and point out to me that I have always expressed the opinion that a separate set is desirable for short waves. Even the male sex is allowed to change its mind sometimes.

MOVING-COILS FOR THE MILLION

NEW "WB" MODEL P.M. 4



42! PERMANENT MAGNET Moving Coil Speaker.

Complete with special output transformer mounted on top.

Write for leaflets (post free.)

WHITELEY ELECTRICAL RADIO CO., LTD.
Radio Works,
Nottingham Road,
Mansfield, Notts.

Irish Free State Distributors: **KELLY & SHIEL, LTD.**, 47 Fleet Street, Dublin.

A triumph by Britain's most famous makers, after months of research. Glorious and true moving-coil reproduction from ANY 2-, 3-, or multi-valve set. No mains needed. Sheffield-made cobalt steel magnet guaranteed for 5 years.



ON THE TEST BENCH

—continued from page 469

commend itself to the constructor on account of its compactness and reasonably high efficiency.

It has been designed for universal application, although there is to be a special H.F. type for use in centre-tap tuned-anode circuits.

A New Output Choke

Equally attractive in its way is the new Lotus output choke, having an inductance of 20 henries, and designed for sets in which the anode current of the output valve does not exceed 12 milliamperes. The price is 5s. 6d., but despite its small size this choke has a D.C. resistance of only about 700 ohms, which is by no means high for this class of article.

And within the limitations of its specification it functions very well indeed, and should prove a good seller among the owners of the smaller types of sets.

In a quite different category is the new Lotus ganged condenser which incorporates a really splendid slow-motion drive. It is a thoroughbred Lotus product in every way, and is one of the best pieces of condenser engineering we have come across.

It is built on robust lines in order to ensure a permanence of matching between the units, each of which is completely screened from the other. There are easily accessible and easy-to-adjust trimmers.

Easy to Fit

A great feature from the constructor's point of view is that the component is particularly simple to mount. There is an illuminating light and a handsome escutcheon.

In operation this Lotus gang is delightful to handle, and the readings are quickly and accurately obtainable. It is available in two-, three-, and four-gang models, with either disc or drum drive.

NEXT MONTH

Look out for a special article by "M.W.'s" popular contributor, W.L.S., in which he will describe his new

ALL-WAVE RECEIVER

The June "M.W." will be
ON SALE JUNE 1st.
1/- ORDER NOW.

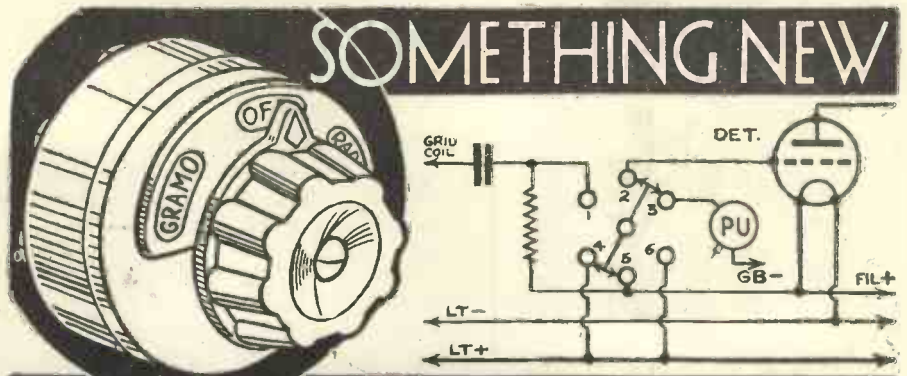

SOMETHING NEW
IN RADIO-GRAM SWITCHES

THE LATEST SWITCH IN THE BULGIN RANGE

This unique switch is just the instrument you require where economy of space is a prime consideration. It simplifies the operation of a set by eliminating one control.

The action is totally enclosed and dustproof and operates with a reassuring "snap." The hexagon shaft is fully insulated and six hexagon terminals are fitted.

Specification:
Double Pole Double Throw Rotary Switch. Fitted with bakelite plate engraved: **GRAM-OFF RADIO.** List No. S110

2/6

Send 2d. postage for 75 pp. Illustrated Catalogue and Manual.

A. F. BULGIN & CO. LTD.
Abbey Road, Barking, Essex

Telephones: - - - Grangewood 3266 & 3267.
London Showrooms: 9, 10, 11, Cursitor Street, E.C.4.
Telephone: - - - Holborn 2072.



Quality Radio Components

Famous Makers' Offer! **£5 Radio Gram CABINET for 65/-**
7 DAYS' FREE TRIAL

Polished Oak, Piano-Tone Cabinet (32 in. high x 24 in. wide) ON APPROVAL. You may return at our expense if you wish to part with it. (3,000 clientele, B.B.C., Radio Press.)

10/- monthly if desired

PIANO-TONE

Patent 8123 acoustic chamber yields mellow, rich, full volume that your speaker is really capable of.

PHOTOGRAPHS AND LISTS FREE.

PICKETTS Piano Tone Cabinets (M.W.), Albion Rd., Bexleyheath, Kent.

ALL MODELS FROM 35/- to £15.

"SQUARE PEAK"

REG. TRADE MARK

MODERN SQUARE PEAK BAND-PASS CIRCUITS

FREE!
Post
This
Coupon
to

Varley DATE

Advert. of Oliver Pell Control, Ltd.
To Messrs. **VARLEY**, Kingsway House, 103, Kingsway, London, W.C.2.

Please send me, free and post free, the "Square Peak" circuit booklet entitled **MODERN "SQUARE PEAK" BAND-PASS CIRCUITS FOR EVERY REQUIREMENT.**

NAME

ADDRESS

M.W.3.

The Picture Paper with the **MOST News—**
SUNDAY GRAPHIC
and **SUNDAY NEWS.**

THE "MORCO" GOTHIC CABINET No. 1069
Selected for the "Timepiece" Three.
For particulars write **R. Morton & Co., Ltd.,**
Mappin Buildings, Norfolk St., Sheffield.

WE invite readers to support our Advertisers. Care being taken to accept only announcements of reputable firms!



Send me—

Details of the D.150 Mains Unit which gives an output of 120 or 150 v. at 25 m.a., Tappings: 60/80 v. Var. S.G., 120 v. and 150 v. fixed. Complete in neat steel case. Westinghouse Rectification. Ready to switch on. I enclose 3d. stamps.

M.....
Address.....

M.W.



MONARCH OF THE MAINS.

10, FINSBURY ST., LONDON, E.C.2.
(One minute from Moorgate Und. Stn.)

**GET ALL YOUR
RADIO FROM
READY RADIO**

EASTNOR HOUSE, BLACKHEATH, S.E.3.
Lee Green 5678.

**A "SOUND"
INVESTMENT!**

"Sound"—in looks and performance. Camco Cabinets are in step with Set and Speaker, and represent astonishing value. Write for the Camco Radio Cabinet Catalogue—FREE.



CABINET

GARRINGTON MF., CO., LTD.
Showrooms: 24, Hatton Garden, London, E.C.1. Phone: H. Lborn 8202.
Works: S. Crorden.



THE
"WINDSOR"

ADVERTISEMENTS

As far as possible all advertisements appearing in "Modern Wireless" are subject to careful scrutiny before publication, but should any reader experience delay or difficulty in getting orders fulfilled, or should the goods supplied not be as advertised, information should be sent to the Advertisement Manager. "Modern Wireless," 4, Ludgate Circus, London, E.C.4.

MEET STRAVINSKY . . . !

—continued from page 401

the best selling of modern-music records is his Capriccio for Piano and Orchestra. That was the piece in which he recently played at the Queen's Hall when Ansermet conducted.

Stravinsky went with a Russian producer to a gramophone studio in Paris, and the producer rehearsed the Walthar Straram Orchestra of Paris in this exceedingly difficult concerto, while Stravinsky looked on and ejaculated staccato comments.

Saving the Record !

On the final day, when the recording was ready to take place, Stravinsky turned up in a sporting outfit, woollen pull-over and flannel "slacks," and played the loud piano passages in the manner of a boxer! But the engineers were expecting it, and careful handling of the volume control prevented the cutting needle jumping right off the wax! As a matter of fact, it is a very good record.

He is not always able to have his own way, though. Just before the Queen's Hall was taken over by the B.B.C., Stravinsky came over to England to conduct the first performance in this country of his *Les Noces*. It was not broadcast. The B.B.C. was not asked to do so.

Even if there had been an invitation, the engineers would probably have turned it down! *Les Noces* is scored for four solo singers, four pianos, a xylophone and a battery of percussions!

It was not broadcast, but a concert-hall audience heard it. So many rude things were said by anti-modernists that Mr. H. G. Wells wrote to "The Times" asking that there should be a fair hearing for what he thought was a work of genius!

Listeners Like Him

Yet, strangely enough, he doesn't seem to infuriate listeners in the way he upsets concert-goers. He has broadcast eight times, and yet even the most musically uneducated listener doesn't class his music as "foul," as he may do of other modernists.

Although he knew that the Capriccio for Piano and Orchestra would be recorded in Paris, and he probably guessed that the B.B.C. would ask him to do it over here, it is a most unsuitable piece for the microphone. There are huge climaxes of

sound suddenly ending in a sustained note on the piano, while the orchestra ceases entirely.

When at the Queen's Hall last year he spent the best part of a day discussing with Jack Hylton how a dance orchestra could orchestrate some of his (Stravinsky's) pieces for broadcasting and gramophone recording.

Deserves a Hearing

He was quite prepared to change the scores of some of his less important pieces if a better microphone effect could be obtained.

After all, if a modern musician can try to rope in his genius to accommodate the deficiencies of the "mike," then we ought to give him a hearing.

To me the Queen's Hall doesn't seem the right place for Stravinsky. John Ireland, one of our own British modern musicians, spent long hours with Jack Payne in arranging broadcast material, and he worked up in the studio.

That is in the Stravinsky style. Stravinsky is more at home in a gramophone or broadcasting studio, in sports outfit, than in the dress-shirt atmosphere of a concert hall.

**BEHIND THE SCENES
OF BROADCASTING**

—continued from page 467

one of the control-room engineers. As a by-the-way, I asked:

"Did I come over well when I broadcast the news?"

"Did you broadcast?" he returned with a grin.

And that is where the story ends. To this very moment I cannot say for certain whether or not I really did broadcast. You see, it was a highly irregular proceeding if I did, and the engineer might have been giving me a broad hint that *officially* I had not broadcast. On the other hand, the whole thing may have been a leg-pull, for our broadcasters, or many of them, are sufficiently human to enjoy little jokes of that character! I had neither the opportunity nor the inclination to probe the matter deeply, and so it remains one of the minor mysteries of my life!

But I should make it clear that the above incident happened about five years ago, and even if the officials concerned are still with the B.B.C. they need have no fear that I shall reveal their names, and this also applies to the following.

(Continued on page 491.)

BEHIND THE SCENES OF BROADCASTING
—continued from page 490

At around about the same period, but at another British broadcasting centre, a jovial radio "uncle" was conducting a children's hour. It was a cheery little performance, and no doubt tens of thousands of kiddies thoroughly appreciated it.

Poor Listeners !

There was appropriate music and much lively patter by the various "aunts" and "uncles." At length the conclusion arrived and our particular "uncle," thinking the microphone had been switched off, emitted a loud "Phew!" and added: "Thank heavens we've got that so-and-so slosh off our necks!"

But he didn't say so-and-so, and the microphone *hadn't* been switched off!

Which reminds me of a very similar radio *faux pas*.

At yet another station the announcer was reading something for the benefit of listeners. For the space of about twenty minutes he had been exercising his epiglottis with all the grace and skill at his command. He had nearly reached the end of his session when the door of the studio was abruptly opened and an engineer appeared and said, loudly:

"We've broken down."

A Little Forcible !

The announcer threw aside his book.

"Oh, well," he said, resignedly, "let me know when we're O.K. again. How long have we been down?"

"About a quarter of an hour, I think."

"And you mean to say you've let me blurb away here !!! * * * * !—"

His language was forcible, if not quite B.B.C.-ish!

And the tragedy was that two seconds before the engineer had burst in, the transmitter had been got working, and the whole of the above dialogue broadcast through the startled ether!

Although, as I have already indicated, the people concerned in the foregoing incidents must remain anonymous, there is no reason why I should not tell you that the Cardiff station was the locale and Mr. Settle my informant of my next batch of radio reminiscences.

Cardiff's first broadcasting studio was situated on the premises of the Castle Street Cinema, and it was a rather cramped, tiny studio. There were four microphones, and one of these had been fixed only a few inches from the floor level in order to cope with certain "effects" necessitating a particularly low "mike" position.

The Resourceful Director

The station director of the time (he has since resigned) was broadcasting something one evening when his "mike" suddenly went out of action. Quickly, but without panic, he sprinted across to another, but that also was "dud."

With growing anxiety he tore across to the third, but, as luck would have it, that too was right out of commission. Not to be daunted, he threw himself down on to the floor and continued his broadcast through the fourth and floor-level mike!

And yet, so I was informed, this resourceful broadcaster's speech went out perfectly and nothing of the behind-scenes contretemps was evident in his voice except a slight pause!

On another occasion this same man was taking part in a radio play. There was a scene when, in naval

fashion, he was supposed to drink a toast and then throw the glass over his shoulder into the fireplace.

Being a great stickler for realism, he had provided himself with a full glass of—water. But presumably the liquor did not prove sufficiently inviting to ensure him polishing it off. In actual fact he only sipped at it, and then cast the glass behind him.

The fluid swished over his head, swamped down his neck and cataracted down his shirt-front. And yet such was his and the other actors' self-control that not an exclamation or a giggle was allowed to escape into the ever-alert mike, and the play proceeded uninteruptedly!

Another Cardiff Story

Although it may not sound true, but it is a fact that during a serious play of a military character one of the actors had to utter the melodramatic words:

"Ah! I hear soft strains of mysterious music."

This was the cue for the band which was in attendance to play, very softly, "St. George For England." But the cue badly miscarried, and instead they blared in loudly with "It's a Long Way to Tipperary!"

Very funny—but the station director didn't think so!

USED UNIVERSALLY
The World's Standard for Eight Years—Still the Best.

"B" Type. Non-rotating name. 2 B.A. stem. Price 6d. each.
"R" Type. Rotating name. 4 B.A. stem. Price 3d. each.

BELLING-LEE TERMINALS

Advert. of Belling & Lee, Ltd., Queensway, Ponders End, Middlesex.

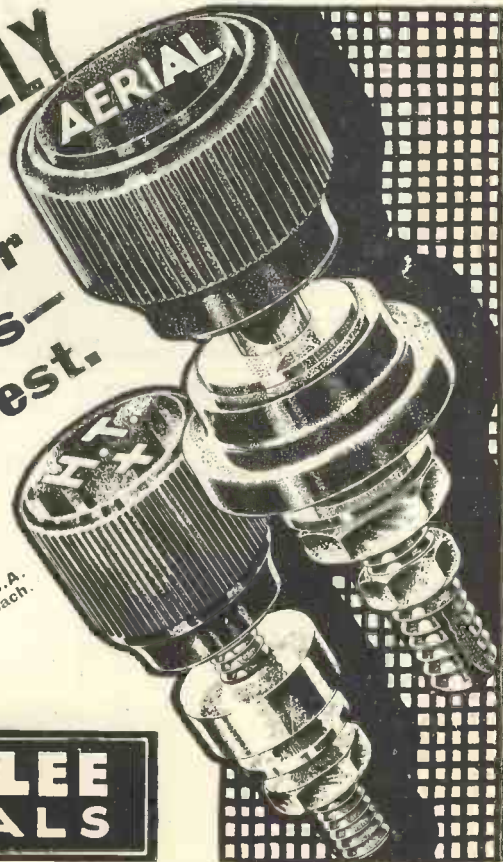

IN PASSING

—continued from page 472

“Waal, I’m Amurrican, and I’ve been putting over a bit of painting in Minalj, yonder. Guess I sorter strolled too far last night, and got kinder lost. Then I hit that burg where the Mayor fell for me.”

The Mayor! *Der* Mayor! Just the veriest trace of *der*! I didn’t like it a little bit.

“Got some Dutch in you on mother’s side?” I asked—very rudely I suppose.

“N—no! Er—yes! That is—how did you know?”

Jane Gets Scared

“I didn’t know! Well, Miss—er—as I said, I’m afraid you’ll have to find your way back to Minalja directly it’s light.”

“He’s coming after me again. Look, over there!” she cried.

We looked, and to the west, about 200 feet below, we saw a man coming slowly over the broken boulders towards the camp.

She retired to Buck’s tent during the shindy, and I’m bound to say I forgot her. But Alonzo didn’t. Somehow he managed to spit out the gag.

“Quick! Mister! Ze gal. She are espy. I got papers about ‘er. Damfino espy. She go!”

We turned like Shell’s famous

policeman in the advertisements, and, by gum, she had mizzled!

Buck dashed to his tent.

“The code book’s gone, too,” he yelled.

“My sainted aunt,” I groaned, “this is a mess.”

Then I went to my tent, and the first thing I saw was my old topee with my copy of “Boswell” lying in it; I never travel without that book. The next moment I was flying out of the tent.

**The JUNE ISSUE of
“MODERN WIRELESS”**

will be on Sale on
WEDNESDAY, JUNE 1st

and will be an exceptionally
interesting number for long-
distance listeners.

“Buck,” I yelled, “it’s O.K. I’ve got the code and Jane’s got my Boswell. They’re both covered alike—and I must have mixed ‘em up last night!”

A SIMPLE “SUPER”

OWING to a draughtsman’s error, there was a mistake in the theoretical diagram of the above set last month. The wire joining the anode of the fourth valve to H.T. positive should be omitted.

A DE-LUXE RADIO-GRAMOPHONE

—continued from page 462

On test we heard an amazing number of stations, and the 80 or 90 claimed by the makers should often be exceeded, while volume and quality with which they were received made most of them definitely of real programme value. The gramophone side, of course, is up to the usual H.M.V. high standard.

The idea of having the push-pull amplifier in a separate unit under the main six-valve super-het. chassis is good, as it makes for easy servicing, while the suspension of all the chassis on sorbo rubber does a great deal to ensure trouble-free running.

Automatic Record Changer

We have said a lot about the set, but we have left one most important thing to the end—the fact that the 531 is, in addition to all we have said before, equipped with the H.M.V. automatic record changing device. This final touch places the set definitely at the head of all radio-grams.

And don’t forget that all H.M.V. radio-grams can be heard in your own home, without obligation to buy, if you will just drop a line to the Gramophone Company, or have a chat with your local H.M.V. dealer.



for Better Reproduction

The **GRAHAM FARISH**

Driven by 4-pole adjustable Unit.
Cobalt steel magnet. Distinctive Bakelite cabinet in Walnut, Oak or Mahogany finish.

“AMAZING” SPEAKER

At all Radio Dealers.



INDEX TO ADVERTISERS

	PAGE
Baker’s “Selhurst” Radio	486
Belling & Lee, Ltd.	491
British Blue Spot Co., Ltd.	Cover ii
British Hard Rubber Co., Ltd.	487
British Insulated Cables, Ltd.	Cover iii
Bulgin, A. F., & Co., Ltd.	489
Burne-Jones & Co., Ltd.	486
Carrington Manfg. Co., Ltd.	490
Clarke, H., & Co. (M/cr.), Ltd.	471
Cossor, A. C., Ltd.	398
Celestion, Ltd.	481
Dubilier Condenser Co. (1925), Ltd.	471

	PAGE
“Daily Telegraph”	479
Edison Swan Electric Co., Ltd.	Cover iv
Ferranti, Ltd.	397
Gilbert, J. C. (Cabinets)	487
Graham Farish, Ltd.	487 & 492
Gramophone Co., Ltd.	476 & 477
Heyberd, F. C., & Co.	490
Igranic Electric Co., Ltd.	479
Jackson Bros.	487
Lissen, Ltd.	486
Lyons, Claude, Ltd.	488
Morton, R., & Co., Ltd.	489

	PAGE
Peto-Scott Co., Ltd.	479
Pickett’s Cabinet Works	489
Pifco, Ltd.	479
Ready Radio, Ltd.	490
Reproducers & Amplifiers, Ltd.	Cover iii
Taylor, M.	487
Varley Products	489
Whiteley Electrical Radio Co., Ltd.	488
Wingrove & Rogers, Ltd.	491
Wright & Weaire, Ltd.	481

All communications concerning advertising in “Modern Wireless” must be made to John H. Lile, Ltd., 4, Ludgate Circus, London, E.C.4. Telephone: City 7261.

B.I. ENAMEL COVERED WIRES

B.I. Enamelled wires are unequalled for the field windings of small motors, measuring instruments, radio transformers, and other pieces of electrical apparatus where space is all-important. They are produced throughout in our own works, from the raw material to the finished wire, and every phase of manufacture is under the strictest control as regards quality of material and accuracy of gauge. B.I. Enamelled Wire is unexcelled for its high insulation, dielectric strength, flexibility of enamel, and general dependability. We regularly manufacture Enamelled wire as fine as '002" dia.



BRITISH INSULATED CABLES

LIMITED

PRESCOT-LANCS

Makers of B.I. Cables

Telephone No.: PRESCOT 6571.

London Office: Surrey House, Embankment, W.C.2

Telephone No.: Temple Bar 4793, 4, 5 & 6



The R & A 'Challenger,' notwithstanding its phenomenally low price, will, given an undistorted input, reproduce speech and music with absolute fidelity. Its sensitivity is such that it gives satisfactory results when used with the average power valve, and it will accept 3 watts undistorted A.C. without distress, thus providing a volume of reproduction more than sufficient for normal requirements.

35/-

INCLUDING
MULTI-RATIO
FERRANTI
TRANSFORMER

(TO R & A SPECIFICATION)

BRIEF SPECIFICATION:—

- CHASSIS.** 8½" diameter, pressed steel, stove enamelled black, fitted with felt facing sectors.
- DIAPHRAGM.** 6½" diameter, moulded in one piece with surround.
- COIL.** 1" diameter, 6.7 ohms impedance at 1,000 cycles.
- MAGNET.** Forged 15% cobalt steel, cadmium plated. Flux density 6,800 lines per square centimetre.
- TRANSFORMER.** Bolted to chassis. Ratios 19, 33 and 44 to 1, large core, sectional primary winding. Made by Ferranti, Ltd., to R & A specification.

Your Dealer will gladly demonstrate. Write us for Descriptive Literature.

Reproducers & Amplifiers Ltd., Frederick St., Wolverhampton.

The R & A "CHALLENGER"

**PERMANENT MAGNET MOVING
COIL REPRODUCER**

2 VOLT MAZDA MASTERPIECES

REDUCED PRICES

H.210	-	-	-	7'6
HL.210	-	-	-	7'6
★HL.2	-	-	-	7'6
★L.2	-	-	-	7'6
P.220	-	-	-	8'9
P.220A	-	-	-	12'6
P.240	-	-	-	12'6
PEN.230	-	-	-	17'6
PEN.220	-	-	-	17'6
PEN.220A	-	-	-	17'6
S.G.215	-	-	-	16'6
★S.215A	-	-	-	16'6
★S.215B	-	-	-	16'6

★ METALLISED



LOOK FOR
"EDDY" IN
YOUR DEALER'S
WINDOW

THE AMAZING

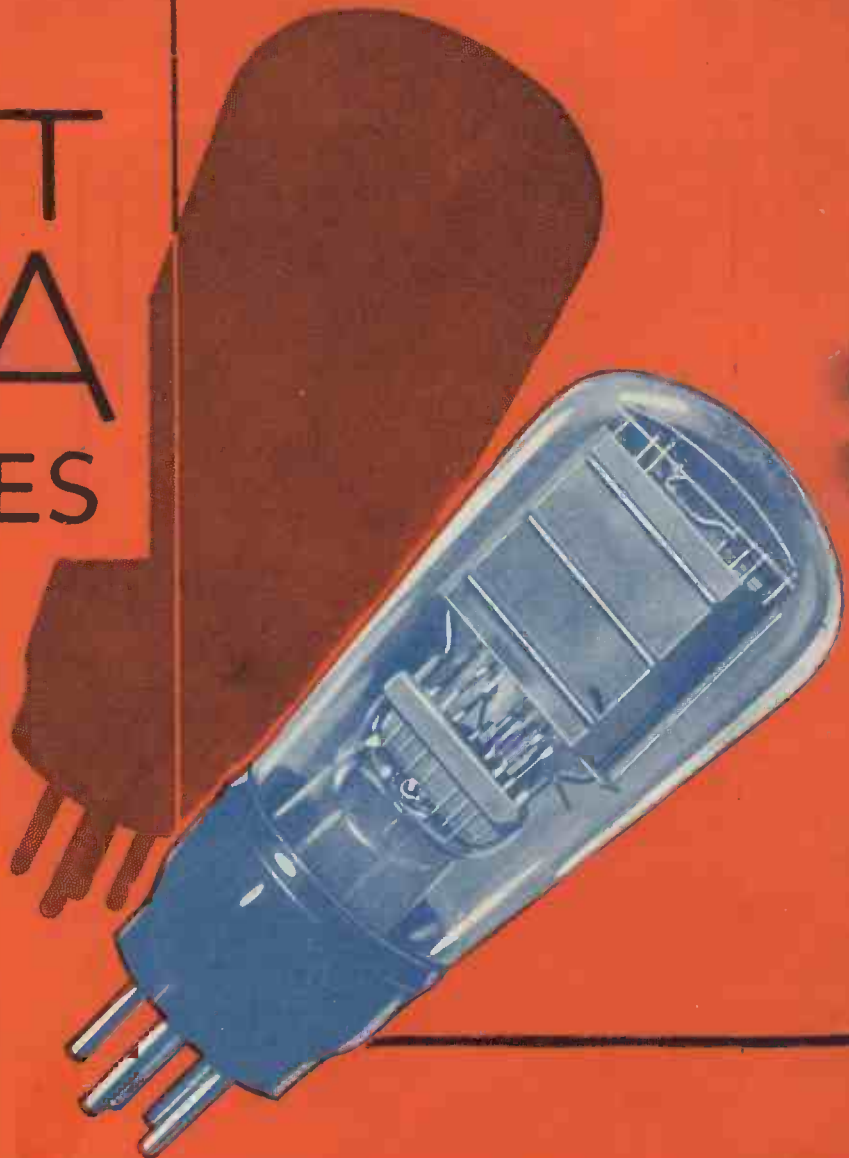

Never, in the history of 2-volt valves, has there been such an amazing range as this—so much evidence of brilliant engineering—so many valves with outstanding characteristics. Instance the Pen.220; a pentode valve which at once presents the solution to the output stage problem in portable sets, giving an extraordinary large output for a combined screen and anode current of under 5mA. It is a valve for which dry battery users have long waited.

Being typical of all Mazda valves, it is outstanding in its efficiency. Mazda 2-volt valves, both metallised and clear bulb types, are sold by all good radio dealers.

MAZDA PEN. 220

Characteristics:

Filament Voltage	-	-	2.0 volts	Anode Current (Max)	-	12 mA
Filament Current	-	-	0.2 amps.	Screen Voltage (Max)	-	150 volts
Anode Voltage (Max)	-	-	150 volts	Mutual Conductance	-	2.5 mA/V
At Ea	-	-	100;	Es	-	100;
				Eg	-	0.

PRICE 17'6

MAZDA THE BRITISH VALVES

