

# Sets for Every Pocket

A COMPLETE  
RANGE OF  
RECEIVERS  
FOR ALL  
PURPOSES &  
AT ALL PRICES

FROM 2/6<sup>d</sup>  
TO  
£10







**USE YOUR OWN  
INITIATIVE—  
GET BETTER  
RESULTS—and  
SAVE MONEY**

A childlike ease of assembly alone is not sufficient inducement to offer the thinking constructor as a reason for rushing in to blindly build. Constructors to-day are capable of using their own hands and brains, and there are 10,000 Lissen dealers who will help them. When they build they are capable of using their own judgment in selecting the parts which offer them the certainty of better results and best value for the money they are asked to spend.

Lissen now offer the constructor a complete range of important parts. Take any circuit you like, but before you build compare side by side the quality of the parts, compare prices, criticise, analyse. And when you come to hearing results, it will be an achievement you will be proud to remember, that you adopted a circuit, and of your own initiative substituted Lissen parts and in that way got such far better results and at less cost than your friends, who merely followed easy instructions.

**LISSEN L.F.  
TRANSFORMER**

The popular Transformer, 4 to 1 ratio, that became known last year as "the transformer that never breaks down." **8/6**

**LISSEN SUPER  
TRANSFORMER**

This is a Transformer of advanced design, which you will use when particularly pure reproduction is desired. Ratios  $3\frac{1}{2}$  to 1 and  $2\frac{1}{3}$  to 1. **19/-**

**LISSEN VARIABLE  
CONDENSER**

·0001 mfd. capacity .	5/9
·0002 " " ..	5/9
·0003 " " ..	6/-
·00035 " " ..	6/3
·0005 " " ..	6/6

**LISSEN WIRE-WOUND RESISTANCES**

The Resistances are made in the following values:

Ohms	Price	Ohms	Price
10,000 ..	3/6	80,000 ..	4/-
20,000 ..	3/6	100,000 ..	4/6
25,000 ..	3/6	150,000 ..	5/6
50,000 ..	3/6	200,000 ..	6/-
	250,000 ohms ..	6/6	

**LISSEN FIXED  
CONDENSERS**

Deliver all their stored-up energy.

·0001 to ·001	1/- each
·002 to ·06 ..	1/6 each

You can get the new Lissen Components from practically every radio dealer.



# SETS FOR EVERY POCKET

Specially compiled by the "M.W." Technical Staff, and presented free with "Modern Wireless" for November, 1928.

**H**OWEVER much one schemes and "wangles" one cannot obtain, honestly, more than a certain amount of radio gear for a definite sum of money. Therefore, it is useless for an amateur with a one-valve pocket to have four-valve aspirations. In such circumstances he must see that the one-valve size of set to which he is restricted is the best possible available.

Unless he is an expert he will need guidance, and it is in this manner that he will find this "M.W." book of the greatest possible value.

## Every Set Fully Described

We have chosen a range of eight receivers, the costs of which vary from 2s. 6d. to £10, which is representative of first-class modern set design. Each of the sets is fully described in this book and every relative constructional detail is given. The descriptions are supplemented by photographs, wiring diagrams and everything else necessary to make the task of the constructor as simple as possible.

In this range of sets there are designs suitable for every pocket and for every purpose. If you have only a few shillings to spend there is a set which will meet even this difficult proposition. If pounds are at your command, then you can choose between several instruments giving first-class loud-speaker results from far-distant broadcasters.

The prices given are as close as is practical; it will be appreciated that a certain latitude must be allowed in order that the constructor can pick his components from a number of the reputable manufactures. In all cases the figures given cover the cost of first-class components and parts. Considerable economies may in certain instances be effected, but the constructor should not endeavour to go about such business without expert assistance.

The reader can rest assured that none of the sets incorporates extravagant refinements, but on the contrary, every endeavour has been made to reduce initial outlay to practicable minimums. Where still further money can be saved by certain minor or major sacrifices or by compromise, these are fairly and impartially brought forward in the various articles, and the case for and against candidly placed before the reader.

## Real Value for Money

Better than building a four-valver with shoddy gear is to assemble, for the same outlay, a first-class two- or three-valve set; it will probably give just as good results.

Now a word or two in regard to the actual sets dealt with in this book. The first two are crystal sets, one of which can be built for 2s. 6d. This is an extraordinarily minute sum when one considers what the set will do. That a crystal set gives one concerts every night of every week, with never a penny to pay for maintenance, is one of the wonders of wireless. That a good crystal set can be

## Introduction

By G. V. DOWDING, Grad.I.E.E.

(Technical Editor).

built for half-a-crown is even more wonderful! And it is a good set which will give as loud and clear results as an expensive show-room model.

The de luxe crystal receiver is a more expensive

assembly. But here again the constructor gets value for money spent. The set is fitted with a "wave-change" switch and merely by pressing this the long-wave band in which 5 X X (Daventry) is active becomes immediately available. Another flick of the switch and you are back on the "local" wave-lengths.

If you think 70s. is rather a lot of money to spend on a one-valve set, we would earnestly request you carefully to read the article concerning this set in order that you can see what you get for that sum. In short, this set enables you to obtain just about as many stations on a one-valve set as is—with our present knowledge of the art—possible under varying conditions.

## Up-to-Date and Reliable Designs

The "M.W." Short-Wave Converter is a very novel instrument, and no representative range of "M.W." sets could fail to include it. Based on the original "Antipodes Adaptor," it instantly renders any ordinary set suitable for the reception of short-wave stations such as 3 L O of Australia, K D K A of America, and so on.

The "Two-Valver For 100s." is another flexible set, although its flexibility is of a different nature to that of the above-mentioned one-valver. The "100s. Two" is suitable for the reception of the

short waves as well as for ordinary broadcasting—you merely have to change the coils—and should make a strong appeal to the constructor having experimental tendencies.

A "Three-Valve Set for 80s." is a technical bargain. And our "80s. Three" is no rag-and-bone assembly. This is proved among other things by the fact that it incorporates a right-up-to-date wave-change scheme. Ordinary and long waves are available without coil-changing. The circuit used in this set is known technically as a Det.-Resis-Trans.—without doubt the most popular arrangement of valves so far introduced. Very respectable long-distance loud-speaking is possible with this set.

The "H.F., Det., L.F. Loud-Speaker Set for £8" is one of the most efficient designs we have ever produced. Its selectivity and sensitivity are both much above the average.

The "£10 Four-Valver" is a really long-distance loud-speaker set capable of producing punch with purity. In its way it is just as good value for money as the 2s. 6d. crystal set. It is a thoroughbred design—were it otherwise it would not have been described in this book.

In conclusion, we would like to point out that reliability and ease-of-construction were factors which were clearly borne in mind in the design of all the sets in this book as well as the other qualities indicated. Every set was very thoroughly tested before being "passed for publication."

## CONTENTS.

	PAGE
A Crystal Set for 2s. 6d. . . . .	2
A De Luxe Crystal Receiver . . . . .	4
A One-Valver for 70s. . . . .	6
The "M.W." Short-Wave Converter . . . . .	9
A Two-Valver for 100s. . . . .	13
A Three-Valver for 80s. . . . .	17
An H.F., Det., L.F. Loud-Speaker Set for £8	21
A £10 Four-Valver . . . . .	25

\*\* Pages 15-18 are missing \*\*



# A CRYSTAL SET FOR 2/6<sup>d</sup>

The cost of this receiver has been cut down to a barest minimum, but it is not a toy and is capable of really efficient reception of the programmes.

At first sight the reader of the title of this article will probably think that besides being cheap the set is inefficient. But though this may be true with some sets where the costs have been cut down to a minimum, it does not necessarily refer to all, and very good wireless sets can be built for quite moderate sums.

All that has to be done in order to build a cheap receiver is carefully to choose one's components and the circuit, bearing in mind for what purpose the receiver is to be used. It is no use expecting a set where the components have been cut down as far as possible to do the same as a receiver in which *carte blanche* has been used with regard to choice of components, but when a definite job has been decided for any set then it is possible to cut down the costs to the very minimum.

That is exactly what has happened in the present receiver. Everything has been made as simple as possible, and it will be noticed that the appearance of the set is not as polished and as elaborate as it might be, but this in no way detracts from the operation of the receiver.

As a beginner's set, the receiver can be said to be almost ideal, for it has been built especially to help the beginner who is rather doubtful as to what sort of set to use, and yet who is within range of one or more stations, even though he may use a crystal set.

It is not a set which will enable him to hear five or six stations, but if he lives within a reasonable distance of the local station, say five or ten miles, and within 80 or 90 miles of Daventry experimental station, he should have a choice of programmes from the two without any difficulty occurring.

## No Variable Condenser Necessary

It will be noticed on an examination of the photographs that no variable condenser has been employed. For this type of receiver a variable condenser is quite unnecessary, and would add very considerably to the cost without increasing the efficiency of the set in any way. The construction is extremely easy, about half an hour to one hour's work seeing the job right through from the time it is begun to the time when the constructor will be listening-in to the local programme.

The circuit is, of course, simplicity itself. It merely consists of a large hank-wound coil, suitably attached, with a crystal and a pair of 'phones placed across the circuit. Only four terminals are needed, one for aerial, one for earth, and two for the telephones. The crystal is of the ordinary "ite" variety, having an adjustable contact, for this type of crystal is more sensitive than the semi-permanent types now on the market, although the latter could be used if the constructor so desired, and if he lives within five or six miles of the local station.

Tuning is carried out by means of variable tappings on the coil. It is, of course, handy to have a good aerial when using any crystal set, though if you are very close

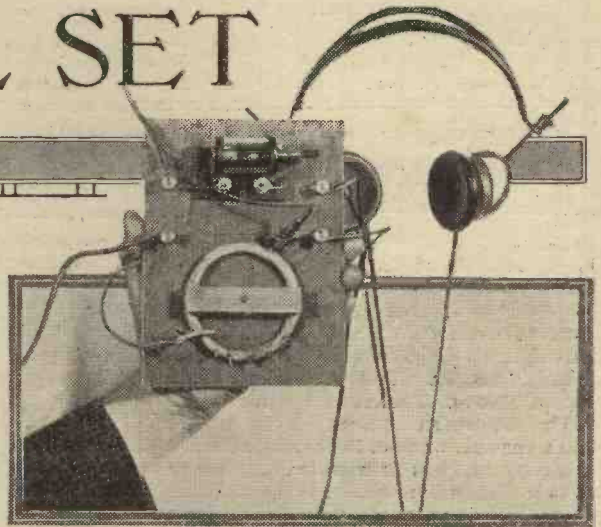

to a station an indoor aerial even will give quite good results. There is nothing very much that can be said about the circuit, for there is nothing special about it except that the arrangement of tappings on the coil enables the best possible results to be obtained.

As regards construction, the main item is, of course, the crystal, which costs a small sum, but is the largest on the whole list. Besides the crystal you will require the baseboard, about a quarter of a pound of No. 24 D.C.C. wire, four terminals, and a couple of tapping clips, a little wire for wiring-up, and a small piece of wood to hold the coil down.

## Extremely Easy to Build

The baseboard merely consists of a piece of dry wood about six by eight inches, and about half an inch thick. On this the crystal detector, the four terminals and the coil are mounted, as seen in the photographs. Ordinary brass terminals can be used, and if these are mounted so that the nuts and shanks are counter-sunk on the under side and the shanks cut off close to the nuts, the set will sit easily and will not scratch any piece of furniture on which it may be placed.

The only thing that requires any explanation at all is the coil, which is of the hank variety, the wire merely being wrapped round and round a jam-jar or a jug, or something of that calibre, having a diameter of somewhere about three and a half inches.

Although this type of coil is sometimes considered inefficient, it is not nearly so inefficient as might be supposed, and for the purpose of a crystal set is quite suitable for giving excellent results. The No. 24 D.C.C. is used, and about a quarter of a pound will easily cover the coil and leave a little over. The coil is wound as closely as possible, layer upon layer on a jam-jar, and the layers are piled up, while the total width of the coil wound on the jar must not be above half an inch. Afterwards it is slid off the jam-jar and to prevent it coming undone it is tied together and clamped down on the baseboard.

While winding the coil, however, you have to make tapping points to get the tuning points for the two clips. This is done in a very simple manner, and you proceed as follows:

First ten turns are wound on, and then the wire, without being broken, is twisted into a loop of about three-quarters of an inch in length, and then the winding is carried on. After another ten turns have been put on another loop

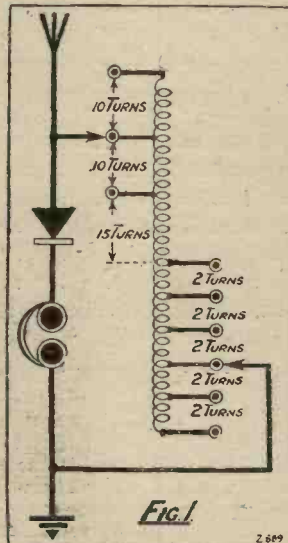



is made and so arranged that it comes about an inch or so further round the coil.

You must not make the various loops altogether, otherwise you will have difficulty in using your tapping clips later on. They should be spaced round the coil at distances of about three-quarters of an inch apart.

### Finishing the Coil Tappings

After the second loop a third one is made, ten turns farther on, this one being placed about an inch farther round than the second loop. So far we have got three loops, and now we come to the "close tappings" portion of the coil. Wind on two turns and make a loop about three inches away from the last loop, then another two turns and make another loop about an inch from the last one. This is followed by another two turns and another loop, another two and another loop, another two and then leave a short length of wire and the coil is finished.

This last length of wire can be about an inch long, and is then cut off from the rest of the wire. After you have made the third loop from the beginning of the coil, and commenced to wind the two-turn sections, the fourth loop was made considerably more than an inch away from the other three, because if you do this then when the coil is mounted you will be able to distinguish which is the beginning of the "fine tappings," because one clip operates on the ten-turn intervals and the other clip operates on the five two-turn tappings.

Now, when the coil has been finished and the wire cut off the ends, it should be bound round with thread or string to make it secure, and then all that remains to be done is to make the wire bare at each end. After the loops have been scraped absolutely clean the wire should be twisted well together to make a stiff series of tapping points on which the clips can be fixed. You now have a coil with two sets of tappings.

### The Completed Crystal Set

For the wiring-up of the set itself, the remainder of the 24-gauge D.C.C. wire can be used, or bare tinned copper wire, plain copper wire, Glazite, or any type of copper wire can be employed so long as it is not too fine and is capable of lying flat and thus enabling a neat job

to be made. It should be reasonably stiff to enable it to be bent where necessary.

The ends of the coil are not connected in any way to the other part of the circuit, being merely there so that the tapping clips can be pressed on to them. Other connections are made to the terminals of the crystal and to the four terminals on the board.

### ALL YOU NEED!

- 1 Baseboard, 6 in. x 8 in.
- 1 Crystal detector.
- 4 Terminals.
- 2 Tapping clips.
- 1 lb. No. 24 D.C.C. wire.

A little wire for wiring-up, a small piece of wood to hold the coil down, and some screws.

Tuning the set is an extremely easy operation, all that has to be done is to see that the cat's-whisker lightly touches the crystal, which, as remarked before, can be of the "ite" variety, such as Hertzite, Tungstallite, etc., and then you take the tapping clip connected to the detector and the aerial and tap it at the beginning of the coil, that is the starting-point when you were winding it, and the other clip is tried in turn on each of the five tappings, i.e. at the tappings which have only two turns.

### Getting Best Results

If nothing is heard, the first clip is then placed on one of the four large tappings and the others are then tried in turn again. This is continued (with the 'phones on the head, of course) until each of the four tappings has been tried and each of the five has been tried and a combination has been found which will give the best results.

When this has been found you can turn your attention to the crystal detector again and search for the best possible setting of the cat's-whisker on the crystal. When this is done there is nothing more to do except to sit down and enjoy the programme.

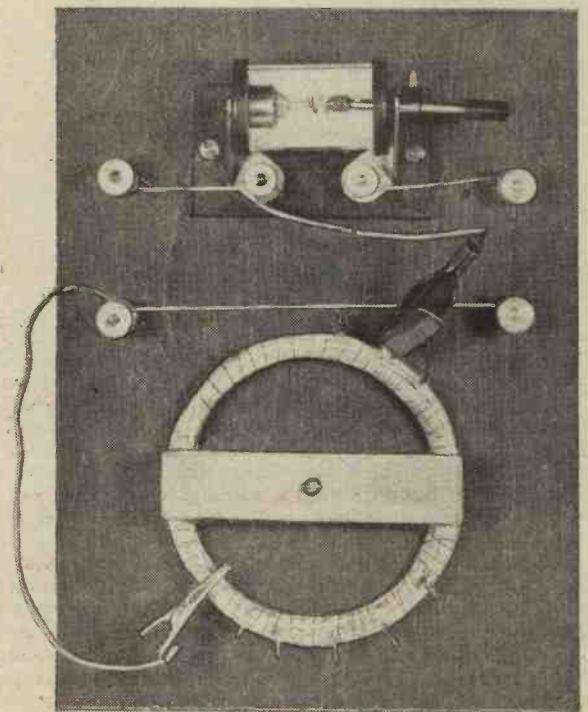
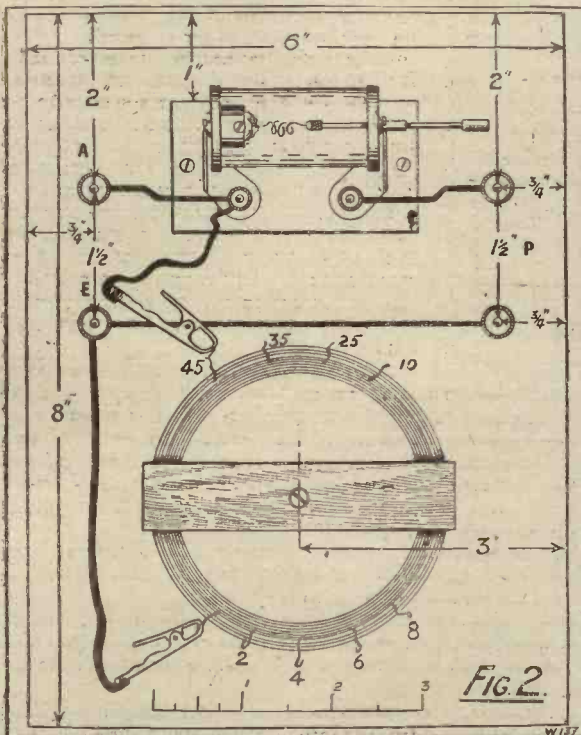

The few connections which complete the wiring of this remarkable easy-to-build set are shown in all their simplicity in the above diagram and photo. Note how closely these two positions agree in detail and how you can trace every wire throughout its route in the photo.





# A De Luxe Crystal Receiver

This set gives you everything that can be expected of a modern, de luxe crystal-set design. Ease of control, selectivity, loud signals, wave-change without coils, and reliability are its special features.

**A**LTHOUGH valves have become very much cheaper during the past two or three years, the crystal set still retains a considerable measure of its quondam popularity. And there is undoubtedly a great deal to be said for crystal reception. The first great advantage is that there are no maintenance costs. There are no batteries needed, and the apparatus is so simple that anyone can safely manipulate it.

Further, there is the advantage that a purity of reception is possible which can only be duplicated by loud

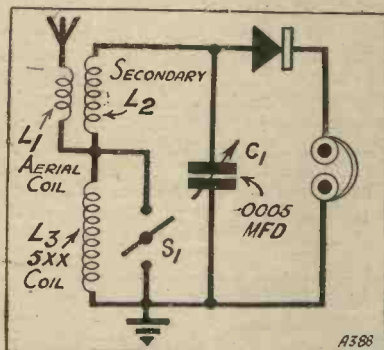

speakers of the most expensive variety, operated by high-class valve sets.

Some people regard crystal sets as unsocial instruments, but it is possible to work two or three telephone receivers and listening can be carried out without interrupting anybody else in

the room not interested in the programme.

As proved by another article in this book, a crystal set can be constructed for as little as 2s. 6d. But the constructor who can spend a little more still has the knowledge that he will not be up against considerable replacement costs and maintenance, and should find this de luxe version a most attractive proposition.

## What the Set Will Do

Using the best components, it will cost about thirty-five shillings; but what, the constructor might ask himself, will he get for this money? The chief feature of this set is that it enables a switch-over to be made from 5 X X to the local station without any coil changing and at a moment's notice.

Additionally, the set possesses a degree of selectivity greater than the average. Nevertheless, it must be pointed out that no crystal set can be as selective as a two- or three-valver, although, within the limits of its sensitivity, the selectivity possessed by this de luxe set will be found ample under the majority of circumstances.

With a good outdoor aerial, this set will enable stations of the power of 2 L O, 5 W A, etc., to be tuned in up to a distance of 25 or so miles, while Daventry, 5 X X and 5 G B, should be tunable up to 80 or 100 miles. Therefore, some constructors might find themselves in the fortunate position of being able to tune-in any one of three programmes, and most will have at least two at their command.

A wave-change crystal set will not appeal to a man whose

local station is 2 L O, for the simple reason that 5 X X duplicates the majority of 2 L O's items. If you are a 2 L O listener, then a crystal set capable of tuning in the long-wavers will not be of much interest to you.

## Selectivity Variable at Will

This de luxe crystal set will prove of greater interest to people not in London, but within that 80 or 100 miles

## COMPONENTS REQUIRED.

- 1 Ebonite panel, 7 in. x 6 in. (Original was Becol. Any good branded material).
- 1 Cabinet and baseboard, about 11 in. deep. (This is a cabinet commonly used for mains H.T. units, available from the usual firms).
- 3 Baseboard-mounting coil sockets (Lotus, Peto-Scott, Burne-Jones, etc.).
- 1 .0005-mfd. variable condenser (Bowyer-Lowe in set. Any good make, Lissen, Cyldon, J.B., etc.).
- 1 Crystal detector (See text).
- 4 Terminals (Plain or engraved, such as Igranic, Belling-Lee, Eelex, etc.).
- 1 Push-pull on-off switch (Lissen, Lotus, Benjamin, or similar type).
- 1 A length of wire for wiring-up, and plug-in coils, sizes as given in the article.

range of 5 X X and 5 G B, or to other listeners who are within that range of the Daventry stations, and whose local station is some other than 2 L O. These are the lucky people who may find three programmes available.

The design of this set is due to Mr. A. Johnson-Randall, and while it incorporates no particularly novel features, it is essentially sound and efficient. As you will see from the circuit, the aerial is inductively coupled and the degree of selectivity can be varied by varying the size of the aerial coil.

This set uses three plug-in coils. These do not in the usual way have to be changed. The one coil (at the back) provides loading (which is operated by a panel switch) for the long-wave Daventry station.

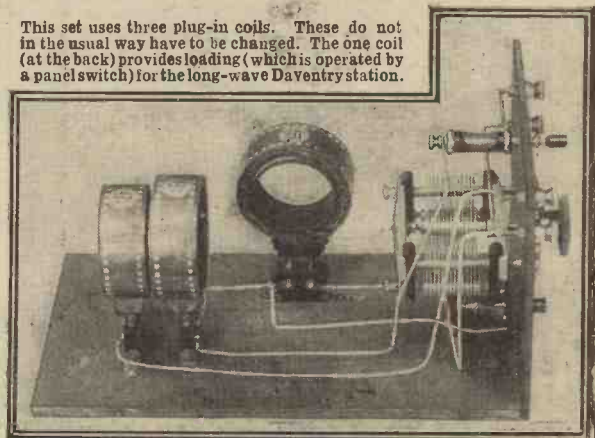



This aerial coil,  $L_1$  in the theoretical diagram, is mounted close to, and therefore is intimately coupled with, the secondary coil  $L_2$ .  $L_2$  is tuned by means of a .0005-mfd. variable condenser  $C_1$ . The  $L_3$  5 X X coil is shorted in or out of circuit by means of a panel switch in accordance as to whether the set has to be loaded for the reception of 5 X X or not. A crystal detector and telephone receivers complete the arrangement.

**The Variable Condenser**

Little need be said about the components for these are few in number and, for the most part, any of the leading makes should be quite satisfactory. You should note, however, that the variable condenser need not have a slow-motion movement. One having a direct dial drive is all that you will need.

**POINT-TO-POINT WIRING.**

Join aerial terminal to one side of coil socket  $L_1$ . Join other side of  $L_1$  socket to one side of long-wave socket  $L_2$ , to one side of wave-change switch and to one side of secondary coil holder  $L_2$ . Join the other side of coil socket  $L_2$  to fixed vanes of variable condenser and to one side of crystal detector. Join other side of crystal detector to top telephone terminal. Join bottom telephone terminal to earth terminal and to remaining side of coil socket  $L_3$ , also to moving vanes of variable condenser, and to remaining side of wave-change switch.

The type of the crystal detector can be left to the discretion of the individual constructor. He will have to make a choice of one or other of two main types: the semi-permanent variety and the cat's-whisker kind. One of the former was used in the original model and is shown in the photograph. It has the advantage that the adjustment, which rarely need be made, is easily carried out.

**Drilling the Panel**

An actual start on the assembly can be made by drilling the panel. Do not forget that you require metal-working drills for this and not the wood-working variety. There is no need to buy a special set of drills for this one task. A more economical procedure is as follows:

Purchase a cheap drill of the Archimedean variety and a reamer (which costs about ninepence). Eighth-inch

holes should be drilled in the 7 in. by 6 in. panel, in accordance with the accompanying diagrams. These holes can then be enlarged to the exact size required, using the reamer, the operation taking but a few minutes.

Do not clamp the ebonite directly in a vice or the material will be damaged. It is best, while drilling, to get somebody else to hold the panel for you on a wooden board. If you use flat-headed screws for mounting the panel on the baseboard the appropriate holes should be countersunk; but countersinking necessitates a large drill or special tool, so many constructors may prefer to use round-headed screws.

You will probably find that half-inch screws will be the ones required for mounting the coil holders on the baseboard. If you have desired to avoid soldering, you will have seen that all the components are provided with terminals. In these days components of all varieties so fitted are available, but you should note that there are a few makes of push-pull switches, for instance, which only have soldering tags.

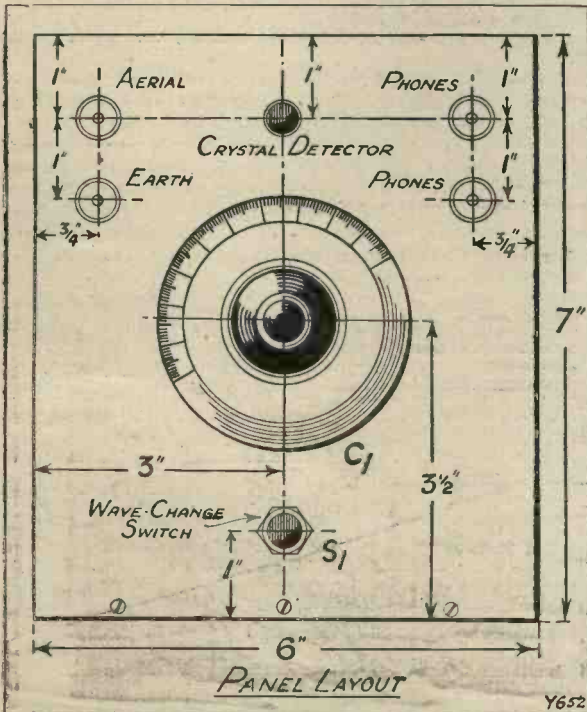
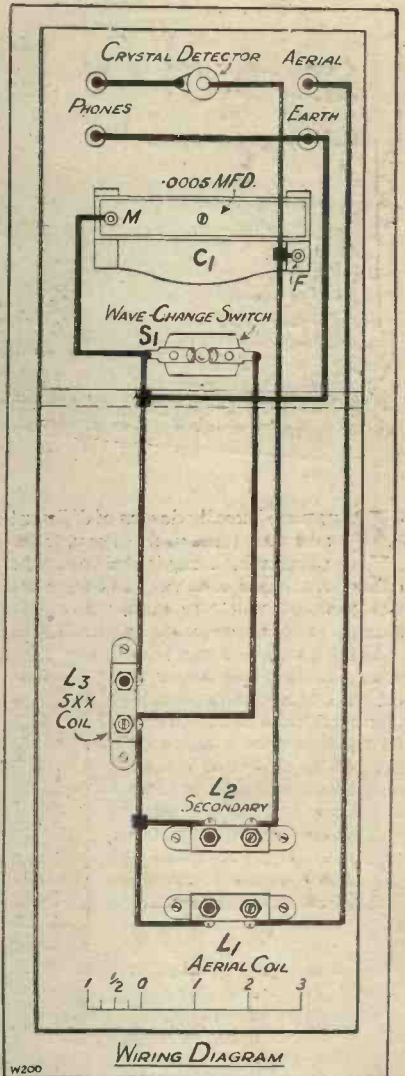

**The Coils to Use**

A very pleasing back-of-panel appearance will be given to this set if Glazite wire is used, but do not rely upon the use of one nut upon each terminal for holding the leads in position.

The size of the aerial coil determines the selectivity of the receiver. If you are very close indeed to your local station, that is, within three or four miles of it, you may find a 35- or 40-turn coil will be required. In other cases, one of 50 turns will answer the purpose.

No advantage would be obtained by using a very large aerial coil. The 50-turn size referred to represents the useful maximum. Perhaps in the case of 5 G B a 60- or 75-turn aerial coil might frequently prove of advantage, but the constructor who employs the No. 50 will be losing little.

For the coil marked "secondary" in the diagram a No. 75 size will be needed for stations operating from about 450 metres up to 5 G B. For stations of lower wave-length a No. 60 coil will "fill the bill." The 5 X X coil should be a No. 200. Plug-in coils of any of the leading makes can be used in this set.





# A ONE VALVER FOR 70/-

This receiver embodies two reaction schemes, either of which are immediately available by referring to a single switch. This flexibility is additional to alternative aerial couplings and other novel schemes which makes it possible to get the very best results under varying local conditions.

**T**HERE are literally dozens of different one-valve circuits, and it is impossible to say, from an all-round viewpoint, which one is the best. Aerial and earth and other local conditions vary to enormous extents and a one-valver which will give excellent results in certain circumstances may, under other conditions, prove disappointing.

Therefore, there must be many attractions about a set of a moderately simple character which enables one to modify circuit arrangements to suit one's own conditions. Such a receiver is the one to be described.

This novel design is due to Mr. G. T. Kelsey, and it has many points of exceptional interest. The most important concerns the reaction control. As most readers will know, the D.X. qualities of a one-valve set will depend, to a very great extent, upon the efficiency of its reaction adjustment, and in their turn there are several things which will affect this quality of a circuit.

With a given reaction arrangement, Reinartz, Schnell, etc., it is obvious that the best results are obtained when a particular type of valve having a certain H.T. voltage and an aerial having particular characteristics are employed. Many experimenters will have found that by juggling about with these things a one-valve receiver can be "hotted up" to an exceptional degree.

### A Useful Switching Scheme

But this Kelsey design obviates the necessity of all this by providing alternative forms of efficient capacity-controlled reaction. By means of a switch on the front of

the panel you can turn from the one to the other while you are actually receiving distant stations.

The one control is the so-called Reinartz, a well-tried method which has held its popularity against many rivals for a number of years. The alternative method is another straightforward capacity control, the condenser in this

case being connected across the H.F. choke; the adjustment of regeneration effects depending upon the degree to which this variable bypasses H.F. impulses.

### Reaction Control

In the ordinary course of events the H.F. choke tends to impede reaction effects, but this component is, as it were, rendered more inoperative as the capacity of the variable condenser is increased.

As we have indicated, both reaction schemes are of a standard and well-tested nature. Either one may be better under certain conditions, and both are immediately available for you to choose from.

Another important feature in the seventy-shilling one-valver is the provision of alternative methods of aerial coupling.

A selection can be made between two tappings taken directly on the grid coil, this being an auto-coupling giving a high degree of selectivity. The provision of another small coil permits inductive aerial coil coupling to be used.

These aerial adjustments are carried out with a clip and can be made while the set is in operation. It is an unfortunate fact that great selectivity with a one-valve receiver is only obtainable at the sacrifice of volume, but it is possible, in many cases, to achieve very interesting

### COMPONENTS REQUIRED.

- 1 Ebonite panel, 7 in. x 12 in. x 1/2 in. (Original was a "Kay Ray." Any good branded material).
- 1 Cabinet for above, and baseboard 7 in. deep (Caxton, Pickett, Raymond, Artercraft, Makerimport, Cameo, etc.).
- 1 S.L.F. slow-motion variable condenser, '0005 (J.B. in original. Cyldon, Lissen, Igranic, etc.).
- 1 Ordinary square-law variable condenser, '0003 (See above).
- 1 Three-pole change-over switch (Utility).
- 1 Two-way push-pull switch (Lissen).
- 1 H.F. choke (R.I. & Varley in original. Any good make, Bowyer-Lowe, Lewcos, Lissen, Colvern, Burne-Jones, Climax, Igranic, etc.).
- 1 Anti-microphonic valve holder.
- 1 Fixed condenser, '0003, with clips for grid leak (T.C.C., Lissen, Igranic, Clarke, Dubilier, Mullard, etc.).
- 1 Grid leak, 2 megohms (Dubilier, Mullard, Clarke, Igranic, Lissen, etc.).
- 1 Fixed condenser, '002 (See above).
- 1 Baseboard-mounting filament resistance to suit valve (Igranic, Lissen, etc.).
- 2 Single-coil mounts (Lotus).
- 1 Terminal strip carrying 6 terminals.
- 1 Terminal strip carrying 2 terminals.
- 2 Clix plugs and two sockets, Glazite, flex, screws, etc.

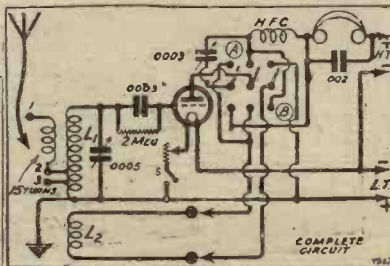
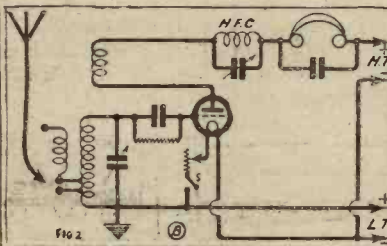
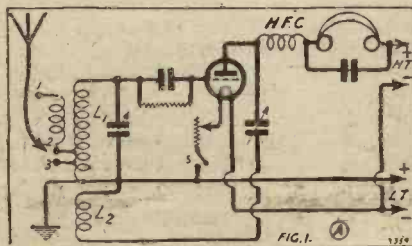







required. Then you can mark out the panel in accordance with the appropriate diagram and drill the necessary holes.

Do not forget that the diagram of the panel layout shows the front. Many constructors centre the holes with dividers in preference to the use of a pencil and ruler. In this case drilling can be carried out from the front of the panel, and this is a better scheme for, as ebonite is a somewhat brittle material, great care is needed to avoid chipping as the drill passes through the material.

#### Panel Drilling and Wiring Hints

When the holes are drilled from the front of the panel any such chippings will be confined to the back, and will be out of sight. If you have to resort to pencil lines, then we advise you to drill from the back of the panel, but do not forget in this case to reverse the measurements shown.

When the panel is drilled this can be screwed to the baseboard and the components mounted on the panel. Then the parts should be arranged on the baseboard in accordance with the wiring diagram, which is drawn to scale, and the photographs.

Having made sure that all these components are correctly laid out they can be screwed down. Finally, the terminal strip should be screwed in position.

Do not be misled by the apparent simplicity of the wiring and rush this portion of the work. It is a good plan to work through the connections as they appear in the point-to-point list. There are nine points to the switch,

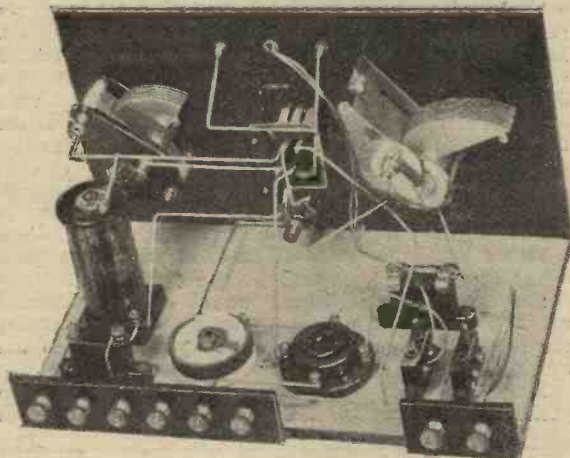

Another view of the "works" of the set illustrating its compact and clean design. Note the 3-pole change-over switch which enables the reaction control to be varied at will.

and although these are laid out in a logical and practical manner, unless the joints are made carefully an error may creep in.

If you decide to tackle the connections to the switch before anything else, you will discover that at the conclusion of the operation practically all the wiring is completed.

#### Coils for Various Wave-Bands

A few inches of flexible wire must be joined to the aerial terminal and the end of this lead fitted with a spade terminal. If you buy a spade terminal at a shop it will not cost you more than a penny, although if you have a small portion of sheet brass on hand one can be cut from it. Flexible leads are also joined to the reaction coil-holder.

For long waves an ordinary "X" coil of 250 turns will be needed in the aerial holder and an ordinary plug-in coil of 150 turns for the reaction position. On this wave-band you will not find it necessary to employ an additional aerial coupling coil.

For the normal broadcasting wave-band, an "X" coil of a No. 60 or 75 size will be needed. For the reaction position a No. 35 or 50 plug-in coil is necessary. The additional coil you can make yourself.

Obtain a small quantity of either 22 or 24 gauge D.C.C. wire. Wind this in the form of a hank of the same diameter as the "X" coil. Fifteen turns will be needed. This coil should be tied to the "X" coil with thread, as shown in the photographs.

One end should be connected to the highest tapping point on the "X" coil and the other left free for connection

#### WIRING IN WORDS.

Join E terminal to pin of L<sub>1</sub> coil base, to L.T.+, to moving vanes C<sub>1</sub>, to one side of L.T. switch and to contact No. 1 on switch. Join socket of L<sub>1</sub> coil base to one side of grid condenser and leak and to fixed vanes C<sub>1</sub>.

Join remaining side of grid condenser and leak to "G" terminal of V<sub>1</sub>.

Join P terminal of V<sub>1</sub> to contact No. 5 on switch. Join contact 2 on switch to fixed vanes of reaction condenser, to one side of H.F. choke and to contact 7 on switch.

Join contact 3 to contact 8 on switch and also to left-hand Clix socket.

Join remaining Clix socket to contact 4 on switch.

Join moving vanes of reaction condenser to contact 6 on switch.

Connect contact 9 on switch to remaining side of H.F. choke, to one telephone terminal and to one side of telephone condenser.

Join remaining side of telephone condenser to remaining telephone terminal and also to H.T.+

Connect H.T.- to L.T.-, and also to one filament terminal on valve holder.

Join remaining filament terminal on valve holder to one side of filament resistance. Connect remaining side of filament resistance to screw on rim of L.T. switch.

A flexible lead should be joined to terminal A, the remote end of which lead should be equipped with a spade tag.

Join two flex leads to the reaction-coil holder and pass them through the hole in the centre of the panel.

to the flexible lead from the aerial terminal when needed. You will now see the constitution of the three tapping points available for the aerial.

Two are the terminals on the "X" coil, the third being the free end of the additional coil just referred to. You can use a valve of any voltage rating in this set. Most of the so-called general-purpose types will be suitable as will practically any H.F. or detector variety.

#### Operating the Receiver

A 60-volt H.T. battery will provide ample anode pressure. The selectivity of this receiver is not likely to be altered by varying the form of reaction control, therefore after you have inserted the coils and valves, join up the batteries and telephone receivers, and then proceed to experiment with the selectivity adjustment provided by the aerial tappings.

If the set fails to oscillate you can try the effect of reversing the connections to the reaction coil by means of the plugs on the panel. In cases this may be necessary when changing over from the one reaction control to the other.

Minimum regeneration is achieved when the reaction variable is at a minimum capacity adjustment.

Tuning is carried out in the following manner: Starting with the reaction variable at zero, the tuning variable is rotated slowly through a section of its movement. Gently traversing this area backwards and forwards the reaction variable is gently rotated towards its maximum. An approach to oscillation is heralded by a considerable increase in the sensitivity of the set and a subdued breathing noise. Squeals and squeaks varying in tone in accordance with the movements of either of the dials indicate that the set is oscillating.

Although you will find it necessary to operate on the edge of oscillation in order to obtain D.X. results with a simple set of this nature, you should do your utmost to prevent the set actually bursting into oscillation, for this is what causes interference with other listeners. It will not be wise to attempt operating the set in the nervous condition of extreme sensitivity achieved by this edge of oscillation condition until you have had considerable experience in the manipulation of the dials.

When you have achieved the knack of getting the utmost from the set in the minimum of time, you will be surprised at the number of stations which can be tuned in.





**W**E are now approaching the time in the wireless year when short-wave signals will be coming in abundance and in great strength, and when it will be possible regularly to receive Australia, South Africa, and other far-distant places.

Of course, it is impossible to pick up these stations with any regularity, or with great success, unless one has a set capable of doing the job, but it is not everybody who wishes to build a separate short-wave receiver. Most people, when they have a broadcast receiver, feel that they have gone to as much expense as they ought and so leave the short-waves alone, missing the fascination which comes from hearing a short-wave broadcast from a really distant country. Others attempt to build a set which can be converted for either broadcast or short-waves, a very good method, but it is rather inclined to be a tedious job when it comes to the changing of coils, and the method in most cases does away with the possibility of having H.F. amplification in the set.

**Special Set Unnecessary**

H.F. amplification is really required in some broadcast receivers, and is often desired by a great many listeners, but when it comes to short-wave work the H.F. amplifier is inclined to upset things unless very carefully designed on the screened-grid principle. Others run that popular set, the Det.-2 L.F.,

**A remarkable unit which transforms practically any ordinary set into an efficient short-wave receiver.**

and here, if this receiver is built for broadcast reception, it is often not really suitable for short-wave work. To build two sets, one for short-waves and one for ordinary broadcasting, is an expensive business, so it was decided to design a little unit which will convert any receiver into a short-wave set. So if you have a detector and 2 L.F., an H.F.-Det.-L.F., and so on, by the use of this little converter, due to Mr. G. T. Kelsey, you can make your receiver into a short-wave set which will be really efficient.

**Just Plugged In**

What happens is that the unit is plugged into any straight set with one or more L.F. stages without in any way upsetting the layout or operation of the broadcast receiver. If the broadcast receiver has an H.F. stage this, of course, is turned out and not used, for the adaptor on the converter plugs straight into the detector socket of the ordinary broadcast receiver.

In actual fact, this special "M.W." short-wave converter is a specially designed short-wave detector unit, which is plugged by means of an ordinary four-pin adaptor on a piece of flex into the detector socket of the broadcast receiver, and then the output from the converter is automatically passed from that socket to the L.F. amplifier section of the broadcast set.

So if you have a detector and 2 L.F. ordinary broadcast set and you use this converter you will have a short-wave

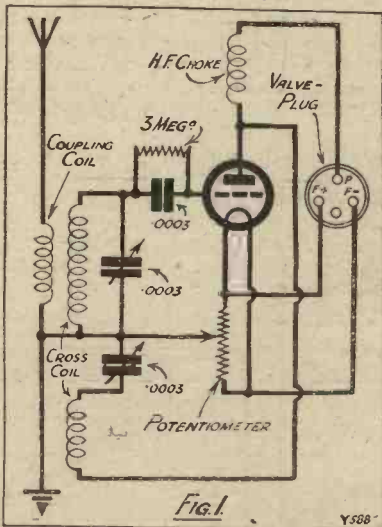

**ALL YOU REQUIRE IN THE WAY OF COMPONENTS.**

- 2 .0003 variable condensers (Igranic in original unit). (Any good make. Lissen, Cyldon, J.B., Bowyer-Lowe, Dubilier, etc.)
- 2 Slow-motion dials (Any pattern giving a really smooth slow drive).
- 1 Grid condenser and leak, .0003 and 2 meg. (Dubilier, Lissen, T.C.C., Mullard, Clarke, Igranic, etc.)
- 1 Valve holder, anti-microphonic type (Igranic, Lotus, Benjamin, Ash'ey, Mareoniphone, Formo, W.B., Burne-Jones, Bowyer-Lowe, Redfern, etc.)
- 1 Single-coil mount (Lotus, Burne-Jones, etc.)
- 1 Potentiometer, 400 ohms, baseboard type (Lissen in original. Any similar type. 200 ohms, will serve).

- 1 Ebonite panel, 12 in. x 7 in. (Any good branded material).
- 1 Small ebonite sub-panel, 2 in. x 5 in.
- 1 Cabinet (see note in text re size), and baseboard 8 1/2 in. deep.
- 1 Valve plug (this can be home-made from an old valve base if desired. Obtainable from Messrs. Lectro Linx, Lissen, etc.)
- 1 Sheet of copper, 12 in. x 7 in.
- 1/2 lb. of No. 22 D.C.C. wire, and ebonite, etc., for construction of cross former.
- Flex, clips, valve legs and pins, and Glazito, etc.



converter detector followed by the L.F. amplifiers—all that is necessary for really good short-wave reception. It is not every set that has really slow-motion dials and suitable variable condensers for short-wave work. The average broadcast receiver has a tuning condenser of something of the order of .0005 mfd.

For short-wave work a .0005-mfd. variable condenser is rather too big. Stations whizz by with far too great a rapidity, so that for short-wave work a .00025 or a .0003 mfd. is ample, and a slow-motion vernier dial is a necessity. These features the "M.W." Short-Wave Converter contains, and here, again, you see that everything required for short-wave reception—slow-motion dials, suitable condensers, special short-wave coils—can be used with your ordinary broadcast receiver, without upsetting it in any way. Moreover, the "M.W." Short-Wave Converter is not expensive to build.

**Quite a Simple Circuit**

A glance at the theoretical circuit will show that it is quite an ordinary Reinartz type of circuit, but that a potentiometer has been supplied to control the bias on the grid of the adaptor. This is a useful thing where short-wave work is concerned, as it frequently does away with that annoying threshold grid howl which sometimes occurs just as you are going into and out of oscillation.

In this way the most effective control of oscillation can be obtained, and the bias on the grid altered from full

positive to full negative by means of the potentiometer until the best results are obtained (it is best to work as near the positive end as possible). Obviously these features are very desirable in short-wave work, and do a great deal towards the really successful operation, especially when telephony is being received.

**Avoiding Hand-Capacity**

Another point which is most valuable in short-wave work is to have the moving vanes of the variable condensers at earth potential. This helps to obviate hand-capacity, especially if the panel is also screened and the fields from the coils thereby confined to the set itself.

It is very rare to find a broadcast receiver which has both moving vanes of its tuning and reaction condensers at earth potential. Usually one or the other, or both, are at a potential above earth, and this does not matter much where ordinary broadcast wave-lengths are concerned, but is a serious matter where short-wave reception is being considered.

The photographs show the "M.W." Short-Wave Converter in a cabinet, but this need not be used if cost is to be kept down to the lowest possible figure—less than 30s. On the other hand, if the cabinet is made to match that of the ordinary broadcast receiver with which the converter is to be used, then the two will form a very useful and ornamental outfit capable of receiving practically anything you want to hear.

And while discussing the reception point of view, we would make it clear that this adaptor is capable of enabling you to hear Australia practically any Sunday evening during the winter months of the year and at quite considerable strength, especially if you have two L.F. stages in your broadcast receiver. What is more, tuning by means of this adaptor is not difficult. If you go carefully you will not fail to pick up a great number of short-wave stations.

**The Panel**

As regards the constructional work, the panel, of course, is drilled and laid out according to the diagram, and then we come to the drilling of the copper screening sheet underneath. This screening sheet is supplied at the back of the panel so that all hand-capacity is completely done away with and the tuning of the short-wave adaptor is made as easy as that of an ordinary receiver.

Clamping the panel and the screen flat on the baseboard enables the drilling of the panel and the screen to be carried out in one operation and in such a way that no mistake regarding the holes can be made. The photograph of the original adaptor shows a cabinet with a white-faced oval front. This white facing is obtained by placing a piece of Bristol board or thick cartridge paper across the front of the panel, this paper having been previously thoroughly dried in an oven, and the holes made in the appropriate positions.

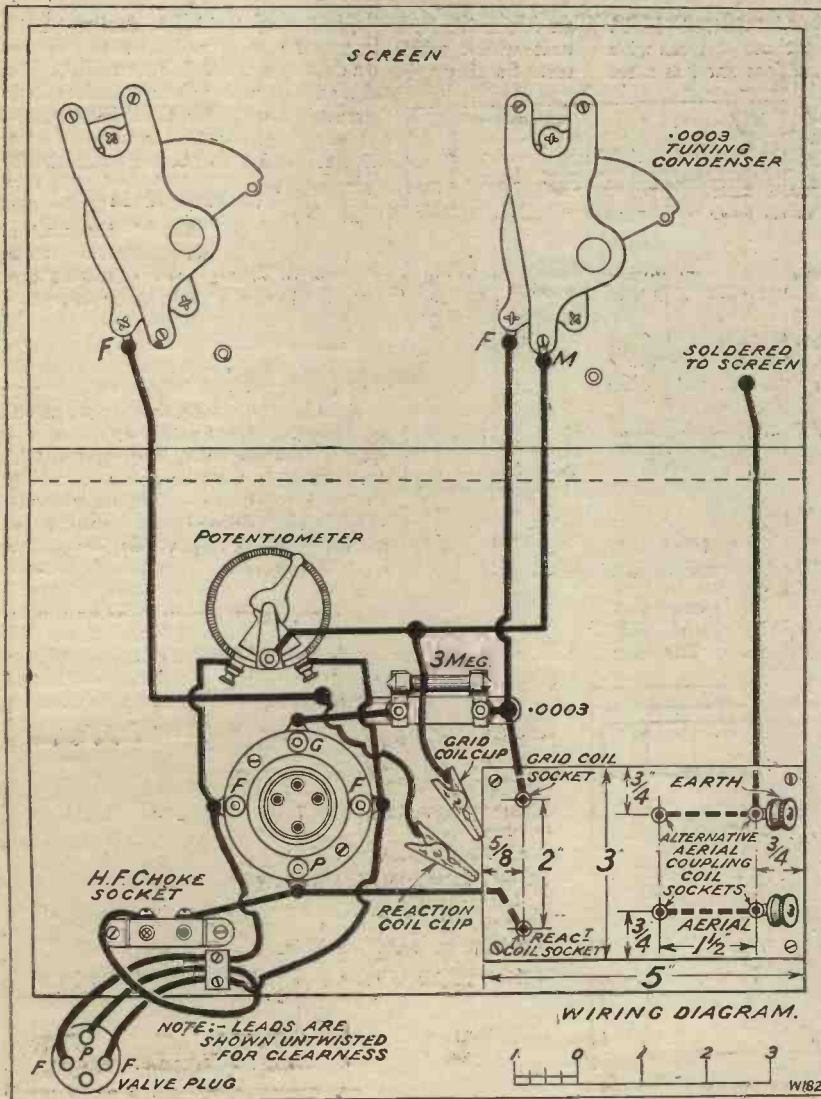



Next the panel and screen and, if desired, the white front to the panel should be secured to the baseboard; a fairly thick baseboard being used. You will notice from a view of the set that a little sub-panel about 5 in. long and 3 in. across is employed on the baseboard at the back left-hand corner looking from the front of the set. This panel holds the sockets for the aerial coil and the reaction and grid coils. The dimensions are given in the back-of-panel diagram, and it is secured to the baseboard by means of two small wooden end-pieces about 1 in. in height.

Two blocks of wood about the same length as the end-pieces and about half an inch square form a convenient method of fixing either by glue or by screws. Six sockets are required on the sub-panel, and to the two end ones on the right of the panel, looking at it from the back of the baseboard, two terminals are fixed by means of soldering tags under the two sockets. A glance at the photographs will make this clear. It will be seen that the two terminals stick out at an angle to the sockets well away from the little panel, the soldering tags to which the terminals are soldered being placed under the valve sockets on the panel.

The coils are what are known as "cross" coils, and are formed by making a cross former, the details of which are given in Fig. 2. Here it will be seen that two pieces of ebonite 5 in. long and 1 in. across, and slots  $\frac{1}{4}$  in. apart, are cut in this, on alternate sides, commencing about  $\frac{3}{8}$  in. from either end. These slots are continued until six are done from each end and the slots are about  $\frac{5}{8}$  in. deep. Right in the centre of the slots on one side of one piece of ebonite, and on the other side on the other piece, a  $\frac{1}{2}$ -in. slot is cut so that the two pieces can be slotted together.

### Reaction and Grid Coils

Then the reaction and grid coils are wound round and round these slots until the requisite number of turns have been placed on. The windings are carried out in this manner. First of all you commence in the second slot from the centre, and, securing the end of the wire, you wind on three turns spaced about an  $\frac{1}{8}$  in. each. The wire

used being No. 22 D.C.C., of which a quarter of a pound is required altogether. Next you cross over and, proceeding in the same direction, you wind on a further three turns the next slot up, at the termination of which the wire should be cut off and secured. One photograph of the set shows the general appearance of the coil.

### Wound in Alternate Slots

In the end you get a two-layer coil, the layers being concentric with three turns to each layer.

The fourth and fifth slots carry the second winding, which is done in the same way and in the same direction as the first. This completes the grid and reaction coils. Connections are as follow: The start of the inner winding and the end of the outer winding are each connected to a pin, the criss-cross holder and the base on which the two pins are placed being joined together by means of tightly wound string.

We have now connected the end of the outer winding and the start of the inner one each to a pin. This leaves us the two inside "ends" of the coils—that is, the end of the first coil and the beginning of the outer coil still unconnected, and contact is

made to them by means of spring clips. The outside winding on the former is the grid coil and the inside is the reaction coil.

### Mounting the Aerial Coil

The aerial coil is mounted on a base and is supported by a vertical wooden support, screwed or glued to the base, and the coil merely consists of a hank winding of about five turns fixed to the coil holder in the way shown in Fig. 3. This is quite a simple coil to wind and will cause no trouble whatsoever. Nothing need be said about the wiring now, because it is perfectly clear from the photographs and the wiring diagram.

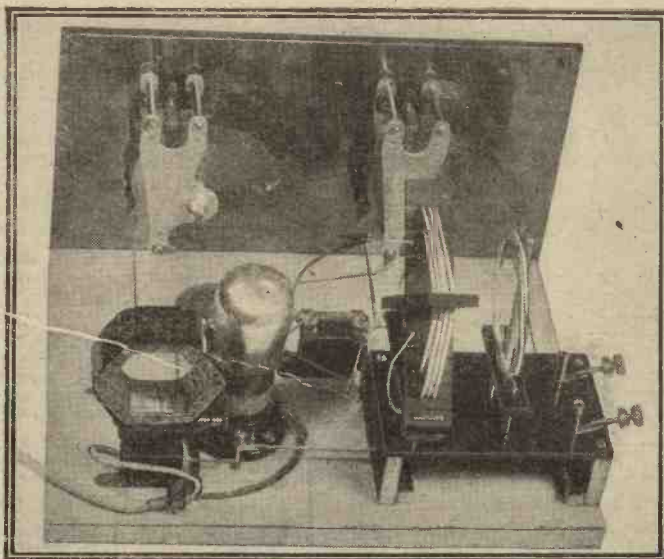

Note the simple design of the unit and the novel home-made coils and holder.

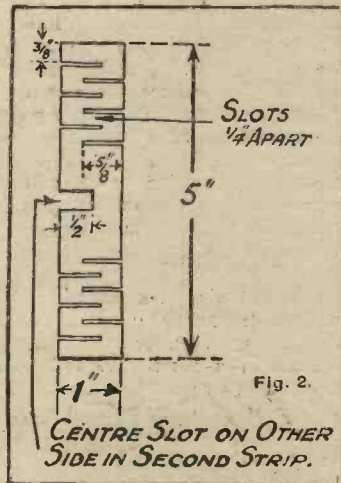
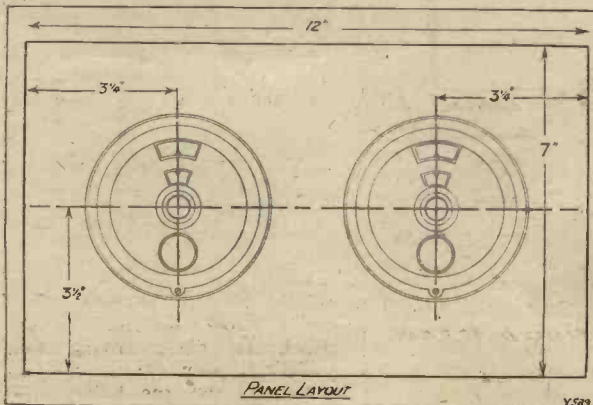

The arms of the cross former are made to the pattern shown on the right, the coil being layer-wound in alternate slots. You start on one side of the arm and go across after a certain number of turns to the next slot, up which is cut on the other side of the former. Thus you get four layers (two for each coil), with the first and third layers on one side of the former and the second and fourth on the other.

CENTRE SLOT ON OTHER SIDE IN SECOND STRIP.



There is nothing that can go wrong, and as long as you have made sure that the moving plates of the variable condensers make contact with the screen on the panel, and the panel screen to that socket on the sub-panel which carries the earth terminal—that is, the one nearest the main panel—everything is all right. Those two sockets under which the terminals are fixed are joined underneath to the next two sockets into which the aerial coil is plugged.

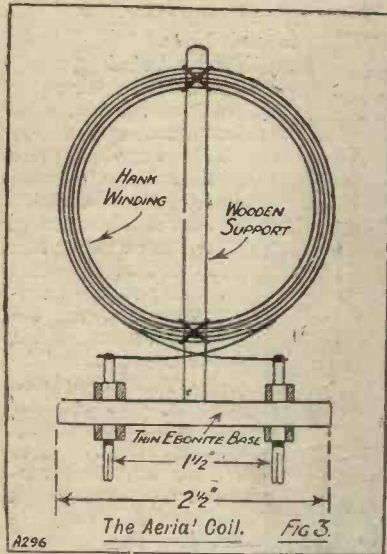

When all this has been done and a suitable plug-in coil of about 75 turns inserted in the choke socket—that is, the ordinary coil holder by the valve holder—and the detector valve from the ordinary set put in the socket of the "M.W." converter, the set is ready to connect up.

As soon as you place the adaptor plug in the detector socket of the set in lieu of the valve, you have connected to the unit all the necessary batteries, and the whole thing is ready to work when the aerial and earth are attached to the converter, the phones being left on your ordinary set. The plugging in of the adaptor is the only connection required to the "M.W." Converter.

**External Connections**

Aerial and earth go on the two terminals. No batteries have to be used whatsoever as regards the adaptor itself; they can thus remain connected to your ordinary broadcast receiver and do not have to be touched. It is just a matter of plugging the adaptor into your detector socket in the broadcast receiver and the whole thing is automatically switched on. The first thing to do is to find out whether the converter will oscillate.

With the grid tuning condenser—the left-hand dial—at zero, the capacity of the reaction condenser should be increased until the set commences to oscillate. If there is any doubt about this a moistened finger placed on the grid socket of the cross coil should give a double click. One on placing the finger and one on taking it away. Failure of the set to oscillate may be due to the use of too little H.T. (which is remedied, of course, by altering the tapping on your H.T. battery going to the detector of your broadcast set) or possibly due to an unsuitable valve. Changing over the valve will very often remedy the trouble if you have an unsuitable valve in use.

**Testing on Sigs.**

It is not always a criterion that a valve which oscillates satisfactorily in a broadcast receiver will necessarily oscillate in a short-wave set. Sometimes a valve which is perfectly satisfactory in a broadcast receiver will refuse to oscillate at all in a short-wave set owing to the unsuitable characteristics of that particular valve. As a

rule, however, a good detector in a broadcast set will be quite a good detector in a short-waver.

The set is now ready for testing on signals. With the reaction condenser adjusted so that the set is just oscillating, and using the tuning very, very slowly from zero, you will probably be able to hear chirrup after chirrup. If the chirrup that is heard is a telephone carrier-wave, slightly slacking back the reaction condenser will enable you to resolve in the ordinary way as you do on a broadcast set. If it is a C.W. station, then as soon as the reaction has been slackened back from the oscillating point the carrier-wave and all signals will disappear.

**Variable Aerial Coupling**

Under average conditions the aerial coil should be coupled moderately tightly to the cross coil, and for this purpose the two centre sockets, which are connected underneath the sub-panel to the aerial and earth sockets. These latter enable the aerial coil to be plugged in farther away from the cross coil when looser coupling is required, as might be the case should patchy or unsatisfactory reaction be encountered.

**COIL DATA.**

The aerial coupling may be altered, but the same number of turns for the aerial coil will probably be suitable—namely, 5 turns.

Wave-lengths. (approx.)

Cross Coil Number of Turns.

25-50 metres.

Six turns for each coil. That is 6 turns for reaction and 6 for grid, making a total of 12 turns wound on the former in four layers of 3 turns each.

For 2 XAD and 5 S W, and stations between 20 metres and upwards of 30.

Four turns of each coil, making a total coil of 8 turns wound in 4 layers of 2 turns each.

Above 50 metres—for KDKA and those stations not covered by the 6-turn coils.

Ten turns each coil, making a total of 20 turns, wound in 6 slots (3 for each coil) consisting of 4, 4 and 2 for the grid coil and then 2, 4 and 4 for the reaction coil.

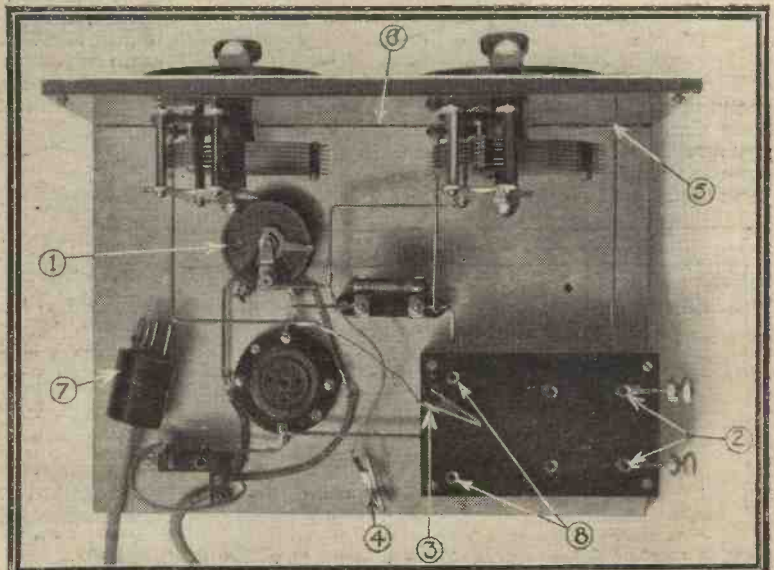

You can identify all the parts in this photo. (1) Potentiometer; (2) Aerial coil sockets; (3) Reaction coil clip; (4) Grid coil clip; (5) Lead soldered to screen; (6) Metal screen behind panel; (7) Adaptor plug; (8) Cross-coil sockets.



# A TWO-VALVER for 100/-

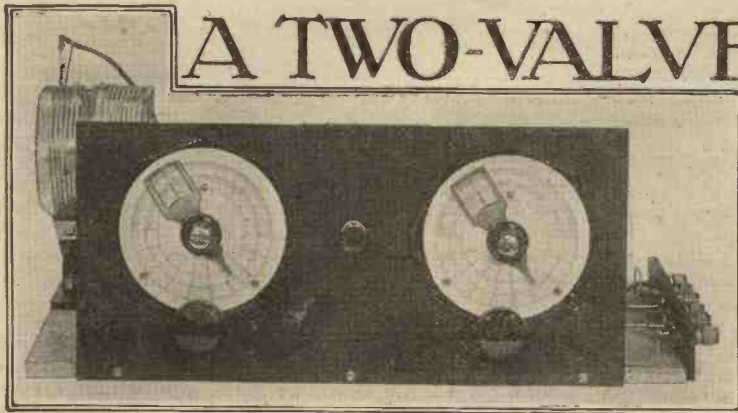

A set which will appeal to the amateur who wants to roam through the ether. It can be made suitable for the reception of short, medium and long wave-lengths by changing the simple plug-in coils. 3 L O (of Australia) as well as 2 L O is available with this set.

HERE is a set with which it is possible to tune in stations on practically any wave-length. If you so desired you could go right down to the very short-wavers, such as K D K A, 2 X A F, 2 X A D, or 3 L O of Australia. Additionally the set has proved remarkably efficient on the normal broadcast band, and 5 X X and the long-wavers come in at creditable strengths.

As a matter of fact, a set which will receive the high-frequency broadcasters is almost bound to be efficient on the ordinary wave-lengths. But you must not expect long-distance loud-speaker reception with this set. Good loud-speaker results are possible up to about thirty miles from an ordinary station of the calibre of 2 L O, and up to one hundred miles or so from 5 G B or 5 X X. Telephone receivers will be necessary for the short-wavers and the more distant stations.

The set is of the simplest possible nature in both construction and operation. For the one hundred shillings you will be able to provide first-class components throughout, and this is advisable if you desire optimum results. Very great economy can be effected, but the extent to which this is done depends upon the discrimination of the individual constructor.

## An Aerial-Adapting Condenser

In the first place no cabinet need be used, and this agrees with the ideas of many short-wave enthusiasts. But we cannot say we have noticed any deterioration in results when the set is fixed in a case.

The circuit is of the detector-L.F. variety, and is shown theoretically in the accompanying diagram. It will be noticed that a fixed condenser is shown in series with the aerial. This should be of .0001 mfd. capacity. A

special word in regard to this component is necessary.

If you have only a short aerial, say not greater than 35 ft. in length, you will not find a series condenser necessary, and, further, should your aerial be greater than 60 ft. in length, the purpose of this component, which is to cut down the capacity of the aerial in order to enable short waves to be received, will not prove successful.

In fact, a long aerial will militate against the receiver operating efficiently on these low waves. Incidentally,

the series condenser increases the selectivity of the receiver, but the real efficiency of the set in this regard is due to the employment of a tapped aerial coil.

## The Coils

The reaction coil, as with the aerial coil, is of the plug-in variety and is mounted on the baseboard. A .00025-mfd. variable condenser is employed for tuning purposes, and although admittedly this tends somewhat

to limit the tuning range of any given coil on the ordinary broadcast band, it is definitely suitable for short-wave reception. A condenser of similar capacity is employed for reaction control.

You will see that a fixed condenser of .0003 mfd. is in series with the reaction variable. This fixed condenser should be short-circuited when the set is used on normal wave-lengths. Its object is to reduce the effective capacity range of the reaction variable for the reception of the short-wavers.

## Rheostats May Be Unnecessary

The L.F. valve is transformer-coupled and grid-bias connections and separate H.T. terminals are provided. If two-, four- or six-volt valves are to be used from an accumulator of similar rating, then the filament

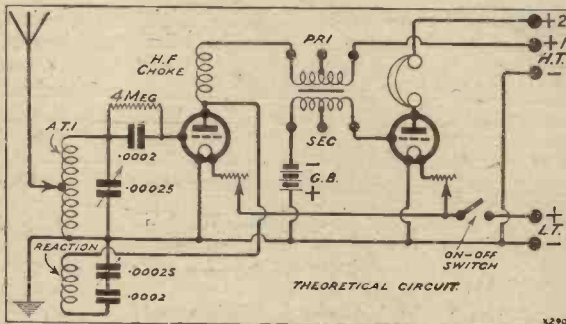

## COMPONENTS REQUIRED.

- 1 Panel, 14 in. × 7 in. × 1 in. (Original was "Ebon-art." Any good branded material).
- 1 Baseboard, 16 in. × 8 in.
- 2 .00025 variable condensers (Ormond, or other good make). (.0003 mfd. is also a suitable capacity.)
- 2 Slow-motion dials (Ormond, or other good fairly low-gear type).
- 3 Fixed coil holders (Lotus, Peto-Scott, Burne-Jones, etc.).
- 1 On-off switch (Lissen in set. Any similar type, Lotus, Benjamin, etc.).
- 2 Baseboard rheostats (Lissen, or similar type).
- 2 Fixed condensers, .0002 (Mullard, Lissen in set. Any good make, Clarke, Dubilier, T.C.C., Igranic, etc.).

- 1 Fixed condenser, .0003 (Mullard in set. Any good make, T.C.C., Dubilier, Lissen, Igranic, etc.).
  - 1 2-meg. grid leak with suitable clips or holder (Igranic, Lissen, Mullard, Dubilier, etc.).
  - 2 Valve holders (Benjamin, Lotus, Bowyer-Lowe, Burndept, Burne-Jones, B.T.H., W.B., Igranic, Marconiphone, Pye, etc.).
  - 1 L.F. transformer (Any good make, Lissen, Igranic, Marconiphone, Mullard, R.I.-Varley, etc.).
  - 1 Terminal strip, 6 in. × 2 in.
  - 1 Terminal strip, 2 in. × 2 in.
  - 8 Terminals (Ealex, Igranic, Belling-Lee, etc.).
  - 1 Bulldog clip.
- Wire, screws, wander plugs, etc.



resistances will be eliminated, but you should note that the slow-motion dials are by no means refinements. They would be if you purchased variable condensers having in themselves efficient slow-motion drives, but down among the short waves, where a degree on the condenser dial may mean the passing from one station to another, vernier tuning control is indeed a necessity.

**Only One Drill Necessary**

And as with the building of most sets, the first step in assembly will be the drilling of the panel. You will see from the panel-drilling diagram accompanying this article that the panel is perfectly symmetrical. It is, therefore, important that you should drill the holes as shown. It is surprising what a difference in balance even an eighth of an inch can make.

The actual sizes of the holes will depend upon the makes of components used. Some variables demand panel holes of half-inch diameter. Few constructors will possess drills of this size, but ebonite is a very easy material to ream. As a matter of fact, the constructor will find a reamer, which costs but a few pence, an invaluable article. It will replace several drills in his kit.

For instance, in the drilling of this particular panel only one drill of an eighth of an inch to make holes for the countersunk-headed wooden screws for securing the panel to the baseboard need be used. The same drill can also be employed for making the holes necessary for mounting the L.T. switch and variable condensers.

Subsequently, these latter holes could be reamed out with a reamer to the required dimensions. Failing the use of a reamer, the tang of a file or even one of the blades

of a pair of scissors can be employed for enlarging holes in ebonite panels.

But before we go any farther it will be necessary to refer to the question of the cabinet. If you definitely decide that a cabinet is necessary, then it will simplify matters if you use an 18 in. by 7 in. panel. Otherwise, some such scheme as a "vignette" front would have to be employed. A "vignette" front for this receiver would have to measure 16 in. by 8 in. and be of thin wood. An oval could be cut in this through which the controls would project.

In either case, if a cabinet is to be used the large terminal strip should be fixed to the back of the baseboard similarly to the aerial and earth terminal strip. This modification would not affect any of the connections in the wiring, but would alter the lengths of several of the leads from them shown in the wiring diagram.

The position of the terminal strip at the side of the baseboard will no doubt be found very convenient by many constructors. The actual reason why it was so positioned was to enable a shortening of several important leads to be effected. And this undoubtedly has an important bearing upon the efficiency of the receiver on the short waves.

**Concerning the H.F. Choke**

In this set an ordinary plug-in coil can be used as an H.F. choke. On the ordinary broadcast wave-lengths this coil should not be of less than 250 turns, while for short-wave reception a 25- to 30-turn coil will be necessary. But it is worth noting that there are now H.F. chokes available which satisfactorily function from the shortest to the longest wave-lengths encountered in broadcasting.

(Continued on page 52)

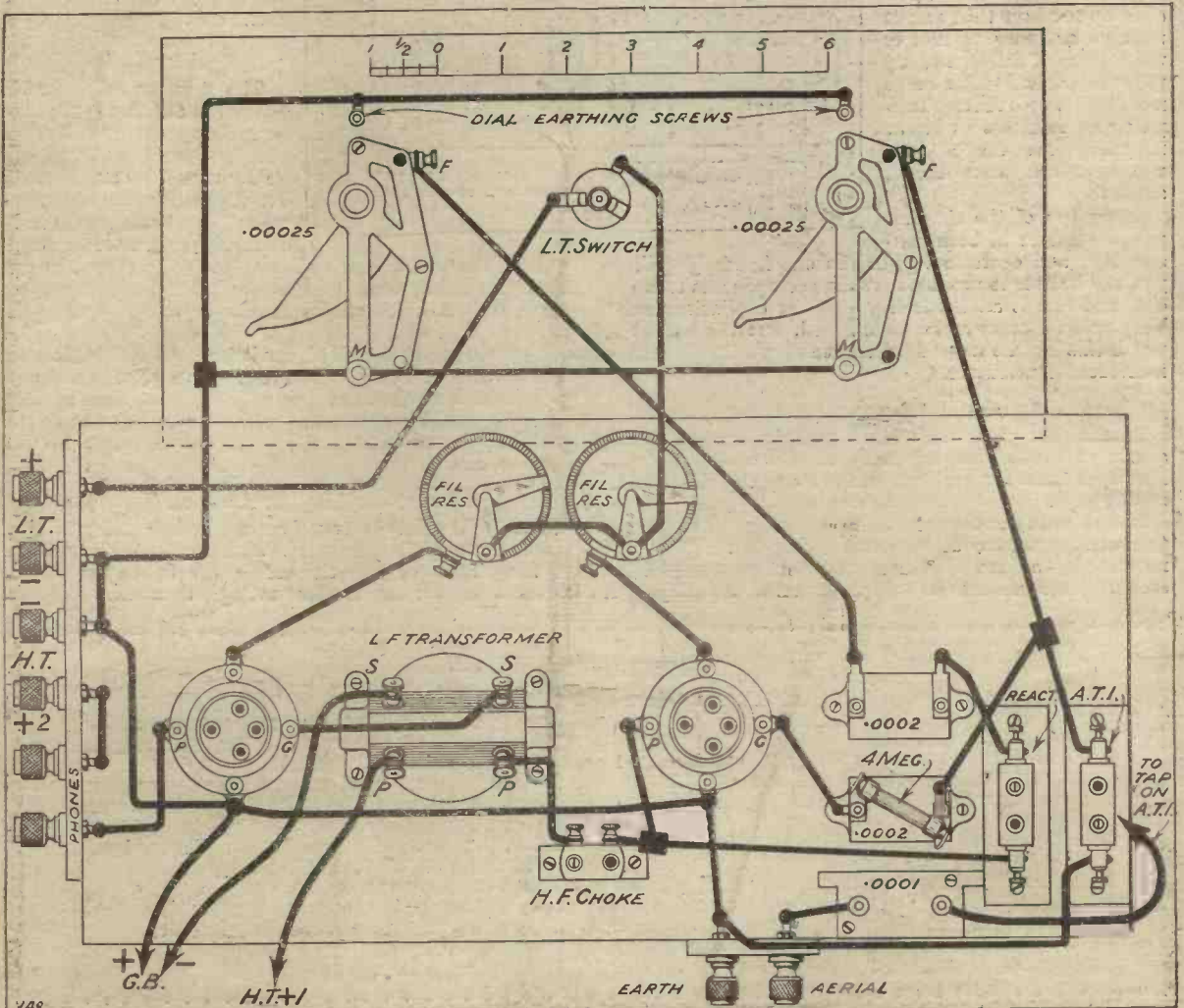



wire is wound on in a single layer, the wire being secured through two holes at the start, and wound on carefully so that each turn nestles snugly against the preceding turn, until the 30 have been wound, when the end of the wire is passed through a couple of little holes in the tube, and is secured by a dab of sealing wax or candle grease. This is the reaction coil.

A space of about  $\frac{1}{8}$  in. is left, and then the secondary winding is commenced. This is wound in the same direction as the first winding. The secondary coil consists of 60 turns of No. 24 double-cotton-covered wire—a much thicker wire—and you will find it will take up more than twice the space that the thirty-turn reaction coil took. As a matter of fact, it will occupy nearly all the remainder of the tube, only about  $\frac{3}{8}$  in. being left at the end.

### The Aerial Coil Spacers

You will wonder where the aerial coil is to go. This, however, is wound on top of the secondary coil, but is spaced so that it shall not actually be wound straight on top of the secondary coil. The spacing consists of placing six or seven strips of wood—wooden rod is perhaps the best for the purpose, such wooden rod as is used for the

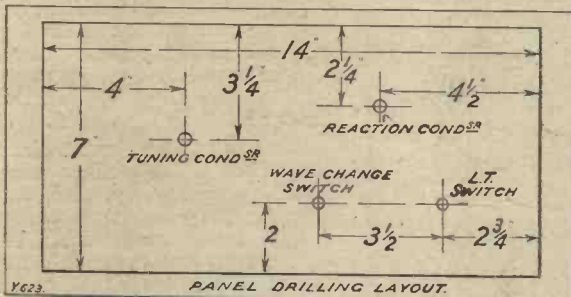

packing of Glazite—round the secondary at even intervals. Then the wire is wound on top of these wooden strips.

Unless you fix them in some way, you will find it difficult to wind the wire on these strips as they will keep on shifting, so you want to get two or three rubber bands and carefully fix these wooden rods at each end, over the coils already wound, and then wind on your aerial coil, removing the rubber bands afterwards, when it will be found that the aerial coil keeps the wooden spacers in position perfectly.

The coil itself consists of 24 double-cotton-covered wire, and has a total of 25 turns. It is tapped at the 10th, the 15th and the 20th turns, and is wound over the top of the secondary coil at the lower end—i.e. the end nearest the reaction coil, which you wound first.

It will be noted from the wiring diagram that the

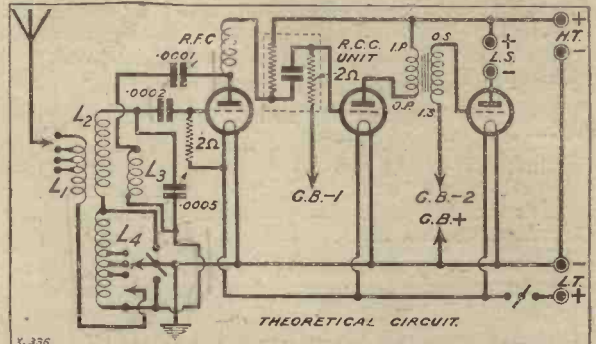

three coils are marked "L<sub>1</sub>," "L<sub>2</sub>," "L<sub>3</sub>." These refer to the aerial winding, the secondary winding and the reaction coil respectively. This completes the ordinary short-wave coil. The loading coil is wound on one of the standard formers, as was mentioned before, if you do not choose to buy the coil complete, and is wound in a series of rims or slots round the former.

In each slot there are about 27 turns, so that in the 8 slots you have a total of 216 turns, and the wire used is No. 26 double-silk-covered. Tappings are made at any convenient place, such as 25, 60, 80 turns or so, counting from the beginning, which should be labelled 0, of course, and the finish of the winding on the coil is marked "216."

### Completing the Construction

As regards the rest of the constructional work, this really requires no lengthy explanation—the wiring diagram and the photographs making it quite clear what connections you should make, and how the components should be arranged. As far as possible you should space out your components as shown in the wiring diagram, which is drawn to scale. Ordinary stiff wire should be employed for the wiring. Glazite may be used, but it is not necessary to use insulated wire.

The handling of the set is not a difficult matter. The short-wave range is obtained by pulling the wave-length change switch out, and the long wave by pushing it in.

### COMPONENTS REQUIRED.

- |  |  |
|--|--|
| <ul style="list-style-type: none"> <li>1 Panel, 14 in. × 7 in. × <math>\frac{1}{8}</math> in. (Any good branded material).</li> <li>1 Cabinet to fit, and baseboard 12 in. deep (Pickett, Camco, Raymond, Bond, Aircraft, Makerimport, Caxton, etc.).</li> <li>1 .0005-mfd. variable condenser, with slow motion (Dubilier K.C. in original. Any good make, Lissen, Formo, J.B., Igranic, Brandes, etc.).</li> <li>1 .0001 or .00015-mfd. miniature type reaction condenser Peto-Scott, Cyldon, Bowyer-Lowe, Igranic, J.B., etc.).</li> <li>1 L.T. on-off switch (Benjamin, Lotus, Igranic, Lissen, etc.).</li> <li>1 Push-pull type on-off switch for wave-change switching (Lissen, Lotus, or similar type).</li> <li>3 Valve sockets. One (that for the detector) should be of the sprung type, such as the Lotus, Benjamin, Bowyer-Lowe, W.B., Burne-Jones, Formo, Igranic, etc., but the other two can, if desired, be of the plain type, such as the Igranic or Lissen, which only cost 1s.</li> <li>1 R.C. coupling unit, with anode resistance of .5 meg. and grid leak of 2 meg. (Lissen in set, costing 4s. complete. Another good and inexpensive unit is the Dubilier).</li> </ul> | <ul style="list-style-type: none"> <li>1 .0003-mfd. fixed condenser (Lissen in set. Any good make, Mullard, Dubilier, T.C.C., etc.).</li> <li>1 2-meg. grid leak and holder (Lissen in set. Any good make, Igranic, Mullard, Dubilier, etc.).</li> <li>1 H.F. choke (home-made, by winding a Redfern choke former according to the instructions on the box. This is quite easy and a decided economy, but if desired any standard make of choke can be used).</li> <li>1 Standard loading-coil former ("M.W." and "P.W." type), and 4 oz. of No. 26 D.S.C. wire, or if desired a ready-wound loading coil (Burne-Jones, Paroussi, Wearite, etc.).</li> <li>1 L.F. transformer, fairly low ratio (a number of good types are available at prices under 20s.—e.g. the new Lissen, A.F.4, R.I. &amp; Varley "General Purpose," etc. This is largely a matter of the constructor's taste).</li> <li>1 Terminal strip, 12 in. × 2 in. × <math>\frac{1}{8}</math> or <math>\frac{1}{4}</math> in., and 8 terminals.</li> <li>1 Piece of tubing, 3 in. diameter and 3 <math>\frac{1}{2}</math> in. long, for short-wave coil (Any good insulating material, Pirtoid, Radion, etc.).</li> <li>4 oz. No. 24 D.C.C. wire and 1 oz. No. 32 D.S.C. wire.</li> <li>Small quantity of bare tinned copper wire for wiring up, flex, G.B. plugs, 3 tapping clips, sundry small pieces of wood, screws, etc.</li> </ul> |
|--|--|



It is best to start off with your local station, of course, and we presume this is of the short-wave variety, so we will pull the wave-length switch out, and also pull the L.T. switch out, so as to switch on the set.

It should be stated here that the valves used are of the normal types, i.e.—an H.F. valve in the first stage, followed by another H.F. valve (of about 15,000–30,000 ohms impedance), and finally by a power or super-power valve. Either 2-, 4-, or 6-volt accumulators may be used, as required, and 120 volts H.T. should be available, with grid bias up to 18 volts.

#### Adjusting the Aerial Coupling

With the aerial tap on the aerial coil at the maximum position, i.e. at the end of the coil, and the second tapping clip on "0" on the loading coil, the aerial condenser will be turned round as slowly as possible, and the operator should listen for his local station. The reaction con-

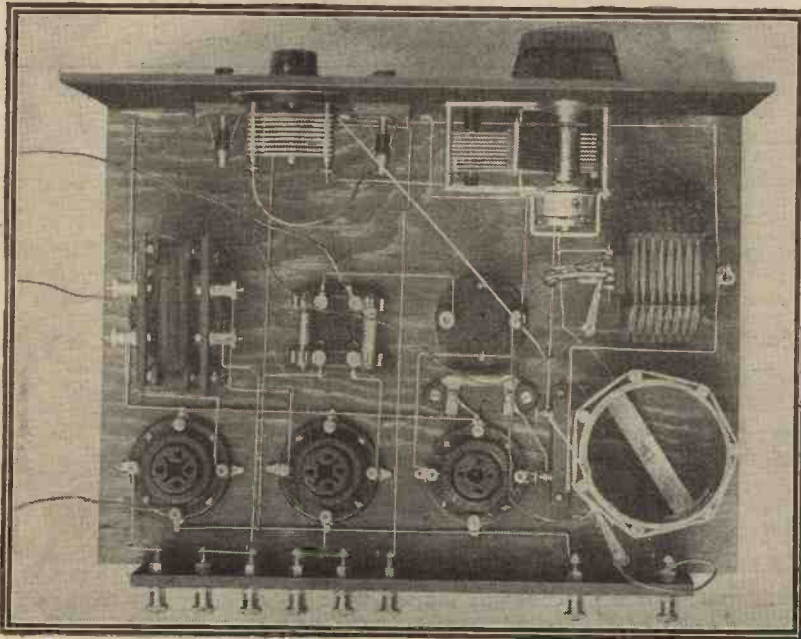

Another photo of the interior of the set, in which it is possible to identify most of the leads. Compare this photo with the wiring diagram.

denser should be varied to see if the set will go into oscillation or not, the state of oscillation being denoted by placing a damp finger on the fixed vanes of the aerial condenser.

When the set is oscillating, a distinct plop will be heard when the finger is placed on, and another plop when it is taken off. When the local station is being received, of course, plops which might be confused with signs of oscillation can be obtained when the set is not oscillating, so that the test of oscillation should be carried out when the local station is off or when no station is being tuned in.

When it has been determined how the set oscillates and whereabouts the reaction condenser should be placed to get oscillation, then this condenser should be decreased in its value until the set is well away from oscillation point, and the local station tuned in. When this has been tuned in to the best advantage, the aerial tapplings should be varied on  $L_1$ , until the best selectivity or signal strength is obtained.

#### Getting Best Results

You must remember that as the tapplings are varied downwards, i.e. as less coil is employed, so the selectivity of the receiver will go up and the sensitivity will go down, so that with the local station you will find it not a difficult matter to obtain the best results, but for a distant station you must carefully balance your selectivity and sensitivity

by means of the tapplings until you get the desired result. After a few hours' practice with this receiver it will be quite easy to find a position on the  $L_1$  coil which will give you a compromise between selectivity and sensitivity suitable for most of your requirements.

#### The Long-Wave Tapplings

When you have got used to handling the set on the lower wave-length band, you should push in the wave-length switch and tune in 5 X X. This will be an easy matter and probably you will not have to use your reaction in any way before you hear it quite loudly. Reaction will, of course, bring up the signal strength, while you should also play about with the tapplings on the loading coil and see you get your best results.

By means of the tapplings on the loading coil, you will be able to arrange your sensitivity to the best advantage. As a general rule, the aerial feed tapping from the bottom

of  $L_1$  can remain on "0" on the loading coil, though for increased selectivity it can be placed on "25." The filament tapping from the centre of the wave-change switch (i.e. earth) should be varied on the 60 or 80 tapping according to which gives best reaction control. This tapping does not, of course, affect the shorter wave-length results as the whole of the loading coil is shorted out by means of the switch.

There is one little point about this switch which perhaps wants a little clearing up, and this concerns the connections to the switch. It will be noticed from the photographs that the switch is of the usual type, having two spring contacts on either side of an insulated plunger with a metal cap.

When the switch is "in" the cap is away from the metal springs and no contact between them is made, while when the switch is "out" the metal cap makes contact between the springs.

In the long-short switching scheme used in the set we have described the switch is connected so that the spring contacts go to the ends of the loading coil so that the metal cap shorts this coil out when the switch is in the "short-wave" position. In addition, the metal cap is connected by a flexible lead to earth, so that not only is the loading coil shorted but it is earthed thereby, as will be seen in the theoretical diagram, taking the short-wave coil straight to earth at the same time as the long-wave coil is shorted.

#### How Reaction Changes

When this latter is in use—the switch being in the "in" position—the main reaction coil, instead of going direct to earth, as in the case where the lower wave-lengths are being received, goes to the tapping on the loading coil, which can be varied to increase or decrease the reaction coupling as desired, and this thereby gives an extra Hartley reaction effect on the longer waves.

It must be emphasised that the tapping from the bottom of the aerial coil ( $L_1$ ) must be placed on "0" when the set is being used for the shorter wave-lengths, and as remarked before it will be usual to leave it here for all purposes, but it is essential for efficient operation that this be on "0" for the shorter waves.

A study of the theoretical circuit diagram will show exactly how the tapping variations will affect the operation of the receiver, and why it is important to have the different tapping clips on the right places if the maximum efficiency is to be obtained.



# An H.F. Det., L.F., Loudspeaker Set for £8

**T**his receiver is undoubtedly one of the best that has ever been produced by the "M.W." Research and Construction Department. It cannot be called an expensive set, and its costs-results ratio is a very low one indeed. The circuit is perfectly straightforward and the gratifying results obtainable with the set are due to the layout and design, on which much time and research were spent.

The set has a high order of selectivity, and on an average aerial, when conditions are favourable, it will tune-in at least twenty stations at good loud-speaker strength. The eight pounds quoted in the title is, as in the case of the other receivers described in this book, an approximation.

The set can be built with first-class components throughout for eight pounds, but it is possible considerably to reduce this figure. For instance, if the constructor happens to be fairly efficient at carpentry, he can make his own cabinet and in one stroke effect a considerable saving.

## A Word Regarding Economising

Further, if 2-volt or 6-volt valves are to be used throughout, with a 2- or a 6-volt accumulator supply, there is no reason why the filament rheostats or resistances should not be omitted. Such components are really only essential when the voltage ratings of the valves and the voltage of the L.T. supply differ considerably. Thus, if 2-volt valves are to be operated from a 4-volt supply, then filament resistances must be used.

Similarly, it is advisable to employ such devices when 5-volt valves are to be connected to a 6-volt L.T. supply. But if you are intent on cutting down costs as much as you can, go about the business very carefully. Some cheap components are good value for money, but others definitely are not.

Now for a few words regarding the circuit of this receiver. As we have already stated, it is perfectly straightforward. There is an efficient stage of H.F. amplification

A first-class three-valver capable of long-distance loud-speaker results. The design is a novel one and is the successful result of an endeavour to solve several problems. Great sensitivity and a very high degree of selectivity are features of this "last word" receiver.

employing what is known as "split-primary" transformer coupling.

The H.F. transformer used for coupling the first two valves has three windings. These are the primary, secondary and reaction. The primary winding has a centre tapping in order to enable neutralisation to be effected.

A single aerial coil is employed, and this is provided with tappings enabling alternative degrees of selectivity to be obtained. A simple screen provides separation between the H.F. stage and the detector. This latter employs a grid leak and condenser.

## Concerning the Circuit Used

It will be noticed that there are two condensers in series with the reaction winding and the plate of the detector valve. One is a variable, and with this the control of regeneration is carried out. The other condenser is of the fixed variety and its purpose is to prevent the H.T. battery shorting should a "short" occur across the variable condenser.

It will be seen that if this fixed condenser is omitted, the only break occurring in a direct path between the H.T. and the L.T. and earth is the variable reaction condenser. Should the plates of this touch, or in any other way an accidental connection between them occur, the plus of the H.T. battery is taken direct to earth which, as H.T. — via L.T. — is also taken to earth, is tantamount to a direct short of the H.T. battery.

The L.F. valve is transformer-coupled. One H.T. positive terminal is common to both the L.F. and the H.F. valves, while a separate one is supplied for the detector. Grid bias is provided for the last valve.

The layout of the receiver is unorthodox. Instead of the coils being mounted on the baseboard, holders for these are provided on each side of the simple screen partition that we have already mentioned. Not only is compactness achieved by this arrangement, but also the screening is made more

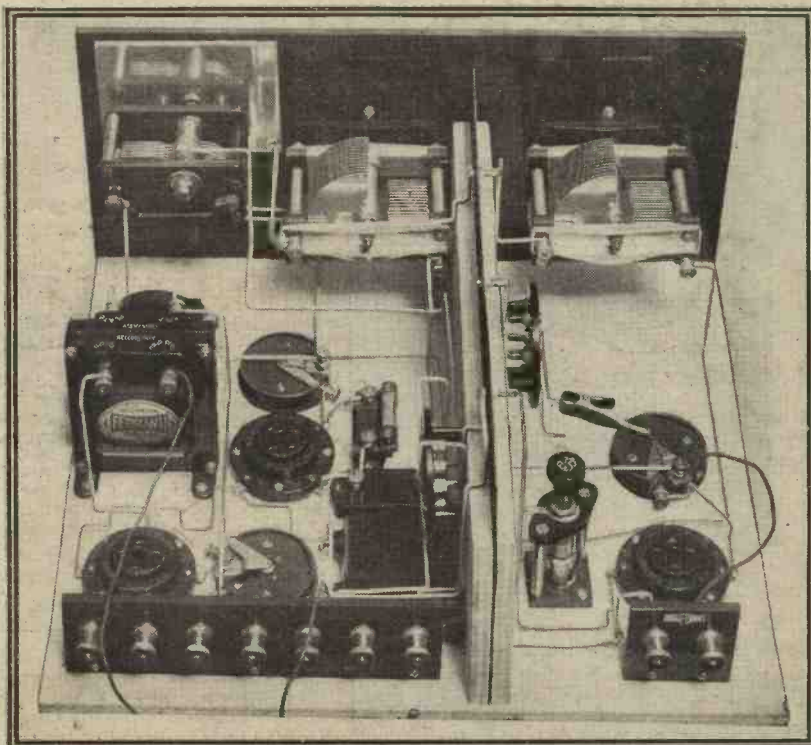

The coils are mounted one on each side of a screening partition. Efficient electrical separation of parts and useful accessibility are the happy results of this measure.



efficient and the insertion and removal of the coils greatly facilitated.

In order to enable the coil holders to be mounted, two pieces of wood are fixed to the screen in a manner shortly to be described. This is perhaps the only complication in the construction of the set, and it is not a very great one.

Taken all round the receiver is quite an easy one to build. Providing he takes care, the constructor who has

so far not built a valve set need not fear to make this his first venture. But especially is it important that the layout should be adhered to. A matter of an eighth of an inch deviation here or there will not matter a scrap, but wide variations from the component positions indicated in the accompanying photograph may possibly be attended by disappointing results.

Regarding the actual constructional work, the first step that must be taken is to get all the necessary parts

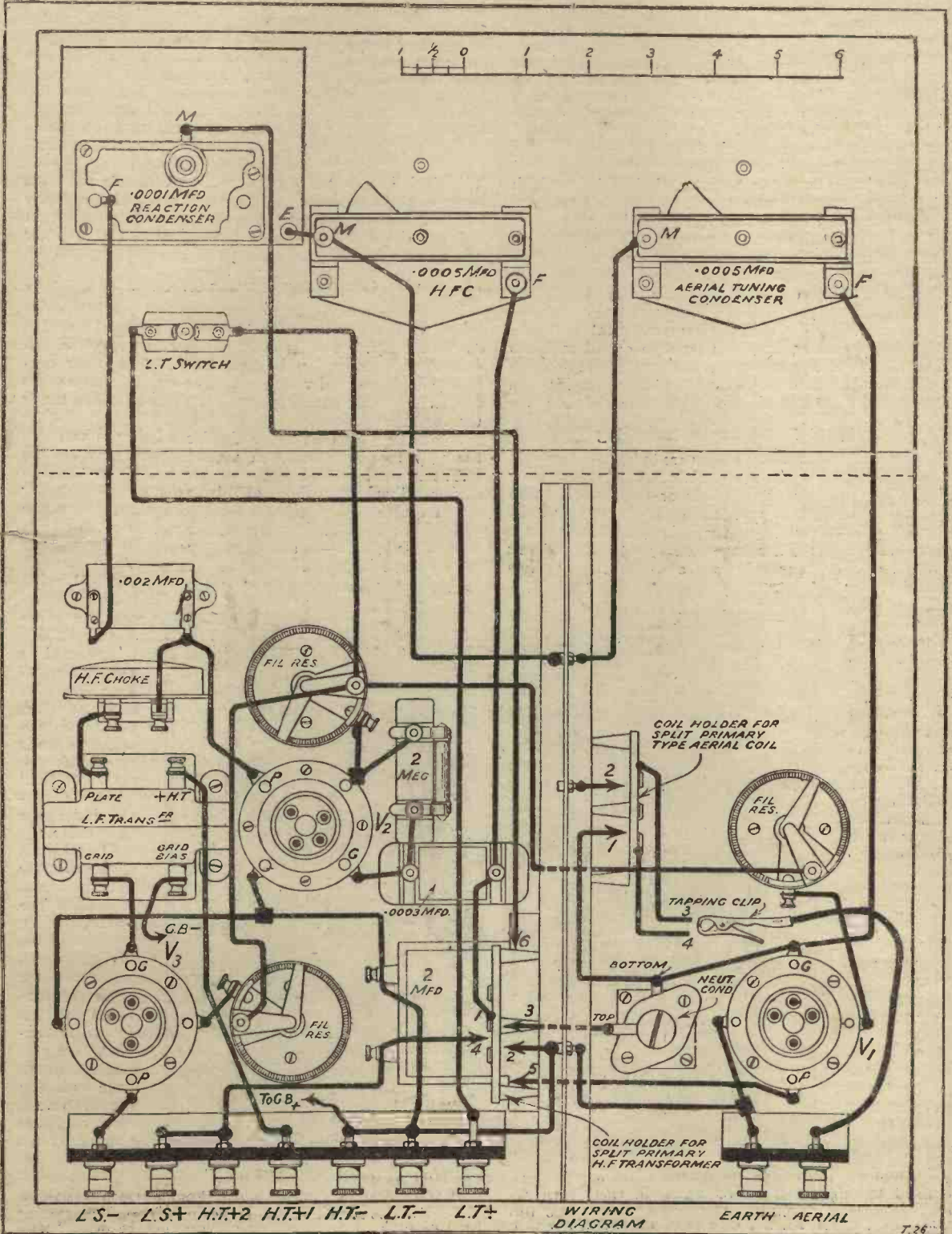



together. Do not start the work until this has been done. See that you have every screw, piece of wire, and so on, before you pick up your screw-driver to mount the first component.

As it involves the most actual construction, it perhaps may be best to get the screen and its "face boards" finished first. If the constructor desires to dodge this part of the work, he can obtain a suitable partition already for assembling in the receiver from Messrs. Paroussi, Raymond, Burne Jones, etc.

**Making the Screening Partition**

However, it consists of a copper sheet measuring, as is shown in the accompanying diagram, 11½ in. by 6 in. On each side of this is fixed a piece of ¾-in. wood, 11½ in. by 4½ in. A fair number of holes have to be drilled through this partition, some for holding the wooden panels in position and others through which leads will eventually pass. All these holes are shown in detail in the photographs.

The top three holes through the copper only are for screws and nuts to which connections are taken. These connections to the screen, which is earthed, facilitate the wiring and shorten many important leads.

The number of leads which have to pass through the partition have been reduced to a minimum. It will be noticed that the holes which carry these leads have to be pierced through both wood and metal. Unless you are a very skilful craftsman you will find it best to drill all the holes after the wooden plates have been fixed to the metal. Then there can be no possibility of trouble through the separately drilled holes failing to come in line on the assembly of the pieces.

The partition completed, the next job is the drilling of the panel. Here, again, you have the scale-drawn wiring diagram to assist you. There are two reasons why you should get your holes drilled exactly in accordance with the dimensions.

**Mounting the Terminal Strips**

The first is that discrepancies here may ruin the symmetry of the panel and spoil the appearance of the set. The second reason is perhaps an even more important one, and this is that your variables will get in the way of the partition unless they are placed, more or less, exactly as shown:

When the panel has been screwed to the baseboard, the partition can be fixed in position. You will find that perfectly satisfactory fixing results if you use 1¼-in. screws of a slender character driven up through the baseboard into the wooden portion of the partition. Four such screws will be ample.

It will be noticed that, in the original set, the terminal strips are not mounted directly on the baseboard in the usual manner. The strips are placed some way in and are fixed to lengths of wood, which in their turn are screwed to the baseboard. The result is that the terminals are covered when the set is in its cabinet and the leads pass through holes made in the cabinet, and thus

external short-circuits through straying metal objects like scissors, pencil cases, etc., are avoided.

There is, of course, no reason why the terminal strips should not be mounted in the usual manner, direct to the baseboard, if the constructor so desires. The position of the screening partition and the terminal strips—and, indeed, all the components—are clearly shown in the wiring diagram, which is drawn to scale.

In order to use this (it is reproduced in the top right-hand corner of the diagram), you should make an exact copy of the scale on a small piece of paper. The figures represent inches, and you should take measurements from the diagram as though your drawing were an ordinary ruler.

**Positions of the Components**

Every effort was made by the designer of this receiver to simplify the wiring. You will be able roughly to gauge the positions of the coil holders on the partitions by the accompanying photograph of the back of the set. But you should leave the fixing of these articles until you have

everything else in the set screwed down.

Then insert the valves, if you have them, and put coils in the holders and experimentally hold the holders in the positions you judge they should be fixed. You will be able to gauge this again by the wiring diagram which, as has already been mentioned, is drawn to scale.

The final part of the construction is

reached when the coil holders are screwed to the partition. Little need be said about the wiring as this is essentially of a simple character, but as a comparatively large expanse of metal, in the form of a screen, is used, which is connected to earth, it will be advisable to employ a covered wire such as Glazite. Anyway, it is particularly important that some such protected wire, or wire supplemented with a protective covering of the nature of Systoflex, be used for those leads which pass through the partition.

When you have completed this set and carefully checked all your connections, the time has arrived when it will be necessary to consider the accessories.

**Coils for the Set**

The coils in this receiver are of vital importance. It should be noted that coils especially suitable for this receiver can be obtained from the "Lewcos" people and other well-known manufacturers, such as Messrs. Bowyer-Lowe, Peto-Scott, etc. The coils are ordinary six-pin coils of the split-primary type aerial and split-primary transformer varieties. Although they are perfectly standard, it will be safe when giving your order to specify coils for the MODERN WIRELESS Eight Pounds Three-Valve Booklet Set. But, being standard coils, they are available at quite standard prices.

If your aerial coil holder is not provided with terminals you can adopt the scheme employed in the original receiver for taking the tappings. Two short lengths of stiff wire were soldered to the soldering tags on sockets Nos. 3 and 4.

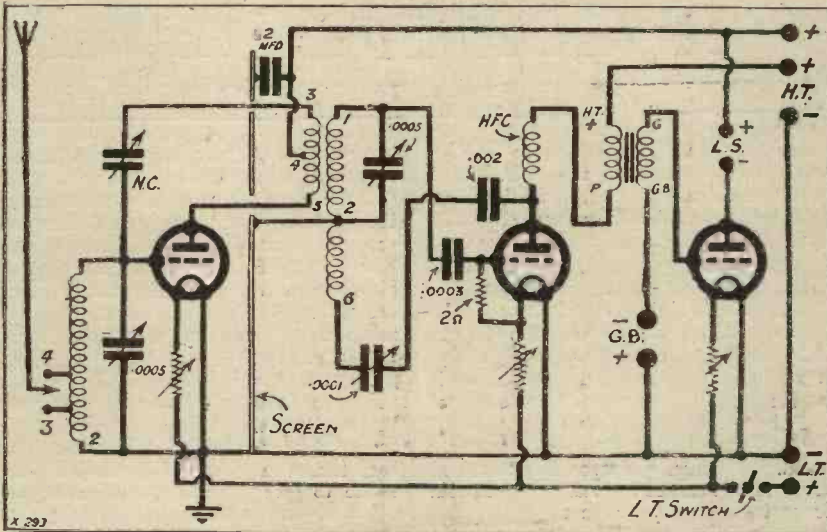



A small tapping clip was then connected to the aerial terminal by means of a short length of flexible wire.

Either 2- or 6-volt valves can be used with this set. In the H.F. and detector positions, valves having impedances of somewhere between 12,000 and 30,000 ohms should be employed. Suitable varieties which occur to mind are, Cossor 610 H.F., the Six-Sixty 6075 H.F., Mullard P.M.5X., Marconi or Osram H.L.610, Ediswan H.F.610, B.T.H. H.F.607, and so on.

The L.F. valve should be of the small-power type— that is to say, of the ordinary power variety, not super-power. You will need about 60 volts on the detector and between 100 and 120 for the H.F. and L.F. valves. A grid-bias battery of 9 volts should be ample. This battery should be fixed by means of clips inside the back of the cabinet.

Short flexible leads having wander plugs and joined to the H.T.— terminal and the G.B.— terminal of the L.F. transformer are connected to this battery as indicated in the wiring diagram. Neutralisation should be carried out in the following "M.W." standard manner:

#### Some Notes on Neutralisation

Set the reaction control at minimum and likewise the neutralising condenser. Now, on setting the tuning condensers so that the two tuned circuits are in step with each other, it will probably be found that the set is oscillating. To test for oscillation, touch one or other of the sets of plates of the tuning condensers.

You will probably find that the set will only oscillate under the above conditions when the two circuits are in tune with each other, and this can be used as an indication. It is convenient to perform the operation at some point

near the middle of the tuning range. Now increase the capacity of the neutralising condenser. (In the case of such condensers as the Gambrell "Neutrovernia" this means screwing downwards.)

Test at intervals for oscillation as this is done and you will presently find that the set has ceased to oscillate, and will not recommence even when the tuning dials are slightly readjusted. Now increase the reaction a little, until the set once more oscillates, and again increase the neutralising condenser setting until oscillation ceases.

Slightly readjust the tuning condensers again to make sure that the set is completely stable once more. Proceed in this way until it is found that the correct adjustment of the neutrodyne condenser has been over-shot. Once this point has been passed it will be observed that further

increases of the neutrodyne condenser setting no longer stop oscillation, but cause it to become stronger.

The object is to find such an adjustment of the neutralising condenser as will permit the greatest setting of the reaction condenser to be used without producing oscillation. It will then be observed that when the two tuned circuits are in step and the set is brought to the verge of oscillation, a slight movement in either direction of the neutrodyne condenser will cause the receiver to break into oscillation.

Now, although the method of mounting the coils provides very efficient screening and greatly facilitates the insertion of the coils, a word of warning is necessary in regard to the removal of these accessories. You should ease them out gently, for unless you do this they are liable to give suddenly and cause you to knock one or other of the valves.

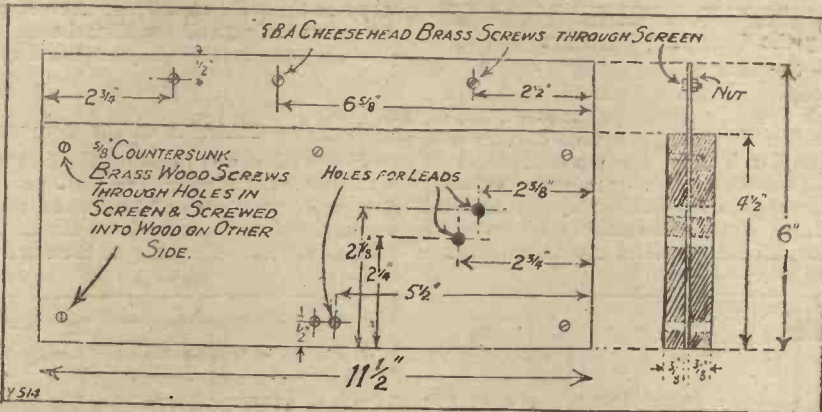

#### THE COMPONENTS AND PARTS REQUIRED

- 1 Panel, 14 in.  $\times$  7 in.  $\times$   $\frac{1}{4}$  in. or  $\frac{3}{8}$  in. (Original was Resistor. Any good branded material).
  - 1 Cabinet to fit, with baseboard 12 in. deep (Camco, Raymond, Pickett, Bond, Artercraft, Makerimport, Caxton, Peto-Scott, etc.).
  - 2 .0005-mfd. variable condensers, square-law or S.L.F., etc. (Bowler-Lowe "Popular" in set. Any good make, Lissen, Cyldon, J.B., Igranic, etc.).
  - 2 Slow-motion dials (Bowler-Lowe in set. Any good make).
  - 1 .0001-mfd. miniature type reaction condenser (Burndept in set. Other suitable types are the Cyldon, Peto-Scott, Bowler-Lowe, Igranic, J.B., etc.).
  - 1 On-off switch (Any standard type, such as Lotus, Benjamin, Lissen, Bowler-Lowe, L. & P., Igranic, etc.).
  - 3 Sprung valve sockets (Any standard make, such as Igranic, Benjamin, Lotus, Bowler-Lowe, B.T.H., Burndept, Burne-Jones, W.B., Marconiphone, Pye, Redfern, etc.).
  - 1 Baseboard-mounting neutralising condenser (Peto-Scott in set. Any standard type).
  - 3 Baseboard filament rheostats or resistors (see text) (Lissen 6-ohm in set. Any standard type to suit valves).
  - 1 Baseboard-mounting neutralising condenser (J.B. in set. Any standard make).
  - 1 Tapping clip.
  - 2 Plain unscreened 6-pin coil sockets (Any standard make, Colvera, Bowler-Lowe, Lewcos, Burne-Jones, Peto-Scott, etc.).
  - 1 .002-mfd. fixed condenser.
  - 1 .0003-mfd. fixed condenser.
  - 1 2-mfd. Mansbridge type condenser.
- Note.—The fixed condensers in this set are of Dubilier and Mullard make. Any standard type can be used, Lissen, Clarke, T.C.C., Goltone, Igranic, etc.
- 1 2-megohm grid leak with mounting clips or separate holder (Any of the standard makes, such as Igranic, Lissen, Mullard, Dubilier, etc., can be used).
  - 1 H.F. choke (Igranic in set. Any standard make, Lissen, R.I.-Varley, Colvera, Cosmos, Burne-Jones, Bowler-Lowe, Lewcos, Wearite, etc.).
  - 1 L.F. transformer (Ferranti A.F.3 in set. Any good make, R.I.-Varley, Lissen, Igranic, Mullard, etc.).
  - 1 Terminal strip, 2 in.  $\times$  2 in.  $\times$   $\frac{1}{4}$  in., with two terminals (Burne-Jones engraved type in set. Can be cut and fitted with engraved terminals if desired, such as Belling-Lee, Eelex, Igranic, etc.).
  - 1 Terminal strip, 7 in.  $\times$  2 in.  $\times$   $\frac{1}{4}$  in., with seven terminals (see above).
- Materials for screening partition (see text), flex, and Clix plugs for G.B. leads, screws, wire for wiring up, etc.
- Note.—The original was wired with Glazite, but any desired material can, of course, be used, such as bare tinned wire and Systoflex, Junit, etc.





# A £10 FOUR- VALVER

**T**HE owner of a good four-valve receiver can generally be said to have practically a complete choice of programme. If he does not like his local station, he can switch off to one of the other main stations, or one of the longer-wave stations, or he can tour the Continent, and under favourable conditions even America, in search of a programme which is more to his liking.

It was with this feature in view that the receiver described here was designed, but at the same time, consideration of the cost, which, after all, is one of the main considerations in building a wireless set, was kept well to the fore, and the price of the receiver kept as low as possible.

Naturally, a high standard of efficiency had to be maintained, as it is never advisable to sacrifice efficiency for cost. Far better is it to do away with one valve, and perhaps limit your range of reception, but at the same time to build an efficient receiver for the type of circuit which you use.

There is no use in using a four-valve circuit of inefficient design simply because you only want it to cost only as much as a three-valve set. A good three-valver will often do better than a poor four, and will be cheaper to run, besides giving far more satisfactory results from the point of view of quality of reception and general behaviour.

### Perfectly Straightforward Design

The design of the circuit of the four-valver under description is perfectly straightforward and well-proved methods of construction have been maintained, but things are so arranged that, although there are only two main tuning controls, the set has a really first-class degree of selectivity, while the panel layout is attractive and well balanced.

In this receiver, as in many others, the broadcast coils can be wound by oneself, using the usual standard six-pin coil

formers; or the man who does not like the idea of making his own coils can purchase them from any of the well-known manufacturers and be absolutely sure that they will be efficient.

These coils are by no means complicated, being of the ordinary tapped and split-primary types, and having been on the market now for some considerable time.

It should be noted, however, that the coils are not of the screened variety, as were popular some year or so

**A powerful loud-speaker set in which purity of reproduction is a leading feature. Dozens of stations at comfortable loud-speaker strength can be tuned-in with this set.**

ago; instead the MODERN WIRELESS standard screening box is employed, and the H.F. transformer, the H.F. valve, the neutralising condenser, etc., are

all placed together inside the screening box, thereby counteracting any likelihood of interaction between the H.F. and the aerial stages, or between the H.F. and stages coming later on in the set.

As regards the circuit itself, nothing very much can be said except that it is perfectly straightforward, consisting of an H.F., detector and two L.F. stages, the first L.F. being resistance- and the second transformer-coupled. This method of coupling has become very popular, and for a good reason, because it is wonderfully efficient, easy to build and gives the best results from the two L.F. valves, with a quality that is hard to beat.

### "Anode-Bend" or "Grid-Leak"?

It will be noticed that the grid-leak of the detector valve goes down to a plug, so that it can be connected either to the positive filament leg of the valve or can go to a grid-bias battery. This enables the constructor to have either grid-leak rectification, with its attendant sensitivity—a very useful point when D.X. results are being attempted—or he can have anode-bend rectification, with the purity which attends that type of rectification.

Ordinary Reinartz reaction upon the secondary of the H.F. transformer is carried out, and the .002 condenser placed in series with the .0001 reaction condenser enables very fine reaction control to be obtained. Incidentally, upon the local station where maximum purity is required when anode-bend rectification is being carried on this reaction condenser can be

placed at its minimum, which will then be a very low minimum, and the reaction can be said to be practically cut out, this being a valuable feature where purity of results is concerned.

As regards the performance of the set, this is extremely good,

for at no point in its construction have results been sacrificed for cheapness. The main tests of the set have been carried out on quite an average aerial; as a matter of fact, rather smaller than the average type of aerial, being only about 20 ft. high at one end, and a little less at the other, and being rather badly screened.

Even under these conditions it is quite a usual performance to get well over a dozen stations at full loud-speaker strength. At times, of course, this can be greatly exceeded,

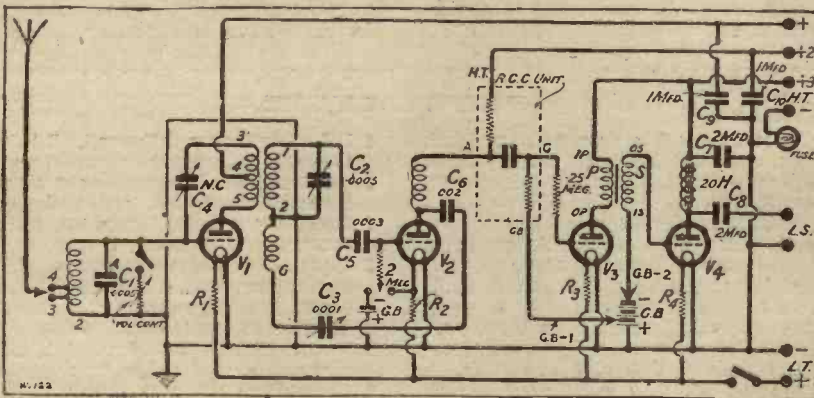



but for an average night we think a dozen can be said to be really well worth expecting.

Results will, of course, vary with location, and upon a good aerial in a good district the results should be very greatly improved.

Let us return once more to the aerial circuit. A glance at the diagram shows that quite a conventional scheme has been employed, the aerial being auto-coupled to a tuned secondary circuit, and a couple of alternative taps have

therefore any reaction effects that may be present are cut out.

As is well known, the reaction effects, especially when tuned in to the local station, are liable so to sharpen the tuning that serious distortion may occur. This is especially the case when one is situated about fifteen to twenty miles from the local station.

In regard to the H.F. coupling between the H.F. and detector valves, this is merely the ordinary split-primary

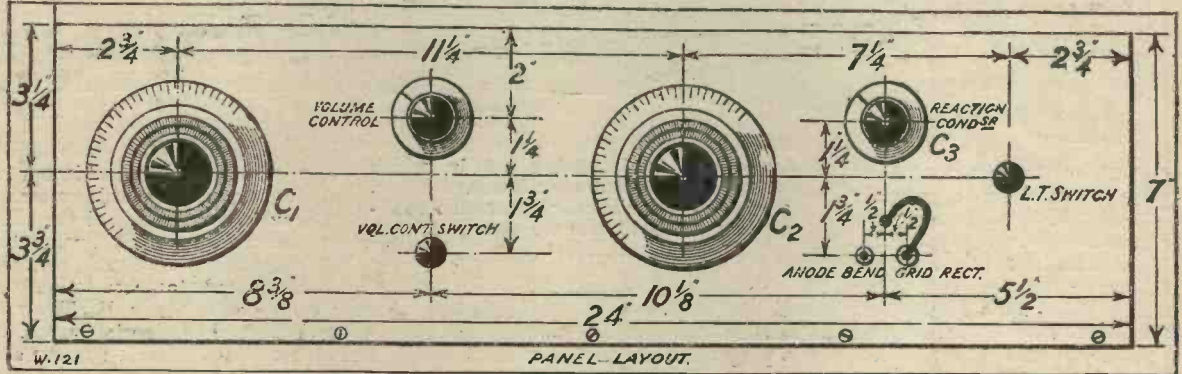

been provided for the aerial to give a rough adjustment of selectivity and sensitivity. This is a valuable feature, as it enables the individual to adjust for his own particular aerial.

Across the secondary circuit will be seen a switch and variable resistance, which is a volume-control damping device, and has proved to be of great value when listening to the local station. It enables the tuning to be broadened so that the maximum quality can be obtained, and it also enables the signal strength to be cut down without need for detuning.

#### Controlling the Volume

It merely consists of a variable high-resistance of the non-inductive type, and is connected by means of a switch so that it can be used either to increase the damping of the circuit, to reduce the signals of the local station, or the switch can be placed in the "off" position, when the variable resistance is disconnected altogether.

These lesser volume controls, as they are called, have found their way into a great number of designs recently, and are fully worth a trial. Where H.F. valves are concerned, they, of course, damp the grid circuit, and any feed-back which may remain, even though the valve may be neutralised, is satisfactorily damped out, and

type of transformer, which is provided with the reaction winding and can be of either one of the standard six-pin type or a special fixed one if wave-length band changes are not required. For those who wish to wind their own coils details will be given further on in the article.

#### Neutralised Stage of H.F.

The tuning is carried out upon the secondary portion of this circuit and the primary is tapped, so that neutralisation of the H.F. valve can be carried out. This primary, of course, is connected so that the H.T. is tapped into the centre of the coil, one end of this going to the plate and the other end connected back through the neutralising condenser to the grid.

This supplies the correct neutralising potentials to the grid and enables any feed-back between the plate and grid circuits to be washed out. Though the neutralising may not be constant over all the range, it is easy to carry out, and when accomplished is sufficiently near to enable the set to be operated over the whole of the range.

When one changes over to long-wave coils, neutralisation should not have to be carried out afresh, as the coil is arranged to suit the neutralising already done with the short-wave broadcasting coils, and at no time, if

#### COMPONENTS REQUIRED.

- 1 Cabinet, 24 in. × 7 in. × 9 in. deep, with baseboard, panel brackets, and panel 24 in. × 7 in. × 1/4 in. or 3/8 in. (Bond, Caxton, Raymond, Cameo, Makerimport, Pickett, Artercraft, etc.).
- 2 .0005-mfd. variable condensers with vernier movements (J.B.). (Any good make, Bowyer-Lowe, Lissen Cyldon, Igranic, Formo, Raymond, etc.).
- 1 C.R.L. modulator or similar high-resistance (R.A. Rothermel, Ltd.).
- 2 On-off switches (Benjamin, Igranic, Lissen, Lotus, etc.).
- 1 .0001-mfd. variable condenser, midget type (Peto-Scott, J.B., Bowyer-Lowe, Cyldon, Dubilier, etc.).
- 1 Standard screening box with usual contents (Coil holder should be arranged as shown on diagram).
- 1 Six-pin base for aerial coil (Lewcos, Bowyer-Lowe, Collinson, Burne-Jones, etc.).
- 3 Sprung valve holders (Lotus, Igranic, Formo, W.B., Benjamin, Burne-Jones, Marconiphone, Redfern, Bowyer-Lowe, B.T.H., Burndept, Ashley, etc.).
- 3 Baseboard-type rheostats (Burne-Jones). (Any good make of the lengthwise type. See photos.)
- 1 Output filter L.F. choke.
- 1 L.F. transformer (Ferranti, R.I.-Varley, B.T.H., Lissen, Igranic, Marconiphone, Mullard, etc.).
- 1 R.C.C. unit, anode resistance about 1/2 meg., (Dubilier, Lissen, Mullard, R.I. and Varley, etc.).
- 1 H.F. choke (Igranic, Lissen, R.I. and Varley, Burne-Jones, Climax, Dubilier, Lewcos, Colvern, etc.).
- 2 2-mfd. Mansbridge condensers (Lissen, Dubilier, Clarke, Ferranti, G.E.C., Mullard, T.C.C., Hydra, etc.).
- 2 1-mfd. Mansbridge condensers. (See above.)
- 2 Grid-leak holders (Lissen, Dubilier, etc.).
- 1 2-meg. grid leak (Dubilier, G.E.C., Ediswan, Igranic, Lissen, Mullard, etc.).
- 1 .25-meg. grid leak. (See above.)
- 1 .0003-mfd. and one .002-mfd. fixed condensers (Lissen, Clarke, Mullard, Dubilier, T.C.C., G.E.C., etc.).
- 1 H.T. fuse holder complete with fuse.
- 10 Terminals, markings as per diagram (Eelex, Belling-Lee, Igranic, etc.).
- 2 Ebonite terminal strips, one 2 in. × 2 in. × 1/4 in., one 8 in. × 2 in. × 1/4 in.
- 2 Sockets and 4 plugs for grid bias (Clix, Eelex, etc.).
- Wire, screws, nuts, etc.



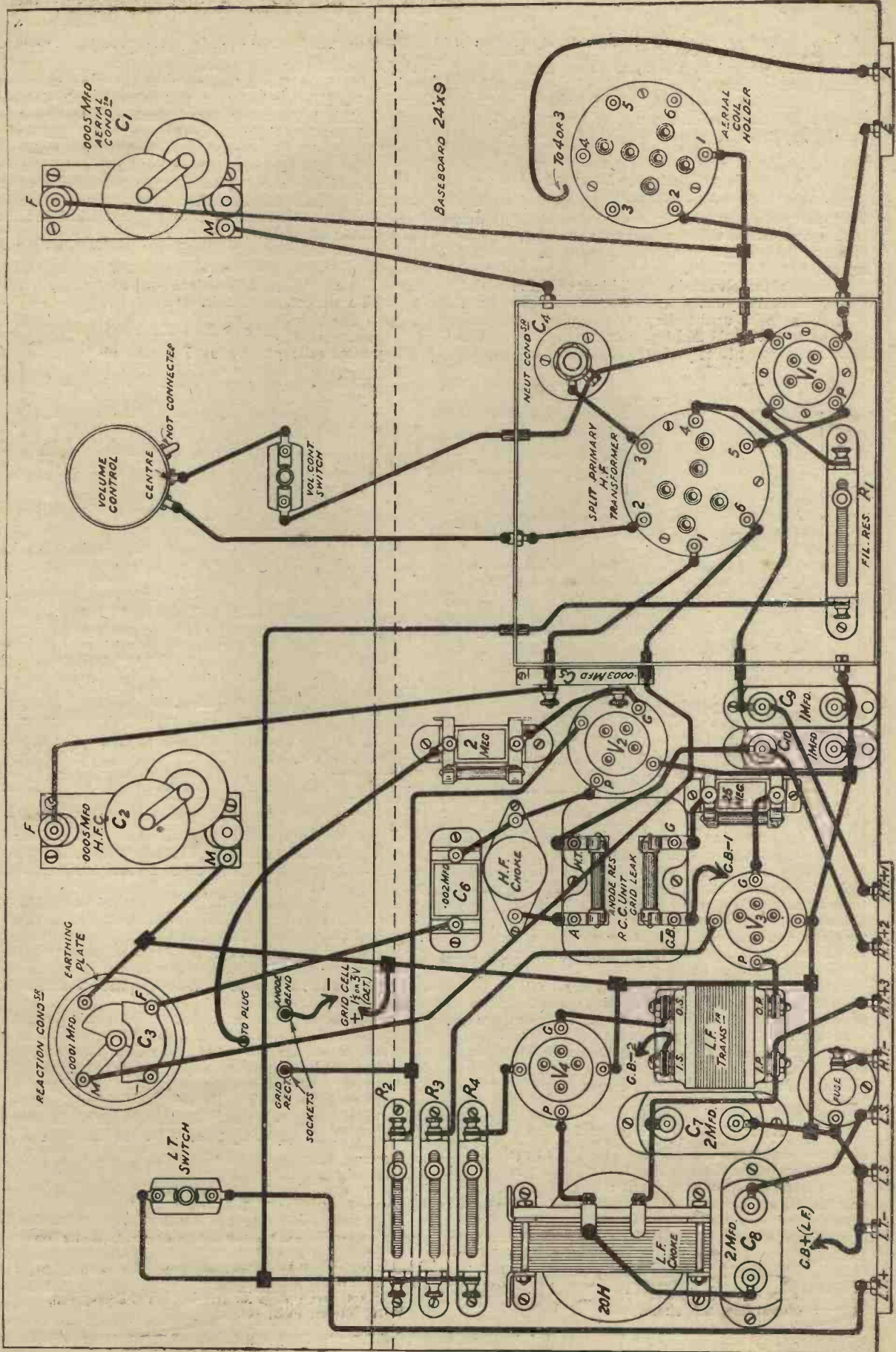



neutralising is carried out properly, is there risk of the set suddenly going into oscillation or anything annoying of that sort. It may be a little bit off neutralisation at some point in the wave-band, but that will only have an effect upon the sensitivity, rather increasing it than causing any trouble.

### Very Efficiently Screened

The set is efficiently screened, the screening boxes designed by the MODERN WIRELESS Research Department having been found to be wonderfully effective, especially in neutralised circuits, in enabling a really sharp neutralising point to be obtained.

In many old receivers, due to all kinds of H.F. feed-back, which, of course, was due to inefficient screening, the neutralising point used to be very difficult to find, and in some cases one would find two points, at neither of which did the set appear to be perfectly neutralised.

and in many cases this is the real secret of obtaining D.X. results that are really worth calling results.

Passing from the detector on to the next valve one notices the H.F. choke in the plate circuit of the detector valve. This is essential if good reaction is to be carried out, and in order for this to be the case it is advisable that the H.F. choke be a good one, though not necessarily expensive. Chokes vary in price, but as long as it gives a moderate choking action, quite sufficient reaction can be obtained. It should, however, be free from those annoying little resonance points which occur in some of the badly-designed chokes.

After the detector valve there are two stages of L.F. amplification, of quite straightforward types, and it should be noted that the resistance-capacity stage is made up with a self-contained unit.

### The R.C.C. Units

Separate units can be used if desired, consisting of

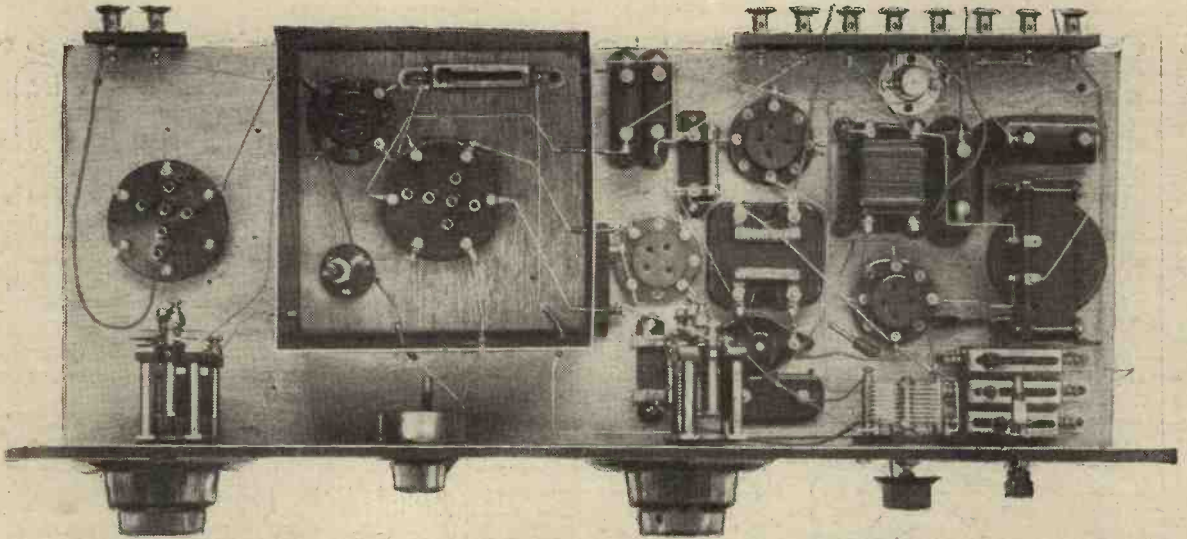

A "M.W." standard screening box is used in this four-valver. This contributes to the wonderful stability of the set and does not detract from its extreme sensitivity.

Going farther on in the circuit of the set under consideration we come to the point of the grid leak again. This can be varied by means of a plug, so that you can either employ leaky-grid or anode-bend rectification, simply by altering the plug on the face of the panel.

This plug can be inserted into either of the two sockets provided, one of these sockets being wired to L.T. positive, which gives the leaky-grid rectification, the other one being wired to the grid-bias battery.

This should preferably be a separate small battery, placed upon its end inside the receiver, though it can be part of the main grid-bias battery used for the L.F. valves if desired.

In the opinion of the writer, however, it is better to use a separate battery for the detector, tucking it away neatly in the set, so that it will not be disturbed when the grid bias is altered for the other stages.

### When Tuning-in Distant Stations

As has been remarked before, it is better to use grid-leak rectification when distant stations are being received as this greatly increases the sensitivity of the set, and in any case, when distant stations are tuned in the quality is never quite so good as can be obtained from the local station, and so the slight lack in quality which one sometimes notices when using leaky-grid rectification is more than compensated for by the greatly increased sensitivity of that type of rectification over the anode-bend method.

Another advantage of leaky-grid rectification is that it is easier to obtain really satisfactory and smooth reaction control than it is with the anode-bend method,

ordinary anode resistances, condensers and grid leaks, but it is more convenient, and certainly easier to wire up, if one uses complete units such as are available from most reputable firms.

The anode resistance should not exceed about 250,000 ohms. As a matter of fact, this is quite a suitable value if the grid leak is about 2 megohms.

The coupling condenser, if it is used separately, and apart from the resistance-capacity unit, should not exceed .1 mfd.; .01 to .05 mfd. being quite suitable values for this set.

A quarter-megohm grid leak will, it will be noted, have been placed between the top of the grid leak or the L.F. stage and the grid of the L.F. valve. This is provided to prevent any trouble from the passage of H.F. impulses into the low-frequency circuit. It is an important point whenever resistance-capacity coupling is used, and it is a safety device which is well worth incorporating. The value is not critical, anything from .1 to .25 megohm being suitable.

### The Output Stage

The second L.F. stage is transformer-coupled, though it is not important what make of transformer one uses provided it is of satisfactory design, and one which the constructor will know will work well or one which he has had previous experience with. The ratio should be not more than 3½ to 1.

As regards the loud speaker used with the set, this will, of course, again rest with the constructor himself, and he



must use a type of loud speaker which he has already heard or which he has had recommended to him.

The valves are easily chosen, and consist merely of an ordinary H.F. valve, followed by another H.F. or even a resistance-coupled valve (personally, the writer prefers the H.F. type in the detector stage) followed by an L.F. valve having about 10,000 ohms impedance, and then a power or super-power valve, preferably the latter, in the last stage. H.T. values up to 120 volts should be available for the last valve, the others requiring anode potentials of about 80, 80 and 100 volts. Grid bias up to 18 volts should be available, and this should be set, of course, in the usual way, bearing in mind the valve-maker's recommendations.

### The Output Filter Choke

It should not be forgotten that if a super-power valve is used, a fairly large H.T. battery will be required, i.e. one having a fairly high capacity.

In the anode circuit of the last valve will be seen an output filter arrangement, consisting of the usual L.F. choke, and the Mansbridge condenser. This increases the cost of the set by about 20s. or so, but is a very desirable feature when modern power and super-power valves are used. It prevents the direct plate current from flowing through the loud-speaker winding, possibly reducing the power of the magnets in the speaker, or else causing saturation of the core, which would introduce distortion.

The choke can be of quite low ohmic resistance, the lower the ohmic resistance the better, while the inductance should be about 20 henries. In any case, the D.C. resistance of the choke should not exceed about 400 ohms, or else a rather serious cut down of H.T. voltage on the anode of the last valve will occur.

When using a choke filter output, of course, you can connect up your loud speaker in any way you like. You need not worry which is the positive end and which is the negative, which is the case, of course, when the loud speaker is connected direct to the plate of the last valve.

### An Important Point

All the constructional work is very easy, and there is not a great deal to go into in this matter. One or two little points should be brought out, mainly perhaps the fact that when the wire—it should be insulated wire in this set—is carried through the screening box an additional covering of Systoflex should be put over the wire, where it goes through the box itself.

The holes through these screening boxes are inclined to be a little sharp, and if one is not careful and one gets any extra bearing on the wire the sharp edges round the holes of the box will cut through the insulation and cause a short-circuit between the wire and the box itself. The box itself, of course, is connected to earth by the terminal provided on it. In other words, it is connected to the filament circuit, and as you have several wires going through the box, and some carrying the H.T., a dead short here would be a serious matter.

As regards the special coils, if it is desired not to buy the standard design on the market, you can get some 3-in. diameter 6-pin formers; such formers as the Colvern Featherweight, the type fitted with an interchangeable primary, can be used for the H.F. transformer, though this is not essential.

The aerial winding consists simply of 50 turns of 24 D.C.C. wound side by side. The lower end is connected to pin No. 2, and the upper end is connected to pin No. 1, the winding being tapped at the 14th and 18th turn and taken to pins Nos. 3 and 4 respectively, the positioning of these tapings completing the coil.

The other 6-pin coil consists first of a secondary of 55 turns of 24 D.C.C., the lower end being connected to pin No. 2 and the upper end to pin No. 1, and in addition there is a reaction winding of 30 turns of No. 44 S.S.C. wire in a groove at the lower end of the former, about  $\frac{1}{4}$ th of an inch away from the secondary. This groove is produced by a file, using the edge to file a groove about  $\frac{1}{4}$ th of an inch wide right round the former, or if the former is ribbed, in each of the ribs of the former.

The commencement of this reaction winding is also connected to pin No. 2, and the winding is carried on in the same direction as the secondary, the winding being finally finished and taken to pin No. 6. The primary and neutralising winding is carried on the interchangeable former, which fits inside the secondary. This former is ribbed to enable spaced winding to be put on, but as this is not required in this case, the first step is to cover the former with a strip of thick dry paper of a fairly stiff character, or some kind of Empire cloth.

### Completion and Neutralisation

This is gummed on the former in order to obtain a smooth surface. Then the first half of the coil is wound on, consisting of 20 turns of 34 S.S.C. wire, starting at the lower edge of the former and connecting this end to No. 5 pin, and finishing up at the other end of the former and connecting it to pin No. 4, but not breaking the wire.

Over this winding another strip of thin paper or Empire cloth should be placed, and the winding continued back (in the same direction) until it is finished, after a further layer of 20 turns. Then we have the commencement of this second winding taken to pin No. 4, so that you have two coils connected to pin No. 4, and the end of the second half goes to No. 3. In effect we have one large winding (in two 20-turn parts) going from No. 5 to No. 4 (then covered over with tape) and back to No. 3.

From this H.F. transformer you now have the following connections. The beginning of the secondary coil to pin No. 2, the end to pin No. 1; the beginning of the reaction coil in pin No. 2, the end to pin No. 6; the beginning of one part of the primary coil to pin No. 5, and the end to pin No. 4; the beginning of the second part of

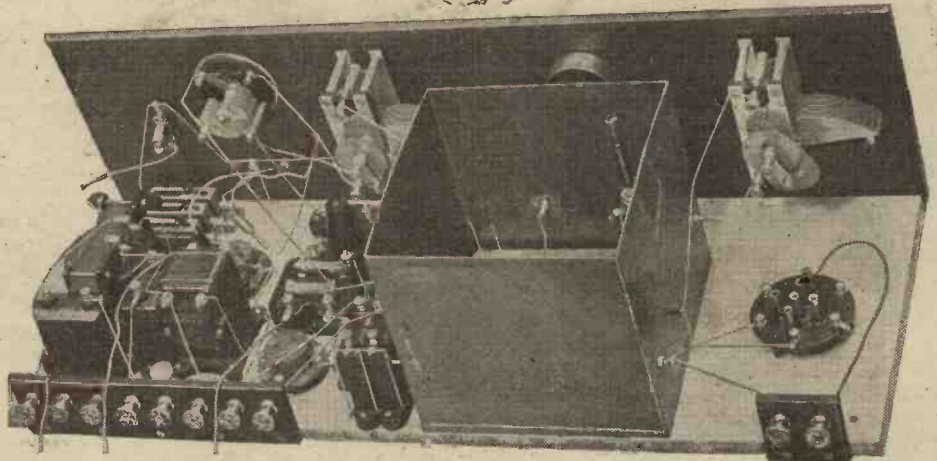

The apparent spaciousness of the H.F. end of the layout indicates an efficient and wide separation of the vital components, which is an essential feature if really good H.F. amplification and tuning control are to be achieved.

the primary coil to pin No 4, and the end to pin No. 3. It is best when winding these coils to wind every one in the same direction to avoid confusion.

As regards neutralising the set, the details given in the preceding three-valve set should be followed.



**THE "M. W." SHORT-WAVE CONVERTER.**

Build this remarkable unit, which transforms practically any ordinary set into an efficient short-wave receiver. Complete kit of components including drilled panel and cabinet—  
8/- down and 11 monthly payments of 8/-.

# The Easy Way

## TO PERFECT RADIO

**A THREE-VALVER FOR 80/-.**

An ideal 3-valve receiver presenting a maximum value for money in efficient loud-speaker sets. Complete kit of components, including drilled panel and cabinet.  
10/- down and 11 monthly payments of 10/-.

**MARCONIPHONE MOVING COIL LOUD SPEAKER.**

The latest addition to the range of moving coil loud speakers bears the name of Marconiphone—in itself a guarantee of quality.  
11/7 down and 11 monthly payments of 11/7.

Here is the opportunity you have been waiting for! Now everything radio is within your means. The Easy Way to perfect radio is just this. Select your requirements and on payment of the initial instalment the goods are delivered.

**WE CAN SUPPLY ANY MAKE OF SET ACCESSORY OR COMPONENT ON EASY TERMS. SEND ALONG YOUR REQUIREMENTS. WE WILL QUOTE YOU.**

**CELESTION C 12 LOUD SPEAKER.**

An instrument combining handsome appearance with all-round efficiency.  
13/9 down and 11 monthly payments of 13/9.

**CONSOLE LOUD-SPEAKER CABINET.**

Handsome polished Console Cabinet, dark oak or golden oak, including baffle board,  
8/3 down and 11 monthly payments of 8/3.

Write, Call or 'Phone—

**PETO-SCOTT CO., LTD.,**  
77, CITY ROAD, LONDON, E.C.1

'Phone: Clerkenwell 9406.

AND AT

**62, HIGH HOLBORN, LONDON, W.C.1**

'Phone: Chancery 8266.

**POST THIS COUPON FOR OUR BIG LIST.**

Full details of everything Radio on Easy Terms, please.

NAME.....  
STREET.....  
TOWN..... M.W.B.

GA 6246

# GOOD NEWS FOR CONSTRUCTORS

In response to the demand for first-class sets for family use, Mr. PERCY W. HARRIS, M.I.R.E., has compiled the

## Wireless Constructor Envelopes

The first two of this series are now on sale, price 1/6 per envelope (by post 1/9).

Envelope No. 1.

**THE RADIANO THREE.** A famous loud-speaker set which you can build in an hour or so—no soldering necessary and a wide range of components to choose from.

Envelope No. 2.

**THE CONCERT FOUR.** Made of standard parts, this is a highly sensitive set, giving powerful reproduction of wonderful quality. Also covering both long and short waves, it is a set to enjoy, in building and operation.

In each envelope you will find every detail of the set simply explained; photographic reproductions and diagrams are included, as well as a full-size Blue Print. Obtainable from all newsagents.

**NOW ON SALE—Price 1/6**

By post 1/9, from Wireless Constructor Envelopes, The Amalgamated Press, Ltd., Bear Alley, Farringdon Street, London, E.C.4.



Britain's Leading Radio Journal  
is  
**POPULAR WIRELESS**

"P.W." was the first popular radio journal issued in this country before Broadcasting began.



"P.W." has always kept the premier place, because it gives the non-technical listener Readability and Reliability.

Sir Oliver Lodge, F.R.S., is Scientific Adviser to "Popular Wireless."

- Full of Hints, Tips, and practical How-to-make Ideas, "Popular Wireless" is essentially the paper for the man who wants to get the best value for his radio expenditure.
- Possessing the largest circulation, "P.W." is able to offer unparalleled value to readers and to advertisers.
- Scores of regular readers have testified that one copy of "P.W.", costing threepence, has saved them pounds.

**EVERY THURSDAY—THREEPENCE**

Make sure that you get  
**POPULAR WIRELESS**  
THE PAPER THAT MADE  
**WIRELESS POPULAR**



(Continued from page 14.)

One such could be used and the necessity of coil changing in regard to the H.F. choke obviated. But you should very carefully note that not all H.F. chokes are suitable over the wide band indicated. Only if you obtain a component definitely corresponding with the foregoing specifications can the plug-in coil arrangement be displaced.

There are, of course, additionally H.F. chokes suitable only for short-wave reception, and H.F. chokes suitable

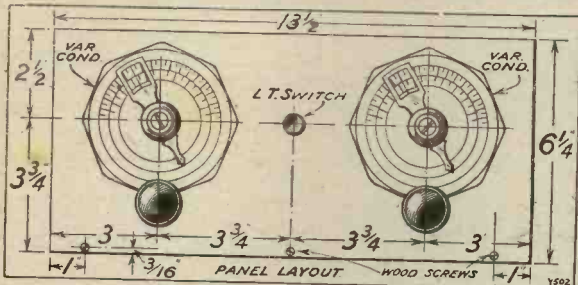

only for normal wave-length reception. But the constructor would not want to go to the trouble of changing H.F. chokes for different wave-bands. The plug-in coil scheme is one solution of the problem, and one which will appeal to the constructor who has a range of plug-in coils on hand, although in many respects the one H.F. choke having a wide functional band is the better arrangement.

#### Fixing the Components

In view of the fact that this set is to be used for short-wave reception, more strict attention must be paid to the selection of some of the ordinary components than is usually the case. Small parts such as valve holders, coil holders, grid condenser, etc., are as vitally important as, for instance, the L.F. transformer.

Wide separation of the parts on the baseboard is allowed for, and you should not try to compact the design. Crowding of components might upset matters. You can, if you so desire, fix the aerial condensers and switch to the panel before this is fixed to the baseboard, but we do not advise this. You will find it better to secure the panel first, and when this has been done and the terminal strips are mounted the components should be laid out in their approximate positions and the assembly reviewed in comparison with the accompanying wiring diagram and photographs.

Then if it is ascertained that everything is in place, screwing down can be commenced. For this operation  $\frac{1}{2}$ -in. wood-screws will be found very useful. Subsequently, the underneath of the baseboard should be carefully examined to see if any of the screws have protruded through. Should any screw points have made their appearance in this manner they should be neatly filed down, as otherwise they may catch in table covers, etc.

#### The Wiring

In these days practically every radio component is provided with terminals, or we should say radio components with terminals can be obtained, thus making soldering unnecessary. Perhaps we should have said before this that if you do not wish to tackle soldering you should make sure that every component has terminals. There are still many makes of various components on the market fitted only with soldering tags, and these obviously necessitate soldered joints.

Very neat wiring can be carried out with a set of this nature using Glazite, that attractive covered wire due to The London Electric Wire & Smiths Co., Ltd. Three flexible leads, two provided with wander plugs and one with a tapping clip, will be needed. Single cables taken from twin flex will be suitable for these.

On the ordinary broadcast band any standard plug-in coils will be found to be suitable. For the reception of London and 5 G B and similar stations the reaction coil

#### WIRING INSTRUCTIONS.

Join the aerial terminal to one terminal of the .0001 series condenser.

Join the other terminal of the condenser to the flex lead to which the tapping clip is attached.

Join the earth terminal to the plug of the aerial coil holder, to one filament terminal of each valve holder, to the L.T. negative, and the H.T. negative terminals, to the moving plates of both variable condensers, and to the earthing terminals of the slow-motion dials.

Join the L.T. positive terminal to one side of the L.T. switch; the other side of the switch to one terminal of each rheostat, and connect the other terminal of each rheostat to the remaining filament terminal on the corresponding valve holder.

Join the socket of the aerial coil holder to the fixed plates of the A.T.C. and to one side of the grid leak and condenser; join the other side of the leak and condenser to the grid terminal of the first valve holder.

Join the plate terminal to the socket of the H.F. choke holder, and to the socket of the reaction coil holder. Join the plug of the H.F. choke holder to the P terminal of the L.F. transformer. Join the other P terminal of the L.F. transformer to a flex lead to the H.T. battery.

Join the plug of the reaction coil holder to one side of the reaction series condenser; the other side of the condenser to the fixed plates of the variable reaction condenser. Join one S terminal of the transformer to the grid terminal of the second valve holder. Join the other S terminal to the G.B. negative. Join G.B. positive to L.T. negative. (The two G.B. leads are flex.)

Join the plate terminal of the second valve holder to one 'phone terminal; join the other 'phone terminal to the H.T. positive terminal.

This completes the wiring.

should be of 40 turns, and a Lewcos and Lissen centre-tapped coils have given good results in the aerial position. On the short waves, Igranic short-wave coils Nos. 6 and 9 were used in the aerial and reaction positions respectively, with the aerial clip taken to the centre-tap on the aerial coil and the fixed condenser in series with the reaction condenser short-circuited.

The valves are not critical items in this receiver and all the standard varieties rated as suitable for detector and L.F. positions have been found to give good results. A small power valve in the L.F. stage is to be recommended. Up to 9 volts grid bias may be needed.

Sixty volts will be ample H.T. for the detector, although, if possible, the L.F. valve should be given up to 120 volts.

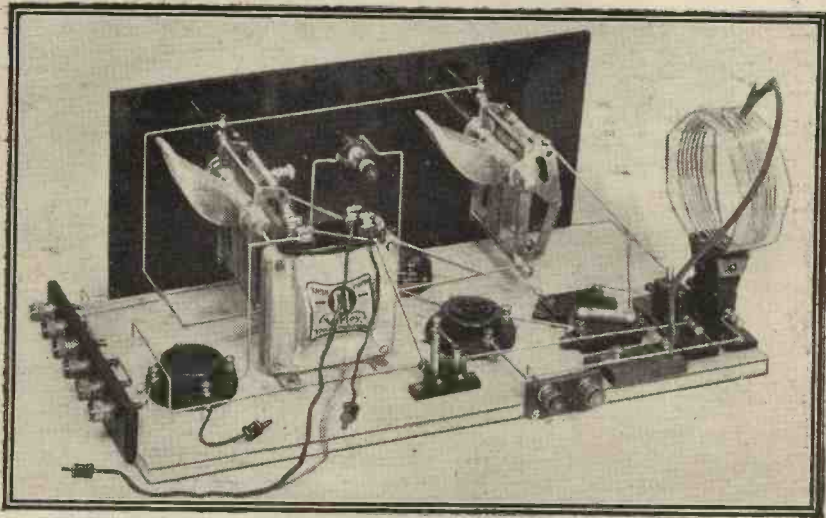

This is the complete set. A short-wave aerial coil is in position, a tapping on it being taken as described in the text.



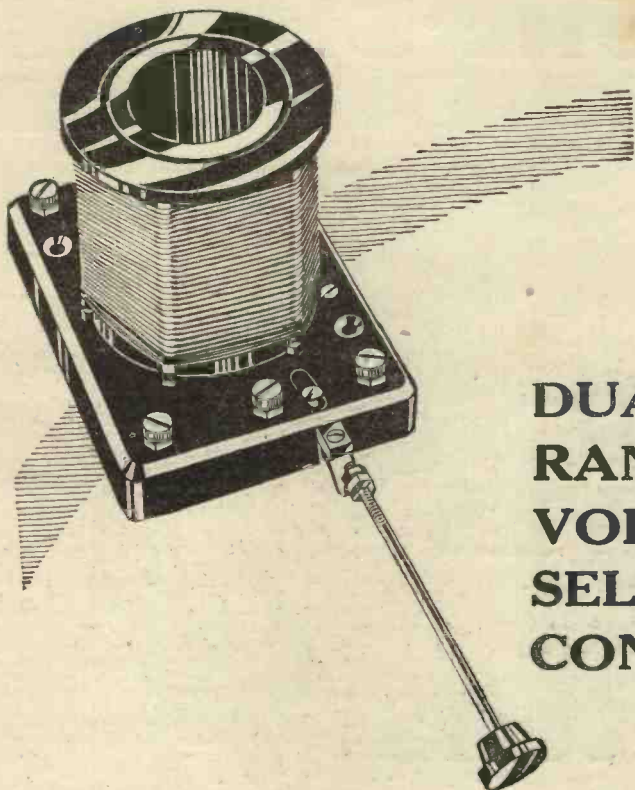

DUAL  
RANGE—  
VOLUME—  
SELECTIVITY—  
CONTROL.

# THE COLVERN DUAL-RANGE COIL

Specified for the new Mullard "Master Three Star"  
and the Six-Sixty Great Mystery Receiver.

## COLVERN ACCURATE SPACE WOUND COILS

COLVERN LTD., MAWNEY'S ROAD,  
ROMFORD.

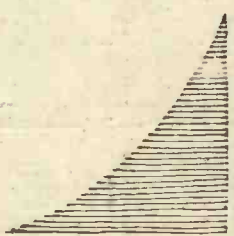



# · TONE · VOLUME · DISTANCE ·

## Use MULLARD P.M. VALVES for "M.W." CIRCUITS

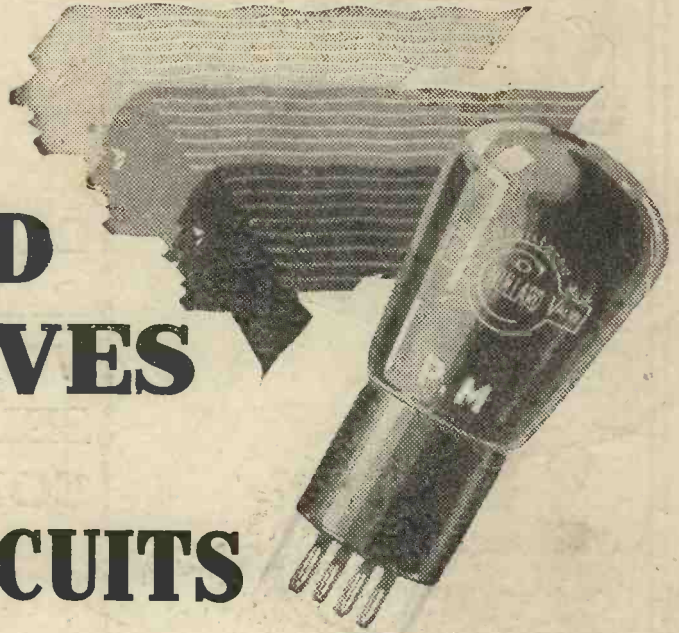

### A One-Valver for 70/-.

2-Volt—P.M.1 H.F.  
4-Volt—P.M.3.  
6-Volt—P.M.5 X.

### The "M.W." Short-Wave Converter.

2-Volt—P.M.1 H.F. or P.M.2 DX.  
4-Volt—P.M.3 or P.M.4 DX.  
6-Volt—P.M.5 X. or P.M.6 D.

### A Two-Valver for 100/-.

2-Volt—P.M.1 L.F. and P.M.2.  
4-Volt—P.M.3 and P.M.4.  
6-Volt—P.M.5 X and P.M.6.

### A Three-Valver for 80/-.

2-Volt—	4-Volt—	6-Volt
P.M. 1A.	P.M.3 A.	P.M.5 B.
P.M.1 L.F.	P.M.3	P.M.5 X.
(or	(or	(or
P.M.2 DX.)	P.M.4 DX.)	P.M.6 D.)
P.M.2	P.M.4	P.M.6
(or	(or	(or
P.M.252)	P.M.254)	P.M.256.)

### An H.F., Det., L.F. Loud-speaker Set for £8.

2-Volt	4-Volt	6-Volt
P.M.1 H.F.	P.M.3.	P.M.5 X.
P.M.1 L.F.	P.M.3.	P.M.5 X
(or	(or	(or
P.M.2 DX.)	P.M.4 DX.)	P.M.6 D.)
P.M.2.	P.M.4.	P.M.6.

### A £10 Four-Valver.

2-Volt	4-Volt	6-Volt
P.M.1 H.F.	P.M.3.	P.M.5 X.
P.M.1 A.	P.M.3 A.	P.M.5 B.
P.M.1 L.F.	P.M.3	P.M.5 X.
(or	(or	(or
P.M.2 DX.)	P.M.4 DX.)	P.M.6 D.)
P.M.252.	P.M.254.	P.M.256.

# Mullard

## · THE · MASTER · VALVE ·