

A SHILLING BOOK FREE FOR READERS

MODERN WIRELESS

1/6
MONTHLY

Vol. X. No. 23.

Edited by
NORMAN EDWARDS

NOVEMBER, 1928.

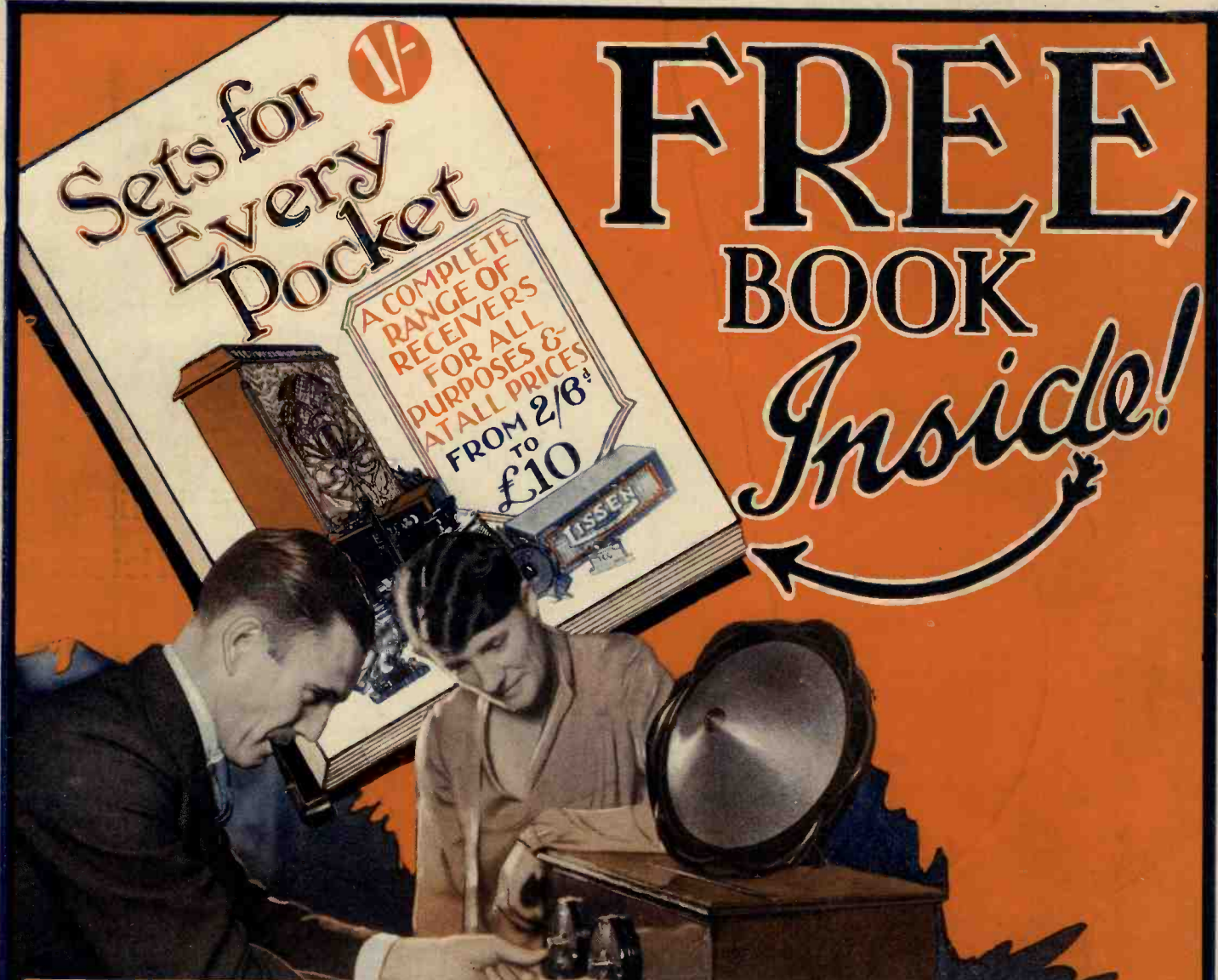

TWELVE SETS FULLY DESCRIBED
Including
THE 1929 MULLARD "MASTER THREE"
(This is shown in the above photograph)



UNIFORMITY

Uniformity of Filament
Uniformity of Vacuum
Uniformity of Construction
Uniformity of Emission
Uniformity of Efficiency

*Always use Mullard
P.M. Valves—four
years ahead in design*

Mullard

THE · MASTER · VALVE

CONTENTS

Vol. X. No. 23. MODERN WIRELESS NOVEMBER, 1928

	Page		Page
Editorial	443	Radio Abroad	484
Wireless Beacon Stations	444	H.F. on the Short Waves	485
New Short-Wave Circuits	445	How to Avoid Distortion	489
On the Short Waves	448	The Radio Furnace	491
The "Harris" Three	449	The "Rhapsody" Four	493
Questions Answered	454	Lazy Listening	498
More About Home Charging	455	Provisional Protection	499
Testing the New Valves	457	Building Your Set	519
The "Invincible" Five	459	One-Valve Wonders	520
Sir Oliver Lodge	465	Television Notes of the Month	524
What Readers Think	468	My Broadcasting Diary	526
Short-Wave Paths	469	In Our Test Room	530
Woman and Wireless	471	In Passing	534
Volts on the Grid	473	Radio Notes and News	538
The 1929 Mullard "Master Three"	475		

SPECIAL SUPPLEMENT, "RADIO AND THE GRAMOPHONE" PAGES 501-516

As some of the arrangements and specialities described in this Journal may be the subject of Letters Patent, the amateur and trader would be well advised to obtain permission of the patentees to use the patents before doing so.

Edited by NORMAN EDWARDS.

Technical Editor: G. V. DOWDING, Grad.I.E.E.

Scientific Adviser: J. H. T. ROBERTS, D.Sc., F.Inst.P.

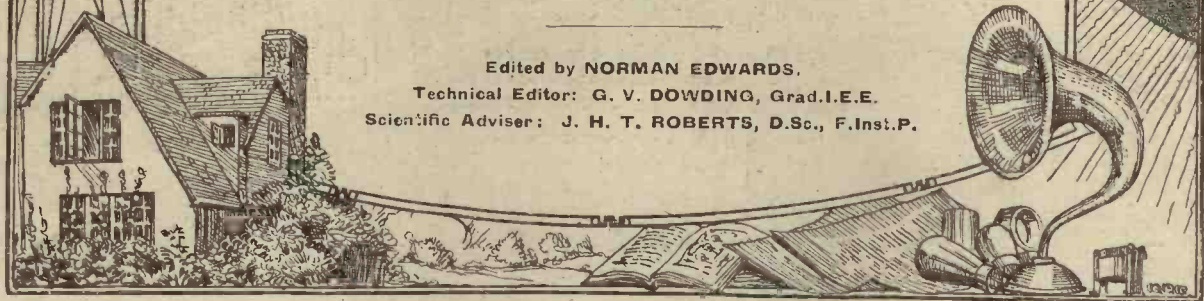

An amazing New Speaker

Moving coil quality without Batteries or Mains connections

HERE is a speaker that can raise its voice to brilliant magnitude . . . or hush it to a whispered, soft caress. All that the microphone hears, you hear. The new Amplion adds nothing . . . and here is the greater wonder . . . it subtracts nothing. All the depths of tone, all the subtleties and inflections, are retained in full.

Every listener with a simple valve set can secure the quality of performance associated with the moving

coil type of speaker, without the use of extra valves, batteries or mains connections. This is the triumph of the new Amplion.

* * *

The illustration is of the Pedestal Cabinet Model, in Oak. Price £13 10s. Table Models, £9 10s. and £10 10s. Standard Chassis, £6.

* * *

Other Amplion Models. Cone and Horn Type: Standard Speakers from 52/6 to £5. Junior Speakers from 35/- to £3 3s. Write for Catalogue to Graham Amplion, Ltd., 26, Savile Row, W.1.

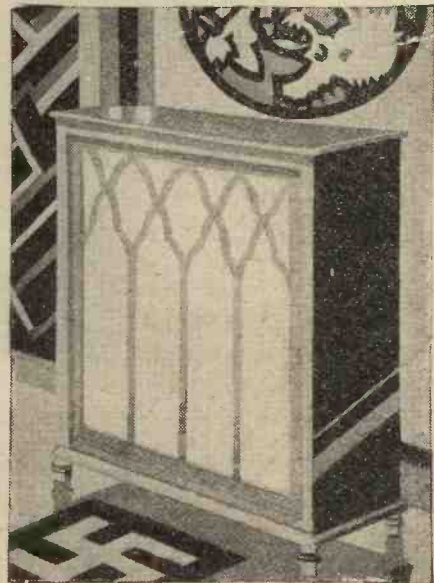

AMPLION

The World's Standard



FROM THE BOX OF PARTS TO THE FINISHED SET



IN 90 MINUTES



NEVER before has there been a Set that is so easy to build. You can buy all the parts for the new Cossor Melody Maker—including the valves and even the tools—in a sealed box. Because the box is sealed you are sure of obtaining the components which have been manufactured especially for it. This method of supplying the parts in a sealed box ensures that every Melody Maker has the same knife-edge selectivity, the same long range and perfect tone. Fill in the coupon now.

NOT A HOLE TO DRILL

The baseboard and panel are drilled by machine before they leave the factory.

NOT A WIRE TO SOLDER

Merely cut and bend a few lengths of wire—no skill is required.

NOT A PANEL TO SAW

Metal Panel, baseboard and cabinet are supplied ready for assembly.

AS SIMPLE AS MECCANO

Anyone can build this amazing Set. Fill in the coupon and learn all about it.

Post this Coupon now!
Please send me free of charge one of your Constructor Envelopes which tells me how to build the wonderful new Cossor Melody Maker.
Name.....
Address.....
M. W. NOV.

THE WONDERFUL NEW

COSSOR Melody Maker

MODERN WIRELESS

Vol. X. No. 23.

November, 1928.

This Month's Gift to Readers—Variety of Interest—Broadcasting's New Home—"Radio Never Stands Still."

By The EDITOR.

This Month's Gift to Readers

THIS month's issue of MODERN WIRELESS should make a wide and varied appeal to all classes of home constructors.

Not only are we presenting to our readers a shilling book, which in truth contains full details of a series of sets "for every pocket," but we are able to offer to our readers exclusive details of the new Mullard "Master Three" Star Receiver.

This fine set has been specially designed by Mullard engineers, and an article we publish in this issue has also been specially contributed by Messrs. Mullard's technical engineers.

Our readers will see at a glance—the photographs alone will show you—that the new "Master Three" is a simple and inexpensive set to build. We have had the receiver on test in our own laboratory and can vouch for its all-round excellence.

Variety of Interest

MODERN WIRELESS always makes a point of catering for a wide variety of radio interests. It is the Editor's belief that "sets, sets, sets" all the time, and for page after page in a magazine of the size of "M.W.," tend to become monotonous.

Radio is such a big and varied subject, its effects these days are so manifold and so manifest, in so many walks of life, that it would not be a real "Modern" WIRELESS if sets and purely technical subjects were dealt with in our editorial pages.

Consequently we make no apologies for including in this issue a special article on "Women and Wireless." Here we have a well-known writer—Mr. A. Corbett-Smith—dealing with an aspect of the development of radio which has not before received the attention it deserves.

Mr. Corbett-Smith is eminently qualified to deal with such a subject. As director of the Cardiff station and as artistic adviser to the B.B.C. he has had practical experience of broadcasting—experience, by the way, which he has put to the acid test on more than one occasion.

By a novelist and journalist, and a psychologist of no mean order, Mr. Corbett-Smith's article in this issue—provocative as it is—must inevitably stimulate argument. We hope, in future issues, to publish other special articles of this nature—and correspondence commenting on them will be welcomed from our readers.

Broadcasting's New Home

THEY say that rumour is a lying jade. But not always. Both in "M.W." and in our contemporary, "P.W.," we started the "rumour" months ago now that the B.B.C. were planning to move from Savoy Hill to more commodious and up-to-date premises.

That "rumour"—as our special broadcasting correspondents knew perfectly well—was founded on definite facts and on excellent authority. But for a long time the B.B.C. refused to confirm the "rumour."

Newspaper editors, seeing the news of the impending move in "M.W." or "P.W.," sent reporters to Savoy Hill to get the truth.

And for months the facts were not given. But at last the B.B.C. has admitted that a new "Broadcasting House" is to be built—near the Queen's Hall, as we forecast—and a move will be made in two years. Perhaps less.

These facts are pointed out because they illustrate a point we wish our readers not to miss—that the latest and most reliable news concerning B.B.C. policy is only to be found in the "Big Three," i.e. MODERN WIRELESS, "Popular Wireless," and the "Wireless Constructor."

It is a point the B.B.C. might also bear in mind.

"Radio Never Stands Still"

OVER one hundred thousand people visited the recent wireless exhibition at Olympia. Up to a few minutes before closing-time people were still paying their entrance money and flocking into the great New Hall, where the finest radio show ever organised was holding the close interest of thousands of radio amateurs.

Some people profess to be amazed that the popularity of radio is growing instead of waning, but the impartial visitor to the exhibition must have realised that the hobby of radio continues to grow and to increase in popularity for one very simple reason—radio never stands still. As a hobby it never seems to grow stale. Always there is something fresh, something novel, cropping up. Always there is a new development in the offing—something to stimulate interest and even to revive any waning interest in the bosom of the amateur who thinks there are no new sets to build and that radio has exhausted its interest.

That is the fascination of radio: it is alive; it is virile; it is inexhaustible. And so it will continue to be so long as the amateur continues to experiment and the British manufacturer continues to better and better his goods and pay the amateur the compliment he deserves by giving him of the best and only the best.



Full details of the latest developments in radio "light-houses."
From a Special Correspondent.

THE wireless direction-finder is a recognised navigational instrument of the first importance. During the earlier stages of its introduction, the few ships which were then equipped with wireless direction-finders were compelled to rely upon the signals transmitted by existing wireless telegraph stations engaged upon traffic services, from which they could pick up their bearings when these stations happened to be working in the ordinary course of their business.

Since the direction-finder has become firmly established and more generally employed on the merchant vessels of the world, the demand has arisen for the erection of permanent installations situated at points of advantage from a shipping point of view, near the coast, and whose function it is to send out a recognised signal at convenient intervals purely for the purpose of enabling ships fitted with direction-finders to take their bearings and thereby find their exact positions when approaching the coast.

The Main Features

Such stations are called "beacon stations," and are usually erected and maintained by the Government or by the harbour and coastal authorities responsible for the maintenance of shipping facilities round a particular section of the coast. The world-wide importance of this recent development in the application of radio science has been recognised by the various permanent Government committees which are responsible for the international regulation of wireless traffic, and the service requirements to be fulfilled by a beacon transmitter are now being formulated.

The most important of these requirements may be enumerated as follows:

1. The wave-length normally used must be fixed at 1,000 metres, provision being made for adjustment

between the limits of 950 and 1,050 metres.

2. The equipment must be capable of continuous operation during extended foggy periods.

3. The equipment must be simple in operation and must run for long periods without attention by skilled personnel.

4. Every precaution must be taken to prevent risk of breakdown.

5. Provision must be made for the incorporation of an automatic code-sender which will ensure great accuracy of time-keeping.

Beacons Being Built

The installation of wireless beacon stations at suitable places round the coasts of the British Isles is proceeding rapidly. The Marconi Company have already erected six stations, which are now in operation, and work is proceeding on seven more which have been ordered.

Among those stations now in operation, the Mersey Bar, Coningbeg and

can be installed in any position as it does not require a fixed zero point.

This makes it particularly suitable for lightship installations, and allows navigators to lay off their wireless bearings on familiar points on the chart. Another advantage is that the determination of bearings is under the direct control and supervision of the navigating officer, who otherwise has to be satisfied with his position as given by a shore direction-finding station on request.

The next seven stations to be erected, and for which apparatus is now being constructed, are at Start Point, Lundy Island, Sule Skerry, Dungeness, South Bishop, Kinnaird Head and Cromer.

Submarine Signalling

By the provision of submarine signalling apparatus in conjunction with a wireless transmitter, simultaneous signals can be transmitted in two different media involving a difference in the rate of travel of the signals. This system is used at the Spurn and Coningbeg light vessels.

Since the speed of propagation of wireless signals is practically instantaneous, while that of submarine signals is approximately .8 sea-mile per second, the two signals are heard at different moments, the time elapsing between the receipt of the wireless signal and the submarine signal being a measure of the observer's distance from the transmitting station.

To obviate the necessity of timing these intervals, a special system of signals has been evolved in which the synchronised wireless signal is followed by wireless dots spaced 1.25 second

The masts carrying the aerial and reflector system north-east of Cape Town. The masts are 300 ft. in height and the distance between them is 650 ft. Two bays are in use for the 16-metre wave and the other two for the 34-metre wave.

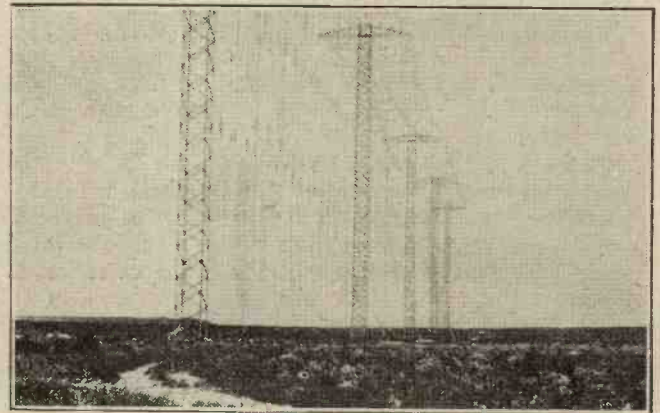

Spurn are on lightships, while those at Skerries, Round Island and Casquets are on land. One of the great advantages of the system of position-finding in which a beacon station is used in conjunction with a direction-finder on board ship is that the beacon

apart, so that the observer has only to count the number of dots he hears on the wireless receiver up to the time he hears the commencement of the submarine signal. The number gives the distance in sea-miles the observer is from the transmitter.

New Short-Wave Circuits

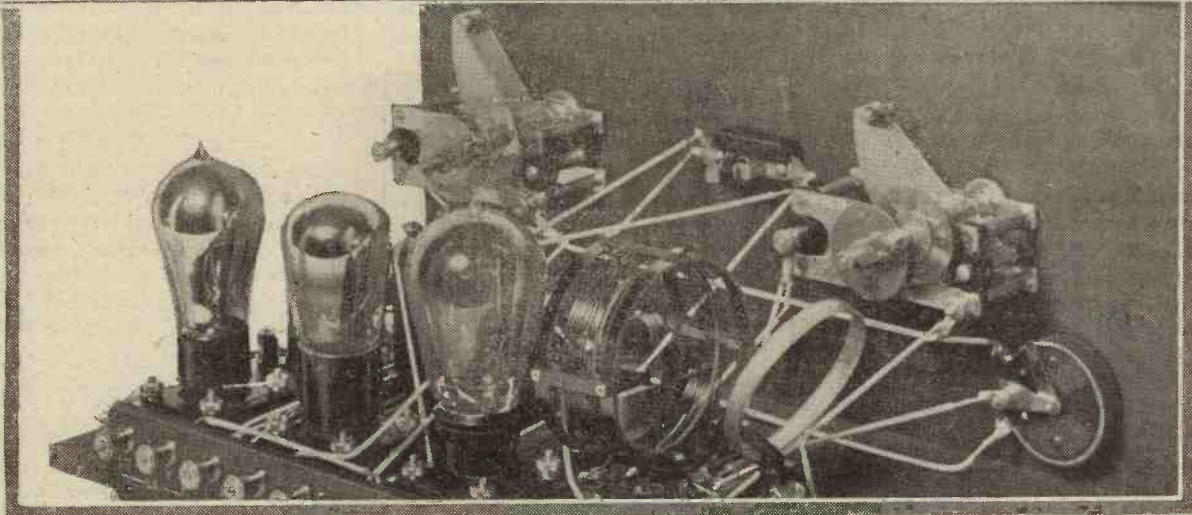

THE reaction control of a receiver, necessitating as it usually does either a tapping on the tuning coil or a separate coil, is a source of inconvenience when one wishes to use the receiver on several wave-bands, particularly if switching is resorted to.

The well-known oscillating circuit shown in Fig. 1 seemed to offer possibilities of doing away with the reaction winding in a receiver, if the reaction effects could be controlled in a smooth and silent manner, and although this has been achieved to a certain extent before by other methods, the writer believes that the method of obtaining a silent and vernier control of reaction to be described is original, and certainly gives extremely good results in practice.

Screened-Grid Tests

Some time ago experiments were carried out by the writer, with the Fig. 1 circuit, using a D.E.7 valve, and it was noticed that on turning up the filament rheostat slowly, the circuit started to oscillate when the filament was comparatively dull, but that the oscillation ceased before full filament voltage was reached, when using 15 to 30 volts H.T.

An effort was made to control the oscillation with a vernier rheostat, but this proved erratic and noisy. Owing to the small range of tetrodes then available, experiments were dropped, until the advent of the Marconi S.625 valve renewed the writer's interest in the circuit.

The circuit shown in Fig. 2 was tried out, and gave very good results

An interesting account of some short-wave experiments carried out with tetrode valves.

By Wm. E. MATHER.

from 300 metres upwards, but was difficult to operate on lower wave-lengths. It should be noted that the grid leak is taken to positive L.T. The addition of shunting condensers and an improved reaction control, as shown in Fig. 3, made the circuit easily controllable down to 20 metres or lower.

In Fig. 3, R_1 may be a 400-ohm potentiometer, with the movable contact set roughly as shown, while R_2 is a 400 or 500-ohm potentiometer. It is most important to keep R_1 set roughly as shown and never to move

it with the L.T. switched on, or you may short the accumulator.

The condenser values shown were adopted after some experiment, and smaller ones may prevent the circuit oscillating on the lower wave-lengths.

The voltage on the grid should be kept as low as possible consistent with obtaining oscillation over the wave-bands desired, and on no account should the voltages indicated in the table be appreciably exceeded, as the grid circuit takes about 5 milliamps at 20 volts and about 12 milliamps at 30 volts, with an S.625 valve, owing to the fact that the filament has to be turned up with each increase of grid voltage. Filament emission may be impaired if the grid voltage is increased.

One S.625 valve oscillated readily down to 20 metres, with 20 volts on the grid, until an H.T. and L.T.

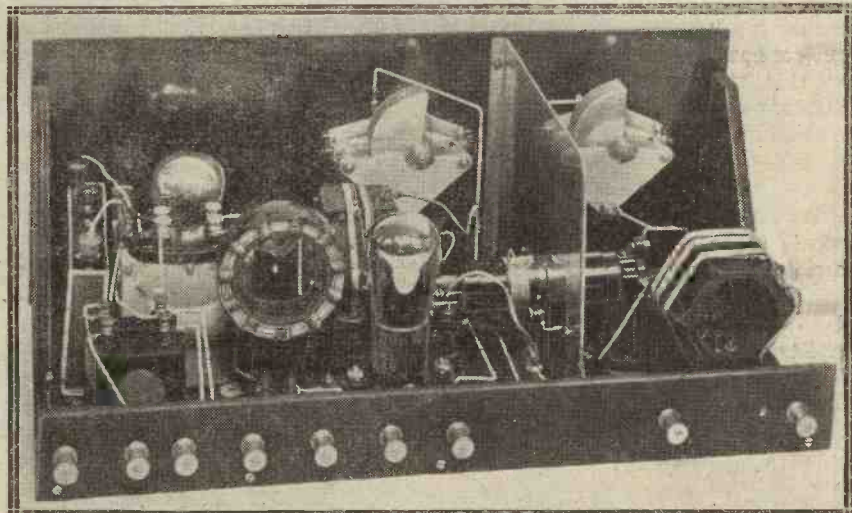

The "Austral" Three—a popular "Modern Wireless" short-wave set which incorporated a screened-grid H.F. valve.

entanglement stopped it! Successors required varying voltages up to 30 volts, and only 3.8 to 4 volts is required on the filament when using the S.625.

Suitable Tetrodes

Further experiments proved that not every screened grid or other form of tetrode was suitable for this circuit. Some refused to oscillate at all, while others suffered from reaction backlash.

Two others, however, gave excellent results, and only required 20 to 30 volts total H.T. supply. These were the A.P.412H.F., and the A.P.412R.C., made by Aneloy Products, and these worked best with 20 to 24 volts on the grid circuit and 22 to 30 on the anode. Oscillation was readily obtained and controlled on all wave-lengths above 20 metres, and, in fact, these valves would oscillate with a single-turn coil in the grid circuit.

To adjust and operate the circuit, proceed as follows: Do not connect the aerial or earth. Plug in a coil (about No. 75), and turn the resistance R_2 to its maximum.

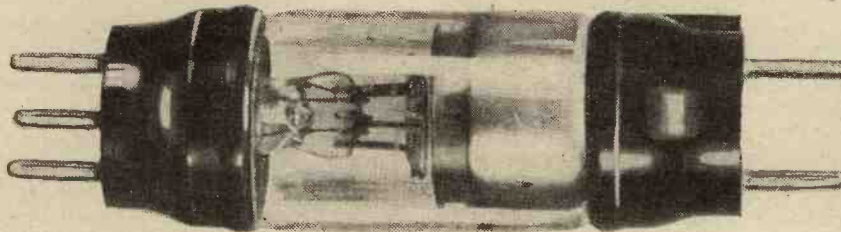

The Marconi and Osram S.625 discussed in this article.

Turn the rheostat R_3 on *slowly* while listening in the headphones, when a pop will be heard. Continue turning until a rushing sound is heard, followed by a second pop as the circuit stops oscillating. The rheostat should be left alone when the oscillation has just stopped. These adjustments are better made finally when the set has been on for a few minutes, so that the accumulator voltage is normal and the resistances have attained their normal working heat.

Results Obtained

Assuming these preliminary adjustments to be correct, connect up the aerial and earth, plug in a suitable coil for the desired wave-band, and tune in the usual way, decreasing the resistance R_2 to increase reaction.

As the smoothest reaction control is obtained when R_2 is operating near the maximum position, it will be found an advantage to readjust R_3 slightly when changing from short to medium or long wave-lengths or vice versa.

For the long waves a .001-mfd.

condenser may be connected in series with the aerial, and a .0003 for the medium waves, while the short waves require a very small series condenser, which in the writer's case consisted of a small five-plate neotrodyne con-

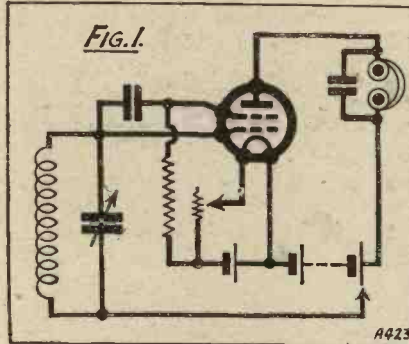

denser set near the minimum position for the outdoor aerial, and set to about half capacity when using a 6-ft. indoor aerial.

On a badly screened aerial in Edinburgh, 5 X X came in at better strength than on any other single valver the writer has tried (a stage of H.F. is usually necessary to bring

as very good amplification can be obtained with the quenching frequency above the audible limit. The amplification falls off, on the broadcast wave-band, unless the quenching frequency is lowered to audibility; but even here quite good results can be obtained with an inaudible frequency.

The circuit shown in Fig. 4 is more stable and easier to tune on the short waves than most straight circuits, and, of course, gives very much louder signals, provided atmospherics are not too prevalent.

As it is well known that the usual valve circuit may be made to oscillate at two or more frequencies, with suitable tuning and reaction coils, there does not appear to be anything to prevent the circuit shown in Fig. 3 functioning as a super, if a suitable coil and condenser were included in series with the tuning coil. This was tried out with the quenching combination in various positions, but the circuit shown in Fig. 4 was finally adopted, and excellent results were obtained with it.

Use Indoor Aerial

On the short waves, hand-capacity effects practically disappeared, and the tuning was sufficiently flat to obviate the necessity for vernier movements on the condenser. The controls remain as before, the tuning condenser, which in the writer's case was a .0003, and the reaction resistance knob.

A super-regenerative receiver must on no account be coupled to an outdoor aerial or serious disturbance will be caused in the neighbourhood,

Daventry up to scratch), while one or two foreign stations were also heard on the long waves.

On the medium waves many stations, both British and foreign, were obtained besides the local one. With a 6-ft. indoor aerial and a S.W.4 Dimic coil, P C J J was heard at excellent strength, on several afternoons, while 2 X A F was received at good strength on several evenings after 11 p.m. 2 N M, in Surrey, came in at good strength on Sunday evenings, followed by 3 L O (Melbourne), which was rather had with atmospherics and fading on the one or two occasions its reception was attempted.

A further addition to the circuit enables one to use the super-regenerative principle with success.

This super-regenerative idea, which enjoyed some popularity two or three years ago, appears to have been disregarded lately, partly no doubt owing to its somewhat erratic behaviour and to the difficulty in eliminating the high-pitched whistle.

As far as the whistle is concerned, it is unnecessary on the short waves,

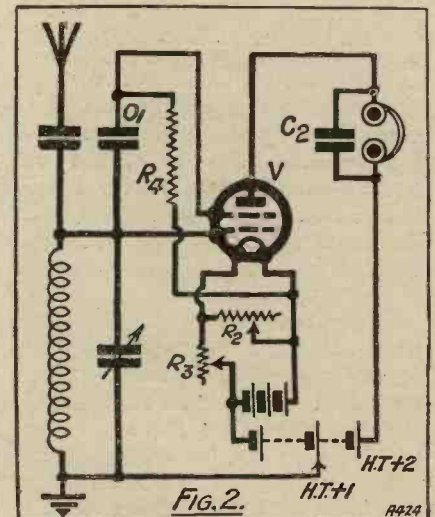

but it should be used with a small indoor aerial, or with a frame.

With the Fig. 2 circuit, it is only necessary to short-circuit the

quenching coil with a switch, and control the reaction in the usual way when receiving on an outdoor aerial or on the long waves.

To operate the circuit, the reaction control is turned until a rushing sound is heard in the 'phones, and the tuning condenser turned until a station is heard.

The reaction is then adjusted until the music and speech are as loud in

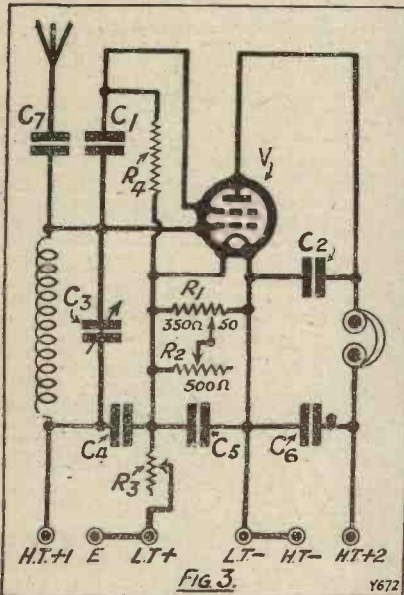

proportion to the mush as possible. It will be found that if a station is of any strength, it will blanket the reaction mush, and will be received without much background, unless atmospherics are very bad.

PCJJ, 2 X A F, 2 N M, and a foreign station, which was heard from 12.15 a.m. one Friday morning, were audible two or three feet from the loud speaker, on the 6-ft. indoor aerial in Edinburgh. Owing to the flat tuning of the receiver, 2 N M, in Surrey, transmitting on 32.5 metres, swamped 3 L O, Melbourne, on 32 metres; but 3 L O was received at much greater strength on the super than on the straight circuit, when 2 N M closed down. Atmospherics, however, were very bad on 3 L O on the only two Sundays its reception was attempted.

Below 20 Metres

In common with other single-valve supers, this one will only be found to "super" properly over part of the range of a .0003 condenser, and coils must be chosen accordingly. With a Dimic No. S.W.4 coil (6 turns) the circuit worked as a super from 0 to 120 on the dial, the 30-metre stations coming between 50 and 70 degrees.

Using half the coil (3 turns) the circuit would not "super" strongly

at all, although with the quenching coil shorted oscillation was obtained over the whole range, 2 X A F coming in about 140 degrees, and what appeared to be a telephone service at 20 degrees, which must have been well below 20 metres.

Probably with an undamped frame aerial the super effect would be obtained well below 20 metres also.

If the super circuit only is required, reaction does not require such fine adjustment, and an ordinary 4-electrode valve, such as the D.E.7 (which requires 20 to 30 volts on both plate and grid), may be tried, with a compression type rheostat for reaction control.

As a Portable

The writer obtained very good results from the local station with such a combination, in a miniature portable set; a 2,000-ohm telephone bobbin being used for the quenching coil, and a frame aerial 6 in. square.

A telephone bobbin should not be taken as an efficient substitute for a good No. 500 or 1,000 coil, however, as it was only used to save space.

The 500 coil with a .006 shunting condenser gives an inaudible frequency, and is recommended for all-round purposes, particularly if an amplifier is contemplated.

HIGH-TENSION TIPS

Howling, crackling, and distortion can all be caused by batteries which are running down.

Just as the strength of a chain is that of its weakest link, so the effect of many good cells can be ruined by their being connected to one dud cell.

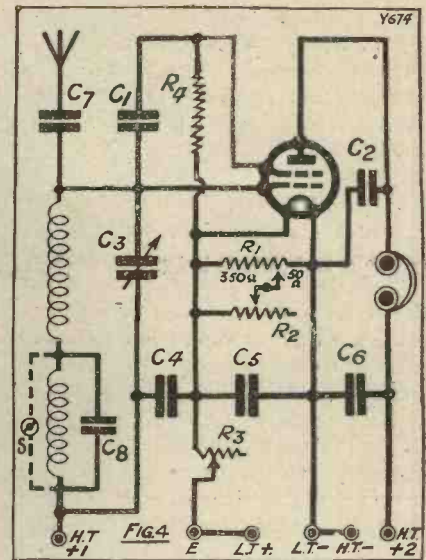

In general, the more H.T. on the plate the less is the risk of distortion.

Like accumulators, high-tension batteries can easily be ruined by over-discharge, so the capacity of the H.T. battery should always be adequate to the anode current taken, by the set.

Cause of Distortion

Insufficient H.T. voltage is one of the commonest causes of distortion.

If your house is fitted with electric light remember that one of the best and cheapest methods of H.T. supply is a mains unit.

H.T. accumulators should not be moved unnecessarily, and they should always be kept clean and covered, to prevent surface leakage.

An important part of the correct care of H.T. accumulators is to maintain the acid at its proper level.

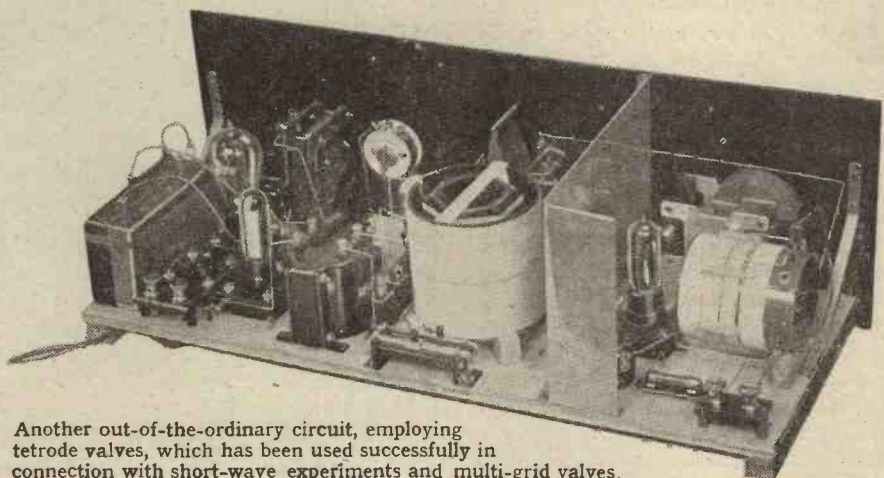

Another out-of-the-ordinary circuit, employing tetrode valves, which has been used successfully in connection with short-wave experiments and multi-grid valves.

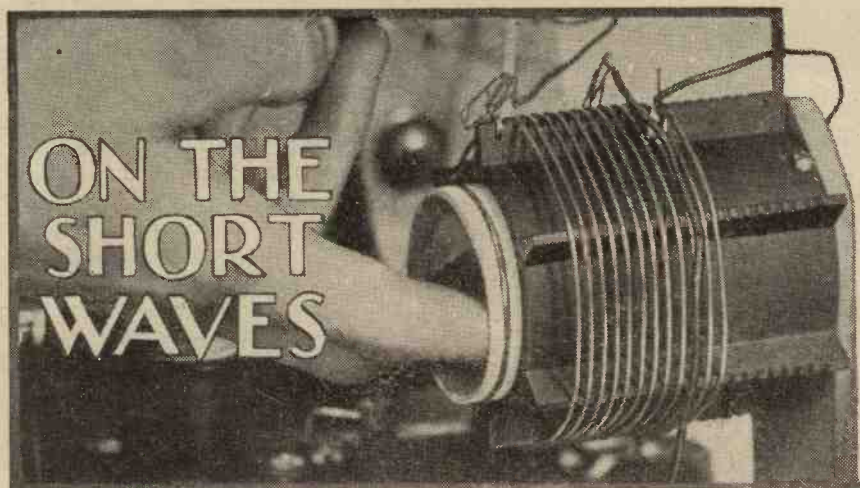

Notes of Interest on Short-Wave Receivers and Reception Conditions.

By W. L. S.

THE past month has seen many interesting developments of the newest wave-length with which amateurs have seriously been experimenting, namely, the 10-metre band, or, to give it its correct designation, the "10-03-10-67-metre band."

Ten-Metre Record

During past years much experimental work has been carried out on 8 metres, but the tests have mostly been confined to laboratory benches, owing to the absence of stations willing to co-operate. Now, however, quite a useful little band of workers has interested itself in our latest child, "10 metres," and some positive results have been obtained.

In the States they have succeeded in working from coast to coast on this wave-length with quite reasonably low powers. I hear unofficially that O Z-3 A R, in New Zealand, has been in touch with a Californian station, which would appear to be the long-distance record for this wave as yet. In this country numerous receiving stations have heard the Americans, and short-distance work has been carried out. In general the atmosphere is one of enthusiasm, and I foretell the discovery of some very interesting facts about this wave, and a great development of this band for useful purposes.

German Short-Wavers

Short-wave broadcasting has been advertising itself in much better style lately, owing to the sudden improvement in reception conditions. 2 X A D, 2 X A F and 8 X K (Pittsburg) are

still the three star stations, although I suppose it is natural that those who live abroad should say that 5 S W was entitled to premier position.

There are several very powerful German broadcasting stations testing on various wave-lengths between 25 and 45 metres, and if they start up with full programmes we may expect some good things. Not being too proficient in German, I have not as yet gathered the significance of the announcements made by the station that works on about 42 metres.

Perhaps some of my readers know where it is and what it is doing? At

my home station, and also on the test bench in the MODERN WIRELESS laboratory it is received at almost equal strength with 2 L O!

Call-Sign Alterations

Incidentally, from my reading of the Washington Conference regulations, many of the familiar call-signs of German and British stations will have to go by the board next year. It appears that no commercial calls are to begin with A, B, or C.

All the Nauen short-wave stations, both telephony and C.W., have call-signs of the "AGB, AGC, AGJ, etc.," variety, and, of course, all our own Admiralty stations, both at home and abroad, begin with BY, BX, or similar letters. The lot of the short-wave D.X.-hunter without a new list of call-signs next year is going to be somewhat hard!

The "Q" Quandary

All the familiar "Q" abbreviations are also to be changed. "QRZ" will no longer mean "Your signals are weak," but "You are being called by _____." "QSB," instead of meaning "Your note is bad," will mean "The strength of your signals varies."

All the sea-going operators will have to revise the familiar abbreviations that they have used for many years, simply to satisfy the craving of officialdom for the introduction of a small improvement, and a doubtful one at that.

TEUTONIC TELEVISION



One of the striking exhibits at the recent German Radio Exhibition was Mihaly's latest television receiver. The above photo shows the instrument being adjusted by the inventor.

sd1

The "HARRIS" THREE

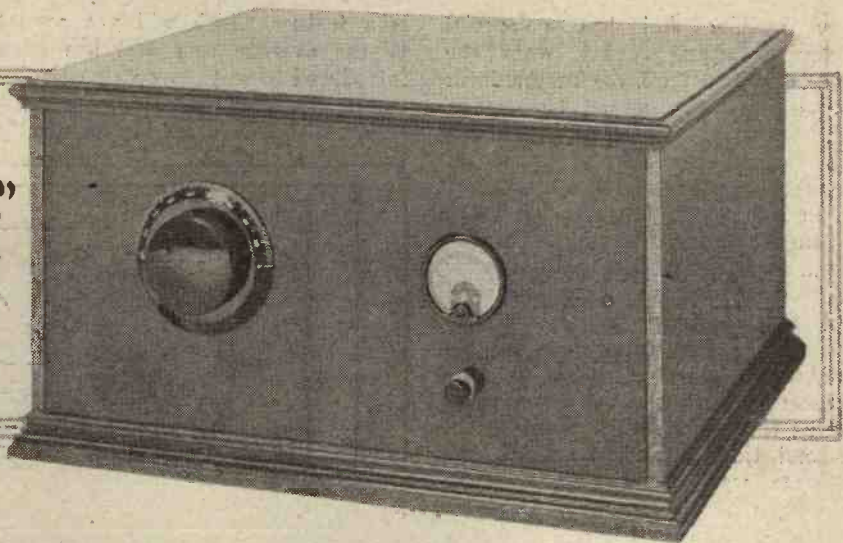

IN America some little time ago the motor trade began to agitate itself as to whether the saturation point in selling motor cars had been reached. Sundry economists pointed out that soon there would be one car per family, after which sales would merely be replacements. Unfortunately for the theorists the general public soon upset their ideas by purchasing two cars per family, whereupon the possible saturation point receded still farther into the distance.

Two Per Family?

I am convinced that two wireless sets per family—if indeed not more—may easily become the rule in this country, as tastes differ considerably, and while one member may desire to obtain a wide range of reception, perhaps aiming to find the maximum number of stations that can be received, other members of the same household may prefer to concentrate on the local station, getting from this the best possible quality in all conditions. A set which in practice fulfils one ideal rarely suits the other, for which

An easily built "family" set which will appeal to the constructor who wants a real "household" receiver.

By PERCY W. HARRIS, M.I.R.E.

reason there is a growing tendency to keep one set for local station reception alone and another for long-range work or "general exploring."

A receiver I have used very satisfactorily for some time for the local station, having its own indoor aerial and working entirely from the mains, has aroused some little interest among my friends.

The circuit consists, as will be seen, of an "anode-bend-detector," followed by a resistance-coupled stage which in turn passes on the signals to an output stage, transformer-coupled by the "push-pull" arrangement. No reaction is fitted, nor is any special attempt made to obtain selectivity, for the set is kept permanently tuned to 2 L O and is operated at a distance of seven miles from that station. The indoor

aerial used consists of a piece of rubber-covered wire run across the loft immediately above the room in which the set is situated, and the earth connection is made to the common earth wire used for general experimental work.

It will be noticed that no on-and-off switch is fitted as the set is operated from another part of the house by means of a "Lotus" relay, the relay acting as the switch. Incidentally it should be mentioned that many people still do not realise the advantages of distant-control systems, for the set itself can be placed at any convenient position of the house, while the control switch and the loud speaker can be situated at any convenient point.

The "Juice" Supply

High-tension is supplied from a mains unit working from the A.C. mains, this giving an output of 180 volts on full load. Low-tension has been supplied in the past from an L.T. accumulator automatically controlled from a Runbaken automatic charger. This device consists of a trickle charger using a Westinghouse

LIST OF COMPONENTS

- 1 Panel, 16 × 8 × ½ in. (Ebonart, or other good branded material).
- 1 10-in. baseboard.
- 2 Panel brackets, and wire for wiring-up (Glazite).
- 1 Variable condenser, .0005 mfd., with vernier motion (Polar in set. Any good make).
- 1 0 to 75-milliamper meter (Turner in set).
- 1 On-and-off switch (Lotus, Lissen, Benjamin, Igranie, etc.).
- 4 Valve holders for English valves (Lotus, Igranie, Benjamin, W.B., Burndept, Bowyer-Lowe, Burne-

- Jones, etc.), and 2 valve holders for American valves (Pilot).
- 1 Single-coil holder (Peto-Scott, Lotus, Igranie, Burne-Jones, etc.).
- 1 Centre-tapped Gambrell "B" coil.
- 1 9-volt grid-bias battery.
- 10 Terminals, as marked, and terminal strip.
- 1 Wire-wound resistance, 100,000 ohms, in holder (R.I.-Varley in set. Any good make, Dubilier, Mullard, Lissen, Igranie, etc.).
- 1 Fixed condenser, .01 mfd. (T.C.C.

- mica in set. Any good make, Lissen, Mullard, Dubilier, etc.).
- 1 Fixed condenser, .0001 (See above).
- 1 Grid-leak holder (Lissen, Dubilier, etc.).
- 1 .5-megohm grid leak (Dubilier, Lissen, Igranie, etc.).
- 2 .25-megohm grid leaks in holders (Lissen, Igranie, Dubilier, etc.).
- 1 Push-pull transformer, type A.F.5.C. (Ferranti).
- 1 Output transformer, type O.P.4.C. (25-1) or O.P.3.C. (1-1) (Ferranti).

dry rectifier and has a special relay so arranged that when the set is switched off the accumulator is automatically placed on charge, and similarly when the set is switched on the accumulator is taken off charge and connected to the set.

In addition to this a socket fitted to the Runbaken charger takes a plug from the mains unit, so that switching the set on and off switches on and off both high- and low-tension, and controls the automatic charger. An additional relay is used so that pressing a button in the dining-room turns the set on, while pressing it a second time turns the set off, the scheme working on the principle of on, off, on, off, with alternate pushes of the switch.

Easy to Build

Since I have recently developed low-tension mains units, I am now changing over to one of the Lotus all-mains relays, so that the set is now run entirely from the mains, both for L.T. and H.T., with distant control.

The constructional work is very simple, ample room being allowed on the baseboard for all the parts. Incidentally it will be noticed that

is a feature which will not appeal to the average user and has been introduced to suit my own particular work. In passing, it may be mentioned that I have not yet found any

passing the output of the 25-1 transformer into the low-resistance side of another 25-1 transformer, which is thus used "in reverse" to step-up the voltage again to that

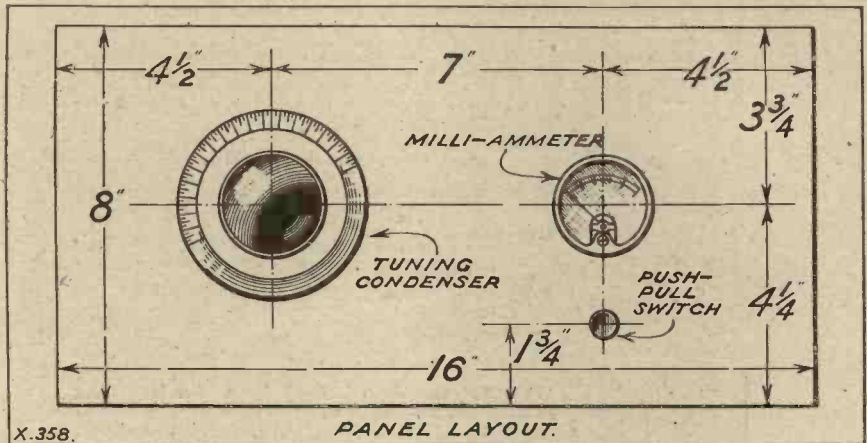

American valves (even the latest types) equal to the best British.

Although normally controlled from a distant point, the set, of course, can also be operated from my laboratory, where it is situated. For general reception by the family, a high-grade cone loud speaker is used, and in the laboratory I use a moving-coil instrument. For this reason the

suitable for the cone. A switch enables me to change over from one arrangement to the other as desired.

The Output

Readers who build up this set for their own use can choose either a 25-1 or a 1-1 output transformer here, and will not need any additional external transformer.

The front panel carries, as will be seen, the variable condenser dial, a milliammeter, which is placed in the plate circuit of one of the output valves, and a switch which short-circuits the meter when readings are not desired. This should not be confused with the usual on-and-off switch. No filament resistances are used on the first two valves, but Amperites are fitted to control the filament current of the output valves; more will be said about this later.

Suitable Valves

With regard to valves, in the first two stages I use the "H.F." type of valve, those at present in use being the 6075 H.F. of the Six-Sixty type. In the two push-pull sockets I have tried a variety of valves with varying success, most satisfactory of all at the voltage given being the L.S.5A, although, of course, these are very greedy in the filament current (.85 ampere each). The various makes of quarter-ampere super-power valve all work well, but if the maker's rating of 150 volts is much exceeded their emission declines after a few months' work and usually one falls off earlier than the other, thus upsetting the push-pull arrangement. In American valves I have obtained very satisfactory

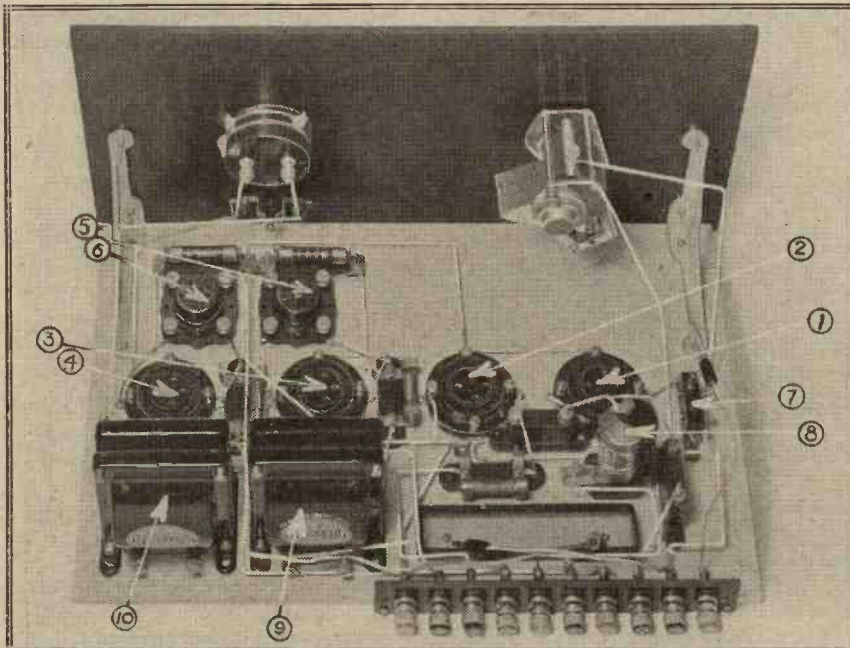

(1) Detector valve; (2) 1st L.F. valve; (3) and (4) push-pull valves; (5) and (6) duplicated sockets for push-pull valves; (7) aerial coil holder; (8) 100,000-ohm resistance; (9) and (10) push-pull transformers.

in the push-pull stage there are four valve sockets, two being for English valves and two for American, the English and American sockets being wired in parallel, so that I can test out either English or American super-power valves from time to time. This

output transformer in the receiver is of 25-1 ratio, so that a moving-coil speaker can be operated direct when desired. Although the idea may sound inefficient for normal use with the cone loud speaker, I find that there is no perceptible distortion by

results with the Cunningham C.X.371A, but the life of these did not exceed that of the British super-power valves similarly used.

vides an alternative of comfortable strength.

It will be noticed on examining the photographs and diagrams that

I have seen it stated in several places that satisfactory results with push-pull cannot be obtained unless the valves are carefully matched. My experience is that perfect matching is not very important if quarter-megohm resistances are inserted, as shown in the diagram, and which incidentally are now recommended by Messrs. Ferranti themselves. In this set I have, at times, used two valves—one of which has lost a considerable portion of its emission and the other almost new—with quite good results, although, of course, the undistorted strength could not be made so great as with two good valves.

Filament Control

The use of the Amperites was primarily decided upon because of the rather critical filament voltage of the American valves. They can be dispensed with if valves are used which will run satisfactorily with the full six volts on their filaments.

While the receiver described gives wonderfully good quality reproduction with only a reasonable high-tension voltage, the set should not be constructed by any reader who is unable to obtain high-tension either from the mains or from a really large-size

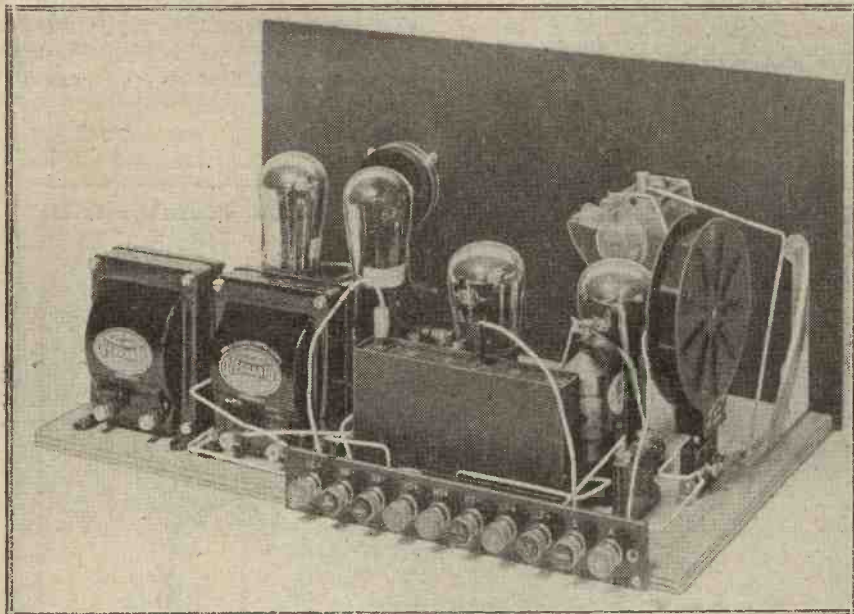

The "Harris" Three ready for action, with grid battery, valves and coil on board.

Grid bias, of course, must be carefully adjusted at such high voltages, so as not to overrun the valves, and with 180 volts on the plates of a couple of L.S.5A's something in the neighbourhood of 40 volts grid bias is not too much. The purity of this receiver is really wonderful, and the results given on any loud speaker are a revelation to those who have not heard a set in which the output stage is properly designed to give good room strength without overloading.

"Uncannily Natural"

On a good moving-coil type of speaker results are uncannily natural, and it is a great advantage to be able to run a good strength of signal on all kinds of reproduction without any overloading.

The milliammeter in the output stage will work as steady as a rock save when the set is so tuned that the signals are louder than is comfortable for an ordinary room.

The adjustment of the voltage for the anode-bend detector is not critical, and using about 120 volts on the detector stage I find about 6 volts negative on the S.S.6075 H.F. is about right. Although a centre-tapped coil is used without reaction, tuning is quite sharp, a couple of degrees either way on the .0005-mfd. condenser bringing about a considerable reduction of strength. 5GB does not come in satisfactorily with the small indoor aerial at Wimbledon, but on a good outdoor aerial it pro-

no special terminals are provided for the loud speaker, as the two output terminals of the push-pull transformer are used for the purpose.

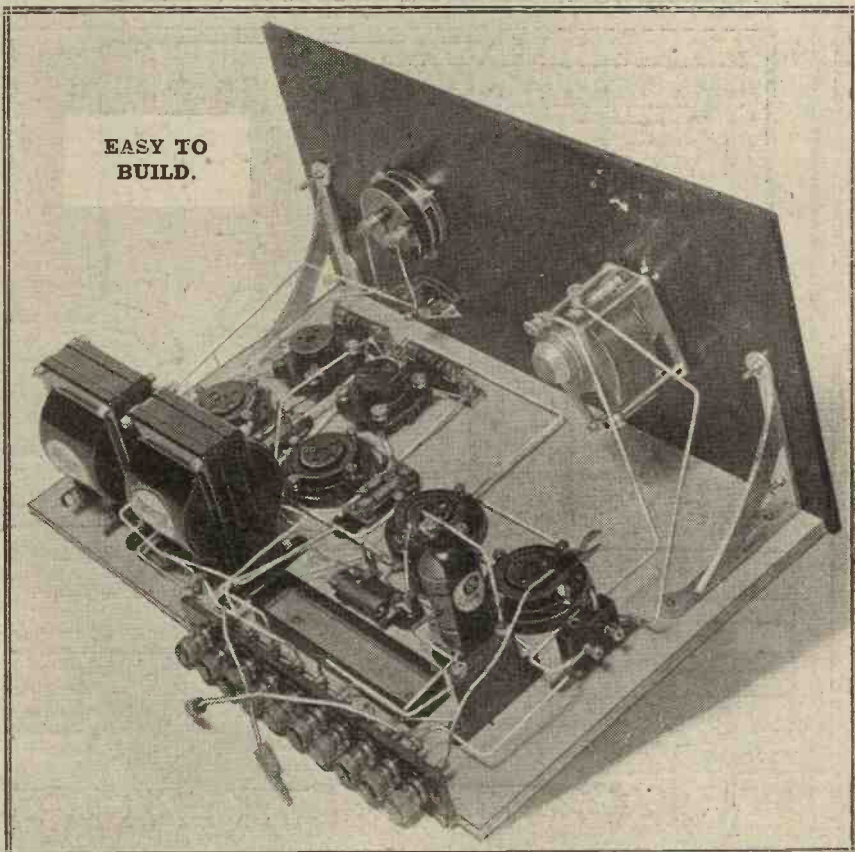

This view clearly shows the detector end of the set, which makes use of a centre-tapped aerial coil.

high-tension accumulator, as the current consumption necessary to obtain the quality and purity is very high.

Actually the set in use at the present time takes 45 milliamperes, and the filament current is nearly 2 amperes. A well-designed or large-size mains unit is necessary to give 45 milliamperes at 180 volts, and many sold will give barely 120 volts

at such a load. Provided, however, the right kind of high-tension mains unit is chosen with the correct valves, the reader will have a set which will do justice to the best moving-coil speaker going.

For "Local" Only

A set of this kind must not, of course, be looked upon as anything but a means of getting remarkably

good quality from the local station, and some readers may think that with four valves one should be able to receive quite a number of others.

It should be remembered, however, that the last two valves really act as one, for they are included in one stage of magnification and not in two, as is the case when they are used separately. Again, the magnification given by a super-power valve is low,

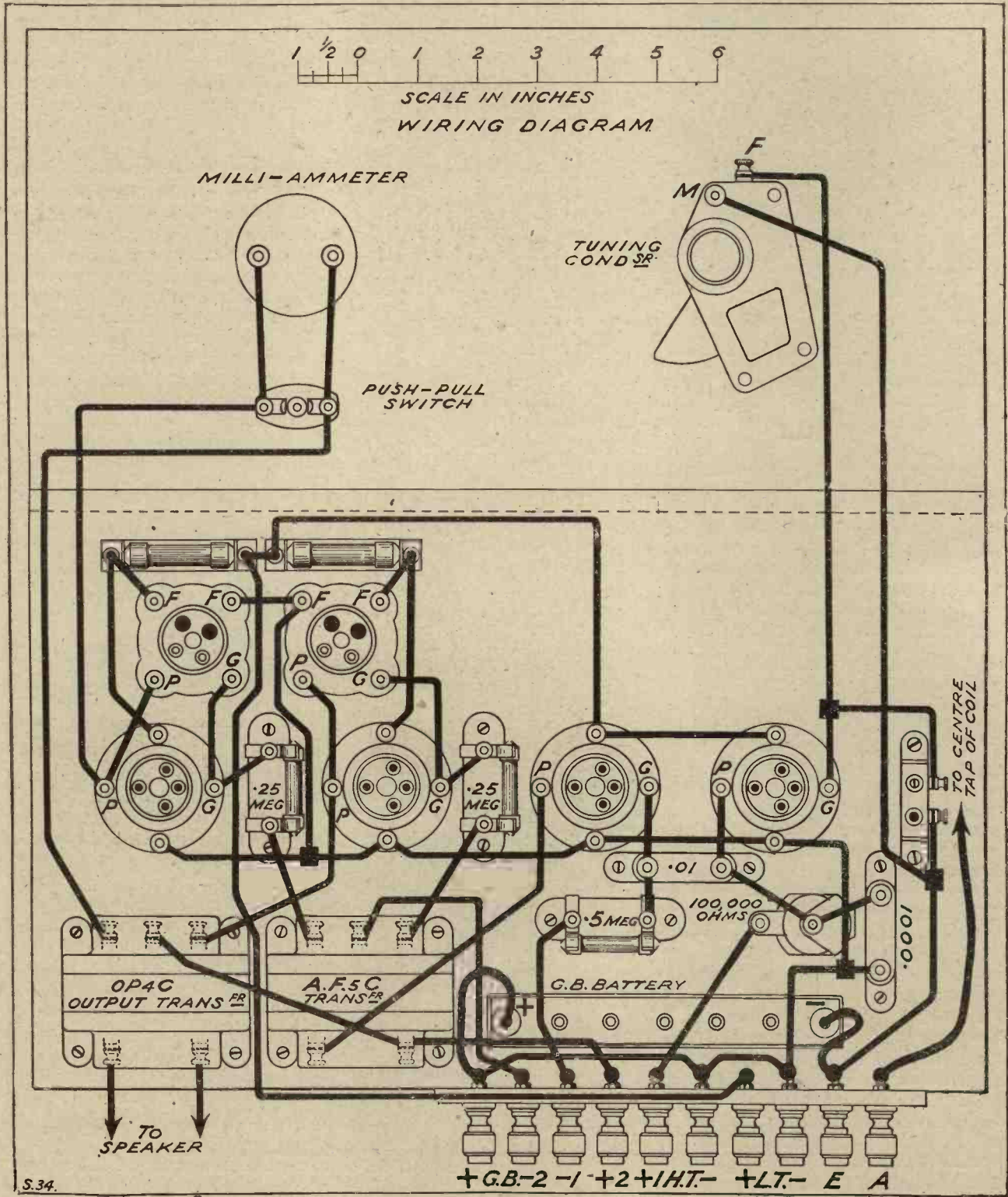

S.34.

which also reduces the sensitivity.

Furthermore, the fact that the detector valve makes no use whatever of reaction amplification means that, so far as range is concerned, a detector with reaction followed by one good stage of low-frequency will be at least as good as this set, but quality considered, there will be no comparison between the two.

Just recently I have been trying

reproduction, without perceptible distress, as loud as one can tolerate even in a large living-room.

It is also easy to understand the popularity of some makes of loud speaker, for these over-accentuate certain low tones very unpleasantly on the present receiver and sound much better on sets which in themselves are weak on these very tones.

When, as is the case with my own

important. The best form of volume control is obviously that which reduces the input applied to the detector valve, but such a scheme is not practicable at a distance.

Simple Volume Control

The method I use is the somewhat heretical one of shunting a continuously variable volume control resistance (a table type Clarostat) across the loud speaker itself, and as this arrangement does not affect the plate current in the last valve very little noticeable distortion results.

At the same time it is there, and can be noticed by the discriminating ear, so the strength of reproduction from the set without the volume control in circuit is adjusted to be just pleasant for the room, and the volume control is only used when critical listening is not indulged in.

Thus it often occurs that one does not want to switch off for fear of missing something important, and yet has no desire to follow in detail the seemingly interminable sports results at the end of the news bulletins; one simply cuts down on the volume control.

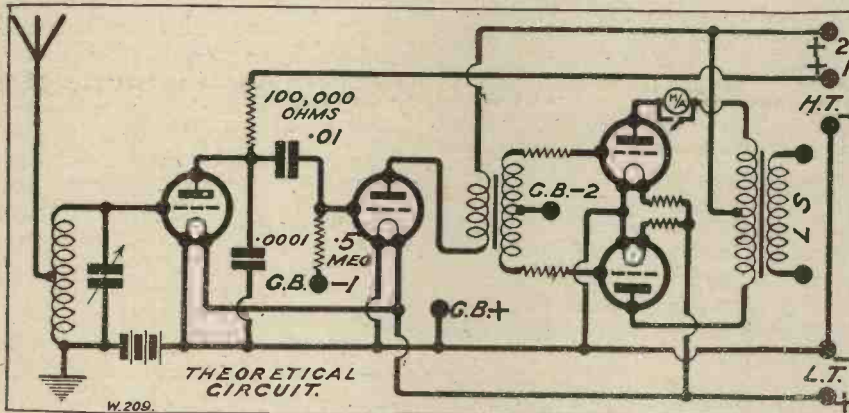

out the new 625 and 625a types of super-power valve which were shown to the public for the first time at the Wireless Exhibition this year. They represent a great improvement, not only in the reduction of filament current, but in considerably increased magnification.

At the same time, this increased "mu" makes the subject of matching more important, and I have found that even with the quarter-megohm resistances trouble occurs unless the valves are approximately matched.

In investigating this trouble I find that there is scarcely a mains H.T. unit on the market that cannot be greatly improved (when used with the rather heavy load of this set) by the addition of another 6 or 8 mfd. across its output terminals!

Valve Overloading

A few days' trial of a set such as this teaches one a great deal about loud speakers. Often one hears the remark that such and such a speaker is very good, but will not stand much of a load. The actual fact is generally that the speaker in question shows up valve overloading very quickly, whereas other types disguise it either by having no genuine low-note reproduction (and therefore no means of showing low-note blasting), or else by covering it up in a "boxy" boom.

The Western Electric or B.S.A. cone, for example, is held by many to be a speaker which is particularly susceptible to overloading, whereas on this set it will handle very loud

receiver, the loud speaker is used in, and controlled from, a room some distance away from the set itself, the question of volume control becomes

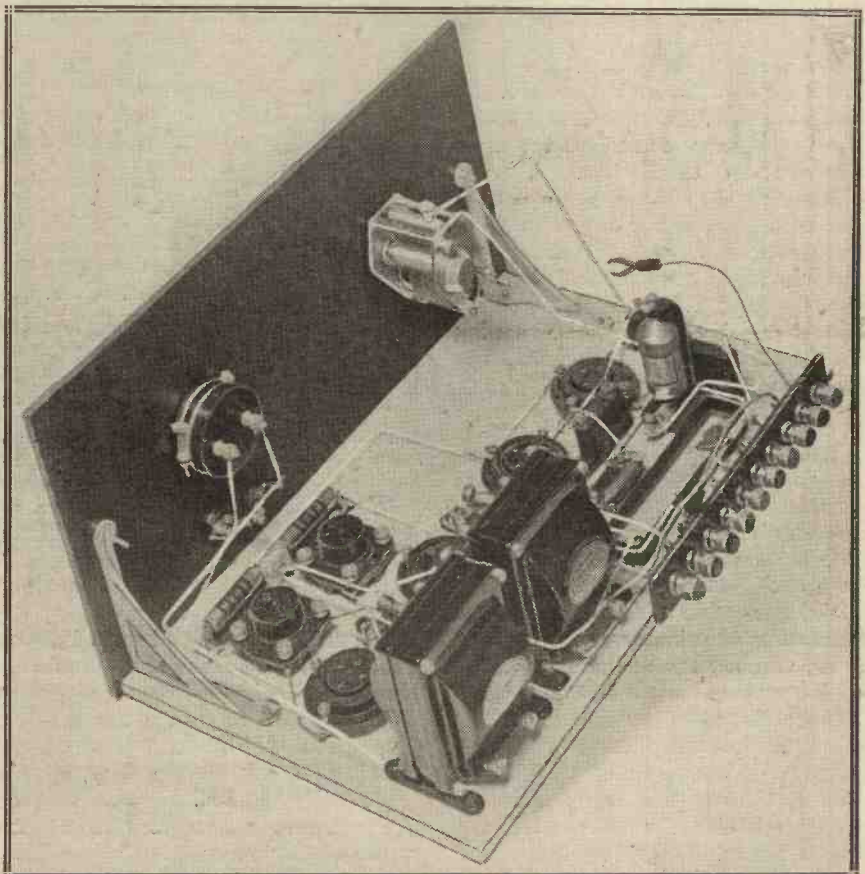

The two valve holders with the Amperites in the filament leads, just under the milliammeter, are for American type "tubes," and are connected in parallel with the two behind the transformers.



Questions Answered

A Grid-Bias Problem

W. M. (Bedford).—"I have a 'Solo-dyne' Three which had been working perfectly until a week ago, when there was a sudden falling off in tone and volume. I overhauled the set and found that all was in perfect order. I removed the G.B. battery and the volume and tone immediately improved. In fact, I am now running the set with the G.B. battery out of the circuit, and it gives just as good results as it did before. What is the cause of this? Will running without a G.B. do any harm to the set?"

W. M. does not say whether he has tested his H.T. battery, and we suggest that he attends to this first. A run-down H.T. battery would produce these symptoms, and this is the most likely cause of the trouble.

Running the set without a G.B. is not to be advised. It will produce distortion and possibly choking on loud passages, and in addition the load on the H.T. battery is increased, thus decreasing its life. Also running the valves in this condition does not do them any good.

Loose-Couplers

S. S. (London) asks us what a loose-coupler is. He has heard the term mentioned, and wishes to know whether it would be advantageous for him to use this form of coupling in his own set.

A loose-coupler is an aerial tuner consisting of primary and secondary coils, variably coupled and tuned.

A few years back it was quite usual for experimenters to employ this form of aerial coupling when maximum selectivity was desired. The aerial and secondary coils are placed in a two-coil holder, and both circuits are tuned with variable condensers. Selectivity is adjusted by varying the coupling between the two circuits. The modern method is to use an

untuned aerial circuit in order to simplify control. If the number of turns on this "aperiodic" arrangement is chosen wisely the results will not be appreciably different from those obtained when both circuits are separately tuned.

THE TECHNICAL QUERIES DEPARTMENT

Are you in trouble with your set?

Have you any knotty little Radio problems requiring solution?

The MODERN WIRELESS Technical Queries Department has been thoroughly reorganised and is now in a position to give an unrivalled service. The aim of the department is to furnish really helpful advice in connection with any radio problem, theoretical or practical.

Full details, including the revised and, in cases, considerably reduced scale of charges, can be obtained direct from the Technical Queries Department, MODERN WIRELESS, Fleetway House, Farringdon Street, London, E.C.4.

A postcard will do: on receipt of this all the necessary literature will be sent to you free and post free, immediately. This application will place you under no obligation whatever. Every reader of MODERN WIRELESS should have these details by him. An application form is included which will enable you to ask your questions, so that we can deal with them expeditiously and with the minimum of delay. Having this form you will know exactly what information we require to have before us in order to solve your problems.

Screened-Grid Valves

W. M. A. (Brighton).—"I have a set employing a split-primary H.F. stage. Can I adapt a screened-grid valve to this circuit without altering the coils?"

No. The screened-grid type of valve has a high impedance and requires a similar type of tuned circuit in series with its anode for maximum results. The primary winding of a split-primary transformer is very small, and it is common practice to use screened-grid valves in conjunction with tuned-anode arrangements. This scheme enables the advantages of the high-amplification factor of the valve to be obtained.

Using a Pentode

P. H. (Northampton) has a three-valve set with one transformer-coupled L.F. stage. He asks whether he could employ one of the new Pentode valves in the L.F. socket.

Yes, you could use one of these valves, but there are certain factors which should be taken into account.

In the first place, a Pentode valve takes a rather heavy anode current. At the anode voltages normally used by the average listener it is in the neighbourhood of 14-16 milliamperes, which means that if you are using dry batteries they will have to be of really large capacity.

Then there is the question of a suitable output circuit. This, in the case of many loud speakers, is rather an awkward problem with this valve. The Pentode, it is to be understood, is a valve of very much higher A.C. resistance than the normal super-power valve. This means that the output winding in series with the anode must have a high inductance value for most loud speakers, a feature which, in practice, is very difficult to obtain, because you must remember that the Pentode requires a high anode-current. In the absence of a suitable device the speaker tends to give a high-pitched tone when working with a Pentode. To correct this it seems that a suitable output transformer will be desirable, and we understand that some of the larger manufacturers are bringing out transformers for the purpose.

Amplifying the High Notes

G. T. K. (Chatham).—"I have a cone loud speaker which, in my opinion, is deficient on the upper register. Certain of the higher frequencies do not seem to be amplified at all. Can this be corrected by over-amplifying these higher notes in the set itself?"

Yes, you can do something to make up for this loss by using an L.F. transformer having a primary winding with a very large number of turns. With this type of instrument it is usual to employ a valve in series with the primary of the so-called "H.F." type.

Instead of this we suggest a valve having an impedance of about 8,000 ohms. It is, of course, necessary to cut down the anode current by applying sufficient grid bias to avoid passing more current through the primary than the makers recommend.

The effect of a low-impedance valve is to cause the upper register to be over-amplified, thus to some extent correcting for the loss in the loud speaker.

Eureka enamelled resistance wire. Gauge No.	Safe current in amps. Open winding.	Resistance per yard in ohms.
22	2.2	1.093
26	1.0	2.645
30	.59	5.575
36	28	14.84

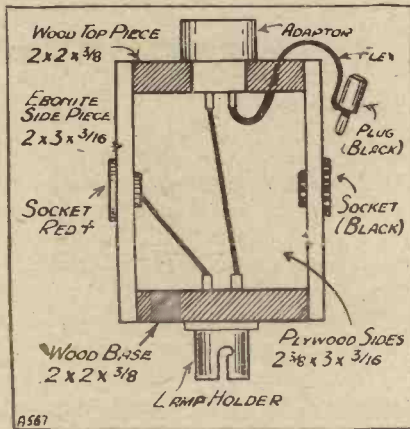

For resistance wound upon formers of cylindrical shape, the safe current should be reckoned at about half that specified.

Amount of Wire

We now have to determine the amount of wire required for a given purpose; and it is an easy matter to wind a suitable resistance upon an

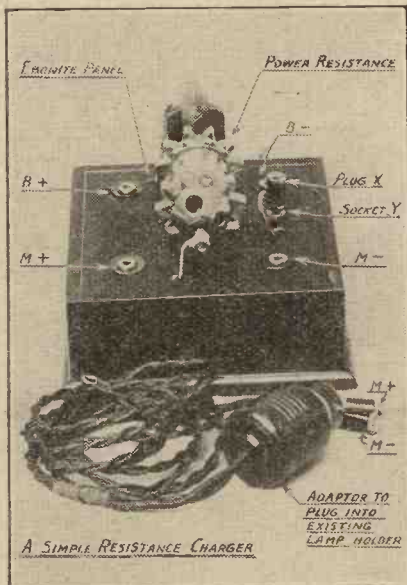

A resistance charger which is extremely simple to construct.

ebonite former for charging purposes. For example, to charge at .25 amp. from 230 volt mains, we require a resistance of 920-ohms. As this has to pass a current of .25 amp., No. 30 wire will suit the occasion with perfect

safety, and this gauge has a resistance of 5.575 ohms per yard.

If we divide 920 by 5.575, the answer will give us the amount of wire in yards which will be required, i.e. 174 yards.

If enamelled resistance wire is chosen it may be close-wound in a single layer for preference.

The construction of the resistance charger is similar to that of the first lamp charger dealt with in these articles. The panel and the wiring, and also the five sockets, are arranged in the same order and for the same purpose, and it is therefore quite easy for the constructor to try both methods at very little extra expense and trouble, or alternatively choose whichever he may prefer.

Necessary Parts

The details are clearly given in the drawing, and may also be followed from the photograph. The following is the material which will be required if the constructor wishes to buy the parts ready made.

- Box to take panel, 4 in. by 4 in., inside depth 1 in.
- Ebonite panel, 4 in. by 4 in.
- Sockets and indication rings and plugs.
- Connecting wire.
- Power resistor (R.I. and Varley).

The panel is first cut and drilled, and then the five sockets are mounted in the order shown. The holder for the resistor is secured to the centre of the panel by means of two small screws, and thus it is possible to change the resistance if it is so desired. With the few connections necessary the unit is completed.

Connection is made from the house lamp-holder to the unit by means of twin flex leads, the extremities of which are equipped at one end with an adaptor of the type shown in the photograph. The other extremities are provided with a black and red plug respectively. The adaptor should be marked, and also the plug into which it is to be inserted for connection to the mains, so that it is easy always to insert it the right way round.

Easily Attached

Another twin lead such as was used for the first charger is required for connection from the unit to the battery on charge, and this is equipped with a red and black plug at one end and a red and a black spade terminal at the other extremities.

The method of linking up is the same as before, and provision can be made for the interposition of a

500-milliamp. meter for the purpose of checking the charge.

When choosing the resistance care should be taken to see that the value

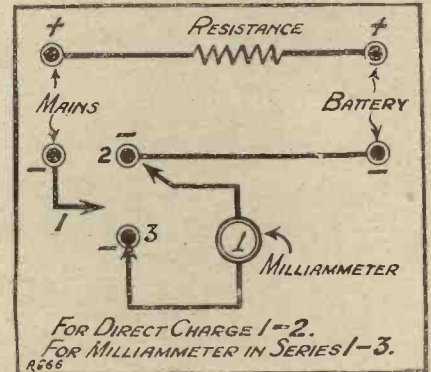

chosen will carry the current to be passed, as will be specified by the makers, but in any case the unit is intended for trickle charging and not for heavy charging.

The house lighting fuses are sufficiently safe for all the charging methods described, as these are designed to carry the maximum current which may be passed from the mains safely. There is no need therefore to have fuses on the units, and in no case should any connections be made before the house fuses.

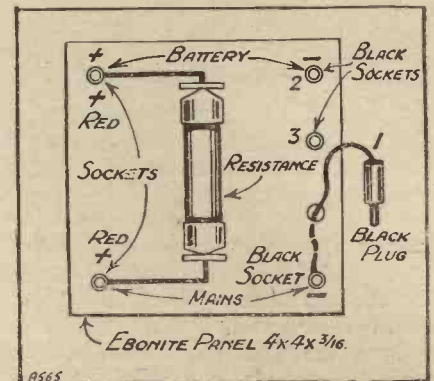

INTERESTING ITEMS

Frothing in an accumulator is generally due to impurities in the celluloid case. A thin layer of oil will sometimes tend to lessen the trouble.

Watch the sediment at the bottom of your accumulator case. It should never under any circumstances be allowed to touch the plates.

Neglect of the grid-bias battery means that there will be a heavier drain on the high-tension supply.



TESTING THE NEW VALVES

Some interesting details concerning some of the new valves.

By KEITH D. ROGERS.

LAST month I mentioned briefly a number of valves which were to be seen for the first time at the National Radio Exhibition at Olympia. And this month I want to discuss a few of the valves other than those I mentioned, and which since then I have had the pleasure of testing out.

First of all, let us take some of the Ediswan batch which was sent to me, and the curves of two of which are reproduced here. One of the most important from the point of view of public acclaim is the P.V.225, which is a 2,700-ohm impedance valve with a magnification factor of 3, and is suitable for quite big work, using only a 2-volt

accumulator. It takes about 20 milliamps. This, of course, is not a small figure, but those people who want really big results must be prepared to use fairly large H.T. accumulators or mains H.T. units. Used properly, this valve is therefore capable of carrying quite a good grid swing.

For those who want to use ordinary H.T. batteries, and yet want quite a good output with 2-volt accumulators, I would recommend the P.V.215, which has a higher impedance (6,600), but also a higher magnification factor, viz., 8. This means that it will not carry such a great input as the large one—the 225—but it will give quite a good output for the smaller input. With 120 volts on its plate and about 6 volts to 7 volts on the grid, it only passes about six milliamps and is quite an efficient little valve.

The H.F.610 belonging to the same class is also exceedingly efficient as an H.F. or as a detector valve. It has a good magnification factor and the impedance is only 21,000 ohms.

So far, I have not been able to test the mains valves brought out by the Ediswan people, but there is no



The Ediswan P.V.225, shown here, was specially designed for loud-speaker operation, and is capable of satisfactorily handling a large input, as will be seen by the curves reproduced opposite.

accumulator. For the 2-volt enthusiasts this should come as an especially good piece of news.

When 120 volts is applied to its anode, and the grid bias is somewhere

Good L. F. Valve

These two valves have their counterparts in the 4- and 6-volt classes in the form of the P.V.425 and the P.V.410, and the P.V.625 and the P.V.610, the characteristics being very similar, although when it comes to the P.V.625 you are getting into the really big power class.

I find the P.V.610 a very efficient little valve, and so is the L.F.610, the curve of which appears here. As a first stage L.F. valve this one is exceedingly good, having an impedance of 10,000 ohms and an amplification factor of 15, and taking .1 amp. at 6 volts. With 120 volts and properly biased you will find it only takes between 3 and 4

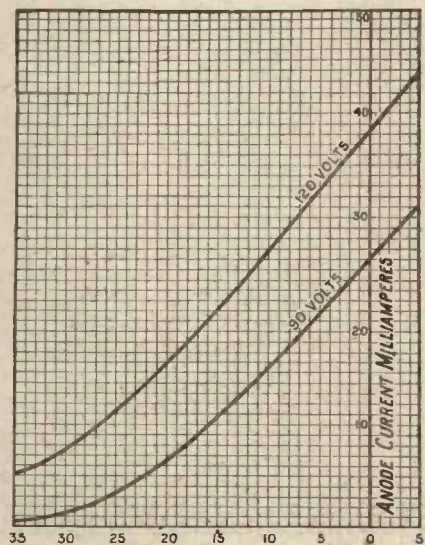

The curves of the P.V.225 Ediswan valve.

reason to believe they will be anything else but successful. In fact, for the average critic who usually likes to be able to slang someone or something, the Ediswan range is rather disappointing. I am bound to say that the valves are good, in fact, very good; and however hard the critic may try to find adverse criticism he will have a difficult job.

The same can be said for the B.T.H. range of Mazda valves. Both the

2- and 4 volters are exceedingly efficient, while the 6's live up to the reputation of the best of the 6-volters. For the man who likes big noise the P.X.650 is a good valve, having an impedance of only 1,750 ohms and a magnification factor of 3.5. It takes



With an impedance of 10,000 ohms and a magnification factor of 15, this L.F. valve is specially suitable for transformer-coupled L.F. stages. The characteristic curves of the valve are given below.

rather a heavy plate current (as is natural), for when 150 volts is applied it takes something of the order of 30 milliamps, but for moving-coil speakers this valve can be recommended.

A "Smaller Brother"

Its smaller brother, the P.615, is on the market, and this also is suitable for moving-coil work if necessary. It has an impedance of 2,600 ohms and a magnification factor of 6.

It will be noticed it comes in the same class as the Marconi and

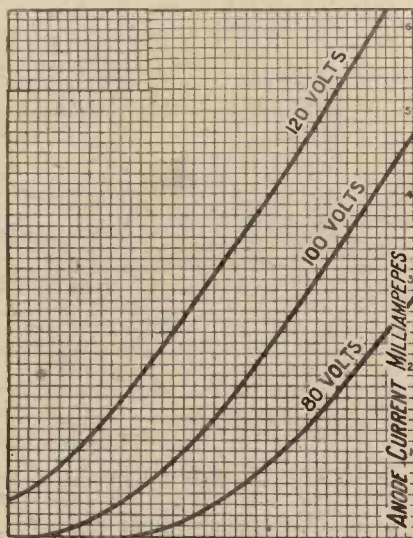

The characteristics of the L.F.610

Osram P.625, with which it compares very favourably indeed. The filament current of the B.T.-H. is only .15, against the others .25 at the same voltage, though the Marconi and Osram valve will take 250 volts with

ease, while the B.T.H. is not recommended to take such a high voltage.

The "Double" Valve

So far, I have not been able to test the special double valve brought out by the B.T.-H. Company and known as the P.X.215. This valve functions in a dual capacity as a detector and L.F. amplifier, or as two stages of L.F. amplification. It is supposed to do the work of two valves with a filament consumption of one. It works off a 2-volt accumulator, and takes only .15 amp. at a maximum H.T. voltage of 120, and at 120 volts it gives an amplification factor for the first stage of 57, and the second stage of 6.5, with A.C. resistances of 100,000 ohms and 7,000 ohms respectively.

The circuit recommended by the makers for use with this valve is a two-valve set which really gives three-valve results, and this is shown below.

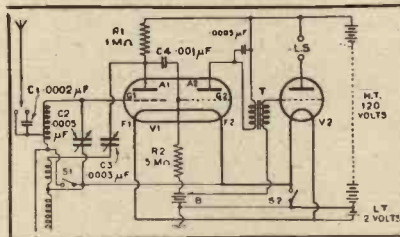

Since the exhibition I have had the chance of testing out the P.425 of the Marconi and Osram valves. The P.425 is a 4-volt valve taking .25 amp. with anode volts of 150 maximum, at which it consumes about 20 to 22 milliamps. It has an impedance of 3,200 ohms, and a magnification factor of 4.5, and is eminently suitable as a last stage power amplifier.

Valves for "M.W." Sets

And now let me just run over the types of valves most suitable to use with the larger sets described in this issue of MODERN WIRELESS. Let us consider the "Invincible" Five.

The choice of valves can be made from either the 2-, 4- or 6-volt classes, and should consist of three H.F. valves, for H.F. stages and detector, and an ordinary L.F. valve, followed by a super-power type. The H.F. valves should be of the 18,000 to 30,000-ohm type, such as the H.L.210, H.L.610, Ediswan H.F., Cossor H.F., B.T.-H. H.F., P.M.5X, etc., according to the L.T. voltage required.

Similar characteristics should be used for the detector valve, while the first L.F. valve should have a much lower impedance and a reasonable grid swing. Such valves as the Ediswan L.F.610, Cossor L.F.—any valve having an impedance between

10,000 and 15,000 ohms. A lower impedance than 10,000 ohms would tend to cause saturation of the trans-

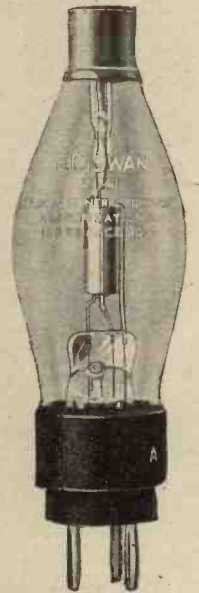

So far we have been unable to test this valve—the M.I.41 L.F.—which is of the indirectly heated cathode type, for use with A.C. mains, and has an impedance of 9,000 ohms with a magnification factor of 16.

former core, unless a special transformer were employed.

In the last stage the super-power valve can be of anything between 4,000 ohms and 1,500 ohms, dependent upon the H.T. supply. Do not forget that a super-power valve will take a good deal of anode current, but it is well worth it. Such valves as the P.M.256, P.625 (or even P.625A), Ediswan P.V.625, P.V.225, P.M.252, P.M.254, P.V.425, D.E.P.240, P.425, Cossor super-power valves, B.T.-H. P.615 (or the larger P.X.650) would all be suitable.

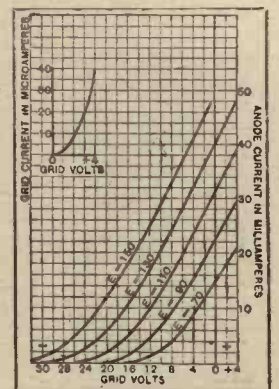

The P.425 has a grid swing of nearly 20 volts, and will take up to 150 volts H.T. with ease. It has an impedance of 2,300 ohms and a magnification factor of 4.5.

In the case of the "Rhapsody" Four the same kinds of valves should be used, in spite of the fact that for long waves a resistance coupling is provided. A good H.F. valve having an impedance of 17,000 to 30,000 ohms in the first position will give the best all-round results. The detector should be of the same type, while the L.F. and last stages should have L.F. and power or super-power valves respectively.

THE "INVINCIBLE" FIVE.

An exceptional Wireless Receiver.

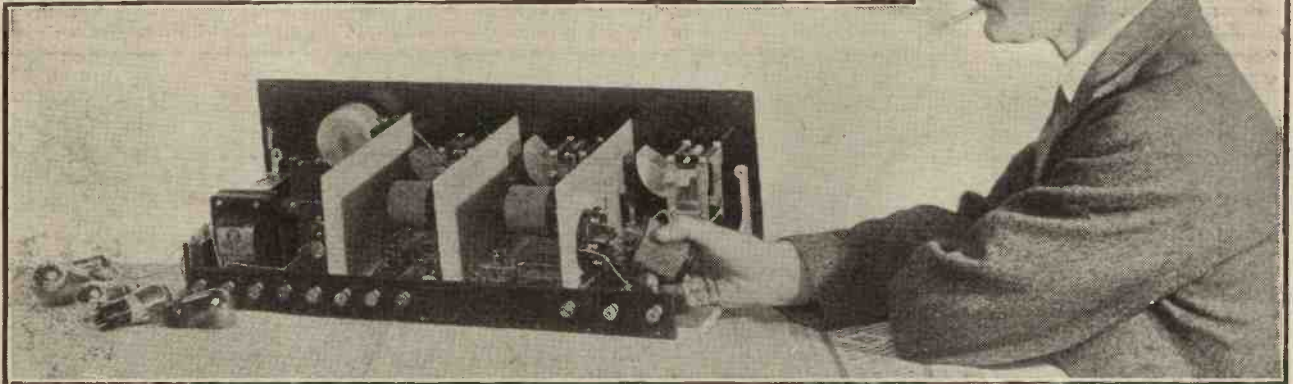

WHAT constitutes an exceptional wireless receiver? Is it selectivity, ease of handling, handsome appearance, perfect quality of reproduction, or some other more elusive attribute? Handling as we do something like two new sets per week all the year round in the "M.W." Research Department, we have probably a better chance than most of giving a correct reply to this question.

"Thoroughbred" Behaviour

In our experience it seems that the answer is to be found in the possession by a given set of two main features. These are (a) a certain pleasantness of operation, each control function-

The "Invincible" Five sets a new standard in the design of multi-valve receivers, giving the benefits of very perfect inter-stage screening with the simplest possible arrangement of screens and using entirely standard parts throughout. The construction of the set is much simplified by the special method of screening and coil mounting, and the results are definitely superlative.

Designed and described by the "M.W." RESEARCH DEPT.

ing smoothly, and exactly as one expects it to do, unobtrusively but effectively, the impression given being that of a thoroughbred doing its work with a certain effortless ease, so that the operator is led on to make

greater and greater calls upon its powers. This is perhaps a rather imaginative description of the quality which we are trying to convey, but it is one with which the experienced constructor is likely to agree.

Elusive But Important

The characteristic in question is rather an elusive one, and is a little difficult to analyse, but it is certainly by no means the least important feature of a really good design. One effect of the possession of this quality is to give the user a general sense of pleasure in operating the receiver, so that he goes out of his way to put it through its paces at

COMPONENTS AND MATERIALS

- | | | |
|--|---|---|
| <p>1 Panel, 26 in. × 8 in. × $\frac{1}{4}$ in. (Resiston, Becol, "Kay Ray," Ebonart, Red Seal, or any other good branded material).</p> <p>1 Cabinet to fit, with panel brackets and baseboard 10 in. deep (Camco, Raymond, Pickett, Makerimport, Bond, Artercraft, Caxton, etc.).</p> <p>3 .0005-mfd. variable condensers, slow-motion or with vernier dials (Cyldon condensers and Lissen dials in original. Any good make, Igranic, J.B., Dubilier, Bowyer-Lowe, Ormond, Raymond, etc.).</p> <p>1 .0001- or .00015-mfd. miniature type reaction condenser (Igranic in set. Any good make, J.B., Dubilier, Ormond, Bowyer-Lowe, Cyldon, Peto-Scott, etc.).</p> <p>1 L.T. switch (Lissen, Lotus, Benjamin, Igranic, Peto-Scott, Burne-Jones, etc.).</p> <p>1 Volume control, potentiometer type, of 1 or 2 megohms (Burne-Jones in set. Any good make, Igranic, Gambrell, G.E.C., etc.).</p> | <p>3 Standard screens (type with row of perforations across lower edge), 10 in. × 6 in. (Burne-Jones, Paroussi, etc.).</p> <p>5 Sprung valve holders (Lotus, Benjamin, B.T.H., Burndept, Marconiphone, W.B., Bowyer-Lowe, Wearite, Burne-Jones, Pye, Redfern, Igranic, Formo, etc.).</p> <p>2 Baseboard-mounting neutralising condensers (Peto-Scott, Igranic, Gambrell, J.B., Bowyer-Lowe, Burne-Jones, etc.).</p> <p>Fixed condensers of .0002, .0003, .001 and .01 mfd. (Lissen, Mullard, Dubilier, Clarke, Marconiphone, T.C.C., Burne-Jones, etc.).</p> <p>1 2-mfd. Mansbridge type condenser (T.C.C., Lissen, Hydra, Dubilier, Mullard, Ferranti, Polymet, etc.).</p> <p>1 $\frac{1}{2}$-meg. and one 2-meg. grid leaks with holders (Dubilier, Lissen, Igranic, Mullard, Ediswan, Pye, etc.).</p> <p>3 6-pin coil bases, unscreened type (Lewcos, Colvern, Bowyer-Lowe, Peto-Scott, Burne-Jones, etc.).</p> | <p>1 H.T. fuse and holder (Burne-Jones or similar type).</p> <p>1 H.F. choke (Lissen, Lewcos, R.I.-Varley, Dubilier, Bowyer-Lowe, Igranic, Colvern, Cosmos, Climax, Burne-Jones, Peto-Scott, etc.).</p> <p>1 250,000-ohm wire-wound anode resistance and holder (R.I.-Varley, Dubilier, Lissen, Mullard, Igranic, etc.).</p> <p>1 Low-ratio L.F. transformer (Igranic type "G" in set. Any good make, Ferranti, Lissen, R.I.-Varley, Marconiphone, Mullard, Brown, Philips, etc.).</p> <p>1 Heavy-duty filter output choke (R.I.-Varley 28/14-henry type in set. Any good make).</p> <p>1 Terminal strip, 26 in. × 2 in. × $\frac{1}{4}$ in., and 11 terminals (Ealex, Belling-Lee, Igranic, etc.).</p> <p>1 Ebonite strip, about 2$\frac{1}{2}$ in. × 1 in., carrying 2 small sockets; G.B. plugs, flex, wire, screws, 3 pieces of wood 3 in. × 3 in. × $\frac{3}{8}$ in.</p> |
|--|---|---|

every opportunity, and so in the end gets a much finer performance from it than he would obtain from another of equal sensitivity but "ugly" and cantankerous disposition.

Just what constitutes this thoroughbred impression is rather difficult to define, but, as we have said, it is largely a matter of the way the set answers to its controls. To take

so without affecting any other adjustment in the slightest degree—i.e. without altering the tuning, the reaction setting, or the tone of the signals.

Standard of Performance

So much for the first essential of a set in the true "de luxe" class. Now we come to requirement (b),

maximum degree possible within the limits (number of valves, etc.) to which they are working, but the former one, namely, the general "manners" of the set, commonly receives far less attention than it deserves.

It was with these points in mind that we designed the "Invincible" Five, and the final result is a receiver about which it is very difficult to

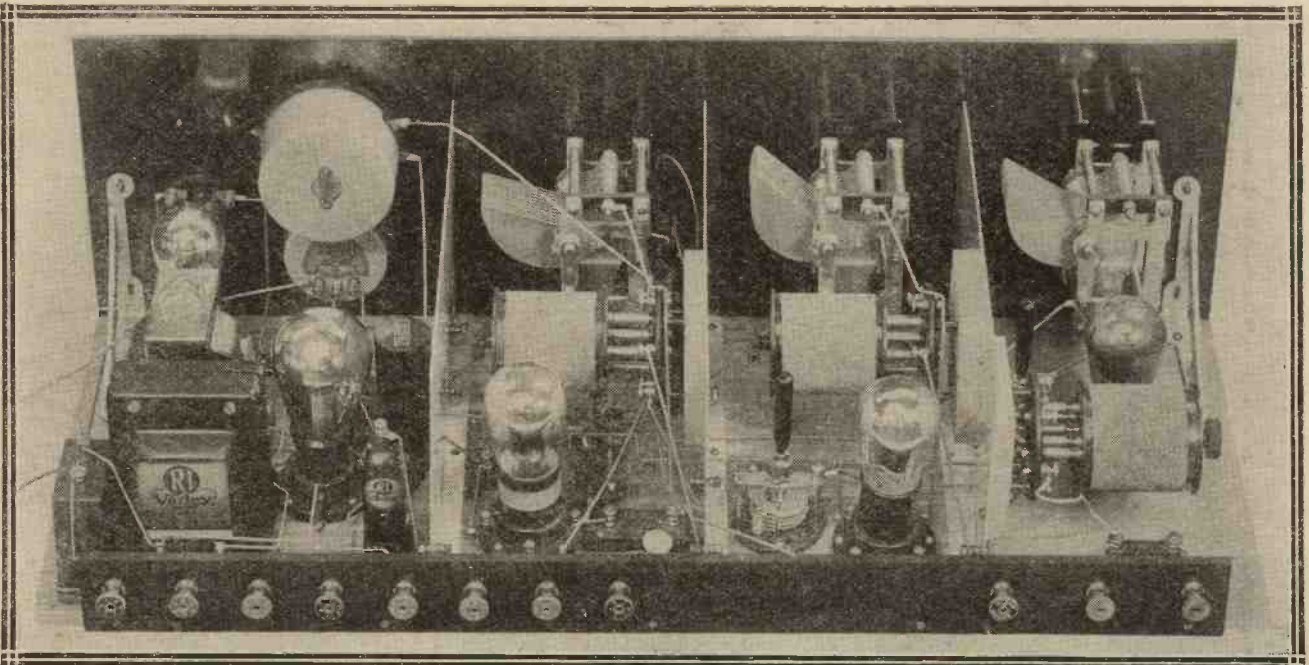

One of the special features of the "Invincible" Five is the very simple but highly efficient method of screening. Although only plain vertical partitions are used, the method of coil mounting reduces inter-stage, inter-action to extremely small proportions.

just one example: Suppose that the receiver is fitted with a volume control. If this device is to function as it should in a set of the kind we are describing, it should smoothly and gradually vary the signal strength from the maximum down to a mere whisper, through all the intermediate gradations. Further, it should do

which is the obvious one of a high standard of general performance, comprising a good balance of sensitivity and selectivity, perfect stability, and, of course, high quality of reproduction.

This aspect of the question is fairly well understood by designers, and is usually provided for to the

avoid the use of superlatives, possessing as it does those special attributes which lead the discriminating operator to bestow praise which must run the risk of seeming exaggerated to those who have not handled it for themselves.

Accordingly, we do not propose to attempt a test report of the

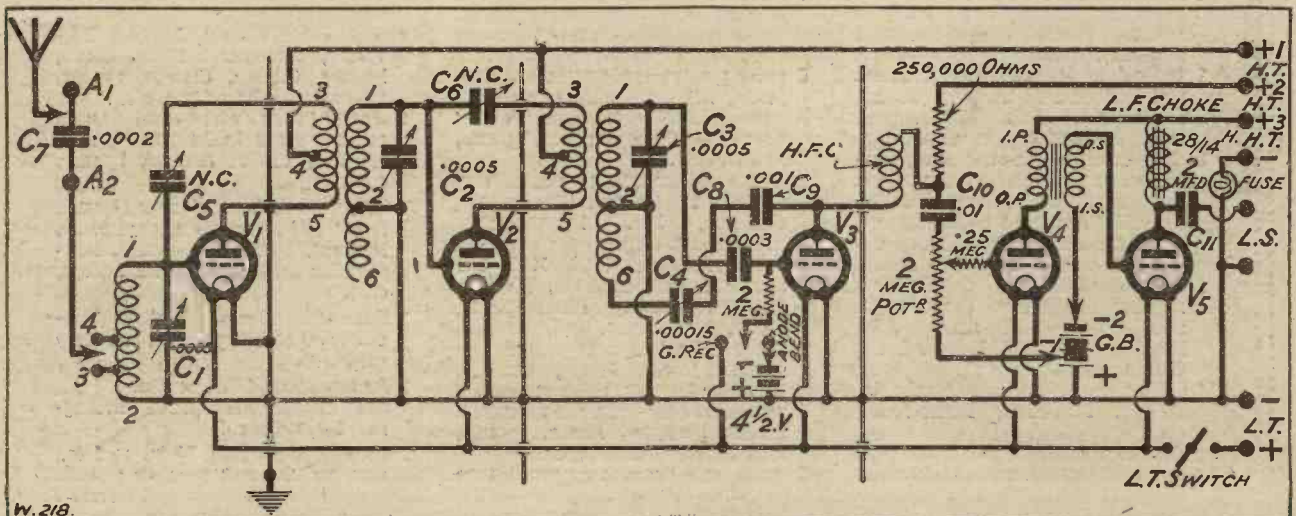

This circuit diagram shows the main features of the set, with a slight simplification in the placing of the screens for the sake of clarity.

set's behaviour under normal conditions, but shall confine ourselves to an account of its performance under extremely adverse ones of a poor and badly screened small aerial.

Severe Conditions

The actual conditions were these. The aerial was only 30 ft. long, was

perfectly with our definition of an exceptional receiver.

Now for a general survey of its features. It incorporates two high-frequency amplifying stages, a detector (with reaction for use on the weaker stations) which can be made to function on either the leaky-grid or anode-bend principle at will, a resistance-coupled L.F. stage, and

The H.F. side, of course, is the specially noteworthy feature of the set, although a passing glance at the circuit diagram may not reveal the fact. It is actually a perfectly straightforward H.F. transformer-coupled circuit, with "split primary" neutralising, such as was used in the original "Solodyne" receiver, and on paper its special features are scarcely apparent.

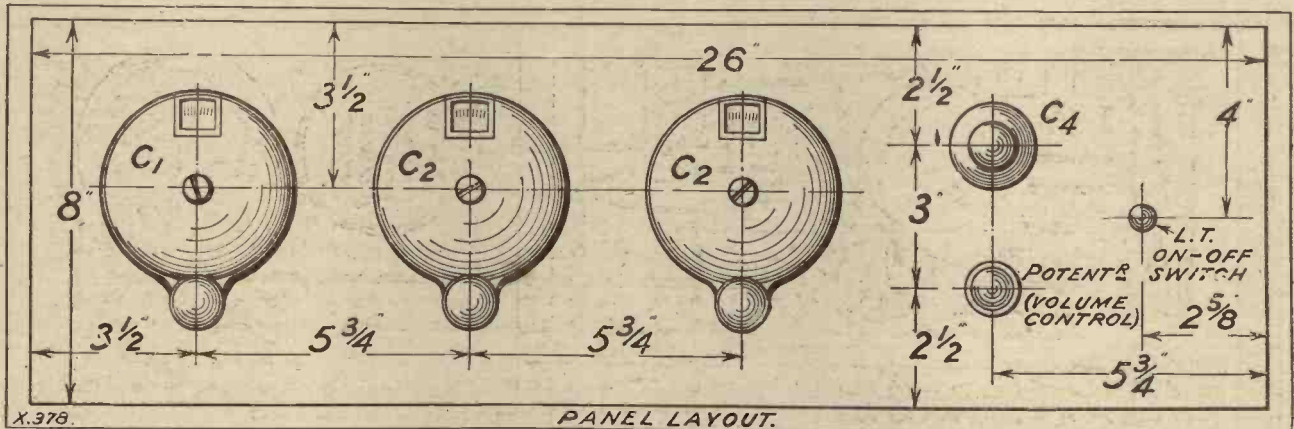

only 20 ft. above the ground, and not more than 8 ft. above the set itself, the earth being a fairly good one. The aerial is screened on two sides by high trees, on a third by a house, and slightly on the fourth by trees of about its own height. Under these conditions a log of 42 distant stations has been compiled, all at full loud-speaker strength!

Selectivity was found to be remarkably good, and the performance on long waves was also particularly pleasing. As an instance of its power here may be quoted the fact that even in the bad conditions described it has proved capable of bringing in the Constantinople long-wave station on the loud speaker at full volume in daylight. At all times its "manners" have been admirable, and it complies

a final transformer-coupled stage.

Special pains have been taken to please the quality enthusiast on the L.F. side, the values chosen being those to give a particularly even response over the musical scale, with the addition of a good output filter circuit to ensure that the last valve shall function under the best possible conditions, at the same time ensuring that the loud speaker shall be free from the load of D.C. anode current.

A volume control of the efficient potentiometer type is provided immediately after the detector valve, where it can be used to protect both L.F. stages from overloading. This type, it is to be noted, has the least possible effect upon the quality of reproduction, and is particularly smooth and gradual in operation.

However, the majority of "M.W." readers will scarcely need to be reminded that the secret of a modern multi-valve receiver lies far less in the theoretical circuit, which is usually a fairly standard one, than in the practical arrangements, particularly the screening.

Secret of the Set

It is here that we find the key to the success of the present design, for if you look at the photos you will see that the screening and assembly of the H.F. stages is on decidedly novel lines. Screening, of course, is a very vital factor in a set like this, and although it is easy to design a screening system which is fairly perfect in the electrical sense, it may be anything but ideal from the point of view

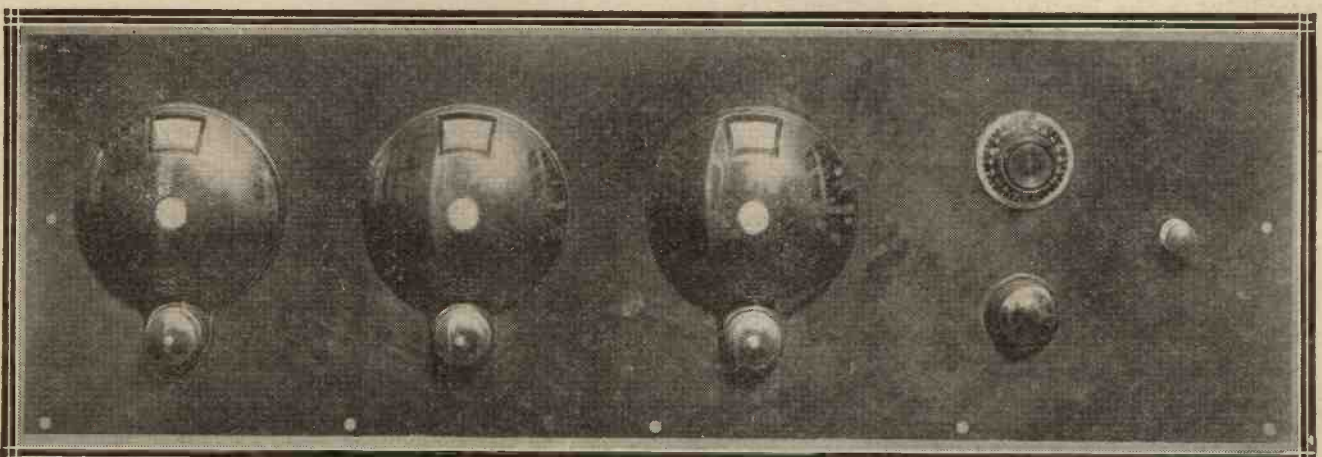

Although there are three dials and tuning is sharp, operating the set is not difficult, since the readings keep step quite closely. The small graduated dial to the right is the reaction control, while the knob below this is the volume control on the first L.F. stage. On the extreme right is the on-off switch.

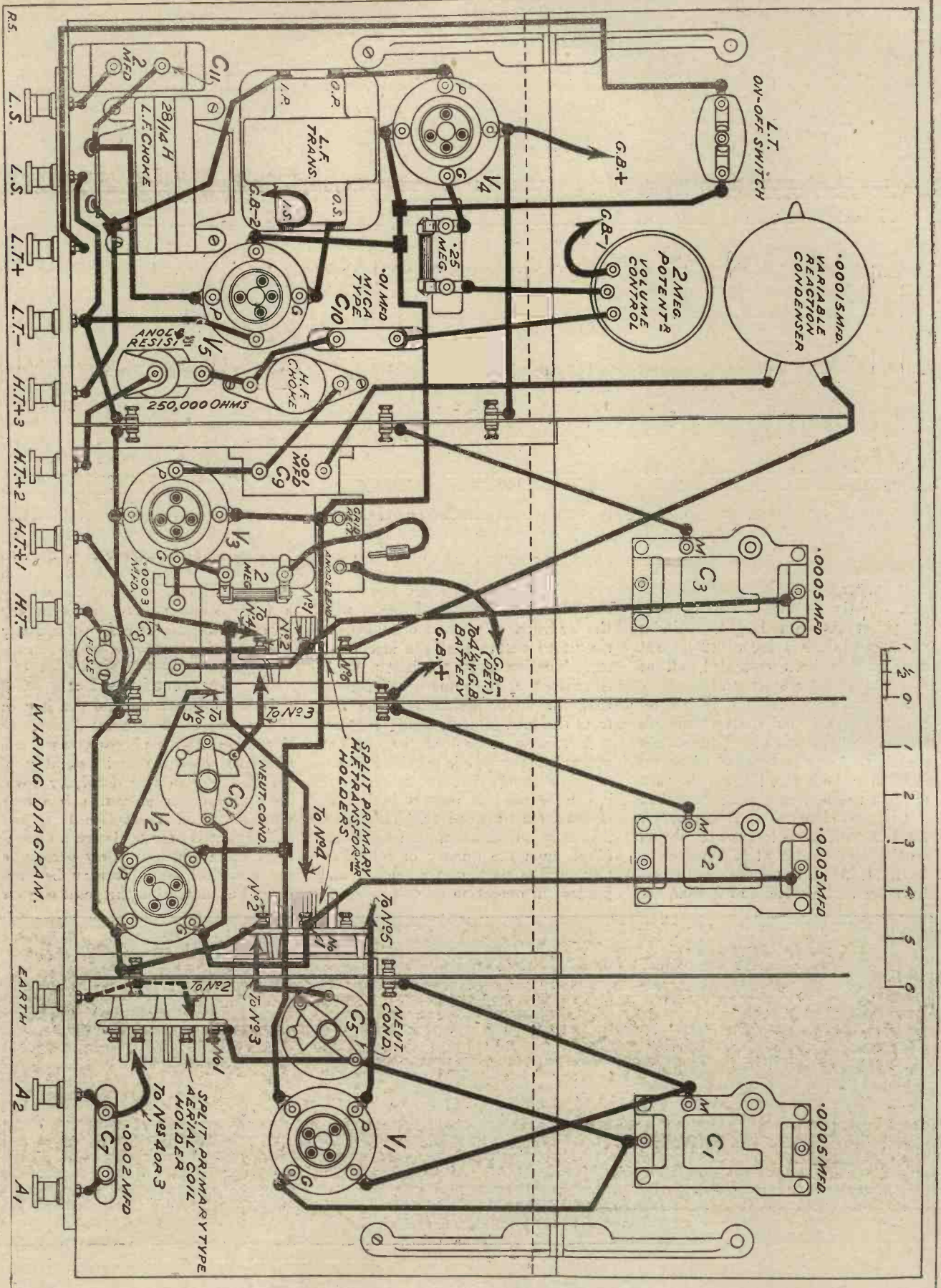

WIRING DIAGRAM.

of the home constructor, for unless the designer denotes a great deal of care and thought to the problem it is likely to be heavy and expensive and to make the set a difficult one to build.

In the "Invincible" Five we have used a system which adds to the total cost an amount of, roughly, 7s. 6d., involves only a very little extra work, yet gives a very high degree of efficiency indeed. This system is one which was first used in a simple form in the three-valve version of the "Solodyne," where only one H.F. stage was involved. Here it proved highly successful, the receiver in question being, in our estimation, the most sensitive three-valve combination which we have produced. So effective was it in this set that we have ever since felt that it possessed considerable possibilities, and have lately carried out the necessary tests to determine its suitability for a set with two H.F. stages.

These gave even more promising results than we expected, and it was forthwith decided to adopt it for use in the "Invincible" Five. The

method, briefly, is this: Plain vertical screens of standard pattern are fixed on the baseboard so that it is divided into compartments, and standard six-pin coils are mounted on the sides of these by screwing the bases to small pieces of wood which in turn are secured to the metal sheets. The coils are thus mounted in a horizontal position, so that the screens cut off their fields at a suitable point and prevent interaction to a very complete degree.

Economy in Screening

The screens are now a standard line, costing, roughly, 2s. 6d. each, according to size, and being supplied ready for mounting, with the necessary holes ready drilled, and also with a row of perforations running right across the lower edge just above the baseboard, so that leads can be passed through at any desired point without drilling. The extra work involved in building a set screened in this way, as compared with an unscreened one, is very slight indeed.

Before we leave the set for this month there are one or two points of

a practical nature with which we must deal as briefly as possible, in order that the reader may get the set finished and working without waiting for our next issue.

First, as to the coils. You will require two split-primary-type H.F. transformers (standard 6-pin variety) and one split-primary type aerial coil for each wave-band—i.e. one set for the normal 250 to 550-metre wave-band, and another for the long waves. In this connection there are two warnings which must be given, the first being a reminder that the efficiency of a set can readily be spoiled by bad coils, and the use of a reputable make is strongly urged.

The second point is just this: Be very careful never to make the mistake of inadvertently inserting the aerial coil in one of the transformer sockets, for a short of the H.T. battery will result if you do. True, the fuse will blow and prevent any very serious consequences in such an event, but it is annoying to have to stop and replace the bulb when

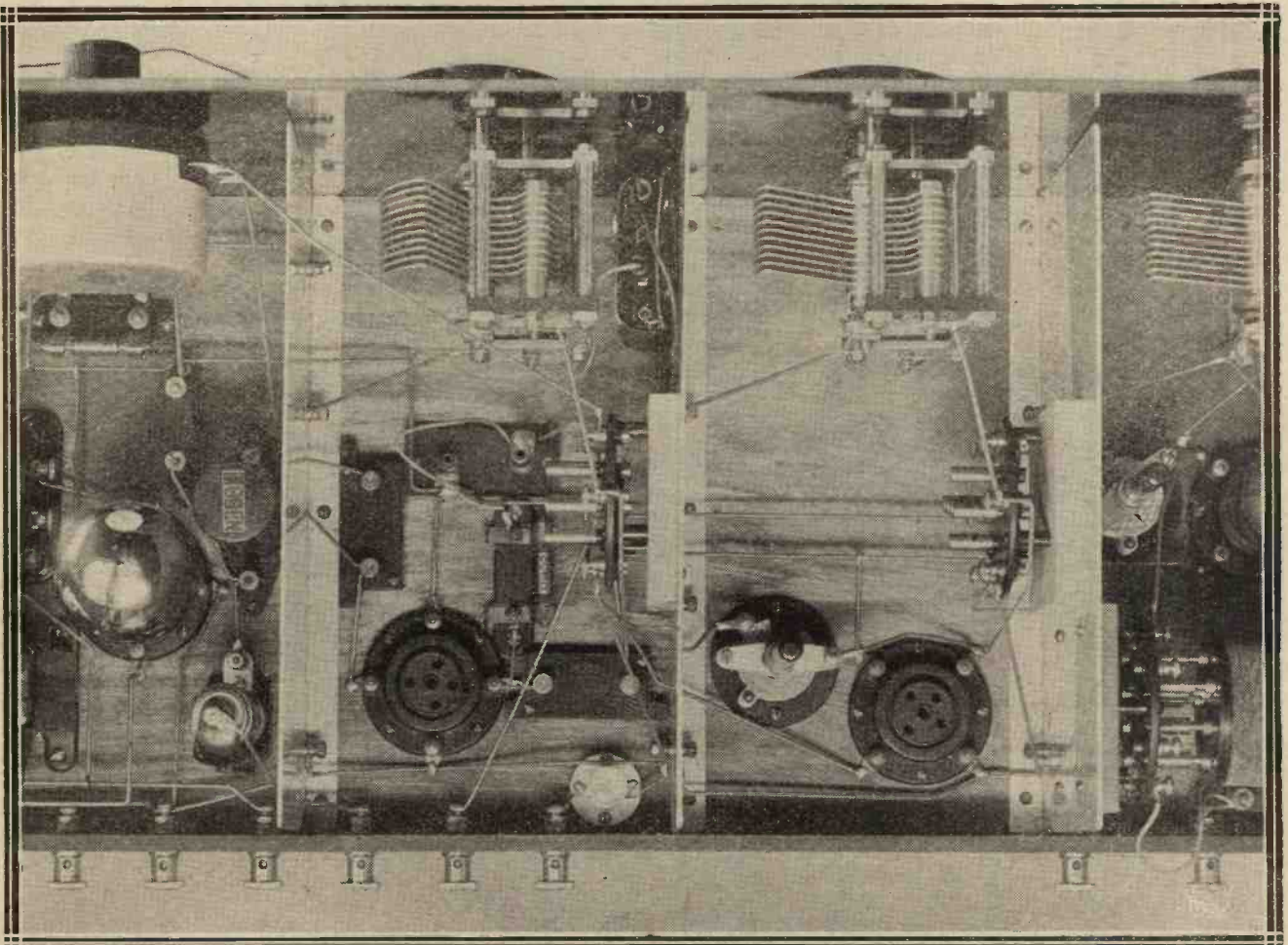

A good copy of the layout and wiring of the H.F. side is strongly to be advised in the case of any multi-valver, and this photo was taken specially to show the important points as clearly as possible.

you are in the act of changing over to catch a particular item.

Many makes of coils have a distinctive marking on the aerial coil to prevent mistakes of this kind (the Lewcos type used in the original has a white spot in a conspicuous place), and with just a little care there is little risk of anything untoward happening.

The H.T. voltages to use with the "Invincible" Five are the normal ones for a set of this type, namely, 80-100 volts on the H.F. valves (H.T.+1), 60-80 on the detector (H.T.+2) (adjust this to get the smoothest reaction) and the maximum available on the L.F. stages (H.T.+3).

A discussion of the valve question you will find elsewhere, but it may be as well to add that a considerable number of different makes and types have been tried in the set, and it has been found that it is not at all critical, working well with any type approximately quite roughly to the figures given elsewhere. By the way, you need not be afraid to use two-volters, since we have found that the modern types work quite well, and give none of the trouble experienced with neutralising in some circuits.

Now for some practical points. First, you should be careful to mount the 6-pin transformer sockets as you see them in the photo elsewhere,

i.e. with the No. 1 socket nearest the top, to obtain the best wiring. The aerial coil holder should be placed so that the main row of sockets runs horizontally, with No. 1 nearest to the "neut" condenser C₅.

The remainder of the constructional work calls for no comment, since it is a straightforward job of panel drilling and component mounting. Wiring should be done with a certain amount of care to ensure a reasonably close copy of the original, and the photos will help you here. All those wires which pass through the screen must, of course, be insulated. There we must leave you for this issue, but further notes will follow next month.

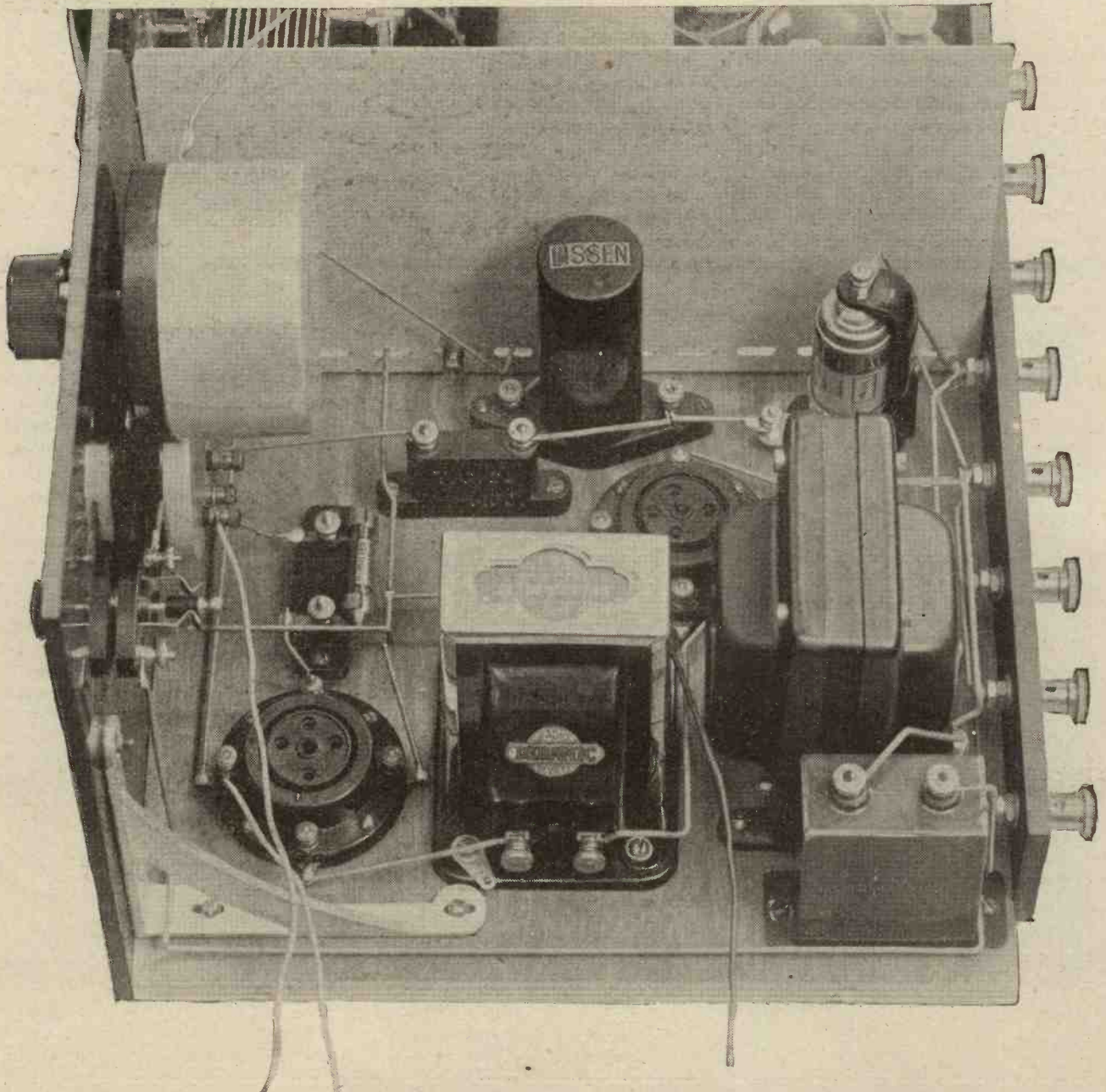

The L.F. end has been laid out to ensure a very high standard of reproduction and immunity from trouble. Note the heavy-duty choke in the output filter and the careful spacing of the important wires.

SIR OLIVER LODGE

A STUDY by
NORMAN EDWARDS



It may be truly said that there is no living scientist better known to the public than Sir Oliver Joseph Lodge. And it may also be said with truth that besides his scientific eminence, there are few men to-day who can command such respect and admiration because of qualities of heart equally as great as those of mind.

Many men have attained to greatness in the world of science, but very few have attained to equal greatness by the practice of those qualities which entitle a man to be termed not only great but lovable.

It is not my intention in this article to write about Lodge the Scientist; the details of his scientific career and especially the many contributions he has made in the course of his pioneer investigations in connection with wireless telegraphy would fill many pages of MODERN WIRELESS; but about Lodge the Man much can be written which should prove of interest, for by his books and by his popular broadcast talks, and equally by his extraordinary personality, he is one of the outstanding figures of the age we live in, and a man who, throughout his long life, has always devoted himself unsparingly and unselfishly to what I can only term the furtherance of the progress of civilisation.

Rapid Progress

To-day, at the age of seventy-seven, Sir Oliver Lodge is still a fine, imposing figure of a man. Well over six feet in height, his upright carriage and noble, intellectual head stamps him out at one glance as no common man.

Indeed, I do not think he has ever been really ill or seriously unfit in his life, and his capacity for work and for the enjoyment of life in the full sense of the word is still that of a vigorous young man in his early thirties. He was born in June, at Penkhull, near Stoke-upon-Trent, in 1851, and at eight years of age went to the Newport Grammar School. At fourteen he went into business to help his father, but his love of science was great, and in the evenings he prepared for the London University Matriculation Examination. Finally, he gave up the idea of going into business and, in 1872, at the age of twenty-one, went to University College, London. His progress and the

growth of his reputation from that date were rapid. He was made a Doctor of Science in 1877, and was made the First Professor of Physics at Liverpool University in 1881.

In 1887 he was elected a Fellow of the Royal Society, and in 1900 the Crown appointed him the First Principal of the University of Birmingham. He was knighted in 1902.

Since his retirement in 1919 he has lived at Lake, a delightful village close to Salisbury Plain.

Supremely Human

It is about this period of his life that I intend writing, and although I am at least fifty years younger than he is and have known him but six years, our acquaintance has ripened into a friendship which has given me, among other things, the opportunity of knowing him well, and gaining

many glimpses of aspects of his character about which, unfortunately, all too little is known by the general public.

Many people have a preconceived idea about scientists, which is usually founded upon ignorance.

They imagine beetle-browed Olympians of intellect, moving aloof from the common herd and always, mentally, on a plane far above the comprehension of laymen. Scientists, of course, are always supposed to be absent-minded; that is, their minds are "absent" in the sense that mundane things occupy no place in their thoughts.

But how that preconceived idea crashes to the ground when you meet Sir Oliver Lodge! The first time

I met him he walked into my office to discuss some business. Scientists are usually supposed to be ignorant of business, but I soon found out that Sir Oliver Lodge has excellent business ideas, and his knowledge of the intricacies of the Income Tax is surprising! And could anything be more mundane than the Income Tax?



A recent picture showing Lady Lodge picking flowers, with Sir Oliver, in the grounds of their beautiful house near Salisbury.

He is extremely fond of the theatre, and one evening we both paid a visit to "St. Joan," in which our mutual friend, Miss Sybil Thorndike, was playing the title rôle. As we had both seen Shaw's masterpiece before, we discussed the play at dinner. I remember we sat at the famous corner table in the Athenæum, and I was prompted to suggest to my host that Joan probably went to the stake in a state of ecstasy, and consequently she may not have felt very much pain.

But Sir Oliver disagreed.

"No," he said. "I don't think she was an ecstatic. She went to the stake with her eyes open." He shuddered, and then smiled whimsically. "I don't think I'd have gone to the stake if I'd been her," he said, as we discussed her famous recantation.

"I'm sure I wouldn't," I said bluntly; and then, curiosity impelling me, I asked: "But imagine yourself in Joan's position to this extent—that if you did not deny your belief in personal immortality, you would go to the stake. Would you recant?"

He thought deeply and then a look of determination passed over his face.

"I'd go to the stake!" he said shortly. And he meant it.

Not Easily Convinced

That is where so many critics of Sir Oliver's known interest in psychic matters make a great mistake. They believe, for example, that "Raymond" was written as the outcome of a great grief, and that personal sorrow has made him susceptible to belief in psychic matters.

But great as his grief was at the tragic termination to his brilliant son's career, no sentiment or personal sorrow could ever lead him into the bypaths of snares and delusions. His long training as a scientific investigator would inevitably prevent him from accepting psychic manifestations unless supported by evidence and by hard facts.

That evidence has been obtained and is still being obtained few intelligent students of the subject will deny.



This charming and informal picture was taken in the drawing-room at Normanton House.

Many cases of psychic phenomena we have discussed at various times and often he would conclude a discussion on some particular case by saying:

"But I don't know about this; it's not a good case, and is second-hand evidence . . ." and so on, and so on.

I remember the first time I paid a visit to Sir Oliver's country home commenting on the fine old church door in the front of the house, and, later, the interest with which I listened to my host as he told me of the curious and, indeed, extraordinary history connected with the door and with the house; and how he and Lady Lodge came to live there.

An Interesting Prediction

I believe this story has been told by Sir Oliver in his latest book, but it will not be out of place to repeat it in brief in this article.* It is, in fact, a most extraordinary



Although now seventy-seven years of age, Sir Oliver is a great believer in an active life, as this characteristic attitude shows.

example of pre-vision, or prediction, which, being completely authenticated, is of considerable importance and interest.

In 1913, Lady Lodge met a lady who was clairvoyant. Lady Lodge made verbatim notes of the medium's remarks at a sitting, and these were copied out by her son, Raymond. This was, of course, before the war. This is exactly what was written:

"A house in the country, a happiness, a stream or river that runs at the bottom of the garden. The house seems long and low-built, straggling; a piece that leads down to water. A happy condition; a happy period. On a height; the garden goes down to water, a feeling of good luck. Old fashioned; a church door. The rooms are old fashioned; no two rooms alike. Low steps, very funny, up a step and down a step. Some rooms long and narrow—all shapes. Something that will be associated with your life. Hall not large, house low, old oak. This house is where you are going to be. Large pictures hanging, old pictures. Wall opposite more like stone. It is in the country and hilly. Long way from the station. A summer house, large, that goes across, inside there is a table and chairs; the front is glass."

As Sir Oliver said when he told me of this incident: "We were all interested at this description of an imaginary home. But a house with a church door and so far from a railway station seemed unlikely features for any house we should take."

But now for the sequel. In 1914, Sir Oliver and Lady Lodge went to Australia for the British Association meeting; war broke out; and in 1915, Raymond was killed.

*"Why I Believe in Personal Immortality," by Sir Oliver Lodge, published by Cassell, 5s. net. See page 81.

Years later, in 1919, on retiring from the Principalship of Birmingham University, Sir Oliver and his wife began looking for a house. Lady Lodge searched everywhere; in fact, she began house-hunting with a vengeance.

About this time a message was obtained through a medium from Raymond. The message was as follows:

"Tell mother to stop house-hunting. I have found one and am only waiting to push it to you."

The End of the Search

Lady Lodge was abroad at the time this message was received, and Sir Oliver was staying with his friends, Lord and Lady Glenconner, at Willsford Manor, eight or nine miles from Salisbury. One afternoon, when walking with Lord Glenconner, they stopped to look in at an old farmhouse in the Avon Valley, which Lord Glenconner had purchased. It had barns and a kitchen garden and was surrounded by a thatched wall, such as one sees in Wiltshire. At the bottom of the garden ran a stream, and Lord Glenconner said he would like to let it if he could find the right sort of people.

The upshot was that Lady Lodge and her daughters saw the house and liked it, and, on an understanding that certain alterations could be made, the Lodges took the house. The roof was lifted and a spacious library built in. Eventually they entered into occupation in 1920.

Later on, looking through some of Raymond's papers, they came across his copied-out record of the imaginary house described to Lady Lodge by the clairvoyant in 1913. It was then noticed how extraordinarily well the description fitted in with their new house, Normanton.

As Sir Oliver explained: "It is a long way from the station—eight or nine miles from Salisbury. The River Avon runs close by, there is oak panelling in the entrance hall, and certainly no two rooms are alike. The dining-room, which used to be the hall, is long and narrow, and some of the old pictures still remain."

There is also a step out of the sitting-room and one along a corridor in most unusual places. Many other features correspond exactly with Raymond's record, but most amazing of all is the fact that the porch, built to protect the entrance, has a real church door studded with bolts and rivets!

As Sir Oliver has remarked: "How to explain the prevision of the clairvoyant, if it was pre-vision, I do not understand; nor can I understand the foreseeing of the church door which, in 1913, was *not fitted to the house*!"

The door, in fact, had for a long time been stored away in a barn on Lady Glenconner's estate, and was not fitted to the porch until just before the Lodges took over the tenancy!

A "Delightful Experience"

It is all very strange. The materialist may talk of coincidence, and, although coincidence has admittedly a long arm, it seems to have been stretched to an extraordinary length if we are to explain this curious story by reference to coincidence. In fact, the more one looks at it the more ridiculous it seems to attempt to explain it as a coincidence; and to attempt to explain it at all is not the intention of the writer. My readers may draw their own conclusions, and if they are any the wiser afterwards they will be very clever people.

To stay at Normanton is a delightful experience. I shall never forget how, on the morning of my first visit, I woke up at about half-past six to find the hot July sun pouring into my bedroom, and how, for once in my life I was impelled to get up early. Glancing out of the

window, who should I see on the lawn smiting most lustily at a dummy golf ball but my host, Sir Oliver Lodge.

Later on that day, after luncheon, he put on a large and comfortable Panama hat, gripped two substantial walking-sticks from a stand, and led the way through the hall out into the kitchen garden and so up the steep road which leads to Salisbury Plain and Stonehenge. Despite the heat, Sir Oliver had invited me for a walk. I had been lounging about in the garden watching the cows contentedly cooling themselves in the stream which flowed nearby, and, frankly, I had agreed to the walk with some misgivings. It was really very hot, and before we had gone half a mile—we were making for Amesbury—I began to wish myself back in that cool garden.

An Informal Evening

But Sir Oliver breasted the steep hill with ease and, swinging his sticks, expatiated on the beauty of the day, upon the rabbits which sometimes scuttled in front of us, and upon the birds which shrilled around our heads as we climbed higher up the hill; and, later, when we espied the majesty of Stonehenge, on the mysterious rites of the Druids and the possible mechanical and engineering methods they employed in raising those huge blocks of stone into upright positions.



Sir Oliver Lodge, F.R.S., talking to the Duchess of York during a recent jubilee at Oxford. Sir Oliver was the inventor of tuning-in electrical circuits, an invention that made selectivity in radio possible.

Perhaps the best time of all when on a visit to Normanton is in the evenings, when he will sometimes pick up a favourite book and read aloud.

There is a great art in reading aloud; beauty of voice and diction are essential; and Sir Oliver Lodge has been blessed with both.

And, later, with one of his favourite cigarettes neatly inserted in its holder, his feet up on a stool, he will discuss the book he has been reading aloud, and those present who do not find it easy to talk eloquently will gradually find themselves joining in the informal debate and speaking with an ease and enthusiasm which, later on, surprises them.

Yes, an evening at Normanton is an experience not to be forgotten; the memory of it is something to treasure; and the thought of a repetition a keen sauce to the palate of anticipation.



WHAT READERS THINK

The "Self-Contained" Portable—"2.35 for Australia"—D.X. Reception, etc.

The "Self-Contained" Portable

SIR,—Reference the "Self-Contained" portable set designed by Mr. J. English, described in your journal of July, 1927, I would like to express my appreciation of this little set.

I had difficulty at the outset, but with a little patience and one or two slight alterations I obtained excellent results from 2 L O and 5 G B and enabled four people to listen-in on 'phones, to the delight and wonder of the listeners, at seven to ten miles from 2 L O.

I omitted the two resistances in the filaments and also spaced the aerial, both of which, in my case, improved reception.

In a second set I made I put in a .0005 variable condenser (Formo) with a .00035 variable (Formo) reaction in place of those in the list of components, and the result was even a louder reception—using Mullard valves, R.C.C. and L.F.

It is an excellent little set for indoor reception, with an accumulator, where loud speaker is not desired.

Yours sincerely,
W. A. M.

Cranbrook Park, Ilford.

"2.35 for Australia"

SIR,—With reference to your August issue of MODERN WIRELESS.

The "2.35 for Australia" is a most marvellous little set.

One morning, between 1 and 2 a.m., American stations were received splendidly by me on an indoor aerial, and there was no need for anyone to miss a word of the programme.

When using larger coils, even on the Daventry 1,600 wave-length, the set works just as well, and takes a loud speaker at good strength. I am using two Mullard 2-volt valves, one is an H.F. and the other L.F., with 60 H.T. on both valves and no grid bias.

Yours faithfully,
P. R. A.

Norfolk.

As regards Mr. Waley's results, I quite agree with Mr. Allen's comments on the subject, but Mr. Allen must not think it impossible to receive U.S.A. stations on the broadcast band, as I have received W G Y and W P G (Atlantic City), several times at L.S. strength.

Yours truly,
A. E. BEAR.

Rotherhithe, S.E.

The "Austral" Three

SIR,—The "Austral" Three S.W. set with a screened-grid valve on the H.F. side is very interesting. It somewhat resembles Roberts' circuit published in the "G. and R. Bulletin" some months ago. I should like to say, however, that if it can only be "operated down to 25 metres" it will not meet the wants of your readers abroad, as 5 S W is our best station, at any rate in these latitudes, transmitting on 24 metres. I understand the screened-grid valve ceases to function efficiently at that frequency and, if so, it should be for you, sir, through your excellent journal, to demonstrate to the valve manufacturers the desirability of further research.

I am, Sir,
Yours truly,
GEORGE BOAG.

Aguilas,
(Murcia), Spain.

[We are publishing a special article on H.F. valves and short-wave work which will be of interest to our correspondent and other enthusiasts.—Ed.]



Members of the 600 City of London Auxiliary Air Force Squadron undergoing radio tuition at one of the aerodromes. The instrument being discussed is the Townsend wave-meter.

SHORT WAVE PATHS

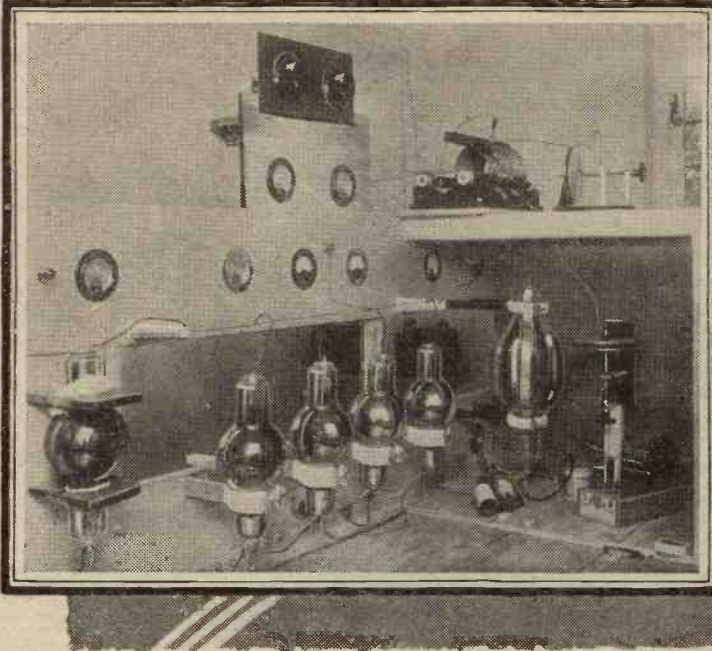

A description of some recent experiments carried out in order to determine the exact paths which short-waves follow.

From a Special Correspondent.

SHORT waves do not travel so directly to their destination as the very long waves of the transatlantic telephone service. The existence of what are now known as skip distances was discovered when short waves were first being experimented with, but there still exists a lack of complete information on the actual path they follow in journeying between two points.

Efforts have recently been made, however, to obtain some of the missing information by determining the direction in which the waves approach the receiving station. Complete information regarding the receiving angle will greatly help the computation of the actual path, it will add to the understanding of factors affecting short-wave transmission, and it will give data of value in designing receiving antennæ.

An Ingenious System

Two receiving antennæ spaced a short distance apart will, in general, receive an incoming wave at slightly different times, depending on the direction of reception. If the output of these receivers is each connected to a pair of deflection electrodes of a cathode-ray oscillograph, the pattern traced on the face of the tube by the stream

of electrons will be different for each direction of the incoming wave.

In recent experiments made at the Bell Telephone Laboratories, in America, a local oscillator was added to obtain a beat-note of 500 cycles with the incoming waves. This is necessary so that the signal may be amplified to operate the cathode-ray oscillograph.

The method of determining the direction of reception may be readily understood by reference to Fig. 1. The two receivers R_1 and R_2 are at right angles to the direction of the transmitter, whereas the local oscillator is in line with it.

How Direction Affects Oscillograph

If the signal is received in the vertical plane passing through the transmitting station, the local oscillator, and the centre of a line joining R_1 and R_2 , there will be no phase difference between the received beat signal at R_1 and that at R_2 , and the figure shown on the oscillograph will be a straight line as given at "A" in Fig. 1B. As the receiving angle increases through positions indicated as "B", "C", "D", etc., of Fig. 1A, the phase difference between the received signal at R_1 and R_2 increases, and the figures on the oscillograph change as shown in Fig. 1B.

If, on the other hand, two receivers R_2 and R_3 are placed in line with the transmitter and the local oscillator, as shown in Fig. 2A, a phase difference between them will also exist, depending on the direction from which the received signal arrives. In the arrangement of receivers of Fig. 1A, only the horizontal plane component of the reception angle will produce a phase difference between the two receivers.

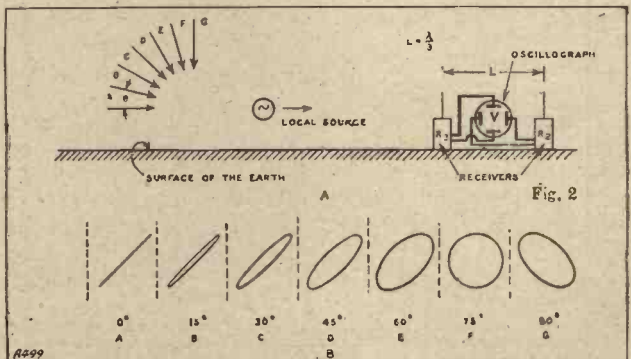
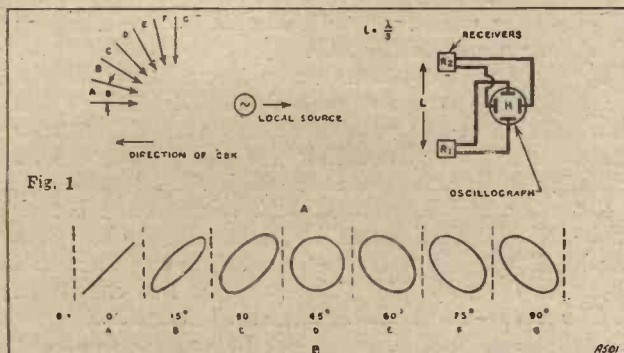

An arrangement of receivers and local oscillators for determining horizontal-plane angle of reception (Fig. 1), and (Fig. 2), the arrangement for detecting vertical-plane angles.

In the arrangement of Fig. 2A, however, either a horizontal or vertical component of the angle of reception will produce a phase difference. If only angles in the horizontal plane are to be determined, the set-up of Fig. 1 will give the data. To determine angles in a vertical plane, both arrangements of receivers must be used together. Arrangement 2 is not sufficient in itself, as this arrangement is responsive to a change of angle in either the vertical or horizontal plane.

By using arrangements 1 and 2 together, however, with receiver R_2 common to both, it is possible to determine both the horizontal and vertical components of the angle of reception. Extensive observations have been made, using the British beam station, G K B, as the transmitter, and much interesting data has been collected.

It has been found that when daylight exists over the entire transmission path, the horizontal angle of reception is small; the figure on the oscillograph is a straight line or a very thin ellipse. When the sunset or sunrise shadow-wall lies across the path of transmission, however, the angles increase at times to as much as 30 degrees, which seems to indicate a refraction of the short waves along the shadow-wall.

How Fading is Caused

The vertical plane component of the reception angles varies from time to time and occasionally reaches as high as 60 degrees. In the mornings the figures would indicate small angles. Towards noon they would change rapidly, showing much variation in height of the reflecting layer, and this variation would continue on into the afternoon.

Occasionally large changes were found in the mornings also, which indicated an extreme variability. So variable is this vertical angle that any regular laws of variation of height could be determined only after a very long series of observations.

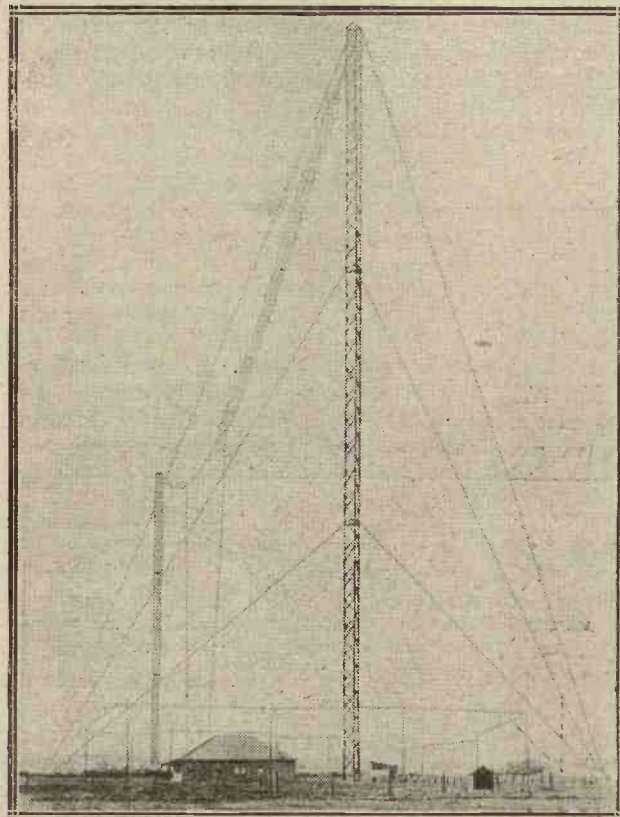

The four-wire cage aerial of 3LO, Australia, a station which is hunted by all short-wave fans. Also can be seen in this photo the counterpoise around the base of the aerial.

In watching the patterns traced by the two cathode-ray oscillographs it was noticed that they changed not only from straight lines to ellipses but in size as well. As there was no change in strength of the local oscillator, this could mean only a fading of the received signal.

In many cases there seemed to be a cycle from large to small figures taking from one to five seconds. The small figures seemed at first very irregular in shape, but careful observation proved that usually they consisted of a small line or ellipse rotating rapidly one way or the other.

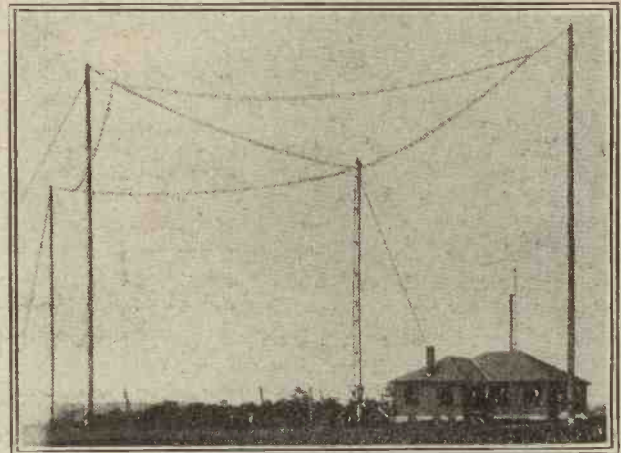

A view of the radio experimental station at East Pittsburgh. Known to most short-wave enthusiasts, its call-sign is K D K A, and it is situated on the second highest point in Allegheny County. The short-wave aerial is a copper tube 60 ft. long.

These rotating figures, and the constant change in the direction of reception, suggested that fading is caused by wave interference. Two waves travelling by slightly different paths and so arriving at slightly different angles would suffer interference and produce a continually changing series of figures on the oscillograph. Although fading of short waves may be caused also by rapid changes in absorption, it is believed that wave interference is by far the more common cause of this phenomenon.

THAT THRESHOLD HOWL

Of all the various "cures" for that disaster of disasters in short-wave work, threshold howl, perhaps the most generally successful is the fitting of a potentiometer to control the bias on the grid of the detector valve.

It usually happens that if the grid leak is taken to positive the howl is bad, if taken to negative the howl is done away with, reaction is smooth, but signals drop about 10 per cent in strength.

By using the potentiometer an intermediate position can be obtained and a compromise effected so that you can get as near the positive end as is consistent with smooth reaction and sensitivity, as well as allowing the operation to be quite free from the howling trouble.

Alteration of grid leaks, of L.F. transformers, output chokes (H.F. in the 'phone leads, or filter choke of the usual L.F. type), by-pass condensers here and there, and alteration of spacing all assist at times, but one of the best methods—not infallible, but with perhaps a majority of "successes" to its credit—is the old potentiometer method, and if you are troubled by threshold howl you should certainly try it.



"Woman never reveals her secret."—KANT.

A Special Article by A. CORBETT-SMITH.

ALL the world—or, at least, that section of it which reads books—has been reading the autobiography of Isadora Duncan. And, for once, "all the world" is justified in its choice. For, without exception, it is the most genuine and sincere story of her own life which a woman has ever published.

Before I had half finished the volume I found myself exclaiming, "Ah! if only this woman had directed a radio station of her own, what a revelation of woman's nature she would have given to the world. What a revolution in thought and action she might have effected!"

A Monument to Woman

For the world of men knows nothing of woman's secret. Indeed, perhaps it is as well for them to remain in ignorance. It is by no means rare for a woman to live an absolutely natural life, according to her innermost convictions. But it is not only most rare, but quite unique, that a woman should express that natural life in words—that she should describe in intimate detail the adventures of her soul.

Isadora Duncan lived her natural life without restriction; she expressed that life and the beauties of nature and art in her own dancing; and, lastly, in the legacy of this book she has raised a monument to the Eternal Woman "more lasting than brass."



Mr. A. Corbett-Smith.

Why is it that women play so small a part in radio work? And why is it that, as listeners, they take comparatively little interest in the radio programmes? In that revelation of Isadora Duncan we have, I think, something of the answer.

Oh, yes! I know that my long-suffering Editor will at once receive indignant letters of protest from "A Lonely Wife" and "A Grateful Invalid." Written from the Hebrides and the Orkneys and the Cumberland fells, no less than from the solitude of a flat in Pimlico or Putney, the letters will pour in to assert stoutly that "we would not be without wireless for worlds; it is the one thing which links us with civilisation."

"Radio Belongs to Men"

I remain unmoved and unshaken. I know those letters from listeners. I have received a few thousand of them in my time. Radio, as a recreation or hobby, belongs to men and not to women. It is men who form the real listening public. Women use it to pass the time, to fill in gaps and to help with the ironing.

A radio item, even more than a good gramophone record, demands concentration in the listener. Women do not concentrate, except in the things which really matter to them—such as motherhood (sometimes), their men folk, dress, and care of the person. That is why you never meet

a woman who can make a good pot of tea. She cannot be bothered with all the detail of it. (Have you ever known a woman bother to warm the cups?)

A woman could never be content with the cold, mechanised speech and song of the average radio item emerging from a camouflaged trumpet. Being herself Life incarnate, the eternal spirit, instrument and purpose of Life, it is Life itself with all its glowing pageantry and colour which she demands in her progress through the world.

Woman packs the cinemas, and, in the theatre, outnumbered the men by ten to one. These media give her life and movement. She pours out hysterical adulation upon a Tallulah Bankhead because that young woman expresses in her own person the spirit of young, modern womanhood. She dotes ardently upon the screen hero of any sex appeal because she sees in him a vision of her own complement, designed to the fulfilment of her eternal destiny.

Radio Almost Entirely Impersonal

But in radio there is nothing of this. Radio is the very negation of all action. It is essentially static. Woman is herself a negative instrument. She demands the positive for her complement. Only in its dance music is radio really possible to her. For here it invites to action.

Radio entertainment, as we know it in England, is almost entirely impersonal. In other words, the projection of any strong, individual personality is very rare. Until quite recently such a factor in a speaker has been actually discouraged by the authorities.

Here, again, we have the very antithesis of woman. For woman, unlike man, oozes personality at every pore. Thus, since radio, both in manner and in matter, is so patently lacking in personality and vivid human interest, it is only natural that woman should find in it little to interest her, and still less to prompt her towards regular and serious consideration of it as an important factor in the daily life of our modern and active world.

If, then, we are able to find at least some foundation of truth in these suggestions we shall, I think, have discovered one part of the answer to the other question.



The late Isadora Duncan, whose autobiography all the world has been reading. "It is the most genuine and sincere story of her own life which a woman has ever published" says the author of the accompanying article.

For it is, surely, a somewhat remarkable fact that, with the large excess of women over men in the population, with woman's much-advertised claims to full equality, and with her vast amount of talking to a minimum of action, she should seem to hold so aloof from urging her claims and arguments by radio and, indeed, that she should refrain from demanding a more active share in its direction.

How are we to account for this? A new young woman dramatist, whose first play has been produced with success, has been protesting that women and the "woman's

point of view" (whatever that may be) are rigorously suppressed by men who largely control the theatres and other media of publicity.

The argument does not bear a moment's serious examination. For no one in these days would dream of trying to prevent woman from expressing any decent views that



A portrait of Dame Ethel Smyth, whose mental vitality is so keen, and whose prowess in musical composition is so great that Mr. Corbett Smith refers to her as a "rule-supporting exception."

she pleases. And, further, women now have it fully in their power to create and direct theatres, cinemas, newspapers and publishing houses, to the top of their bent.

If, then, there were the least overt demand upon the part of women, either from listeners or from those already engaged in public work, or a fully responsible share in radio direction, and so more frequent appearances at the microphone, it would be impossible for the B.B.C. to deny them.

The fact that this claim is not made becomes still more significant when we recall that the only woman upon the Board of Directors is by far the most capable member of that Board—excepting, of course, the executive chief. We must assume that this lady would unflinchingly support the demands of her own sex. I also recall that the most attractive and compelling programme announcer that I have heard in British radio was a woman—Miss Cathleen Nesbit. But as announcer only, be it noted.

"Woman Never Reveals Her Secret"

Why is woman so indifferent to her radio opportunities? Why, as Lord Birkenhead has lately reminded us, is woman so casual and negligible a figure in politics? Why, with all her chances, is she of so little account in the Law Courts, in painting, in sculpture, in literature, in music, beside the leaders and often the giants of the other sex?

Is it because woman lacks the intense mental energy and drive which is ever the distinguishing mark of genius in man, however frail in physique that man may be? (We note the rule-supporting exception in the strong mental vitality of Dame Ethel Smyth.) That may form an excuse for failure in some directions, but hardly in radio.

No, to my mind, the real, ultimate reason lies very much deeper. The autobiography of Isadora Duncan gives us the clue. "Woman never reveals her secret," Immanuel Kant has declared. Has any man yet penetrated that secret? For woman steadfastly refuses to express in words her real nature.

And that is why I should have wished to see Isadora Duncan in command of her own radio station. For I believe that she alone would have revealed something, at least, of that secret, under such exceptional conditions of intimacy as radio provides.

(Copyright in the U.S.A.)

VOLTS on the GRID

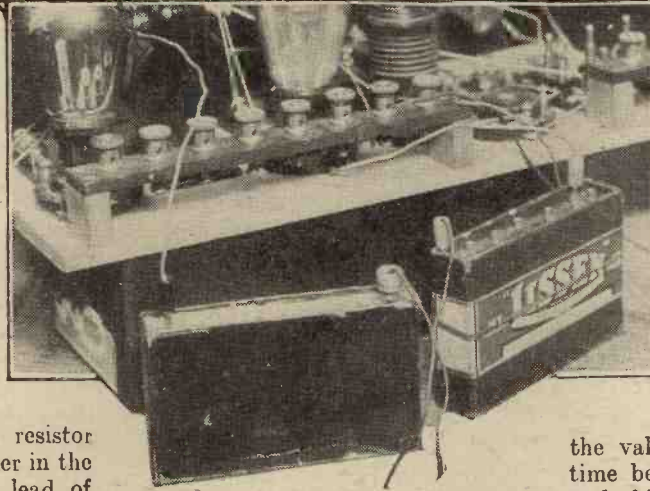

The various ways in which a filament rheostat or resistor and a grid leak can be connected offer a very confusing series of alternatives.

In this article the subject of grid-filament connections is dealt with in a practical and interesting manner.

By D. GLOVER.

A FILAMENT rheostat or resistor can be connected either in the positive or negative lead of the L.T. battery circuit and a grid leak can be connected to the L.T. battery negative or positive direct or to the filament side of the filament resistance. A very confusing series of alternatives to the average constructor no doubt, and it is probable that he has the idea that the effect is the same in every case.

taken direct the grid leak. The only alteration in Fig. 1A is that the filament rheostat is transferred to the positive filament lead. Fig. 2 shows the rheostat in a similar position to Fig. 1A, but the grid leak is now joined to the positive terminal of the battery.

the valve can be regarded, for the time being, as a resistance element, and this is shown as R_1 . In series with this is joined the rheostat, another simple resistance (R_2). Both resistances, joined in series, are connected across the filament battery.

The grid (through the grid leak, which can be ignored) is joined to point A. Supposing the battery is of a 4-volt type, then it is obvious that point A (the grid) will be 4 volts

Negative Bias

A distinct variation is shown in Fig. 2A, where the grid is joined to the rheostat. Further variations are possible, but these examples will suffice both to illustrate the apparent complexity of the problem and, eventually, how logically they can be regarded as a sequence of effects.

When we talk about the grid of the valve being given a negative bias we mean that it has been made negative in relation to the filament. But a point you should carefully note is that we cannot give the grid a definite value of bias to the whole of the filament. If in general terms the grid is biased negatively, it will be more (or less) negative in

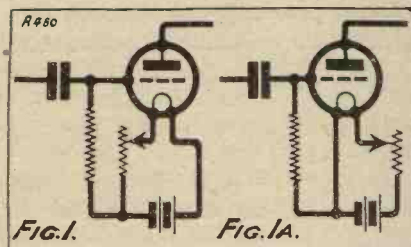
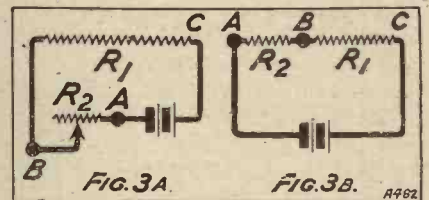

This is not so, and it may happen that in certain circumstances just the one particular arrangement is the only one suitable. The variations referred to are very easily understood if one takes the trouble to analyse them carefully.

Important Effects

They are all concerned with the grid of the valve; by varying the grid connection and the position of the filament rheostat in the manner indicated, one varies the initial voltage on the grid. This will, in some conditions, very materially affect the operation of the valve.

I have drawn four small diagrams illustrating some of the essential connections that might be encountered in a detector circuit or first L.F. stage (resistance-capacity coupled).

In Fig. 1 the filament rheostat is in the negative lead of the L.T. battery, and to the negative terminal of this is

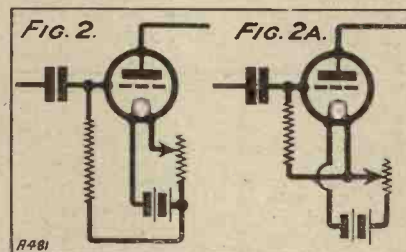

relation to one end of filament than the other. The filament will have a potential slope.

Let us redraw the filament circuit of Fig. 1 as one complete electrical circuit (Fig. 3A). The filament of

minus to one end of the filament; that connected directly to the positive terminal of the battery.

But it won't be 4 volts negative relatively to the other end of the filament, the exact potential difference between these two points is going to depend upon the resistance of the filament itself and the resistance of the rheostat R_2 . Now, perhaps you are beginning to see the importance of the rheostat's position.

Analysing the Circuits

In anticipation of the possibility that I have not quite made my first point clear I am going to redraw Fig. 1 yet again. This time there is no real alteration, Fig. 3A is merely straightened out. And here in Fig. 3 the two resistances R_2 and R_1 (rheostat and filament) are shown similarly connected electrically but are drawn in line.

Carefully note that between A and B the resistance sign indicates the

rheostat. At B the filament of the valve starts, and at C it ends. The whole forms as simple an electrical circuit as could be.

The potential difference between A and C will be the whole voltage of the battery (I am ignoring internal resistances of battery and so on as they do not affect the main problem). The difference of potential between any other two points will depend upon the resistance between them. If the resistance of R_2 were 20 ohms, and that of R_1 60 ohms, the potential difference between points B and C would be 3 volts. B would be 3 volts negative to C, and C 3 volts positive to B.

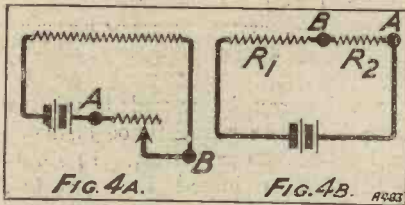

You see, the potential difference will be the exact proportion of the total voltage that the resistance between the two points is of the total resistance. In our present case the resistance between B and C is 60 ohms, which is exactly three-quarters of the total 80 ohms in the circuit. And three-quarters of 4 (the voltage across the terminals of the battery) is 3. Quite simple, isn't it?

Expressed as a simple formula :

$$PD = \frac{R}{R_1} \times V,$$

where R = resistance between any two points in the circuit.

R_1 = total resistance in circuit.

V = voltage of battery.

Or, again, $PD : V = R : R_1$.

A "Potential Slope"

In Fig. 5 I show another way of looking at this same point. Here you have the actual potential slope. Strike up from any two points of the resistance and you can see almost at a glance the difference of potential between them.

Perhaps you are coming to the conclusion that all this is a mere juggling with figures and of no real practical interest or value. But this is far from being so. It often happens that a resistance-capacity-coupled valve will operate efficiently with no other grid bias than that one can arrange for it to be given by the L.T. battery, thus dispensing with the need for a grid-bias-battery tapping.

Fig. 1 shows you the way to give the grid the greatest possible negative bias within these limited means. But

in instances this might be too much. Less would be given by joining the grid leak to the other side of the rheostat. This point is B in Fig. 3A and Fig. 3B, and is the point we have discussed above.

Obviously point B, while being 3 volts negative to the one end of the filament, will not be so to the other end, for the other end will be point B! Therefore, the grid will have the same initial bias as this end of the filament, the potential difference or bias increasing towards the maximum 3 at the other end.

Some Complications

With the grid joined to the negative terminal of the battery direct, the "grid bias" will be from 1 volt to the full 4 volts (the P.D. between A and B is 1 volt, assuming R_2 has a resistance of 20 ohms and R_1 60 ohms).

But this "slope" is not so relevant as, for simple explanatory purposes, it should be, because it is a fact that in most ordinary valves the extreme ends of the filament do no work. The reason for this is that there is a dissipation of heat through the filament supports with consequent cooling effects.

There are other more complicated events in addition which make it impossible to adhere strictly to simple

The purpose of a grid-bias battery is to adjust the initial potential of the grid of the valve.



figures. However, for practical purposes one can think in terms of averages.

Now in some detector circuits you will see that the grid of the valve is

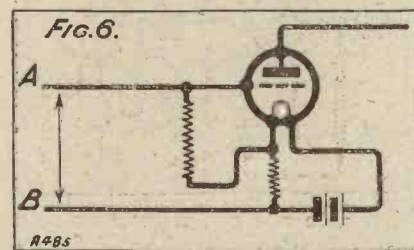

joined (through the grid leak) directly to the positive terminal of the L.T. battery (Fig. 2). This gives the grid

the greatest possible positive bias. If the connections were made to the other side of the rheostat (Fig. 2A) (the same thing being to take the grid leak direct to the filament terminal of the valve holder) somewhat less positive bias would be given the grid. The amount in this case depending upon the resistances of R_1 and R_2 and the voltage of the filament battery. (See also Figs. 4A and B.)

The resistance present in some rheostat adjustments may be only 2 or 3 ohms and the resistance of the valve 80 or so ohms. In this case the difference between the two positions will be for practical purposes of little moment.

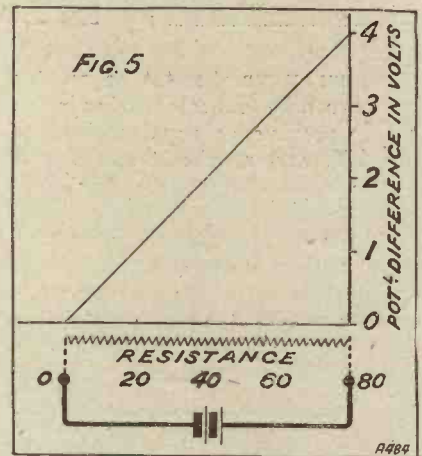

"Quite Another Matter"

The voltage across the input circuit of the valve is quite another matter. If in Fig. 6 the grid leak were taken direct to the negative terminal of the battery, the potential difference across A and B would be nil. By joining the grid leak as shown, A actually becomes positive in relation to B. Not negative, please note.

But what of the other end of the filament? The input is not only on to the one end of the grid and the functioning of the valve does not depend upon the operations of one end of the filament. As I have already said, it is highly probable that neither of the extreme ends "works" at all.

It will give the interested reader some absorbing food for thought if he will refer to some of the standard circuit diagrams and endeavour to ascertain fairly closely the relation between "grid bias" and the differences of potentials between the filaments and grids. Perhaps the only effect of this article will be that he will find himself thoroughly confused. But at the worst I can only hope that out of the confusion one or two useful facts will emerge.



One of the sets which has created the greatest interest among constructors is undoubtedly the "Master Three." This famous set has recently been revised and improved by the inclusion of an ingenious wave-change switching scheme, and readers of "Modern Wireless" will welcome this special article on the new "Master Three" Star model.

By THE MULLARD TECHNICAL STAFF.

THE popularity of the three-valve receiver is as great as ever it was, if one is able to judge from the interest displayed in this type of receiver at the recent exhibition held at Olympia. There we saw representative models of every type of receiver, from the modest crystal set up to the ambitious six- and seven-valve receiver. Each has its separate and distinctive merits which attract radio enthusiasts in varying numbers according to the degree of popularity. It would appear, however, that the three-valve receiver embodies the greatest number of distinctions, and in view of this fact continues to attract more followers than any other type of set.

Popular Design

In the design of a receiver which is intended to appeal to the many, it is apparent that its popularity will depend upon the ability of the designer to satisfy as many varying tastes as is within the capabilities of the number of valves it is proposed to employ. It is true to say that a designer may set out to satisfy the desire of radio enthusiasts for distant reception in such a way that other things—quality, by way of example—are sacrificed entirely. Again, a designer of a receiver may decide to achieve a

very high degree of quality, in order to attain which he may completely disregard selectivity. Speaking for ourselves, and most certainly for the majority of our readers, the design of receivers along these lines no longer finds us attracted to them.

We take this view not for the reason of imposing difficult tasks upon designers, but rather that modern radio apparatus entitles us to expect a high all-round performance. In days gone by it was held that quality

was not compatible with sensitivity. One heard speak of the long-distance receiver being unsuitable for the good reception of the local station. Then the radio enthusiast operated two receivers—one to satisfy his desire for distant work and the other to employ for the local station. Such a practice was probably imperative in those past days, when the efficiency of apparatus was below the standard of the present time.

An Essential Feature

Under these conditions radio had a very limited appeal. While the taste of thousands may be served by a receiver of limited power, there are many more thousands who find their greatest degree of pleasure only satisfied by the possession of one receiver which enjoys the merit of being universal, in that it provides the means to listen to distant stations at the same standard of quality as the local.

That the popularity of a receiver is dependent upon this one essentiality will be admitted by all. It would be impracticable usefully to employ two receivers in any place bar the wireless den. If a radio set holds any power to entertain, it must be capable of serving us with as many of the pleasures inherent to radio as is

THE FIRST STEP



Bringing home the set of parts.

WHAT THE PARCEL CONTAINS

- 1 Cabinet to dimensions (Lock).
- 1 Baseboard.
- 1 Aluminium panel, 18 in. x 7 in. (Colvern).
- 3 Receiving valves (to specification) (Mullard).
- 3 Valve holders, new type (Lotus).
- 1 Combined wave-coil (Colvern).
- 1 Permacore transformer (Mullard).
- 1 Low-frequency transformer (Type L.F.A.) (Climax).
- 1 High-frequency choke (Climax).
- 1 Battery switch (Benjamin).
- 2 Log variable tuning condensers (.0005 mfd., .00035 mfd.) (J.B.).
- 2 Slow-motion dials (Sovereign).
- 1 Combined condenser and leak holder, complete with condenser, .0003 mfd., and leak 2 megohms (Mullard).
- 1 Fixed condenser, .0001 mfd. (Mullard).
- 8 Battery plugs, 4 red, 4 black (Lisenin).
- 1 Pair of panel brackets (Burne-Jones).
- 2 Terminal strips (2½ in. x 2 in. x ¼ in.).
- 2 Spade connectors, 1 red, 1 black (Lisenin).
- 4 Terminals, A., E., L.S. —, L.S. + (Belling-Lee).
- Low-tension battery (voltage determined by the classification of the valves used) (Exide).
- 1 High-tension battery, 108 volts (super-capacity type, if super-power valve for V₃) (Siemens).
- 1 9-volt grid-bias battery (2 if super-power valve for V₃) (Siemens).
- 1 Packet of connecting links (Junit).
- Quantity of twin flex.
- 100-ft. aerial wire.
- 4 Aerial insulators.
- 1 Earth tube (Climax).

possible within the efficiency of the number of valves chosen.

Apart from this aspect of the situation, not all of us are able to claim a large credit balance at the bank. The purchase of the necessary parts for two receivers would be beyond the means of most. Radio in such circumstances would become very expensive and as such would be limited to the wealthy few, rather than extended to the millions. Therefore, good design aims at the production of an all-round performance with an economical number of valves. Here we have in essence the intention of the designer of the new "Master Three."

Keeping Down Cost

There are many good reasons for the adoption of three valves. Primarily, the number of valves in a receiver governs the overall cost of the complete outfit. With each valve it is necessary to use certain apparatus



All the tools required—just a screwdriver, bradawl, pliers and penknife.

and, in the main, every additional valve adds two or three pounds to the cost of the set. This is a very important point and cannot be overlooked either by the designer or the builder.

It is approved radio practice to-day to standardise on two stages of low-frequency amplification when loud-speaker reception is required. Latterly, as most readers know, a special low-frequency amplifying valve has been introduced which enables loud-speaker reception to be obtained with only one stage of low-frequency amplification, but where the more familiar three-electrode L.F. valve is employed, good loud-speaker results imply two stages of L.F.

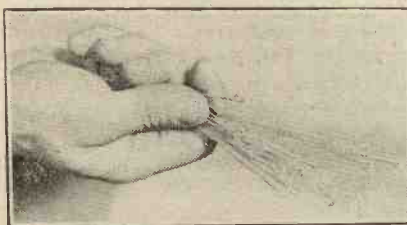

The connecting wires are ready looped at the ends.

As headphone reception belongs to the past, good design insists upon two L.F. valves with some room for choice as to the number of additional valves. Prior to last season there was a definite leaning towards at least one stage of high-frequency amplification. Most of the popular set designs then incorporated H.F. stages—many only one H.F. stage, several two, and a few up to three. In the last group high initial and high running costs considerably limited the popularity of this ambitious class of set. Even in the case of two H.F. receivers, the expense involved in the purchase of the parts placed the ownership of such receivers outside the ability of all except those with a spare twenty-five or thirty pounds.

The advantages of high-frequency amplification are more to be gained

by the use of one stage than two or three stages, and it is usually experienced by set designers that, whereas one stage alone may give an overall amplification of thirty or thirty-five, it is more difficult in a two-stage high-frequency amplifier to gain an overall amplification of thirty or thirty-five for each stage. Usually, it is found that additional H.F. stages in front of a one H.F. receiver prove very disappointing, and for reasons not easily found do not increase the power of the receiver proportionately.

In the main, one could say that the cost of the additional stages hardly justifies itself as compared with the expense of one high-frequency stage, bearing in mind the relative performances. Several experimenters have worked hard on this problem; they are still carrying out extensive experiments proportionately to increase the performance of two or more H.F. receivers commensurate with the increase of the number of H.F. valves.

The Best System

With these thoughts in mind it is not surprising that where H.F. became necessary for one reason or another, general opinion went in favour of the one stage rather than two or three.

That a measure of popularity was registered for this arrangement came after a previous season or two of favour for a three-valve arrangement. It was found that a set embodying a detector valve and two stages of low-frequency amplification was very satisfactory from many points of view. Despite the fact that a detector valve responds only to signals above a certain strength, it is remarkable what feats a simple detector valve was able to perform even in those days when radio receiving valves were far below

EIGHT O'CLOCK



All ready for the word "Go."

their present high standard of efficiency. One is able to recall, as though it were only yesterday, the tremendous run on the Reinartz type of reacting detector and two L.F. receiver. It gave us experience. It

taught us what the simple set could do. It showed that there were latent powers in the simple detector.

With the valve as we knew it then it was possible to design a receiver which was sensitive to transmissions emanating from distant stations, and at the same time offer a large signal energy at the output of the second L.F. valve. It was only natural that the greatly improved valve now available should bring the three-valve set once more into popularity.

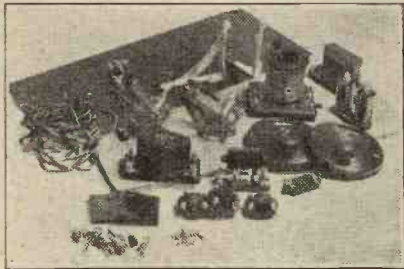

The components laid out ready for use.

It was last season that set designers returned to it. The Mullard Company issued the "Master Three." Not only did it cause the more expert radio enthusiast to forget his high-frequency receivers, but it was also the means of bringing many thousands of newcomers into radio.

This particular receiver was highly popular last season. We understand from many quarters that it was built by the experienced to a no lesser degree than the inexperienced. That the radio enthusiast with a long experience of set building to his credit is attracted by the merits of any one particular receiver speaks highly of that set. It implies, on the one hand, an outstanding and an apparent efficiency—and, what is equally important, performance at reasonable cost on the other.

Question of Reliability

In addition to these points, it should be remembered that the popularity of this receiver increased as its inherent reliability became more self-evident. Should we not assess the merit of a radio receiver as much on account of its reliability as its initial efficiency?

Thus we touch upon an interesting aspect of the popularity of any one particular receiver. It seems that reliability, or, in other words, long service without trouble, is become an essential factor in the design of a radio receiver. In the early days of broadcasting, when the pleasures of radio were confined to the enthusiast able to locate fault and breakdown without guidance, it really mattered

little whether thought was directed to this point or not. But now that radio is more the pleasure of the non-technical than the technical, the efficiency of a receiver is bound up very closely with its ability to operate day in and day out without fault and breakdown.

It is true to say that the more complicated the design of a receiver the greater the risk of breakdown, and the greater the difficulty created in the location of breakdown.

Extreme Simplicity

There is everything in favour of a simple design therefore. Simplicity enables the designer to produce a receiver with which breakdown will not be associated. It is a great point. Let it be said that even ultra-efficiency in a radio set is not to be preferred if it is at the expense of reliability.

In the Mullard "Master Three," this extreme simplicity introduces success as well. So many excellent set designs, by virtue possibly of complication, are not always within the skill of all builders. One hears of various troubles which arise when the receiver is duplicated by the home constructor. Not that there was any fundamental fault with the original design, but that individual components have varying characteristics to affect the performance of the receiver into which they are incorporated. This is often the case, and being of this nature it is very difficult to trace where a receiver fails to come up to the standard of performance exhibited by the original.

*

This photograph shows the ingenious switching which is incorporated in the base of the double coil.

This enables a single movement to change the wave-band from the lower to the higher and vice versa.

*

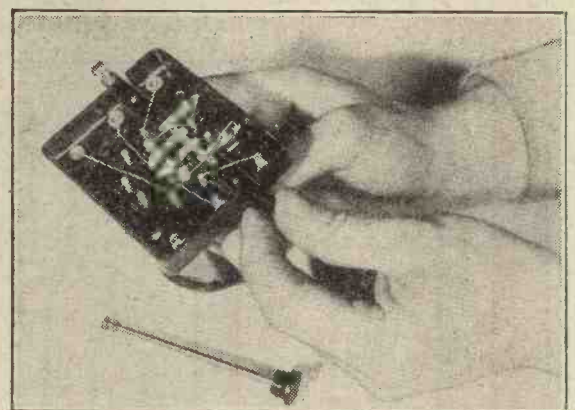

It would be clear, after a moment's thought, to appreciate the necessity always to embody efficient components in a set. The designer aims at maximum signal energy consistent with the number of valves and directs his choice of components accordingly; but, at the same time, bears in mind that his choice will be duplicated by many thousands. Is

he not, therefore, compelled to schedule such parts as bear the name of reputable manufacturers?

RECOMMENDED MULLARD P.M. VALVES.

With a 2-volt low-tension battery :

- V₁. (Detector) Mullard P.M.1 H.F. (high-frequency valve).
- V₂. (First L.F.) Mullard P.M.1 L.F. (L.F. valve).
- V₃. (Second L.F.) Mullard P.M.2 (power valve).

With a 4-volt low-tension battery :

- V₁. (Detector) Mullard P.M.3 (general-purpose valve).
- V₂. (First L.F.) Mullard P.M.3 (G.P. valve).
- V₃. (Second L.F.) Mullard P.M.4 (power valve).

With a 6-volt low-tension battery :

- V₁. (Detector) Mullard P.M.5X (general-purpose valve).
- V₂. (First L.F.) Mullard P.M.5X (general-purpose valve).
- V₃. (Second L.F.) Mullard P.M.6 (power valve).

Home constructors cannot appreciate this point too much. The well-designed receiver embodies components in the manufacture of which a standard efficiency is maintained. An inconsistent performance is a two-edged sword. Should the designer be fortunate in building the original receiver with "peak" efficient components, followers of his receiver will not be able to duplicate his results; while, if he be unfortunate to embody just averagely efficient parts, builders may purchase more efficient parts with the effect that the increased efficiency in their instance may introduce instability.

titles, loops and blobs—all so bewildering to the uninitiated. Small wonder that a simple set appeals to the newcomer.

Apart from every other concomitant of simplicity he is at least able to read sense into the numerous white lines. The new "Master Three" limits rigid connections to twenty-one wires only. Moreover, it is possible to procure these rigid connections already cut to the correct length and eyeletted. We illustrate the tools with which builders of this receiver should be equipped. Observe the absence of the formidable soldering iron. The specified components are fitted with terminals.

It is also interesting to record that intending builders of the new "Master Three," particularly those who have never before assembled a radio set, are further assisted by a special baseboard which may be obtained for this receiver.

Importance of Layout

Most will realise the importance of adhering to the layout of the original receiver. The object of a blue print over and above that of giving wiring details is to give the exact position of each component on the baseboard and panel. It is by no means an easy affair to lay out correctly the various components so that wiring is kept as short as possible, easily accomplished and interaction between adjacent parts and connections avoided. A careful designer will spend as much as one whole evening on the layout of a receiver. He may, during the process of wiring, see where the layout might be improved. All the past practical

experience of the designer, as well as his experience on the actual receiver in question, is reduced to the plan view of the set as it is expressed by the blue print. To suggest that the blue print saves the time and trouble of the home constructor would be to state something which is very obvious. As helpful as it is, the blue print has its characteristic problems, so for the assistance of builders of the new "Master Three" a special baseboard has been prepared. This, by means of a special printing process, is engraved with every detail of the baseboard layout contained in the blue print itself.

Absolutely "Foolproof"

Thus one is saved the necessity for taking any of the measurements between component parts, nor need the plan of assembly be consulted during the laying out of or the wiring up of the baseboard components. Not only is much time and trouble saved, but one also has the knowledge that the juxtaposition of parts follows that of the original receiver precisely in every respect. In addition to any other reason which dictates the adherence to the specified components, here we have at least one which must not be passed by, if the construction of the receiver is to be accomplished with as much ease, simplicity and rapidity as the designer intended. The components are screwed into position exactly in register with the printed outline on the baseboard.

By arrangement with the makers of the specified panel, this may be obtained ready drilled correctly to carry the two variable condensers,

the slow-motion dials, the battery on-and-off switch and the aperture through which the switch arm operating the combined wave coil passes to allow the wave-length change to be made without opening the lid of the cabinet.

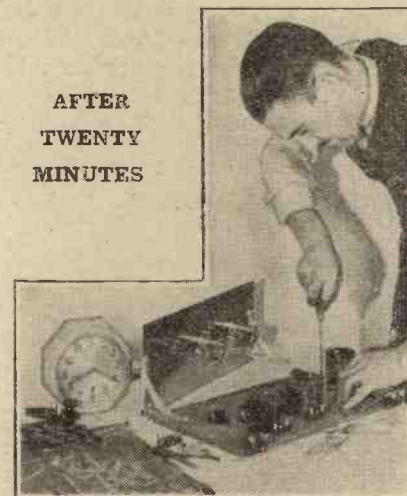

**AFTER
TWENTY
MINUTES**

Panel and baseboard components are mounted.

It will be seen that everything has been done towards achieving utter simplicity in the design of the new "Master Three." A baseboard plan upon which one is able to work, as it is engraved on the baseboard itself, a panel which is obtainable drilled to specification, and eyeletted connecting wires cut correctly to length. Everything is prepared except the actual screwing down of the various components, mounting the panel components, attaching the panel to the baseboard, and wiring up, all of which are very straightforward jobs calling for no constructional or technical experience whatsoever.

Straightforward Circuit

As the circuit diagram shows, the new "Master Three" consists of a detector circuit followed by two stages of transformer-coupled low-frequency amplification. Direct in the aerial lead we have a fixed condenser, the value of which is .0001 mfd.

This system of aerial coupling was adopted in that it gave best results on both wave-bands with the combined wave method employed in the receiver. It may happen, owing to varying aerial characteristics, that either a lower or higher value than this will give increased efficiency, and it should be noted that with very long aerials the value of this condenser may usefully be decreased to .00005 mfd. without impairing the selectivity of the set. In the case of

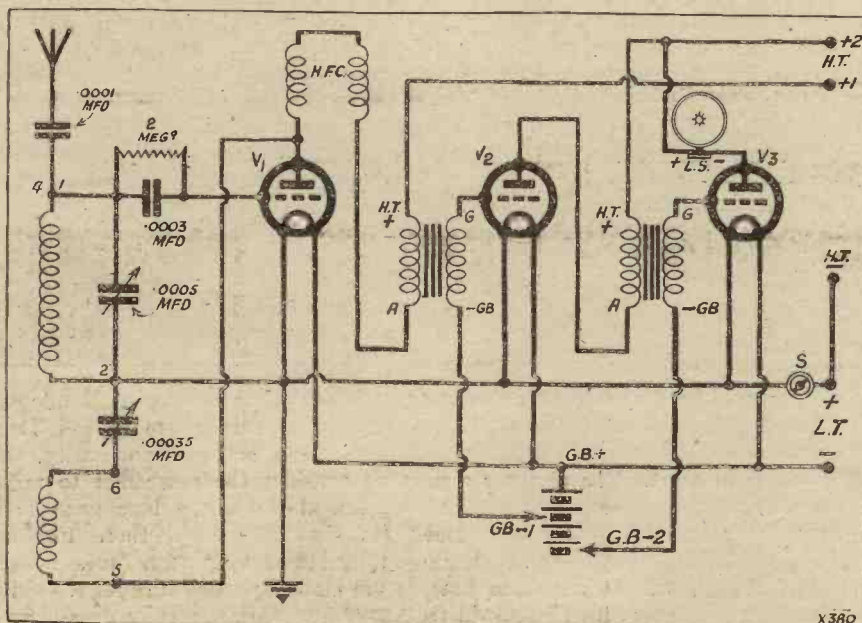

The theoretical circuit of the Mullard "Master Three."

short aerials, its value may be increased up to .0002 mfd., or even .0003 mfd., still to maintain the selective properties of the receiver. Some difficulty might be experienced in obtaining a fixed condenser of so low a capacity as .00005 mfd., in which event this value may be obtained by connecting in series two .0001 mfd.

Many Coil Experiments

Much experimental work has been put into the specified coil in order to maintain efficiency with the combined wave system. It may be generally accepted that in the attempt to design a coil which has the distinction of eliminating coil changing many difficulties are encountered,

TWENTY TO NINE



The panel is now being secured to the baseboard by means of the brackets.

chief among which is a loss of signal strength. With this in mind the designer of the "Master Three" continued to experiment with this one coil until a degree of signal strength was attained greater than that in the case of the original receiver published last season, in which the interchangeable system of coils was employed. Mark the point, that it is comparatively a simple affair to gain signal energy at the expense of selectivity, and here we encounter the main difficulty, particularly as we were concerned with two wave-bands at the same time. However, a design was finally adopted, which gives a degree of selectivity equal to the old system of interchangeable coils.

Very Sensitive

Those with experience of the first model will have nothing but praise for its sensitivity, for which it is noteworthy. In point of fact, the new "Master Three" gives much greater

signal strength than the original design. In practice, this means something quite important to those who propose to assemble it for their own entertainment. Most readers will know that a detector valve is very sensitive to even very weak signals. A pair of headphones will quickly demonstrate that a single-valve receiver is a very sensitive arrangement if a smooth system of reaction is employed. The problem is to amplify all the faint chirps up to comfortable loud-speaker strength.

We know that the impulses are in the aerial circuit, and it is important, therefore, that maximum efficiency should be attained in the coil, otherwise we shall not be able to hear the maximum number of stations at loud-speaker strength. Remarkable as it may seem, coil efficiency plays a leading part in the success of a receiver such as the "Master Three." Every effort taken to increase its efficiency above what may be considered normal makes just that difference between a good set and an average set. The experimental work on this coil has had that effect, and in the opinion of the Mullard Technical Staff it is easily the most efficient set which has ever been designed with combined waves. Apart from its own performance the fact that its measured signal output is greater than the original model produced last season gives to it a merit which is founded upon the experience of more than the one hundred thousand who up to the present are known to have built the earlier model.

The Wave-Change Scheme

The physical design of the coil is arranged to give control of the alternative wave-band from the front of the panel. This, we think, is the ideal method. Therefore, there is no necessity to disturb the lid of the cabinet when a wave change is desired. To operate the switch, which is concealed under the base of the coil, it is only necessary either to push or pull, depending upon the wave-band to which one happens to wish to change. For the B.B.C. band the switch operating arm is pulled out, while it is pushed in to receive

on the long waves. The movement of the switch operating arm is through a matter of about half an inch.

AT EIGHT-THIRTY-FIVE



Making the final adjustments to the base-board layout.

The diagram also shows that capacity reaction is incorporated into the detector circuit. One side of the reaction condenser is at earth potential, with a resultant complete absence of hand-capacity effects. One side of the tuning condenser is also connected to earth, so that here, also, hand-capacity effects are absent. By such a system tuning is as simple as it is possible to make it; there is the tuning condenser on the left-hand side of the panel when operating the receiver, and the reaction condenser on the right.

The Earthing System

Immediately below the dial operating the tuning condenser we have the coil switch-arm. It should be noted that a metal panel is specified, and it is used to join certain common points of components together. The panel is connected to earth through the panel bracket. Therefore the two spindles of the variable condensers make contact with the panel, as also does the spindle of the battery switch. Do not attempt to insulate the spindles of these components from the panel.

LOOKS GOOD, DOESN'T IT ?



Having a final look at the panel after wiring-up. It makes a nice-looking job.

It does not matter if the switch operating arm makes contact with the panel, as it is connected to a strip of insulating material where it is attached to the coil. Make a point, however, of keeping away from this arm any wire inside the set. This remark might apply to wires numbered six, seven, or ten.

The Detector Stage

The popular system of leaky-grid rectification is employed, and the usual 0003 mfd. paralleled with a 2-megohm grid leak are the components required for this operation.

After detection the signals pass through the high-frequency choke to the primary of the first L.F. transformer, when they are transferred to the secondary to be impressed upon the grid of the first L.F. valve. Here further amplification takes place by means of the valve, after which the signal is passed on to the primary of the second L.F. transformer, transferred to the second

8-9. This stage amplifies about twenty-six times.

In the second L.F. stage we have another three-to-one L.F. transformer, associated with a valve, in the case of the Mullard P.M.2, rated with an amplification factor of 6.2. This stage amplifies about eighteen times. Under ideal conditions the two stages of L.F. amplify about 468 times.

The assembly of the receiver should be mapped out in the way suggested by the illustrations, and when wiring is completed, including the battery leads, the receiver should be placed into the cabinet. If the specified grid-bias battery is used, it may be attached conveniently on the inside back of the cabinet by means of two drawing-pins passing through the flap. Battery leads numbered five, six and seven may then remain

After attaching aerial and earth and connecting loud speaker to its respective terminals, L.S.—and L.S.+, one is now ready to insert the valves. The list of specified valves for each voltage range is given separately on another page.

Easy to Operate

Operation of the receiver presents no difficulty. When the batteries are connected up, the valves inserted, the loud speaker, aerial and earth connected, the set should be switched on by pulling out the battery switch. The reaction condenser should be set to zero—its minimum capacity—and the tuning condenser slowly rotated to tune in the local station, presuming, of course, that the coil is switched to be functioning on the B.B.C. wave-band. Should you prefer to make the initial test on the long waves the coil should be set with the switch arm pushed in. No reaction should be necessary for the reception of the local station unless the set is installed at some great distance away.

Wherever reaction is demanded for the reception of any station, the reaction condenser should never be adjusted beyond the most sensitive point, as when the tuning condenser tunes through a carrier-wave an unpleasant squeal will result. Maintain the reaction condenser to the left of the oscillation point, and after the station is properly tuned in decrease the reading of the right-hand dial until the received programme is heard at comfortable loud-speaker strength.

Results Obtained

For the information of readers we are reproducing an extract from the test report which appears in the Mullard "Master Three" Supplement to the September issue of "Radio for the Million," the quarterly

Preliminary Test

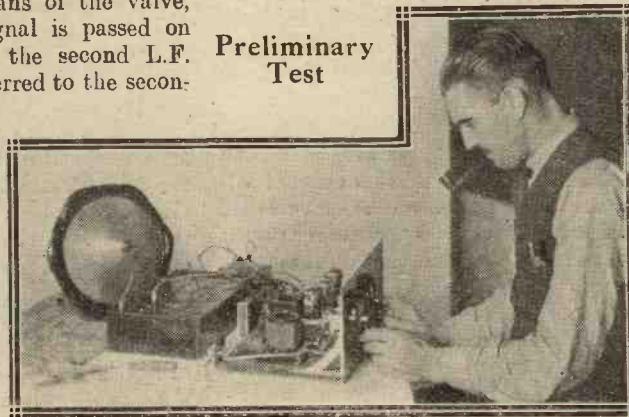

You will be anxious to get a bench-test, but do not be tempted to hurry the work so as to arrive at the stage shown. It is far better to work steadily and methodically through the instructions.

dary, and impressed upon the grid of the second L.F. valve. By the time the signal reaches the output of this valve it has been greatly amplified. The first L.F. transformer has a turn ratio of three to one, associated with a valve, in the case of the P.M.1 L.F., possessing an amplifying factor of

inside the cabinet, leaving those numbered one, two, three and four to be brought through one of the slots at the back.

Full directions for these seven battery leads are given in the tables, as also are the wiring details for the twenty-one rigid connections.

POINT-TO-POINT TABLE.

Wire No.	Description
1	Connect together furthest terminals (F +) of valve holders V ₁ and V ₂ .
2	Connect together furthest terminals (F +) of valve holders V ₂ and V ₃ .
3	Connect together nearest terminals (F -) of valve holders V ₁ and V ₂ .
4	Connect together nearest terminals (F -) of valve holders V ₂ and V ₃ .
5	Connect furthest terminal (F +) of valve holder V ₃ to right-hand terminal of switch S.
6	Connect terminal No. 1 of coil H to terminal on right side (fixed vanes) of variable condenser C ₁ .
7	Connect terminal No. 1 of coil H to furthest terminal of combined grid leak and condenser holder R ₁ and C ₂ .
8	Connect nearest terminal of combined grid leak and condenser holder R ₁ and C ₂ to right-hand terminal (G) of valve holder V ₁ .

Wire No.	Description
9	Connect terminal No. 2 of coil H to nearest screw securing right-hand panel bracket to baseboard.
10	Connect terminal No. 6 of coil H to terminal on right-hand side (fixed vanes) of variable condenser C ₂ .
11	Connect left-hand terminal (P) of valve holder V ₁ to terminal L.S. — on terminal strip T.S. ₂ .
12	Connect terminal No. 2 of coil H to terminal E on terminal strip T.S. ₁ .
13	Connect terminal A on terminal strip T.S. ₁ to nearest terminal of fixed condenser C ₂ .
14	Connect furthest terminal of condenser C ₂ to terminal No. 4 on coil H.

Wire No.	Description
15	Connect terminal No. 5 of coil H to furthest terminal of H.F. choke (H.F.C.).
16	Connect nearest terminal of H.F. choke (H.F.C.) to terminal A of transformer T ₁ .
17	Connect left-hand terminal (P) of valve holder V ₁ to furthest terminal of H.F. choke (H.F.C.).
18	Connect terminal G of transformer T ₁ to right-hand terminal (G) of valve holder V ₂ .
19	Connect left-hand terminal (P) of valve holder V ₂ to terminal A of transformer T ₂ .
20	Connect terminal G of transformer T ₂ to right-hand terminal (G) of valve holder V ₃ .
21	Connect terminal + H.T. of transformer T ₂ to terminal L.S.+ on terminal strip T.S. ₂ .

magazine of the Mullard Wireless Service Co., Ltd.

"One Sunday evening the original model of the new 'Master Three' was tested about eight miles from London's aerial. It was connected to a good aerial and earth system during the early part of the tests. The



Nearly finished! Don't forget to check the wiring by the table given on the preceding page.

aerial was about forty feet high, stretched across the roof of the house, ten feet lower. From end to end, including the lead-in, the length of the aerial was not more than sixty feet. During daylight, Radio-Paris was far too strong for the comfort of the speaker, and it was not possible for people present to converse without detuning. Hilversum, though not quite as strong, was heard at full speaker volume. Daventry, of course, excelled either. After dark the signal strength was tremendous from quite

a dozen stations, and it was necessary to change over to a smaller aerial round the rafters in the loft. For the remainder of the evening the tests were confined to this second aerial. It was an excellent test for the reason that this small, inefficient aerial was representative, and placed us at no advantage over the average conditions under which the set would normally be expected to operate. Its performance could only be adjudged as amazing. Stations at full speaker strength were tuned in from one end of the scale to the other. To onlookers it appeared almost magical, and it was put by one: 'stations came in almost tumbling over the heels of one another.' This was the experience whether set for long or short waves."

In Conclusion

As it has been remarked in the early pages of this description of the Mullard "Master Three" there is much in favour of it as an efficient three-valve arrangement. So far as present design takes us it represents a very attractive receiver. It is comparatively inexpensive, bearing in mind its performance. Provided builders do not substitute less efficient components for those which are specified, every builder may expect full return for the money expended upon the purchase of the parts and accessories. Now that the dark evenings are here distant reception is easily achieved, and with even a very inefficient outdoor aerial the Mullard "Master Three" is capable of providing endless entertainment from the first moment it is switched on.

Every part of the receiver operates at maximum efficiency, whether this be from the angle of quality, sensitivity, volume or ease of operation, with which of these merits any one part of the set is concerned, either

separately or in combination. For those whose means are limited, yet demand from radio as much as the owner of ambitious four, five or six-valve receivers, there are features in the new "Master Three" which indicate it to be an ideal receiver. It is sensitive, which means to say that in addition to the local station and 5 X X it will provide a number of programmes from other stations whenever it is desired to tune them in. Moreover, as a receiver for home entertainment it has the distinction of possessing a combined wave arrangement which will enable anyone in the family to operate the receiver, not only to obtain a programme from the nearby local, but an alternative on the other wave-band, to receive which it is not necessary to open the cabinet to effect the change of wave-bands, as was necessary with the old system of coil changing.



The time has come to plug in the valves, and in a few minutes you should be "all set" for station after station.

BATTERY LEADS

No. 1.—Take a piece of black flex wire about a yard in length: bare each end, attaching to one a black wander plug. About twelve inches from this same end remove the braid and rubber insulation at which point attach a red spade. Fix the other end of this wire under the left terminal of the on-off switch S. The red spade on this lead is placed under the + terminal of the L.T. (wet) accumulator. The black wander plug on this lead is inserted into the socket marked negative of the dry high-tension battery. This wire is labelled Battery Lead No. 1.

No. 2.—A second piece of black flex, cut to a length of about 2 feet, is bared at each end; to one extremity attach a black spade which is placed under the negative terminal low-tension (wet) accumulator. The other end is attached to the terminal F — of the

third valve holder into which the L.F. valve called V₃ is placed.

No. 3.—A piece of red flex about 2 feet in length is bared at either end; one extremity is placed under the terminal marked + H.T. on transformer T₁. To the other end attach a red wander plug and insert this into the socket marked 60 v. in the dry high-tension battery.

No. 4.—Another 2-ft. length of red flex is similarly treated at each end; one end is taken to the terminal marked L.S. + on the terminal strip T.S.₂. To the other end attach a red wander plug which should be inserted into the socket marked 108 v. in the dry high-tension battery.

No. 5.—A 9-in. length of red flex is bared at each end; take one end under the terminal F — of the valve holder marked V₁ and attach a red wander plug to the

other extremity. This plug is inserted into the positive socket of the grid-bias battery.

No. 6.—A 9-in. length of black flex wire is then bared at each end, one end being taken to the terminal marked — G.B. of transformer T₂, and a black wander plug being attached to the other is inserted into the first or second negative socket (1½—3 volts) of the grid-bias battery.

No. 7.—Another 9-in. length of flex is treated in the same way. One end is taken to the terminal marked — G.B. on transformer T₂, and the other end, to which is attached a black wander plug, is inserted into the fifth negative socket (7½—9 volts) of the grid-bias battery. When a Mullard super-power valve is employed, this lead will be taken to the last negative socket in the second G.B. battery.

Little time need be spent to assign reasons for the overwhelming popularity of the three-valve arrangement. Radio as most of us would wish to have it in our homes is far beyond the small limits of our incomes. For all that, and most naturally, too, we place favour in that type of set which will enable us to obtain as much fun out of radio as limited pin-

sets or will decide to become owners. radio public. That this is possible reflects credit upon the blueprint system, which, it would appear, has brought radio into the homes of people where it otherwise could never have entered. Therefore, the simplicity of the blueprint, or as it is called in the case of the new "Master Three," The Plan of Assembly, removes every possible cause of difficulty as

sets or will decide to become owners.

The Aerial Question

Good results are not altogether the sole responsibility of a receiver. It is necessary to erect the best aerial circumstances will allow, as it will be clear to most that the more energy collected by the aerial the better will be the ultimate results. In point of

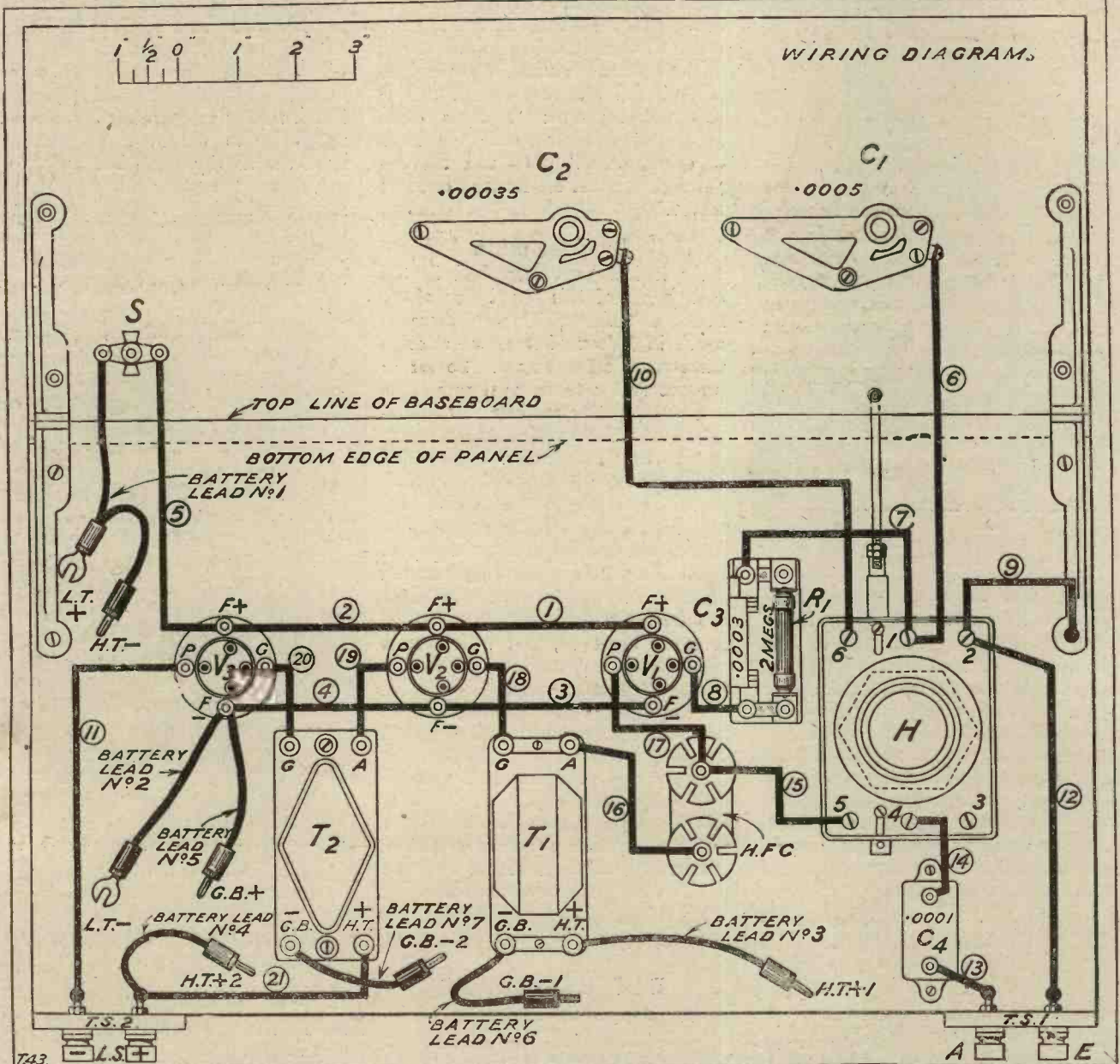

money permits. But in addition to this aspect of popularity with which the three-valve receiver is so generously endowed, there is the additional factor of installation to consider.

Success of Blueprints

Many are able to build a receiver simply by a patient following of constructional details, and it is surprising to note that this group comprises a large proportion of the

we know, but the builder, successful to the point where the last wire is placed into position, may then find himself puzzled when it comes to instal the receiver so that time and money are more than equitably rewarded by the good performance of the set.

A few notes on this matter may not come amiss, as it is believed that many present readers interested in this article will have "Master Three"

fact aerial efficiency is a very important asset. Not only will a good aerial repay the time and trouble to put it into service where distant reception is concerned, but it also enables the set owner to obtain increased quality. This, of course, for the reason that the desired volume may be gained with less reaction.

If, therefore, the new "Master Three" is to be your first radio receiver, choose

a high aerial up to sixty feet long rather than a low aerial as long as one hundred feet. By thus limiting the length of the aerial there will be no loss of stations. On the contrary, it is highly probable that the increase of selectivity secured with the shorter aerial will allow the reception of further stations allocated to a wavelength nearer to that of the local. Instead of the local transmission swamping these stations—and really most of us are very anxious to receive as many stations as possible, particularly those to be tuned-in very close to the local—it will then become more practical to listen to them. Reaction may help to limit this swamping

the front garden rather than carry the earth lead to a water-pipe which may be many many feet away. This then is the ideal—a high aerial of medium length, a short lead-in and a short earth lead. With such an aerial system one gains maximum efficiency. It does not follow that a very long aerial will be more efficient than one of the length recommended.

The Output Stage

There is little option in the choice of valves except to decide whether it will be 2-volt, 4-volt, or 6-volt. Most prefer the first, and know why: some swear by the last, and they also

is so great that if overloading is to be avoided a super-power valve is necessary—nay, imperative. This is to the credit of the receiver. It is report of performance. It proves that it has the power to amplify the received signals to a strength rightly to be described as loud-speaker strength. It shows that the new "Master Three" provides an economical set which is able to operate a loud speaker satisfactorily not only near a local station but many, many miles away. If more valves cannot be afforded—and every additional valve adds pounds to the initial cost and shillings to the running expenses—the three-valve receiver is by no means in the nature of the next best thing to an ambitious receiver. This is quite apparent when the performance almost insists upon a super-power valve for the output.

The Overloading Bugbear

Much is gained by the employment of a valve of this type in the new "Master Three." Distortion resultant upon overloading is not very attractive. Volume is something of which every ounce should be used up to the limit of the loud speaker itself. Have we not all discovered that, as volume is increased, realism increases proportionately? Radio enthusiasts are all in favour of volume.

Volume, however, brings its little complexities which are readily overcome by the use of a correct output valve, one capable of handling very loud signals without overloading. Owners of the new "Master Three" are recommended to obtain from their dealer the correct super-power valve as specified in the list of valves—P.M.252, P.M.254, or P.M.256, according to the voltage range preferred.

Here is the completed set, and below will be found a useful list of dial readings for both the ordinary wavelength band and for the long waves.

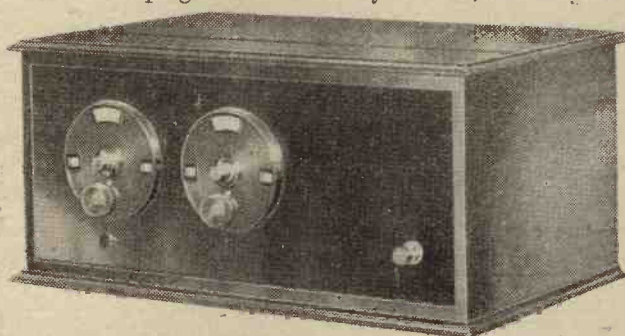

band, but mostly at the expense of quality on the station being received.

Avoid Long Lead-In

Avoid also, if it is at all possible, a long lead-in. Sometimes it is impossible as the radio set is more often than otherwise installed in the front of the house with the aerial strung over the garden at the back. This necessitates a very long lead-in which has no pick-up properties whatsoever. An aerial lead-in of this kind is not good. Nor should the earth lead wander through room after room. If the set is installed in the front of the house, prefer to use an earth tube in

know why. Others consistently use the second—the 4-volt range—and are not likely to change over to either of the other voltage ranges. But it should be remarked that, wherever possible, preference ought to be given to 4- or 6-volt valves.

Referring to the output valve in the new "Master Three," a super-power type is usually called for, though ordinary power valves are given in the list on a previous page. Reports have come to hand from various districts—one might say anywhere within fifty or so miles of a powerful station—that the signal strength of the new "Master Three"

DIAL READINGS

SHORT WAVES (with the switch pulled out).

Metres		
200	..	34
225	..	55
242	Nurnberg	67
250	Muenster	72
252.1	Bradford (2 L S)	73
254.6	Kiel	74.5
245.7	Toulouse	70
260.1	Malmo	77.5
273	Sheffield (6 F L)	85
276	Nottingham (5 N G)	87
277.8	Leeds (2 L S)	88
288.2	Edinburgh (2 E H)	94
294.1	Hull (6 K H)	97
297	Liverpool (6 L V)	98
303.6	Konigsburg	101
306.1	Belfast (2 B E)	103
312.5	Newcastle (5 N O)	106
319.1	Dublin (2 R N)	109

Metres		
323.2	Breslau	111
326.1	Bournemouth (6 B M)	112
340	Paris (P P)	118
345.2	Barcelona	120
349.2	Prague	122
353	Cardiff (5 W A)	123.5
361.4	London (2 L O)	127
366.8	Leipzig	128.5
370	Paris (Radio L L)	130
374.5	Madrid	132
379.7	Stuttgart	134
384.8	Manchester (2 Z Y)	136
389.6	Toulouse	137.5
396.3	Hamburg	140
400	Plymouth (5 P Y) and Cork (6 C K)	142
405.4	Glasgow (5 S C)	143.5
409.8	Berne	145
429	Frankfurt-on-Main	151.5
441.1	Brunn	155

Metres		
448.4	Rome	157.5
461.5	Oslo	161.5
471.6	Langenberg	164
483	Berlin	168
491.8	Daven'rj (5 G B)	170
500	Aberdeen (2 B D)	173
508.5	Brussels	175.5
517.2	Vienna	178
522	..	180

LONG WAVES (with the switch pushed in).

1071	Hilversum	55
1153.8	Kalundborg	70
1250	Konigswusterhausen	85
1604.8	Daventry (5 X X)	135
1765	Radio Paris	152
1875	Huizen	165

RADIO ABROAD



Making Stars

IT has been said that the separate development of Broadcasting and Cinematography has been responsible for the great success of both, and that had earlier experiments with combined sound and sight been more successful, the film as we at present know it might never have been evolved at all—that the many film "stars" might never have found an outlet for their particular types of genius, which lie in telling a story in pictures without the use of the spoken word, and sometimes without the use of the printed word.

League's Broadcasts

Reports on the international broadcasts of the sessions of the League of Nations, which are now being tabulated, may lead to the establishment of a regular short-wave radio service for the broadcasting of these meetings.

As an experiment, the sessions have been broadcast over PCLL, Kootwijk, Holland, on a wavelength of 18.4 metres, with a power of 25 kw. The announcements were made in English, French, Dutch and Japanese, and all listeners were asked to write and report the strength and clarity of signals.

So far, the results are not properly known, for reports are still coming in from distant parts, but it is believed that there is sufficient interest in these reports to justify the erection of a special high-power short-wave station which can be used for broadcasting and for carrying on the League's own business.

From Prague

Radio was first used by the League of Nations in 1925, and in 1926 an opening address was sent over long-distance lines from Geneva to Prague and there broadcast. Later, English, Danish, German and French stations joined in broadcasting other important speeches from the meetings.

The Dutch short-wave station at Kootwijk, which is often heard in America and other distant parts of the world, was originally designed to carry on radio-telephone experiments with Java.

Simultaneous Broadcasting

An interesting experiment in simultaneous broadcasting was carried out recently in Australia, when an interview from Melbourne with an artiste at the broadcasting station 2FC, Sydney, was put on the air. There was no perceptible lag between question and answer, despite the distance of over 600 miles between the stations.

Another demonstration was successfully carried out from 5CL, Adelaide, when a solo selection from Victor Harbor, South Adelaide, was sung to the accompaniment of a piano played at Tanunda, 100 miles

Germany, and those projected for the near future, are to be fitted with wooden aerial masts instead of the usual steel ones hitherto used. This decision is the result of the success of Munich's station with this type of aerial support. It was found that the previous system resulted in the radiation of only about 20 per cent of the energy fed into the aerial system.

Broadcasting Monopoly Troubles

An example of the mischievous results of giving a broadcast concessionaire the monopoly of radio apparatus as well is provided by the case of Peru, where the Lima station was first opened in June, 1925, by a private company, known as the Peruvian Broadcasting Co. This concern went into liquidation and was bought up by the Peruvian Government, who now hold the broadcasting monopoly.

AMATEUR PROVIDES COMMUNICATION LINK



Mr. Pomerantz, a Brooklyn radio amateur, and the apparatus with which he maintained communication with Porto Rico during the terrific hurricane which swept that area.

away. Singer and accompanist wore 'phones, and were connected by land-line through the studio of 5CL, Adelaide. Listeners were under the impression that singer and piano were in the same room, and there was no distortion.

German Stations

Stations under construction in

The original company apparently set out to charge exorbitant prices for radio sets and replacement parts, such as valves and batteries.

The public were charged extravagant prices for the sets in the first place, but notwithstanding this many people bought them, only to find that when replacements were

(Continued on page 558.)



Until recently it was not considered practicable to apply H.F. amplification to short-wave work, but the author's researches and experiments prove the screened-grid valve definitely to be efficient for the purpose when used in certain ways.

By C. P. ALLINSON, F.Inst.P.Inc., A.M.I.R.E.

I HAVE recently been carrying out quite a considerable amount of work with a view to obtaining H.F. amplification on the very short waves.

My first experiments with ordinary 3-electrode valves and various forms of neutralised circuits speedily convinced me that these were of little use below a hundred metres, and I therefore turned my attention to the screened-grid valve as supplying the solution to the problem of obtaining high-frequency amplification on wavelengths lying between 20 and 80 metres.

Now we know that the residual capacity of a screened-grid valve is almost negligible at the broadcast frequencies, although, as a matter of interest, it can be shown that with highly efficient circuits, even though complete screening be used, sufficient capacity is left to give a certain amount of feed-back, so that with extremely efficient circuits a screened-grid valve will actually oscillate when input and output circuits are brought into tune.

Noticeable Feed-Back

At the very high frequencies, however, the residual capacity is by no means negligible, and I found in my experiments with the standard low-loss coils which are at present available for short-wave work that the H.F. valve can be made to oscillate quite strongly without any difficulty when the two circuits are brought into tune.

These results were obtained notwithstanding the fact that I was using shunt-feed for the H.F. valve, which,

as you no doubt realise, introduces extra damping into the anode circuit, quite apart from the fact that it reduces any feed-back from battery coupling.

I did not wish, however, to obtain stability with this receiver by introducing still more damping, as this would diminish its efficiency, and I felt it was not a sound way of going about the problem.

Now, there are three ways of introducing stability into an H.F. amplifier.

1. We can balance out the capacity which produces the unwanted feed-back—neutralisation.

3. We can introduce losses into the circuit until they become stable—lossing.

3. We can eliminate the unwanted capacity at the very fountain head.

Now, this third method is already employed in the screened-grid valve, since a capacity shield or screen is placed between grid and plate inside the valve with the intention of eliminating this unwanted capacity between them.

Neutralised and Screened

Unfortunately, I had already found in practice that the residual capacity was apparently sufficient to cause oscillation, especially at the very high frequencies. I did not wish to introduce further losses as a means of producing stability, and therefore I was left with the only other alternative, which was to balance out or neutralise the unwanted capacity.

Let us look for a moment at the question from a practical point of view and see what particular

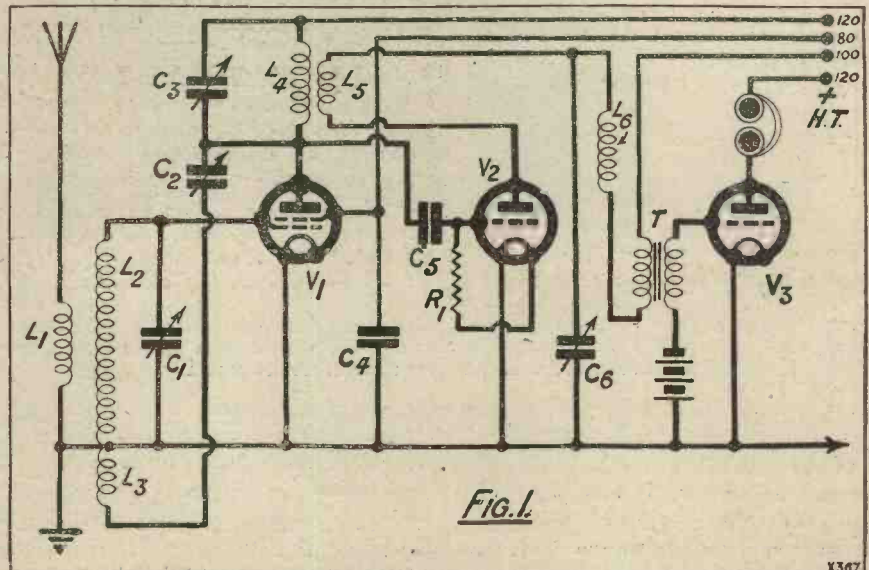

advantages we should obtain by neutralising with a screened-grid valve.

Take, for example, a short-wave receiver using one stage of H.F. amplification of this type. With the valve not neutralised it would be necessary to employ extensive and careful shielding, special coils might be needed, in all cases a shunt-fed would certainly be required, numerous by-pass condensers would have to be provided all over the show, and, in fact, a great deal of expense would result from the provision of all these precautions to prevent battery coupling, capacity coupling, magnetic coupling, and the like.

Decreased Cost

By neutralising this H.F. stage, however, we can save anything from ten to fifteen shillings expended on special chokes and condensers and, instead, spend 2s. 6d. on a small neutralising condenser. At the same time, the construction of the receiver will be enormously simplified in view of the fact that stringent precautions do not have to be taken in the layout and construction of the receiver to prevent various forms of feed-back,

whatsoever, whether it be the capacity between a couple of leads, linkage between two coils, or resistance common to two circuits, will be sufficient to send the set off into oscillation.

So sensitive, indeed, is the screened-grid valve that the capacity between two pieces of wire, each about four inches long, placed a quarter of an inch apart, end to end, is sufficient to send a screened-grid valve into oscillation under some conditions. So small is this added capacity that it cannot be measured by ordinary means. Similarly, a minute degree of magnetic coupling will also send it up in the air, while a resistance common to two circuits as low as two or three ohms may, in some cases, be sufficient to produce oscillation. By neutralising the screened-grid valve all these extensive precautions can entirely be done away with.

Small Neut. Winding

I constructed an experimental model of a short-wave receiver as the next step in my experiments, in which provision was made for neutralising. In view of the fact that the residual capacity to be neutralised was so very small I thought that

of turns, in relation to the whole coil, for neutralisation, in conjunction with an ordinary neutralising condenser. Experiments showed that my conclusions were correct, and Fig. 1 shows the circuit diagram of a three-valve short-waver which I constructed

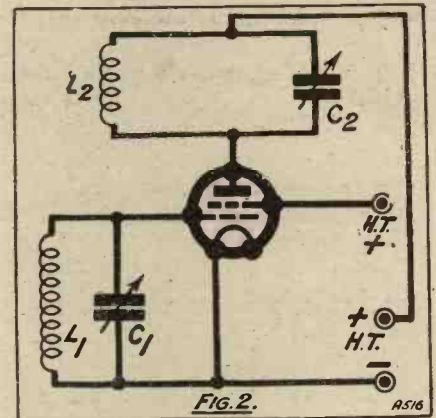

and used with great success on the wave-band lying between 18 and 80 metres.

The aerial is coupled by means of a coil L_1 to the grid coil L_2 of the H.F. valve, which is tuned by the usual variable condenser. An extra coil L_3 , as shown, is provided. This is connected to one side of a neutralising condenser, shown at C_2 , the other side of which is connected to the anode. In practice I have found that with the ordinary baseboard-mounting neutralising condenser the number of turns on L_3 need be not more than one-tenth of those on L_2 . Neutralisation can be carried out in the normal manner either by the maximum reaction demand method on the detector valve or by the zero signal point when the H.F. valve is turned out.

Unusual Problem

I would like to emphasise here that the question of neutralising a screened-grid valve is a totally different proposition from that of neutralising the ordinary three-electrode valve. This, of course, is due to the extraordinary small capacity that has to be neutralised in the former case.

In the case of a three-electrode valve where we have to neutralise a fairly large capacity, recourse has to be made to a bridge system or a negative reaction circuit, and we frequently find that in applying these principles trouble from other sources, of which the most well-known is parasitic oscillation, results.

In other cases a loss in efficiency owing to the reduction of the H.F. potentials applied to the valve is

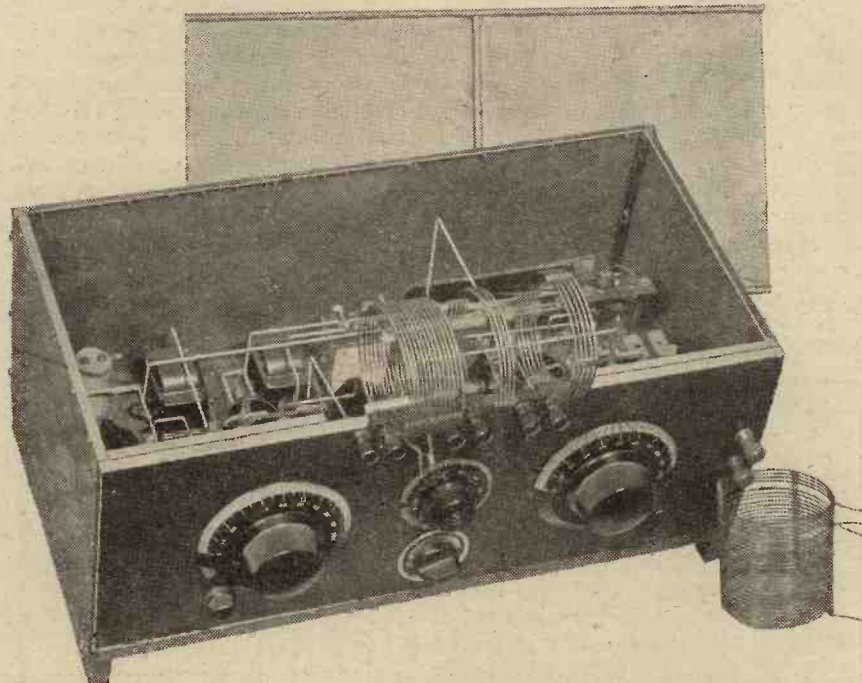

A short-wave receiver of normal and simple design which is capable, with fairly close reaction adjustments, of excellent performances. H.F. amplification makes for easier regenerative control and still more efficient results generally.

and also as regards the provision of adequate and complete shielding.

It will readily be realised that, in cases where the set is on the edge of stability with a screened-grid valve when complete shielding is used, any additional feed-back of any description

probably some form of split-secondary neutralising circuit would be perfectly satisfactory, notwithstanding the fact that the anode circuit was to be fully tuned, and, further, I anticipated that it would only be necessary to use a very small number

obtained, while in many cases difficulty is experienced with the actual handling of the receiver by the less experienced amateur.

A Simple Procedure

In neutralising the screened-grid valve, however, the problem is such a simple one as not to be worthy of the name of problem at all. If you want to you can neutralise by the usual silent signal method; if you don't, you merely give the condenser a bit of a twist until you get the set stable.

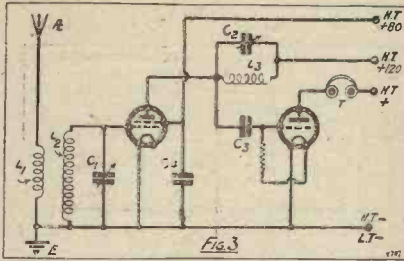

I have myself found it so extremely uncritical that as long as the condenser is connected up to the few turns necessary for neutralisation it really does not greatly matter where you set it. For maximum efficiency, certainly, it is desirable correctly to neutralise the valve and this also assists in obtaining smooth reaction.

An extremely important point to bear in mind, however, is the fact that when using a neutralised circuit with a screened-grid H.F. valve the use of extremely low-loss coils is entirely permissible, since there is no reaction present at all in any of the circuits, which reaction would reduce the damping in them and so reduce the effective series resistance of the tuned circuit to a value below that at which distortionless telephony can be received.

No Regeneration

Let us suppose, for instance, that an H.F. amplifier using screened-grid valves can be constructed in which the effective series resistances of the coils were reduced to 5 ohms without instability resulting. There would, nevertheless, be a certain amount of regenerative feed-back in each stage owing to the residual capacity of the valve which would result in the series resistance being lowered below the value of 5 ohms, and thus bring it below the safe limit for the pure reproduction of speech and music.

If, however, we neutralise this small residual capacity we can bring the circuits into a condition where no reaction of any description is present. This means that not only

is the H.F. resistance of each coil at its true value, but, if anything, it is somewhat higher owing to the introduction of damping from extraneous sources. This means, therefore, that the lowest of low-loss coils can be used without the risk of introducing side-band cut-off when receiving speech.

To return to the circuit which I am discussing, however, it will be seen that the usual tuned-anode circuit consisting of a coil L_4 , was used, while magnetic reaction from the plate of the detector valve was employed with throttle reaction control. The set was constructed on a metal panel so that no hand-capacity effects of any description were experienced, though, of course, care must be taken to see that the tuned-anode condenser C_3 is insulated from the metal panel. If, however, the moving spindle of this condenser is connected to H.T. it is to all intents and purposes at earth potential, so that no hand-capacity effects are introduced.

No Elaborate Shielding

No special precautions as to shielding were taken in the rest of the construction of the receiver, the only shielding employed being an inter-stage shield to prevent capacity coupling between the input and output circuits of the H.F. valve. At the same time, a certain amount of care was taken to see that the coils did not link up and produce unwanted feed-back.

I would emphasise the fact here that it is absolutely necessary to employ a metal screen behind the

panel or else a metal panel should be used. If this is not done coupling will be introduced between the input and output circuits of the H.F. stage by the operator when his hands are brought up to the tuning condenser dials. This will serve to give you some idea of how extremely sensitive a screened-grid valve is to added capacity.

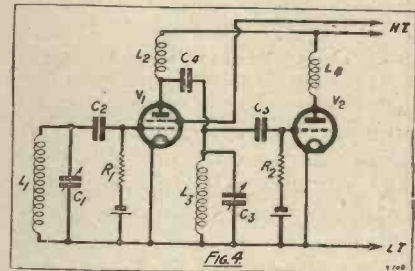

A number of comparative tests were made between this receiver and similar sets not using H.F. amplification, and it was found quite definitely that a very appreciable degree of H.F. amplification was being given.

At the same time, the particular circuit I have used here has certain advantages which recommend it for short-wave work. Firstly, it removes the damping of the aerial from the detector circuit, which naturally includes the reaction circuit.

Smooth Reaction

This makes the reaction control ever so much more simple, since the only factor which varies the reaction control now is the variation in H.F. resistance of the tuned-anode circuit with frequency. Very little more reaction is required, therefore, at the top end of the tuning condenser, and the reaction

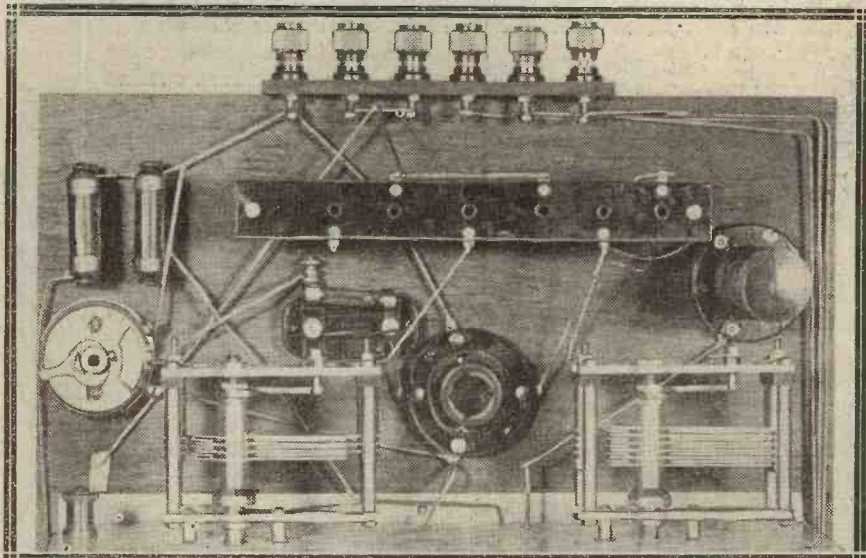

A section of a short-wave three-valve receiver designed and built by the author. In this set the detector and L.F. stages are separated by a metal screen. The detector portion is shown in the above photo.

remains comparatively constant over quite wide wave-bands. At the same time, no "dead spots" are experienced, while one of the factors which I have found conducive to threshold growl, namely, incorrect aerial coupling with the detector circuit, has also been removed.

The adjustment of the tuning condenser C_1 is quite flat, so that the handling of the set is not made more critical by the introduction of this extra control. For searching, the condenser C_1 may be set anywhere within about 20 degrees of the station without appreciably affecting its signal strength. Having tuned the station in on condenser C_3 , it may then be brought up to full strength by slight readjustments to C_1 .

Very Successful Set

The use of this screened-grid H.F. stage also largely prevents re-radiation from your aerial, which saves you from that annoying habit which listeners in one's immediate vicinity always seem to have of mistaking your oscillating receiver for a transmitting carrier, and heterodyning it, sitting on it with a steady howl, thus making it impossible for you to hear the station you happen to be tuning-in to.

Up to the time of writing I have not been really successful in getting much below 18 metres with this receiver, but this is largely due, I think, to the coils I am using, and I am at present working on a special new type of low-capacity coil with a view to getting the receiver down to a still shorter wave-length.

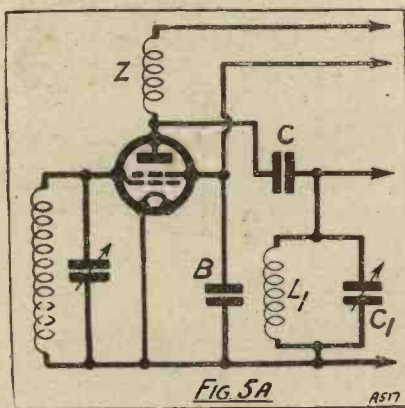

As a matter of interest, having found my experiments on the short waves so successful, I determined to see just what the effect of using this receiver on the broadcast waves would be. I first of all worked out some of the figures bearing on the question, with a view to obtaining some idea of what I might expect the results to be.

Some of these figures are somewhat surprising, and I am going to give you a few details which I think you will find of considerable interest.

Not Completely Screened

First of all, it has been shown theoretically that the limit of residual capacity permissible for complete stability in a screened-grid valve is in the neighbourhood of .05 m/mfd., and in the original Hull valve from which the present screened-grid valve has been derived the residual capacity was less than this figure, so that exceedingly efficient circuits could be used without instability resulting.

In the case of the screened-grid valves on the market over here, however, the residual capacity is in excess of the limit permissible, for ordinary commercial manufacturing considerations, I presume, do not make it feasible to get it below the limit.

As a result of this, it is not always possible to use highly efficient coils in the tuned circuits and yet retain complete stability, especially if any form of feed-back other than that within the valve itself should happen to be present.

A screened-grid valve, therefore, does not by itself give us an absolute cure-all for instability, so do not remain under the impression that the screened-grid valve will not oscillate.

What the screened-grid valve does do, however, is to make it considerably easier to obtain stability, and it does make it possible to obtain complete stability by the use of average coils. At the same time it enables the less experienced wireless amateur to construct a receiver giving a very high degree of H.F. amplification per stage, somewhat higher indeed than that which has usually been obtainable in normal H.F. work.

A Valuable Accessory

For the inexperienced experimenter, therefore, there is no doubt that the screened-grid valve supplies a very valuable accessory in that it enables him to build an amplifier for high-frequency amplification which will, with reasonable care in its construction, give complete stability without the necessity for neutralisation or adjustments of this description. I know that many experimenters find a certain difficulty in the neutralising of a receiver, and this, of course, is increased tenfold should any trouble from parasitic oscillation be present at the same time as normal instability.

With a neutralised circuit, therefore, even if he faithfully follows the

design of the receiver as published in a technical journal, he may nevertheless find difficulty in operating it after he has completed it, simply because he has not got the neutralising adjustment quite right.

By constructing a set according to design where the screened-grid valve is used, on the other hand, if he faithfully follows the design he need have no fear whatsoever that the receiver will not operate correctly immediately after being completed. No adjustments have to be made, nor is there any need for neutralisation to be carried out.

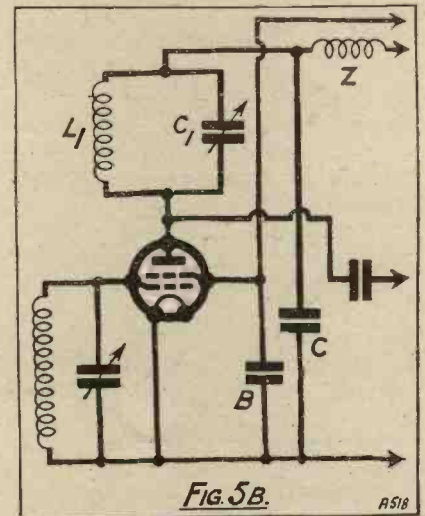

The experimenter, however, who really desires to obtain the very utmost efficiency from each stage when using a screened valve may find some difficulty, owing to instability resulting, when highly efficient coils are used.

A few figures on this question may be of interest here. It can be shown theoretically that at 2LO's frequency, using a circuit as shown in Fig. 2, the input and output circuits being completely shielded from each other, it is necessary that the two coils L_1 and L_2 have a series H.F. resistance in the neighbourhood of 15 ohms for stability to result.

Litz Coils

This does not appear to be a very high figure, and indeed there are probably quite a number of ordinary plug-in coils which have an H.F. resistance in this neighbourhood. If we remember, however, that an efficient Litz coil can be made having a resistance of only 2 to 3.5 ohms, then we begin to throw a rather different light on the question.

The Fig. 2 circuit, however, is not one that is used in practice—not as it
(Continued on page 544.)

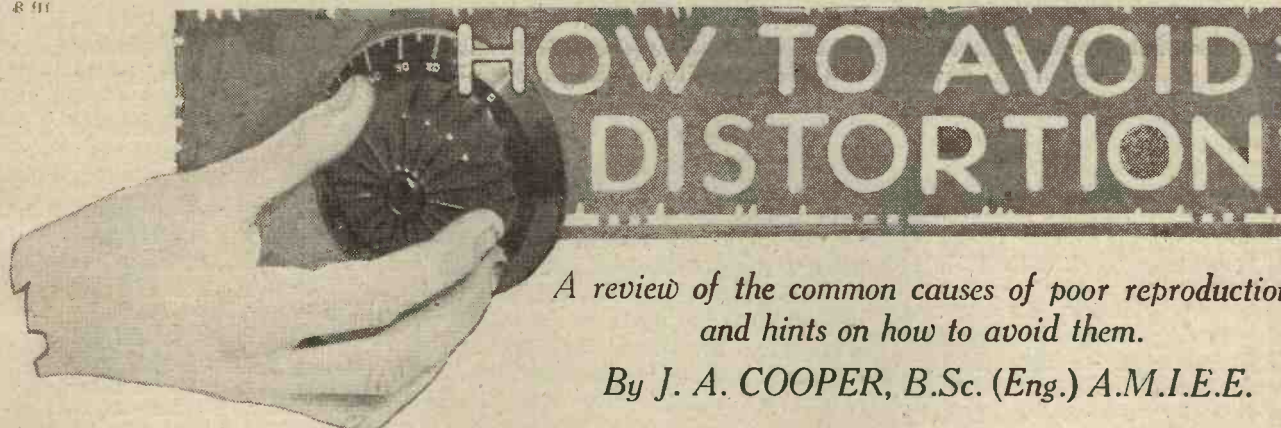

A review of the common causes of poor reproduction and hints on how to avoid them.

By J. A. COOPER, B.Sc. (Eng.) A.M.I.E.E.

THE first serious source of distortion met with in the radio receiver is reaction. This may be brought about intentionally by coupling back a plate circuit to the grid circuit of a preceding detector or H.F. valve in the receiver (so that the resistance of the circuit is reduced and its decrement lessened), thus increasing selectivity by making the circuit only resonant to a limited band of frequencies. It may also be brought about accidentally by capacitative coupling between wiring, and between the component parts of the valve.

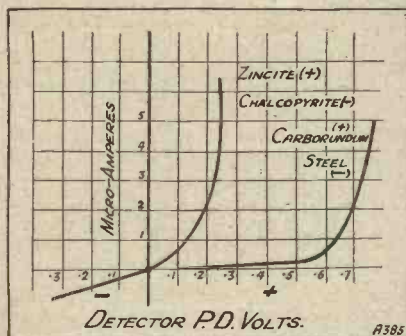

There is also a possibility of coupling between coils and between wiring and shielding. Accidental capacitative coupling can be made negligible by careful layout, and the modern tendency is probably to avoid this source of trouble. It is the unintelligent use of reaction that causes most trouble. If reaction is over-applied, tuning will be so sharp that the full effect of the side-bands is lost and hence only part of the radiated frequencies are adequately reproduced.

Response and Cut-Off

The ideal broadcast receiver should give equal resonance to the carrier frequency, plus and minus 10,000 cycles, to allow for the side-bands and cut-off sharply at these limits.

If too much reaction is applied the resistance of the tuned circuit is so reduced that oscillation takes place

and not only the one listener suffers, but also his neighbours, owing to re-radiation. This must result in frequency distortion and the usual evidence is that speech and music becomes low toned. Such distortion may occur without the usual heterodyne whistle or "howl" being audible.

Assuming that our electrical impulse has survived the aerial circuit undistorted and that H.F. amplification is used, it has now to pass to the detector valve via some form of coupling.

The detector, whether crystal or valve, is probably the weakest link in the chain. For perfect reproduction the characteristic of the detector should be a straight line with a sharp bend at the bottom. Some crystals are very good, but for best results their curves should be studied. Such curves show rectified current (in micro-amperes) plotted against potential difference (in fractions of a volt) across the detector. These curves also indicate if a polarising potential difference would improve sensitivity with weak signals.

Alternative Detectors

The valve can be made an equally good detector. The shape of its anode-current grid-volts characteristic can be made to have almost any slope we wish, and thus by careful design one can make a detector valve which will work on a part of its curve which is nearly straight, and at the right part of the curve. Two methods are available, anode rectification and cumulative grid rectification.

The former introduces least distortion because the valve is working on the best part of its curve and incidentally is not taking appreciable energy from the oscillatory system. Unfortunately the amplification of the valve is less than its maximum when so used and signals are correspondingly a little weaker than with cumulative grid rectification.

Cumulative grid rectification may readily, with strong signals, introduce sensible distortion. Perhaps the easiest way of understanding this is to think of the electron flow. Electrons flow on to the detector valve grid at a given impulse and before they have all had time to leak

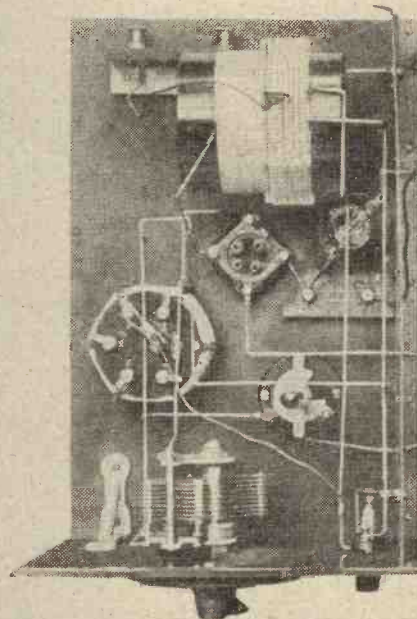

"If too much reaction is applied the resistance of the tuned circuit is so reduced that oscillation takes place, and not only the one listener suffers, but also his neighbours, owing to radiation."

off via the grid leak, more electrons have come on to the grid. There is thus a time lag and the voltage of the grid cannot vary in exact step with the transmitter impulses.

Too Much Reaction

The less the resistance of the leak, of course, the better the detection, but reducing the leak values also reduces signal strength and so many people are led to introduce deliberate distortion into their receivers because they must have loud signals with few valves.

We now pass on to the low-

frequency amplifier. Distortion is often caused here more than anywhere else in the circuit, apart from that caused

.....
 "Resistance coupling is usually considered to introduce least distortion because the voltage drop across the anode resistance is independent of frequency."

by reaction. We have already seen that coupling through wiring and shielding may introduce distortion, but the more noticeable causes are due to the valves used and to the methods of coupling. The valves themselves should be used with correct plate voltages and the grids should be so biased that the valves work always on the straight part of their characteristics. They must never work on either bend, and grid current must never be allowed to flow. If either thing happens distortion creeps in.

As amplification increases, the grid voltage changes are greater and the sweep on the characteristic lengthens, therefore one must use valves suitable for each stage of amplification. Power is required in the last stage to operate the loud speaker. Now we know power depends upon ampere turns. There is a practical limit to the number of turns so that the signal current in the loud-speaker winding needs to be as large as possible.

The Main Factors

Since $E=IR$, then power which = $EI=I^2R$.

It depends upon seven main factors :

- (1) The voltage E of the H.T. battery.
- (2) The emission of the filament (since the electron flow is I).
- (3) The mesh of the grid (the more open it is the more room there is for electrons to pass).
- (4) The internal resistance of the H.T. battery (the less this is, the greater the current it can deliver).
- (5) The impedance of the loud speaker (R).
- (6) The impedance of the valve (this depends largely on 3).
- (7) The applied voltage swing (depending on the L.F. amplification).

(7) should be large in order to obtain a large signal current flow from the valve (a consideration of an anode current grid volts characteristic will make this clear). It should never cause the valve to work off the straight part of its characteristic. An open-mesh grid implies a low impedance valve. (1) implies that it must be capable of taking a high anode

voltage ; and (2) implies a "power" valve. Incidentally (4) and (1) point to the desirability of using accumulators or the mains as a source of H.T. supply.

Forms of Coupling

In a low-frequency amplifier we require to reproduce faithfully all notes having a frequency of from about 50-10,000. This can readily be done with resistance-capacity coupling. The value of the coupling condenser should be calculated for a frequency of 50 cycles, and the

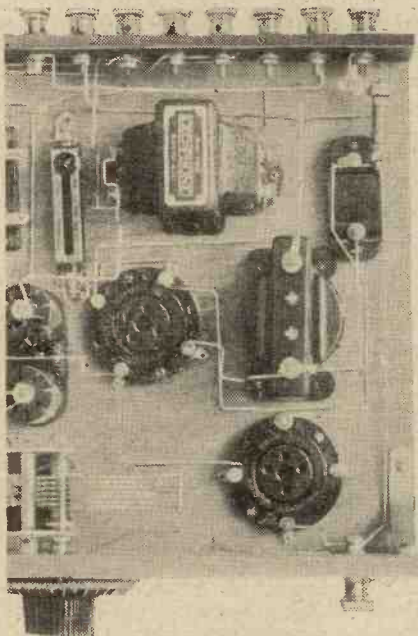

"Distortion is often caused more in the low-frequency amplifier part of a set than anywhere else in the circuit, apart from that caused by reaction."

impedance of the condenser at this frequency, together with the resistance of the grid leak, should be greater than that of the preceding anode resistance. It should be remembered in this connection that grid-leaks should have a relatively low value of the order of about one megohm, otherwise feed-back through the inter-electrode capacity of the valve will in effect shunt the grid leak, and so cut down the reproduction of the highest frequencies.

We will now return to the L.F. amplifier and consider forms of coupling. There are three methods in general use—resistance, choke, and transformer.

Resistance coupling is usually considered to introduce least distortion because the voltage drop across the anode resistance is independent of frequency. It must, however, be

remembered that to prevent the H.T. battery affecting the L.F. valve grids, a condenser is introduced in the grid circuit. This condenser passes high-frequency impulses better than low ones, for its impedance varies inversely as the frequency, so that the higher the frequency the less the impedance.

Choke coupling is becoming popular because it needs less H.T. voltage. The impedance of the choke varies as a

.....
 "As amplification increases, the grid voltages are greater and one must use valves suitable for each stage of amplification."

function of the frequency, being greater with the greater frequencies. Low frequencies are therefore liable to be lost unless we use a choke of very high inductance, and so we get frequency distortion. We also still need a capacity in the grid circuit and further frequency distortion may occur here.

Turning now to transformer coupling we see that the transformer primary may act as an L.F. choke, and if its inductance is too low it will omit the lower frequencies. The self-capacity of the windings may also complicate matters.

Effect of Iron Core

Transformers are now being built with negligible self-capacities and high primary inductances. From the published curves it may be seen that amplification below 500 cycles is still often unsatisfactory.

It should be noted here that the iron core also introduces a source of distortion. It is well-known that iron is non-linear in its action. Some slight distortion must, therefore, result from its use, but this can be reduced to a very small quantity if the iron used is very permeable and is used unsparingly.

The Final Stages

We now arrive at the output of our receiver. Headphones have yet to be perfected. Distortion can be introduced by the diaphragm favouring certain frequencies, and in headphones this is often, if not always, the case. Headphones also sometimes have cavity resonance which results in a form of distortion known as sound persistence.

Good loud speakers usually have better diaphragms, but designers still have much to learn. For faithful reproduction one must take account of inertia, sound radiation, rigidity of the diaphragm and also interaction of sound waves.

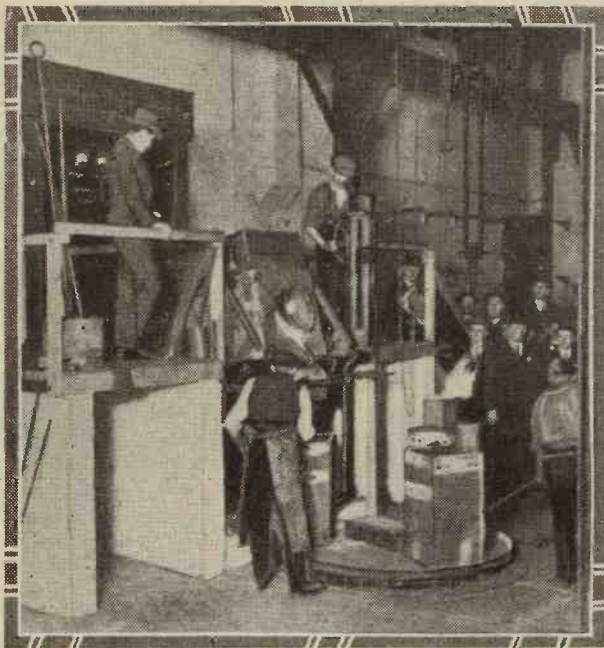

Fig. 1. A typical high-frequency electric furnace.

The RADIO FURNACE

The latest application of radio-frequency currents is concerned with the smelting of metals and is described in this interesting article.

By
F. JACQUET.

as asbestos, and the metal to be melted is placed in this. Such, in its essentials, is the constitution of the radio furnace.

How It Works

The mode of operation of the furnace is as simple as its construction. Radio-frequency currents are led into the copper coil, which acts as the primary of a large step-down transformer. The mass of metal to be melted acts as the secondary of the transformer. Under these circumstances, the radio-frequency current at high voltage is stepped-down by the transformer arrangement to a current of lower voltage in the transformer secondary (consisting of the mass of metal to be melted), but at the same time is greatly increased in amperage.

Outside Remains Cool

The result is that whilst the radio-frequency current flowing through the primary coil of the furnace hardly heats the coil at all, the stepped-down current induced in the mass of metal within the coil rapidly heats the latter, owing to the production of eddy currents within the metal. The rapid pulsations of the stepped-down currents serve to keep the molten

SINCE the dawn of industry, and, indeed, since the very beginning of history, the melting and refining of metals and alloys has been a very laborious and wasteful process. For hundreds of years, steel and iron have been smelted in large and complicated furnaces, which necessitated large amounts of fuel to actuate them, and which needed, also, a period of time extending over many hours to bring the metal or alloy completely to a molten condition.

Platinum and some other metals needed special electric-arc furnaces

So successful has this invention proved in the steel and iron industry alone, that it is safe to say that in years to come the radio furnace operating on radio-frequency currents will displace most of the other methods of metal refining. The radio furnace, again, has other important applications of especial interest to the wireless enthusiast, as we shall see later.

Construction of Furnace

Essentially, the radio furnace consists of a heat-insulated metal box or container, inside which is arranged a coil of wire of about fifty turns. Sometimes the coil is composed merely of wire, at other times it may be composed of copper tubing, along which a current of water flows for

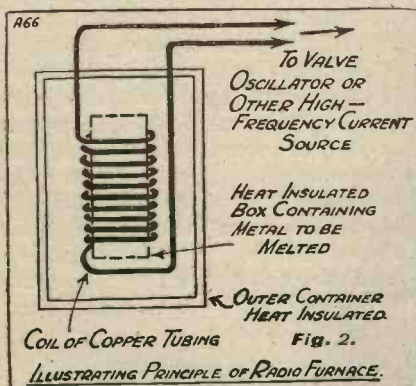

of their own to effect their complete melting; furnaces which, needless to say, were costly and consumed large amounts of heating power.

Important Wireless Applications

A study of the possibilities inherent in radio-generated currents, however, has within very recent times resulted in the development and successful practical application of what may be termed the "radio furnace."

Fig. 3. The new electric furnace is a great advance upon the old heating methods such as the Bessemer converter, an illustration of which is given here.

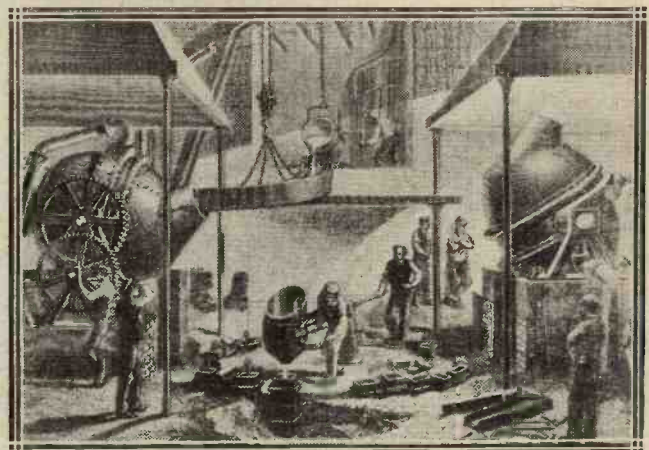

cooling purposes. Within the copper tubing is placed a smaller container of some heat-insulating material, such

metal in constant motion, and thus a metal or alloy of the highest possible degree of homogeneity is obtained.

It should be borne in mind that, despite the enormous temperature developed inside the furnace, the outside of the latter remains almost perfectly cold. In fact it is possible to place one's hand *inside* the furnace without feeling any ill-effects. This, of course, is due to the fact that the radio-frequency currents flowing through the primary coil of the furnace can only induce the stepped-

work is shown at Fig. 1. It has been developed and installed in the works of Messrs. Edgar Allen and Co., the well-known steel manufacturers of Sheffield. It is interesting to contrast the diminutive and neat appearance of this furnace with that of the older types of rotary furnaces such as is shown at Fig. 3.

Generating the Current

In general, there are two methods of generating the radio-frequency current which is required for the operation of the furnace. In the first place, a 60-cycle alternating current may be transformed by means of a converter into a higher-frequency current of the order of anything from 5,000 to 300,000 cycles. This method is the one employed by Messrs. Edgar Allen for the production of their high-frequency current, and an illustration of the high-frequency generator employed will be seen at Fig. 4.

An Interesting Experiment

On the other hand, many of these types of furnace utilise a bank of oscillating valves for the production of their radio-frequency currents.

So much for the working principles of the radio furnace. If any reader wishes to carry out a few experiments on these principles, let him support an ordinary neon lamp or small vacuum (Geissler) tube on a stick of sealing wax. Place two large metal objects (insulated by resting on sheets of glass) near the insulated neon lamp, and then connect the metal objects to the secondary terminals of an induction or spark coil. On passing current into the coil the neon lamp will be seen to glow quite brightly.

The effect, of course, is due to the high-frequency current in the metal objects adjacent to the neon lamp acting in a similar manner to that in which it does in the case of a radio furnace.

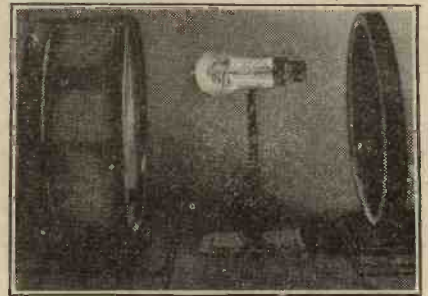

Fig. 6. A neon lamp glowing under the influence of radio-frequency oscillations.

However, a reader possessing a small spark coil and a neon lamp or vacuum tube can conduct many interesting experiments along these lines, and to this end the necessary circuit of the apparatus is given at Fig. 5, whilst an actual photograph showing a neon lamp glowing under the influence of the high-frequency oscillations present in two neighbouring metal objects is shown at Fig. 6.

"Boiling Out" Gases

To come back to a very important application of the radio furnace proper, however. It is well-known by wireless enthusiasts that during the last stages of exhaustion of radio valves, the valves themselves have to be heated in order to boil out, as it were, the last traces of air which are absorbed and retained by the metal electrodes within the valves.

Now, previous to the application of the radio furnace, this process of "boiling out" absorbed gases from the electrodes within the valve was a very difficult one, for the reason that it was almost impossible to heat the electrodes within the valve without at the same time softening the glass bulb. Thus all the earlier valves contained residual traces of air absorbed or "occluded" by the metal parts within the valve.

A Simple Matter.

A modification of the radio furnace, however, has rendered it a very simple matter to rid completely the inner electrodes of the valve from their absorbed or occluded air. The method is to connect a specially-constructed coil to the output terminals of a valve oscillator, and during the last stages of the valve-exhausting process, just before the valve is ready to be sealed off, in fact, to slip the coil over the valve.

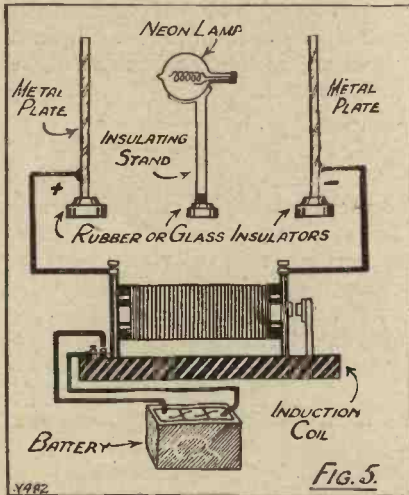

down heating currents in metal objects, and therefore if these are absent the furnace remains cold.

The First One

With a medium-sized furnace, a temperature of 2,500 degrees centigrade can be obtained in about twenty minutes, whilst with the furnaces specially constructed for the melting of platinum and similar metals, a still higher temperature can be obtained.

The first radio furnace in this country to be used for iron and steel

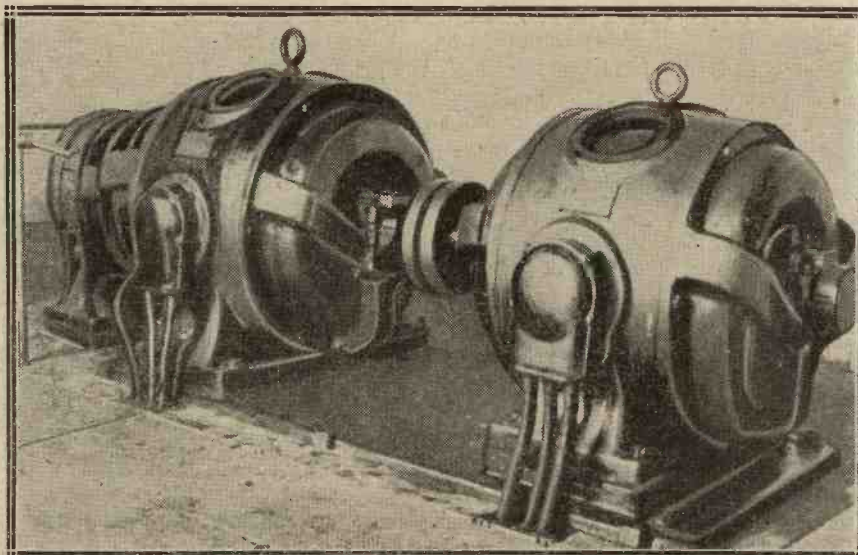
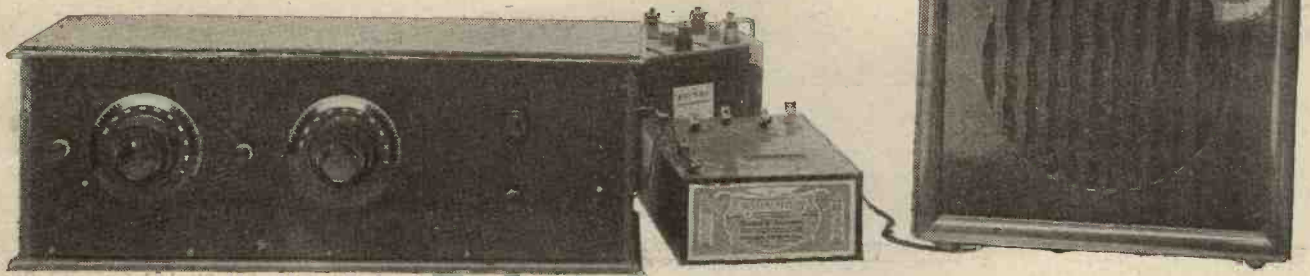

Fig. 4. The high-frequency generator supplying the current for the furnace shown in Fig. 1.

THE "RHAPSODY" FOUR



A magnificent long-range loud-speaker set of the most modern wave-change design. Not the least of its attractions are that it is not expensive or difficult to build. The "Rhapsody" is one of the "M.W." Research Department's latest and best products.

Described by A. JOHNSON-RANDALL.

I FEEL enthusiastic about this latest four-valve receiver which the "M.W." Research Department has evolved.

In my opinion, a set employing this number of valves must be selective, sensitive, and perfectly stable.

It should be capable of bringing in distant stations at loud-speaker strength, and with good quality reproduction. Moreover, it should not be necessary to change the coils when one desires to receive 5 X X, or any of the other stations working on the 1,000-2,000-metre wave-band.

The "Rhapsody" Four possesses all of these desirable features, and is the result of a considerable amount of experimental work. There is one other point, and that is the set is not expensive.

The efficiency is not the result of "stringing" together a number of high-priced components—it has been

Suppose we examine the circuit in some detail and without becoming too technical.

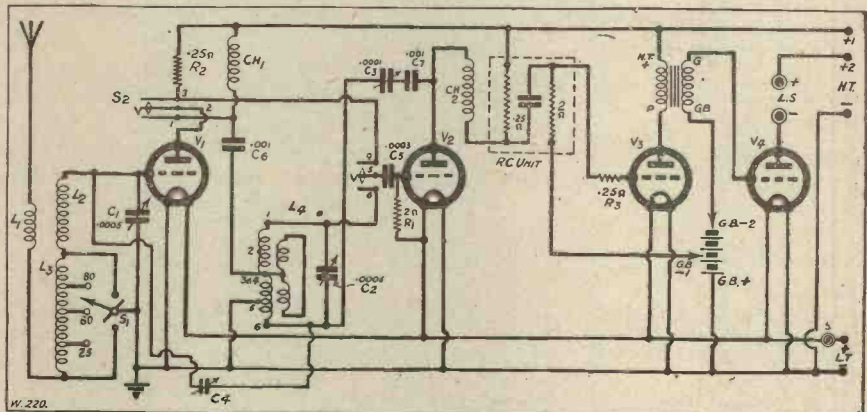

achieved by careful design and a choice of parts which can be duplicated in a number of different makes.

To make the understanding of the circuit more simple it is a good scheme to deal with the "short"

COMPONENTS AND MATERIALS REQUIRED.

- | | | |
|---|---|--|
| <ul style="list-style-type: none"> 1 Ebonite panel, 21 in. × 7 in. × 1/4 in. or 3/8 in. thick (Radion, Red Seal, Ebonart, "Kay Ray," Becol, Trelleborg, etc.). 1 Cabinet, 21 in. × 7 in. × 9 in. deep (Carrington, Raymond, Bond, Pickett, Peto-Scott, Makerimport, Caxton, Artercraft, etc.). 4 Sprung valve holders (Lotus, Benjamin, Burne-Jones, Bowyer-Lowe, Igranie, etc.). 2 Single-coil sockets (Lotus used in set. Any good make). 2 Push-pull on-off switches. (One of these must be of the type commonly used for wave-change switching, with two side contacts and a central plunger to which a third lead can be connected). (Lissen, Lotus, Burne-Jones, etc.). 2 .0005-mfd. variable condensers (J.B. shown; other good makes are Lissen, Cyldon, Raymond, Igranie, Bowyer-Lowe, Marconiphone, Gecophone, etc.). 1 Standard loading coil (Burne-Jones | <ul style="list-style-type: none"> in set, Wearite, Paroussi, etc.). 1 A.N.P. coil and six-clip base. A standard A.N.P. coil, 200/600 metres, will be required. 1 Neutralising condenser (Burne-Jones, Bowyer-Lowe, Peto-Scott, Igranie, Polar, etc.). 2 H.F. chokes (Those shown are Igranie and R.I.-Varley. Any other good makes such as Burne-Jones, Lissen, Dubilier, Lewcos, Colvern, Bowyer-Lowe, Cosmos, Marconiphone, Climax, can be employed). 1 R.C.C. unit. The anode resistance should have a value of approximately .25 meg. (250,000 ohms) and the grid leak approximately 2 megs. (Dubilier in set, Lissen, Marconiphone, etc.). 1 .0001-mfd. miniature variable condenser (Cyldon, Bowyer-Lowe, Dubilier, Peto-Scott, Ormond, etc.). 1 L.F. transformer (Lissen shown. Other good makes are Ferranti, | <ul style="list-style-type: none"> R.I.-Varley, Marconiphone, etc.). 2 .001-mfd. fixed condensers (Lissen, T.C.C., Dubilier, Burne-Jones, Mullard, etc.). 1 .0003-mfd. fixed condensers (Lissen, T.C.C., Dubilier, Burne-Jones, Mullard, etc.). 1 Lotus push-pull double-pole change-over jack switch. (The Utility double-pole change-over switch, either of the knife or rotary type, is also suitable.) 2 .25-meg. grid leaks and holders (Lissen, Dubilier, Mullard, etc.). 1 2-meg. grid leak and holder (Lissen, Dubilier, Mullard, etc.). 1 Ebonite terminal-strip, 19 in. × 2 in. × 1/4 in. 9 Insulated terminals, markings according to wiring diagram (Igranie shown, Belling & Lee, Elex, etc.). 2 Panel brackets (Burne-Jones, Peto-Scott, Raymond, etc.). <p>Quantity of No. 18 or 20 S.W.G. tinned copper wire and Systoflex, or, alternatively, Glazite.</p> |
|---|---|--|

and "long" wave portions separately, afterwards combining the two.

Let us commence with the "short" wave arrangement. By "short" waves I mean the normal broadcast band extending from about 250-500 metres.

If you refer to the theoretical diagram you will see a double switch S_2 . When this switch is arranged so that the centre points 2 and 5 make contact with 1 and 6, the circuit to the H.F. valve is completed through the H.F. choke $C.H._1$, then

The small winding shown in the centre of this coil is an anti-parasitic winding designed by the makers to cut out any unwanted oscillations occurring at frequencies different from that to which the circuit is tuned.

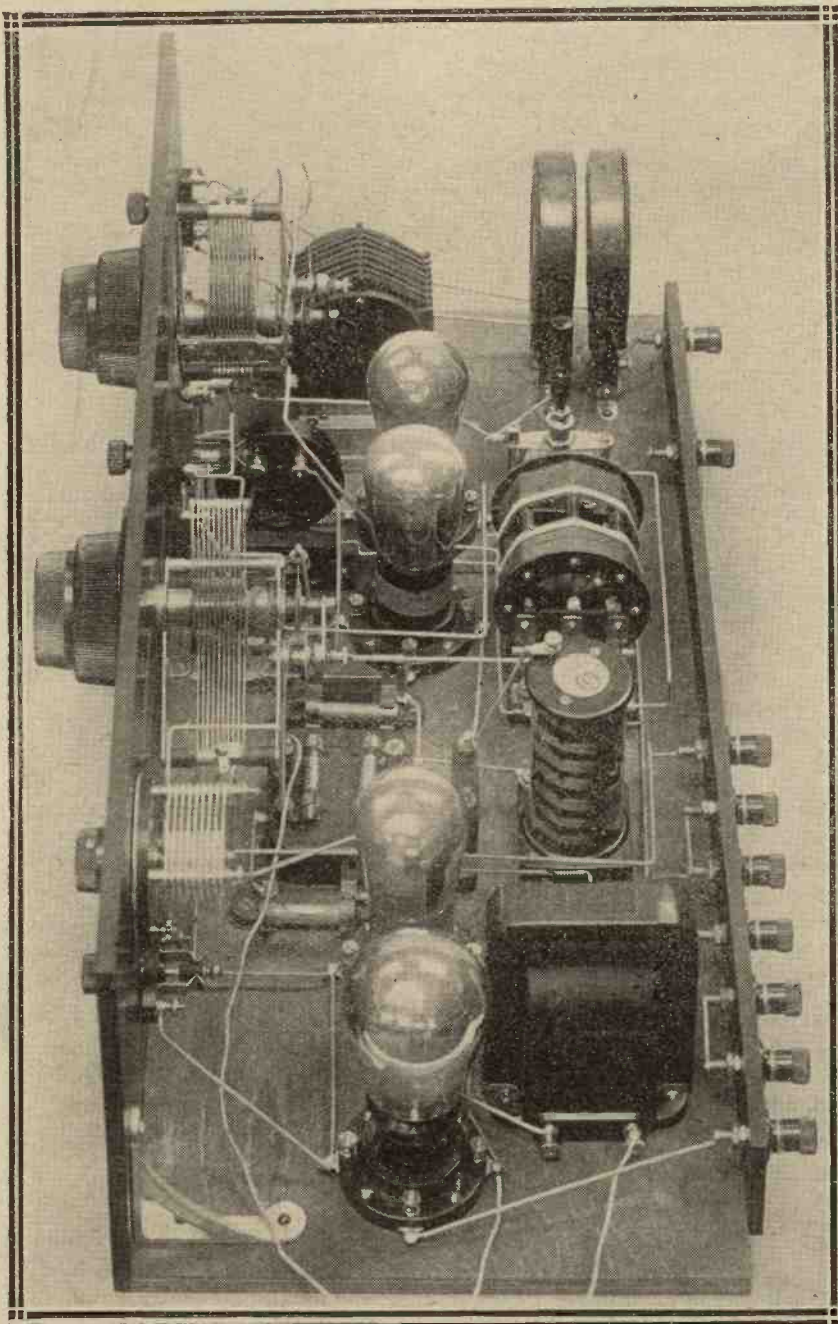

Symmetry in component layout has been achieved without the slightest sacrifice. Much experimenting preceded the completion of the design, in which is incorporated a novel circuit arrangement due to the "M.W." Research Department.

The aerial circuit consists of two plug-in coils marked L_1 and L_2 in the diagram. L_1 is a "semi-aperiodic" coil of about 35 turns, and L_2 , the secondary, is a No. 60 coil. Tuning is carried out by means of the variable condenser C_1 .

to the detector grid circuit via a .001 fixed condenser to an "astatic" coil marked L_4 . Actually, this "feed" from the H.F. valve is taken to the centre point of the coil and the scheme is simply the usual "parallel feed" tuned-anode.

Obtaining Reaction

Reaction is arranged for in a simple manner by utilising that portion of the "astatic" winding between the points 5 and 6. A .001 fixed condenser is connected between the second H.F. choke and the .0001 reaction control, and the purpose of the condenser is to prevent the H.T. battery from short-circuiting should the moving vanes of the reaction control touch the fixed vanes.

Now, with an "astatic" coil there is little danger of inter-action occurring between the aerial and H.F. circuits, and screening is not essential. There is, however, still the inter-electrode capacity of the H.F. valve itself to be considered. This, in spite of all other precautions, is enough to produce feedback and self-oscillation. It is therefore advisable if perfect stability is to be obtained, to connect a small neutralising condenser in such a manner that any danger of feedback via the valve capacity is obviated. This is achieved by joining a neutralising condenser between 6 on the astatic coil and the grid of the H.F. valve.

Now, suppose we change over to the "long" wave side. The switch S_1 will be open. The aerial circuit then consists of the secondary coil L_2 , plus the loading coil L_3 . This loading coil is simply one of the "M.W." standardised coils described in the May issue of MODERN WIRELESS.

The aerial-earth circuit passes through a proportion of the loading coil via the centre-point of the switch. This is called an "auto-coupled" circuit.

Resistance Coupling

Now for the H.F. valve coupling. For the long waves the centre points of the double switch S_2 will make contact with 3 and 4. The H.F. valve then becomes resistance-coupled.

All the tuning is then carried out on the aerial tuning condenser C_1 .

Resistance coupling was employed in order to avoid the usual troubles with wave-change switching of having to re-neutralise or re-adjust the aerial or H.F. circuits when changing over.

No reaction is normally provided, but the H.F. valve will give adequate

amplification for the reception of 5XX for domestic purposes. For really long-distance work on the long waves another scheme is used which will be described later, when we are considering practical operating details on the long wave-lengths

It may be argued that resistance-coupling on the long waves is not the ideal method, but it should be remembered that the amplification given increases with the wave-length and is sufficient to bring in the Daventry long wave station. The one possible snag may occur where the prospective constructor lives on the coast, and for this reason the receiver is not recommended where Morse interference is prevalent, nor is it suggested that the set is the best type to employ in cases where the listener resides within the "shadow" of a powerful broadcast transmitter such as 2LO. In each of these cases a special circuit is desirable.

The L. F. Stages

It will be seen that to change from the broadcast band to the long waves, the switch S_1 must be "opened" and the double switch S_2 pushed in.

So much for the H.F. side. The L.F. side is a straightforward combination of resistance-capacity and transformer coupling. Any R.C. unit of reputable make can be used, but

the anode resistance must not have a higher value than .25 megohm, otherwise it may not be possible to obtain adequate reaction.

A .25-meg. leak is inserted between the unit and the grid of the first L.F. valve to prevent stray H.F. currents from getting through into the L.F. stages and producing distortion.

with the aid of a steel rule and a scriber. Then take a centre-punch and punch-mark the drilling points. Next take the components which have to be mounted on the panel. These are the two tuning condensers, the reaction control, and the three switches.

Select the drills for these and for the holes which secure the panel to

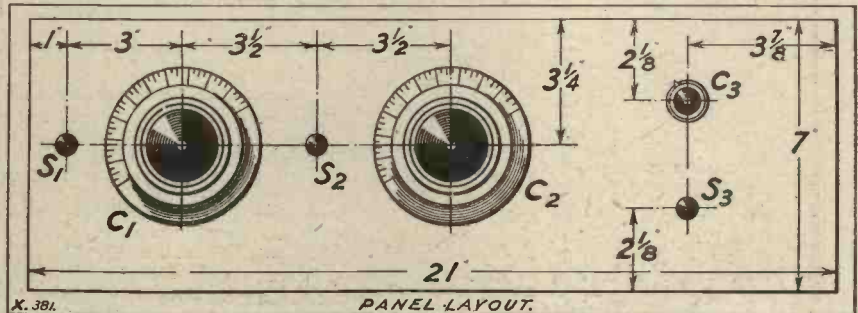

The L.F. transformer chosen should have a fairly low ratio, certainly no greater than 4-1.

Incidentally, the H.F. chokes used must be good ones. C.H.₁ is critical, because if this choke is a poorly-designed specimen it will be quite impossible to obtain the highest efficiency from the "parallel feed" arrangement. We can now pass on to the construction.

Take the panel and mark it out on the back to the dimensions given. The usual procedure is to do this

the angle brackets and baseboard.

In most cases where single-fixing components are used you will need a 3/8-in. twist drill and a carpenter's brace, but it is advisable, first of all, to run a pilot drill through in order to obviate the risk of the larger drill wandering out of centre.

A 3/16-in. drill should be O.K. for the small screws which secure the panel to the baseboard.

Having drilled the necessary holes, screw the panel to the baseboard, place the two angle brackets in

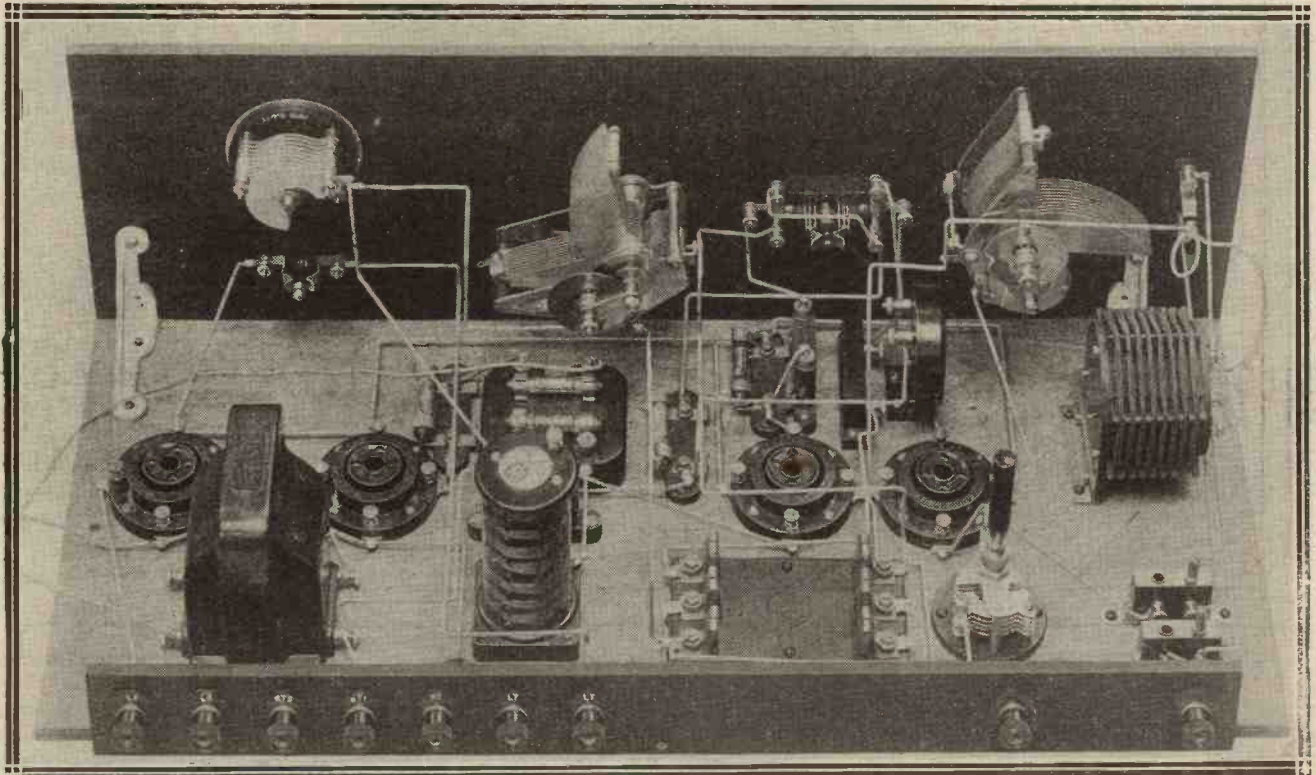

A large back-of-panel view of the set, which will help you to assemble the components. Note the well-separated wiring from the wave-change switch and the ample spacing allowed for the H.F. end of the set.

cut to shape. Glazite and similar types of insulated wiring will do just as well.

Now start to bend the various leads, joining up the points as shown on the wiring diagram. Always connect up commencing with the components nearest the baseboard and carry out the wiring layer by layer. This is the only practical method if the finished job is to be both neat and efficient. You can use terminals throughout if you wish, or, alternatively, you can solder all the joints.

If you decide to make use of the terminals, do not forget to screw them down tightly, because a loose connection means a noisy receiver.

The flexible leads to the grid-bias battery and to the tapings on the loading coil are simply ordinary rubber-covered lighting flex.

Be careful to see that the valves when in position do not foul any of the leads.

There is not much more to be said concerning this part of the work, except, perhaps, that soldered joints should not be made with components such as grid leaks in position.

Testing Out

When you have finished the wiring the receiver will be ready for testing.

Insert a No. 35 coil in socket L_1 and a No. 60 in L_2 . Place the switches in position for receiving on the "short" waves by pulling out both S_1 and S_2 , that is, if your switches are of similar type to those shown in the photographs.

Insert a broadcast-band A.N.P. coil in the special base provided and then place the valves in their respective holders.

For the H.F., detector and first L.F. sockets, valves of the "H.F." type are suitable. Such valves as those having an impedance of roughly 20,000 ohms and an amplification factor of 20, or thereabouts.

In the last socket you will need a power valve, impedance 3,000-6,000 ohms.

Then connect up your batteries. For H.T. +1 you will require about 80 volts, and for H.T. +2, 100-120 volts. Apply grid bias in accordance with the instructions which are given with the valve.

Incidentally, you can place your grid battery inside the cabinet, securing it to the cabinet itself by means of a small bracket. You will notice that there are no filament resistances in this set. These were left out on the assumption that modern valves designed to work from 2-, 4-, or 6-volt accumulators, according to type, would be used.

Connect up your loud speaker

and the aerial and earth, and the set is ready to work.

Then with the valves alight, and the reaction control at its minimum, tune in the local station by rotating the two tuning dials.

There is a possibility that self-oscillation may occur. This is due to the inter-electrode capacity of the H.F. valve, and the following procedure should be adopted.

Set the reaction control at minimum and likewise the neutralising condenser. Now on setting the tuning condensers so that the two tuned circuits are in step with each other it will

probably be found that the set is oscillating.

Adjust the neutralising condenser little by little until you find a point where no oscillation occurs when the two tuning condensers are adjusted in step.

This is the neutralising point.

Next try out the set on 5 X X by switching over to the "long" waves.

Join the flexible lead to the 25, 60 and 80 tapings on the loading coil in order to see which gives you the best results.

Further details will appear next month.

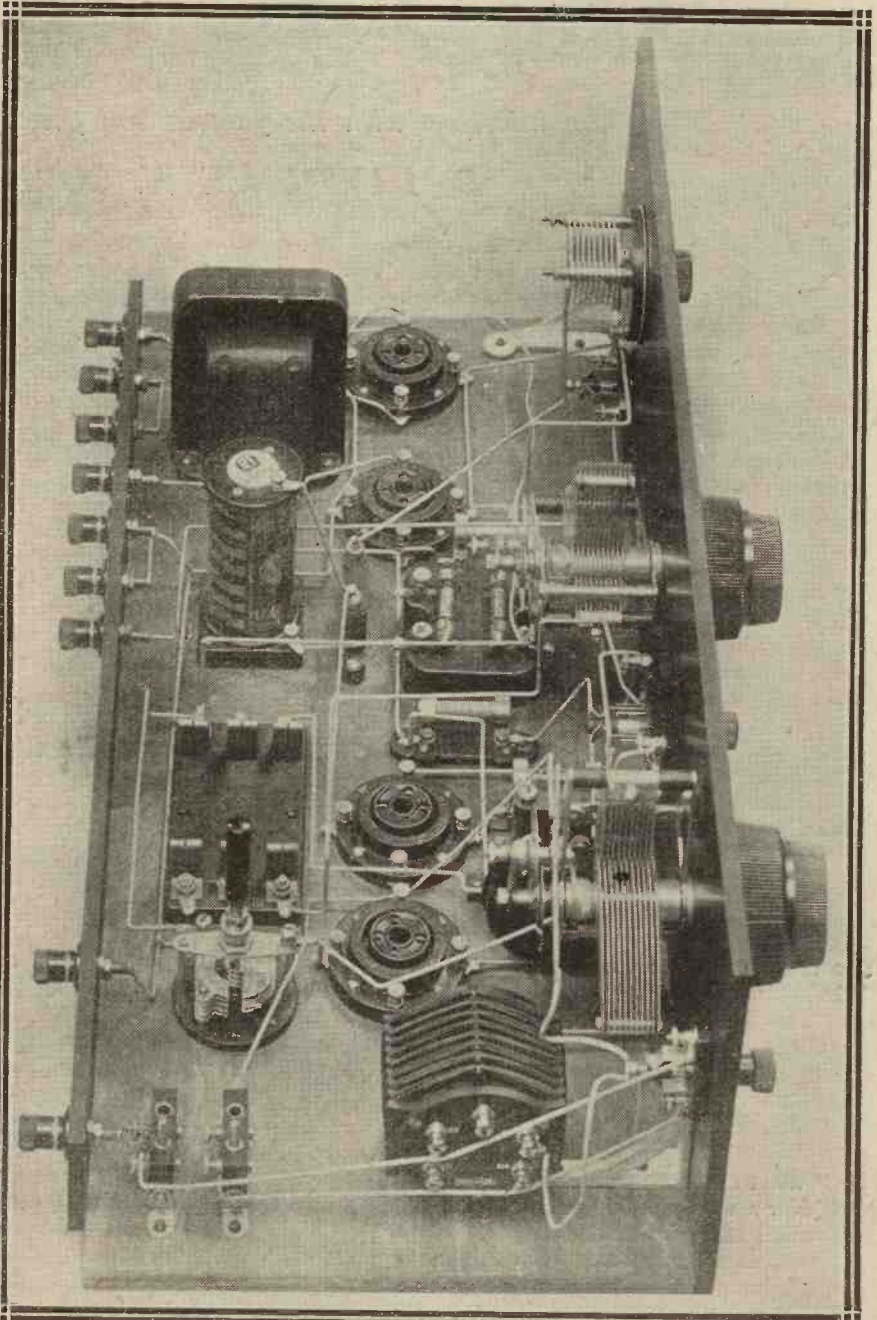

A view of the "Rhapsody" Four taken from the H.F. end of the set. The A.N.P. coil has been removed. The "M.W." standard loading coil, which is an essential item in this receiver, can be seen in the immediate foreground.



An interview with the famous composer, Cyril Scott

By LAWRENCE W. CORBETT.

"CYRIL SCOTT? Let me think," demurred the oldest inhabitant, scratching his head. "Ain't nobody by that name in Portloe."

The "oldest inhabitant," I subsequently learned, lives in the cottage next to that of Mr. Scott! There are probably few places in England where the famous composer and writer might go without his presence soon becoming known, and no doubt fewer where one's next-door neighbour does not learn in a very short time one's name. Portloe, however, is one such place.

Mr. Scott had been walking, and greeted me generously upon his return to the cottage. Of medium height, fair, and with clear-cut features, he is a man of slight build, typically an artist. He was informally clad in a white shirt open at the neck, in trousers drawn tightly at the waist to obviate the necessity of a belt, and wore rough walking shoes. "Excuse my informal attire," he said. "We don't really bother about what we wear here."

Armchair Audience

"How do you manage about a piano down here?" I suggested, looking round to make sure that there was not one in the room.

"Just do without one. It would require a whole regiment to get one over from Truro down these narrow roads," replied Mr. Scott. "Anyhow, I don't need one."

"No gramophone?"

"No gramophone."

"What about a wireless set?" I added timidly.

"Nor a wireless set," replied Mr. Scott, in a tone that surprised me by its mildness.

"I understand that you feel very bitter against wireless broadcasting of good music?"

"That's a very broad statement. In many ways I look upon broadcasting as an ideal medium for introducing the best music into the home. There couldn't, perhaps,

be found a better way of providing for the recluse and those who are situated too far from a large town to be constantly journeying to and fro to hear concerts at first hand. The city dweller, on the other hand, is becoming a victim of broadcasting.

"He is learning to be extremely lazy and independent of the entertainment provided for him at the concert hall, and I don't blame him. He no longer stirs from his armchair at night, but prefers to accept his music from a wireless set, which is all too frequently incapable of reproducing the music even as it is broadcast. Modern methods, I know, permit of the most remarkable quality in transmission and reception, but how few of these so-called wireless receivers there are!

Indolent Instrumentalists

"Another form of indolence is manifest," Mr. Scott continued, "and is, I think, the direct outcome of the convenience of listening-in. People are not bothering so much nowadays to cultivate individuality. Fewer are troubling to learn to play musical instruments themselves. The temptation to listen to a good programme—and there are plenty such—instead of practising, is very great."

"The gramophone has existed for a good many years," I reminded the composer.

"Yes, but not until the present era have the opportunities for listening to music with so little effort been as great as they are to-day. We don't have to exert ourselves one whit."

Mr. Scott was reticent in discussing the monetary effect that broadcasting had upon composers, and it was not difficult to see that his criticisms upon the subject were sincere and unbiased. "A noticeable improvement in musical taste, however, has resulted from the broadcasting of good music," admitted my host in reply to a query. "Although I have nothing to thank broadcasting for, I shall not condemn it altogether."



Mr. Cyril Scott.



PROVISIONAL PROTECTION

SOME ADVICE FOR THE AMATEUR INVENTOR

Have you any bright ideas? If so, it is quite likely that they may be worth money and should be protected. This article tells you how to go about getting patent protection.

By a Patent Expert.

MOST wireless enthusiasts have at one time or other, when working at their favourite hobby, been struck by some happy inspiration of an inventive nature which might be "worth a mint of money" if properly protected by Letters Patent.

Radio-science covers such a wide field of application that the scope for invention is practically limitless. Not only is this so, but wireless differs from most other technical industries in that the amateur who merely "messes about" with gadgets in his own home stands, in many respects, an equal chance with the fully-fledged engineer in his laboratory. It does not require expensive apparatus or an elaborate workshop to hit upon a brainy "wireless notion" that may find a wide market.

Many Opportunities

Problems connected with such things as high-powered transmission, or with systems of modulation or "Beam" signalling, must, of course, remain largely in the hands of the professional engineer. The amateur can hardly expect to compete on an equal footing in a field where there is so little chance of testing out one's ideas in practical form.

But on the receiving side the same handicap does not exist, and here the amateur "with an idea" may easily succeed in outstripping his professional rival. Many of the circuits which have won world-wide recognition, such as the Flewelling and Reinartz, represent the outcome of amateur ingenuity.

Even the Super-regenerator, the Super-heterodyne, and the Neutrodyne were evolved in the first place by private research, as distinct from being the outcome of organised staff-work in the laboratories of the big companies.

Again, when de Forest and Armstrong were working out the principle of reaction, they did so on apparatus that could be set up in any amateur's "den" just as well as in the most elaborately equipped laboratory.

Apart from the admittedly difficult problem of discovering some new circuit principle which may result in

improved selectivity, or give a greater degree of amplification than any receiver yet known, there is plenty of scope for the ingenious amateur in designing new gadgets, such as wave-traps and where to put them, compact intervalve coupling-units, methods of tuning-control, valve-protecting devices, automatic and remote-control switches, and a hundred and one other things which may help to improve the operation or lessen the running costs of the ordinary broadcast receiver.

The Amateur's Attitude

The keen amateur knows exactly what he or the "other fellow" wants better perhaps than the big companies, because he is so much

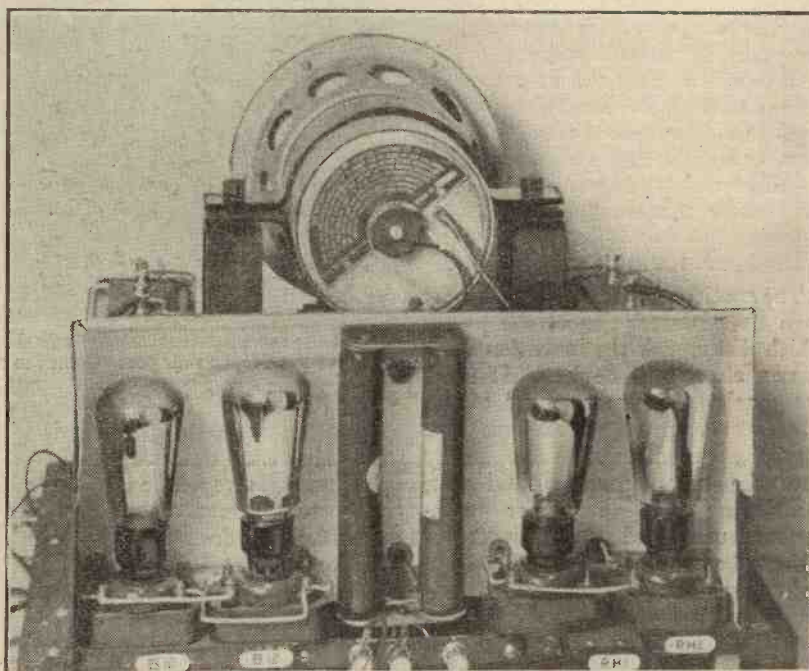

The B T.-H. moving-coil speaker equipment is the result of many patents covering various points of design.

at home with the apparatus in use and the particular problem to be solved.

Suppose that he should be lucky enough to hit upon a valuable improvement, either by some happy chance or after a long spell of deep thinking and hard work, how is he to set about the job of trying to protect himself by taking out a patent?

“Half-Way” Measure

To most people this is an undertaking that is largely wrapped up in technicalities, legalities, and expense. To some extent this conception is true. Before an inventor can obtain full patent protection he must prepare a written specification in which the invention is fully described and illustrated, and in which the essential features of the invention are clearly set out in the form of definite claims.

This is, of course, skilled work, and the more ingenious and far-reaching the invention appears to be, the greater is the desirability of leaving the drafting of the final patent specification in the hands of the skilled professional agent.

Unfortunately this is bound to cost money, and in the case of an inventor with more brains than capital the expense involved may well prove an insuperable obstacle.

But there is a half-way measure which may help to save the situation. It is known as securing Provisional protection. This can be done by filing at the Patent Office a Provisional or preliminary Specification in which it is only necessary to set out the nature of the invention in comparatively broad terms.

Such a document can be drawn up by anyone who has the mental equipment necessary to produce the invention in the first place, provided the following simple rules are carefully borne in mind.

Brief Description Required

The specification should be confined to a short description of the points which distinguish the invention from known circuits or devices. It must not consist of a mere recital of the advantages of the invention, but should state definitely but briefly how the new circuit is laid out, mentioning the particular components used and their circuit relation to each other.

In the case of an improved “gadget” the inventor should describe how the device is constructed, i.e. what are its component parts, and also what exactly it is used for.

For instance, taking the case of the Reinartz circuit, a description on the following lines would be sufficient for a Provisional Specification.

“My invention relates to a new method of introducing reaction in a thermionic valve circuit. To do this I divert some of the H.F. energy from the plate circuit of the valve on to the grid of the same valve through a shunt path comprising a condenser and an inductance in series, a choke coil being inserted between the H.T. supply and the plate of the valve. The inductance in the new reaction circuit may be coupled to the ordinary input or grid inductance of the valve.”

It will be noticed that the novel points are clearly specified, and that although only one arrangement is described it covers the essential principle of the invention.

Such a Provisional Specification usually requires no drawings, and is not really difficult to draw up. The stamp fee is only £1, and in the case

During this time he can safely approach manufacturers, or any capitalist friends he may have, and explain to them the nature of his invention in order to convince them of its merits and persuade them to assist him in placing it on the market. Once he has secured Provisional protection he can safely disclose his idea without danger of having it stolen, because his Provisional Specification is already safely on record at the Patent Office and cannot be forestalled.

The “Complete”

The full Patent grant involves the preparation of a complete description and drawings, and the drawing-up of a carefully worded statement of claim. This is a matter which in most cases is best left in the hands of a Registered Patent Agent.

If during the nine months’ period allowed by the filing of the Provisional Specification the amateur inventor

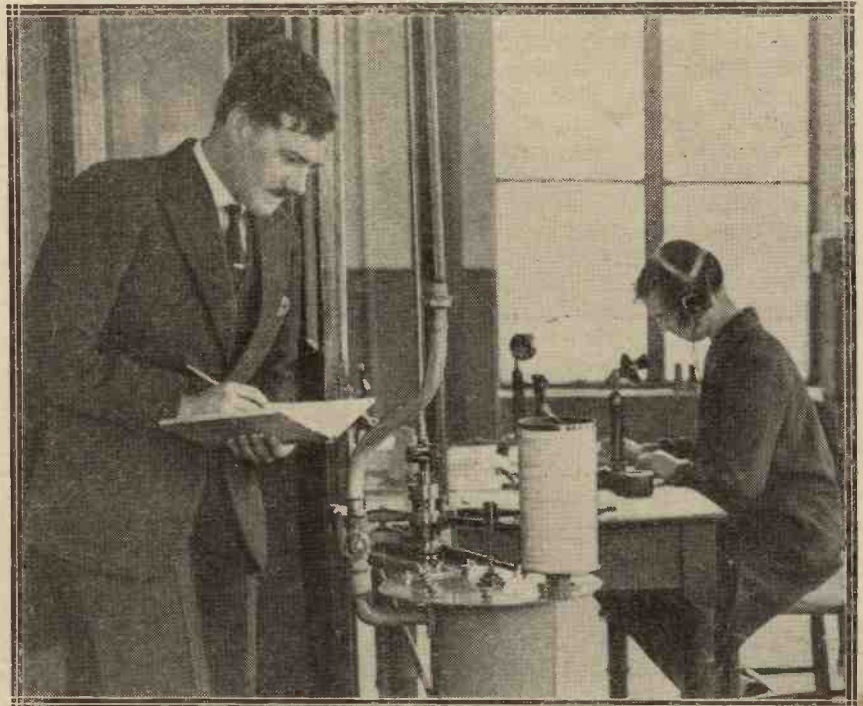

One of the special patent meteorological instruments for the creation of weather condition maps at the Croydon air port. Upon the accuracy of these weather charts largely depends the safety of the air liners.

where the inventor prepares it himself there is no other expense.

It must, however, be borne in mind that the filing of a Provisional Specification does not give the inventor the status of a patentee. What it does is to hold his future rights in safe keeping until the inventor is in a position to complete the necessary procedure, provided he does so within nine months.

should discover that he has been unduly optimistic regarding the commercial value of his invention, or should he find out by subsequent inquiries that he has been forestalled by some earlier inventor, he need go no further in the matter. In these circumstances the Provisional protection already acquired automatically lapses at the end of nine months.

Radio and the Gramophone

In this section of MODERN WIRELESS each month will be discussed both technical and other data of interest to the set owner who is also interested in gramophones.

Besides articles of a practical nature, a brief survey and critique of the latest gramophone records is included, making the section of vital interest to all music-lovers.

Conducted By **KEITH D. ROGERS.**

CONTENTS

	Page		Page
Round the Turntable	2	Record Wear and Tear	6
A collection of "odds and ends" of interest to radio and gramophone enthusiasts.		We all know that gramophone records wear out, but how many know exactly why and how? An interesting article on a subject that touches us all.	
This Month's Pick-up Programmes	2	Pick-up "Notes"	8
A representative collection of items specially chosen for their suitability for pick-up reproduction.		Test your pick-up reproduction by the records mentioned in this article. You will soon find how things are shaping.	
Picking Pick-ups	3	A Pick-up for 7s. 6d.	9
The choice of a suitable pick-up is not always a simple matter. This article gives some useful details concerning many of the pick-ups on the market, with valuable hints as to how to make your choice.		Details of an easily made instrument which is capable of surprisingly good results.	
		Recent Record Releases	10
		Our regular review of some of the records published during the month, written from the point of view of their suitability or otherwise for electrical reproduction.	

A New Industry

THE Wireless Exhibition at Olympia is over, and we are now rapidly settling down to a really good season of radio reception, while the evidence of the exhibition shows very strongly that the electrical reproduction of gramophone records is rapidly becoming a most popular addition to radio amongst wireless listeners and constructors.

That this would be so, some time or other, was a foregone conclusion when we first commenced this section, but the rapid development of pick-up construction, together with the introduction of really good loud speakers and valves capable of carrying a considerable input, without the need of colossal high-tension, has increased the popularity of electrical reproduction at a greater rate than was expected by the majority of the wireless trade.

Increased Efficiency

Many members of the wireless industry have expressed the opinion to us that during the next month or two they will have to devote the greater

part of their energies to the production of pick-ups, mains eliminators and amplifiers to go with them, and, indeed, the development of the gramophone pick-up has been rapid in the extreme, from the adapted earpieces of what seems only a few months ago to the advanced scientific designs capable of reproducing really first-class quality, and bringing out of the average gramophone record a tone and brightness which we hardly knew existed a few months back.

The Ideal Programme

Indeed, pick-up reproduction, if you have a good amplifier, is one of the great delights of owning a wireless set, and, moreover, it enables the oldest and poorest gramophone to be transformed into a producer of music that cannot be equalled by any gramophone on the market.

So look to your amplifiers, get good pick-ups, and add to your radio enjoyment with that marvellous cure of all broadcast programme grouches—the ideal home-made programme!

ROUND THE TURNTABLE



*A page of odds and ends
radio or gramo-*

*of interest and value to all
phone enthusiasts.*

The Needle Question

EVEN with the ordinary gramophone it is important that the correct type of needle should be used, and when the pick-up is being employed this need is even greater. It is often thought that in the average record and pick-up it is better to use a medium tone needle than a loud tone, and though in many cases where the damping of the pick-up is exceedingly great this may be true, when the pick-up is properly aligned and the damping is not too excessive then the "whip" which a soft needle or a medium needle may possess is more detrimental to the record than the use of a full-size loud needle.

* * *

A Fallacy

It is often said that a fine needle is less sensitive to foreign matter in the grooves than a loud one, and in

this way the scratch is reduced. To some extent this may be true, but it is usually found that soft needles do not alter the ratio between undesired noises and the reproduction of the music, and in many cases they result in a serious loss of brilliancy.

* * *

Fibre Needles Unsuccessful

Fibre needles are rarely successful with pick-up work. The writer usually employs the ordinary H.M.V. or Columbia hard steel needle of the loud type. In fact, he prefers to use an ordinary loud needle more than the permanent type such as the Petmecky or the tungstyle, although the latter is certainly useful for dance records, where one does not want to waste time changing the needle for every record.

* * *

Whatever type of needle you use it is best to put it fairly well in the

pick-up and not to leave a long portion of the needle sticking out from the needle chuck. This length of needle will tend to whip and cause havoc to the record, besides giving unnatural vibration to the pick-up, resulting in impure reproduction. It is better to grip the needle well home so as to keep it as rigid and as straight as possible.

* * *

Causes Rattle

Particularly awful is the result of a soft or medium tone needle when the record is a swinger, and as the tone-arm sways from side to side, the needle, of course, has more play in the grooves than in the case with a loud needle, and causes a very unpleasant rattle on the loud notes.

* * *

If you require really to use a medium needle, then you should put it well into the pick-up.

This Month's Pick-up Programmes

ORCHESTRAL.		SYNCOPIATED ORCHESTRAL.	
Prelude in E flat minor—Bach	H.M.V. D1464	Good News Selection	Col. 9482
Philadelphia Symphony Orchestra.		Debroy Somers' Band.	
L'Arlesienne—Incidental Music—Bizet	Col. 4988/92		
Orchestre Symphonique de Paris.			
Evening Lullaby—Squire	Col. 4983		
J. H. Squire Celeste Octet.			
LIGHT INSTRUMENTAL.		SYNCOPIATED VOCAL.	
Land of Hope and Glory—Elgar	H.M.V. C1529	Best Things in Life are Free	H.M.V. B2766
Reg. Foort and Royal Albert Hall Organ.		Jack Smith.	
Quartet in G Minor—Debussy	Col. L2141/4	Back in Your Own Backyard	Parlo. R187
Lener String Quartette.		Lily Lapidus.	
A Birthday Serenade	Bruno. 60010	'Varsity Drag	Bruno. 3832
Paul Godwin Orchestra.		Zelma O'Neal	
		DANCE RECORDS.	
		Wa-da-da	Col. 5006
		Paul Whiteman's Rhythm Boys.	
		Farewell	Parlo. R185
		Pavilion Lescaut Orchestra.	
		Adoree	Bruno. 3834
		Herbert Gordon's Whispering Orchestra.	
		HUMOROUS.	
		Sailing up the Clyde	Col. 9468
		Will Fyffe.	
		A Bedtime Story	H.M.V. B2780
		Wish Wynne.	
		MISCELLANEOUS.	
		Aldershot Command Torchlight Tattoo	H.M.V. C1552



The choice of an "electrical sound-box" is not an easy matter for the uninitiated. The following article discusses the various pick-ups on the market, and tells you what to look out for when comparing pick-up design.

By KEITH D. ROGERS.

DURING the recent radio exhibition I had ample opportunity of examining the various pick-ups and gramophone accessories that were being exhibited. Moreover, I



The Burndept "electrical sound-box." A good low-priced pick-up.

also had several opportunities of meeting my readers at the MODERN WIRELESS stand, where we discussed in detail the various points concerning pick-up reproduction.

It was made clear to me as well, at the same time, how very difficult it was for the average man to choose a pick-up; price seemed to be no indication of the actual value of the instrument, and unless he was an expert he seemed unable to predict how a pick-up would behave when in use on a record, and whether it would tear up the record or not.

The Main Features

Accordingly, I want in this article to run over some of the main points of a collection of well-known pick-ups, and to give some idea of what to

look out for, and what to avoid when making your choice of such an instrument.

There are three main factors which go to make bad record wear, and in choosing your electrical pick-up these should be borne in mind. The first is the sheer weight of the pick-up and tone-arm bearing on the record. The second is the angle at which the needle from the pick-up meets the record, in other words, the alignment of the pick-up and tone-arm, and, thirdly, the method of damping employed in the pick-up's mechanism.

With regard to the first feature, it is advisable to choose a pick-up arm which has some weight adjustment enabling you to vary the effective pressure of the pick-up and tone-arm upon the record.

In the case of the second, there are tone-arms on the market now which are so arranged that the pick-up track is practically straight on the record the whole way across; instead of traversing an arc it follows a

straight line from the edge to the centre of the record. This means that wear owing to bad alignment is

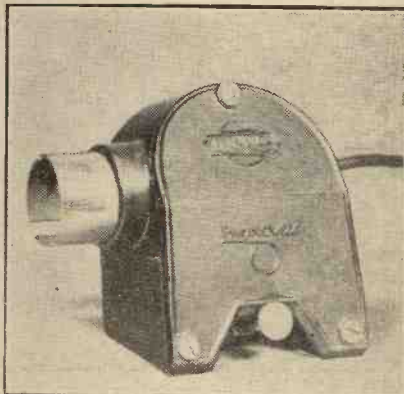

The Igranite "Phonovox" has recently been redesigned, though the old one (shown here) was capable of excellent results.

cut out, and centring of the pick-up and tone-arm is made much easier.

The last point, the damping of the pick-up, is a more treacherous one.

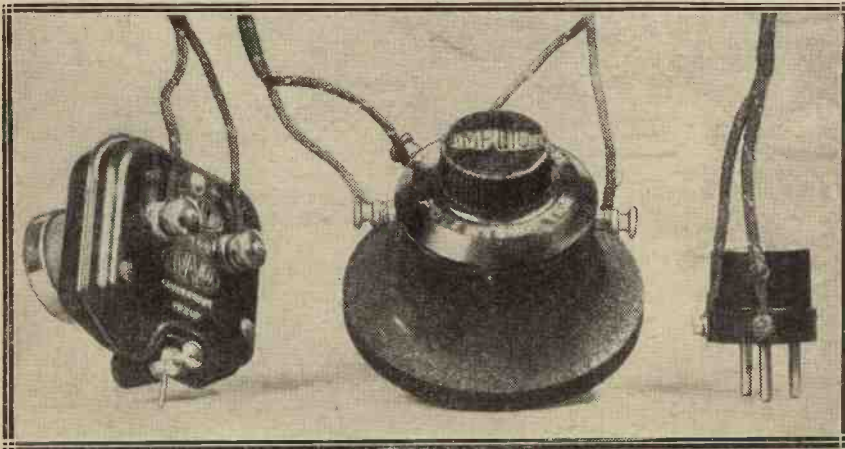

The complete Amplion Vivavox outfit is reasonable in price and efficient in operation.

It is difficult to tell at a glance, or by even feeling the mechanism of the pick-up and seeing how free the needle carrier is, to tell how much damage it will cause to the record.

Effect of Damping

Very highly-damped pick-ups sometimes wear the record considerably unless they are very carefully aligned. and so with regard to this matter of damping I would advise all my readers to make their preliminary choice between two or three pick-ups and then to hear these pick-ups on test and to see how they behave as regards the record.

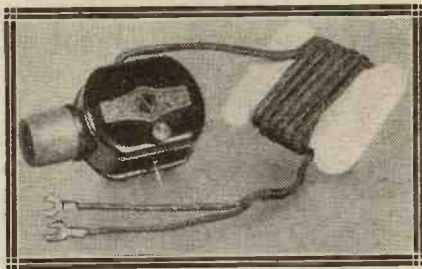

The Loewe pick-up costs 18s. 6d.

The question of tone and sensitivity does not enter into the problem quite so much, as sensitivity can be made up by amplification, and the tone depends partly on the loud speaker, but it must be remembered that very highly-damped pick-ups are very often a little bit deep and "woofy," whereas the lightly damped pick-ups are inclined to chatter and give undue prominence to the high notes.

These points must also be looked out for when the pick-up is heard on test, and as I have remarked before in this

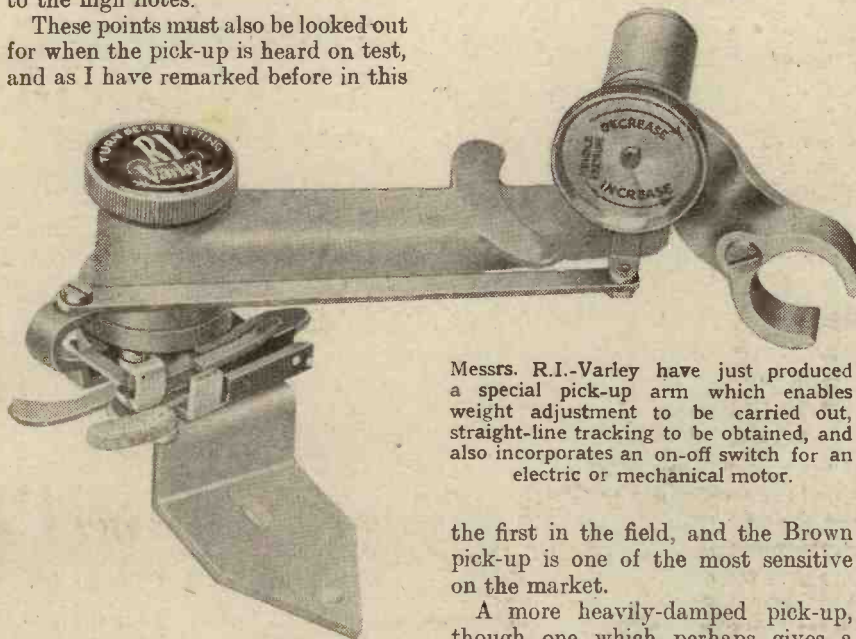

Messrs. R.I.-Varley have just produced a special pick-up arm which enables weight adjustment to be carried out, straight-line tracking to be obtained, and also incorporates an on-off switch for an electric or mechanical motor.

the first in the field, and the Brown pick-up is one of the most sensitive on the market.

A more heavily-damped pick-up, though one which perhaps gives a fuller reproduction of the bass notes, though with not quite the same brightness on the high notes, is the

And now let us run over a few of the features of some of the most prominent pick-ups. One of the earliest pick-ups on the

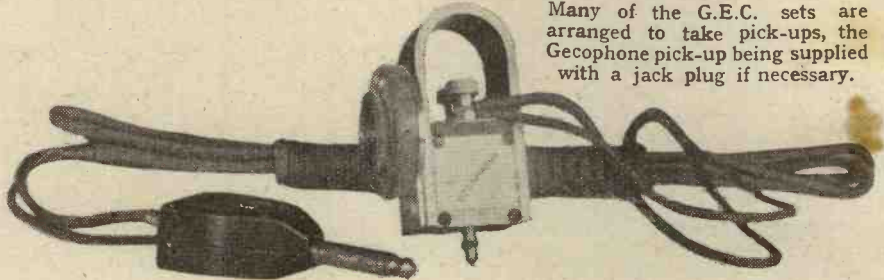

Many of the G.E.C. sets are arranged to take pick-ups, the Gecophone pick-up being supplied with a jack plug if necessary.

market was the Amplion, made by Graham Amplion Co., Ltd., and costing about 35s. This is a neat little instrument and is one of the more sensitive types upon the market. It is quite good on the high tones, though perhaps it is a little inclined to over-emphasise them. This, however, is not a fault that need be worried about as it tends to make the reproduction brilliant. The weight of the pick-up is not excessive.

High-Note Brilliance

One that is perhaps a little lighter is the Brown, which also is very brilliant on the high notes. This pick-up sells for about four pounds, although I believe a cheaper model at 28s. can be obtained. Noted for their excellent earphones and loud speakers, Messrs. Brown may also be said to have been noted for their pick-up. As usual they were one of

weight may be slightly decreased, thus minimising the wear on the record.

The sensitivity of this pick-up is very high, and it costs only 20s.

Adjustable Pick-Up Arm

Messrs. The B.T.-H. Co. have dealt with the weight problem of the pick-up in rather an interesting manner by employing a telescopic tone-arm which is fitted with a concealed spring acting as a weight counterbalance, and thus reducing the pressure of the needle on the record. Adjustment is carried out by varying the length



The B.T.-H. pick-up and adjustable tone-arm.

of the arm. Results when using this pick-up, however, which I understand is the type used on the Panatropé, are extremely good, and with the adjustable tone-arm the weight can be so reduced to a considerable degree.

Automatic Tracking

Messrs. Clifphone and Records had rather an interesting tone-arm on show down at Olympia, and this, if used with the B.T.-H. pick-up, is so arranged that the track of the pick-up is automatically kept fairly straight, and the needle is kept practically parallel to the groove across the majority of the playing surface of the record.

It consists of a parallel-action tone-arm attached to a supporting pillar, so that alignment is maintained throughout the majority of the track.

Complete with the pick-up this device costs £3. This tone-arm, however, has no adjustment for weight, although during a short test which I had I could detect no excessive wear on the record. I hope, however, to carry out further tests with this

section, good firms will give ample tests of their pick-ups before selling them to you.

YOU are the best judge of which TRANSFORMER to use

and Lissen believe you want to be free to choose your own parts and to replace them in a free market, and not be forced to pay any more than the price you choose when you come to renewals or alterations.

Lissen Offer You Two Transformers.

There is the famous 8/6 Lissen Transformer which has sold by the hundred thousand and has been used, it is safe to assert, in almost every known radio circuit during the two years since it was introduced. When Lissen produced this transformer, it was as good for every purpose as any transformer, however high in price. That is why it enjoyed such a huge popularity. Even now you cannot do better than try

*for general use
the famous model 8/6*

URNS RATIO 3 to 1.
RESISTANCE RATIO 4 to 1.

In a different field altogether is the new Lissen Super Transformer. If you want music on a background of utter silence, if you particularly require constant amplification over the whole band of audible frequencies, if you have a fancy to get the best value in transformers in this price field—in fact, wherever in your opinion a SUPER TRANSFORMER is called for, there it will pay you to use a

LISSEN

super transformer 19/-

RATIOS $3\frac{1}{2}$ to 1 and $2\frac{1}{2}$ to 1.

OBTAINABLE AT ALL RADIO DEALERS.

LISSEN LIMITED,

Friars Lane, Richmond, Surrey.

(Managing Director: THOS. N. COLE.)

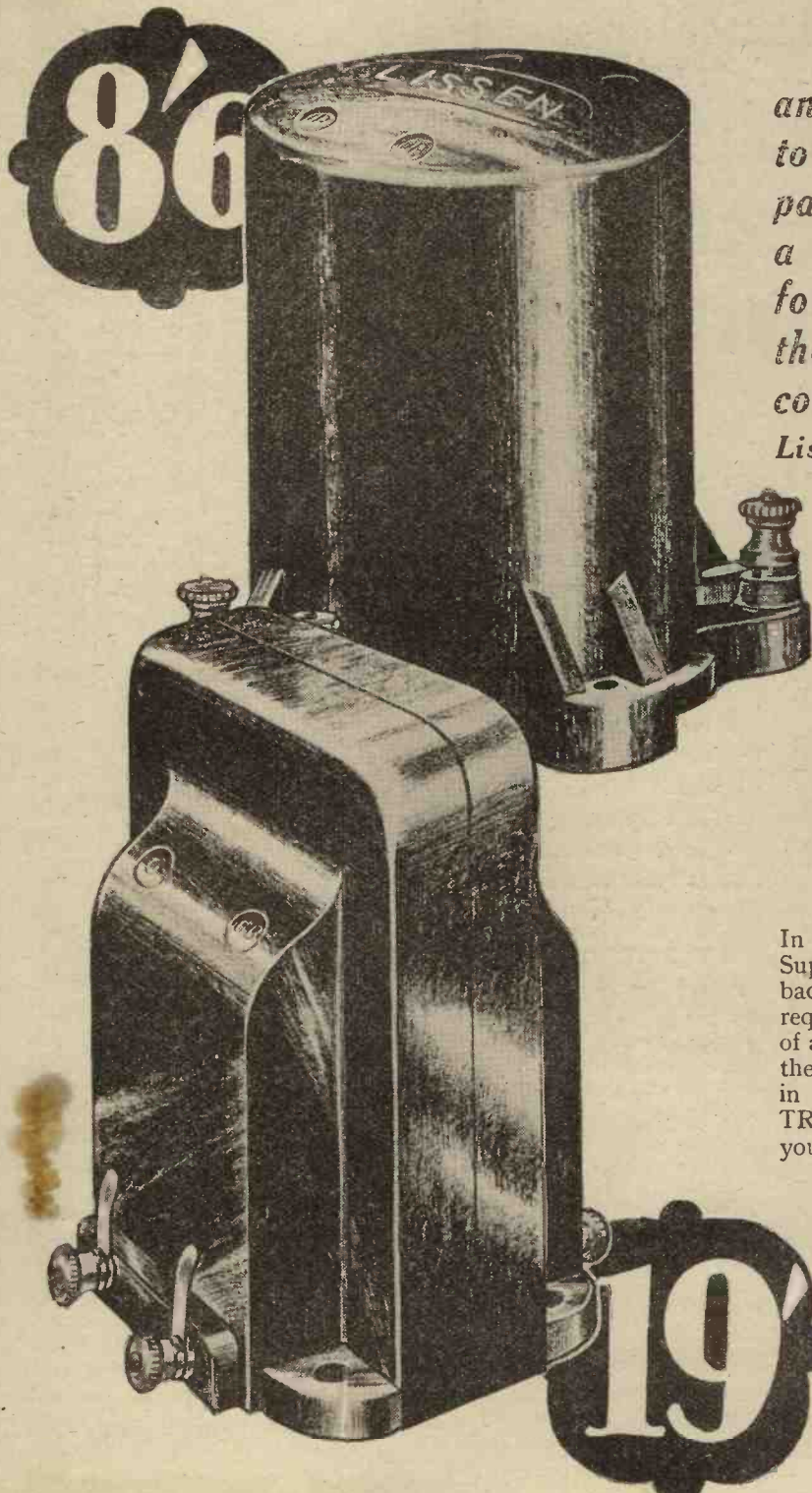

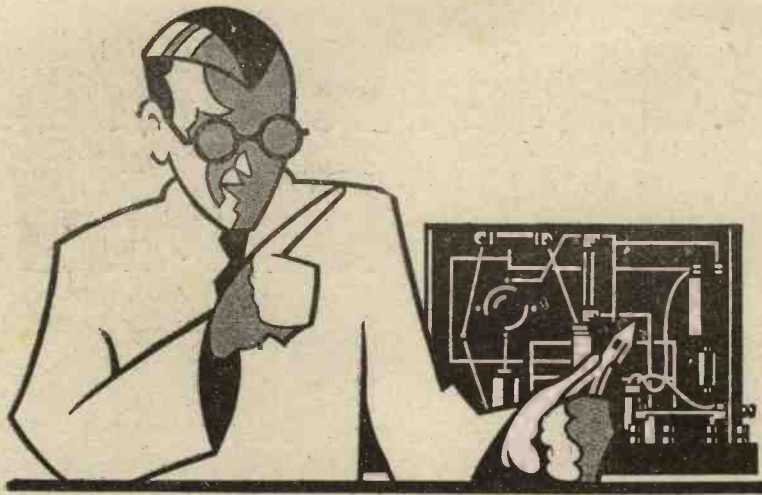

**don't blame
the programme!**

If your reception is faulty, probably a LEWCOS Coil is the remedy. Review your set and fit LEWCOS parts and you'll be surprised at the tremendous improvement in reception on all wavelengths. The reason is clear, for every LEWCOS product is subjected to the most searching tests and each part leaves the works—perfect.

**THE LEWCOS
STANDARD
LOADING COIL**

Can now be purchased through all Radio Dealers. Suitable for use in all circuits in "Modern Wireless" where the standard loading coil is specified.

LEWCOS
REGD.

**Radio
Products**

The London Electric Wire
Company and Smiths Limited,
Church Road, Leyton, London, E.10

Trade Counter and Cable Sales:—
7, Playhouse Yard, Golden Lane, E.C.1.

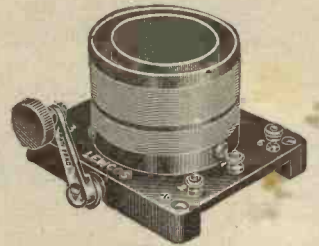

"Q" COIL.

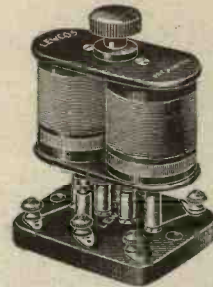

BINOCULAR COIL
(Pat. No. 277,876)

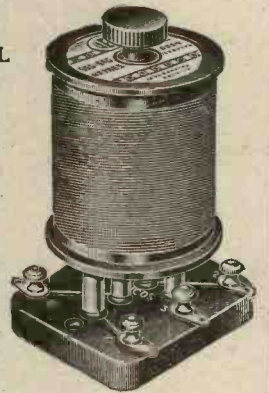

SIX-PIN COIL



CENTRE-TAPPED
COIL
(Pat. No. 271,384)

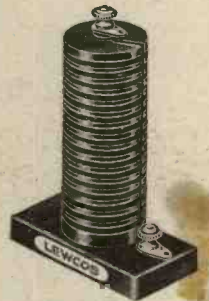

H.F. CHOKE

GLAZITE
BRITISH MADE

COLOURED CON-
NECTING WIRE

pick-up and tone-arm, when a report will be published.

The Dubilier pick-up is the only one which has the electro-static principle, and this also I hope to be able

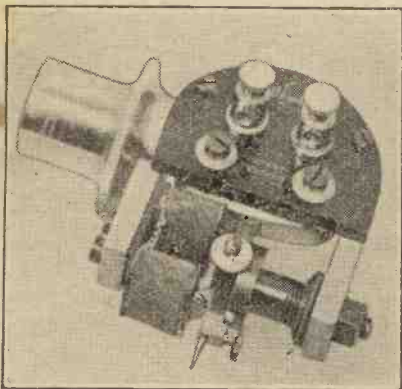

One of the most popular pick-ups is the Woodroffe which is shown here.

to review before very long. Among some of the other pick-ups which I have tested, and which can be recommended for the attention of readers, I might mention the Gecophone, the Lissen, McMichael, Igranic, the Loewe, and the Magnum, all of which are quite sensitive and suitable for use with an ordinary set.

The Loewe especially is a compact little pick-up which, selling at the price of 18s. 6d., is remarkable value money. The Lissen, perhaps, scores a trifle on the high notes, while the Gecophone and Igranic are good all-round quality pick-ups.

A New-Comer

Another great favourite amongst pick-up users is the Woodroffe, sold by the Celestion people at about four guineas, and is capable of giving very fine reproduction with well-balanced bass and high notes. The R.I.-Varley, a newcomer to the field, was introduced at the show, and is

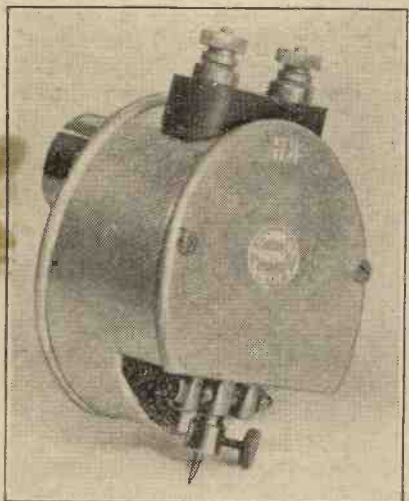

The Brown £4 pick-up which is very sensitive.

also rapidly becoming popular, and this is distinctly lighter than many of the others on the market.

Incidentally, Messrs. R.I.-Varley are bringing out a special tone-arm for their pick-up, which gives true alignment over the whole record, and also adjustable weight, besides little gadgets for automatically starting and stopping the motor according to the position of the tone-arm. The arm, I understand, will be on sale very shortly at the price of 35s.

Matter of Personal Choice

Now, although I have mentioned the various points of a certain number of pick-ups, it must not be taken that those mentioned are the only pick-ups on the market worth considering, nor must it be imagined that any preference of the writer for any particular one or other is either expressed or inferred. They are typical pick-ups as sold to-day, and it rests with the reader which he will use out of any of those mentioned, or any other on the market

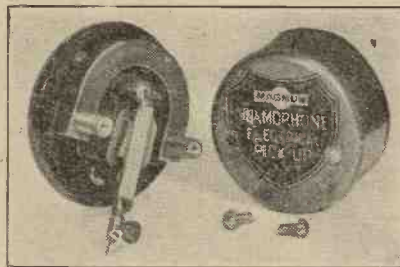

The "ins" and "outs" of the Magnum pick-up (Burne-Jones).

which the writer has not yet had the pleasure of testing.

It is largely a matter of personal choice. If a pick-up is particularly "bright" it may suit one person and not another, whereas if the pick-up emphasises low notes at the expense of the high notes, it may suit the other person. It depends upon the personal likes and dislikes of the prospective purchaser, and upon his loud speaker and amplifier.

A Test Essential

There is only one point which I really want to emphasise, and that is that before you purchase any pick-up, no matter what the make, you should hear the thing in action and see it work. Notice the effect upon the record and its dealing with the various musical frequencies which are contained in that record.

The foregoing article is merely a guide, giving a rough idea of types and prices and appearances. It

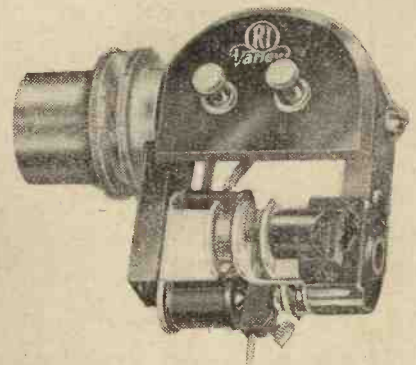

The new R.I. and Varley dual mass suspension pick-up (£3 3s.) which employs an exceedingly novel method of suspension which does away with the need for heavy damping.

rests with the reader which he will use, and his decision can only come after he has heard the various pick-ups which take his fancy.

Finally it must be recognised that it is unfair to test any pick-up with the lid of the gramophone open or on a portable gramophone if the pick-up and loud speaker are in the same room. The chatter of the pick-up itself will cause you to imagine that it is distorting, and will spoil the reproduction for the loud speaker.

It is essential for best results under those circumstances that the gramophone have a lid, and as sound-proof a lid as is possible. The ordinary lid can be improved by lining both the edge of the lid and the edge of the cabinet with felt, stopping up the sound chamber and drilling small holes at the back to take terminals, so that the leads from the pick-up do not have to go through the cabinet or keep the lid ajar and thereby release a certain amount of the chatter.

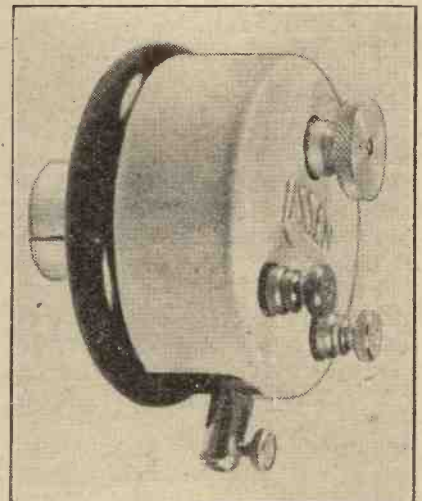

The Lissen pick-up is a simple but sensitive instrument. It costs 15s.

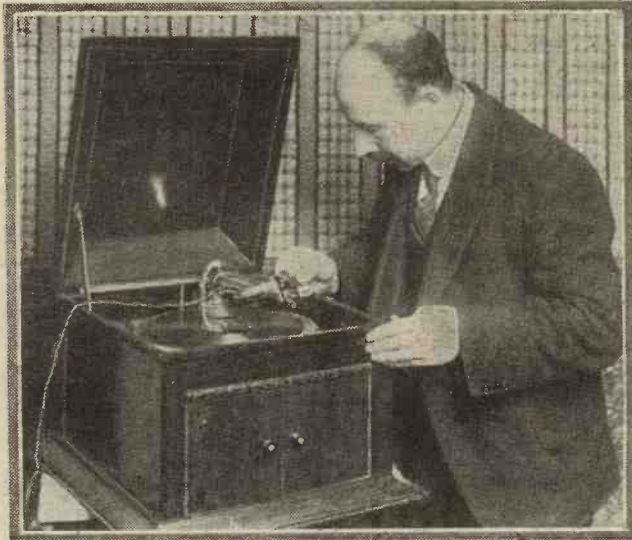

RECORD WEAR AND TEAR

We all know that all gramophone records wear out, but how many know exactly why and how?

*An interesting article on the subject by
Dr. J. H. T. ROBERTS, F.Inst.P.*

IF you possess a library of gramophone records, there are sure to be some which you prize more highly than the others. This may be because they cost more in the first instance, or because they happen to be selections of which you are particularly fond.

Whatever the reason may be, these favourite records are played more rarely and with more care and circumspection than the rank and file.

Why? Because you realise, consciously or unconsciously, that your records have a *limited life*, and that every time you play them you take out of them something which cannot be replaced.

In spite of all your precautions, you cannot make your records last indefinitely; but, at the same time, by following out certain simple rules, you can get a much longer life from them than would otherwise be the case.

Wear is Inevitable

The wear and tear of the record is inevitable, inasmuch as there is a definite mechanical and frictional engagement between the moving record surface and the stationary needle. Wherever there is friction there is bound to be wear, and our object, therefore, must be to reduce the friction to the minimum.

Since the needle is usually made of steel, whilst the record surface consists largely of shellac, you may be sure that the total wear on the record is considerably greater than the wear on the needle.

At first you will probably be inclined to disagree with this statement, since the wear upon the needle after playing a record only once is apparent to the naked eye, and

is very easily observable under a magnifying glass, or other form of low-power microscope, whilst the wear upon the record produced by a single playing is not noticeable.

Inasmuch, however, as the material of the needle is so very much harder than that of the record, and since the needle is also tough as well as being hard, it is quite certain that the record suffers more than the needle; and the reason you notice the wear and tear upon the needle so much more than that upon the record is simply because the area of

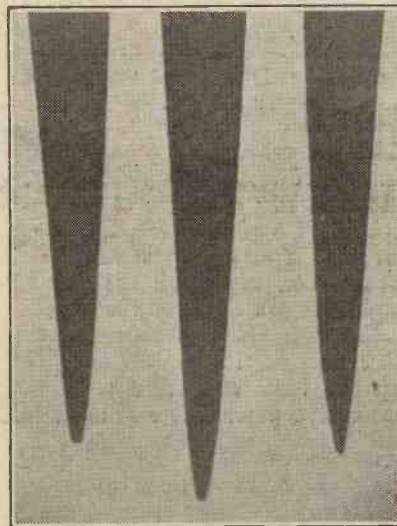

The "soft-tone" needles, showing gradual taper. Note how the actual points differ in shape.

the tip of the needle is extremely small, and therefore the removal of a given amount of material is readily apparent, whilst the area of the record is very large, and therefore the removal or dislodgment of a much greater amount of material may be imperceptible.

However, although it is interesting scientifically to try to visualise what is actually taking place between the needle and the record, what we are really concerned with is the fact that the record surface is being gradually broken down and the means which we may adopt to minimise this effect as much as possible.

When a fresh needle is inserted into the holder of the sound-box, or pick-up, the needle point does not accurately fit the sound groove on the record, and during the first few revolutions of the record the needle point is being rapidly "ground in" to the same shape as the groove.

Grinding Down the Needle

The discrepancy between the shape of the needle point and the shape of the groove is therefore much greater for the first few tracks than it is afterwards, and this is one of the reasons why the "commencement" of a record soon becomes much more "scratchy" than the rest. The opening portion of the record is continuously having thrown upon it the unpleasant task of "grinding in" fresh needles (or, what is worse, used needles turned the wrong way round) to the proper shape to fit the sound groove.

If you are using steel needles—that is, needles which are not of the extremely hard or so-called "indestructible" variety—it is very clear that you should use a fresh needle for each playing of a record; or, in the words of the manufacturers, "use each point once only."

Effect of Damping

In the case of the ordinary sound-box method (or non-electric method) of reproduction the whole of the energy which is necessary for the production of the sound is derived

The valves which maintain their emission throughout life

EDISWAN

HIGH EFFICIENCY VALVES

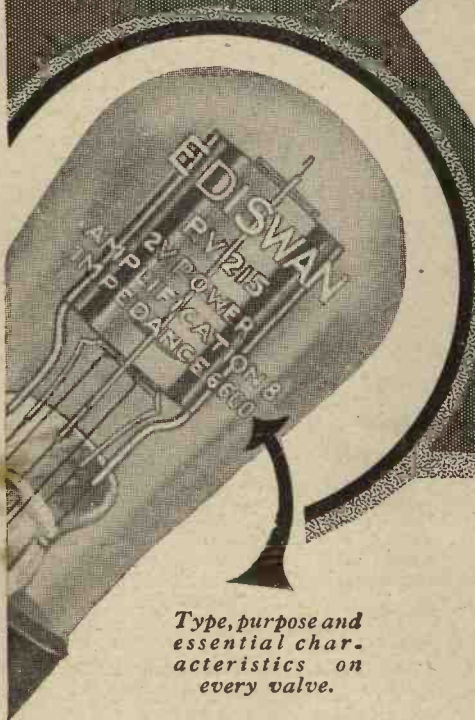

Type, purpose and essential characteristics on every valve.

The very complete range of Ediswan Valves includes Screen Grid, Pentodes and A.C. Mains Types.

The most complete and useful catalogue of receiving valves ever produced is available to you on request to The Edison Swan Electric Co. Ltd., Publicity Dept., 123/5 Queen Victoria Street, London, E.C.4.

MANUFACTURERS OF THE WORLD'S FIRST RADIO VALVES

from the swaying of the needle point by the wavy sound-track.

The damping effect of the sound-box diaphragm—due partly to the radiation of energy in the form of sound-waves, partly to energy losses of various kinds, and partly to other causes—throws a load upon the needle and record groove which, in turn, has its effect in the wear and tear upon the sides of the sound-track. Naturally, the needle would prefer to follow a plain course without being deflected from side to side, and consequently it rubs with considerable force against what I may call the "convex" wall of each wavy part of the track.

How "Heavy" Should it Be?

You can easily visualise this if you imagine a barge trying to travel rapidly through a very wavy canal. The barge will tend to strike the bank of the canal at any point where the bank juts in so as to deflect the barge from a straight course, and the barge will strike the bank at each indented or convex part.

The question is often raised as to whether it is better to use a heavy sound-box or a light one, and also as to the pressure (or, to be more accurate, the force) with which this should be allowed to bear upon the record surface.

The greater the force between the needle and the record, obviously the greater will be the tendency to wear. It is necessary, however, to have a

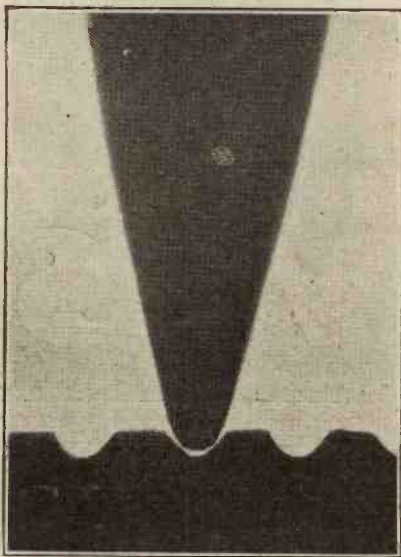

A new needle, placed in position on surface of record. Note that the point of needle does not fit the sound groove, and has yet to be "ground in."

certain force between, the two in order to ensure proper engagement of the needle point with the sound groove and so as to prevent the needle from

simply floating along the surface without having the necessary vibratory motion properly imparted to it.

When using the ordinary gramophone or non-electric method of reproduction, greater loudness is usually obtained by using a shorter or stouter needle. This simply means

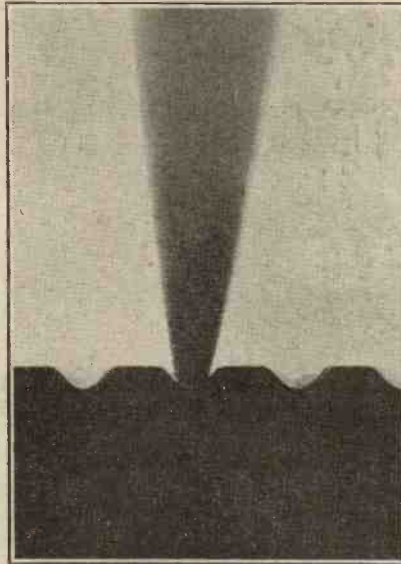

A needle after playing half the record. Note how the tip of the needle now fits the groove.

that the actual amplitude of vibration of the sound-box diaphragm is increased, but it is easy to see that this again means fiercer engagement between the needle point and sound groove, with a correspondingly more rapid rate of wear or disintegration of the record.

Advantage of Pick-ups

It is for reasons such as these that the more recent electrical method of reproduction is such a boon, because this electrical method enables us, having taken up a very small amount of energy from the record, to augment that energy (by means of valve amplifiers) without in any way throwing any extra load upon the record itself. This is indeed the proper scientific method of handling the problem, and it would doubtless have been introduced much earlier had radio amplifiers and loud speakers been earlier in common use.

Reverting again to the question of the weight of the sound-box or pick-up, you will see that when using an ordinary sound-box, and especially if you want extra volume, you are bound to have a reasonably large force between the needle and the record, and therefore it is impossible to reduce the weight of the sound-box (by counterbalancing or otherwise) too much.

With the electrical pick-up you can arrange a degree of mechanical engagement between needle and record which, with an ordinary sound-box, would correspond to an extremely feeble volume of reproduction.

Effect of Lightness

The use of a light reproducer, whether the electrical pick-up or ordinary sound-box, often means a smaller signal strength, and I have many times been asked what is the reason for this effect.

The first reason is that, owing to the smaller force between needle and record, the needle does not enter so firmly into the grooves, and therefore does not follow the waves of the track so effectively.

The second reason is one which perhaps might not occur so readily to your mind. When the needle is oscillating, it tends also to set the sound-box as a whole into corresponding vibration. The signal strength, however, depends upon the relative motion between the needle system and the sound-box or pick-up. If the sound-box is light in weight it will not, as it were, "stand still" sufficiently, and therefore the relative motion will be less.

You see, then, that a light sound-box or pick-up will generally give a

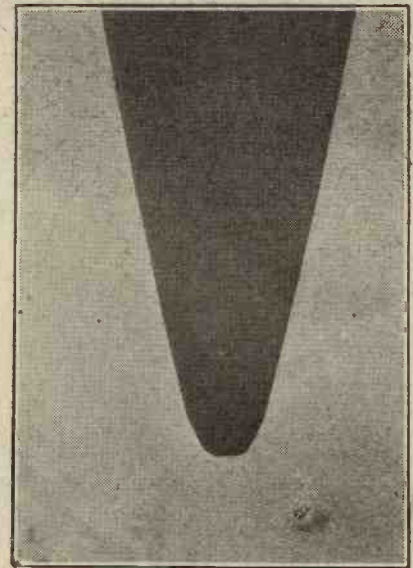

The end of a "very loud" needle, showing stout form. This needle has played a record with "U" track, and has been rounded at the tip.

feebler reproduction for the above two reasons. You can, however, obtain the advantage of a fairly heavy reproducer without undue force upon the record by the very simple method of counterbalancing some portion of the weight of the reproducer.

LET YOUR EARS JUDGE—

Your ears will tell you—more surely than any curve—that the Mullard “Permacore” Transformer gives pure amplification.

Build the Mullard “Permacore” Transformer into your receiver—use it for first or second L.F. stage—and you take the surest step to better radio.

The special core material of high permeability, the non-corroding silver primary winding of high conductivity, the nickel secondary winding which prevents resonant peaks at high frequencies, all contribute to the remarkable purity and richness of tone enjoyed by users of the Mullard “Permacore” Transformer.

Modernise your old receiver by fitting a Mullard “Permacore” Transformer—and use it in every new receiver you build.

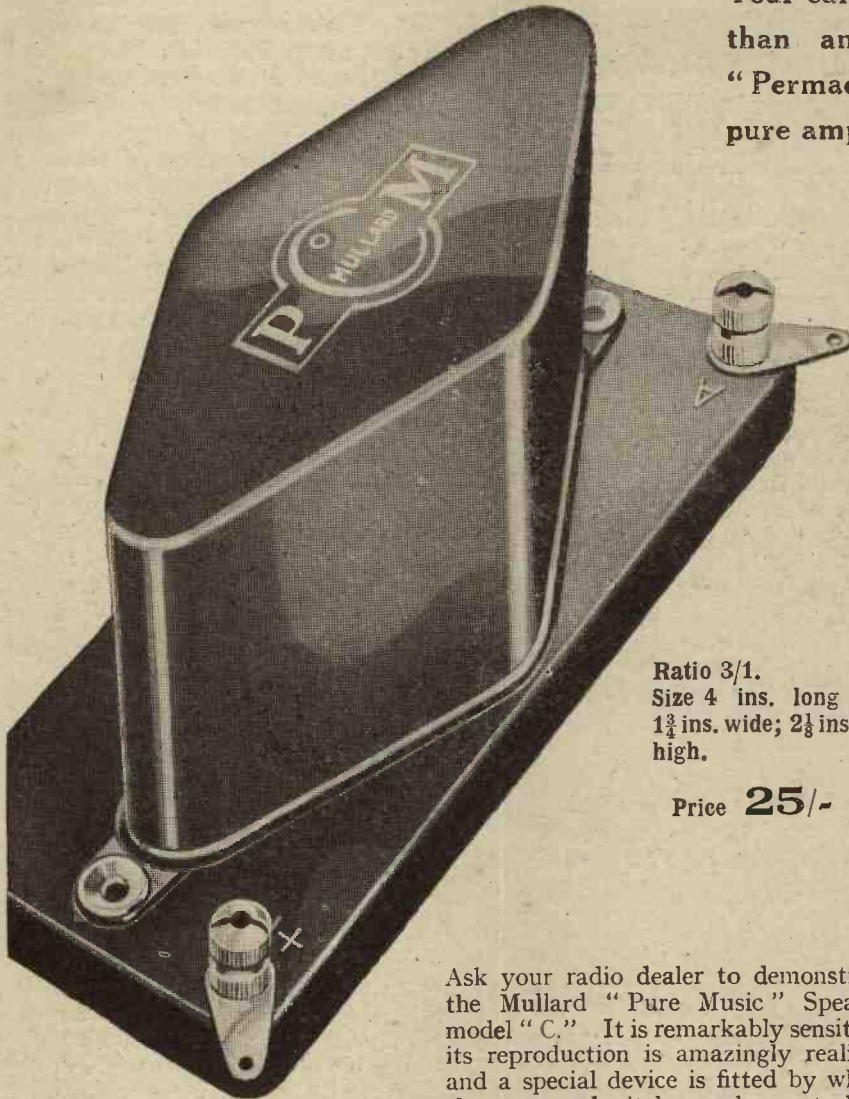

Ratio 3/1.
Size 4 ins. long ;
1 $\frac{3}{4}$ ins. wide; 2 $\frac{1}{8}$ ins.
high.

Price 25/-

Ask your radio dealer to demonstrate the Mullard “Pure Music” Speaker model “C.” It is remarkably sensitive, its reproduction is amazingly realistic and a special device is fitted by which the tone and pitch can be controlled. An easel type support makes the speaker suitable for hanging or standing.

Mullard “P.M.” Speaker, Model “C”

53/6



Mullard

MASTER · RADIO

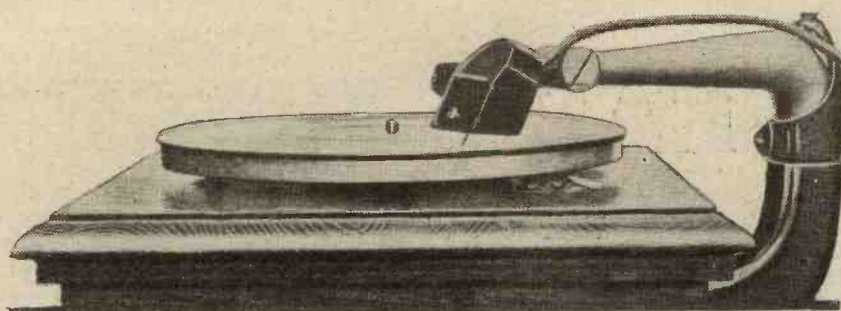

PICK-UP "NOTES"

Is your pick-up working properly? Test it out by the records described below.

By A. G. McDONALD, B.Sc., A.C.G.I., A.M.Inst. C.E.

IT is frequently desirable, when testing the performance of a pick-up and its associated amplifier and loud-speaker equipment, to try its response over a limited frequency band. An amplifier will, perhaps, overload on bass notes or will cut them off altogether, but will reproduce faithfully tones above, say, 256 cycles.

A suitable set of records to assist the experimenter to find out exactly what is happening is "Instruments of the Orchestra." These have been re-recorded by Columbia on Nos. 9421-2; the corresponding H.M.V. series is C.1311-2. Both sets are extremely well done.

On these records each instrument plays a short tune, which has been selected to show the instrument's range and characteristic tone. Some sections, notably those of the double bass, contra bassoon, bass trombone, tuba and tympani, provide music entirely in the bass register. Thus if you play over these sections you can settle quite definitely whether your outfit will deal satisfactorily with low notes.

Testing the High Notes

For testing in the upper register, the violin, piccolo, harp and celeste sections can be used. Incidentally many of the instruments are so well recorded that reproduction on good equipment is positively uncanny in its realism.

The success of Eva Turner at Covent Garden naturally draws attention to her records. The two latest—issued by the Columbia Co., D.1619, "In questa Reggia"; and D.1578, "Ritorna Vincitor"; selections from "Turandot" and "Aida" respectively—are splendid specimens of her art.

The most noticeable feature of these arias is her sustained, clear voice-production on the high-note passages. Both of these records reproduce well on a pick-up. Gall-curci and De Luca are well known to record collectors, and in "Imponete" and "Dite alla giovine," from La Traviata (H.M.V. D.B.1165), they appear at their best. In this record Gall-curci appears to sing with more feeling than she has done in some of her earlier records. The voices are well-balanced; and the recording, which is vigorous in character, does justice to the opera.

Instrumental Records

Of the instrumental records, Kreisler's "Syncopation" (H.M.V. D.A.691), a composition of his own, is a good record. Although the subject is, perhaps, not on as high a level as one would expect from a genius of Kreisler's standing, it is, nevertheless, a delightful piece of work.



The Crosley "Merola" pick-up—of American make—has a heavy stand and combined volume control which enables it to be used without requiring mounting or disorganising the gramophone in any way.

The Columbia Co. have issued a set of four records of Greig's piano concerto, played by Friedman, and an orchestra under Phillippe Gaubert (9446-9). Friedman's performance is a brilliant exposition of a very popular classic.

The tone of the piano is natural, although the recording is distinctly loud. The listener's attention is held throughout the whole of the four records. The balance between the piano and the orchestra is well maintained.

In the Parlophone series the Second Hungarian Rhapsody (E.10725) is well played and excellently recorded. Another good Parlophone record is E.6042, "The Entry of the Gladiators," played by a massed military band. The volume from this record is very great.

In Lighter Vein

Of records of subjects lighter in character probably those of Gracie Fields are as popular as any. Her latest records, "Our Avenue" (H.M.V. B.2758), and "We're Living at the Cloisters" (H.M.V. B.2739), are both excellent and should be very popular. Sophie Tucker has had a remarkable success as a music-hall artist, and perhaps her finest record to date is "He's Tall, Dark and Handsome" (Col. 4942).

Foster Richardson has recently recorded the "Four Indian Love Lyrics" for the Zonophone Co.

Negro spirituals continue to be as popular as ever. Paul Robeson contributes two on H.M.V. B.2771, "Scandalize My Name" and "Sinner Please Doan' Let Dis Harves' Pass," which are good examples of his style. Layton and Johnson have also entered this field, and their record, "Every Time You Feel the Spirit" (Col. 4939) is quite up to their usual standard. It is all to the good that they should record subjects likely to be more permanent in character than their usual fox-trot chorus.



3024. THE BRITISH THOMSON-HOUSTON CO. LTD.

Still
the best Horn
LOUD SPEAKER

PRICE
1925-£5.0.0
1926-£3.0.0
1927-£2.10.0
TODAY-£2.5.0
and better than ever

B T-H C2 LOUD SPEAKER

The above price is applicable to Great Britain and Northern Ireland only



A little instrument which, though not intended to compete with the products of pick-up manufacturers, is capable of surprising results.

By G. T. KELSEY.

THE weird-looking contraption illustrated in the accompanying text is nothing whatever to do with Heath Robinson, and is not in any sense of the word a joke.

I feel that such an introduction is necessary in view of its appearance, for I am ready to admit that at first sight I should feel very much inclined to treat it as such myself!

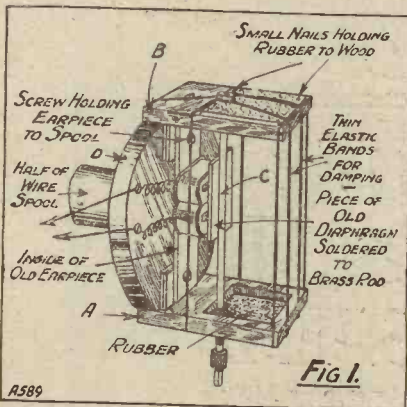

But the assembly (I prefer to call it that) is actually a pick-up which, costing less than 7s. 6d. to make, can be used quite successfully for playing the gramophone through the loud speaker.

Cheap "Components"

Do not expect for five shillings or so an instrument comparable to some of the leading commercial pick-ups. That would be expecting rather too much, but in all seriousness this home-constructed effort does give surprisingly good results.

The "components" consist of a wooden wire spool, two pieces of four- or five-ply wood, an old earpiece (the windings must be intact and of high resistance), a piece of brass rod, a

small piece of sheet iron (a diaphragm will do), two pieces of fairly stiff rubber about $\frac{1}{2}$ in. thick, a holder for the needle and some thin elastic bands.

Commencing with the wooden spool, this should be cut in half and two flat surfaces should be filed on the circular end-piece as shown at D in Fig. 1.

The projecting piece of the spool should be filed down until it makes a tight push fit into the gramophone tone-arm, and incidentally it should be cut down in length until when pushed as far as it will go into the tone-arm the circular end-piece comes flush against the tone-arm.

The magnets and bobbins should next be removed from the earpiece, which, if you have not already got one, will be obtainable for about four or five shillings. The way in which these are fixed to the wooden spool is shown in Fig. 1.

Fixing the Armature

An idea of the shape of the two wooden supports can be obtained from Fig. 2; but the actual dimensions of the openings will depend upon the depth of the bobbins in use.

The rectangular hole in each support can be cut out quite easily with a fretsaw, after which the supports can be secured by screws to the flat surfaces of the spool.

We next come to the rubber supports which fit over the holes in the plywood. These should, of course, be slightly larger than the holes over which they are to fit, and in the original it was found most convenient to hold them in position with small brass brads.

Only the top one is fixed in position at this stage, the reason for which will be apparent later.

The welding of the brass rod and the small piece of iron forms the next operation. This latter, which, if desired, can be cut from an old diaphragm, should be sufficiently wide and long to cover the ends of the bobbins, and it is fixed to the brass rod by means of solder.

The Needle Chuck

If you happen to be in possession of an old sound-box, the difficulties of obtaining a suitable needle holder will soon be overcome, but when making the original I was not quite so fortunate, and consequently it was necessary to press into service one of those split brass knobs such as may be found at the back of almost any old clock.

The holes for the brass rod in the top and bottom supports should be so arranged that the iron plate is about $\frac{1}{2}$ in. away from the bobbin magnets.

The two nuts at the top serve to hold the brass rod quite secure at this end, but at the needle end the hole should be just sufficiently large to allow the rod to move sideways reasonably easily, and, having secured the top, the bottom rubber can now be passed over the rod and secured.

For extra damping the four elastic bands come into use (see heading photo).

The pick-up is now ready for use and the two ends of the bobbin windings should be joined across the grid and filament of the input valve.

In conclusion, I would just mention that the iron plate, although close, should never actually touch the

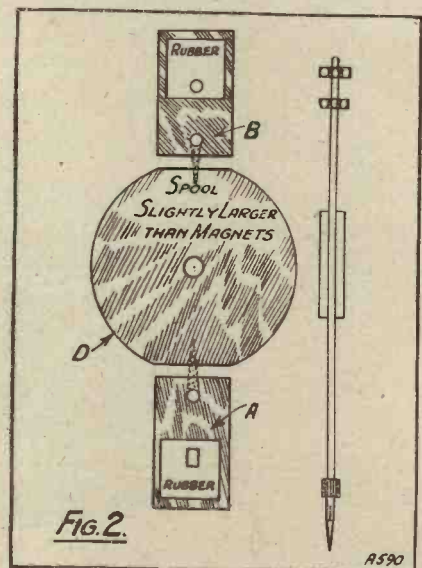

magnets, even when the brass arm is vibrating in sympathy with the vibrations on the record.

THE FERRANTI SPEAKER

*Let the Ear
decide!*

When choosing *your* loud speaker endeavour to forget all questions of horn v. cone.

Give your ear a chance! Listen to the Ferranti speaker on broadcast speech or music. Be as critical as you like; compare with any speaker you like, irrespective of pattern.

Then, when you've listened, LOOK! Just as the ear tells of reproduction supremacy, so the eye will tell of constructional perfection.

Built on the unrivalled exponential system, the Ferranti is exceptionally robust throughout. All metal parts are non-rustable, and the use of heavy-gauge wire for the windings gives immunity from breakdown without loss of sensitivity.

A truly remarkable speaker, capable of truly great performance; but then, it's a Ferranti production.

£3-3-0

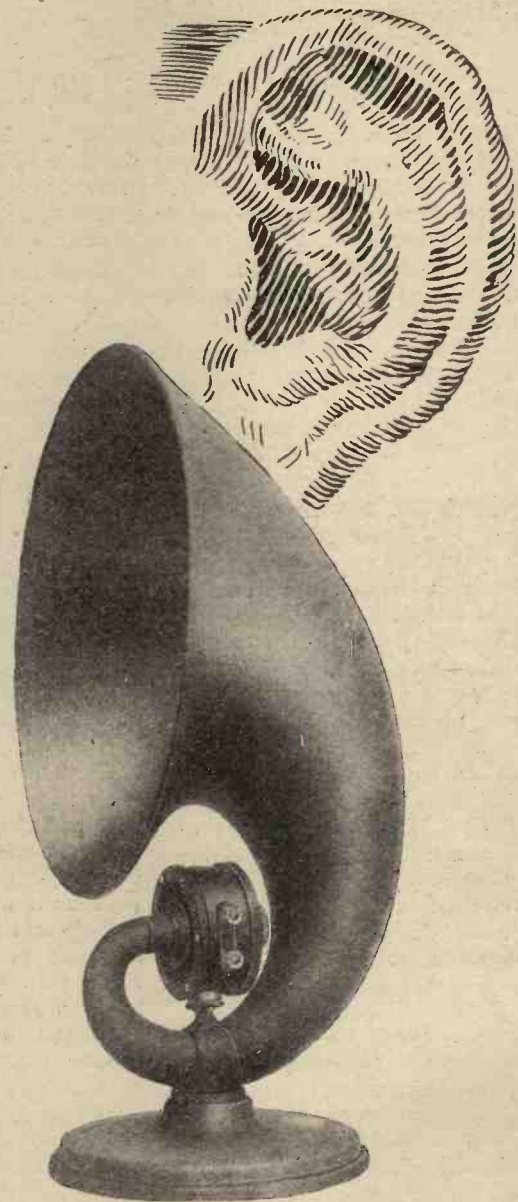

FERRANTI LIMITED
HOLLINWOOD LANCASHIRE

RECENT RECORD RELEASES



British Brunswick

The records turned out by this enterprising firm are getting better and better, and among this month's releases are some of the best recordings we have heard.

A notable example is *A Wedding Serenade* and *A Birthday Serenade*, by the Paul Godwin Orchestra (60010. 12 in. 4s. 6d.), which is perfectly played and perfectly recorded. It is a treat to hear them reproduced by a good pick-up outfit.

Further "recommended" records are *Melody in F* and *Waltz in C Sharp Minor* (Chopin), by Leopold Godousky on the piano (15137. 10 in. 5s. 6d.), and *Can't Help Lovin' Dat Man*, with *Ol' Man River*, Organ Solos by Archie Parkhouse—another very good disc (193)

Among the lighter items the best is probably that of Zelma O'Neal, the "Good News" Star, singing *The 'Varsity Drag* and *Can't Help Lovin' Dat Man*. The former, of course, is her star number, and her personality comes over as well as it does in the actual theatre—a triumph of recording (3832. 10 in. 3s.).

Of the dance numbers we like best Herbert Gordon's Whispering Orchestra in *It Was The Dawn of Love* (F.T.) and *Adoree* (F.T.), both of which are excellent from the recording and orchestration point of view.

Broadcast

The Vocalion Gramophone Co. have captured quite a large market with their Broadcast "Twelve"—the "celebrity" records, as they might be called. Among this month's successes must be mentioned: *The Prize Song* (Meistersingers) and (a) *Liebesfreud* and (b) *Tranmerei*, violin solos by Peggy Cochrane (5025),

also *O Paradiso* (Meyerbeer) and *Your Tiny Hand is Frozen* (La Bohème—Puccini), sung by Frank Titterton (tenor) with orchestral accompaniment (5022). The latter is exceptionally good.

The Broadcast "Ten," as it might be termed, is better than ever this month, outstanding items being *Just Like a Melody* and *Toy Town Artillery* (Foxtrots) (295); which latter is a surprisingly good record; and *On the Road to Mandalay* and *Jogging Along Behind the Old Grey Mare*, sung by Arthur Vivian (Baritone), with orchestral accompaniment (301).

Finally, we must mention the Ciros Club Band in *Rosalie* (F.T.) and *'Varsity Drag* (F.T.). The latter introducing "Good News" with good effect.

H.M.V.

Those who are keen on organ music will be well advised to hear *O Sole Mio* and *Simple Aveu*, played by Leslie James on the New Gallery Cinema organ. These two items (B2792. 10 in. 3s.) are excellent for pick-up work, and have really full bass, the pedal notes of the organ being perfectly recorded, while the rendition is not spoiled by too much use of the "sugar" stops. *Serenade* (Schubert) and *Somewhere a Voice Is Calling* form two real cinema organ pieces which are sure to be favourites. They are recorded by Jesse Crawford on B2811.

We must not forget the latest Philadelphia Symphony Orchestra Bach recordings on D1464. Both sides are excellent, the tympani coming out exceptionally well, and the whole of the rendering being sharp and clean-cut. The two sides are made up by the *Prelude in E*

Flat Minor and *I Call Upon Thee, Jesus*, and are well-nigh perfect.

Parlophone

These are so good we cannot differentiate between them. Those we like especially are *The Magic Flute* (E10750), Berlin State Opera Orchestra; *Tales of Hoffmann* (E10752), Edith Lorand Orchestra; and among the dance numbers—*I Must be Dreaming* (F.T.) and *'Tain't so Honey, 'Tain't so* (F.T.), by Joe Venuti and his Concert Orchestra. This latter is a perfect gem, though it is a pity "Joe" does not come forward himself a little more. (R182) *Farewell* (Tango Blues) and *Il Canto dell' Attesa* (Tango Serenade), by the Pavilion Lescaut Orchestra, are also both excellent. (R185).

Pathé Records

The Actuelles are still "looking up," and seem to be getting better and better. Perhaps they have a new system of recording—anyway, the 12-inchers made by the Pathé Symphony Orchestra this month are exceptionally good. The best are the *Meistersingers Overture* (3 parts) and *Bridal March* (Lohengrin) (15263 and 15264).

Among the light items, Miss Annette Hanshaw gives us a couple of items: *'Cause I Feel Low Down* and *Lila* (11565).

Zonophone

Among the best of the Zonophones this month must be mentioned the Gilbert and Sullivan *Vocal Gems from "Princess Ida"* and *"Ruddigore"* (A342). Both sides of this disc are well recorded and quite up to the high standard set by the light operas that Zonophones have already recorded.

Four more old favourites have been recorded on these famous green-labelled records in the form of the *Four Indian Love Lyrics*, sung by Foster Richardson (bass), with orchestral accompaniment (5172-5173). The only fault we have to find is in *'Till I Awake*, which could have a little more *verve* in it, both from the orchestral and the vocal points of view.

For those who prefer much lighter music we can recommend the Banjo Boys' recording of *Down South* and *When the Robert E. Lee Comes to Town*. Two really "snappy" banjo items that are excellent tests for good quality reproduction. If your loud speaker is at all woolly, these will show it up.

Specified for the new Master 3

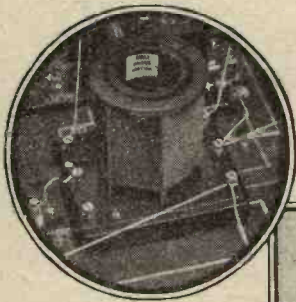

*Recognition
of efficiency*



Here we show the Colvern Combined Wave Coil in the new Mullard Master Three* as well as a view of the ingenious switch concealed in the base.

The Colvern Combined Wave Coil gives selectivity and volume

THE fact that coil-changing is dispensed with in The New Mullard Master Three is the outcome of the specially designed Colvern Combined Wave Coil specified. Its high efficiency is entirely due to skilful manufacture on the one hand and efficient design on the other.

Each coil is tested before despatch in a duplicate New Master Three Receiver in order to ensure that it functions exactly in conformity with that used in the original receiver. This is your safeguard and you are advised to adhere to the author's specification.

17/6

COLVERN ACCURATE SPACE WOUND COILS

Advertisement of Colvern Ltd., Romford, Essex.

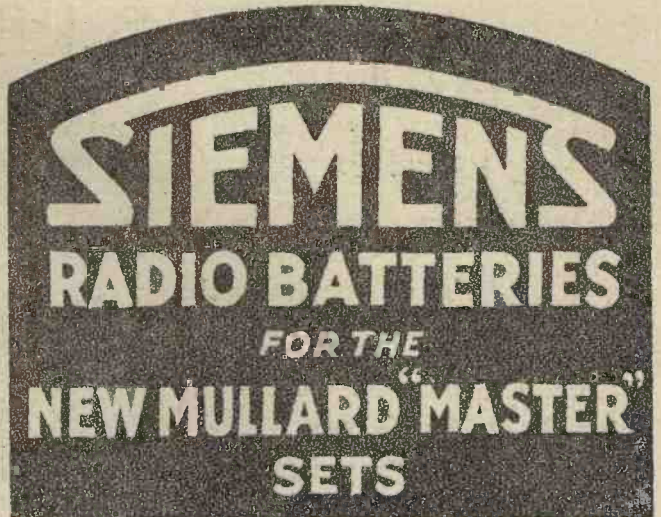

THE best results can only be obtained by using specified components. Therefore, to ensure satisfaction *insist* on Siemens Batteries which are British Made throughout and offer the highest efficiency, finest value and longest life—at competitive prices.

SPECIFIED FOR THE

“MASTER” 3*

AND

“MASTER” 5 PORTABLE



Size No. 1202.

100 Volts.

PRICE **13/-**

An alternative BATTERY for “Master” 3.
Size No. 1206. “Power” 100 Volts.

PRICE 22/6

This will last three times as long as the 1201 size and costs less than double.

SIEMENS BROTHERS & CO., LTD. WOOLWICH. S.E.18

THE KEY TO YOUR SET

The switch is the key to the set, therefore, make sure you use the best — the Benjamin.

The improved Benjamin battery switch is designed for one-hole fixing and is fitted with terminals for ease of wiring.

Two sliding arms ensure a double point of contact, giving a 'snap' action and absolute efficiency to the switch. The new Benjamin design is "The switch that works without a hitch."

1/3

Price of improved switch without terminals - - 1/3.

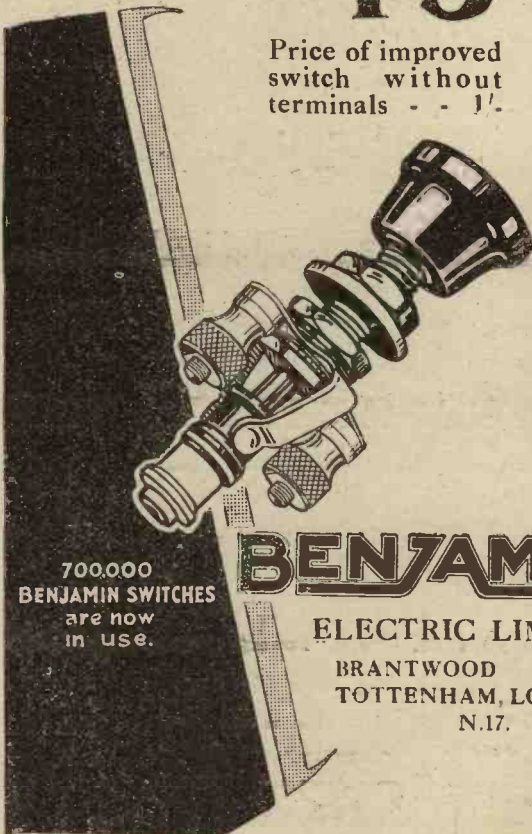

700,000 BENJAMIN SWITCHES are now in use.

BENJAMIN

ELECTRIC LIMITED,
BRANTWOOD WORKS,
TOTTENHAM, LONDON,
N.17.

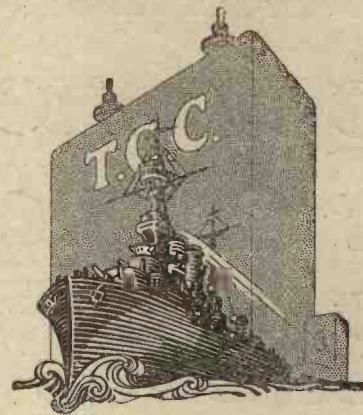

Safeguards

Just as the fleet safeguards our shores against invasion, so do the letters T.C.C. safeguard you against faulty condensers.

THE letters "T.C.C." on a condenser are a hall-mark. For nearly a quarter of a century "T.C.C." has been synonymous with accuracy, durability and dependability.

"T.C.C." Condensers are guaranteed. Everyone is individually tested before leaving the factory. You have never known a faulty "T.C.C." because such cannot pass the test-bench.

Look for "T.C.C." on the next condenser you buy. It is your safeguard.

Specified for the Cossor "Melody Maker"

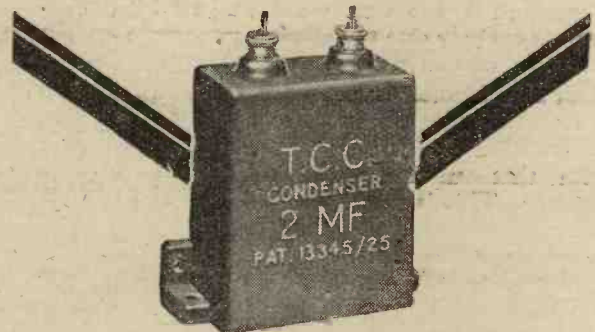

T.C.C.

Adv. Telegraph Condenser Co., Ltd., Wales-Farm Rd., N. Acton, London, W.3

CA 6039

BUILDING YOUR SET

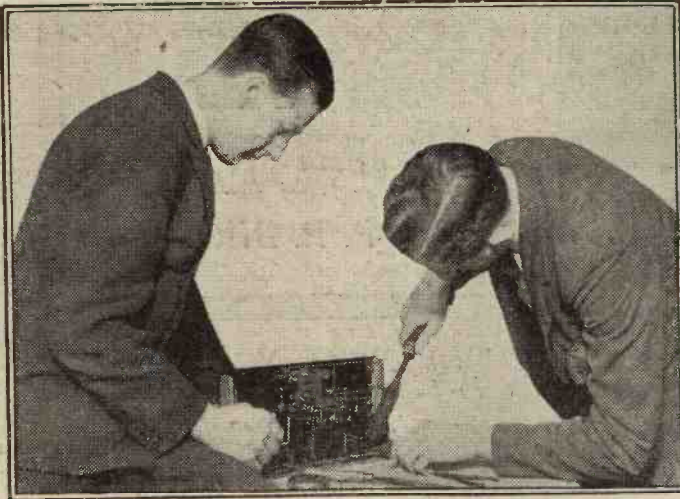

Keep this page by you when you build your next "M.W." set, and you will find the tips given will help you to read the diagram rapidly and easily.

By Our Chief Draughtsman.



WITH almost every receiver described in MODERN WIRELESS at least three diagrams are given for the benefit of the constructor. (1) A theoretical circuit; (2) a panel-drilling diagram; (3) a back-of-panel and baseboard wiring diagram.

The theoretical diagram needs no explanation. The panel drilling diagram is always drawn to scale, and the essential dimensions for finding any required drilling point are clearly indicated.

Panel Procedure

Before scribing a panel for drilling, make certain that the panel is absolutely "true." In other words, see that it is actually the size required, and that the four corners are square.

If the panel is out of alignment, the

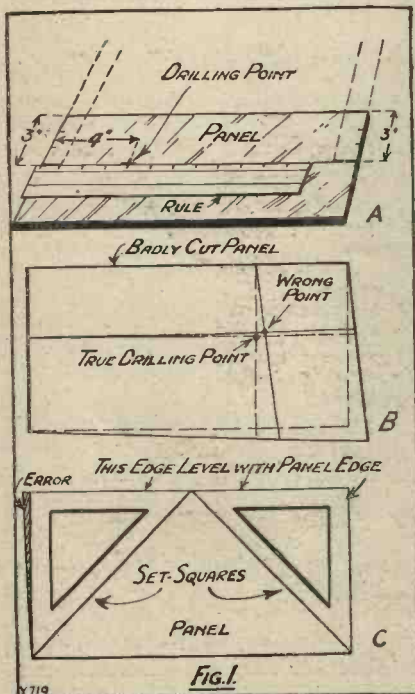

drilling point will not be in the right place, but will be in the position indicated in Fig. 1B. If there is any doubt about the panel, apply a set-square, as in Fig. 1C, to each corner of the panel. Any error will then be obvious.

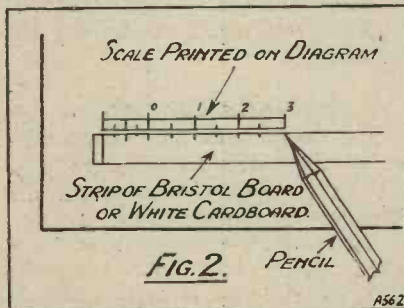

The back-of-panel and baseboard-wiring diagram should be, from the constructor's point of view, the most important illustration of all.

These diagrams are invariably drawn to scale, and the appropriate scale included on the diagram. A proper application of this scale by the constructor would enable him to dispense with the figured dimensions given should he so desire. The best method of using this scale is to cut it from the paper, or copy it on to a stiff sheet of cardboard or "Bristol" board, in the manner indicated in Fig. 2. By moving the strip along to the left as the scale is dimensioned, a 12-in. scale (a useful length) can quickly be made. The scale can then be applied to any part of the wiring diagram.

The Baseboard Overlap

When the required dimension has been discovered—suppose it is a measurement of $3\frac{1}{2}$ in.—this distance is marked on the baseboard or panel in actual inches.

When a wiring diagram is being prepared by the draughtsman, the

primary consideration is to see that the wiring of the components, as illustrated, is absolutely clear.

For this reason the back of panel and baseboard are shown in "plan"; the overlap of the panel, where it is fixed to the thickness of the baseboard, being indicated by a dotted line. This overlap should always be looked for, and taken into account when scaling from the diagram. Again, for the sake of clarity, wiring is never drawn over components where this can possibly be avoided, but reference to the photographs in conjunction with the diagram will usually show the position of the wire in the instrument.

For Plan Views

Certain components, too, when mounted, have terminals or soldering tags placed one above the other, and this means that in the plan view the lower terminal is not visible. This terminal is therefore brought forward, as shown in Fig. 3A, and marked, so that no error shall be made when wiring up the set from the diagram.

One other little point! When a length of wire or flex is illustrated, as in Fig. 3C, it only means that the wire is of a length which cannot conveniently be drawn in the space allotted to the diagram, and not that the wire is to be cut at this point!

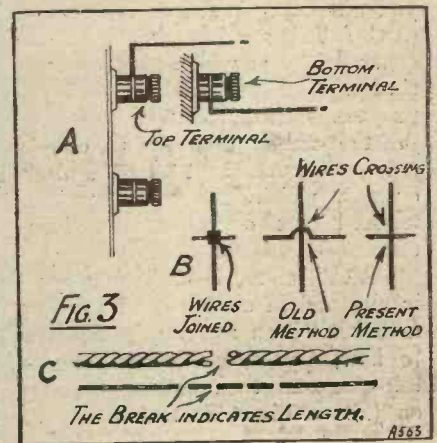



ONE-VALVE WONDERS

By P. R. BIRD

Before your ear hears the programme, your aerial has to pick it up. What happens between these two events?

LET us imagine an ordinary house in an ordinary street with an ordinary aerial attached to an ordinary set. Is there anything extraordinary going on there when the telephones announce "London calling"? The aerial and the lead-in look inactive enough, but from an electrical point of view they are intensely active. True, there is very little power present in the aerial, but what is lacking in size or "punch" is made up in speed.

A tiny oscillatory current is flowing there, but though extremely small in volume it is a curiously complicated current. If we compare this with ordinary electrical current, we shall find it has some special and surprising features. There are, as everybody remembers, several forms of electric currents, the commonest being those derived from a dry cell or battery used for ringing doorbells, and the lighting of filaments, etc. This class is simple *direct* current (D.C.), flowing direct from one pole of the battery to the other, directly the connection is made, by any direct metallic route, and ceasing directly the connection is broken.

Different Kinds of Current

Another form of electrical current, you will recall, is alternating current (A.C.). This sort of current is readily generated at power-stations, and although it can be used for household purposes, such as lighting and heating, just the same as direct current can be, it is entirely different. Unlike direct current, which is a plain straightforward sort of thing, alternating current is continually changing.

"A.C." changes in two ways—in size and in direction. When you first switch it on, a current commences to flow, but instead of growing to full size and then keeping steadily on (like a direct current does), an

alternating current has no sooner started to flow than it falls away and dies down!

It dies down to nothing at all. And then, just to be contrary, it starts to grow again, but in the *opposite* direction. No sooner has it fairly got going this way than it changes its mind once more, dies away to nothing, and then restarts the whole business over again, continuing thus indefinitely.

1,000,000 Per Second

This complete change round is called a "cycle," and an ordinary alternating current performs about fifty of these cycles per second.

These two kinds are the ordinary electrical currents. The current in your aerial, however, is neither direct (D.C.) nor alternating current (A.C.) like those described above, but it is *oscillating* current.

This is a kind of A.C., for the difference between oscillating and alternating current is chiefly one of time; whilst an alternating current is that class which performs one complete cycle about fifty times every second, an oscillating (or "oscillatory" or "H.F.") current is one that does exactly the same thing, only *much faster*. Instead of consisting of about fifty cycles per second, the ordinary aerial currents are changing round completely in this double-hesitation fashion no less than about *one million times per second*.

The Magnetic Effect

So it is quite easy to imagine that even if the current concerned is a very small one, the fact that it first chases up your aerial, then down through your aerial coil to earth, then back again up to the aerial, and

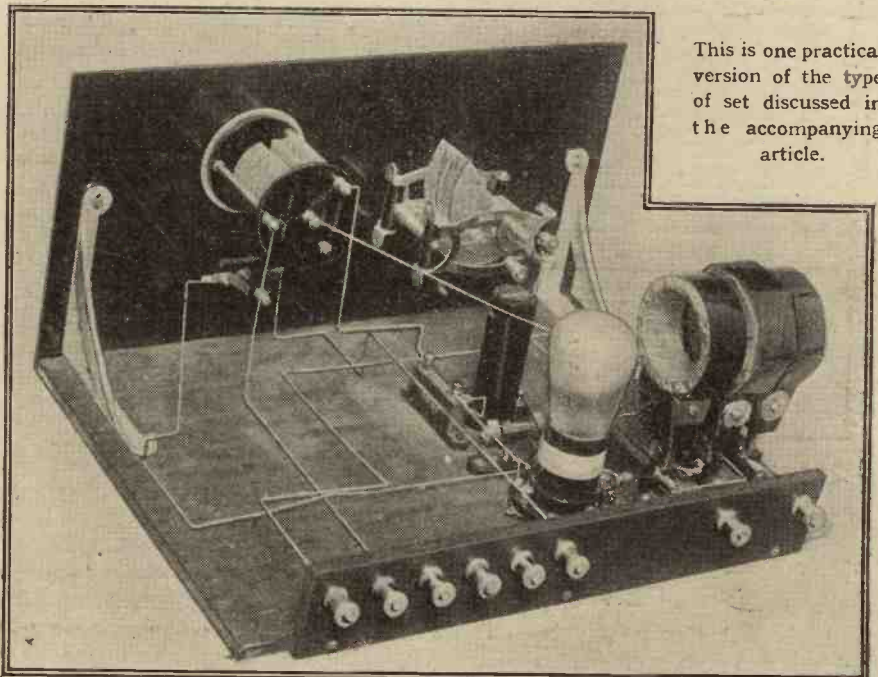

This is one practical version of the type of set discussed in the accompanying article.

HERE IS
THE GREAT MYSTERY
RECEIVER



SIX-SIXTY

You can solve the Great
Mystery Receiver at last!
For the past three weeks
the whole country has
been on tiptoes awaiting
this momentous day in
the history of Radio.
Fill in the coupon to-day
and solve
**THE GREAT MYSTERY
FREE**

SIX-SIXTY RADIO COMPANY,
122-124, Charing Cross Road,
London, W.C.2.
Please send me the solution of THE
GREAT MYSTERY RECEIVER.
NAME (Block letters)
ADDRESS
M.W.

The Romance of the Animal Kingdom—A Fascinating New Work

WONDERS OF ANIMAL LIFE

To be completed in about 30 Fortnightly Parts. 1s. 3d. Per Part.

Natural History Told in A New Way With Thousands of Marvellous Illustrations

Do you know that dragons still exist? Do you know that there are forms of life so small that 30,000,000 of them could be crowded together in a salt-spoon? Do you know why the pelican carries a bag under his beak? Do you know that every fresh-water eel is born deep down in Mid-Atlantic? Every page in WONDERS OF ANIMAL LIFE is alive with wonderful revelations of the animal world.

Famous naturalists, scientists and popular authors will tell in this new work a fascinating story of the marvels of Nature; the astounding realities and mysterious ways of the thousand-and-one inhabitants of the animal kingdom. Each part will contain enthralling chapters dealing with the life histories, habits and customs of animals, birds, reptiles, fishes and insects.

Over 2,000 Photographs Numerous Coloured Plates

WONDERS OF ANIMAL LIFE will contain the most marvellous collection of animal photographs ever brought together; photographs that bring to your fireside the living realities of jungle, forest, river, air and sea. Some of the photos have been taken at risk of life and limb; there are pictures of wild animals taken within a few feet of their fangs. There are photos which have taken days of patient waiting to secure, some which the animals have been trapped into taking themselves. WONDERS OF ANIMAL LIFE is in no sense a "conventional natural history." It will have all the authority of an acknowledged text book but will be a thousand times more interesting. The work will be completed in about thirty fortnightly parts. Each part will contain a wealth of fascinating pictures and a superbly printed full-size colour plate. These colour plates will add immeasurably to the value and attractiveness of the work, which will contain in all over 2,000 photographs and numerous colour plates.

Buy Parts 1 and 2 TO-DAY
1/3 each

At all Newsagents, Booksellers and Bookstalls.

Magnificent
FREE GIFT

With PART 1

198 Pictures of Animals in their NATURAL COLOURS

A superb 3-fold plate showing the Living Rainbow of Animal Colour will be presented in Part 1 of WONDERS OF ANIMAL LIFE. The complete plate shows the 7 colour bands of the rainbow, and on each the particular animals which derive their main hues from that colour. In all, there will be nearly 200 pictures of mammals, birds, reptiles, fish and insects shown on this remarkable plate.



*Look for this
Mandrill on
the cover of
Part 1.*

then down to earth again about one million times *every second*, is sure to have a queer effect somewhere. One such queer effect is the moving magnetic field which appears around the turns of the aerial coil.

This magnetic field varies in exact accordance with the current, so that this, too, makes a million-a-second-change.

Input and Output

Now, the queer thing about any moving magnetic field is that if you place a wire across this field a corresponding current flows in the wire; so that the grid coil, in an ordinary set, which is placed up close to the ordinary aerial coil, cuts across the aerial coil's magnetism and thereby picks up a current exactly like that flowing in the aerial.

The tuning condenser which is put across this coil can be adjusted to just that size (capacity) where it exactly "suits" the received current, so that when the grid coil receives from the aerial an impulse of current, this is handed to the condenser, and handed by it back to the coil, at exactly the right speed to keep this little coil-condenser current in perfect step with the aerial-earth current. (It sounds a bit involved, I know, but your set takes only a millionth of a second to do it.)

Attached to the tuning coil and condenser is a valve. The valve is a voltage-operated device, depending for its action upon the difference in voltage between its filament and its grid. Apart from the received voltage which operates the valve, and is applied by the tuning-coil and condenser currents, the valve has a high-tension and a low-tension voltage applied to it.

The L.T. is applied across its two filament terminals. By heating the filament to the required degree it releases inside the valve a great crowd of electrons. The high-tension voltage, which is placed across the filament and the plate, attracts a steady stream of these electrons through the vacuum in the valve, through the meshes of the grid, and across to the plate or anode, thus constituting the anode current.

The Carrier-Wave

Compared with the current in the aerial itself, the anode current is an enormous one, but as all the anode current flows past the grid, and as the grid is operated solely by the received aerial current, the valve is able to impress upon its output (the plate current) the characteristics

of its input (the tuned currents). Thus the valve, even the straightforward one-valve detector, acts as an amplifier, and this amplifying action can be enormously strengthened if some of the valve's output is fed back into its input by means of a reaction coil and condenser.

In order not to seem too dreadfully complicated, we said at the start that the aerial was carrying an oscillatory current. It was explained that an oscillatory current was like alternating current except that alternating current had a frequency of, say, fifty cycles per second, whilst oscillating current was of the order of a million or so per second. These oscillations flowing through the aerial coil set up across it and around it a million-a-second magnetic field.

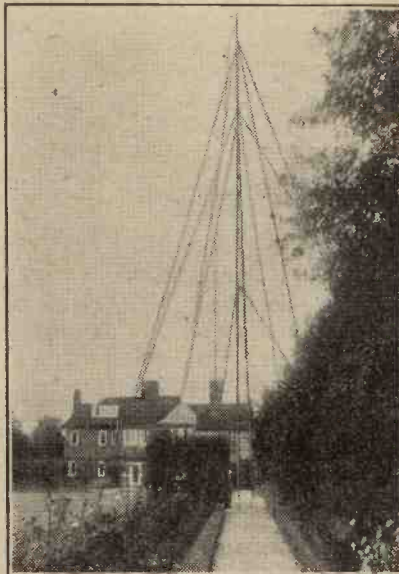

As the input to the set depends, in the first place, upon the aerial, the higher this is placed the better.

We have seen that this in turn sets up another million-a-second current in the grid circuit, and that this, in its turn, is employed to apply a million-a-second voltage across the grid and filament of the valve. Here it will impress the plate current with its variations, and thus provide us with an amplified version of itself.

This may all sound very complicated and curious, but what is even more curious is the fact that all this is going on before broadcasting has started! All this is true of your set before anyone says a word at the microphone, the truth being that the aerial current which we have been discussing is only a sort of "prelude" current. It is, in fact, only the "carrier wave," and not until someone whistles or speaks or otherwise starts up in front of the microphone

does the real broadcasting begin.

The oscillating current flowing in the aerial then undergoes a remarkable change. With every word or sound its amplitude, or size, is altered. Altered much or little according to whether the noise is loud or soft, and also altered simultaneously by fast or slow alternations, according to whether the noise is a high note or a low one!

An Electrical Counterpart

For every sound, and for every intensity, from a soft and accidental "tishoo" by the announcer to the combined clamour of the Savoy Band finale, *there is an electrical counterpart*. Electrical currents flow which, in their extraordinary changes, speed, and size, duplicate the character of the sound itself, and its intensity.

At the broadcasting station, the high-frequency currents being sent out by the aerial are, all the time the microphone is in use, altered by every sound which reaches it. And that tiny oscillating current in *your* aerial has corresponding tiny alternations impressed upon it.

Your one-valve set amplifies the whole affair with the utmost ease. With one charming gesture, it hands itself back a high-frequency fillip on the input side, and by means of properly controlled reaction it strengthens its own input. At the same time—and do not forget that in the eye of a valve a millionth of a second must of necessity be a very long time—it employs its leisure in sorting out the speech currents from the million-a-second currents! It not only follows faithfully every tiny variation in the input, and magnifies it—quite a work of art in itself—but before you hear anything it calmly throws half its cargo overboard because, as shipped by the aerial, it is inaudible!

Mute Magic

You probably know that although you can hear speech in a broadcasting studio there is none to be heard from the transmitter or at the transmitting aerial. Similarly, the valve's input, magical though it is, is mute magic. Not so the output, for the valve cleverly contrives that most of its activities are of the personal form, which no one but the valve itself knows about. A portion of its output is picked out and presented to the telephones, and this portion is so tingling with life that it can reproduce voices, drums, piccolos, bugles, harps, nightingales, sneezes—or even silence! Quite a good performance, don't you think?

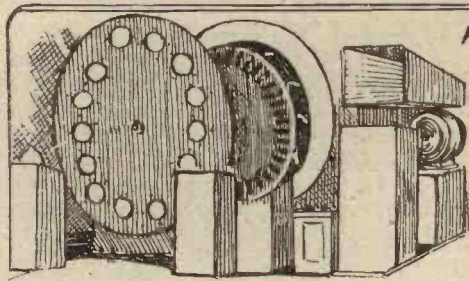

TELEVISION NOTES OF THE MONTH

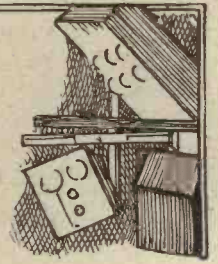

C FRANCIS JENKINS, of Washington, is making a new television set. The principle is as old as the year 1880, and Jenkins admits he had an idea to use it thirty-four years ago. But modern television developments now make it feasible. It has no holed disc.

Giant Camera

A camera bigger than most people have seen is to be pointed at a baseball match, or at a broadcasting artist. The image will fall, instead of on a photographic plate or a ground-glass screen, on a plate of ebonite more than 2 ft. square, studded with 2,304 baby photo-electric cells.

Each cell will send out a current proportional to the strength of the light in the part of the image falling on it.

No, there won't be 2,304 wires leading from the transmitter to every receiving set. Behind the camera the wires will come together in a switching gear, and the currents will pass on down one wire or along one radio channel.

Bank of Lights

At the receiver the currents will be directed by a commutator down 2,304 wires again. Each of these wires will lead to a tiny lamp in another closely studded ebonite screen. As clear an image as can be built up from 2,304 elements will then appear on the screen.

For Halls

Home television with such a set is, of course, out of the question. Jenkins suggests it will be good for theatres and cinemas. He says that tests he has already made show that his screen will have more light than cinema screens, and it will be white light, not neon pink. From his transmitter he will have 100,000 times as much current as comes from a transmitter using a scanning beam of light.

In a Year

You will have recognised already many advantages over television sets

The latest developments chronicled by **WILLIAM J. BRITTAIN**, our Special Television Commissioner.

with mechanically moving parts. Jenkins says that a year hence his new set will be in practical use.

Programmes

Another practical-looking sign is the television programme, occupying half a page, I have noticed lately in the "Science Newsletter," Washington. Nine stations are mentioned, with times, wave-lengths, number of lines in image, and the number of images a second.

Book of Praise

I wish Mr. Alfred Dinsdale wouldn't. Baird is written all over the enlarged and technical version of his pamphlet "Television," now a book on sale at 5s. That I expected, for he has said to me, in effect, that Baird is the only man doing anything worth considering in television. But couldn't he have refrained from slurs when dealing with other people's work?

Selenium

Calling Dénes von Mihály, of Budapest, and now in Berlin, Denoys von Mihály, of Vienna, he gives a description of the Hungarian's apparatus as printed in von Mihály's book published in 1926. He says that with this apparatus television could not be achieved partly because a selenium cell was used. von Mihály showed me photo-electric calls he was using eighteen months ago!

"Not Television!"

We are given particulars of the "latest type of Jenkins machine." Follows a description of Jenkins' apparatus for transmitting cinematograph films, and we are warned: "It should be clearly understood that it does not produce television." Should a cigarette machine produce pipes? Higher in these notes you will have read of the latest Jenkins television apparatus.

Truth About Lighting

Another inaccuracy is the statement that "with all systems so far

(Continued on page 554.)

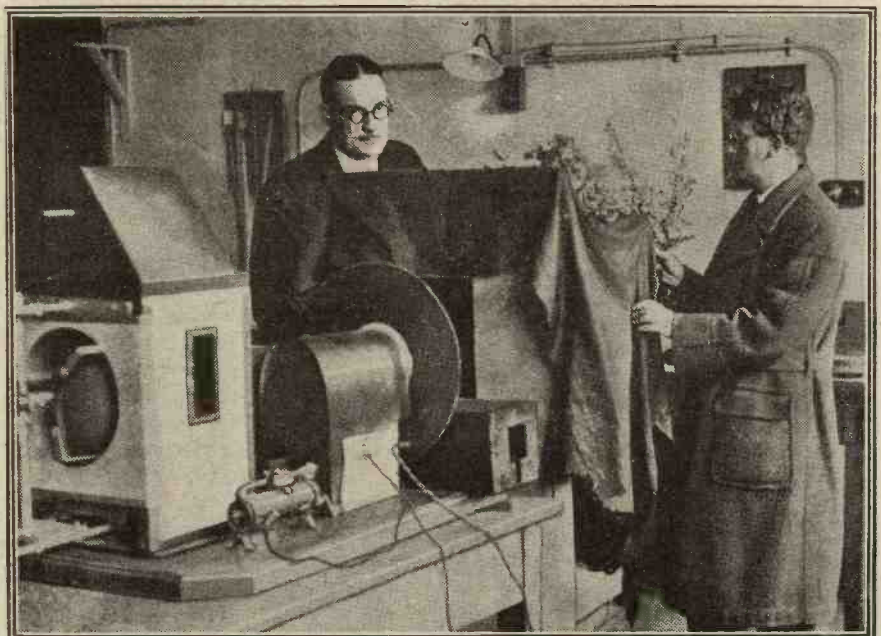

Here is John L. Baird with some of his more modern apparatus, and, left, Mr. G. W. Mitchell, founder of the Television Society.

EVERYTHING

The
G. E. C.
your guarantee

ELECTRICAL



MADE IN ENGLAND

UTMOST SENSITIVITY
AMAZING SELECTIVITY
REALISTIC REPRODUCTION
SIMPLE CONTROL
NO REACTION

the

GECOPHONE
REGISTERED TRADE MARK

WORLD WIDE SCREEN-GRID **4**

*Suited to either
aerial or frame*



Price, including ROYALTY and special OSRAM VALVES

£23.10.0

Price, including Batteries, £28

De Luxe floor model in solid polished mahogany, £34.7.6 including Royalty and OSRAM VALVES

Price, including Batteries, £39

Full particulars of this set, and all GECOPHONE Radio Receivers, are given in the beautifully illustrated brochure B.C. 4766, a copy of which will be sent POST FREE on request.

You will be amazed at the performance of this wonderful receiver. No matter where you live, or how you are situated—even in a district where good broadcast reception has been considered impossible—you cannot fail to get the most surprising and satisfactory results.

Disappointment is absolutely impossible. *This is guaranteed.* You have the choice of the world's broadcasts at your command. Turn the dial slowly—slowly. Here comes one station, then another—clearly, loudly, and with perfect purity. There are dozens of them. Stop or turn just as you fancy.

Never will you have a dull evening with this latest radio masterpiece.

Manufacturers (Wholesale only):

THE GENERAL ELECTRIC CO. LTD.

Head Office and Public Showrooms:

MAGNET HOUSE, KINGSWAY, LONDON, W.C.2

Branches and Showrooms throughout Great Britain.

Sold by all Wireless Dealers.

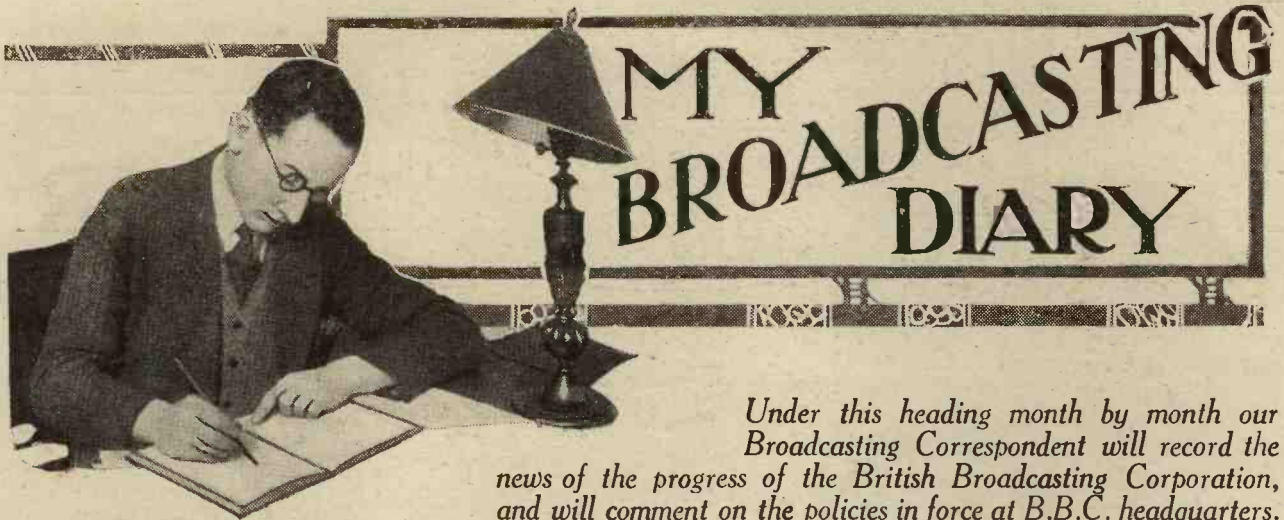

Under this heading month by month our Broadcasting Correspondent will record the news of the progress of the British Broadcasting Corporation, and will comment on the policies in force at B.B.C. headquarters.

Wales and Wails

It seems pretty certain that, contrary to all expectation, the West Country organisation of the B.B.C. under the Regional Scheme will be predominantly Welsh. After holding out for years against the agitation to give Wales a "national station," it looks now as though the B.B.C. was at last giving way to an agitation which, to say the least of it, has had more persistence than rationality.

This is the position: When the new Manchester station is under way next month, the B.B.C. will begin looking for a new site near Cardiff. It is understood that Savoy Hill is pledged to pick a site within the mountains of the southern part of the Principality. This means in effect that the "West Britain" as distinct from a "Welsh" station has gone by the boards.

It may be pretended that the new station is for the whole of the West Country; but its certain proximity to Cardiff makes the realisation of this extremely unlikely. For one thing the Cardiff station staff carries on with strengthening on the Welsh side only. Fortunately, most of the West Country takes its programmes from Daventry anyway, and would not be seduced from this allegiance even if Cardiff were transformed into a real West British station.

Perhaps, after all, the B.B.C. is right to be illogical in conclusion even if the rest of the syllogism is defied. This is the way in which characteristically British things succeed; and there is nothing more characteristically British than the B.B.C.

Exams. for Broadcasters

The Treasury appear to be keeping on with their idea of making the staff of the B.B.C. an integral part of the Civil Service at the earliest possible occasion, which would appear to be in 1936, when the present licence of the B.B.C. expires. A correspondent has been informed by a high Treasury official that there is now no doubt as to the incorporation of broadcasting into the state services. If this is to come about, presumably all the staff at Savoy Hill and in the Provinces will be required to pass the Civil Service examinations if they wish to be retained. My own view is that the Treasury are counting their chickens a little in advance.

I am not at all sure that Parliament will not jib at this move. There is some element of the ridiculous in asking Captain Eckersley, for instance, to take a Civil Service examination in order to stay on as Chief Engineer of the

B.B.C. In order to be successful entertainers it should not be necessary also to be Senior Wranglers; in practice the latter would probably disqualify the former.

Efficiency v. Sentiment

The recent outburst between Sir Henry Wood and the B.B.C. would not have come as a surprise to readers of MODERN WIRELESS, who were aware months ago of the growing friction over the composition of the Promenade Orchestra. The trouble was not novel or unprecedented.

On the one hand was Sir Henry with an orchestra built up through thirty years and attached to him by ties of fondness, as well as by common artistic interests. On the other hand was the B.B.C. trying to secure the best

TUNING-IN TO TELEVISION



This is an American television receiver invented by John Geloso, who is here shown "tuning-in" a broadcast picture.



RIPAULTS BATTERIES ARE BEST

RIPAULTS chosen for the new Cossor "Melody Maker."

RIPAULTS' SELF-REGENERATIVE H.T. DRY BATTERIES

GIVE 50% LONGER LIFE

Standard Capacity	Double Capacity	Treble Capacity
60 volts .. 10/6	60 volts .. 15/6	60 volts .. 19/6
99 volts .. 16/6	90 volts .. 22/6	90 volts .. 29/6
9-volt Grid Bias .. 1/9	18-volt Grid Bias .. 3/6	

Until you have used a "Ripaults" you do not know the full capabilities of your set. They make a wonderful improvement in reception.

LIGHT ON THE H.T. BATTERY

Get a copy of this extremely interesting and easily understood 24-Page Booklet on H.T. Batteries, specially written for us by one of the best known contributors to Radio publications who is recognised as an expert on H.T. Dry Batteries.

Published at 6d., but sent Post Free for 2d. stamp if you mention "Modern Wireless."

RIPAULTS' LATERAL ACTION CONDENSERS

The New improved model of the famous Ripaults' Lateral Action Condenser is a great advance in variable condenser design.

The die-cast framework and runner plates give absolute rigidity, while the cam and spring method of movement entirely eliminates all signs of jerkiness and backlash.

Tuning with the Ripaults' Condenser is a delight.

PRICES :

·00025

·0003

·0005

10/6

each.

Slow Motion Dial,

4/6

Standard 4-in. Dial,

2/3



Obtainable from all Dealers

Ripaults
Ltd.

1 KING'S ROAD, LONDON, N.W.1

Naturally - The STAR CONDENSER for the STAR RECEIVER

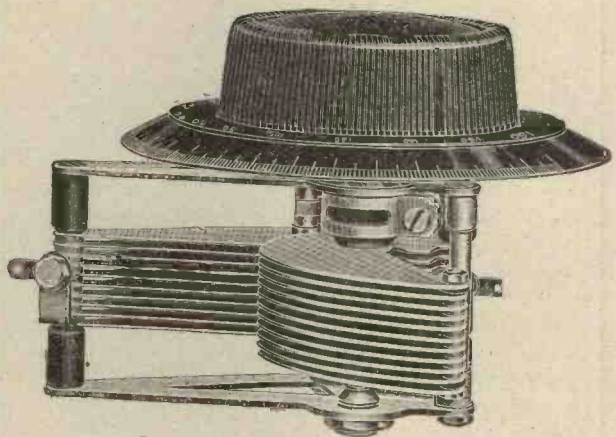

J.B. Log Plain

The famous J.B. Precision Logarithmic condensers have again been specified for the new "Mullard Master Three Star," described in this issue of "Modern Wireless."

Wherever you find a really STAR circuit, there you also find one or more of the STAR range of Condensers—J.B.

You cannot forget the name—it's so completely British and reliable.

Prices of "Master 3" Log Condensers:—

·0005 mfd., 11/6

·0003 mfd., 10/6



PRECISION INSTRUMENTS

Advt. of Jackson Bros., 8, Poland Street, Oxford Street, London, W.1.

value for its money, and discounting the sentimental tie which meant so much to Sir Henry. Conflict was inevitable, but the B.B.C. was at fault in not anticipating it and using more adroitness in handling the situation.

It is understood that Savoy Hill gave way with rather bad grace for the Promenade season of 1928, giving Sir Henry a strong hint that he would not have things entirely his own way in 1929. This the conductor took very much to heart, especially when it was suggested as a detail of the contemplated reforms that the women members of the Queen's Hall Orchestra were to be turned out.

The recent public storm has not had much effect on the situation, except to make it a little more difficult to

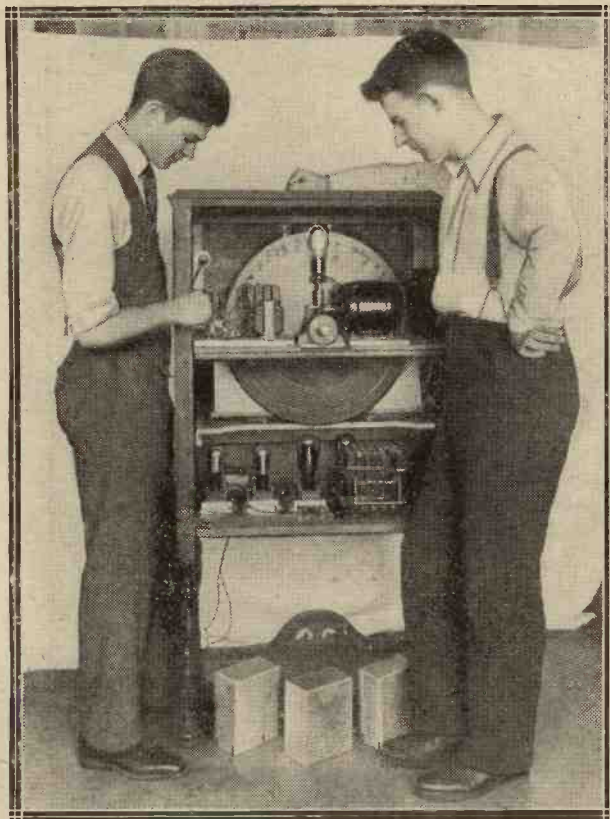

This is a view of the back of the receiver shown on the preceding page. It will be noticed that the radio outfit is housed by itself in the lower part of the cabinet.

secure a continuance of the present conditions for another season. Nevertheless, I confidently expect to see Sir Henry giving a real farewell season of Proms. in 1929.

The Picture Muddle

It does not require much penetration to analyse the muddle about picture broadcasting. The B.B.C. had for years avoided any public recognition of the Baird

television method on the reasonable ground that they wished to protect the public against the impression that an interesting laboratory experiment could suddenly be turned into a satisfactory public service. The Baird people naturally resented this attitude and construed it as professional jealousy.

Then came along the Fultograph, with results more to the liking of Savoy Hill, because apparently more related to service possibilities. So the B.B.C. gave the Fultograph the opportunity of trial outside programme hours, and this opportunity is being taken advantage of now. Meanwhile the Baird people got busy behind the political scenes. Several members of their Board are well-known Conservatives in close touch with Ministers.

It is not known, of course, whether this activity had anything to do with a sudden change of front at the Post Office, but the fact is that the Post Office, late in September, arranged an independent private test of the Baird apparatus, after which they practically instructed the B.B.C. to grant the Baird method the same facilities as the Fultograph had already been promised. News of this development greatly alarmed the Fultograph Company, who were anxious to avoid distraction or competition during their tests. The outcome is still uncertain, but I would give long odds that the Baird television method will be tried out by the B.B.C. early in the New Year.

The Consolidation of 5 G B

It is at last possible to say with finality that the Davenry Experimental Station (5 G B) is to be transformed into the Midland Regional Transmitter. This will be particularly gratifying news for the people of the Birmingham-Nottingham areas who have been in some doubt about their future under the Regional Scheme. Mr. Percy Edgar, the amazingly popular and versatile director of the Birmingham station, will become regional director for the Midlands. Incidentally, Mr. Edgar has been more successful than any other station director in identifying himself closely and continuously with local opinion and aspirations.

The B.B.C. and the Opera League

Sir Thomas Beecham has been working with the B.B.C. for about six weeks now, and the expected explosion is still deferred. It is stated that the reason for this is not because Sir Thomas agrees with the B.B.C. on artistic matters, it is because he finds the B.B.C. very helpful with his Imperial League of Opera, and, pending the success of this enterprise, he is prepared to swallow his pride in other directions.

Personally, I am not sure that Sir Thomas really means to quarrel with the B.B.C. Their alliance is of enormous advantage to the artistic interests of the whole country, and if he sticks it, Sir Thomas will soon control the music policy of the B.B.C., because of his dominating personality and super-abundant energy.

"M.W.'s" Exclusive Broadcasting News.

- ☐ Now that Broadcasting is a powerful force in the life of the nation, a well-informed survey of its developments and possibilities is becoming increasingly necessary.
- ☐ In "My Broadcasting Diary" MODERN WIRELESS presents to its readers, month by month, a thoughtful, exclusive, and authentic review of British Broadcasting. Compare this with any similar feature in any other periodical and you will realise at once the superiority of

"Modern Wireless."

MAGNAVOX

The Originators of the Moving Coil Speaker

And now read what others say:—



R.4.

The "Wireless Constructor."

The Magnavox Speaker gave a rendering of programmes which was a sheer delight to the discriminating ear.

The "Broadcaster."

Our tests convinced us that the Magnavox is the best moving coil speaker sold. The reproduction was as realistic as could be.

Mr. W. James in the "Morning Post."

Regardless of price the very best I have ever heard.

Radio Editor of a well-known Northern Newspaper.

No other speakers compare in the slightest degree with the Magnavox.

To endeavour to publish all the testimonials which we have received from the leading Radio Engineers and amateurs in the country would necessitate our booking all the advertising space in this journal.

Realism—

You can hear the bowing of the strings of the double bass and the beats of the drums in their true tone colour. There are no jarring sounds and the harp does not sound like a flute with Magnavox Speaker Units. There are models for A.C. or D.C.

REMEMBER THAT ALL MAGNAVOX SPEAKER UNITS ARE EQUIPPED WITH INPUT TRANSFORMERS, 10-FT. INPUT AND FIELD CORDS AND FIELD SWITCH.

ALL MAGNAVOX MOVING COIL UNITS ARE GUARANTEED AGAINST MECHANICAL DEFECTS FOR A PERIOD OF ONE YEAR AFTER DATE OF PURCHASE.



D.80.

GOOD NEWS—Reduced Prices

TYPE R.4	6-volt D.C., ½ amp.	£8 0 0
" R.5	100/240-volt D.C.	£8 5 0
" D.80/1	100/120-volt 50/60-cycle A.C.	£11 0 0
" D.80/2	200/240-volt 50/60-cycle A.C.	£11 0 0
" M.7.K.	Magnetic Unit	£3 2 6

THE GREAT VOICE

Write for your copy of this new 32-page booklet to-day. It tells you all about moving coil speakers, power amplifiers for A.C. or D.C., pick-ups and volume controls, etc. Price 3d., post free.



Telephone:
Mayfair 0578-9

The
ROTHERMEL
CORPORATION, LTD.
24-26, MADDOX ST, LONDON, W. 1.

Telegrams:-
Rothermel, Wesdo, London

In Our Test Room



A "Lotus" Valve Holder—Burndept H.F. Choke—Useful Igranic Units—Formo Variable Condenser—Colvern Coil Base—Some Dubilier Items, etc.

A "Lotus" Valve Holder
 AN anti-microphonic valve holder for one shilling and threepence would be cheap even if it were only of medium-class quality. That one can now be purchased for this price bearing the well-known brand of Lotus will be good news to constructors. It is the "miniature type" and is fitted with terminals. It is in every respect well up to "Lotus" standard; in fact, we are inclined to think that it is the best thing of its kind that has emanated from the Garnett, Whiteley works.

Further claims made for it are that it is the strongest valve holder on the market at the present time, and that even the roughest treatment will not fracture or damage it. It is certainly a robust structure, and vastly different in this respect from many we have come across.

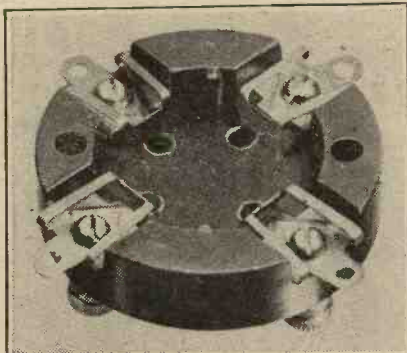

A "worm's-eye" view of the miniature type "Lotus" valve holder.

Burndept H.F. Choke

Burndept Wireless, Ltd., have produced a new H.F. choke. It is extremely compact in structure and occupies very little baseboard space. Nevertheless, it has the high inductance of 50,000 micro-henries with

an extremely small self-capacity. Further, its D.C. resistance is only 480 ohms.

As you will see from these characteristics, it is suitable for both short and long wave-lengths. The retail price is 3s. 6d. After a series of adversities, Burndept Wireless, Ltd., is, we believe, entirely reconstituted. In

Manufacturers and traders are invited to submit for test purposes radio sets, components and accessories to the "Modern Wireless" Test Room at Tallis House, Tallis Street, London, E.C.4. Under the personal supervision of the Technical Editor all tests and examinations are carried out with the strictest of impartiality. Readers can accept the Test Room reports published monthly under the above heading as reliable guides as to the merits and demerits of the various modern productions of the radio industry.

our opinion, this firm has a very rosy future if it can continue to produce lines of the character of this H.F. choke and others of its productions that we have recently reviewed. There must surely always be ample room for any firm producing high-class, dependable components at really low prices.

Useful Igranic Units

There are devices which are ingenious and original without being particularly useful, and there are others—remarkably few—which have all three qualities. Among the few we would include the new Igranic dual-resistance capacity-coupling unit. In essentials, this is a complete R.C.C. unit, having an anode resistance, coupling condenser and grid leak. In appearance it is not unlike an H.F. choke and is not much larger than a representative

model of such, although it has four terminals on its base.

The original feature is that the anode resistance is tapped, and by twisting the milled top of the casing to reveal either a figure 1 or 2, either a high or low value of anode resistance can be obtained. The ingenuity of the design is not so much that it has a tapped anode resistance, we have had these before, but in the combination of this for a definite purpose with carefully chosen values of grid leak and coupling condenser. This enables the unit to be adjusted for the maximum amplification of weak signals, or, alternatively, by providing a low value of resistance for preserving a high standard and quality of reproduction when receiving powerful signals. The unit is connected in circuit in the usual manner. The retail price is 17s. 6d.

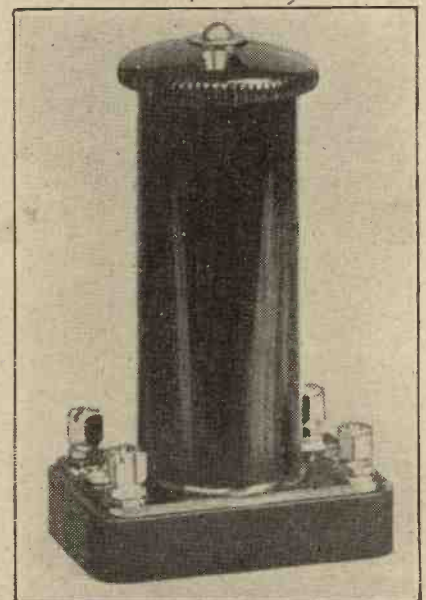

An Igranic dual-capacity coupling unit.

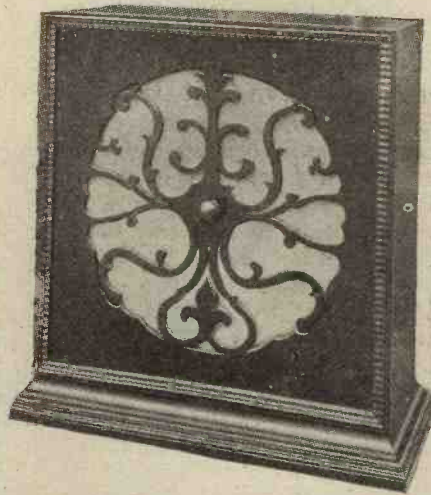

EXCLUSIVE TO M.P.A!
A POPULAR-PRICED MOVING COIL SPEAKER WHICH WORKS PERFECTLY OFF A 2-VALVE SET WITHOUT ACCUMULATORS, MAINS, SPECIAL VALVES, OR TRANSFORMERS

And . . . performance such as you have never heard before! Here is no mere speaker boxed; but a masterpiece of wireless mechanism enshrined in a symphonic mahogany cabinet, attractively fretted both sides . . . fretted, too, with the same scientific regard for melody as a violin. Hence its beautifully mellow tone, pure and without the slightest trace of artificiality. Boomless! Rattleless! Yet . . . its volume is immense. Hear it at your dealer's! Ask for the DUAL INDUCTANCE SELF-ENERGISING MOVING COIL SPEAKER. It costs only 7 guineas.

* * * * *

Other M.P.A. Models include the Popular Plaque, 29/6; De Luxe Plaque, 47/6; Moving Coil Speakers, from 10 guineas; "Octroda" 8-Electrode Self-Contained Stationary Set, 12 and 17 guineas; "Ethatropé" All-Electric Radio Gramophone—"As good as an Orchestra"—Standard Model, 135 guineas, Super Cinema Model, from 200 guineas.



For Illustrated Literature of all M.P.A. Models write Dept. 10, M.P.A. Wireless Ltd., 62, Conduit Street, London, W.1. Telephone: Gerrard 6844-8.

THE M.P.A. WAY
 Products to the value of £5 or over can be obtained on the Hire Purchase Terms for £1 down,

Streets

We carefully tested the device in a straightforward circuit, and it was remarkable to notice how amplification increased by the switching in of the greater anode resistance value. And regarded purely as an R.C.C. unit, the Igranic dual is perfectly satisfactory.

Formo Variable Condensers

You will remember the Formo condenser of some years back as being one of the very few makes worth buying. In those days it had corrugated vanes, the idea of the corrugations being to provide greater surface area. In the course of years the Formo condenser lost its corrugations, but, judging by recent samples received, none of its comparative soundness.

The De Luxe model (this is obtainable in various capacities at 6s. each—the price is not de luxe!) is provided with two end brackets as against the one of the ordinary model. As will be seen by the accompanying photograph there are no end plates in the usual meaning of the word, the spindle being carried on two stout ebonite brackets which also form the only solid dielectric in the structure.

These ebonite brackets are fixed to a metal bar carrying the fixed vanes and the terminals. One of the most novel features of the design is that the pigtail is accommodated inside the spindle. The movement can be adjusted by means of a single screw controlling a friction brake. This permits a velvety action of any required degree of mechanical resistance to be obtained.

Altogether, it is a clean, compact component, undoubtedly destined for popularity.

Short-wave enthusiasts will be interested to learn that the .00015-mfd. De Luxe Formo is obtainable fitted to a screen and provided with an insulated extension spindle. This assembly, together with the con-

denser's smooth action free from backlash, is an ideal one for work on the higher frequencies.

Colvern Coil Base

Although the "screened coil" is now practically obsolete in favour of more efficient screening schemes, the base arrangement remains a very useful setting, and recently Colvern, Limited, have produced a new 6-pin coil base, retailing at two shillings. It is well up to Colvern's standard, which, as readers will know, is a high one.

We particularly like its neat terminals. These take the form of slotted, milled screws; thus they can be tightened with fingers, final fixing being accomplished with a screwdriver. The terminals themselves cannot possibly come loose as they are riveted at their under sides. The insulation moulding is a clean one, and enables one to see at a glance the connections between the various sockets and terminals.

a very useful holder of original design for "Dumetohm" grid leaks. The holder consists of two portions, a base having a socket and terminal and a spring cap which carries the remaining terminal. Between these two sections the leak is held vertically with complete security. Both

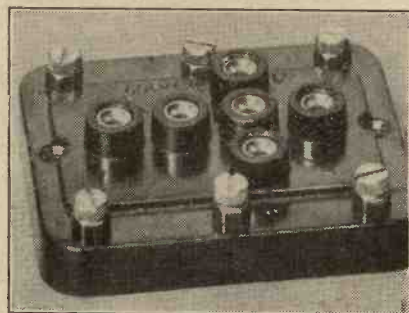

The new Colvern coil base.

experimenters and set builders will appreciate this natty contrivance.

An H.F. choke suitable for use on the whole broadcast band is cheap at 4s. 6d. It is more so when it is as neat and efficient as the new Dubilier component of this nature. This Dubilier choke has a low self-capacity and "peaks" well away from the working wave-bands.

That R.C. coupling makes for compactness has always been one of the advantages of this system. Still further space is saved in using a Dubilier R.C.C. unit as this incorporates the necessary valve holder as well as resistance clips, condenser and terminals. By this inclusion wiring is further facilitated. That the resistances, in the form of Dumetohms, can be changed in a few seconds is another advantage that warrants emphasis.

The device covers but little area, and its height has been reduced as much as possible. In view of the components it replaces, 8s. 6d. is an attractive price for the article.

Four N.S.F. Components

Radio products of a continental origin are frequently referred to in disparaging terms, but while a great deal of dud gear certainly does originate in Germany and Austria, there are exceptions, and among these we have no hesitation in including four components sent us for test by S. W. Lewis and Company, Ltd., 39, Victoria Street, S.W.1.

While not quite equal to the better British makes, the N.S.F. variable condenser is distinctly sound in construction and design. It can be mounted either on a baseboard or panel (by a single hole) and its action is smooth and positive.

(Continued on page 550.)

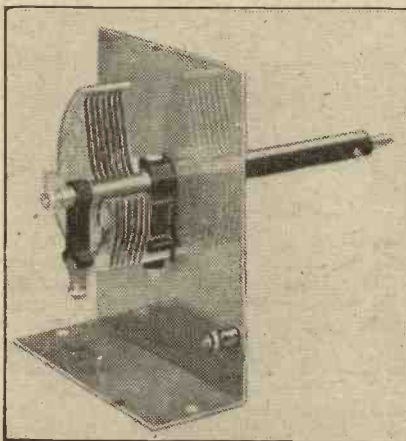

The "Formo" variable mounted on a screen for short-wave work.

Some Dubilier Items

A number of new Dubilier components were recently received, and among them are several of more than usual interest. There is, for instance,

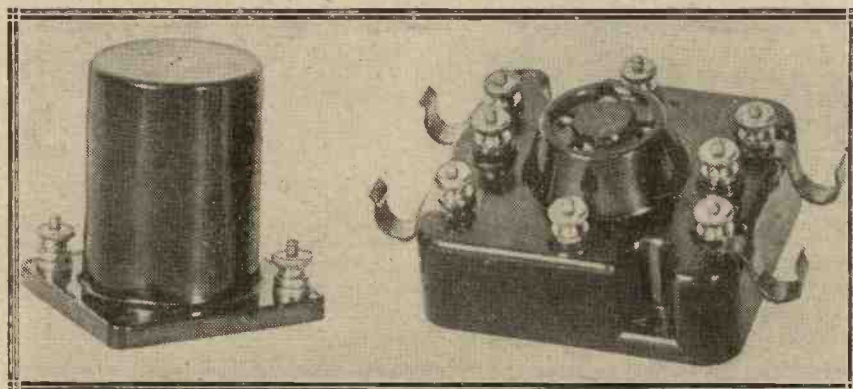

Two of the new Dubilier components. On the left is the H.F. choke, the R.C.C. unit being shown on the right.

LOTUS

THE MASTER VALVE HOLDER

SPECIFIED FOR Mullard Master 3*

Again Mullard have chosen Lotus Valve Holders for the Master 3. A good set demands a good valve holder, and Mullard have chosen the best their experts could find.

The new Lotus Miniature Valve Holder is anti-microphonic, almost indestructible, and only 1 5/8ths" in diameter.

Phosphor bronze leg sockets and springs are all in one piece, all surplus metal has been removed between the valve legs, and the very finest bakelite mouldings have been used.

If you are building the Master 3 or any other good set, make sure you buy the new Lotus Miniature type Valve Holder. It will make all the difference to your set.

*From all radio dealers, price 1/3.
Other types 1/6 and 1/9.*

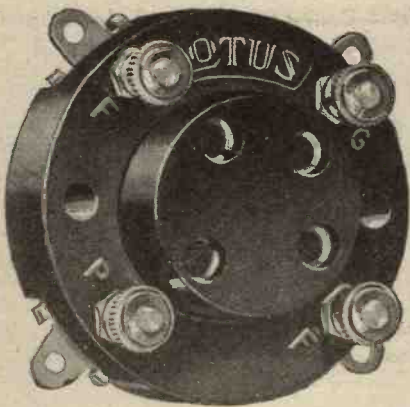

*London Representative:
W. J. Holland,
Room 60, Craven House,
Kingsway, W.C.2*



Made by

Garnett, Whiteley & Co., Ltd., Broadgreen Road, Liverpool

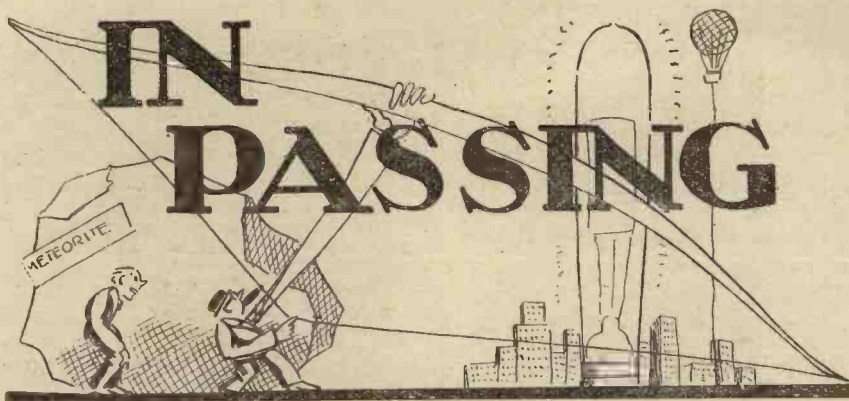

HIGH HO, brothers! Here we all are again, back on the job, noses skinning over nicely and well and truly clamped to the grindstone once more. But it was a mighty fine summer. Even the radio enthusiast, burning inwardly with the inspiration and rapture not given to the common cry of men, needs a spot of sun, if only to light up the interior of his set and reveal the lurking blackbeetle. But it may be said of him and his kind that they rise superior to most physical adversities, except "fading" and the expressed sarcasm of female relatives who have not the Light or the Truth within them.

The New "Season"

And here is jolly old October again, not lacking enough Fahrenheit to remind us of winter, not so far behind the splendid days of September that we have forgotten the bronzed bracken, painted trees and brilliant mornings of that best of all months. October ushers in the season which



The chilly vigil of the D.X. hunter.

is heralded by the Radio Show; the sap then rises in the veins of club secretaries, who forthwith demand syllabuses, fees and new members. There is a smell abroad of very ripe leaves and undergrowth which is on the point of becoming "mulch," a delicious scent of burning rubbish from gardens and allotments. The first fires are specially cosy and—may it be so!—the B.B.C. programmes have a little sparkle. Here

begins the "long, dark evening," and the chilly vigil of the D.X. hunter. The home firm's money is unevenly divided between the autumn sales and the purchase of component parts. Radio begins in real earnest.

Sounds like a lump of highbrow talk, doesn't it? Let's smother it and get down to the agenda.

Getting Back to Work

After the relaxing influence of the holidays I suspect that most of you need an injection of pep. Ah, aye! No doubt you have come back most disgustingly "fit" in the physical plane. I did so myself, but I found, as you also may discover, that the pleasant dalliance by sea, lake, stream, hill, peninsula, volcano, "Three Bells" or bandstand, is apt to blunt one's finer radio feelings.

For instance, when I returned, bronzed, handsome, and hungry, all I seemed to desire was "oodles" of oxygen and the privilege of sleeping out on the verandah. The mere sight of a condenser affected me in the same way as cats affect others. I could feel the presence of a condenser and had no peace until the thing was removed. Bad, bad! Very bad! Having, as I said in August, become acquainted with certain Somerset sheep and other animals, I tried to strike up an acquaintance with a local cow—and was badly snubbed—besides being suspected of cattle-maiming by Jno. Watkins, the local milk-feller.

It takes on an average a week to cast off the insidious effects of a fortnight at the seaside, and attune oneself to higher things such as work and radio. Hence I propose to inject a special regenerative tonic. The charge will be one shilling—and there is no larger size at two-and-three, containing four times the quantity sold for a bob. It's kill or cure. One dose, one price.

My experience is that the spirit of competition is the best incentive to

effort. We love to have a shot at a record, and that's how records are made. Oh, Goddess Competition!

*Thou art the voice
To kingly boys,
To lift them through the fight.*

as Kipling sings of Romance. And what Kip says is right. Though he adds:

*And comfortress of unsuccess
To bid the dead good-night.*

There is a precious little "good-night" for the inveterate D.X. specialist. He lives on ether and ebonite, mostly. His pillow is the set and his dream is the call-signal of the station upon which he has pinned his heart's desire.

Story of Jake Bolum

In order to arouse the competitive spirit in you I must set a mark for you to aim at. Hence the following story of Jake Bolum, of Hot Dog, Pa., as related to me by an American whom I met in the Savoy Hotel. He resided there; I was just hanging around trying to snare "copy." In the interests of the B.B.C.'s experts



Jake Bolum, of Hot Dog, Pa.

in English I have spokeshaved my friend's diction pretty severely, and I believe it is now fairly intelligible to the untravelled reader:

"You're a radio man? Is that so? Say, that's dandy! I'm real glad to have met up with you. Do I dicker with radio? Waal, guess I know my way round the ether and best part way back again. Not that I'm a show-boat in that line! Nope! Run a couple of eight-tube gorrarity's t' amuse the boys and girls and such. Real estate's my meat. Sell you a Florida swamp if you so much as take your hand off your wallet for the space of a skeeter's eye-blink.

A Good Listener!

"But this radio, now. J'ever hear of Jake? Jake K. Bolum, that was boss of Hot Dog, Pa? (He said, Hart Darg). Nope? Gee! It's coming to you then, and it's good for two front-page columns and you get it for nix because I like your ree-action to my theory of toobes, what I told you in the saloon yonder.

*What's the slope
of your valves?*

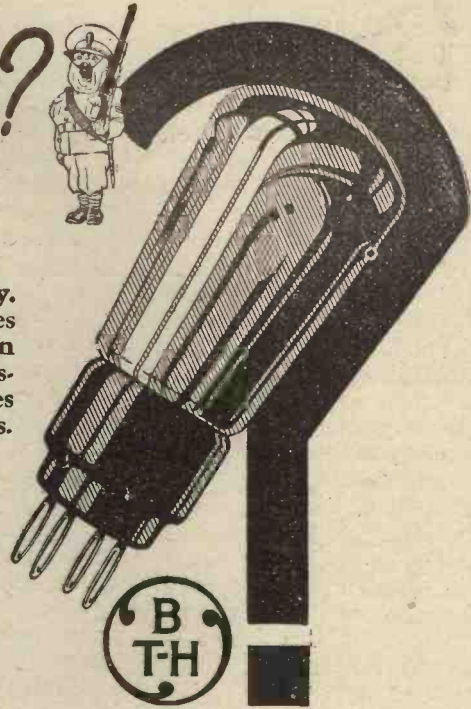

Slope means valve efficiency. Mazda Nickel Filament Valves have higher slope values than any other valves of corresponding types. Mazda Valves are therefore *better* valves.

MAZDA

Steep Slope
NICKEL FILAMENT
VALVES

The British Thomson-Houston Co., Ltd

3024

ALWAYS ASK FOR NICKEL FILAMENT VALVES

JUST OUT! WEILO CIRCUIT No. 1

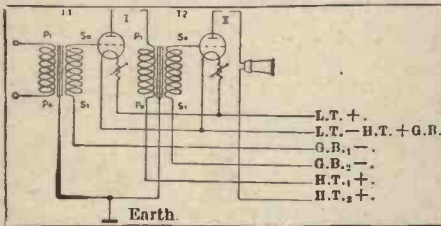

Look out for these circuits in every WEILO advertisement.

No. 2 will be a PUSH-FULL GRAMOPHONE AMPLIFIER.

This new series of circuits, built with N.S.F. components, will help you to obtain remarkable results. The above circuit shows a very effective two-valve low-frequency amplifier. To get the utmost purity of amplification, use WEILO—the Transformer that is built up to a standard that rivals the highest price class.

WEILO SETS AN AMAZING NEW STANDARD OF TRANSFORMER VALUE!



Never before! A heavy core transformer, completely saturation proof, with an amazing purity of maximum amplification, and bearing a two-years' guarantee—that is WEILO—and at the wonderful price of:—

Model 10. POWER. Heavy Type Shrouded,	Model 3. Heavy Shrouded Type,
---	-------------------------------------

11/6 8/6

GUARANTEED TWO YEARS.

Stocked by Harrods and good class dealers. Write now to Dept. M.W. for details of Weilo Transformer and the complete N.S.F. range of quality components.

S. W. LEWIS & CO. LTD.
39 Victoria St., London, S.W.1.

Indian Agents: Bombay Radio Co., Bombay, Calcutta.

M.B.

DUBILIER MIDGET CONDENSER

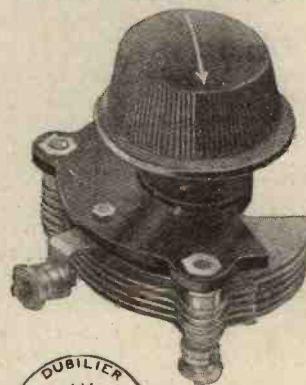

A small variable condenser for panel mounting. Especially appropriate for use as a reaction condenser, it can also serve when a neutralising condenser of large capacity is required.

If unobtainable from your dealer write direct to us giving his name and address.



**DUBILIER BUILT
IS BETTER BUILT**

Advertisement of Dubilier Condenser Co. (1925), Ltd., Ducon Works Victoria Road N. Acton W.3.



" Jake belonged to poorish rich but middling conscientious folk in the canned goods trade.

" His pa reckoned he had sold more cases of junk that there are electrons in Brooklyn Bridge. Yeh! And all along of his pa having to hoist his ears to the limit in order to check up the number of pig-squeaks per can, Jake was born with a pair of harkers which would have caused Jumbo to die of envy! Dog my cats! —pardon! Believe me or believe me not, that Jake had such a hearing that he could get the gist of what his nurse said before she said it! Yup! And he used to amuse himself by telling her what she was going to say! I *should* smile. Let's drift over to that saloon for another spot of prohib. My call, pard!

Some Crystal!

" Fine! (*gbig*) *Mighty* fine! Fine city, London, if it is shy of ice-wadder. But there, you all *keant* be expected to kotch holt of our notions in a hurry, I guess. I was saying, that young Jake cud hear the female May-bug telling her old man he lacked pep and vim, because he smoothed off when a bee lighted near him with all decks cleared for suction. Quite naturally the boy horned into the radio game soon's he could get the bearings of it.

" Started in on crystal sets. Crystal not big enough for Jake, so he kidded his pa to borrow the three-ton meteorite from the local museum. Hitched it to a solenoid wound by



America's a white man's country!

the Mackacak Bridge and Viaduct Corporation and gathered in signals from stations not built but down on the budget for the next year. These darned cocktails lack pep. I heard that the railroad wanted to negotiate for the right to use his solenoid as a tunnel. It's a lie! These goldarned cocktails seem to be thinned down some. Call the bar-keep!

" Yup! that's more like Manhattan! As I said, Jake sold his crystal set to the Harbour Board and Coast Lights Commission, who tuned it to W P P W and set it on Staten Island as a foghorn. Yeah! Some set!

" Next Jake started in on toobes. (*Valves—Editor.*) Made 'em himself out of pa's cans and empty 'Grapowine' bottles. Say!! That 'Grapowine' is the buffalo's trousseau! Guess it's com-pounded with bicarb and gooseberry juice. Ha! the bar-keep stirred slightly. I reckon the slightest movement of the dead is of su-preme importance. Two more, and make it snappy!

A "Super-Toobe"

" Did I mention that Jake's first toobe set shifted the Libbuty statoo haff a point off her pedestal? No? That's so. Had the City police out gunnin' for I.W.W.'s and what-all. Shut up four wops and several Chinks in the process. All to the good, brother, all to the good. America's a white man's country, anyway. That's Ira P. Harbloom talking.

" Ah, yes! This radio! Young Jake couldn't waste time rattling statooos. Said he'd build a toobe fit to knock the Mason and Dixie line clean into Mexico. Hired two hundred glass-blowers and got him a toobe big's the dome of the Capitol, Wash. D.C. Pretty nigh! Left the glass-blowers inside out. Sold 'em to the Columbia University as freaks.

" Puzzle was—how to work the super-toobe. Jake didn't hesitate the fraction of a second it takes J. P. Morgan to identify a ten-dollar note. Got an option on Niagara and had a hydroelectric plant fixed in four days. When the hi-jee was let loose on the toobe, seismologists all over the world predicted earthquakes, and Billy Sunday announced the conclusion of the world, sharp at eight-fifteen ante-meridian the next Saturday.

"That's a Detail"

" Then Jake tuned-in all the stations in the world and, using the Grand Canyon as a loud speaker, definitely blew three planets, including two undiscovered ones, into sheer powder. But that was only a trial. After he got into proper trim he changed direction and melted all the snow and ice on Mount Everest. Hence these here floods your newspapers report. But that's a detail. Jake's real work was still to come. Call the bar-keeper and with his assistance I'll give you a bill of particulars.

" Is this gin, or only Thames wadder? Seems that I've got to get sorter acclimatised! Was that one bar-keep or him and his folk. I swan! I counted at least seven! No matter. Carry on, pard. Oh, quite so! This

Jake. Waal—did I mention that for to keep the filament of his toobos from melting the glass Jake bought the South Polar region and wadded it up against the set. That sure caused a *situation* betwixt your Foreign Office and ours. They're still talking pretty.

" My grief! That was a toobe, if ever. Filament made of cold-drawn steel rail left over from the noo line, N'York-Frisco. Plate was the lining of the old under-water tunnel be.



"Was that one bar-keep or seven?"

tween Hot Dog and Saskawichie. Whenever Jake was working her the City lighting and power plant shut down for an overhaul, for the filament lit up the top half of Pa., like it was a prairie fire, and enough juice leaked through the insulation of the toobe's legs to electrocute every Mexican on the map.

Real Volume!

" Jake had to train a squad of window-cleaners specially to keep the outside of his toobe slick. Took 'em a month to get right over her. Week to buy new kit—then start again. Lost one man on top of the bulb for five days. When found, said he'd been living on broadcast food ads., which came through so powerful that the beef was overdone and the beans all of a cinder. Reckon he was lying.

" But that give Jake an idea and he went up in a balloon to the 'pip' of the toobe. Took him day and a half, easy going, not counting the time he wasted coming down before he was more than half-way up—to borrow oxygen breathing gear on account of the altitude.

" That would be five months come Sunday. Still up there s'fars I know. Drops notes to say he's feeding well, thanks to the broadcast ads. of the Moose Gut Canned Goods, Incorporated. Says, if that firm are replaced by the Cast Iron Bucket and Trolley Merger we are to send Lindbergh up to take him off. No use for buckets.

" Mus' you go, brother? Ri, g'bye."

Now then, beat Jake and you will not have lived in vain.

Spare 3 minutes over 4 vital voicings on "DARIO" selling at 5/6

"I purchased on 28/8/27 a 2-volt Dario general-purpose and a 2-volt Dario Bivolt Power Valve. I have been regularly using them ever since, especially the Power Valve. I am surprised at the current consumption considering I had a very small accumulator running several months on these valves. I have lent the Power Valve to several of my fellow-workers, and they all agree it is the best valve they have tried in that stage."

(Signed) C. T. Cowell, Fulham, S.W.6.

"Praise where due! I was trying a 2-valve receiver for a friend of mine, employing a detector and power valves of a very well-known and much-advertised make. I thought this a good opportunity for comparing the Dario with them so placed a G.P. and S.P. in the sockets and switched on. I was astonished at the difference in quality and emission. The Darios, in my opinion, were far superior to the others sold at a far higher price."

(Signed) W. E. Iles, Camberwell, S.E.5.

"Just a congratulation on your new 'Dario Micro' 4 volts. Having been a short-wave experimenter for over two years I know how difficult it is to procure a detector which is both sensitive and at the same time non-microphonic. I must say the 'Dario' I recently purchased is the best I have tried so far. I receive both the Australian and American transmission better now than ever before. Hoping this valve will soon be more widely known."

(Signed) C. C. Lappell, Barnsley.

"Dario has been working constantly for eighteen months without a break and during that time it was used in H.F., D. and L.F. on a 3-valve loud-speaker set, and later in experimental short-wave work as a one-valver. It is a 3.5 valve. At present I am using 2-volt type as they are more economical. I have had the greatest satisfaction."

(Signed) C. Newey, Bronsgrave.

**DARIO VALVES
RADIO MICRO'S
OUTSTANDING
1929 RANGE**

**THE VALVE THAT
LASTS FOR EVER**

DARIO VALVES

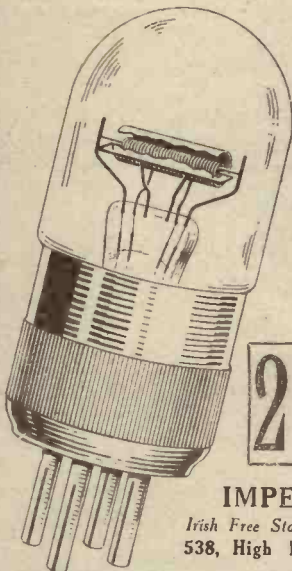

2	V G.P. .05	4	V G.P. .05
	amps. 5/8		amps. 5/6
	O R.C.C. .06		O R.C.C. .07
	amps. 5/6		amps. 5/6
L Super-power	L Super-power	T	T
T .18 amps. 7/6	T .1 amps. 7/6		

IMPEX ELECTRICAL, LTD.

Irish Free State Agent: **BURWOODS OF CORK.**
538, High Road, Leytonstone, London, E.11.

IGRANIC

9 Components specified by Six-Sixty for the famous MYSTERY RECEIVER

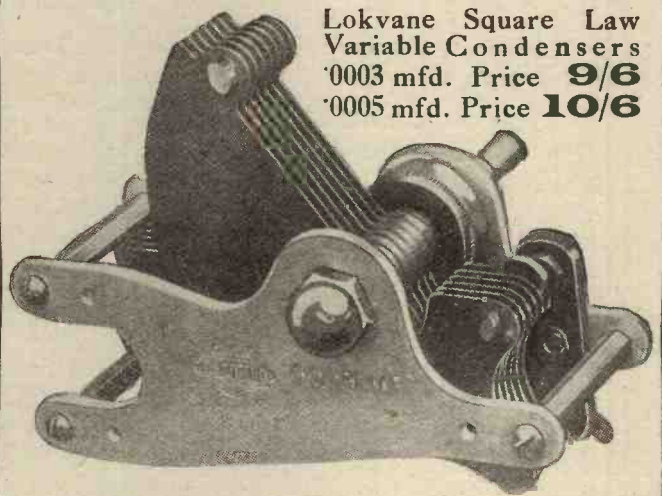

**Lokvane Square Law
Variable Condensers**
.0003 mfd. Price **9/6**
.0005 mfd. Price **10/6**

	Price
Also Indigraph Slow Motion Dials	6/-
Indigraph 2" Dial	1/6
Rheostat 50 Ohms	2/6
Neutralising Condenser (Baseboard Type)	4/-
Single Filament Lighting Jack	3/9

Igranic can supply your every radio need. Send for illustrated catalogue —post free.

HAVE YOU READ "RADIO"

—How it works and how to get the best from it"—price 6d.? Send this coupon with your name and address and get your copy FREE!



IGRANIC ELECTRIC Co. Ltd.

149, Queen Victoria Street,

LONDON, E.C.4.

Works - BEDFORD

Please send me entirely free "Radio. How it works and how to get the best from it."

NAME

ADDRESS

Dept. M.W.

RADIO NOTES AND NEWS OF THE MONTH

A feature in which our Contributor brings to your notice some of the more interesting and important Radio news items.

Conducted by "G.B."

So at last the B.B.C. has come into the open and admitted that it is going to leave Savoy Hill. There has been a lot of denials from Savoy Hill concerning certain aspects of B.B.C. policy. But over a month ago it was mentioned in these notes that Savoy Hill was getting overcrowded and that a move would have to be made.

New Broadcasting Headquarters

Even now, of course, it will be two years before the new Broadcasting House, which is to be built at the corner of Langham Place, very near the Queen's Hall, will be ready. Although nothing is definite, it is quite likely that His Majesty the King will be invited to open this new headquarters for the B.B.C.

It will certainly be one of the wonder buildings of London; the very nature of the service required by such a building will make it unique. Certainly it is an indication of the progress of broadcasting in this country that money can be found for this magnificent new building.

"Jam On It"

And, by the way, wireless is growing. A visit to the Exhibition at Olympia was enough to convince even the greatest sceptics. I have often wondered what would happen if, by any chance, the licence fees were reduced from ten shillings to seven and sixpence. Would that make a great deal of difference? Probably it wouldn't, because even for ten shillings, whatever we may say in criticism about the B.B.C., we do get value for money. It is probably one

of the few things to-day in the way of a public service where value for money is really given "with jam on it."

Wireless Pictures

The Fultograph tests have resulted in another complication of policy at Savoy Hill. Although the B.B.C. engineers have investigated television and, from time to time, have given their opinions—our readers, of course, know that Captain Eckersley has given his considered opinion on television more than once in our contemporary "Popular Wireless"—it is certainly a necessary matter of policy that the television business should be investigated properly at Savoy Hill.

"Public Service" Prospects

There is, of course, only one real serious television concern in this country, and that is the Baird Television Development Company, and as these notes are being written I understand that tests are already under way in connection with Mr. Baird's system. The Post Office engineers have already investigated his system, but I understand unofficially that although Mr. Baird has now received permission to start up an experimental station at Long

(Continued on page 540.)

These MAGNUM Components are used and specified for the "INVINCIBLE" FIVE

DESCRIBED HEREIN.

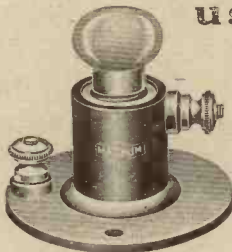

AUTO FUSE, 1/6



MAGNASCREEN, 2/6

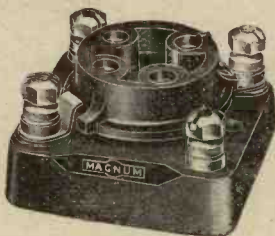

VALVE HOLDER, 2/-



MAGNUM "UNIVERSAL" THREE
15-2,000 metres, including 4 Coils, Valves and Royalty,

£18

Free Demonstrations Arranged.

The ideal set for the Overseas listener.

New Catalogue and Lists on receipt of 1d. stamp.

BURNE-JONES
& CO. LTD.,

MAGNUM HOUSE

TELEPHONE: HOP 6257-8

288, BOROUGH HIGH ST.
LONDON. S.E.1

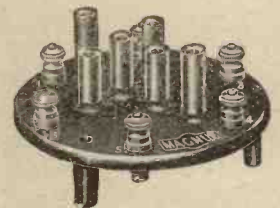

6-PIN BASE,
2/-



VOLUME CONTROL
7/6

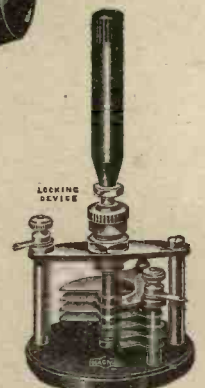

NEUTRALISING
CONDENSER,
5/-

A Loud Speaker for 16/-

built by yourself



The Brown C.T.S. Unit makes a Loud Speaker easy to build and easy to buy. Though the price is only sixteen shillings there is a complete set of parts for either a horn or cone type model. You can build it yourself—the instructions given and the quality of the Brown Unit supplied ensure your success.

The Brown C.T.S. Unit for building a horn-type Loud Speaker costs only 13/6

Additional parts for converting this to a horn-less type cost 2/6

Supplied by any first-class Radio Store.



The

Brown

CONSTRUCTORS' UNIT

MULLARD SPECIFY

★ Exide ★

BATTERIES

FOR THE

MASTER FIVE PORTABLE

AND THE

MASTER 3 STAR



Mullard—a name that is synonymous with all that is best in radio—specify Exide L.T. Batteries as standard for both sets.

For the Master Five Portable you will require the Exide Unspillable Battery, Type USP7, price 14/6.

For the Master 3 Star we recommend a choice to suit your selected valve voltage from the Exide "Mass" Type range for L.T., the DFG, DMG, or DHG, capacities 45, 70 or 100 amp. hrs., prices 6/6, 11/-, or 14/6 per cell, respectively. These types give more burning hours per charge in relation to first cost than any other battery.

For full Exide range see folder No. 5000.

Obtainable from all Exide Service Agents and reputable dealers.

Exide BATTERIES

CLIFTON JUNCTION, NR. MANCHESTER

RADIO NOTES AND NEWS OF THE MONTH
 —continued from page 538

Acro, no licence has yet been issued for him to give a public service.

Keeping Pace With Pictures

I understand from some of our technical people that a special television receiver is already being prepared in our laboratories, so that we shall be quite ready to receive any transmissions if the B.B.C. decides to send them out. We shall, of course, from time to time keep our readers thoroughly *au fait* with regard to the technical progress in the construction of the receiving apparatus for television and for still pictures.

B.B.C. Doing Too Much

There are now twelve B.B.C. school advisory engineers, who spend two or three months in a particular area paying daily visits of investigation to schools and other places where there are wireless sets installed. Of course, good reception is essential

if the B.B.C.'s educational broadcasts are to be of any value. It looks as though the B.B.C. is going all out in catering for schools. And this,

of course, has given rise to a good deal of criticism as to whether the B.B.C. should supplement the educational authorities by spending listeners' money on providing educational broadcasts.

There certainly is something in the suggestion that the B.B.C. is trying to do too much.

A Study in Studios

The B.B.C.'s new big studio at Savoy Hill is nearly ready. It is probably going to be the only one of its kind in the world. It will be designed in a fantastic green, blue, silver and yellow scheme. The walls are felt-covered, and sound-absorbing walls have been constructed, also. On the walls are pictures of castles towering from a shore of a lake into the clouds, and the effect is heightened by subdued indirect illumination. Altogether it sounds rather like a dream palace. Much better ventilation has been secured and, according to an official of the B.B.C., the studio will no longer possess the old unnatural atmosphere of early designs, but it will now be a cheery, bright place which will make artistes feel happy and will give them the right colour and atmosphere.

(Continued on page 542.)

SPECIAL NOTICE TO SET BUILDERS

In last month's "M.W." it was announced that five sets would be described in "M.W.," this month.

Owing to the inclusion of special features, slight modification has been necessary, but in the Gift Booklet we are presenting every reader with full details of no less than eight sets (in addition to "M.W." ordinary constructional articles), so at the usual price of One Shilling, this represents

UNPRECEDENTED VALUE FOR CONSTRUCTORS



Remarkable reproduction —the reason why



"One-o-one," the new cone speaker, incorporates our driving unit 66K, embodying the improved adjustment for armature and the High-Ideal filter cone, and the output is another and goodly step forward to perfect reception.

The filter cone is designed to damp down the dominant middle notes of the musical scale and to reproduce both ends of the audio range with equal volume and clarity.

The surrounding "Trolite" case is worthy of these two components. It is of bold and unconventional design and does not detract in any way from the faithful output of the unit and cone.

The price of the complete speaker is £3 13s. 6d. Alternatively, the constructor who prefers to build his own speaker, either to his own design or to one of the many designs that have been published, can purchase the separate driving unit for 25s.

The Blue Spot range of Cone speakers includes an attractive range of models of varying design, fitted with the Blue Spot driving units and varying in price from £1 17s. 6d. to £3 13s. 6d.

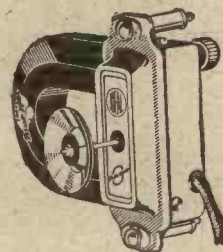

F. A. HUGHES & CO., LIMITED, 204-6, Gt. Portland St., London, W.1.

Distributors for Northern England, Scotland and North Wales :
 H. C. Rawson (Sheffield and London) Ltd., 100, London Road, Sheffield.
 185, Princess Street, Manchester.



**DUBILIER
BUILT
IS
BETTER
BUILT**

**DUBILIER
DUMETOHM**

A high resistance of special construction which has many uses and is supplied in nine resistance values—25, 5, 1, 1.5, 2, 3, 4, 5, and 10 megohms. Holders are supplied either horizontal or vertical.

If unobtainable from your dealer write direct to us giving his name and address.

PRICES
Dumetohms,
all resistances
2/6 each
Holder
Horizontal or
Vertical
1/- each

**DUBILIER
CONDENSERS**

Advertisement of Dubilier Condenser Co. (1925), Ltd., Ducon Works, Victoria Road, N. Acton, W.3.

181

**The IDEAL
GANG CONTROL
AT LAST!**
SYNCHRATUNE
(REG^d)
another exclusive feature of

CYLDON

VARIABLE CONDENSERS

To the many merits of Cyldon Condensers is now added yet another outstanding feature which has met with instantaneous success. The "Synchratune" system provides gang control with the added advantage of individual adjustment of the aerial and H.F. stages from the front of the panel. The condensers are mounted on a strong aluminium chassis which requires two holes only for panel mounting. The bakelite drums protrude through a beautifully finished bakelite escutcheon plate with recessed window, through which is shown scales reading 0-180°.

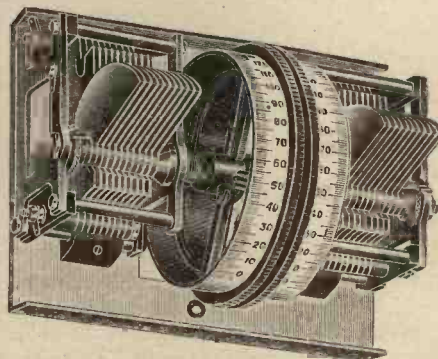

PRICES:

List No.	2T5	Twin	.0005	£2 7 0
"	2T3	"	.0003	£2 5 0
"	3T5	Triple	.0005	£3 12 6
"	3T3	"	.0003	£3 9 6

Escutcheon Plate and Drums are of Standard Black Finish, but Walnut, Oak, Mahogany or Rosewood can be supplied at 5/- extra.

3 Cyldon Log. Mid-Line (.0005) Condensers are specified for the "INVINCIBLE" V. Price 15/6 each.

Described in this issue.

SYDNEY S. BIRD & SONS, LTD.,
Cyldon Works, Enfield Town, Middlesex.

Telephone: :: Telegrams: Enfield 2071-2. "Capacity, Enfield."

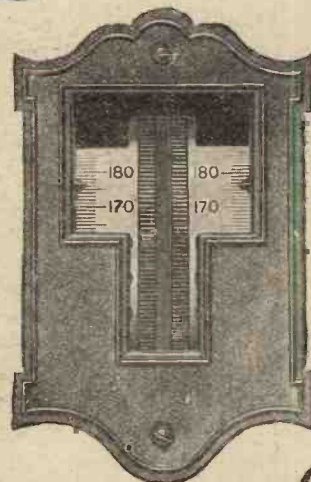

EVERY NOTE

WITH

PURITY

TELSEN

Radiogrand
L.F. TRANSFORMER
FOR BETTER RADIO RECEPTION



Whether it be the highest or the lowest notes.

The new Season's improvements render this already popular L.F. Transformer more efficient even than before, and, whatever the set, it will be improved by installing a TELSEN.

Shrouded and in Ratios
5-1 and 3-1. **12/6**



For pure production
TELSEN gets all the
votes.

TELSEN ELECTRIC COMPANY, LTD.,
207, ASTON ROAD, BIRMINGHAM
Phone: Central 5285.
Grams: "Escort, Birmingham."

RADIO NOTES AND NEWS OF THE MONTH
—continued from page 540

For Scotland Only

It was a great pity about Sir James Barrie's broadcast. "Popular Wireless"—our contemporary—gave the first news in any of the wireless periodicals that Sir James was to broadcast, coupled with the unhappy fact that it would only be a relay from Scotland. Let us hope that before long Sir James will agree to have his voice relayed again, and that this time a real S.B. arrangement will be fixed up.

Fultograph For Fatherland

By the way, Germany has adopted the Fultograph still-picture broadcasting system. After a good deal of investigation and examination of some rival systems, Captain Fulton passed with flying colours in a recent test. No definite programme details are yet to hand, but I understand that very shortly from ten to twelve pictures will be broadcast

every day from a main German broadcasting station.

Olympia Omens

Business at the Wireless Exhibition at Olympia this year was of a record nature. One loud-speaker firm alone

YOUR WEEKLY TONIC

If you would learn all about every new radio development, if you would preserve your enthusiasm in matters radio, YOU MUST

Read "Popular Wireless"

Every Thursday.

Price 3d.

reckoned that it would sell at least 150,000 loud speakers in the coming season. Already British radio goods are invading the American market, says a well-known manufacturer; foreign competition is no longer feared, and the Continent now looks to Britain for its supply of radio gear.

The Australian Market

Within two days of the Exhibition opening one firm received an order from Holland, in face of German competition, for 25,000 variable condensers, and orders from Japan, India, and many Continental countries poured in. Australian markets are made very difficult for British goods by a heavy import tax. And that means that a component costing 30s. here costs 57s. in Australia. But, despite this great drawback, business in Australia has been brisk as regards British wireless goods.

Not Too Bad

Even in July our export figures for radio trade were not too bad. The "Wireless Trader" gives the following figures: Total value, £75,910 (including valves, £14,738). Australia was the best buyer, her share amounting to £16,992, of which sum £7,288 was spent on valves.

5 G B's Fate

5 G B, by the way, is to be the new Midland Regional broadcast station. Exactly when the technical transformation will take place it is hard to say at the moment, but the definite future of the old experimental 5 G B now seems assured.

The Original
Moving-Coil Speaker

The R.K. was the first of the moving-coil speakers. It is still the first in quality, for there is no other instrument capable of giving such faithful reproduction.

Similar to the R.K. Senior (the original model) is the R.K. Junior—an instrument which gives perfect reproduction over the whole range of audible frequencies. Supplied for operation direct from A.C. or D.C. electric light mains.

If you prefer to build your own equipment, ask your dealer for a copy of the new B.T.H. Booklet "Sound Reproducing Devices."

Here is the R.K. Unit—the actual sound reproducing portion of the R.K. Speaker. Supplied complete with special output transformer & cone diaphragm

Price £8:5:0
Filter Unit £1:5:0

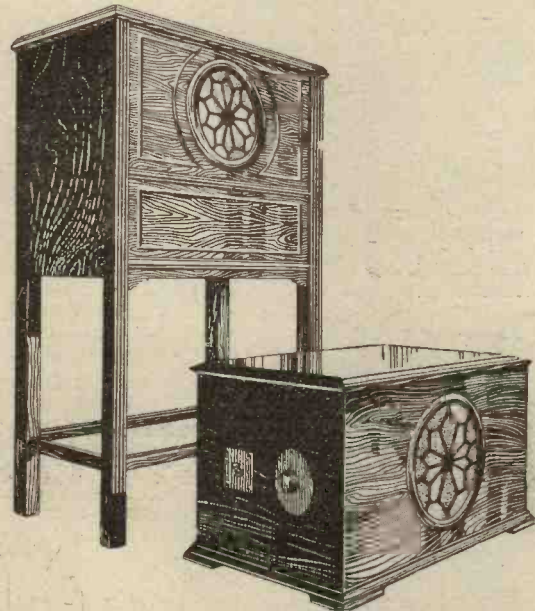
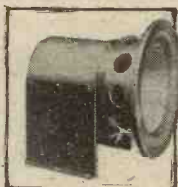

Table Grand Junior R.K. ...	A.C.	£34	15	0
	D.C.	£30	5	0
De Luxe Junior R.K.	A.C.	£40	0	0
	D.C.	£36	5	0



R.K. SPEAKERS

The British Thomson-Houston Co. Ltd.

SIMPLICITY

in Radio Set Construction

COLLAPSIBLE
CABINET

28/-

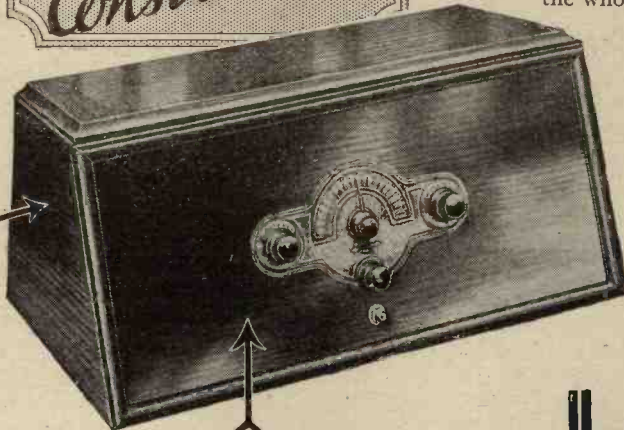

PANEL PLATE
UNIT
INCLUDING
PANEL

35/-

EST.
1912.



Here is the set you can construct in a few minutes. Only the main parts to assemble and the result is a receiver of proved efficiency.

The Panel Plate Tuner Unit, which is half a receiver, consists of a richly embossed Metal Panel in antique brass, on which are mounted coils covering wave-lengths from 250-2,000 metres, tuned by a S.L.T. Slow-Motion Condenser. A Switch is provided for changing from high to low wave-lengths and a Switch for putting off batteries, the whole being mounted on a special wooden panel of Oak, Mahogany or Walnut.

To provide the finest professional finish so much desired, the Collapsible Cabinet has been specially designed for the Panel Plate Tuner Unit.

This new departure in wireless practice brings within the reach of everyone the finest wireless entertainment.

Go now to your Local Lamplugh stockists or send for Lists and Circuit Diagrams from manufacturers.



LAMPLUGH

S. A. LAMPLUGH LIMITED,
KING'S ROAD, TYSELEY, BIRMINGHAM.

ALL LAMPLUGH RADIO PRODUCTS ARE GUARANTEED FOR 12 MONTHS.

CLIX-LOX

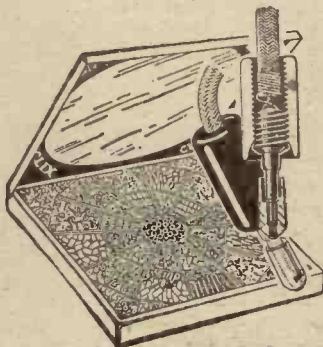

Look for this Showcase on your Dealer's counter.

Clix-Lox Adjustable Wander Plug is a complete solution to faulty contact caused through variations in diameter of H.T. Battery Sockets.

Clix-Lox adjustable wander plugs cut out all risks of shorts. They 'stay put' in any H.T. socket and can, if desired, be permanently locked in position by a turn of the insulator.

NOTE:—When wiring, screw insulator well down on wiring shoulder. Expanding leaf should be eased up to ensure suppleness.

Clix-Lox in 3 colours, Red, Black or Green.

PRICE 2½D. EACH.

CLIX ACCUMULATOR KNOBS

defy the damage caused by creeping acid, because of the patented vaseline trap which ensures clean and constant contact, gives purity to reception as well as lengthening the life of all accumulators fitted with them.

Note the special socket provided for a clean, quick connection with a Clix-Lox Wander Plug.

Supplied in Red and Black, PRICE 5d. EACH.

Extension stems for counter-sunk type of accumulators, price 1d. each. Supplied in various threads to suit most accumulators.

"CLIX"—WORLD WIDE PATENTS.

LECTRO LINX, LTD.,

254, Vauxhall Bridge Road, London, S.W.1



The Battery That "Pulls Them In"

The steady, silent H.T. or L.T. current supplied by Premier Batteries will give your set the best chance. Premier Batteries are noted for the extra thick plates and the persistence of their efficient service over long periods.

Ask your dealer for list range of Premier H.T. and L.T. Batteries, or write for literature to

PREMIER ACCUMULATOR CO. (1921) LTD.,
Estd 1898. NORTHAMPTON

LONDON:
53, Victoria Street, S.W.

GLASGOW:
149, St. Vincent Street.

H.F. ON THE SHORT WAVES

—continued from page 488

stands. For instance, we couple the aerial to the coil L_1 , thereby increasing the damping of the tuned circuit L_1, C_1 . Similarly we couple the detector to the circuit L_2, C_2 , thereby introducing damping into this circuit, which, further, has the valve damping in parallel with it.

The extra damping introduced into a tuned circuit by coupling it to an aerial and earth system may be anywhere from 5 to 20 ohms, while the damping introduced by a rectifier into a tuned circuit may be anything up to 10 ohms for anode-bend rectification. These figures are, of course, only very approximate, but give some idea of what happens under practical working conditions.

Reducing H.F. Resistance

In the case of a practical circuit therefore, as shown in Fig. 3, we can reduce the H.F. resistance of the coil L_2 to about 5 ohms and that of the anode coil L_3 to the same value without instability occurring.

In many cases it will be found that

L_2 may be considerably lower than 5 ohms and yet stability results, or else if the resistance of L_2 is not decreased then the resistance of L_3 instead can be decreased to a lower value.

If, however, we attempt to reduce these values still lower, then instability results when the two circuits are brought into tune.

The tendency in receivers employing screened-grid H.F. valves is to use fairly high-loss coils, or introduce damping by other methods in order to obtain stability. Some designers advocate the use of shunt feed and apply grid bias to H.F. valves by the use of a fixed condenser and grid leak. Fig. 4 shows what I mean.

Consider the tuned circuit L_3, C_3 . In parallel with this tuned circuit we have the valve damping R_1 of V_1 , we have the effective resistance of the H.F. choke L_2 , and we also have the resistance of the grid leak R_g .

Not only do we do all this, but we sometimes further wind our coils astatically, so increasing their H.F. resistance. If, therefore, we could find a means of obtaining complete stability and yet reduce the H.F. resistance of our coils to a reasonable value, we could obtain a far greater degree of amplification per stage.

A method used in some cases, of course, is to weaken the coupling between the H.F. and detector valves by using a transformer or tapped anode circuit, and this will produce stability, and improve selectivity, especially since the circuits can now be made "low loss." These benefits are obtained at the expense of amplification.

Difficulties Increased

Our difficulties are further increased when we deal with a second stage of screened-grid amplification, for here we have another stage giving a very high degree of amplification, but which has no aerial damping in front of it, thus making it more liable to instability than the single stage.

In carrying out experiments in this direction the most important point, of course, is to see that instability is not being introduced from some other cause than that due to the use of a highly efficient circuit.

One of the most serious sources of instability in shielded-grid H.F. amplifiers is due to battery coupling. So sensitive is this valve to external coupling—which may even be introduced through the filament circuits—that even if an H.T. accumulator be

(Continued on page 546.)

HAVE YOU HEARD ABOUT

Clarke's 'Atlas' New Low Tension Supply Unit?

For the first time in the history of Wireless a perfect Low Tension Battery Eliminator is produced which will give smooth and unvarying current to your set. We are now in a position to offer this L.T. Supply Unit, which can easily be adapted to your present receiving set without any alteration to existing wiring. You just plug into the electric lighting system and attach to your existing connections.

THERE ARE NO FLOATING BATTERIES — NO LIQUIDS — NO CHARGERS—NO HUM—IT IS FOOL-PROOF AND ALWAYS BONE DRY. Clarke's "Atlas" L.T. Supply Unit is suitable for 2-, 4-, or 6-volt Valves and can only be used on ALTERNATING CURRENT MAINS.



LOW TENSION SUPPLY UNIT

Send for Leaflet No. 36, giving full particulars and prices, from the sole makers:

H. CLARKE & CO. (Mcr.), LTD., "Atlas" Works, Old Trafford, MANCHESTER.

HEAT DAMP OR COLD

will not harm
GRAHAM-FARISH
Ohmite
ANODE RESISTANCES

An Ohmite can be boiled or frozen without affecting its performance; but what is more important it is guaranteed to carry 10 milliamperes on voltages up to 500 volts D.C. They are

*Better than
Wire Wound!*

PRICE ANY SIZE UP TO 1/2 MEG **2/3**
GRAHAM-FARISH OF BROMLEY KENT

£300 A YEAR FOR YOUR SPARE TIME!

Wonderful New Invention YOU can Make and Sell under My Patent.

REALLY, genuinely, you can make at home and in your spare time a sum of extra money up to £300 per year. The work is of fascinating interest. It will open up to you new ideas, new vistas of money-making; provide many of those luxuries and necessities which you have so long wished for, and give you occupation just at those hours when time is apt to hang heavily on the hands.

to manufacture under my Royal Letters Patent, in order to ensure a fair market for all. Let me hear from you NOW before somebody else is granted the licence and the extra income that can so easily become yours.

Simply forward the coupon and, by return of post, I will send you every par-



Others are doing this by working my enormously successful patents. Why not you? It costs you nothing to write for full particulars, and you can then see for yourself exactly what you can do. My patents are in very great demand in the field of wireless and electricity—so much so that

IN THE COMFORT OF YOUR OWN HOME YOU CAN DOUBLE YOUR INCOME. The work is a delight. You can keep at it just as long as you like each day or week. No "plant" or expensive machinery is needed. A spare room or even the kitchen table can serve as your profit-making "factory"—and the children can help, too!

particular with which you may wish to be acquainted. It is those who seize opportunities who succeed. Take this opportunity NOW.

"MAKE-MONEY-AT-HOME" COUPON

To Mr. V. ENGLAND-RICHARDS, 106, King's Lynn, Norfolk.

Sir,—Please send me at once, and FREE, full details as to how I can Make Money at Home in my spare time. I enclose 2d. stamp for postage.

Print your name and address bold in capital letters on a plain sheet of paper and pin this coupon to it. "Modern Wireless," Nov., 1928.

I GUARANTEE

your profits, and further guarantee to protect you against any infringement or interference with your market. Only a restricted number of persons are allowed

"PAREX"

SCREENS

COILS

"INVINCIBLE 5"

Standard Copper Screens as specified, highly polished 4/6 each
Six-Pin Bases 2/- each
H.F. Fieldless Choke 7/6 each

"RHAPSODY 4"

Standard Loading Coil 7/6 each
Short-Wave Coil 8/6 each

£10 Four-Valver

Standard Screening Box 12/6 each
Fieldless Choke 7/6 each
Six-Pin Base 2/- each

£8 Three-Valver

Screen as specified 3/6 each

80/- Three-Valver

Standard Loading Coil 7/6 each
Short-Wave Coil 8/6 each

"M.W." Short-Wave Converter, Screen 3/6 each.

E. PAROUSSI, 10, Featherstone Buildings, London, W.G. 1. Phone: Chancery 7010

The Sensation of OLYMPIA

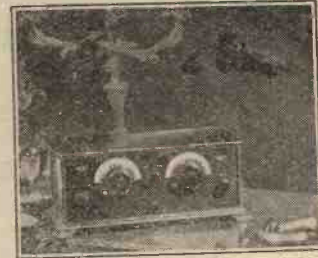

THE PENTOVOX THREE

A BIGGER brother to the marvellous Pentovox Two, the extra screened grid H.F. Valve extending considerably the range of stations and satisfying within few limitations the most ambitious "searcher."

Log scales are provided to chart the various stations.

List No. 344. **£11-0-0**

The Pentode amplifying

Set with three special valves tested and matched to set. Including Royalty.

Write for the full literature of Bowyer-Lowe sets and components.



Bowyer-Lowe Co., Ltd., Icknield Way, Letchworth

Other New Bowyer-Lowe Sets.
The Pentovox Two. The Vox Populi Screened Three. The Vox Populi Screened Four. The Gramo Radiophone.

High-grade

QUEEN ANNE STYLE FIGURED OAK CABINET

Height 3 ft. 3 ins. Depth 1 ft. 3 ins.
For Panels up to 21 ins. X 7 ins.
Baseboards up to 11 ins.

£5.5.0

Packing Free. Carriage Paid.

Prices of other sizes in proportion. Manufacturer of all types of wireless cabinets and furniture of every description. Illustrated lists free.

GILBERT, CABINET MAKER, SWINDON.

Estimates Free. Estd. 1866.



H.F. ON THE SHORT WAVES

—continued from page 544

used, preventing an apparently negligible common resistance, there may nevertheless be sufficient resistance in this battery and sufficient inductance in the leads to it to introduce battery coupling between stages. Where a dry battery is used, or any form of H.T. supply which has a higher value of resistance in it, the problem becomes serious.

Battery Coupling

Two methods of overcoming battery coupling are shown in Fig. 5, at A and B. A shows the use of shunt-feed, in which an H.F. choke shown at Z is connected in the plate circuit of the valve, while a coupling condenser shown at C allows the H.F. component in the plate circuit to be passed on to the next tuned circuit.

At B is shown a filter arrangement in which the choke Z is connected in series with the H.T. lead, a by-pass condenser C being connected as shown between the top of the tuned circuit and L.T. negative. In the case of the Fig. A circuit, of course, the

damping due to the H.F. choke is virtually connected in parallel with the tuned circuit L_1, C_1 .

Where, however, a good choke is used this should have an effective parallel resistance in the neighbourhood of $\frac{1}{2}$ megohm, and with an average coil for L_1 the effective resistance of the circuit at resonance will probably not be higher than about 100,000 ohms, so that the damping

effective resistance of the circuit. I am assuming, of course, that the set has been constructed so that perfect shielding is employed to cut out any possibility of capacity coupling between stages. Another cause of instability may be due to the use of an unsuitable or faulty condenser for by-passing the screening grid.

Another Cause

This condenser is shown at B, in both the sketches in Fig. 5. It is most important that this condenser not only be big enough, but also be connected quite close against the valve, and a simple experiment with a screened-grid-valve amplifier will show that the removal of this condenser can cause an amplifier, which was previously stable, to oscillate.

We do not need to consider the question of magnetic coupling, since if the shielding has been properly carried out this will not be present.

Another cause of instability is the capacity coupling between input and output leads. For instance, should the aerial lead have to travel in a direction which brings it close to the telephones or loud speaker, then capacity coupling between input and output circuits will result.

(Continued on page 548.)

You get
MODERN
Wireless Results
if you build
"Modern Wireless"
Receivers.
Make sure of your copy every month.
Price 1/- On Sale Everywhere
Place an order now.

introduced by the choke is practically negligible. The damping given by the valve, however, is a much more important factor, since this, under average working conditions, may be in the neighbourhood of 150,000 ohms, which is very nearly the same as the

PERFECT OUTPUT

Half the H.T. yet treble the power—think of the economy, convenience and improvement!

The Aneloy L.S. 680 is the only valve, designed for the existing set, that will deliver **10 watts at 200 volts H.T.**; hitherto a voltage of 400 has been necessary.

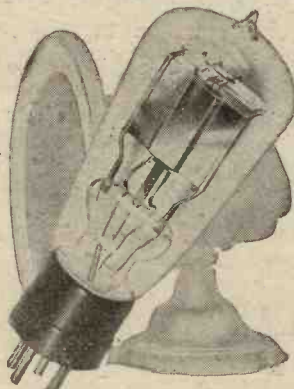

Send for facts concerning this and other remarkable "A.P." 4-electrode valves.

As usual our fair

3 DAYS APPROVAL

ANELOY PRODUCTS, 36, HINDMAN'S ROAD, EAST DULWICH, LONDON, S.E.22.
'Phone: New Cross 4074.

YOUR RADIO SPECIALIST SHOULD BE WILL DAY LTD.

19, LISLE STREET, LEICESTER SQUARE, LONDON, W.C.2.

'Phone: Regent 0921 and 0922

'Grams: "Titles" Westrand London

If you appreciate the best in music and the spoken word, come to us as specialists and we shall be pleased to give you our unbiassed advice.

Get your supplies direct from the most up-to-date radio firm in town.

The new Cossor Melody Maker Kits	£7 15 0
Pentode Valves	£1 5 0
Pentode Valve Holders	£0 2 3
The New Exide A.C. L.T. Charger	£3 10 0
H.T. Charger	£5 0 0
Or L.T. and H.T. combined	£8 0 0
Fuller Trickle Charger, A.C.	£1 17 6
Wates' Special Volt 2 Range Meter	£0 8 6
Milliam. Range	£0 8 6

Special attention is drawn to the new Soldometa Sets, designed for those who experience difficulty in soldering.

Demonstrations or Leaflet on request.

Write for our comprehensive Catalogue, postage 6d. Free to callers.

OPEN UNTIL 7 P.M.

Build a **FORMO**

Completely

"SCREENED-GRID THREE"

An amazingly simple set to construct and handle.

NO COIL CHANGING

From HIGH to LOW WAVE and vice versa with ONE PUSH-PULL SWITCH.

One switch only operates Aerial Coil and the Coil in the Plate circuit of the S.G. Valve.

NO WIRELESS KNOWLEDGE NECESSARY

You can **BUILD** and **OPERATE** this set in **ONE EVENING**

Your dealer can supply a complete Set of Components including a most ELEGANT ALL-METAL CABINET, PRINTED BASEBOARD and all wires CUT TO SIZE and LOOPED.

THE COST is a revelation

Send Postcard for FREE COPY.

"THE FORMO SCREENED-GRID THREE"

THE FORMO CO., CROWN WORKS, CRICKLEWOOD LANE, N.W.2.

Now!
a fine
shockproof
valveholder



a popular price

Like all Peerless products this new shock-proof valve holder is of the highest efficiency. The actual valve socket rests on four jointless springs that stop all jolts, shocks and vibrations before they reach the valve. The capacity has been minimised by eliminating all unnecessary bakelite. Terminals are fitted. Fine valve for 1/6. Send for new Catalogue.

BEDFORD ELECTRICAL & RADIO CO., LTD.
22, Campbell Road, Bedford, 113, St. Vincent St., C.2
London: 21, Bartlett's Bldgs., E.C.4.

PEERLESS
VALVEHOLDER
1/6

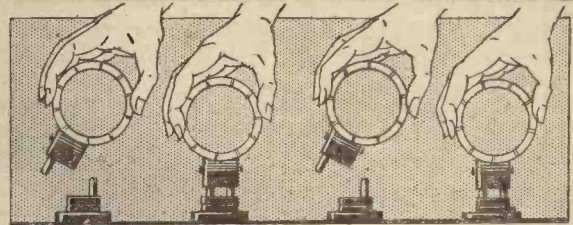

Why keep changing coils?

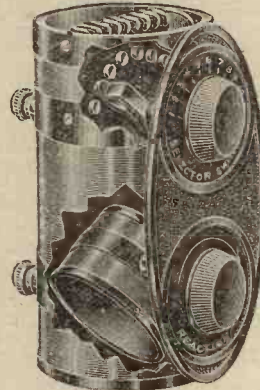

BRITISH GENERAL AERIAL TUNING UNIT

means that you no longer need use plug-in coils. It covers all wave-lengths between 250-2,000 metres by means of a 10-stud Tapping switch. Re-action is smooth and tuning simple. New bakelised former and special reversible dial to allow of upright or horizontal panel mounting.

Price **18/6**

From all good dealers, or direct from

BRITISH GENERAL

MANUFACTURING CO., LTD.
BROCKLEY, LONDON. S.E.4.

For Discerning Men & Women

NO AERIAL
NO EARTH
NO RISK
NO EXTRAS

ONE PRICE
£24.15.0

COMPLETE, INCLUDING ROYALTIES, TECHNICAL DETAILS WITH PLEASURE.



The MELOSET for TONE

The DISTASET for RANGE

TWO NEW TRUPHONIC MODELS

The "Meloset" (illustrated) is an upright mahogany model (5 valve straight circuit) giving a beautiful tone on the local and all high power stations.

The "Distaset" is a suitcase model (screened grid H.F.) for extreme range. The set for the South Coast, West Country, and all difficult situations.

TRUPHONIC LTD.,
121-122, Rosebery Avenue, E.C.1.
Showrooms, 524, Regent Street, W.1.
Ask your dealer to demonstrate your choice.

WHEN ORDERING CABINETS FOR
THE SIX-SIXTY MYSTERY RECEIVER
THE MULLARD PORTABLE V, etc.
BE SURE AND SPECIFY



AND ENSURE PROMPT DELIVERY

Send for our Latest Lists to:-
CARRINGTON Mfg. CO. LTD., CAMCO WORKS,
SANDERSTEAD ROAD, SOUTH CROYDON.
Phone: Croydon 0623

H.F. ON THE SHORT WAVES

—continued from page 516

The H.F. valve may be made to oscillate in some cases when tuning the set if headphones are worn, but this is an extreme case which probably will not occur very often in actual practice.

To return to the Fig. 2 circuit, which we will say is at the limit of stability when the total series resistance of the two tuned circuits is 15 ohms each, if we could reduce this series resistance to, say, 3 or 4 ohms and still obtain stability, a theoretical increase in amplification of something like 300 or 400 times would result. These figures include the coil magnification, and therefore express the total magnification for the whole stage.

Neutralisation

In practice, of course, it would be highly undesirable actually to reduce the coil resistances to such a low value in view of the fact that distortion would result on telephony owing to cutting off the side-bands.

We are safe, however, in reducing our *total series resistance* to 5 or 6 ohms, and therefore in a working circuit such as that shown in Fig. 1, if we did actually reduce the coil resistances to about 2.5 to 3 ohms in each case, the additional damping introduced from the sources previously referred to would bring the coil resistances well above the limit required to give distortionless reception on telephony.

A WONDERFUL SHILLINGSWORTH

No less than *Twelve* fine sets are described in detail in the Gift Booklet and this month's

MODERN WIRELESS

This unprecedented value is sure to result in a *huge demand* for the November issue, so before it is too late get any extra copies you need and

TELL YOUR FRIENDS

The desired result was obtained by neutralising the small residual capacity which remains within the valve; and not only was it easy to carry out, but it produced the expected results in a marked increase in efficiency.

All this was done by introducing a few extra turns at the bottom of the

grid coil and a small neutralising condenser. Although it still remains desirable for certain reasons to employ shunt-feed, it is not necessary to do so. Inter-stage shields only are required, numerous and costly by-pass condensers can be left out, the wiring, layout and construction of the receiver considerably simplified, while a marked increase in efficiency is obtained.

Completely Stable

Using the circuit shown in Fig. 1 for broadcast reception, the coils L_2 and L_4 being wound with Litzendraht wire, on large formers, designed to give an optimum diameter length ratio, the set would oscillate violently unless the neutralising condenser was correctly adjusted.

With this done, however, the set was completely stable from top to bottom, while owing to the use of highly efficient coils, not only was a satisfactory degree of selectivity obtained, which is usually somewhat lacking with the screened-grid-valve circuit, but also a tremendous increase in H.F. amplification resulted, making it possible under average night conditions to listen to stations from all over Europe, with only three valves, with tremendous volume.

THE CABINET THAT COMPLETES THE MULLARD "MASTER THREE"

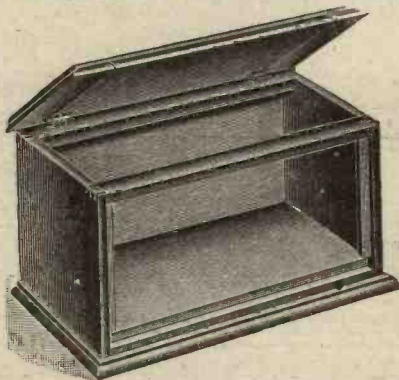

This cabinet is a decidedly fine example of woodcraft, and the fact that it was chosen and is definitely specified by Messrs. Mullard for their famous receiver is a fine tribute to its quality and appearance.

PRICE: In Oak - 26/- PRICE: In Mahogany - 29/-

KABILOK CABINETS OF DISTINCTION

are also specified for the following—

"THE MULLARD H.F. UNIT"

PRICE: In Oak - 15/- PRICE: In Mahogany - 16/6

THE "MASTER FIVE" PORTABLE BY MULLARDS

PRICE: In Oak - 52/6



W. & T. LOCK, LTD.
ST. PETER'S WORKS, BATH
LONDON: 11, Red Lion Sq., London, W.C.1

THE DONOTONE THE BEST LOUD SPEAKER

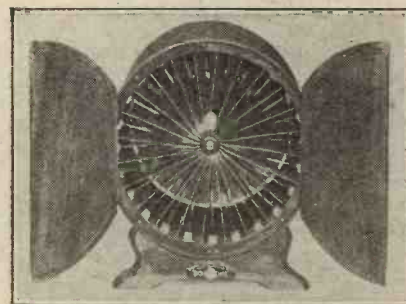

FROM £5 : 5 : 0

DEMONSTRATIONS DAILY AT

THE DONOTONE (Regd.) LOUD SPEAKER, Dept. M.,
40, Farnival Street, Holborn, E.C.4. W. K. Webster, Propr.

KITS OF PARTS at the Right Price

THE INCEPTOR 3 WIRELESS MAGAZINE, OCT. 1928

.0005 Cydon Twin Thumb Control Condenser 47/- .0001 Bulg. 5/6, 7 ohm Lissen, 2/6 3 W.B. Valve Holders, 4/6. 3 Coil Stands, 3/- 1 M.F.D., 2/6. .0003 Dubilier 2/6. Grid Leak, 2/6. Series Clip, 6d. H.F. Choke, Lissen, 5/6. L.F., R.I. & Varley, S.L.F., 22/6.

FREE WITH KIT OF PARTS

Screen Assembly Grid Bias Clips, Pair Panel Brackets, 9 Engraved Terminals and Strip, Wire, Tags, Flex, Plugs, Dial Indicator.

Total £4 : 18 : 0

Good Quality American Type Cabinet, 14/11 Best Grade "A" Panel Drilled, 6/- (The two if purchased with kit for 16/6. Carriage 2/-) Screened Grid, 22/6
VALVES: Detector, 10/6; Pentode, 25/-
LEWCOS COILS CENTRE TAPPED
25, 3/6; 2 £0 @ 3/6; 1 150, 5/3

MASTER THREE *STAR*

(MULLARD)
This new and wonderful set must appeal to young and old, amateur or experimenter, in fact, EVERYBODY!

YOU CAN PURCHASE

ANY ITEM SEPARATELY (OR A KIT OF PARTS). Every component is available at short notice. This list is strictly to Mullard specification.
3 Valve Holders, Lotus, at 1/3. Colvern Combined Wave Coil, 17/6. Pernacore Transformer, 25/-, Climax "L.F.A" Transformer, 25/-, Climax H.F. Choke, 7/8. Benjamin Battery Switch, 1/2. J.D. .0005 Log, 11/8; .00035, 10/6. Mullard .0003 and 2 meg. 5/-, Magnum Panel Brackets, 2/6. Mullard .0001 Fixed, 2/6.

Total £5 : 12 : 6

Carriage paid
VALVES 2 at 10/3 Power, 12/6
OAK CABINET hinged lid, 12/6. Carriage, 2/-
NOTE GENEROUS OFFER
Please add 3/6 to above price (total £5 16 0) and I will include: 2 Handsome S.M. Dials, Set of connecting Links, 8 plugs, 2 Spades, 4 Engraved Terminals, 2 Ebonite Strips, Twin Flex, Splendid Aluminium Panel, 18 x 7, drilled ready for use. 9-volt Grid Bias, Baseboard. Carriage Paid.

RADIO THREE COMPONENTS ORIGINAL

"Wireless Constructor," March, 1927.
2 Ormond S.L. Variables, with Friction Gear; 3 Coil Sockets; T.C.C. .0003 and Clips and 2-meg. Leak; 3 Benjamin Valve Holders; 3 Fixed Resistors and Bases; On-and-Off Switch; Geophone 1st Stage L.F.; Igranite 2nd Stage L.F.; Engraved Strip, with Terminals and Nuts; 2 Terminals for Front Panel; 4 Gross Pinch-on Spades; Rubber Flex; All with Terminals. **79/6**

BLUEPRINT FREE WITH PARTS Post Free

CABINETS



LARGE STOCKS of really nice CABINETS. American type, hinged lid, baseboard. Oak (3 qualities).

12x8 9/11 11/9 13/6
14x7 12/11 13/11 16/6
16x8 12/11 15/6 17/11
18x7 15/- 18/6 21/-
21x7 15/- 18/- 21/-
Carriage and Packing Free. Extra Irish Free State.

COUPON No. 6

Only one coupon on any one order

If you spend 25/- or more you can buy for 3d. extra one (only of the following):

S.M. Dial. Fuse and Holder. Permanent Detector. 100 ft. 7/22. 12 Nickel Terminals. Battery Switch. Indoor Aerial. 60X Coils. .0003 and 2 meg. 12 yds. Lead-in. H.F. Choke. 9-volt Grid Bias.
ONE OF ABOVE, 3d. WITH 25/- ORDER.

THE "CONCERT" FOUR

By Percy W. Harris, Editor "Wireless Constructor." COMPONENTS AS SPECIFIED

2 Ormond .0005 mfd., with S.M. Dials, 22/-, Panel Mounting, .0001 Var. Condenser, 5/6. Utility D.P.D.T. Lever Pattern, 4/- 2 P.P. Switches, Ormond, 2/6. Copper Screen, 8 1/2 x 6, to stand on baseboard, 2/6. 4 Lotus or W.B. Valve Holders, 7/- 2 Coil Stands, 2/- 4 Temprytes and Bases (carriage type), 10/-, Neutralising (Jackson), 3/6. 2 Lissen .0003 Fixed, 2/- .0001, 1/- .01 Mullard (Mica), 3/- Lissen 2 meg., 1/- Dubilier 1 meg. and Clips, 2/9. Lissen H.F. Choke, 5/6. R.I. Varley (Type A), R.C.O. Unit (important), 20/-, Geophones 4-1 L.F., 20/- Lissen or Dubilier, 2 mfd., 3/6.

List Total **£5 17 9** Post 1/-

FREE with above

21 x 7 High Quality Panel (drilled); Strips, 8 x 1 1/2 and 2 x 1 1/2; Pair Brackets; 12 Engraved Terminals; Wood Screws and Connecting Wire; 5-ply Baseboard, 21 x 10 1/2.

The Original COSSOR MELODY MAKER



This was recently acclaimed as the "Wonder Set of the Season." It still remains so

SPECIAL PRICE £4 : 4 : 0
SPECIFIED COMPONENTS:

2 Ormond .0005; 2 Do. S.M. Dials; 6 T.C.O. Condensers; 2 B.B. Clips; 1 B.B. Rheostat; 5 Dubilier Leaks; 3 Lotus V.H.I.; Ferranti A.F. 5; 2 Switches; Cossor Wound Coil, Terminals; Glazite Grid Bias.

Handsome Oak Cabinet, 12/6 with parts, Baseboard Free. Also Cabinets at 15/11, 18/11, and Mahogany Polished, at 20/- Carriage 2/-.

COSSOR VALVES 2, 4, or 6-Volt for above. L.F., D., R.C., or H.F., 10/6 each. Power, 12/6 each.

FREE WITH PARTS

Drilled High-grade 21 x 7 Polished Panel and Strip, Wood Screws. Carriage 1/- or 6-Volt for above.

COSSOR VALVES 2, 4, or 6-Volt for above. L.F., D., R.C., or H.F., 10/6 each. Power, 12/6 each.

ASTOUNDING BARGAIN IN THREE-VALVE LOUD-SPEAKER SETS

Receives London, 5GB, 5XX, and many Continental stations.

D. & 2L.F.

Call and hear one demonstrated.

NO OBLIGATION TO Purchase



AS SHOWN **£5 - 12 - 6**

SPECIFICATION Tax Paid. Carr. & packg. 5s. Beautifully finished cabinet with hinged lid, all parts enclosed—3 British Dull Emitter Valves (1 Power). Latest Type Condenser. S.M. Dial, distant stations are easily obtainable with standard aerial. High Tension Battery 100 volts. L.F. 2 volt. Extra or Oldham. All Aerial Equipment, Earth Switch and wire. Tuning Coils 250 to 2000 metres. A REAL set, at a price within anyone's reach. TRY ONE.
2 VALVE SETS exact to above complete Carr. and Packg. 5s. **£4 17s. 6d.**

COSSOR NEW MELODY

I CAN SUPPLY SPARES FOR SAME (sold separately, post extra).

2 Ormond .0005 Log at 6/- each; 2 Cossor pattern S.M. Dials at 3/9 each; Ormond Reaction .0001 (bushed), 4/-; Ormond P.P. Switch, 1/3; 6-ohm Rheostat, 2/- (all knobs to match cabinet); 5 Lotus new type Valve Holders at 1/3; 1 Wearite H.F. Choke, 6/6; 3 T.C.C. Condensers, 2 mfd., 3/10; S.P. .0001, 2/4; 1, 1/10; 1 Dubilier 3 meg., 2/6; 3 to 1 L.F., 15/- (compact, well-known British make); 2 Wound Coils (Wearite), 15/- pr.

Total £4 : 0 : 0

CARRIAGE 1/-

For 7/6 extra, if you purchase above lot only, I will include handsome Metal Cabinet to specification, ready to assemble, drilled, with all nuts, bolts, spanner, screwdriver and baseboard, brackets, Glazite, 9-volt grid bias, rubber flex and plugs, screen assembly, 2 drilled terminal blocks and 9 terminals.

CARRIAGE 1/- (Free to callers.)

SCREENED GRID VALVE, 22/6.

R.C. VALVE, 10/6. POWER, 12/6.

K. RAYMOND

27 & 28a, Lisle St., London, W.C.2

Come to LEICESTER SQUARE TUBE

This address is at the back of Daly's Theatre.

Phones: Gerrard 4637 and 2821

C.O.D.

Orders despatched same day as received where possible. Send ORDER with instructions and pay Postman.

C.O.D. APPLIES TO UNITED KINGDOM ONLY.

WE ARE OPEN

ALL DAY SATURDAY
ALL DAY THURSDAY
ALL DAY EVERYDAY
Hours 9 a.m. to 8 p.m.
Sat. 9 a.m. to 9 p.m.
Sunday morning 11-1

Ebonite cut while you wait at 3d. square inch, also 1 in. at 3d. Only the best supplied. Drilled Panels for all Circuits.

EELIX Terminals, Plugs, and Spades Stocked.

We stock Igranite, Climax, Ever-Ready, Hellesen, Siemens, Formo, Ferranti, Wearite, Ormond, J.B., Benjamin, Lotus, Mullard, Dubilier, Lissen, Lewcos, Utility, Magnum, Peto-Scott, Peerless, Burndept, Pye, Marconi, McMichael, Cosmos, Carborundum, R.I. & Varley, Gambrell, Brown's, Sterling, Amplions—in fact, everything it is possible to stock.

KITS of parts for all CIRCUITS. Make out LIST for keen quotation. DON'T worry, if it's Wireless WE HAVE IT.

COSSOR VALVES

MULLARD VALVES SIX-SIXTY VALVES B.T.H. VALVES EDISWAN VALVES MARCONI VALVES

H.F., L.F., R.C., 10/6. Power, 12/6. Super Power, 15/-, 2-v., 4-v., 6-v. Screen-Grid. 22/6. Pentodes, 25/-

LISSEN

Valve-holders, 1/-; Fixed Con., 1/-, 1/6; Leaks, 1/-; Switches, 1/6, 2/6; Latest 5-way Cam Verner, 4/6; Rheostats, 2/6; B.B., 1/6; Lissenoia, 13/3; L.F. Transformers, 8/6; Coils, COX, 6/4; 250X, 0/9; 00-H.T., 7/11; 100-v. 12/11; Super 60-v., 13/6; Grid Bias, 1/6; 4, 5, 5d.; Super L.F. 19/-; Variable .0003, 9/-; .0005, 8/6.

LEWCOS PRODUCTS

C.T. Coils, 40, 50, 60, 75, 3/6 each, 100, 150, 200, 5/3 each. Glazite, 10d. 10 ft. Litz Wire, 9/38, 4/- 50 yds.; 9/38 all silk, 5/6 50 yds. Also in 20-yard reels, Litz, 27/42, 11/6 50 yds. Frame Aerial Wire, 3/6 100 ft. Battery Leads, 4-way, 5/6; 5-way, 5/6; 6-way, 7/6; 7-way, 8/6. All Binocular Coils. "Q" Coils, 21/- Aerial, 15/- In stock.

Authorised Dealer for

BRANDES

L.F. 3-1, 12/-; 5-1, 12/6. Matched Headphones, 8/- pair. .0005 Variable, 12/6. .0003, 12/-

BRANDES TABLE TALKER, 30/- BRANDOLA HORN TYPE, 50/- THE ELLIPTIC CONE SPEAKER, 77/-

"DARIO" VALVES

(Genuine Radio Micro) Best in the World.

BIVOLT 2-v. .05, 5/6; Loud-speaker Valve 7/6; R.C. .05 1.8, 5/6; 3.5, .05, 5/6; Loud-speaker Valve, 7/6; 3.5 R.C. .07, 5/6. Post 6d. each.

ADVERT. OF K. RAYMOND

J.B. CONDENSERS

T.T. Friction Ver. .0005, 16/6; .00035, 16/-; .00015, 15/3.

S.L.F.

.0005, 11/6; .00035, 10/6; .00025, 10/-; .00015, 10/-; Neutralising ... 3/6

FOR MASTER 3 STAR Log .0005, 11/6. .0003, 10/6.

ORMOND

No. 3 CONDENSERS. .00025, 5/6. .00035, 5/9. .0005, 6/- (With 4-in. Dial). Friction Gears, .0005, 15/-; .0003, 14/6. .00025, 13/6. Straight Line Frequency Friction Gears, .0005, 20/-; .00035, 19/6. S.L.F. .0005, 12/-; .00035, 11/-; Log .0005, 13/-; .00035, 12/6. .00025, 12/-; S.M. Dial, 5/-.

All Components Stocked.

R.I. & Varley H.F. Choke, 9/6. R.C.O. Unit, 20/-; Type B, 22/6; Tuners Model A, 47/6; Model B, 37/6; Standard, 39/6. Straight Line Super L.F., 25/-; with 4 terminals, 22/6. General Purpose L.F., 15/-; Push Pull Output Transformer, 22/6. Filter choke, 21/-; Wire-wound resistances, all capacities. ALL PARTS STOCKED

LOUD-SPEAKERS

Ediswan One-Der 50/- M.P.A. Plaque ... 29/6 Phillips Seven-Corner ... 50/- Amplion Cabinet 60/- Do., Mahogany ... 63/- Ferranti ... 63/- Orphean Gem ... 30/- C12 Celestion ... 145/- Amplion Cone ... 37/6 Sterling Mellovox 50/- Marconi Moving Coil Assembly, 65 6s.; in Cabinet, 21/6- for D.C. Mains, etc.

HYDRA CONDENSERS

Tested on 500 volts D.C. (working voltage 240 d.c.) 1 mfd., 2/6; 2 mfd., 3/6; 4 mfd., 5/3.

CONE SPEAKER CABINETS take 12 in. cone (will take Blue Spot unit), handsome design, all enclosed, 9/11, 10/11, 12/11 each.

OAK FINISH. 2/- each more by post. "A.W." "P.W." & "M.W." LOADING COILS, 7/6

There must be a reason

WHY CELESTION

is the most popular Loudspeaker in Europe—

and there is one

It is THE CELESTION REINFORCED DIAPHRAGM

This conveys little to the non-technician. Suffice it to say that the Diaphragm (the hidden face of the Loudspeaker) of every cone speaker is the vital force in its powers of reproduction.

The foremost set manufacturers use Celestion with all their models.

BRITISH THROUGHOUT. Made under licence.

CELESTION

The Very Soul of Music

Write to Dept. H,
THE CELESTION RADIO CO.
London Road, Kingston-on-Thames.

Phone: Kingston 5656 (4 Lines).

Showrooms:

106, VICTORIA STREET, S.W.1
(One minute from Victoria Station).

Associated Company:
CONSTABLE-CELESTION & CO.,
69, RUE DE MONCEAU, PARIS.

Models from £5 10s.
Write for New Booklet!

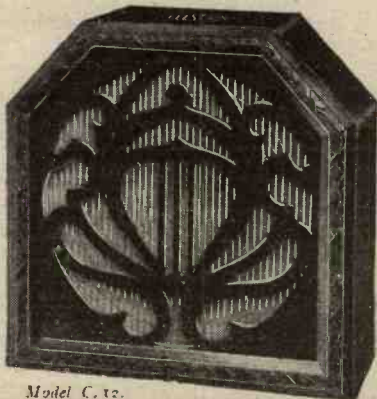

Model C. 12.

IN OUR TEST ROOM
—continued from page 532

The N.S.F. Paper Condenser is even more sound. The sample sent us is of the 2 M.F. 800-volt type. It is one of the most compact condensers in this capacity we have come across, and it takes its strain and holds a charge remarkably well.

The third N.S.F. component is a valve holder, and this is probably the outstanding item of the range. It is of the anti-microphonic type, and has several attractive and novel features.

The Weilo power transformer was tested against several others, and it carried itself well. If it is to be retailed at fifteen shillings or under, which we presume will be the case, then it will be good value for money.

A Splendid Catalogue

We recently received a copy of the latest catalogue issued by Metro-Vick Supplies, Ltd. It consists of a number of sections bound together in one thick book. Any section can be obtained separately at radio dealers. The catalogue is an excellent example of modern printing at its best. The paper is heavy and glossy, and the type and illustrations bright and clear. It is a fascinating production from the point of view of its contents, and of interest in its wide, comprehensive character.

R.I.-Varley "Anti-Mobo"

The trouble known as "motor-boating" is sometimes extremely difficult to cure. It is more frequently met with in receivers having several stages of L.F. amplification and is generally due to battery coupling. To prevent or overcome motor-boating, Messrs. R.I.-Varley have produced a special device known as the "Anti-Mobo."

It embodies a resistance, having three tappings at 20,000, 30,000, and 40,000 ohms, and wound on the well-known bi-duplex method. There is also a fixed condenser. When the device is connected up it introduces a scheme of shunt H.T. feed. The resistance is brought into series with the anode circuit of a valve and operates as an effective barrier to L.F. impulses, taking the place of the L.F. choke in more conventional schemes.

The condenser provides a comparatively low-resistance by-pass. Further, in regard to L.F. impulses, the H.T. battery becomes isolated. Thus any coupling between the stage

in which the "Anti-Mobo" is connected and any other through the H.T. battery is effectively prevented. On test we found, as was only to be expected, that it operated perfectly.

The "Anti-Mobo" is a small, well-made article. It can easily be connected up to a set and tucked away



The R.I.-Varley "Anti-Mobo" device

in any convenient position. This season, with the popularity of gramophone pick-up work and moving-coil loud speakers, with their accompanying and necessary several stages of L.F., there should be a considerable demand for this R.I.-Varley product.

Four Harlie Products

The new slow-motion dial produced by Harlie Bros. is known as Model 15, and retails at 4s. 3d. It has a smooth, direct drive (it is better in this respect than the average) and a fine tuning control which can be brought into action when desired by pressing down and turning a small knob. The slow-motion movement is positive and has just the right gearing. The dial is well-made and attractive in design.

Another new Harlie line is an anti-microphonic valve holder, the Model 3, which will retail at 1s. 3d. It is a well-sprung holder, and has well-separated sockets, the anode one being distinctively coloured. Four terminals are provided, in addition to soldering lugs.

The Harlie new model neutralising condenser is of the vertical baseboard-mounting variety. A notable point of its design is that shorting between the two plates cannot in any circumstances take place. The screw adjustment is such that close control is achieved smoothly, but with sufficient resistance to enable definite settings

(Continued on page 551.)



**EVERY-
THING
FROM
THE
MAINS.**

THE HOME CHARGER

As illustrated in "Modern Wireless," October.

Complete Charger. Model A2- **42/6**

Set of Component Parts - - - **32/-**

(Comprising Transformer A2, 17/6;
Valve No. 451, 12/6; Resistance, 2/-)

L.T. ELIMINATORS

L.T. accumulators abolished. Parts re-
quired comprise Model A2 Rectifier, 42/6;
2 Chokes, 12/6 each; Condenser, 3,400
mfd., 25/-; Resistance, 2/-.

H.T. ELIMINATORS

Absolute success with our components is a
guaranteed certainty. Any output supplied
from 100 to 500 volts, as required.

*Largest and most varied stocks in London
of L.T. & H.T. Components and Meters.*

F. C. HEAYBERD & CO.,

8/9, Talbot Court, Eastcheap,
London, E.C.3.

(One minute from Monument Underground Station.)

A Quality Cabinet

for your Set

Full illustrated particulars from the Actual Manu-
facturers, V.C. Bond & Sons, 81, Hackney Grove,
Waltham St. London, E.8. Phone 0115010 0482.

THE ONLY WAY

BUY your Components, Loudspeakers,
H.T. Units, etc., etc., from US.

BUILD your Receiver and SAVE MONEY.

EVERYTHING WIRELESS

ON

EASY PAYMENT TERMS

NEW COSSOR MELODY MAKER;

NEW MASTER THREE *;

NEW COSSOR H.F. UNIT;

NEW MASTER FIVE PORTABLE;

MULLARD H.F. UNIT; NEW EDISWAN

SETS; RADIANO FOUR, etc., etc.

And all "P.W." CIRCUITS.

COMPONENTS for ALL circuits supplied.

COMPLETE RECEIVERS of all makes supplied.

Call and see us or post
your list of requirements.

Est Monthly Terms Quoted By Return

The P. D. P. Co., Ltd.

(Dep. M. 127, Cheapside, London, E.C.2.

Phone: City 9346.

The Picture Paper with the MOST News

:: SUNDAY GRAPHIC ::

This Free 36-page Book
is yours for the asking!



It will tell you how to be certain
of perfect reception. Send a
postcard TO-DAY.

BAKER'S
Selhurst
RADIO
89 SELWICK RD,
100th NORWOOD, SE23

PLEASE MENTION "MODERN WIRELESS"
WHEN REPLYING TO ADVERTISEMENTS.

IN OUR TEST ROOM
—continued from page 530

to be fixed. The component can,
if desired, be mounted by means of
a single hole on a panel. The retail
price is 3s. 9d.

The fourth Harlie item recently
to hand is a wave selector. The retail
price of this is 12s. 6d., and it is
designed for the normal wave-band
(the makers state that they will be
producing one to cover the higher
wave-band). In appearance it is not
unlike a screened coil of tubular form,
although on the top there is an
adjustment dial and at the base four
sockets. One socket is connected
to the aerial terminal of the receiver,
the aerial itself being connected to
one or other of the other three
sockets.

The device is, of course, a series
wave-trap. Carefully tested on several
sets, we found it quite satisfactory.
Within three or four miles the local
station can be completely cut out
on a plain Det. and L.F. set without
weakening available distant stations.

Wates Test Meter

A very useful instrument has
recently been produced by the
Standard Wet Battery Co. It only
costs 8s. 6d., and with it the listener
can do all the battery testing and
grid-bias adjustments he will find
necessary. It is a watch pattern
meter having the usual flexible leads
and low and high voltage scales; but,
in addition, the device is provided
with two terminals, and when it is
connected up by these, a third—a
milliamperage range—comes into opera-
tion.

The three ranges are thus 0 to 6
volts, 0 to 150 volts, and 0 to 30
milliamps. The meter has a moder-
ately high resistance, but, of course,
not sufficiently high for it to be
suitable for use with mains units.
However, where batteries are con-
cerned, it answers its purposes. In
the nature of the instrument the
scales are, of course, small; but the
needle has a dead-beat action and
sufficiently close readings for ordinary
services to be taken. At its price it
will certainly occupy a place of
its own as a popular and necessary
radio accessory.

Ekco Mains Unit

Of the several mains units we have
tested during the past few weeks
to the time of writing, two due to
(Continued on page 552.)

**To avoid
all Distortion**

If it isn't one thing it's
another! Either someone
walking across the room, or
closing the door, causing
those horrible microphonic
noises right in the middle of
your favourite programme.
We all know there's nothing
more exasperating than that.

But there is a really effec-
tive way of stopping it. Fit
W.B. Anti-phonic Valve-
holders in your set and you
kill all distortion.

The sockets of W.B.
Valve-holders are sprung on
specially shaped springs, so
that all microphonic noises
are definitely excluded from
the valve. Also capacity be-
tween the valve legs is mini-
mised by the removal of
"dead" ebonite.

*In addition to being specified
for "Six-Sixty's Great Mystery
Receiver" and the "Cossor
Melody Maker," W.B. Anti-
phonic Valve-holders have been
chosen for an enormous number
of other well-known published
circuits. New reduced price:*

1/6

Complete with terminals.

New W.B. Rigid Valve-holder:

1/-

Complete with terminals.

USE THIS

W B



**ANTI-PHONIC
VALVE HOLDER**

**WHITELEY,
BONEHAM
& Co. Ltd.,
Nottingham Road,
Mansfield, Notts.**

IN OUR TEST ROOM

—continued from page 551

E. K. Cole, Ltd., stand out in regard to both performance and prices. The two units come in the 20-milli-ampere range of E. K. Cole productions, and are known as Models 1V.A.20. Each has two voltage tappings, the one being fixed and providing the maximum 120 volts at 16 milliamps., the other being variable up to the maximum and giving up to 6 milliamps.

The A.C. model employs a Philips rectifying valve, and retails, complete, at £5 8s. 6d. The price of the D.C. model is £2 18s. 6d. On test we found that in each unit the variable tapping provides a smooth, continuous variation of voltage, and there is a silence in operation that is a noticeable feature of all the Ekco units. The units are substantially made, and are compact and convenient in design.

We also recently received full particulars of the new Ekco deferred payment system whereby all Ekco mains radio devices of the value of £2 10s. and upwards will be obtainable on the easy payment system. The scheme certainly appears to be a simple and attractive one. It seems that the system operates through factors, wholesalers, or retailers, and there are no complications at any point.

Ferranti Fixed Condensers

Ferranti, Ltd., recently sent us samples of their two types of 2-mfd. fixed condensers. They are excellent

components, and their prices make them competitive even with foreign productions. Type C1 is a high-voltage variety tested at 1,000 volts D.C., and designed for use in H.T. supply units and in mains sets. Its working voltage is 400 volts. The working voltage of the C2 model is 200 volts, it being tested at 500, and suitable for battery-operated receivers working at relatively low pressures. The prices are 5s. 6d. for the C1 and 3s. 6d. for the C2 pattern.

Going to Build a Set?

Don't forget the two

WIRELESS CONSTRUCTOR ENVELOPES

—now on sale at all bookstalls
—giving full details of

**THE "RADIO" THREE
AND
THE "CONCERT" FOUR**

Price 1s. 6d. per envelope from any bookseller, or by post, 1s. 6d., direct from The Wireless Constructor Envelopes, The Amalgamated Press, Ltd., Bear Alley, Farringdon Street, E.C.4.

Messrs. Ferranti claim that they have now equipped themselves with the most up-to-date condenser manufacturing plant in this country. The construction of their condensers is of the rolled foil pattern, their internal resistances low and insulation resistances extremely high. Each is enclosed in a very substantial metal casing, substantial milled and slotted terminals being provided. They are thoroughly sound components in every respect.

Mullard's Loud-Speaker

Is it a fantastic idea to presume that Messrs. Mullard were forced into the production of loud speakers by hearing what their very good valves were sometimes made to work with? Be this as it may, it is a fact that the Mullard loud speaker is undoubtedly an instrument worthy to handle the output of P.M. valves.

It is not a new accessory, although it is only recently that we have had the opportunity thoroughly to test it. It is a cone of unusual construction and appearance. Regarded from the front, it is not unlike the large flare of a horned model, having a moulded disc in the centre, but the bowl is shallow and is cut away at the back. No haphazard design this, but one bearing the stamp of scientific thought. No means of adjustment are provided, but this is a point in its favour, inasmuch as it possesses all the required sensitivity, together with a capacity to handle large inputs.

The Mullard P.M. speaker is a faithful reproducer in that its ejection is crisp and clean, and there is a complete absence of colloration.

In regard to speech and the higher register, it is definitely superior to some moving-coil speakers we have heard, and its base cuts away lower than at least one reproducer of this kind known to us.

The "Clarostat"

A "Clarostat" figured in the "James H.T. Unit" described last month. This component is of American origin and the agents for it are Claude Lyons of Liverpool. The firm mentioned in our article is one of several London distributors.

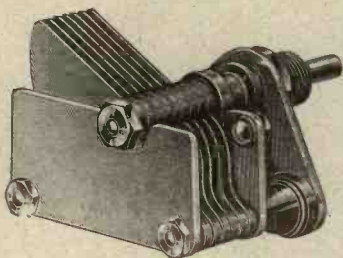

Baby Condenser

Designed along the same lines as our standard Condensers. Marked low-loss features, ball bearing spindle. Not a freak, a thoroughly efficient job appealing in every case where space is restricted.

Prices:

Capacity, '0005	11/-
Capacity, '0003	10/6
Capacity, '0002	10/-

**Smaller Components
... for Small Sets!**

You need not cramp the components in your portable or small sets now—you can buy "Utility" Condensers and Switches that have been specially designed to economise space. They are small, but thoroughly efficient, and fully Guaranteed. Ask your local wireless dealer to show them to you—if he does not stock, we can fill your orders by return post. "Utility" Components include Dials, Switches, and Condensers of various kinds and super-quality. Write to-night for a complete List.



Made and Guaranteed by

WILKINS & WRIGHT, LIMITED
"Utility" Works, Holyhead Rd., Birmingham.

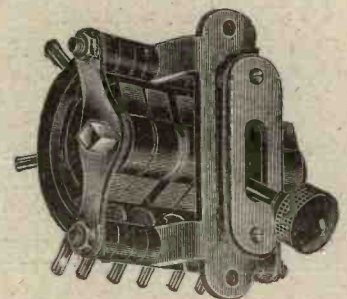

Small Anti-Capacity Switch

Of entirely new design—and little larger than the illustration. Its anti-capacity characteristics are excellent, and it can be panel-mounted, baseboard mounted, or GANGED.

Prices:

No. W190/1,	1 pole change over	4/8
" W190/2,	2 pole change over	5/-
" W190/3,	3 pole change over	6/-
" W190/4,	4 pole change over	7/8
" W190/5,	5 pole change over	9/8
" W190/6,	6 pole change over	9/6

**A FIRST CLASS
METER REPAIR SERVICE**



**FOR EVERY
USER OF -**

SIFAM

RADIO METERS

This enterprising innovation marks a new step forward in after-sales meter service. Now you can buy Sifam, the unchallenged leader in popular priced Radio Meters, and at the same time be assured of a first-class meter repair service. Repairs are carried out in our own works by a staff of experts. In price and guaranteed accuracy Sifam meters are all that you need. Use them for tracing and rectifying distortion, correctly regulating filament supply, avoiding burnt-out valves and run-down batteries. Ask your dealer to show you the complete range and send for free leaflet "What Simple Meters Can Show You" to:—SIFAM ELECTRICAL INSTRUMENT CO. LTD. (Dept. M.W.), RADIOMETER HEADQUARTERS, BUSH HOUSE, ALDWYCH, W.C.2.

SIFAM
MILLIAMMETERS

Moving Iron 10/-
Moving Coil 25/-
C-30 Flush Type (Illustrated)



MILLIAMETER 25/-

**The HOME for your
WIRELESS SET**

OUR STANDARD CABINETS

fit for any Mansion, are the best made on the market, at most moderate prices. The Model D, illustrated, solid oak throughout, is made in various sizes for small or large Receivers. Accommodation for batteries and loud speaker. Many other models for choice. Sent on 7 days approval, so you take no risk. Delivery from stock.



With Drop Front.

From £4 : 15 : 0

Write for full particulars FREE:—**MAKERIMPORT CO. (Dept. 2), 9, YORK STREET (off Duke Street), LIVERPOOL**

YOUR HOOK-UP BOARD
By SYDNEY P. O'ROURKE

THE wonders of the short waves has renewed enormous interest in the oft-times incredibly efficient one- and two-valve circuits which were invented two, three, or more years ago, e.g. super-regenerative circuits, the Filadyne, Unidyne, and many other special forms of detector circuit.

You may be proud of your efficient one-, two-, or three-valve home receiver; hence it is not wise to pull it to bits every time you spot a new circuit—you may draw several blanks and miss your favourite programme items while you are struggling to wire up the old circuit again.

The Better Plan

It is better in every case to go to the expense of a few extra components and rig them up on a stout baseboard whereon you may experiment to your heart's content, with greater efficiency, convenience and interest.

A good stout baseboard should be selected in the first instance, preferably of American white wood, which possesses insulating properties almost as good as ebonite; 18 in. by 10 in. is a convenient size, and the thickness of the wood should not be less than 3/4 in., otherwise there is danger of screw ends protruding right through if anything but small screws are used. The variable condensers should be of the vernier control type.

Whether they are of the square law, log, or S.L.F. type, is quite immaterial. A slow-motion dial or vernier movement is not absolutely necessary, but may be incorporated with advantage if much D.X. work is to be contemplated.

Plug-In Coils

As regards the inductances in an experimental hook-up, the writer prefers to use the handy old plug-in coils, which nowadays are much more efficient than they used to be. It must be remembered that when experimenting with a variety of single-valve detector circuits, some particular types may require quite wide differences in the size of reaction coil and coupling, and it is in this particular, and also that of wavelength change, that the simple plug-in

(Continued on page 554.)



3 into 1 will go!

**Columbia
"Layerbilt"**

This defies all mathematical rules, but nevertheless three ordinary batteries will go into one Columbia "Layerbilt" when electrical properties are compared, and easily, too. The Columbia "Layerbilt" will last three times as long, will yield three times the current and will cost in the long run about three times less than any other battery.

Price 25/-

**Columbia
"Layerbilt"
THE 100% BATTERY**

J. R. Morris, Imperial House, Kingsway, London, W.C.2.

Scotland: J. T. Cartwright, 3, Cadogan St., Glasgow.

READY RADIO

SUPPLY COMPANY,
41, NEWCOMEN ST.,
LONDON BRIDGE, S.E.1.

Telephone: HOP 5555 (Private Exchange).
Telegrams: READY. HOP 5555, LONDON.

DEMONSTRATIONS

DURING BROADCAST HOURS AT OUR WORKS

HEAR THE

"MULLARD MASTER THREE"

Before You Buy

Also Demonstrations of other successful Radio Press receivers.

IMMEDIATE DESPATCH

of ALL the CORRECT parts for these Receivers.

Write, Wire or Phone Your Orders

"MULLARD MASTER THREE"

	£	s.	d.
1 Solid Mahogany or Oak Cabinet and Baseboard (Ready Radio)	1	5	0
1 Aluminium Panel, 18" x 7" (Colvern)	1	3	6
3 Valves (to specification) (Mullard)	1	13	6
3 Valve Holders, new type (Lotus)	3	9	9
1 Combined Wave Coil (Colvern)	1	17	0
1 Permacore Transformer (Mullard)	1	5	0
1 Low-frequency Transformer (Type LFA) (Climax)	1	5	0
1 High-frequency Choke (Climax)	7	6	
1 Battery Switch (Benjamin)	1	1	0
2 Log Variable Tuning Condensers, 0005, 00035 (J.B.)	1	1	6
1 Combined Condenser and Leak Holder (complete with Condenser, 0005 mfd. and Leak, 2 megohms) (Mullard)	8	0	
1 Fixed Condenser (0001 mfd.) (Mullard)	2	2	6
8 Battery Plugs, 4 red, 4 black (Lissen)	1	4	4
1 Pair of Panel Brackets (Burne-Jones)	2	6	8
2 Terminal Strips (2 1/2" x 2" x 1/4")	1	5	0
2 Spade Connectors, 1 red, 1 black (Lissen)	1	5	0
4 Terminals (A., E., L.S., L.S.+) (Belling-Lee)	2	0	
Low-tension Battery, 2 volt, 50 amp. hrs.	11	0	
1 High-tension Battery, 108 volts (Siemens)	18	0	
1 9-Volt Grid Bias Battery (Siemens)	1	6	6
3 yds. Twin-Flex	1	8	8
100 feet Aerial Wire	1	0	
4 Aerial Insulators	1	0	
1 Earth Tube (Climax)	5	0	
2 Slow-motion Dials (Sovereign)	7	0	
TOTAL (including Valves)	£11	8	3

1 Packet of Connecting Links (Junit) FREE.

"RHAPSODY FOUR"

	£	s.	d.
1 Ebonite Panel, 21 1/2" x 7 1/2"	9	6	
1 Cabinet in Oak or Mahogany (Ready Radio)	1	10	0
4 Valve Holders (Lotus)	7	0	
2 Single-Coil Holders (Lotus)	1	4	
1 On-Off Switch	1	0	
1 Wave-change Switch (Lissen)	1	6	
2 0005 Variable Condensers with S.M. Dial	1	12	0
1 Standard Loading Coil (Magnum)	7	6	
1 A.N.P. Coil and Base	9	6	
1 Neutralising Condenser (Magnum)	5	0	
2 H.F. Chokes (Igranic)	10	0	
1 R.C.O. Unit (Dublier)	7	0	
1 0001 Condenser (Cydon)	7	6	
1 L.F. Transformer (Lissen)	19	0	
2 001 Condensers (Lissen)	2	0	
1 0G03 Condenser (Lissen)	1	0	
1 Lotus Jack Switch, No. 3	4	0	
2 25-meg. Leaks and Holders (Lissen)	3	0	
1 2-meg. Leak and Holder (Lissen)	1	6	
1 Terminal Strip	2	6	
9 Insulated Terminals (Belling-Lee)	4	6	
1 Pr. Panel Brackets (Magnum)	2	6	
20 ft. Glazite	1	6	
4 Valves, as specified	2	6	6
TOTAL (including Valves)	£10	17	0

READY FIJLT SETS COMPLETE

(Prices Include Royalties)

- "Mullard Master Three" £13 10 0.
- "Rhapsody Four" - - £14 0 0.
- "Touchstone" - - £17 5 6.
- ("Wireless Mag.")
- "Radiano Four" - - £19 0 0.
- ("Constructor")

RING HOP DOUBLE FIVE DOUBLE FIVE

INLAND: All orders post free. OVERSEAS: Consignments carefully packed and insured.

YOUR HOOK-UP BOARD

—continued from page 553

coil scores over all its contemporaries.

If full use is to be obtained of the advantages of the plug-in inductance, a good two- or three-way coil holder should be included, and if, for the sake of simplicity and convenience, you intend using variable coupling for reaction control, then, of course, one is absolutely necessary and should be fitted with a vernier movement. Baseboard-mounting rheostats or resistors should be used, and they should be conveniently variable by means of an insulated knob.

It is usually chiefly for permanency that connections are soldered in a radio set; so for a circuit which may be altered almost as soon as it is completed it is quite unnecessary. Every connection to each component should be provided with an accessible terminal, and in selecting your components for experimental work always make sure that they are complete with terminals or some easy, simple method of connection other than soldering tags.

Connecting Up

It is not at all necessary to provide small panels of terminals for the aerial, earth, or batteries; you will find it far easier and much simpler to take flex connections direct from a convenient component to the batteries. Similarly the aerial and the earth leads can be provided with small spring clips and attached to any point on the coils or in the circuit in much less time than it takes the writer to pen these few words.

Wiring up should be carried out with 18-gauge D.C.C. or the special insulated wire, such as Glazite, and before commencing examine your circuit diagram in conjunction with the layout of your components, noting the shortest route that can be taken to wire up the common L.T. leads.

You will find that you may be able to connect up to half a dozen different points before snipping off the wire. Cut off a length of wire accordingly.

Make full use of the convenience of your components on the baseboard by altering their layout to suit the new circuit you wish to try

You will find it will take very few minutes to alter component positions if they have been selected with such an end in view.

TELEVISION NOTES OF THE MONTH

—continued from page 524

developed (with the exception of one of Baird's most recent developments) it has been customary to flood the entire scene with light"—and this, we all know, burns sitters' faces. The entire opposite is nearer the truth. What of Bélin's zig-zagging light beam, the A.T. & T.'s, and the G.E.C.'s?

I wish Mr. Dinsdale would not let his zeal overcome him. Facts speak best for themselves.

Ends Image Shooting

An automatic speed control has been developed by a firm supplying television parts in America. Mounted on the motor shaft is a centrifugal governor actuating a pair of contact points in series with the motor

TELL YOUR FRIENDS

about MODERN WIRELESS and particularly about this November issue. The Gift Book is unique in that it covers constructionally no less than eight sets. A tremendous demand is inevitable and your friends will thank you for reminding them to get their copies

BEFORE IT IS TOO LATE

current supply. The contact points are shunted by an adjustable resistance.

How It Works

As the speed of the motor becomes too high the governor opens the contact points and the resistance is thrown into circuit. If the speed becomes too low the contact points close, short-circuiting the resistance. The knob adjusting the contact points serves as a vernier to make it possible to obtain the correct speed. When the apparatus was tested the image remained centred during a twenty-minutes' programme.

Life-Size Images

Dr. E. F. W. Alexanderson, of the American G.E.C., reports that he has built a television set which gives life-size figures and much greater detail than the small sets. I take it that he has developed the system using his large mirror drum, which zig-zags seven light spots across a screen. But he mourns that he cannot use it because it demands a wider broadcast band 20,000 cycles—than is available at present.

"MICROMETER-LIKE ADJUSTMENT"

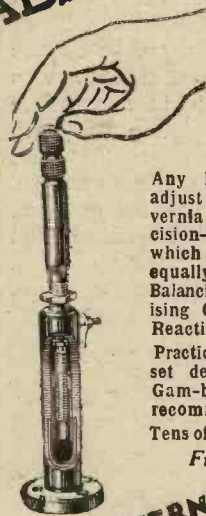

2 to 38
M/MFDS.

Any hand can accurately adjust the Gam-brell Neutrovernia because of the precision-like construction which enables it to be used equally as well as either a Balancing Condenser, Neutralising Condenser or Capacity Reaction Control.

Practically every known expert set designer has used the Gam-brell Neutrovernia, and recommends it too.

Tens of thousands already sold

From all dealers

"NEUTROVERNIA"
PRICE 5/6 EACH

GAMBRELL RADIO, LTD.

6, Buckingham Street, Strand, W.C.2.

ALEXANDER BLACK,
The Wireless Doctor,
will call and cure your set (London and Home Counties). A specialist in quality reproduction. Sets repaired and modernised.
2a, Woodville Grove, N.16. Sloane 5105. Uxbridge 3687.

CAN YOU AFFORD TO MISS

POPULAR WIRELESS

?

Out Every Thursday, full of good radio fare and containing all the latest wireless news, inventions and developments — "P.W." constitutes

A RADIO INVESTMENT

saving you its cost many times over.

But be sure to get

POPULAR WIRELESS

EVERY THURSDAY
THREEPENCE

DRILLING GLASS

By C. A. J. MEADOWS

G LASS panels, which have been more or less confined to sets for exhibition purposes, always command a great deal of respect when seen on an amateur receiver, not because of the appearance but principally because it is widely known that there are inherent difficulties in drilling this material. Many suggestions are put forward, and all concern the method of hardening and shaping the tool which is to be used.

Extremely Hard

Glass is so hard that any ordinary tool is absolutely useless, and it is no exaggeration to say that there is no perfect treatment for a glass-working tool, in other words, no treatment yet known will harden a tool to such an extent that it will put a good number of holes through glass and retain its original hardness.

The treatment prescribed here-with will put a dead-hard finish on a tool which will enable at least one panel, having an average number of holes, to be drilled with a greater ease than is usually associated with the operation, and the time taken will not be much more than that required for a similar amount of work on an ebonite panel.

The tool itself is made from a three-cornered file which must be capable of making a hole of the size required without being taken to its fullest extent. The thick end must be softened, and turned or ground down to fit a drill chuck. This process must be accurate, as the drill must rotate dead true when in use. The thin end is then ground to a fairly fine point, with the three sides sharply defined.

The Hardening Process

Last comes the hardening process, and this is what needs the care; the drill is placed in the fire till it is white-hot, but it must not burn—that is, there should be no pieces flaking from it. While it is heating, a suitable vessel containing mercury should be placed close handy, and as the idea is to harden as much of the tool as possible, it is best to have something deep and fairly narrow.

When the tool has attained its maximum heat, remove it from the fire, and plunge it into the mercury, holding it there for about three seconds. The tool should then be stone cold, but it is not advisable to

(Continued on page 556.)

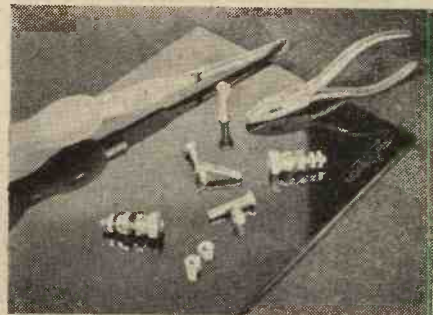

"Resiston" panels are as good as they look. They have enormous insulation properties as well as a fine appearance;

choose "Resiston"

Visit a wireless shop. Ask to see a "Resiston" panel and note, first, its lustrous polish. So hard it resists scratches with ease. No minute cracks or roughness to harbour dust and invite leakage. Then examine its colour. You will appreciate at once how remarkably free it is from sulphur and other adulterants used in "cheap" ebonite. Its superior quality is obvious. Remembering that everyone will judge your Set first by its external appearance, you'll very wisely decide to use a "Resiston" panel.

"Resiston" panels are supplied in black and also in a mahogany finish. Either finish possesses the same enormously high insulation properties and the same beautifully polished surface.

"Resiston" panels come to you like this—each in a sealed envelope, squared-up and cut dead to size.



Send for new booklet.

Please send me, free, a copy of your new booklet, "The Panel Makes all the Difference."

"M.W." Nov.

NAME.....

ADDRESS.....

RESISTON
PANELS

6045 CA

American Hard Rubber Co., Ltd., 13a, Fore St., E.C.2.

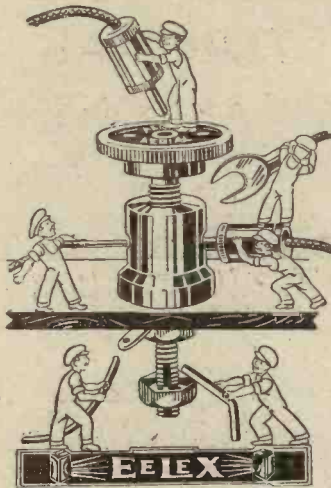

GNOMES OF EFFICIENCY

demonstrating the many connections that can be made to an Eelex Treble-Duty Terminal.

They are the little beings that look after the small things in a wireless set. Their life work is to perfect very important small accessories and see that they function efficiently to the utmost of their ability. Losses in a wireless set are enormous, and are in hundreds of cases due to faulty connections or bad joints.

Terminals are the centre of industry in a wireless set and unless secure joints can be made their efficiency is impaired.



TREBLE DUTY TERMINALS

are so designed that anyone without any experience can make secure connections. Every constructor should write for our booklet 31, which tells you all about the Eelex gnomes of efficiency, Eelex Terminals and their accessories.

J. J. EASTICK & SONS,

Eelex House, Bunhill Row,
Chiswell Street, London, E.C.1

DRILLING GLASS

—continued from page 555

touch the mercury, which will probably have attained a temperature of about 2,000 degrees.

If the tool is as hard as it should be, an emery grinding wheel should make no impression on it, and it is a simple matter, if the tool is in this condition, to drill quite a dozen holes through $\frac{5}{16}$ -in. plate glass without affecting its hardness appreciably.

Once the tool has been used for a fair number of holes it will lose its hardness suddenly, and it will then be noticed that it can be ground, filed, and, in fact, treated just as an ordinary piece of mild steel, from which it will be seen that the dead-hard portion is only a skin, and that under it the metal is quite soft. This will perhaps explain why the tool does not break while in use, as is often the case when a tool is used dead-hard.

When the first hole is attempted it will be immediately apparent why stress is laid on the necessity for accurate turning or grinding of the shank. If this has not been perfectly accurate, the tool will try to wander round the subject, and if force is used the tool will probably break.

This description may seem involved and difficult to follow, and should this be the case I must apologise. I trust, however, those who attempt to make use of these hints will have the success they deserve as, after all, it is no easy job.

ABSOLUTE ZERO

By G. H. DALY

LOOKING more or less dimly on the wireless horizon of our present age are quite a number of wonderful future discoveries and inventions—television, the cold valve, and so on. And amongst them is a discovery which, when developed, will probably revolutionise not only wireless and wire communication, but also affect our everyday existence—a discovery which may lead, someday, to man shaking the foundation of our universe. In truth, a very secret of the ether.

No Resistance

What is this discovery? The reader will imagine something spectacular, awe-inspiring, with the usual complicated gadgets. Not a bit of it. The

discovery is merely the effect of intense cold on a piece of wire. It has been found that if a piece of wire is frozen cold enough it loses all resistance. If one volt is put in at one end, exactly the same amount will come out at the other end, no matter how long the wire. There is no loss, no voltage drop. Resistance is, in fact, *non est*. Furthermore, a current once applied to a complete circuit of this description will keep circulating indefinitely, so that here is a definite form of perpetual motion.

We have long known the power of intense heat. Now we realise that intense cold is just as omnipotent, only the latter is more difficult to attain.

What will Happen?

At Leyden a temperature very near absolute zero was obtained by liquefying helium, when the elimination of resistance was noticed. But

BUY THE BEST.

All the articles in "Popular Wireless" are written

BY THE BEST

radio contributors and set designers. Why not get authoritative information from

POPULAR WIRELESS?

Every Thursday. Price 3d.

the production of these low temperatures involves very much more than the reduction of resistance, for at absolute zero all molecular motion stops.

Once absolute zero is obtained, it is impossible to estimate exactly what will happen. Maybe matter reduced to this stage will disappear—turn into ether—or it might become unpleasant and blow us all up. Whatever happens, we shall undoubtedly learn something new.

It is quite likely that we are coming near the discovery of the ether of space. For example, we know space to be at a temperature of absolute zero, and the only thing that exists in empty space is the ether (which provides the medium through which electro-magnetic radiations take place) and its denizens, these radiations.

Therefore it seems probable that all efforts to find ether have failed because we have failed to attain to absolute zero—the necessary condition. Discover one and the other will probably turn up with it.

(Continued on page 557.)

CIRCULAR MOTION VALVE HOLDER

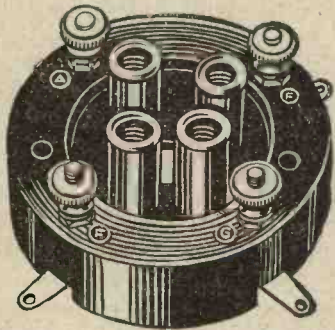

THE GREATEST ANTI-MICROPHONIC VALVE-HOLDER DISCOVERY

No matter how much you may jar your set, the circular motion of vibration of the NEW CASON VALVE-HOLDERS guarantees safety to your valves. They will not swing sharply to and fro, but will rotate smoothly and without the least strain. This wonderful device is so finely sprung that it ensures perpetual valve-motion, a necessity to the best reproduction.

Made under an entirely new process. Guaranteed to be only the highest grade mouldings, insulated parts and springs.

ANTI-MICROPHONIC VALVE-HOLDER, 1/6
With Terminals and Red Anode

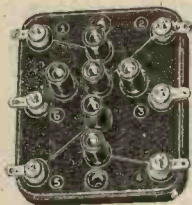

NEW CASON SIX-PIN BASE, with Moulded Legs. Size $2\frac{1}{2}$ in. \times $2\frac{1}{2}$ in. With terminals **1/6**

Recommended by experts as a sound and excellent accessory for all circuits.

Write for New Season Folder, free!



Chiswick Road, Lower Edmonton, London, N.9.
Tel. : Tottenham 3446.

'Grams: "Casmould, Lowered, London, N.9."

WET H.T. BATTERIES



Solve all H.T. troubles
SELF-CHARGING, SILENT, ECONOMICAL
JARS (waxed) $2\frac{1}{2}$ " \times $1\frac{1}{2}$ " sq., 1/3 doz.
Zincs, New type, 11d. doz. SACS 1/2 doz.
Sample doz. (18 volts), complete with bands and electrolyte, 4/3, post 9d.
Sample unit, 6d. illus. booklet free.
Bargain list free.

AMPLIFIERS, 30/- 2-VALVE SET, £4.
M. TAYLOR, 57, Studley Rd., Stockwell, London.

ASTONISHING BARGAINS in our NEW CATALOGUE

72 pages, well illustrated and containing all latest and best apparatus and 1,000 Bargains for experimenters. Get a copy. Post Free 4d.

ELECTRADIX RADIOS
218, Upper Thames St., London, F.C.4

ABSOLUTE ZERO

—continued from page 556

Regarding the more practical application of this phenomenon of elimination of resistance with reduction of temperature, it seems likely that a wire cable will be produced thinly encased in some chemical substance which will keep the temperature of the cable very low. Some such cable would reduce enormously the cost in telephone, telegraph, cable, lighting, and power systems.

Of course, it would not do to freeze an electric lamp or valve, for these depend upon resistance to cause them to become hot and emit electrons; but there is no reason why the wires leading up to the lamp should not have their resistance reduced to a minimum by freezing. There are a great many other ways in which this discovery may be applied practically, but the most important of these pales in significance if further research in this direction enables man to control molecular motion and tap the inexhaustible reservoir of energy into which all heat disappears.

MAKING AN ADJUSTABLE CONDENSER

By H. BRAMFORD

A CONDENSER of the kind which is adjustable to a fixed value is very useful for many purposes, and such a component may

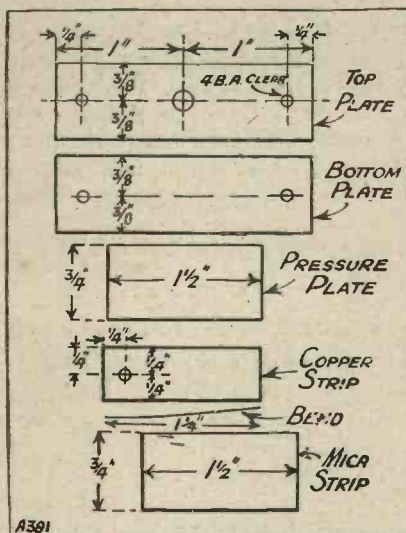

easily be made by those who desire to do so. The method of procedure (Continued on page 558.)

BELLING-LEE TERMINAL CARTONS

For The

"MASTER 3 STAR"



Mullard has again specified Belling-Lee patented terminals for the "Master 3 Star" Circuit described in this issue of "Modern Wireless." For your convenience we have packed the specified terminals in a neat and attractive carton which can be obtained at your dealer's.

Prices :

- Type 'B' Carton - 2/-
- Type 'M' Carton - 1/6

BELLING-LEE TERMINALS

Belling & Lee, Ltd., Queensway Works, Ponders End, Middlesex.

The Easy Way TO PERFECT RADIO

A GOLDEN OPPORTUNITY
PURCHASE THE COMPLETE
KIT OF COMPONENTS FOR BUILDING
THE 'INVINCIBLE' FIVE
OUT OF INCOME

26/6

DOWN

Secures a complete kit of components for building this wonderful receiver. Balance in 11 similar monthly payments. Write for detailed price list.

Hear your favourite receiver at our new demonstration salon—
77, City Road, E.C.1.

We can supply any make of set or component on easy terms. Send along your requirements we will quote you.

Write for our big list free.

PETO-SCOTT CO., LTD.,
77, City Road, London, E.C.1
and at
62, High Holborn, London, W.C.1.

(CA) 6035

The Famous "RADIOLA" TRANSFORMS

Your Set →

Moving Coil L.S. and Batteries →

SAVES UPKEEP EXPENSES

From £5.5.0

To your size.

OAK or MAHOGANY

INSTANTLY!

Snug: Trouble free: Delightful!

Brings to your Set a NEW CHARM!—a FURNITURE model enhancing the HOME!

Over 3,000 delighted clients have bought Pickett's Cabinets THROUGH THE POST. Every Cabinet is sent ON APPROVAL. Guaranteed complete satisfaction.

"The HALL MARK by which your Set is judged and admired."

LET US HELP YOU. Send for lists to actual makers:—

PICKETT'S
CABINETS

ALBION ROAD, BEXLEYHEATH, Near London.

ALL APPLICATIONS FOR ADVERTISING SPACE in "MODERN WIRELESS" must be made to the Sole Advertising Agents, JOHN H. LILE, LTD., 4, LUDGATE CIRCUS, LONDON, E.C.4.

MAKING AN ADJUSTABLE CONDENSER

—continued from page 557

is shown in detail in the accompanying diagram. All the materials that are required are some scrap pieces of ebonite, some mica strip, and some copper strip, two terminal heads, two 4 B.A. countersunk screws, and some 4 B.A. nuts.

First cut three pieces of ebonite and drill to dimensions given. The centre hole in the top plate is drilled to receive a bush tapped with an inside 4 B.A. thread. A 4 B.A. nut will do for this purpose if it is forced in a "round" of suitable size, the ebonite being just slightly warmed for this purpose. Any number of

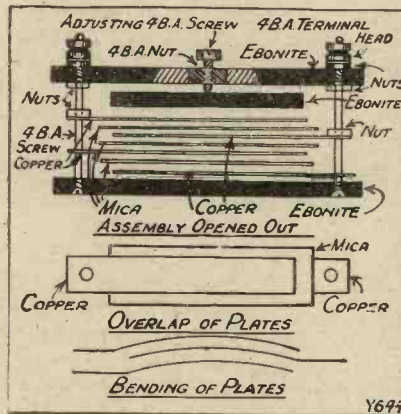

copper strips may be cut, punched, and bent, as shown in the sketch, according to the total capacity required. The number of mica strips will be one less than the number of copper strips used.

The complete assembly is shown in the drawing, and this process should not prove in any way difficult if the order of procedure is carefully followed out, each item being built up one upon the other. When completed the edges may be neatly wrapped round with fibre or paper, to enclose the internal parts and keep dust from entering between the plates.

A SWITCH TIP

A POINT worth noting is that the majority of switches in house lighting circuits are of the simple on-off variety. They break only one of the leads of the mains circuit. Therefore, if you have a mains unit connected in the house lighting circuit by means of an ordinary plug, it is possible that when you switch off you still retain one

direct connection between your set or mains unit and the house supply system.

In the ordinary course of events this is hardly likely ever to cause trouble, but it is just as well completely to isolate the apparatus when it is not in action. More especially is this advisable if you contemplate experimental work in the interior of your outfit. Therefore, pull the adaptor plug right out and then do not forget to discharge the condensers in the mains unit before touching them, otherwise painful little shocks are possible!

A GRID-BIAS NOTE

ALWAYS see that the H.T. supply to a set is completely cut off before grid-bias connections are adjusted. The moment that negative grid bias is taken away from a valve the anode current rises. This current rise can be very considerable in the case of a super-power valve, which is frequently biased to the extent of twenty or more volts, and it is possible for this sudden increase to cause a breakdown of components. Similarly you should never switch on the H.T. until the grid-bias plugs are in their approximately correct positions in the battery.

RADIO ABROAD

—continued from page 484

necessary, the extortion was carried a stage farther. The result was that the radio industry, before it had a chance to get properly on its feet, was practically extinguished.

Government Control

Under the Government ownership, however, broadcasting is in the hands of the Department of Posts and Telegraphs, and this Department is run for the Peruvian Government by the Marconi Co. The Lima station is operated by a Peruvian staff, but under the supervision of a Marconi Co. representative.

In the Tropics

I understand that in South America, as indeed in tropical countries generally, there is a crying need for the further development of short-wave transmission and reception. In S. America and other countries remote from broadcasting stations, the only

(Continued on page 559.)

At
STAND 107
Manchester
Radio
Exhibition
(by the courtesy of Messrs. K. N. Ltd.)



The famous "CENTREX."
A remarkable advance in Moving-Coil Speaker Design. Correct tensioning and centring assured with minimum of trouble by the use of a separate member, supported on special springs, adjustable by wing nuts. POT STAND is of unique and exceptionally sturdy design, incorporating our famous Pot Centring feature. Sold separately for any Pot up to 5" diameter.
Price of STAND and FRAME **32/6**



Complete in Bronze Case, **27/6**
Patented. Beware of infringing substitutes.

The P.G.3 DOUBLE ACTING REED UNIT
A wonderful movement, four-pole, adjustable, ultra-sensitive. Handles bass volume and gives remarkably pure and undistorted reproduction.

GOODMANS
27 FARRINGDON ST. LONDON E.C.4
Telephone: City 4472.

RADIO ABROAD
—continued from page 558

dependable reception to be had is on short waves. There is a virgin market in S. America for short-wave receivers. The figures with regard to the issue of wireless licences in Australia, and particularly as to New South Wales, are rather peculiar and interesting. In the first place, N.S.W. has the largest population and the largest capital. There are about 2,500,000 people in the State and about 1,000,000 in the capital. Victoria, on the other hand, has about 1,800,000 and Melbourne about 950,000. Yet the licences in Victoria have reached the number of 136,000, whilst those in N.S.W. are only 76,000.

A Curious Difference

This very curious discrepancy was investigated by a Royal Commission, which found, amongst other things, that the programmes put out by the Melbourne station were much superior to the others.

This, however, cannot entirely account for the great difference, and it would seem that broadcasting has simply "caught on" in Victoria in an entirely different way from what it has in N.S.W. Incidentally, radio broadcasting originated in N.S.W. with a very bad start, and perhaps that is an important part of the explanation.

Adaptability

The extraordinary adaptability of a radio set is shown by an account of some of the purposes to which it is put in New York, Washington, and other American cities. Barbers' shops instal radio receivers to entertain their patrons whilst their tonsorial needs are being dealt with, and shoe-shine parlours have replaced gramophones with radio receivers as a means of "handing out" entertainment. Cafes and restaurants have gone in extensively for large cone-speakers, situated at different points, and some of the railway companies are now equipping their saloon coaches with wireless apparatus to entertain the passengers during long journeys.

Longest Radiophone

One of the longest regular radiophone services which has yet been established is that which has been in service some few months between Mukden and Berlin. It is not clear whether this is a single span by radio or whether there are links of landlines.

The new
Mullard Master Three★

USE THESE SPECIFIED
CLIMAX COMPONENTS

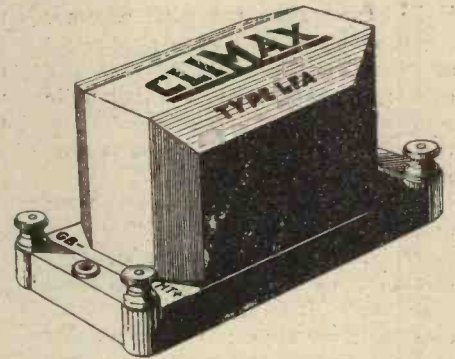

CLIMAX L.F.A. TRANSFORMER

Specially produced to the requirements of modern revolutionary developments in transformer design. Chosen by the designer to ensure maximum signal strength and faithful reproduction. Small, neat, robust. Price **25/-**

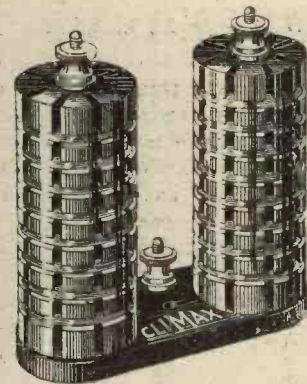

CLIMAX Popular H.F. CHOKE
now **7/6**

Specially recommended for effective H.F. operation owing to the Climax binocular winding possessing no field effects. High self-inductance, low self-capacity. Accepted as the world's finest H.F. Choke. Insist on the name Climax.

The whole success of the "Master Five" turns on the use of the Climax H.F. Choke Kit. Price, as specified **15/-**

CLIMAX
A YEAR AHEAD

CLIMAX RADIO ELECTRIC LTD.,
Quill Works, Putney, S.W.15.

HYDRA
Serves you well

There must be something unusual in this condenser to win and hold the confidence of the most important Eliminator manufacturers, not only in Britain, but the world over.

CAPACITIES from 1 upwards. Tested at 500 volts D.C., 500 volts A.C., and upwards to 10,000 volts D.C.



Obtainable from your Dealer, or
LOUIS HOLZMAN,
34, Kingsway, London, W.C.2.
Telephone: Holborn 6209
See us at STAND 60, Manchester Wireless Exhibition

L.F. Transformer Developments

A short review of an interesting innovation in design

By P. R. BIRD.

ALTHOUGH in essentials it is such a simple piece of apparatus, the low-frequency transformer has probably puzzled more purchasers and confounded more critics than any other radio component. For within the memory of most set-constructors the transformer has itself been transformed, time and time again.

Not many years ago the quest for quality of reproduction threw a searchlight upon the then existing transformer's weaknesses; and since then there have been many radical changes in the appearance, the weight, and the size of the various popular designs.

The most startling change of all is the recent reappearance of the *small* L.F. transformer. Memories of the small variety of the past are almost invariably unpleasant memories!

For in the "bad old days" a small L.F. transformer generally meant an inadequate core, low impedance, and consequent saturation and uneven amplification.

Because that was true a year or two ago it does not mean to say that it is true of small transformers to-day. Recent tests with one—the Philips L.F. transformer—have proved that here is a class of instrument that will play havoc with preconceived notions of necessity for large size. Although its height is only a couple of inches and its weight a few ounces, it proved anything but small in performance. As a matter of fact, this comparatively diminutive component is a real quality product,

capable of putting up an excellent performance over the whole range of musical frequencies. How is it that such a little fellow—no bigger than a compact R.C.C. unit—can compete with its larger brethren? Was previous experience with small trans-



The new Philips low-frequency transformer.

formers at fault, that size and weight can now be reduced, with a corresponding reduction in quality or volume?

Truly "Material" Improvement

The answer is that whereas in the past small size meant an insufficient number of turns, or the use of a very thin wire, or perhaps an inadequate iron core, this is no longer true. It is now possible, owing to improvements in the materials used in L.F. transformer construction, to pack efficiency into a small compass. The Philips transformer is a good example of the application of Permalloy in modern low-frequency design, and with the introduction of this class of component

we are enabled to take advantage of the benefits of compactness and of light weight.

When the makers can claim—as in this instance—that the amplification obtained with the transformer is absolutely constant between 200 and 10,000 periods, it will be obvious that the improvements due to recent research into the materials used, etc., are very real improvements, which are certain to have a great effect upon transformer dimensions and performance in the future.

TIPS AND TECHNICALITIES

Threepennyworth of distilled water from a chemist is sufficient to keep an accumulator "topped-up" for twelve months.

If you charge your own accumulators, do not let them go on gassing too long at the end of the charge.

A penny tin of petroleum jelly with which the terminals can be coated to prevent their being eaten away is an investment that every va've-set owner should afford.

After an accumulator has been used for twelve months or so it is a good plan to renew the electrolyte, and this should be done at a charging station which can be trusted to put in new acid of the correct specific gravity.

Even an H.T. mains unit will not provide satisfactory and undistorted service unless it is capable of supplying the full anode current required by the receiver.

INDEX TO ADVERTISERS

American Hard Rubber Co., Ltd.	Page 555
Aneloy Products	546
Baker's Selhurst Radio	551
Bedford Electrical and Radio Co., Ltd.	547
Belling & Lee, Ltd.	557
Benjamin Electric, Ltd.	518
Bird, Sydney S. & Sons, Ltd.	541
Black, Alexander	555
Bond, V. C. & Sons	551
Bowyer-Lowe Co., Ltd.	545
British General Manufacturing Co., Ltd.	547
Brown, S. G., Ltd.	539
British Thomson-Houston Co., Ltd.	513, 535, 542
Burne-Jones & Co., Ltd.	538
Carrington Manufacturing Co., Ltd.	547
Cason Mouldings	557
Celestion Radio Co.	550
Clarke, H., & Co. (M/cr.), Ltd.	544
Clinax Radio Electric, Ltd.	559
Colvern, Ltd.	517
Cossor, A. C., Ltd.	442
Day, Will, Ltd.	546
Donotone (Regd.) Loud Speaker	548
Dubilier Condenser Co. (1925), Ltd.	535, 541

Exide Batteries	Page 539
Eastick, J. J., & Sons	556
Edison Swan Electric Co., Ltd.	509
Electradix Radios	557
England-Richards Co.	545
Ferranti, Ltd.	515
Formo Company	547
Gambrell Radio, Ltd.	555
Garnett, Whiteley, & Co., Ltd.	533
General Electric Co., Ltd.	525
Goodmans'	559
Gilbert, J. C. (Cabinets)	545
Graham Ampion, Ltd.	441
Graham-Farish	545
Heayberd, F. C. & Co.	551
Holzman, Louis	559
Hughes, F. A., & Co., Ltd.	540
Iuranic Electric Co., Ltd.	537
Impex Electrical, Ltd.	537
Jackson Bros.	527
Lampugh, S. A., Ltd.	543
Lewis, S. W., & Co., Ltd.	535
Lissen, Ltd.	505
London Elec. Wire Co. & Smiths, Ltd.	506
Lock, W. & L., Ltd.	548
Lectro Linx, Ltd.	533
Makerimport Co.	554
Metro-Vick Supplies, Ltd.	Cover iii
Morris, J. R.	553

M.P.A. Wireless, Ltd.	Page 531
Mullard Wireless Service Co., Ltd.	Cover ii, 511
Paroussi, E.	545
Peto-Scott Co., Ltd.	558
Pleckett's Cabinet Works	558
Premier Accumulator Co. (1921), Ltd.	543
P.D.P. Co.	551
"Popular Wireless"	555
Raymond, K.	549
Ready Radio Supply Co.	554
R.I. & Varley, Ltd.	Cover iv
Ripaults, Ltd.	527
Rothermel Corporation, Ltd.	529
Sifian Electrical Inst. Co., Ltd.	553
Six-Sixty Radio Company	521
Siemens Bros. & Co., Ltd.	517
Taylor, M.	557
Telsen Electric Co., Ltd.	541
Telegraph Condenser Co., Ltd.	518
Triphonic, Ltd.	547
Whiteley, Boncham, & Co., Ltd.	551
Wilkins & Wright, Ltd.	552
"Wonders of Animal Life"	522

All communications concerning advertising in "Modern Wireless" must be made to John H. Lile, Ltd., 4, Ludgate Circus, London, E.C.4. Telephone: City 7261.

An Elastic Aerial

CAN you imagine what it would mean to your Wireless reception if you had an aerial that you could stretch out from nothing to its full length or vice versa?

Even Elastic will not do that, but the new Met-Vick Elastic Aerial Unit will, *in effect*, enable you to vary your aerial backwards and forwards to any desired length, from your maximum length to zero, or zero to your maximum.

It is as though you had a thousand aerials, from the very shortest to the longest your situation allows; as if you had, whenever you wanted, the exact length of aerial to give the utmost selectivity combined with signal strength for any particular station you are trying to get.

With the new E.A. Unit, you can erect the biggest aerial, and still bring your set into its most sensitive condition for the reception of distant or difficult stations, without the "Local" or loudest station overpowering everything. It makes the most perfect volume control imaginable.

Simple and inexpensive, this device, which will add so greatly to the pleasure of thousands of Valve-Set users, is now available at most radio dealers.

It sells for 12/6—14/-, according to the style of mounting.

Ask your Dealer for Leaflet.

MET-VICK

The new sectional Met-Vick Catalogue is a regular "mine of information" on Radio apparatus.

Section "A" includes the whole range of Cosmos Valves, including the wonderful A.C. valves with indirectly-heated cathodes, rectifying valves, etc.

Section "B". Mains-operated 3, 4 and 5-valve sets for operation from A.C. and D.C. mains and batteries.

Section "C". Apparatus for complete mains operation, A.C. and D.C., L.T., H.T. and G.B. eliminators and spare parts.

Section "D". Accessories and Components, A.N.P. Coils, Resistance Units, Aerial Equipment, Accumulators, H.T. Batteries, etc.

Ask your dealer for the Section in which you are interested, or write to:—

METRO-VICK SUPPLIES LTD

(Proprietors: Metropolitan-Vickers Electrical Co. Ltd.)

**155, Charing Cross Road,
LONDON, W.C.2.**

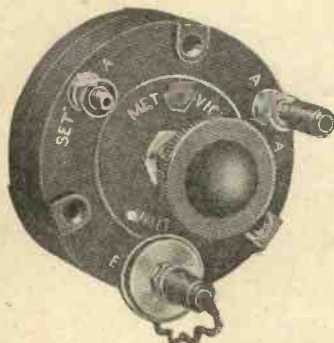

*E.A. Unit Table Mounting
Price 14/-
with series condenser.*

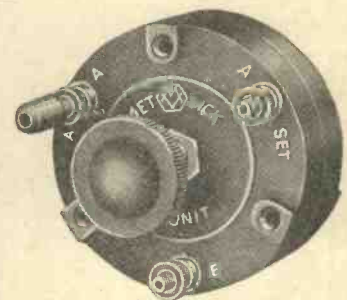

*E.A. Unit Panel Mounting
Price 12/6
without series condenser.*

WE MAKE ALL THE COMPONENTS NECESSARY TO CONSTRUCT A DRY RECTIFIER

It will be of interest to those who know the **QUALITY** of R.I. and Varley products to learn that we make all the components required for "Westinghouse Metal Rectifier" Eliminators, with, of course, the exception of the Rectifier itself.

The components illustrated include a new Potential Divider, for a special Grid Bias Rectifier.

Our Dry Rectifier Transformers are specially designed for use with Westinghouse Metal Rectifiers which are now popular.

Our Universal Power Transformer—for both *A.C. Valves* and *ordinary Valves*—is far in advance of any other Power Transformer on the market, in that it has a universal application to all Radio Receivers.

Our Heavy Duty Power Transformer is becoming increasingly popular, because it can be relied on to provide the large output necessary for operating Moving Coil Loud Speakers with brilliancy.

All these Transformers conform in every way to the recommendations of the I.E.E. Sub-Committee relative to Eliminator components.



Potential Divider.
18/6.



L.T. Eliminator
Rheostat,
12/6.



H.T. Metal
Rectifier
Transformer
28/6.



Universal
Power
Transformer
£2/7/6.



Heavy Duty
Power Trans
former £3/0/0



THE MARK OF BETTER RADIO



Kingsway House, 103, Kingsway, London, W.C.2.

'Phone : Holborn 5303.