

20-page "Solodyne" Supplement and Free Blue Print

MODERN 1/6 WIRELESS

Edited by

NORMAN EDWARDS

M.I.R.E., M.R.S.L., F.R.G.S.

Vol. IX. No. 16

APRIL, 1928.

SPECIAL "SOLODYNE" SUPPLEMENT



THE "SOLODYNE"
THREE
FREE
BLUE PRINT
INSIDE

MODERNISING
THE 1926
CIRCUIT



NOTES
ON THE
1928
MODEL



In Mullard lies the secret to perfect radio reception.

A good valve means good reception—the best valve means the best reception.

Mullard valves with the wonderful Mullard P.M. Filament are the keynote to improvement in any radio receiver.

Mullard
THE MASTER VALVE

CONTENTS

Vol. IX. No. 16. MODERN WIRELESS APRIL, 1928

	Page		Page
Editorial	331	Selective Crystal Circuits	406
"Mains Drive" Receivers	332	The Tetrode as a Detector	407
Cathedral Broadcasts	333	Cutting Down Costs	410
The M.W. "Station-Getter"	335	A Simple "H.F." Ohm-meter	411
The Perfect Loud Speaker	339	Questions Answered	416
The Dual Nature of Electrons	341	Europe's Long-Wave Broadcasters	417
"One-Valvers"	343	On the Short-Waves	418
Broadcasting in Japan	347	Gramophone Pick-ups	420
Seeing by Wireless	349	Radio and the Gramophone	421
The M.W. "Avao" Unit	353	Radio Abroad	426
A Modulated Short-Wave Oscillator	379	Reception Realities	428
The Calibrator	391	Britain's Radio	429
Is the B.B.C. a Failure?	384	What Readers Think	432
Carpentry for the Radio Amateur	385	Television and Radio Vision	433
More About the "Radio-Gram" Four	388	My Broadcasting Diary	440
"35W"	389	Automatic Volume Control	445
Our £1,000 Television Challenge	395	The Fascinating Fixed Condenser	449
Norddeich	397	In Passing	452
The "Greyhound" Four	399	In Our Test Room	454
		Radio Notes and News	454

As some of the arrangements and specialities described in this Journal may be the subject of Letters Patent, the amateur and trader would be well advised to obtain permission of the patentees to use the patents before doing so.

THE "SOLODYNE" SPECIAL SUPPLEMENT IN THIS ISSUE
(Pages 359 to 378.)

Edited by NORMAN EDWARDS, M.I.R.E., M.R.S.L., F.R.G.S.
Technical Editor: G. V. DOWDING, Grad.I.E.E.
Scientific Adviser: J. H. T. ROBERTS, D.Sc., F.Inst.P.

"SOLODYNE" RECEIVERS

The amazing popularity of the range of Solodyne Receivers in which we have specialised since 1926 has induced us to concentrate our efforts in the production of these receivers, both as kits of parts and also ready wired and tested.

We have pleasure in announcing that we are specialising in the modernised 1928 "Solodyne," the 1928 "Solodyne," and the Three "Solodyne" Sets described in this issue.

Lists dealing with this range will be sent on receipt of stamp.

Magnum Products are fully guaranteed.

THREE "SOLODYNE" SETS Set "A"

1 High-Grade Mahogany Cabinet, with base-board	£ 15 0
1 Polished Ebonite Panel, 14" x 7" x 3/16", ready drilled	0 8 0
1 Cylind Double Drum Driyo Condenser, "0005"	2 7 0
1 Gridon Bebe Reaction Condenser, "C001"	0 7 6
1 Sprung On-and-Off Switch	0 2 0
3 Sprung Valve Holders	0 5 0
1 Neutralising Condenser, B/M Type	0 4 0
2 6-pin Bases	0 1 6
1 Fixed Condenser, "002"	0 1 0
1 Fixed Condenser, "0003"	0 1 0
1 Mansbridge Type Condenser, 2 mfd.	0 3 6
1 Grid Leak, 2 meg., and Holder	0 1 6
1 Magnum H.F. Choke	0 7 6
1 Igratio L.F. Transformer, Type G, 3.6 to 1	1 10 0
1 Magnum Terminal Strip with 2 Terminals	0 1 0
1 Magnum Terminal Strip with 7 Terminals	0 3 6
Screening Partition	0 3 6
Glaizite and Tags	0 2 0
	£8 10 0

Price of Coils on application.
Kit of Components for Set "B" £7 3 0
Kit of Components for Set "C" £6 15 0
Any parts supplied separately as required. Either of above sets can be supplied ready wired and tested.

ANNOUNCING A NEW MAGNUM PRODUCT

The unprecedented popularity and demand for the Magnum H.F. Choke which has become recognised as the most perfect of its type has encouraged us to produce an H.F. Choke suitable for Short Wave Receivers.

This Choke is similar in design to our Standard H.F. Choke, but is wound to give a choking effect from below 10 metres up to 100 metres.

The price of this new Choke is the same as the standard type, viz.,

7/6



BURNE-JONES & CO. LTD.,

MAGNUM HOUSE

TELEPHONE: HOP 6257-8

288, BOROUGH HIGH ST.
LONDON. S. E. 1

STANDARD WAVETRAP



As used in the original 1928 "SOLODYNE" and "BUSINESS MAN'S FOUR." 15/-

Screening Box for the above 5/-

This indispensable unit is suitable for use with any receiver and eliminates the unwanted station.

COILS FOR 1928 "SOLODYNE"

As used in the original set.



Per set of 3 including bases, B.B.C. £2 5 0
" " 3 excluding " 5 X X £2 5 0

"BON SOIR, MESSIEURS"



**RADIO PARIS
AT THE TOUCH
OF A SWITCH**

SWITCH on—so! Radio Paris at your command! Turn the dial—German, Dutch, Swiss, Italian and Spanish broadcasting as you will. That's how easy Radio is with the wonderful Cossor "Melody Maker."

All over the country thousands have built this famous Set—thousands who know nothing about Radio. You can build it—even if you've never seen a Wireless Set before. Not an atom of Radio knowledge is needed to follow the simple instructions in the chart, "How to build the Cossor 'Melody Maker,'" free from your Dealer. It's as simple as Meccano. There's nothing to hinder you. No puzzlesome blueprint. No soldering to thwart you. Just follow the instructions and in a few hours you'll build a Set that is better than many factory-built Receivers costing twice the price.

Don't be tied to one broadcasting station. Build a Cossor "Melody Maker" and take your pick of Europe's best. Ask your Dealer for the free chart or send a P.C. to A.C. Cossor, Ltd., Highbury Grove, London, N.5.

**ON THE
WONDERFUL**

COSSOR "Melody Maker"

Adv. A. C. Cossor Ltd.
Highbury Grove. N.5

MODERN WIRELESS

Vol. IX. No. 16.

April, 1928.

The £1,000 Television Challenge—Lifting the Ban—Our "Solodyne" Supplement.

By The Editor.

The £1,000 Television Challenge

ELSEWHERE in this issue we publish the details of the £1,000 Television challenge made to Mr. J. L. Baird, in conjunction with our contemporary "Popular Wireless"—a challenge which was made in all friendliness to Mr. Baird, and with the desire to modify the excitement and misapprehension which recent television experiments have created in the public mind.

Television, as we have pointed out many times in this journal, is a very curious subject—curious because the problem involved cannot be completely solved by known systems; and although certain crude and elementary progress can be, and has been, made the logical assumption that further progress is inevitable becomes fallacious when the methods at present employed are considered in the light of scientific possibility.

The most eminent scientists in the country are of the opinion that true television is not scientifically impossible—but they are generally of the opinion that a new system will have to be discovered before television in the home can become a matter of practical utility.

And because recent television experiments have led many people to believe that those experiments can be improved in the near future—and that detail in a television picture is in itself a detail—we issued our friendly challenge to Mr. Baird.

His excuse for not accepting it has taken more than one form—but whatever the real reason he had in mind, we feel that the public attention drawn to the challenge and to Mr. Baird's refusal has had the effect of making people less inclined to excessive credulity with regard to television, and that their optimism will in future be tempered by a more respectful regard for scientific fact. That accomplishment alone more than repays us for the trouble we have been put to in connection with the challenge to Mr. Baird—and although he has, seemingly, decided not to consider the acceptance of that challenge, he will in future, we hope, realise that there are some people in this country who will not remain silent when certain references to the Baird system of television are made in speech and in print which scientifically cannot possibly be fully justified.

We trust that our £1,000 challenge has taught a lesson and pointed a moral.

Lifting the Ban

THE best piece of news in connection with broadcasting during the last month was that which made known to the world the Prime Minister's decision to lift the ban on controversial broadcasts.

For some time past it has been evident that the B.B.C.'s debates were badly handicapped by the restrictions on controversy, and debacle after debacle occurred when well-known people who had agreed to broadcast, but who eventually found that their utterances must be free from real argument, decided at the last minute not to broadcast.

It was not, indeed, until Mr. Churchill and Mr. G. B. Shaw gave utterance to some very pointed criticisms concerning the restrictions imposed on broadcast debaters that the Government considered the matter at all. Red-tape and apathy held full sway. But, thank Heaven, energetic measures were taken to bring the matter before the Prime Minister, a reconsideration of the matter was demanded, and with the satisfactory result that Mr. Baldwin was able to appreciate the importance and urgency of lifting the ban. We may now justifiably expect to hear future broadcast debates conducted with more liveliness, more reality, and more real interest.

A little of the red-tape has been cut away. It is a good omen.

Our "Solodyne" Supplement

DOUBLE numbers of MODERN WIRELESS are only published, as a rule, four times a year; but when they are published there is usually a big demand, for the value offered in "M.W." for a modest 1s. 6d. is generally considered to be extraordinarily generous. If you doubt this, have a look at other shilling magazines—and also at any "double numbers."

A "double number" has one great advantage: it enables the Editor to give his readers more varied contents and articles at greater length and in greater detail in connection with special subjects which have been proved worthy of special consideration.

This month's double number, for example, with the consequent increase in editorial space available, makes it possible to publish a twenty-page special supplement devoted to that king of sets—the "Solodyne."

Ever since 1926 the Solodyne has been tremendously popular—and with good reason, too. The first of modern sets successfully to employ one-knob tuning control, it still, in its 1928 guise, maintains the premier position among multi-valve receivers.

And our "Solodyne" Supplement should make a special appeal to all those who have built a "Solodyne"—whether it be the 1926 or the 1928 model—and to all those who want a 3-valve set based on the "Solodyne" principle and costing, all told, a very reasonable sum of money.

In fact, this issue is a tribute to the "Solodyne."

"MAINS DRIVE" RECEIVERS

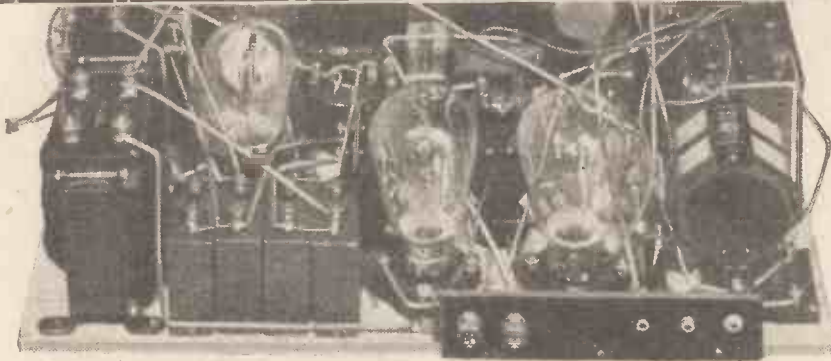

At very small current expenditures the electric supply mains can be made to do much useful work for the radio amateur quite additionally to such things as battery charging.

By D. GLOVER.

At present the complete elimination of batteries from a radio receiving outfit imposes definite limitations. This is more serious where the mains supply available is D.C. The great advantage of an A.C. supply is that voltages can be juggled about more or less as desired, whereas D.C. is comparatively difficult to deal with; one has a certain voltage above which one cannot go without complications. To break down voltages one has wastefully to employ resistances.

With the operation of a valve filament the primary consideration is current and not voltage, and we find that when it is desired to operate a receiver on D.C. mains it is not practical to employ a current greater than about 1 ampere. This means that the filaments of the valves of a multi-valve set have to be wired in series. With skilful design satisfactory receivers on these lines can be built, but there are circuit and other restrictions which would dismay the amateur desirous of building on these lines a modern and powerful five-valve set.

H.T. Mains Units

The introduction of valves having indirectly-heated cathodes has partially solved the problem in the case of the A.C. supply, but the range of indirectly-heated cathode valves is not comprehensive and does not, for instance, include a screened-grid variety. H.T. from the mains is perfectly satisfactory with either A.C. or D.C., using any type of receiver—that is, providing the apparatus employed is suitable and is efficiently arranged.

Taking everything into considera-

tion, it seems that we must become reconciled to the use of at least one battery, that is, the accumulator for heating the valve filaments. Additionally, there is, of course, the grid-bias battery, but this is an item that causes but little concern.

Five good valves can be operated in these economical days at an expenditure of but .5 of an ampere. This means that a small accumulator can be used. H.T. may, however, run up to 200 volts and 20 or 30 milliamps. A huge and expensive battery is needed to supply this, but 200 volts and 20 or 30 milliamps is a very small drain on electric supply mains. It is only a proportion of the consumption of a single electric lamp.

Moving Coil Loudspeakers

Progressing upwards in loudspeakers, we eventually come to the moving-coil type. This is the goal of all true enthusiasts, for there is no other type in common use which can approach it for complete faithfulness in reproduction. The majority of moving-coil loud speakers require

current for electro-magnet actuating purposes. This current makes but a slight additional drain on supply mains. Again, it is merely a matter of milliamps, and these show absolutely negligible reflections in quarterly electric light or power bills.

And, having exhausted all the possibilities of present-day radio reception, one inevitably turns to the gramophone. Not to the gramophone as a separate instrument, but to this machine as coupled with the radio receiver, and really remarkable results can be obtained in this manner.

But, in my opinion, there is one thing wrong with the average gramophone. I refer to the mechanical portion of its construction. The winding up of the clockwork motor is a tedious operation, and incongruous when the instrument is lined up against the completely electrical radio receiver.

But, again, the mains can be utilised. However ancient a gramophone may be, it can be made ultra-modern by taking out the clockwork motor and in its place fixing an electric drive.

A Useful Device

It is not very expensive equipment. For instance, the General Electric Company supply an electric turntable suitable for all voltages at six guineas. The little universal motor runs silently and smoothly, and has an impeccable speed control. Then, if one fits to the pick-up a "Tungstyle" needle which can be used forty or fifty times without replacement, all the tedium is taken out of the gramophone side of the combination.

But I fear I am transgressing somewhat on Mr. K. D. Rogers' ground, who, I believe, will have something further and fuller to say in regard to electrically-driven and operated gramophones in future issues of MODERN WIRELESS.

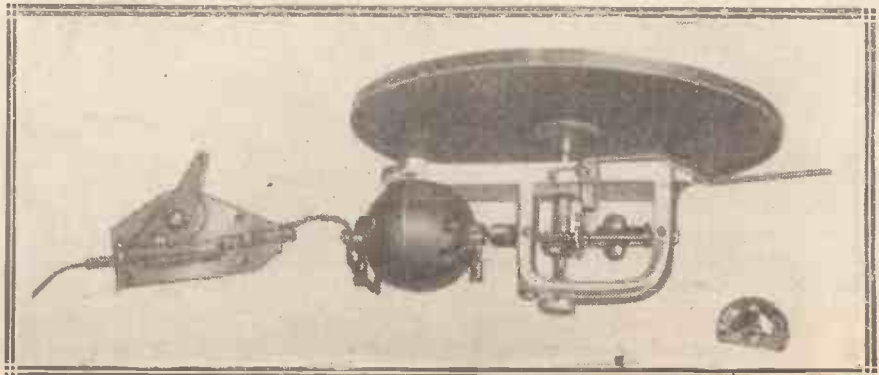

This is the electric gramophone turntable equipment manufactured by the G.E.C. people. On the left can be seen the automatic switch.



What a contrast! The beautiful old cathedral, unchanged through the centuries—and that most modern miracle, the microphone. Yet the glory of one can be conveyed by the other, as this interesting article explains.

By L. W. A. BAILEY.

THE broadcast from York Minster last New Year's Eve—one of the biggest outside broadcasts ever undertaken by the B.B.C.—was such a success that we are likely to see York Minster and other cathedrals in the programmes more often in the future. When the wiring was done in the Minster it was done as a permanency.

Well Hidden Wiring.

The method adopted was extremely interesting. Sixteen hundred yards of double lead-covered cable was used to link up the nine microphone positions with the little room near the organ which the B.B.C. uses as a control room. The Post Office engineers were responsible and ex-



B.B.C. engineers installing a microphone in Canterbury Cathedral.

tremely well and neatly they did it. It needs a very close scrutiny of York Minster to reveal that it is ready "wired for wireless."

There are two Post Office lines from Leeds to York Minster. One is for carrying the music and speech, and is known as the "music" line; the other is the "control" line. The lines terminate at a double-throw switch, so that should the "music" line become noisy the instant throw of the switch would reverse them, sending the "stuff" along the control line.

The Amplifiers Used.

From this switch, of course, the "music" line is connected to the output of the amplifiers; the "control" line to a telephone. The amplifiers are brought and taken away on the occasion of every broadcast; on the last occasion six stages of resistance-capacity-coupled amplification were used

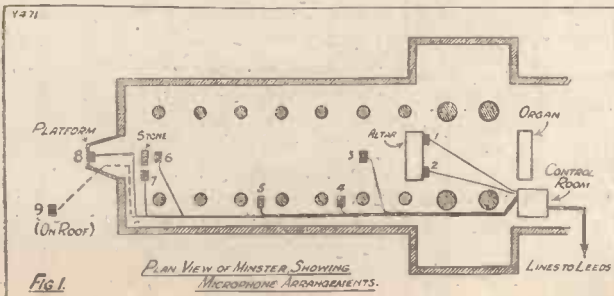

As the above plan view shows, nine microphones were used in the York Minster broadcast. The service commemorated the completion of the thirteen-hundredth year of the Minster.

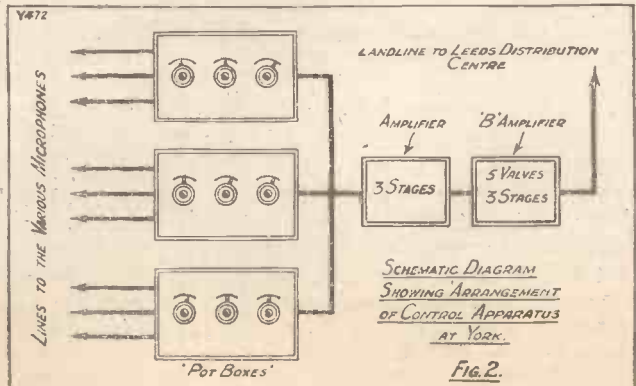

It is improbable that exactly the same arrangement of microphones will be utilised again, as the service on New Year's Eve was something more than an ordinary Watch Night Service. It was also a commemoration of the completion of the thirteen-hundredth year of the Minster, and the ceremonial was carried from one end of the Minster to the other.

Because of this, and owing to the echoes for which the Minster is notorious, an unusually large number of microphones were used. Only once before, in fact, had so many as nine microphones been used at once in this country for one broadcast—on the occasion of the unveiling of the Edinburgh War Memorial last July.

1,300 years of the Minster, tapping it thirteen times. Microphone 6, on the floor, was merely to pick up the taps. Microphone 7 picked up the speech during this part of the service.

Not Enough "Mikes"?

The Archbishop then passed through the Great West Doors on to a specially erected platform outside and addressed the public. Microphone 8 served this part of the ceremony. Microphone 9 was placed on the roof and picked up the bells—one of the most successful and impressive features of the broadcast.

For an ordinary service, such as will be broadcast in the future, microphones 6, 7 and 8, and pos-

and the Dean were within a few yards of each other each had his own microphone. Thus it was possible to pick up the voice without an undue proportion of echo and other unwanted noise. Had one microphone been used for both of them it would have been farther away from both of them, and the proportion of echo picked up would have been greater.

Each microphone is connected to a potentiometer control by means of which it can be operated at any sensitivity, from "nil" to "full out." Three of these controls are mounted in a "pot. box," so that on the last occasion, when there were nine microphones, three "pot. boxes" were in use. The arrangement of the control apparatus is shown in Fig. 2.



York Minster—one of England's best examples of architectural grandeur.

The arrangement of the microphones is shown in Fig. 1. Microphones 1 and 2 were behind the altar, and were for the Archbishop and the Dean respectively. Microphone 3 was slung above the congregation. Microphones 4 and 5 picked up the singing of a procession which passed down the Minster from the Altar to the West Doors. Here the Archbishop laid in the floor a stone commemorating the

sibly either 4 or 5, will not be required, but the wiring is there. I maintain, however, that the B.B.C. did not use enough microphones, and on future occasions another one should be placed near the organ.

As I have already stated briefly, one of the reasons for the use of so many microphones was echo. Microphones 1 and 2 provide a good instance. Although the Archbishop

Duplicated Apparatus

The outputs of the "pot. boxes" are connected together and go to the input of the first amplifier.

Spare amplifiers are provided and all the batteries are duplicated. The "spares" are all wired up so that any one can be brought into action by throwing over a switch. Good, silent functioning of the batteries is absolutely essential for outside broadcasts.

York's bells are in two towers. The famous Big Peter is in the north-west tower and the other bells are in the south-west corner. Before the last broadcast various positions outside the Minster were tested, but they were unsuitable.

On the dark night when I inspected the apparatus, the O.B. engineers (who have many such adventures) went out on the roof with a storm lantern and a microphone. It was pitch dark, it was cold, and there was frozen snow on the roof. But they found an excellent position for that microphone—and left it there.

Extraordinarily Deep Tone

This brings me to an interesting point. During future broadcasts from York Minster, listeners should listen very attentively to the ringing of Big Peter. This bell has an extraordinarily deep tone, and is yet very sweet and clear. It was recently recast and the ringer says it is the lowest-toned bell in the world now.

However that may be, it is certainly so low that many loud speakers will trip up on it. So if, next time Big Peter is broadcast, he sounds to you like the beating of a tin can, do not blame the B.B.C. or Big Peter himself—examine that loud speaker!



The M.W. "STATION-GETTER"

A DETECTOR valve with reaction if followed by one or two stages of L.F. will achieve wonders in the way of distant reception, provided the reaction control is used intelligently, but the results cannot be compared with those obtainable with the aid of a good H.F. valve. Sooner or later the listener begins to feel the need for something that will bring in the distant stations without his having to push reaction up to the limit—a point where, in all probability, the signals will be so badly distorted as to be scarcely worth listening to.

He is faced with two alternatives, either to scrap his existing set and to utilise the parts for the construction of a more sensitive receiver, or to build a separate unit. The latter is

This is a thoroughly reliable H.F. unit which, using one valve, can be attached to practically any set in order to increase its range of reception. Details concerning the use of this unit with the "Master Three," "Melody Maker" and "R.C. Threesome" are given.

By A. Johnson-Randall

obviously more economical, and, moreover, has the advantage of leaving the existing set intact, so that it can be used by itself for the reception of the local broadcasting if necessary.

The "M.W." Station-Getter" is an H.F. unit which can be used in conjunction with any set employing not more than one high-frequency valve. It is particularly suitable for use with receivers of the detector and L.F. type and can be attached to the Cossor "Melody Maker," Mullard "Master Three," and the "R.C. Threesome."

Easily Stabilised

Not only will it increase the range very considerably—selectivity will also be much improved and reaction can be employed without fear of interfering with one's neighbours. The circuit chosen is of a type that can be easily stabilised, and in addition it will work well with 2-, 4-, or 6-volt valves, although it is just as well to point out that the 6-volt class is preferable.

Practically any degree of selectivity can be obtained by varying the size of the aerial coil. A filament resistance is inserted in the positive

filament lead, and is a very valuable method of controlling the volume of the nearer stations.

The construction of the unit is a very simple matter. As will be seen from the photographs there are only two components to be mounted on the panel. Looking at the front of the panel the dial on the left controls the aerial circuit tuning condenser.

Constructional Details

The other small knob is the H.F. valve filament resistance, that chosen having an "off" position, so that it can be used as an on-off switch in order that the valve filament may be turned out when the unit is not in use. The panel is secured to the baseboard by means of one small aluminium bracket, the weight of

LIST OF COMPONENTS

- 1 Ebonite panel, 12 in. x 7 in. x 1/8 in.
- 1 Cabinet to suit.
- 1 Baseboard, 12 in. x 6 1/2 in.
- 1 Angle bracket (Magnum).
- 1 Filament resistance, 25-30 ohms.
- 1 .0005 variable condenser (Brandes).
- 1 Neutralising condenser (Peto-Scott, Jackson Bros., etc.).
- 1 Valve holder (Benjamin, or any good make).
- 2 Baseboard-mounting coil sockets (L. & P.).
- 1 H.F. choke (McMichael, Magnum, R.I.-Varley, etc.).
- 1 .001 fixed condenser (Dubilier).
- 6 Terminals.
- 1 Centre-tapped 60 coil and 1 centre-tapped 200 coil (Leweos).
- 1 100,000-ohm anode resistance and holder (Dubilier, Mullard, R.I.-Varley) (See note elsewhere).

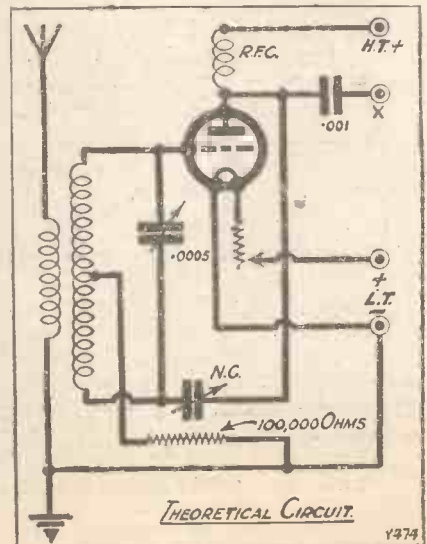

the baseboard not being sufficient to necessitate the use of an angle-bracket at each end.

Two main holes are therefore required, one for the condenser and the other for the filament rheostat. If a Brandes variable condenser is used a $\frac{7}{16}$ th hole will be necessary, and for the rheostat a $\frac{3}{8}$ th hole will suffice. In addition, there are four small holes. Three of these are $\frac{3}{16}$ ths of an inch up from the bottom edge of the panel, and serve to hold the panel against the baseboard. The remaining hole is for the angle-bracket screw.

Baseboard Components

Now let us look at the components on the baseboard. Starting from the aerial end you will see that there are two coil sockets mounted parallel with each other. These coil sockets are placed $\frac{5}{8}$ in. apart, but it is advisable to space them out, with the coils you intend using in position.

The sockets should be arranged so that the two coils practically touch one another. In addition, there must be clearance between the centre-tap socket on the secondary coil and the variable condenser, otherwise you will not be able to remove the small centre-tap connection when changing over to the Daventry size coil.

Place the valve holder so as to allow plenty of clearance between

the coils and the valve itself, when it is inserted in the holder. Now we come to the terminal strips, one of these is a piece of ebonite 4 in. long

tinned-copper wire has been used throughout, but those constructors who would rather employ one of the insulated wires, such as Glazite, may

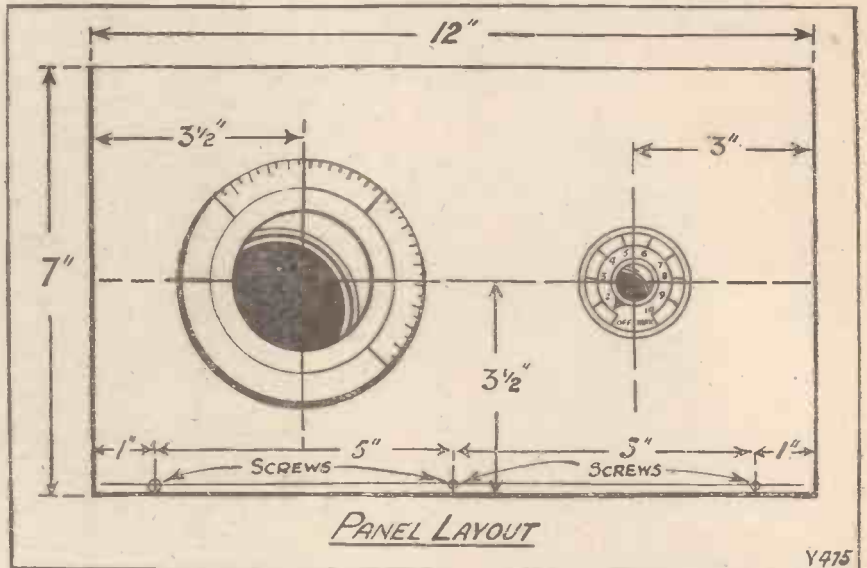

by $1\frac{1}{2}$ in. high, and has four terminals which are spaced 1 in. apart. The other is a similar piece of ebonite 2 in. long by $1\frac{1}{2}$ in. high, and is drilled to take the aerial and earth terminals, which are also spaced 1 in. apart. These two strips are simply secured to the edge of the baseboard at distances of about $\frac{3}{4}$ in. from each end.

Now for the wiring. In this particular unit, No. 16 gauge round

do so if they wish to be on the safe side. Tinned-copper wire, however, is very easy to handle, and is perfectly safe to use provided it is carefully spaced.

Connecting Up

Having completed the wiring you will be wanting to try the unit in conjunction with your existing set. The procedure is as follows: For the ordinary broadcast band place a No. 25 or 35 coil in the aerial socket, and a No. 60 centre-tapped in the secondary socket. Use one of the special H.F. type valves such as the Cossor 610 H.F., Mullard P.M.5X, Marconi or Osram D.E.L.610, or any valve in the 2- or 4-volt classes having equivalent characteristics.

Connect the aerial lead to terminal A on the unit and the earth lead to terminal E. Join two leads for L.T. plus and minus to the existing L.T. terminals on the set, or direct to the L.T. battery. Plug H.T. plus on the unit into the 80-volt tapping on your H.T. battery. Join terminal X to the aerial terminal on your set. The unit is then ready for use. If your set employs a plain aerial circuit consisting of a No. 35 or 40 plug-in coil, you will have to insert a No. 60, since this "aerial" circuit now becomes the H.F. circuit.

No Alterations

If your receiver is one of the type which incorporates a centre-tapped or "aperiodic" aerial coil there will be no need for any alterations, terminal X on the unit simply being joined to

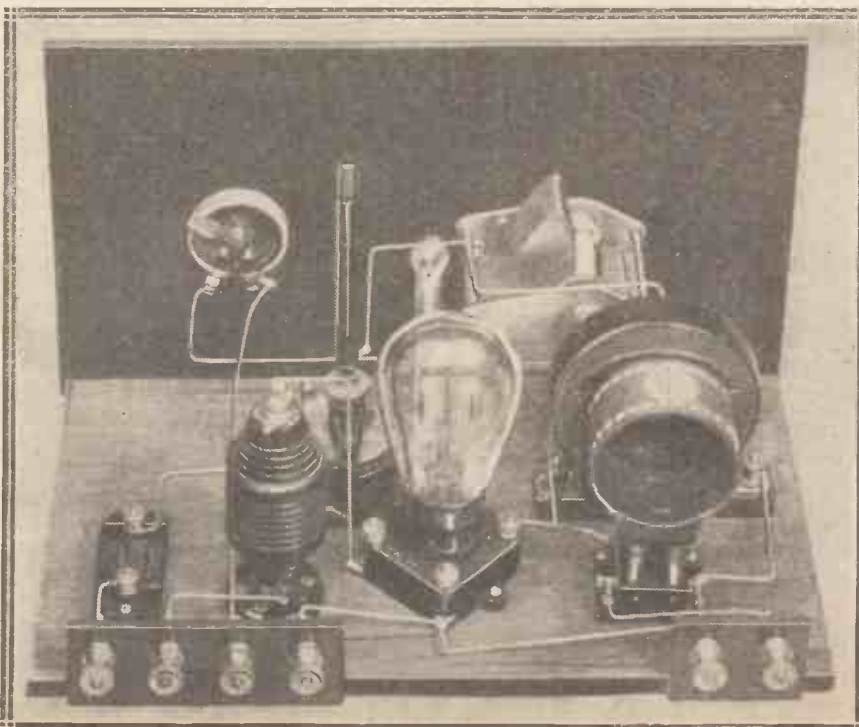

Although ample baseboard space is allowed in order to achieve the highest efficiency, as will be seen the unit is a moderately compact design.

the aerial terminal on the set or direct to the centre-tapping on the coil.

Neutralising

Now try to tune in your local station in the usual manner. It is quite probable that directly the aerial and H.F. circuit are brought into tune the H.F. valve will tend to oscillate. The procedure then is to find the correct setting on the neutralising condenser which will enable stability to be obtained over the whole wave-band covered by the particular centre-tapped secondary coil in use.

There are two methods of neutralising. The first is called the silent point method. This scheme can only be employed successfully in cases where the unit is being used within distances up to about ten to fifteen miles from a main broadcasting station.

The First Method

The procedure is to turn out the H.F. valve by means of the filament rheostat and to endeavour to tune in signals with the moving vanes of the neutralising condenser out of mesh. The moving vanes are then rotated until a minimum point is obtained, that is to say, the signals either fade out completely or become very nearly inaudible. Any movement of the neutralising condenser beyond this position will bring the signals back again. When you have found this point you can switch on the H.F. valve and the set is then ready for use.

The second method of neutralising is often called the "reaction demand" scheme, and is carried out as follows: Set the reaction-control condenser

or moving, according to the particular set).

You will probably find that the set will only oscillate under the above



The "Station-Getter" constitutes a complete H.F. amplifier which can in a few seconds be hooked on to any set in order to bring in dozens of distant broadcasters.

or swinging coil, as the case may be, at minimum, and likewise the neutralising condenser. Now, on setting the tuning condensers so that the two tuned circuits are in step with each other it will probably be found that the set is oscillating. To test for oscillation touch one or other of the sets of plates of the tuning condensers (this may be either the fixed

conditions when the two circuits are in tune with each other, and this can be used as an indication. It is convenient to perform the operation at some point near the middle of the tuning range. Now, increase the capacity of the neutralising condenser. (In the case of such condensers as the Gambrell "Neutrovernia" this means screwing downwards.)

The Reaction Method

Test at intervals for oscillation as this is done, and you will presently find that the set has ceased to oscillate, and will not recommence even when the tuning dials are slightly readjusted. Now increase the reaction a little, until the set once more oscillates, and again increase the neutralising condenser setting until oscillation ceases. Slightly readjust the tuning condensers again to make sure that the set is completely stable once more. Proceed in this way until it is found that the correct adjustment of the neutrodyne condenser has been over-shot. Once this point has been passed it will be observed that further increases of the neutrodyne condenser setting no longer stop oscillation but cause it to become stronger.

The object is to find such an adjustment of the neutralising condenser as will permit the greatest setting of the reaction condenser to be used without producing oscillation. It will then be observed that when

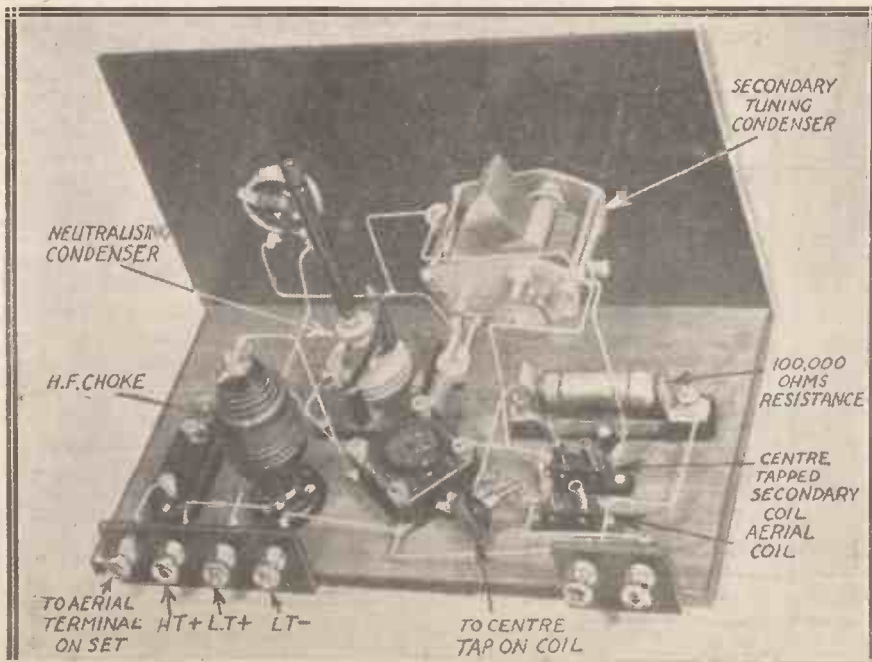

If you compare this descriptive photograph with the wiring diagram which appears on the next page, you will appreciate the effective simplicity of the arrangement of the components. You can build this unit with every confidence, as the Research Dept. submitted it to searching tests before passing it for publication.

the two tuned circuits are in step and the set is brought to the verge of oscillation a slight movement in either direction of the neutrodyne condenser will cause the receiver to break into oscillation.

For reception of the longer waves, such as 5 X X, you will need a No. 100 coil in the aerial socket of the unit and a centre-tapped 200 in the secondary socket. If the set to which the unit is attached employs plain aerial tuning use a No. 250 coil in the aerial socket of the set. On the other hand, if a tapped aerial or "aperiodic" coil is being used in the existing receiver it will only be necessary to change over to the usual sizes employed for the reception of the Daventry long-wave station.

Popular Circuits

The unit is joined up to the Cossor "Melody Maker" as follows: Join X on the unit to terminal A₁ on the "Melody Maker," or alternatively to the terminal on condenser C₁, which

is connected to C₂ by lead No. 32, on the "Melody Maker" diagram. The aerial and earth leads go direct to their respective terminals on the unit;

WIRING INSTRUCTIONS.

Join aerial terminal to pin of aerial coil holder. Join earth terminal to socket of aerial coil holder, to L.T.- terminal on valve holder, and to one side of 100,000-ohm resistance.

Join L.T.- terminal to side of valve holder which is joined to earth.

Join L.T.+ to one side of filament resistance, other side of filament resistance to remaining filament socket of valve holder.

Anode of valve holder to fixed plates of neutralising condenser, to H.F. choke, and to one side of .001 condenser.

Other side of H.F. choke to H.T.+ terminal.

Other side of .001 condenser to X terminal.

Moving vanes of neutralising condenser to moving vanes of .0005 variable condenser and to socket of secondary coil holder.

Pin of secondary coil holder to grid of valve holder, and to fixed vanes of variable condenser.

Flexible wire for centre tap to remaining side of 100,000-ohm resistance. (See note.)

E on the "Melody Maker" being left blank.

In the case of the Mullard "Master

Three" greater care should be taken, since L.T. + in this receiver is joined to earth. Referring to the "Master Three" plan of assembly, No. 302, X on the unit is joined to A on the set. Terminal E on the "Master Three," is left unconnected. The aerial and earth leads are joined direct to their respective terminals on the unit.

The connections for the Ediswan "R.C. Threesome" are: Terminal X on the unit to AE on set. The aerial and earth leads go to respective terminals on unit.

Tapped Coils

It may be necessary to use a size larger coil in the aerial coil holder of the "Threesome." Suitable sizes would be a No. 60 for the B.B.C. band and No. 250 for 5 X X.

With sets employing tapped aerial coils it is possible that louder signals will be obtained if terminal X is connected direct to the grid end of the aerial winding instead of to the tapping. This may be tried with the "Melody Maker" and "Master Three."

An Important Point

The 100,000-ohm resistance used in this unit is employed to prevent parasitic oscillations which may occur in certain cases. With many circuits to which the unit will be attached there is no danger of these parasitic oscillations occurring. It is impossible to say whether a particular arrangement will produce these unwanted oscillations without trying it, and in consequence the resistance has been inserted for safety.

The unit should therefore be tried with the resistance in circuit as shown, and also with the flex lead (to which is attached the centre-tap plug) joined to the other terminal of the 100,000-ohm resistance holder, thus cutting the resistance out of circuit. This is equivalent to joining the centre-tapping direct to E and L.T.-, and frequently results in much greater sensitiveness. Therefore try both schemes in order to see which gives the best results with your particular circuit.

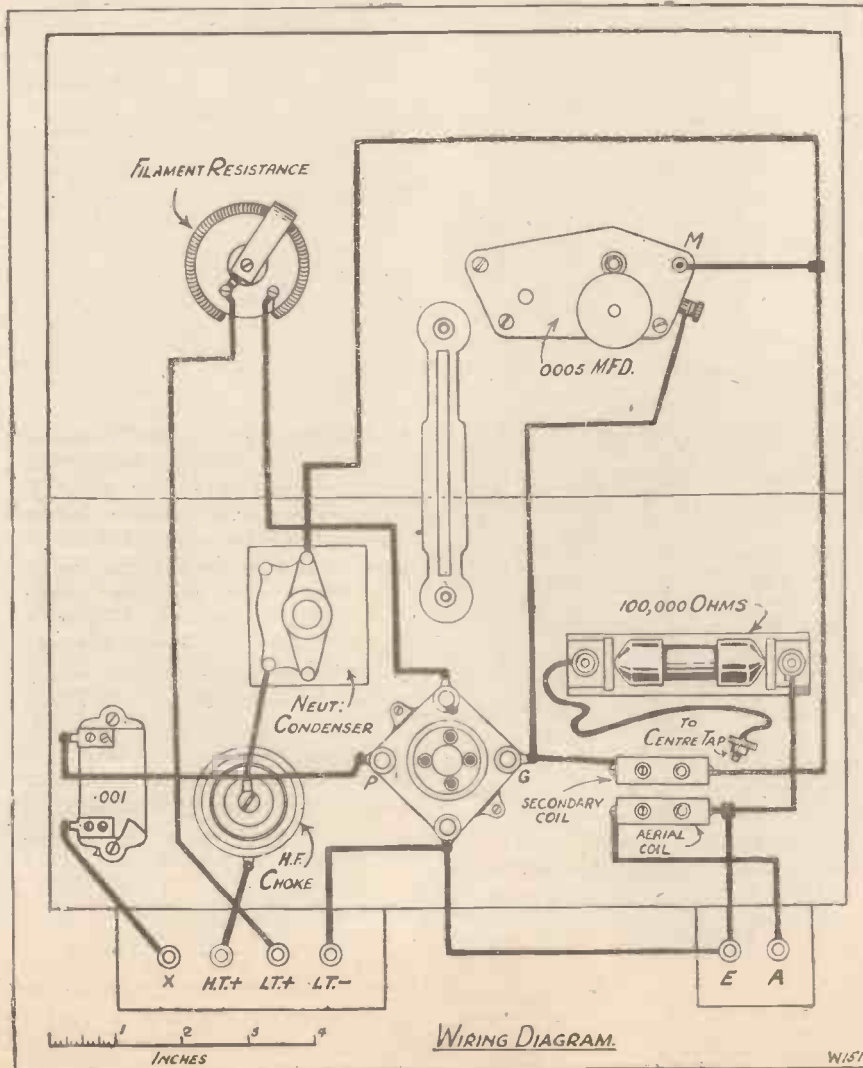

"POPULAR WIRELESS"

Britain's Brightest and Best Radio Weekly.

P.W. is the journal which made Wireless Popular.

Price 3d. Every Thursday.

The PERFECT LOUD SPEAKER

There is not an instrument of this kind available any more than there is a perfect version of anything. But scientists are striving to approach the ideal and are meeting with great success.



By **SEXTON O'CONNOR.**

AFTER a received signal has been passed through the wireless set and duly rectified and amplified, the resulting current is applied to the loud speaker, which converts it into sound waves or mechanical movements of the air.

This change or conversion usually takes place in two stages. In the first place, the electric current from the set is converted into a magnetic field by being passed around a magnet. And in the second place the magnetic field vibrates a metal diaphragm and so sets the air into motion.

Increasing the Volume of Sound

The modern form of loud speaker has, of course, been gradually developed from the original telephone receiver, which acts in exactly the same manner so far as the conversion from electric into mechanical or sound energy is concerned.

In order to increase the volume of the sound so produced, some makers have adopted the plan of adding a horn or resonating chamber, whilst others have increased the size of the vibrating diaphragm, thus producing the two principal types of speaker in common use to-day.

In both cases the object aimed at is to set as large a volume of air as possible into motion. In the first type of speaker the sound wave is built up or concentrated inside the horn, before being finally liberated; whilst in the second, the surrounding air is directly agitated by as large a vibrating surface as possible.

Horn versus Cone

Whilst there is still a considerable difference of opinion as to the relative merits of the horn and cone speaker, the latter is undoubtedly gaining in

popular favour. Provided sufficient energy is applied to it, the cone speaker is certainly capable of reproducing the low rich notes, say of an organ or 'cello or a contralto voice, more faithfully than the horned instrument.

At the same time it must be admitted that where there is not much margin of power, a good horn speaker gives a more satisfactory all-round performance than a cone.

However this may be, it must be assumed that the up-to-date listener has ample power at his disposal, and for this reason prefers the superior capabilities of the cone to the limited response of the older type of speaker.

The inherent qualities of the cone are, as previously stated, due to the fact that a large vibrating surface

acts directly upon the surrounding air. It is obvious at first sight that this must entail a considerable input of power.

The Rice-Kellogg Speaker

This necessity has in turn led to the development of the electro-dynamic type of speaker, of which the Rice-Kellogg instrument is one of the best-known models.

In the Rice-Kellogg speaker a strong magnetic field is first created by means of a continuous current drawn either from a special accumulator or a mains eliminator, and the output from the wireless set is passed through a series of small coils of wire which normally "float" in a narrow cylindrical gap between the poles of the magnet.



Three loud speakers of very unconventional patterns. Their purposes are completely disguised, and they make ornamental additions to any drawing-room. They embody special acoustic designs which, it is claimed, give very natural reproduction.

When the current through the coils is varied, an intense reaction is set up between the magnetic field and the current-carrying coils, causing the latter to vibrate violently. The resulting movements are then applied to a diaphragm, which is fitted with a suitable baffle-plate in order to augment the sound.

Advantages of Moving Coil

The excellent tonal qualities of this speaker are largely due to the freer movement of the floating coil, as compared with the restricted vibrations possible with the ordinary fixed reed or plate clamped close to the magnet poles.

This, of course, allows a larger amplitude of movement to be imparted to the diaphragm, and so produces a purer and more powerful response, particularly in the bass portion of the scale.

The improved performance is also due in part to the increased amount of power applied to the vibrating system which, in turn, is derived from the extra energy supplied by the "field" accumulator.

The Defects of the Diaphragm

In all the methods so far mentioned there is a fundamental weakness which can be traced to the action of the diaphragm. It must be borne in mind that the electric current does not act directly upon the air, but is first made to vibrate the diaphragm, which then communicates its movements to the air.

Now, if the diaphragm were a perfectly elastic body, so that it responded truly and faithfully to every shade of variation in the applied current, all would be well, and perfect reproduction would be ensured.

Unfortunately any solid or material diaphragm must have mass and elasticity, and these two factors give it a natural tendency to respond to

the natural or inherent frequencies occur they are over-emphasised, relatively to the others, and the reproduction becomes tinny, or gruff, or woolly, as the case may be, or else tends to boom or blast on certain notes.

In the horn type of speaker the vibrating diaphragm is of relatively small size, and is accordingly unable to do full justice to the bass tones, where a low vibration period is necessary.

Fixed and Free Edges

The diaphragm is usually clamped around its edges and is impulsed from the centre where the magnet poles are located. The actual move-



This is a Rice-Kellogg loud speaker made by the B.T.H. people, who handle the patents in this country. It is a rather expensive instrument, but is probably the closest approach to the Perfect Loud Speaker yet produced. So proudful of this production are the makers that they will not sell the speaker without its specially designed low-frequency amplifier.

ments under the varying attraction of the magnet partake partly of the nature of a to-and-fro or piston motion, and partly of a bending or flexing movement from the clamped edges.

In some cone speakers the edge of the large or outer diaphragm are firmly clamped to a metal supporting ring, and the centre or conical point is directly connected to a small metal plate or reed, which in turn is vibrated by the driving magnets in the same way as in the horned instrument.

The addition of the large cone, however, increases the capacity of the system to vibrate slowly and thus do full justice to the bass notes. The high-pitched characteristic of the

"Whilst there is still a considerable difference of opinion as to the merits of the horn and cone speaker, the latter is undoubtedly gaining in popular favour."

horn is accordingly replaced by a deeper and better balanced response, particularly at the lower end of the scale.

In other large diaphragm models the edges of the cone or disc may be left entirely free, or else are held only by elastic supports. In such cases the actual motion of the diaphragm is mainly similar to that of a piston, though this will be combined with more or less flexure, according to the degree to which the edges are fixed or left free to move bodily.

In practice the two motions interfere, so that at any given moment some parts of the diaphragm are moving in one direction, say, outwards, and some in the opposite direction, whilst there are intermediate spots or zones which remain stationary. All this tends to prevent a perfect reproduction of the original sounds.

Special Substitutes

In short, wherever a diaphragm is used it is practically impossible to eliminate all tendency for the moving parts to have certain natural periods of vibration. These impose their effect upon the original impulses from the electric current, and so introduce a greater or less degree of distortion.

Attempts have previously been made to utilise special types of mechanically vibrating bodies in the effort to find a perfectly elastic substance free from such limitations. For instance, one of the first practical applications of the piezo-electric effect of quartz and other crystals was to the conversion of electric currents into sound waves.

For the same reason a suggestion has been made to utilise magnetostrictive action—or the peculiar property of certain magnetic bodies which causes them to change their volume or vibrate mechanically under the impulse of an applied current.

(Continued on page 471)

"The modern form of loud speaker has been gradually developed from the original telephone receiver, which acts in exactly the same manner so far as the conversion from electric into mechanical or sound energy is concerned."

certain frequencies more favourably than to others. Consequently the reproduction is not constant throughout the whole musical scale. When

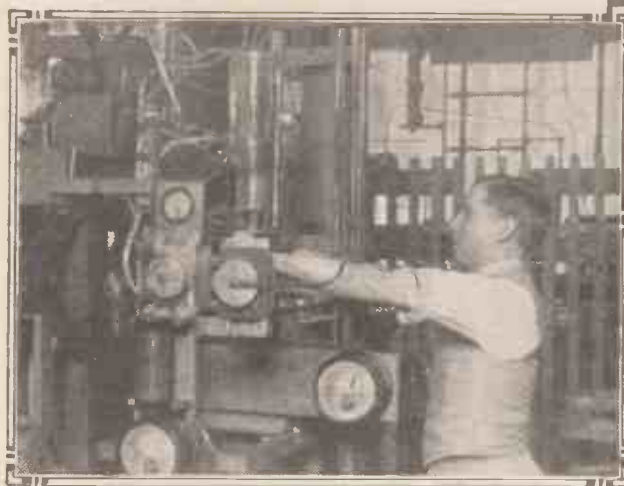

The Dual Nature of Electrons

Recent experiments carried out by Prof. Davisson and Dr. Germer throw an entirely new light on electrons and their activities.

By GAUTIER HAMECON.

UNTIL Professor Davisson commenced his investigation, it could be said, with more or less accuracy, that all the experimental facts about the electron could be explained by regarding it as a particle of negative electricity. But the experiments, of which Professor Davisson has now supplied us with ample details, demonstrate that a "wave-length" is connected with the electron's behaviour.

Bombarded by Beam

The investigation had its inception in a simple but significant observation. In the course of his research work in the Bell Telephone Laboratories, Professor Davisson observed, some time in the year 1919, that when a beam of electrons is directed against a metal target, electrons having the same speed as those in the incident beam stream out in all directions from the bombarded area.

It seemed at the time that these could be no other than particular electrons from the incident beam that had suffered large deflections in simple elastic encounters with single atoms of the target. The mechanism of scattering, as Professor Davisson and Dr. Germer pictured it, was similar to that of alpha ray scattering.

Deflected Electrons

There was a certain probability that an incident electron would be caught in the field of an atom, turned through a large angle, and sent on its way without loss of energy. If this were the mechanism of electron scattering, it would be possible, they thought, to deduce from a statistical study of the deflections some information in regard to the field of the deflecting atom.

The unusual interest that attaches to these experiments is due to their revealing the phenomenon of electron scattering in a new role. Electron scattering is not, it would seem, the mildly interesting matter of flying particles and central fields that was supposed, but is instead a much more interesting phenomenon in which electrons exhibit the properties of waves.

The experiments reveal that the way in which electrons are scattered by a crystal is very similar to the way in which X-rays are scattered by a crystal. The analogy is not so much with the alpha ray experiments of Sir Ernest Rutherford as with the

X-ray diffraction experiments of Professor von Laue.

The Crystal Lattice

In the original Laue experiment a beam of X-rays was directed against a crystal of zincblende; about the transmitted beam was found an array of regularly disposed subsidiary beams proceeding outward from the irradiated portion of the crystal, and these subsidiary beams could be interpreted completely and precisely in terms of the then already popular wave theory of X-radiation. They could, indeed, be explained as diffraction beams that resulted from the superposition of secondary wave-



Professor C. J. Davisson and Dr. L. H. Germer, the two scientists responsible for the experiments described in this article. They have established the theory that electrons have a dual nature.

trains expanding from the regularly arranged atoms of the crystal lattice.

There are two features of the Laue experiment which must be remembered. The first is that diffraction beams issue not only from the far side of the crystal along with the transmitted beam, but also from the near or incidence side of the crystal; these latter being disposed in a regular array about the incident beam.

The second is that each diffraction beam is characterised by a particular wave-length, and that a given beam appears in the diffraction pattern if the incident beam contains radiation of this characteristic wave-length, or of some submultiple value of this wave-length, but not otherwise.

Critical Speeds

If the incident beam is monochromatic, no diffraction beams appear at all unless the wave-length of the incident beam happens to coincide with a wave-length of one or more of the diffraction beams. In that case the favoured beams appear, but no others.

With this picture of X-ray scattering in mind one sees at once the significance of the main results of the Davisson experiments. A homogeneous beam of electrons is directed against a crystal of nickel, and at certain critical speeds of bombardment full-speed scattered electrons issue from the incidence side of the crystal in sharply defined beams—a few beams at each of the critical speeds—and the total of such beams makes up a regularly disposed array which

is similar to the array of Laue beams that would issue from the same side of the same crystal if the incident beam were a beam of X-rays.

A New Idea

The electron beams are not identical in disposition with the Laue beams, and yet it is possible to treat them as diffraction beams, and from their position and from the geometry and scale of the crystal to calculate "wave-lengths" of the incident beam—just as we might do if we were dealing with X-rays or with any other wave radiation. When this is done we arrive at a definite and simple relation between the speed of the electron beam and its apparent wave-length—the wave-length is inversely proportional to the speed.

Surprising as it is to find a beam of electrons exhibiting thus the properties of a beam of waves, the phenomenon is less surprising to-day than it would have been a few years ago. We have been prepared, to a certain extent, by recent developments in the theory of mechanics for surprises of just this sort—for the discovery of circumstances in which particles exhibit the properties of waves.

We have witnessed, during the last three years, the inception and development of the idea that all mechanical phenomena are in some sense wave phenomena—that the rigorous solution of every problem in mechanics must concern itself with the propagation and interference of waves. The wave nature of mechanical phenomena is not ordinarily apparent, we are told, because the length of the waves involved is ordinarily small.

Wave-Mechanics

It is only in such small scale phenomena as the intimate reactions between atoms and electrons that the wave-lengths are comparable with the dimensions of the system. Here only are we to expect notable departures from classical mechanics, and here only are we to find evidence of a more comprehensive wave mechanics. (* See Footnote.)

The success of this new theory has been confined, up to the present time, to explanations of certain of the data of spectroscopy. In this field the theory has appealed very strongly because of the elegance of its methods and because of its remarkable facility in accounting for various of the

inhibitions with which the radiating atom is afflicted.

We have been prepared by these successes to view with not too great surprise—or alarm—evidence for the wave nature of phenomena involving freely moving electrons. And any reluctance we may feel in treating electron scattering as a wave pheno-

.....
 "Doubtless electrons have a dual nature—when they produce tracks in a C.T.R. Wilson cloud experiment they are particles, but when they are scattered by a crystal they are waves."

menon is apt to be dispelled when we find that the value calculated for the wave-length of the equivalent radiation is in acceptable agreement with that which L. de Broglie assigned to the waves which he associated with a freely moving particle—that is to say, the value h/mv (Planck's constant divided by the momentum of the particle).

There remains only the conceptual difficulty in which the Davisson experiments involve us. When Laue and his collaborators investigated the scattering of X-rays by crystals, the results of their observations were accepted at once as establishing the wave theory of X-rays.

X-Rays Too

It was a very simple matter for Bragg and others to give up the corpuscular theory because of the hypothetical nature of the X-ray corpuscle.

If the electron were not the well-authenticated particle we know it to be, it is possible that the Davisson experiments would cause it to vanish in like manner. No such event can however be anticipated. The electron as a particle is too well established to be discredited by a few experiments with a nickel crystal.

The most that Davisson and Germer claim is that there are circumstances in which it is more convenient to regard electrons as waves than as particles. Doubtless electrons have a dual nature—when they produce tracks in a C.T.R. Wilson cloud experiment they are particles, but when they are scattered by a crystal they are waves.

A quite similar situation exists, of course, in the case of X-rays which also exhibit a dual nature—when they give rise to diffraction patterns they are waves, but when they exhibit the Compton effect or cause the emission of electrons from atoms they are particles.



The apparatus used for the diffraction tests with a nickel crystal. When in use the instrument shown above is mounted in a glass bulb, in which an extremely high degree of vacuum is maintained.

* In 1925 Elasser predicted that evidence for the wave mechanics would be found in the interaction between a beam of electrons and a crystal (See *Naturwiss* 13,711, 1925).

"ONE-VALVERS"

A comprehensive and practical survey of all kinds of one-valve circuits, with theoretical and operating notes.

By L. H. THOMAS.



THE object of this article is to offer a few hints for the beginner on the initial construction of a single-valve set, and also to make a few comments on the troubles likely to be encountered, and the improvements that may be made after the first start.

The writer does not propose to enter into any technicalities, for they simply confuse the absolute beginner

.....
 "The very best working point of the set is that at which it is as near as possible to the point of oscillation without actually having reached it."

—he is better advised to wait for a while, and his practical experience, however small, will help him enormously to understand them.

Put into the simplest language, however, the principle of the valve

set is this—that the incoming signals cause the voltage imposed on the grid of the valve to vary, and this variation causes the *current* flowing in the plate circuit (and therefore through the telephones) to give corresponding variations, which cause the diaphragms of the telephones to move and give forth audible sound.

Directly Coupled Aerial

From this it is fairly clear that our object is to provide for as great a variation of the voltage on the grid of the valve as is possible, for this will, of course, give a greater variation in the anode current, which is the same thing as saying "louder signals." This voltage applied to the grid is provided for by the coil and condenser connected between the

grid and the filament, this circuit being tuned-in to the station being received in such a manner as to set up a difference in voltage (or "P.D.") between its two ends.

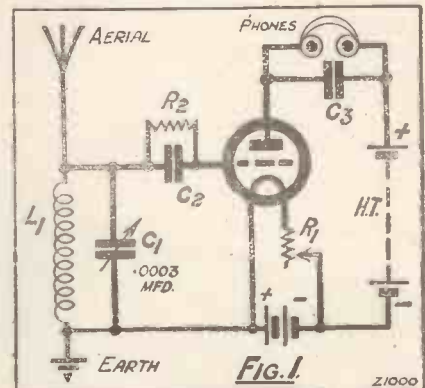

The aerial and earth are either coupled to this circuit by means of another coil, or connected directly across its two ends. This arrangement is shown in Fig. 1, which may be called a "direct-coupled circuit without reaction."

To avoid confusion, the functions of the grid condenser (C_2) and the grid leak (R_2) will not be gone into, but it will suffice to say that they form one method of making the valve *detect* signals, when it is working in quite a different manner from when it is used for amplifying signals.

"Overflows"

Consider the working of this circuit. The grid circuit (coil L_1 and condenser C_1) is receiving energy from the aerial and handing it on to the grid of the valve, and the valve, behaving as it should, is converting this energy into changes of the anode current, which are audible in the 'phones.

Now, if we insert another coil between the anode of the valve and the telephones, the rapidly varying

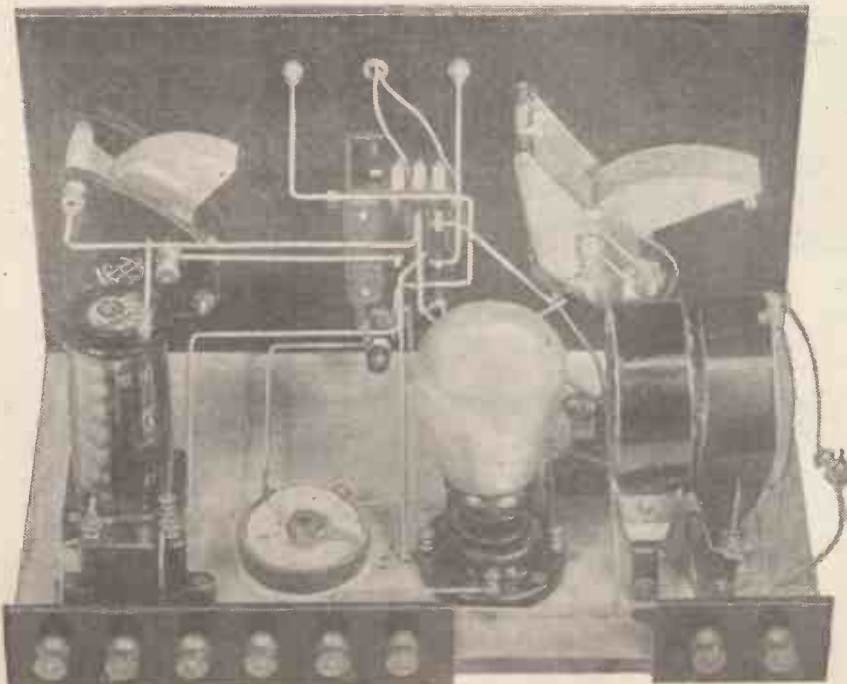

This one-valve receiver incorporates a switch which makes available two methods of reaction control, both, however, being adjustable by one of the variable condensers.

plate current will, of course, be passing through this, and if we put it back near the grid coil we can increase the energy picked up by this coil. Put in a very crude way, it may be said that this new coil behaves as another aerial and earth. The variations in grid voltage will now be greater, and

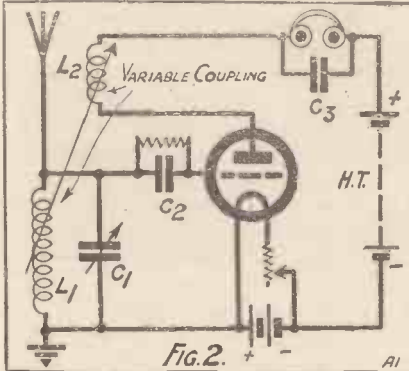

this will cause a still further increase in the variations of the anode current. This further increase will in its turn be handed back to the grid circuit, and the whole thing will go on building up to a higher and higher value until it "overflows." This "overflow" marks the state of oscillation, which occurs when the valve finds it im-

possible to handle any more energy. The extra coil is called the "reaction" coil, and a circuit with reaction is shown in Fig. 2.

Having touched on the process that is going on in a valve receiver, one or two more practical tips will be given. Referring back to Fig. 2, imagine that the reaction coil (L_2) is taken as far as possible from the grid coil. This is practically the same as removing it altogether. But bring the reaction coil slowly up towards the grid coil, and the volume will increase until that point of oscillation is reached.

Best Working Point

It is impossible to receive telephony with the set in this condition; also, it is causing serious interference to other listeners, for it has become a young transmitter instead of a receiver. The very best working point of the set is that at which it is as near as possible to the point of oscillation without actually having reached it. This is the point at which the set should always be worked.

Now, you will see that there is

one more adjustment to make than there was in the crystal set, or the single-valve without reaction, for in addition to the tuning of the grid circuit by the condenser C_1 we have the distance between the coils to control.

Obtaining Close Adjustments

Unfortunately it is not possible in the average set to place them so that it is "just not oscillating" and leave it there. If we do that we shall find on altering the setting of C_1 that at some points it may start oscillating, and at others it will go so far off from the oscillation point that it ceases to be sensitive. The two controls must therefore be worked together.

This is by no means a difficult business, but it has a "knack" which is not acquired in half an hour, but requires patience. The presence of oscillation, by the way, is heralded,

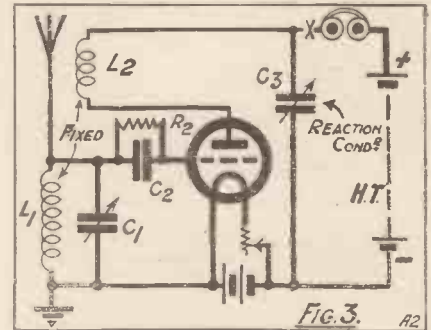

not by squeals, as many imagine, but by a gentle hissing noise which is soon recognised. Also, if the set will oscillate, gentle tapping of the aerial with the finger will produce loud double "plonks" in the 'phones, which are not present when the set ceases to oscillate.

Throttle Reaction Control

Although it is advisable to use this "swinging-coil" method of controlling reaction at first, it is by no means the only method, and one of the best, which is used in many sets to-day, may be called the "throttle-control" method. Fig. 3 shows a receiver rigged up on this principle, and it will be seen that the coupling between the two coils, instead of being variable, is now fixed.

Instead, however, of having a small fixed condenser across the telephones, we have connected a variable one; and instead of placing this just across the 'phones we have taken it across the H.T. battery as well.

One side is thus connected to the joint between the reaction coil and the telephones, and the other side goes to the negative end of the H.T. battery. Variation in the capacity

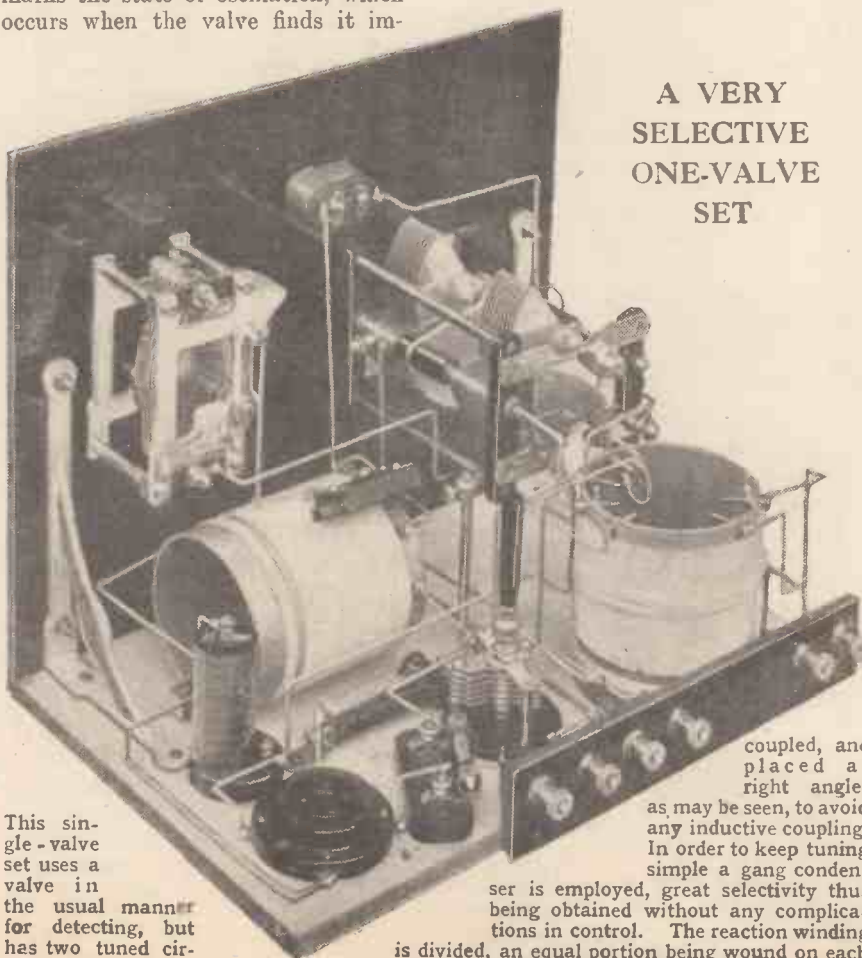

A VERY SELECTIVE ONE-VALVE SET

This single-valve set uses a valve in the usual manner for detecting, but has two tuned circuits. The two coils are capacitatively

coupled, and placed at right angles as may be seen, to avoid any inductive coupling. In order to keep tuning simple a gang condenser is employed, great selectivity thus being obtained without any complications in control. The reaction winding is divided, an equal portion being wound on each former so that reaction adjustments do not upset the balancing of the gang condenser.

of this condenser will now have almost exactly the same effect as variation in the coupling of the two coils had in the first receiver. Probably when the condenser is about "half in" the receiver will be just oscillating. Reduce the capacity, and the receiver will gently stop oscillating at a well-defined point.

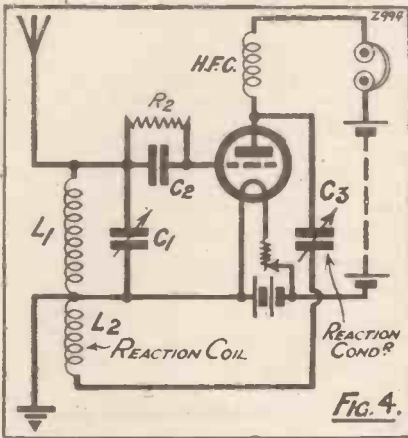

Searching for stations may now be performed on the two condenser dials, the one tuning to the desired wave-length and the other making sure that the receiver is "just not oscillating." If the set is found to oscillate with the condenser all out, an H.F. choke must be inserted at the point X.

Reaction Coil Sizes

A few words should also be said about the size of the reaction coil. In the first set it should be of such a size that the receiver just oscillates when the coils are coupled as tightly as possible. This means, for broadcast reception, that if L_1 (the grid and aerial coil) is a No. 50, the reaction coil L_2 will need to be a No. 35 or No. 30. It is assumed that about 45-60 volts H.T. is used. With a lower value a bigger reaction coil may be needed.

With the "throttle-controlled" set the same applies—the reaction coil should be of such a size that the set is oscillating satisfactorily when the reaction-control condenser C_3 is nearly "all-in."

The First "Reinartz"

As an alternative to the circuit shown in Fig. 3, let us consider Fig. 4. Here, instead of taking the H.T. through the 'phones and reaction coil to the anode, as was done in the first circuit, it is taken through the 'phones and a high-frequency choke.

The reaction coil and its associated condenser may now be placed as in Fig. 4 (i.e. the condenser next to

the anode, and then the coil, the far end of it going to the filament), or as in Fig. 5, in which the coil is connected to the anode and the condenser at the far end, one side of this going to the filament.

Each system has its advantages, the chief point about the Fig. 4 circuit being that, since the two coils have a common point (at the filament), they may conveniently take the form of one coil only, with a tap at about one-third of the way up. This was the form taken by the first Reinartz circuit.

Better For Short Waves

Against this advantage we have the disadvantage that both sets of plates of the reaction condenser C_3 are at high-frequency potential, and therefore capacity effects are liable to be troublesome unless the circuit is very carefully adjusted. Naturally, when one has one set of plates of a condenser connected to filament and earth, especially when they are the moving plates, capacity effects are almost entirely prevented.

In the Fig. 5 form we have lost one advantage and gained the other. Obviously two coils must now be used, but the condensers have a common point this time, and this common point is earthed. Both spindles and sets of moving plates

“Probably the 'D.O.G.,' or 'direct-on-grid,' method shown in the first five diagrams will give greater signal strength than any other. But it is not as selective as most.”

can therefore, be earthed, and this is the better arrangement, in the writer's opinion, particularly where short-wave sets are concerned.

One disadvantage common to all three circuits shown is this: that should the reaction condenser accidentally develop a "short," the H.T. battery forthwith empties its contents through the telephones! This is, to say the least of it, undesirable; but, fortunately, it can easily be prevented.

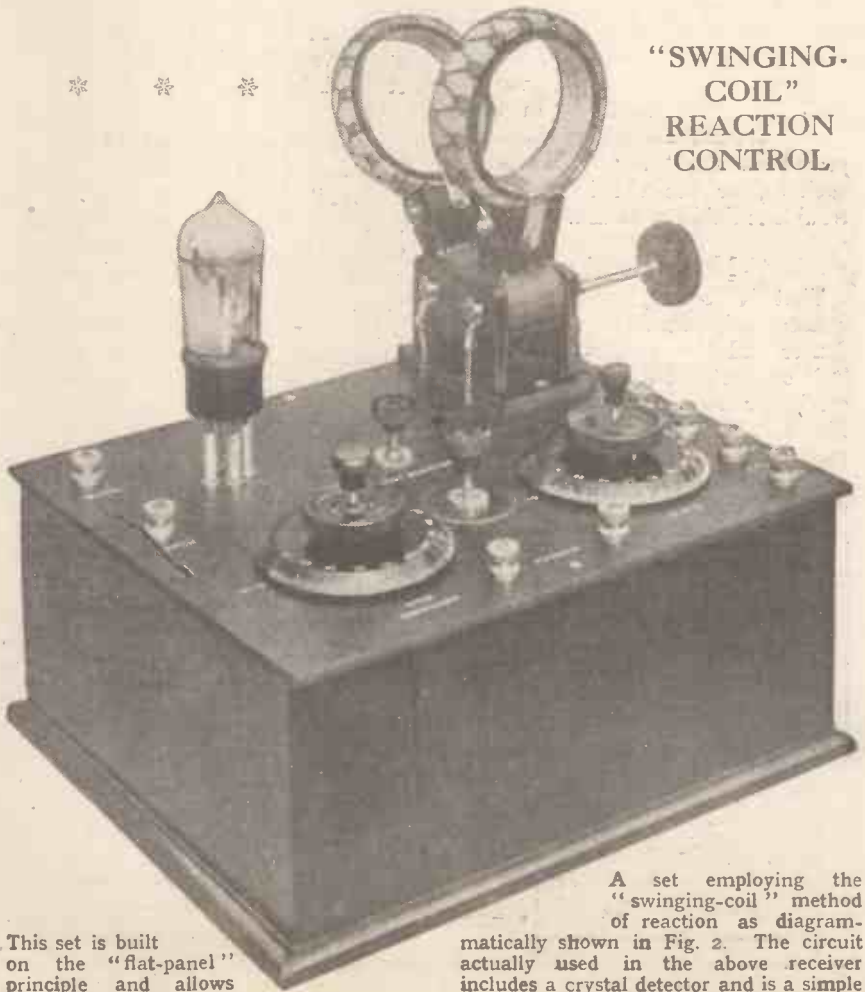

This set is built on the "flat-panel" principle and allows quick access to the coils.

A set employing the "swinging-coil" method of reaction as diagrammatically shown in Fig. 2. The circuit actually used in the above receiver includes a crystal detector and is a simple "reflex" arrangement.

The obvious thing to do is to connect a fixed condenser (preferably with mica dielectric) in series with the variable. If the fixed condenser is somewhat larger than the variable, the effective capacity of the latter will hardly be changed.

Variable Condenser Values

There are cases, however, in which the variable incorporated in the set is found to be too large, the symptoms being that the set does not stop oscillating as the condenser is reduced until one reaches the last few degrees on the dial. In this case we can kill two birds with one stone, and use a small fixed condenser, which will keep the H.T. from the variable, and also reduce the effective capacity of the latter.

Generally speaking, with the normal sizes of coils the size of a variable condenser used for controlling reaction in either of the three circuits shown should be about .00025 or .00035 mfd. Anything larger than this is unnecessary and sometimes troublesome.

If you have a .0005 variable condenser that needs "using up," however, simply insert a .0005 fixed condenser in series with it, and the effective capacity of the variable becomes .00025 mfd.! In every case the fixed condenser should be placed on the "live" side of the variable, or the old hand-capacity trouble is liable to return.

Not Selective

That is to say, in Fig. 3 it is connected between the variable condenser and the 'phones. In Fig. 4 it is connected between the variable condenser and the anode, and in Fig. 5 between the variable and the reaction coil. If the capacity of the variable is right, use a fixed condenser of about .002 in series with it.

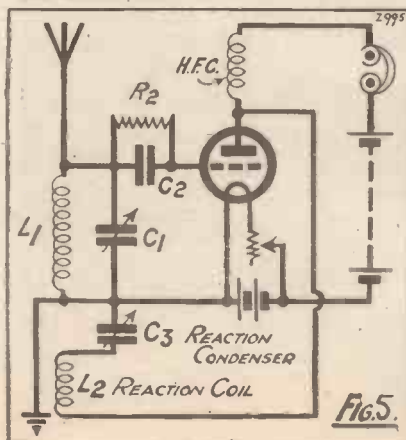

In all these three circuits the aerial

has been shown connected directly to the end of the grid coil. This has, however, been for the sake of simplicity, and a few remarks on the various methods of coupling the aerial to the set should not be out of place.

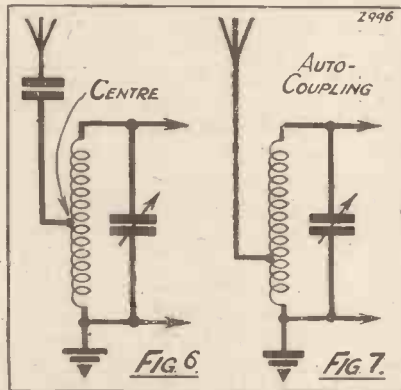

In the first place, the reader must understand that to gain great selectivity he must be prepared to give up a little of his signal-strength. This being understood, we may go ahead, but many novices adopt an "all-take-and-no-give" attitude, and expect to tune the local station in and out in about a quarter of a degree on their dial and at the same dial obtain a perfectly fabulous degree of strength!

Increasing the Selectivity

Probably the "D.O.G." or "direct-on-grid" method, as shown in the first five diagrams, will give greater signal strength than any other, particularly where a fairly small aerial is used.

If the aerial has a high capacity, however, i.e. if it is either very long or very low, this method will be very unsatisfactory indeed from the point of view of selectivity.

An alternative is to use a centre-tapped coil for L_1 , and to connect the aerial to the centre. This will noticeably improve the selectivity, without materially reducing the volume. We may, however, take things much further than this, and may connect the aerial to the centre-tap through a condenser of about .0002 capacity (Fig. 6). This arrangement should give very good selectivity indeed.

Tuning Range Altered

It must, of course, be realised that shifting the aerial from the top of the coil will considerably alter the tuning range, and a larger size of coil will be needed to cover the same wave-band. For ordinary broadcast reception, with the circuit arranged as in Fig. 5, a No. 35 coil will probably be in use.

When the aerial is moved and connected as in Fig. 6, a No. 50 or even No. 60 coil will be found necessary.

Fig. 7 shows another method, in which the type of coil commercially known as an "X" coil is used. The aerial is now connected to a tap very near the earth end of the coil. This arrangement is, of course, known as "auto-coupling."

Fig. 8 shows an alternative way of using a centre-tapped coil. Only half of it is now tuned to form the grid circuit, and the other half, which is not tuned, comprises the aerial circuit.

A much larger coil will be needed (a No. 75 centre-tapped should be satisfactory), and this method will, in general, give greater selectivity than is obtainable by connecting the aerial to the centre-tap, as previously mentioned.

Aerial Damping

It must be remembered that the principal cause of inselectivity in the Fig. 5 circuit is the enormous damping effect of the aerial and earth, which are connected across the whole of the grid coil. The actual amount of damping in this circuit normally is fairly small, on account of the quite low grid-filament capacity of the valve.

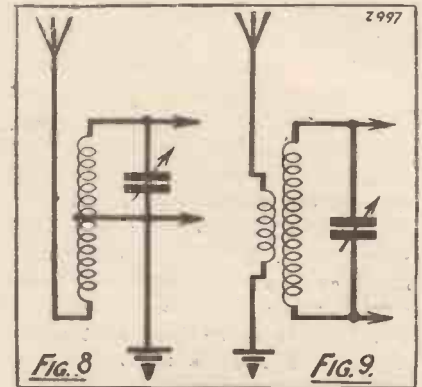

The introduction of the aerial and earth in the manner shown completely spoils the picture and flattens the tuning.

Inductive Coupling

Any method by which the damping effect of the aerial system can be reduced is therefore beneficial to selectivity, and it is at this that we have been aiming in the various modifications.

A reduction in this damping effect may also be achieved by inductive coupling of the aerial to the set. That is to say, instead of connecting the aerial and earth to the two ends of the grid coil, they are connected to a separate coil which is coupled to the other, as shown in Fig. 9.

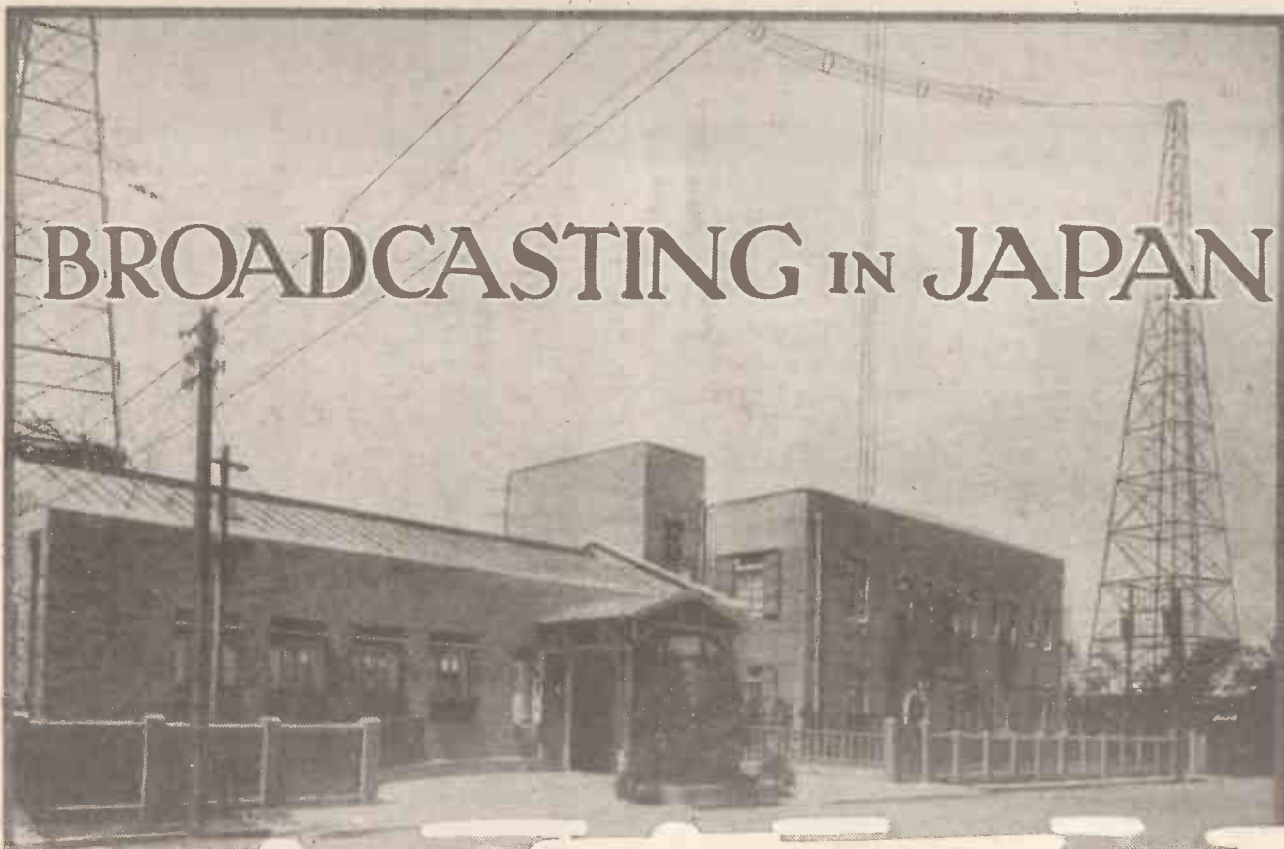

BROADCASTING IN JAPAN

Japan is gradually getting her broadcasting system under way, but, as this article shows, is still very far behind European countries in this respect.

By Our Special Correspondent.

As there are so many points of resemblance between the island Empire of Japan and our own country, in the matter of modern activities, at least, the development and present state of broadcasting in Japan is an interesting study. When one considers that less than a century ago the Japanese were prone to resist the influx of the foreigner and his devilish arts by force of arms—very primitive arms—the present situation of the country in world-politics, and in broadcasting, is amazing, though when we consider the last-mentioned we are bound to confess that listeners in England are far better served.

Broadcasting in Japan was started by the Tokio Broadcast Company, which erected a 6-kw. set in March, 1925. This was followed by the formation of the Osaka Broadcast Company, with a transmitter of the same power, in May of the same year. Then in July, 1925, the Nagoya Broadcast Company also put up a 6-kw. set.

At that time the licence fee was 2 yen per month, or about £2 8s. per annum, and the companies had to issue the licences and collect the fees.

More Stations Being Built

In January, 1926, the Tokio fee was reduced to £1 4s.



(Left) The ladies' orchestra and vocalists during a performance at Nagoya. It is interesting to note that while the vocalists have music the instrumentalists are not supplied with any. (Right) A few of the musical instruments employed in the men's orchestra can be seen in this photograph. Here also no music is used.

per annum, and the Osaka fee to £1 10s., the Nagoya fee being unaltered. The number of subscribers was then: Tokio, 140,000; Osaka, 49,000, and Nagoya, 16,000.



A soloist at the Nagoya Broadcasting Station. It will be noticed that the music-stand and the microphone have been adapted to meet the customs of the country.

The first Government regulations for broadcasting allowed for the formation of eight companies, of which only three were formed, but during the summer of 1926, the Japan Broadcast Association came into being and combined the three, with a directive board appointed by Teishinsho (Japanese Government Communication Dept.) consisting of ex-Teishinsho officials—the equivalent, one supposes, of the B.B.C. Board of Governors.

In March, 1927, the J.B.A. placed orders for six 10-kw.

(aerial energy) stations, three Marconi type and three Western Electric type, destined for (Marconi stations) Tokio, Osaka and Kumanoto, and (Western Electric type) Hiroshima, Sendai, and Sapporo. These stations are to be capable of working at 20 per cent overload for at least one hour per day, and all are expected to be ready by the middle of this year. They will transmit within a band of 330-400 metres.

Somewhat Spartan Fare

At present the Japanese listener has not much to attract him, and it is said to be almost impossible for him to receive either of the other two stations when the one nearest to him is working, as Tokio works on 375 metres, Nagoya on 360 metres and Osaka on 385 metres. The only thing which will save such a situation is the provision of excellent programmes, but these appear to be lacking. Here is the Tokio programme for November 3rd, 1927:

- 9.40 a.m.—Chorus, "Kimigayo." Lecture.
- 10.30 a.m.—Lecture.
- 11.15 a.m.—Market news and weather report.
- 11.20 a.m.—Lecture.
- 12.10 p.m.—Drama, "Kiichi Hogen."
- 2.0 p.m.—Lecture.
Koto, by Ikuta School.
Story-telling.
Songs for children.
- 3.40 p.m.—News and weather report.
- 6.0 p.m.—Play for children.
- 6.30 p.m.—Lecture.
- 7.10 p.m.—News; English lesson; Nagauta, soprano solo; Utazawa, Gidayu; weather report.

(Continued on page 470.)



Though their programmes may not be of a very high order, and may be even more "talky" than our own, the Japanese follow Western methods in the design of their transmitters. This photograph shows the Nagoya transmitter, which is of the famous "Q" type and has a power of 6 kw.



Mr. Baird photographed in his laboratory.

"SEEING BY WIRELESS"

A lucid article which clearly shows how far television experiments have progressed, and pointing out the tremendous difficulties that still have to be overcome.

By Dr. J. H. T. ROBERTS, F.Inst.P.

(Scientific Adviser to "Modern Wireless.")

THERE has been so much talk lately about television (or seeing-by-wireless) that many people seem to have got quite a wrong impression as to facts. The individual vaguely known as "The Man in the Street" naturally has neither the knowledge nor the time to consider matters of this kind in detail and, if he is told or if he reads about "seeing by wireless," he naturally thinks that the "seeing" is going to be more or less of the kind he has been accustomed to either in his daily life or, say, in a cinematograph theatre.

In view of the possibility of serious misapprehension on the part of the public in this respect I have been asked to set out briefly, on the one hand, what has been accomplished in the way of television and, on the other hand, what are the difficulties and obstacles which may well prove to be an insuperable barrier to any appreciable further progress.

Many Scientists Engaged

The subject of television—that is, the transmission of moving pictures, either by line or radio—has engaged the attention of numerous experimenters during many years past; the best-known investigators in this field at the present time being Dr. Alexander, Chief Consulting Engineer of the General Electric Company, New York; Dr. Ives, of the American Telephone and Telegraph Company; G. Francis Jenkins (United States); J. L. Baird (London), and von Mihaly (Germany).

Most of these investigators claim to have demonstrated television in various degrees of crudeness and over

distances ranging from a few miles to thousands of miles. I may remark at this point that the transmission of a moving representation by radio over a thousand miles is a matter of little more difficulty than the transmission over a thousand yards. Having accomplished radio transmission of moving pictures AT ALL, the increase in the distance between the sending and receiving stations involves comparatively little further technique.

Quality and Definition

But what has always been and must be the aim and object of television experimenters is to improve the *quality* and *definition* of the re-

ceived pictures or representations. Up to the present, crude reproductions of simple objects such as a face or a hand have been rendered, usually in a flickering, though perhaps recognisable, form. I am informed by a friend (a distinguished Professor of Physics in one of the English Universities) who witnessed a special demonstration of television by the American Telephone and Telegraph Company recently that their production (in this case a face) was quite recognisable.

It must be borne in mind that the American Telephone and Telegraph Company have immense resources both in money and in brains, but

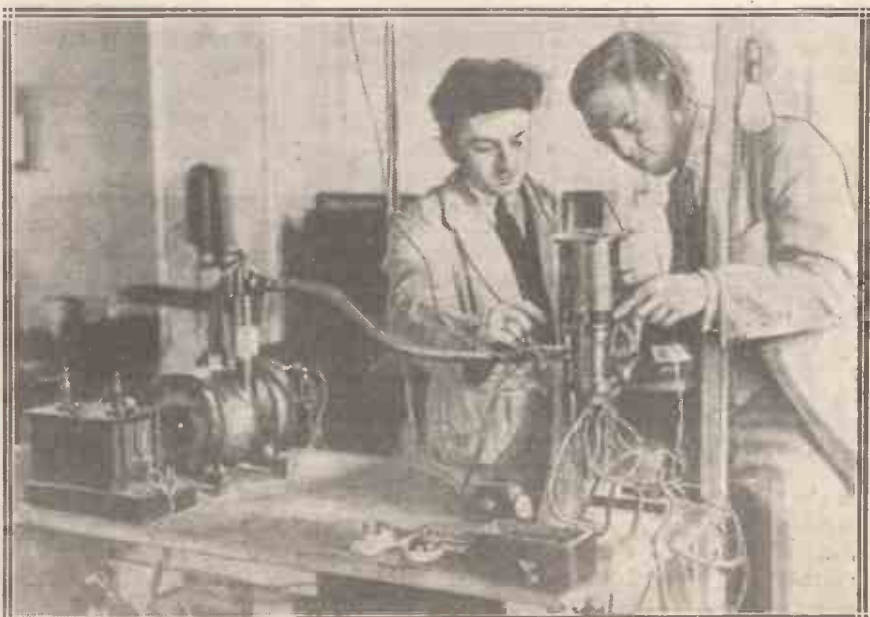

M. Belin, the famous French scientist, has been experimenting with the cathode oscillograph in his latest television researches. The cathode stream is controlled at high speed by the magnets indicated by the assistant on the right.

notwithstanding this, and notwithstanding their achievement just mentioned, they themselves (I am informed) are extremely reticent as to television ever becoming a practical possibility in the commonly accepted interpretation of that phrase, or as to the possibility of any appreciable further progress being made.

Question of "Detail!"

If television has any real future it lies, not in the increase of the distance over which the moving representations may be sent, but in the improvement of the quality, recognisability and "detail" of the moving pictures received. Up to the present television transmissions have been confined to simple objects such as a face, where even in the absence of detail it is possible, in a general way, to recognise the object.

But there would be little point in continuing to transmit simple objects of this kind if the process were not capable of being extended to include, for instance, a distant view, or a view of the interior of a room, or any other such view involving a number of objects each small compared with the whole picture. It is clear that to accomplish this it is necessary to increase enormously the "detail" of the received picture, and this is precisely where the difficulties of television come in.

"Exploring" Pictures

In television the method employed is to "explore" the object to be televised—a picture, a face, or whatever it may be—by means of a spot of light or by an optical system or some equivalent. Without going into details of the various modifications of this method, we will suppose for simplicity that the object is to be rapidly explored by means of a spot of light. The exploring spot of light may start

In this way it rapidly traverses a series of parallel lines, starting at the left-hand edge, progressing across the picture and finishing up at the right-hand edge. Instead of moving in this particular way, it may vibrate up and down, and the motion may be from right to left, or the lines of exploration may be of a circular character, or separate spots may successively traverse the picture. With the actual details we are not concerned; the

of the picture or object as it passes over. The picture may be explored by reflected or by transmitted light, and there are all manner of minor modifications in the system, but these do not affect the basis of the system, which is the exploration of the picture successively.

Now it will be evident that the exploring spot will be unable to pick out objects or details of the picture which are smaller than itself. There-



Mr. John L. Baird, who was recently challenged by "Modern Wireless" and "Popular Wireless," carrying out some tests with a section of his apparatus in an attempt to televise his hand.

point is that the picture is rapidly traversed by an exploring spot, which must pass over every detail of the picture successively.

The amount of light which is reflected from the picture will evidently depend upon whether the exploring spot is passing over a light or dark

fore, in order that fair detail may be picked up from the object which is to be transmitted, it is essential that the exploring spot be at least as small as the details which are required to be brought out. Let us take as a very rough figure a square spot 1/20th in. edge.

"... Unless some totally new principle is discovered which gets away entirely from the host of enormous difficulties which I have touched upon, television has got just about as far as it is ever likely to do," says the Author.

at the top left-hand corner and travel rapidly downwards along the left-hand edge of the "picture," until it reaches the lower left-hand corner, after which it commences again at the top, but a little bit to the right, and follows a second path close and parallel to the original one.

portion of the picture. If it is passing over a light portion more light will be reflected, whilst if it is passing over a dark portion less light will be reflected.

The reflected beam of light thus varies in intensity or strength in accordance with the varying features

Two Hundred Excursions!

When this spot has travelled down the "frame" at the left-hand edge and is making its second journey, it will be clear that its second path should be as nearly as possible edge-to-edge with its first path, without either overlapping or leaving a space. If perfect conditions are secured, the exploring spot in this case must make twenty excursions in the space of an inch long along the upper edge of the frame, or, if the picture is enclosed within an explored area which is 10 in. broad, a total of 200 excursions in order to get across the picture.

The whole picture (I am using the word "picture" meaning the total area of the "frame" within which the picture, say a face, is contained) must be explored in this way in a period of time which is smaller than 1/16th of a second, as the whole

only for the duration of three oscillations or waves of the carrier-wave itself!

I will not attempt to enter into questions as to the possibility of modulating effectively a carrier-wave at this enormous frequency, or to

matter of fact, this is stating the problem in far too easy terms, for in order to obtain proper detail to make the picture comparable with a "real picture," as ordinarily understood, it would be necessary to give the equivalent of a much finer "screen," and it is probable that by the time proper conditions were reached we should find ourselves called upon to transmit details of the picture the transit time of which details was no more than one-ten-millionth or one-twenty-millionth of a second.

.....
 " . . . It is significant that Dr. Alexanderson, Dr. Ives, and other big experts in America, who would seem to be specially in a position to make progress with television, if appreciable progress were possible, are, if not silent, at any rate extremely reticent on the subject of the possibility of television as a practical proposition."

system depends, in any case, upon what is known as the "persistence of vision." ("Persistence of vision" is a phenomenon which is made use of in ordinary cinematography. It has been found that if the eye receives a number of separate but slightly differing impressions at the rate of not less than about 16 per second, these cease to be distinguishable as separate impressions and the brain receives them as a continuously moving effect.)

As a matter of fact, although 16 pictures per second must be sent, the actual time for the exploration of the picture is considerably less than 1/16th of a second, and, to put a very favourable construction upon it, we may set it down as 1/25th of a second. It has been estimated by some experts in America at 1/80th of a second. However, let us take it as 1/25th of a second for the moment.

A Radio Frequency !

The exploring spot, then, has to make 200 tracks across the picture in 1/25th of a second, or it makes each passage over the picture in 1/5,000th of a second. Now let us see what is going to happen when this exploring spot is passing over a fairly small detail of the picture. Let us suppose that the detail in question is the pupil of a man's eye and that this occupies an area of 1/20th in. square. Since the exploring spot has to travel 10 in. in 1/5,000th of a second, it will travel over this feature in 1/1,000,000th of a second.

The variation of the intensity of light from the picture which is to be transmitted is sent out as a modulation upon a radio carrier-wave. If we assume a wave-length of 100 metres (which is the sort of length which has been used by investigators in this field) we have a carrier-wave frequency of approximately 3,000,000 vibrations per second. Therefore a modulating feature lasting for one-millionth of a second would persist

the still more difficult question as to the handling of such modulation-frequency by the valve apparatus either at the transmitting or at the receiving end. Those of my readers who are expert in the theory of radio transmission and reception by valve apparatus will, I think, have no difficulty in realising the extreme nature of this particular part of the problem. Even if the wave-length is reduced to 50 metres, we have only six oscillations' duration for the feature in question.

Not the Worst !

The figure of one-millionth of a second was arrived at by considering a detail feature 1/20th in. square in a picture 10 in. by 10 in. As a

Further Difficulties

Then there are difficulties connected with the refinements of the mechanical devices employed for the exploration of the picture at the transmitting and receiving ends, with the perfect synchronisation of the two apparatus, with the photo-electric device necessary for picking up the varying light-energy at the transmitting end and converting this into a form suitable for modulating the carrier-wave, with the discharge lamp or other device at the receiving end by which the varying incoming electro-magnetic energy is transformed into varying light-energy, with questions of fading, interference, wave-length, amplification, distortion of image due to exploration system, etc., etc.

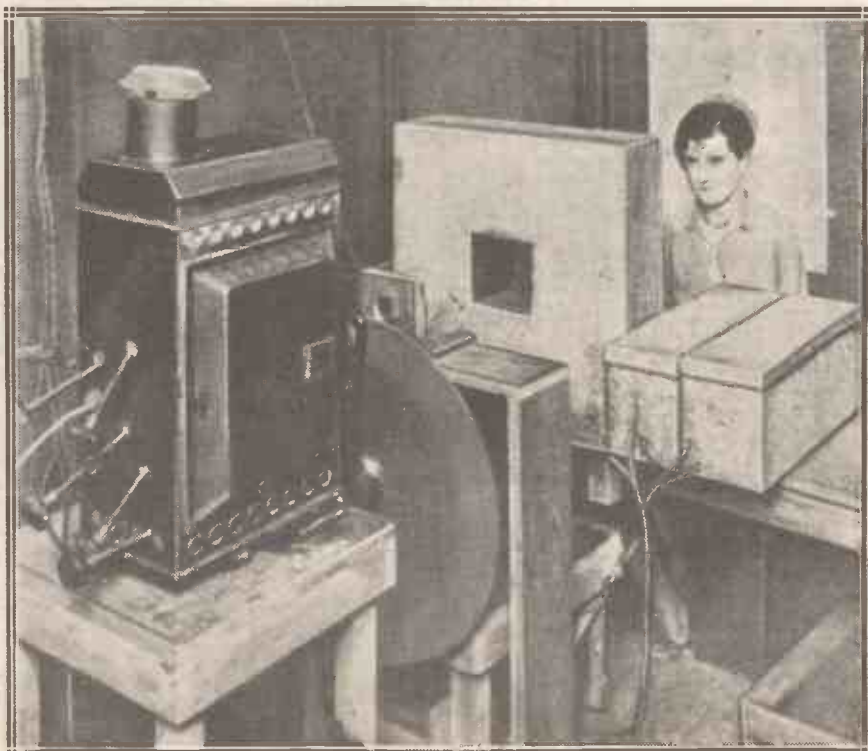

One of the most successful attempts at the solution of the television problem has been made by Dr. Alexanderson, but even he, backed by the G.E.C. of America, can hold out no hope of a final solution in the near future.

I have outlined the main difficulties involved in television by any of the methods which have up to the present been brought forward. At the same time, I do not wish to seem unduly sceptical as to the prospect of development, nor do I seek in any way to detract from or minimise the achievements of those who have long devoted their efforts to this problem in different parts of the world.

Like Perpetual Motion

It seems to me, however, that unless some totally new principle is discovered which gets away entirely from the host of enormous difficulties which I have touched upon, television has got just about as far as it is ever likely to do, and I feel that great care should be taken to avoid undue optimism or what I fear may prove to be merely pious hopes.

I am not going to say that television (meaning always the full sense of the term as indicated in the foregoing) is impossible, any more

was absolutely and for ever impossible. In my own mind, I class real television (in the full practical sense indicated above) in the same category of impossibility or improbability as perpetual motion.

Significant Reticence

As a subject for experiment, television, even in its present rudimentary state, may have a certain fascination, but even assuming that any appreciable percentage of the public will be able to construct or operate television receiving sets effectively, it remains to be seen how long the public will be content to receive crude images of simple objects such as heads and hands.

If anyone can show, within the next ten years, by true radio television, moving pictures even remotely comparable with the pictures seen at the present-day cinema, something will certainly have been accomplished which is entirely beyond the expectation either of myself or of the many

big experts in America, who would seem to be specially in a position to make progress with television, if appreciable progress were possible, are, if not silent, at any rate extremely reticent on the subject of the possibility of television as a practical proposition.

TWO USEFUL TIPS
 About Accumulators—Removing Dust

A STRANGE fault due to keeping an accumulator in a tight-fitting wooden carrier recently came before my notice. There is a tendency in such instances to pull the accumulator out of the container by the terminals. This is sometimes apt to dislocate one or perhaps both sets of plates, as each terminal is attached to a bar which holds together the complete set of plates.

In the instance I refer to, one of the positive plates had been levered upwards causing it actually to touch the negative bar joining all the negative plates. This effected a definite "short" and the accumulator was instantly discharged at a rate which could not fail to prove ruinous.

If trouble of this nature is suspected, carefully inspect both sets of plates to see if they touch at any point across the bars.

It is difficult to remedy the matter, as the tops of most accumulators are sealed, but if the top is of celluloid, a small hole might be drilled directly over the point of contact. A knitting needle is then carefully passed through and tapped with a light hammer. This will force the plate back into position. Make sure that the knitting needle itself does not "short" the plates or terminals.

In the case of waxed tops, or glass tops waxed in, it is perhaps best to send an accumulator to the maker for repair.

Removing Dust

DUST, dirt, or ebonite drillings may easily be removed from any awkward internal part of a wireless set by using a camel-hair mop. Where the undesired matter cannot be swept straight up with the brush, it is only necessary slightly to damp the hair, or even breathe upon it, and thus pick up the dust on the brush tip. Rub the brush on a cloth, and repeat the procedure until all the dirt is removed in this manner.

H. B.



Part of the Bell Laboratories system of television, recent experiments with which have once again emphasised the tremendous difficulties that still have to be overcome before anything like success can be claimed.

than I should care to assert that perpetual motion was impossible. No doubt my readers are well aware that perpetual motion is one of those things which has long been regarded as a standard of impossibility, but, at the same time, neither I nor, I think, any other scientific man would care to assert that perpetual motion

distinguished scientific friends who have expressed to me their views upon this subject.

Indeed it is significant that Dr. Alexanderson (Chief Consulting Engineer of the American General Electric Company), Dr. Ives (one of the chiefs of the American Telephone and Telegraph Company), and other

The "M.W. AVAC" UNIT



From the ordinary user's point of view one of the only real drawbacks of mains H.T. units is that the voltages obtained are apt to be rather a matter of guess-work. To remove the difficulty this unit (the name means "Accurate Voltage A.C. unit") has been specially produced by the M.W. Research Dept., and with it you will find that you can adjust and measure each voltage accurately while the set is actually working.

Described by G. P. KENDALL, B.Sc.

I WONDER how many housewives would use an electric iron if the only ones available required to be supplied from a cumbersome dry battery, a dry battery, moreover, which could only be expected to last about six months, and towards the end of the time heated the iron more and more poorly? To the average domestic user of electrical appliances such things are inevitably regarded as for use with the aid of power from the electric mains, and it probably never occurs to him or her that they might be employed in any other way.

Surely it is high time that we began to regard our radio sets in the same way? If one will but look at the matter without prejudice, one must realise that they are simply electrical appliances like all the rest, and as such should obviously be run from the most convenient source of electric energy, namely, the electric mains, wherever they are available.

True, there will always be cases where it is desired to use a radio set

and no electric mains are available and so batteries will still be required; but it does seem strange how many people will go on submitting to the inconvenience of batteries when an

abundant and unvarying supply of current is ready at hand in the mains already installed in their houses for lighting and heating. Probably there are two main reasons for it, one being that we do not yet realise that the wireless set, for all its wonderful possibilities, is just an electrical appliance like all the rest and should naturally derive

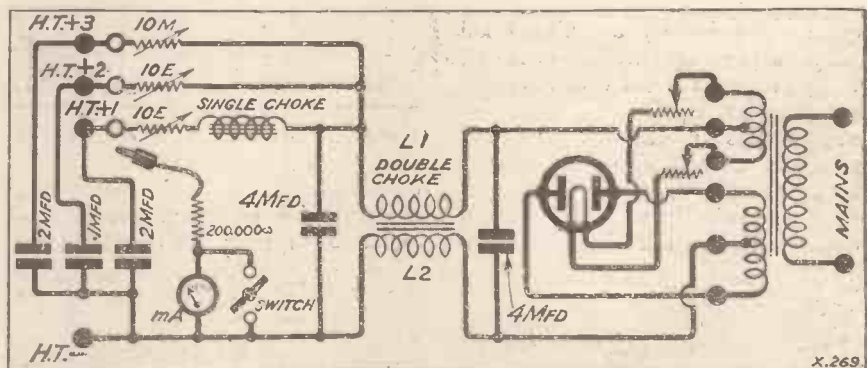

The unit employs full-wave rectification, with very effective smoothing arrangements and a special scheme of voltage adjustment and measurement.

abundant and unvarying supply of current is ready at hand in the mains already installed in their houses for lighting and heating.

Probably there are two main

its supply from the public mains. The other reason, and this is a more weighty one, is that unfortunately one cannot satisfactorily switch the average wireless set straight on to the

COMPONENTS REQUIRED

- 1 Panel, 9 in. x 7 in. x 1/4 in. (Any good insulating material).
- 1 Cabinet to fit, with baseboard 12 1/2 in. deep. (Arterraft, etc.)
- 1 Milliammeter, 0-1.5 m.a. (See text).
- 1 On-off switch, insulated type (L. & P., or similar type).
- 2 Bradleyohms, No. E.10 (10,000-500,000 ohms). (R. A. Rothermel & Co., Ltd.)
- 1 "Centralab" heavy duty "Radiohm," No. 10M (0-10,000 ohms). (R. A. Rothermel & Co., Ltd.)
- 4 Insulated engraved terminals (H.T. -, H.T.+1, H.T.+2, H.T.+3). (Belling & Lee, or similar type.)

- 1 Wire-wound anode resistance, 200,000 ohms, with holder (See text). (Must be of accurate value.)
- 1 Double choke (R.I. & Varley in original).
- 1 Single choke. (Pye in original. See text).
- 1 1-mfd. mica fixed condenser (Dubilier or other standard make).
- 2 4-mfd. and 2 2-mfd. fixed condensers, Mansbridge type (See text for working voltage). (Dubilier in original. Any standard make in which the desired type is available; slight alterations of layout may be needed with other makes of different shapes and sizes.)

- 1 Valve holder (Benjamin, Bowyer-Lowe, Burndep, Burne-Jones, Igranic, Lissen, Lotus, Pye, W.B., etc.).
 - 2 Baseboard-mounting filament rheostats capable of carrying fairly large current, and preferably roughly calibrated (Igranic, Lissen, McMichael, etc.).
 - 1 Power transformer (See text).
 - 2 Plain terminals mounted on small ebonite strips.
 - 3 Sockets and 1 insulated plug (Eelex, Clx, etc.).
- Bare wire, Junit, etc., and Systoflex or covered wire such as Glazite; flex, screws, etc.

mains, as one does any appliance which has been specially designed for the purpose.

The ordinary public supply is not, as a rule, suitable for applying direct to the set, and something must be interposed between the set and mains to produce the desired effect, with a consequent slight extra complication and initial expense. If one honestly faces the facts, however, the initial expense involved is one which is soon balanced off against the inevitable running expenses of batteries.

Simple Facts

I trust the more experienced reader will forgive me if I digress for a few moments to explain why it is necessary to provide some intermediate apparatus between the wireless set and the mains, a fact which will, perhaps, not be quite clear to those who have not gone into the question before.

The point is this: A wireless set requires for its high-tension supply (this is one with which we are concerned at present) a quite small supply of perfectly pure direct current, that is to say, current which is quite free from any ripple or fluctuation of voltage. The average public supply of direct current does not usually agree with this requirement, since in the great majority of cases there is a considerable amount of ripple super-

imposed upon it, and this causes a loud hum to be heard if it is used for supplying the high-tension of a wireless set.

What we require to place between

which has the effect of smoothing out the ripples. In most cases quite a simple arrangement is sufficient, but in addition we generally require some means of obtaining several different

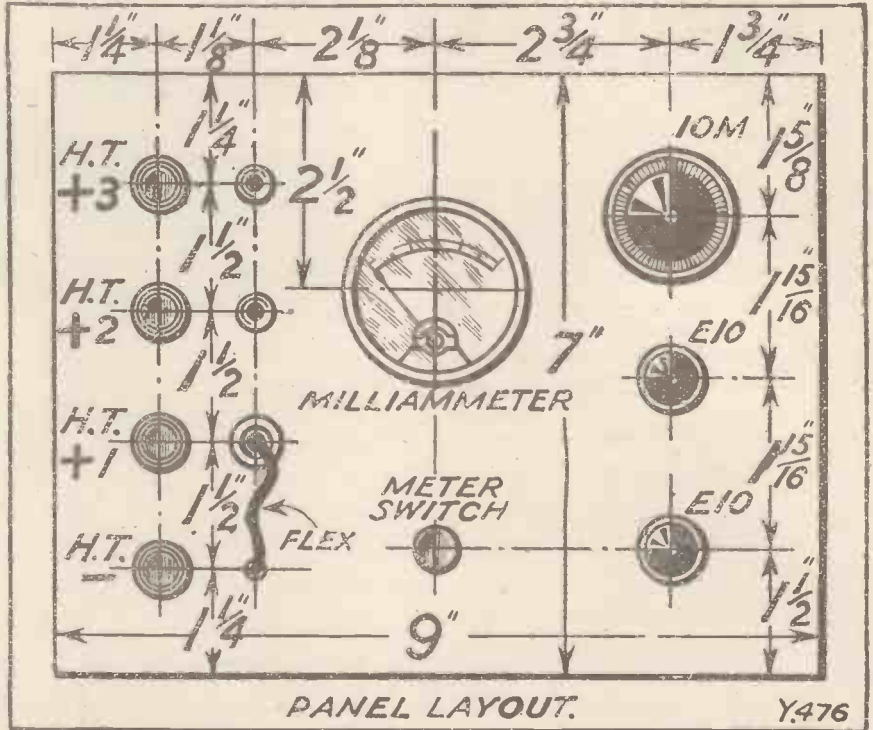

our set and the mains, in a case like this, is simply what is called a filter or smoothing circuit, which consists of an arrangement of iron-cored chokes and large-capacity fixed condensers,

high-tension voltages, and here again some slight additional complexity is involved, in the way of variable resistances, potentiometers, or something of that sort to enable us to obtain the various voltages. Nevertheless, an H.T. battery eliminator, as it is called, for working with D.C. mains, can be made a very simple affair.

Rectified A.C.

Where the public electric supply is of the alternating variety, of course, something further is needed in addition to the smoothing circuit and voltage-adjusting devices already mentioned. Obviously, alternating current is useless to us for our high-tension supply, and we must first turn it into direct current, and to do this what is called a rectifier is needed, which in many cases is simply a special form of valve working on the self-same principle as the earliest wireless valve.

The fact that rectification is needed with alternating current sometimes leads people to assume that alternating mains are not so good as direct mains from the wireless point of view, but this scarcely follows. Although some little extra expense is involved, it must not be forgotten that with alternating mains it is

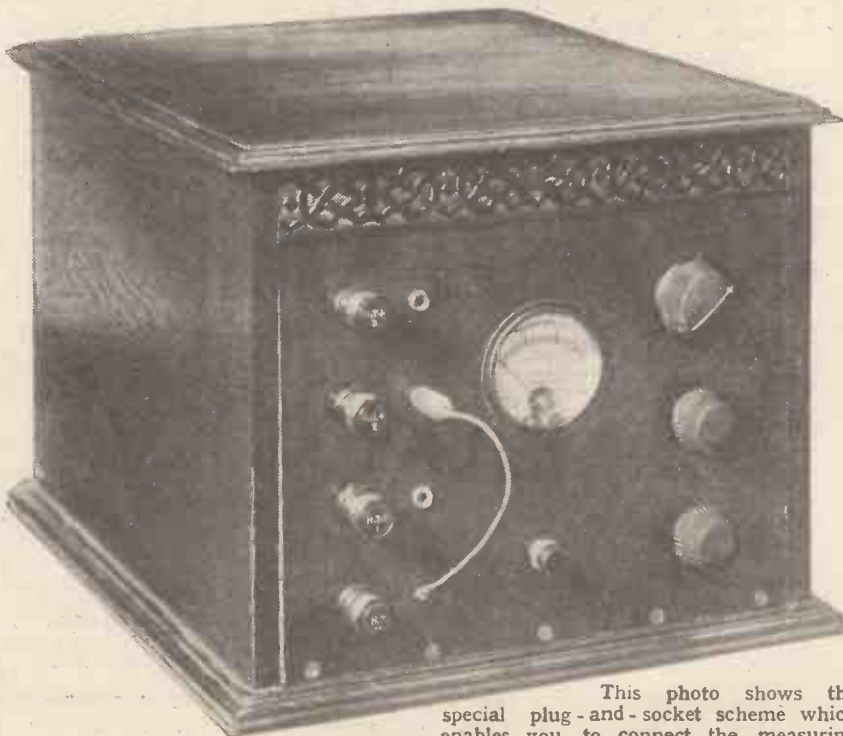

This photo shows the special plug-and-socket scheme which enables you to connect the measuring device (a milliammeter and series resistance) across each H.T. terminal in turn. The diagram above gives a key to the panel layout for drilling, and indicates the positions of the various adjustable resistances.

possible to use a transformer to increase or reduce the voltage as required before the current is applied to the rectifier, and so it is possible to obtain practically any desired high-tension voltage to apply to our set.

In the case of direct-current mains, on the other hand, one cannot obtain any voltage higher than that of the

of smoothing circuits, which involves some slight extra expense, but which, in my opinion, is well worth while, since there is nothing more annoying than to hear a steady droning hum in the intervals of the programme such as results from the use of an eliminator with an inefficient smoothing arrangement.

As regards the actual output which can be obtained, this will be found to be quite adequate for all cases except where it is desired to work very large "super" valves, such as the L.S.5A class, for running moving-coil loud speakers. Actually, the detector and H.F. tappings will supply any current which is likely to be required at pressures up to about 150 volts, while the third tapping, which is intended for supplying the L.F. valves, will give 25 to 30 milliamps at a maximum voltage which will vary between about 180 and 200, according to the load.

Of course, any of these voltages can be cut down as required, by means of the controls on the panel, to suit the particular requirements.

It is scarcely possible in an article like this, which is intended to deal mainly with the practical side, to go very far into the theory of the working of an H.T. eliminator, but to give a general idea with not too much detail will probably be useful. The alternating current from the mains is taken to the two input terminals of the unit, and from there is led through the primary winding of a small power transformer, which has no direct connection with the rest of the apparatus, which is a valuable safety feature of this type of unit.

Complete Safety

Thus, a complete short-circuit can take place across the output terminals, or even in the internal circuits of the eliminator, without resulting in a large current being drawn from the mains, with a consequent blowing of fuses and so on, so that it may be assumed that there is little or no need to provide additional fuses on the unit itself.

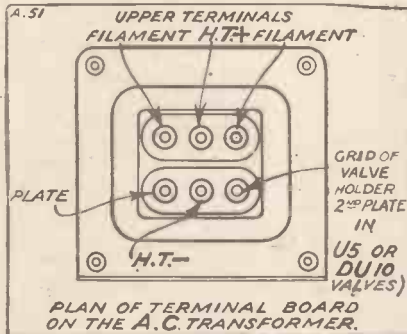

This diagram is a key to the connections of the particular power transformer used in the original unit. The upper terminals are those of the L.T. secondary winding, and the references on the leads indicate the points to which the terminals are wired on the rectifier valve socket. The middle terminal is the centre tap, and this can be regarded as H.T. positive. The lower terminals are similarly marked, and are those of the H.T. secondary.

mains themselves by means of simple apparatus, and actually it is not possible by means of the ordinary simple eliminator to obtain more than about ninety per cent of that voltage to apply to our set. In many cases this means that we are rather limited for a supply for our last power stage, and so it will be seen that from the point of view of the super-quality enthusiast, who wants a high-voltage supply for his last valve, the alternating mains are decidedly to be preferred.

Good Smoothing

In the present article an instrument is being described for use on alternating-current mains which is intended to meet the needs of those who are prepared to spend rather more than the minimum amount to obtain a really satisfactory H.T. unit capable of giving a good supply of current up to quite high voltages, provided with very convenient means of voltage adjustment, and, further, of giving a really pure and clean supply of current with the minimum of hum.

As regards this latter point, it can be taken that hum is entirely absent unless some very strenuous tests are applied, such as listening with headphones on the end of a multi-valve set. A special feature of this eliminator, in fact, is that very particular pains are taken to provide a really good series

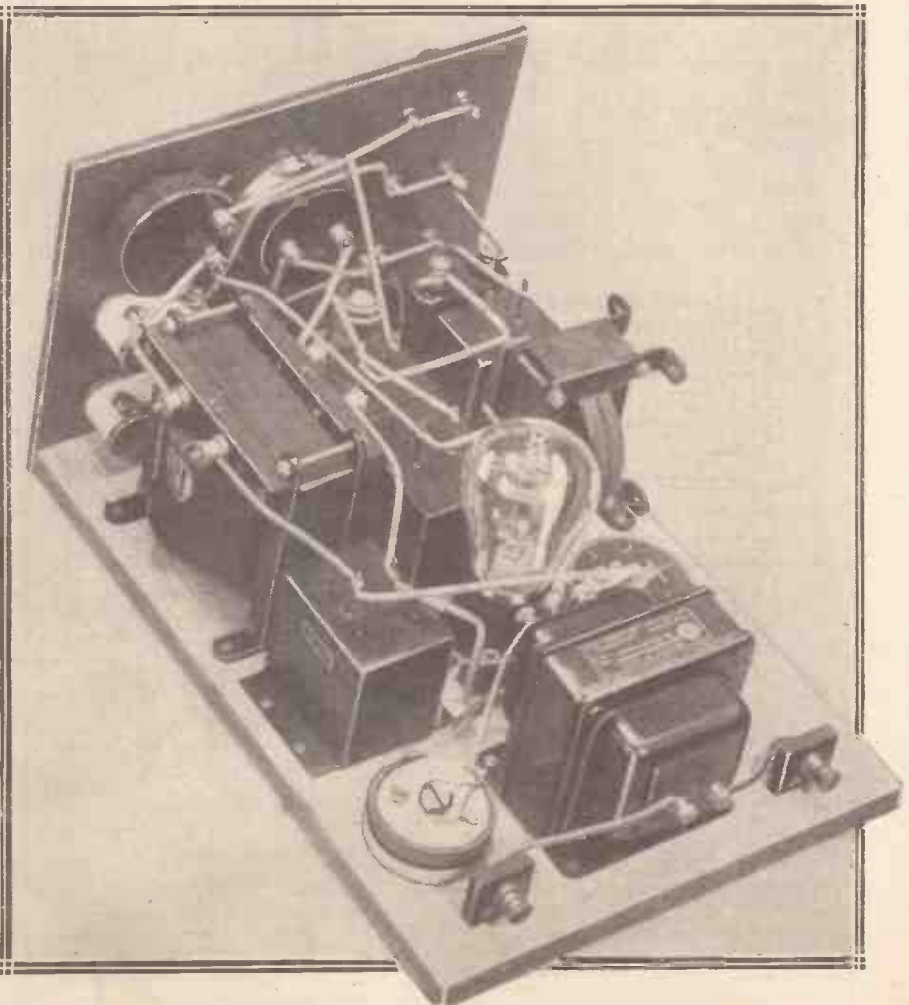

Note the large space allowed for the power transformer, to permit different makes to be accommodated, and the wide separation of the input terminals.

The risk of a short-circuit taking place on the mains side of the eliminator is so very slight that it

may be taken as non-existent for practical purposes. Of course, if one wanted to be ultra-careful one could

interpose a couple of fuses in the leads between the input terminals and the primary of the power transformer.

The power transformer is provided with two secondary windings, each having a centre tap. One of these is designed to provide a large current at fairly low voltage for heating the filament of a special rectifying valve, while the other is a high-voltage winding which provides the high-tension alternating current which is

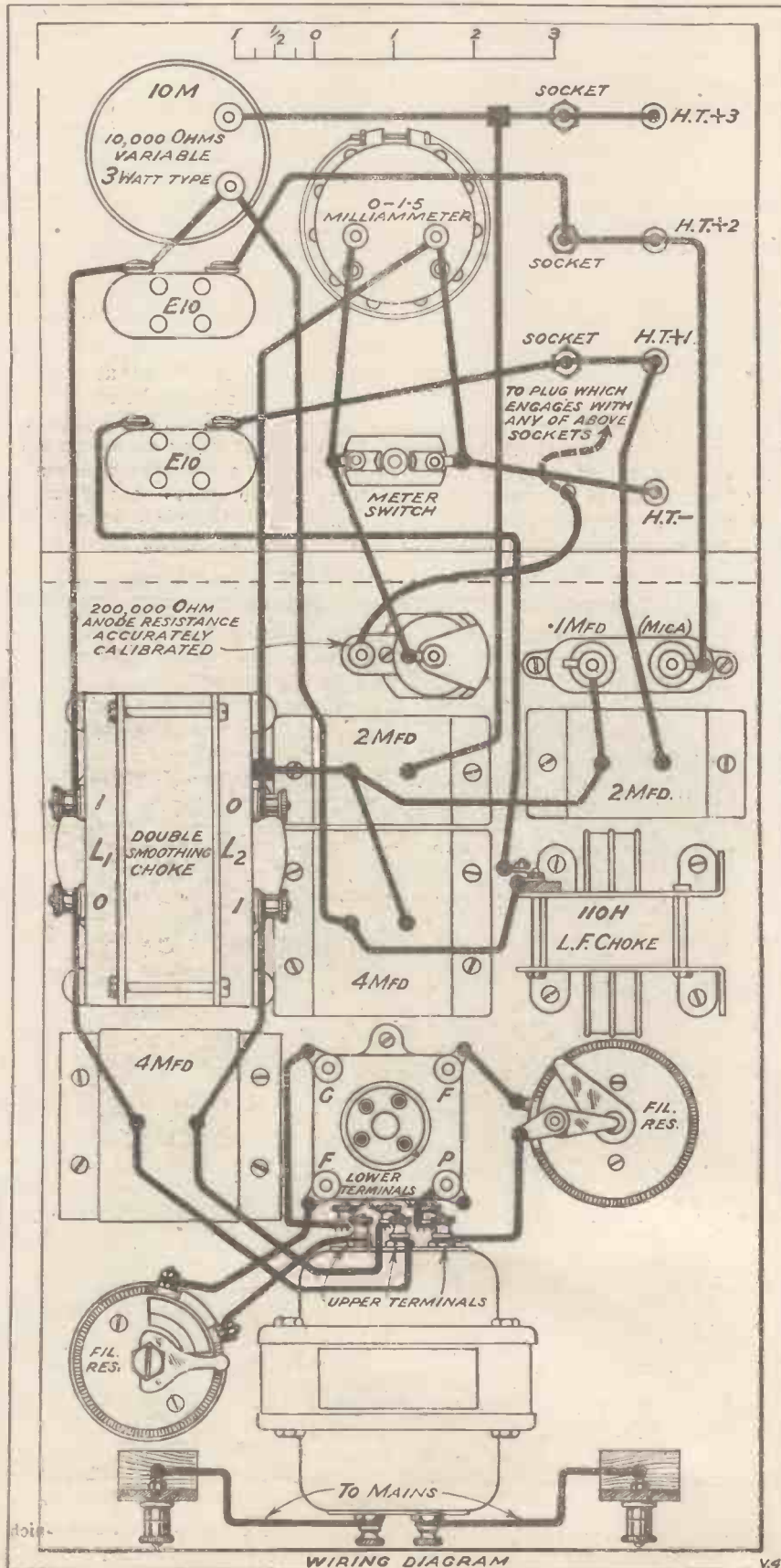

WIRING IN WORDS.

- One side of each filament resistance to one filament socket on each side of the valve holder.
- Remaining side of the left-hand filament resistance (looking at eliminator from back of baseboard) to the top-left-hand terminal on the A.C. transformer. Top right-hand terminal to the remaining side of the right-hand filament resistance.
- Plate of valve holder to the bottom right-hand terminal of transformer.
- Grid of valve holder to the bottom left-hand terminal.
- Centre bottom terminal to one side of the 4-mfd. condenser C₁, and to the "I" of the L.F. choke L₂ (double choke).
- Top centre terminal on the A.C. transformer to the remaining side of C₁ (4 mfd.) and to the "O" of L₁ (double choke).
- "I" of L₁ (double choke) to the left-hand screw on the centre variable resistance (E 10) on panel, to the bottom terminal on the top variable resistance (10 M) on panel, to one side of the 4-mfd. condenser C₂ and to the top connection of the 110-henry L.F. choke.
- Remaining side of the 4-mfd. condenser C₂ to one side of the 2-mfd. condenser C₃, to one side of the 2-mfd. condenser C₄, to one side of the 1-mfd. mica condenser C₅, to the "O" of L₂ (double choke) to the negative side of the milliammeter, to one side of the on-off switch for meter and to the H.T.- terminal.
- Other side of on-off switch to the "+" side of the milliammeter and to the top connection to the 200,000-ohm anode resistance. Remaining side of anode resistance to a plug on front of panel via a flexible lead.
- Top terminal on top variable resistance (10 M) on panel to the remaining side of the 2-mfd. condenser C₃, to the socket on panel facing the H.T. + 3 terminal, and also to this terminal.
- Remaining screw on the centre variable resistance (10 E) on panel to the socket facing the H.T. + 2 terminal, to this terminal and to the remaining side of the 1-mfd. mica condenser C₅.
- Bottom contact on the 110-henry L.F. choke to the left-hand screw on the bottom variable resistance (10 E) on panel.
- Right-hand screw on same resistance to the socket facing H.T. + 1 terminal, to this terminal and to the remaining side of the 2-mfd. condenser C₄.
- To complete the wiring, join the terminals for the "Input" on the A.C. transformer to adjacent terminals respectively, fitted on the baseboard. These terminals are then connected to some flex which is fitted with a suitable plug or socket at its remaining end to connect with the A.C. mains.

to be rectified and converted into the desired direct current for supplying the valves in the receiving set.

This winding will usually supply a voltage of perhaps 120 to 250 volts on either side of the centre tap, according to the particular make and type of transformer which is used.

In a large proportion of A.C. mains units what is called "full-wave" rectification is employed, and the present instrument is no exception. In this method it is possible to use either two separate simple rectifying

valves, or one special one of a double type, to enable both halves of each alternation of the original current to be usefully employed.

If the reader will examine the circuit diagram he will see how this is done. In the present unit a special rectifying valve is used of a type provided with what is in effect a single filament and two anodes. The anodes are connected respectively to the two opposite ends of the high-voltage secondary winding, the centre tap on this winding forming the negative pole of the rectifier circuit.

How It Works

At a given moment of the alternating-current cycle one of these anodes will naturally be made positive and the other negative, and a flow of electrons will take place from the filament to whichever of these anodes may chance to be positive at a given instant. Thus there will always be a flow of electrons taking place to one or other of the plates, and so the

This eliminator will give three different high-tension voltages, being provided with one negative and three separate positive terminals, and on the panel will be found means of varying any one of these voltages within quite wide limits, also a specially convenient device for actually measuring the voltage on each terminal in turn, so that you may know exactly what you are doing, thus overcoming one of the main difficulties in using eliminators of this type.

direction of flow of the current of the external circuit will be made constant.

What we get in this way is obviously a pulsating current always in the same direction through the external circuit, and this is fed into the main smoothing circuit, where we endeavour to flatten it out, so to speak, into a perfectly smooth direct current, without any ripple or fluctuation of voltage. The positive pole, by the way, is provided by the centre tapping on the small winding which provides the filament current for the rectifying valve.

The Main Smoothing Circuit

Immediately following upon the rectifying part of the circuit comes the main smoothing circuit, and this consists of the following arrangement: An iron-cored choke of high inductance is connected in series with the positive lead, and another in the negative lead, and across each end of these

will be found a fixed condenser of 4 mfd.

Thus, one of these acts as a reservoir for the rectified current before it reaches the chokes, and the other forms the second reservoir across the outer ends of the chokes. (By the way, in the actual unit you will not find that two separate chokes are used in the positions just mentioned, but instead a combined unit is employed which has a single iron core carrying two separate windings, which, of course, serves the same purpose and saves a good deal of space.)

This arrangement of double choke and reservoir condensers comprises

the main smoothing circuit and the negative lead now goes direct to the negative output terminal of the unit. From the positive side, however, three leads branch-off to the various voltage-adjusting devices for each of the three positive output terminals.

The Voltage Adjustments

These voltage-adjusting devices are simply variable high-resistances included in series with each lead, these resistances being of a type suitable for carrying the necessary small current without causing any hissing or crackling noises or heating up unduly, and by virtue of variations of resistances they give the necessary

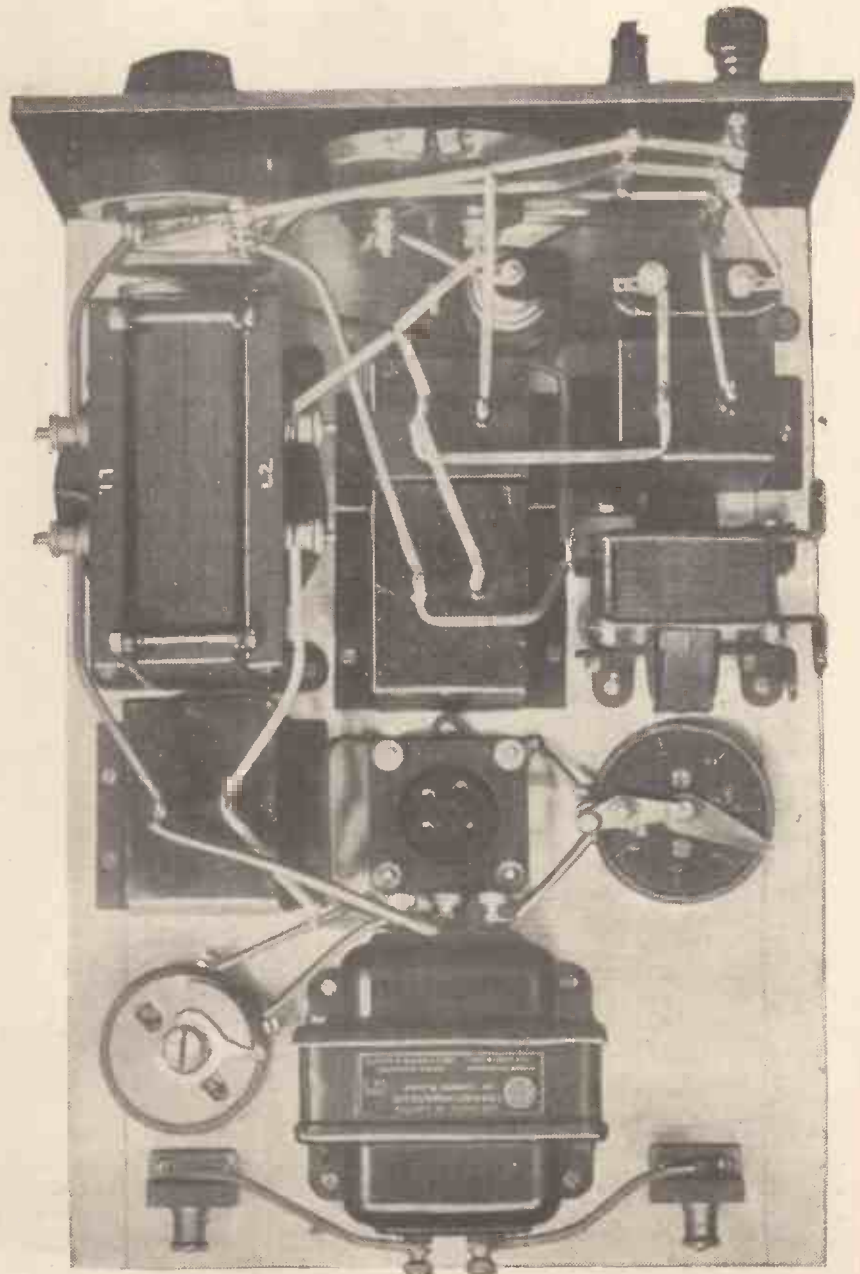

This plan view will be very useful in working out any small changes of spacing which may be necessitated by the use of components of different size or shape.

control of output voltage. It will be realised that when a current is flowing through these resistances a voltage drop will be set up across them, and we have here a means of adjusting the actual voltage on the output terminals to any desired figure within certain wide limits.

In many eliminators it is necessary to calculate the actual resistance required to produce the desired voltage drop and then to insert a fixed resistance of this value in a pair of clips; but in the present instance no such trouble is involved, since there is a means provided on the eliminator

the high-frequency and detector portions of the set, these resistances are of the very useful type known as Bradleyohms, which will carry a medium current quite satisfactorily, and give a very smooth and wide control of resistance. In the third tapping (intended to supply the low-frequency portion of the set), a different type is used, namely, a "Centralab" power type, which will carry considerably larger currents without trouble. You will find the actual details of these resistances marked on the various diagrams, and you will find that in practice they give ample

there is some risk of overheating the transformer if this is done.

Shunted across from each high-tension positive terminal direct to negative you will find an additional large condenser, intended to provide extra smoothing and also to act as a by-pass condenser to prevent coupling effects being produced by the series resistances in each lead.

In the case of the detector and low-frequency terminals these are 2-mfd. Mansbridge condensers, but in order more effectively to reduce coupling troubles the condenser across the terminal intended to serve the high-frequency valves is of the mica type, which is a more perfect condenser from the high-frequency point of view. In order to keep down expense this latter is only of .1 mfd. capacity, but this will be found quite sufficient for all normal purposes. All three of these condensers are extremely important, and should not under any circumstances be omitted.

THE COMPLETED UNIT

The two rheostats are provided to allow various types of rectifying valves to be used.

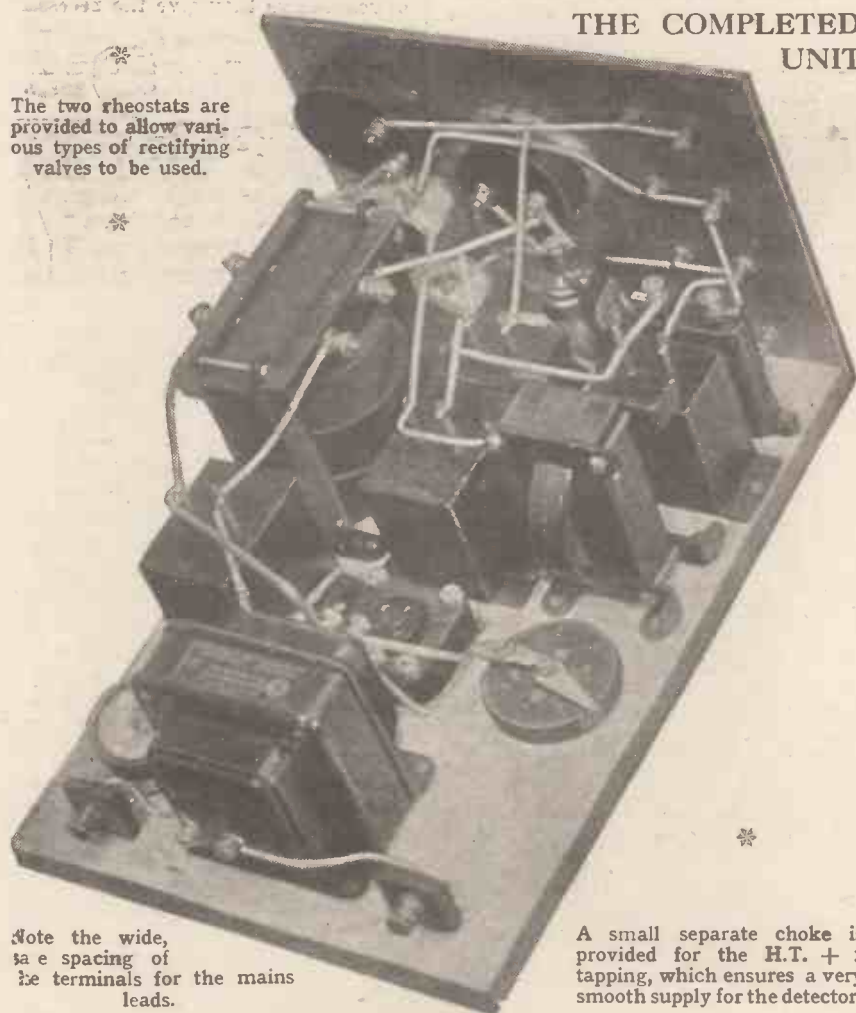

Note the wide, safe spacing of the terminals for the mains leads.

A small separate choke is provided for the H.T. + 1 tapping, which ensures a very smooth supply for the detector.

itself for measuring the voltage on each terminal, and thus all one has to do is simply to turn one of the adjusting knobs until the desired figure is registered (this must be done, of course, while the unit is actually supplying current to the receiving set and not on open circuit).

The Resistances

In the leads to H.T.+1 and H.T.+2, which are intended to supply

control of the output voltages: From H.T.+3, for example, you will find that on moderate loads, up to about 15 or 20 milliamps, you will be able to obtain a voltage variable from quite a low figure, much lower, in fact, than you will ever need to utilise, up to about 200 volts. When larger currents are drawn (up to about 30 milliamps), the maximum obtainable will perhaps be only about 180 volts. Larger currents still can be obtained at proportionately lower voltages, but

Extra Smoothing

One further point before leaving this part of the circuit. You will see that in the lead intended for the detector valve there is an additional iron-cored choke. It should be explained that this is provided because it is found that any slight imperfection in smoothing the current for the detector valve immediately shows up as a bad hum. This extra choke, of course, puts up the cost of the eliminator a little, but I think that you will find that it is really worth while in the end to make sure that you are really going to get a smooth and pure supply.

We next come to one of the special features of this particular mains unit, namely, the device provided to enable you to measure the voltage on each output terminal while the apparatus is actually in use. This is a feature which I do not remember to have seen done in a proper manner in any eliminator for home construction, and proved a great convenience in use, cutting out as it does all the element of guesswork.

A Good Feature

It is really very pleasing to be able to decide that, for example, the low-frequency valve requires 140 volts, and thereupon to switch in the measuring instrument and turn a little knob until the meter reads the exact figure, and thereupon to rest assured that the valve will get just what you wish it to get, no more and no less.

(Continued on page 444.)



INTRODUCTION

THE first section of this special supplement deals, as indicated above, with "This Year's Solodyne," a full description of which appeared in the January issue of MODERN WIRELESS. This five-valve receiver, which incorporates very many modern and attractive features, has achieved considerable popularity, and reports from traders indicate that practical interest in it is increasing rather than decreasing.

In view of its acknowledged simplicity of construction, ultra-simple manipulation and super-sensitivity, this modern "Solodyne" Five is not an expensive set to build. Comparisons show, in fact, that, on the contrary, it almost deserves to be termed "inexpensive." Nevertheless, it is in every respect a "de luxe" receiver, and the Research and Construction Dept. carried out a great number of experiments, and weeks were spent in research in order to achieve these remarkable results.

But inexpensive and thoroughly sound as is this "Solodyne" Five, there are doubtless many readers who have found the design out of their practical reach or just a trifle too ambitious for them. There is now, however, a "Solodyne" for practically every pocket. In this Supplement there are full descriptions of threethree-valve "Solodyne" receivers.

When the decision to present a smaller "Solodyne" design was made, the Research and Construction Dept.

was asked to eliminate very special or expensive valves and to employ as many of those components that figure in conventional sets as was possible. But after carefully considering this problem it was found that to embody full "Solodyne" advantages the use of a special system of gang tuning was essential.

After much careful thought it was finally decided to give full descriptions of three versions of the special three-valve "Solodyne" design produced, in order that the fewest restrictions possible would be imposed on constructors. Consequently we are now able to present two "Solodyne" Threes employing different types of gang condensers (many constructors will already possess one or the other), and a third version using ordinary variables.

All these versions embody the same essential circuit arrangement, and we wish to take this opportunity of

making it clear that we claim no originality for it. But we do claim that the layouts of these sets are the result of intense research and are novel, very efficient and representative of the high radio engineering standards we are endeavouring to preserve in all our sets from the simplest crystal arrangement upwards.

The concluding portion of the Supplement is devoted to an article which should prove of distinct value to owners of the original "Solodyne" Five. During the past two years some noticeable progress has been made in many departments of radio reception, more particularly in L.F. circuits.

Mr. Johnson-Randall tells you exactly how the L.F. portion of the original "Solodyne" can be brought right up-to-date and made to give those results expected of a modern multi-valver.

.....
 Once more we have made special arrangements with Mr. John Scott Taggart to use the word "Solodyne."
 This time we have something of particular importance and interest to place before our readers—no less than a Special Supplement devoted to "Solodyne" designs—old and new.
 The section headings given above show the wide ground we cover. Whether you have one of the original "Solodyne" Five's, or have built a 1928 model, or are contemplating the building of a new set, here you have something of direct personal interest.
 In introducing another entirely new "Solodyne" design, the "Solodyne Three for the Economist," we have given the closest consideration to that factor of paramount importance—the constructor's pocket. And we believe we have found the solution to the problem of "de luxe economy" by the presentation of alternative versions of one essentially sound and attractive design.
 A 1/- BLUEPRINT OF THE "THREE VALVE SOLODYNE FOR THE ECONOMIST" IS PRESENTED FREE WITH THIS ISSUE.



The important subject of accessories for this modern multi-valver is dealt with.

By G. P. KENDALL, B.Sc.

IT is always interesting, when a "star" design has been out a few months, to note whether there are many inquiries from readers for suggestions as to accessories for use with the receiver, for this is one of the surest guides to the real performance of the set in readers' hands. When a constructor begins to take a really keen interest in the adjuncts of his set it is a pretty sure sign that he is pleased with its behaviour.

It is gratifying to observe, therefore, that a very considerable volume of correspondence is being received concerning the 1928 "Solodyne" and its accessories. So many inquiries, in fact, have come in that it seems worth while to try to cover some of the main points in article form, selecting those which appear to be of general interest.

Worthy of a Good Speaker

First, there is the question of the loud speaker. There seems to be some uncertainty in the minds of some constructors as to the standard of quality to be obtained from the set, and hence as to the pains worth taking in the selection of a loud speaker. Actually, the quality which the set will give when working properly is of quite a high order, and it can be assumed that it will take in a great deal of the bass end of the register, so that it is well worth while to provide it with one of the speakers capable of giving a good response on the lower frequencies, such as those of the "cone" or open diaphragm type. As a matter of fact, the L.F. circuits will give a good deal of amplification on frequencies even below those which the average loud

speaker of this type will respond to properly.

It must not be forgotten, however, that if really fine reproduction is desired it is most essential to use a good low-impedance super-power valve in the last stage. It is hopeless to expect to handle real loud-speaker volume with a small valve if the speaker itself is sufficiently good to show up the imperfections in the reproduction. This may perhaps be something of a new point of view to some readers, but it is a fact that a

Many inquiries have been received regarding the use of "Mains Units" with "This Year's Solodyne" in order to eliminate H.T. batteries. The fear has been expressed that this would be impossible in view of the employment of a special type of H.F. valve in the set.

Mr. Kendall, however, has some reassuring remarks to make on the subject in the accompanying article. He also deals with other such all-important points as the loud speaker.

Constructors of the "Set of the Year" should carefully read the article, for even though their results may be all that they desire the information is worth adding to one's store of knowledge against future contingencies.

rather poor speaker will hide defects which a good one will make painfully apparent.

Success with Mains Units

The other requirement for making the best of a good speaker is a really adequate amount of H.T. on the last valve, and this brings us to the question of mains units, which has been raised by some readers. Large and sensitive sets are sometimes a little difficult in this respect, and tests are necessary before a definite verdict can be given in each case. As a result

of our experiments we feel that there need be no hesitation in using a mains unit of any reputable type with the 1928 "Solodyne," provided that it will provide the fairly large current necessary for any five-valve set. The actual current drawn will obviously depend mainly on the last valve, since the earlier stages take comparatively little, but as a general guide 20 to 30 milliamps may be taken as a likely figure.

A Special Scheme

A point of difficulty likely to arise with some eliminators is that they do not provide a sufficient number of positive tapplings. It is obviously desirable to allot a separate tapping to the H.T. terminal on the set which supplies the screening electrodes of the H.F. valves ("G₂") since we required a fairly accurate 80 volts here. If no separate tapping is available the following expedient will overcome the difficulty. Supply terminal G₂ from one of the higher voltage taps, but place in series with the lead from set terminal to eliminator terminal a variable high resistance such as the No. 10E Bradleyohm (R. A. Rothermel, Ltd.), which will enable you to vary the voltage on G₂ as desired, and find experimentally that which gives the loudest signals. (It is impossible to measure with ordinary instruments and methods.)

A Cure For Hum

When you are using an extra control in this way you should try the effect of connecting a condenser of 2 mfd. capacity between terminal G₂ and L.T.—. If this seems to result in greater stability and better behaviour generally, you should make it a permanent addition. (It will be as well to mount the Bradleyohm and the extra by-pass condenser together in a little ebonite-topped box to eliminate risks of shocks.)

With some eliminators in which the smoothing and by-passing is not very thoroughly done, there may be a certain amount of hum and even "motor-boating." In the majority of cases a cure will be found in the use of an extra iron-cored choke in series with the lead from the eliminator to the H.T. + 2 terminal on the set (the secondary of an old L.F. transformer will do), with an extra 2-mfd. condenser between H.T. + 2 and L.T. —. As in the case of the voltage-control device, these two components can be placed in a small box and used as a separate smoothing unit to compensate.



A THREE-VALVE "SOLODYNE" FOR THE ECONOMIST

To most people there is certainly something very fascinating indeed about the idea of a sensitive long-distance receiver which can be tuned entirely by means of a single knob or dial. One of the best proofs of this appeal is to be found in the really extraordinary popularity of the 1926 "Solodyne" receiver, a popularity which must surely have been based to a very considerable extent upon the attractiveness of the single-dial idea.

Difficult Problem

The "M.W." Research Department has devoted a good deal of time during the last few months to the problem of developing a design for a three-valve receiver which should be tuned on these lines, and yet give a really high standard of performance.

This latter condition is a very difficult one to meet in a "ganged"

receiver, since the very fact of gang control is usually accepted as meaning

Three versions of this remarkable three-valve "Solodyne" receiver are described in the following pages. First of all there is a model having a drum-drive tuning control.

THE 1/- BLUEPRINT PRESENTED FREE WITH THIS ISSUE OF "M.W." ACCOMPANIES THIS FIRST VERSION.

Subsequently we give a model embodying an ordinary gang variable, and, finally, one which uses ordinary condensers.

In this way we not only hope to widen the appeal of the set considerably, but also to make it possible for the greatest number of constructors to use components they happen to have on hand.

The whole of the experimental, constructional and descriptive work on these sets was carried out by the "Modern Wireless" Research and Construction Department.

a certain inevitable loss of efficiency. It was early decided that this junior

version of the "Solodyne" should contain three valves, one a high-frequency amplifier, a detector and one low-frequency amplifier, and further to employ a circuit closely similar to that of the first "Solodyne," but the knotty problem of maintaining full efficiency in spite of ganged control remained to be overcome.

As a matter of fact, it has been found that this difficulty can be overcome in various somewhat elaborate fashions, but it was not considered that any of these were suitable for use under amateur conditions, depending as they do upon more or less laboratory operations.

Simple Solutions

Instead, we decided to adopt modified systems of gang tuning which removed completely the difficulty which confronted us, permitting a readjustment of the gang tuning actually during the process of operation and in the simplest possible manner, so that the ease of tuning was in no way sacrificed.

THE COMPONENTS YOU WILL REQUIRE.

- 1 Panel, 14 in. × 7 in. × $\frac{1}{4}$ in. or $\frac{1}{8}$ in. (Original was Resiston. Any good branded material).
- 1 Cabinet to fit, with baseboard 12 in. deep (Artercraft, Bond, Cameo, Caxton, Makerimport, Pickett, Raymond, etc.).
- 1 Double drum-drive condenser, .0005 mfd. each section (Cyldon).
- 1 .0001-mfd. miniature type reaction condenser (Peto-Scott in set. Other suitable types are the Cyldon "Bebe," Ormond, etc.).
- 1 On-off switch (Igranic in set. Any standard type, such as Benjamin, Bowyer-Lowe, L. & P., Lissen, Lotus, etc.).
- 3 Sprung valve sockets (Lotus in set. Any standard make, such as Benjamin, Bowyer-Lowe, B.T.H., Burndept, Burne-Jones, Igranic, Marconi-phone, Precision, Pye, Redfern, W.B., etc.).
- 1 Baseboard-mounting neutralising condenser (Peto-Scott in set. Any standard type).

- 2 Plain unscreened 6-pin coil sockets (These should be of a type which support the coil to a height of about 1 in. Those in the set are of Peto-Scott make. Other suitable types are the Bowyer-Lowe, Burne-Jones, Colvern, Lewcos, etc.).
- 1 .002-mfd. fixed condenser.
- 1 .0003-mfd. fixed condenser.
- 1 2-mfd. Mansbridge type condenser. Note.—The fixed condensers in this set are of Lissen make. Any standard type can be used: Clarke, Dubilier, Goltone, Mullard, T.C.C., etc.).
- 1 2-megohm grid leak (Igranic in set, mounted at one end on the grid condenser by means of one of the clips provided, and at the other with one of the 3-point tags supplied with the leak for direct attachment to the wiring. Any of the standard makes, such as Dubilier, Lissen, Mullard, etc., can be used with a separate holder).

- 1 H.F. choke (Burne-Jones in set. Any standard make: Bowyer-Lowe, Colvern, Cosmos, Lissen, Ormond, R.I.-Varley, Wearite, etc.).
- 1 L.F. transformer (Igranic 3-6 to 1, type G, in set. Any good make of low ratio).
- 1 Terminal strip, 2 in. × 2 in. × $\frac{1}{4}$ in., with two terminals (Burne-Jones engraved type in set. Can be cut and fitted with engraved terminals if desired, such as Belling-Lee, Eelex, Igranic, etc.).
- 1 Terminal strip, 7 in. × 2 in. × $\frac{1}{4}$ in., with seven terminals (see above).

Materials for screening partition (see text), flex and Clix plugs for G.B. leads, screws, wire for wiring up, etc.

Note.—The original was wired with Glazite, but any desired material can, of course, be used, such as bare tinned wire and Systoflex, Junit, etc.

At this point let it be said that the expedients adopted have proved very considerably more successful in every way than our most sanguine hopes led us to expect, and it is felt that it should be pointed out to readers of MODERN WIRELESS that the expected wide popularity of the smaller "Solodyne" will be based to at least as great an extent upon the very excellent results which are obtainable from each of the three forms of the design as upon the attractive idea of ganged tuning.

Careful Testing

In preparing our test reports, in general we are influenced always by the fear of misleading the relatively inexperienced constructor, since we have found that it is one thing for the skilled operator to produce a marvellous list of stations under good conditions with the aid of a wave-meter, and quite another for the home constructor to get such results under his own conditions.

We, therefore, make it a practice to test all our sets under decidedly adverse conditions, upon a rather poor aerial, and even then to issue a serious warning to the effect that the set was in the hands of a really skilled operator using a wave-meter for rapid identification of stations.

Such a procedure does undoubtedly go far to protect the reader from any risk that the report may not always enable him to form a true estimate

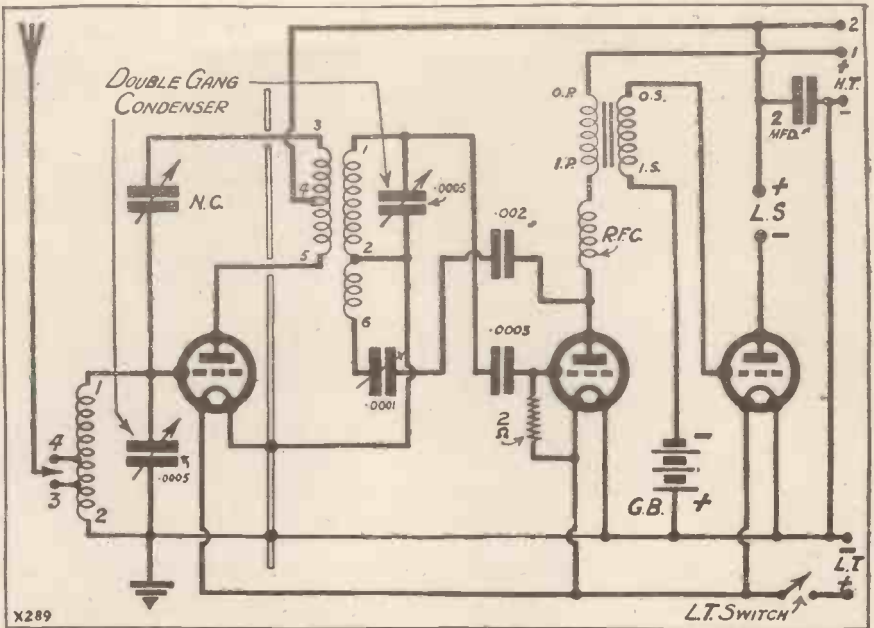

of the capabilities of the set in his hands, but there is a danger of underestimating them in comparison with other sets, which may have been tested under at least average conditions, and therefore it was decided to treat the three-valve "Solodyne" rather differently.

As soon as the first set was completed it was subjected to the usual preliminary test, in which it was attached to a very inefficient aerial and earth system in the "M.W." Laboratory at Fleetway House.

To receive Langenberg here in daylight, with a three-valve set, is distinctly difficult, yet type A not only brought in the station in daylight, but actually brought it in on the loud speaker at moderate volume. The selectivity, too, was found to be highly satisfactory, since although 2 L O is only a mile and a half away, there was no interference whatever from this station when receiving Langenberg, and it would have been possible to go considerably farther down the wave-length scale before such interference began to be felt.

A Fine Performance

No three-valve set consisting of H.F., det., and L.F. of the normal three-electrode type has ever put up a performance like this in our hands before. Later, as the other two models—types B and C—were finished, it was found that each was capable of repeating this performance without the slightest difficulty, and it can be taken that there is very little indeed to choose between the three types as regards actual results.

All three models had shown such great promise in their preliminary tests that it was decided that to give a fair basis of comparison with other receivers it would be necessary to carry out two further tests; one our normal one under distinctly adverse conditions on a poor aerial at a distance of between seven and eight miles from 2 L O, and another in the same locality, but on a fairly good aerial and earth, and a report of these two tests will be found elsewhere.

As will be seen, they indicate a very high standard of performance

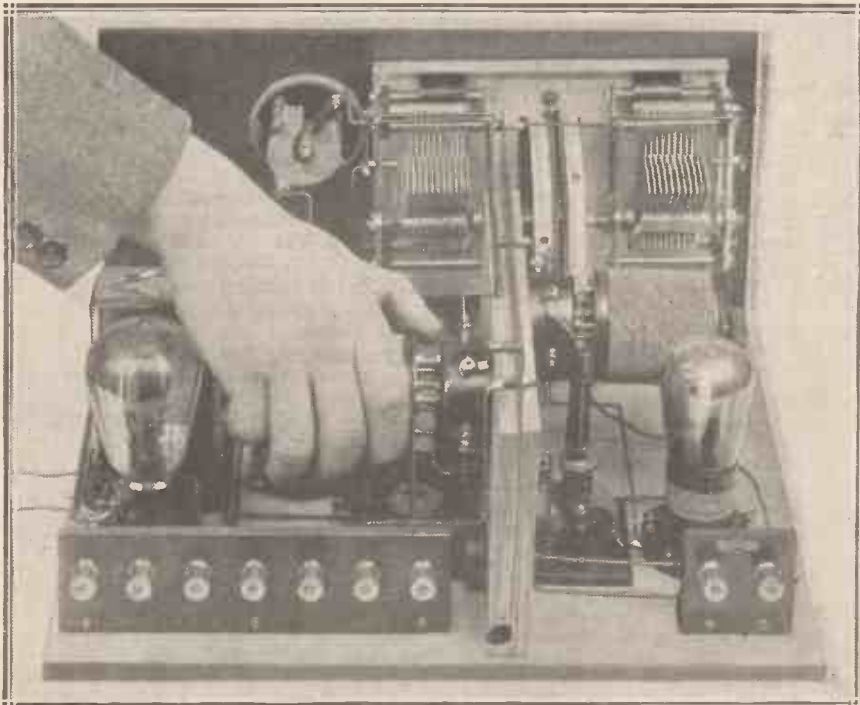

A special feature of the set is the horizontal mounting of the coils, which makes possible a highly efficient system of screening. You should be careful in withdrawing the H.F. transformer to give it a slight up-and-down motion to ease it out gently.

indeed, and this is all the more gratifying in view of the fact that it is possible to construct these receivers with perfectly standard parts.

It will be seen at once that there is nothing really out of the way in the circuit, and it is indeed one of the

merely to tune in any given station, get the two drums in correct relation to each other, and then run them together up and down the wave-length scale. As other stations are picked up, very slight readjustments of each section can be made independently, by

The layout and general arrangement of the H.F. and detector stages, with the appropriate screening, are, of course, the most important features, and you will observe that across the baseboard is placed a vertical screening partition, which consists of a sheet of aluminium or copper faced upon its two sides with plywood of about $\frac{3}{8}$ in. thickness.

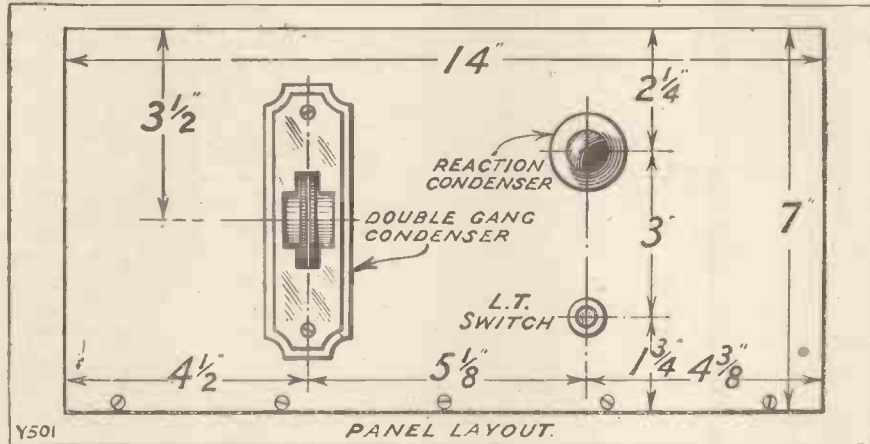

most straightforward and satisfactory methods of using three valves for long-distance reception (and, of course, for local work, if desired) which can be imagined. The high-frequency valve is of the neutralised type employing the popular split-primary circuit, and this is followed by a grid-condenser rectifier with condenser-controlled reaction upon the secondary of the intervalve H.F. transformer. The third valve acts as a low-frequency amplifier, being transformer-coupled to the detector.

You will see that it is not in any startling development of the circuit that the high efficiency of the three-valve "Solodyne" is to be found, but rather in the simple but very effective and efficient system of screening and layout.

Accurate Tuning

Before we leave the circuit there is just one point to be noted, and that is that for types A and B no filament resistors are indicated, and it should be explained that this is a point which is left to the taste of the constructor. (See Set C regarding this point.)

The method of ganging adopted in the type A receiver, which we are considering at the moment, is that which is aptly christened "thumb control." This consists in the use of a special double condenser with two sections placed lengthwise along the panel, each being controlled by a single disc or drum whose edge projects through the panel very close to the other so that it is quite easy to run the two together by placing the thumb upon them.

Operating a receiver of this nature is simplicity itself, since one has

using both thumbs, and so one can be assured of a perfect tuning adjustment upon any wave-length within the range of the coils and the condenser.

With properly matched coils you will find that the two sections run together very closely over the tuning scale, and that slight variations only will be needed at the top and bottom, these being the regions over which gang-controlled receivers usually give slightly weaker signals, a defect which is, of course, not present in any of the smaller "Solodyne" receivers.

Low Screen Losses

Here it may be remarked that this is one of the most important features of the set, and it will be realised that the effect of this method of screening is to cut off only those portions of the fields of the coils which would otherwise pass from one stage of the receiver to the other, and cause the familiar undesirable effects of interaction, with their disastrous consequences of imperfect neutralisation, direct passage of signals from one circuit to the other, with consequent loss of selectivity and so on.

A further practical advantage of this arrangement is that it is very easy to insert the coils correctly in their bases, since the pins can be seen as they engage with the sockets, and there is no difficulty in deciding which way round the coil should be turned before insertion.

Just one word of warning must be given, however, about this method of mounting the coils. You should be careful in removing the

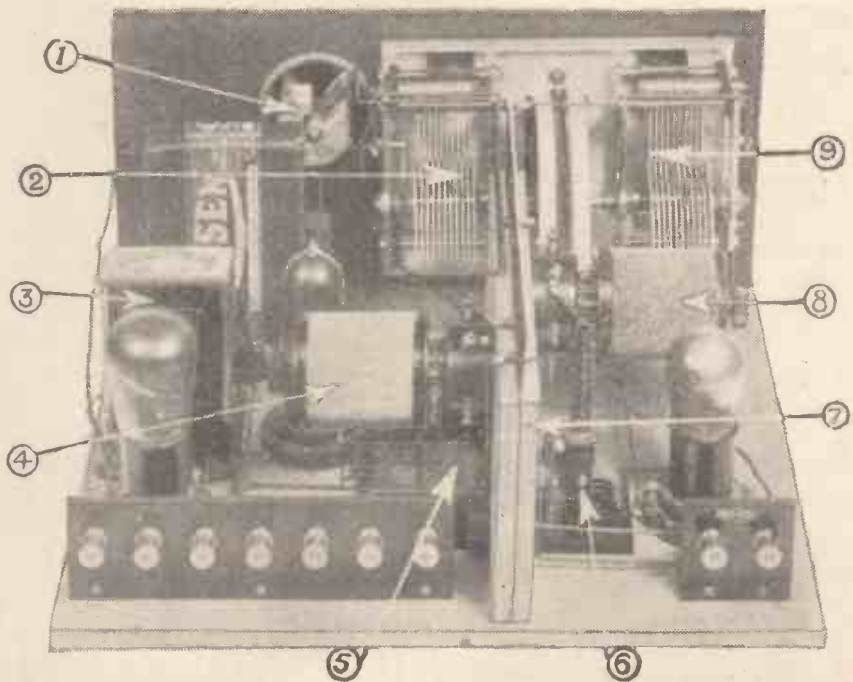

Here is a key to some of the special features of the type A version: (1) is the reaction condenser; (2) and (9) the sections of the double condenser tuning the H.F. transformer and the aerial coil respectively; (3) is the L.F. transformer; (4) and (8) are the H.F. transformer and aerial coil; (5) is the 2-mfd. condenser; (6) the neutralising condenser; and (7) is the special screen.

H.F. transformer from its socket lest it should come out with rather a rush and administer a shrewd knock to the L.F. valve in doing so.

The necessary working dimensions for the construction of the screening partition with its two wooden facing pieces will be found accompanying this article.

All that you will need is a drill of the same kind that you employ for drilling the panel, some wood-screws for securing the two pieces of wood (the screws pass right through from one to the other through holes in the metal), and some small brass screws which can be placed and secured through suitable holes in the metal for connections thereto.

Ready-made Screens

Incidentally, if you do not wish to go to the trouble of constructing this screen you will find that various advertisers in MODERN WIRELESS (Messrs. Paroussi, Raymond, etc.) can supply it all ready for assembly in the set. The partition is secured to the baseboard by passing screws upwards through the latter and into the edges of the wooden facing pieces.

One or two other points should, perhaps, be mentioned in connection with the layout and construction of this set. First, it will be noticed that only one Mansbridge type condenser is provided, this being of 2 mfd. capacity.

This is secured by means of the usual two screws through its feet into

the wooden facing-piece of the screening partition, so that the condenser lies flat upon the baseboard in a position where it occupies very little room. This condenser, it should be

fitted by a more careful adjustment of H.T. (in the neighbourhood of 60 volts) to ensure a smooth control of reaction.

Turning now to operating matters,

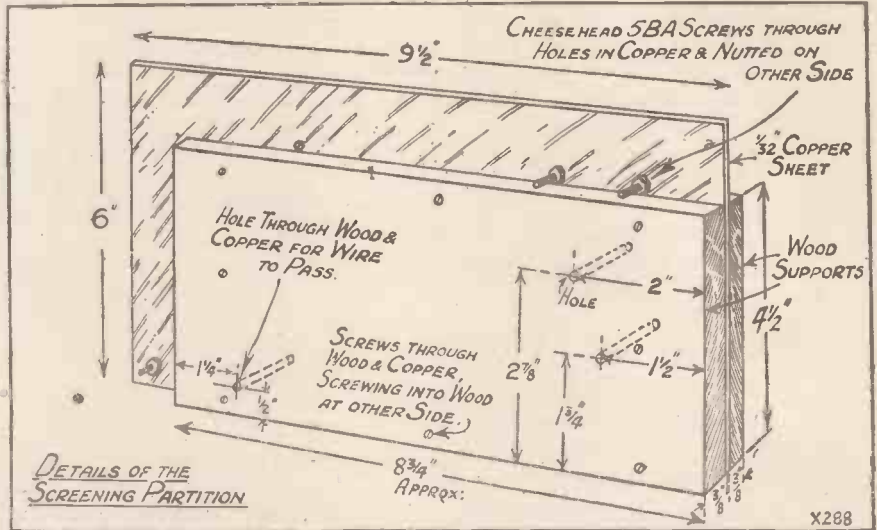

explained, is connected across the H.T. tapping which supplies the low-frequency valve and also the high-frequency stage. These two valves are given a common H.T. in the neighbourhood of 100 to 120 volts, which will be found to suit practically all combinations of valves. The other H.T. positive terminal is a separate one provided for the detector valve, which is usually bene-

the first points which should have our attention are the valves and coils. The coils you will need are one split-primary type aerial coil, and one split-primary H.F. transformer, these being for the broadcast band. Another pair of coils will be needed if you propose to receive the long-wave stations. These coils, it should be pointed out, *must* be of really good quality, since to a very large extent they make or mar the performance of the set.

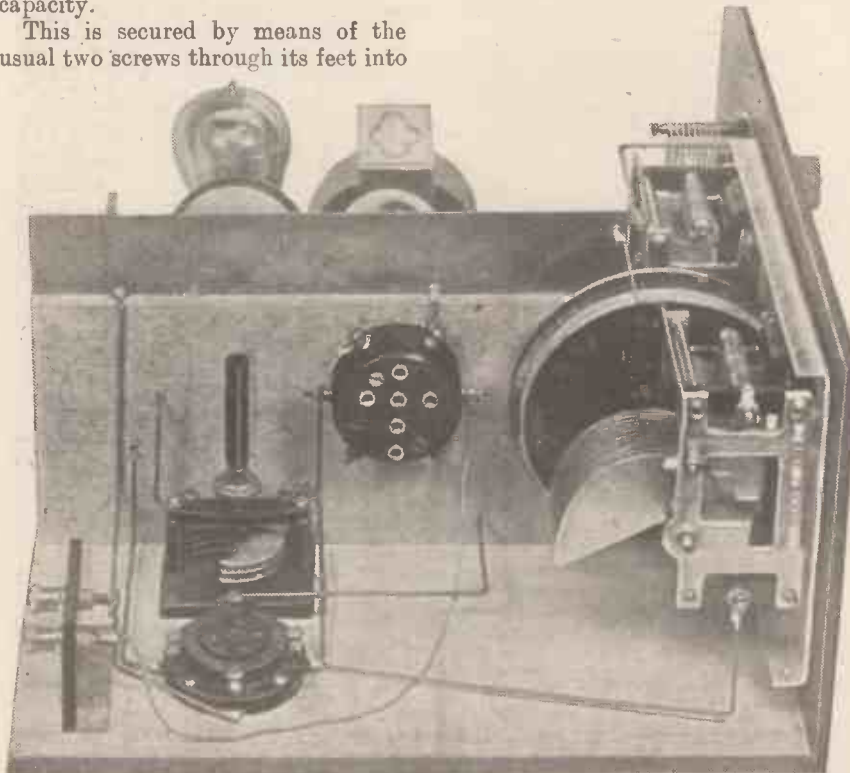

Everything constituting the "input" side of the H.F. valve is visible here. Note the exact position of the aerial coil socket.

Suitable Valves

The valves to use in the set are not really critical, and either 2- or 6-volt types can be employed. The 6-volt types will naturally be used by those who wish to obtain the maximum possible efficiency from the set, and the 2-volt valves will appeal to those to whom economy is a more vital factor. For the H.F. and detector stages you should use valves with an impedance of between 13,000 ohms and 25,000 ohms, and, of course, of as high an amplification factor as can be obtained within those limits. In the 6-volt range the following are suitable examples: D.E.L.610, Cossor 610 H.F., S.S.6075 H.F., P.M.5X, E.S.5.D.E., etc., etc. In the third socket you should, of course, use a power valve, with grid bias adjusted according to the makers' instructions for a particular value of high tension.

With all the batteries connected up and the earth attached, but not the aerial, attach a pair of 'phones and proceed as follows: Having inserted

the coils in their sockets, set the aerial section of the drum condenser at about the middle of its scale.

With the neutrodyne condenser at zero, and likewise the reaction condenser, revolve the right-hand section of the drum slowly round its scale, noting whether the set bursts into oscillation at any point. If it does not do so, bring up the reaction condenser slightly until it does and you will then find that it will oscillate over a narrow band of adjustment of the right-hand condenser.

Now gradually increase the setting of the neutrodyne condenser, slowly revolving the right-hand drum as you do so until you find that the set has ceased to oscillate at any setting. Now slightly increase the setting of the reaction condenser until the set once more breaks into oscillation when the two circuits are in step, proceeding to increase the neutralising condenser once more, until oscillation is stopped.

Obtaining Stability

Proceed in this way, gradually increasing the capacity of the reaction condenser and the neutrodyne condenser until you find that you have overshoot the most stable condition of the set and discover that further increases of the capacity of the neutrodyne condenser will make the set oscillate more strongly instead of stopping it. With a few experiments on these lines you will quickly find a setting for the neutrodyne condenser at which the set can be adjusted to the verge of oscillation on the reaction control, and so that slight movement of the neutralising condenser in either direction will cause it to break into oscillation when the tuning condensers are brought into step with each other.

It is as well to check this adjustment after the aerial has been connected and a distant station has been tuned in, since testing is then somewhat easier. (Don't let the set oscillate for more than a moment then, of course.)

Gang Adjustment

Having neutralised the set you can turn your attention to the setting of the two drum dials, and to do this you should tune in a distant station somewhere near the middle of the scale. Having done this, note whether the two drums read exactly alike, and if they do not it is a simple matter to cast one loose and revolve it without turning the vanes so that identical readings are given, whereupon you can tighten it up once more and you will then find that as you run the two

drums together the readings remain very close to each other throughout the scale.

Operating the set is now a very simple and straightforward matter, and is merely a matter of running the two drums more or less together with the thumb, at the same time operating the reaction control to keep the set just a little below the oscillation point when searching for distant stations.

A Compensating Device

A final point which may perhaps puzzle some people. It will be noted that the two coils are "staggered" on the screening partition, one being much closer to the tuning condenser than the other, and it might at first sight be thought that this would upset the accuracy of the ganging arrangement.

As a matter of fact, quite the reverse is the case, and this was done advisedly. The point is that a certain proportion of the capacity of the aerial is transferred to the first tuned circuit by the auto-coupling scheme and affects its tuning to some extent; therefore, somewhat longer leads were arranged for the other coil, to provide some measure of compensation for this effect.

It is not a very important point, however, in a set where we are not rigidly limited to definite gang tuning, and it is merely explained for the benefit of those who like to understand all the ins and outs of the design which they are building up.

(Anyone who is considering building any individual member of this family of receivers is strongly urged to read through the matter describing all three.)

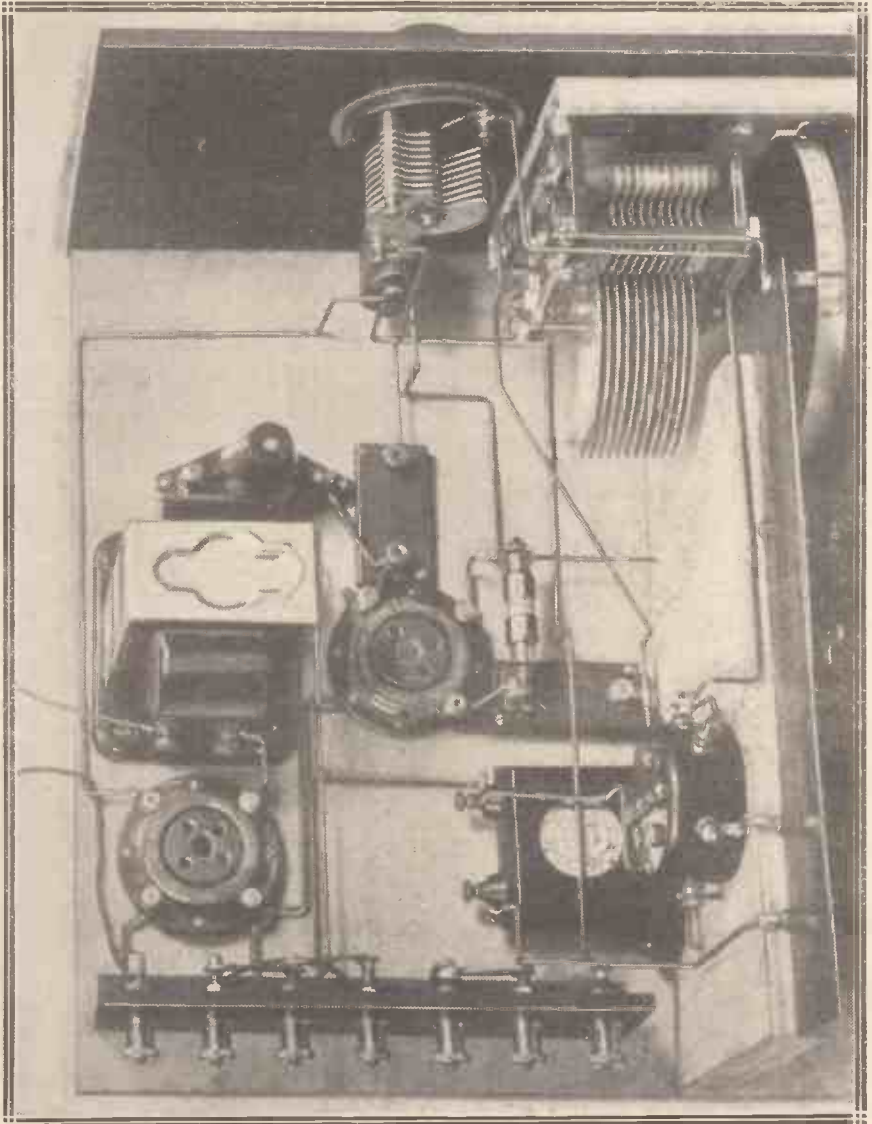

Special pains have been taken to produce a very compact and efficient layout for the L.F. side, as well as for the H.F. circuits. Note the space behind the panel for the G.B. battery.

THE "SOLODYNE"
THREE
SECOND VERSION

THE second receiver of the new series of three-valve "Solodyne" sets is one that can be more truly described, perhaps, as a ganged instrument, since one of the conventional types of double-gang condensers is used. However, the great difficulty of using this system, namely, the fact that the two circuits are very apt to

Thus when the set is being handled by one of the family, this trimming condenser can be left set to a mid-position and all tuning done on the main dial. In this way quite a range of stations can be brought in, but, of course, the more experienced operator would work the trimmer as a vernier control when he has picked up his station, and by bringing the two circuits more perfectly into step with each other will reap his reward in louder signals and better selectivity.

This design is really intended to cater for the large number of constructors who may have on hand a

sisting of an H.F. valve with split-primary intervalve transformer, grid-condenser rectifier with reaction, and one stage of transformer-coupled L.F.

However, you will note that across the section of the gang condenser which tunes the secondary of the H.F. transformer the little trimming condenser is shown, and it should be stated here that the position for this is chosen to allow for the fact that across the other tuned circuit a certain amount of the capacity of the aerial is transferred by the fact that it is coupled thereto.

It is quite possible under favourable conditions to find a value of the trimming condenser at which it can be left permanently set, and where it will compensate with a good deal of accuracy for the capacity effect of the aerial over nearly the whole range of the gang condenser. If you can find such a setting, of course, the trimmer can be left there and all tuning done on the main dial, but this is by no means essential.



This is the second version of the Junior "Solodyne," referred to as "type B" in the text. The engraving on the panel gives a key to the various operating controls.

Using the Trimmer

In other cases, of course, you will turn the trimmer to a medium value, tune in on the main dial, and then make the final adjustment on the trimmer, with perhaps just a touch on the main dial to make quite sure that you have got the best tuning. (By the way, it should be mentioned here that it is assumed that anyone making up this set should first go to the trouble of running through the section relating to type A and picking out the main features of the circuit, some idea of the results that it will give, and so on.)

The only other difference between type B and type A which can be discerned in the circuit diagram lies in the fact that a fixed condenser

fall out of balance at the upper and lower ends of the tuning range, has been overcome by means of one of the simplest and most effective methods, namely, the provision of what is called in America a "trimming" condenser across one of the sections. This can be regarded simply as a vernier control, which may or may not be used, according to the skill of the operator.

double-gang condenser, or who wish to take advantage of the fact that such condensers can now be obtained very cheaply, and the details of the set have been worked out to see that such constructors shall not have to pay for their preference in loss of efficiency.

Where It Differs

In all the main features, of course, the circuit is exactly the same, con-

COMPONENTS REQUIRED.

- Panel, cabinet and baseboard, as for Set "A" (Cabinet in first case was actually an "Artercraft," and for this set a Peto-Scott).
- 1 Double-gang condenser, .0005 mfd., each section (Ormond in original, any standard make, square law, log-mid-line, or S.L.F.).
- 1 Slow-motion dial (Ormond "D.I." in original. Any good make).
- 1 .0001-mfd. miniature type reaction condenser (Cydon "Bebe" in original. For alternatives see Set "A").
- 1 Panel-mounting variable condenser ("Trimmer"), of very small capacity, such as the Igranite "Micro" or a neutralising condenser of the

- rotary vane type, i.e. the type which resembles a miniature of an ordinary variable condenser.
- Note.—A maximum capacity of about .0005 mfd. is suitable here.
- 1 On-off switch (Lotus in set. For suitable alternatives see Set "A").
- 3 Sprung valve sockets (Igranite in original. For suitable alternatives see Set "A").
- 1 Baseboard-mounting neutralising condenser (Burne-Jones in set. Any standard make).
- 2 Plain unscreened 6-pin coil sockets (Burne-Jones in set, but see also Set "A").
- 1 .002-mfd. fixed condenser.
- 1 .0003-mfd. fixed condenser.
- 1 .0005-mfd. fixed condenser.

- 1 2-mfd. Mansbridge type condenser. (Note.—The fixed condensers used in this set were a mixture of Clarke and T.C.C. For suitable alternatives see Set "A").
- 1 2-megohm grid leak and holder (Mullard in set, but see also Set "A" re these).
- 1 H.F. choke (Lissen in set. Any good make, such as those mentioned in list of components for Set "A").
- 1 L.F. transformer (R.L.-Varley "Straight Line" in set. Any good make of fairly low ratio).
- Terminal strips as for Set "A." Materials for screening partition (see text). General sundries as for Set "A."

of .0005 mfd. is indicated across the primary of the L.F. transformer in type B, and it is to be noted that this results from the fact that in this model one of the latest R.I.-Varley "Straight Line" transformers has been used, which calls for the provision of such a condenser.

was no longer any need to try and equalise the effect of the aerial capacity by means of leads of varying length, since the small trimming condenser takes care of this point. The two coils were therefore set in line, and the screen between them ensures that any interaction between them

be observed that an Igranic balancing condenser has been used, which is simply a miniature condenser with two sets of fixed plates and one moving, which was first incorporated in testing out another scheme of compensation. Actually, however, all that is used in the final design is the moving plates and one set of the fixed plates, so that the correct component to use here would be the Igranic Micro condenser.

Suitable Trimmers

This point is explained lest any constructor should be puzzled when examining the photographs, which may show that the condenser actually used has three terminal points. On the wiring diagram you will find that the two terminals actually used are marked to indicate which is the fixed and which is the moving, and this will serve as a guide when wiring up whatever type of condenser may be employed. Instead of the Igranic Micro condenser it is quite feasible to use one of the panel-mounting types of neutrodyne condenser, provided that one of a fair capacity is chosen.

This should be of the rotary vane type, i.e. one of the types which is simply a miniature variable condenser, since these are rather more suitable than one of the screw-down types which require quite a number of rotations to pass from maximum to minimum—a tedious business when used for tuning.

The arrangement of aerial and earth and battery terminals is exactly the

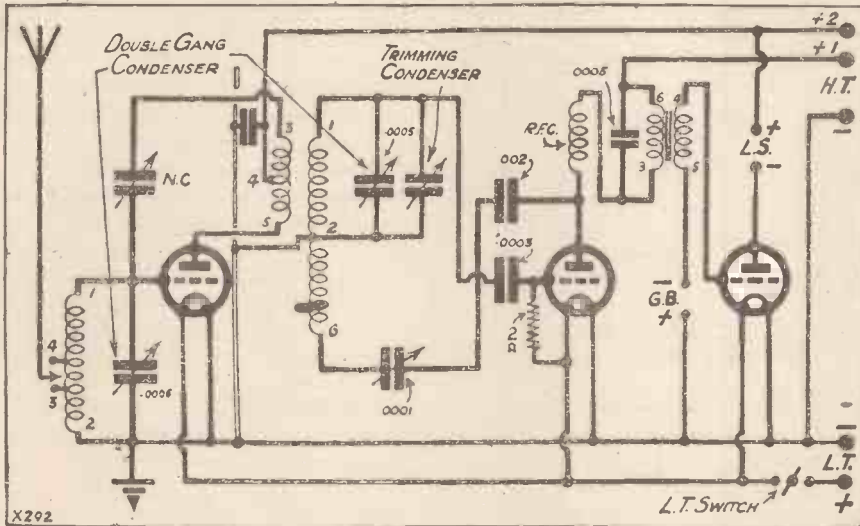

Before we start to deal with the constructional and practical matters for type B, there are one or two points which should be made clear concerning the layout and design side. If the reader will refer to one of the photographs giving a general view of the interior of the set, he will see that a very similar vertical screening partition is used, consisting of a sheet of aluminium or copper, faced upon either side with pieces of plywood of about $\frac{3}{8}$ in. thick, which is placed across the baseboard approximately in line with the centre line of the double gang condenser.

Screen Details

The metal to be used for the screening sheet, as already pointed out, may be either copper or aluminium, and the thickness is not at all important. It does not require to possess any great thickness since it is adequately supported on either side by the plywood facing, so that quite a thin gauge can be used, and this is a good deal easier to drill. To emphasise the fact that either metal can be used, copper was employed in type A, aluminium in type B, and copper again in type C.

In the case of the type B receiver it will be noted that the two coils are placed in line on either side of the screening partition, and this was done for two reasons. First, the size of the partition was necessarily reduced by reason of the arrangement of the gang condenser, and, secondly, there

shall be cut down to a very small figure indeed.

At the same time, as in type A, only that portion of the coil field which may cause trouble is cut off by the screen, the remainder of the field being free to extend in the usual manner of an open coil, so that screen losses in the circuit are reduced to quite a small value, and the efficiency therefore remains high.

Now as to the type of trimming condenser. In the original set it will

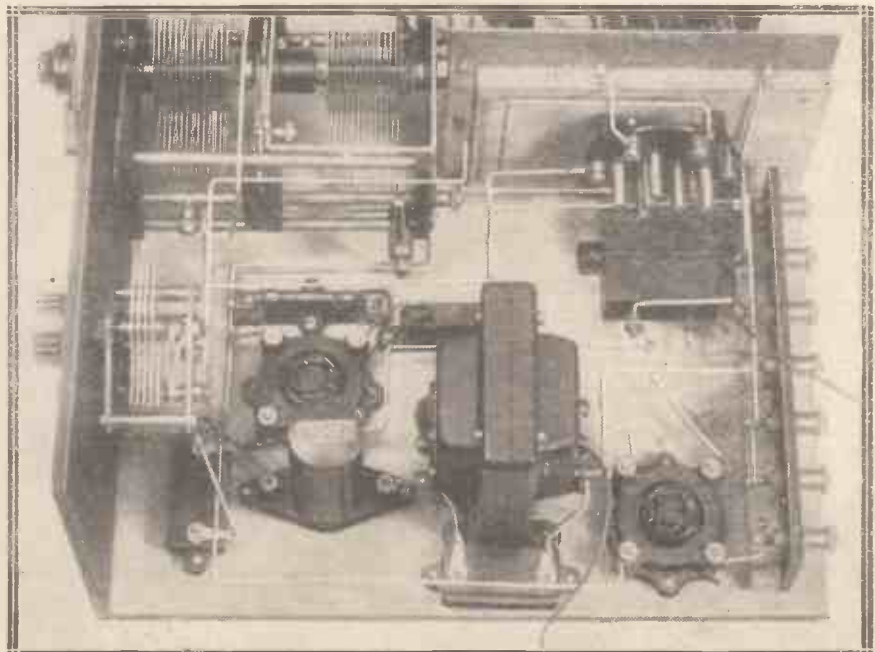

The L.F. end of the set is again very neat and compact. A space can be found for a G.B. battery beside the H.F. choke.

same on type B as on type A, and it will be seen that a common H.T. positive tapping is provided for the high-frequency and low-frequency valves, and, further, that only one Mansbridge type condenser of 2 mfd. is used: this, it should be observed, is mounted exactly as before

independently, since the separate drums made this quite easy.

A similar effect can be achieved in the case of type B, as will be seen in the following notes. First of all, by rotating the dial set the section of the gang condenser which is nearest to the panel at about the middle of its

the operation exactly as before, except that the variation of tuning for one of the circuits will be done by moving the rear section of the gang condenser by means of the fingers.

When you have satisfied yourself that the set is exactly neutralised (which you will not find at all a difficult matter if you carefully follow out the method as described for type A) you can proceed to attend to the matter of adjustment of the gang condenser. First set the two sections of the gang exactly in line with each other, and tighten up the coupling between them. Now place the reaction condenser at minimum and the trimming condenser at a midway position.

Adjusting the "Gang"

Now tune in your local station, set free the coupling between the two sections of the ganged condenser, and manipulate the two sections, one by means of the dial, and the other with the fingers, until the local station is heard as loudly as possible. Now tighten up the coupling between the sections, and proceed to search for distant stations, bringing up the reaction control so that the set is just a little below oscillation point.

Having picked up a distant station, slack off the gang condenser coupling once more, and manipulate the two sections exactly as before, until the station is heard as loudly as possible; tighten up once more and you will then be ready for searching for distant stations, and as each is picked up you can make such slight readjustments on the trimming condenser as may be necessary.

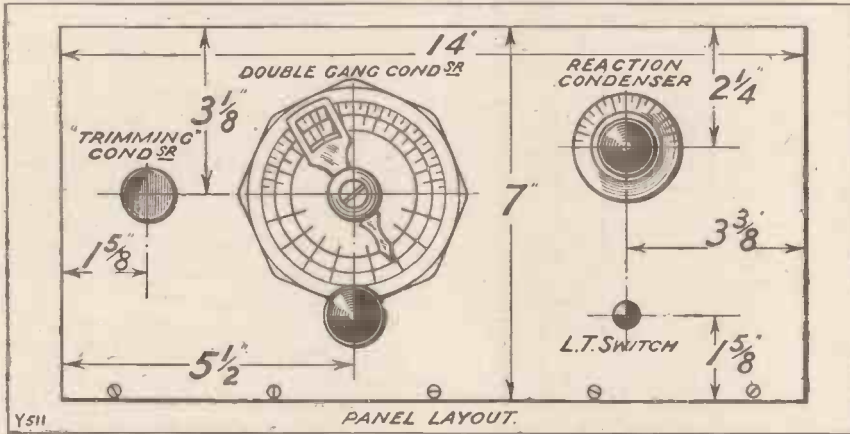

by being screwed to the vertical partition so that it lies flat on the baseboard of the set. Just as in type A the other H.T. positive terminal supplies the detector valve, and upon this the usual voltage of about 60 will be correct for most valves to obtain smooth reaction, with about 100 to 120 upon the first-mentioned H.T. positive terminal.

The remainder of the layout of type B is on the lines of type A, and the actual positioning of a number of components will be found very closely similar. Some slight differences will be noticed, resulting from the different size and shape of the double-gang condenser, and one is that the space available for the grid-bias battery behind the panel at the right-hand side is considerably reduced.

Space for Grid Bias

Nevertheless, there was found to be just room for a 9-volt unit standing on end close up against the side of the H.F. choke and between the choke and the side of the cabinet. If more grid bias than this should be desired, say for a super-power valve, accommodation can be found for it by attaching the battery to the side of the cabinet itself in a very similar position to that already indicated.

Turning now to operating features, it is to be noted that such points as coils and valves will be exactly the same in this set as in type A and in type C also. When we come to the neutralising adjustment, however, some differences must be observed owing to the different method of tuning. In type A it is very simple to vary the tuning of the two circuits

scale. Then undo the coupling between the two sections and you will find that you can turn the moving vanes of the section nearest to the rear of the set by means of the fingers, and this can be done while the set is being operated, since the moving vanes are connected to earth, and placing the fingers upon them will not have any effect on the tuning.

Neutralising Notes

With the necessary valves and coils inserted, and batteries, 'phones and earth (but not aerial) connected up exactly as before, you can proceed to make the necessary adjustments, starting with the neutralising condenser, and proceeding to carry out

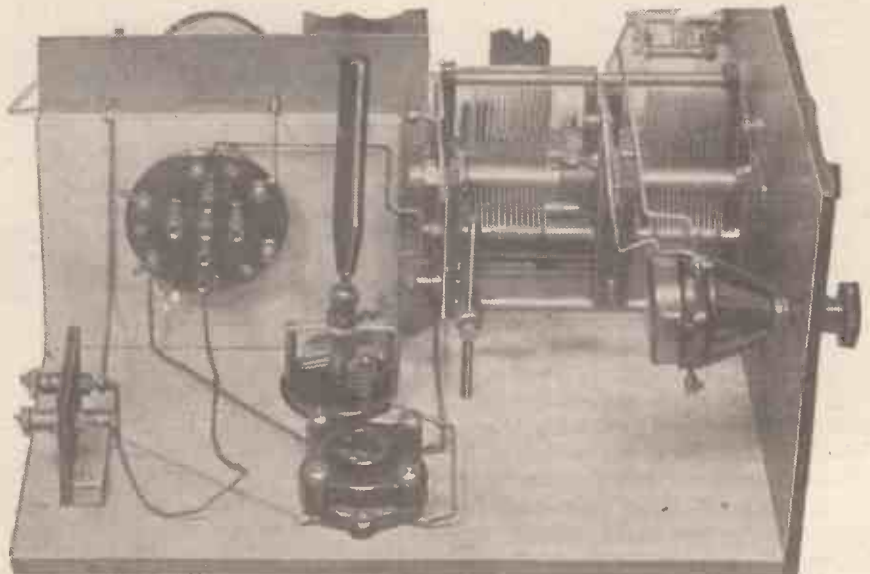

If you compare this view carefully with the corresponding one for Set A, you will see just what alterations are needed to allow for the double-gang condenser.

After a while, when you have got the hang of the set, you will be able to see whether you can find a setting for the trimming condenser which

case of very small aerials. With indoor aerials and others of very small size, you can take it as a general rule that terminal 4 will be the one to use.

where valves of the two-volt class are used, when it is important to obtain the last ounce out of the set itself.

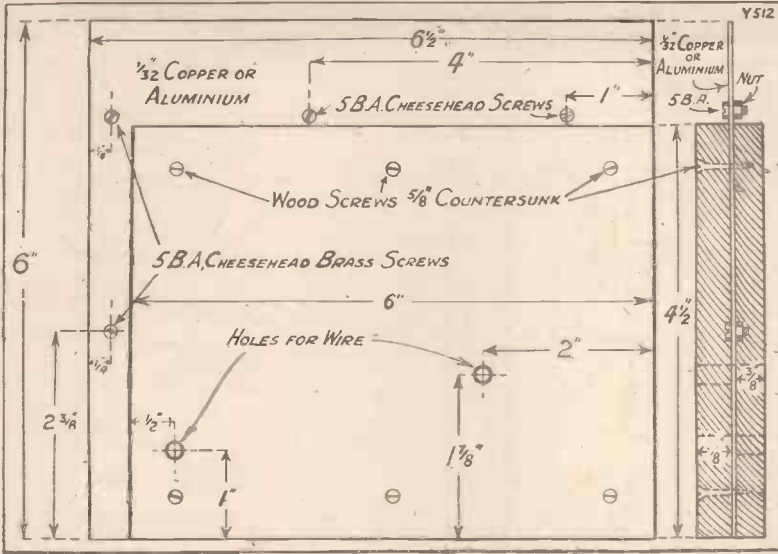

"SOLODYNES" AND
THE "LOCAL"

The selectivity of all three versions of the junior set is quite good, but, of course, there are only two tuned circuits, and so you must not expect to cut out the local station very easily if you are only a mile or so away. At very short distances (say, under two miles) a wave-trap will be a great help, and the "standard" type used in the 1928 "Solodyne" is advised. Do not, however, attempt to squeeze it inside the cabinet, but use it as a separate unit.

On the long waves there should be no difficulty in getting rid of 5 X X when desired, but if your aerial chances to be an inefficient one, or of unusually large capacity, you may find it helpful to put a fixed condenser of .0002 mfd. in series with the aerial lead. If this proves to be so, it can be fitted upon the baseboard near the aerial terminal, and a piece of flex and a clip arranged to cut it out when not required.

enables the circuits to keep pretty well in step over the greater part of the tuning range, and to do this you should try setting the trimmer at various capacities between the minimum and maximum, readjust the gang setting on a distant station, and then tune in to various stations over the range, noting whether any readjustment of the trimmer is needed.

It is assumed, as in the case of the type A set, that ordinary six-pin coils of the split-primary type aerial and split-primary transformer varieties can be regarded as standard for this set, but if the very finest results are desired, it should be noted that a slight increase in efficiency will be obtained by the use of the special coils to be mentioned when discussing type C. This is particularly desirable

Good Selectivity

It is quite likely that by using the trial-and-error method you will find a setting for this trimmer which will achieve the desired end, but it is not worth while spending too much trouble on this adjustment, since the use of the trimmer as a vernier is a perfectly practical and satisfactory solution of the difficulty.

The selectivity of all three of these receivers is quite good, and unless you live very close indeed to a powerful local station you are not likely to have any particular trouble in eliminating the local programme when desired. Do not forget, however, that by placing the flex lead from the aerial terminal upon either terminal 3 or 4 of the aerial coil base you can vary the selectivity of the set.

On terminal 3 the selectivity is distinctly higher, but, of course, at a slight sacrifice of signal strength in most cases. You should always try both terminals, and decide upon the one which suits your particular conditions best, and do not forget that when you do this a slight adjustment of the gang condenser is likely to be necessary, except in the

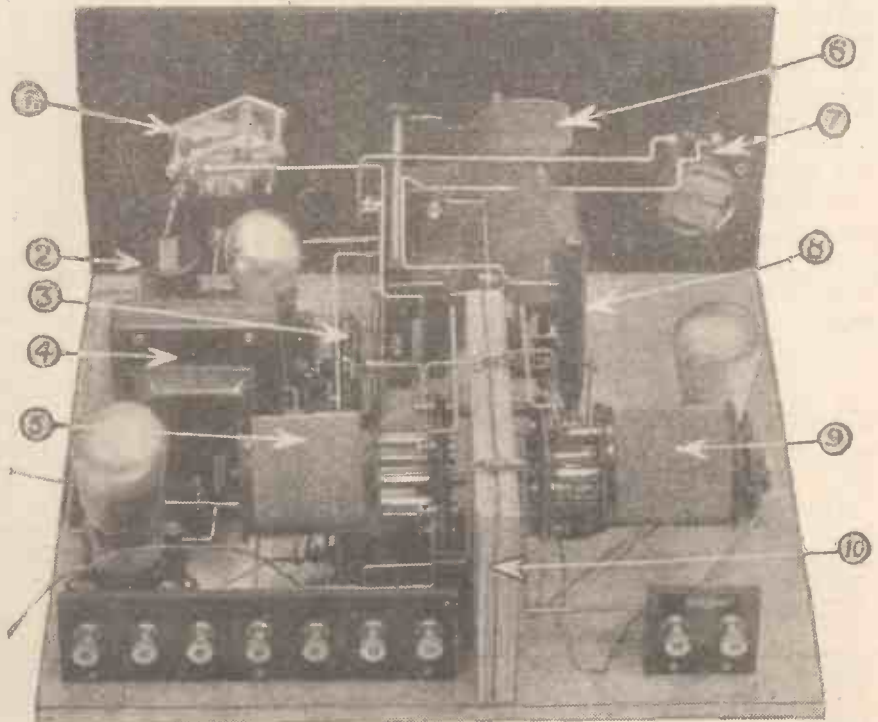

A general key to the interior arrangement of type B: (1) is the reaction condenser; (2) the H.F. choke; (3) the grid leak; (4) the L.F. transformer; (5) and (9) are the H.F. transformer and aerial coil; (6) is the gang condenser; (7) the "trimmer"; (8) the neutrodyne condenser, and (10) is the screening plate.

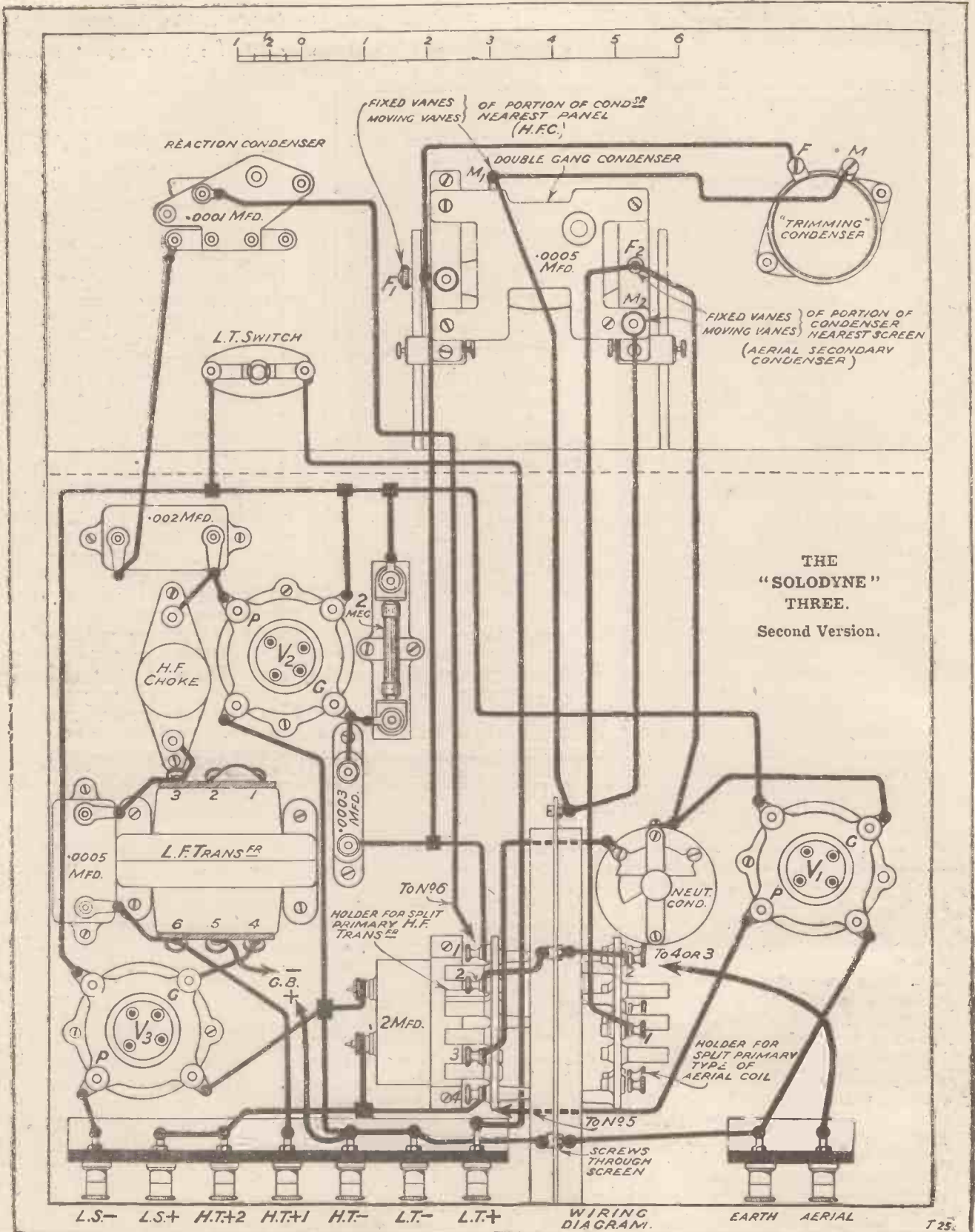

This is the wiring diagram of the second version of the "Solodyne Three for the Economist," which is referred to in the text as "Set B." You will note that it incorporates a double gang condenser of conventional type. The two sets of moving vanes of this condenser are wired to a convenient point on the earthed screening system.

THE "SOLODYNE" THREE THIRD VERSION

IF you inspect this third receiver closely you will see that the general arrangement is such that you can build it with practically any odd parts you may have on hand, and yet get the full "Solodyne" Three results without having to obtain any special parts, except perhaps the six-pin coil bases and the materials for the screening partition. Just one word of warning in this connection.

Keep to the Layout

It is not advised that you should attempt to make use of some existing panel and cabinet if the dimensions differ more than an inch or so from those specified, since this involves alterations of layout and spacing which may quite well have very undesirable effects. Perhaps it should be admitted therefore that a new panel and cabinet should be regarded as a more or less inevitable expense.

The circuit for the type C receiver is exactly the same in its main features as those of types A and B, but it should be noted that there is one difference in detail, and this is the provision of a filament rheostat for each valve, a point of which mention has already been made in dealing with the other sets. The fact, it will be remembered, is that the average modern 2- or 6-volt valve works perfectly well straight from a 2- or 6-volt accumulator without a resistance, therefore in the previous sets they were omitted.

Filament Controls

This particular receiver, however, is intended to meet the needs of the man who wishes to use up as much of his existing material as possible, and

it is probable in such a case that it is as well to make provision for valves of odd types and mixed voltages, and therefore resistances are indicated. They will, of course, be of suitable values for the particular valves employed, and they can be either of the fixed interchangeable variety or of the actual rheostat type which can be varied at will.

the type C, and the sockets wired up directly as in the cases of A and B.

The Screen

There is little further that can be said regarding the layout and construction of the receiver, since these points have been dealt with in the preceding articles, and the constructor of this particular design is strongly

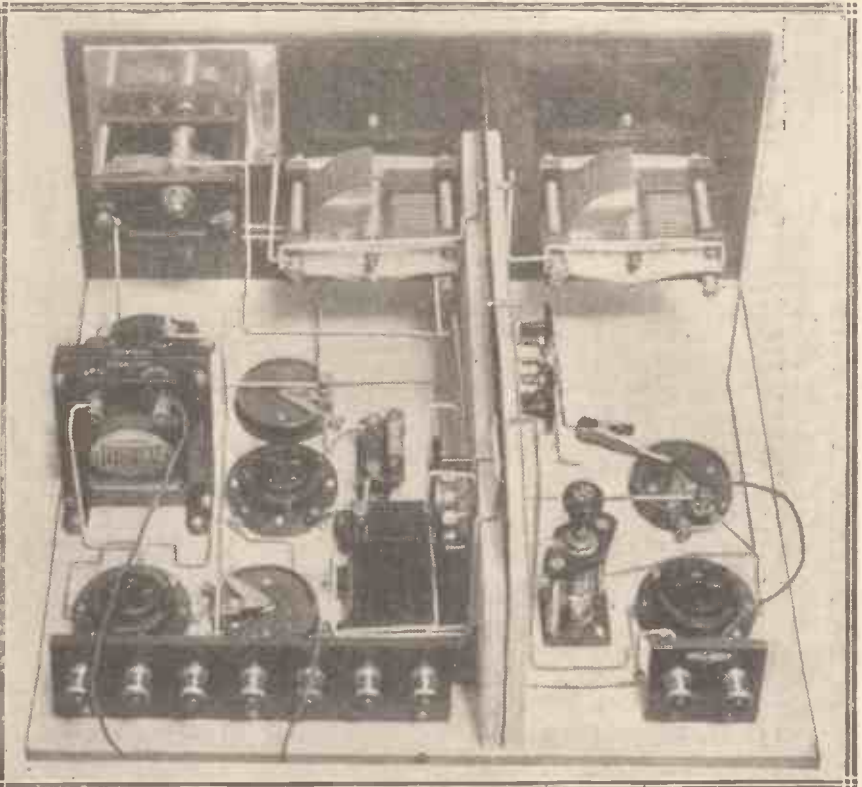

This view of the back of the panel shows the screen and the various components mounted "edgewise" upon the baseboards.

Incidentally, rheostats or resistors could perfectly well be included in either of the other types, if it is anticipated that various valve voltages may be encountered at a later date, and care has been exercised in leaving room in the layout for resistors of any of the fairly compact types. Equally, they could be omitted in

advised to go carefully through the preceding matter, and note the various remarks therein made. The necessary working drawing is given for the making of the screening partition for the set, and no difficulty will be experienced here.

The partition is mounted exactly as before, namely, by passing screws

THE COMPONENTS YOU WILL NEED.

- Panel, cabinet, and baseboard, as for Set "A."
- 2 0005-mfd. variable condensers, square law or S.L.F., etc. (Bowyer-Lowe "Popular" in set. Any good make).
- 2 Slow-motion dials (Bowyer-Lowe in set. Any good make).
- 1 0001-mfd. miniature type reaction condenser (Burndept in set, but see also Set "A").
- 1 On-off switch (L. & P. in set. See Set "A" for alternatives).
- 3 Sprung valve sockets (W.B. in set. Any standard type, such as those suggested for Set "A").

- 3 Baseboard filament rheostats or resistors (see text). (Lissen 6-ohm in set. Any standard type to suit valves.)
 - 1 Baseboard-mounting neutralising condenser (J.B. in set. Any standard make).
 - 1 Tapping clip.
 - 2 Plain unscreened 6-pin coil sockets (Colvern in set. Any standard make).
 - 1 002-mfd. fixed condenser.
 - 1 0003-mfd. fixed condenser.
 - 1 2-mfd. Mansbridge type condenser.
- Note.—The condensers in this set

- are Dubilier and Mullard, but see Set "A" for alternatives.
- 1 2-megohm leak and holder (Dubilier in set. See Set "A" on this point).
- 1 H.F. choke (Igranite in set. See also Set "A").
- 1 L.F. transformer (Ferranti A.F.3 in set. Any good make of fairly low ratio).
- Terminal strips as for Set "A."
- Materials for screening partition (see text).
- Sundries as for Set "A."

upwards through the baseboard of the set into the edges of the wooden face-pieces of the screen, which will be found to hold it quite sufficiently rigidly in this way, provided that fairly long and slender screws are used of, say, 1 in. or 1 1/4 in. length. By the way, it is advisable to countersink these screws slightly from below, to avoid projections on the underside of the baseboard.

Wiring Hints

So far, little has been said about the practical side of the wiring of the sets, and, as a matter of fact, this is a point which can quite well be left to the discretion of the constructor, since there is nothing at all critical about it. The wiring is of a very simple nature, as a result of the special method of construction, and of the fact that we are only dealing with a relatively small number of valves, so that the constructor cannot very well go wrong provided he observes the usual simple principles necessary in turning out any efficient set.

As regards the material for wiring, it is recommended in the case of all sets where metal screens are used that some form of covering upon the wire should be employed, since there is some slight risk attached to the use of the bare material, specially for those wires which pass through holes in the screen. The original sets were wired with the covered material known as Glazite, and this gives quite a workmanlike finish.

On the other hand, a very good appearance and perfectly satisfactory job can be obtained by the use of ordinary tinned copper wire and Systoflex sleeving, preferably of rather a small size, so that it will fit snugly upon the wire, and not make the

receiver look heavy. Again, if you wish to relieve yourself of the trouble of soldering as much as possible, you can use the very convenient specially prepared material known as Junit, which can also be covered quite easily with Systoflex sleeving.

120 on H.T. + 2, which latter feeds the H.F. and L.F. valves.

For the first operation you should connect up the batteries and 'phones and earth lead (not the aerial), insert the valves and coils and proceed to carry out the neutralising

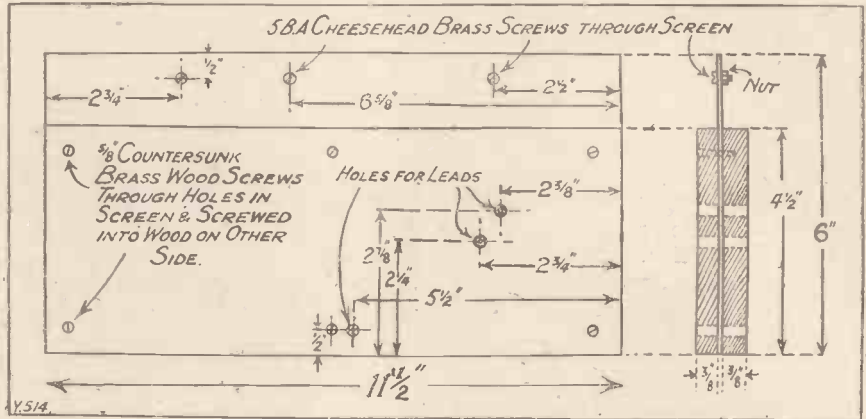

Whatever material you decide to adopt, it is urged that you should resist the temptation to hurry over this part of the construction of the set and spend as much time as your patience will permit in making a really sound and workmanlike job, because nothing spoils the appearance of a home-constructed set more than untidy wiring, badly soldered joints, carelessly made bends, and so on.

Neutralising Notes

When the set is finished, you will first require to go through the description of the operating details of the previous receivers, and note the procedure to be adopted in getting your new set into working order. The arrangement of battery terminals is exactly as before, and the same specifications apply, namely, about 60 volts on the H.T. + 1 and 100 to

adjustments already detailed. Those given for the type A receiver you will find will meet the present case perfectly, and you will have no difficulty in getting the neutralising adjustment quite quickly.

That being done, you can proceed to attach the aerial to the set and check the neutralising adjustment on a distant station, exactly as before. All that remains is to carry out tests with the receiver to find out how many distant stations you can tune in, and whether you are likely to have much interference from your local station. If you find the latter troublesome, of course, you should remember that transferring the aerial lead from socket No. 4 to No. 3 on the aerial coil base will give a higher degree of selectivity, although at the expense of a slight loss of strength.

The Aerial Lead

By the way, in this receiver the "Colvern" six-pin coil socket was used, and this is not provided with terminals, so you may at first wonder how the flex lead can be transferred, as has just been mentioned, from socket No. 4 to No. 3, and vice versa. The method adopted in the original set was to solder a short piece of stiff wire to each of these two sockets, so that they projected about half an inch from the side of the base.

The flex lead from the aerial terminal was then provided with an ordinary spring tapping clip, and this can be easily attached to either of the projecting wires just mentioned. Alternatively, of course, you could mount two small sockets such as Clix, or Eelex, upon a small piece of ebonite, and secure it to the

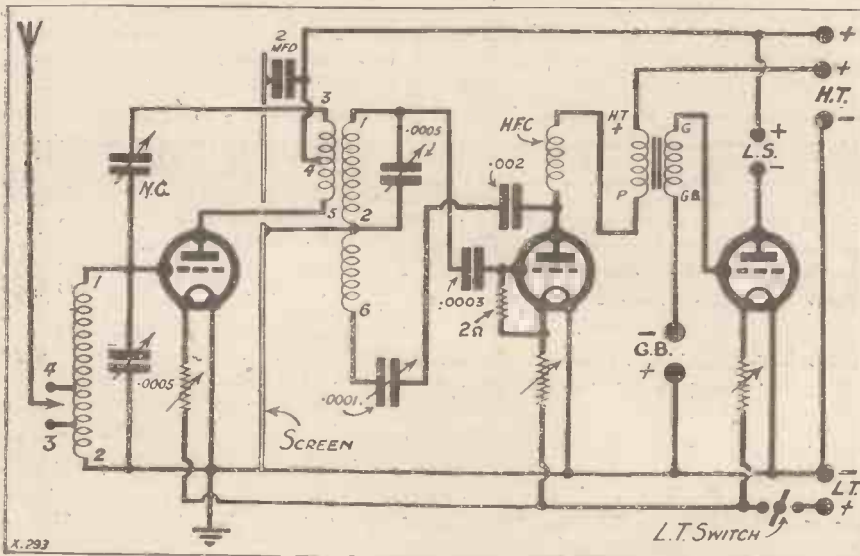

wooden face-piece of the screening partition by the side of the coil socket. These would then be linked respectively to sockets 3 and 4 on the coil base, and the flex lead from the aerial terminal would be provided with a plug which could be inserted in either socket at will.

and it is not possible to produce a very highly efficient coil in this way under ordinary limitations. By using a 3-in. diameter former, such as the Colvern "Featherweight" type, a quite perceptible improvement can be achieved.

This is extremely desirable if you

Just one point should be explained in this connection. The Colvern Featherweight former is provided with an interchangeable primary which fits inside upon pins to enable the constructor to experiment with different sizes of primary and neutralising windings to suit the types of valves, and this will be found to provide an interesting field. For the aerial coil you can either provide a tapping upon the separate primary winding inside and use the terminals 3 and 4 upon the base as usual, or you can simply wind up a series of primaries of various sizes to give you a varying degree of selectivity and signal strength.

Aerial Coupling

When these coils are used, by the way, it should be noted that a separate inductively coupled aerial winding is provided, whereas with the standard split-primary type of coils the terminals 3 and 4 are connected to tappings on the main winding itself, so that what is called auto-coupling is being used.

There remains just one final point to consider. It is the question of the use of alternative components, and it has already been pointed out that it is permissible to choose any good standard makes for practically any part. This is an important point, so that we should like to emphasise the fact there is nothing at all critical about the components to be used in any of the three designs, and the constructor is left full discretion to use any good make he may prefer.

It is obviously impossible to name every possible alternative, and we have endeavoured merely to give a few possibilities as a general guide.

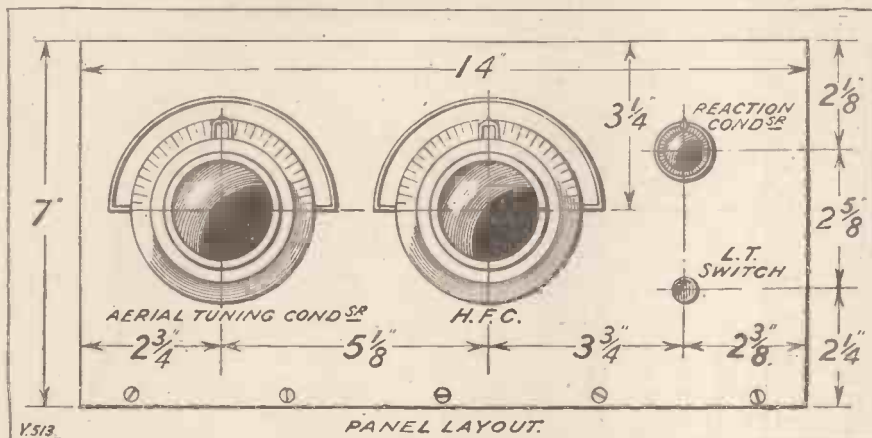

The types of valves used in the "Solodyne" Three have already been discussed in previous articles, and no more need be said on this point here. The choice of coils has, however, been reserved until this point, and stress must again be laid on the fact that only those of really high efficiency should be used, since they are the most vital components in the whole set.

It is useless to employ coils of cheap non-standard makes and to expect to get anything like the full results of which the set is capable. The constructor is strongly urged to go to the expense of procuring coils of one of the really well-known and reputable makes, such as the one mentioned in the test report, namely, the Lewcos, which is one example of a standard type of high efficiency (other good makes, of course, could be quoted, such as the Bowyer-Lowe, Peto-Scott, etc.).

Special Coils

The results actually obtained on test will give an idea of what can be done with really good coils of the standard commercial type, but it should be noted that even a higher standard could be achieved by using a specially wound coil of still lower H.F. resistance.

It must be remembered that the commercial coils were designed to be used inside a cylindrical screen of decidedly small size, and therefore it was necessary to keep down the size of the former employed to about 2 in. diameter. This severely handicapped the coil manufacturers,

are going to use 2-volt valves, since, of course, such valves do not in themselves give such a high standard of performance as the 6-volters, and therefore it is necessary to get the utmost possible out of the set. Also, they really require a larger primary winding than is provided in the standard six-pin coil. It is recommended here that the reader should use the standard aerial and split-primary transformer coils described for use in the "Viking Four," which appeared in MODERN WIRELESS for October last. (These coils can be wound from the specification therein given, or they can be purchased ready wound for use from the Collinson Precision Screw Co. Ltd.)

TEST REPORTS ON THE "SOLODYNE" THREE.

Test conditions: For the first test a fairly efficient full-sized aerial, situated 7 miles S.W. of 2 L O, was used, and a fairly good night was chosen. Lewcos coils and S.S.6075 H.F., E.S.5 H.F. (as detector) and Cosmos S.P.55-R valves. The list below gives the stations logged as giving clear loud-speaker signals, with the dial readings (right-hand drum of Set A).

For the second test (a severe one) a bad aerial, only 15 ft. high and considerably screened, was used, with the same coils and a similar selection of valves (Mullard, Marconi and Cossor makes this time). Stations heard on the loud speaker were those marked with an asterisk in the list. Remainder were reduced to good 'phone strength.

Station.	Dial Reading.	Station.	Dial Reading.
Zurich	162	Bilbao	107
Unidentified German	156	Hamburg*	104
Milan	151	Toulouse	103
Munich*	149	Bournemouth*	74
Vienna	143	Breslau*	71
Brussels*	140	Dublin*	70
Berlin	132	Lyons	61
Paris (heterodyned)	126	Cologne	56
Rome	123	Grenoble (?)	49
Frankfurt*	115	Danzig	44
Kattowitz*	112	Bremen	34
Berne*	110		

Again, the constructor can suit his own taste as to the actual prices he pays for his parts, and if he chooses wisely he can keep his costs down considerably without approaching

dangerously near the point where his results begin to suffer.

For example, if he desires to economise on the L.F. side he can choose a cheaper transformer, such as

the Lissen, which is remarkably good value at the price of 8s. 6d., and can rest assured that in so doing he will not adversely affect the working of any other part of the circuit.

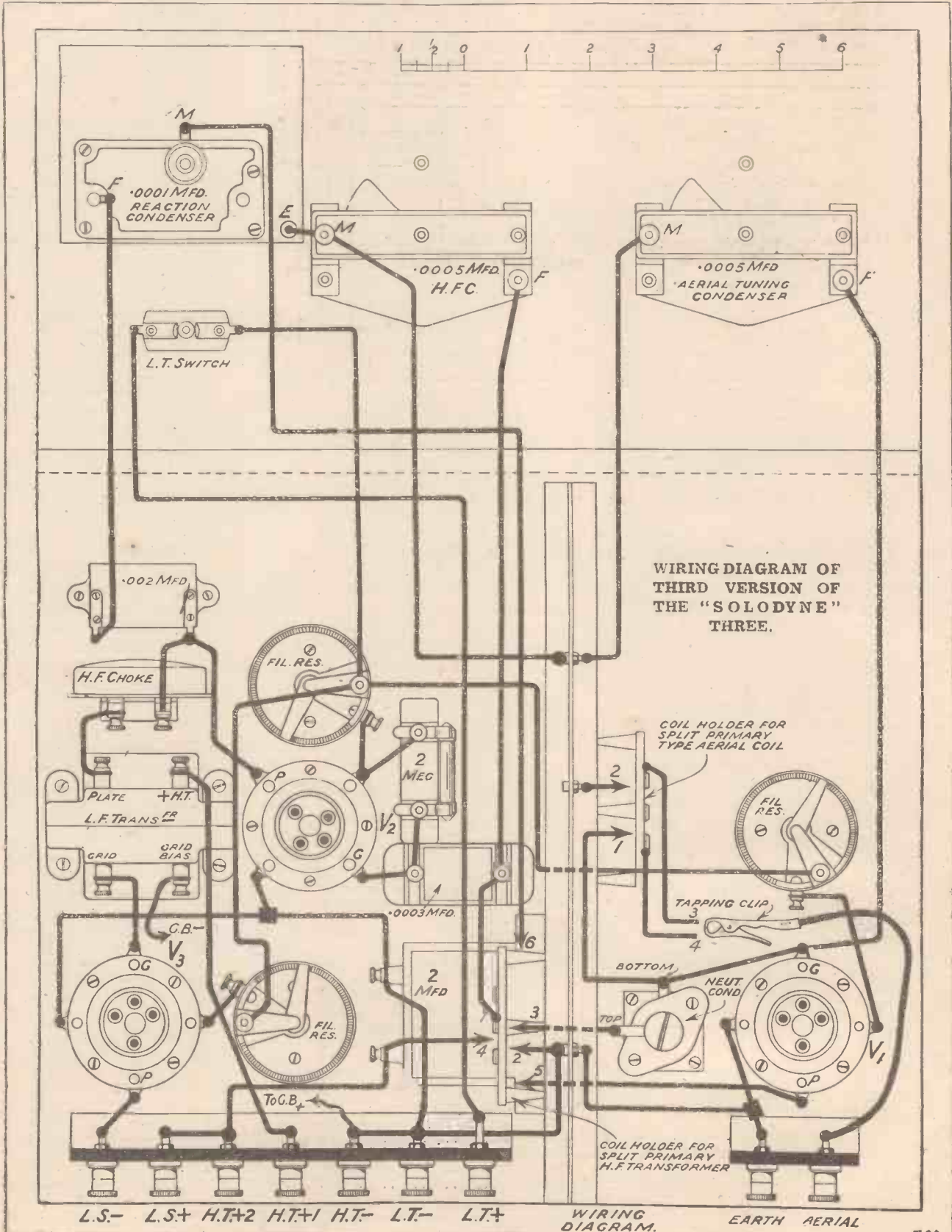



MODERNISING THE 1926 CIRCUIT

Efficient as was the original "Solodyne" for its time, the years that have passed since its introduction have seen some considerable progress made in the art of radio reception. In this article is shown how the L.F. circuit can easily be revised to bring it in line with the most modern of designs:

By A. JOHNSON-RANDALL

WHEN the original "Solodyne" was published by John Scott - Taggart, F.Inst.P., A.M.I.E.E., in the September, 1926, issue of MODERN WIRELESS, it achieved a popularity equalled only by such sets as the S.T.100 and the "P.W." Combination receiver. The simple tuning of three different circuits by means of a single dial, the fact that two highly efficient screened and neutralised H.F. stages were employed, and the remarkable results obtainable from distant stations, all exercised a most powerful appeal.

Here was a receiver with which one was able to bring in station after station on the loud speaker with one hand in one's pocket, so to speak. No skill was required to operate the set once the "gang" condenser had been set and H.F. valves neutralised.

The Original Model

In fact, thousands of these sets were constructed by enthusiasts all over the world. Radio, however, is a progressive science and naturally many new developments have taken place during the past eighteen months. In 1926 the use of two transformer-coupled L.F. stages was fairly common, while moving coil and cone types of speakers were then practically unknown.

In these days most of those who own multi-valve sets employ a super-power valve in the last stage, and as a consequence the 1928 multi-valver usually incorporates an output filter circuit, to protect the loud-speaker windings, and to prevent an excessive drop in anode voltage.

The "1928 Solodyne" is typical of the progress which has taken place since September, 1926. To see what could be done in the way of modernis-

ing the original model, however, the MODERN WIRELESS Research Staff decided to endeavour to procure one of the 1926 "Solodynes" for this purpose. The department enlisted the aid of the secretaries of a number of prominent radio societies, and of these, the Golder's Green Radio Society was able to locate a reader who proved to be willing to lend his set for modernising purposes.

This receiver proved to be a very close copy of the original published design, and on test was found to give very good results. The Technical Staff then set about considering as to what would be the simplest and most useful method to adopt in bringing the set up-to-date.

During the past year vast strides

have been made in the direction of realistic reproduction. Loud speakers and loud-speaking equipment have been improved beyond recognition. The present-day loud speaker will reproduce frequencies as low as 50 cycles, whereas eighteen months or so ago it was quite usual for the average loud speaker to cut off at a figure somewhere between 200 and 300 cycles.

Modifying the L.F. Side

It is quite obvious, therefore, that if one is to take advantage of these improvements, the low-frequency end of the receiver must be designed to suit. It was decided, therefore, first of all, to bring the low-frequency side of the "Solodyne" right up-to-date.

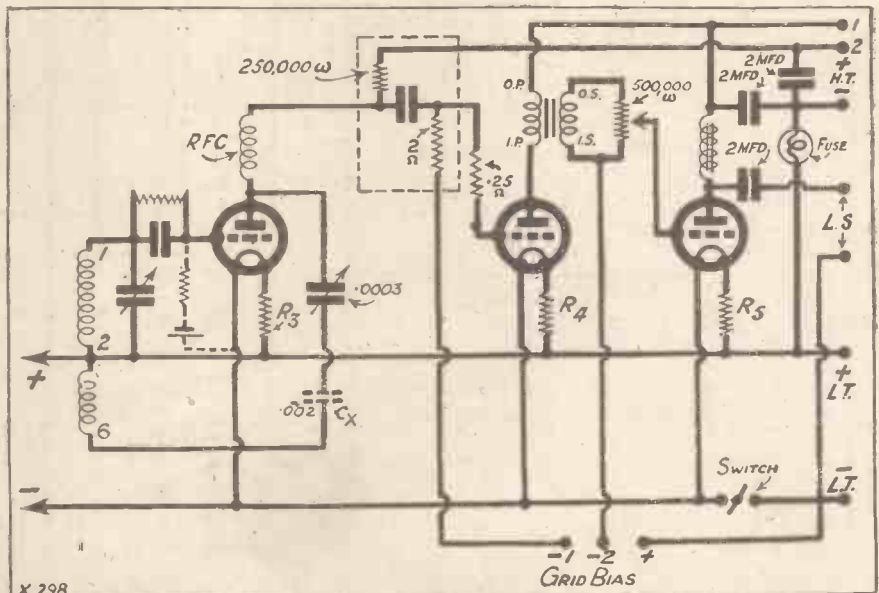

This is the modern L.F. circuit designed to replace that in the original "Solodyne." The author explains how the change-over can be made with the minimum of re-wiring. You will see that this circuit embodies the popular "Resis-Trans" arrangement, a loud-speaker by-pass, and all modern refinements.

This modification is quite straightforward and can be carried out with a very slight alteration to the layout of the receiver. The H.F. side is left untouched. As readers know, the H.F. and L.F. sides in the original model are entirely separate, the original "gang" control forming a division between them.

Now the H.F. side, as originally designed, is still quite capable of giving most excellent results both from the point of view of signal strength and selectivity. Moreover, the neutralisation and the balancing up of the "gang" condenser has been found to be, to some extent, critical,

and it was felt that a very large number of readers, in view of the good results which they are obtaining, would not wish to disturb this adjustment. The scheme finally adopted by the technical staff was as follows:

Few Extra Components

First to bring the L.F. side up-to-date in the simplest possible way, and after this had been thoroughly tested, to set about re-designing the high-frequency side for the benefit of those who might care to undertake this alteration. It was felt that by splitting up the actual modernising into two separate portions, "Solodyne"

enthusiasts would be able to decide for themselves whether it was worth while for them to modify their receivers completely or only just the L.F. stages. On the L.F. side very few extra components are necessary. The essentials are an output filter choke having a low D.C. resistance and an inductance value of 20 henries. That actually used is an R.I.-Varley. A 2-mfd. Mansbridge condenser, such as a Lissen, Dubilier, T.C.C. Mullard, etc. A resistance-capacity coupling unit, of any good make, and a 500,000-ohm non-inductive potentiometer for the volume control.

Reference to the photograph of the

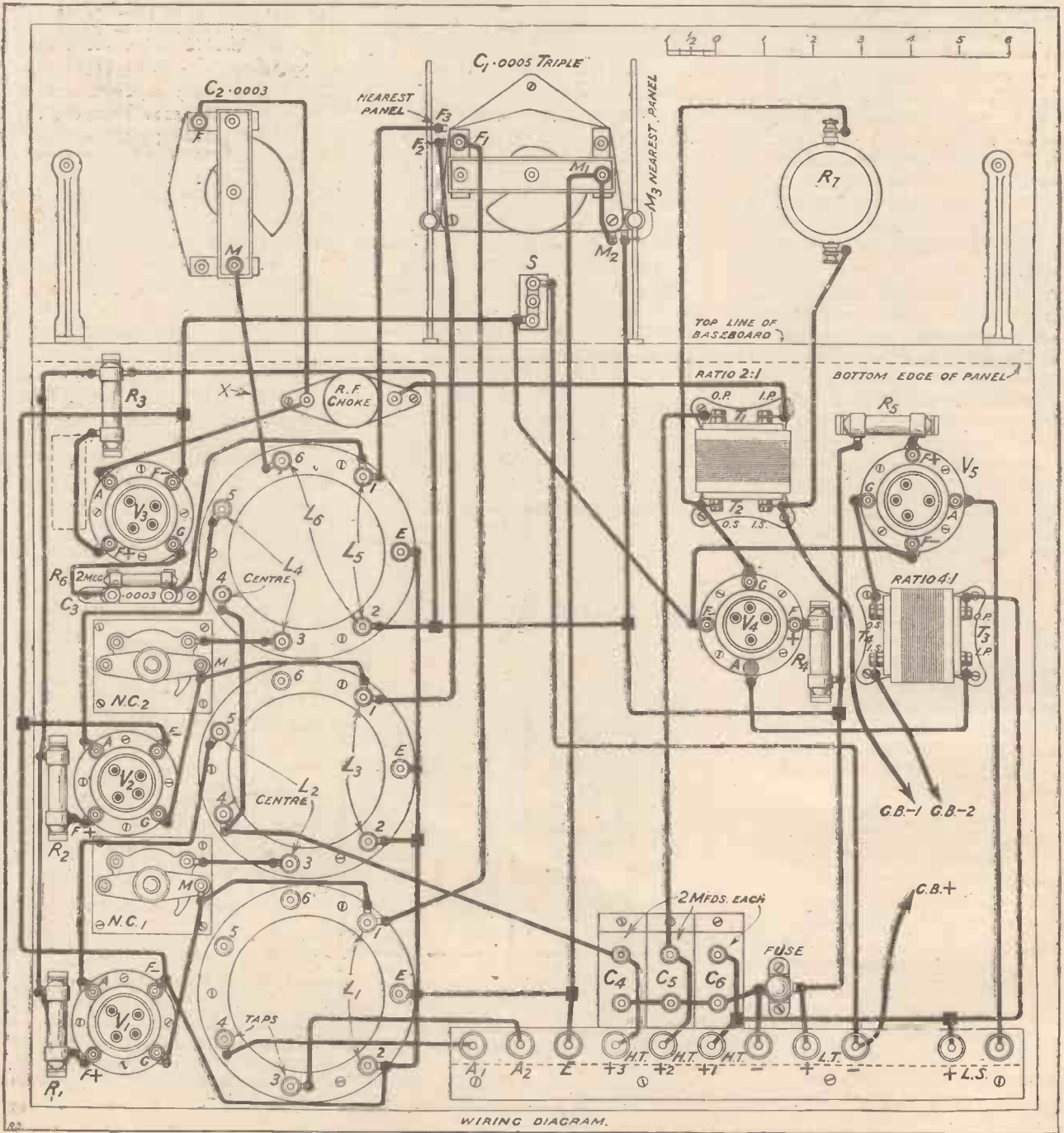

WIRING DIAGRAM.

original "Solodyne" before alteration will show that on the L.F. side there is a considerable space between the transformers and the two loud-speaker terminals. In most of the models this has been utilised for grid-bias purposes, and when the modification was considered it was decided that this was the ideal portion of the set for the output filter choke and condenser.

Volume Control

Further examination showed that, even when these two components were placed in position, there was still ample room for two 9-volt grid-bias batteries between the first L.F. valve holder and the H.T. shunting condensers. This was very fortunate because it made the alteration comparatively easy. In carrying out the modernisation of this side of the set it is necessary, first of all, to remove the existing volume control from the panel.

This older scheme of controlling volume by placing a variable resistance across one of the windings of an L.F. transformer has now been super-

On the opposite page is the wiring diagram of the original "Solodyne" five-valve receiver, while on this page is a wiring diagram of the L.F. end after having been modernised. The remainder of the wiring remains unaffected.

sed by the more up-to-date method involving the use of a potentiometer. If a suitable potentiometer is employed a variation in volume is possible from full strength to a mere whisper without introducing the slightest amount of distortion in so doing.

The two ends of the potentiometer resistance are joined to the secondary terminals of the L.F. transformer preceding the last valve and the moving arm is taken direct to the grid of that valve. The "Centralab" potentiometer actually used in the modernising, which incidentally is obtainable in this country from The Rothermel Radio Corporation of Gt. Britain, can be slipped straight into place on the panel instead of the existing control.

Alterations Required

Next we come to the rearrangement of the baseboard components. As will be seen from the diagram the modernised L.F. circuit consists of one stage of resistance-capacity coupling followed by a transformer

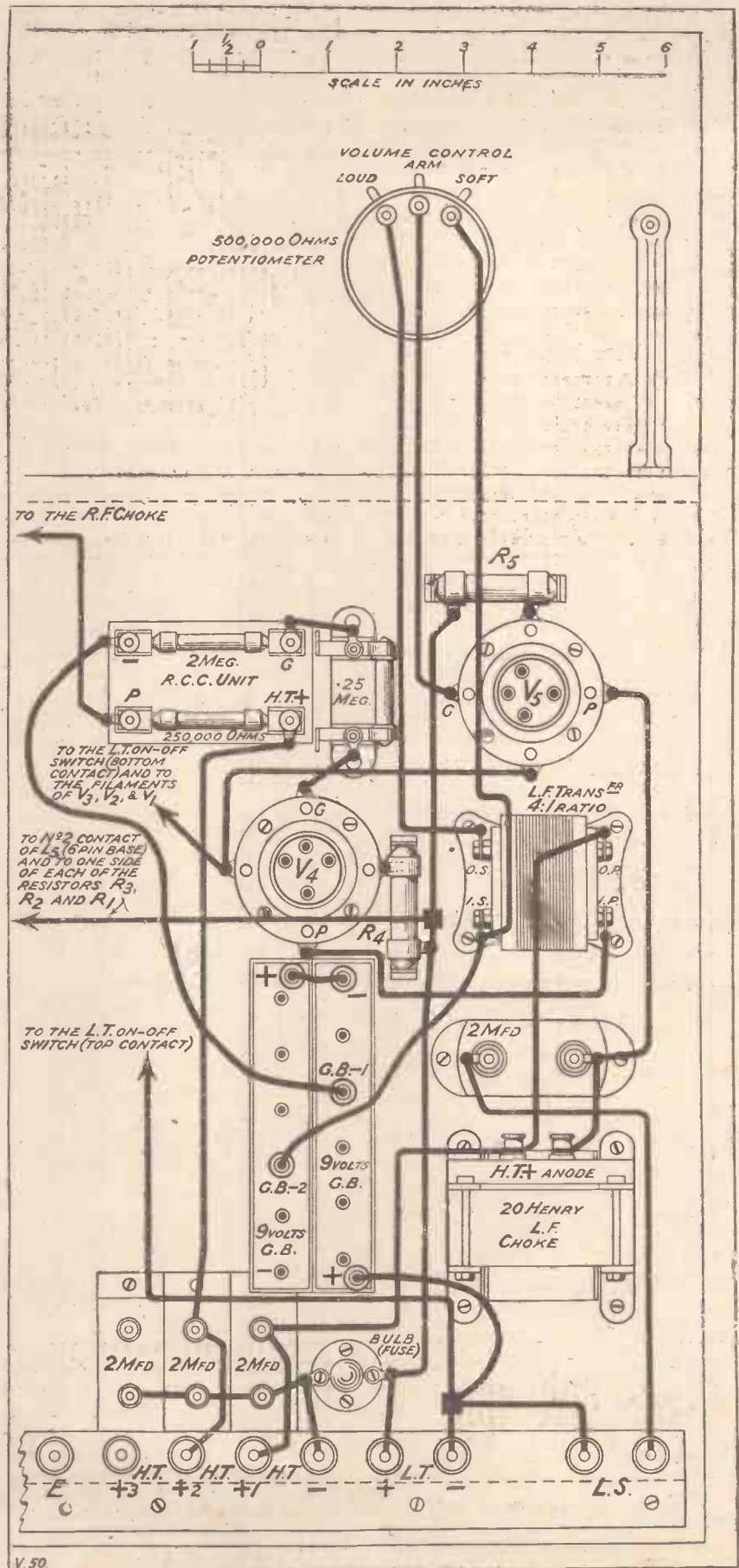

stage and finally an efficient output filter. It is just as well to remove the whole of the existing L.F. side and to start afresh.

The layout then becomes as shown in the modified wiring diagram on page 19. The 2-1 ratio transformer is replaced by the resistance-capacity coupling unit. The second L.F. transformer is left more or less in the same position and that which was once a blank space is now occupied by the output filter choke and its condenser.

The New Wiring

The new wiring commences from the H.F. choke, but the filament leads to the valve holders remain the same as before. During the past year experimenters have learnt to appreciate the importance of keeping high-frequency currents away from the low-frequency side of a multi-valve receiver. It has been proved that not only do these unwanted H.F. currents spoil quality but they also tend to make the H.F. side unstable.

In the modernised version, therefore, a resistance of 25 megohm is inserted between the resistance-capacity coupling unit and the grid of the first L.F. valve in order to stop stray H.F. currents from getting into the L.F. side.

A very suitable valve for the first L.F. socket is one having an impedance of between 20,000 and 30,000 ohms, and a magnification factor of about 20, or alternatively an L.F. valve with an impedance of 8,000 ohms can be employed. In the last

socket, with a powerful receiver of this type, readers will no doubt wish to employ a super-power valve, and they will be able to do this without any danger of damaging their loud-speaker windings.

moving vanes of this condenser accidentally touch the fixed vanes.

This might also result in serious damage to the valves. It is usual in modern sets for a small condenser to be placed in series with the reaction

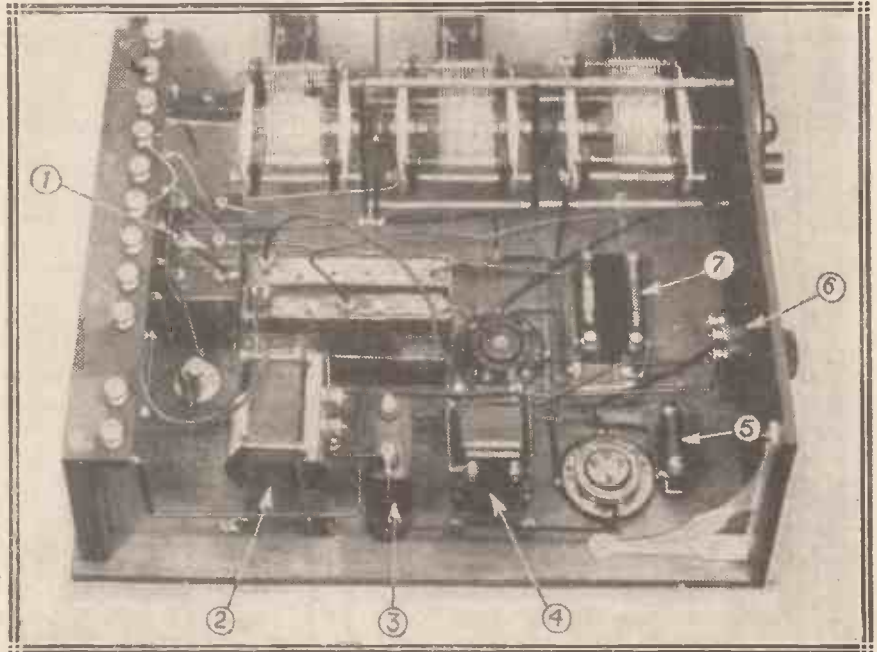

This view shows the L.F. side of the "Solodyne" after modernisation. (2) and (3) are the filter choke and output condenser respectively; (7) is the R.C. unit which replaces the first transformer used in the original model, and (6) is the potentiometer for controlling volume.

There are one or two other small refinements which the enthusiast may wish to include in his receiver. For instance, with the existing arrangement of the reaction control, there is nothing to prevent the H.T. battery from being short-circuited should the

control as a guard against accidents of this type. This small fixed condenser is shown dotted in the modified diagram and may have a value of .002 or more.

Then, again, some readers might prefer to use anode-bend rectification in conjunction with the modernised L.F. side.

Anode Rectification

The alteration can be made by disconnecting the parallel grid leak and adopting the series scheme. A new grid-leak holder is required. One terminal is joined to the grid of the detector, and to the remaining terminal a short length of flex is connected. A 4½-volt tapped battery is placed in a convenient position on the baseboard (shown dotted in diagram) and the flex lead is plugged into the 1½ or 3-volt tapping. The positive connection on the battery is joined to L.T. negative. If it is desired to return to leaky-grid rectification the flex lead from the grid-leak holder can be taken direct to L.T. +.

Experiments with the H.F. side of the "Solodyne" are still being carried out and it is hoped that further details concerning the complete modernisation will be published at an early date.

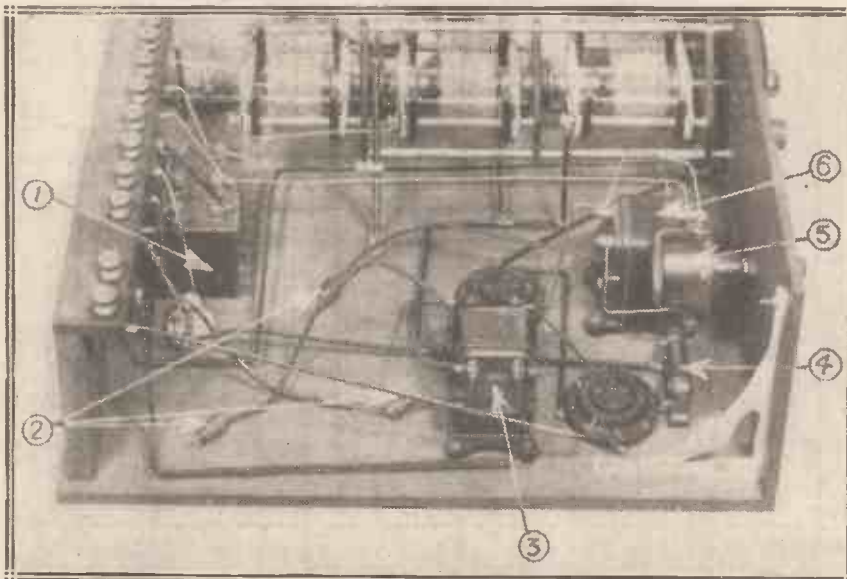

The L.F. side of the original "Solodyne." From the photograph of the modernised version it will be seen that the space between the second L.F. transformer (3) and the terminal strip has been utilised for the output filter choke and condenser. In spite of this there is still ample room available for two 9-volt grid-bias batteries; (5) and (6) are the "old" volume control and first L.F. transformer.

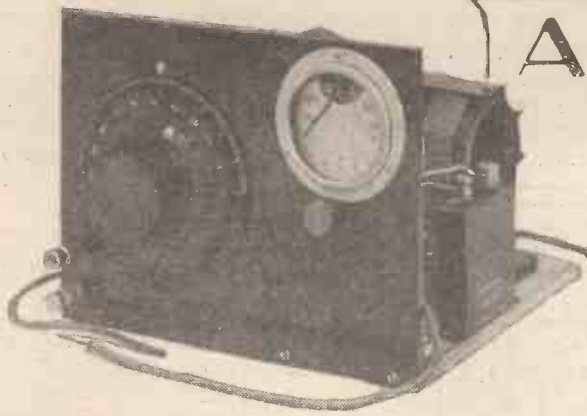

A MODULATED SHORT-WAVE OSCILLATOR

An interesting instrument that can be easily constructed, and which forms a valuable accessory for every short-wave "fan."

By A. V. D. HORT, B.A.

INTEREST in short-wave telephony is on the increase now that the B.B.C. is using its new short-wave station at Chelmsford. Several amateurs have recorded occasions when reception of 2FC, the short-wave station at the Australian end, was better direct on their own receivers than through the medium

ones, they do not transmit at very convenient times for people in this country, and also their transmissions last for a few hours only. In order to test a short-wave telephony receiver thoroughly, one must have some source of short-wave telephony. If the signal strength available from this source is constant, so much the better for comparative tests. No short-wave transmitting station can be expected to fulfil this requirement.

with the receiver quiescent. A buzzer, with a coil of one or two turns shunted across it placed near the tuning coils of the oscillator, will give a steady modulation; but this gives us no chance to make satisfactory adjustments of the receiver to secure reception of good quality.

Miniature Relay Station

So long as our local B.B.C. station is working, we have a constant source of telephony picked up on the ordinary broadcasting receiver. By applying the output of the receiver to the short-wave oscillator, we can modulate the output of the latter. The oscillator can be designed to operate on any desired wave-length. In this case, we tune it to the short-wave band on which the short-wave receiver under test is to work. We can then tune this receiver to receive

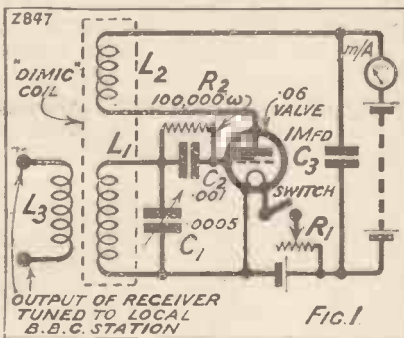

of the B.B.C. relay. Now the design and construction of a short-wave set to receive Morse signals is not difficult, until one tries to get down below about 10 metres. For Morse reception the receiver is normally operated so that it is just oscillating. Smooth reaction control is essential.

A Local "Transmitter"

The necessity for good control of reaction becomes more marked when we attempt to receive telephony. We now have to keep the receiver just off oscillation, and this is often not so easy a condition to maintain. To mention only one trouble which is commonly experienced, a howl is sometimes set up just as the set ceases to oscillate. Nothing but the howl is audible so long as it persists, and fine adjustment of the tuning round about the threshold point is therefore impossible until steps are taken to get rid of the cause of the trouble.

Although there are several stations regularly working on the short waves, such as the well-known American

It remains for us to provide a local source of signals. The ordinary heterodyne oscillator will give us signals which are useful for testing a receiver in the oscillating condition, but they are, of course, useless when the receiver is not oscillating. If, however, we modulate the "carrier-wave" of the oscillator in some way, we shall be able to pick up the modulated output of the oscillator

The oscillator is a compact little instrument enabling it to be built in a semi-portable form, thus rendering it doubly useful to the short-wave enthusiast. The variable coupling coil is shown to the right of the Dimic plate-grid coil.

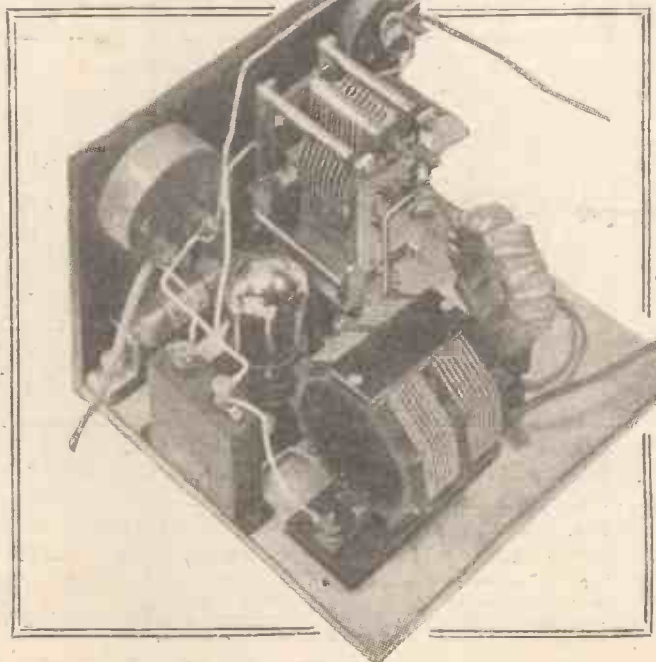

the telephony from the oscillator, just as though the oscillator were a distant station.

Simple Circuit

The circuit used for the oscillator is given in Fig. 1. Any suitable circuit such as is used for a wave-meter may be employed. The variable condenser and the design of the tuning coils should be robust, so that the oscillator can be calibrated with reasonable accuracy to serve as a wave-meter as well. In the oscillator shown in the photographs a former of the "Dimic" type is used, with a special short-wave winding. The milliammeter is included in the anode circuit to show when the valve is oscillating. Almost any valve may be employed, one of the '06 ampere type being used here, because its filament can be conveniently heated by a flash-lamp battery.

To the grid coil of the oscillator is coupled a plug-in coil, itself connected to the output terminals of the broadcast receiver. This coupling is made variable by fixing the coil plug to the baseboard with one screw only, so that the coil may be swung away from the oscillator coil. By varying this coupling, and by changing the plug-in coil for one larger or smaller, the degree of modulation of the oscillator output may be correspondingly varied.

Varying Modulation

If you require considerably greater modulated output from the oscillator, you can obtain it by modifying the circuit as shown in Fig. 2. Here an L.F. transformer is used. The

is quite simple (see Fig. 3). First switch on the oscillator valve, note the reading on the milliammeter, and then touch with a moistened finger the fixed vanes of the variable condenser (these should be connected to the grid end of the coil). If the

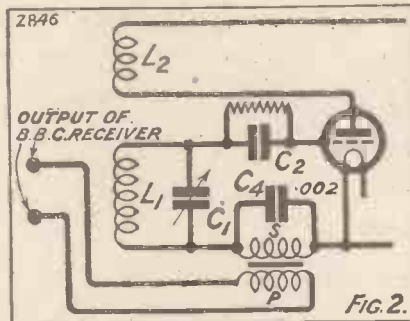

reading on the meter increases, the valve is oscillating. Switch on the short-wave receiver, keep it oscillating, and find the beat note with the oscillator output.

Results Obtained

Now switch on the local broadcast receiver, make sure with the help of the telephones or loud speaker that signals are coming through, disconnect the telephones, and connect in their place the leads to the coupling coil or transformer in the oscillator. When you listen on the short-wave receiver you will hear the modulation of the "carrier-wave" from the oscillator, and you will be able to set the receiver off oscillation and tune in the telephony in the usual way.

A few notes on the signal strength to be expected may be useful as a rough guide. The oscillator valve

oscillator, loosely coupled, signals were just audible with the oscillator about 10 ft. from the receiver. Tight coupling increased the signal strength by about 50 per cent. Larger plug-in coils gave stronger signals, though the increase was not considerable when a larger coil than a No. 250 was used.

With the L.F. transformer in the grid circuit of the oscillator, signals were overpoweringly strong, even when the oscillator was about 30 ft. away. For this test the oscillator was connected to the loud-speaker leads in another room. Generally speaking, the absorption modulation method, using the plug-in coil, will be found most useful. The strength of the modulated output can be varied at will, and the weak signals of a distant station can be imitated.

PERTINENT PARS

It is impossible to make a good soldered joint on nickel-plated metal unless the nickel-plating is filed away so as to expose the brass or other metal underneath.

Only first-class quality condensers should be used as coupling condensers between valves, as leakages here will often result in a positive potential on the grid of the succeeding valve.

The Best Aerial

One of the best aerials in the world is that suspended from the Eiffel Tower, Paris. (The great height of this ensures efficient radiation.)

High-frequency apparatus, such as used by doctors, hairdressers, etc., is capable of causing intense interference with neighbouring wireless sets.

To light the filament of one of the huge transmitting valves used by the station W G Y, Schenectady, New York, it requires a power of nearly seven kilowatts.

Grid-Bias Precaution

When a power valve with a high anode voltage is being used with a milliammeter, the grid bias should not be adjusted while the filament current is on, otherwise damage may be done by the sudden increase in plate current flowing.

The Air Ministry's great new wireless station on Mitcham Common is nearing completion.

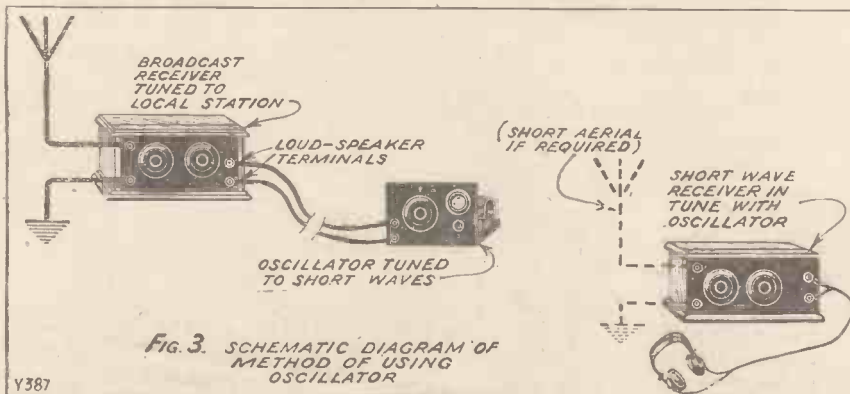

secondary is inserted in the grid-filament circuit of the oscillator, and is shunted with a .002 fixed condenser. Omission of this condenser will usually prevent the oscillator valve from oscillating. The primary is connected to the output terminals of the broadcast receiver.

The method of using the oscillator

was of the '06 ampere type, supplied with 50 volts H.T. Signals on the broadcast receiver were adjusted to moderate loud-speaker strength. The short-wave receiver consisted of a straightforward detector and one L.F. circuit. An aerial was not needed.

Using a No. 25 plug-in coil in the

The "CALIBRATOR"

This is a combined oscillator and wave-meter which is both easy and cheap to construct. It provides a ready means of carrying out a multitude of useful and interesting tests and measurements.

By PERCY W. HARRIS, M.I.R.E.

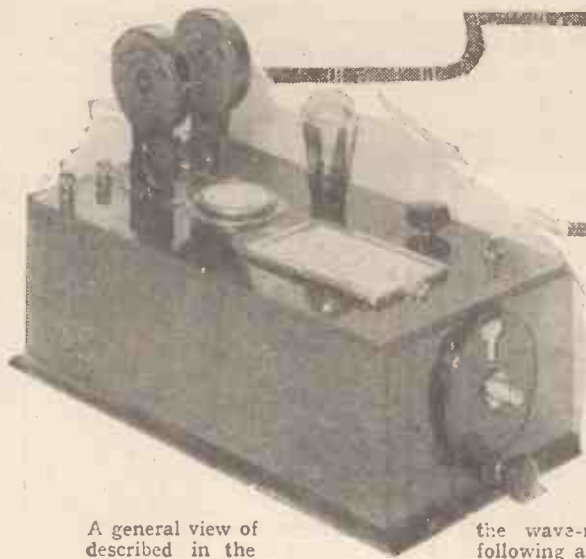

A general view of described in the

the wave-meter following article.

A COMBINED oscillator and wave-meter, which has proved of very great utility in my experimental work, is illustrated in the accompanying photographs. Not only does it serve as a heterodyne wave-meter, but also as a powerful oscillator for high-frequency measurements and as a rapid means of making a multitude of other tests, such as the tuning of ranges of coils with given capacities.

Its particular utility in this last regard lies in the fact that a grid current meter is included in the

The "Calibrator" has been thoroughly tested and has been very favourably commented upon by a number of independent experimenters who have visited Mr. Harris's laboratory to see it in action.

instrument, the needle giving a sharp kick whenever a nearby coupled circuit comes into resonance with it. This means, of course, that one can at once ascertain the frequency range of a circuit consisting simply of a coil and condenser, it being unnecessary to attach or insert any indicating instrument in the circuit under test.

Accurate Indicator

This indication of resonance by the sharp dip of the grid-current meter needle is most accurate, and makes experimental work of this kind very rapid. Take as an illustration the simple coil shown in the photograph. It was desired to find the approximate tuning range of this coil using a particular condenser.

Although the coil, being a single-layer solenoid, had a readily calculable inductance, it was much quicker and more certain to connect the coil

across the condenser, as shown, and make the actual measurement. For convenience in photography the coil and condenser have been placed closer to the oscillator than necessary, as an indication by the kick on the needle was obtained with the coil shown a foot away from the oscillator,

Interesting Circuit

For the circuit of this instrument I am indebted to Mr. W. H. Hoffman, who described it in Engineering Circular No. 12, published by the Burgess Battery Company. Although the circuit used in this instrument is the same as that described in the publication, I have modified the practical make-up to suit English components and my own convenience. As the instrument in the form illustrated works well, and has been very favourably commented upon by a number of experimenters who have

visited my laboratory, a description is here given for the benefit of those who care to reproduce it.

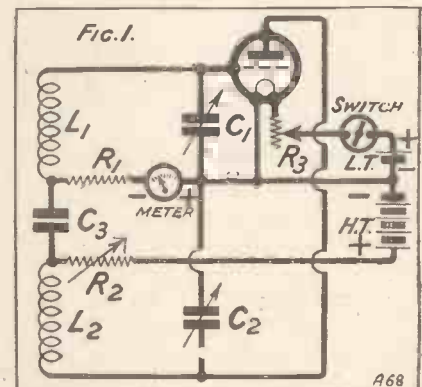

The circuit itself is quite interesting. The condenser C_1-C_2 is a standard .0005-mfd. double condenser in which the moving plates of both halves are connected together. This means, of course, that used in this way the capacity of the whole unit is .00025 mfd. The tuned circuit consists of this double condenser and the coils

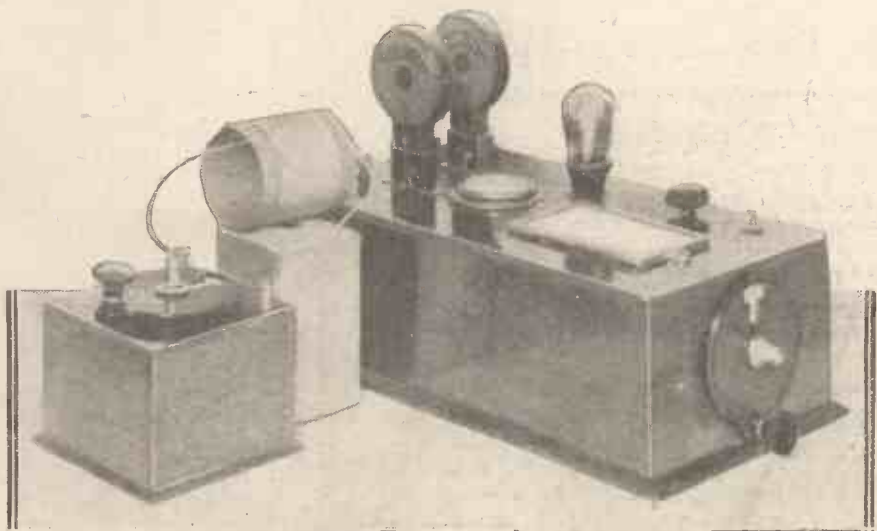

This illustrates one of the many additional uses of the "Calibrator," that of testing the wave-length range of a home-made coil.

L_1 and L_2 in series with the condenser C_3 . We thus have a tuned circuit consisting of $L_1-C_3-L_2-C_2-C_1$, the grid and plate of the valve being connected across the coils as

A few moments' consideration will show that the point at which the resistance R_2 is connected to the oscillatory circuit is practically at filament potential, so that the usual

potential for high-frequency purposes, so that no damping is introduced into the oscillatory circuit by this grid leak. The grid current meter in

THE PARTS REQUIRED ARE:

- 1 Ebonite panel of convenient size, say 15 in. X 8 in.
- 1 Wooden box, not less than 5 in. deep internally, of the general shape shown, with detachable bottom.
- 2 Baseboard-mounting coil sockets.
- 1 0 to 15-milliamperere meter (Sifam flush pattern is shown). (Any good meter can be used, but a precision meter is not required, as one does not need a measurement but an indication of grid current.)
- 4 Terminals (It is just as well that these should be of the indicating type, such as Belling-Lee, Eelex, Igranie, etc.).
- 1 Valve socket (I recommend the Pye for this meter, as it can be mounted from the back so that the top of the holder is flush with the top of the panel, making it easier to keep the instrument free from dust).
- 1 30-ohm variable filament resistance.
- 1 On-and-off switch.
- 1 .0005-mfd. double condenser (I

- have used a Cyldon, but any other high-grade make can be used).
- 1 Vernier dial (Indigraph, or similar good pattern). (A vernier dial is essential in this instrument, for tuning is exceedingly sharp.)
- 1 Fixed condenser, .015 mfd. or more (mica).
- 1 400-ohm baseboard-mounting potentiometer.
- 1 5,000-ohm resistance (R.I.-Varley, Rothermel, etc.).
- 2 Plug-in No. 60 coils of good make (A pair of these coils with the .0005 double condenser cover a wave-length range of about 170 to 570 metres, and will give a straight-line wave-length calibration on a good S.L.W. condenser from 230 metres upwards. Two No. 200 cover from about 670 metres to 1,900 metres).

NOTE.—Any standard parts can be used in most cases, and names are therefore omitted except where guidance is likely to be helpful.

shown, and the filament to the mid-point of the condenser.

Particularly interesting is the method of feeding the high-tension current to the plate of the valve. This is done through a 400-ohm resistance.

high-frequency choke problems which worry the designer of a good oscillator are absent.

Similarly the grid-leak resistance R_1 , of 5,000 ohms, is connected to a point which is also at filament

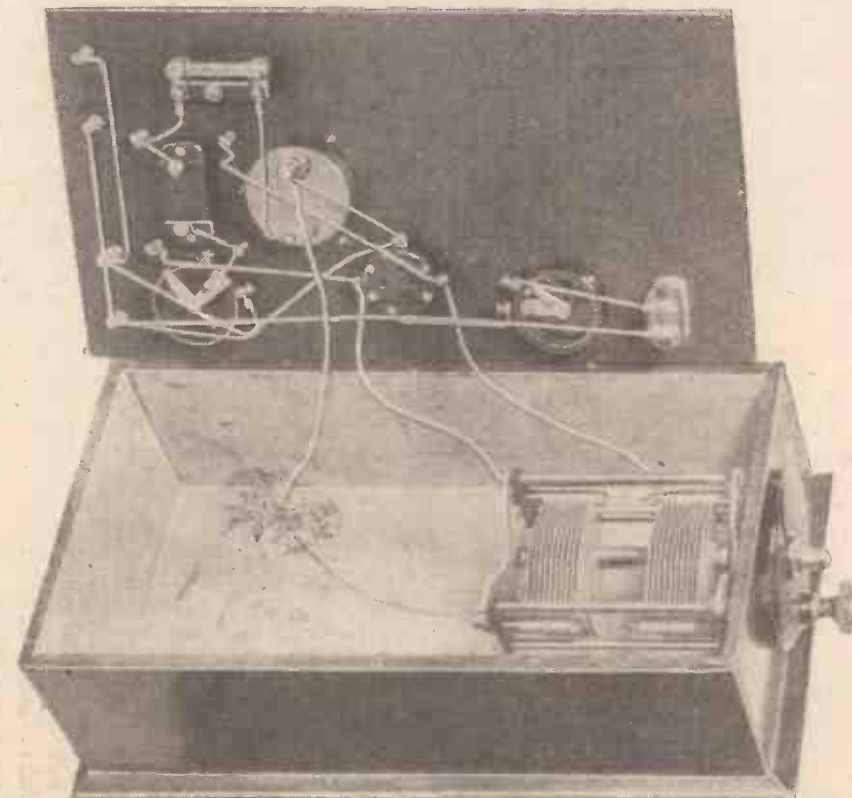
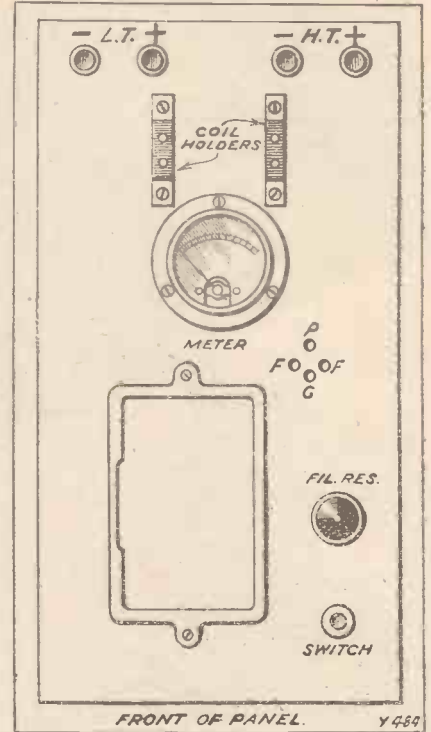

Showing the internal wiring of the instrument. The flexible leads to the variable condenser are temporary, and are included in order to show to where the leads are connected.

series with this leak should read from 0 to 15 milliamperes (the grid current you actually obtain with this instrument will surprise you). Condenser C_3 should be a high-grade mica condenser of fairly large value, such as .006 to .02. In practice I use a .015 mfd.

R_2 , the plate supply resistance, is not at all critical, and, in fact, it is only there to act as a radio-frequency impedance if there should be any lack of symmetry in the electrical make-up of the apparatus. I use a 400-ohm baseboard-mounting potentiometer screwed underneath the panel and used not as a potentiometer but simply as a series resistance.

Resistance Values

The value of the grid leak is also not critical, but the ordinary type of carbon grid leak is, of course, useless, since it will not carry the necessary current. I use a 5,000-ohm transmitting grid leak, which I happened to have on hand. Messrs. R.I.-Varley will supply a 5,000-ohm wire-wound resistance to order, and the Rothermel Radio Corporation also have a number of resistances which will suit this purpose.

For convenience of photography and in order to show the instrument wired up, the connections between the variable condenser and the instruments.

on the panel have been made by flexible wires, but when the instrument is made up the points shown joined with flexible wires in the photograph should be connected as shortly as possible with rigid wires.

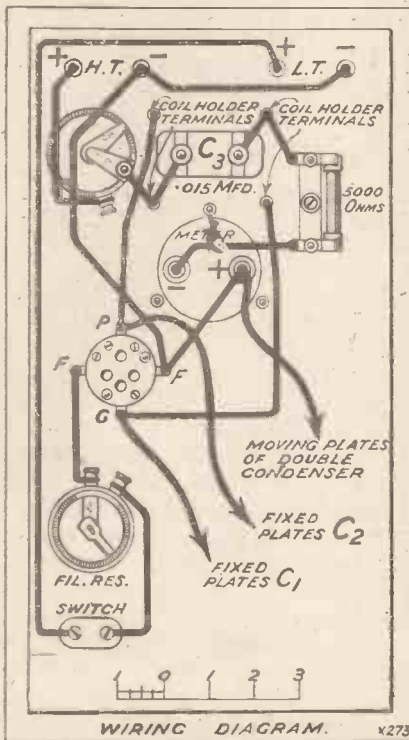

It was not possible to photograph the wiring in its completed form with the panel in position. All the wiring on the panel should be done first, the condenser then mounted in the box, and finally the leads from the variable condenser soldered in position before the bottom of the box is attached. Be very careful that the parts on the panel are so mounted that they do not foul the variable condenser.

"Calibrator" In Use

It is, of course, possible to make up the instrument so that the condenser, as well as the other components, are mounted on the one panel, but you would need an unduly big box, and in practice it will be found more convenient to have the dial in the position shown and to use the blank space on the top of the panel for a calibration card which can be slipped into one of the frames sold by the makers of the Decko components.

A dimension wiring diagram is not given as it is realised that many experimenters will like to use an existing box and parts. So long as the general layout indicated is followed it will work quite satisfactorily. The coils should be mounted about 2½ in. apart.

With regard to the use of this instrument as an accurate wave-meter, it has a particular advantage over many other instruments. Every experienced wireless enthusiast knows that in a heterodyne wave-meter an alteration of the valve, filament current, or high-tension will alter the frequency of the circuit so that however accurately one calibrates a wave-meter with a particular valve this calibration will not necessarily hold good with another valve. In the present instrument, owing to the use of the grid-current meter, very accurate calibration can be formed.

Operating Details

In addition to the present instrument, make up in some simple form (but rigidly wired) a single-layer inductance coil and a good quality variable condenser. The coil can be a standard six-pin type if desired, but in such a case make sure that the pins make thoroughly sound contacts with the base. The condenser should be well made, or it will not retain its calibration.

Keep this as your wave-length standard, for if the coil and condenser are good the frequency to which the circuit will tune with a particular adjustment on the condenser will remain constant. Now pick up on any convenient receiver a transmission from a station whose wave-length is reliable (the British stations keep theirs very constant in these days), set the oscillator going, and adjust for the zero beat-note. Now switch off the receiver, bring the

condenser and coil circuit near the oscillator, and vary the tuning condenser on the coil and condenser combination until you get a sharp kick on the grid-current meter on the oscillator. (Keep the coil as far away as possible from the oscillator.) This will indicate that the two circuits are in resonance, and you can mark

.....
 "Quite apart from acting as a general-utility heterodyne wave-meter, this instrument (the "Calibrator") will give the earnest experimenter many opportunities of carrying out very interesting measurements."

on a chart the condenser setting of your standard for that particular wave-length or frequency. Repeat the process with as many stations as possible, and you will be able to calibrate your standard.

Two-Volt Valves

A note of the oscillator calibrations should also be kept, and at any time when you want to use the oscillator as an accurate wave-meter it is only necessary to bring it into resonance with your standard and you will be sure that your oscillator is correct for that particular frequency.

For general experimental work a 2-volt accumulator and one of the new 2-volt super-power valves will serve excellently. As an example, the D.E.P.240 is very suitable, and it will surprise many readers that 100 volts on the plate will give 6 milliamperes of grid current!

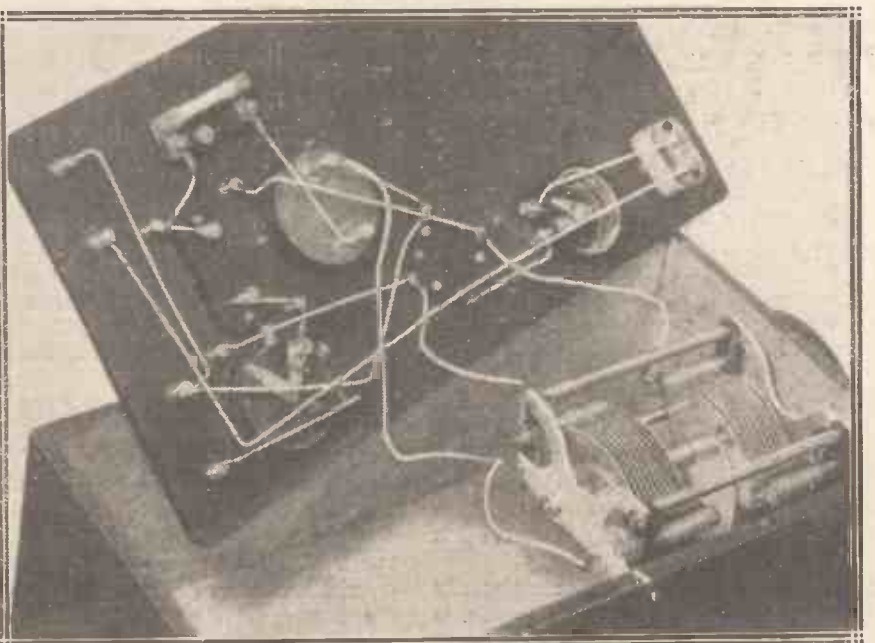

Another wiring view of the "Calibrator." The flexible leads referred to in this page are still in position.



IS THE B.B.C. A FAILURE?

Whatever view you take of this important question you will be interested in the opinions of Mr. John Drinkwater, the famous poet and dramatist, as expressed in the following interview.

By OSCAR M. SHERIDAN.

FROM the window of the interesting study of John Drinkwater, at his house in Kensington, I stood gazing on the scene, awaiting the famous dramatist and poet, who had kindly agreed to discuss broadcasting with me.

He was not long in coming. "A real winter's morning. Certainly the right kind of weather for wireless," and he smiled cheerfully. Mr. John Drinkwater's striking appearance is curiously reminiscent of a younger Chaliapine, with possibly a touch of John Barrymore. A light grey suit and a brightly-coloured tie accentuated his breezy manner.

"From its inception broadcasting has always been a subject of great interest to me. And lately I have had the opportunity of forming the conclusion that the organisation which is behind British Broadcasting is splendidly awake to all that wireless means and hopes to accomplish.

Of Great Value

"It is in the country that wireless is of such great value," he said, accepting and lighting the cigarette I proffered. "My wife's parents, for instance, who always live in the heart of the country, cut off from almost everything, have as one of their most useful possessions a wireless set. To the homes of those who live in villages and towns out of touch with the cities wireless is a godsend."

It is not from that angle, however, that wireless interests Mr. John Drinkwater, who, like his wife, Miss Daisy Kennedy, the violinist, has broadcast repeatedly with great success. Wireless, purely from an entertainment point of view, is a subject that Mr. Drinkwater has studied close at hand.

"To my mind what is most vitally wrong about broadcasting to-day is that those who are responsible for it take too much notice of the opinion of what they term 'the man in the

street.' If one is to believe what one hears, wireless programmes are broadcast solely as a means of satisfying the prejudices of those who find time to write to the B.B.C. and say what they like and what they don't like in the average wireless programme.

Valueless Opinion

"In my opinion, the views of those who care to write in to the B.B.C. do not matter at all. It is obvious that the more important type of listener is not going to air his views, and whether he is pleased or displeased remains, more or less, a secret with himself.

"After all, the average listener, the man in the street, or whatever you care to call the licence-holder, can have very little to say to the B.B.C. He has the best bargain. In return for a small fee he has one of the most wonderful entertainments in the world. It is unreasonable for him to pick on a programme's bad moments, and cause a lot of fuss about it, when in other more important and unfortunately unsounded directions it passes unchallenged.

"The B.B.C. can never hope to achieve the perfect programme if it is to base all its convictions on an almost valueless opinion. The audience of broadcasting is so large that it can never be properly gauged on so unrepresentative an opinion as that of the letter-writer to 2, Savoy Hill."

Doing Too Much

Another interesting view of Mr. John Drinkwater is that just now the B.B.C. is trying to do too much.

"The present state of affairs in the British theatre should be a good enough lesson for Savoy Hill. There are not enough good plays to go round. It is just the same with the wireless. It seems an almost impossible proposition to be able to

supply such a vast quantity of entertainment per year and still hope to maintain originality and superior entertainment value. I certainly think that if the programmes were cut down there would be a general improvement all round."

One of the weakest points in broadcasting to-day, according to Mr. Drinkwater, is the morning relays of music.

Poor Quality Music

"I do not know who is responsible for this," he said, "but I think the quality of the music and the choice of it is very bad indeed."

Mr. Drinkwater also told me of another item which he thought did not broadcast well.

"The purely wireless play has always disappointed me," he said, thoughtfully, lighting another cigarette. "I do not think that plays, on the whole, are suitable wireless subjects. As an example of this you can ascertain that out of the large number broadcast, only a few have been really successful.

"I do not think that outside broadcasts of musical shows are very convincing. I for one would never



Mr. John Drinkwater, who thrilled theatre-goers the world over with his wonderful play, "Abraham Lincoln."

dream of listening. To my mind the most interesting outside broadcasts—and they are among the best items in present-day wireless programmes, possibly because they are not rehearsed—are the speeches by public and famous men. There is always a note of originality about these. Public functions of various kinds on the wireless are always of noteworthy interest."



CARPENTRY FOR THE RADIO AMATEUR



VERY little attention seems to have been given to the specialised art of design for wireless cabinets. The prevalent idea seems to be any old box to house any type of receiver. Admitting that the picture is more important than the frame, one cannot deny that the frame goes a long way towards making the picture.

Concise and clear details are given for the construction of a handsome pedestal cabinet which can be made by the amateur at home at a cost of about 10/-.

By H. BRAMFORD.

To make one is, however, a vastly different financial proposition.

The cabinet described in this article, of which photos are shown, can be made for a total inclusive expenditure of 10s. at the most.

Neat Appearance

It is designed to incorporate a frame aerial, as an alternative to an ordinary aerial and earth, in addition to housing the set, all batteries, or eliminator. The complete cabinet

LIST OF COMPONENTS REQUIRED.

- 1 Large sheet of thin plywood (Hobbies).
- 4 Legs (any suitable style), 1 3/4 in. sq. section.
- 8 Lengths of 1/4-section pip beading.
- 4 Diamond ornaments.
- 4 Domes of silence, or ball castors.
- 2 6-ft. lengths of 1 3/8 in. x 7/8 in.
- 1 Piece of ebonite, 6 in. x 1 3/8 in. x 1/2 in.
- 4 Clix sockets with bushes, in four colours (Lectro Linx).

A set, of course, will do no more, nor less, whether it is in a packing-case or an elaborate cabinet de luxe; but the design of the cabinet may, on the other hand, be such as to render adaptability, portability, or even operation, a much simpler matter than it would be otherwise. No one would think of putting a good gramophone in an old box. Why, then, should not a wireless receiver be considered not only a thing of pleasure, but of beauty?

Extremely Cheap

It might be a good idea, therefore, to take that set of yours out of its rough-and-ready case and house it in something more imposing and impressive, and thus give it the honour of a place in the best corner of the best room instead of tucking it away in some dark and out-of-the-

way recess where wireless tackle is usually cast. Those who make their own sets can certainly with a little practice make their own cabinets.

Some cabinets of an elaborated type are extremely expensive to buy, and far beyond the means of many.

The complete cabinet takes the form of a pedestal table, the top being used to support the loud speaker. No external wires need be visible.

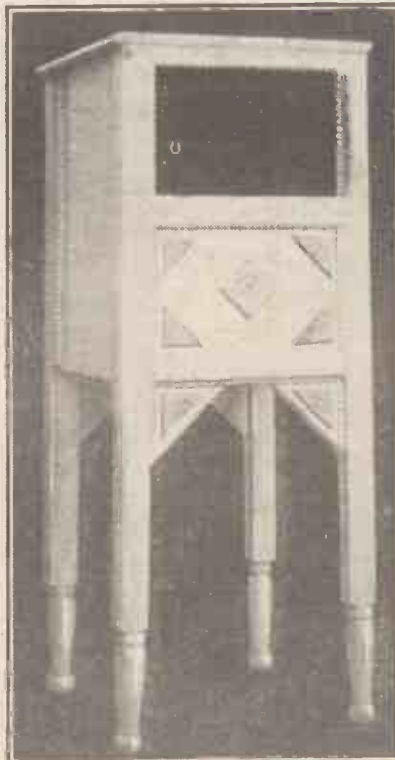

This is the cabinet which is described in detail in the accompanying article.

takes the form of a pedestal table, the top being used to support the loud speaker. There are no external wires other than the loud-speaker leads, and the aerial and earth leads, where the frame is not used.

These connections, however, are placed at the back of the cabinet and are completely out of sight when in use. To use the frame, the cabinet is turned in a suitable direction, the feet being equipped with "domes of silence" or ball castors to render this easy. Before considering the various details of construction, the list of materials required should be consulted.

A Simple Task

Many of the minor constructional details may be clearly followed from the details and dimensions given in the drawings, and assembly may be easily followed from the photographs. I will only deal, therefore, with the important points to note regarding

the procedure and method of carrying the work out in the easiest manner.

The construction itself is handled throughout to enable the beginner

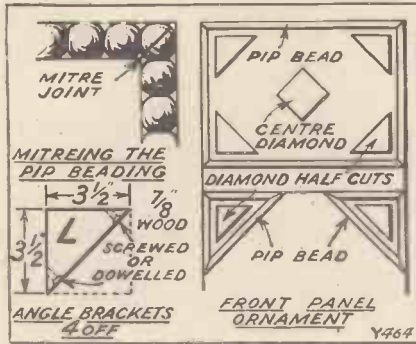

to make a satisfactory job of the cabinet without difficulty, and for this reason mortice and tenon, or dovetail, or dowelling, has been entirely eliminated. The finished appearance or strength of structure, however, suffers in no way as a result of this, and if the details are carefully followed the work may be started with confidence.

Commencing Operation

First trim the tops of all four legs perfectly square, and see that the overall length of each leg when finished is perfectly accurate in relation to each of the others. For square cutting a steel square must be used, and a pencil line should be drawn all round the four sides of the leg where the saw is used. The cut should be made with a tenon saw, as the work must be fine and accurate. The sawn section should be finished with sandpaper to render it perfectly smooth and flat.

Next prepare all the cross bars which constitute the frame in a like manner, using the steel square in every case for marking purposes, and making sure that all end cuts are finished dead square if a good fit-up

is to be ensured. Also make sure that where a number of lengths should be equal, absolute accuracy in this respect is obtained.

When complete, the entire framework may be quickly and easily assembled by screwing at the points shown. All screw holes should, however, first be drilled in true positions and countersunk. The frame is now ready for panelling, and pieces should be cut to the dimensions given. Each piece must be marked out perfectly square before cutting.

The two side panels are tacked to the frame with pin nails. The front panel is inserted from the inside after the pip beading has been secured.

centre division and the low division. All these pieces are secured to the frame with pin nails, and all must be quite square and truly assembled.

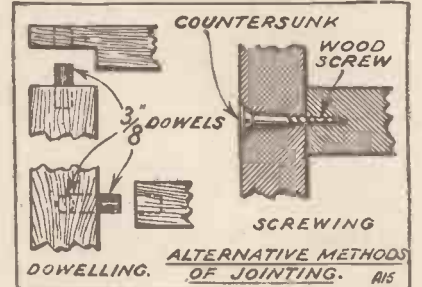

The pip beading is used for effective decoration, as shown in the photos and diagrams. This should be secured by glueing and pinning. The mitre cuts should be made, as shown, and a mitre block should be used for this purpose if neat joins are to be made. The top of the table is made to look very effective by edging with pip beading on both sides, one side being glued and pinned first, the wood then being turned over for working on the other side. It is not advisable to try and secure both edgings in one operation.

The diamond ornaments make a very artistic panel front, and are simply glued on. The triangular ornament is made by cutting a diamond in half diagonally.

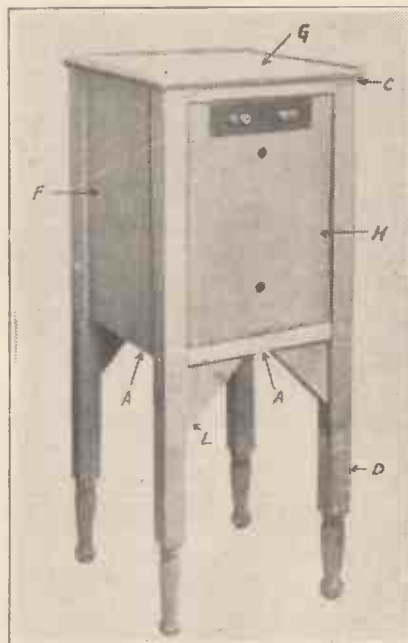

The back of the cabinet. The letters indicate the plywood cuttings denoted in the diagram below, and the framework diagrammatized in the next page.

The back panel is left, to be prepared for a frame aerial, and is finally hinged as shown. The top of the table is also cut from plywood, also the

The Hinged Back

The construction of the hinged frame back, as completely detailed in the drawing, completes the cabinet. This back piece is provided with an ebonite strip which carries Clix sockets for connection to the frame winding, aerial, or earth and loud speaker; flex leads being carried internally to the set.

Two holes are also made, the upper one as a thumb-hole for opening the back, and also as a peep-hole, where dull-glow valves are used. The lower hole provides ventilation to the battery compartment, which is partitioned entirely from the set.

The panel and baseboard of the set is slid in from the back of the cabinet on the frame runners provided. Wiring may be carried out under the baseboard, if desired, which if bare would be quite safe from contact with the batteries below, this being the object of the wood division and the clearance between it and the lower face of the baseboard when the set is in the cabinet.

For final remarks, I would suggest that all cutting is done first, then all

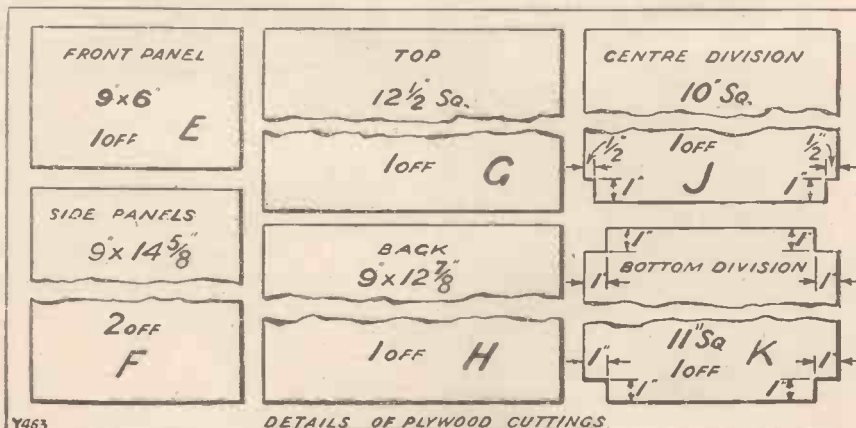

trimming and truing up, then assembly in progressive stages, and finally a rough sand-papering all over. Save the dust obtained from this operation

First prepare the stain. For this, permanganate of potash may be dissolved in water to any desired shade. A light shade is preferable. Alter-

place twice. If there are any muddy patches, it means that the surface is damp. If left alone, they will disappear, but if any effort is made to get them off by applying more varnish, matters will become worse.

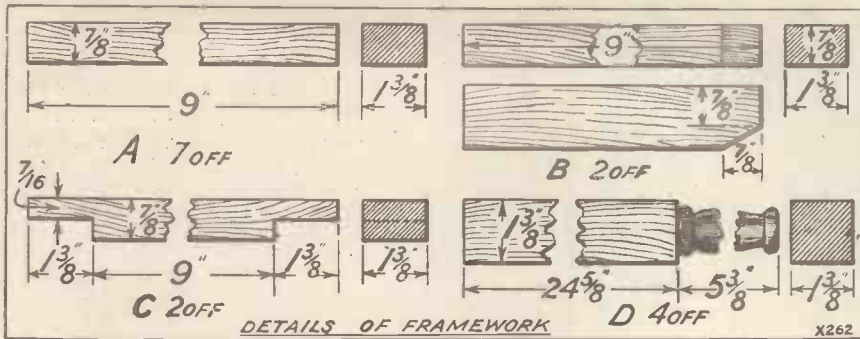

for wood filling. To make this, mix the sawdust with glue and water and fill in over all screwheads, cracks, faults, etc., if any.

Treat the whole finally with fine sand-paper, and not a joint, screw, pin nail, or flaw should be visible, as the filling is the natural colour of the wood from which the cabinet has been made. Before the final papering, however, let the filling set hard.

"Finishing" the Cabinet

The process of finishing may be handled in a number of ways, but I intend to describe a method which can be undertaken with success by all. It is effective on all woods, whether hard or soft, very little skill is required, and the result if properly carried out is equal to any average polished cabinet. It is essential, however, to adhere closely to the following instructions.

nately, logwood chips may be boiled down in water, the quantity of water governing the depth of shade. Do not make stain thick. It is preferable, if necessary, to give more than one coat.

Apply the stain cold, quickly, evenly, and thinly, with a soft brush or rag, and leave till absolutely dry. Remember that wet stain when applied looks darker than the results when quite dry. The next operation is to apply a thin coat of linseed oil, or beeswax dissolved in turpentine, with a soft rag. This should be well rubbed in and left for several hours.

Those who like a dull polish will find that repeating this process gives splendid results. For a brilliant polish, however, a coat of pure spirit varnish or button polish should be quickly, evenly and thinly applied.

The brush should be soft and should not be swept over the same

Must Be Dry

If the work is dry and properly waxed and left to stand the application of varnish will be easy. The oil or wax prevents the varnish soaking into the wood, thus enabling one light coat to be sufficient for a full polished surface, it also permanently fixes the water stain, but it must not be applied before the stain is thoroughly dry and all moisture drawn out.

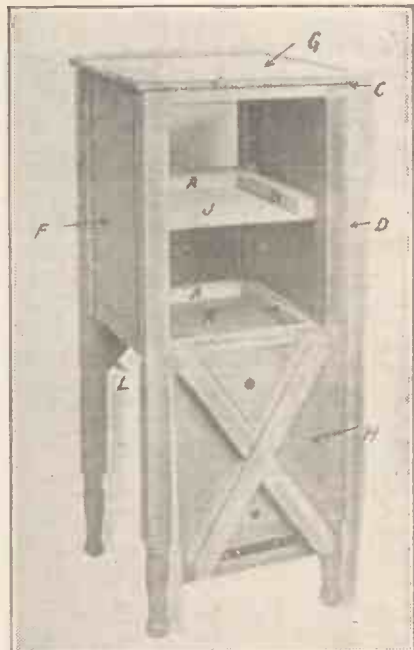

The front of the cabinet, showing how the front hinges. The letters agree with those occurring in the diagrams.

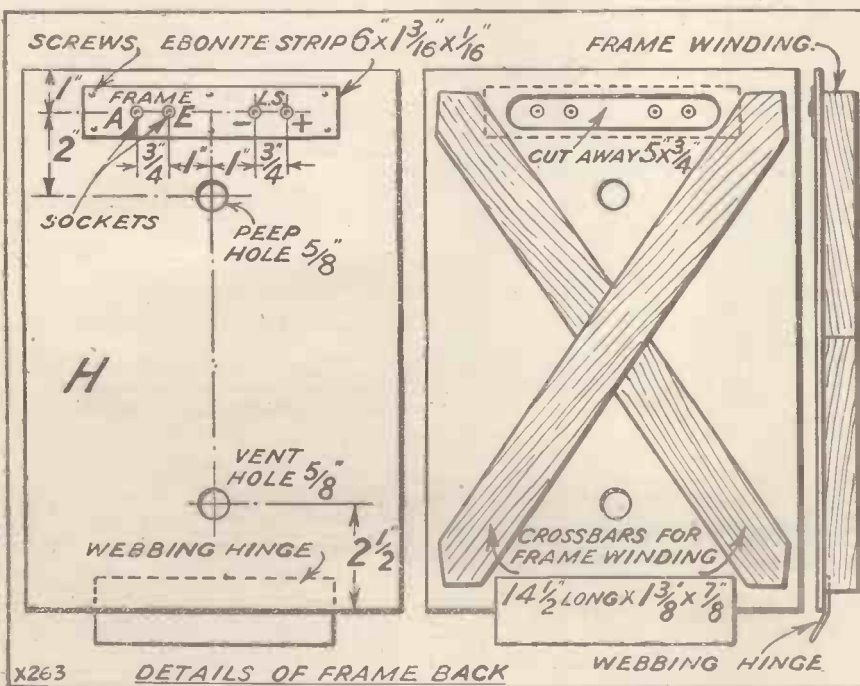

As a final remark, see that you buy well-seasoned wood, ready planed. Do not attempt to plane your own wood. For one thing, it is not worth it, while for another, machine-planed wood results in a constant working thickness.

Connecting Up

The method of using the connections at the back of the cabinet is obvious. Two of the Clix sockets are for loud-speaker connection and the other two for frame aerial or aerial and earth leads, being taken in each case from set to sockets and from sockets to external plug connections. The set housed may be any type of three, or two-valve receiver, preferably with one dial control, and reaction control by midget condenser, or moving coil.

MORE ABOUT The "RADIO-GRAM" FOUR



Full coil details and other essential and interesting notes are given.

By A. JOHNSON-RANDALL.

IN my article last month I stated that for maximum sensitivity it was preferable to use Litz-wound coils. I mentioned that these coils were fully described in the December issue of this journal in my article entitled "Easily-Made Astatic Coils." It has occurred to me, however, that there may be a number of readers who are not in possession of this particular issue, and who are therefore held up through lack of constructional details relating to these Litz coils. For the benefit of these readers I will therefore give the necessary particulars regarding their construction.

The Anode Coil

The necessary dimensions are given on this page, as will be seen from the photograph the former is $3\frac{1}{2}$ in. in length and 3 in. in diameter. These formers can be of Paxolin or Pirtoid, or even cardboard provided this is well shellaced or waxed. Fifty yards of 9/38 silk-covered Litz wire, which incidentally can be obtained from The London Electric Wire Co., Ltd., will be sufficient for two coils. In addition, five valve sockets and five valve legs will be needed. One commences the construction of the coil by marking off the former. A line is scribed across the cylinder lengthwise. Three drilling centres are then marked: one exactly in the centre of the cylinder, that is, $1\frac{1}{4}$ in. from either end; the other two are made each $1\frac{1}{2}$ in. from this centre point, or $\frac{1}{4}$ in. from the end of the former.

Now drill three holes, screwing two valve legs into the two end holes. In the centre hole insert a small 6 B.A.

screw and nut for the purpose of securing the centre of the winding. Then, commencing from one end of the former, wind on forty turns of the 9/38 Litz in a clockwise direction. Punch two holes in the former near the centre and cut the wire, passing the ends through the two holes so as to secure it. Now reverse the former and wind on another forty turns in the opposite direction to the first half. Solder the two ends of the wire at the centre of the former to the small 6 B.A. screw, and connect the two outside ends to the two valve legs. The completed 80-turn coil will have an approximate inductance value of 200 mics., and is quite suitable for the tuned-anode circuit.

The aerial coil is wound on exactly the same principle, except that each half of the winding consists of 35

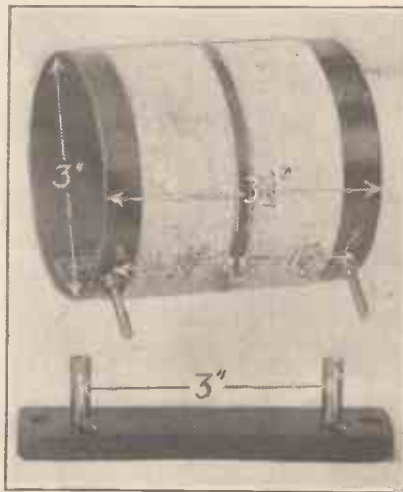

The dimensions for the Litz wound coils and base are given in the above photograph. The aerial coil has additionally a third valve leg for the centre-tapping.

turns, that is to say, there are 70 turns altogether. In this case, instead of using a small 6 B.A. screw and nut to secure the two ends at the centre of the former, a third valve leg will be needed. The coil will therefore be centre-tapped so as to permit the aerial lead to be taken to this centre point either directly or through the small series Formodensor. The mountings for the coils consist of strips of ebonite $4\frac{1}{2}$ in. long by 1 in. wide. A centre line is scribed on each strip, and for the anode coil two holes are drilled exactly 3 in. apart. In the case of the aerial coil a third valve socket placed midway between the two outer sockets is necessary. Each strip is then mounted upon a small piece of wood in order to provide the necessary clearance between the contact sockets and the metal floor of the baseboard.

The Daventry Coils

For the Daventry coils similar 3-in. formers are employed. The centre-tapped aerial winding consists of 175 turns of No. 40 gauge D.S.C., and the anode coil 200 turns of No. 40 D.S.C. I would have preferred to use thicker wire for the 5 X X coils, but unfortunately this would involve much larger formers. I am now experimenting with coils wound in two or more layers, using No. 30 gauge D.S.C. The experiments are quite promising, and I hope to give details of the coil at a later date.

The list of components given in last month's article are those actually used in the set, but, of course, any alternative equivalent types of reputable manufacture can be employed.

The Output Condenser

Some readers may have noticed that in the list of components a 5-mfd. Mansbridge condenser was specified, whereas in the theoretical and practical wiring circuits this value was given as 4 mfd. Actually either 4 or 5 mfd. would be equally suitable. The set originally incorporated a 5-mfd. condenser, but this at a later date was changed to one of 4 mfd. to see whether there was any noticeable difference in the results. The test failed to produce any noticeable difference, and for this reason the 4 mfd. was specified on the score of price.

Those readers who wish to get absolutely the maximum volume out of the set may try a resistance of 250,000 ohms in the first L.F. stage in conjunction with a valve having an impedance of 20,000 to 30,000 ohms, and a magnification of 20.

"3 SW" A THREE VALVER FOR THE SHORT WAVES

Here is a short-wave receiver designed on novel and highly-efficient lines. Its great features are stability and reliability. It was tested by the "M.W." research department, and it was found completely satisfactory from every point of view.



By C. P. ALLINSON, A.M.I.R.E.

I HAD for some time been considering the question of building myself a short-wave receiver on "straight" lines. Although in my usual short-wave work I employed a super-heterodyne I had for some time felt that this was no longer pulling its weight.

There was no reason that I could discover for any drop in efficiency, but it certainly gave me the impression that some of the valves were passengers instead of being working hands.

Preliminary Considerations

I therefore determined to attack the problem of a short-wave receiver from a somewhat different angle. The final outcome is the receiver which I am about to describe.

The most important thing to settle on, of course, was the circuit. There are many short-wave receiver circuits and I don't think there are many of them which I have not tried.

I finally came to the conclusion, however, that one thing which I did want to do was to use magnetic reaction. At the same time the control of magnetic reaction by a swinging coil

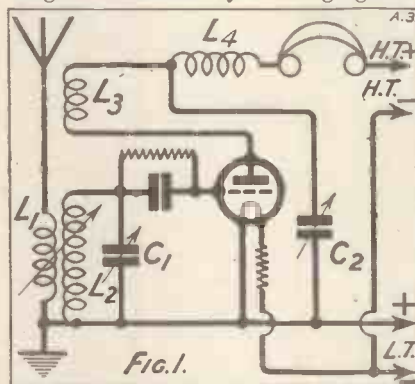

was out of the question, so that I finally came down to the circuit shown in Fig. 1, which shows the detector portion of the receiver. The aerial is variably coupled to the grid

coil of the receiver by means of a swinging coil L_4 , while the grid and reaction coils L_2 and L_3 are fixed in relationship, being wound side by side. The control of reaction is obtained by means of a variable by-pass condenser C_2 , giving us the familiar form of throttle control.

The advantage of this circuit is, of course, that the moving spindles of the condensers C_1 and C_2 are both at earth potential, so that hand-capacity effects are reduced to an absolute minimum.

The Reaction Choke

In order for the reaction to be controlled by the condenser C_2 it is necessary to insert an H.F. choke, shown at L_4 , in the H.T. lead to the anode of the detector valve, and it is necessary, of course, that this choke should be suitable for use in a short-wave receiver if the utmost efficiency is to be obtained.

COMPONENTS REQUIRED.

- | | | |
|---|--|---|
| <ul style="list-style-type: none"> 1 Short-wave coil kit (Collinson). 1 .00015 and 1 .00025 short-wave tuning condensers, with extension handles and brackets (Cyldon). 1 Multi-range H.F. choke (Collinson in original. Any good make suitable for short waves). 1 R.C. coupling unit (Mullard in set. Any good make with anode resistance of about $\frac{1}{4}$ meg.). 1 L.F. transformer, type A.F.5 (Ferranti, but see text). 1 H.F. choke (short-wave type). (C.E. Precision in original, but see above.) 1 .001 fixed condenser (Clarke, Dubilier, Igranic, Lissen, Mullard, T.C.C., etc.). 1 Anti-capacity valve holder (Bowyer-Lowe, or similar anti-capacity, non-microphonic type). | <ul style="list-style-type: none"> 1 .0002 fixed condenser and 3-megohm leak (Clarke, Dubilier, Igranic, Lissen, Mullard, T.C.C., etc.). 1 Super dual 60-ohm rheostat (Burndept or similar type). 1 Potentiometer (Igranic, Lissen, etc.). 2 Fixed resistors and clips (Sydney S. Bird, Dubilier, or similar type; alternatively, baseboard rheostats, such as Igranic, Lissen, etc.). 2 Slow-motion dials (Any good pattern. Ripault on set). 2 Non-microphonic valve holders (Ashley, Benjamin, Bowyer-Lowe, B.T.H., Burndept, Burne-Jones, Igranic, Lotus, Pye, W.B., etc.). 1 Single-circuit, single-filament-control jack (Bowyer-Lowe, Igranic, Lotus, etc.). | <ul style="list-style-type: none"> 1 Aluminium panel, 14 in. \times 7 in., and 1 sub panel, 6$\frac{1}{2}$ in. \times 13 in. (The ones I have used were supplied by Messrs. Burne-Jones, who, I understand, are willing to supply them ready drilled if desired). 1 Cabinet with 14 in. deep baseboard (Areraft, Camco, Caxton, Makerimport, Peto-Scott, Pickett, Raymond). 1 Set of indicating terminals (Belling-Lee on set. Eelex, Igranic, etc.). 1 Strip of ebonite for terminal strip, together with a quantity of Glazite (Junit and Systoflex, etc.) for making connections. 1 Neutralising condenser, if required (baseboard-mounting type). This should have a fairly high maximum capacity. (Burne-Jones, Peto-Scott, etc.). |
|---|--|---|

It seems a pity, however, that a choke should be tied up always in one receiver, and I therefore determined to use one of the Colvern interchangeable chokes, which can be used for short, medium and long waves. By this means it is only necessary to include the plug-in base in the receiver itself, and the choke can then be transferred from one receiver to another, depending on which one is in use.

I have found that this choke is perfectly satisfactory down to 10 metres and lower. At the same time, if you happen to have a suitable choke on hand which will go down to this wave-length there is no reason why it should not be used.

Comparative Tests

Before coming down to the final circuit a number of different arrangements were tried so as to make sure that the circuit which I had decided on was the most suitable for this purpose. A comparison was made between throttle control and Reinartz reaction, and the effect was also tried of using R.C. coupling in the first stage as against transformer coupling.

Using R.C. coupling between the detector and first L.F. valve it was found that the best results were obtained by the use of anode-bend rectification, using a high- μ detector valve and a high value of coupling resistance. Trouble was found, however, in obtaining satisfactory reaction control down in the neighbourhood of 10 to 15 metres, and although the reaction was de-

lightfully smooth I felt that the results were not sufficiently uniform, and varied too much under varying conditions to allow me to use this scheme.

coupling between the first and second L.F. valves, and concluded that this could be done with safety in view of the fact that very strong signals do not have to be handled in this receiver.

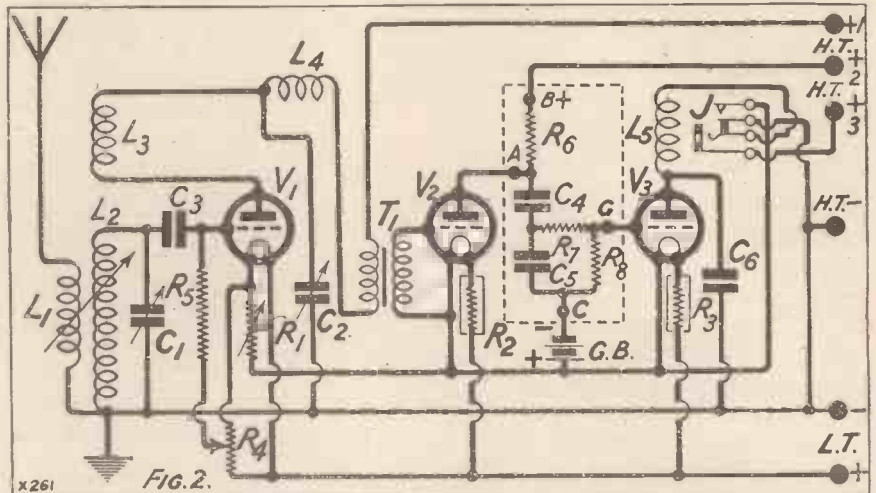

It should be noted that a metal panel is used and is connected to certain components. For simplicity the screening is not shown in this diagram.

The results of these experiments showed it to be desirable to use transformer coupling between the detector and first L.F. stage.

Important Features

The question of the second L.F. coupling now cropped up, and I found that if I used another transformer not only was there a liability of trouble from L.F. oscillation to occur, but also a marked threshold growth developed at certain settings on the tuning condenser. I therefore determined to use a stage of R.C.

For the rectifier valve I have used leaky-grid condenser rectification, since this allows a smoother reaction control to be obtained, and in order that the utmost efficiency both as regards rectification and the smoothness of reaction control might result I have taken the grid leak to the slider of a potentiometer instead of direct to L.T. negative or positive.

With the grid leak taken direct to L.T. positive I found that there was a tendency for floppy reaction to result, while if the leak was taken direct to L.T. negative, although the reaction control left nothing to be desired, there was a certain drop in signal strength.

When taking the grid leak to the slider of a potentiometer I found that the best results were obtained with the grid leak about 1 to 1½ volts positive. Under these circumstances a satisfactory control of reaction was obtainable, while there was no drop in signal strength which could audibly be noticed.

The Final Circuit

The complete circuit of the receiver is shown in Fig. 2. The tuning condenser C₁ is a variable condenser having a maximum capacity of .00015, which is the correct size for use with the short-wave coil which I have employed. C₂, which is a by-pass reaction condenser, has a maximum capacity of .00025.

The L.F. transformer coupling the detector to the first L.F. valve is a low-ratio instrument having a very high primary impedance, while the

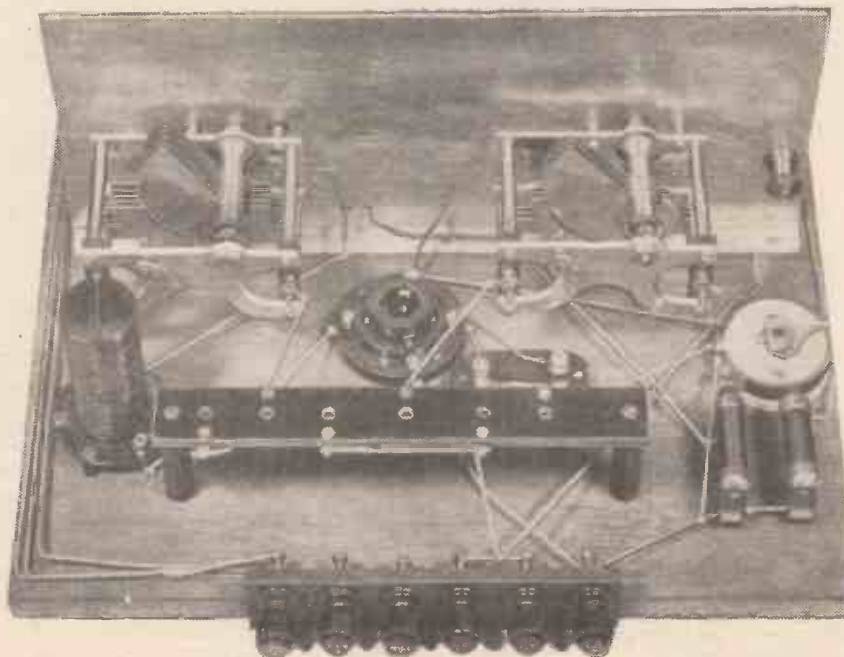

The short-waver is divided into two portions by means of a transverse metal screen. Here you see the H.F. section of the set, containing the tuning and detector circuits.

resistance-capacity coupler is a complete unit and includes the resistances R_6 , R_7 , R_8 , and the coupling condenser C_4 and the by-pass condenser C_5 .

In the output of the second L.F. valve I have connected a short-wave choke and a by-pass condenser C_6 , so as to keep any H.F. currents as far as possible out of the telephones, since their presence would result in undesirable hand-capacity effects and interaction with the tuning control. I have used a filament jack in the output circuit so that the insertion and removal of the telephone plug switches the set on or off as the case may be.

Grid Biassing

The potentiometer to which the grid leak R_5 of the detector valve is connected is shown at R_4 , and is connected to the filament side of the variable resistance R_1 in the negative lead of the detector valve, since this is controlled by the jack. Otherwise the potentiometer would be in circuit even if the set were switched off and the L.T. accumulator would quickly get run down. I have used a 60-ohm rheostat in this position to enable different types of valves of all voltages to be used as desired, and although the resistance is in the negative lead the circuit is so wired as not to affect the grid potential of the detector.

In view of the fact that the resistance R_6 has a value in the neighbourhood of 400,000 ohms, I have used a high- μ valve for the first L.F. valve V_2 , and I have, therefore, considered it unnecessary to use any grid bias with this valve, though in some cases an advantage may be obtained by

applying a small value of negative bias. In the case of a high- μ valve this will best be done by connecting the filament resistance R_2 in the negative instead of in the positive lead, while if a valve having a lower impedance is used in this position a $1\frac{1}{2}$ -volt dry cell may be connected

was particularly anxious not only to obviate hand-capacity effects on the controls of the receiver, but also to prevent any possibility of trouble occurring owing to H.F. transfer into the L.F. circuit.

Now we know when working on the very high frequencies in the

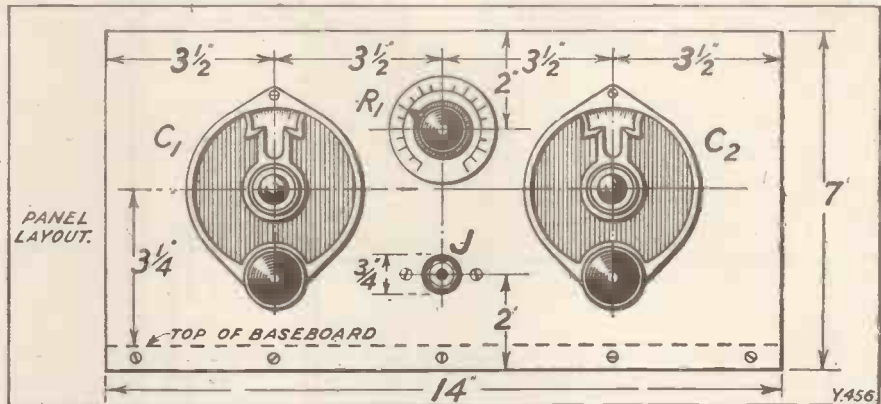

in series with the secondary so as to apply a small negative bias to the grid of the valve.

In the case of the third valve I have used a small power valve, and here, of course, grid bias is indicated, a suitable value being between 9 and 15 volts, depending on the type of valve and the H.T. employed. For headphones an H.F. valve can successfully be employed for V_3 , and this results in an increase in signal strength while the H.T. current consumption is reduced.

Unusual Layout

Having decided on the circuit to use, the next question to determine was the layout to be employed. In view of the fact that I intended this receiver to go down to wave-lengths in the neighbourhood of 10 metres I

neighbourhood of 10,000 kilocycles that metal objects placed within two or three feet of the receiver are extremely sensitive to the H.F. field when the receiver is in an oscillating condition. This has frequently been noticed by amateurs, who have remarked that on touching a pair of pliers or a screw-driver or any piece of metal within a couple of feet of a short-wave receiver which is oscillating, scraping and scratching noises are heard in the headphones.

I therefore concluded that it would be a very valuable feature if the detector portion of the receiver was shielded from the low-frequency side.

As I intended using tuning condensers with extension handles it occurred to me that the best way of completing this shielding and making it most effective would be by mounting the tuning condensers on a metal panel behind which would be the detector valve and the coils, in front of this metal panel would be the L.F. amplifier and in front of this another metal panel which would carry the controls of the receiver itself.

Distinguished Appearance

The use of this metal panel for mounting the controls will be seen from the heading photograph to give the receiver an extremely distinctive appearance, the black dials contrasting favourably on the engine-turned aluminium finish. The photographs of the receiver also show the layout of the controls on the panel, while the exact layout of the receiver itself behind and between the panels will be seen by consulting the photographs taken of the receiver and also from the wiring diagram.

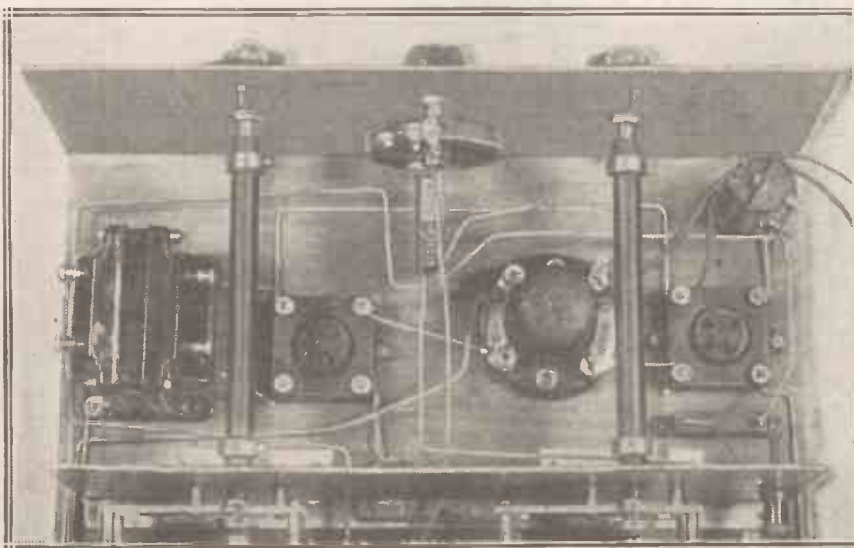

The two L.F. stages are restricted to the one compartment, and are well separated electrically from the coils and other H.F. components by the metal screen.

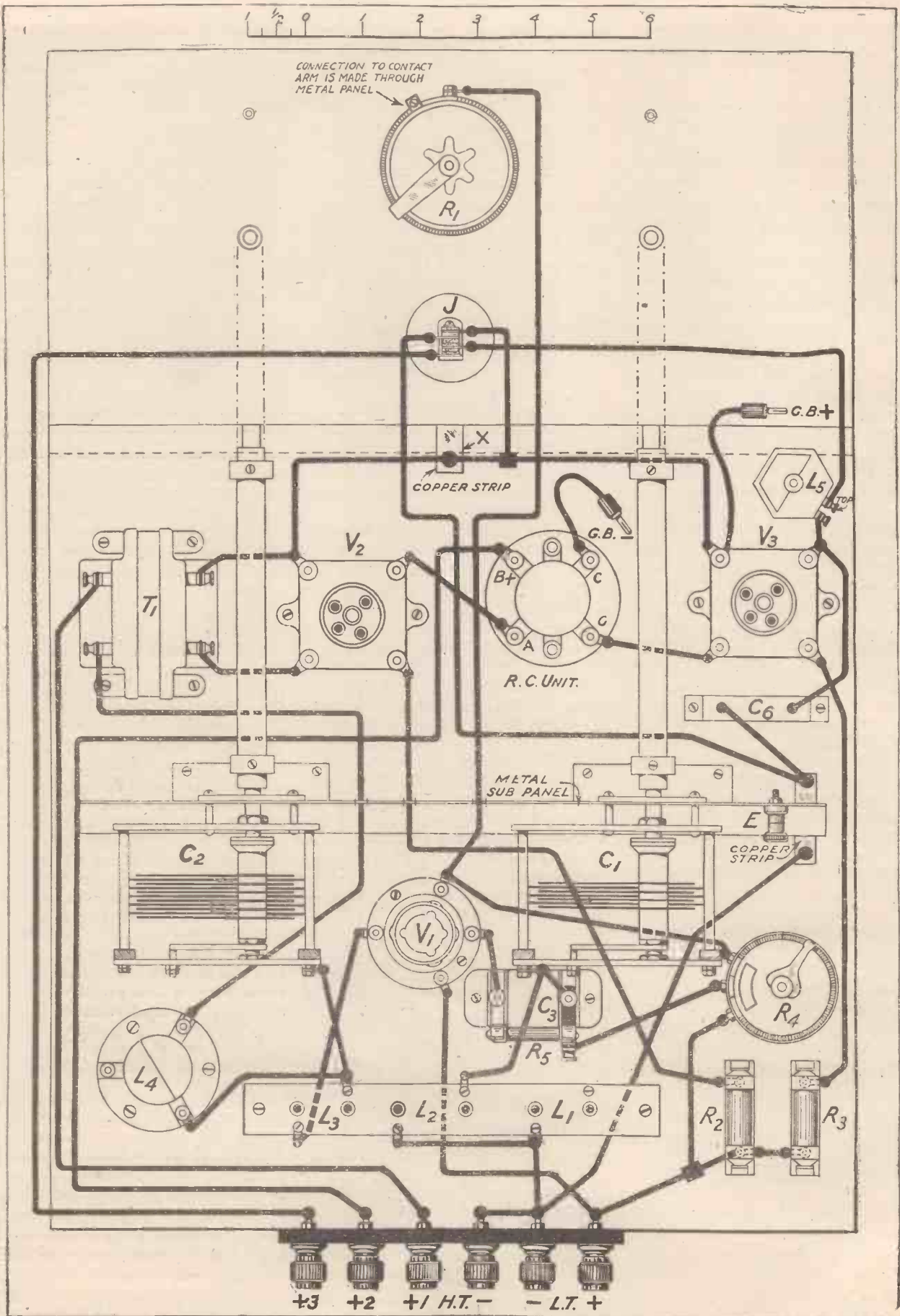

For cheapness of cost and lightness of weight I have used aluminium panels, and these have proved perfectly satisfactory in practice.

The use of these metal panels is further simplified by the circuit which I have chosen, and I think I can claim that this receiver incorporates certain features which have not previously appeared together in a short-waver.

An examination of the photograph

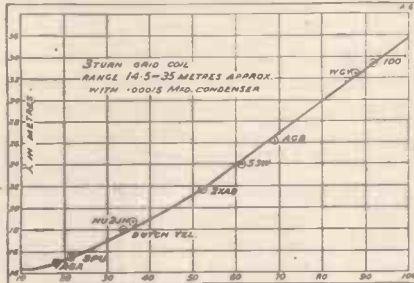

taken from the front of the set will show that the controls are most conveniently located for operating the receiver, the tuning condenser is controlled by a slow-motion dial which is seen on the left, while the right-hand dial is for reaction control.

Smooth Control

It was found desirable to include a slow-motion dial at this point, even though the condenser gives a delightfully smooth control. In the centre at the top will be seen the filament resistance R_1 , while the output jack is mounted on a small ebonite panel which is fixed to the aluminium panel and will be seen at the bottom.

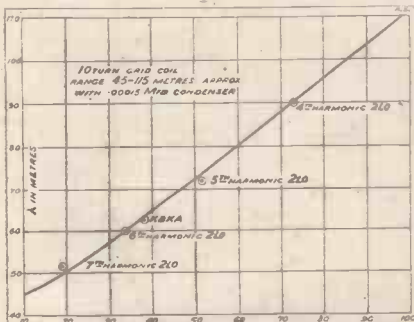

The battery terminals are carried on a strip along the back edge of the baseboard, while the earth terminal is connected directly to the second aluminium shield, the aerial terminal being carried on the aerial coil itself. I have provided three H.T. tappings for the three valves.

H.T. Values

I myself use a common H.T. voltage on all three valves, and in nine cases out of ten this will be found perfectly satisfactory, but there are cases when it may be desirable to use different values of H.T. for the

detector and for first L.F. valve.

While on the subject, I think I ought just to mention a point with regard to the use of a super-power valve in the last stage. Although there may be times when valves of this description may prove useful in view of the strong signals which are sometimes obtained with this receiver, particular care should be taken not to use a super-power valve in the last stage when plugging in a pair of headphones unless a filter circuit is employed.

Preventing Capacity Effects

The heavy anode current taken by a super-power valve is much too great for a pair of headphones; not from the point of view of burning out the windings, but from the point of view of saturation, so that the signal strength is a fraction of what it would be if the anode current were reduced. Of course, grid bias may be increased till the anode current is cut down to a suitable value, but this would necessitate the use of an extra grid-

bias battery at least, and is therefore not to be recommended.

It should also be noted that an H.F. choke is connected in the plate circuit of the second L.F. valve, and a

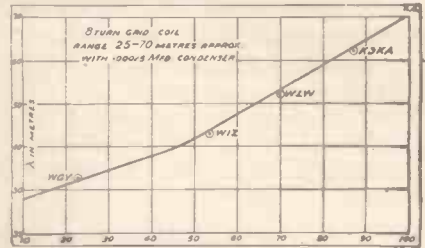

shunting condenser connected between plate and L.T.—. This has been done in view of the fact that a certain amount of H.F. is still transferred to the low-frequency amplifier, notwithstanding the special precautions which have been taken to obviate this, and the result is that capacity effects are introduced when wearing the 'phones owing to the presence of this H.F. component.

To build this receiver you will need the components listed, and though

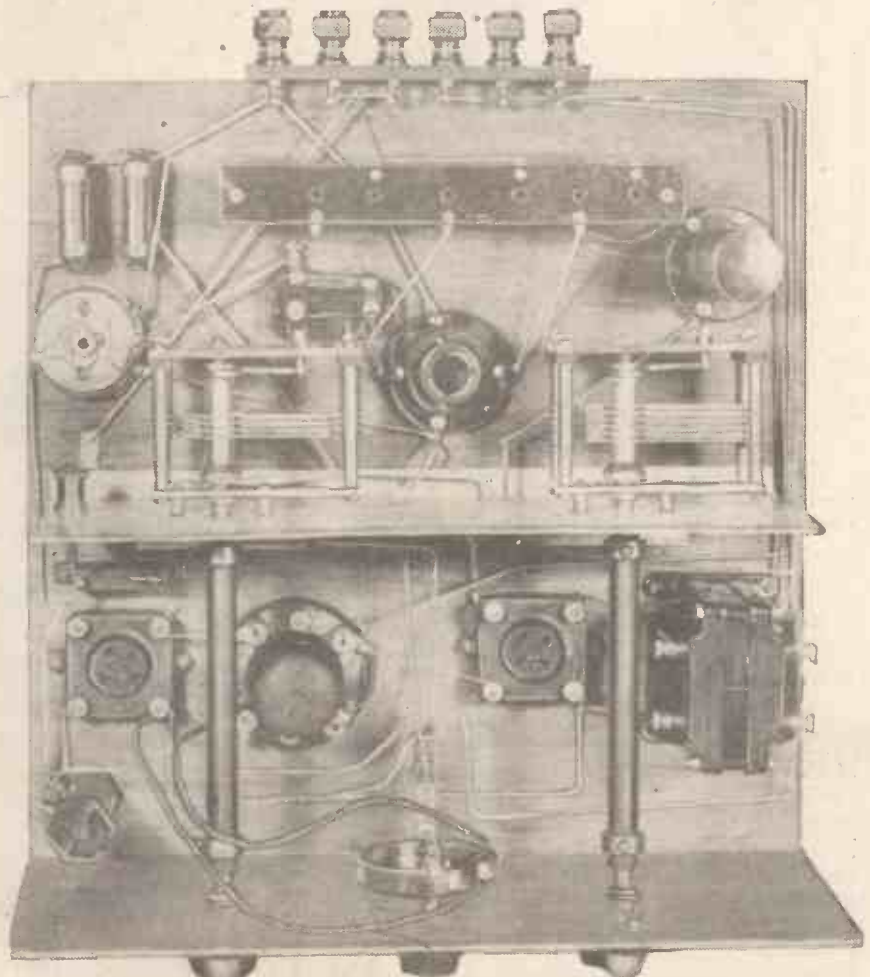

This photograph shows the complete baseboard and back-of-panel assembly of the receiver. Note the long extensions fitted to the variable condensers. Two earthed metal panels shield these components from the hands when tuning the set.

in most cases alternative makes of suitable quality can, of course, be used there are one or two points which I would like to discuss.

Alternative Components

With regard to the short-wave coil kit the connections which are given in the wiring diagram are correct with the Colvern kit which I have used. If another make is used, care should be taken to obtain the correct connections, since otherwise the func-

(Igranic type P.68) the metal framework of the jack is not connected to any of the spring contacts in the jack, so that when the plug is withdrawn there is no fear of a short-circuit occurring should the plug make contact between the nut fixing the jack to the ebonite panel and the aluminium panel. With other types of jacks where the frame is in contact with one of the springs care will need to be taken, when inserting the plug, to see that it is not inadvertently allowed

The other three holes are $\frac{3}{4}$ in. clearance, while five small holes are drilled along the bottom edge of the aluminium panel so as to fix it to the baseboard. Two small holes are also required to fix the jack panel to the aluminium, and possibly a hole for a fixing screw for the slow-motion dial.

The Variable Condensers.

Next mount the condensers which go on the sub-panel into position and fix this to the baseboard. Attach the extension handles to the two condenser spindles and fix the bushes in the aluminium panel, which is mounted on the front edge of the baseboard. Put this into position, and bring the spindles on the extension handles through the bushes on the front panel.

Now mount the jack on a piece of ebonite $\frac{1}{4}$ in. thick, and fix this to the panel by means of two 6 B.A. nuts, as shown in the front-of-panel layout. Place the filament rheostat in position and put the dials on to the spindles.

It will be noticed from the dimensioned panel lay out that the distance of the centres of the extension handle spindles is marked from the *top of the baseboard*. This is done in view of the fact that the height of the condenser spindles has to be measured from the top of the baseboard. If,

(Continued on page 448.)

tioning of the receiver may be affected.

The R.C. coupling unit which I have used incorporates an H.F. stopper resistance R_7 , so that where another unit is used which does not incorporate this resistance it may be an advantage to connect one up externally which will consist of a .25-megohm grid leak put into circuit as shown.

The L.F. transformer which I have used is a Ferranti A.F.5, which gives a very high degree of efficiency following a high- μ detector valve. Other transformers, such as the Ferranti A.F.3, or the Marconi Ideal 2-7-1, can, of course, be used, but it may be desirable in this case to use a different valve in the rectifier position.

An Important Point

The first point in the construction of this receiver, if you have obtained the panels undrilled, is to drill them according to the panel layout previously given. It should be noted that the hole through which the jack appears is $\frac{3}{4}$ in. in diameter, and this is necessary in order to give ample clearance between the metal frame of the jack and the aluminium panel which is connected to L.T. negative. With the jack which I have used

to make contact between the nut fixing the jack and the aluminium panel.



The completed "3 SW" set makes a very attractive instrument, and moreover one capable of providing attractive results.

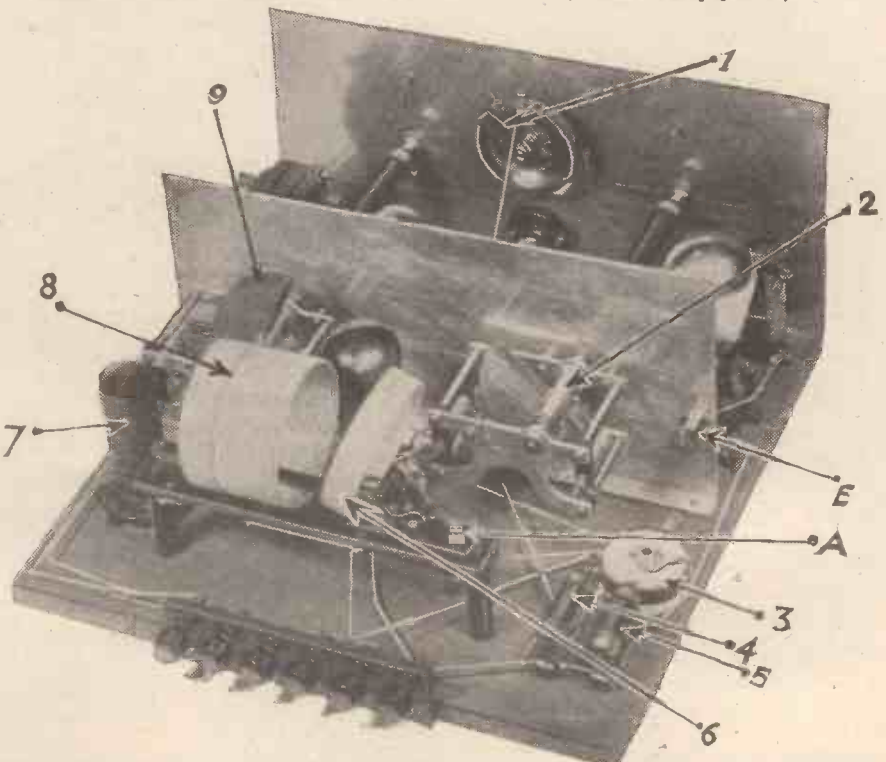

The numbers indicate: (1) Filament control rheostat; (2) C_1 , Tuning condenser; (3) R_1 , Potentiometer; (4) R_2 , Filament resistor; (5) R_3 , Filament resistor; (6) Aerial coil; (7) H.F. choke; (8) grid and reaction coils.

The £1,000 TELEVISION CHALLENGE

IN the issue of our contemporary, "Popular Wireless," dated March 10th, there were made known the details of a challenge which "Popular Wireless" and MODERN WIRELESS invited Mr. J. L. Baird to accept. The challenge was made for the sum of £1,000, and it was based on the fact that wireless television—real vision at a distance—

is, in the opinion of reputable scientists, a distinct possibility but is not likely to come as a development of the methods being used by Mr. Baird.

That is to say, *that some new method will have to be discovered before television in the home becomes a practical possibility.* (Vide Sir Oliver Lodge, Dr. Roberts, etc., etc.)

As our readers know, Mr. Baird has publicly stated from time to time details in connection with various spectacular tests, and at a recent luncheon given in his honour he said: "It is from this beginning that I hope to instruct and guide amateurs so that they will be able to receive the television broadcasts now being sent out from our station in Long Acre. Anyone listening in with a wireless set on forty-five metres after midnight will hear a peculiar humming sound. The amateur with a televisor will be able to transform this peculiar sound into pictorial images."

2-Hours Limit

From this it would seem clear that Mr. Baird thinks his system capable of greater development, sufficient at any rate to justify the sale of component parts for home television sets. It has also been pointed out that these home television sets when built require a high-tension supply of six to seven hundred volts—a voltage sufficient to give anyone a fatal shock. But even when the home television set has been built, the listener—or perhaps we should say the "see-er"—would naturally

A brief outline of the details of the "Popular Wireless" and "Modern Wireless" Television Challenge to Mr. Baird, and the reason why the challenge was made—and not accepted.

By THE EDITOR.

want a more or less regular service of television broadcasts.

We understand from an authoritative source at the General Post Office that the question of granting licences for the transmission of television on a commercial basis has not yet arisen, but if and when there is an insistent demand for the issue of such a licence, the whole

matter will have to be gone into very thoroughly in a similar way to that in which broadcasting was examined before the old B.B.C. was formed.

And we further understand that anyone asking for such a licence would have to satisfy the Post Office that his apparatus and plans were technically capable of conducting television either as a public service or on a commercial basis in a satisfactory manner.

Experimental transmitting licences have, of course, been granted to bona fide experimenters, and there is nothing to stop them transmitting—or trying to transmit—anything in the nature of television, providing they do not make a commercial proposition of such transmissions. This licence, however, restricts the transmission to two hours per day, and the transmissions can only be made on short waves, where, as is well known, even telephony is still more or less unreliable.

No Licence

We understand that Mr. Baird has one of these licences, but we are informed that no commercial licence has been granted to him, and that Mr. Baird is not really legally entitled to start a commercial broadcasting television service.

The question of constructors who do not hold a transmitting licence, but who build home television apparatus for both transmission and reception, is one which, according to an official at the Post Office, would have to be "very carefully gone into."



Miss D. Selvey before Mr. Baird's Televisor during the recent "Berengaria" experiment.

But the fact is that at present there is no licence issued for the working of anything in the nature of a television B.B.C., and amateurs would therefore have to rely entirely upon experimental transmissions. The Post Office engineers, we understand, are keeping a very careful watch for any television-possibilities or developments.

The Conditions

While realising to the full the value of Mr. Baird's pioneer work in connection with television, the Editor of "Popular Wireless" and MODERN WIRELESS and his scientific consultants nevertheless remain unconvinced that much progress farther than that already achieved can be made along the lines on which Mr. Baird is working,

A RADIO-EQUIPPED HOTEL



This is the control room of the Pennsylvania Hotel's radio system. Every room has a connection, and guests can choose their own individual station. Over 33 million feet of wire were used for this system in the great New York hotel.

and because of the misapprehension existing in the minds of the general public with regard to the possibilities of Mr. Baird's system, "Popular Wireless" and this journal have issued a friendly challenge to Mr. Baird, and offered to pay him the sum of £1,000 if he will televise by wireless over a distance of not less than twenty-five yards the items mentioned below, under the conditions specified, and in the presence and to the satisfaction of a selected committee of competent investigators.

The detailed conditions of the challenge are as follow :

1. Three faces to be recognisable, together or separately, by the members of the committee. These three faces will be decided upon by the members of the committee,

but they shall be three faces which are sufficiently familiar to the members of the committee so that under reasonable circumstances they shall be recognisable when televised by wireless. The committee shall not be informed as to the order in which these faces shall be televised.

2. That the committee shall be able to identify five simple solid geometrical models, singly, in slow motion, and televised in sequence to be chosen by the Editor.

3. That the committee shall be able to recognise and state the number of dice and marbles shown in motion on a flat tray or board—the number of dice and marbles combined not to exceed twelve.

4. That the committee shall be able to recognise four animal toys grouped together and in slow motion. The members of the committee must be able to identify the animals these four toys represent. Only animals which might reasonably be found in a box of toy animals as sold in an ordinary toy shop will be used.

5. That Mr. Baird shall televise by wireless a clock face, the hands of which he may artificially rotate at the transmitting end, at a speed to be left to his own discretion, but which must be recognisable by the committee at the receiving end, and in such a way that when the hands are not rotated the members of the committee shall be able to tell the time on the clock.

These were the main conditions, the others being matters of detail.

In making this friendly challenge to Mr. Baird, the hope was expressed that he would win the thousand pounds offered. The offer also had the proviso that the investigatory committee should consist of two qualified scientific men and two laymen, and that neither the Editor of "Popular Wireless" and MODERN WIRELESS, nor any of the staff or consultants connected with the papers in any way whatsoever, would be on the investigatory committee.

The Public Must Judge

This challenge was made public on the morning of Thursday, March 8th, and considerable prominence was given to it by the daily papers.

According to the "Daily Express," an official of the Baird Television Company, when questioned with regard to the challenge, replied: "This challenge is simply a continuation of mischievous attacks made on Mr. Baird. There is no need to answer criticism of that kind. Mr. Baird is above it. A certain section of the wireless press regards television as a menace to its interests and will endeavour to hinder progress of this new science."

In reply to this statement, the Editor of "Popular Wireless" and MODERN WIRELESS said: "It is just what I expected Mr. Baird or his representative would say. The public must be left to judge whether or not the attacks are 'mischievous.' My only comment is that such criticisms as I have made have been supported by eminent scientists."

Our readers will note that Mr. Baird regards the criticisms we have published as "mischievous." We, on the other hand, suggest that the encouragement for the building of home television receivers when there is no official service, and when it is suggested that a high-tension supply of six or seven hundred volts should be used, etc., is misleading. In any case, we cannot understand Mr. Baird's answer to our challenge, for we made it clear that this challenge was made in all friendliness and sincerely with the desire of clearing up any misapprehension which existed in the public mind with regard to the capabilities and possibilities of Mr. Baird's television system.



NORDDEICH GERMANY'S MARINE RADIO-CENTRAL

Some interesting details of one of the most famous wireless stations in the world, now used by Germany for communicating with ships at sea.

By Dr. ALFRED GRADENWITZ.

THE Norddeich Coast Station carries out long-distance wireless telephone and telegraph marine service, whereas three other coast stations, viz., those at Cuxhaven and Bremerhaven, on the North Sea, and Swinemuende, on the Baltic, are designed to afford to incoming and leaving vessels as rapid a wireless connection as possible with the ports concerned and to immediately re-transmit any S.O.S. calls.

Though Norddeich has been in operation for about twenty years, its installations have been repeatedly enlarged and improved in accordance with the trend of radio development. However, its technical equipment seems to have been brought to an at least temporary conclusion last summer.

New Building

A new transmitter building has lately been erected where the following are accommodated: One 20-kw. valve transmitter; one 10-kw., two 5-kw., three 500-watt valve transmitters, and one 2-kw. quenched spark transmitter. It is a lengthy hall building, and to it has been added on the side opposite the entrance a transversal building accommodating the high-tension generator, and switchboard plants.

The masts and the aerial and earth systems are, as yet, only provisional. Six braced steel lattice masts, four of which are each 260 ft., and two each 230 ft., high. These are, however, in the near future to be replaced by four 650-ft. masts, and when these have been installed existing transmitters will be equipped with their definite aeriels adapted to actual outputs and operating wave-lengths.

Operation of the existing transmitters is effected by different methods, the two largest, viz., the 20- and 10-kw. units, being operated direct from the 3 × 5,000-volt, 50-cycle, three-phase system, and the two 5-kw. units as well as the small transmitters from 500-cycle dynamos.

Gigantic Accumulator

All 500-cycle machines are fed from a 220-volt continuous-current system, the extensive power plant being arranged as follows: An annex comprises an accumulator battery of 220 volts, with a capacity of about 725 ampere-hours. This battery is charged either from Diesel engine-operated continuous-current generators, or from single-armature converters. Two Diesel engines, each of 80 h.p., have been each coupled direct to a 50-kw. continuous-current generator.

The two single-armature converters are driven on the motor side from the 3 × 380-volt, three-phase current system, and on the generator side have an output each

of 48-kw. continuous current at 220 volts. These single-armature converters are normally used for operating all the transmitters, with the exception of the two large ones, viz., the 10- and 20-kw. units. When used to charge the station battery, each single-armature converter is connected up to a booster machine of about 13 kw. The 220-volt battery, as already mentioned, is only used as standby, the two single-armature converters in normal operation generating the continuous current required.

Anode Current Supply

The high-tension central station comprises the following double rooms: Compartment I, containing the switching devices for the incoming 3 × 5,000-volt cable; Compartment II, comprising oil switches and a 75-k.v.a. transformer (5,000/220) for operating the two three-phase transmitters of 10 and 20 kw. respectively; Compartments III and IV, housing oil switches and a 75-k.v.a. transformer (5,000/380) for operating the two single-armature converters.

The switchboard system is made up of a total of 24 compartments, arranged symmetrically to the entrance door of the transmitter room. The 12 compartments at the left contain the switches and measuring instruments for the 500-cycle converters required for operating the two 5-kw. valve transmitters and the minor transmitters.



Above is shown the control switchboard, where the engineer-in-charge has all Norddeich's powerful apparatus at his finger-tips.

Two sets of machines have been provided for operating the two 5-kw. transmitters, as well as one standby set. The latter is switched on at will to either of the two transmitters, and the same is true of the three 500-watt transmitters. The 2-kw. quenched spark transmitters are operated from two vertical 500-cycle converters, which can be as well connected up to the transmitting station.

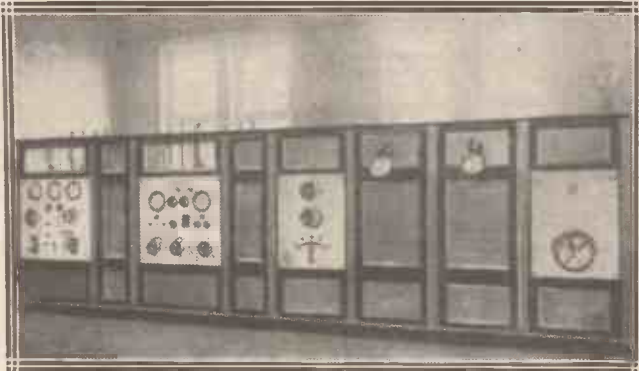

A front view of the 20-kw. valve transmitter.

All converters (with the sole exception of those destined for use in connection with the quenched spark transmitters) are visible on one of our pictures.

The twelve compartments on the right comprise switches and measuring instruments for the two single-armature converters, the two booster charging machines, for the transformers, and the incoming cable. Three compartments to the left, and as many to the right, have been left disengaged for future extensions of the station.

Commercial Telephony

The two 5-kw. transmitters are mainly destined for operation at medium distances and as standbys for the larger units. They are separate-controlled intermediary circuit transmitters for telegraphy, which, however, by providing some additional apparatus are readily used for commercial telephony as well. The anode is operated from 500-cycle converters, at 10 k.v.a., and 3 k.v.a. for heating. The range of wave-lengths of the two transmitters is 1,000-5,000 metres, according to the aerial actually used. This range comprises five fixed waves, which are readily adjusted for. The transmitters are arranged in switchboard fashion and comprise the following: Control transmitter and telephone apparatus,

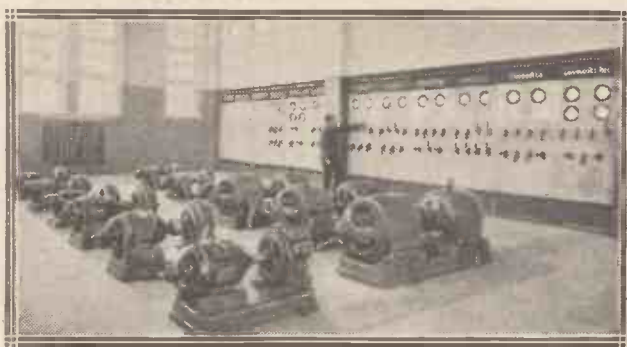

Norddeich's giant switchboard and the power plant.

valve and rectifier systems, intermediary circuit, and aerial tuners. Each of the two 5-kw. transmitters comprises two rectifier valves, one control valve, six main oscillatory valves, and one modulating valve.

One of the three 0.5-kw. transmitters gives out weather reports, storm warnings, and news for navigators, on a

wave-length of 1,100 metres, at certain times of the day; whereas the other two are destined for local communication on the wave-lengths of 600 metres (call) and 725 metres (operation) respectively. A short-wave transmitter has been installed for experimental purposes, but is to be replaced next summer by an up-to-date crystal-controlled 10-kw. short-wave transmitter.

Long Distance Service

The 10-kw. transmitter is mainly destined for the long-distance service. However, it is also resorted to in connection with the telephone service, its telephone output in accordance with international rules being 4 kw. It is twice daily placed at the disposal of the "High Sea Broadcasting Service," broadcasting by telephone weather reports, storm warnings, fish market reports; etc., for fishing steamers, high-sea cutters, and other small sea-going craft.

Like the 5-kw. transmitter, it is a separately controlled intermediary circuit transmitter of about 9-kw. output in the aerial, and is arranged both for telegraphy and telephony. It comprises four compartments, viz., a rectifier system, the valve system, controlling transmitter and telephone plant, intermediary circuit and antenna tuner.

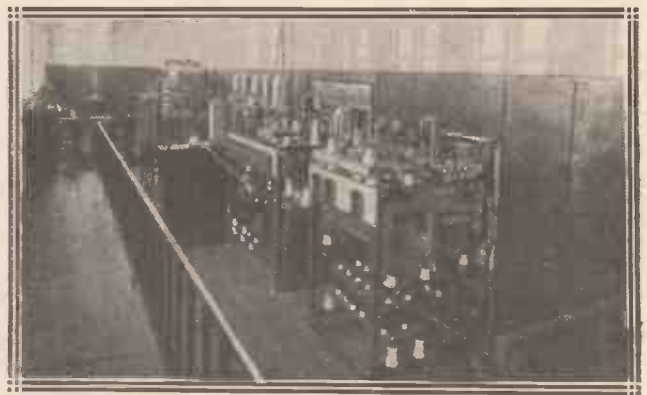

This "back-of-panel" view shows the "works" of the two 5-kw. transmitters.

The range of wave-lengths is between 1,000 and 4,000, in which interval there are five tuned waves, which are readily adjusted for by simple switching operations. The anode and heating energies are derived direct from the three-phase current system (3 x 220 volts, 50 cycles), through proper transformers, 220 volts continuous current being used only in connection with the auxiliary circuits of the transmitter (contactor, etc.).

The 220-volt three-phase current is, in connection with the anode circuits, stepped-up in a transformer to 10,000 volts, and rectified in a rectifier plant comprising six high-vacuum rectifier tubes.

Increasing Life of Valves

Special transformers have been provided for heating the rectifier and main generator valves respectively. The heating of the control and modulating valves is derived each from a special transformer inserted between two phases of the three-phase system. While the three main generator valves are designed for yielding a total of about 15 kw., the whole plant has been so dimensioned as to have them yield only about 10 kw. to the intermediary circuit with a view to increasing the life of the valves.

The 20-kw. transmitter is used for long-distance operation, its range far exceeding that of ship transmitters.



A "DX" receiver capable of bringing in the majority of European broadcasting stations on the loud speaker.

By
C. P. ALLINSON, A.M.I.R.E.

DURING the course of the experiments which I have been carrying out on the tapped-grid neutralising circuit which I employed in the "Forty-Station Four" receiver, I had occasion to make up an amplifier panel using two stages of this description.

I was so struck by the performance given by this receiver when using only one stage of L.F. amplification that I thought it only fair to pass the results of my investigation on to the wireless experimenter.

Valuable Features

I have therefore designed and constructed the receiver which is described in this article, since it is a receiver which incorporates certain features of great value for long-distance reception.

Perhaps I ought to say here that in view of the fact that three tuning controls have to be kept in step when

searching for distant stations, and that the circuit as a whole is selective probably above the average, this

STATIONS RECEIVED	
Milan	Cork
Munich	Hamburg
Vienna	Toulouse
Brussels	Manchester
5 G B	Stuttgart
Langenberg	Graz
Berlin	Bournemouth
Radio Lyons	Oslo
Koenigsberg	Newcastle
Frankfurt	Belfast
Cattowitz	Nuremberg
Brunn	Malmo
Berne	Kiel
Glasgow	Muenster
	Bordeaux

A number of other stations were not definitely identified, except by wave-length. On the long waves were: Huizen, Radio Paris, Daventry, Berlin, and another station, probably Kalundborg, Hilversum, and one or two other transmissions not identified.

receiver is hardly suitable for construction by the amateur or, shall we say, the beginner to wireless experimental work. Rather it is a receiver suited to the more advanced experimenter, who has considerable skill in operating receivers and who does not think that condenser dials are merely to be twiddled, but considers them as more or less scientific adjustments.

Improved Neutralising

You will no doubt remember that the tapped-grid circuit is a great improvement on the split-secondary neutralising circuit which I have recently evolved, the main differences consisting in this: Firstly, that the low-tension return is not taken to the centre of the coil but only a quarter the way up from the end; and, secondly, that instead of connecting a high value of resistance in this L.T. return as I have hitherto done, I have found it possible to reduce the value

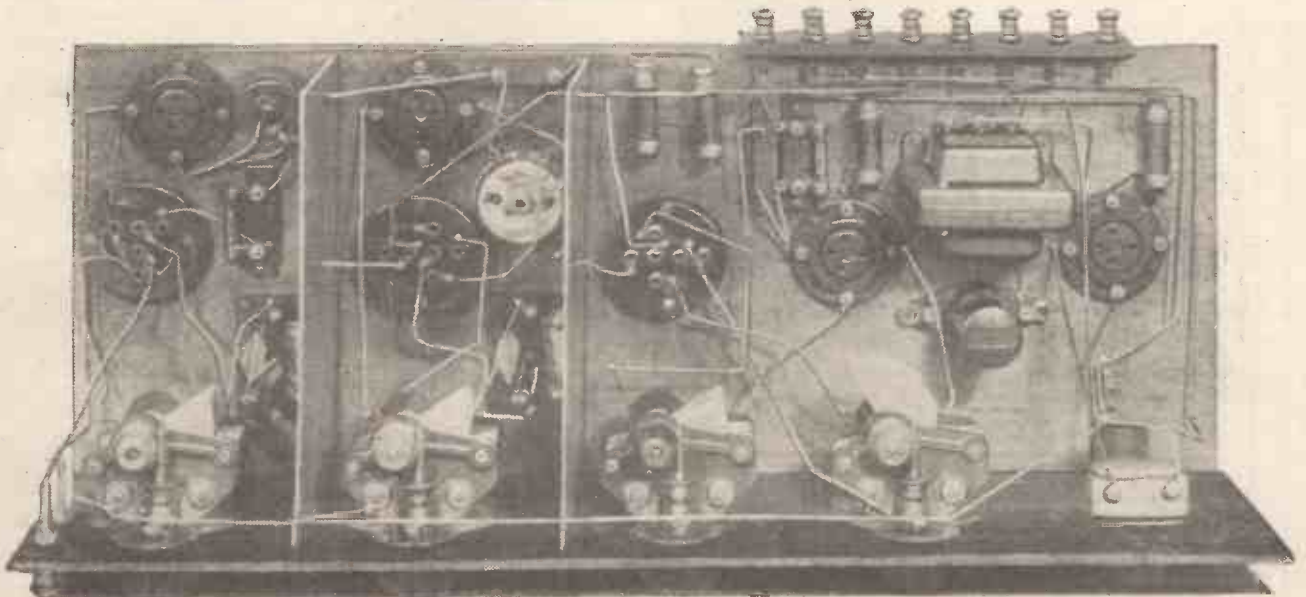

This receiver employs the author's special tapped grid coils, which greatly increase the efficiency of the neutralising.

of this resistance to 200 or 300 ohms, which is a high-enough value to damp out parasitics.

As the result of these alterations to the circuit a curious point was discovered, a point incidentally which I have been aiming at in the experi-

point where it was naturally flat in tuning, and inherently most stable.

When using two stages of H.F. amplification, as in the receiver to be described, this point is quite noticeable, and it is exceedingly curious, when increasing the con-

receiver is such that the full amount of reaction is very seldom required, and stations from all over Europe can be received at loud-speaker strength without pushing the receiver in any way.

In using two stages of the tapped-grid circuit I found that on the short waves perfect stability was obtained by using two 400-ohm resistances connected in the L.T. return of both coils. On the long wave-lengths, however, when using the two stages, I found that with some types of coils a certain difficulty was experienced in obtaining stability, and in such cases I found that this trouble could easily be cured by connecting a high value of resistance in one grid return instead of the 400-ohm potentiometer, and although the inclusion of this resistance gave the desired stability, no perceptible reduction in amplification was incurred.

COMPONENTS REQUIRED

- 3 .0005 variable condensers (If these are not of slow-motion type then 3 slow-motion dials will also be required). (Collinson, Ripault, Ormond, Igranic, Jackson, Cyldon, J.B., Bowyer-Lowe, etc.)
- 1 .0003 variable condenser (see above).
- 1 L.F. transformer, ratio 2-1 or 3-1 (R.I.-Varley, Igranic, Marconi Ideal, Ferranti, etc.).
- 1 H.F. choke (Lissen, other of the standard makes).
- 3 6-pin coil bases (Colvern, Leweos, Peto-Scott, etc.).
- 2 Double-capacity B.M. neutralising condensers (Peto-Scott Co., Ltd.).
- 2 Tapped-grid H.F. transformers for long and short waves (Collinson Precision).
- 1 B.R.T. Reinartz transformer for long and short waves (Lewcos, Colvern, etc.).
- 1 200 or preferably 400-ohm baseboard - mounting potentiometer (Igranic, Lissen, etc.).
- 4 Filament resistors (Cyldon Tem-

- pryts, Peto-Scott, Burne-Jones, Lissen, Igranic, etc.).
 - 4 Non-microphonic valve holders (Benjamin, Lotus, Burndep, Burne-Jones, Bowyer-Lowe, Igranic, W.B., etc.).
 - 1 Volume control 10E (Rothermel).
 - 1 Fixed condenser, .0003, and 1 5-megohm grid leak and clip, and 1 2-megohm grid leak and clip (Dubilier, Mullard, Lissen, T.C.C., etc.).
 - 1 .01 by-pass condenser (Dubilier, T.C.C., Mullard, Lissen, etc.).
 - 1 Single-circuit jack (Igranic, Ashley, Lotus, etc.).
 - 1 On-off switch.
 - 2 Pieces of copper 8½ in. × 7 in., 22 gauge, for inter-stage screens.
 - 1 Terminal strip and terminals for battery connections, and two terminals for aerial and earth connections.
- A quantity of wire for connecting up.
 1 Panel 24 in. × 8 in. × 3/16th in.
 1 Cabinet and baseboard 9 in. deep for the above.

mental work carried out with this circuit, to the effect that when correctly neutralised at, say, 250 metres, the valve was somewhat under-neutralised when coming on to the longer wave-lengths in the neighbourhood of 450 and 500 metres. This, therefore, introduces a certain amount of natural reaction in the H.F. circuits, which sharpens up the tuning and generally livens up the set at a

densers tuning the two H.F. circuits from, say, 450 to 500 metres, to note that if anything a slight reduction in the reaction control is required instead of an increase, as is usually the case.

Actually it was found that the reaction control remained set over an extremely large wave-band, so that the control of the receiver is considerably simplified thereby.

In any case, the sensitivity of the

Quiet Background Obtained

Further, when tried out on the short wave-lengths with this resistance in circuit the overall efficiency of the receiver did not appear to be in any way impaired, and I therefore retained it as part of the final design so as to obviate any possibility of difficulty occurring in any case whatever.

In comparing the results obtained with this receiver, using two stages of H.F. and one only of L.F., with another receiver using one stage only of high-frequency amplification and two stages of low-frequency, although the latter receiver certainly gave greater signal strength on the whole the difference was not very marked. On the other hand, the use of two

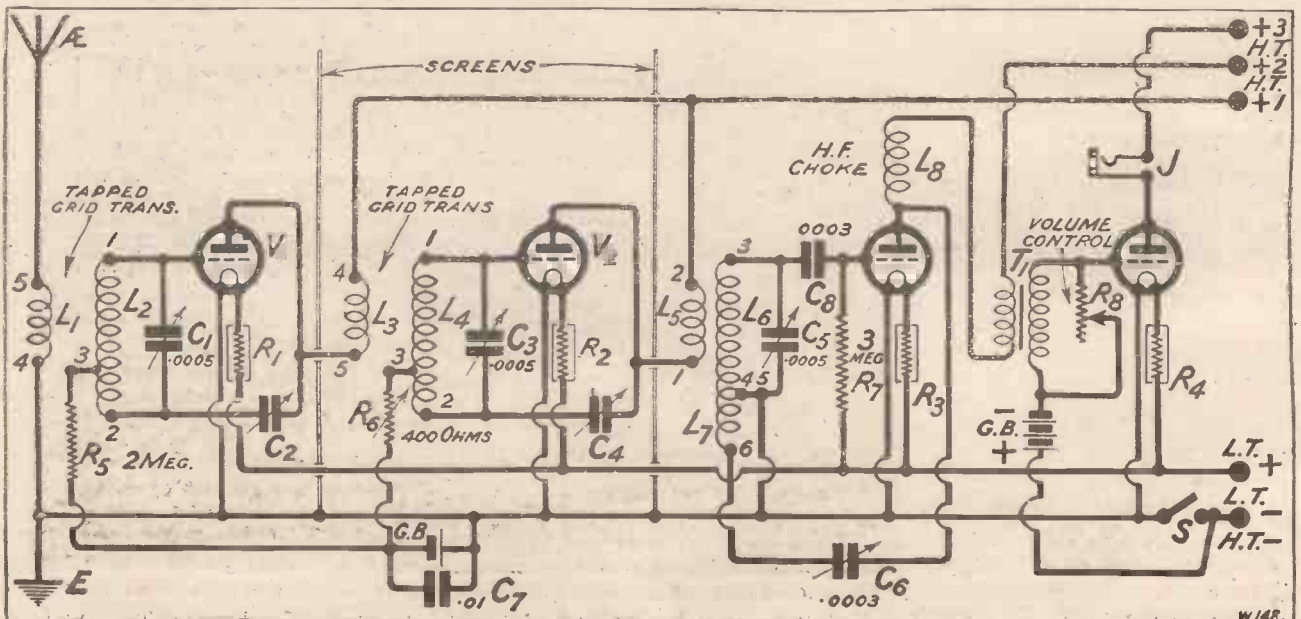

stages of H.F. amplification certainly gave a quieter background and, of course, gave a marked increase in selectivity, which in many cases is a most desirable feature, in view of the many powerful transmissions now on the ether.

The French have now caught the craze for physical jerks over the ether, and the Radio-Paris station has recently been broadcasting gymnastic instructions at 7.45 a.m.

A specially-designed broadcasting organ is now being built for the studio at Frankfort-on-Maine.

The Voxhaus station, Berlin, is to have an open-air studio.

I know that many listeners are complaining of interference from some of these more powerful stations spreading to transmissions close to them.

Selectivity Can Be Varied

As a matter of fact, almost any desired degree of selectivity can be obtained with this receiver, since the aerial coupler and first H.F. transformer are provided with interchangeable primary windings. Where, therefore, a very high degree of selectivity is desired, by cutting down the primary windings to a small number of turns this can be obtained. In other cases where selectivity is not needed, then, of course, a larger number of turns can be used with the result of an increase in signal strength.

The photographs taken of the finished receiver show that it is quite simple to construct, the components on the panel all being of the one-hole fixing type. These components have also been reduced to a minimum, though it is true that the volume-control resistance which I have included in the set might in some cases be left out.

Screened H.F. Stages

I found, however, that this volume-control is exceedingly useful, especially on some of the very powerful transmissions, which would otherwise come in at uncomfortable strength when particularly favourable conditions exist.

The photographs taken behind the panel show that I have used inter-stage screens which consist of a copper sheet placed vertically on the baseboard. With this particular receiver the most important form of coupling which had to be eliminated between adjacent H.F. stages was the capacity coupling, and the screens

which I have used amply achieve their object, and also largely reduce any magnetic coupling which might otherwise be present between the inductances.

Easily Made

The screens are easy to make, and only require two holes drilled in them for wires passing through from one stage to the next. This is due, of course, to the particular form of neutralisation used and the general layout and design of the receiver.

One of the points I had considered in the construction of this receiver was whether or not to gang the two H.F. stages together so as to simplify the control of the receiver. I was very tempted to do this in view of the greatly simplified operation that would result, but I had to consider the question from another angle as well, and that was from the point of view of cost.

The average experimenter is certainly not in the position to keep buying new components and apparatus, and I did not wish him to turn down a receiver which would otherwise give many pleasurable hours of

enjoyment, and prove of great interest in experimental work, just for the sake of introducing a component which, though simplifying the handling of the receiver, would put up its initial cost.

I have therefore retained separate tuning controls for all stages, and although the selectivity of the receiver is of no mean order they will not be found to be individually particularly critical in adjustment.

The Neutralising Condensers

There is one thing I must point out, however, about the components used, and that is with regard to the neutralising condensers. When using the tapped-grid circuit as used in this receiver it is important that the neutralising condensers have a value somewhat higher than that usually used. Messrs. Peto-Scott Co., Ltd., have kindly supplied two condensers specially for this purpose, and these will be known as Double Capacity B.M. Neutralising condensers.

I have had these condensers fitted with long extension handles, since

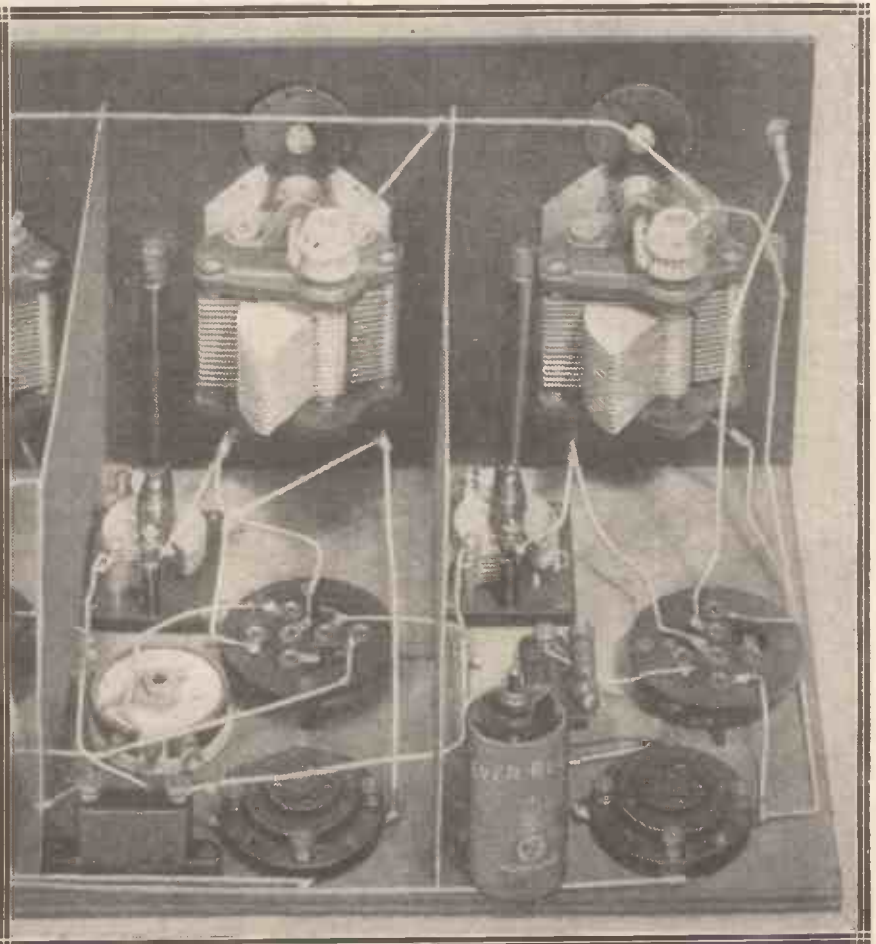

The H.F. stages are well screened, each section being self-contained, and "grid biased" by the single cell shown in the foreground to the right of the first screen.

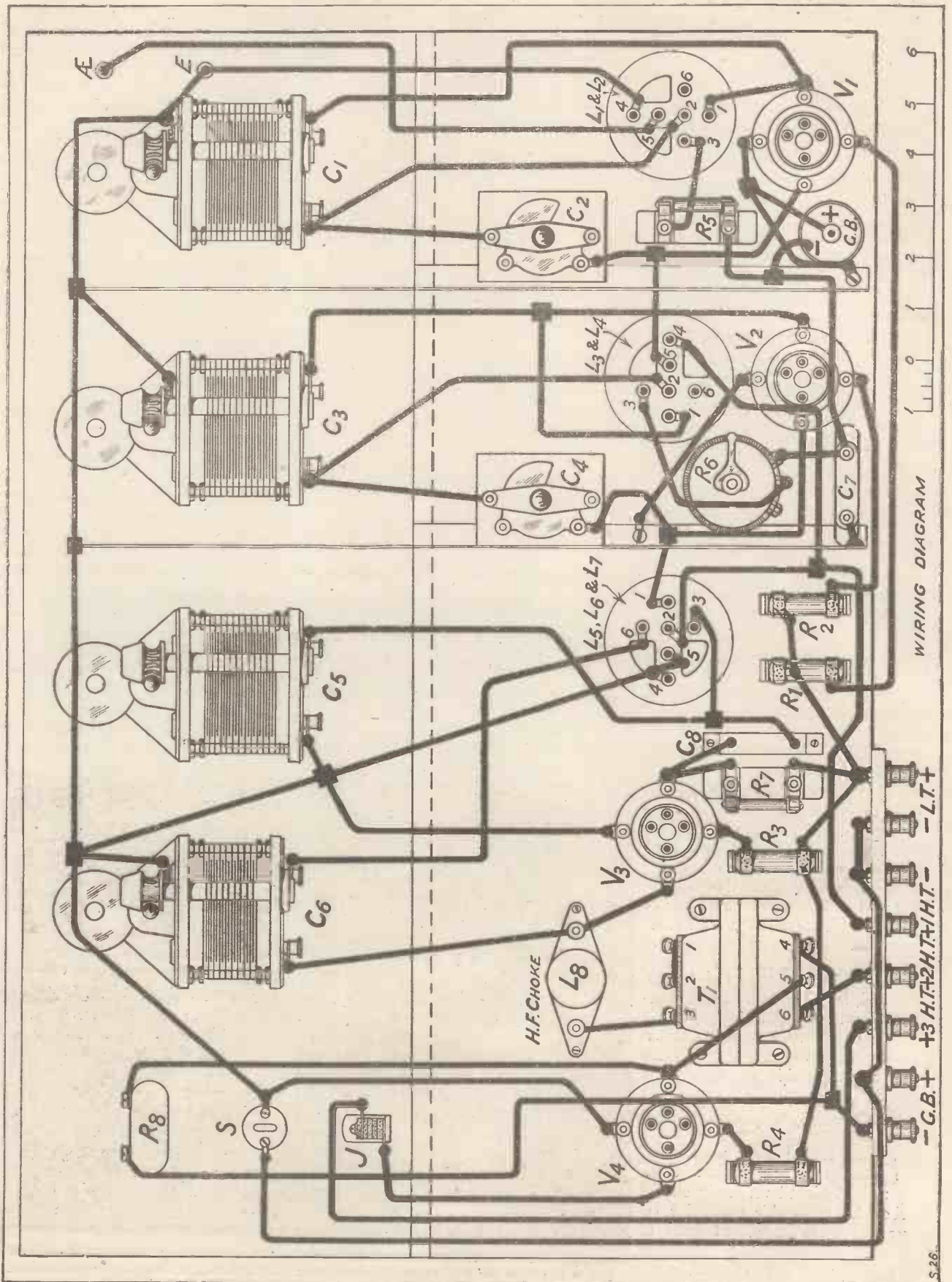

this enables any adjustment to be made with the hand well away from the tuning condensers and coil, so that errors are not introduced owing to body capacity.

Questions of Grid Bais

Another point which I have considered well worth inclusion is the use of grid bias in connection with the H.F. valves. Where two stages of H.F. amplification are used it frequently occurs that the H.F. voltage handled by the second H.F. valve will be of measurable magnitude, and in this case it is certain that we do not get the full amplification from the stage owing to grid current damping on the positive swing. By introducing a small grid-bias battery, having a value of $1\frac{1}{2}$ volts, so as to place a negative bias on the grids of the H.F. valves, we can get a greater degree of effective amplification for the two stages, especially when dealing with strong signals, while at the same time, owing to the slight increase in the impedance of the valves, a higher degree of selectivity is to be obtained. This grid-bias battery is just a small $1\frac{1}{2}$ -volt cell.

Important Points

Although it may seem that the components have been somewhat crowded between the screens, actually it will be found perfectly simple to make all the various connections, and all these are accessible without difficulty.

With regard to the aerial coupler

and the first H.F. transformer, which are necessary for use in the tapped-grid circuit, I believe at the moment the only make available is the Colvern, though I have no doubt that other makes will be available in due course.

The American broadcasting authorities have fitted up a super-receiving station at Riverhead, Long Island, N.Y., for picking up European programmes to be relayed by the different American broadcasting stations.

Experiments are still going forward at Daventry in the hope of providing a perfect aerial for 5 G B.

The question of the tuning condensers should also receive consideration, since when using the tapped-grid circuit neither side of the condenser is actually at earth potential in the case of the two H.F. condensers. In practice it will be found that by connecting the moving spindle to the bottom of the coil which goes to the neutralising condenser, practically no hand-capacity effects will be obtained unless the receiver is operated just on the edge of oscillation. Nevertheless, in cases where the constructor would prefer to be certain that no effects of this description would be experienced, it is advisable to use some form of condenser with an insulated operating spindle, such as the Colvern slow-motion condenser which I have used.

The only actual constructional work involved in making this receiver is

drilling the panel for mounting the components on it and making the two inter-stage screens. These two screens are made of two pieces of copper each $8\frac{1}{2}$ in. by 7 in., being turned over $\frac{1}{2}$ in. at the bottom so as to mount them on the baseboard. Two holes are drilled in the turned-over portion which is at right angles to the remainder of the screens, so as to allow of screws passing through into the baseboard so as to fix them securely in position.

Two holes are drilled in each screen near the bottom edge, one to allow the anode lead from the previous valve to pass through to the six-pin coil base and the other for the grid return from the second valve to pass through the screen so as to make connection to the grid-bias battery for the two H.F. valves.

Assembling of Components

In assembling the receiver, first of all mount the components which go on the panel into position and fix the panel to the baseboard by means of a number of small screws along the bottom edge. Having done this place the inter-stage screens into position, connecting soldering tags beneath the heads of the screws which fix the screens to the baseboard so as to allow of connections being taken from the screens as required.

After this is done the components which are not mounted on the base-board may be placed in position, and the wiring diagram which is drawn to scale, will give you

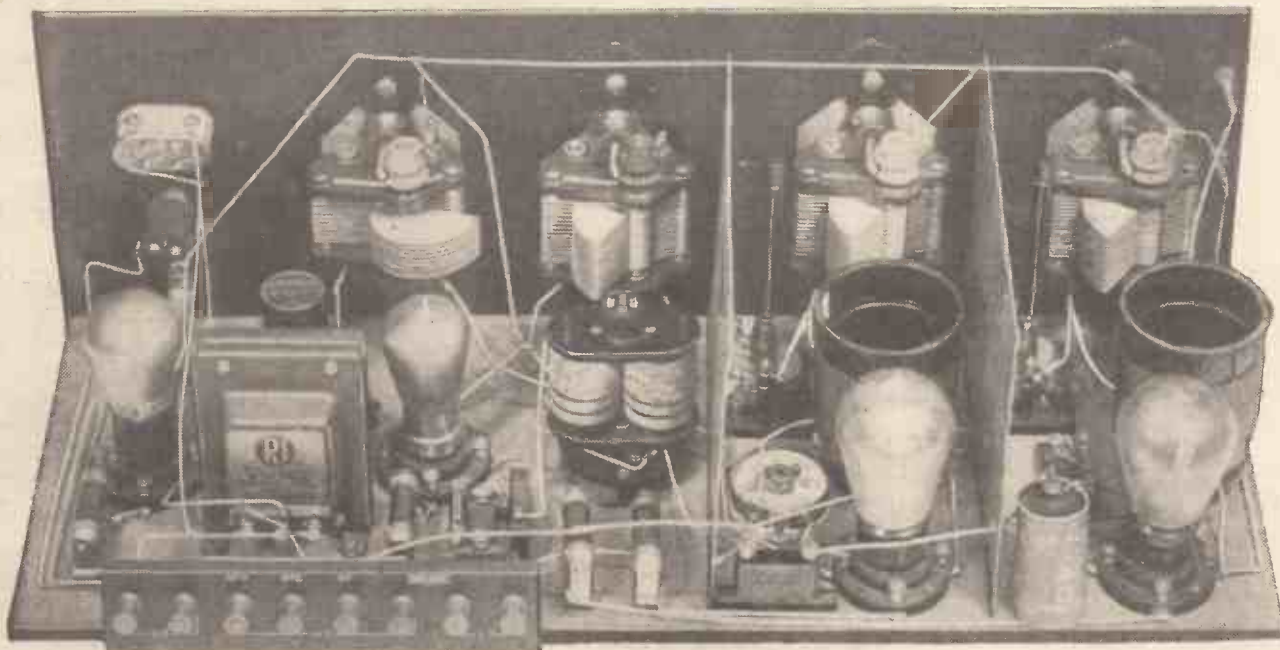

The sensitivity of the "Greyhound" Four is such that the full amount of reaction is very seldom required, for stations from all over Europe can be received at full loud-speaker strength without "pushing" the receiver in any way. Its selectivity, of course, is excellent, while the degree can be varied by means of the interchangeable primary windings of the aerial and first H.F. transformers.

all the necessary details as to the layout of the various components. Although it may appear that the components are fairly closely spaced, there is actually no crowding and all connections are quite easily get-at-able for soldering purposes.

The battery terminal strip is placed at the left-hand end of the baseboard at the back when looking at the receiver from the rear, while the aerial and earth terminals are carried on the panel itself.

Easily Wired Up

For wiring up this receiver I do not think I need give any special instructions, since it will be found that all leads go into place without difficulty. I myself started by completing the low-tension circuit and the connections to the screens which are fixed underneath the condensers.

After this I started at the aerial end of the receiver and finished the circuit in rotation. It should be noted that the small by-pass condenser C_7 , which is shunted across the grid battery for the H.F. valves, is connected directly to this screen by means of a short lead of wire soldered to the edge of it.

By making the holes in the inter-stage screens through which the leads pass $\frac{1}{16}$ th in. in diameter it will be found that there is an ample

Having completed the wiring of the receiver the usual tests should be carried out with regard to ascertaining that the H.T. and L.T. circuits are correctly separated. All coils, of course, should be plugged in when these tests are being carried out,

NEW STATIONS

The new broadcasting station which has just started up in Northern Iceland (call-sign N I) is under the control of a missionary society. For experimental purposes it is also using the call-sign G 2 S H, and a wave-length of 192 metres.

Sweden plans to have two more super-broadcasting stations on the air during 1928, namely, Malmo and Gothenburg. In both cases the power will be increased to 10 kilowatts.

since should a mistake have been made when connecting up the six-pin bases it will not show up if the coils are not inserted.

Suitable Valves

The only point with which I have not as yet dealt is the question of the choice of valves, and on this, of course, depends the choice of suitable fixed resistors for each position.

For the two H.F. valves ordinary H.F. valves may be used, though

theory would say that a valve having an impedance not higher than 30,000 ohms should be used, I have found in practice, owing to the fact that leaky-grid-condenser rectification is employed, that a high- μ high-amplification R.C. valve may be used without any audible loss of quality of reproduction. On the other hand, a great increase in amplification and delightfully smooth reaction are obtained, and I certainly think that a valve of this description may be used in the detector stage. Suitable valves in the 6-volt class are the Cosmos 55B, Mullard P.M.5B, Osram D.E.H.610, etc.

H.T. Voltages

For the L.F. valves I have found that the volume given by this receiver generally requires the use of a super-power valve, if anything like reasonable strength of reproduction is to be obtained without overloading.

On the local station and 5 G B, and one or two other transmissions of great strength, I have found it necessary to employ the volume control to cut down the input to the L.F. valve, since otherwise I found overloading resulted. For maximum power on distant stations and ability to handle large volume I certainly recommend the use of 6-volt valves, though 4-volt and 2-volt

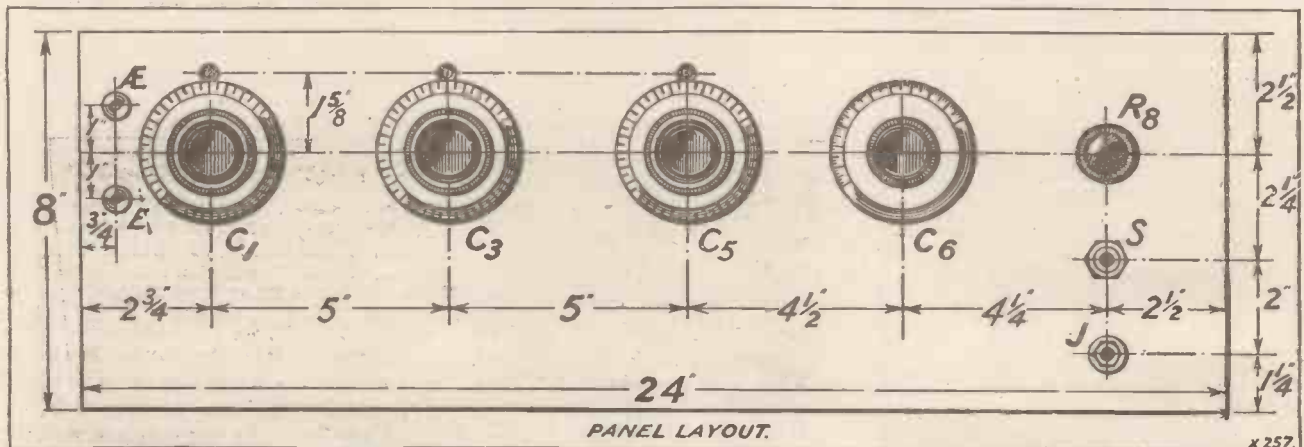

clearance all round the leads. Nevertheless, it is important to use insulated wire so as to eliminate any risk of a possible short-circuit.

The L.F. transformer I have used allows of different ratios to be obtained. In view of the fact that I used a high-impedance high-amplification factor valve for the detector, the transformer has been connected up to give a 3-1 ratio, and the maker's instructions to obtain this ratio should therefore be followed where the same transformer as I have used is employed.

if you happen to have a spare power valve there is no reason why this should not be used in the second stage, as I have found that quite excellent amplification is to be obtained with a valve of this description.

High Amplification Type

If this is done it would be advisable, of course, to use separate grid bias for the two H.F. valves, so as to enable a power valve, if used, to be given the correct amount of bias.

For the detector valve, though

valves will, of course, work well in the receiver.

The values of H.T. which I have used are 120 on the two H.F. valves, 80 to 90 on the detector valve, and 120 to 150 on the L.F. valve. Lower values of H.T. may, of course, be used, but I always like to work with as high a value as possible, since this enables the maximum efficiency to be obtained from the receiver.

Having made the preliminary tests and found everything in order, the receiver may be connected to the

aerial, batteries attached, and valves inserted in position.

Preliminary neutralisation should be carried out on the local station or the nearest powerful transmission by means of the usual zero signal method. While this is being done the reaction condenser of the detector valve should be placed in its zero position.

Ivory labels which have become detached from panels can generally be fixed quite well with ordinary rubber solution as used for mending bicycle tyres.

* * *

The use of too much high-tension shortens the life of the valve.

Having obtained a provisional setting on the neutralising condensers which gives stability on the particular wave-length on which the tests are being carried out, the three tuning condensers should be reduced to a value where they are about only one-third in.

Final Neutralising Adjustments

It will probably be found that the set will now go into oscillation, but a small adjustment on the two neutralising condensers will again stabilise it. Now reduce the value of the tuning condensers again, and, if the set once more tends to oscillate, make further adjustments on the neutralising condensers till a setting is found at which the set is stable over the whole range.

If you happen to be the possessor of a buzzer wave-meter or a modulated heterodyne wave-meter, then the neutralisation should be carried out by means of this accessory. The receiver should be neutralised at a wave-length in the neighbourhood of 250 metres by the zero signal method, and if this is correctly carried out it will be found to be stable over the whole wave-band.

Stable Reaction Control

Distant stations may now be searched for, and it will be found a simple matter to go from station to station by adjusting each dial a few degrees at a time. Although the selectivity of the receiver, as a whole, is fairly high, it will not be found that individual circuits are critical in adjustment, and once a little practice with this receiver has been obtained it will be found a simple matter to go from station to station on the loud speaker. Once the 300-metre mark has been passed,

it will be found that very little attention need be paid to the reaction condenser, which can be left set for all but the weakest transmissions.

On the Long Waves

In these cases the value of reaction may be increased to the required degree, and care should be taken not to let the receiver oscillate, since the reaction control is so smooth and gradual that you may have the receiver oscillating without knowing it. Of course, as soon as you detune slightly the familiar whistle will be heard, though if you happen to be dead in tune with the station the fact that the receiver is oscillating will be shown by a decrease in signal strength occurring as the reaction is increased, instead of an increase.

When plugging in the long-wave coils for the reception of Hilversum, Berlin, Daventry, Radio Paris, etc., it may be found necessary to make a slight readjustment of one of the neutralising condensers in some cases. This depends, however, to a certain extent on certain variable factors introduced in the construction of the receiver, and in most cases it will be found that the set is perfectly stable without any readjustments being necessary on the neutralising condensers. If, however, any readjustment is necessary, it will probably be found on the second neutralising condenser, and that only a small movement either way will provide complete stability.

On the long waves the selectivity of this receiver is again of a very satisfactory order, and no difficulty at all will be experienced in separating Radio Paris from 5XX and the Dutch transmission just above it, while other long-wave transmissions are received at great strength on the loud speaker.

In the course of a short test carried out one evening with this receiver, about 40 to 45 stations in all were received on the loud speaker on the short and long wave-lengths, and some of these came in at such strength as to require the use of the volume control.

Loud-Speaker Results

While the greater part of the stations listed were received at quite satisfactory loud-speaking strength for a small room, the exact degree of volume depends to a certain extent on one's personal interpretation of loud-speaker strength, and I do not wish the intending constructor to be misled as to the performance of this receiver. At the same time, I certainly think that I can justifiably claim some 30 to 35 stations at good loud-speaking strength on this receiver; but this, of course, is subject to interference, fading, and other atmospheric conditions.

Notwithstanding the fact that three tuning dials require some manipulation, I am certainly of the opinion that the handling of this receiver is extremely simple.

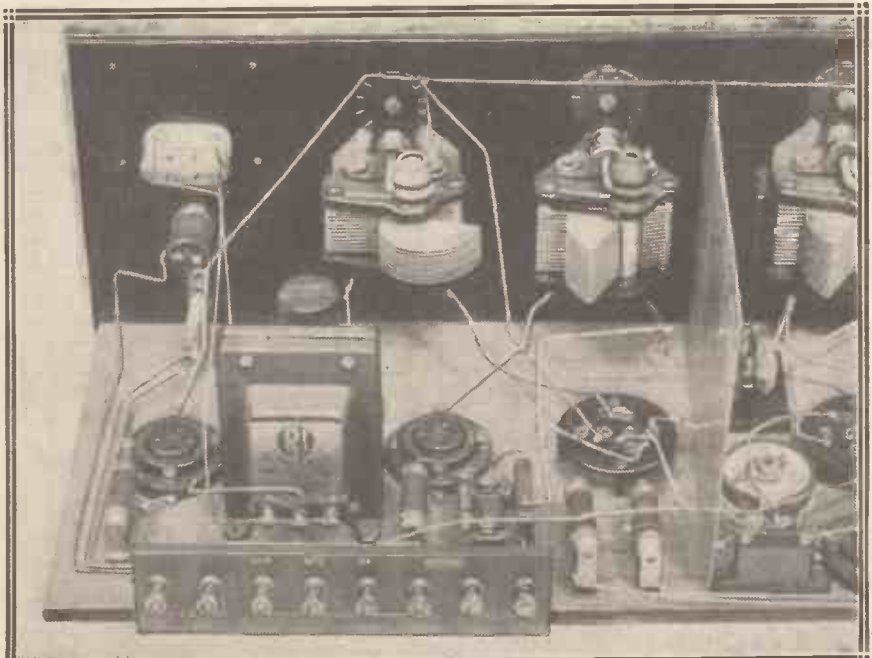

The L.F. end of the set is exceedingly simple and merely consists of a transformer-coupled stage. The "cartridges" in the foreground are the resistors for the four valves used in the receiver.

SELECTIVE CRYSTAL CIRCUITS

Some further details of that fascinating circuit juggler, the "Century" Crystal Set.

By G. V. DOWDING,
Grad.I.E.E. (Technical Editor).



WHEN a set is not sensitive, selectivity is not such a very vital consideration, but modern radio conditions demand that even a crystal receiver should provide moderately sharp tuning. On this type of set 5 G B is available over a very wide area of the country, and the old-fashioned plain aerial tuning is not quite good enough to separate this station from the local.

Last month, in the description of the "Century" Crystal Set, I gave

1 and 12, or 13, according to the degree of selectivity required. Joining 1 to 13 gives you the greater degree of selectivity. Finally, you insert plug X in socket 11.

Circuit E incorporates the detector circuit tap, as well as an aerial lead tap. This reduces the damping of the aerial circuit, and as well as greater selectivity, it is sometimes possible that greater sensitivity results. This is the procedure for circuit E. The majority of the connections are exactly as in the preceding instance, that is, circuit D, except that sockets 10 and 12 should be linked together, the link between 10 and 3 and 5 being broken. In instances such as the connections mentioned, that is, the link between 10 and 12 sockets, it might be found that a slightly longer link than those usually required is necessary.

Very Selective Arrangement

Now we come to circuit F, which is a very selective arrangement

indeed. Link sockets 1 and 5. Link sockets 6 and 12 or 13, according to the degree of selectivity required, as in circuit D. Link sockets 3 and 9, and sockets 2, 4 and 10. In all three circuits you have two of the coils standing idle, and the use of these suggests multifarious possibilities.

For instance, if you wish to receive 5 X X, the 1,600-metre wave-length Daventry station, with circuit D, it will be necessary to bring the 100-turn winding in series. In order to do this you must disconnect socket 4 from the 2, 6 and 9 group, then link Nos. 4 and 7 sockets together. Finally, socket A must be linked with the 2, 6 and 9 group.

The wave-length tuning band of the circuit F will be somewhat low because the small variable condenser is placed in series with the coil. As it stands, the circuit will be incapable of tuning above about 300 metres, but it can be loaded with the 25-turn winding in a similar manner to that in which circuit D is loaded with the 100-turn coil.

Trap For Long Waves

By the way, the circuit H wave-trap which I detailed last month is

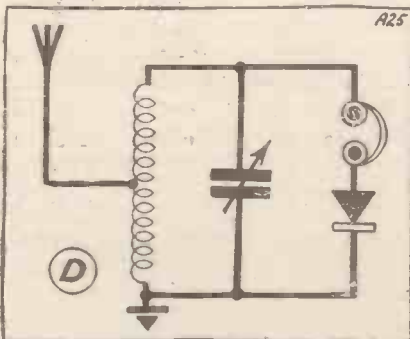

Here is a simple selective circuit, a single tuning coil being provided with an aerial tap.

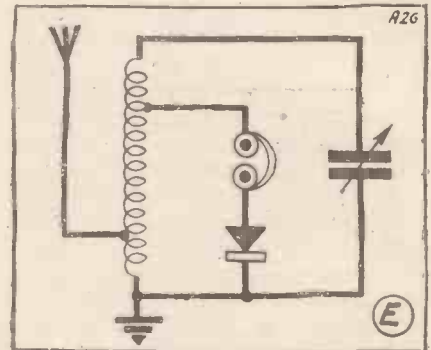

This is more selective than circuit D; a detector-circuit tap is included.

three selective circuits, but I omitted to give the connections for three of these in order to provide some of you with mild amusement in digging them out. There is circuit D, for instance, a straightforward aerial-tapped arrangement. This is quite suitable for elementary alternative-programme work and, using only the 60-turn tapped coil, the tuning range will easily include the Daventry 5 G B station. This is the way it is obtained.

Detector-Circuit Tap

Connect together sockets 2, 4, 6 and 9. Link sockets 3, 5 and 10. You should then insert plug Y into socket 14. Link together sockets

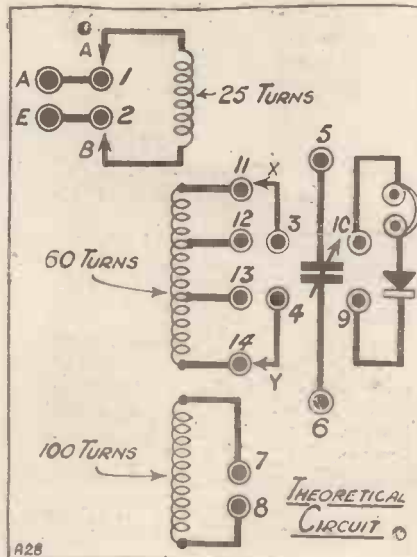

A28

suitable only for the medium wave-length stations such as 2 L O and 5 G B. If you require this wave-trap to operate on the 5 X X high wave-length band, you will have to make use of all three windings. Here are the simple connections.

Link sockets 1 and 3. Link sockets 2, 6 and 8. Link sockets 4 and 7. Insert plug A in socket 5. Insert plug B in socket 11. Insert plug Y in socket 14. Insert plug X in socket 13. In my previous article on the "Century" Crystal Set I omitted to mention the capacity of the small compression type variable condenser used. I employed one having a .0005 mfd. maximum capacity and I found this a suitable value for the purpose.



A further interesting article pointing out the advantages of four-electrode thermionic valves from the economy and efficiency points of view.

By J. ENGLISH.

IN a recent article I have attempted to give, in a somewhat condensed form, a general survey of the aspects, theoretical and practical,

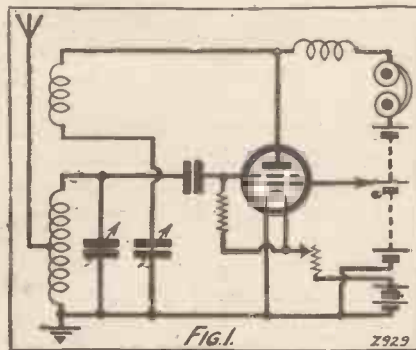

of the tetrode as an L.F. amplifier. Typical circuit arrangements were discussed for power amplification and stages of high magnification; it was shown that in each case the tetrode gave results equal to the best obtainable with three-electrode valves but with a considerably smaller voltage demand upon the H.T. battery.

Gain in Efficiency

Since the introduction, comparatively recently, of really efficient and economical types of tetrodes we are beginning to appreciate their manifest advantages as low anode-voltage amplifiers. I might go so far as to say that L.F. amplifier design will progress rapidly when tetrodes are more widely used.

Certainly they are going to be of immense assistance in the solution of that problem every amateur comes up against sooner or later—H.T. supply and maintenance. Already tetrode

L.F. valves can effect a very considerable economy in all classes of valve receivers, in many cases with an appreciable gain in efficiency.

Not only in the L.F. stages of your receiver, but also as the detector, the tetrode will give you quite as good results as the ordinary valve with even more economy in H.T. supply. The modern tetrode detector, in quite orthodox circuits, functions extremely well on 9 to 15 volts H.T. Since these four-electrode valves are low filament consumption types, not voracious L.T. current consumers like the older tetrodes, we have available a remarkably economic valve detector of considerable efficiency.

More important still, certain special features of the tetrode are peculiarly suited to the production of new

detector circuits giving improved results. A few examples described below show that further development of the valve detector has not yet

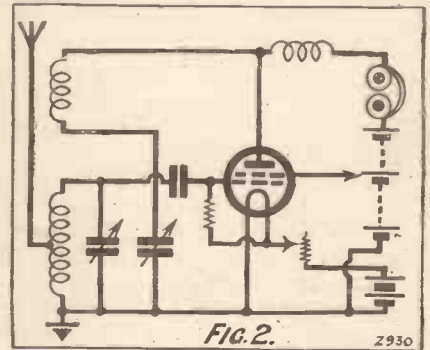

ceased, and the man who is after the utmost efficiency with economy should find these tetrode detector arrangements of special interest.

Triode v. Tetrode

Before dealing with the practical side of the tetrode as a detector it would be well to prepare the ground by considering the similarity or otherwise between the tetrode and the triode. The latter, as a detector, is really a combination of a rectifier and a low-frequency amplifier. The amount of L.F. amplification obtainable is governed by the valve's magnification factor, its impedance having a bearing upon rectification efficiency and also upon smooth reaction capabilities. Thus the moderate impedance valve is a good detector, gives smooth control of reaction and a fair degree of amplification.

On the other hand, the high-impedance R.C. valve, by reason of

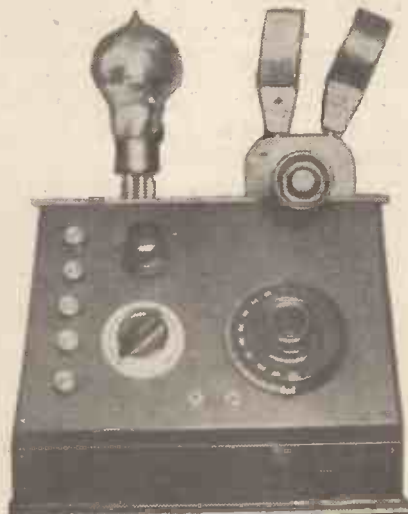

An early "Unidyne" detector set which, by using a four-electrode valve, was able to dispense with an H.T. battery.

its high-magnification factor, is a very good detector, an excellent amplifier but rather poor in the matter of easy reaction. Therefore the valve of medium impedance is best as a regenerative detector, while the special R.C. valve is most useful for a high-magnification detector without reaction.

Good Reaction Detector

Similarly the tetrode used solely as a low anode-voltage valve makes a good regenerative detector, when it requires very small values of H.T. But as a high-magnification detector it scores considerably over the triode,

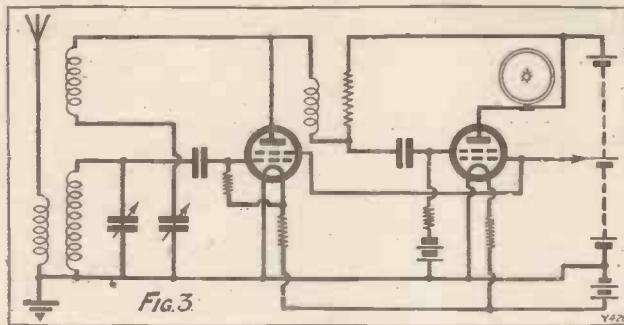

for besides giving excellent amplification and detection it can be arranged to give very smooth reaction control. This leads to the development of detector arrangements not possible with the three-electrode R.C. valve.

Taking the tetrode as a low anode-voltage valve pure and simple, we can substitute it in any detector stage, where it will work just like an ordinary valve, the only difference being a reduction in H.T. voltage to one-half or a third. A typical circuit very widely used at present is shown in Fig. 1, a tetrode being substituted for the three-electrode.

A suitable positive potential is given to the inner grid which, in its capacity of "space charge" reducer, produces an increase in anode current to compensate for the smaller anode voltage. Some tetrodes work excellently with a 9-volt grid-bias battery as sole H.T. supply.

Useful High-Mag. Valve

Others work quite well, as in the well-known Unidyne circuit, without any H.T. battery at all! The adaptation of an ordinary detector circuit, such as that of Fig. 1, to tetrode valves is therefore an extremely simple matter, since no constructional changes are necessary. All that is required is another lead to the H.T. battery, which need not exceed 15 volts. Operation is, then quite normal in every way

While the tetrode detector as a low anode-voltage device must naturally be of great interest to those of you who desire to reduce upkeep costs to a minimum, its use as a high-magnification valve should be even more attractive to the experimenter. The tetrode as a high-magnification detector, when developed along certain lines, provides ample scope for experiments, while leading immediately to the production of some very efficient receivers.

Essentially the method of employing the tetrode as a high-amplification valve consists in using the inner grid as the control electrode and the outer

matter, any three-electrode detector circuit. Used as shown in Fig. 2, the tetrode can be adapted to any detector circuit, whatever form of

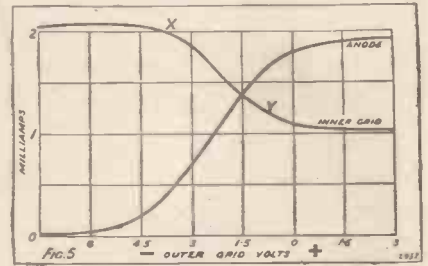

reaction control be used. A noticeable feature is the extremely smooth control of reaction obtainable with a circuit such as Fig. 2. It is very easy to adjust anode and outer grid voltages to give complete freedom from backlash.

Excellent D.X.

Then, as a one-valve receiver, some excellent D.X. results are obtainable, signal strength being remarkably good, especially in view of the small anode voltages used. This form of detector can be coupled to a first-stage L.F. valve in the usual way by means of a transformer or a choke coupling. Since the valve has a high "mu," it is especially suitable for R.C. coupling, and a useful arrangement is that shown in Fig. 3, the L.F. valve also being a tetrode.



A four - electrode valve ; the connection to its additional grid is taken from the small screw terminal mounted on the side of its base.

Owing to the drop in anode volts across the coupling resistance, the H.T. voltage needs to be increased to 30 or so, in order to give full play to the reaction control.

High Quality

The tetrode as a detector, whether of the cumulative grid-condenser or anode-bend type, introduces no more distortion than the three-electrode valve. Signal quality with a tetrode detector can be extremely good, so that this type of valve is at no disadvantage as far as reproduction is concerned.

After trying out the circuits already described, and their several modifications, it occurred to me that the

A circuit in which a four-electrode valve is employed preceding a resistance-capacity coupled L.F. stage. A tetrode is also used in the L.F. position.

grid as the "space charge" reducer. When used in this way valves can be designed to have very high-magnification factors without an undue increase in valve impedance. In fact, the high "mu" tetrode has a much lower impedance than a three-electrode valve for the same magnification factor.

Better Results

If we now take the circuit of Fig. 1 and change over the grid connection, as shown in Fig. 2, we have immediately a high-magnification detector, thus getting much better results for the same H.T. voltage. Suitable tetrodes used in this circuit give very excellent results on less than 15 volts H.T., the outer grid having a positive potential between 4.5 and 9 volts, the actual value not being at all critical.

While not new, the circuit of Fig. 2 is certainly more efficient than that of Fig. 1; or, for that

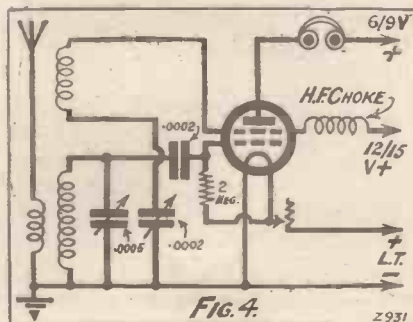

"space charge" reducer grid might very well be made to serve other purposes at the same time. A little consideration showed that this would be most effective with the high-magnification arrangements.

Reaction Difficulties Overcome

Accordingly the outer grid was allotted the function of reaction "anode," as shown in Fig. 4. Here the outer grid is connected to the H.T. battery through the usual H.F. choke, and also to the series reaction circuit L_2C_2 . The outer grid now functions as the "anode" of an ordinary valve in the capacity of an H.F. amplifier, while the actual

rotating the tuning dial This average sensitivity is, of course, more a matter of proportioning the parts of the circuit than a property of the circuit itself.

However, this type of circuit certainly gives an extremely even reaction control, unless the inner grid is made too positive or too negative. When the receiver is brought to full sensitivity the number of stations receivable is just a matter of patience in tuning.

Another feature of this circuit is the relation of outer grid volts to the degree of reaction, as mentioned above. If the outer grid potential is less than a certain value, no

new circuit will constitute a regenerative detector of great simplicity and efficiency.

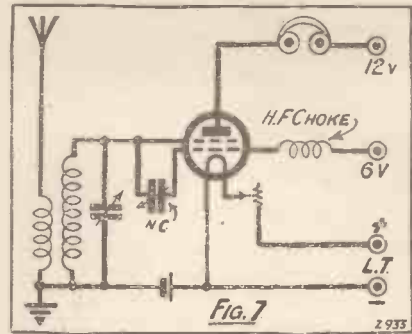

Returning to the present circuit (Fig. 4), anode potential is adjusted to 6 or 9 volts positive, and outer grid volts increased until oscillation commences with the reaction condenser at maximum. This will occur about 12 to 15 volts positive.

Typical Tetrodes

Some control of reaction is also possible with the filament rheostat, but this is hardly necessary with capacity reaction control. This circuit can also be adapted to R.C. coupling on the lines of Fig. 3, the detector working very well on less than 30 volts H.T.

While most tetrodes work well in these special circuits, the valve I have found most suitable is the Aneloy Product's A.P.412 H.F., to which all the operating voltages mentioned above apply. This valve, one of a range of tetrodes of different types, is remarkably efficient as a low voltage, high-magnification detector.

The A.P.412R.C. is particularly suitable for a resistance-capacity-coupled detector, giving fine results on 30

(Continued on page 463)

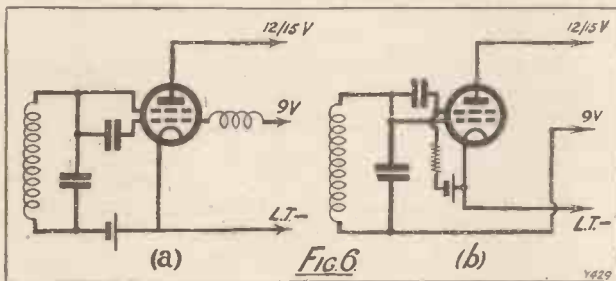

These two four-electrode valve circuits are two forms of the Numans Oscillator, a Dutch circuit of some years' standing.

anode deals solely with the L.F. output.

There are several important advantages accruing from the separation of the H.F. and L.F. portions of the output of the regenerative detector, which separation is only possible by means of this tetrode circuit arrangement. First of all, the degree of reaction is dependent chiefly upon the outer grid voltage, and not on the anode voltage as before. Therefore R.C. coupling can be used without the usual reaction difficulties.

Also, the outer grid circuit impedance is lower than the anode impedance, so that smoother reaction is obtainable. I also find that the degree of amplification depends upon anode volts, while reaction feedback is governed by outer grid volts, thus giving separate control of both.

The circuit of Fig. 4 proved to be very successful as a low anode-voltage detector.

Even Control

Results were even better than those obtainable with the circuit of Fig. 2, one improvement being the greater constancy of reaction feedback required. That is, with one setting of the reaction condenser the receiver was of good average sensitivity all round the dial. In fact, on several occasions, having made a rough adjustment of reaction, over two dozen stations have been heard at good 'phone strength simply by

oscillation will take place. On increasing outer grid volts above this value, any degree of reaction or full oscillation can be maintained.

Also, decreasing anode volts increases reaction, and vice versa; but the variation of anode potential has not such a marked effect upon the degree of reaction as the variation of outer grid volts. A modification of this circuit now in the final stages of development is based on this relation of reaction and outer grid volts. This

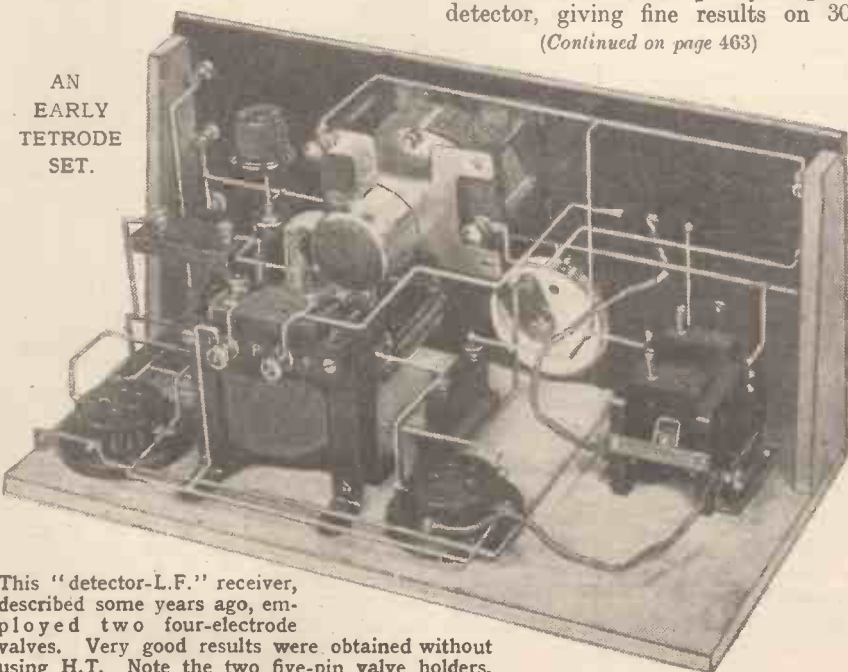

This "detector-L.F." receiver, described some years ago, employed two four-electrode valves. Very good results were obtained without using H.T. Note the two five-pin valve holders.

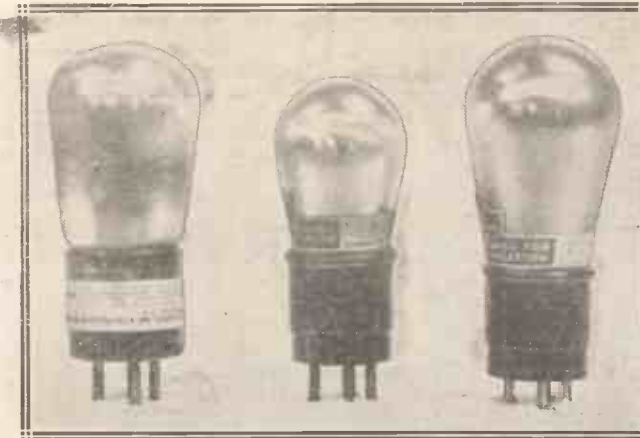

CUTTING DOWN COST

Does your wireless set cost you too much to run? Perhaps it is because you are using unsuitable valves and grid bias. This article shows how running costs can be minimised.

By KEITH D. ROGERS.

Do you find wireless more expensive than you expected? Are your high-tension batteries running down more quickly than they should? If so, it is probably because you are using wrong valves in the L.F. stages of the set, or wrong grid-bias voltages. Possibly it is due to both causes.

Reducing Anode Current

It is well-known by most constructors that grid bias is essential for best results from the point of view of purity of reproduction, but it should also be realised that the more the grid bias, the more the saving in H.T. current.

Of course, the grid bias cannot be increased indefinitely, or distortion due to partial rectification, will take place. But you can do quite a lot in the way of economising by judicious use of the bias battery. It is far better to cut down H.T. current by means of grid bias than to attempt to do it by using less H.T. voltage.

An average super-power valve will give up to about 35-40 milliamps at 120-150 volts H.T. with no grid bias, but in many cases this can be cut down to 15-18 milliamps with suitable grid bias, and the writer knows of a case where 12 milliamps only is passed by the last valve of a four-valver using a super-power valve and 150 volts H.T. Test your bias by results, under working conditions and you may find that more bias can be used than you thought was possible.

"Super" or Ordinary?

And that reminds me. Are you using a super-power valve, or the ordinary power type of L.F. valve? I ask this question because I want to remind many readers what the true purpose of the super-power valve is.

In the first place the valve is wrongly termed; it should have

been called a "super-swing" or "large-swing" valve, for the term super-power tends to infer that it will give extra punch to any given input, when compared with the average power valve. As a matter of fact, it will not give as much, as a rule.

The whys and wherefores are as follow: The power valve has a certain magnification factor which enables it to amplify a certain input to, say, four or five times its amount (in voltage, not volume). So that the volume increase given by a power valve is a certain amount. But in order to give this magnification we have to cramp its carrying capacity, and it will not deal with a very large voltage on its grid without distortion occurring. About 10 volts is near the limit on some power valves.

Take the super-power or large-swing valve. As the latter name infers, it is capable of dealing with a large voltage swing on its grid without

or 2, giving a very slight volume increase, almost imperceptible in some cases. But it will handle the power, and is excellent from other technical points of view, such as bringing out the bass notes, etc., etc.

Volume v. Purity

So, side by side for any given signal input, the power valve beats the super-power hollow when it comes to sheer amplification, while where the purity question crops up, and large volume has to be handled, this volume necessitates the use of the super-power valve.

Having got that straight, it should be realised that the super-power valve, even with greater grid bias, takes a greater anode current than the power valve, and is therefore more costly to run.

So, if you don't need large volume, use the smaller valve, and save H.T. and increase your signal strength

It must not be forgotten that the average super-power valve was designed to carry and deliver large volume. It has a small amplification factor. An ordinary power valve should be used where amplification of fairly weak signals in the last stage is required.

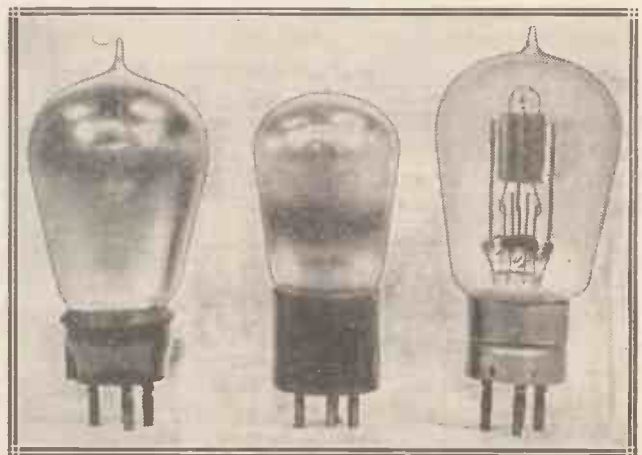

distortion occurring. Twenty volts is a quite common amount for an average super-power.

But what of its magnification or amplifying properties? These are small as compared with the ordinary power valve, being only about 1.5

—a super-power valve would be wasted here. But if you need large volume, you must use the latter type of valve to avoid distortion, and you will have to cut down your H.T. current as far as possible by means of grid bias.



A SIMPLE H.F. "OHM- METER"

To measure H.F. resistance with moderate accuracy is not a difficult task, as the following article shows.

By P. C. BAKER.

ONE of the most important instruments to the serious experimenter is one by means of which he can make H.F. resistance measurements. Without such apparatus he has no definite basis on which to make comparisons of different types of coils, test components for losses and other quantitative work of this description.

Very few designs, however, have ever appeared for an instrument of this description, and such as have been published from time to time, though they may have been fundamentally sound, have been badly applied, so that an H.F. resistance bridge built on those lines would have been inaccurate in actual use.

The method I employ is roughly as follows: As you know, if a circuit, tuned to the same frequency as

COMPONENTS REQUIRED

- 1 Anti-phonic valve holder (Any good make).
- 1 Special balancing condenser (Peto-Scott).
- 1 2-megohm grid leak and clip (Any good make).
- 1 Variable condenser, .0005 capacity (This should be compact so as to allow of it being mounted on the base inside the screen, as shown in the photograph).
- 1 .001 fixed condenser (Any good make).
- 1 Filament resistance (Cylton Tempryte or similar type).
- 1 H.F. choke (Should be compact).
- 1 Coil socket.
- 1 .0005 variable condenser (This should be extremely efficient since it will be used for tuning the coil under measurement. I have used a Cylton).
- A length of 47-gauge Eureka wire for the resistance. This gauge of wire is chosen since its H.F. resistance is to all intents and purposes equal to its D.C. resistance which, of course, can easily be measured by means of a resistance bridge.
- 1 Ebonite panel, 6½ in. × 6½ in. × ¼ in.
- 1 Slow-motion dial (I have used a Gee-haw).
- 6 Sockets and 1 plug.
- A piece of strip brass 1 in. wide × 1/16th in. thick, and a length of ebonite 8 in. long and 1½ in. wide for the extension handle.
- Various terminals as required. Glazite or Junit, etc., for connecting.

For Testing your Components.

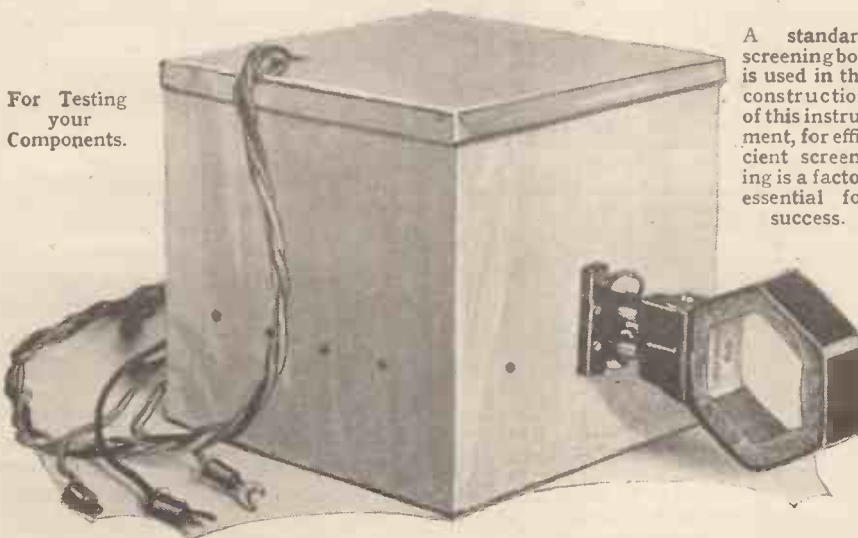

A standard screening box is used in the construction of this instrument, for efficient screening is a factor essential for success.

that at which a wave-meter or receiver is oscillating, is brought up to it so that the coupling between the two circuits is appreciable, a change in plate current of the oscillating valve will result. If the tuned circuit is brought close enough to the oscillator this will cease oscillating.

Loose Coupling Essential

For the system I am describing, however, which makes use of this change in plate current, it is most important that the coupling be very loose, so that the actual variation in the anode current does not exceed more than 80 or 100 micro-amperes.

Incidentally, I may mention here that it will not be found possible to obtain satisfactory readings if the coupling is too tight, owing to a form of overlap which is experienced under these conditions.

The instrument in its completed form, with coil inserted. Note the permanent battery-leads which are a convenient feature and greatly assists construction.

The theoretical circuit diagram of the instrument which I have constructed is shown in Fig. 1. It will be seen that this consists of what may be called a form of modified Colpitt's oscillator, and I have adopted the particular system shown in view of the fact that I wished to be able to change from one frequency range to another by simply interchanging one coil.

Completely Screened

At the same time I considered it desirable that only one coil should be employed, to which the tuned circuit should be coupled, and this circuit, to my mind, provides the simplest method of doing so. It is

R	I	t
0	90	.01111
2.5	55.4	.01805
4	45	.02222
6.7	33.16	.03015

Fig. 4.

further desirable that the whole of the oscillator, bar the coil itself, should be screened, and this circuit simplifies the construction of the unit.

The coil L_1 , which is a plug-in coil, is tuned by a variable condenser C_1 , while connected in parallel with this is a special balancing condenser, shown at C_2 . This consists of the usual arrangement of one set of moving vanes interleaving two sets of stationary vanes. The moving vanes

suitable potential to be impressed on the grid of the oscillator valve so as to enable sufficiently strong oscillations to be obtained with only a low value of H.T.

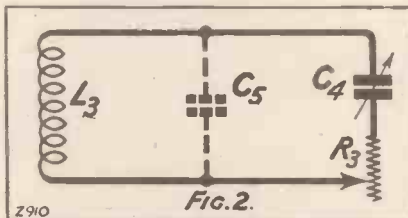

A shunt-feed circuit is used, the plate being connected to the opposite end of the tuned circuit through a fixed condenser C_3 , the H.T. potential being applied through the H.F. choke L_2 . A photograph of the complete unit is shown and it will be noted that the battery leads have been plaited together and brought out through a hole in the lid of the screen. On one side of this screen a coil socket is mounted to enable the inductance L_1 to be interchanged as desired, and on the other is a terminal for earthing the screen.

To Obviate Errors

L_3 in the theoretical circuit diagram represents the coil of which we wish to measure the H.F. resistance. This is tuned by means of a variable condenser C_4 , a variable resistance R_3 being connected in series.

The condenser C_4 and the resistance R_3 are also contained within a screening box, two terminals being provided to which the coil L_3 is

and whether screening does not unduly complicate the construction of the apparatus.

The question of screening the whole of the oscillator bar the coil is, however, a most important one, since if this is not done very serious errors will be introduced owing to capacity coupling between various portions of the oscillator, and the coil and tuning condenser to which the oscillator is coupled. The errors introduced generally serve to raise the H.F. resistance of the coil being measured to above its true value.

Points to Watch

Unless the condenser tuning the coil under test is also screened, capacity coupling between this and the oscillator coil will result, thus also introducing errors into the readings.

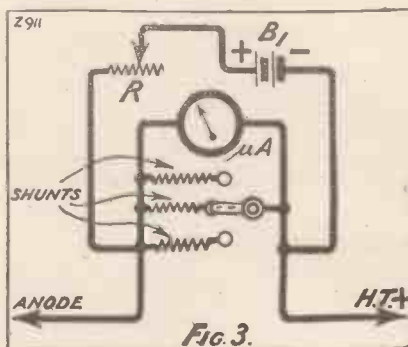

A further point that is most important is that the condenser C_4 tuning the coil under test should have negligible losses, since otherwise a true and correct reading for the H.F. resistance of the coil will not be obtained.

Another cause which may give rise to serious errors will easily be understood by reference to Fig. 2. This shows the coil test circuit in fuller detail. A point which we have not yet discussed is the self-capacity of the coil L_3 . This is shown in dotted line at C_5 .

Constructional Details

If the size of the inductance L_3 and the frequency at which it is being measured are such that the condenser C_4 has to be set near or at its minimum value, the coil having a fairly high self-capacity C_5 , a very serious error will result in the readings obtained owing to the presence of this high self-capacity. The frequency of the oscillator should, therefore be so adjusted that when the tuned circuit coupled to it is brought into tune the value of the condenser C_4 is always fairly high, so that the

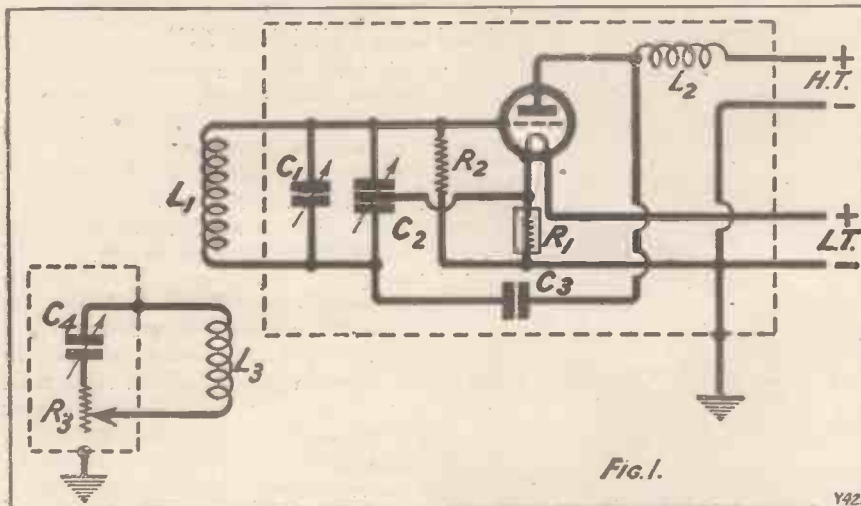

are connected to L.T. —, as shown, and the two sets of stationary vanes connected to either side of the coil. A portion of C_2 acts as grid condenser, and this with a grid leak enables a

connected. A photograph of this unit also is given, so as to show the method of construction employed.

It may be asked why there should be all this necessity for screening

self-capacity of the coil becomes negligible in comparison to it.

Dealing with the constructional aspect of this H.F. resistance bridge, the two screening boxes containing (1) the oscillator unit, (2) the tuning condenser and calibrated resistance unit, are standard cube screens of the type developed by Mr. G. P. Kendall, B.Sc., for use in H.F. amplifiers.

The construction of the oscillator itself is quite simple and straightforward, the relative components being mounted on the baseboard inside the screen as is found most

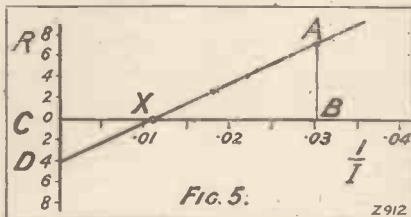

convenient according to the particular components you are using, the coil sockets being mounted on the outside as shown in the photograph. A terminal is fixed to the screen at a convenient point by means of which it is earthed, while a lead is also taken to this terminal from the L.T.—lead inside the screen.

Since the use of a terminal strip would rather complicate the construction of this unit permanent battery leads have been employed.

Further constructional details of the unit are shown in the practical wiring diagram of the baseboard.

Efficient Condenser Required

The variable condenser (Cylcon) was chosen for its known efficiency, while the resistance wire, which consists of 47-gauge Eureka, is soldered between a number of small sockets which are fixed to the panel. Purely arbitrary lengths of wire were employed and the value of the resistances between socket and socket were afterwards accurately determined. The construction of the extension handle will depend, of course, on the type of dial you are using.

It will next be necessary to determine the value of the resistances connected between the sockets on the ebonite panel, and this may conveniently be done with a bridge. Great care should be exercised in taking these readings, as it is most important that they should be accurate, and it is advisable, therefore, to check them over several times so as to make sure that you have got them right. Remember that this wire will not carry a very

big current, which means that whatever method you employ to measure this resistance should be one which does not involve the wire carrying an appreciable current.

I find it convenient to increase the values of the resistances between adjacent sockets, as the normal value of an inch of Eureka resistance wire soldered between the two sockets is about 2.5 ohms. Under these circumstances, the full value of resistance available is only in the neighbourhood of 12 ohms, and it is frequently desirable to be able to use a bigger value than this.

The Anode Circuit

I suggest that by increasing the value of the resistances progressively, we can have a total value of 20 to 30 ohms available. Where a fairly long length of wire needed to be included between the two sockets, a loop was made as shown in the wiring diagram, and this was just stuck down on to the ebonite panel.

The remaining point to be dealt with is that of the inclusion of a meter in the plate circuit of the oscillating valve by means of which the change in current is measured. In view of the fact that it is necessary to limit our change in current to a matter of 100 micro-amperes, it is

obvious that we must be able to use an extremely sensitive meter.

It is, therefore, necessary that the steady current flowing through the meter be cancelled out by a local and opposite current of equal value so that only the change in plate current is measured.

One of the first vessels to be fitted with wireless telegraphy was the Royal Yacht "Osborne." The apparatus was installed in order that Queen Victoria might communicate with the Prince of Wales (the late King Edward VII) who was suffering from the results of an accident to his knee.

The method of doing this is shown in Fig. 3. The H.T.+ lead is broken and the two ends provided with spade tags by means of which they can be connected to the meter used. This should be a micro-ammeter having a maximum deflection of about 100 micro-amperes, and it should, of course, be provided with shunts so that the maximum sensitivity is not obtained until the value of plate current has accurately been balanced out.

The micro-ammeter is backed off by means of a local battery B₁, in series with a variable resistance R, which is used accurately to adjust

Note the copper strip underneath this terminal for earthing the moving vanes of the variable condenser.

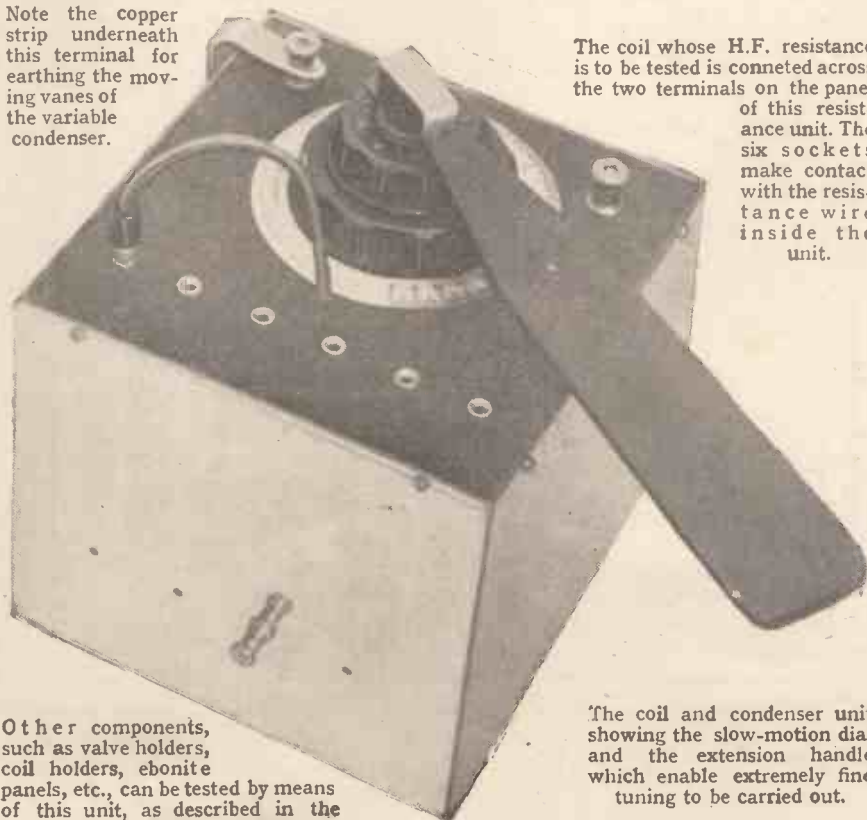

The coil whose H.F. resistance is to be tested is connected across the two terminals on the panel of this resistance unit. The six sockets make contact with the resistance wire inside the unit.

Other components, such as valve holders, coil holders, ebonite panels, etc., can be tested by means of this unit, as described in the accompanying article.

The coil and condenser unit showing the slow-motion dial and the extension handle which enable extremely fine tuning to be carried out.

the value of the current so as to be equal and opposite to that passing through the H.T. circuit. In view of the fact that the resistance R is virtually in shunt with the micro-ammeter, it is necessary that this should be at least 15 or, preferably, 20 times greater than the resistance of the meter itself. It is, therefore, necessary to choose the value of the battery B_1 accordingly.

Let us now see what our method of obtaining H.F. resistances is, and exactly how the various operations are carried out.

Preliminary Adjustments

First of all, a valve is inserted in the oscillator socket. Any valve will do, which will oscillate at a fairly low value of plate potential. I myself use a power valve of the 2-volt class, and find that with about 20 volts H.T. sufficiently strong oscillations are generated for these measurements to be taken.

The meter is connected up with the lowest resistance shunt in circuit, since the oscillator must be adjusted to the correct frequency before the plate current is backed off, for every adjustment of H.T., L.T., grid-leak value, frequency, or the like, is fol-

lowed by a substantial variation in plate current when we are measuring micro-amperes.

CONTINENTAL COMMENTS

Langenberg celebrated its first anniversary some months ago, this station having been opened on January 15th, 1927.

A new broadcasting station has just been opened at Wilno, Poland. Many of the programmes are relays from Warsaw, and the station works on a wave-length of 435 metres.

The Radio Vitus broadcasting station, Paris, sends out programmes on 37 metres as well as upon its normal broadcasting wave-length.

The existing Rome broadcasting station with a power of 3 kilowatts is to be replaced by a new 25-kilowatt station.

coil socket, and we find out whether the valve is oscillating by touching the grid with the finger. If no change in plate current results when this is done the valve is not oscillating, so the condenser C_2 should be adjusted until the valve is oscillating.

The oscillator should now be adjusted to whatever frequency it is intended to take the readings at, and it should be borne in mind that this frequency should be fairly accurately known, since the H.F. resistance of the coil varies more or less directly with the frequency. An absorption or heterodyne wave-meter may be used, whichever is handiest.

Having settled this point, the steady plate current passing through the meter is backed off and the meter ad-

denser unit, with the wander plug placed in the zero resistance socket.

With the coupling between the two coils fairly loose, the variable condenser is slowly rotated till a kick is given by the meter needle, showing that the circuit has come

into tune. The condenser C_4 is now adjusted until the maximum deflection of the needle is observed, and it will be found necessary not only that a very fine vernier adjustment be provided, but that it will also be advisable to have an extension handle, such as that shown.

Correct Coil Coupling

Should the deflection on the meter only be in the neighbourhood of 30 or 40 micro-amperes, the coupling between the two coils should be tightened until a value of between 80 and 100 is obtained.

A small table should now be prepared, similar to that shown in Fig. 4. Under R we place the values of resistances obtained by placing the plug in the various sockets. With the plug placed in the zero resistance socket the coil under test is carefully tuned to resonance with the oscillator, and the change in plate current which results by bringing it into tune is noted under I.

The plug is now shifted into the next socket, which includes, say, a resistance of 2.5 ohms in series with the condenser and coil. The reading of plate current is again noted. This is continued till three or four readings have been taken.

Reckoning the Resistance

Having obtained the values of I, we now obtain the reciprocal of these values, and these are entered up in the third column under $\frac{1}{I}$.

We now plot the value of R against $\frac{1}{I}$, as shown in Fig. 5.

If the apparatus has been carefully built and the readings taken with care it will be found that the four points will lie exactly on a straight line. A straight line is therefore drawn through them as accurately as

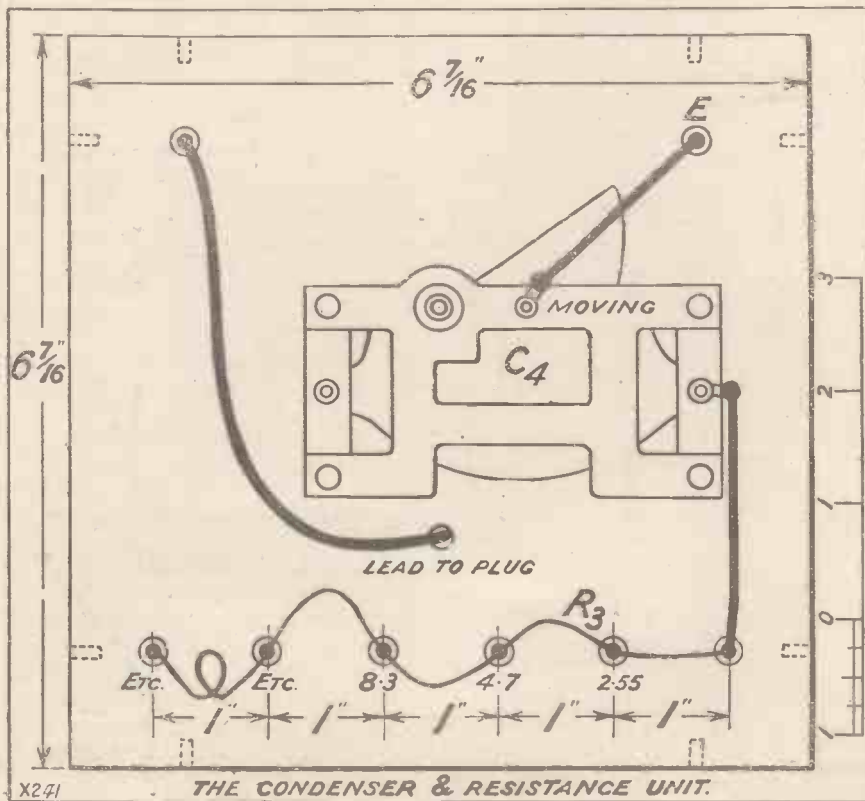

lowed by a substantial variation in plate current when we are measuring micro-amperes.

A suitable coil is plugged into the

justed to its most sensitive condition.

The coil to be measured is now connected to the terminals of the con-

possible, and projected to cut the resistance axis below the zero line.

The point at which the projection of this line cuts the resistance axis

to $\frac{CD}{AB}$. CX represents the value of $\frac{1}{2}$ for zero resistance, and CB

otherwise spent in finding a piece of graph paper and deciding on your various ordinates and plotting the graph, etc.

Testing Components

The attached example will serve to explain the calculation rather more clearly, and we turn again to the table shown in Fig. 4 for our values.

CX = .01111 CB = .01805
∴ XB = .00694 and AB = 2.5 ohms.

$$\text{Since } \frac{CX}{XB} = \frac{CD}{AB}$$

$$CD = \frac{CXAB}{XB} = 4 \text{ ohms}$$

We know from the figures given for the next value of resistance that this is the correct answer for the resistance of the coil. We can, however, check it up once again by working it out again from the figures in the last line of the table.

This resistance bridge can also be used to obtain comparative measurements of various pieces of apparatus as regards losses. Thus we can connect valve holders, fixed or variable condensers, coil holders, and other pieces of apparatus in parallel with the tuned circuit, and get an idea of their relative merits.

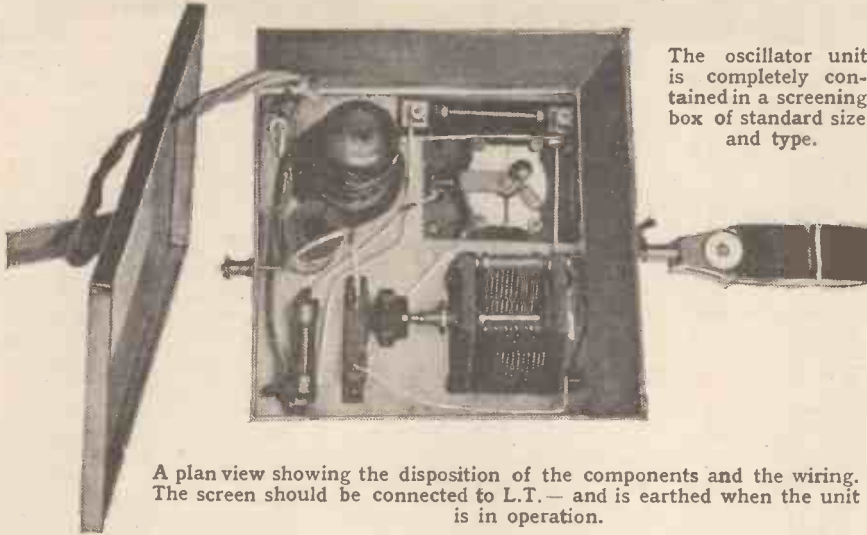

The oscillator unit is completely contained in a screening box of standard size and type.

A plan view showing the disposition of the components and the wiring. The screen should be connected to L.T.— and is earthed when the unit is in operation.

represents the value of the H.F. resistance of that coil at the particular frequency at which it was measured. If it is desirable for the particular coil that you are measuring that a very accurate estimate of the H.F. resistance be obtained its value may be checked by taking a number of different readings, at different values of coupling between the two coils. It should be found, however, that the values obtained should all be within 3 or 4 per cent of each other.

It may be noted here that an approximate idea of the H.F. resistance of a coil can be obtained from one reading only. In the example given in Fig. 4 it will be noted that when 4 ohms was placed in series with the tuned circuit the current had fallen exactly to a $\frac{1}{2}$. Under these conditions the value of the H.F. resistance was exactly 4 ohms.

Obtaining Approximate Figures

It is a simple matter, therefore, having obtained the first reading of the change in plate current, when no resistance is included in the tuned circuit, to find out what value of resistance gives a reading which most nearly approximates to half the value of plate current. This resistance will then be approximately equivalent to the H.F. resistance of the coil.

Another method by means of which the H.F. resistance of the coil may be obtained from two readings only is based on the fact that, on referring to Fig. 5, we find that we have two similar triangles, ABX and CDX.

We know, therefore, that $\frac{CX}{XB}$ is equal

represents the value of $\frac{1}{2}$ for a value of added resistance AB. XB is therefore equal to CB—CX; AB is known, therefore, CD can easily be calculated.

It is a simple matter to check up the H.F. resistance of the coil by taking two or three readings, and it certainly saves considerable time

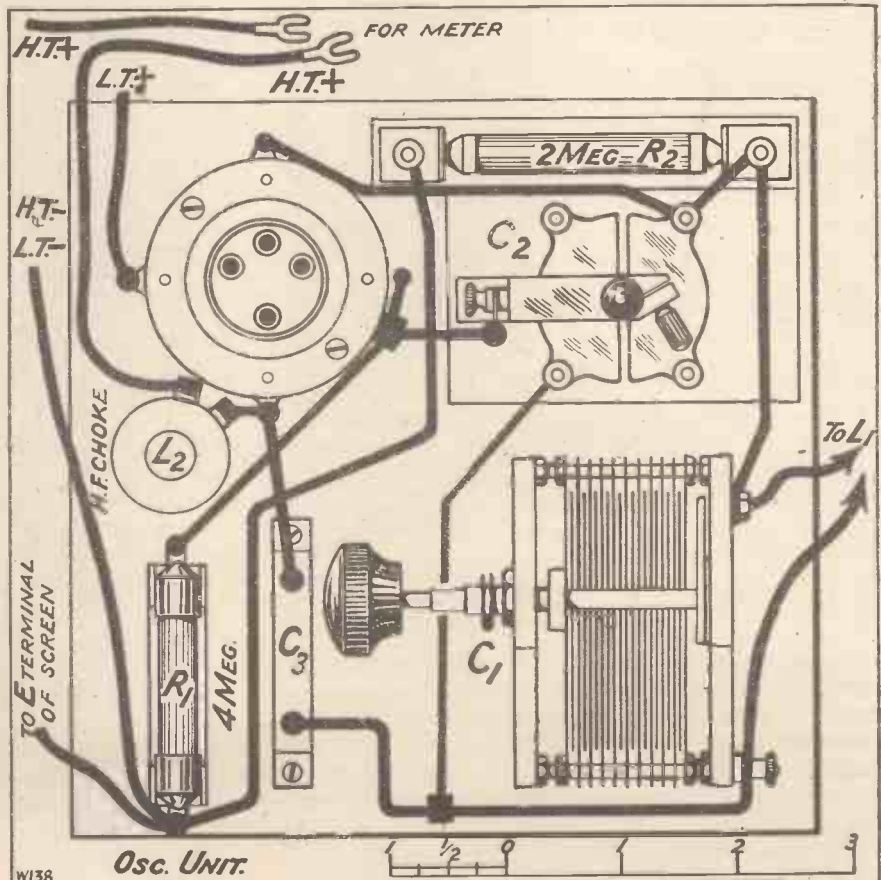

W/38



Questions Answered

The De Luxe D.C. Unit

H. R. (Bromley) is a little puzzled over the method of calculating the value of the resistance A in the D.C. Unit described in MODERN WIRELESS, Vol. VIII, No. 11.

The method of finding this value was given on page 459, but unfortunately an error occurred in the explanation given. Referring to Col. 1, line 13, *et seq.*, this should read: "Having found the voltage which must be dropped in the resistance A, multiply this by 1,000 and divide your answer by the current (in milliamps.) which will be drawn from terminal H.T. + 1. The result is the resistance required in ohms."

The Standard Wave-Trap

L. R. (Wallsend) asks how the "Standard Wave-Trap" which was described in the November issue of MODERN WIRELESS should be joined up to his set.

If L. R. turns to page 524 of the November issue he will see that there are three terminals marked A₁, A₂, and A. A₁ and A₂ are the two tappings on the wave-trap coil, and the aerial lead is taken direct to them by means of a suitable plug designed to fit the two sockets. Terminal A is joined to the aerial terminal on the set.

The trap is then ready for use.

Obtaining Reaction

P. B. (Lee).—"I have been using a two-valve set consisting of a detector and one transformer-coupled L.F. valve, with Reinartz reaction. The primary of the 5-1 ratio transformer also formed the H.F. choke, and was perfectly satisfactory on the 250-500-metre band. Recently I have replaced the old transformer with a Ferranti A.F.5, and I am now unable to obtain any reaction. Why is this?"

The Ferranti A.F.3 and A.F.5

transformers have small fixed condensers connected *internally* across their primary windings. Since you are not using a radio-frequency choke, the H.F. currents in the plate circuit of the detector valve are being bypassed by this small condenser, and

THE TECHNICAL QUERIES DEPARTMENT

Are you in trouble with your set?

Have you any knotty little Radio problems requiring solution?

The MODERN WIRELESS Technical Queries Department has been thoroughly reorganised and is now in a position to give an unrivalled service. The aim of the department is to furnish really helpful advice in connection with any radio problem, theoretical or practical.

Full details, including the revised and, in cases, considerably reduced scale of charges, can be obtained direct from the Technical Queries Department, MODERN WIRELESS, Fleetway House, Farringdon Street, London, E.C.4.

A postcard will do: on receipt of this all the necessary literature will be sent to you free and post free, immediately. This application will place you under no obligation whatever. Every reader of MODERN WIRELESS should have these details by him. An application form is included which will enable you to ask your questions, so that we can deal with them expeditiously and with the minimum of delay. Having this form you will know exactly what information we require to have before us in order completely to solve your problems.

the primary of your A.F.5 exercises no choking effect.

The remedy is to insert an H.F. choke between the anode of the detector and the primary winding.

This, incidentally, is a wise procedure in all cases, whatever may be the make of transformer used, if proper reaction is to be obtained over a wide wave-length range.

Resistance-Coupling Values

T. A. (Bournemouth) is building a detector and two L.F. receiver (resistance-coupled), and wishes to know what values should be used for the anode resistances, coupling condensers, and grid leaks. He intends to employ a cone type loud speaker.

The first anode resistance may

have a value of 100,000 ohms, and the second 250,000 ohms. Suitable values for the coupling condensers and grid leaks would be .01 mfd. and 2 megohms respectively.

If anode resistances having higher values are used, some of the brilliance in the music may be lost, and this is undesirable with the cone type of loud speaker.

Adding an H.F. Stage

E. R. (Gravesend).—"I am using a set consisting of one screened-valve H.F. stage, a detector and 2 L.F. valves. Selectivity is not good, and I have been wondering whether it is possible to add a stage of neutralised H.F. in order to improve the tuning and increase signal strength. Would such a circuit be stable?"

If the existing H.F. stage is properly screened, a simple neutralised H.F. unit could be used successfully.

The H.F. unit described in this issue is of a suitable type, and the arrangement should be perfectly stable. If an interchangeable aerial coil is used, as in the unit mentioned, different degrees of selectivity are possible by varying the size of the aerial coil. Normally a No. 35 would be the best for all-round results on the 250-500 metre wave-band.

Split-Secondary Transformers

J. W. (Southampton).—"Will you please give details of the standard split-secondary H.F. transformers for the 250-500 metre band?"

These H.F. transformers were primarily designed for use with .00025 tuning condensers and to be placed inside screens. In consequence the number of turns on the secondary windings is rather high. The turns are as follow:

Secondary: 130 turns of 28 D.S.C. on a 2-in. former, made up as two separate windings of 65 turns.

Primary: 20 turns of 30 D.S.C. on a 1½-in. former placed centrally inside the secondary.

If .0005 tuning condensers and the cube type screening boxes are to be employed, it is advisable to decrease the number of secondary turns by 20 per cent.

With this type of H.F. transformer it is usual to employ a small condenser of the "neutralising" type for reaction purposes. Even with this small capacity reaction is not always smooth, i.e., the set goes quickly into oscillation, since a slight change in capacity produces a big difference in reaction effect. To obviate this it is essential for H.F. stages to be perfectly neutralised and very careful adjustment of the H.T. voltage is necessary.



As alternatives to British broadcasting the best programmes available from abroad are the long-wave transmissions listed below. Some of these stations afford regular daylight programmes of excellent quality to British listeners.

EUROPEAN STATIONS BROADCASTING ON WAVE-LENGTHS BETWEEN 500 AND 1,000 METRES.

Wave-length in Metres.	Name of Station.	Remarks.	Wave-length in Metres.	Name of Station.	Remarks.
508.5	BRUSSELS	Same power as a B.B.C. main station (1½ kw.).		(Augsburg (Germany) Hamar (Norway) St. Michael (Finland) Bloemendaal (Holland) Zurich (Switzerland) Lausanne (Switzerland)	Also share this wave-length.
517.2	VIENNA (ROSENHUGEL)	Power 5 kw. Lessons in English sometimes given before evening concert (7 p.m.).	566		
526.5	Riga (Latvia)	Evening concert, etc., from 5 p.m. to 8.30 p.m. on 2 kw.	583.2		Power of 2 kw. (Call sign H B 2). Daily concert at 8 p.m. on low-power (6 kw.).
536	MUNICH (GERMANY)	Sunday morning concert at 10.30 a.m. (Uses power of 4 kw.).	680		2-kw. station, relaying Sundsvall programmes.
545.6	Sundsvall (Sweden)	Relays Stockholm, power 1 kw.	720	Ostersund (Sweden)	Concert weekdays 7.40 p.m. (Power 5 kw.).
555.6	Budapest (Hungary)	Evening concerts and Tzigane music (same power as 2 L O).	760	Geneva (Radio-Genevé)	Power of 1 kw.
566	Cracow (Poland)	Often relays Warsaw programmes. Uses power of 1½ kw. and closes down at 10.30 p.m.	820	Kiev (Russia)	Power of 4 kw. Talk at 3.10 p.m.
			850	Rostov/Don (Russia)	Power of 1.2 kw.
			860	Nijni Novgorod (Russia)	Power of 4 kw.
			870	Tiflis (Russia)	Power of 10 kw. Concert daily at 6.30 p.m.
			995.5	Leningrad (Russia)	

NOTES.—Vienna and Munich are probably the best programme providers. At one time the Brussels station (wave-length 508.5 metres) transmitted upon a wave-length just below 300 metres, and its transmissions were then well and regularly received in South-East England. But the present Brussels wave-length is subjected to great interference from ships, though signal-strength from this station is still good. Several of the Russian stations in this group are using sufficient power to permit of fairly regular reception when conditions are good; but on the above band of wave-lengths are many Government and commercial stations, and interference from these and from ships is almost incessant. (Aircraft and aerodrome stations also are working all day, in the neighbourhood of 900 metres, using telephony and Morse.)

EUROPEAN STATIONS BROADCASTING ON WAVE-LENGTHS ABOVE 1,000 METRES.

Wave-length in Metres.	Name of Station.	Remarks.	Wave-length in Metres.	Name of Station.	Remarks.
1069	HILVERSUM (HOLLAND)	Call-sign A N R O. Works practically all day on Sundays from 9.40 a.m. to 10.40 p.m. (Morning, afternoon, and evening concerts.) Both quality and strength exceptionally good.	1315.5	MOTALA (SWEDEN)	Power of 30 kw. Relays the Stockholm programmes.
1100	Basle (Switzerland)	Daily, 7.30 p.m. to 9 p.m.	1450	Moscow (Old Komintern)	Power of 20 kw. Daily talk at 2 p.m.
1111.1	Warsaw (Poland)	Power of 10 kw. Good afternoon and evening programmes. Generally commences evening concert at 7.30 p.m.	1604.8	DAVENTRY (5 X X)	Relays London, 2 L O, power 25 kw.
1117	Novo Sibersk (Russia)	Power of 4 kw. Talks at 5 p.m.	1700	Kharkov Narkompotshtel (Russia)	Power of 1½ kw.
1153.8	KALUNDBORG (DENMARK)	Copenhagen programmes relayed upon power of 7.5 kw.	1750	PARIS (RADIO PARIS)	Power of 3 kw.
1180	Stamboul (Turkey)	Power of 5 kw. Generally music at 3 p.m., 5 p.m., and 7.15 p.m.	1800	ANGORA (TURKEY)	Power of 6 kw.
1250	BERLIN (ZEESEN, formerly KONIGSWUSTERHAUSEN)	Power of 35 kw. Transmits at intervals all day. Good evening concerts.	1820	Norddeitch (Germany)	Weather report at midnight.
			1840	HUIZEN (HOLLAND)	Power of 4 kw. (changes wave-length to 1,950 metres at 5.40 p.m.)
			1870	Kosice (Czecho-Slovakia)	Concert 6.30 to 9 p.m. daily. Power 5 kw.
			2000	Kovno (Lithuania)	Generally concert at 6.30 p.m. Power of 15 kw.
			2650	PARIS (EIFFEL TOWER)	Power of 5 kw. Good Sunday and evening concerts.
			4000	KONIGSWUSTERHAUSEN (BERLIN) call-sign A F P	Power of 8 kw. (see Berlin (Zeesen) 1,250 metres).

NOTES.—Recent alterations to the Hilversum station have greatly benefited British listeners. In quality and strength of signal this station compares favourably with 5 X X in many parts of the country. Huizen, also, is an excellent station for South of England listeners. Both the new Turkish stations are picked up at fair strength, but are interesting more as novelties than as programme-providers. Zeesen is employing more power than any of the other stations at present, and its orchestral items are received well even in daylight.



News of interest on short-wave receivers and reception conditions.

By W.L.S.

THE tests recently organised by the American Radio Relay League, which, by the way, were an unqualified success, have done much to show the reliability of modern short-wave communication and to remove the idea so frequently expressed that all short-wave work over long distances may be attributed to freaks.

The idea underlying the tests was this: Each American station participating was given a large sheaf of messages of an "experimental" character, one of which was to be given to each foreign station with whom the American could get into contact.

The foreign station was then to send a reply to the message, together with the number which accompanied the original message, to another American station. No American was allowed to give more than one message to any single foreign station, and no foreign station was allowed to give more than one reply to any given American.

A Good Score

Any unreliable communications will therefore be easily detected by the scrutineers, since there can be no "guessing" at the reply messages, for the simple reason that the stations receiving them did not know what the original questions were!

One British station has, to the writer's knowledge, put up a score of some 1,400 (one point being allotted for each message received and two for each reply sent).

Some of the commercial stations using the shorter waves must really be remarkably inefficient, for they seem to cover no greater distances

with their many kilowatts than some of the more careful amateurs do with 10 or 15 watts. This is, in the writer's opinion, largely on account of the bad notes that most of them turn out. A really steady signal with a pure and clear note, even if it is only R5 or so, will produce a more favourable impression at the receiving end than a "rockcrusher" noise at R7.

Steady Wave-lengths

Many of the old difficulties that were experienced in keeping the wave-length steady do not now seem to be heard of at all. This, of course, is always the way. Probably the first

stations to venture as low as 300 metres found it quite hard to keep the wave-length from swinging about.

The swinging aerial is almost a thing of the past, now that its bad effects have been realised to the full, and the only remaining cause of unsteady transmissions on short waves is the wicked habit of making a 10-watt valve groan under a load of 50 watts or so! Naturally, the valve makers do not approve of this, and it is difficult to see why the habit is so prevalent, especially in the U.S.

Miniature Transmitters

"Baby" portable transmitters for short-wave work can be real works of art. The writer has recently seen two which have really been cut down to something very near the "vest-pocket" size! Of course, for ranges up to 600 miles or so two 100-volt batteries are a sufficient power supply, and a dull-emitter receiving valve which is very economical on filament current behaves splendidly with fairly low powers.

All the coils and condensers may be quite diminutive, and the set is finished!

The Dominions are entirely justified in their complaints about the apathy of the B.B.C., so far as they are concerned. 5SW continues to relay 5XX, it is true, but the transmission still leaves much to be desired, and the wave-length is acknowledged by many to be unsuitable. Meanwhile, 2XAD provides the programmes that should be coming from London.



This well-known British amateur station, 2ZG, is operated by Mr. W. J. Badman, of Weston-super-Mare.

Hear the rousing music of massed bands

— with a
LISSEN BATTERY
in your Set

You can almost hear the stamping feet of marching soldiers as martial music floods your room— you get the spirit of the massed band festival as you listen with a Radio set whose power is supplied by Lissen Batteries. You hear the delightful blending of all the many instruments because the pure D.C. current of the Lissen Battery is noiseless, abundant and always smooth flowing, providing power for your valves such as you never had before and can never get in any other way, because the new process and chemical combination known only to Lissen is embodied only in the Lissen New Process Battery.

Buy this fine Battery at one of 10,000 Radio dealers, and show plainly by the way you ask for it that you mean to have a Lissen and no other.

60 volt
(reads 86 v.)

7/11

100 volt
(reads 108 v.)

12/11

60 volt
(Super Power)

13/6



LISSEN LIMITED (Managing Director: THOS. N. COLE), 20-24, FRIARS LANE, RICHMOND, SURREY

GRAMOPHONE PICK-UPS AND HOW THEY WORK



The design of a pick-up is not a complicated matter, as will be seen by the following article.

From a Correspondent.

ALMOST everybody is acquainted with the common or garden magnet, and with its pleasant little trick of picking up any stray small pieces of iron or steel that may be in its near vicinity. Possibly it has been noticed, too, that to relieve a magnet of one of its victims takes

Therefore from past experience it will be gathered that across these gaps (one at each end of the pole pieces) there is a great concentration of the magnetic flux (which is another name for the lines of force). In between the bend of the U-shaped pole pieces is put a coil of wire very similar to one of those used in a telephone earpiece, and wound with sometimes as many as 10,000 turns of wire not much thicker than a hair:

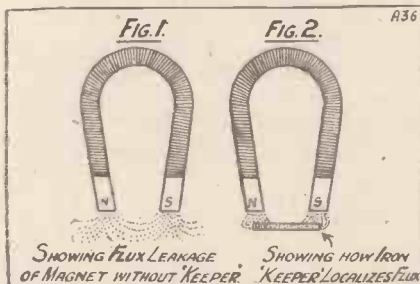

quite a little persuasion in the form of a gentle pull, for the magnet increases its pull the closer the article comes to it.

This is due to the "lines of force" or "magnetic leakage" of the magnet localising themselves through the piece of iron because they prefer the path of least resistance, for iron to a magnet is like carrot to a donkey—it likes it.

Simple Principle

Now the pick-up makes use of these lines of force in this way. On the ends or poles of the magnet are fixed pole-pieces of soft iron, usually in the shape of the letter "U," and so proportioned that when the ends of the pole-pieces are pointing one towards the other, there is a very small gap about the width of a paper match.

The Armature

Through the centre of the bobbin is a hole through which is placed a piece of iron of very small dimensions and which is provided with a rubber-covered pivot, which is in turn clamped between the lower ends of the pole pieces, thereby allowing the upper end of the armature, which is the name of the pivoted iron member, to move fractionally between the upper ends of the poles. At the lower end of the armature provision is made to take the usual type of gramophone needle.

When the needle is screwed in place and the pick-up placed on a record, the needle moves in a line at right-angles to the movement of the record, that is to say, the irregularities in the groove are from side to side and not, as so many people imagine, up and down. Therefore when the needle moves from side to side in a groove, the armature also moves in a similar manner, and in so doing comes up closer to one side or other of the upper pole-pieces.

When it approaches close to one

pole-piece the flux flows across the decreased gap, down the armature, through the pivot and its rubber covering, to the opposite pole, for opposites attract in the magnetic world; when the armature goes over to the other side the action is the same except that the polarity of the flow is reversed. It must be remembered that this action takes place many thousands of times a second, corresponding, of course, to the variations in the record groove.

Valve Amplification

Now the flow through the armature causes a disturbance in the normally well-balanced world of the magnet, and the coil of wire being in the centre of the tumult has a very small voltage set up in it by the lines of force. This varying voltage is taken to the wireless set by two wires, and is connected to the grid leg of the detector valve and to the negative of the low-tension battery, and is so passed through the set.

The reproduction on a good cone or moving-coil loud speaker is really wonderful, and must be heard to be appreciated, for the pick-up reproduces notes which are not heard on many gramophones, and comes as near to perfect reproduction as is at present possible. These pick-ups are marketed by several wireless firms, some of them being exceedingly good and moderate in price.

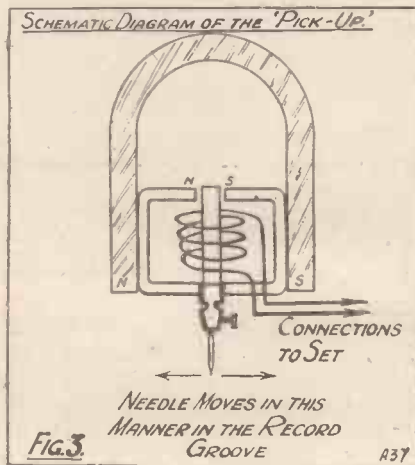

An essential factor in pick-up design is the question of weight. The average gramophone sound-box weighs about 5½ ozs., and this should not be exceeded if wear on the record is not to be excessive. Equal thrust, either magnetic or mechanical, on the pick-up armature must also be arranged or the needle will wear one side of the record groove more than the other side.



RADIO and the GRAMOPHONE

*A section for the Music Lover.
Conducted by KEITH D. ROGERS.*

THIS month I said I would discuss the use of gramophone pick-ups with those three famous wireless sets—the Cossor “Melody Maker,” Mullard “Master Three,” and the “R.C. Threesome.” Let us take them in the order I have mentioned.

All that is necessary is to have a pick-up of the high-resistance type such as the Amplion, Igranic, Lissen, G.E.C., and many others, and to have a small plug-in adaptor and a volume control. This latter is an exceedingly useful little gadget and, though it may cost a little extra, it is well worth the money spent on it.

The directions with the pick-up will show how the pick-up and the volume control are wired up to the adaptor. This latter is then inserted in the detector socket of the set.

The “Melody Maker”

Now, in the case of the Cossor “Melody Maker,” the design of the detector grid circuit is such that no alterations are necessary inside the set. Nothing has to be disconnected or connected up, and all one has to do is to plug in the adaptor from the pick-up into the detector socket of the set, removing, of course, the detector valve, and then to plug this valve into the top of the adaptor.

What happens is that the pick-up is placed across the grid and filament of the valve, and the valve itself is now operating as an L.F. valve and not as a detector, so that you really have a gramophone pick-up and three L.F. stages after it. This will be too much for some records, and this is where the volume control comes in, for by its means you can vary the strength from a mere whisper to more than enough to fill a large room. The pick-up adaptor must be wired so that when this is plugged into the detector

socket of the set the connections to the pick-up go to the grid and to the filament *negative* sockets.

An Essential Precaution

If it were wired up so that the pick-up went to the filament positive socket, you would get rather serious distortion because the valve would then be operating at the top end of its curve, and you would run into grid current. Those who want to experiment a little with a pick-up will do quite well to add a little

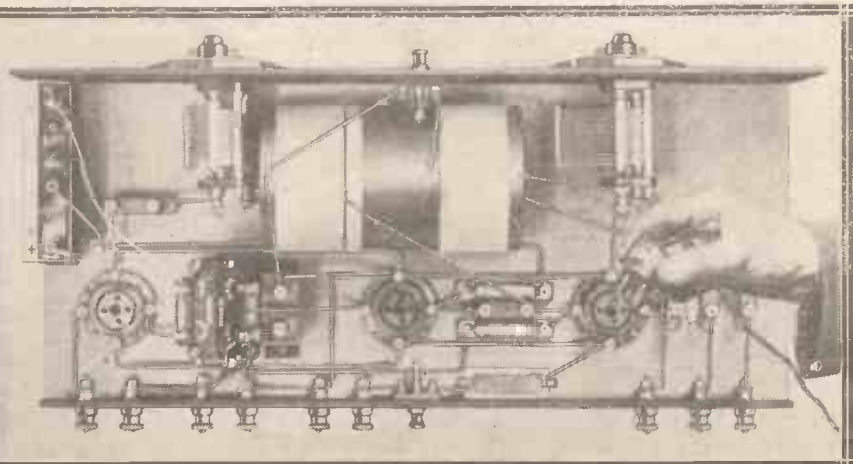

Using the Cossor “Melody Maker” with a gramophone is the easiest thing in the world. The pick-up adaptor is merely plugged into the detector valve socket, the valve replaced in the adaptor, and there you are!

grid bias to this first stage, and this can very easily be obtained by using a separate lead with a negative bias plug, plugging it into the grid-bias battery of the set and then taking this lead to the side of the volume control which went to the negative socket on the adaptor, leaving this point unconnected.

You will easily be able to trace this because the volume control is placed across the pick-up, the slider goes to the grid socket of the adaptor, and one end of the volume control goes to the pick-up and to the negative filament of the adaptor. To this terminal then you take your grid-bias lead and plug into about 1½ volts negative. The only connection to the adaptor now being that to the grid socket.

Set Remains Unaltered

With the valve used in the Cossor, and recommended by the makers, I do not think you will find the grid bias makes any great difference, except perhaps it may cut down signal strength a little. As a matter of fact, I should prefer a valve of slightly lower impedance and magnification than the one recommended by the makers, such as an H.F. valve or, possibly, one of the D.E.L. 610 types, with an impedance of about 13,000 ohms, which works admirably on the set.

However, you will get quite good results with the valves recommended by the makers, and I should certainly not recommend anyone to alter anything until he has given the apparatus a thorough test with those valves in use. Afterwards changes could be made, if desired.

Of course, in order to stop broadcasting coming through at the same time as the pick-up music, it is advisable either to detune the set considerably or, to remove the aerial

from the aerial terminal. The earth should be left on. Otherwise the set is used as normal. No tuning will, of course, be done and the reaction should be kept at minimum. The L.F. valves must be biased as usual and the loud speaker will be attached at the end. So you will see that there are no alterations inside the set at all unless you want to go to the added luxury of adding grid bias on the first valve.

In the case of the Mullard "Master Three," a little difficulty arises owing to the fact that the grid leak here goes through the coil to L.T. positive.

There are two ways of putting a pick-up on to this set. You can do as in the case of the Cossor "Melody Maker," by inserting an adaptor into the detector socket (making sure that the pick-up goes to the lead which goes to L.T. negative and the adaptor socket), and removing the aerial coil from the set, as this goes to L.T. positive, and thus gives a certain positive bias and leakage of current which might slightly impair the quality obtained from the pick-up.

An Alternative

Another plan is to use an adaptor such as that provided by the Amplion people in which the grid pin is missing, so that there are three pins on the adaptor, although there are four sockets. Thus, when you plug in, you make contact with the two filaments and the plate (only one of the filaments being used, of course), and you make no contact with the grid of the detector holder. Your pick-up is connected to one filament socket (negative) on the adaptor, and to the grid socket.

Then when you plug in your valve you have the pick-up between the grid and the filament part of the valve, and all connections to the previous

grid socket of the original valve holder can be neglected. This adaptor is completely foolproof, so that if you have any doubts about any set I would strongly advise you to use that type.

There is no need, of course, to remove any coils nor to remove the aerial from the set.

The "R.C. Threesome"

Now we will take the "R.C. Threesome." In this case the pick-up can be inserted as before into one of the three-pin four-socket adaptors into the detector socket or, rather, the socket on the Unit A. The aerial should be disconnected or the set detuned if a four-pin socket is used.

The pick-up and volume control is used in exactly the same way as with the two previous sets. Another method of connection is to do away with the adaptor, remove the grid leak on Unit A, and connect the pick-up direct, or via a volume control, across the two grid-leak clips. The bias should be altered on the first unit to give negative potential. With regard to valves, in this case I should prefer to change over the valves in Unit A and the first Unit B, so that the H.F. 210 valve is placed in the second unit and the R.C.2 valve is placed in the first and to rearrange the bias. This will probably enable you to handle the signals from the pick-up better than if the valves were the other way round.

PICK-UPS TESTED.

One of the best pick-ups that I have tested so far is the Amplion Vivavox, which is retailed at 35s. This can be obtained either by itself or with an adaptor and a volume control at extra price. Incidentally, it is well worth having the volume control, which enables one to vary the strength of reproduction within wide limits.

Well-made Instrument

The instrument itself is encased in a neat bakelite case, and is provided with a screw sensitivity control which operates a damping device at the bottom of the needle holder. This control is fixed by the makers, and should not be altered unless one is reasonably sure that the pick-up is too highly or too little damped.

The needle seems to be well centred, and I have found on very careful tests

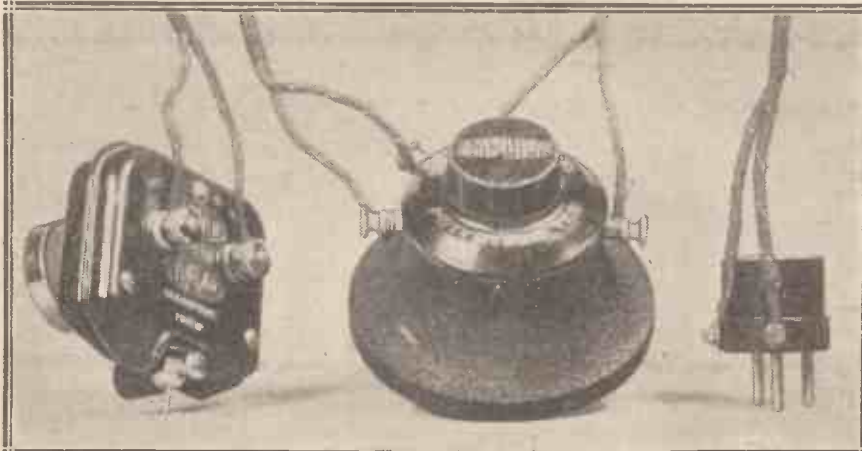

The component parts of the Amplion Vivavox outfit. The pick-up is shown on the left, connected to the volume control (centre), and thence to the three-pin adaptor.

HOW TO USE YOUR GRAMOPHONE

AS AN ORCHESTRA FOR REAL DANCING!



Use the Lissen Electrical Pick-up on your gramophone and you can amplify the music, adjusting the volume with the round milled nut provided until it fills the largest room or hall. You can dispense with an expensive orchestra and yet enjoy real dancing to the finest bands.

The Lissen Electrical Pick-up helps your gramophone to reproduce the low notes of the music more perfectly than ever you have heard them — it takes the needle scratch from old records and makes new records last longer.

LISSEN ELECTRICAL PICK-UP 15/-



INSTRUCTIONS:

Replace your sound box with the Pick-up, connect from Pick-up to Grid Terminal of the Lissen Pick-up Adaptor and to one filament terminal of the Adaptor. Plug the Adaptor with valve fitted in it into the Detector Valve Socket of a two or three valve set.

Full particulars included in every Adaptor Carton. Obtainable at most dealers, but if any difficulty send direct to factory (post free or C.O.D.).

LISSEN LTD., 20-24, FRIARS LANE, RICHMOND, SURREY

(Managing Director: Thomas N. Cole.)

That this pick-up does not seem to injure the record in any way. I make this remark because it appears to be a rather general idea that the use of a gramophone pick-up is necessarily accompanied by extremely heavy wear on the record, making the latter

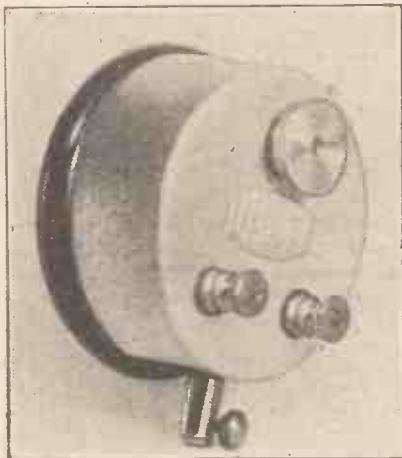

The Lissen electrical pick-up. A useful instrument which is obtainable for the modest sum of 15/-.

last only about half as long as it would with an ordinary gramophone reproducing sound-box.

The Amplion pick-up is of the high-resistance type, so that the leads from the volume control go direct to the grid and filaments of the valve. The adaptor supplied is of a very useful design, in that no grid pin is supplied on the adaptor, although a grid socket is there.

Fool-Proof Scheme

The adaptor plug is plugged into the detector socket of a set; it does not matter what the grid circuit of that set is; the pick-up is connected to the grid and L.T. minus socket of the adaptor and the valve is plugged into the top of the adaptor.

The Vivavox pick-up is supplied with a tone-arm adaptor so that it will fit any class of tone-arm, the fitting being supplied with a very convenient rubber connection. Used with a three-valve set the Amplion pick-up is capable of giving very good reproduction, and can be confidently recommended.

The Lissen Pick-Up

The least expensive of all the pick-ups that I have tested is the Lissen, which retails at 15s. This is a simple little instrument which should command a ready sale.

It is not so elaborately designed as some of the more expensive models, though it must be stated that in the matter of pick-ups price is not

necessarily an indication of true value. I have had under operation several expensive types which have, in my opinion, been outclassed by models of half the price.

The Lissen pick-up is supplied with an adaptor, if required, and is quite sensitive in operation. It is adapted for use with either fibre or metal needles, and I have found it operate best on needles of the "loud" variety. The half-tone types appear to cause a certain amount of unnecessary chatter, which can be obviated by employing the stouter kind.

S. G. Brown, Ltd.

This well-known firm, whose head-phones and loud speakers have earned world-wide fame, are naturally well to the front when it comes to the question of gramophone pick-ups.

The model that I have tried, of the high-resistance variety, is perhaps the lightest model I have come across. In fact, it gave me the impression that it was too light, so that an unnecessary amount of chatter from the pick-up was noticed. This is not detrimental to final reproduction, and as long as the gramophone lid is soundproof, or nearly so, one can neglect this noise.

On test the pick-up, which sells for £1, gave very good results. It is sensitive, and is able to deal with the

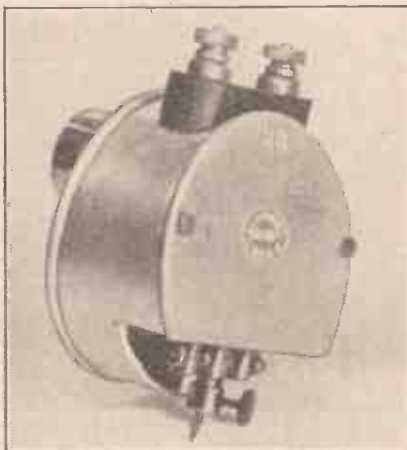

The Brown high-resistance pick-up; one of the lightest on the market.

various types of records in a very praiseworthy manner. I know of one gramophone concern, by the way, which speaks very highly of the Brown pick-up, and the light way in which it treats the surface of the record.

Loud needles of the steel or Tungstyle type seem to suit the pick-up better than the half-tone types, while the reproduction with fibre needles is far too "breathy" for my liking.



It is essential that the pick-up and tone-arm of the gramophone be so arranged that the needle runs true in the record channels. If the needle is at all out of truth harshness will result and the record will be spoiled. In most cases the pick-up will automatically be O.K. in the standard tone-arm, but I have come across instances where the tone-arm is bent to the wrong angle, and a new one had to be fitted to take the pick-up.

Needle Alignment

When a needle is on the record it should make an angle of about 60 degrees with the record face. It should also, when half-way across the record, be *in line* with the tangent taken to the channel of the record at the point at which the needle touches.

On swinging the tone-arm across the record it will be found that, when the pick-up is properly arranged, the needle-point will come directly over the centre of the turntable pin.

Don't forget to change the needle after every *side* of the record unless you are using Tungstyle or other semi-permanent type.

Gentle Treatment

Slide the needle into the *first* groove; do not drop it, however gently, into *any* groove on the record.

Lower your pick-up on to the record on the outside edge when the turntable is spinning, and lift the pick-up off the record before stopping the motor unless the needle has left the main channels and has entered the special track near the centre of the record.

A little grid bias on the first valve will often clean up apparent "roughnesses" which are often due to the incorrect functioning of this valve.

RECENT RECORD RELEASES



Orchestral and Band

British Brunswick. Dubinuschka; and (a) *Old Forgotten Waltz*; (b) *Bouran*. The Gypsy Orchestra. 3697-B. (10 in. 3s.)

A record that is specially suited for pick-up reproduction where the various instruments of a small orchestra are required to be heard in turn and together. A rather monotonous record from an entertainment point of view. The 'cello and piano parts in the first-named provide good tests for pick-up outfits.

Intermezzo—Waltz in two parts. (Richard Strauss.) The State Opera Orchestra of Berlin. 80027. (12 in. 6s. 6d.)

A new waltz which should be heard by all.

Intermezzo from "*Cavalleria Rusticana*" and the *Ballet music* from "*Aida*." State Opera Orchestra (80021. 6s. 6d.)

Here again the strings are a little bit too pronounced in some places, and if one is not careful a little bit of chatter or blasting may take place. The Ballet music from "*Aida*" is the side I prefer more than the other, as it is delightfully dainty and tuneful. These records will want a little bit of handling, but when one is used to it it is easy to adjust the set to suit the record, when it then becomes a sheer delight.

Broadcast Record (Vocalion). *Shepherds' Dance* and *Morris Dance* (Henry VIII). Edward German. The Symphony Orchestra. (210. 1s. 3d.)

A very pleasing performance that can be recommended to all lovers of light, tuneful orchestral music. It is remarkably good value for money.

Electron (Edison Bell). John Barbirolli and his Symphony Orchestra. *Overture to the Flying Dutchman*, three parts, and *Introduction to Act 3 of Die Meistersinger*. (X521-522. 12 in. 4s. 6d.)

These two records form a very good test of a pick-up, and can be confidently recommended for use with that instrument. The extreme clearness of these two records is, I think, emphasised by using them in an electrical way rather than on the ordinary gramophone, and I think that perhaps the bass comes out even better on a pick-up than it does with the ordinary gramophone. In the latter it is just a little bit harsh. The records are certainly well worth getting for anyone who is fond of orchestral music.

H.M.V. London Symphony Orchestra. Bavarian Dances Nos. 1 and 2, by Elgar. (D1367. 12 in. 6s. 6d.)

An exceedingly good record. The strings are perhaps a little bit harsh on some of the higher notes, but on the whole the record is remarkably mellow. The bass is recorded with wonderful clarity and faithfulness. It is a record which requires a good pick-up to do it justice, and I have tried it over on several types of pick-up and would say that it needs a little bit of care in its handling.

Parlophone. Berlin State Opera House Orchestra. Overture to William Tell. R20035.

An extremely good and dignified rendering of the famous overture. An extremely good record for pick-up use, being wonderfully clear and of that constancy which means so much when electrical reproduction is being carried out. When I say constancy I do not mean flatness, all the brilliance that is necessary to give a true reproduction of the piece is present in the record, but the modulation is nearly perfect.

Zonophone. Second Connecticut March and *Semper Fidelis March*. United States Marine Band. (5050. 2s. 6d.)

Two rousing tunes, the latter by Sousa, which will be welcome to all

who are fond of band pieces. The both sides are excellent records and are played extremely well, with plenty of vim, the drum parts especially coming out well on a good loud-speaker.

Instrumental

Broadcast (Vocalion). *Les Millions D'Arlequin* and *Minuet in G* (Beethoven). Organ solos. (201-B. 1s. 3d.)

Two excellent recordings that should be extremely popular. Almost ideal for average pick-up work.

Electron (Edison Bell). *Cherry Ripe* and *Londonderry Air*. The Brosa String Quartette. (0201. 10 in. 3s.)

An excellent piece of recording that is capable of being reproduced to the greatest advantage. The orchestration of both pieces is very intriguing, being one of the most weird I have heard on a record for many a long day. To lovers of modern harmonising I suggest a trial of this record.

Zonophone. Raymond Overture (in two parts). Organ solo. (5057. 10 in. 2s. 6d.)

Another organ record that gives full possibilities for skilful pick-up handling. I would advise every pick-up enthusiast to get this as a test record.

Vocal

Broadcast (Vocalion). *Land of Hope and Glory*, and *Jerusalem*. Choir. (198. 1s. 3d.)

A pleasant little record that should be popular. It is somewhat marred by the difficulty obviously encountered in getting even modulation with a large body of singers. The "volume" control at the recording end could perhaps have been done a little better.

Columbia. Rex Palmer's new record, The Roadside Fire. (4502.)

Excellent for pick-up work. Rex Palmer is a radio favourite who needs no introduction from me, and here in these recordings we have him at his best. On the reverse side is *For You Alone*, which is excellently sung.

Electron (Edison-Bell). *O Divine Redeemer*, and *Abide With Me*. Edith Furmedge. (X 513. 12 in. 4s. 6d.)

Comes out very well on a pick-up. I do not think there are any criticisms to be made as regards quality or the way this record should be handled. I advise a loud needle for this, as this seems to reduce chatter on some of

(Continued on page 463.)

RADIO ABROAD

Voices From the Sky

SKYWRITING—or advertising by means of letter-writing against the clouds by the smoke from a generator attached to an aeroplane—created a great sensation when it was first introduced. A somewhat similar sensation was lately created in New England (U.S.A.) towns when a tremendous voice from the sky was heard—a voice so loud that it drowned out the roar of the aeroplane from which it came and swamped ordinary traffic noises and the noise of the elevated railroads.

The aeroplane was 3,000 ft. up, and the words from the loud speaker from the aeroplane—for it was a special loud-speaker equipment that was in operation—could be heard and understood at a distance of 5 miles from the machine.

To generate such a voice that it drowned out the roar of three aeroplane motors and made a whole city stop to listen was naturally the work of a loud-speaker system that must at least be classed as unusual. Fundamentally it operates on the usual lines, beginning with a microphone in a sound-proof booth in the aeroplane and, after various valve-amplifiers, passing to three high-power loud speakers built into the aeroplane and pointing vertically downwards.

The last stage employed four Western Electric 250-watt valves, fed at full voltage by a pair of 500-watt wind-driven generators. Several such machines are operated by a company styled "Voice of the Sky, Inc." It is estimated that during a five-hours' flight a total of 300,000 people were reached.

Ceylon Radio

Radio continues to spread to the four corners of the globe, and the latest new Radio Journal to reach me is the "Ceylon Radio Times," of which Volume 1, No. 1, January, 1928, is just to hand. This journal is published by the Ceylon Amateur Radio Society, and, although the Journal has only just made its debut, the Ceylon Radio Society was founded so far back as 1922.

Ceylon was the first colony (outside the Dominions) to inaugurate a

broadcasting service, and this was the first service in the British Empire to be operated as a Public Service under Government control. The Ceylon station was the first one (excepting possibly in Japan) to give regular broadcasting programmes in the East. For some time past the Colombo Broadcasting Station has been operated at the rate of 1,000 hours per annum. Many lectures are given, both in English and in the vernaculars.

Broadcasting in N.S.W.

Plans for the New South Wales State broadcasting service originally budgeted for an expenditure of about £23,000, but plans have been extended and it is now estimated that about £30,000 will be spent. In addition to the Sydney broadcasting station and half a dozen relay stations there are

graphic. A receiving set is also to be installed capable of picking up messages from any part of Europe. The installation is expected to be in operation by May 16th next.

Italian Broadcasting Activity

An agreement has been concluded between the Italian Government and the Italian Broadcasting Company, and the latter company will now provide for the purchase and installation of a series of broadcasting stations.

A Cable Achievement

An interesting cable installation took place recently when the new Pirelli 132,000-volt cable was put into service, connecting the Hell Gate station of the United Electric Light and Power Company with the Dunwoodie sub-station of the New York Edison Company. The cable is 12 miles in length and is of the single-conductor hollow-cone oil-filled type. The line comprises three cables, each of these installed in ducts. This cable represents the latest development in underground construction and is capable of transmitting over 130,000 horse-power, sufficient for the total electric services of 300,000 people.



"Radio Milano" is situated three miles from the city of Milan. Built by the Marconi Co., it develops a power of 7 kilowatts in the aerial. The station is generally "on the air" from 8.30 to 11.30 p.m., and employs a lady announcer.

to be probably thirty subsidiary stations of low power.

New Bulgarian Station

Arrangements have been made for the erection of a wireless station at Sofia, Bulgaria—two transmitting sets to be installed, one capable of communicating with London and the other with Vienna, and the second one to be telephonic as well as tele-

Transatlantic 'Phone

The recently inaugurated transatlantic radio-telephone service carries an average of three calls per day originated at the English end, and four from America. The P.M.G. recently stated that the operating expenses are just about being covered, but it is expected that the service will be increasingly used in the future.

(Continued on page 472.)

FERRANTI

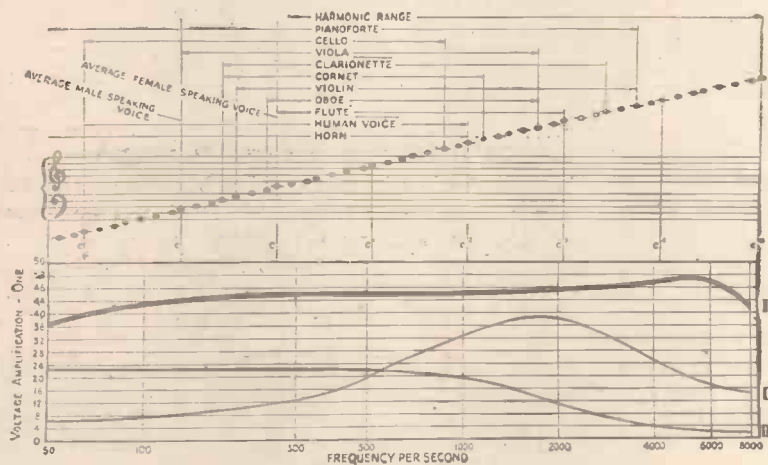

CURVE I.—The Ferranti AF-3 Transformer.
 * CURVE II.—A Cheap Transformer. † CURVE III.—Resistance-capacity Coupling.

**A.F.3 is still the Best
 TRANSFORMER**

except one, i.e.,

The A.F.5 which is

25/-

A.F.3

SUPERLATIVE

30/-

A.F.5

Deliveries are being effected in rotation

FERRANTI LTD., HOLLINWOOD, LANCS., and BUSH HOUSE, LONDON, W.C.1



RECEPTION REALITIES

Receiver "Improvements" which may not improve results.
By P. GLOVER.

THERE have been such vast strides in the art of radio reception during the last year or so that modernising is becoming a very popular practice among enthusiasts. But beware of haphazard "improvements." If you want to spend a little money and bring your set and its accessories right up to date, you will have to go very methodically to work.

Perhaps you have become intrigued by the performance of one of the modern moving-coil loud speakers. These are expensive articles, but when properly used are well worth their money. However, if you buy one and hook it on to a receiver built in, say, 1922, and incorporating three transformer-coupled L.F. amplifiers, it is very likely that you will be very disappointed and will consider your old horn-type loud speaker to be the better reproducer.

Super-Power Valves

And so it might be in the circumstances. To do the moving-coil loud speaker justice you would have to scrap your old set and invest in an entirely new outfit. Again, lured by the name, you might decide to purchase one of those "super-power" valves for the last valve holder in your receiver. But you take out the original L.F. valve (which may be of the "general-purpose" type!), put this new one in, and there is an immediate decrease in volume. The word "super" as applied to super-power valves does not mean that it will produce super-power, but that it is capable of HANDLING super-power. You see the difference? Its actual amplifying properties will be low.

You may know this but anticipate a return in an improved quality of reproduction. This may not result

any more than might be the case if you were to place two valves in parallel in the last stage of your receiver. One of the incidental effects of such a procedure is to cause a considerable increase in anode current.

"In fact, every component and every accessory directly or indirectly concerned with the L.F. portion of a 'multi-valver' needs to be chosen with discrimination."

An ordinary low-frequency valve will only have an anode current of about five or six milliamps.; a super-power valve will pass anything up to twenty milliamps. If your set has a plain output, that is, if the anode of the

last valve goes straight to the loud speaker and the loud speaker is joined direct to the H.T. battery, then this instrument will suffer from the greatly increased current which passes through its windings.

What is known as "saturation" will occur with consequential distortion. This also applies to the choke in a choke-capacity-coupling scheme; there are very few L.F. chokes on the market capable of handling the current which flows in the anode circuit when a super-power valve is employed!

H.T. Current Limitation

There is also another snag, and that is your H.T. outfit might not be able to provide you with the current required to operate the super-power valve efficiently. And you come up against all sorts of obstacles when you invest in a mains unit and decide to do without H.T. batteries unless you proceed warily. Every mains unit has a definite current limitation. In the case of some of the cheaper ones on the market, this is not a very high value, and imposes definite limitations regarding the number or types of valves used. In fact, every component and every accessory directly or indirectly concerned with the L.F. portion of a large multi-valver needs to be chosen with considerable discrimination.

One is frequently advised to employ a power valve in the first low-frequency
(Continued on page 466.)



This is the transmitter room of the Marconi Short-Wave Beam Wireless transmitting station at Dorchester. The transmitter on the left is used for communication with New York on three wave-lengths and the transmitter on the right is used for working with Rio de Janeiro on one wave-length.



BRITAIN'S RADIO

With the completion of the Beam services and the opening of the transatlantic radio telephone at Rugby, Britain leads the way in up-to-date and efficient systems of radio communication.

*By Lt.-Col. CHETWODE CRAWLEY, M.I.E.E.
(Deputy Inspector of Wireless Telegraphy, G.P.O.)*

THE outstanding advance in point-to-point communication has been the opening of the transatlantic wireless telephone service in January, and the completion of the main line of wireless telegraph communication for the Empire by means of the beam stations.

The Rugby Transatlantic 'Phone

The wireless telephone service was opened between England and the United States of America, and has recently been extended to Canada. This service has proved a great success, and will hall-mark 1927 as one of the outstanding years in the advance of wireless point-to-point communication. The wireless transmission at this end is carried out from the high-power station at Rugby.

The reception was at first carried out near Swindon, but a more northerly position was found to be preferable, and the receiving station now normally used is at Cupar. The single side-band system is employed on wave-lengths between 5,000 and 6,000 metres. The minimum charge for a three minutes' conversation is £15, and the revenue already covers the running expenses, which augurs well for the future. The system was installed and the service is conducted by the Post Office, working in conjunction with the American Telephone and Telegraph Company.

Imperial Beam Service

The Imperial wireless telegraph beam service was opened by the Canadian link at the end of 1926, and the main system was completed in 1927 by the links with Australia, South Africa, and India. The rates for the Canadian service are in the main the same as the cable rates, but for the others the rates are lower than the corresponding cable rates. The English transmitting stations for Canada and South Africa are at

Bodmin, the receiving stations at Bridgwater.

The English transmitting stations for Australia and India are at Grimsby, the receiving station at Skegness. The Grimsby station for transmission to Australia uses a wave-length of about 26 metres, and is arranged so as to be able to transmit eastward or westward according to atmospheric conditions, the other stations transmit over the shortest routes, using a wave-length of about 16 metres by day and 34 metres by night.

The stations were erected by the Marconi Company, and are operated by the Post Office. The keying and transcription of telegrams are carried out at the General Post Office in London. Machine telegraphy is used at speeds of between 100 and 200 words a minute. All the services are working satisfactorily when conditions are favourable, but the con-

tinuity of service is not at present up to the standard of cable services.

Various other short-wave services, but not on the beam system, have been opened during the year, and a steady development has taken place in medium-wave services with the continent and the long-wave broadcasting services from Rugby, but all these have been overshadowed by the inauguration of the beam services with the Empire.

An Important Safeguard

The most important advance during the year in maritime wireless has been the introduction in this country of the auto-alarm. This is a receiving device which automatically responds to the alarm signal as laid down in the Merchant Shipping (Wireless Telegraphy) Rules, 1927.

This alarm signal consists of a series of twelve dashes sent in one

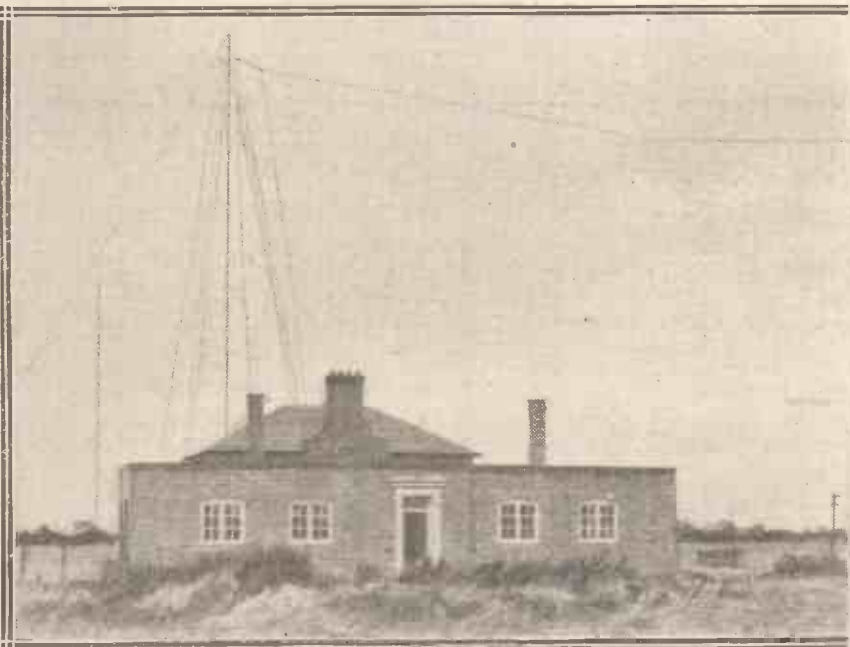

The Devizes radio station is one of our most important stations, for from here communication is carried out with ships all over the world. One of the three receiving points belonging to this station is situated at Burnham and is shown in the above photograph.

minute, the duration of each dash being four seconds and each space one second. The alarm apparatus is being rapidly fitted in our ships, as all those which carry between fifty and two hundred persons, and are fitted with wireless apparatus according to law, must have an auto-alarm device before July 18th next.*

Direction Finders

The great majority of ships fitted with wireless are in this class, and have been obliged hitherto to carry watchers in addition to an operator. When the auto-alarm is fitted no watchers need be carried, as if the operator is not on watch when an alarm signal is received the signal will operate the alarm apparatus, which in its turn will ring a bell to call the operator to the wireless-room.

The fitting of directional apparatus in ships has progressed steadily, and some 400 British ships are now fitted. The whole question of direction finding and beacon stations has been under constant consideration by the authorities concerned. The first half-dozen "all round" beacons have been erected during the year at various points on the coasts, and the erection of others is in hand. These beacons send out distinctive wireless signals at regular intervals on a 1,000-metre wave, to enable ships fitted with wireless direction finders to take bearings on the beacons.

The effective range of the beacons is between fifty and one hundred miles. Some of these beacon stations also transmit a submarine sound signal, so that a ship can determine its distance as well as its bearing from the station by allowing for the difference

in time between the reception of the sound signal and the wireless signal. Experiments are being carried out with wireless beacons which transmit a revolving beam of waves by which any ship fitted with a wireless receiver can obtain a bearing.

Ship and Shore Services

None of these is yet in commission, but it seems not unlikely that this form of beacon may eventually come into commercial use. The installation of direction-finding apparatus at coast stations has been continued during the year, and six coast stations are now available for giving bearings to ships. Over 7,000 bearings were given to ships during the year.

Interrupted continuous-wave transmitters are being installed at out-coast stations in place of spark transmitters and are already in use at the Seaforth and Humber stations. A few ships, too, have been fitted with I.C.W. sets, and this policy has been confirmed at the International Conference at Washington.

The capacity of our only ship and shore continuous-wave station, the Devizes station, has been increased so that two transmitters and three receiving points are now available for dealing with the growth of traffic to and from our large passenger ships.

New Time-Signal Broadcast

Commercial communication with ships on short waves was commenced during the year, but only a few ships have as yet been fitted. A set for this work is in operation at the Devizes station.

A broadcast time-signal service from the Rugby station, worked from Greenwich Observatory, was commenced in December, and is available for the use of ships and stations all over the world.

During the year, wireless telephony has at last come into commercial use for ship work. The first shore set has just been installed at the Humber station, and a number of whalers and other fishing craft have been fitted.

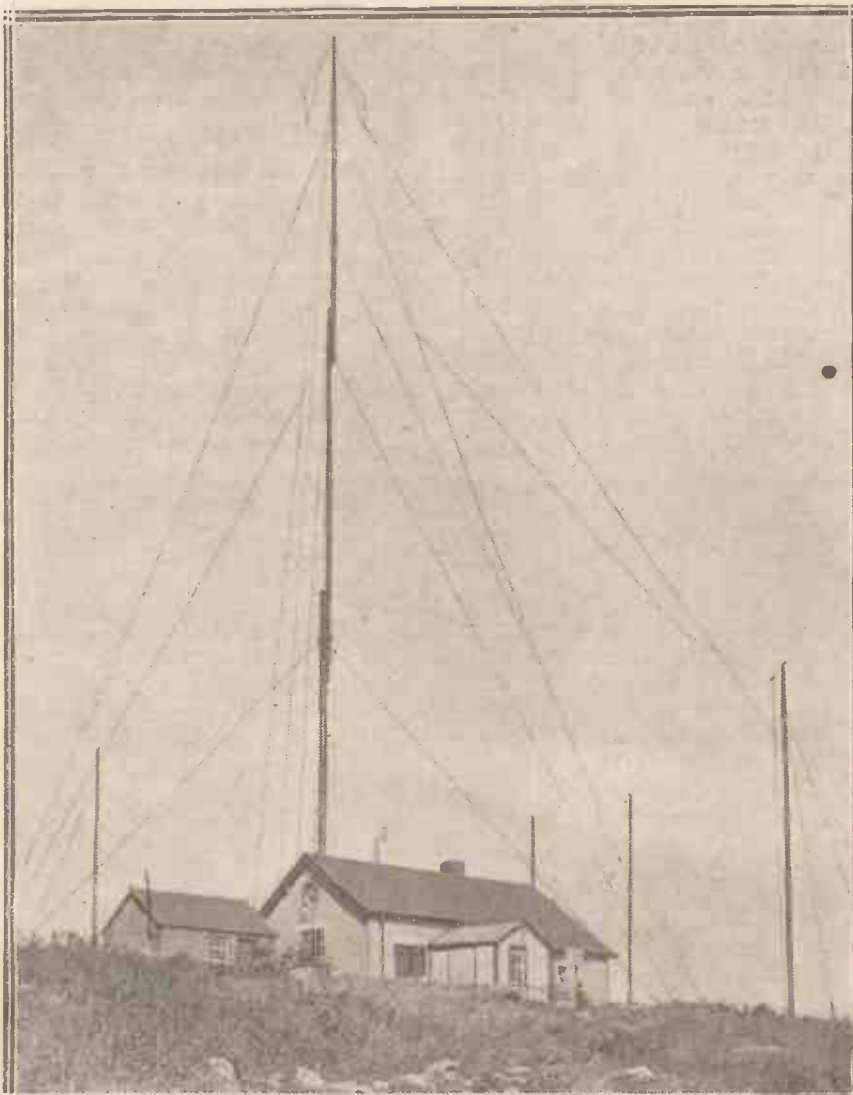

Every British sea-going wireless operator knows GRL, the famous Fishguard station illustrated here. This station carries out a tremendous amount of traffic with ships, especially those transatlantic vessels journeying to and from Liverpool. Together with Land's End, Fishguard is one of those many "outpost" stations that are never silent, day or night.

*ED. NOTE.—It was as a direct result of the terrible *Titanic* iceberg disaster, when hundreds lost their lives, that compulsory regulations regarding the fitting of ships, especially passenger vessels, with adequate radio apparatus were drawn up by the maritime nations of the world. Special "watchers" for icebergs, and similar vessels fitted with radio, were instituted as patrols to report to all ships any unforeseen dangers that might be lurking in the ocean highways. Later the regulations were increased until now-a-days everything above a certain tonnage, or is carrying more than a certain number of persons, has to be fitted with wireless gear. The auto-alarm will do much to make life at sea less hazardous.



BRAINS!

RADIO Valves are the brains of your Wireless Receiver.

When you buy a new set look to the valves.

In nine cases out of ten you will find that they are Six-Sixty valves—first-class valves that are fitted as standard by Britain's leading set manufacturers.

Fit a new set of Six-Sixty's in your existing set. We need not tell you

to notice the difference—it will be obvious at once.

Six-Sixty valves are non-microphonic, are matched valve with valve, and give perfect electrical balance. There is no radio valve like Six-Sixty, and no other radio valve is as good.

We publish a booklet that will plainly tell you why. Ask for a copy at the nearest radio shop, or write direct to us.

All types and voltages, from 10/6

USE ONLY

**SIX-SIXTY
GLOWLESS VALVES**

THE ELECTRON CO., LTD.

122-124, Charing Cross Road, London, W.C.2

Telephone: Regent 5336

NO VALVE LIKE IT



WHAT READERS THINK

An Interesting Circuit

SIR,—I was greatly interested in Mr. L. H. Thomas's remarks in the December number of MODERN WIRELESS regarding selectivity in a receiver consisting of detector followed by low-frequency.

He considers that this type of receiver is being neglected in favour of those using H.F. amplification. This is rather a pity, considering the excellent circuits that have been put forward from time to time in your periodical. For my part I have derived more pleasure from the detector and low-frequency types than any H.F. type I have yet tried.

One great advantage is its adaptability to the short waves, provided a good layout is followed. But this is getting away from the point I wish to discuss, viz., selectivity in a receiver using no H.F.

Doubtless you will remember an article in MODERN WIRELESS, Decem-

ber, 1923, by E. H. Chapman, in which he described a crystal set, using an untuned aerial circuit. This

was followed by further articles on aperiodic aerial coils in "Wireless Weekly," May 7th and 21st, 1924, respectively. I have experimented with this class of coil ever since, and proved to my own satisfaction that to get equal amplification over all wave-lengths the aerial must also be tuned.

Eventually I was able to design a crystal receiver that was capable of receiving 5XX while 5NO was working two miles from my receiving station. This set won first prize in "Manchester Evening Chronicle" Competition, 1926 (Daventry crystal section). In applying the principle to a valve circuit, I was confronted by a lot of difficulties, but after many months' experimenting I was able to overcome these, with the result that I have a Det. and 2 L.F. receiver which I consider the equal of any four-valve receiver using H.F.

I am not going to give a list of stations received, but I assure you I have a good choice of programmes, with the local only two miles away. I have not patented this circuit, and I am giving it to you to use in your Wireless periodicals as you think fit.

To enable you to duplicate my receiver I am giving full details of components used.

Yours truly,
A. HURST.

Newcastle-on-Tyne.

Television—Its Future

SIR,—Experiments in connection with television are taking place in various parts of the world, and as optimistic reports in connection with some of these are frequently given in the newspapers, it is well, to prevent any possibility of the public being misled, to point out certain important facts in regard to television.

In the first place, all scientific men competent to judge are of the opinion that the inherent difficulties of television will, in all probability, prevent it from becoming a practical propo-

sition for many years to come—that is to say, in a form in which it can be given to the layman in the same way as the present-day broadcast receiver.

In order to achieve television successfully, it is necessary to transmit at least sixteen complete pictures per second, and each picture is built up by the successive transmission of a series of impulses amounting in the case of a small picture to perhaps 5,000 to 10,000 per picture. Therefore, a minimum number of impulses of, say, 100,000 to 200,000 per second must be transmitted! It is evident that the really successful

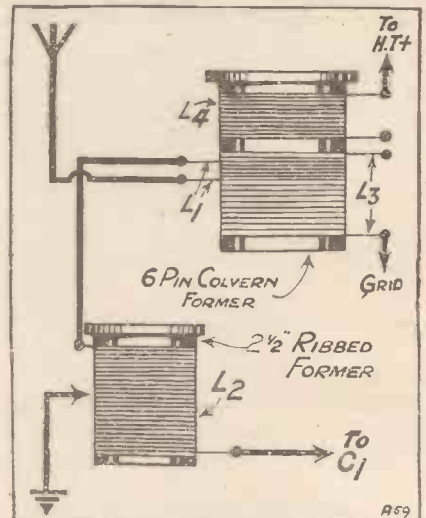

The coil L_2 consists of 100 turns of 30 S.W.G. on $2\frac{1}{2}$ -in. ribbed former. Tappings were taken at the following turn numbers: 5, 10, 15, 20, 25, 30, 35, 40, 45 and 50. These were operated by switch on front of panel. C_1 is of about .0002 mfd. and only requires to be set once. The desired selectivity is obtained by varying C_1 .

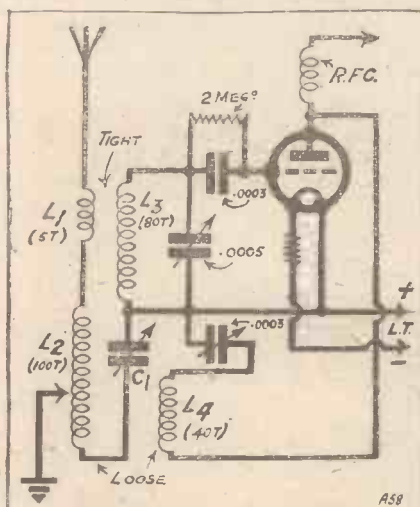

The coils are wound on a 6-pin former, turn numbers being as follow: L_1 , 40 turns; L_3 , 80 turns; L_1 , 5 turns, wound over L.T.+ end of L_3 . (See also other diagram)

ber, 1923, by E. H. Chapman, in which he described a crystal set, using an untuned aerial circuit. This

solution of the problem is one of transcendental technical and manipulative difficulty.

Up to the present, technical difficulties have been found so great that it is utterly impossible to transmit a scene such as a boat-race, a horse-race, or anything of that kind, in which the main objects are only small parts of the whole picture, and in which, therefore, greater detail is required in order to render them faithfully. The greater the detail required in a televised picture, the more the number of impulses per second have to be multiplied up, and, as already mentioned above, the stupendous number of between 100,000 and 200,000 impulses per second is necessary even for transmitting a crude representation of a human face with little or no detail; the number of impulses per second

(Continued on page 436)



THE term television can fairly be applied to any system by which moving-picture effects, as distinct from a mere still-life photograph, can be transmitted to a distant observer. The signal impulses necessary to convey impression may be fed over metallic wires connecting the transmitting and receiving stations, or they may be propagated through the ether in the form of wireless waves.

Photographic Transmission

There is a tremendous gap, however, in the technical difficulties necessary to secure the same effect in the two cases mentioned. Television over connecting wires, although in itself an extremely intricate affair, is relatively simple in comparison with the problems to be overcome in attaining true radio vision—or the transmission of moving-picture effects by purely wireless methods.

The conception of television, in the first instance, was probably based upon the successful transmission of



C. Francis Jenkins, the American scientist, whose television apparatus was thought some four or five years ago to hold many possibilities of useful development.

An informative and interesting survey of the facts.

By J. C. JEVONS.

still-life photographs and facsimile handwriting by using the ordinary telegraph wires. Here the necessary light and shade effects are conveyed over a connecting wire piecemeal, so that in due course the complete picture is built up, or repeated, at the distant end.

Such methods of photographic transmission by telegraphy date back nearly fifty years, and they have been in commercial use for newspaper work for approximately a quarter of a century. The time taken to transmit a complete picture in this way depends, of course, upon the size of the picture and upon the fineness or quality of reproduction that is aimed at, but the average time varies from ten to twenty minutes.

Applied to Radio

It is only within the last year or two that the same methods have been successfully applied to radio or wireless transmission of still-life pictures. This fact, in itself, speaks volumes for the difficulties to be overcome in bridging the gap between the transmission of ordinary wired or telegraphic pictures and the field of radio or wireless picture transmission.

The time taken to send a wireless still-life photograph across the Atlantic varies again with the size and quality of the work handled, but it is of roughly the same order as in the case of line telegraphy.

Such speeds of transmission are, of course, very far removed from even the threshold of television proper. They are only quoted here

because from such still-life transmission sprang the first inspiration that television proper might at some time be brought within the range of human possibility.

The Fundamental Difference

How far one achievement is separated from the other may be estimated from the fact that, to advance from still-life transmission to television, it becomes necessary to repeat the complete picture from twelve to sixteen times every second, instead of laboriously building it up once in every quarter of an hour.

Here it is necessary to emphasize one fundamental difference between the transmission of sound or music by wireless and the transmission of a visual effect by the same means. The ordinary man in the street, having witnessed the extraordinary progress of broadcasting, and the perfection to which it has been brought



D. v. Mihaly, a noted Continental experimenter.

in a comparatively short number of years, may be inclined to argue that television and even radio vision should be perfected with similar rapidity.

That this may come to pass is undoubtedly the ardent desire of

“ . . . to advance from still-life transmission to television it becomes necessary to repeat the complete picture from twelve to sixteen times every second, instead of laboriously building it up once in every quarter of an hour.”

every wireless enthusiast. Radio vision, once it has been developed into a form where it can be introduced into the home, will open up an entirely new and enormously fascinating field of interest to all our readers. But meanwhile it is only reasonable, especially in the face of recent claims that have appeared in the non-technical Press, to temper credulity with an intelligent appreciation of the problems involved, for instance in the successful transmission of moving-picture effects from this country to America by purely wireless methods.

High Speed Essential

Reverting back to our argument, the fundamental difference between telephony and television lies in this simple fact. In the case of telephony all the different sounds that go to form articulate speech and music involve no distribution in space, but only a sequence in time that is appreciated by the ear. In the case of television more than this is required to satisfy the eye.

In order to see a transmitted picture all the diverse light and shade effects which go to form a picture, and which are transformed into electrical effects by the selenium cell or other optically sensitive device, so that they may be conveyed along a wire or through the ether, must be assembled in their proper and definitely-spaced distribution on the viewing screen at the receiving station. Otherwise the effect is a mere blur of light without recognisable definition.

Synchronisation

It is here that all the trouble arises. How can one ensure that the “ spot of light ” which is used to analyse the picture at the transmitting end, cutting it up into thousands of elements, and repeating this operation sixteen times a second, can be kept accurately in step with the corresponding “ spot of light ” at the receiving end. The latter, moving at incredible speed over a suitable viewing screen at the receiving end, must build up or synthesize the transmitted signals into the original picture, and it must keep accurately in step—or be synchronized—with its companion light, hundreds of miles away, or else failure will inevitably result.

Difficult as this problem may appear at first sight, it has been tackled with considerable—though by no means absolute—success by many inventors. Rosing, Jenkins, Alexanderson, Baird, Korn, Belin, Mihaly and Karolus are but some of a large band of workers who have devoted much time and ingenuity to the study of this apparently insuperable problem of synchronisation.

It is perfectly obvious that in order to maintain the two sets of apparatus, one at the transmitting station and the other at the distant receiving end, accurately in step with each other, there must be some connecting link



Dr. E. F. W. Alexanderson (right) watching a demonstration of his television apparatus.

between them. For the slow reproduction of still-life photographs it is possible that two separate motors at the two stations might be maintained in sufficient synchrony by means of accurate tuning-fork or similar local control, without the necessity of any connecting wire. But this degree of accuracy would not suffice where television speeds of sixteen repetitions per second are involved.

In practice a separate frequency control current is sent out from the transmitter and is fed directly to the receiving motor in order to keep the two sets of apparatus in accurate synchrony. No successful television result has ever been achieved without some such form of direct synchronisation control.

Easier by Landline

Here, again, is evidence of the gap between wired television and true radio vision, or corresponding wireless effects. If a connecting wire can be laid between the two stations, the transmission of a synchronising current, in addition to the picture-signalling current, becomes a comparatively simple matter, as compared with the difficulty of transmitting a special synchronising frequency through the ether—over and above the essential picture signalling elements, particularly where long distances are to be covered.

In the first place, a wire will readily convey a current of considerable energy—such as is necessary to control the speed of a motor—whilst it is extremely difficult to pick up an adequate amount of energy for this

(Continued on page 467)

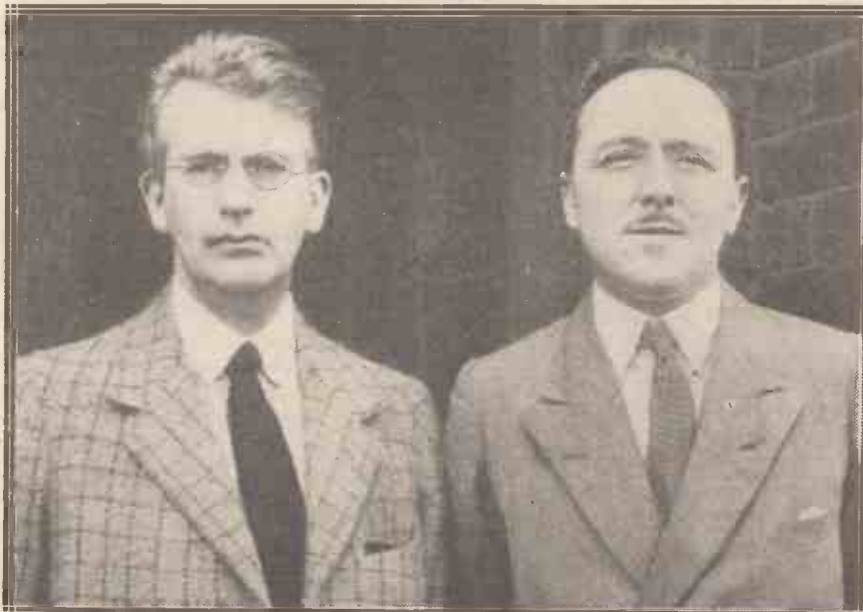

Mr. Baird (left), and Captain Hutchinson, Business Manager of the Baird Television Development Co., Ltd.



THE new Mullard "Permacore" Transformer is absolutely revolutionary in design and construction. No transformer so compact and at the same time so efficient has ever been produced. It is a master product giving better results than the best of the big ones. The reasons are these:

- (1) The iron in the Mullard "Permacore" is a specially treated and scientifically prepared material, carefully handled in manufacture to preserve its high permeability.
- (2) This high permeability allows a high flux density to be used without any possibility of saturation in an iron circuit of exceedingly small dimensions.

(3) The windings of the Mullard Transformer have been so selected that no resonant peak occurs at about 8,000—10,000 cycles as is usually the case. This eliminates all shrillness.

(4) The primary is wound with silver, the secondary with nickel. Silver for the primary has the advantage of good conductivity and no deterioration. Nickel for the secondary has the advantage of high resistance and magnetic properties.

(5) The amplification of the Mullard Transformer is high and uniform at all frequencies from 250 cycles upwards, below this limit, even at 50 cycles, giving a large percentage of its full amplification.

As pure in reproduction as the silver of its winding

Mullard

MASTER · RADIO

No shrillness. Resonant peaks eliminated.

WHAT READERS THINK
—continued from page 432

for rendering any proper details of the picture becomes simply staggering.

It would appear that even if a really practical Home Television Set is ever produced at all, the public will have to wait many years for its advent, and it is significant that, in spite of all manner of reports and half-promises from various people engaged on this subject, no one has shown any real signs of preparing even to design, much less to manufacture and market, a really practical Home Television Set.

Because crude images have been

published in the March issue of MODERN WIRELESS, I am inclined to think he has rather overestimated the number of valves necessary to receive 5 G B and 5 X X in London.

I am situated about five minutes' walk from the London transmitting aerial, with a three-valve set, and by employing a wave-trap I can cut out London and get 5 G B and 5 X X when broadcasting a different programme at full speaker strength.

Yours faithfully,
London, W.1. A. G. Bence.

“Television,” “Photoradio,”
and “Facsimile.”

DEAR SIR,—In a paragraph which recently appeared in a number of newspapers dealing with an advertisement—concerning the Province

are actually happening at the moment. This has not yet been put into practice commercially.

Photoradio or Facsimile transmission is, on the other hand, the transmission by electrical means of still pictures and of documents and diagrams of various kinds which are received in the exact form in which they are transmitted. This system has been in commercial use between the Radio Corporation of America's station in New York and the Marconi Company's station in London since May, 1926.

As references to these different processes are likely to be frequent in the near future you might find it useful to draw the attention of your sub-editors to this fundamental distinction between these methods.

Yours faithfully,
Marconi's Wireless Telegraph Co., Ltd.
W. G. RICHARDS,
Chief of Publicity Dept.

Marconi House, Strand.

NOTE.—The confusion referred to above chiefly concerns the daily Press. We have not noticed errors of this nature in “M.W.” or in our contemporaries.—Editor.

IS YOUR AERIAL HIGH ENOUGH?

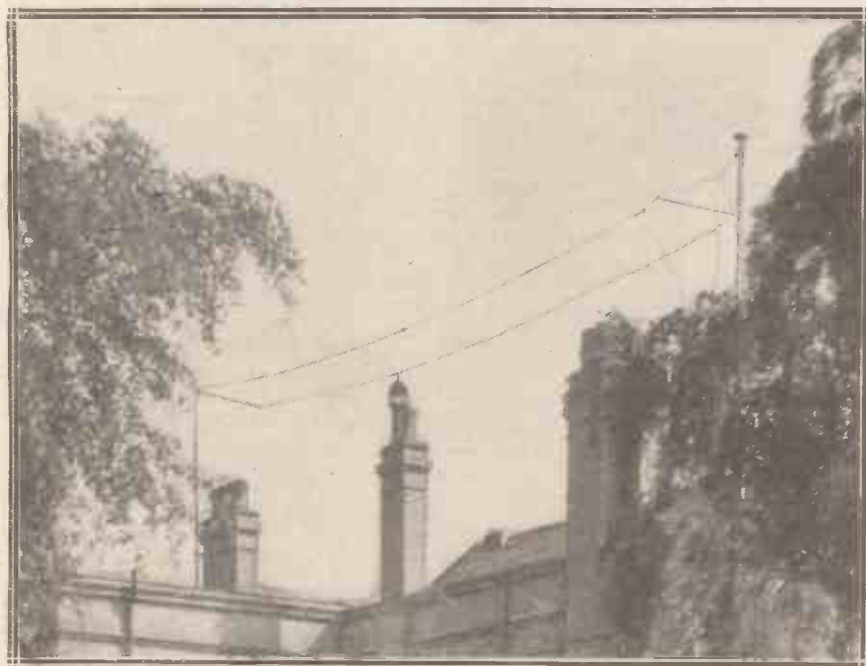

Unless an aerial is high it is liable to be screened by the surrounding buildings, trees, etc., which absorb a large proportion of the energy that would otherwise reach the wires.

Is Distortion Inevitable?

SIR,—I venture to suggest that much of the argument advanced in Mr. Scroggie's article, “Is Distortion Inevitable?” is based on fallacy. Firstly, the acoustic properties of a hall or studio are the inevitable accompaniments of any musical performance, and although the effect may be noticeable to the highly expert or sensitive ear, they do not normally require to be taken into account. Secondly, the acoustic imperfections of an ordinary room are no more a legitimate excuse for emitting “dud” music from a loud speaker than are those of the Albert Hall for employing a bad symphony orchestra therein. Thirdly, acoustic imperfections which we cannot help are no excuse for putting up with electrical forms of distortion which by taking a little extra trouble we may overcome or, at least, minimise. Fourthly, many of these distortions may occur in different links of the broadcast chain, in which case they are cumulative—a 20 per cent fall-off in response becomes a 36 per cent fall in a further stage. Your contributor writes glibly as if 30-50 per cent fall passes almost unnoticed by the human ear. In most discussions on this subject 10 per cent is taken as a reasonable limit, rising in the case of weak

(Continued on page 472)

more or less televised—how crude the public does not realise—it is believed that development in television will be as rapid as in broadcasting.

As far as the known television systems are concerned, there is no doubt that this belief is an impossible one.

Yours faithfully,
J. J. WALHAM-SCOTT.
London, W.

Is 5 G B Worth While?

SIR,—With reference to your article, “Is 5 G B Worth While?” and in answer to my friend at Clapham,

of Buenos Aires Loan—transmitted by wireless from New York to London, the process by which this advertisement was transmitted was described as Television, and the heading put up “Advertisements by Television.” This is not correct.

Seeing that Television is now frequently mentioned in the newspapers we think it might not be out of place if we draw your attention to the fact that there is a distinct difference between Television and Photoradio or Facsimile transmission. Television is essentially the reproduction at a distance of things that



Under this heading month by month our Broadcasting Correspondent will record the news of the progress of the British Broadcasting Corporation, and will comment on the policies in force at B.B.C. headquarters.

Demand for Naturalness

THE instantaneous success of Charlot in his broadcast debut, and the enthusiasm with which the announcement of his second series of twelve special shows has been received, signify a good deal more than the ability of Charlot and his colleagues. For a long time past there has been growing irritation with the tendency to stereotyped methods which has been evinced by B.B.C. programmes.

The ban on personal publicity, all very well up to a point, was taken to such an extreme that the microphone manner became consistently mechanical. In their very correctitude, the announcers were exasperating. Similarly with programmes, organisation seemed the great objective. As long as things ran along smoothly, little attention was paid to artistic variety or surprise effect. Then into what was becoming a self-centred world of robot methods came the exquisite Charlot.

The very naturalness and directness of his approach guaranteed success from the first. I am glad to observe that the lesson is not being lost at Savoy Hill. They may be a strange lot there, but one cannot convict them of not recognising when they are wrong in programme effects anyway. On talks and education, of course, argument is hopeless. But that is another world!

The comforting thought of the moment is that the advent of Charlot to the microphone has started a real renaissance of entertainment methods at Savoy Hill. Needless to say, "Peter" Eckersley is the heart and soul of the new movement, and his control of programmes will be much more exacting in future than in the past.

Progressive Indiscretions

I gather there is a standing sweepstake at Savoy Hill on the time and character of the next indiscretion that will be perpetrated by a member of the Board of Governors. Fortunately the initial anxiety and bitterness caused by these statements have now been replaced by an amused indifference. Nevertheless, the enemies of wireless still manage to turn them to account outside the business.

Music-Hall War

Unprecedented bitterness has been caused by the rumpus between the B.B.C. and Sir Oswald Stoll over the Command Variety Performance. There has been a general mobilisation of the reserves on both sides. It

is understood that the offensive has been taken by the music-hall people, aided and abetted by theatre interests. There is to be a general tightening of the ban against broadcasting by artistes.

This is to apply to charities as well as to ordinary engagements. A kind of mobile general staff is reported to have been set up to harass the flanks and rear of the B.B.C. In addition to attempting to dry up the sources of broadcasting talent, there will be a persistent endeavour to worry the P.M.G. and the Government by difficult sniping in the House of Commons.

I gather that Savoy Hill is not greatly perturbed by all this warlike activity. It is foredoomed to com-

CHARLOT'S HOUR AT 2LO



M. Andre Charlot and his company before the microphone at Savoy Hill.

plete failure, and the result will be that the theatres and music-halls involved will be a good deal worse off than before. For one thing, they will have effectually prevented the possibility of any concordat with broadcasting—a state of affairs which keen competitors cannot be expected to ignore.

Broadcast Dance Plans

So Sydney Firman and the London Radio Dance Band have given way to Jack Payne and the B.B.C. Dance Orchestra. Many listeners will regret the passing of the first British radio dance band. It marked an

interesting and valuable epoch in the development of the new art. But the present change does not mean that the microphone will not have Sydney Firman again.

It is an accepted axiom in dance music arrangements that periodical change is necessary for the best results. Sydney Firman and his band have had about two years of steady microphone work, and are looking forward to a change. The B.B.C. is right to bring in new human material in this part of the business. Jack Payne will carry forward and develop the tradition so firmly laid by his predecessor.

It is hoped, however, that he will be given greater freedom and more money with which to experiment with studio effects of various dance-band combinations. The B.B.C. should be working forward steadily to the creation of a permanent dance orchestra, as good as, if not better than, any other in the world. There is no reason why the considered policy of the development of the military band and the symphony orchestra should not be applied to the dance orchestra.

A NEW STUDIO AT BELFAST



Work is proceeding apace in the building of new studios at the Belfast station. Above can be seen one of the smaller studios in the course of construction. This is to be used for talks and chamber music. Note the echo-proof lining which is being fixed behind the panelling.

A Listeners' Jury

I hear that the Radio Society of Great Britain has put up a scheme to the Wireless Organisations Advisory Committee. This scheme is aimed at providing a closer "sieve" for the new musical compositions which are broadcast from time to time.

It is alleged by many that there is a clique of ultra-modern musicians at Savoy Hill, who put across too much Stravinsky, and other music of that order. Here is the plan to stop it. The B.B.C. would undertake to arrange trial public performances of all proposed new works.

At these trial public performances a cross-section of the listening public would be present, and would vote on the desirability of each piece submitted. While there is little chance of such a plan being accepted, I imagine the B.B.C. will give it a limited trial in a studio. The moral of the affair is the unhappiness of the ordinary listener with new music.

The problem is too vexed to be solved by rule of thumb. It will never be solved. It is the duty of the B.B.C. to try out modern music, and to adventure in every new field of the range of its art. All new art is unpopular at first. If someone did not run the gauntlet, there would be no artistic progress. On the other hand, however, new compositions should not bulk disproportionately in the programmes.

The Wireless Organisations Advisory Committee

I understand that the Wireless Organisations Advisory Committee continues to do good work unobtrusively, and exercises some influence on B.B.C. policy. But there is a growing desire for more publicity which, if gratified, may not be attended by any increase in results.

By the way, there is likely to be some parliamentary inquiry into the qualifications of membership of this committee. Although purely advisory, it has still some official status, because it is understood to arise directly out of the recommendations of the Crawford Committee.

When formed, the committee represented the Wireless League, the Radio Association, the Wireless Association of Great Britain, and the Radio Society of Great Britain. Captain Ian Fraser, as chairman, has carried out his duties with characteristic tact and thoroughness.

But the Wireless Association of Great Britain and the Wireless League have amalgamated, and still retains separate representation on this B.B.C. committee. Then the Radio Association has practically ceased to exist so far as membership and activity are concerned. It is only natural therefore that elements of the Radio Society of Great Britain are becoming restive at the present anomalies in the composition of the committee.

Some reorganisation would seem inevitable. That energetic young man from Ilford, Mr. David Richards, who figured so prominently in the deliberations of the Crawford Committee, and who is engaged in reorganising the Wireless League, will probably be heard from in connection with a new Listeners' Advisory Committee.

Then there is Mr. J. C. Kemp, the founder of the new liaison organisation in Manchester. He will certainly be in line for representation. Mr. Richards and Mr. Kemp are the recognised "thrusters" in the world of wireless organisations.

The Broadcast News Service

Many listeners were glad to hear Mrs. Snowden's statement that she was agitating in the B.B.C. Board for an early institution of an independent news service for broadcasting. Whoever is to blame, there is no doubt whatever that the news bulletins have been deteriorating since the beginning of this year.

The agencies disclaim responsibility. They say that the sub-editing at Savoy Hill knocks out what life there is in the news at the start. Savoy Hill answers with the suggestion that some important news is being withheld in the interests of newspapers. I do not know who "sub" the news at the B.B.C., but I doubt very much if the officials concerned are experienced newspaper men.

ALL THE LATEST
 NEWS in connection with Radio matters is contained in
POPULAR WIRELESS
Every Thursday Price 3d.

THE STRONGEST, CHEAPEST AND MOST EFFICIENT ALL-STEEL WIRELESS MAST

EVER OFFERED—CAN'T BE BEATEN ANYBODY CAN PUT IT UP

15/- AND WORTH DOUBLE

These Masts are made of British Tubular Steel, are supplied with every conceivable accessory, and fullest directions for erecting. No further outlay is necessary, and the Mast can be easily erected in half an hour with just the assistance of another.

26 FT. HIGH The 26 ft. Mast is in 3 sections of 1 1/2 in. Steel tube tapering to 1 in.

ONLY 15/- Carriage costs approximately London and Suburbs, 1/6; Midlands, 2/6; other districts 3/6. Net weight, 24 lb., approximately. Two Masts for 28/6.

34 FT. HIGH The 34 ft. Mast is in 4 sections of 1 1/2 in. Steel tube tapering to 1 in.

ONLY 21/6 Carriage costs 2/- London and Suburbs, 3/- Midlands 4/- elsewhere. Net weight 34 lb. Two Masts for 40/-

THE "SUPER" MAST

42 FT. HIGH The 42 ft. Mast is in 5 sections of heavy 1 1/2 in. Steel tube tapering to 1 in. A real bargain.

ONLY 29/6 Carriage costs 2/6 approximately for London and Suburbs, 3/6 Midlands, 4/6 elsewhere. Net weight 46 lb. Two Masts for 55/-.

Specification:—All Masts are supplied with Massive Iron Bed Plate, Drilled Steel Ground Pegs, Stay Rings, Galvanized Standard Steel Flexible Wires for Stays, Pulleys, Bolts, etc., and everything down to the last item for erecting. Will stand any gale.

- (1) A High Aerial makes your set louder, and helps you to get away from your neighbours' oscillation.
- (2) A wonderful reception from a Crystal Set can be obtained with a tall Mast.
- (3) A 42 ft. Mast is as good as a valve.
- (4) Takes half an hour to erect.
- (5) A Steel Mast is a direct Earth and saves your set from any electrical disturbances, such as lightning.
- (6) The Mast can be extended by purchasing another section, fullest particulars by request.

THE EASIEST MAST TO ERECT.

**ROT-PROOF
DAMP-PROOF
FOOL-PROOF**

The Mast sent anywhere C.O.D. or in London and Suburbs wherever Messrs. Pickford's or Carter Paterson have an agency. Fullest guarantee with every Mast as to complete satisfaction, or money instantly returned without question. **ORDER TO-DAY OR CALL.**

COME & SEE ONE P. R. MASTS

Dept. 34 (Opposite Post Office Tube)
17 PATERNOSTER SQUARE,
NEWGATE STREET, LONDON, E.C.4

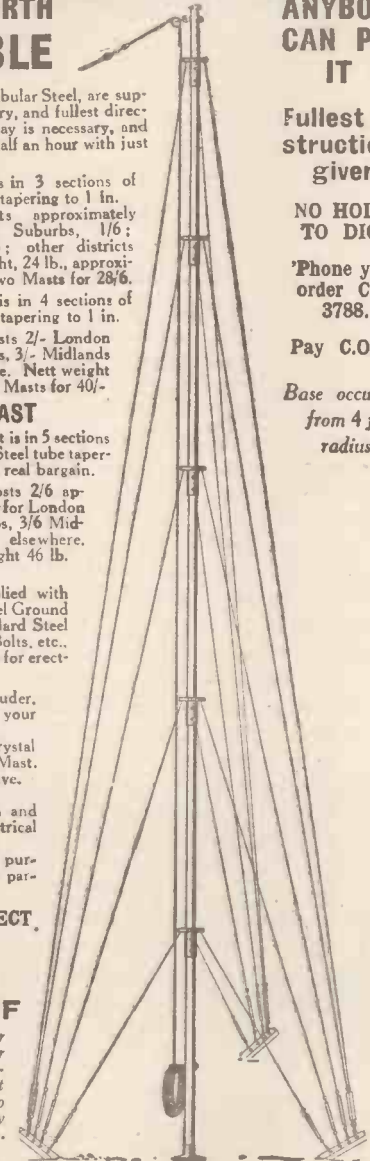

Fullest Instructions given.

NO HOLES TO DIG.

Phone your order City 3788.

Pay C.O.D.

Base occupies from 4 ft. radius.

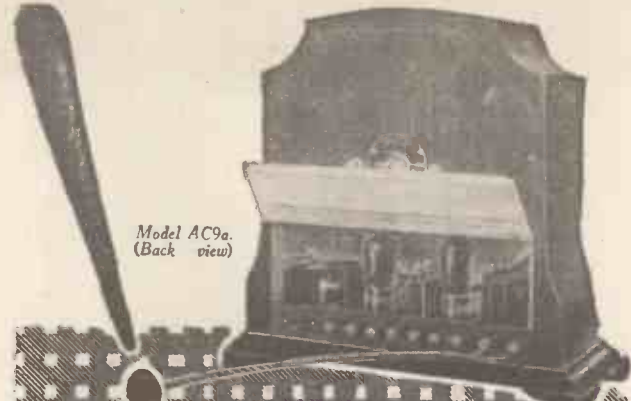

Model AC9a.
(Back view)

Buy or Build The AMPLION CONE AMPLIFIER

A master combination of the world-famous Amplion Loud Speaker with a soundly-designed two-valve amplifier. Prices are as follows: Amplion Cone Speakers with hinged backs ready for home-built amplifiers: Model A.C.7 H.C. (Jacobean Oak), £6:10:0; Model A.C.9 H.C. (Chippendale Mahogany), £7:0:0; or complete with Amplifier, Model A.C.7a, £10:0:0. Model A.C.9a, £10:10:0

Fully illustrated leaflet W.L.26/8, describing both the complete Cone Amplifier and the method of home construction, mailed free on request.

GRAHAM AMPLION LIMITED,
Head Office and Showrooms:
25, Savile Row, London, W.1.

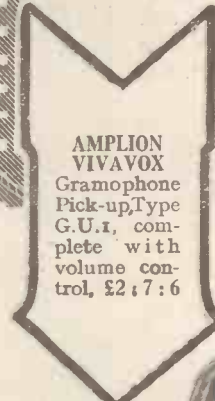

Gramophone Music at its Best





THE UNIVERSAL FAVOURITE SHROUDED TRANSFORMER

10/6 Ratios 1-3 and 1-5
also 1-1, 1-2, 1-4

Send for Complete Catalogue.

THE FORMO COMPANY,
CROWN WORKS, CRICKLEWOOD,
N.W.2. Phone: Hamp. 1787.

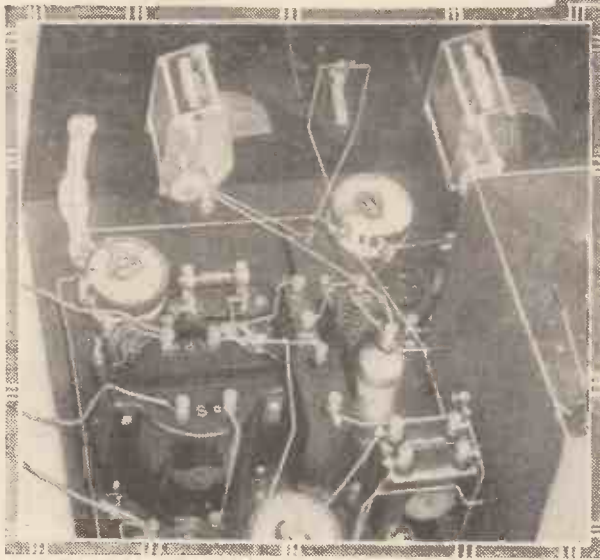

AUTOMATIC VOLUME CONTROL

A novel arrangement by which uniform signal strength from a receiving set can be obtained regardless of input fluctuations.

From a Special Correspondent.

THE loudness of the reproduction which you obtain from the loud speaker bears a relation to the strength of the incoming signals as received at the aerial. If the signal strength suddenly increases for any reason, the adjustments of the set remaining the same, the loudness from the loud speaker will be correspondingly increased, whilst if the signal strength falls off, the loudness will fall off in a corresponding way.

be made whereby the amplification of the set was increased whenever the received signal strength went down and was conversely diminished when the received signal strength increased. The desideratum would, of course, be to arrange that the amplification was automatically increased or decreased to correspond with fluctuations in the incoming signal strength in such a way as

automatically to keep the loudness of the reproduction from the loud speaker at a sensibly constant value.

There are various devices which could be employed to regulate automatically the amplification of the signal, some of these devices employing moving mechanical parts.

Not Difficult

It is, however, possible by comparatively simple electrical arrangements, without any moving parts, to ensure that the amplification is automatically regulated by the signal

Question of Fading

Usually the signal strength from any broadcast station (at any rate, situated in this country) remains fairly constant, but when distant stations are being received the signal strength may fluctuate quite considerably, owing to "fading" and other effects which influence the radiated energy on its way from the transmitting station to the receiving aerial. Again, if you are tuning in different stations, obviously you will get different strengths of signals from the various sources.

In order to provide a fairly uniform standard of loudness in the reproduction from the loud speaker, it therefore becomes necessary to adjust the overall amplification of the set for each station tuned in, whilst in the case of variations in the signal strength due to fading, particularly if these variations are at all rapid, it is generally impracticable to keep adjusting the amplification of the set.

Automatic Control

The result is that the reproduction rises and falls in loudness in accordance with the variations in the received signal strength.

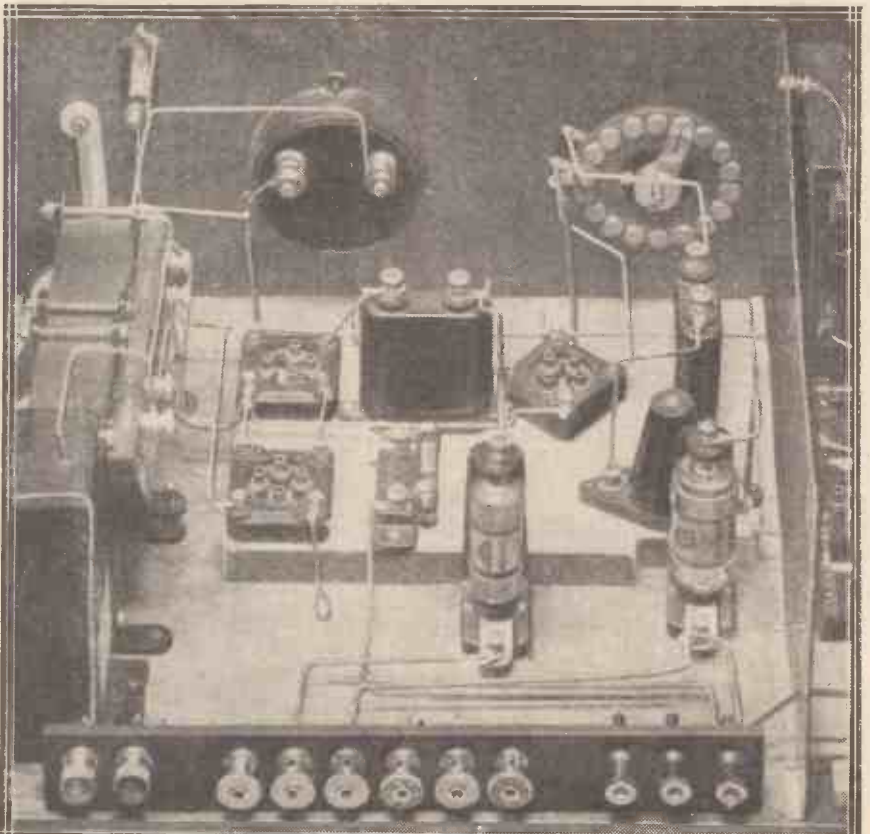

The usual type of L.F. volume control, seen above on the right of the panel, consists of a high-resistance potentiometer. The system described in this article would obviate the need for variations of the potentiometer when broadcasting was being received.

and the loud-speaker intensity reaches approximately the desired level for each signal, independent of the signal intensity, and therefore independent, or practically independent, of "fading."

Any device to accomplish this object without introducing distortion of speech or music must operate by the signal carrier-wave. Variations

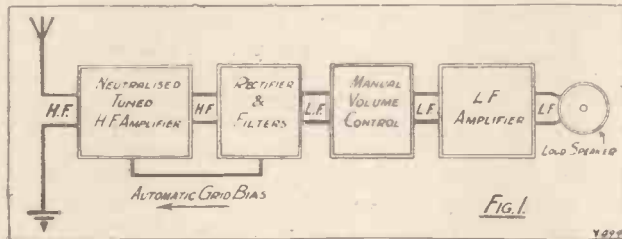

in the strength of the carrier must be compensated for by reciprocal variations in the amplification.

In a method which was recently described to the Institute of Radio Engineers by Mr. H. A. Wheeler, of the Hazeltine Corporation, means are provided for controlling the high-frequency amplifier, thereby maintaining the desired signal level in the detector, low-frequency amplifier and loud speaker.

General Arrangement

Fig. 1 shows the general arrangement of the set, which has been constructed for broadcast reception, embodying this automatic volume control. The arrangement comprises the following component sections:

1. A four-stage H.F. amplifier of the neutrodyne type, the aerial circuit tuned by one dial and the four coupling transformers tuned simultaneously by a second dial, the total amplification being controlled by varying the negative grid potential of the first three valves.

2. A two-electrode rectifier with simple filter circuits to reject the high-frequency currents and to separate the direct and low-frequency components of the pulsating rectified voltage.

3. A manual volume control in the form of a "voltage reducer" connected to the grid of the first low-frequency amplifying valve and

4. A four-stage low-frequency amplifier to the loud speaker.

With the exception of the last two low-frequency stages, the whole set was enclosed in an earthed screened

metal box divided into compartments, one for each valve with the preceding coupling circuit.

In Fig. 2 are shown the essential circuit details. The direct component of the rectified voltage (free of low-frequency variations) is applied to the grids of the first three valves. If the high-frequency rectifier voltage could exceed a value of about 10 volts, this automatic grid bias would thereby cut off the signal through the H.F. amplifier so the rectifier voltage cannot exceed this value.

In Fig. 3 will be seen the effect of introducing this automatic control on the H.F. amplifier. The three curves marked 1, 2, and 3 indicate the effects of applying the automatic grid bias to one, two, and three of the high-frequency valves respectively. The last high-frequency stage is not controlled because it must supply as high as 10 volts to the rectifier.

For the proper working of this control arrangement it is much better to have a 2-electrode rectifying valve

rather than one of the ordinary 3-electrode kind, and in Fig. 4 you will see that the relation between the alternating and rectified voltages with the 2-electrode rectifier is practically linear, whilst with the 3-electrode valve it departs considerably from the straight-line relation.

Two-Electrode Best

The result is that with the 2-electrode valve as rectifier the signal modulation is rectified without distortion, and the average rectified voltage is equal to the rectified carrier voltage; with a "voltage-squared" detector the average rectified voltage is proportional to the average total power of carrier and side-bands. This last feature is worthy of mention in connection with the control system, since the automatic grid bias should depend only on the carrier amplitude, independent of the modulation.

A curious and interesting situation arises when endeavouring to tune-in a receiving set equipped with this automatic control, depending simply upon the loudness as heard from the loud speaker. The amplification of the control valves is decreased as the response to a signal

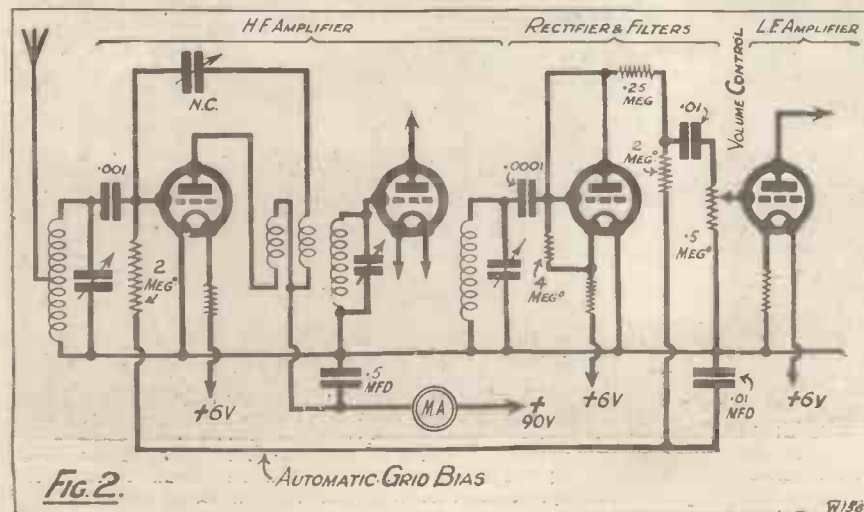
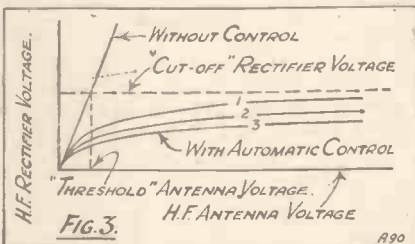

is increased (by tuning) and vice versa.

Consequently the resonance point cannot conveniently be discovered in the ordinary way whilst tuning, and has to be noted from a milliammeter (m.a. in Fig. 2) connected in the plate circuit of the first valve, the point of resonance being shown by a minimum value of the plate current in the high-frequency amplifier.

A Special Problem

There is also a rather special problem which arises in supplying the plate current to all the valves of the set from a common rectifier and filter system. In the controlled H.F. amplifier valves, when operating at low plate current, the signal carrier is modulated appreciably by small fluctuations in the plate voltage.

Such fluctuations are caused by the plate-current pulsations in the low-frequency amplifier. In the presence of a strong carrier-wave these two

effects may co-operate to generate low-frequency oscillation. This disturbance may, however, be avoided by reducing the internal output impedance of the rectifier-filter, by decreasing the amplification at low frequencies in the low-frequency

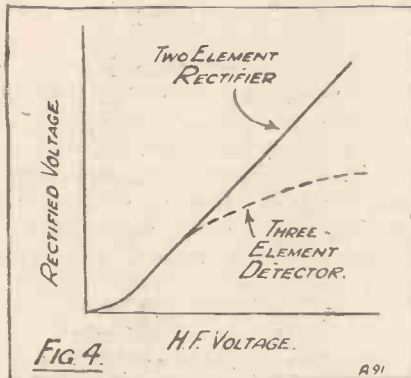

amplifier, or by using separate rectifier filter systems to supply the plate-current of the high-frequency and low-frequency amplifiers respectively.

Uniform Loudness

The question now arises as to what degree of uniformity in the loud-speaker output volume is obtained by the use of this automatic control. This has been determined by careful measurements and it has been found that, taking a maximum variation in the signal voltage in the ratio of 1 in 1,000, corresponding to differences in distance, fading or tuning, the rectified carrier voltage only varies, as a result, in the ratio of about 1 to 3.

This small variation, together with possible differences in the degree of modulation of different stations, can readily be compensated, if necessary, by adjusting the manual volume control of the low-frequency amplifier, which also, of course, determines the "volume level" for the automatic volume control.

Although very convenient, it is hardly likely that any system of automatic volume control will make a distant station behave just like a local one.

Two Limitations

There are two main limitations to the advantages to be gained from automatic control of the kind described. In the first place, as the amplification rises or falls in order to compensate for a fading or varying signal there is a corresponding rise and fall of static and inherent "set" noises which may be very disturbing to the purity of the reproduction.

In the second place, it is well known that speech quality is generally poor during the minimum of a fading

period, and it is found that the automatic control does little to remedy this drawback.

I should mention that the experiments of Mr. Wheeler were carried out in the United States, where questions of fading, static and so on, assume much greater importance than they do in this country (at any rate, for local or comparatively short-distance reception here).

There is scope for much experimental work in the direction of automatic control of volume in this way, and there is no reason to suppose that the drawbacks of the method indicated above may not be capable of being simply overcome.

LOUD-SPEAKER "NOTES"

A loud speaker which has become insensitive through being connected the wrong way round can easily be remagnetised by the makers or by a firm specialising in this type of work.

In any room the position in which the loud speaker stands has an important effect upon reproduction.

The standing of the loud speaker upon the set, or too close to it, is often the cause of discordant, jarring notes in reception.

Do not forget that loss of power in loud-speaker reproduction is sometimes caused by a wad of dust, fluff, or other similar object, entering the horn and partially closing the aperture, or pressing against the diaphragm.

Series or Parallel?

When long and twisted flex leads are used for loud-speaker connecting wires they have the same effect as a capacity shunted across the loud speaker, and reproduction may be affected.

Two loud speakers working in unison will often give a better result than will either loud speaker separately, especially if one is of the horn type and one of the cone type.

When working two loud speakers from one set it is generally better to connect them in series than in parallel.

One of the great advantages of the filter output system is that there is no high voltage between the leads of the loud speaker and earth.

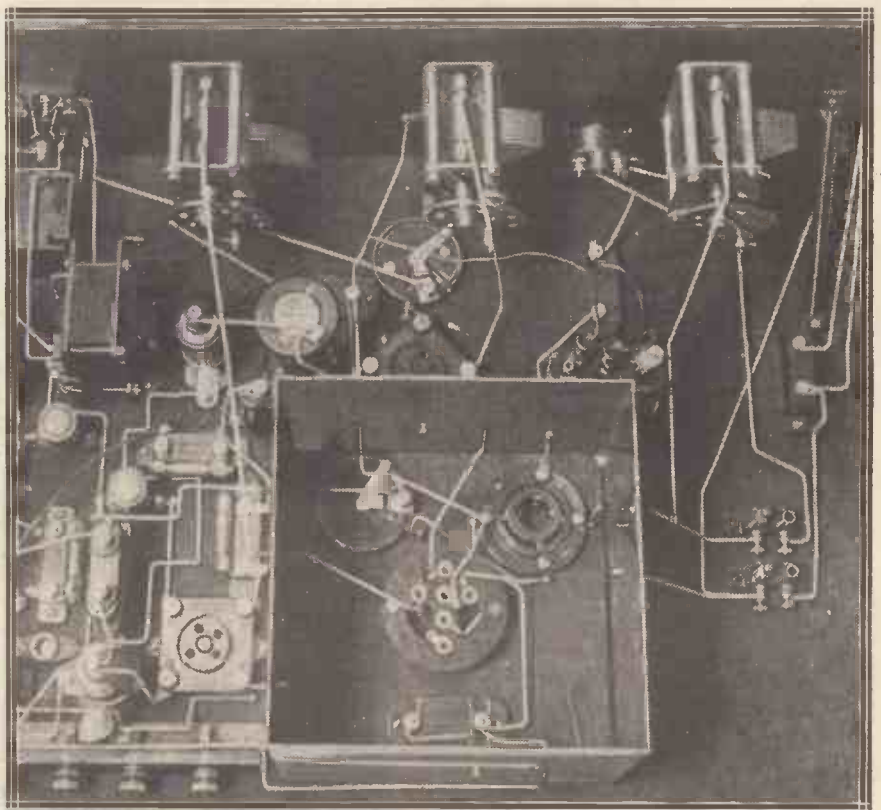

The automatic volume-control system is especially applicable to multi-valve sets having one or more H.F. stages, fading and similar causes of volume fluctuation being compensated for by the action of the signals themselves.

The Solodyne Three



L.F. Transformer, Type "G."
Gives the most even amplification under ordinary working conditions. Two ratios, 3.6:1 and 7.2:1. Price 30/-.



Anti-Microphonic Valve Holder.
For perfect valve suspension. Price 2/-.



Fixed Grid Leak.
For easy mounting and constant service. Price 2/3.

THE Solodyne Three gives really remarkable results for three valves. You could not do better than build it. A great deal of its efficiency is due to the use of these Igranic components in some of the principal positions—as is the case with most outstanding sets. Igranic components are also available for every other position and the efficiency of the set will actually be still further improved by their use.

Write for the complete illustrated catalogue, **List No. J515**, it gives full particulars.



149, Queen Victoria St., LONDON, E.C.4.

Works: BEDFORD

Branches: Manchester, Birmingham, Newcastle, Glasgow, Bristol, Cardiff, Leeds.



H.F. Choke.
The best value in H.F. Chokes on the market. Price 5/-.



Radio Switch.
The most efficient battery switch. Price 2/6.



Fixed Condensers.
The lowest-priced high-grade Condensers.
Capacities: .001-.002, Price 1/3
 .003-.005, " 1/6
 .006 " 2/-
 .01 " 2/6

An Accurate and Reliable Wavemeter



Gambrell Type "D" Wavemeter meets the needs of those requiring an instrument low in price and of a high degree of accuracy. The instrument is totally enclosed in its cabinet—a Battery is incorporated within same, and a switch enables the buzzer to be put in and out of operation without disconnecting the battery leads. The buzzer is the new Gambrell Buzzer—a great improvement over any other on the market.

PRICES:
"WAVEMETER TYPE D" (as illustrated):
Complete with two coils and two Charts, For 50 to 500 metres and 44-volt Battery £5 : 0 : 0
With Coils and Charts for 20 to 500 metres £5 : 13 : 6
Can be calibrated up to 7,000 metres, if required.

GAMBRELL CENTRE-TAPPED COILS
Because of their efficiency and the greatly improved results which their design ensures, they are used and recommended by experts for circuits designed for selectivity, and from which the utmost results are to be obtained. Their use is not limited to centre-tapped circuits. Standard socket fitting. In any circuit requiring plug-in coils, "Gambrells" will ensure the finest possible results.

Size	Price	Approx. No. of Turns.	Size	Price	Approx. No. of Turns.
a2	4/10	80	D	6/3	100
a	4/10	25	E1	6/9	150
A	5/-	30	E	7/9	200
B1	5/3	40	F	8/6	300
B	5/6	50	G	10/-	500
C	5/9	75			

Centre-Tapped '6d. extra.

GAMBRELL BROS., LTD., 76, Victoria Street, London, S.W.1

"PAREX" PRODUCTS PAR EXCELLENCE

1928 SOLODYNE

Triple Gang Condenser. A solid and beautiful job with ball bearing movement. Complete with thick Copper Screens, highly polished, and baseboard screen **57/6**

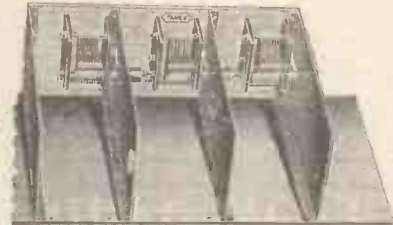

SOLODYNE COILS, made of finest Litz wire { S.W., per set - 45/-
 { L.W., " " - 45/-
STANDARD WAVE TRAP, a real trap made of Litz wire - 15/-

"PAREX" VALVE HOLDERS

SOLODYNE JUNIOR

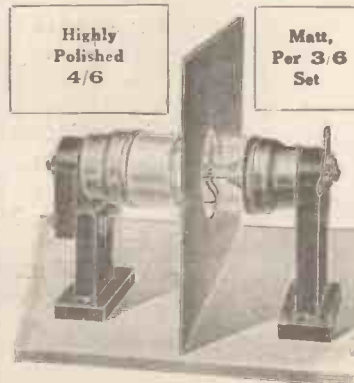

Highly Polished Copper Screens
Type B: 2/6. Type A: 3/6
Type C: 4/6.

SIX-PIN BASES - - 2/-
SIX-PIN COILS, S.W. 5/6
" " " L.W. 6/6

Buy direct from the makers:
E. PAROUSSI,
10, Featherstone Buildings,
HIGH HOLBORN
LONDON, W.C.1.,
Phone: Chancery 7010.

THE M.W. "AVAC" UNIT
 —continued from page 358

At first sight it might appear that this is very easy to achieve, by simply building a voltmeter into the set and providing a simple plug and socket scheme to enable you to connect the meter across each negative of the various positive terminals. As a matter of fact, the solution of the problem is by no means so easy a business.

The Wrong Way

The average voltmeter draws a considerable current when readings are being taken, and if such an instrument is connected across the output terminals of a mains unit the current thus drawn will completely upset the voltage drop across the various regulating resistances in the circuit, and any results obtained will be entirely misleading. What happens is that you may connect the meter across, adjust the voltage to the desired figure, and then when the meter is taken off to measure the voltage on another terminal, that which has just been set rises to a much higher figure.

A satisfactory and cheap way out can be found in a scheme which I have been using for some considerable period for this work, and which I have been endeavouring to bring to the notice of all those who make use of mains eliminators.

Simple But Accurate

This device is a very simple one, and is based upon the use of a high resistance of known value, in series with which one connects a suitable instrument for measuring small currents, such as a fairly low-reading milliammeter. If the value of the high resistance is well chosen, a very simple little bit of arithmetic will enable you to find out what voltage must be applied across to send a given current through it. For example, suppose we choose a value of 100,000 ohms and connect in series with this a milliammeter reading from 0 to 1 milliamp.

Suppose we apply an unknown voltage across the circuit and measure the current and find it to be .5 of a milliamp.

Obviously, this means 50 volts, and thus whatever current the meter reads can be converted into volts simply by multiplying by 100.

I have chosen a value of 200,000

ohms and a milliammeter which reads from 0 to 1.5 milliamp. Thus the whole scale now reads 300 volts, and to obtain the voltage equivalent for any reading of the scale we simply multiply the figure by 200.

A small switch is provided to short-circuit the instrument itself, so that the needle may come back to zero.

This, it will be understood, is the small on-and-off switch on the front panel of the instrument immediately below the milliammeter. When this is closed the meter no longer reads, but current is still being drawn by the 200,000-ohm resistance, and so there is no change of voltage.

The power transformer may be chosen according to the output voltage required.

Next Month

There will be special articles in the May issue of "Modern Wireless" dealing with the subject of

PORTABLE SETS.

An inexpensive, novel and highly efficient "portable" will be fully described. This is in every sense of the word a "portable" set and, completely self-contained, it weighs only a few pounds. It does not necessitate a motor-car for transport purposes!

Then there will be a long, illustrated article by

PERCY W. HARRIS,
 M.I.R.E.

whose practical contribution will help to solve many readers' problems.

ORDER YOUR COPY NOW.

It is advised that a transformer giving at least the output of the one used in the original unit should be chosen.

Transformer and Chokes

The original transformer is a "Croix" (The Wholesale Wireless Co.), with a 3-0-3-volt 1.5-amp. low-tension secondary, and 200-0-200-volt 30-milliamp high-tension secondary.

The chokes in the unit are an R.I. and Varley double type and a Pye 110-henry single model. Other makes

may, of course, be used, but care should be taken to see that they conform to these requirements; the double one should have a total inductance of not less than 40 henries, and a d.c. resistance not exceeding about 500 ohms (less, if possible, of course).

The single choke need not be of quite so high an inductance (50 henries will serve), the one used having been chosen because it happened to be at hand. The d.c. resistance here is practically immaterial, since we never need very high voltages for the ordinary detector.

The smoothing condensers *must* be of the high working voltage type. The ones used in the original unit were of the 200 working volts type, which are, of course, tested at a much higher voltage still.

This is the absolute minimum, and it would be better still to use the 250 or 300 working volt type, as a further safeguard against possible breakdown in the future.

Suitable Rectifiers

As regards the rectifying valve to use, the one originally employed was a Marconi U.5 (also available in the Osram range). The Mullard D.U.2 is also suitable, and since this has a 4-volt filament the voltage of the L.T. winding on the transformer must be cut down suitably. To enable this to be done two rheostats are provided, one in each filament lead. These should each be set to the same approximate adjustment to avoid introducing a hum, and if you use a roughly calibrated type, such as the Igranic or McMichael, it is easy to include the correct number of ohms in each lead to produce the right voltage drop for the particular valve. For example, with a D.U.2 you will need roughly one ohm in each lead, so that a 5- or 6-ohm rheostat will serve.

Remember, however, that these rheostats have to carry fairly large currents (1.6 amp. for the U.5, 1.1 amp. for the D.U.2), and therefore choose a robust one. The two mentioned get fairly warm, but appear to stand up to the work quite satisfactorily.

Even with a U.5 valve it is as well to include a little resistance in each lead, since the transformer gives a nominal 6 volts when about 1.5 amp. are drawn, and the valve requires only 5 volts.

One final point: It is intended that the unit shall be connected to the mains by means of a twin flex lead from the input terminals bearing an adapter or two-pin plug upon its end.

The Fascinating Fixed Condenser

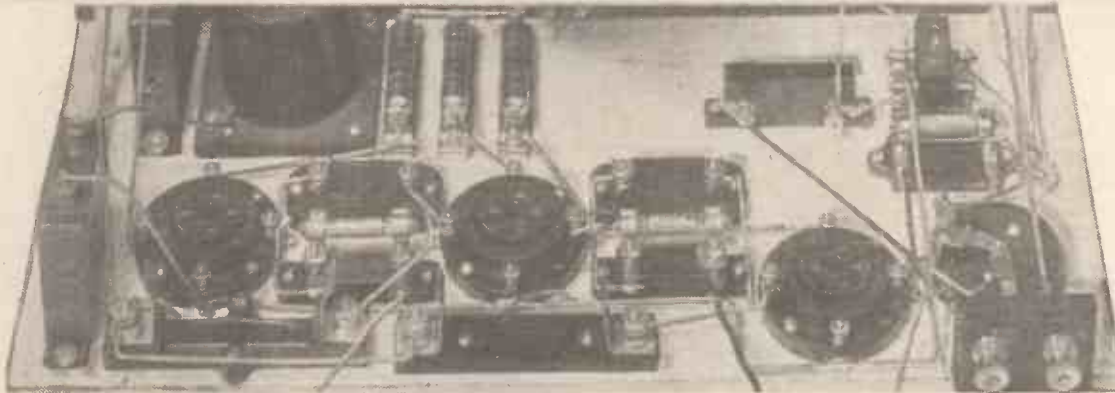

Some sidelights upon the electron activity inside radio's commonest component.

By P. R. BIRD.

THE condenser is the simplest of all wireless components, and yet curiously enough it has more variations of form and shape than any other piece of radio apparatus. Its appearance is familiar enough, but its action is decidedly strange. What is a condenser? What does it do, why is it necessary, and what happens inside it?

How Condensers "Condense"

The name "condenser" does not help us much, and yet there is a sense in which a condenser does condense electricity. How this happens can best be imagined if we take a tuning condenser and metaphorically "take it to pieces."

We find that it consists of two sets of plates (fixed and moving), the distance between which can be varied. All the moving plates are metallically connected together, and so are all the fixed plates; so that in effect we may consider such a condenser as being one large moving surface and one large fixed surface.

These surfaces are of approximately equal size; and if we take one of them, say the moving plate, and try to impart a charge of electricity to it, we shall find that it will only hold a certain amount. The larger the plate the more electricity it will hold, but the point to remember is that its "capacity" to hold electricity is strictly limited.

The Isolated Units

If we could examine such a charge of electricity upon the plate we should find it consists of a large

number of small charges distributed with exact evenness and impartiality over the whole of the surface. Each unit repels and is repelled by the neighbouring units. Being mutually antagonistic the tiny charges refuse to be crowded too much. When the plate is suspended free in space, we can imagine it thus crowded with an incredibly large number of small units of electricity, each of these keeping an equal distance from his neighbours.

If we want to increase the capacity of this plate and make it hold a greater

charge of electricity, obviously we must overcome this natural "stand-offishness" of the separate particles. How can we make the unsociable individuals crowd closer together, and thus leave more room for their fellows upon the plate? The method adopted is a tantalising one.

Controlling the Crowd

Another plate of similar size is placed in close proximity to the first one. Upon this plate is a charge of electricity similar in size but of opposite sign, say positive instead of negative.

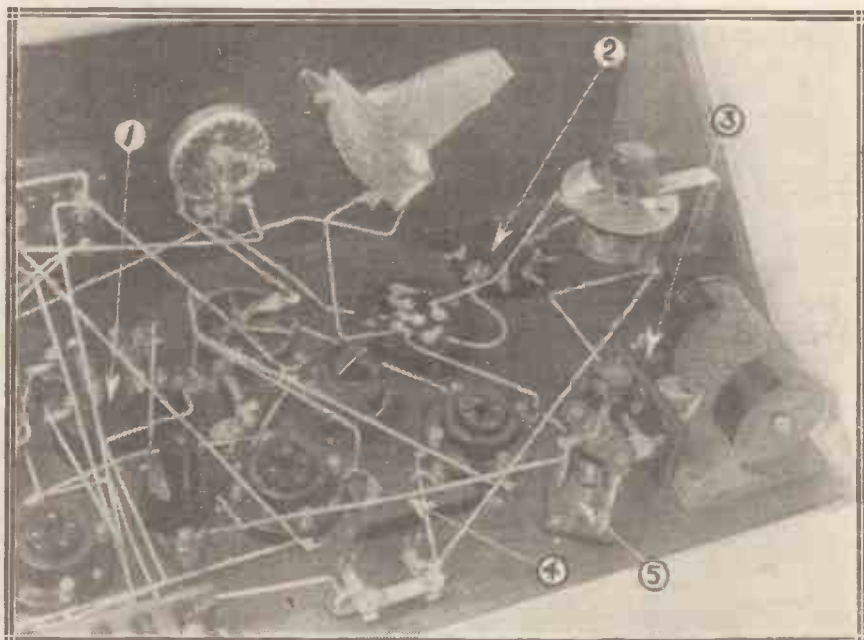

In the above typical four-valve set the fixed or semi-fixed variable condenser plays many parts. Inside the unit marked (1) it is used for R.C. coupling. At (2) and at (3) different types of semi-fixed condensers are handling high-frequency currents, and at (4) is the grid condenser. (5) shows a "neutralising" condenser used for a constant reaction feed.

The plates being of approximately the same size, they will hold approximately the same number of units. On one plate all the units will be negative and on the other plate all the units will be positive.

The "standoffishness" of the negative particles upon their plate is only equalled by the standoffishness of the positives upon their plates. But, if the two surfaces are now brought very close together (but not touching), the whole situation is profoundly modified. For each negative has an attraction for the positive that is only equalled by the attraction that the positive has for the negative. When the two plates are brought close together the whole crowd on one plate feels an enormous attraction for the whole crowd on the other plate!

Attraction Across Space

On the negative plate every single negative unit moves towards the positive units, and on the positive plate every single positive unit moves towards the negatives. On neither plate do the separate units like to encroach upon one another, but on both plates the crowds side-step towards the centre.

Before the plates were placed close together, each separate unit was concerned only with keeping its proper distance from its neighbours. The arrival in the immediate vicinity of a large crowd of the opposite sex, as it were, induces every single unit to change his camp and pitch his tent as

close as he can to the attraction opposite.

The community on the negative plate jumps as one man towards positive. The community on the positive plate jumps as one man (or, should we say, one lady!) towards the negative plate. And consequently behind the positives there is room for more positives, and behind the negatives there is room for more negatives.

Charge and Discharge

Large numbers of fresh negative units can now find a home upon the non-positive side of the negative plate (without upsetting their do-not-mix-too-freely principles) because the original inhabitants are being attracted towards the adjacent positives.

The convenience of the method will now be obvious. Without increasing the size of the plates we have a method which will enable them to hold more electricity. By this proximity-wangle we have persuaded the negative plates to hold more negatives, and the positive plates to hold more positives—in fact, we have increased the electrical capacity. In other words, the metallic area required to hold a given charge is "condensed," and the arrangement really is a condenser.

It will readily be appreciated that the space between the two sets of plates is just as important as the plates themselves. For it is here, in the intervening space, that the action takes place. The ability of the

condenser to condense largely depends upon what insulation is used between the plates, and in practice we find that common use is made of air, mica, and wax-paper.

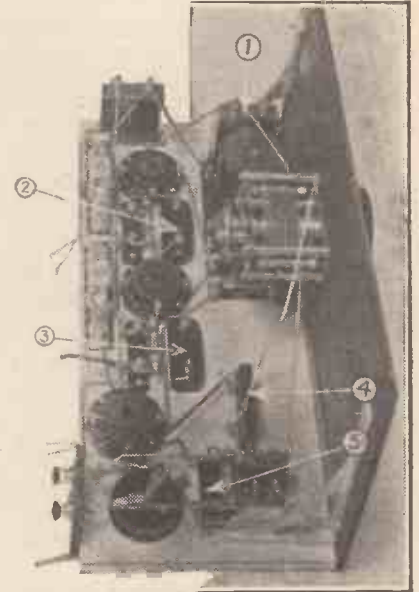

A paper-dielectric condenser is shown at (1), the other numbers showing various uses for mica condensers.

All of these are good insulators. For if they were not the positives would find a way across to the negatives, and the negatives would pass to the positives, and in one glorious rush they would mix and mingle together. The positive and the negative charges, as such, would entirely disappear, and the condenser would be "discharged."

The Classes of Current

Air condensers are extremely efficient electrically, but they are necessarily bulky. The paper condenser is much cheaper to make than the mica variety, so it is commonly employed for condensers of .1 mfd. or greater capacity. For the small condensers (of .00-something or .000-something mfd.) mica is used, and a very efficient component results.

It is interesting to note that at one time the capacities of fixed condensers used to vary very much from that marked upon them, but nowadays the manufacturers have managed to attain a very high degree of accuracy in this respect, so that a .0001 mfd. can be regarded as being really a .0001, or near enough. (A couple of years ago it was not uncommon to find a condenser with a capacity ten times greater or smaller than that marked upon it!)

The most fascinating fact about the fixed condenser is its ability to discriminate between the two classes

(Continued on page 464.)

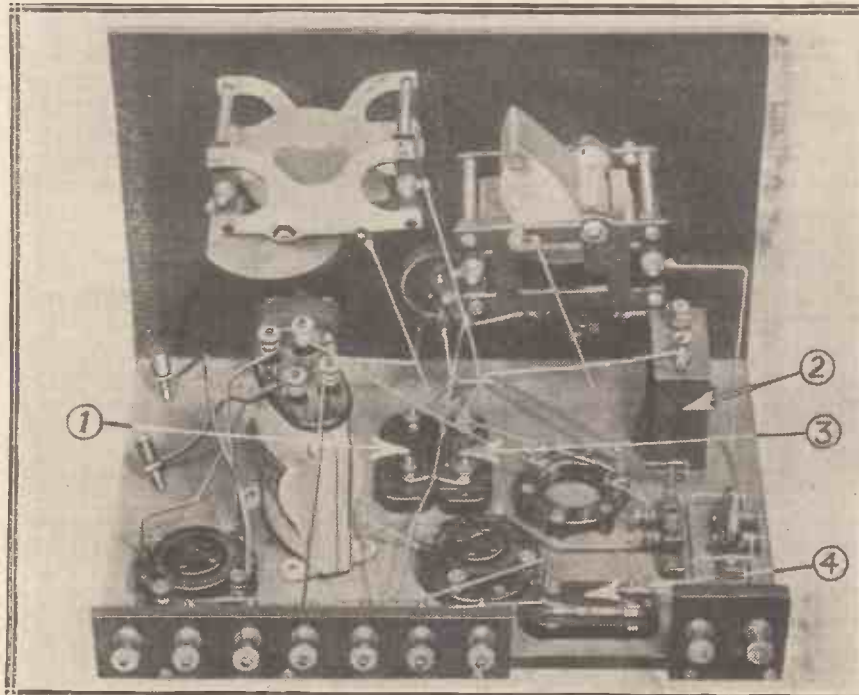

In this set the fixed condensers (1) and (3) are by-passing high-frequency currents; (2) is by-passing low-frequency (speech) currents, whilst (4) is the grid condenser.

SWITCH ON

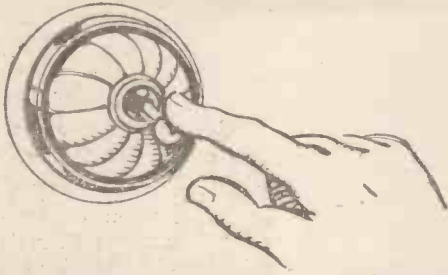

FOR POWER



FOR YOUR COSSOR "MELODY MAKER"

CONSTANT—ECONOMICAL—SAFE

CONSTANT. Power from the mains is even, steady and silent. Entirely dispenses with run down battery annoyance and H.T. crackle.

ECONOMICAL. Power from the mains costs less than a penny per day. No more recharging expenses.

SAFE. An H.T. Eliminator built the T.C.C. way is a unit of proved reliability. Using T.C.C. 600 volt Condensers, it is absolutely safe.

The T.C.C. book "How to build your own H.T. Eliminator" will convince you how simple it is for you to build this efficient unit. It is free—of course—and will be sent to you on receipt of penny stamp for postage. Write for it to-day and—

GET YOUR POWER FROM THE SWITCH

T.C.C. CONDENSERS



WRITE
FOR
THIS

FREE
BOOK
TODAY

Advt. Telegraph Condenser Co. Wales Farm Rd. N. Acton. London W.3. 2/90 

Components of Distinction & Quality



THE COIL for maximum MASTER THREE Efficiency



THE "POPULAR"
L.F. TRANSFORMER.

Suitable either for the
COSSOR MELODY
MAKER or the
MASTER THREE.

3-1 RATIO
297 £1:0:0

Master Three Constructors who have used this Bowyer-Lowe Coil are enthusiastic about the wonderful difference it makes. It enables them to obtain the greatest possible selectivity of this well-known circuit, and to ensure maximum volume of signal strength.

Ask your dealer to prove to you on his Master Three Demonstration Set the difference it makes.

- 304 Broadcast Coil - - - - 7/6
- 305 Long Wave Coil - - - - 8/6
- 306 COIL BASE - - - - 2/6

Write for the Bowyer-Lowe List of "Master Three" Components.

You can obtain Bowyer-Lowe Components through every good wireless dealer.

IMMEDIATE DELIVERIES



Quality Components

BOWYER-LOWE CO., LTD., Radio Works, SPRING ROAD
LETCHEWORTH, HERTS. 

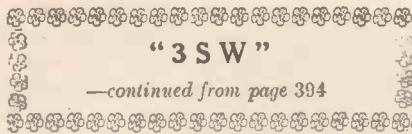

"3 S W"

 —continued from page 394

therefore, the dimensions referred to were taken from the edge of the panel, they would be incorrect if the base-board used were of different thickness from that which I have used.

These dimensions must be obtained with care, or else difficulty may be experienced in getting the extension spindles into position.

With regard to fixing the condensers and extension handles, the dimensions given in the panel layout for the bushes are taken from the top of the baseboard, and will be the same for the sub-panel. The distance of the spindle from the outer edge of the sub-panel is 3 in., since this is mounted so as to be $\frac{1}{2}$ in. from either side of the baseboard.

An Important Connection

It should be noted that the L.T. connection to the slider of the filament rheostat is made via the metal panel on which the rheostat is mounted and the strip of copper foil in contact with this panel (marked "X" in the wiring diagram), and no insulating bush should be fitted otherwise the detector valve will not light up.

Now turn the set round and, working from the back, place the terminal strip in position on the back edge of the baseboard and mount the bakelite strip which carries the coil mounts by means of the two ebonite pillars provided, so as to raise it from the baseboard. Place the anti-capacity valve holder which is used for the detector valve between the two variable condensers, and then place the components which comprise the L.F. amplifier into position.

The Wiring

The wiring diagram is drawn to scale so that this can be used for obtaining the necessary dimensions for placing the various components in position. I myself started the wiring by completing the connections of the detector portion of the receiver and then finishing off in order, first L.F., second L.F. between the two screens. It may be necessary to put in one or two wires to the jack at an early stage in the wiring.

It should be noted that both the metal panels are connected direct to L.T. negative by two copper strips, and this fact is made use of in

making certain connections in the receiver. The filament resistance R_1 I have used, for instance, has a metal frame, and by mounting it on the panel therefore the slider is automatically connected to L.T. negative. There is only need, therefore, for one further connection to be made to it. The by-pass condenser C_6 , it should be noted, is also connected to a common point to which a number of connections come from the panel. The spindles of the two tuning condensers which are connected to this metal panel are, therefore, also automatically connected to L.T. negative and no further connection is required.

The Aluminium Panels

In order to facilitate certain leads being connected to a common point, a small strip of copper foil has been fixed underneath the left-hand fixing screw which screws the back panel to the baseboard, looking at the set from the front, and another under the centre screw of the front panel, and this is an important point to remember since connections cannot successfully be soldered to an aluminium panel directly.

It will be noted that the holes in the second aluminium panel through which several leads have been brought are $\frac{3}{16}$ in. diameter. This allows the wire to be brought through the centre of the hole with ample clearance on all sides so that there is no risk of a short-circuit occurring. Nevertheless, it is important that some form of insulated wire be used.

Having completed the wiring it is advisable to test out the receiver to make sure that there is no short-circuit at any point either in the low-tension or high-tension circuits.

Particular care should be taken in carrying out these tests in view of the fact that both metal panels are connected to L.T. negative, and both L.T. and H.T. shorts should be carefully looked for.

Testing The Set

Having tested out the circuit and found everything O.K., the aerial coil should be placed at about 45 degrees from the grid coil, and with the filament of the detector valve turned well up the reaction condenser should gradually be increased from zero to see whether the set goes smoothly into oscillation. If it is found that the set goes in somewhat with a plop, it is probably due to too much positive bias being applied to the grid of the detector

valve, and the potentiometer slider should be turned towards the negative end of the winding.

Curing "Dead-Spots"

"Dead-spots" can be cured by loosening the coupling between the aerial coil L_1 and the grid coil L_2 , or a small fixed condenser may be placed in series with the aerial lead.

I do not think that any difficulty will be found when taking this receiver down to about 15 metres, but it may be found below this mark that a certain amount of difficulty may be experienced in getting the set to operate satisfactorily, and it may therefore be necessary to experiment with different valves and possibly different turns for the reaction coil.

As a guide to the constructor who uses the same condensers and coils as I have used, I have prepared a number of calibration charts showing the wave-length ranges covered by each coil. These will prove a valuable guide to the constructor when first searching for stations.

Some Stations Received

The first valve may be a high-mu valve of the special R.C. type, and valves which I myself have used and found extremely satisfactory are the Cosmos 50B and the P.M.5B. There are numerous other valves, of course, which are entirely suitable for use in this position.

For the first L.F. valve a high-mu R.C. valve is also required, and for the last valve a small power valve will be found entirely suitable in most cases.

In the course of a short test conducted one evening, I received a large number of stations both European, American, etc., on Morse, while a number of telephony transmissions were tuned in, among which were KDKA on 62.5 metres, WGY, 2XAF, 2XAD, and WLW.

The following stations are taken from a half-hour period in my log-book:

	Call.	Metres.	Call.	Metres.
PNS	..	30.5	NU 1BKE	36
2XS	..	30.6	NU 2HV	37
PCPP	..	30.8	EP 1BX	42
IAJV	.	35	NU 2JN	18.7
8BTR		35	NU 3QW	36
NU 2UD		37	NU 3AIB	36
Broadcast	.	42	NU 2AZD	36.5
1DI	..	35	EP 1BE	36.6
NU 1ZS		35	NU 4UZ	36.7
NU 3SZ		35	IR 1 —
NU 2CXL		36	ANQ 25



TAKE my word for it! This television is heaven's own bunk. It's *na poo* from the word "Go." I've had some and it's just a blight, I give you my Alfred David, as the late-lamented C. Dickens used to say.

You can tell that my nerves are all scuffed up by the way my usually limpid prose has degenerated. But I will now pull myself together and tell plainly my experiences of Keedle's Chromatic Kinevisor. First of all, a few words about Keedle.

Keedle is a man. No, I ought to say that Keedle is a lady and that there is a man called Keedle who is the true Keedle's husband. She lets him refer to her as his wife, and smoke in the kitchen after the maid has retired—to smoke in her bedroom. That's about as much freedom as he possesses. So quite naturally he went a little ga-ga and took to inventing.

Keedle's Evening Classes

By dint of a few skilfully worded hints he allowed Mrs. K.—without actually what you could honestly call lying—to believe that he had joined an evening class for the study of



"There is a man called Keedle who is the true Keedle's husband."

economics. Then he rented a room at the back of a fish-fryer's and began to tinker.

It was a scream to hear that man, fresh from a busy evening amongst a lot of tom-fool batteries and things, calmly telling Mrs. K. a few facts about the effects of the Gulf Stream on (a) the export of calculating machines and (b) the rise of the gold standard, and the fall of the peseta.

I have seen him impale a pickled onion—as we sat to the frugal supper provided by The K., and which I was sometimes allowed to share—on his fork, and have heard him say, "My dear, once the idea of Bimetallism penetrates to the core of the apple trade—good-bye cider." And she swallowed it while he swallowed his onion. Yes, and thought her John was repeating a chunk of his economics.

His First "Effort"

After his fifteenth attendance at night-school Keedle produced his electric egg-whisk. He demonstrated it to the *chef* of the Café Britannica. The electricity was all correct, the whisk was top hole, but it was a sort of *broadcast* whisk, so that the egg had to be wiped off the surrounding waistcoats.

When the evening class session closed, Keedle induced The Great K. to believe that he had joined a Halma club. That sounded quite like her John—steady, intellectual, and inspiring. Thereafter the supper conversation used to run something like this:

"Phew! What a game! (*Is that chutney, my dear?*) I was black. I hate being black. Always puts me off my gambit. (*Pass us an onion, Jones!*) I was playing against our president. Hot man. Beat Czoza-zezhi, the Pole, last year at the Margate International. Well, I ran up the board—like this—and got home with seven men. Then (*Bread, Jones?*) who should come in but Grates, the professional from the Royal Halma Federation. He simply couldn't take his eyes off the board. (*A bit hot to-night! What?*)" etc.

The Radio Fever

A martyr to science, eh? And he had been trying to invent an odourless fish! As a matter of fact, he did succeed in deodorising a hake, but the result was mere batter and bones. Very uneconomic.

Then he got the radio fever, and after quietening The Paramount K. with a crystal set, began to work at

his new valve. He had learned that the "plate" of a valve need not necessarily be inside the bulb. He tried out a model with the "plate" fixed round the outer surface of the bulb. Fair results, though speech was "drummy." Next, he located the anode in the fish-fryer's den.

Further "Education"

The result was passable, though "In a Monastery Garden" came through cloudily. This he attributed to the prevailing odour—and I think he was right. Then he tried placing the valve at Haggerston and the anode at Peckham. When I came back from my holidays I learned that this stunt had failed only because he found the tram fares too much for his income.



"It was a sort of broadcast whisk."

When the autumn session of evening classes opened he — supposedly — joined a class devoted to the study of varnish, always a useful thing about the house. And as neither he, nor I, nor The Almighty K., had the remotest idea of the theory and practice of varnish, his lies in the cause of science went down with the slippery ease of a pickled onion. He even went to the length of describing the theory of "graining." And who could suspect him? You bung the stuff on and then scrape it with a sort of a curry-comb.

The Great Idea

Whether the great idea struck him as a result of his reading Jules Verne while he ate those infernal pickled onions, and then dreaming on it, or whether he was slightly delirious after trying to read the spot-light from a mirror galvanometer through a Thursday's hell of fried "thrup-ney pieces" belonging to his landlord the fish bloke, is a matter of speculation into which I do not care to plunge, being too bruised in spirit. Enough for me, the unfortunate who is forever "in passing" through this "wale," as the late-lamented G. Dickens called this "wur-ruld," as R. Burns and R. Macdonald call it—enough for me

that Keedle conceived the idea of sending faces by radio instead of letting them grow foggy and spotted in the family album.

"Why send a face?" I said. "Whose face? Faces were meant to be—on the whole, I mean—kept in strict seclusion. Most ought to be blotted out. Why convey the mug of a denizen of Clapham to Potters Bar? It's asking for civil war. You are going to muck up the whole idea of Hogarth's 'line of beauty,' for some nations like it hot and some like it cold. Cut it out; send a picture of an onion, pickled, for the use of; transmit an impression of a cod's face and call it 'still—but useful—life'; but don't send faces, human, for the use of."

A Worthy Object

"Jones," he replied, "you are a source of perennial inspiration and encouragement. I will immortalise the lineaments of an hake. My landlord doesn't fry cod. He's superior—quite well-connected. His uncle was runner-up for the job of toast-master to the East Hoxton Branch of the Right Worshipful Brotherhood of Staggering Stags. And a deacon, Baptist, for the use of."

(We both served throughout the Great War at Deal, Kent, as clerks to the De-stoning Dept.—Jam Section, Plum Sub-section—of the Green Howards. Hence this official verbiage.)

"So I will try it out on hake," said Keedle, "as a slight tribute to a man, albeit a fish-fryer, who—oh, dash it! Hake is a worthy object, ain't it? I've an uncle who could go into panto to-morrow as the middle-cut, and play it to a crowded house."



"Good hevings, man," I said, "is that a face?"

So, feature by feature, the mournful distorted lineaments of a decapitated hake were thrown upon a screen in my house. I used to dream about hake and wake all of a lather. My wife began to reprove me for my peeping, and I had to keep a hold on myself when the thrushes got busy with their tug-of-war on the lawn with bee-

utiful long worms. I felt that I could do with a bit of worm myself. Such was the power of hake.

When Keedle had succeeded in sending hake ten miles, he recklessly decided to send a human physog, and he roped me in as a collaborator. He fixed up his gear, added a radio-telephone, and bade me officiate at the screen end. As he held my I.O.U. for fifty jimmy-o'-goblins, I did not see my way to refuse, particularly because I did not see my way to pay. Curse money, anyhow!

At 7 p.m. on February 13th, I sat down in front of his gear, polished the screen, turned on all the batteries, set the switches, got the radiophone going, lit a pipe and sat down to watch. At 7.20 I got a howl from Keedle. By the way, we had loud-speaker reception to avoid muddling with telephone cords.

"Are you all ready, Jones?"

"Ready, aye, ready. Start the magic-lantern and show us Jack and the Beanstalk," I replied.

"Here goes! Screen test! Mind that loose nut at the back, Jones, and if the bimbalator fouls the zoobing-cam, you know what to do. Now then!"

The Great Test

The loud speaker then set up a noise like a cat with a squib tied to its rudder.

"Hello, Keedle, old man!" I cried. "You're aiming at the wrong target. There's nothing on the screen—not even Mr. T. P. O'Connor's O.K.—but the radio has just chucked a fit and is frothing at the output."

"Sorry, Jonesius, my fault. There was a hair in the differential optoscope. Here goes!"

The screen showed some shadowy blobs, mixed with shooting stars and green flares.

"Splendid, Keedle!" I said. "Picture of burglars surprised in a fire-work shop. Bring on the masks and faces."

"Screen seems to be working, anyway," he answered cheerily. "Just a few adjustments to the blicker-shaft and we'll begin."

"Is that a Face?"

While he worked I chattered gaily, poor innocent that I was.

"What's Mrs. K. doing to-night? Is it the night for the Draymen's Reformation Society? I believe she's sweet on the secretary, that infernal boiled-eye little stiff we had to supper last week. Or is she giving her maid a weekly lesson in 'How to knit

plain, respectable stockings for working girls'? Mark my words, Keedlums, you ought to keep the carving-knife out of that girl's way."

"Aw right," came the reply. "How's this?"

I looked at the screen. "Good hevings, man," I said, "is that a face, or are you—"

The screen blacked out. Then it operated again. "Ah, that's clearer,"



"... and, worst of all, my wife is estranged from me."

I shouted. "Splendid, Keedle! I recognised it at once. Now show me another face. I've seen that one far too often."

Back came Keedle with, "Really, Jones, this is beyond a joke. You can shut down. Do you know what I transmitted?"

"Certainly, old fellow! I ought to know. I've sat and watched the blamed horror till I know every wrinkle on its ghastly face."

"Jones!" cried Keedle. "Please, please, don't. Don't you recognise what I transmitted? Don't you realise what you have done?"

"Yes," I yelled, "that confounded hake's head."

The Last Straw

There was no reply. I know now that it was not hake but Mrs. Keedle. The idiot had conceived the idea that if he confessed about his secret experiments and gave Mrs. K. the honour of being the first woman to be televised, she would consent to let him continue his work. But in his excitement, he must have forgotten to switch on the anti-distorter, besides forgetting to tell me about Mrs. K.'s presence.

So now that I.O.U. is a positive menace, and I am the talk of the county, thanks to Mrs. K.'s tongue—I am a secret drinker, a drug-fiend and half mad—and worst of all, my wife is estranged from me, because, she says, I have lost her the best friend she ever had for borrowing patterns from. No wonder my heart hakes!

WIRELESS CABINETS IN SOUND QUALITY OF WOOD

Highly Polished First-Class Cabinet Work

Makers of all designs for old and new Wireless Sets as periodically announced in this journal

Special line of closed cabinets totally enclosing Batteries and Accessories

Thousands of satisfied users. Send for Illustrated Price List

Money returned if quality and workmanship not equal to our guarantee

CAXTON WOOD TURNERY CO., MARKET HARBOROUGH

FOR 'SOLODYNE' CIRCUITS

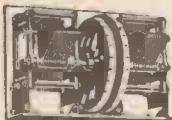

3-VALVE "SOLODYNE"

This circuit specifies the "Cyldon" Twin Thumb Control Condenser. Price, complete with drums (0005) £2. 7. 0.

1928 5-VALVE "SOLODYNE"

Fit the special "Cyldon" 3 Condenser Assembly. Outstanding advantages of greater selectivity, easier tuning, better control, finer adjustment. Price £3. 12. 6, or complete with screens £4. 10. 0. Drilled Aluminium Base 7/6. Drilled Copper Base 12/6 "Cyldon" Bebe Condenser (0001) 7/6.

Write for full particulars

Immediate Deliveries Available

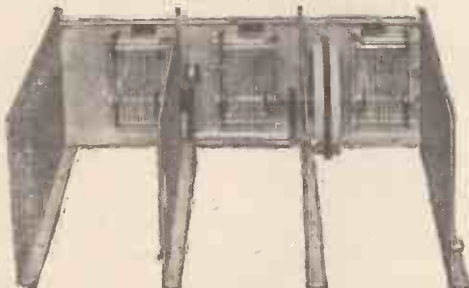

SYDNEY S. BIRD & SONS, LTD.
Cyldon Works, Sarnesfield Road, Enfield Town, Middlesex.

Phone: Enfield 2071-2.

Grams: "Capacity, Enfield."

MODERN WIRELESS

Advertisement Rates

SINGLE insertion	£45 0 0
per page and pro rata	
6 CONSECUTIVE insertions	42 10 0
per page and pro rata	
12 CONSECUTIVE insertions	40 0 0
per page and pro rata	
ONE INCH single col. (2½ in. wide)	1 15 0
Minimum Space, half-an-inch	17 6

IMPORTANT. Copy and Blocks must be in hand by 14th of each month for issue published 1st day of following month.

All communications respecting advertising must be made to

JOHN H. LILE Ltd. 4 Ludgate Circus London E.C.4
and NOT to Editorial or Publishing Offices.

INVALUABLE TO EVERY AMATEUR & CONSTRUCTOR

"POPULAR WIRELESS" BLUE PRINTS

of Tested Circuits

"P.W." BLUE PRINT

Number

1. DETECTOR VALVE WITH REACTION.
2. UNIDYNE DETECTOR VALVE WITH REACTION.
3. 1-VALVE L.F. AMPLIFIER.
4. CRYSTAL DETECTOR WITH L.F. AMPLIFIER.
5. H.F. (Tuned Anode) AND CRYSTAL WITH REACTION.
6. H.F. AND CRYSTAL (Transformer Coupled, without Reaction).
7. 1-VALVE REFLEX WITH CRYSTAL DETECTOR (Tuned Anode).
8. 1-VALVE REFLEX AND CRYSTAL DETECTOR (Employing H.F. Transformer, without Reaction).
9. H.F. AND DETECTOR (Tuned Anode Coupling, with Reaction on Anode).
10. H.F. AND DETECTOR (Transformer Coupled, with Reaction).
11. DETECTOR AND L.F. (With Switch to Cut Out L.F. Valve).
13. 2-VALVE REFLEX (Employing Valve Detector).
14. 2-VALVE L.F. AMPLIFIER (Transformer Coupled, with Switch to Cut Out Last Valve).
16. H.F. (Tuned Anode), CRYSTAL DETECTOR AND L.F. (With Switch for Last Valve).
17. CRYSTAL DETECTOR WITH TWO L.F. AMPLIFIERS (With Switching).
18. 1-VALVE REFLEX AND CRYSTAL DETECTOR, with 1-VALVE L.F. AMPLIFIER, Controlled by Switch.
21. THE 2-VALVE LODGE "N."
22. "THE GUARANTEED REFLEX."
23. THE 1-VALVE "CHITOS."
24. THE "SPANSACE THREE." Three-Valve Receiver employing 1 Neutralised H.F. Valve, Detector with Non-Radiating Reaction Control, and 1 L.F. Valve.
26. A "STRAIGHT" 4-VALVER (H.F., Det., and 2 L.F. with Switching).
28. A "MODERN WIRELESS" 5-VALVER (H.F., Det., and 3 L.F.).
29. AN H.T. UNIT FOR DIRECT-CURRENT MAINS.
30. A REINARTZ ONE-VALVER.
31. A STANDARD TWO-VALVER (Detector and L.F.).
32. The "CUBE SCREEN" THREE (H.F., Det. and L.F.).
33. A "KNIFE EDGE" CRYSTAL SET.
34. AN H.F. AND DETECTOR TWO-VALVER.
35. THE "UNIVERSAL THREE" (Det. and 2 L.F. stages resistance-coupled).
36. The "SPANSACE FOUR" (H.F., Det. and 2 L.F.).

ALL "P.W." BLUE PRINTS 6d. EACH

All orders for these Blue Prints should be sent direct to "Popular Wireless," Fleetway House, Farringdon Street, London, E.C.4, enclosing a stamped addressed envelope and a postal order for 6d. for each Blue Print Ordered.



Zampa Tapped H.F. Choke—“Polar” Variable Condenser—“Modern Wireless” Screening Box—Gecophone Loud Speaker—“Duco” Coil Bases, etc.

Zampa Tapped H.F. Choke
MANY H.F. chokes fail to function over a reasonably wide range of wave-lengths. Indeed, if it is required to operate a set as high as 3,000 metres or down on the low wave-lengths, it is generally necessary to change this component, but the “Zampa” Tapped H.F. Choke which is manufactured by the Mic Wireless Co., Whitehorse Place, Market Street, Wellingborough, successfully overcomes this difficulty.

It has a small stud switch with which various proportions of its windings can smoothly be brought into circuit without removing the device from the set. It is a well-made, neat article, very little greater in size than the average H.F. choke, and on test we found that it successfully fulfilled its purpose.

“Polar” Variable Condenser

From Messrs. Wingrove & Rogers, Ltd., we recently received a “Polar” All-brass No. 3 type variable condenser. It is a first-class piece of radio instrument work. The movement embodies double ball-bearings,

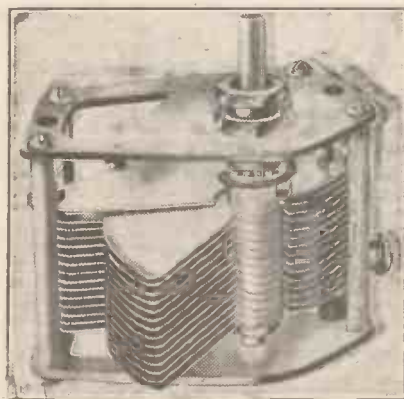

The All-brass No. 3 type “Polar” Variable Condenser.

and is smooth and entirely free from backlash. Vanes, endplates and spindle—in fact, as its name suggests, the whole component—is constructed of hard brass. It is therefore very strongly made, but is neatly compact. It is suitable for one-hole panel mounting, and the two terminals are closely positioned and are accessible. The price of the .0005 mfd. is 8s. 6d., without knob and dial, these not being supplied.

Manufacturers and traders are invited to submit for test purposes radio sets, components and accessories to the “Modern Wireless” Test Room at Fleetway House. Under the personal supervision of the Technical Editor all tests and examinations are carried out with the strictest of impartiality. Readers can accept the Test Room reports published monthly under the above heading as reliable guides as to the merits and demerits of the various modern productions of the radio industry.

“Modern Wireless” Screening Box

The MODERN WIRELESS Standard Screening Box has gone into wide production, as readers will no doubt have noted in our advertisement columns. While strictly adhering to the MODERN WIRELESS specification in point of dimensions, Messrs. Bowyer-Lowe have originated a collapsible variety. The various pieces, complete with baseboard and all necessary screws, are put up in a neat carton at the extremely reasonable price of 6s. 6d. It is the work of but a few minutes to assemble the box.

Apart from the low price, which is a distinctly attractive item, an additional advantage occurs to us.

Being supplied as it is in this way, it makes it easy to cut holes in any side in order to accommodate a screened-grid valve. Aluminium is the material used, and if this is not so easy to drill as some metals, it is at least quite tractable when it comes to cutting. Messrs. Bowyer-Lowe deserve to do a brisk trade with this production.

Gecophone Loud Speaker

A loud speaker which will appeal to the owner of a larger type of set is the Gecophone Super-Cone Cabinet Loud Speaker. It is a large, handsome instrument, and can be obtained either in solid polished mahogany or in solid oak. Its special feature is a large deep cone which operates from a balanced armature. Although one can appreciate its efficiency more when it is given a fairly hefty input, it is capable of providing very pleasing results with smaller types of receivers. It is in every way a high-class cone loud speaker, and takes its place among the best types of the class.

(Continued on page 460.)



The Gecophone Cabinet Cone Loud Speaker

"...ONE OF THE BEST LOUD SPEAKERS WE HAVE EVER HEARD...." says POPULAR WIRELESS.



Fully licensed under Patents Nos. 239331, 243431 & 243432.

THE NEW EDISWAN ONE-DER LOUD SPEAKER.

Read also these two remarkable tributes to the superlative re-production of the New 'One-der' Loud Speaker.

"... It is unusual to find a Loud Speaker which is capable of such characteristic and impressive reproduction."

Prof. A. M. Low, A.C.G.I., M.I.A.E., etc.

"... Selline for the very low figure of 50/-... represents exceptionally good value."

Wireless Constructor.

PRICE £2-10-0 FULL SIZE MODEL.

CHARGE YOUR OWN BATTERIES

Saves money — no trouble—for the radio and the car battery—**ABSOLUTELY SAFE** All that is necessary is to connect Charger to lampholder or power socket, and to the accumulator to be charged, switch on current and leave for a given period until accumulator is fully charged. There is nothing to go wrong. Safe and compact. Full instructions are enclosed with each Charger.

PRICE £2-17-6 Complete.



THE EDISWAN HOME ACCUMULATOR CHARGER.

For A.C. Mains only.

EDISWAN VALVES **CLEAREST · STRONGEST**
LAST THE LONGEST
A Type for every purpose.

THE EDISON SWAN ELECTRIC CO. LTD.,
123/5, Queen Victoria Street, London, E.C.4.



"1928" LOG CONDENSER

·00035 ·0005

5/-

Also mounted
Dual Gang 15/6

Triple Gang £1/1/0

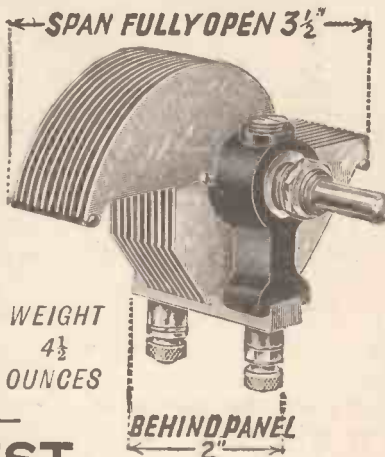

WEIGHT 4 1/2 OUNCES

Absolutely the—
SMALLEST LIGHTEST
and most **EFFICIENT**
yet produced.

Write for Literature containing full details.
CROWN WORKS, 22, CRICKLEWOOD LANE, N.W.2.
Telephone: Hampstead 1787.



This is a Cabinet specially made to accommodate a Gramophone and Wireless Receiver.

It can also be used for the large Receivers such as the 1928 Solodyne.

Splendid workmanship in Oak and Mahogany.

Sent on approval. Inquiries to
MAKERIMPORT CO.
(Dept. 2)
50a, Lord Street, LIVERPOOL

IT IS IT! THE LATEST

4 and 6 Pinless Contact Foolproof Becol Formers. Complete, ready for winding. **NO PINS—NO WRONG CONTACTS.**

Can be fixed in the dark. **FORMER 6/- BASE 4/6.** Inland Postage and Packing, 9d. extra.

Inside formers for above **1 1/2" x 1 1/2" x 2 1/2" 6d. each.** Packing and postage, 3d. extra.

As described and illustrated in "Modern Wireless," January, 1928, issue. Write for Handbook on Circuits and Windings, fully illustrated—Price 6d., post free.

Sole Makers:
THE BRITISH EBONITE CO. LTD., HANWELL, LONDON, W.7.



RADIO NOTES AND NEWS OF THE MONTH

A feature in which our Contributor brings to your notice some of the more interesting and important Radio news items.

Conducted by "G. B."

ACCORDING to the "Daily Telegraph," Potters Bar is still mentioned as the likely site for the new 2 L O, or rather the first of the new high-power Regional Scheme stations, similar to 5 G B. Although the B.B.C. does not definitely confirm this report, the rumour seems to have some firm foundation for its existence, and Potters Bar is at least very much in the running for the site for the first of the new Regional stations.

Two Stations for London

Under the proposed Regional Scheme, the new 2 L O would work on two different wave-lengths, and thus give listeners, in London especially, the alternative service they have so long wanted. But, on the other hand, there are many listeners who object strongly to the moving of

2 L O, and the feeling in the trade is that this moving of 2 L O should not be undertaken lightly without some definite scheme because of the unsettling effect it has on radio trade generally.

Russia's Radio

It is reported that the Radio Society of Soviet Russia has arranged a monthly test through the Moscow wireless station, call-sign S O C, on wave-lengths of 55, 37 and 23 metres.

The New PCJJ

The new PCJJ station is now operating from its new site at Hilversum on Tuesdays and Thursdays, 15/19 G.T.M.; and on Saturdays, 14/17 G.M.T., on a wave-length of 30.2 metres.

The Director of the station writes to me and says that it will be helpful if

listeners in sending in their reports would arrange them as follows:

1. Is there any difference in reception since the station's transfer from Eindhoven to Hilversum?
2. Is fading experienced, and if so at what times?
3. What are the signal strength and general qualities of transmission?
4. Is the station heterodyned?
5. Is the wave-length constant? and readers are asked to state general reception conditions, also details of receiving set used.
6. At what times are the strongest signals received?

Readers should send this information to Phillips Lamps, Ltd., 145, Charing Cross Road, London, W.C.2.

Bernard Shaw and Controversy

Mr. Bernard Shaw, the famous dramatist, recently stated that the B.B.C. talks in the past have always been controversial, and as for himself, if the B.B.C. chooses, as it has done in the past, to stick up its microphone when he is speaking in public, it is welcome to do so.

That is very nice of Mr. Shaw, for it is always a welcome treat to hear a famous man like him broadcast.

(Continued on page 456.)

AGAIN



J. B. Twin Gang,
Complete with dial
£1 10 0
Without Dial
£1 8 6

The Superiority of
J. B. CONDENSERS

is proved once again
by the selection of the

J. B. NEUTRALISING

for

THE 3-VALVE SOLODYNE

Buy also the J. B. TWIN GANG
and know that this important
Receiver is fully equipped with

FIRST-CLASS CONDENSERS



J. B. Neutralising
3/6d.

JACKSON BROS.
8, POLAND ST - OXFORD ST
LONDON - W 1 Telephone -
GERRARD 7414

Recognised leaders in the design of

FOR THE 1928 SOLODYNE

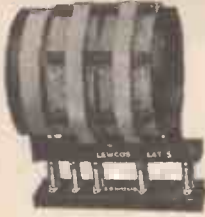

B.B.C. Coils :

Aerial Circuit 1 Ref. LAA 5 } £2-5-0
 H.F. Transformer 2 Ref. LAT 5 } Per Set
 5-pin Bases 3 Ref. LB } including bases

Daventry Coils : (No. 285,723)

Aerial Circuit 1 Ref. LAA 20 } £2-5-0
 H.F. Transformer 2 Ref. LAT 20 } Per Set
 Additional Bases Ref. LB 2/- each.



1 Lewcos Wavetrap 13/6

Solodyne Coils

As manufacturers of the special coils used in the original 1926 Solodyne, Lewcos established a leadership which is still unchallenged. New developments necessitate many alterations in the design of coils for the 1928 Solodyne. But again LEWCOS will give you that extra selectivity and efficiency that constructors have learnt to expect from all Lewcos Coils.

The demand for these new coils and wave-trap will be heavy; place your order now and ensure early delivery. Obtainable through all good radio dealers.

The LONDON ELECTRIC WIRE CO. & SMITHS Ltd.,
 Playhouse Yard, Golden Lane, London, E.C.1.

LEWCOS

(Regd. Trade Mark)

COILS and WAVETRAP for the 1928 SOLODYNE



The most reliable of all chargers. We stock several models for all purposes.

Model A.2. L.T. complete - 42/6
 " " " components - 32/-
 Model A.1. L.T. & H.T. complete 55/-
 " " " components - 42/6

Mr. J. R. Wheatley in "Popular Wireless," Feb. 25th, writes: "The valve since 1925 has been rectifying for 9,936 hours."

Write, phone or call:

F. G. HEYBERD & CO.

8/9 TALBOT COURT, EASTCHEAP, LONDON, E.C.3
 (One minute from Monument Underground Station).

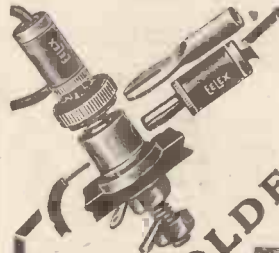

Outstanding Advantages No. 1.

NO SOLDERING

if you use EELEX Treble-Duty Terminals. Write for List S.46 which gives details of the many other outstanding advantages of



TREBLE-DUTY TERMINALS

J. J. EASTICK & SONS,
 Eelex House, Bunhill Row, Chiswell St., London, E.C.1.

MURDER! MURDER!!

Build the "SWEENEY TODD THREE" and MURDER that interfering Local Station.

Sweeney Todd, the Demon Barber of Fleet Street, trapped and murdered his victims ere robbing them. YOU CAN "SWEENEY TODD" YOUR LOCAL station that has been "kyboshing" your DX work and get all stations within range at FULL LOUD SPEAKER STRENGTH. Note the surging power of stations 500 miles away. Note the round melodious tone of music from stations you have never heard before. Note how your "local" can be cut dead out with no "messing about." Simple inexpensive parts. Simple "no soldering" wiring system. Your own "Baby" coils. No stunts. An entirely new and unconventional circuit described fully with full-size blue print in P.P.V. RADIO PLAN No. 30. PRICE 3/- POST FREE.

FREE with each circuit, the P.P.V. 25/- low-wave circuit receiving Sydney (Australia) direct. Also 20 pages of wireless information, some other circuits according to stock and wireless literature. If you cannot send for SWEENEY TODD (price 3/-) send for price lists of P.P.V. circuits.

PRESS EXCLUSIVES, Wireless Publishers,
 29, Paternoster Row, London, E.C.4.



Illustrated catalogue, showing a complete range of Camco Cabinets, Panels, and Brackets, free on request.

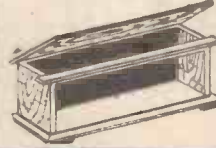

CABINETS

GIVE YOUR SET THE PROFESSIONAL LOOK

The best of sets looks amateurish in a make-shift cabinet. Install your set in a Camco cabinet and make it look as attractive as the dearest sets you can buy in the shop.

SEND A P.C. TO-DAY
 CARRINGTON MANUFACTURING CO. LTD.
 Camco Works, Sanderstead Rd., South Croydon
 Telephone: Croydon 0623 (2 lines).

RADIO NOTES AND NEWS OF THE MONTH
—continued from page 454

Not only is Mr. Shaw well worth listening to from the point of view of common sense, but his voice is admirably suited to the microphone, as many readers will agree if they remember his reading of his play "O'Flaherty" from 2 L O some time ago.

No "Hotheads"

The lifting of the controversial ban has not had any great effect so far on the B.B.C.'s programmes, but we understand the B.B.C. intends to take advantage of the removal of the ban, not by providing more speeches and talks, but by making them more lively.

"We do not intend to do anything suddenly," a B.B.C. official is reported to have said, "as we consider that we have twelve million potential listeners every evening, and we have to study their varied interests very carefully before making any change." Nothing revolutionary might be looked for and no drastic alteration

might be feared. Hotheads will never have access to the microphone.

Lively Talks

But it is interesting to note that if the B.B.C. does not intend to extend the number and duration of broadcast talks, it intends to make them much more lively in the future.

"This does not mean," of course, said a B.B.C. official, "that speakers shall have a free hand. The B.B.C. has its own standards, and we intend they shall be observed."

A Remarkable Accident

Probably a good many of our readers noticed in the Press the other day an account of the unfortunate accident which befell Mr. R. H. White, a coal merchant, of Lincoln Road, Horn-castle, Lincolnshire, who was severely injured about the face by an explosion of his L.T. accumulator.

According to the reports, for a few nights his set had not been working very well. He examined it, but could find no fault. He then disconnected his L.T. battery, and began to examine that, using a naked light. He was bending over it when the battery exploded. This is a very unusual accident, and readers should not think that it is a common happening for a battery to explode like this.

It is thought that in this case the battery was faulty and was giving out gas, which exploded when the naked light was taken near it.

Investigating Atmospheric

The Radio Research Board and Department of Scientific and Industrial Research have taken the curves of many thousands of atmospherics, and they have been investigating the problem generally, but with results which do not seem to be hopeful.

The main wave form of an atmospheric was found to be a pulse lasting approximately 1/500th of a second, on the top of which is superimposed jagged ripples of duration 1/20,000th to 1/10,000th of a second.

It appears, according to the report, that the ripples are the main cause of disturbance produced in a wireless receiver, and since they are also really of the nature of pulses, it is impossible to tune them out, so the bugbear of atmospheric is still with us, and scientists don't seem to be very hopeful about their elimination.

Exchange of Programmes

It is understood that immediate co-operation with radio interests abroad is forthcoming, and that by
(Continued on page 458.)

THE NEW
"AUTOGRAM"
DOUBLE ELECTRIC GRAMOPHONE

Fitted with two Tone Arms, two Celestion Pick-Ups, two 12-inch Turntables, Automatic Stopping Device for motors, two Universal Motors, suitable for any voltage from 110 to 240 volts A.C. or D.C., Speed Regulators, Pilot Lamps, &c., fitted in Substantial Leatherette Covered Mahogany Cabinet. Price, Complete £36. Quotations given for every type of design and outfit.

ONLY A FEW LEFT. AMPLIFEX LOOP AERIAL, the finest loop aerial yet devised, and the best for the reception of European Broadcasting. To clear 30/-.

OUR INTERNATIONAL RADIO CATALOGUE (3rd edition) will be sent to all enthusiasts sending 6d. to cover cost of postage and packing.

WILL DAY, LTD.

(The Best in the West)

19, Lisle Street, Leicester Square, London, W.C.2

Telephone (2 lines): Regent 0921 and 0922.

Telegrams: Titles, Westrand, London.

Working off the Mains

Wherever you find constructional articles on Mains Units you will find Climax Auto-bat Components specified. They were the first mains components that made mains radio possible. Be safe. Insist on Climax. "Popular Wireless" and the "Wireless Constructor" both stipulate Climax for success.

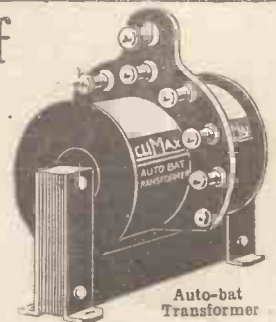

Auto-bat Transformer

CLIMAX AUTO-BAT TRANSFORMER

200-250 volts or 100-125 volts. Double-wave, double-wound 35/-

CLIMAX SPECIAL CHOKE

For H.T. Supply Units 10/6

CLIMAX HEAVY CHOKE

For Mains Receivers 21/-

CLIMAX POTENTIAL DIVIDER

20,000 ohms or 10,000 ohms with ten tappings 5/-

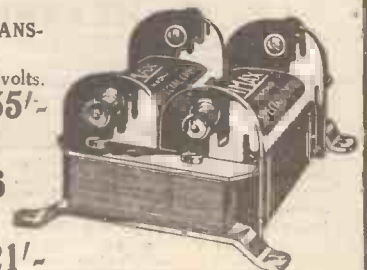

Special Choke

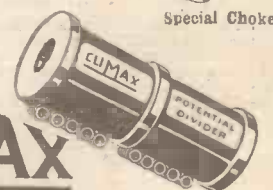

Potential Divider

Complete lists upon application from any radio dealer or direct to:

CLIMAX
A YEAR AHEAD

Climax Radio Electric Ltd., Quill Works, Putney, S.W.15

A New and Useful Work of Surpassing Beauty!

Wonderful Britain

Fortnightly Parts - 1/3 each.

The glories of our own country from Land's End to John O' Groats brilliantly described and illustrated with 1,500 photographs in superb Phototones.

THIS richly printed and fascinating new work will show all that is beautiful, remarkable and historic in England, Scotland, Ireland and Wales. Highways, byways, historic places and beauty spots will be described by great travel writers and illustrated with a remarkable collection of photographs printed on delicately toned paper. There is not a corner of the British Isles that has been left unexplored in the preparation of **WONDERFUL BRITAIN**. It will help you to get the best out of your holidays. It will help you to plan a day's run or a long motor tour, and will lead you to visit the thousand and one places which, in the ordinary way, you might easily pass by. You will be able to turn to it both as a reminder of the places you have seen and as a guide to those you ought to see.

The following list of articles in Part 1 conveys a good idea of the interesting way in which the work has been arranged.

WINDSOR CASTLE AND ITS STORY. *By Rev. C. A. Alington, D.D.*

SHAKESPEARE'S ENGLAND. *By the Dean of Winchester.*

ROMANTIC EDINBURGH. *By Lewis Spence.*

HISTORIC SCENES ALONG THE BRIGHTON ROAD. *By C. G. Harper.*

THE GLORY OF THE CATHEDRALS. *By Rev. Percy Dearmer, D.D.*

THE FOLK DANCES OF OLD ENGLAND. *By Mary C. S. Neal.*

Buy
Parts 1 and 2
TO-DAY
Price 1s. 3d. each

LARGE SCALE ROAD MAP

of Britain's Historic Places

FREE

printed in colours on stout card in 24 sections—one section free with each part of **WONDERFUL BRITAIN**. The complete map, unobtainable elsewhere, would cost at least 10/- in the ordinary way. This map will be invaluable to motorists, cyclists and tourists.

A special transparent-fronted canvas case in which all the sections of this Free Map can be carried will be supplied to all regular subscribers at half price, i.e. 2/6

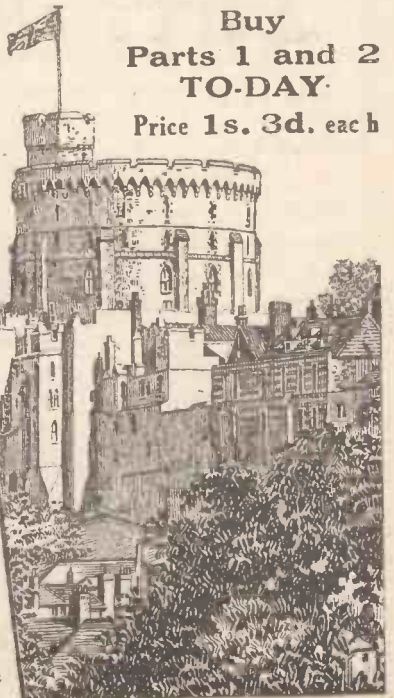

If you have any difficulty in obtaining copies of Parts 1 or 2 from your Newsagent or Bookstall, send 1/6 for each part direct to the Publisher, The Amalgamated Press Ltd., Fleetway House, London, E.C.4.



Something You Never Knew

Hearing the Groton Universal Loud Speaker* for the first time, you will be surprised at the sense of realism in broadcasting that it conveys.

Volume where there is volume, grandly impressive with no suspicion of clamour and where there is softness, a gentle, clear tone that woos your hearing for every perfect note.

"I never knew," you'll say, "that a loud speaker could reproduce like that."

And we would reply that until you hear the Groton Loud Speaker in the comfort of your home, you never will know the pleasure of Perfect Reception.

* The price of the Groton Universal Loud Speaker is £6. Your Dealer will be pleased to demonstrate it.



S. G. BROWN, LTD.,
Western Avenue, North Acton,
London, W.3. Showrooms: 19,
Mortimer Street, W.1. 15, Moor-
fields, Liverpool; 67, High Street,
Southampton. Wholesale Depots
throughout the Country.

CA 2070

RADIO NOTES AND NEWS OF THE MONTH
—continued from page 456

the end of the year foreign programmes will be heard regularly in this country.

According to the "Times," great interest in the matter has been shown by the Union International de Radiophonie, who have long fostered the idea of an exchange of programmes between different countries. It is likely that in the near future 2 L O will be able to transmit a programme from Prague or Berlin as easily as it now broadcasts one originating in Manchester or Newcastle.

Our Programmes Abroad

This opens up an interesting prospect, for crystal-set users will then have regular opportunities of listening to the foreign stations which can at present be heard only by those who have sets capable of receiving distant broadcasts.

The project is to be a reciprocal one, by which listeners in foreign countries will probably be able to hear from time to time some of the

best outside broadcasts arranged by the B.B.C.

Zeesen Calling

According to the "Daily Telegraph" wireless correspondent, the ease of reception of Zeesen, the giant Berlin 40-kw. transmitter, has aroused a good deal of complicating argument.

But there seems to be no doubt that this station is proving a very easy alternative to reception from B.B.C. stations, and it seems to be generally placed among the first of the foreign stations for ease of reception and strength of signals.

Long-Wave Advantages

Captain Eckersley, the Chief Engineer of the B.B.C., speaking at the Institution of Electrical Engineers recently, said that the use of long waves for broadcasting had been criticised but it could be justified, as owing to less rapid attenuation its service area for a given power was greater. In addition, the wipe-out near the station was less pronounced for a given extent of service area. Service without fading up to 300 miles was common; the long wave was not subject to so much interference from ships; spark and shielding

effects were less pronounced in mountainous districts.

Ether Congestion

Most important of all was the estimate that 50 per cent of British listeners relied upon the long-wave Daventry stations, and that no other transmitter was listened to in 90 per cent of the rural areas of this country.

Regarding the disadvantages in long-wave broadcasting reception, he thought that one difficulty was reception in urban areas and, another, increased interference from atmospheric. The great objection to other stations in Great Britain similar to 5 X X was that there was no room in the ether; in other words, there were no more wave-length channels available.

Can You Beat It?

According to the "Daily Mail" report, Mr. C. D. Allen, of Belvedere, Kent, has heard Australia without an aerial. A "Daily Mail" reporter who visited Mr. Allen stated that he heard on the loud speaker music, songs and news from 3 L O, the Melbourne short-wave station. Mr. Allen removed the aerial and earth from his set and the music was

(Continued on page 462.)

MAGNAVOX
ELECTRO-DYNAMIC
POWER SPEAKER UNIT

Manufactured under Magnavox British Patent No. 197,836 of May 24th, 1923.

R4 UNIT
£9.10.0



R4 UNIT
£9.10.0

The World's Finest Speakers by the oldest speaker manufacturers. A revelation in reproduction with results equal to moving coil speakers selling at five times the price.

The field of the Magnavox Type R4 Unit is operated from a 6-volt accumulator or any standard trickle-charger. Consumes ½ ampere. Resistance 12 ohms. This field current is easily available from the L.T. battery of your receiving set.

The unit is supplied complete with attachment cords and built-in input transformer.

Permanent Magnet (balanced armature) Type No. M 7 K-62/6
Write for full list

Our new 1928 Catalogue and circuit supplement is now ready. Send 6d. in stamps to cover cost of postage. It's the most instructive and interesting list available.

THE ROTHERMEL CORPORATION LTD.
24-26, MADDOX STREET, LONDON, W.1
Telephone Mayfair 0578, 0579

MAGNAVOX
Notice!

MAGNAVOX Dynamic Speaker Units (moving coil) are manufactured under the following patents—

BRITISH PATENTS.	AMERICAN PATENTS.
No. 197,836, May 24th, 1923.	No. 1,051,113, Jan 21st, 1913.
Others pending.	" 1,088,283, Feb. 24th, 1914.
	" 1,266,988, May 21st, 1918.
	" 1,443,524, Feb. 6th, 1923.
Foreign Patents issued and pending.	" 1,448,279, Mar. 13th, 1923.
	" 1,524,349, Jan. 13th, 1925.
	" 1,579,392, Apl. 6th, 1926.
	" 1,582,417, Apl. 27th, 1926.
	Others applied for and pending.

Purchasers of these units through our exclusive sales representatives

THE ROTHERMEL CORPORATION, LIMITED
24-26, Maddox Street, London, W.1

are advised that they will be fully protected against any infringement actions.

WARNING

The MAGNAVOX COMPANY serves notice that infringers of the above British patent—manufacturers of moving coil speakers assembled or unassembled embodying any exclusive MAGNAVOX features—will be vigorously prosecuted.

THE MAGNAVOX COMPANY
Oakland, California, U.S.A.

HERE ARE THE COMPONENTS FOR YOUR SET

Specified in this Issue:—

WHEN you have built a Receiving Set you will want to be proud of your achievement—you will want your friends to praise its performance. But besides a good circuit, you must have efficient Components if you would obtain the best results—the reason why Dubilier products are found in every good set.

Whatever circuit you select, by embodying Dubilier components you ensure the perfect functioning of your set constantly maintained.

If unobtainable from your dealer send direct to us.



Dubilier "Dumetohm"
2 megohm each 2/6



Dubilier "Dumetohm"
Holders each 1/-



Dubilier Mica Condenser
Type 610. '0003 mfd. each 2/6
'0005 mfd. " 2/6
'002 mfd. " 3/-



Dubilier Mans-
bridge
Condenser
Type BB
2 mfd.
3/6
each



DUBILIER BUILT

Send for our 1928 Catalogue showing the complete range of Dubilier products.

IS BETTER BUILT

Advt. of the Dubilier Condenser Co. (1925), Ltd., Ducon Works, North Acton, London, W.3

Do You Move With The Times?

If you want to keep right up-to-date in radio—to get the best from your set—to read the news whilst it IS news, be sure every Thursday to "tune-in" your copy of

POPULAR WIRELESS

It costs Threepence—and saves you pounds! It comes out on Thursday—and holds good all the week. It is written by experts, who write helpfully and naturally about the problems of YOUR set.

WHY NOT PLACE A REGULAR ORDER NOW?

POPULAR WIRELESS

The Paper that Made Wireless Popular

Every Thursday.

Threepence.

IN OUR TEST ROOM
—continued from page 452

Duco Coil Bases

Messrs. Brown Bros., Ltd., of Great Eastern Street, London, E.C.2, recently placed on the market two very neat bases for accommodating six-pin types of coils. The type "A" embodies two interesting features, i.e. a complete shrouding of the sockets so as to prevent any likelihood of short-circuiting, and recessed connections beneath the base to obviate contact with the baseboard. The coil bases are of ebonite and very substantial, and to them are fitted nickel-plated terminals and soldering tags.



This is an "Avon" four-valve receiver; the handsome mahogany cabinet which houses both the set and the Ampion Senior Cone loud speaker is something quite out of the ordinary. The set is made by the Avon Radio Manufacturing Co.

Each terminal is plainly marked to ensure correct connections when wiring up. This pattern sells at 2s. 6d.

Type "B" is a cheaper and smaller fitting, suitable for use where space is limited. Soldering tags only are provided, and sockets are not shrouded as in type "A." This is quite a neat, well-finished little component, and at the modest price of 1s. it should have a ready sale.

A Battery Switch

A neat one-hole-mounting on-off switch is produced by Messrs. Garnett, Whiteley & Co., Ltd. It is of the conventional push-pull variety, and of sound design and construction. The action is crisp, clean and positive. The two small terminals are widely and accessibly placed and the spring contacts so fixed that they cannot shift. The device retails at 1s. 6d.

Marconi Valve Combinations

A useful book is being issued free to applicants by The Marconiphone Company, Ltd. This is entitled "Five Hundred Marconi Valve Combina-

tions." The whole comprehensive series of Marconi valves is tabulated with valuable operation details. This book should be in the hands of all practical amateurs. It is sent free to applicants.

A Novel Aerial

We recently received a "Super-antenne" from Paul Dieny, of Southampton House, 317, High Holborn, W.C.1. Its construction is interesting. It consists of non-oxidable metal strips which, when folded up, measure 14 in. long and 3/8 in. wide. From this it can be extended to some 50 in. length "concertina" fashion. A single-strand wire is passed through its centre to regulate its length and add to its strength. It has the active surface of 3,000 square inches. We tested it both indoors and outdoors, and in both cases found it had a definitely better "pick-up" than 7-22's or any ordinary type of aerial. The price of the "Super-antenne" is 10s. 6d.

Useful Pocket Book

The Practical Electrician's Handbook, published by S. Rentell & Co., Ltd., at 2s. 6d. net, is a veritable mine of information concerning everything electrical. The 1928 edition, a copy of which we have just received, includes over 600 pages of articles, tables and general data.

Interesting Trade Organ

We always look forward with interest to the arrival of our copy of the "Brown Budget," a monthly due to Messrs. S. G. Brown, Ltd. A recent issue was largely devoted to the report of the annual banquet and dance given by that well-known firm. The speeches were witty and bright and make excellent reading.

An Instructive Brochure

A leaflet recently issued by C. A. Vandervell & Co. illustrates the construction of a C.A.V. battery in a novel manner. The accessory is pictorially dissected by lifting successive pages, and each step is accompanied by interesting descriptive matter.

A Wet H.T. Battery

A wet high-tension battery consisting of a group of small Leclanché cells offers an attractive alternative to the dry variety or to H.T. accumulators, more especially for country listeners. We have recently had on test a wet H.T. battery submitted to us by the Wet H.T. Battery Co., Ltd., of Brownlow Street, London, W.C.1.

It is a 90-volter, consisting of sixty standard cells of No. 3 size. These are of fairly large capacity, and we found that the battery was capable of delivering anything up to 25 milliamps for considerable periods without fluctuation.

The most attractive feature of the wet H.T. battery is that in addition to being rechargeable, all the various component parts are renewable. And this particular wet H.T. battery appears to be very well designed and assembled, and should have a correspondingly useful life. As a matter of fact, as every part is interchangeable, the battery can almost be said to have an almost indefinite life.

"Wireless Principles and Practice"

This valuable work, by L. F. Palmer, M.Sc., is published by Messrs. Longmans, Green & Co., Ltd., at 18s. net. It should prove of value to the radio engineer and of interest to the amateur capable of coping with the more advanced mathematics of modern radio.

An Efficient H.T. Battery

We have just exhausted a 60-volt H.T. dry battery submitted to us for

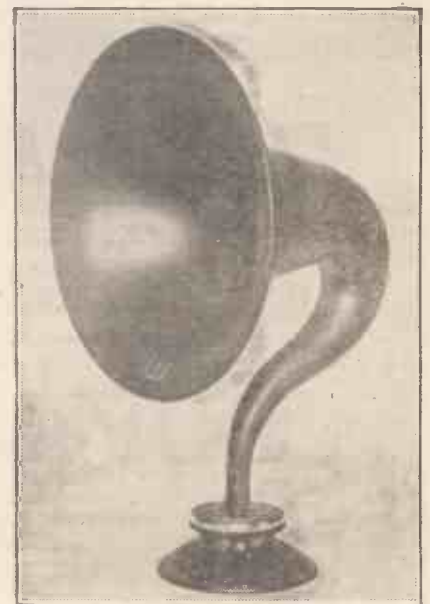

In this page last month a C.A.V. loud speaker was erroneously described. Above we are reproducing the photograph in question. It is of the standard model C.A.V., finished in brown satin enamel, which was recently reduced to £3 15s.

test by Messrs. Ripaults, Ltd. And when we say exhausted, we mean that the battery voltage has fallen below that point at which it can be usefully

(Continued on page 467).

GOOD NEWS *for* SET BUILDERS

In response to the urgent demand for first-class sets for family use, Mr. PERCY W. HARRIS, M.I.R.E., has now prepared the

Wireless Constructor Envelopes

The first two of this series are Now on Sale, price 1/6 per envelope (by post 1/9).

Envelope No. 1.—THE RADIANO THREE. A famous loud speaker set which you can build in an hour or two—no soldering necessary and a wide range of components to choose from.

Envelope No. 2.—THE CONCERT FOUR. Made of standard parts, all easily obtainable; this is a *highly-sensitive long-distance set*, giving *powerful reproduction of wonderful quality*. Covering both long and short wave-lengths, with a switch for 3 or 4 valves, it is essentially *a set to enjoy*, both in building and operation.

In these envelopes you will find every detail of the set simply explained; photographic reproductions and diagrams are included, as well as a full-size Blue Print.

NOW ON SALE Price 1/6

By post 1/9, from the Amalgamated Press, Ltd.,
Bear Alley, Farringdon Street, London, E. C. 4.

What constitutes
an excellent
loud-speaker



Model C.14

- **Even response.**
Not only on the low, but on the middle and the high frequencies.
- **Extreme Sensitivity,**
Sensitive to the output from the weakest set.
- **Adjustment.**
Ability to produce weak as well as very heavy signals without readjustment.
- **Improves with age.**
Improves and *not deteriorates* with the passing of the years.
- **Distinctive appearance.**
An excellent loud-speaker breathes craftsmanship in appearance, so careful and capable is the workmanship wrought upon it. And it must be British.

Let your dealer convince you that "CELESTION," most excellent of loud-speakers, passes all these tests readily.

Write now to Dept. H for the "Celestion" illustrated folder and also for the "Celestion" Gramophone Pick-up leaflet.

CELESTION

THE VERY SOUL OF MUSIC

Write to Dept. H,
THE CELESTION RADIO CO.,
Hampton Wick, Kingston-on-Thames.

Showrooms: VILLIERS ST., W.C.2 | French Agents: CONSTABLE & CO., PARIS.

RADIO NOTES AND NEWS OF THE MONTH

—continued from page 458

faintly audible, although mixed with bursts of Morse and atmospherics.

Mr. Allen uses a 6-volt super-heterodyne. Can any of our readers beat this?

Sir John Reith

Various rumours have been afloat lately regarding the resignation of Sir John Reith, the Director-General of the B.B.C., and Mr. C. B. Cochran has been mentioned as a possible successor. But it seems pretty definite that Sir John Reith has no intention of retiring yet, and Mr. Cochran has already stated that he has never been approached in connection with the position of Director-General of the B.B.C.

B.B.C. and its Critics

Mrs. Snowden, who is a Governor of the B.B.C., is reported to have referred to critics among the listening public as fools whom the Corporation were able to suffer gladly, and she also expressed the opinion that the licence fee of ten shillings a year ought to make the B.B.C. immune from criticism. It is pleasing to note that the B.B.C. engineers repudiated these views: "We have always welcomed criticism," said an official of the B.B.C., "and we do not expect that it will all be either constructive or in our favour. That we should be immune from criticism is, of course, ridiculous."

We hope Mrs. Snowden will bear this in mind in future when speaking in public.

WINDING SKELETON COILS

By C. A. J. Meadows:

MANY constructors have seen, and envied, the possessors of sets in which the coil-turns have no visible means of support, and yet all are as evenly wound as on one having a perfectly round former. This can be duplicated by anyone who cares to take the trouble to do so.

Decide first the diameter of the coil which it is intended to wind, and procure a wooden roller of that diameter; this roller is to be cut in half lengthwise, and this will have to be carried out with the utmost care, as if it is not dead in half there may

be trouble when the coil is to be removed.

Two wedges are next made, and these should be about $\frac{1}{4}$ in. at the thick end. Two pieces about 1 in. wide are next cut from a cardboard tube which will just allow the two halves of the roller to pass through.

The roller, by the way, should be 8 or 9 in. in length.

The Collodion Coating

Fit the two rings over the ends of the roller and drive in the wedges until everything is absolutely tight. Drive a small brad into the roller to secure the beginning of the winding, and carefully wind on the number of turns required, fastening the end of the winding in the same manner as the beginning. Then apply a coat of collodion to the winding with a good quality flat camel-hair brush, and allow to set.

"POPULAR WIRELESS"

If you desire to keep "au fait" with all that is latest and best in radio you must subscribe to this progressive wireless weekly.

Price 3d. Every Friday

Two coats, or even three, may be applied without materially affecting the efficiency of the finished coil; the tacks which have served to anchor the ends of the coil may then be removed, and the wedges drawn. This operation also calls for care, as if the collodion has been allowed to run down on to the roller, it will cause the coil to stick, and this may mean that some of the turns will break away.

Provided, however, that reasonable care is employed, no damage of this sort need result.

Turns on a Tube

Some people rather like to see the coil mounted on some sort of former.

This renders the two rings at the end of the roller unnecessary, but it must be of such a size that the roller will just fit snugly inside it. This tube can then have a number of pieces cut lengthwise from it, leaving, say, three or four wide spaces, with ribs $\frac{1}{2}$ in. wide between. The wire may be wound and anchored as before, but when the wedges are drawn and the roller removed the coil will be supported on a real skeleton former. It is, of course, necessary to coat the windings with "dope" as in the first method.

RECENT RECORD RELEASES

—continued from page 425

the higher and louder notes. As a matter of fact, I should have said eliminate chatter rather than reduce it, for with a loud needle, although the pick-up itself may chatter slightly, nothing of this is heard from the loud speaker.

Electron (Edison-Bell). **Baby and the Silkworm** (2 parts). Mabel Constanduros. (0205. 3s. 10 in.)

A character sketch by a well-known and popular broadcast artist. The various parts of the grandmother, little boy, and girl, and of the harassed mother, are excellently done.

Zonophone. **Forgive Me and Did You Mean It?** Maurice Elwin and vocal chorus and piano. (5053. 2s. 6d. 10 in.)

A light number which is well sung and well recorded. The former side is taken a little too slowly and becomes monotonous, but "Did You Mean It?" is excellently done and equally well recorded.

Zonophone. **Sing Ye Praise** (Hymn of Praise), and **How Vain is Man** (Judas Maccabaeus) Barrington Hooper, tenor, with organ accom. (A333. 4s. 12 in.)

An excellent recording, technically ideal for pick-up work, but somewhat spoiled musically by the fact that the vocalist employs semi-nasal tone and is too inclined to slur his passages. The result is an over-sentimental rendering not suited to items he is singing. The accompaniment is not nearly full enough.

Dance Records

British Brunswick. (10 in. 3s.) **Diane** (W.) and **Under The Moon** (F.T.). Fred Elizalde and his music. (143).

A good even record of modern hot syncopation.

Fair Co-ed (Ch.) and **Our American Girl** (F.T.). The Six Jumping Jacks. (3702).

An excellent record, full of bright life.

My Dream Girl of Honolulu and **My Hawaiian Song of Love**. (Hawaiian instrumental with vocal chorus.) Royal Hawaiians. (3705.)

An interesting record of the Hawaiian guitar type.

Broadcast (Vocalion). 1s. 3d.

Are You Happy? (F.T.) and **Following You Around** (F.T.) (209.)

Diane (W.) and **Sometimes I'm Happy** (F.T.). (195.)

Dancing Tambourine (F.T.) and **Barbara** (F.T.) (193.)
C'est Vous (W.) and **My Blue Heaven** (F.T.) (204.)
Leonora (F.T.) and **Under the Moon** (Yale). (196.)

All good records worth hearing.

So Tired (F.T.) and **Just a Memory** (F.T.). With Stoll Picture Theatre organ accompaniment to band. (208.)

A novel record that is excellent for pick-up reproduction.

Gems from "The Girl Friend." With solos, chorus and orchestra. (203.)

Exceptionally good value for money. The songs are sung with remarkable clearness and the record will make an exceedingly tuneful addition to anyone's store of gramophone music.

Parlophone. 3s. **Clowns in Clover** (2 parts). *Selection*. The West End Players. (R3486.)

A bright record that plays a selection of tunes from the popular revue, in strict dance time—not as broken items that are so usual with "selection" records.

(Note.—W=Waltz; F.T.=Fox-trot; Ch.=Charleston.)

THE TETRODE AS A DETECTOR

—continued from page 409

volts H.T. The screened-grid type of tetrode is also extremely useful as an R.C.-coupled detector where very high magnification is required. This valve, however, requires considerably more H.T. volts for full amplification, and not more than one stage can be used without distortion.

There is another type of tetrode detector circuit which is based on certain peculiarities of tetrode characteristics. In Fig. 5 we have two curves showing the relation of anode current and inner-grid current to outer-grid volts, the valve being used solely as a low anode-volts device.

It will be seen that as the potential of the outer (control) grid is made more negative, the inner-grid current increases while anode current decreases, the relative change in both currents being almost exactly opposite. If the control grid is negatively biased so that a fluctuating voltage applied to it causes the working point to travel over the part of the curves X Y, the inner-grid current fluctuations will be 180 degrees out of phase with the control-grid voltage fluctuations.

(Continued on page 464.)

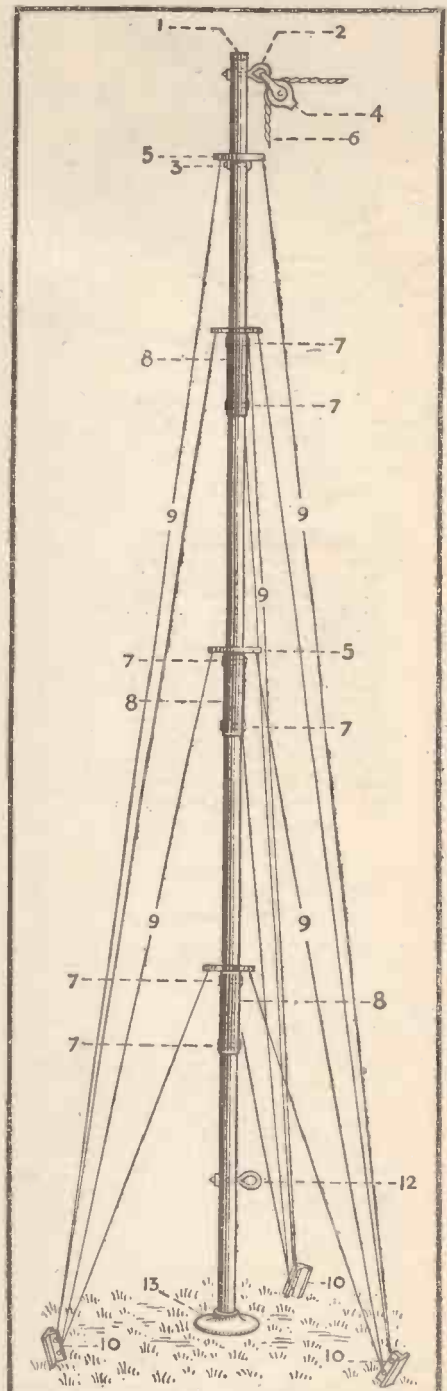

LAKER STEEL MAST
30ft. 22/6

A wonderfully efficient aerial support designed and constructed by Engineers and manufactured from best British Tubular Steel.

A handsome mast that will be a distinct ornament to your garden. Can be erected in a few minutes and occupies only a small ground area.

Mast outfit sent complete as illustrated and carriage paid if you will add 1/6 towards cost of carriage.

J. & J. LAKER CO., LTD., Engineers,
 Kent House Road, Beckenham, Kent.

Contractors to H.M. Govt., British Broadcasting Corp., and to Colonial stations throughout the Empire.

Always bear in mind that an efficient aerial is the most important factor for good radio reception.

Every responsible dealer stocks "Laker" outdoor wireless fittings. Ask for list, or write us direct.

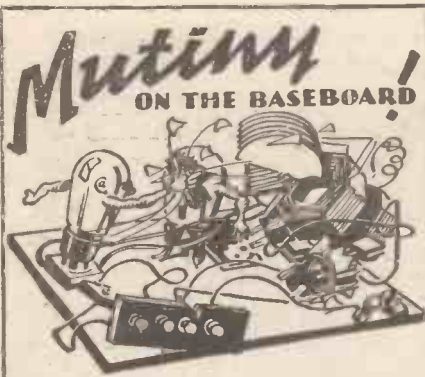

"Hear that!"—a bellowing roar—then a screech. "What a row!"—the loud speaker fairly writhes in agony. "Something wrong to-night," you say, and switch off in disgust!

How often you have wondered why it is that the perfect reception you had last night should have developed into a harsh, distorted discord to-day! But, lift up the cover of the cabinet and consider how difficult it must be for all those sensitive units to work in perfect harmony unless you can control them with microscopic accuracy.

Sifam Radio Meters solve all these difficulties for you. You can trace distortion, correctly regulate valves and be warned of failing H.T. and L.T. long before it has time to let you down. Get a Sifam Radio Meter to-day and ask your dealer to show you the complete range. Send a P.C. for FREE leaflet, "Detecting Distortion," to Dept. M. W., The Sifam Electrical Instrument Co., Ltd. 10a Page St., Westminster, S.W.1



RADIO METERS

NEW MODEL:
Pocket Voltmeter
High Res. 4,000Ω/6
Ohms. Heavy
Nickel Case.

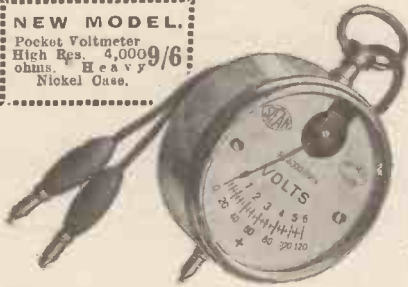

M.B.

1928 SOLODYNE PERFECTA COILS

Short or long, 40/- set; Bases, 4/6 set. Wave Trap, 14/-; Cossor Melody Coil, 6/9; Litz Wound, 11/6.

All above guaranteed true to specification, wound on genuine Paxolin.

All coils to specification. Quotation by return.

Hacker & Sons, 25, High St., Maidenhead

Real ACCUMULATOR HIRE SERVICE. H.T. OR L.T.

We lend you one of our fine wireless accumulators while we recharge yours. Or keep you continually supplied with our own fully-charged accumulators. Collection, maintenance and delivery free, anywhere within 12 miles of Charing Cross. Any voltage or capacity. Skilled service. The famous C.A.V. accumulators supplied for H.T.

Write for full particulars to-day:

RADIO SERVICE (London) LTD.,
105F, Torrano Avenue, Kentish Town, N.W.
Telephone: North 0623-4-5.

THE TETRODE AS A DETECTOR

—continued from page 463

This means that if the inner-grid current is arranged to flow through a tuned circuit connected between control grid and filament, the voltage fluctuations set up will be in phase with the control-grid voltage fluctuations. Therefore the tuned circuit will commence oscillating at its natural frequency, the tetrode then being a negative resistance device. Unlike ordinary oscillatory circuits no reaction coil or coupling condenser is necessary with this particular arrangement.

The Numans Oscillator

The inner-grid current can be fed through the tuned circuit either in parallel or in shunt, as shown in Fig. 6 (a) and (b) respectively. These circuits are two forms of the circuit known as the Numans Oscillator, a Dutch circuit of some years standing. From this it is possible to develop some interesting regenerative detector circuits because the circuit is almost independent of wave-length.

The frequency of oscillations set up is governed by the inductance and capacity of the circuit; L.F. oscillations being obtainable when an iron-cored choke is used. Also by using a tuned circuit and a 1,500-turn coil in series we have at once a very simple form of super-regenerative receiver.

For ordinary broadcast reception the circuit of Fig. 7 is representative of the type. Here the single-tuned circuit is connected between outer grid and filament, the two grids being connected by means of a very small variable condenser, such as a neutrodyne balancer, set just over zero.

A Filadyne Characteristic

The outer grid is given a negative bias of 1.5 to 3 volts, other voltages being as shown. Then as the filament temperature is gradually increased from a dull red, oscillation commences, increasing rapidly to a very violent state, then ceasing altogether as filament brilliancy increases to normal. This peculiarity is very reminiscent of the Filadyne circuit.

In the present case full oscillation takes place when filament current is such that the working point of the inner-grid current characteristic is midway between the points X and Y of Fig. 5.

Thus the degree of reaction can be

controlled entirely by manipulating the filament rheostat, which should have a maximum resistance of about 30 ohms. For the best results filament current will be considerably below normal.

This arrangement is certainly novel as a single-circuit regenerative detector of simple control, but signal strength is not, of course, so good as that obtainable with the special high-magnification circuits mentioned above. This circuit, however, is extremely useful for the construction of simple and efficient wave-meters for all wave-lengths, while as a basis for the development of tetrode "super" circuits it should be of considerable interest to all experimenters.

BLUEPRINTS

A very comprehensive range of blueprints has been published by MODERN WIRELESS and "Popular Wireless," the leading radio weekly. These are obtainable at the standard rate of 6d. each. Every type of set from efficient crystal receivers to de luxe multi-valvers is covered.

The full list can be obtained free upon application.

THE FASCINATING FIXED CONDENSER

—continued from page 446

of electric currents. These two classes are D.C. (direct current) and A.C. (alternating current).

To the direct-current class belong all L.T. currents flowing from accumulator to filament; also the steady anode currents flowing from the H.T. battery across the valves.

To the alternating-current class belong both H.F. and L.F. currents; the H.F. being the wireless currents that flow in the aerial and H.F. circuits in front of the detector, and the L.F. being the "speech" currents that flow after the H.F. has been rectified.

The fixed condenser has very decided views upon these two main classes of current. It stops D.C. of any kind, it passes A.C. of any kind, and it can carry out both these operations simultaneously and almost without loss!

(Continued on page 465.)

THE FASCINATING FIXED CONDENSER

—continued from page 464

The secret of its success in radio traffic-control lies in the fact that there is an insulator between its terminals. This insulator absolutely prevents the flow of direct current, but permits the passage of alternating current through it.

We can see the reason for this if we remember that alternating current continually changes its direction. It starts to flow in one direction, but is no sooner on the way than the current falls away to nothing and then recommences to flow in the opposite direction. This operation, which is called a cycle, is repeated continually at the frequency of the current.

“Going Through” the Condenser

This frequency may be only about 500 cycles per second (a “speech frequency”), or it may be a million per second (radio-frequency), but in either case the effects of such current can pass right through a fixed condenser. For the impulse of such an alternating current supplies a charge to that plate of the condenser connected to it; and this charge, acting against the insulation of the condenser, draws an equal and opposite charge to the adjacent plate.

If the first charge disappears, the induced charge will disappear also. If the first then changes its sign, so will the second change its sign. In other words, alternations on one side of the condenser produce corresponding alternations on the other side. That is to say, alternating currents “go through” the condenser.

The Traffic Controller

From this a very interesting fact emerges. It will be seen that generally we do not use a condenser for its fundamental purpose—that of holding a charge of electricity in a small space—but we take advantage of its peculiar construction to make it stop one sort of traffic (direct currents) and to pass another sort of current (alternating or oscillating currents). A glance at the circuit diagrams in this number of MODERN WIRELESS will show lots of instances of fixed condensers on point duty, by-passing high-frequency current over “difficult” areas, holding up high-tension from passing the appointed places, coupling, shunting or stopping the current with uncanny facility.

Special Offers.

- Dr. Nesper De-Luxe Headphones. 7/11
4,000 ohms.....
Post 6d.
- N. & K. Pattern Lightweight Grand value. 4,000 ohms..... 5/6
Post 6d.
- Dr. Nesper Loud Speaker Unit. 9/11
Latest model.....
Post 6d.
- “Hegra” Cone Units, with fitting at back for Cabinet..... 9/6
Post 9d.
- Ormond Latest On-Off Switch, a beautiful job..... 1/3
Post 3d.
- S.L.F. Variable Condensers, ebonite ends, .0005, .0005, a really wonderful offer. Each 2/11
Post 8d.
- Lissen Electrical Pick-up, the finest at the price. Without adapter, 15/- With adapter 16/6
Post free.
- Triotron Valves (latest), Power 6/3. G.P. 4/3. Detector 4/6. Post 6d. ea. (20/- worth free)
- Special Indoor Aerials, phosphor bronze wire, ebonite separators, 12 ft. x 3, making total 100 feet, 4/11. Post 3d.
- BE SURE YOU READ** “Wireless Constructor,” and “Popular Wireless” for latest sets. (See my advertisements in same.)
- Bulgian Short-Wave Chokes, 8-80 metres, 3/- each. Post 6d.
- Wearite H.F. Chokes, 6/6. Short-wave do., 4/16. Post 3d.
- Dr. Nesper Bronze Finish Horn Type Speaker, worth 35/- Now selling at..... 21/-
Post free.
- Dr. Nesper 35/- Come Type Loud Speaker. Special price, fine 25/-
Post free.
- Radio Micro (Darlo) R.C.C. Unit, 4 terminals, all enclosed (same.) Double Reading (0-6, 0-120) Voltmeters for H.T. and L.T. A 5/11 very special offer.....
Post 6d.

MULLARD MASTER THREE
No solder—only 20 wires to connect. COMPLETE SET OF COMPONENTS. 2 Term Strips 2½ x 2, Lowcos Base, 2 J.B. condensers, Climax H.F. choke, Master Three Coil, 3 Pye Valve Holders, Magnum Brackets, 4 Terminals, Spade Terminals, Wander Plugs, Bulgian Switch, R.I. Unit, R.I. L.F. Transformer, Mullard .0003, 2 meg. Leak, Flex, Screws, &c. AND THREE MULLARD P.M. VALVES £6:17:6
ABOVE KIT

FREE GRID BIAS, 9 VOLTS 100 VOLT H.T. (BRITISH) with above ALUMINIUM PANEL, 18 in. x 7 in. Handsome Oak Cabinet for Master Three, 15/11 with kit of parts, carriage 2/-.

THREE SOLODYNE SETS
 (“MODERN WIRELESS,” April, 1928.)

SET “A”	SET “B”	SET “C”
Cydon D’bile Drum .0005; Peto-Scott .0001; Igranio On-and-Off; 3 Lotus V-holders; Peto-Scott B.B. Neut.; 2 Six-pin Bases; Lissen 2 .0003; Lissen 2 mfd.; 2 Meg. Leaks and Holder; Burne-Jones H.F. Choke; Igranio “G” L.F., 3-6 to 1. Above Kit.	Ormond Twin Gang; Ormond S.M. Dial; Ormond .0001; 3 W.B. V-holders; Burne-Jones .000025; 1 On- & Off Switch; Burne-Jones .002 Neut.; 2 Six-pin Bases; T.C.C. .0003, .0005; T.C.C. 2 mfd.; Lissen H.F. Choke; R.I. Varley S.L.F. Above Kit.	2 Polar .0005; 2 S.M. Dials; 0001 Reaction; 1 On- & Off Switch; 1 Tapp. Clip; 3 B.B. Rheostats; 1 Neutralising; 2 Six-pin Bases; Lissen .002 and .0003; Lissen 2 mfd.; 2 Meg. and Holder; Igranio H.F. Choke; R.I. Varley S.L.F. Above Kit.

110/- 95/- 75/-
Nett. Nett. Nett.

FOR 2/- EXTRA WITH EITHER OF THESE KITS YOU CAN PURCHASE 9 Engraved Terminals, Strip 7 x 2, Do. 2 x 2, materials for screening partition, flex, screws, plugs, wire. This Lot For 2/- WITH PARTS ONLY.

ORMOND COMPONENTS YOU CAN ALWAYS GET THEM HERE! LONDON’S LEADING DISTRIBUTORS!

THE NEW NO. 3 ORMOND S.L.F. CONDENSER

.00025, 5/6; .00035, 5/9; .0005, 6/- With 4-in. Dial. With Friction 55-1 4-in. Dial, 6/- each extra. FILAMENT RHEOSTATS, Dual, 2/6; 5 ohms or 30 ohms, 2/-; Potentiometer, 400 ohms, 2/6; .0001 Reaction, 4/-; Air Dielectric, 2/-; Neutralising, 4/-; Neutrodyne, 2/-; Twin Gang, .0005, 32/-; Triple, 40/-; H.F. Choke, 7/6; Geared Dial, 5/-

LATEST LOGARITHMIC, .0005, 13/-; .00035, 12/6; .00025, 12/-

WE ARE OPEN ALL DAY SATURDAY ALL DAY THURSDAY ALL DAY EVERY DAY
Hours: 9 a.m. to 8 p.m.
Sat.: 9 a.m. to 9 p.m.
Sunday morning: 11-1.

LISSEN
Valve-Holders, 1/-; Fixed Con., 1/-, 1/6; Leaks, 1/-; Switches, 1/6, 2/6; Latest 2-way Cam Variable, 4/6; Rheostats, 2/6; B.B., 1/6; Lissenols, 13/6; L.F. Transformers, 8/6; 100-v. H.T., 12/11; 60-v. H.T., 7/11; Coils, 60 X, 6/4; 250 X, 9/9.

BURNE-JONES (MAGNUM)
H.F. Choke, 7/6. H.T. Auto Fuse, 0-5 bulb, 1/6. Standard Wavetrap, 15/- Screening Box for same, 5/-, 1928 Solodyne Coils (3), 45/- (including Bases). Ditto for Long Wave (no Bases), 45/- Calibrated Rheostats, 6 or 30 ohms, 3/- .00025 Neutralising, 5/- Coil Plug on Base, 4 Terminal, 1/9. Split Primary H.F. Transformers, 8.S. Ditto, Aerial Coils (6-pin), for short and long wave, stocked.

The Corsor “Melody Maker”



COMPONENTS FOR SAME

Post £4:10:0 Kit. Extra

2 Ormond .0005; 2 Do. S.M. Dials; 6 T.C.C. Condensers, .001, .002, two .0003, .0001, 2 mfd.; 2 Grid Lk. Clips, E.R.; 1 Var. B.B. Rheostat; 3 Grid Leaks, 25 3; 4 meg.; 3 Lotus V.H.; 1 Ferranti A.F.3; 2 Panel Switches; 1 Corsor Melody Wound Coil; Terminals, Name Tabs, Glazie, 9-v. Grid Bias (all as specified).

NOTE Drilled High-grade 21x7 Polished Panel, with Radion Strip, FREE with above kit.

COSSOR VALVES FOR ABOVE.

210 D	410 HF	610 HF	10/6 EACH
210 RC	410 BC	610 BC	10/6 EACH
210 F	410 P	610 P	12/6 EACH

COSSOR MELODY CABINET, 21 x 7, as shown above in oak, with baseboard, can be purchased for 12/6 with Components. Carriage 2/-.

MULLARD MIKADO
Component Parts:

- Ormond Logarithmic .0005, Ditto .00035, Two 4 in. Dials, One Igranio “Type G” L.F. 3-6 to 1, Four Engraved Terminals, One on-and-off Switch, Two strips, 2 by 1½ in. Connecting Wire, Six-pin Base, Mullard .0003, Mullard 2 meg, Two Lotus valve holders, Red and Black Flex, Two Spade Terminals, Five Plugs (2 B 3 R).

£3:14:0

MULLARD VALVES, P M 1, 10/6; P M 2, 12/6. MASTER 3-COILS. B.B.C., 7/6; LONG WAVE, 8/6. When purchasing above you can buy 100 volt H.T. for 5/- L.T. 2 volt 45 amp. for 3/11. (Both Best British Make) POST 1/6 for Batteries.

RAYMOND’S FIRST.

Large stocks of really useful cabinets kept or made to order. Solid oak. American type, hinged lid, baseboard.

12 x 8 x 9	11/6
14 x 7 x 9	13/11
16 x 8 x 9	16/11
18 x 8 x 9	19/11
20 x 8 x 9	22/6
21 x 7 x 9	25/-
24 x 7 x 9	27/6

Carriage 1/6.

IT IS IMPOSSIBLE TO ADVERTISE ALL THE WIRELESS PARTS NOW ON SALE, BUT IF YOU WANT THEM TRY

EDISWAN NEW THREESOME LIST OF COMPONENTS.
Three Coupling Units, Tubular Fixed Condenser, Multi-flex Cable and Plug, .0003 Variable with S.M. Dial, 2-way Geared Coil Holder, Connecting Wire, Red & Black Flex.

The lot post free 42/- nett.

EBONITE PANEL 2/6 The two with 5 Ply Baseboard 2/6 above kit only. Ediswan Valves 10/6 each; Power 12/6. Post 6d.

LOW LOSS LOGARITHMIC VARIABLE CONDENSER
as used in the “Music Charming” set. **6/11**
Takes up very little space: .0005, .0003, .00025. Post 6d.

MULLARD TREADOR 3
J.B. .0005 and .00035 S.L.F.; 2 Ormond S.M. Dials, 1 bush; 1 Six-pin Base; 3 Valve holders; P.M. R.C.C. Unit; 1 L.F., 2-5-1 (Pye); 2 2-mfd. Mansbridge; .0003 and 2-meg. Leak; Climax H.F. Choke; 9 Marked Terminals; L & P. On-and-off Switch; Brackets, 3 Plugs, Flex; Screws; Wire. £4:18:3
List Price

FOR YOU CAN BUY with above parts: Aluminium Panel, drilled, best quality; Baseboard, 18 x 10; Ebonite Washers.

MASTER 3 COILS B.B.C. 7/6
Long Wave, for Treador 8/6 L.T., 2 volts, 45 amps, 6/6 (with parts only). H.T., 108 volts, British, 10/- (with parts only). Mullard Valves, 10/6 & 12/6 (Power) (Super Power, 20/-)

K. RAYMOND
27 & 28a LISLE ST., LONDON, W.C.2
Come to LEICESTER SQUARE TUBE
This address is at the back of Daly’s Theatre.
Phone: Gerrard 4637.

NO MORE JACK TROUBLES

NOW you can eliminate the old, messy soldering troubles when fixing Jacks and Switches. The famous Lotus Jacks and Switches are being made with terminals instead of soldering tags. The terminal makes as good a permanent connection as the most expert soldering job.

Lotus Jacks and Switches are made of finest bakelite, with nickel silver springs and pure silver contacts. To establish reliable connections in any set you make, choose Lotus Jacks and Switches. They occupy the minimum space—only 1½ in. behind the panel.

PRICES:

Lotus Jack and Switch. Only 1½" deep. Made of finest bakelite, with nickel silver springs and pure silver contacts. With terminals. Jack No. 3, 2/6; others from 2/- to 3/-; Jack Switch No. 9, 4/-; others from 2/9.

Lotus Jack-Plug. Spring sleeve fitment supplied. Can be used with any Jack. Bakelite mouldings, nickel-plated brass parts. Price 2/-.

Lotus Coil Holder. 2-way, for outside panel mounting, 7/-; 3-way, 10/6; for inside baseboard mounting, with 6-in. handle, 8/-; 3-way, 12/6.

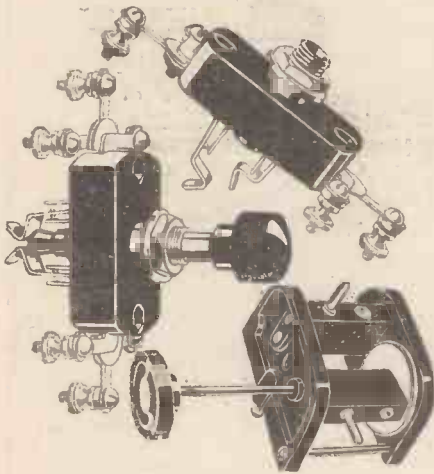

LOTUS

JACKS · SWITCHES · PLUGS

Made by the Makers of the famous Lotus Remote Control and Lotus Buoyancy Valve Holder.

GARNETT, WHITELEY & CO., Ltd.,
Broadgreen Road - LIVERPOOL.

RECEPTION REALITIES

—continued from page 428

position of a Det.-2 L.F. three-valver. The primary winding of an L.F. transformer may come in the anode circuit of this valve. Should this be the case, that transformer must be of a good make and be well designed, otherwise the trouble of saturation will again occur.

Even an ordinary power valve will take its seven or eight milliamps, and this is more than the small, cheap, low-frequency transformers can cope with. Quite recently a special R.C. valve has come into use. This valve has very high-amplification properties and it has been claimed that one used in an R.C. stage will give as much

IS YOUR SET O.K. ?

If it should be giving trouble, or should you experience any kind of radio difficulty, the "Modern Wireless" Queries Dept. can help you. For details of the "M.W." Queries Service

SEE PAGE 416

magnification as a stage of transformer-coupled L.F. amplification, but you will be inviting distortion if you indiscriminately introduce these special R.C. valves in your receiver.

Generally speaking, there is only one position in which they will efficiently function. This is in the rectifier stage. The degree of amplification obtainable in these valves has not been achieved without sacrifice. This has evinced itself in a grid-swing limitation. This means to say that the valve will not handle anything above a rather small input without distorting it. If you were to put one of these special R.C. valves in a last valve holder of your Det.-2 L.F. receiver you would obtain an enormous amplification, but the results would be very horribly distorted.

"Grid-Swing" Limitations

We do not have to worry much about this grid-swing limitation in the H.F. stages or even in the detector stage of a receiver, but from the detector onwards to the loud speaker you have to be very wary of this point indeed. Remember, every valve subsequent to the detector means considerable amplification, so that the

following valve must be able to handle the proportionately greater input.

A rough idea of this so-called grid swing of a valve is to be seen in the characteristic curve supplied by the makers. Along the base line from the left of the vertical line you will see the figures marked in grid volts. The curve starts high up in the vertical line and slopes straight downwards, eventually tending to bend near to the bottom. The vertical line and the point where the curves start to bend mark the extreme limits of its so-called grid swing. Have a look at the characteristic curves of the valves in your receiver and see if their grid swings get larger towards the end of your receiver.

Clipping the "Side-Bands"

On the H.F. side of a set there is very little one can do without revising the design of the whole receiver. You might take steps to modify the inter-valve couplings in order to increase selectivity, but in so doing you may spoil the quality of reproduction by going the wrong way about the job.

It is wrong to suppose that the high-frequency side of the set has nothing to do with the quality of your loud-speaker results. Just as much distortion can occur in that part of a receiver as in the L.F. side. Super-selectivity can be accompanied by what is known as "clipping of side bands" This, in effect, means the elimination of a portion of the received energy.

Also, do not expect a large number of new stations to come in if you replace your ordinary plain variable condenser dials for modern slow-motion tuning devices. A slow-motion dial gives a wonderful control, but it is possible to do just as much with an ordinary plain dial, although this requires far greater skill and experience. But you may have acquired both these qualities and be dissatisfied with the results, which, however, might be obtained rather more easily with the slow-motion type.

Lastly, do not alter your aerial without bearing in mind the fact that you might do more harm than good. If you alter its position you may alter its directional qualities and some of the stations which you have grown to like may tend to fade back.

Again, if you increase the length or height of your aerial you might increase also its pick-up qualities, but in so doing intensify the background of "mush." Your gain may be one small relay station in a corner of Germany, against which you might have to debit a noisy background to all your programmes.



You may look for the trouble that mars reception, but if it is due to a faulty panel, it is most difficult to locate. Buy a panel of proved efficiency, everything a panel should be—always. If your panel's right—you start right. Insist on—



Resiston Panels come in 13 stock sizes in black and Mahogany-grained. From 6 in. x 9 in. in black, 3/5, to 8 in. x 39 in. Mahogany-grained, 19/-. "24 HOURS CUT PANEL SERVICE."

Adopt. American Hard Rubber Co. Ltd. Fore St., E.C.

2166

IN OUR TEST ROOM
—continued from page 400

employed as an efficient H.T. supply. It is, or at least was, a 60-volter of the model B.M. standard type which retails at 10s. 6d. The maximum discharge advised is 7 milliamps, but we ran it for considerable periods at 10 milliamps.

We found that the capacity would give the battery a life of about six months if it were operated at four hours a day regularly during this period. It is possible that it would last even longer run at a lower discharge rate and at more broken intervals. Anyway, it appears to us to be a sound battery, and one that should give useful and reliable service.



This is the Ediswan "One-Der" loud speaker which was favourably reviewed in "Modern Wireless" last month. Owing to an unfortunate printer's error the wrong block was used to illustrate the report. Above we reproduce the correct photograph.

TELEVISION AND RADIO VISION
—continued from page 434

purpose from the ether by means of a receiving aerial, even although one allows for powerful amplification at the receiving end.

In the second place, the special synchronising frequency must be

(Continued on page 468.)

KEYSTONE COMPONENTS CHOSEN FOR THE 3 SOLODYNES



Neutralising Condenser
Baseboard mounting as used by the Author.

5/- each.

SIX-PIN COIL SOCKET.

as used by Author 2/9 each.



MINIATURE TYPE REACTION CONDENSER

'0001, as used by Author - 5/6
'0005, recommended by Author 5/-

"RED TRIANGLE" EBONITE PANELS

14 x 7 x 1/4" .. 6/-
14 x 7 x 3/16" (mahoganite finish) 8/2
All panels drilled free.

HANDSOME GENUINE MAHOGANY CABINETS

3/4" wood, plated piano hinges, and lid stays 37/6
Baseboard 2/- extra.

Send for detailed list of parts and finished instruments.

PETO-SCOTT CO., LTD.
77, CITY ROAD, LONDON, E.C.1.

(Phone: Clerkenwell 9406.)
Branches at 62, HIGH HOLBORN, W.C.1. & 4, MANCHESTER STREET, LIVERPOOL.

BEAUTIFUL TRANSFERS
Perfect Reproduction. Best Inlay. List illustrating 600 Designs and Samples 2/8.
M.W. AXON, JERSEY, C.I.

The WHITELINE VALVE HOLDER

Mechanically and Electrically Perfect.

Bowyer-Lowe 2/3



WHEN YOUR 'DRY' BATTERY DRY'S UP!

REPLACE for the LAST time

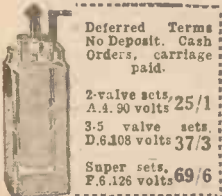

WITH THE PERMANENT STANDARD H.T. SUPPLY

Deferred Terms No Deposit. Cash Orders, carriage paid.
2-valve sets, A.A. 90 volts 25/1
3.5 valve sets D.6.108 volts 37/3
Super sets, F.6.126 volts 69/6

IT RECHARGES ITSELF OVERNIGHT

GET THIS FREE BOOK for FREE Booklet describing every detail for installing and maintaining this super efficient and money-saving battery. (Dept. F.) The Wet H.T. Battery Co., 12, Brownlow St., W.C.1.

Utility

GUARANTEED
COMPONENTS

DO Satisfy!

Constructors in all parts of the world use "Utility" Components and all get complete satisfaction under widely varying conditions. "Utility" can hardly fail to satisfy you, and when you are requiring Micro Dials, Condensers, Switches, Coil Screens, etc., etc., you should see that your dealer supplies no other brand. The makers will send you a List gladly.

WILKINS & WRIGHT, LTD.,
Utility Works,
Kenyon Street, Birmingham.

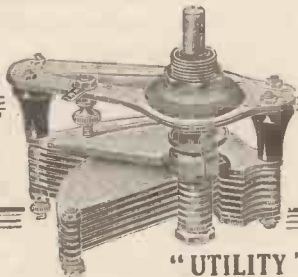

"UTILITY" LOGARITHMIC CONDENSER

Brass or Aluminium Vanes

Light thimble insulators with walls only $\frac{1}{16}$ -inch thick minimise the solid dielectric; ball-bearing spindles, pig-tail connections—an excellent article at a very competitive price.

BRASS.

Capacity	Ref. No.	Price including 4-in. Dial.	With Vernier
•0005	W.182	11/6	17/-
•0003	W.183	10/6	16/-
•0002	W.184	10/-	15/6

ALUMINIUM.

•0005	W.185	9/6	15/-
•0003	W.186	8/6	14/-
•0002	W.187	7/6	13/-

"UTILITY" NEUTRODYNE CONDENSER

5/-
each



Mounts above or below the base-board. Rigidly made, ball-bearing spindle, and sufficient tension to avoid accidental mis-adjustment. Perfect—constructions and finish.

TELEVISION AND RADIO VISION

—continued from page 467

quite distinct from the picture-signalling frequencies proper, in order to prevent any failure or overlap. It must also win its way consistently through extraneous "ether" interference and adverse atmospheric conditions, and keep the picture-building "light" at the receiving station moving at exactly the same rate as the picture-analysing "light" at the transmitting end.

Results by Radio

Within the writer's knowledge only two claims have been publicly advanced to successful television by purely wireless methods. Moving-shadow effects, where the silhouette of a person's face has been thrown upon a suitable background in black and white, and even contour effects, where the shape of intermediate features have been obtained by reflected light—a much more difficult thing—have certainly been claimed by a number of inventors, including Mr. Baird. But with few exceptions,

of persons being involved, together with apparatus costing many thousands of pounds.

The result obtained was a recognisable image of a distant speaker. The image was of size approximately 2 in. by 2½ in., and was only suitable for viewing by a single person. Attempts to enlarge this to a size of 2 ft. by 2½ ft. for more general exhibition were not entirely successful, owing to the coarse grain of the enlargement and the corresponding lack of definition.

These particular radio-vision experiments, though costly, undoubtedly resulted in the successful transmission of a recognisable and animated reproduction of the head and shoulders of a speaker located some 22 miles away.

When Wire Was Used

It may be added that somewhat clearer results were obtained by the same experimenters over a distance of 250 miles between New York and Washington. This was only achieved, however, by using a Pupinised telephone wire connecting the receiver and transmitter. The telephone line was specially loaded to carry high-frequency control and signalling currents with low attenuation.

"WIRELESS CONSTRUCTOR" ENVELOPES

Two envelopes of a new up-to-date series are now on sale. Each includes a full-size blueprint, exceptionally clear photos and full descriptive matter. The sets described are the famous "RADIANO" THREE, and a new design due to Mr. Percy W. Harris, M.I.R.E., THE "CONCERT" FOUR. If you are requiring a straightforward, efficient set, embodying all modern improvements, you cannot do better than build one of them.

The envelopes are ON SALE EVERYWHERE.

Price 1/6 each

no specific claim has been made that such effects have been carried out over long distances purely by radio or wireless waves, and without the aid of any connecting wire.

An American Experiment

The first of these exceptions was the experiment carried out in May of last year between the Bell Telephone Co.'s Laboratories' experimental station, 3 X N, at Whippany, New Jersey, and their main laboratories at 463, West Street, New York City, a distance of 22 miles. For this, three separate ether communication channels or wave-length bands were required—one for the picture signals, a second for synchronizing, and a third to convey speech from the person whose features were being televised.

The arrangements were of a highly organised character, some hundreds

So far as the ordinary amateur wireless enthusiast is concerned, television results received over a line wire can hardly have the same interest as results to be secured *via* his garden aerial. It is only a comparatively limited number of people who could afford to have their homes specially wired-up to a television transmitting station.

The second claim to have attained successful radio vision is that recently advanced by Mr. Baird, who is said to have transmitted recognisable pictures of a number of persons seated in Long Acre, in the West End of London, across the Atlantic to a darkened cellar in a suburb of New York, a distance of some 3,500 miles. The radio transmission took place from a small-powered private station in Coulsden on a wave-length of 45 metres.

(Continued on page 469)

PERFECT TERMINALS



The unique advantages of the Belling-Lee patented terminal:—

- Insulated, Non-rotating, engraved top.
- Highly finished screw-action, insulated head.
- Non-threaded stem and cross-hole.
- Specially made to grip spade or pin terminal or flex.
- Shielded metal clamping faces.
- Highly finished insulated collar.
- Metal parts nickelled.
- Transverse slot with clamping nut eliminating soldering.
- Guaranteed.

PRICES. Type "B"—Standard large insulated model. Polished black bakelite, 9d. each.

Type "M"—As type "B" but smaller, and with only the engraved top insulated, rest nickel-plated brass, 6d. each.

Made with 30 different engravings.

**BELLING-LEE
TERMINALS**

Belling & Lee, Ltd., Queensway Works, Ponders End, Middlesex.

**A Quality Cabinet
for your Set.**

Full illustrated particulars from the Actual Manufacturers, V. C. Bond & Sons, 61, Hackney Grove, Mare St., London, E.8. Phone: Clissold 0883

PLEASE BE SURE TO MENTION "MODERN WIRELESS" WHEN REPLYING TO ADVERTISEMENTS.

**MOVING COIL SPEAKERS,
GRAMOPHONE PICK-UPS, ETC.
DEMONSTRATIONS DAILY.**

In Stock:—Pick-ups from 15/-. Push-Pull Transformers, Pye Chokes, Blue Spot Units, Balanced Armature Type Cone Units, 10/6.

Telephone: Museum 0241. **FREE** Our 136-Page Catalogue, Radio and Electrical.

ELECTRIC (GRAFTON) COMPANY
Dept. M.W.,
54, Grafton Street, Tottenham Court Road, W.1.

WET H.T. BATTERIES



Solve all H.T. troubles. SELF-CHARGING, SILENT, ECONOMICAL. JARS (waxed) 2 1/2" x 1 1/2" sq. 1/3 doz. Zincs New type, 11d. doz. SAGS 1 2 doz. Sample doz. (18 volts), complete with bands and electrolyte, 4/3, post 9d. Sample unit, 6d. 16-page booklet free. Bargain list free.

AMPLIFIERS. 1-Valve 19s. 2-Valve 30s. 2-Valve All-Station Set 41.

M. TAYLOR, 57, Studley Rd., Stockwell, London.

THE DIX-ONEMETER



is a precision instrument of universal use, with an ingenious system of Multipliers, which enable full scale readings of any value to be made over a wide range. 1 Millivolt to 2,000 volts, 50 ohms to 50 megohms. Mirror Scale, Jewelled knife-edge, a £10 de Luxe Model - - PRICE 55/- Multipliers, 6/6 each.

GET OUR NEW 72-PAGE CATALOGUE Over a thousand bargains are listed, and hundreds illustrated. SEND 4d. IN STAMPS.

ELECTRADIX RADIOS, 218, Upper Thames Street, LONDON, E.C.4.

**TELEVISION—MR.
MIHALY'S VIEWS**
—continued from page 468

OUR readers are probably aware of the very important television research work which is being conducted by Mr. Denes Von Mihaly, the Hungarian scientist and inventor. We would refer our readers to an important article by Mr. Mihaly which appeared in the April issue, 1927, of "Experimental Wireless." This article is a contribution to the discussion of a paper by Mr. J. L. Baird before the Radio Society of Great Britain, which was published in the December issue of "Experimental Wireless."

Mr. Mihaly, who has been working on the problem for fourteen years, says in the course of his article:

"Almost every day fresh reports concerning television are published, some of which may be taken seriously while others are merely amusing. In any case, there is an indication that this problem is engaging universal attention, and a keen desire to see expectations materialise is widely entertained. The newspaper articles concerning Mr. Baird's work, savouring more of propaganda than science, and presenting picturesque visions of the future rather than technical details, have made it impossible for me to judge the value of his work.

Nothing New

"In the December issue of 'Experimental Wireless' there is, however, published a paper read before the Radio Society of Great Britain. The paper is of a technical nature, and it is headed by the name of Mr. J. L. Baird. I presume that he was responsible for its preparation."

Continuing, Mr. Mihaly points out that the apparatus Mr. Baird employed (at that time) for analysing the picture consisted of discs which are provided with various slits intercrossing each other and through which light from single small points of the picture are successively allowed to pass. This device, states Mr. Mihaly, presents nothing extremely new, for it is almost entirely the same as proposed by Brillionin, in 1891, and again by Majorana, in 1894, only to be rejected by them as quite unsuited for practical purposes.

Mr. Mihaly points out that apparatus of this nature only serves to demonstrate the principle, and is satisfactory only so long as one is

(Continued on page 470.)

**THE ONLY INSURANCE
POLICY FOR VALVES**

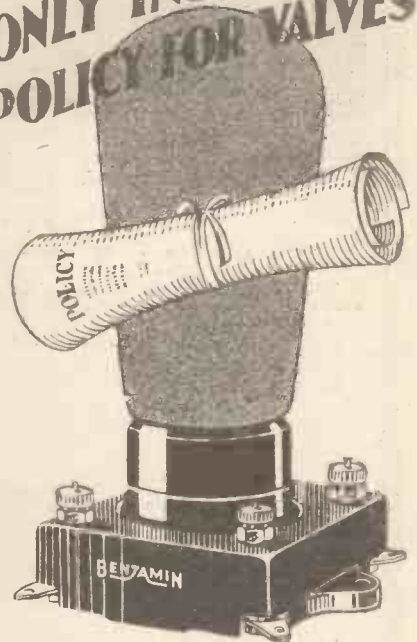

The BENJAMIN Valve-Holder!

The valve-holder that floats your valves on four super-sensitive, one-piece springs which effectively absorb every shock, every quiver of vibration. Prolong the life of valves, eliminate microphonic noises, and improve reception all round by fitting Benjamin in every stage. All radio dealers sell

**BENJAMIN
VALVE-HOLDERS**

- (1) Valve sockets and springs are made in one piece with no joints or rivets to work loose and cause faulty connections.
- (2) Valves are free to float in every direction.
- (3) Valves can be inserted and removed easily and safely.
- (4) Valve legs cannot possibly foul the baseboard.
- (5) Both terminals and soldering tags are provided.

2/-

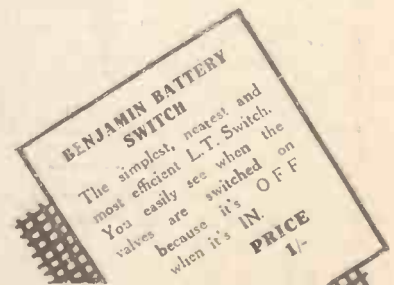

BENJAMIN ELECTRIC LTD., Brantwood Wks, Tariff Rd., Tottenham, N.17

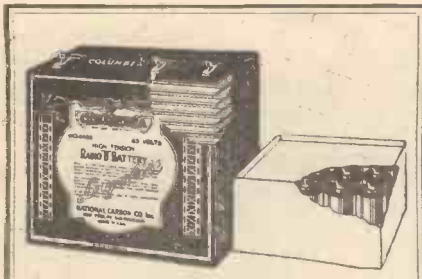

Columbia "Layerbilt"
Every inch a battery

Buy the new Columbia Layerbilt and know that every cubic inch of your battery is packed with electricity-producing material; that its efficiency is increased, and all danger of loose or broken connections avoided by contact of full area of carbon against zinc plate; that it is by far the cheapest battery in the long run though its initial cost may be higher; that it is the H.T. Battery used by all discriminating radio enthusiasts because of its performance and economy.

Price 25/-

No increase in price over old type.

Layer building is a process perfected at immense cost by the world's largest battery manufacturers, and the "Layerbilt" is sold under National Carbon Co.'s full guarantee.

J. R. MORRIS,
15, Kingsway, London, W.C.2.
Scotland: J. T. CARTWRIGHT,
3, Cadoan Street, Glasgow.

When replying to advertisers please be sure to mention "Modern Wireless."

MODERNISE your WIRELESS
Distinctive and Dignified.

Takes your Set →
Batteries, etc. →

FITS THE HOME!

"RADIOLA" De Luxe
SENT ON APPROVAL.
Guaranteed Highest-Grade Craftsmanship.
Full particulars FREE from the
BRITISH Makers.

PICKETT'S
CABINETS
M.W. Works, BEXLEYHEATH, Kent.

EVERYTHING RADIO
EASY ON TERMS
WOOLDRIDGE
RADIO CO. LTD.
17 & 22 LISLE STREET
LEICESTER SQ. LONDON, W.C.2

TELEVISION—MR. MIHALY'S VIEWS
—continued from page 469

content with a transmission of 60 to 100 spots of light. If it is wished to transmit a picture measuring only 10 cm. by 10 cm. and to divide it into areas of only one square millimetre, it will be found that already this means 10,000 light spot elements per picture. To transmit the 10,000 light spots within the time period of the inertia of the human eye, which is about one-tenth of a second, the picture must be divided up into 100 strips, and each strip must be again crosswise or diagonally divided into 100 sections within the brief period of time of one-tenth of a second.

Pointing out that in the case of a picture with a primitive minimum of only 10,000 picture elements, and the fact that the poorest newspaper blocks have a screen which represented a division of three points per millimetre, Mr. Mihaly makes it obvious that in order to produce a result which has any practical value we require, not 10,000 picture elements as suggested by Mr. Baird's method, but at least 90,000.

"Snags" of Synchronising

Dealing with the problem of synchronisation, Mr. Mihaly says: "It must not be forgotten that in practice the transmitter and receiver discs (in television work) are completely separated from one another, but they must rotate in such absolute synchronism that in the period of one second a variation of one-hundred-thousandth of a revolution must not occur. This means, of course, that the picture analysers must synchronise to one-hundred-thousandth part of a second, and must do this without connection by wire."

(This probably explains why in his experiments Mr. Baird is often as long as two hours experimenting before even for the briefest fraction of a second anything like a clear outline is received on the television screen.)

Mr. Mihaly points to a curious statement in connection with Mr. Baird's system that a fluctuating current associated with his method of synchronisation is transmitted to the receiving station by wire or by wireless. Mr. Mihaly states that he would regard this extraordinary assertion as an oversight were it not for the fact that in another part of

Mr. Baird's paper as read before the Radio Society of Great Britain he states that: "At the receiving station the current is amplified by a three-valve low-frequency amplifier." In the case of a long-distance transmission the higher speech frequencies cause enormous difficulties, and when one has to deal with over twenty thousand impulses to the second, transmission becomes impossible. Mr. Baird would actually require to transmit, as a minimum, at an oscillation frequency of 100,000. And yet he makes the suggestion of amplifying the current impulses at the receiver station by means of a low-frequency amplifier.

Significant Silence

Mr. Mihaly concludes his very interesting article by saying: "In view of the considerable amount of publicity which has been given to Mr. Baird's work and the far-reaching importance of television to civilisation generally, I think it only fair in his own interests, as well as in those of the public and technically interested persons, that he should be good enough to give his observations on the problems I have raised."

That article by Mr. Mihaly was published as long ago as April, 1927, but, as far as we are aware, Mr. Baird never replied, nor has he ever replied, as our readers are well aware, to the questions we raised in recent issues of MODERN WIRELESS. We associate ourselves with Mr. Mihaly's request that Mr. Baird should be good enough, in view of the far-reaching importance of television to civilisation, to give his observations on the technical problems, not only raised by Mr. Mihaly, but which we have raised ourselves, and which have incidentally been raised by the publication of articles by Dr. J. H. T. Roberts and other eminent scientists.

BROADCASTING IN JAPAN
—continued from page 348

This to the English mind is somewhat Spartan fare; though, of course, it is possible that Koto, Nagauta, Utazawa and Gidayu may redeem the whole programme. The number of lectures show that the J.B.A. is copying the B.B.C.; and it has just occurred to me that the programme contains no chamber music, unless it is disguised as Utazawa or Koto. I fear that such a type of programme is very dear at £1 4s. a year.

THE PERFECT LOUDSPEAKER

—continued from page 340

Electrostatic Speakers

There is also the so-called electrostatic type of loud speaker. Here the electric current from the set, instead of being first converted into magnetic energy is applied directly to one of a pair of charged plates set close together so that they constitute a condenser. Variations in the applied current alter the static attraction between the plates, causing them to vibrate bodily and so communicate their motion to the surrounding air.

It must be admitted, however, that all these methods depend upon the vibration of some form of material substance, and are therefore subject to the limitations previously pointed out. They vary only in the kind of diaphragm or in the means employed to set it into movement.

**POPULAR WIRELESS
THE PAPER THAT MADE
WIRELESS POPULAR**

Every Thursday. Price 3d.

The Perfect Diaphragm

A distinct departure, and one in which the diaphragm is entirely dispensed with, is the so-called thermic or hot-wire instrument which has already been used with considerable success for small headphone receivers.

In this type of instrument the speech current is passed through a length of Wollaston wire—an extremely fine-gauge wire drawn from platinum. The wire is so sensitive that its temperature changes in sympathy with the strength of current passing through it.

The varying temperature of the wire reacts directly upon the molecules of air in contact with it, and so sets up air-waves which are sufficiently strong to reproduce speech distinctly. It will be noticed that in this case there is no intervening mechanical diaphragm. The electric current acts directly upon the air, and in doing so generates sound waves.

Unfortunately the nature of the reaction is such that it cannot be used to impulse large bodies of air, such as is necessary to give true loud-speaker strength.

Standing room only!

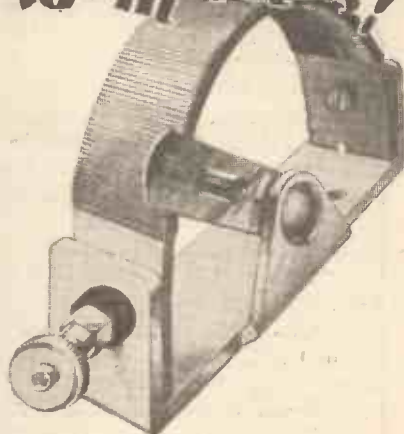

Your baseboard may be crowded. But there's room for the "Peerless Varistor." It stands up, prominent, easy to get at, but clear of complicated wiring.

Wound with finest quality resistance wire and fitted with a Phosphor-bronze adjustable arm that, once set to the resistance for your valves, stays set.

Terminals are fitted in convenient positions. Five different styles—3, 6, 10, 15 and 20 ohms.

From all good dealers or direct.

Then fit
PEERLESS VARISTOR

THE
BEDFORD ELECTRICAL & RADIO CO., LIMITED
22, Campbell Rd., Bedford.

LONDON: 21 Bartlett's Bldgs., Holborn Circus, E.C.4.
GLASGOW: 113, St. Vincent Street, C.2.

1/3



OLD PRICE 8/6

Trade Enquiries Invited

NOW ONLY

3/6

Post & Packing 4d.

'Phone your order: Central 0181. Pay the Post-man C.O.D.
2 Valves for 6/9 Post & Packing 6d.
3 Valves for 10/- Post & Packing 6d.
4 Valves for 13/- Post & Packing 9d.

All valves despatched by return of post under guarantee of Money Back in Full if not satisfied. All valves are carefully packed and breakages replaced. Callers Invited.

INDISPENSIBLE
for 100%
Valve Efficiency
Only Amperite supplies automatically the self-adjusting filament current your valves require. Eliminates hand rheostats. Simplifies wiring. Insist on Amperite. Accept nothing else. Price 5/-, complete with mounting. Sold everywhere. Write for Free construction data.
ROTHERMEL RADIO CORP.
OF GT. BRITAIN LD.,
24-26 Maddox Street,
London, W.1
AMPERITE
REG. U.S. PAT. OFF.
The "SELF-ADJUSTING" Rheostat

ARTCRAFT CABINETS, AS USED IN THE
"SOLODYNE"
Size 14" x 7" x 12"

Oak, 30/-; Mahogany, 32/6. Carriage Paid.

ARTCRAFT RADIO CABINETS
BEST VALUE
New Catalogue Free
THE ARTCRAFT COMPANY
156, CHERRY ORCHARD R' CROYDON

THE CELEBRATED LONDON-MADE
P.R. VALVE NOW ONLY 3/6

Manufacturer's Daring Offer

P.R. SUPER DULL EMITTER VALVES challenge comparison with ANY OTHER VALVE ON THE MARKET. It was only by the use of new elements and new methods of manufacture that the P.R. VALVE at 3/6 became an established fact. Hitherto it had been sold at 8/6. The NEW PRICE BRINGS A GOOD VALVE WITHIN THE REACH OF EVERYBODY.

L.F., H.F., R.C. and DETECTOR in 2 and 4 VOLTS

Type.	Fil. Vts.	Fil. Amp.	Imp. Ohms.	Amp. Fac.	M/C	
PR 1	2	.06	35,000	15	.4	H.F.
PR 2	2	.06	25,000	12	.43	Det.
PR 3	2	.06	18,000	8	.44	L.F.
PR 4	2	.06	120,000	40	.33	R.C.
PR 5	2	.15	40,000	20	.5	H.F.
PR 6	2	.15	30,000	15	.5	Det.
PR 7	2	.15	12,000	6	.5	L.F.
PR 8	4	.06	23,000	15	.65	H.F.
PR 9	4	.06	19,000	9.5	.5	Det.
PR 10	4	.06	11,000	6	.55	L.F.
PR 11	4	.06	120,000	40	.33	R.C.

Power Valves: 2V .20 6,000 5 .82
4V .15 4,000 4 1.0
7/6 Each. Post and Packing 4d.

Tell us what your circuit is. We can help you select the right valves. MATCHED VALVES for the intermediate stages of Super-hets specially selected for 1/- per set extra.

P.R. VALVES Dept. 33 (Opp. Post Office Tube)
17, PATERNOSTER SQ.,
Newgate St., London, E.C.4

RADIO ABROAD
—continued from page 426

A French Mike

At a recent meeting of the French Academie des Sciences, M. Marius Latour, the well-known French engineer, and General Ferric, head of the French Military Wireless Service, exhibited a new "electro-capillary microphone." The essential element is a capillary tube, which is bell-shaped or flared at one end and contains an electrolyte, the other end being immersed in mercury. When anyone speaks before the tube the voice is faithfully reproduced, and the microphone is claimed to give better reception than many other types. Its resistance is easily varied, and it is also claimed to have other special advantages.

Student Manufacturers

A number of students living in the Latin Quarter in Paris have grouped themselves together into a small Company for the manufacture and sale of wireless apparatus, the company being known under the title of "Radio University." Many French University students have not sufficient money to support themselves during the period of their University studies and have to eke out their allowances by earning money in their spare time. Many wireless amateurs among the Paris students have been in the habit of building up inexpensive wireless sets and supplying them to their friends and acquaintances. The company which has now been formed is an endeavour to put this practice on a more regularised and profitable basis.

The nature of the enterprise has gained for it a large amount of sympathy from the Press, and the student

members of the company have therefore started under very good auspices. A certain amount of antipathy has naturally been shown by the trade, but as it is unlikely that the student company, even if it should be successful far beyond its own expectations, will seriously encroach upon the province of legitimate traders, the question is not regarded as a serious one.

"Tour Eiffel"

The wave-length of the Tour Eiffel station, which is at present 2,650 metres, will be reduced before the end of the present year to 1,400 metres. This is in consequence of the decision of the recent Washington Congress, fixing the zone for long-wave stations at 1,340-1,875. It is expected that the power of the Tour Eiffel station will, at the same time, be increased to 100 kilowatts.

ences in quality (some even "prefer" really bad rendering); but the path of progress does not lie in designing down to the level of the "50 per cent ear," and in putting up with the sort of reproduction one hears all too frequently in many of the small dealers' shops. The doctrine that small improvements are "sheer waste of time" doesn't lead us anywhere.

Yours faithfully,
G. M. P.

Woking, Surrey.

The "Long-Range" Five

SIR,—It may interest you to know that I have just constructed, "The Long-Range Five" receiver, as described by W. James in the issue of your magazine for September, 1927, and am extremely satisfied with its performance.

I made it up in the hope that it would enable me to consistently receive Calcutta (1,200 miles distant) on the loud speaker—and it has fully justified my expectations.

Bombay, which is 700 miles away, comes in so loud in the evening that volume has to be reduced by means of the 50-ohm rheostat—a most efficient control.

The best test of the wonderful sensitivity of this set is, however, in my opinion, the fact that at mid-day, in the strong glare of Indian sunlight, I can receive on the phones the morning news bulletin from the Bombay station of the I.B.C., which, as noted above, is 700 miles distant.

Thanking you for publishing the design of such a powerful, stable, and easily-constructed receiver.

Yours faithfully,
J. H. MOORE,

M.B., B.Ch., B.A.O.,
Chief Medical Officer,
Travancore Medical Fund.

Peermade P.O.,
S. India.

READ THE BEST
and latest information about all
radio matters in
"POPULAR WIRELESS"

On Sale Everywhere.

Every Thursday. Price 3d.

WHAT READERS THINK

—continued from page 436

sounds to 25 per cent before the ear notices much difference in intensity.

For purely financial reasons lots of people have to put up with very imperfect apparatus; many others, by reason of musical inexperience, are incapable of appreciating differ-

INDEX TO ADVERTISERS

American Hard Rubber Co., Ltd.	Page 407
Amperite Rheostat	471
Axon Transfers	407
Artercraft Company, The	471
Bedford Electrical & Radio Co., Ltd.	471
Belling & Lee, Ltd.	469
Benjamin Electric, Ltd.	409
Bird, Sydney S., & Sons, Ltd.	451
Bond, V. C., & Sons	469
Bowyer-Lowe Co., Ltd.	447 & 467
Brown, S. G., Ltd.	457
Burne-Jones & Co., Ltd.	329
British Ebonite Co., Ltd.	453
Carrington Manfg. Co., Ltd.	455
Celestion Radio Co., The	462
Cossor, A. C., Ltd.	330
Climax Radio Electric, Ltd.	456
Caxton Wood Turnery Co.	451
Day, Will, Ltd.	456
Dublifier Condenser Co. (1925), Ltd.	459

Eastick, J. J., & Sons	Page 455
Edison Swan Electric Co., Ltd.	453
Electradix Radios	409
Electron Co., Ltd.	431
Ferranti, Ltd.	427
Forno Co.	439 & 453
Gambrell Bros., Ltd.	443
Garnett, Whiteley & Co., Ltd.	466
Grafton Electric Co.	469
Graham Ampflon, Ltd.	439
Hacker & Sons	464
Heyberd, F. C., & Co.	455
Igranic Electric Co., Ltd.	443
Jackson Bros.	454
Laker, J. & J., Co., Ltd.	463
Lissen, Ltd.	419 & 423
London Elec. Wire Co., & Smiths, Ltd.	455
Makerimport Co.	453
Metro-Vick Supplies, Ltd.	Cover iii
Morris, J. R.	470
Mullard Wireless Service Co., Ltd.	Cover li & 435
Maguvox Co. (U.S.A.)	453

"Popular Wireless"	Page 459
"Popular Wireless" Blue Prints	451
Peto-Scott Co., Ltd.	467
Pickett's Cabinet Works	470
Paroussi, E.	443
P.R. Masts	439
P.R. Valves	471
Press Exclusives	455
Raymond, K.	467
Radio Service (London), Ltd.	464
R.I. Varley, Ltd.	Cover iv
Rothermel Corp., Ltd.	458
Sifam Electrica., 1 Inst. Coltd.	464
Taylor, M.	460
Telegraph Condenser Co.	447
Wet H.T. Battery Co.	467
Wilkins & Wright, Ltd.	468
Woodbridge Radio Co., Ltd.	470
Wireless Constructor Envelopes	467
Wonderful Britain	45

All communications concerning advertising in "Modern Wireless" must be made to John H. Lile, Ltd., A, Ludgate Circus, London, E.C.4. Telephone: City 7261.

FOR ADVT. RATES SEE PAGE 451.



BRITISH TRI-COLOUR VALVES

THE 'STANDARD' OF COMPARISON

If you use Two-Volt Valves, why not use the best? "Cosmos-Met-Vick" Short-path Valves, in the 'tri-colour' styles, Blue Spot, Green Spot, and Red Spot, are, by virtue of their special construction, inherently more efficient than any valves built on stereotyped lines. Hundreds of testimonials support this statement. They have become a 'standard' with which other valves are compared.

For your High Frequency stage or Resistance coupling you want the S.P. 16/B Blue Spot, your Detector needs a Blue Spot or perhaps the S.P. 16/R 0.09 Amp. Red Spot. For Transformer or Choke coupling use the S.P. 18/G Green Spot. Your Last Stage Valve must be an S.P. 18/RR Red Spot.



Combinations of these S.P. valves will astonish you if you have not already had experience of them. If you are a constructor you will know, if not ask your dealer which 'Cosmos' (Met-Vick) Valve to buy for each stage. These valves are so sensitive and so full of kick and pep that you may require advice as to the type or types for your particular circuit.

Booklet 4117/3, which also gives particulars of S.P. 6-Volt Valves, and the remarkable 'Cosmos' (Met-Vick) A.C. Mains Valves, sent free on application.

MET-VICK

VALVES, COMPONENTS & SETS



METRO-VICK SUPPLIES LTD., 155, CHARING CROSS ROAD, LONDON, W.C.2.

R
V84

New Eliminator Components



SMOOTHING CHOKE.

The problem of producing efficient smoothing chokes to carry a heavy load without an appreciable fall of inductance has occupied the close attention of our Research Department for some considerable time. We have now solved this problem to an extent hitherto even unapproached. The new Smoothing Chokes which we have just marketed can carry the enormous current of 100 milliamperes without saturation, whilst the size, and therefore the price, has been kept within reasonable limits.

The extensive use of high power output valves calls for an eliminator capable of dealing with the necessary heavy anode current. Such current needs to be adequately smoothed, and the public have now available for the first time smoothing chokes which fulfil the necessary requirements, and which, owing to the special manner in which they are made, are procurable at a very reasonable price.

Price 21/-

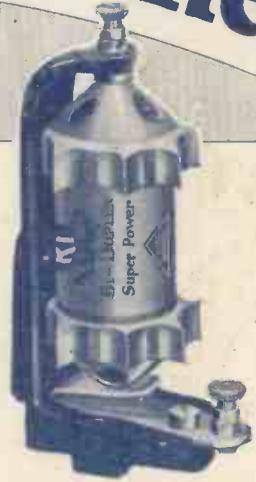

SUPER POWER RESISTANCE.

The series resistance method of adjusting the voltage in eliminators has proved so popular that we have specially designed a new form of resistance for this particular purpose.

These resistances are able to carry a heavy anode current without overheating, and special care has been taken in their design to deal adequately with any slight heat generated.

There are many other uses for these super power resistances which will appeal to the discerning amateur and professional radio engineer.

These resistances are made up as follows: 500 ohms to carry 50 milliamperes; 1,000, 1,500, 2,000, 2,500 and 3,000 ohms each to carry 30 milliamperes.

Price 12/9 each.

SPECIALISTS IN
H.F. AMPLIFICATION

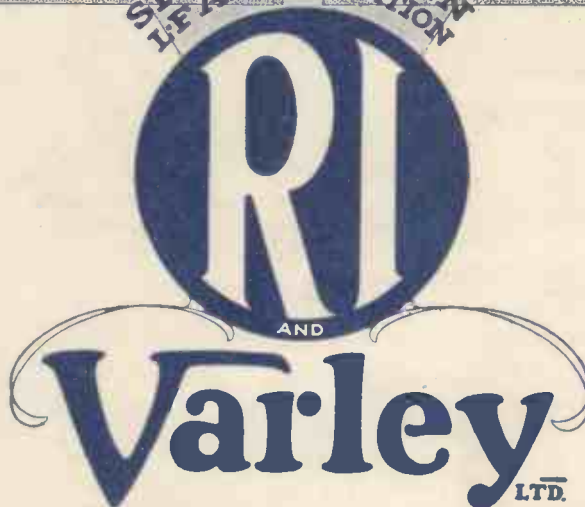

THE MARK OF BETTER RADIO

Kingsway House, 103, Kingsway, London, W.C.2.

Telephone: Holborn 5303.