

MORE ABOUT THE 1928 "SOLODYNE"

MODERN WIRELESS

1 1/2
MONTHLY

Edited by

NORMAN EDWARDS

M.I.R.E., M.R.S.L., F.R.G.S.

Vol. IX. No. 14.

FEBRUARY, 1928.



The "MUSIC MASTER"

BLUE
PRINT
FREE
WITH
THIS
ISSUE



EVERY RADIO WISH FULFILLED

by the
MULLARD
RALEIGH P.M.
Receiver

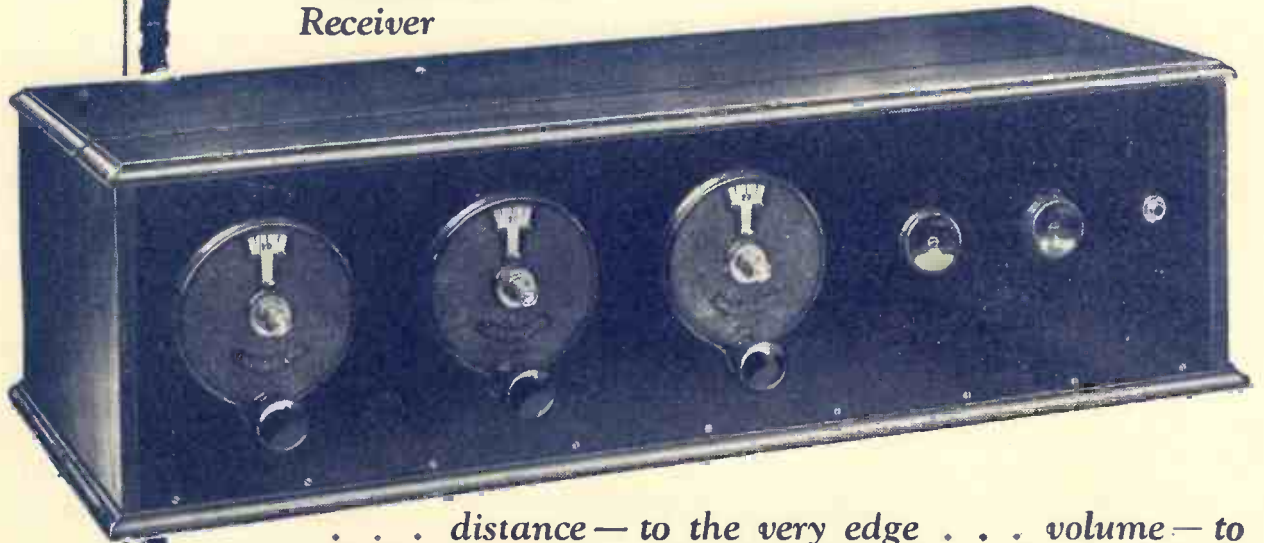

. . . distance — to the very edge . . . volume — to fill the house . . . purity — to give radio the breath of life . . .

"I must confess that the final test upon this receiver was a revelation in the capabilities of a five-valve receiver. So utterly simple to handle, it was extremely difficult to believe that a small aerial in Hampstead could bring in a matter of forty odd stations without the slightest demand upon tuning skill. It was infinitely easier to bring in those forty or more stations on this receiver than any reader would believe. I cannot recall a set which in any way approached it for volume and absolute ease of control. It is held that four valves constitute the ideal arrangement; but since this test I am convinced that every home constructor, after having had the opportunity to 'run over the dials' of a friend's Raleigh P.M., will find his ideal in this great set . . ."

"I have built countless sets, but now I have made a real set, viz. your wonderful Raleigh P.M. receiver! I am less than half-a-mile from the Stoke transmitter, but this no longer troubles me, and although I only completed the set last week I have logged 21 stations and there are many more to be brought in, I know. So selective is the set that I can get Stuttgart without a trace of Manchester although there are only 4 metres difference and Manchester is 35 miles away."

THE MULLARD RALEIGH P.M.

FREE To all who send this coupon to The Publishers, 63 Lincoln's Inn Fields, London, W.C.2, will be forwarded free, complete instructions, blue print, No. 4 RADIO FOR THE MILLION, to build this master receiver.

NAME.....

ADDRESS.....

Mullard MASTER · RADIO

CONTENTS

Vol. IX. No. 14

MODERN WIRELESS FEBRUARY, 1928

	Page		Page
Editorial	115	Remote Control and Loud-Speaker	
Potentiometer Positions	116	Extensions	159
Is 5 G B Worth While?	117	A Universal Short-Wave Set	163
Operating Loud Speakers	119	Insulation Facts and Fancies	167
What Readers Think	122	What Are Valve Curves?	169
The "Music Master"	123	The "DX" Four	171
A Note On Screening	128	Blind Spots	175
That M/I Factor	129	A Variable Tone Control	177
More About This Year's "Solodyne"	131	Another Filadyne Circuit	179
K F I—Giant of the West	135	Radio Abroad	182
Some New Rectifier Applications	137	Concerning The "Forty-Station" Four	184
Questions Answered	140	H.T. For Short-Wave Sets	186
The "Mercury" Seven	141	My Broadcasting Diary	187
On the Short Waves	148	Beam Radio	190
The Cape Town Broadcasting Station	149	In Passing	191
Steering By Radio	151	In Our Test Room	194
The "All-Turn" Crystal Set	153	Notes and News	198
Broadcasting in 1928	157		

Edited by NORMAN EDWARDS, M.I.R.E., M.R.S.L., F.R.G.S.

Technical Editor: G. V. DOWDING, Grad.I.E.E.

Scientific Adviser: J. H. T. ROBERTS, D.Sc., F.Inst.P.

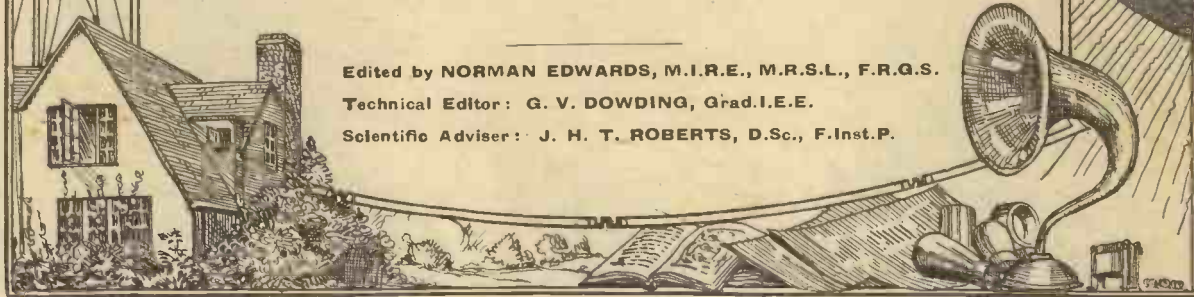

THIS IS THE CONDENSER Specified for the "MUSIC MASTER"

Eureka Loga-cyclic Condensers are specified because they make a Set so amazingly selective. Fit Eureka to your Set. Put Eureka on "point duty." See how it straightens out the traffic tangles of the air. Programmes which you have heard hitherto as confused snatches, cut short and jumbled up, file past in an orderly procession, station after station as you turn the dial. Made with such a nice accuracy, the Eureka Loga-cyclic gives you a feeling of control possible with no other condenser.

The Eureka Loga-cyclic Condenser (0005) 15/6.

ALSO SPECIFIED FOR THE "MUSIC MASTER."

The Eureka Concert Grand Transformer 21/-.

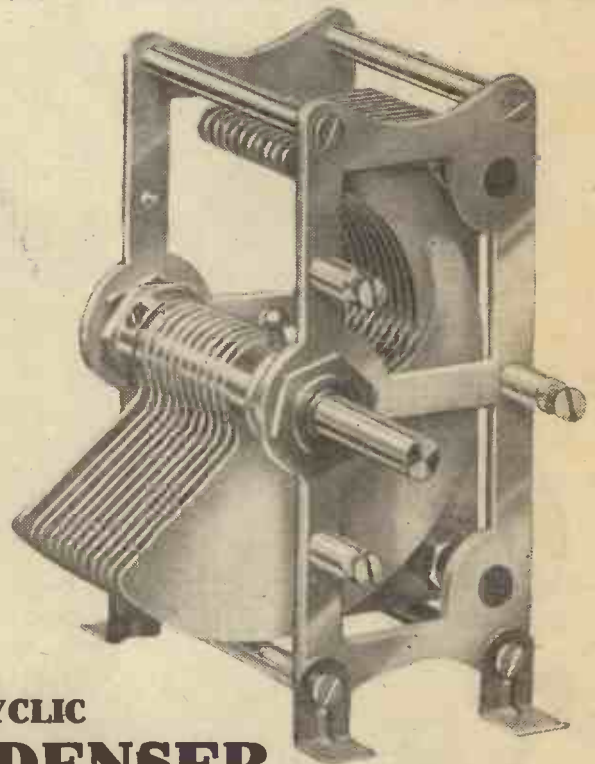

EUREKA

LOGA-CYCLIC CONDENSER

The Portable Utilities Co., Ltd., 8, Fisher St, London. W.C.1

**SAVE MONEY
BY USING
THE NEW**

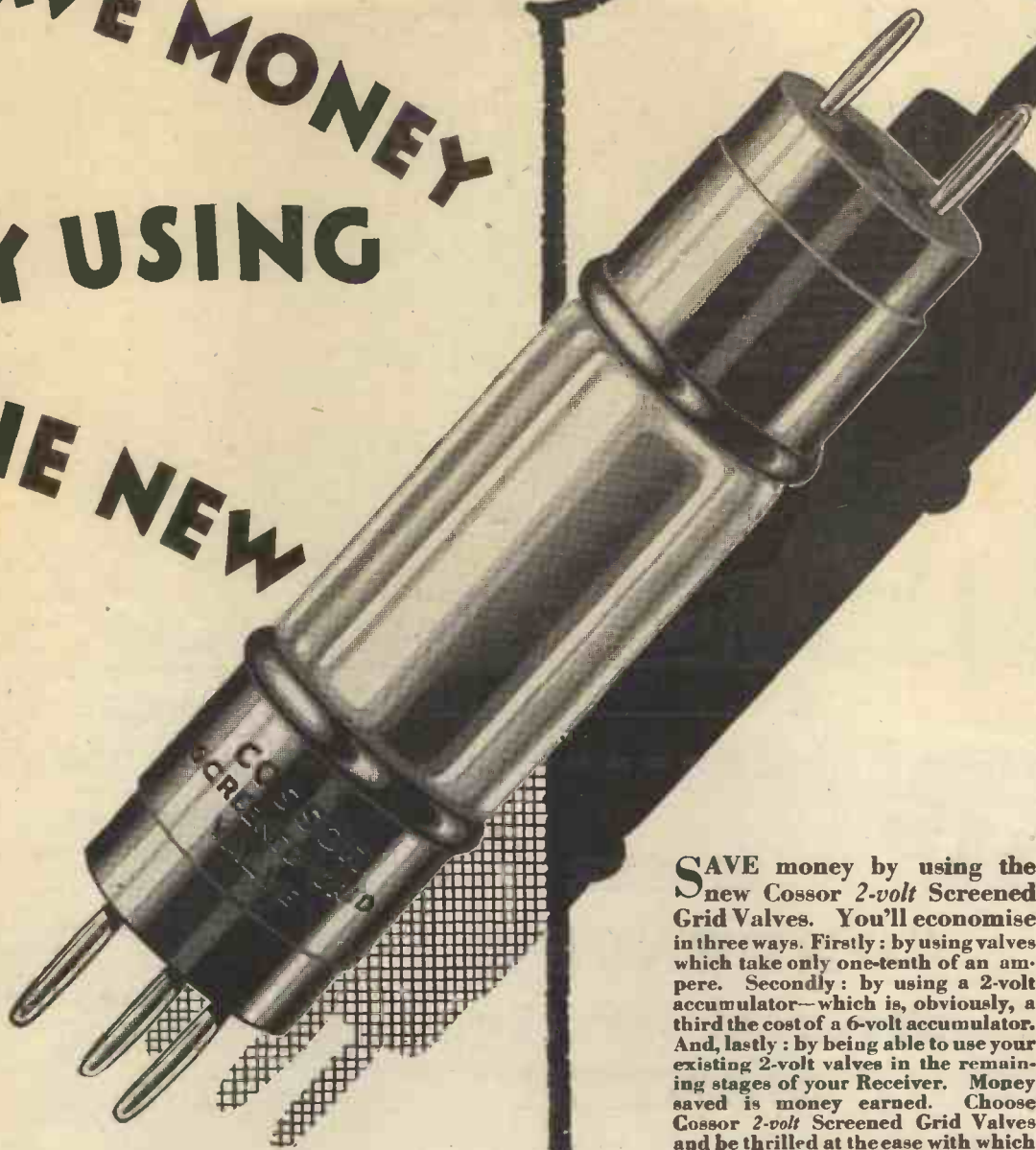

SAVE money by using the new Cossor 2-volt Screened Grid Valves. You'll economise in three ways. Firstly: by using valves which take only one-tenth of an ampere. Secondly: by using a 2-volt accumulator—which is, obviously, a third the cost of a 6-volt accumulator. And, lastly: by being able to use your existing 2-volt valves in the remaining stages of your Receiver. Money saved is money earned. Choose Cossor 2-volt Screened Grid Valves and be thrilled at the ease with which you'll be able to pick up distant stations at tremendous volume.

Price 22/6.

Also 6-volt type (consumption .1 amp) 22/6

**Cossor 2 VOLT
SCREENED GRID VALVES**

MODERN WIRELESS

Vol. IX. No. 14.

February, 1928.

A True Pioneer—Educational Broadcasting—A Magnificent Receiver.

A True Pioneer

FROM time to time we see in the newspapers—often in the form of a small paragraph, tucked away between an account of a murder and a report of a political speech—a note to the effect that it is the birthday of So-and-so, whose name and work posterity has good cause to revere.

Such a notice appeared two or three weeks ago in most of the newspapers—and in this particular case the “So-and-so” mentioned was Michael Faraday. Sir William Bragg had been giving a lecture on how wireless was born, and many people must have been surprised when they read reports of Sir William’s lecture and realised, for the first time, how two fundamental elements of wireless apparatus were Faraday’s distinct creation.

In 1821—at Christmas-time—Faraday ran upstairs to call his young wife to see a magnet turning round and round above an electrically charged wire—and soon after this he made an instrument which clearly showed how a current could be induced in one wire as the current rose or fell in another wire nearby.

The inductance and the condenser will always be associated with Faraday’s name—and whenever you operate a wireless set by adjusting inductance and capacity, you are merely putting into practice laws which Faraday worked out after many years of experiment.

The odd newspaper reports of Sir William’s lecture might well have reported it at greater length, for surely there is a wealth of interest and romance in hearing how a great electrical pioneer laboured, and succeeded, for the benefit of civilisation.

Truly, we do not know nearly enough about the work, and the lives, of our great men who spent their lives laying the foundations on which the modern science of wireless has been so splendidly built.

Educational Broadcasting

DURING 1927 the B.B.C. interested itself in the problem of educating listeners to a very considerable extent—in the opinion of many critics to an excessively considerable extent—and now that 1928 has dawned, it is anticipated that educational broadcasting, unless curbed and controlled, will figure with more than undue prominence in future programmes.

The Advisory Committee which the B.B.C. appointed, under the chairmanship of Sir Henry Hadow, has, after a year’s work, compiled a report which may possibly be

published before this issue of MODERN WIRELESS is on sale; and although we have not yet seen a copy of that report, we understand that it contains suggestions which, if adopted, will have revolutionary and far-reaching effects on the B.B.C.’s educational policy.

Whether this will definitely result in further encroachments on the entertainment programmes remains to be seen—but it is to be hoped that the B.B.C. will realise that, however seriously it takes itself and its self-appointed educational mission, a sense of proportion is eminently desirable, and that the popularity of broadcasting rests almost entirely on the quantity and quality of varied entertainment programmes broadcast from the B.B.C. stations.

Moderation in all things is a good saying. We hope Sir Henry Hadow’s report will show signs that this old saying has not been forgotten—and if it has we will at least hope that before adopting the recommendations made in the report, the B.B.C. will remember the saying and try not to forget it in future.

A Magnificent Receiver

THE details of the 1928 Solodyne which we published exclusively in our last issue are followed, in this number, with operating details and other data which, when studied by the amateur constructor, should enable him to build and successfully work a receiver *par excellence*.

Many excellent sets have been described during the last year or so, not only in this journal, and in its contemporaries, “Popular Wireless” and the “Wireless Constructor,” but in publications issued by several well-known wireless manufacturing firms.

In the latter cases, however, the sets have all been three-valvers; little has been done with regard to multi-valvers of the Solodyne class, and to some extent the amateur desiring a five-valve set has been neglected.

But the 1928 Solodyne more than supplies a long-felt want, and we would once more take this opportunity of urging our readers to give the closest attention to this receiver.

Should any reader of this issue who missed the January number containing the constructional details of the 1928 Solodyne wish to obtain a back number, he should write to the Back Number Department, Amalgamated Press, Ltd., Bear Alley, Farringdon Street, London, E.C.4, enclosing a P.O. for 1s. and postage fee, and thus secure a copy of an issue of this journal which offers details of the finest wireless set ever presented to the public.



POTENTIOMETER POSITIONS

Some hints on the practical employment of a useful component.

By A. S. CLARK.

PROBABLY the most frequent method of using a potentiometer is to stabilise an H.F. valve, or valves, when no method of neutralisation is provided. Fig. 1 shows the connections. Instead of the grid coil and the low-potential end of the grid condenser going direct to L.T. negative or L.T. positive, they are connected to the potentiometer slider. The grid can thus be given any potential desired, which provides a control of reaction, the valve becoming more prone to oscillate as the slider is moved towards the negative end of the potentiometer.

Detector Bias

It is always advisable to insert the .001 fixed condenser, shown dotted, so as to provide a path of low H.F. resistance across the potentiometer

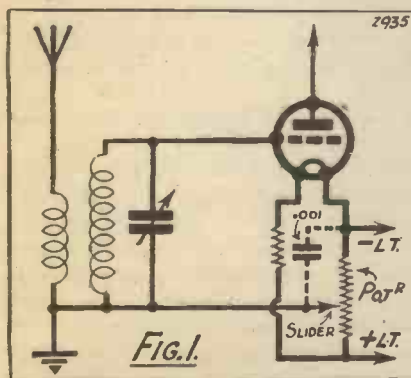

to the filament. When two or more valves are to be controlled in this manner, the low potential side of the grid coils or the grid leaks of the other valves are also connected to the potentiometer slider.

This method of stabilising is very useful for adding to sets with the old types of circuits, such as tuned anode,

tuned transformer, or aperiodic transformer coupling, especially when trouble from uncontrollable oscillation is experienced.

Although it is usually desirable with modern valves to connect the grid return of the detector valve to L.T.+ or the positive side of the filament, it is sometimes a definite advantage to give it a more negative potential. When the grid potential is more negative the selectivity is somewhat increased, but the chief advantage lies in obtaining smooth reaction control. The latter is an absolute necessity for good distant reception on small sets.

It will be realised that the potentiometer provides a convenient method of adjusting the grid potential of the detector valve. The connections are the same as for the control of an H.F. valve, with, of course, the addition of the grid leak and condenser. When the grid leak is not connected across the grid condenser, the bottom of the grid leak is connected to the potentiometer slider. In this case the shunting condenser across the potentiometer is not required.

Carborundum Crystals

Carborundum crystal detectors have certain definite advantages over the ordinary crystal detectors, chief of which is stability. They are very useful for reflex circuits. An applied potential is required across them, and Fig. 2, which shows such a detector before an L.F. amplifier, indicates how this is obtained. It will be seen that our old friend the potentiometer is once more employed.

In this case it is necessary to be able to have either a positive or a negative potential available at will. This is obtained by means of two small dry cells with a connection

made between them. The required effect can also be obtained with a centre-tapped potentiometer and one cell, but this type of instrument is not very common.

Volume Control

In all cases so far described a potentiometer of about 200 to 400 ohms is required, but in the case of a potentiometer used for volume control a minimum resistance of about 500,000 ohms is required.

The slider is connected direct to the grid of the last valve (see Fig. 2), the ends of the resistance of the potentiometer being connected across the secondary of the transformer.

In the case of a resistance-capacity-coupled stage the resistance of the potentiometer takes the place of the

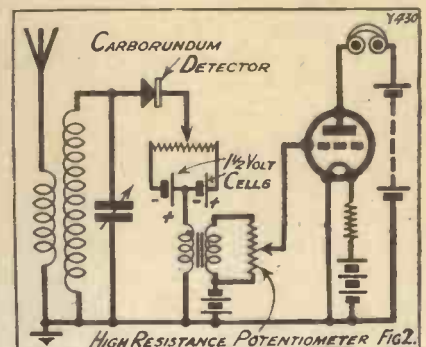

grid leak; the slider still being connected to the grid of the last valve. It will be obvious that the resistance of the potentiometer must be the same as that of the grid leak which it replaces.

INTERESTING RADIO FACTS

To improve the quality of S.B. programmes over land lines, the B.B.C. maintains repeater stations at Gloucester and at Leeds.

A new pamphlet on oscillation has been prepared by the B.B.C., and can be obtained free on application to any of their stations.

The masts of the famous old Poldhu station are now in use at 5 GB. (It was from Poldhu that Mr. Marconi sent his first signal across the Atlantic.)

Warnings of the approach of typhoons are now being broadcast along the Chinese coast, and many of the old Chinese junks have "junk" crystal sets to receive these.

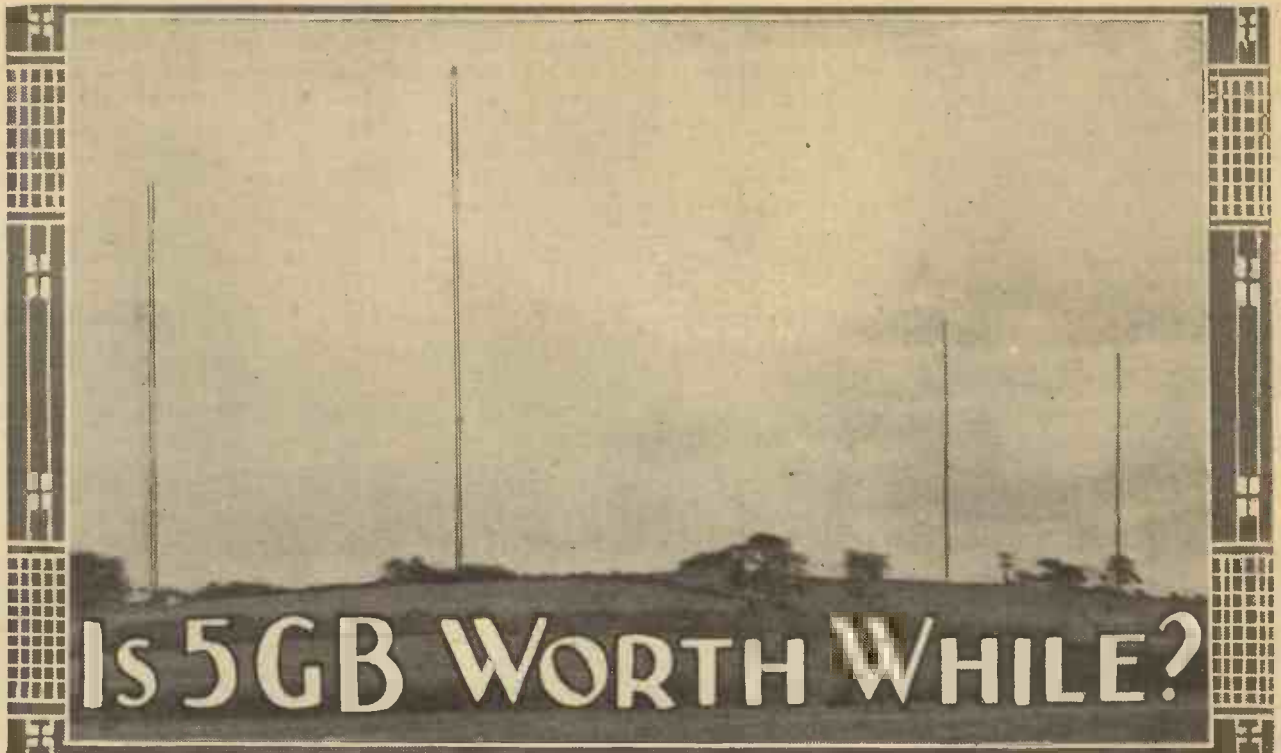

IS 5GB WORTH WHILE?

The reader himself must supply his own individual answer; the following trenchant article impartially outlines the present situation regarding alternative programmes.

By a Special Correspondent.

AFTER several months' working it should be possible now to draw some conclusions about the success or failure of the B.B.C.'s first large-scale experiment in alternatives.

The B.B.C. began with the formula "two programmes for the two average moods of the average listener." A little later they modified this to "contrast between the needs of the keen, receptive, concentrating listener and the needs of the tired, passive listener anxious to avoid any effort."

An examination of the programmes of 2 L O and 5 G B during the past few months shows that neither of these principles has been fully applied. To the extent to which the first formula was recognised, the experiment has been a success; but this, unfortunately, has been in a limited degree. There has been a steady encroachment of a tendency to differentiate in rigid classifications. Thus it would appear that chamber music is a standard contrast to symphony, symphony to jazz, and so on.

No Contrast

The result of differentiating in this generic way is that sometimes there is no actual contrast at all. Surely the programme builders at Savoy Hill know that many items of symphony

are indistinguishable from items of chamber, and, moreover, that there are striking parallels between some jazz and some symphony.

The moral of this is that contrast should not be arranged according to an artificial general classification, but

SAVOY HILL, PLEASE NOTE.

(Some extracts from the accompanying article.)

"Surely the programme builders at Savoy Hill know that many items of symphony are indistinguishable from items of chamber . . ."

"The ideally planned and produced radio programme should give artistic pleasure without demanding any conscious effort."

"... the present experiments are conditional, tentative, and partial."

"... the banning of 'talk' from 5 G B has been so warmly welcomed by listeners that the B.B.C. may well have to revise its future talks policy."

"If Savoy Hill must make sacrifices for prestige and highbrow 'eyewash,' let them do it on some obscure wavelength that no ordinary listener need tap."

"If Savoy Hill cannot get on with the alternative programme job, and solve it satisfactorily within a measurable period, then they had better throw in their hand and allow some other people to have a go."

rather according to the quality and character of the individual musical items. Until this is done the experiment in alternatives will not be artistically satisfactory. Also, the B.B.C. should hark back to the "two-moods" formula and abandon the "concentrationist" formula. The ideally planned and produced radio programme should give artistic pleasure without demanding any conscious effort. The B.B.C. should never admit the necessity of "concentration."

Too Much Talk

Of course, a serious handicap to the full success of the 5 G B experiment on the programme side is the fact that it has no fully contrasted programme with which to compare it. The 2 L O programme is partly contrasted; but then 2 L O continues to feed a large area which 5 G B does not reach. Therefore 2 L O must remain homogeneous and not specialist. Thus the present experiments are conditional, tentative, and partial.

Nevertheless, they have a very important bearing on the probable future of the Regional Scheme. For one thing, the banning of "talk" from 5 G B has been so warmly welcomed by listeners that the B.B.C. may well have to revise its future

talks' policy. The so-called "universal" programmes should certainly have a minimum of talk. If Savoy Hill must make sacrifices for prestige and highbrow "eyewash," let them do it on some obscure wave-length that no ordinary listener need tap. One of the international common waves has been aptly suggested.

Some critics belonging to the Cecil Lewis school of thought have been attacking alternatives, and suggesting that it would be better not to trouble to develop the contrast experiments. Their argument is that more concentrated programme effort at Savoy Hill would produce such a fine single set of programmes that in the end listeners would be better satisfied.

Get On or Get Out

They imply, of course, that the B.B.C. is incapable of producing double programmes of really first-rate quality. This is nonsense. If Savoy Hill cannot get on with the alternative programme job, and solve it satisfactorily within a measurable period, then it had better throw in its hand and allow other people to have a go.

It is confidently predicted that by the end of 1928 the new twin-wave, high-power London transmitter will be on the air. If so, what change will it involve? First of all, the closing down of the transmitter in Oxford Street, and probably also the stand-by transmitter at Marconi House. The change-over will naturally disturb thousands of listeners in the London area, and there is bound to be much clamour and misunderstanding.

But if the B.B.C. engineering side

maintains its efficiency record, the superlative advantages of the new transmissions should soon be recognised. Much depends on the actual site. Until recently it was generally understood that it would be in the south-east of London. But since the aggravation of the Midlands problem, it is believed that the site will be in the north.

the previous proposal of fusion with the north. With effective apparatus and full power the new London transmitter should give all the Home Counties, the South Coast, and part of the Midlands, good service on a double-programme basis. If the B.B.C. is wise it will make no radical alteration in the contrast scheme evolved on 5 G B and



A photograph of the main studio at Birmingham, from which many of the 5 G B programmes originate. This studio measures 55 ft. by 48 ft., and is one of the largest in the world.

The original idea of the B.B.C. was to tie Birmingham and the Midlands on to the tail of Manchester and the Pennines. But they had a shock at Savoy Hill when they realised the strength of opinion in the Midlands. So now the idea is to link Birmingham and the Midlands with London. While this is not satisfactory to the Midlands and may require supplementing, it is a great deal less objectionable than

2 L O. Let the experiment continue to run its course.

It is safe to assume that one of the London services will be largely musical. It is to be hoped that the talk on the other service will be vital and interesting. Thus the inauguration of the permanent London twin-wave transmitter should be made the occasion of the introduction into British broadcasting of the full measure of controversy. It would mean a big boost for radio in and round the metropolis if there were, say, three debates a week on the subject uppermost in the public mind. It would not matter how relevant to burning issues these subjects were.

Trained Talkers

So far as the average run of talks are concerned, most of these should not find a place in the new scheme of things. Anyway, most of the outside speakers should be permanently excluded from the microphone. The B.B.C. should begin at once to recruit and train a small, select corps of "talkers" as distinct from announcers. These talkers would handle the talks of all those "authorities" whose halting performances at the microphone now completely spoil the effect of their efforts and bring them into considerable personal disrepute.

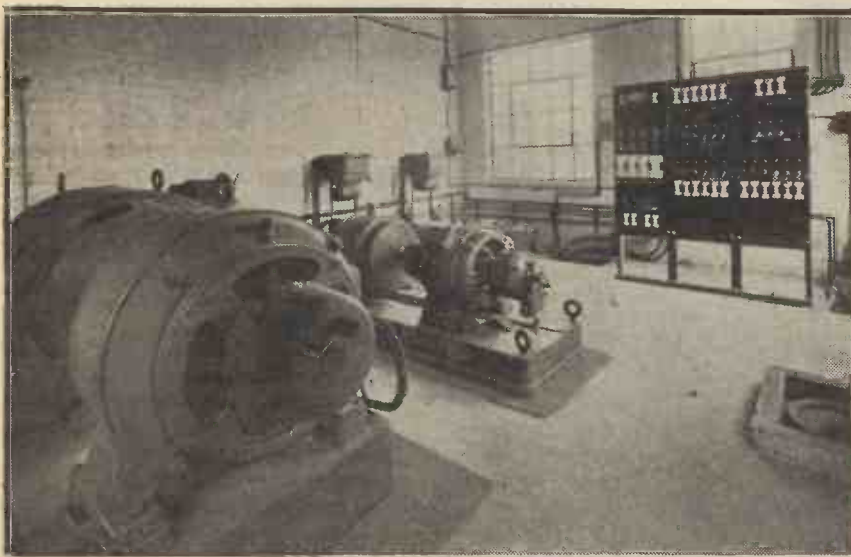

The "machine" room at Daventry, 5 G B. The largest generator provides an output of 10,000 volts D.C., and has a rating of 45 kw. We believe it is the only generator of its kind in the country. It runs silently and with practically no sparking.

OPERATING LOUDSPEAKERS



The performance of an otherwise perfectly designed receiver may be spoiled by the use of an unsuitable

loud speaker, or by an incorrect method of coupling it to the set.

By F. C. TOPHAM, A.M.I.E.E.

IN the writer's opinion direct connection of the loud speaker in the last anode circuit of a power full receiver should be regarded as obsolete. All such receivers, irrespective of their intended scope, should incorporate a loud-speaker coupling unit (commonly referred to as a filter circuit), the correct valve

anode circuit of the last valve, as shown in Fig. 1a. One would expect to find good reason for this practice, but apart from the fact that it is simple and inexpensive, there is little to be said in its favour.

Considerable capacity effects may occur between leads or to earth, more particularly if extension leads are used.

Further Disadvantages

(c) Different loud speakers have widely different characteristics and their impedances may not be the best for the valves employed. The ohmic resistance of the high-resistance type of instrument may be anything from 700 to 4,000 ohms, and the higher values may cause distortion due to the drop in anode volts and consequent overloading of the valve.

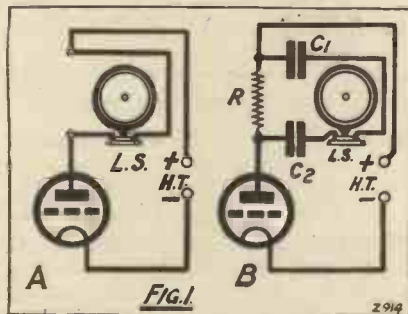

The disadvantages of the method are:

(a) The windings carry the full plate current of the last valve, which may cause distortion due to saturation of the iron core of the speaker. Also the speaker must only be connected the right way round, in order that its magnetic system shall not be affected adversely.

(b) The windings are at a high potential, and this, in conjunction with (a), may cause breakdown.

(d) The low-frequency variations pass through the H.T. supply, which may cause oscillation. This is of

for use with same being specified. In this way the efforts for good reproduction which have been made in other components of the instrument will not be wasted.

This final link is equally as important as the remainder of the instrument, and the performance of an otherwise perfect design may be spoiled by the use of an unsuitable speaker or an incorrect method of coupling same. As far as commercial sets are concerned, the small extra cost of a proper unit will be compensated for by the customer's increased satisfaction.

Faults of Direct Output

A recently published analysis of modern commercial sets shows that about 84 per cent provide for direct connection of the loud speaker in the

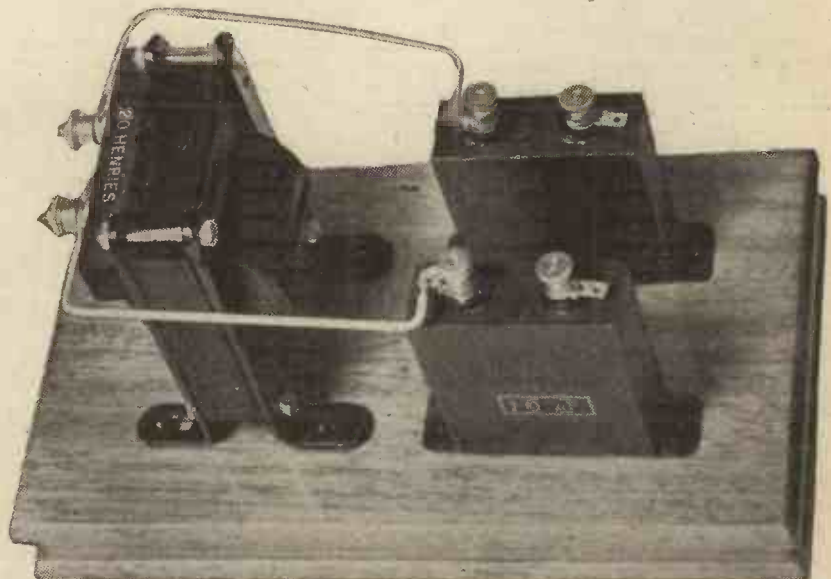

The component parts of a loud-speaker coupling unit. The choke must have sufficient inductance, low D.C. resistance, and must be capable of passing a reasonable plate current flow without saturation or serious loss of inductance. The coupling condenser should not be smaller than 1 mfd.

special importance with the increasing use of battery eliminators.

There are several alternative methods of connecting the speaker in a manner which will obviate some or all of the above faults, and three of these are indicated in Figs. 1b, 2c, and 2d.

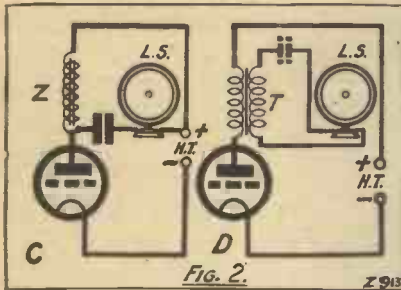

[NOTE.—Unless otherwise stated, this article deals only with ordinary high-resistance speakers.]

This method is but little used, and will be dealt with very briefly. In Fig. 1b, R is a resistance whose value should be high compared with the impedance of the valve or loud-speaker windings. The audio-frequency variations will set up varying potentials across the resistance, causing corresponding currents to actuate the speaker via the condensers C₁ and C₂.

Loss of H.T. Voltage

The advantage of this arrangement is that since R is non-inductive all frequencies will be amplified to an equal extent, and the reproduction should be distortionless. The disadvantage is that as the value of R is

ohms multiplied by the current in amperes flowing through it. A brief consideration will show that with currents of the magnitude used in a modern power valve, the economical limit in resistance is soon reached. This is indicated in Fig. 2c, and as it is the most important method will be treated at some length.

Choke Coupling

In place of the previous resistance we have an iron-core choke coil Z, of high impedance, coupled to the loud speaker through a condenser C.

The impedance (Z) of a choke coil is made up of ohmic resistance (R) and reactance (2πnL), where n is the frequency and L the inductance in henries. It is given by the formula :

$$Z = \sqrt{R^2 + (2\pi nL)^2}$$

In a well-designed choke, R is small and may be neglected in comparison with the reactance. For practical purposes, therefore, we may consider the impedance as consisting of reactance only.

The varying audio currents will set up potentials across the impedance, thus causing currents to flow in the loud speaker exactly as described with resistance coupling. We see, however, from the formula 2πnL that the impedance increases with the frequency, and, at first sight, our knowledge of the ordinary resistance-capacity coupling may lead us to suppose that a low-frequency note will set up a smaller voltage than

resistance of the valve, and the amplification obtained will be almost that of the amplification factor of the valve. This can be seen from the following formula, where M is the amplification, M₀ the amplification factor of the valve, and R_v the A.C. resistance of the valve :

$$M = \frac{2\pi nL}{\sqrt{R_v^2 + (2\pi nL)^2}} M_0$$

The great advantage of choke coupling is that a uniform amplification over the important range of frequencies is obtained with a small ohmic resistance in the plate circuit. It is, therefore, economical, since the small voltage drop will permit the use of a normal H.T. battery.

Inductance Values

The value of inductance required is not critical, but should not be less than 20 henries, particularly if one

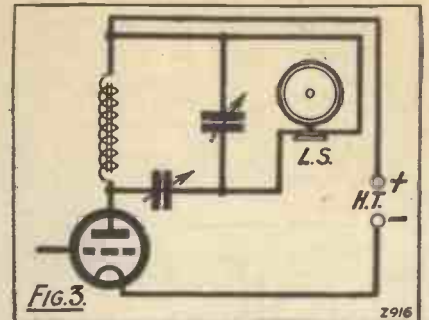

is using a loud speaker which responds well to low frequencies. It may be considerably in excess of this value. A low A.C. resistance valve will give good results with an inductance of smaller value than would be necessary with a high-resistance valve, for reasons which should be obvious. The D.C. resistance of the choke should not exceed 400 to 500 ohms.

Avoid Inferior Chokes

(The loud-speaker windings themselves have an impedance which varies with the frequency, and this variable reacts, to some extent, on the behaviour of the whole circuit. In order to simplify matters, however, we have neglected this effect.)

Readers should beware of inferior chokes, of which there are several on the market, alleged to have been designed for use in loud-speaker filter circuits. These have a high resistance and low inductance and will cause poor reproduction. From what has been said it will be appreciated (although not always by the user) that such a choke may by-pass the lower

TABLE 1.

Frequency	50 henries, 450 ohms.			15 henries, 2,000 ohms.		
	Reactance ohms	Impedance ohms	Amplification	Reactance ohms	Impedance ohms	Amplification
10	3,142	3,178	2.38	943	2,211	1.52
25	7,854	7,866	3.21	2,356	3,090	1.95
50	15,710	15,710	3.41	4,713	5,119	2.61
100	31,420	31,420	3.46	9,426	9,636	3.15
200	62,850	62,850	3.49	18,850	18,950	3.40
300	94,260	94,260	3.5	28,280	28,340	3.43
500	157,100	157,100	3.5	47,130	47,180	3.48
1,000	314,200	314,200	3.5	94,260	94,300	3.49
2,000	628,400	628,400	3.5	188,500	188,600	3.5
5,000	1,571,000	1,571,000	3.5	471,300	471,300	3.5
10,000	3,142,000	3,142,000	3.5	942,600	942,600	3.5

increased the H.T. battery must be also increased in order to maintain the correct voltage on the anode. If this is not done, distortion may occur due to overloading of the valve.

The voltage drop along the resistance is equal to the resistance in

one of high-frequency, and thus cause a smaller response in the loud speaker.

To a limited degree this is correct, but except at very low frequencies (below the range of the average speaker), and assuming the inductance is fairly high, the impedance is always large compared with the A.C.

frequencies, and also cause the valve to work on too low a voltage.

Choke Values

One of the best chokes upon the market has a resistance of 450 ohms and an inductance of 50 henries. In order to illustrate what has been said we have compared this with a poor choke having a resistance of 2,000 ohms and an inductance of 15 henries. In each case we have assumed the use of a Marconi D.E.P.240 valve, with 120 volts on the anode and about 15 volts grid negative. The anode current will be about 9 millamps. and it will be obvious that a much larger H.T. battery will be required when using the inferior choke in order to maintain the valve at the correct working point. The A.C. resistance of the valve will be about 3,000 ohms, and its amplification factor 3.5 approximately.

The theoretical values of the reactance, impedance, and amplifica-

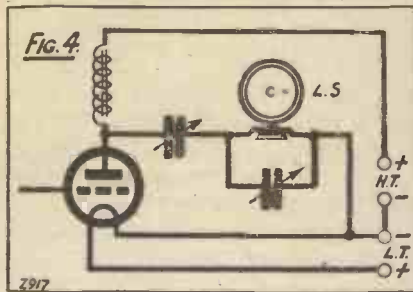

tion obtained with each choke is shown in Table 1.

We see from Table 1 that in the case of the 450-ohm choke we may consider the resistance as negligible, and base our calculations of amplification upon reactance only, but with the inferior unit this cannot be done until the higher frequencies are reached. Furthermore, the amplification of the low frequencies is less in the latter case.

Avoiding Saturation

Stress has been laid upon the fact that the figures which we have obtained are theoretical only. In practice every choke has a certain self-capacity and, speaking generally, this will increase with the resistance or inferiority of the unit. Even if the design is upon the right lines care must be taken that an increase in inductance is not made at the expense of self-capacity.

Now the reactance of a condenser decreases as the frequency increases and thus acts in opposition to the inductive reactance. Therefore, with a poorly designed choke the actual

impedance at high frequencies may become small, resulting in a fall in amplification.

The purchaser of a loud-speaker choke should make certain that the iron core is of generous proportions. If this is too small the steady valve current will cause magnetic saturation. Even partial saturation will cause distortion owing to the fact that the various signal amplitudes will not be amplified to the same extent. It is for this reason that the advice sometimes given to use interval transformers as chokes is bad.

Output Transformers

When complete isolation of the speaker is desired an output transformer T may be employed as shown in Fig. 2d. For ordinary H.R. instruments it should have a ratio of one to one, but for L.R. speakers (with which a transformer is essential) it should step-down in the ratio ten to one. Many people prefer the last-named combination, particularly for loud-speaker extension work, as the secondary circuit is at a low potential throughout and there are no capacity effects to produce distortion.

If a low-resistance moving-coil speaker is employed (say of about 100 ohms) the step-down ratio should be about twenty-five to one.

The selection of a transformer should be governed by rules similar to those described for a choke—namely, the primary should have a high inductance with a low resistance, the iron core should be large, and the windings robust to avoid breakdown. In addition, the self and mutual (between windings) capacities and the magnetic leakage must be low. High leakage will unduly augment high notes.

There exists an erroneous impression that the use of a transformer will

increase the strength of signals; but, of course, this is impossible, as the power available remains unchanged by any transformation ratio.

It is a matter of personal choice whether one coupling condenser (Fig. 2c) is used or whether one is

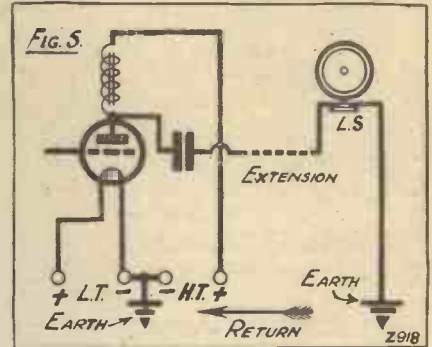

placed in each lead (Fig. 1b) to the choke. The difference in the results is negligible, and one condenser, preferably having a mica dielectric of from 0.25 to 0.5 mfd., will transfer efficiently all frequencies. Some designers prefer higher values; and the B.B.C. Quality receivers, for example, employ 4 mfd.

Pitch Control

As the coupling condenser is decreased its impedance increases, and below a certain value it will offer an appreciable resistance to the lower frequencies. Hence by using a condenser variable in steps, say from 0.05 mfd. upwards, we can control the amplitude of the low notes, causing the high notes to predominate. The speaker will then appear high-pitched. If transformer coupling is used the control condenser may be placed in series with the secondary winding, as shown dotted in Fig. 2d.

The amplitude of the high notes may be reduced by shunting the loud speaker with a condenser variable

(Continued on page 208.)

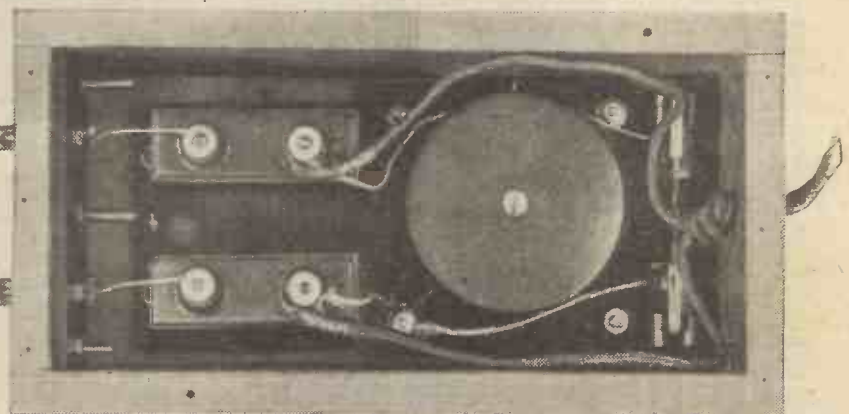

The leads from the set are connected across the choke coil, the direct plate current flowing through this from the plate of the last valve to the H.T. battery. The L.F. variations are impeded by the choke, and find their outlet via the two large condensers connected to the terminals, to which the loud-speaker leads have been connected.



WHAT READERS THINK

The "Sferavox"

SIR,—Our attention has been drawn to a note under the heading of "In Our Test Room," on page 666 of your issue of December, 1927, dealing with the New Sferavox Loud Speaker. In the interest of your readers, especially those who are in the wireless trade and who anticipate dealing in this loud speaker, we think that possibly the following facts should be made public.

The "Sferavox" is manufactured by the Société Française Radio Electrique, of Paris, against whom the Lektophone Corporation of America (acting through Compagnie Générale des Machines Parlantes Pathé Frères, of Paris), the owners of the patent covering the original type of "Sferavox," brought an action in the French court, which was won in the court of first instance, and is now for appeal. Following on this action, the S.F.R. changed their design to the present type which, however, is an infringement of the patents owned in France by our associated company, Le Matériel Téléphonique of Paris. Further, the new type of "Sferavox" as now being marketed is an infringement of the British Patent 231,798 (and others) owned by this company in this country. Actions have already been started by this company against two importers of the "Sferavox" loud speakers, and we reserve our right to attack all others dealing in, or using such, loud speakers.

Yours faithfully,
H. A. P. DISNEY
(Secretary).

Standard Telephones
and Cables, Ltd.,
London, W.C.2.

The European Five

SIR,—I have built your European Five, and it is, without exception, the best set I have made or handled. It's range and power are exceptional, and the tone is as good as any I've

heard. I am using a Ferranti A.F.5 in the first stage, and an A.F.4 in the second, and one of the new Lewcos three-coil units. I have received the following stations on a large speaker: Manchester, Liverpool, Stuttgart, 2 L O, Stamboul, Cardiff, Bournemouth, Dublin, Belfast, Newcastle, Lyons, 5 G B, Berne, Dortmund, Toulouse, Hamburg, Glasgow, Langenberg, 5 X X, Motala, Hilversum,



WIRELESS AID FOR AEROPLANES.

This American inventor has constructed the apparatus shown as an aid to safe flying. It contains a microphone which picks up the noise of a plane flying 1,000 ft. up, and this automatically operates a relay that controls the switches turning on the current for flood-lighting. In this way the presence of a plane automatically lights the air-port ready for landing.

Kalundborg, Radio-Paris, Milan, Hanover, Cologne, Katowitz, Zeesen, Vienna, Frankfurt, San Sebastian, Breslau, Malmo, Berlin (Witzleben), Nürnberg, Dublin, Belfast, Prague, Madrid (Union Radio), Leipzig, Barcelona. And on the 'phones: Warsaw, Moscow, Brussels, Kiel. In addition

to these there are five or six unidentified transmissions. Thanking you for a splendid set.

Yours faithfully,
JOHN R. WHITE.

S. Wales.

Wiring a Receiver

SIR,—I was very interested in your article on "Wiring a Receiver." Regarding the joining of a wire to a terminal, I would suggest that the type of joint shown at D in the photo, and marked weak and not recommended, is probably as strong as any, and unquestionably the neatest. I have always used this method, and if the end of the terminal be slightly countersunk with the point of a drill the joint will be perfectly strong.

I enclose one which I have just made, from which you will see the wire has actually broken before the joint will give way.

Thanking you for much useful information got from time to time from your most interesting publication.

I am, yours faithfully,
C. G. FRASER.

Aberdeen.

TECHNICAL EDITOR'S NOTE:

Examination of the terminal forwarded by Mr. Fraser shows that although the wire was taken to the terminal "end on" (as illustrated at D, on page 55, MODERN WIRELESS, January issue), the joint formed there was a perfect one.

The tip about countersinking the end of the terminal is a good one. We hope that other readers will profit by it, and if they have similar useful hints we shall always be pleased if these are mentioned in letters to the Editor, so that they can be passed on to all interested in the great game of radio.



Quality of reproduction is one feature of this set. In addition it brings in plenty of different programmes on the loud speaker, it is easy to build, and, for a powerful receiver, it is uncommonly cheap.

Designed and Described by W. JAMES.

THERE have been so many good three-valve receivers described in the papers from time to time that one would think it well-nigh impossible to produce a set having novel features. But I believe the set illustrated here to be worthy of description. Great care has been taken to get the circuit values quite right, and the parts have been arranged for ease of assembly.

and 900 to 2,000 metres. The short-wave coil has a tap for the aerial which may be connected directly to the tap, or through a .0001 fixed condenser.

The aerial coil is tapped in this manner in order to provide adequate selectivity with a maximum of signal strength. Naturally the position of

the tapping is an important one, for if this is too near the earth end of the coil the set will be extremely selective, but the volume will not be so great. If, on the other hand, the tapping is too near the grid end of the coil, the tuning will be much broader.

The best position for this tapping will depend upon the size of your

A FREE BLUE PRINT of
THE "MUSIC MASTER"
is enclosed in this copy of
"MODERN WIRELESS"

The circuit is not a new one, by any means. It comprises a valve detector with reaction (see Fig. 1), which is resistance-coupled to the first low-frequency stage. This, in turn, is transformer-coupled to the output power valve.

A single plug-in coil of the single-layer type is used for tuning. One is used for the short-wave broadcast band and another for the long-wave. The tuning ranges of the coils described are from 200 to 600 metres

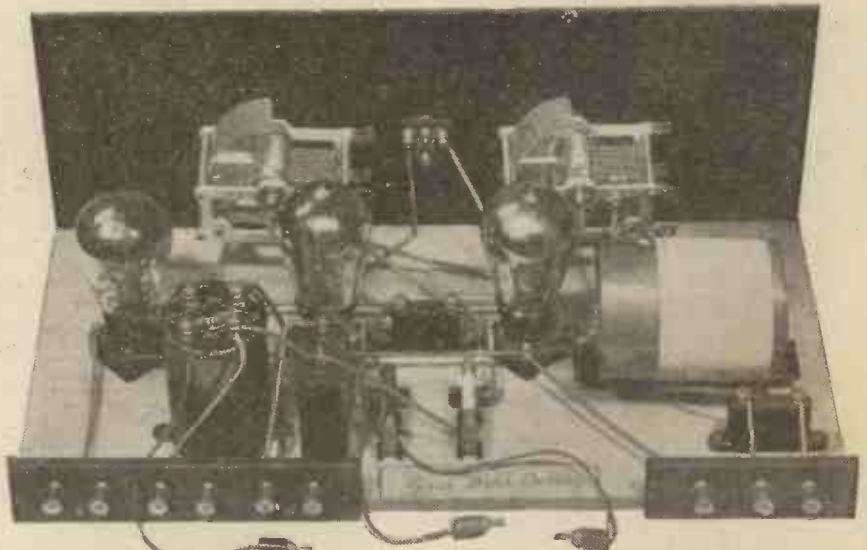

This view of the rear of the set when removed from its cabinet shows practically all the components. A full list of these, embodying suggestions for the prospective purchaser, will be found upon the next page.

aerial and where the set is to be used, relative to a broadcast station. The coil actually has a total of 55 turns. This should be tapped at the fifteenth turn when the utmost selectivity is not desired, but those who use a full-sized outdoor aerial, at a place within three or four miles of a main station, should try a tapping at 10 turns. If a small aerial or an indoor one is used, within about four miles of a main station, the aerial should be tapped at the fifteenth turn. Those who live ten to fifteen miles from a main station, and use a rather small aerial, should tap the coil at the twentieth turn.

Purity of Reproduction

The circuit is, of course, more selective when the aerial is connected to position A₂, for then a .0001-mfd. fixed condenser is included in the circuit.

In order to obtain the maximum purity the grid condenser has been given a value of .0002 microfarad, and the grid leak is of 2 megohms. If the grid condenser had been made of smaller value, the effectiveness of the rectifier would have been reduced on the longer wave-lengths.

In the anode circuit of the detector is a .25-megohm resistance of the grid leak type. Connected across the anode and filament is the reaction condenser and reaction coil, this coil being wound at one end of the aerial coil. No choking coil is used in the anode circuit, the impedance of the reaction circuit to high-frequency currents being quite low compared with that of the remainder of the anode circuit.

A coupling condenser between the first and second valves of .002 microfarad is used, with a grid leak

of 2 megohms. This combination passes 80 per cent of a note of 50 cycles; if the condenser had been

The photographs show the appearance of the finished set. On the front panel are two tuning

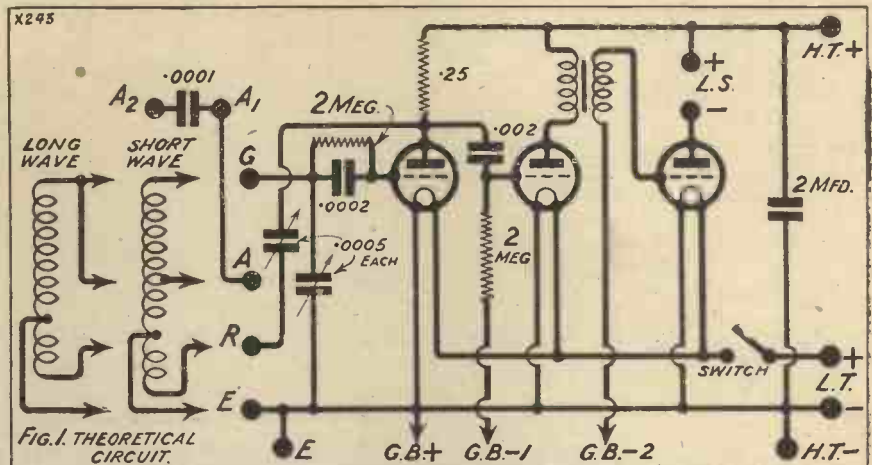

In essentials the set is a Det. and 2 L.F., with condenser-controlled reaction. Of all the possible circuits this is the most popular one.

one of .003 microfarad, only 10 per cent of a 50-cycle note would have been lost.

The second valve is coupled to the power stage through a transformer of good design, which passes the low notes very well, and gives a slight emphasis of the higher notes when used with a valve having an impedance of about 20,000 ohms. This is a most desirable combination, for no matter how carefully a detector is designed, there is some loss of notes of the higher audio-frequencies.

Components Necessary

A common high-tension is used; different values for the various valves are not required. There is one 2-microfarad by-pass condenser across the high-tension. No filament rheostats are fitted, because modern valves do not require them. There is a simple filament "on" and "off" switch.

condensers with a filament switch in the centre. The remainder of the parts, including the grid battery,

COMPONENTS REQUIRED.

- 1 Panel, 13 in. x 7 in. x 1/4 in. (Original is Resiston. Any good branded material).
- 1 Cabinet to fit, with baseboard 9 in. deep (Areraft, Bond, Camco, Caxton, Makerimport, Pickett, Raymond, etc.).
- 3 Valve holders (Originals are Bowyer-Lowe "Whiteline." Any other good make can, of course, be chosen, e.g. Benjamin, Bowyer-Lowe, B.T.H., Burndept, Burne-Jones, Igranie, Lotus, W.B., etc.).
- 1 .0001 fixed condenser (Clarke, Dubillier, Goltone, Igranie, Lissen, Mullard, T.C.C., etc.).
- 1 .0002 fixed condenser (Ditto).
- 1 .002 fixed condenser (Ditto).
- 2 2-meg. grid leaks (Ediswan in original set. Any good make).
- 1 .25-meg. grid leak (Ediswan in original set. Any good make).
- 2 Grid-leak holders.
- 1 2-mfd. Mansbridge-type condenser (T.C.C. in original set. Other good makes are Dubillier, Ferranti, Hydra, Lissen, Mullard, etc.).
- 1 L.F. transformer (Eureka "Concert Grand" first-stage type in original set. Any good make of low ratio).
- 2 .0005 mfd. variable condensers (Eureka "Loga-cyclic" in the set illustrated. Any good make).
- 2 Dials to suit, and 2 dial indicators.
- 1 On-off switch.
- 9 Terminals.
- 2 Terminal strips, 7 1/2 in. x 1 1/2 in., and 4 1/2 in. x 1 1/2 in.
- 2 Tubes of good insulating material, 4 in. long, 3 in. diameter (Original tubes are Radion).
- Ebonite for coil base, and plugs and sockets, wire, etc.
- 1 or 2 9-volt grid-bias batteries.

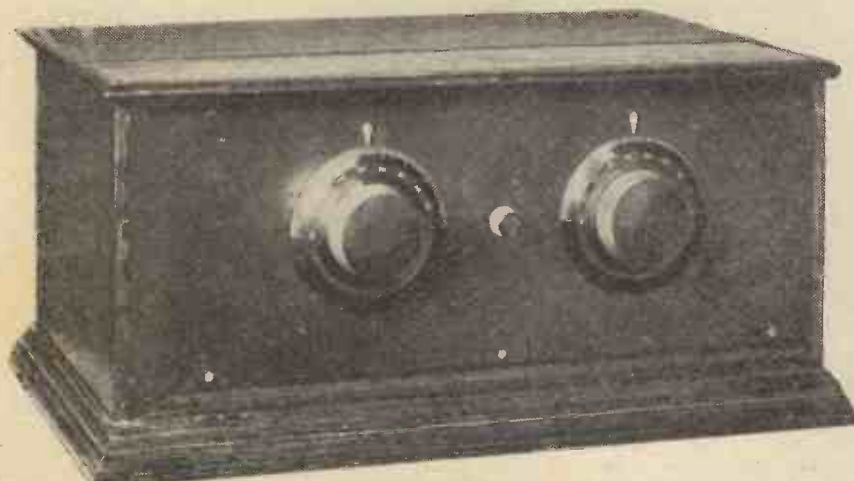

The dial on the left controls the tuning, that on the right reaction. In the centre is the on-off switch that puts the set in or out of action at a touch.

are mounted on the baseboard. To build the set you will require the parts mentioned above.

The two tuning condensers and the battery switch are mounted on the panel as indicated in Fig. 2. All three components are of the one-hole fixing type, although the two

using two small pieces of wood or ebonite in order that the ends of the sockets shall not touch the baseboard. The sockets should be provided with nuts.

on a number of turns until you come to the point where the tap for the aerial has to be taken. As I have already explained, the best position for this tapping will depend upon the size of your aerial and its distance from a broadcast station. The tapping will be taken either at 15 or 20 turns from the earth end of the coil, that is, at 35 or 40 turns from the grid end from which we have commenced winding.

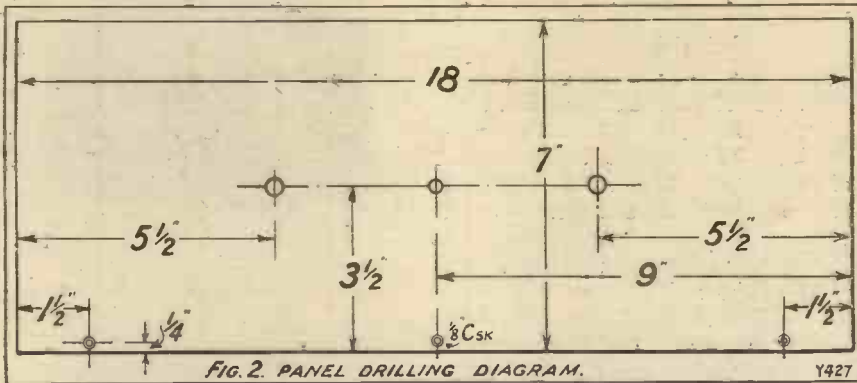

FIG. 2. PANEL DRILLING DIAGRAM.

Y427

Apart from fixing screws, only three holes need be drilled in the panel.

tuning condensers can be fixed at three points if desired. Along the bottom edge of the panel three small holes have to be drilled to take wood-screws, and when dial indicators are to be fitted, two further small holes will have to be made. The remainder of the parts are fastened on the baseboard; the three valve holders shown in Fig. 3 will be easily recognised, as well as the coupling transformer and 2-microfarad by-pass condenser. The parts used have their values marked in Fig. 3, and there should be no mistake in properly arranging them.

It is necessary to make two terminal strips. These are shown in Figs. 4 and 5. One comprises a piece of ebonite 7 1/2 in. long by 1 1/2 in. wide.

This is drilled to take six terminals; two of these are for the low-tension battery, two for the high-tension battery, and two for the loud speaker. The smaller terminal strip measures 4 1/2 in. by 1 1/2 in., and has three terminals, two of them being alternative positions for the aerial, and the other for the earth. These two strips are screwed to the back edge of the baseboard.

The Coil Holder

The only other component fastened to the baseboard which has to be made is the coil holder. This is a piece of ebonite 5 in. long by 1 in. wide; 3/8 in. from each end drill a hole for a wood-screw. Three-quarters of an inch from one end drill a hole to take a valve or other convenient socket. At the other end of the strip three sockets have to be fitted. One of these is 3/4 in. from the end of the strip, and the other two are spaced by 3/8 in. This strip should be raised above the baseboard by about 1/2 in.,

The two coils should now be constructed. Two suitable formers 4 in. long by 3 in. in diameter are required, and both of them should be fitted with four valve legs, as shown in Fig. 7. Be sure and put them in a straight line and make them fit the coil base mounted in the set. A soldering tag or a pair of nuts should be provided on each pin.

Determining the Aerial Tap

The short-wave aerial coil has 55 turns of No. 20 D.S.C. The winding is commenced at the end of the coil connected to the grid. This is the end of the coil having only the one pin. Drill a small hole in the former near this pin, and fasten the end of the wire either by soldering to a terminal tag or by bolting it. Now wind

Reaction and Long Waves

If you propose to try a tap at the thirty-fifth turn from the grid end, when you have wound on 35 turns you will make a hole in the former and draw a loop of wire through, and fasten it to the inside pin marked A in the drawing of Fig. 7.

The winding should now be continued until the full 55 turns have been wound on, when another hole should be put in the former and the end taken to the outside pin which is

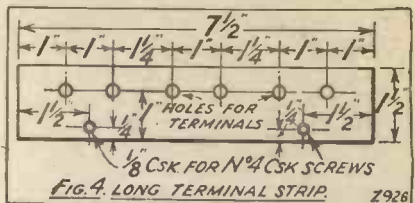
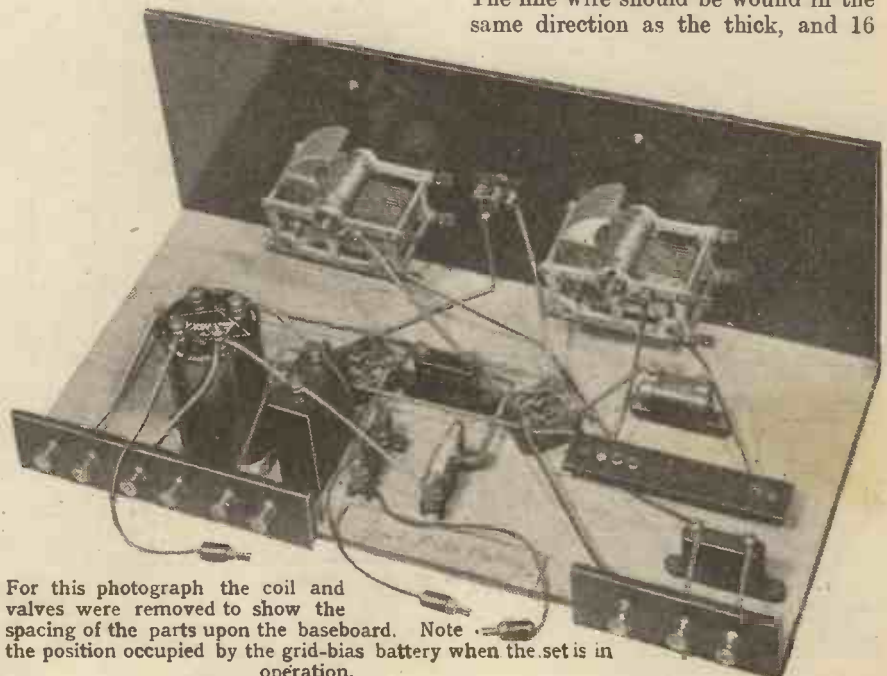

FIG. 4. LONG TERMINAL STRIP.

Z926

marked E in the diagram. You now have to wind the reaction coil, which is of No. 34 D.S.C. Thread one end of this wire through the hole which you have just drilled and join the end to the outside terminal marked E.

There are thus two wires joined to the outside pin of the coil, one being of No. 20 gauge, and the other of 34. The fine wire should be wound in the same direction as the thick, and 16



For this photograph the coil and valves were removed to show the spacing of the parts upon the baseboard. Note the position occupied by the grid-bias battery when the set is in operation.

turns should be put on. The end is taken through a hole in the former and connected to the centre pin marked R. The grid and reaction windings really comprise one coil, except that the grid coil is of No. 20 D.S.C. and the reaction coil of No. 34 D.S.C.

The long-wave coil is a single winding of No. 34 D.S.C. Drill a hole near the pin marked G and wind on 175

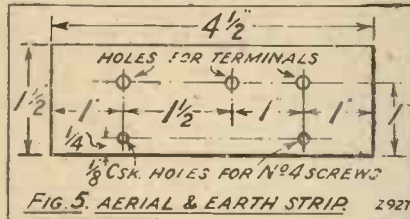

turns; now make another hole and take the loop of wire to the outside pin marked E. Continue the winding, and when you have put on another 40 turns take the end to the centre pin marked R. The inside pin marked A is connected by a wire with the pin marked G.

No Soldering

With the coils constructed and the parts all assembled turn to the wiring diagram given on the blue print.

You will see that all the parts are provided with nuts, so that you need not solder a single wire if you find soldering difficult. The wiring is perfectly straightforward. First of all, connect the filaments of the valves and the filament switch, then the low-frequency transformer and 2-microfarad condenser.

Now join the coupling condenser, anode resistance, and grid leak, and put in the wires for the grid battery.

You will find it convenient to take the coil base off the baseboard and fasten five wires to it, as shown in

the diagram. You will, of course, not have to do this if the base is so constructed that the wires can be conveniently put on with it screwed in position. Now replace the base and cut the wires to length.

Suitable Valves

The remainder of the wiring is easy. No. 18 tinned copper wire with Systoflex should be used for all connections. Finally, fit three lengths of flexible wire to the set and put a plug on their free ends for the grid bias.

For this receiver you will require a valve of the resistance-capacity type for the first stage V₁, a valve of the L.F. type having an impedance of 10,000 to 20,000 ohms for V₂, and a power valve for the output stage V₃.

The figures given above are "safety" figures and I have no doubt that where overloading is not likely to occur a valve having a higher magnification factor could be used in the first L.F. position.

If a 120-volt high-tension battery is to be used, with 6-volt valves, give V₂ a grid bias of negative 4 1/2 volts at G.B.1, and the last valve the full 9 volts. The power valve may take a

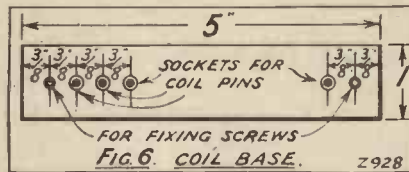

bigger grid bias than 9 volts, but there is room for this additional battery in the receiver.

When 2-volt valves are used the grid bias for G.B.1 will be 3 volts, and for G.B.2 9 volts.

Connect the aerial to terminal A₁; for better selectivity connect to terminal A₂. Now switch on the

valves and tune in a distant station to make sure that the reaction control is satisfactory. The 16 turns given have been found sufficient for



The coils are easily made and, moreover, they are remarkably efficient in operation

reaction with normal aerials. But if the reaction is too fierce a few turns may be removed, or if it is not quite sufficient, a few more turns should be added. It will not be necessary to vary the number of reaction turns when the aerial is a normal one. This is because the effect of the aerial is not very marked, as only a portion of the coil is included in the aerial circuit.

Efficient Results

The best number of reaction turns will be such that the reaction condenser has to be put nearly all in before the set commences to oscillate.

The wave-length range covered by the coils will depend upon which terminal the aerial is connected to. With the aerial joined to terminal A₁, the minimum wave-length will be less than when it is joined to A₂. This is particularly noticeable on the higher wave-length range, because the long-wave coil has the aerial joined direct to the grid end instead of to a tapping, as the short-wave coil. It is important to remember this when searching for long-wave-length stations, as the effect of the series condenser in the aerial circuit is greatly to extend the range downwards.

A large number of stations have been received on this set, both on the long and the short waves. The coils are quite efficient ones and the set is remarkably easy to tune. The type of coil used, besides being electrically

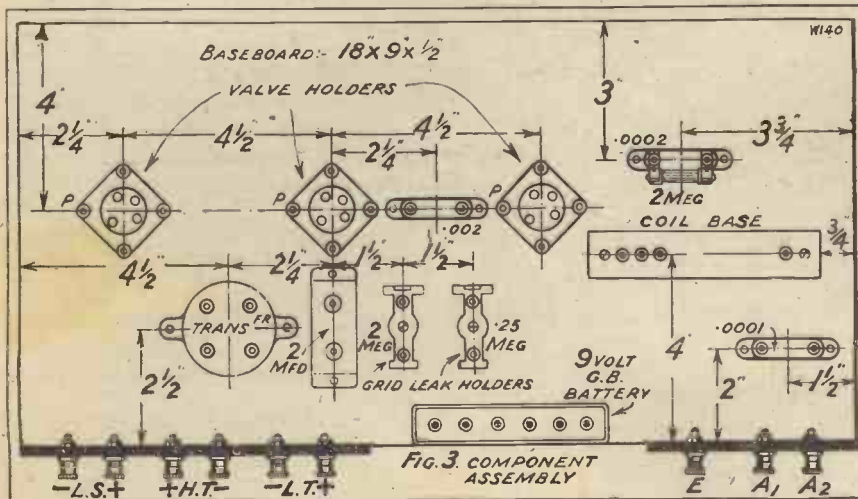

Fix your components on the baseboard according to these measurements.

sound, is quite strong, and as there are three pins at one end and only one at the other, it is impossible to fit a coil round the wrong way.

Having three pins at one end is an advantage from an electrical point

accounts for the two tuning condensers being placed fairly close together. The vignette may have an oval or other shaped opening, and seems to add to the appearance of the finished receiver.

are generally quite low, a small H.T. battery of appropriate voltage to supply this valve only will give good service for a long period.)

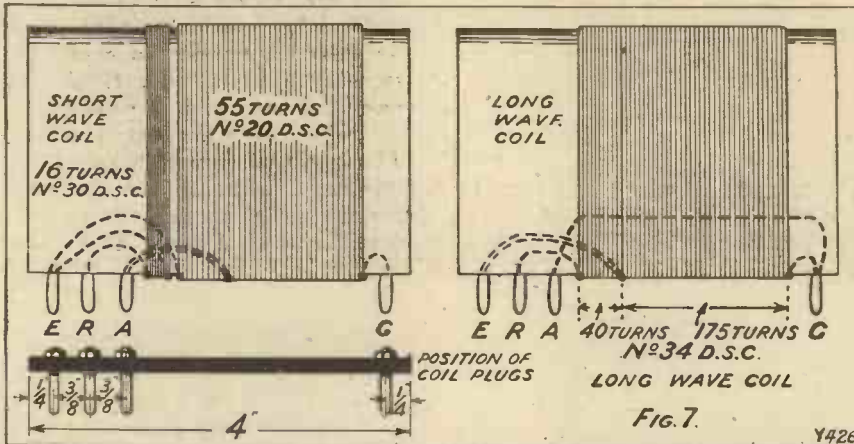

This illustration makes clear the method of making your own coils for the "Music Master"—an easy and interesting task.

of view. In the first place it allows the single pin to be connected to the grid, and, secondly, it allows of short connecting wires from the ends of the coil to the various pins. It should be noticed that there is only a small radio-frequency difference of potential between the pins that are near together.

Consequently the closeness of the pins does not introduce a measurable loss. When all the pins, including that which goes to the grid, are mounted together, there is often a considerable loss, which is best avoided.

Cheap and Reliable

The set is very cheap to build and gives good quality. It would be preferable to use a loud speaker of the cone type with this set, for the volume given is considerable. The selectivity is good, and I have received five stations on the long waves at good loud-speaker strength and more than a dozen on the short waves, although anyone interested in the reception of distant stations would be able to bring in a larger number.

The selectivity depends so much on the size of the aerial and where the set is used that it is difficult to give a clear idea as to how it performs, but considering that it has only the one tuning coil, the selectivity is very good, there being no difficulty in tuning out the local station (nine miles away) and getting distant ones separated in wave-length by fifteen or more metres.

The set was designed for a cabinet fitted with a vignette, which

WORKSHOP GOSSIP

Only first-class quality materials should be used in the home construction of wet H.T. batteries. Otherwise the life is shortened, and there is little or no advantage over an ordinary dry cell battery.

Slight humming on a multi-valve set when using an H.T. battery eliminator can often be overcome by arranging a separate anode potential for the detector valve. (As the current requirements of this valve

Concerning "Supers"

Although the wave-length of the intermediate-frequency amplifier in a super-het. is generally of the order of 8,000 metres, it can be varied considerably without upsetting the performance of the receiver. Good results are obtainable with the intermediate circuits tuned to any wave-length between 6,000 and 12,000 metres.

Owing to the serious interference due to the multiplicity of broadcasting stations in the United States, it is expected that before long at least 300 of the stations will be closed down.

Transmission of Pictures

The transmission by wireless of pictures has been so successful on the Continent, that in several countries it is being adopted by the police to assist in the rapid identification of criminals.

The tuning note with which the B.B.C. stations commence their transmissions is produced by means of a valve "oscillating" at low frequency.

It has been estimated that the maximum error which can occur in the transmission of the standard time signal at Greenwich is never more than one five-hundredth of a second.

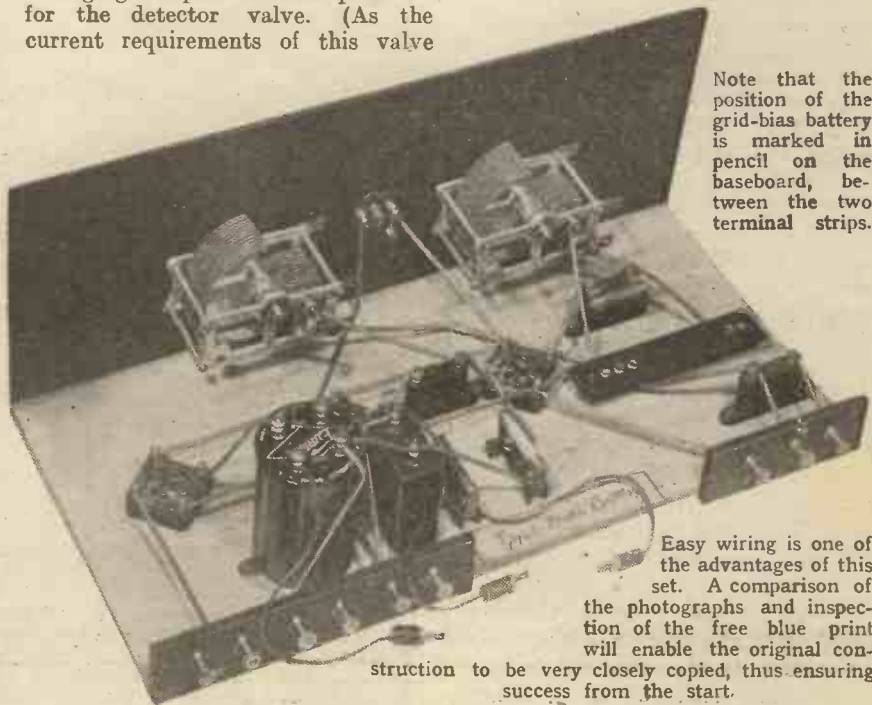

Note that the position of the grid-bias battery is marked in pencil on the baseboard, between the two terminal strips.

Easy wiring is one of the advantages of this set. A comparison of the photographs and inspection of the free blue print will enable the original construction to be very closely copied, thus ensuring success from the start.



A Note on Screening

In which an effect which has an important bearing on receiver design is discussed.

*By Dr. J. H. T. ROBERTS,
F.Inst.P.*

THERE is a rather disadvantageous effect of shielding, and that is its influence upon the resonance frequency of an H.F. transformer or such-like component.

The presence of an earthed metal shield in the vicinity of a tuned unit has the effect of shifting the resonance frequency of the unit.

The resonance frequency of the unit increases as the distance between the transformer and the shield decreases.

In a spider-web type H.F. transformer a frequency change of 560,000 to 820,000 cycles, which means a wave-length change of 535 to 365 metres, has been noted. The change in the case of the solenoidal type of coil is generally much less. The explanation of this difference will be quite clear. The spider-web coil has a very exposed field, and consequently the shield has much greater influence upon that field; whilst in the case of the solenoid the greater part of the field is within the coil itself, and is therefore not affected, or, at any rate, affected very little, by the shield, whilst the "stray" portion of the field which is liable to be affected by the shield is a comparatively small percentage of the whole. Most modern sets use the solenoid type of coil or transformer.

"Fieldless" Coils

In view of these results it would be expected that the effect of the shield upon a coil or transformer of the so-called "toroidal" type would be very small, and measurements have, in fact, shown such to be the case.

It is evident at once from these results that, at any rate in the case of the majority of commercial transformers, the position of the shield in

relation to the coils is a matter of considerable importance, and great care should be taken to ensure that the balance is not upset by the introduction of the shields.

"Matching" Circuits

The ingenious reader may now be tempted to inquire: If the shield has this effect upon the natural frequency of the secondary system, why not turn a disadvantage to account and employ the shield as an adjustment to correct the frequency, so as (for example) to bring a set of intermediate-frequency transformers into unison? This is quite possible, but it must be remembered that the change in the frequency due to the presence of the shield is accompanied by the production of

eddy currents in the shield, with consequent loss in efficiency. Also, the method is limited to increasing the frequency (reducing wave-length), so that if a transformer has a natural frequency which is already too high, it will not be possible, by bringing a shield into proximity with that particular transformer, to adjust its frequency in the desired way. At the same time, however it is possible, by bringing shields into closer proximity to the other transformers, to raise their frequencies, assuming that this process does not give an unsuitable final value for the frequency of all the transformers.

In the Super-het.

A temporary shield may prove useful in testing the matching of the intermediate-frequency transformers in a super-heterodyne circuit. If the bringing of an earthed shield into the field of one of the I.F. transformers produces better selectivity or better tone quality, we may be sure that this particular transformer unit was not previously matched with the others.

Remember, with regard to the super-heterodyne, that practically everything depends upon the correct functioning of the intermediate-frequency stages.

ED. NOTE.—The effect of screening on tuned circuits is a factor that has always been given very close consideration in the design of MODERN WIRELESS receivers. For this reason, if for no other, constructors should adhere closely to layout, coil, and other specifications when building our sets.

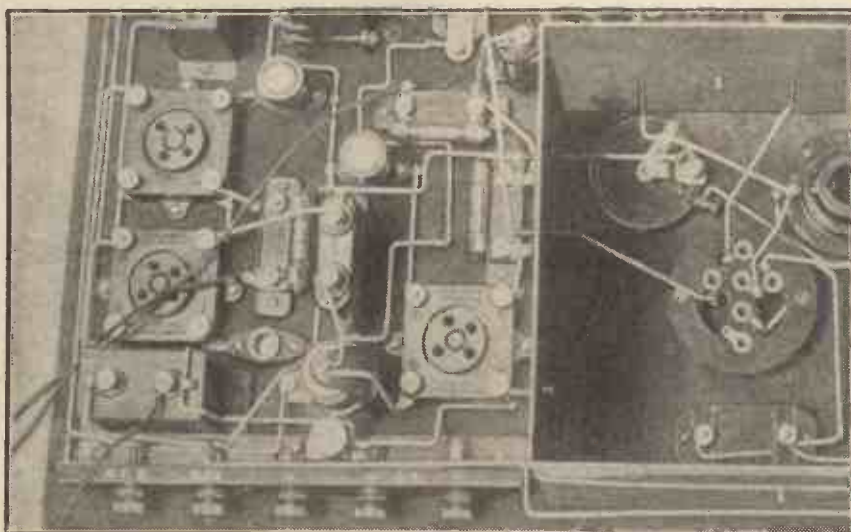

The section of a large multi-valve receiver showing a portion of one of the screening boxes used to shield an H.F. stage. You will note that the L.F. components are fairly closely bunched together, but that the one H.F. valve stage to be seen is well spaced, and that the coil holder is arranged so that the coil is kept well away from the metal shielding.

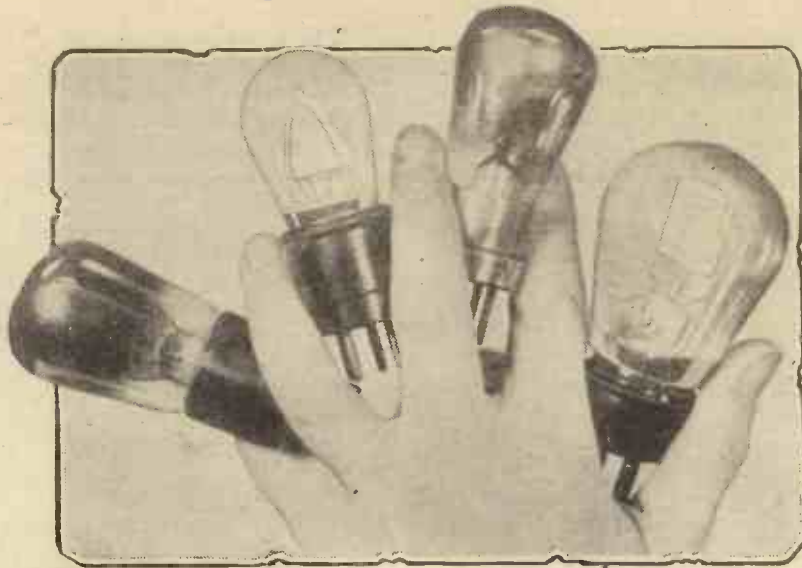

THAT M/I FACTOR

In these days of a multitude of valves of all sizes and descriptions, it is useful to be able to estimate the efficiency of any particular specimen by a glance at its characteristic are discussed in this article.

figures. The meaning and importance of "mutual conductances"

By KEITH D. ROGERS.

AMONG all the various figures that makers, and others, give concerning radio valves there is one factor which has a particular interest, and that is what is commonly termed the mutual conductance of the valve. Sometimes it is referred to as the "slope," or efficiency factor, for it really indicates the control over the plate current that is given by any change of grid voltage in a valve. The steeper the slope of the characteristic curve of a valve the greater

have $MC = \frac{M}{I(\text{ohms})} =$ so many mhos.

Unfortunately the usual $\frac{M}{I}$ is a small fraction of a mho, and so we reduce it to micro-mhos by multiplying by 1,000,000 for the sake of a convenient figure, and you will often see the MC expressed as so many micro-mhos. More often, however, a purely indicative method is adopted of giving the MC as a fraction of *unity* and not as any specific *unit*. So it becomes a mere *figure*, easily translatable into micro-mhos, but much more useful as it is, for it forms an easy, tell-at-a-glance figure without being inaccurate or misleading in any way.

say that the factor is 1, or unity, so that at a glance we can see the valve is more efficient than the former one, actually in electrical parlance it is $\frac{13 \times 1,000,000}{13,000} = \frac{13,000}{13} = 1,000$ micro-mhos.

Now what do all the figures mean? Why should $\frac{M}{I}$ be an efficiency factor? Why should we take so much notice of the mutual conductance of a valve?



In order to show the "works" of this Cossor H.F. valve, the valve was carefully heated in a gas flame so that the "gettering" was vaporised, subsequently condensing on the cold electrodes and leaving the glass clear. This valve gives a good example of high M/I factor, having a mutual conductance of 1,000 micro-mhos.

is the effect of any grid voltage change on the plate current, and the greater is the mutual conductance.

In other words, the mutual conductance (MC) is the magnification factor of the valve divided by the impedance, or $MC = \frac{M}{I}$. But as conductance is the opposite to resistance it must be expressed in mhos; so we

A Simple Calculation

Thus, for convenience we take the $\frac{M}{I}$ factor and multiply it by 1,000, and we get a final figure ranging between 2 and 4 in units.

Let's take an example:

Take a valve having an impedance of 8,000 ohms and an amplification factor of 6.4 — a quite normal L.F. valve. The mutual conductance,

given as a factor of 1 is $\frac{6.4 \times 1,000}{8,000}$

$= 8$. Quite a good figure. Actually, in proper units it is $\frac{6.4}{8,000} = 0008$

mhos. Or, $MC = 0008 \times 1,000,000 = 800$ micro-mhos.

Compare this with a valve whose impedance is 13,000, and whose amplification factor is 13, I prefer to



The plate-grid-filament orientation of a valve has a direct bearing on the M/I factor. In this case the grid is of wide mesh, giving a lower impedance and lower magnification factor, while the closeness of the filament and plate tends to lower the impedance and thus raise the MC.

In an amplifying valve we need two main things—high amplification and low impedance. The former will give magnification of signals, while the latter determines the *power* output (dependent on plate current). Obviously a large amplification with a large plate current will give a greater variation of plate current (greater power change) than where the initial plate current and the magnification factor are small.

Varying M and I

So we aim at a valve with a large M and a small I. These two can be combined in a single factor to act as a guide to the power amplification of the valve, and this will be a ratio of the change in anode current to the change in grid voltage, the anode voltage remaining constant. In other words, it is the "slope" of the characteristic curve.

Thus the mutual conductance forms an excellent guide to the all-round ability of the valve as an amplifier.

We can look at it another way. We have seen that we want a high amplification factor with low impedance if we are to get the ideal of high magnification and plenty of power.

Now take concrete examples. The 13,000-ohm valve we already mentioned has an M of 13 (a). Suppose we decrease M and thus lower its amplification factor. We shall get less magnification while the plate current remains the same. Thus for a given signal less plate current change will occur. Also the $\frac{M}{I}$ factor becomes less—the mutual conductance is reduced (b).

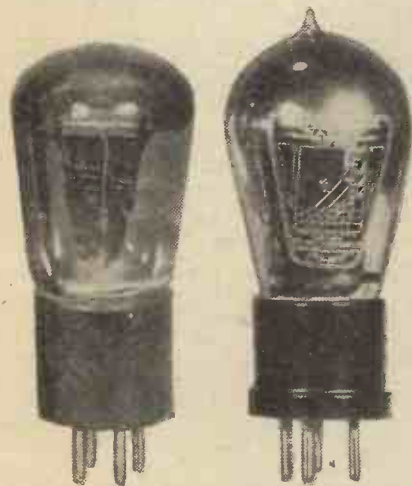

The valve on the left has a moderately steep slope and is an ordinary L.F. valve with a mutual conductance of about .8 (800 micro-mhos), while the other is a super-power valve with a magnification factor of 4.

Let us double M now (c), and leave I alone. The mutual conductance is doubled, for the magnification factor has twice the effect on the plate current—the plate current remaining the same.

Double both M and I (d) and we have twice the *plate current* and *twice the variation*, or, in other words, the same *ratio* between variation and initial current. More *power*, but the same MC factor.

Now decrease I and leave M alone (e). We then get a larger plate current with the same magnification, so that the ratio goes up and we get a bigger change of plate current. In other words, MC is larger.

Let us state these examples in figures and we have :

(a) $MC = \frac{13}{13(000)} = 1$ (taking unity as the standard and not worrying about micro-mhos).

(b) $M = 6.5, I = 13,000$; therefore $MC = \frac{6.5}{13(000)} = .5$.

(c) $M = 26, I = 13,000$; therefore $MC = \frac{26}{13(000)} = 2$.

(d) $M = 26, I = 26,000$; therefore $MC = \frac{26}{26(000)} = 1$.

(e) $M = 13, I = 7,500$; therefore $MC = \frac{13}{7.5} = 2$.

Thus we get a rough-and-ready way of comparing valves, a method that will tell us at a glance how the various amplifiers will behave and how much *power amplification* we can expect out of it.

With H.F. and R.C. valves the mutual conductance is not liable to be as high as with L.F. valves, owing to the necessary high impedance which goes with close-meshed grids such as required for adequate H.F. control and high magnification.

Exceptionally High Figure

In L.F. valves, those with the highest mutual conductance are the indirectly-heated cathode (AC) types, which have in some cases as high a figure as 4. I have one in mind with an M of 10 with an I of 2,500 = $\frac{10}{2.5} = 4$.

Impedance is a necessary *evil*, magnification factor is a necessity for *good* operation, and therefore we want to decrease the former and increase the latter, which will increase the value of M/I, that mysterious factor which I hope I have made a little more easy to understand in this short article.

A USEFUL GRID-LEAK HOLDER
By H. J. B. C.

THE layout of a wireless receiver is governed by so many factors that there are times when departures from accepted practice are necessary to facilitate the convenient accommodation of all the components in the space available, and yet keep the wiring short, where essential, for proper working. In many cases, such as these, I have found the work

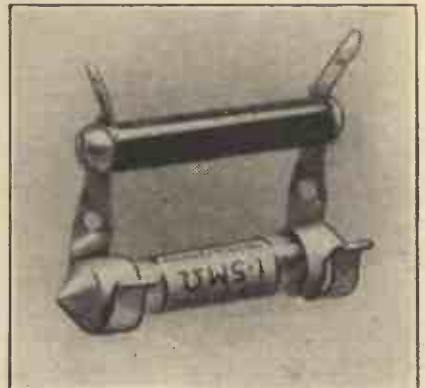

The leak holder described in the article. It consists of a small ebonite tube, two screws and two grid-leak clips and tags, and is very easily made.

assisted by mounting grid leaks with clips direct on the wiring, or soldering the holding clips between the necessary components. To permit this to be done in an efficient manner it is desirable to have grid-leak holders which are light but rigid, holding the cartridge leak firmly in place between spring clips.

Cheaply Made

The idea illustrated has proved excellent for these occasions, and can be made up quickly and cheaply by constructors from materials in the "junk box." Procure an ebonite tube $1\frac{1}{4}$ in. long and $\frac{1}{4}$ in. external diameter and two grid-leak clips—the variety with screw holes and long soldering tags provided. Make a right-angled twist in each clip, and then hold each clip against the ebonite tube ends by means of screws passed through holes in the clips into the ebonite tube.

The grid leak can then be accommodated in the spring ends as shown. Of course, the clips can be held on a strip of ebonite by means of screws, but I have found in practice that the tube suggested above is stronger, lighter and less liable to warp.

MORE ABOUT THIS YEAR'S

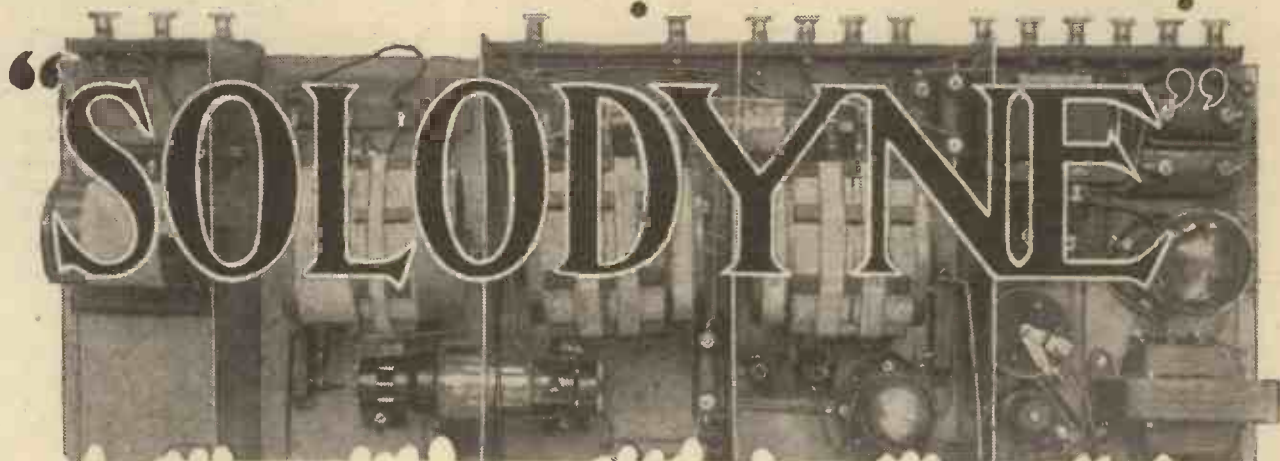

Everybody is talking about this set, which is being acclaimed as a masterpiece of receiver design. Below you will find the results of the official tests, the designer's comments, and further operating details.

By The "M.W." Research and Construction Dept.

IN giving the first practical details of the 1928 Solodyne in my article last month I was unfortunately limited to a very bare outline, since there is so much to be covered in a set with so many features differing from the ordinary run of receivers that the "space" question becomes a very acute one indeed. Consequently, it was necessary to hold over until this month much more than the usual "operating notes," and my first task must be to go over all such details as concern those features which could not properly be considered in the last issue.



How the wave-trap is used: try the plug in each tapping socket and adjust the trap condenser with a screw-driver or a piece of wood cut to a chisel edge.

First of all, a word as to just what we have attempted to produce in this receiver. I gather from correspondence which I have seen that there is some disappointment among owners of the older type of Solodyne because we have not modelled the 1928 version more closely along the lines of the original, so that they could simply convert their existing instruments.

This would appear to indicate that it has not been made quite clear just what the new set really is; it is not a "modernised" version of the parent set, but rather an entirely new receiver carrying out the original single-control idea on present-day lines on both H.F. and L.F. sides.

Greater Amplification

We should have liked to achieve our end by a simple process of conversion, keeping as near as possible to the original layout, components, etc., as possible, but it was regretfully decided that it was not a practical proposition, since the requirements of the new circuit arrangement are so very different.

It must be remembered that the much greater amplification obtained in the H.F. stages of the new set calls for far greater care in the layout, screening, and so on, and to have secured proper stability keeping to the older arrangement would have involved some very elaborate and expensive screening and more difficult constructional work.

Even granted all this, the final result would have been a decidedly

cramped set of lower efficiency, and so the reader will appreciate that the only decision possible was to work out an entirely fresh layout.

The Grid Leaks

It will be remembered that it was briefly indicated last month that the resistance of the grid leaks of the H.F. valves might be either 1 or 2 megohms



The degree of selectivity on any aerial is adjusted by manipulating this flex link and its plugs. It controls the number of turns included in the aerial circuit for coupling purposes, and also brings the series condenser in when required.

and it was advised that the constructor should start with the lower value, trying 2 megohms later, and this point should perhaps be explained next. My own preference is for a set of strictly limited selectivity (a wave-trap gets over the local station difficulty) on account of its usually superior quality of reproduction, ease of handling, and so on, and hence the slight damping effect of the 1-megohm leaks is welcome at times.

For example, if the set is being used for providing a few alternative programmes from the stronger foreign stations, as even a Solodyne often is for many evenings in the week, I like to put in the lower value leaks and flatten out the tuning a little more. For general long-distance work, on the other hand, when a greater amount of selectivity is desired, the 2-megohm leaks will be used. The use of the lower resistance ones is, of course, something of a refinement.

To Suit All Aerials

Next, there is the question of the arrangements made to enable the user to suit various aerial conditions, adjust the degree of selectivity, and so on. Now, this set gives so much amplification that it has been decided to allow for the use of quite small aerials, which have, of course, several practical and also electrical advantages. Accordingly, the aerial coupling arrangements have been designed specially to enable maximum efficiency to be attained when the aerial is comparatively small, with the necessary means of adjustment to enable it to be suited to a full-sized one if required.

If you examine the blue print and the photos, you will see that a fourth five-socket coil-holder is placed in the

first compartment, and a short length of flex carrying a plug on each end serves to provide the necessary variation of connections.

This link is used as follows: one end is inserted in one of the sockets

20 turns will usually be needed. In any case, the smaller the number of turns used the higher the selectivity. A higher degree of selectivity is obtainable by bringing the series condenser into circuit.

56 STATIONS RECEIVED!

The following stations were all logged on the loud speaker during the first week of testing of the set, using a small and poor outdoor aerial. An accurate wavc-meter was employed for identification purposes. The average height of the aerial was only 14 ft.

Stettin	Breslau	Glasgow
Bordeaux	Bournemouth	Salamanca
Muenster	Konigsberg	Berne
Gleiwitz	Naples	Frankfurt
Danzig	Cartagena	Seville
Dresden	San Sebastian	Berlin
Cologne	Prague	Rome
Radio Lyon	Leipzig	Stockholm
Stoke-on-Trent	Madrid	Ecole Supérieure.
Hanover	Stuttgart	Oslo
Liverpool	Manchester	Barcelona
Belfast	Toulouse	Brussels
Newcastle	Hamburg	Vienna
Milan	Cork	Munich
Nurenberg	Madrid	Zurich

LONG-WAVE STATIONS.

Radio Paris	Moscow	Norddeich
Koenigswusterhausen	Warsaw	Hilversum
Motala	Eiffel Tower	Sorö
Basle		

marked "10, 15, 20," and this governs the number of turns brought into circuit for coupling the aerial to the set. For outdoor aerials 10 turns will usually be used, with 15 on some occasions only, chiefly at the upper end of the tuning range to bring up a very weak station.

For quite small aerials, 15 or

This is done by placing the remaining end of the flex link in the socket marked "in" on the blue print. (In the other, of course, it cuts the

DRILLING THE SCREENS

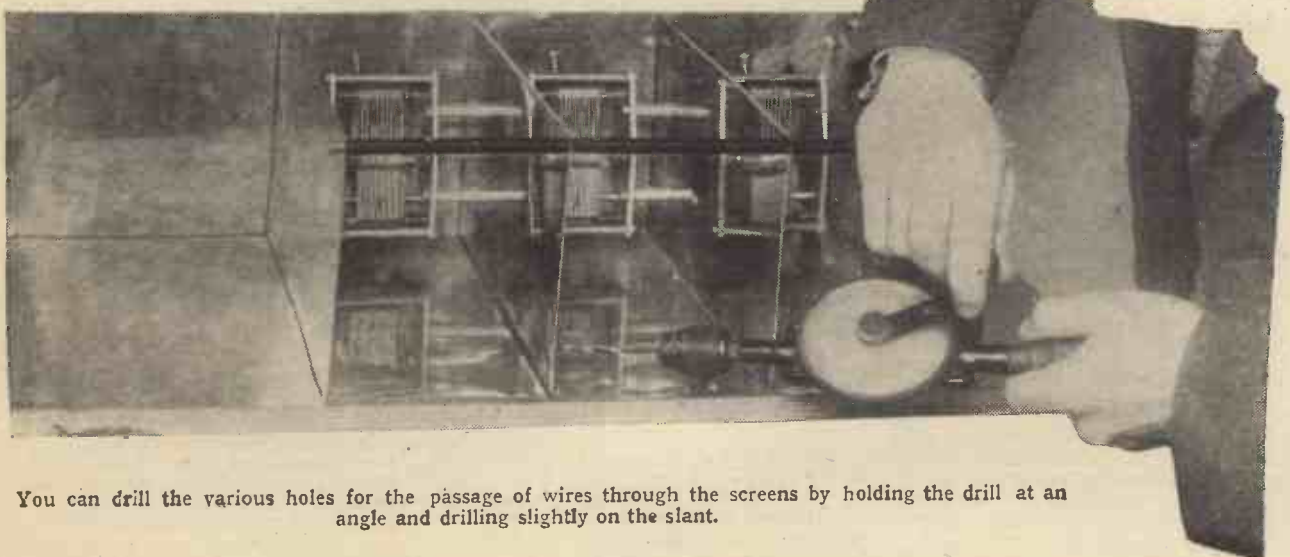

You can drill the various holes for the passage of wires through the screens by holding the drill at an angle and drilling slightly on the slant.

condenser out of circuit.) This condenser will often be useful with an outside aerial, but is rarely necessary with an indoor one.

A little explanation of the use of the wave-trap is probably desirable, since there are one or two points connected therewith which are not quite obvious. First, it must be realised that with so powerful a receiver no trap will cut out a strong local station so completely that it will not be heard when fully tuned in.

Setting the Trap

A trace of energy still leaks through the trap, and where the total magnification is so great this will naturally be brought up to very full loud-speaker strength in most cases. What the trap really does at fairly short distances is to turn the "local" station into what seems to be merely a specially powerful distant one, which is only heard when fairly closely tuned in. There is thus no need, as you will see, to cut the trap out of circuit when you wish to listen to your local transmission. On the contrary, it is better to keep it in circuit, for reasons which we shall see later in dealing with the problem of volume control on the local station.

The actual procedure in using the trap is very simple: first tune in the local station at moderate loud-speaker

volume (you will need to *de-tune* quite a lot to bring it down to this), then bring the trap into circuit, insert the plug into either of the tapping points, and turn the adjusting screw of the trap tuning condenser until you find the trapping point at which the signals are suddenly cut

on other stations on nearby waves.

The ganging adjustment of the new Solodyne is particularly easy and simple, partly because there is no neutralising adjustment to upset it, and partly because the tuning of each circuit is not so "razor-edged" as to make it very critical.

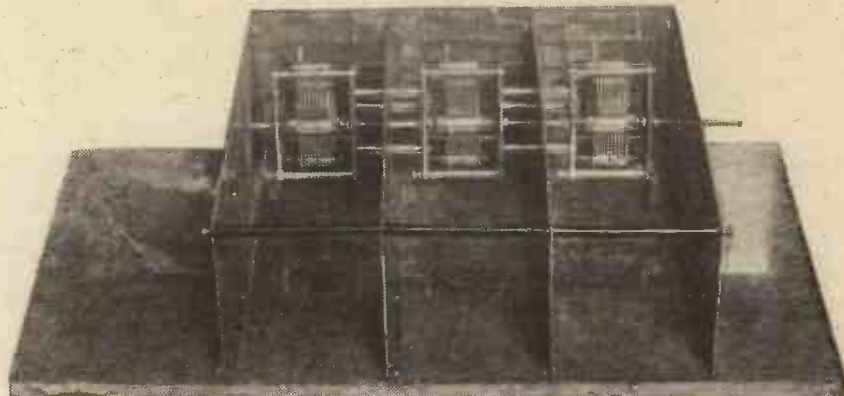

This is the special condenser produced by Messrs. Peto-Scott for the 1928 Solodyne. It is shown completely assembled and mounted on the baseboard ready for the attachment of the panel.

down to a small value and on either side of which they reappear.

Simple Ganging Adjustment

You should then proceed to find out by test which of the two tapplings on the trap (i.e. sockets 1 and 2) is the better in your particular case as regards cutting out the local most perfectly, and with least effect

All that is needed is to set all three sections of the condenser in line, and then tune in a distant station near the middle of the tuning range, preferably rather a weak one. Now free the clamping devices between the sections, and tune each one separately by hand (the moving plates are earthed, so that you can touch

WHY YOU SHOULD BUILD THIS YEAR'S "SOLODYNE"

although the original "Solodyne" was one of the most popular receivers ever designed on account of its undoubted merits.

THE OLD "SOLODYNE"

1. Only partial screening, therefore wiring critical.
2. Neutralising necessary and rather more than usually difficult.
3. Difficult successfully to balance gang condenser.
4. Great selectivity, but with sacrifice of quality.
5. Aerial tuning did not balance with other circuits.
6. Considerable degree of sensitivity, but frequent use of reaction essential.
7. Required moderately good outdoor aerial for full results.
8. Detector and L.F. portion designed for maximum volume at expense of quality.
9. Slight defects caused instability.
10. Frequently required re-neutralising and re-balancing.
11. Efficiency tended to fall with higher wave-lengths.
12. Had plain output with no protection for loud speaker.
13. Volume control did not protect detector overloading.
14. Grid-leak rectification.

THE NEW "SOLODYNE"

1. Easier to build.
2. No neutralising.
3. Balancing very simple.
4. Can eliminate local station at extremely close range with no loss of quality.
5. Far greater accuracy of "ganging."
6. Much greater sensitivity, and by actual H.F. amplification; use of reaction rare.
7. Specially designed for good performances with any aerial, even including moderate indoor aerial.
8. Ample volume available for largest loud speakers, with superb quality.
9. Wide margin of safety; extremely stable.
10. Readjustments exceptional (see 2).
11. Amplification equally enormous on high wave-length band (5 X X, etc.).
12. Filter output protects loud speaker, reduces waste of H.T. voltage, and makes long extension leads practical and safe.
13. Ideal volume control.
14. Both grid-leak and anode-bend rectification available.

There are many other minor points of comparison which could be quoted, but the above will clearly indicate not only how the trend of radio technique has shown a rapid advance in the last two years, but how full advantage has been taken of the fruits of progress, and in such a way as to make it possible for the 1928 Solodyne to be styled, without a trace of exaggeration, a tremendous advance on the 1926 design and, in short, the acme of development in multi-valve receivers.

Need more be said? Yes!—one thing: build it and see for yourself.

them without losing the station) for maximum volume. This done, clamp up again, and the operation is complete, and you should find the adjustment reasonably constant over the tuning range, if well-matched coils are used, and there will probably be no need to alter it when you go over to the longer (5 X X) band of waves.

Volume Control

The problem of volume control on very powerful sets is always a difficult one, especially on single-control ones, where the expedient of de-tuning is not very satisfactory, since one is liable to run into another station if it is attempted. The method adopted in the 1928 Solodyne is to provide a master rheostat which controls the filaments of both H.F. valves simultaneously. By dimming the filaments a little an adequate volume control can be obtained for distant stations, and you will probably find that you will rarely need to run the valves full on.

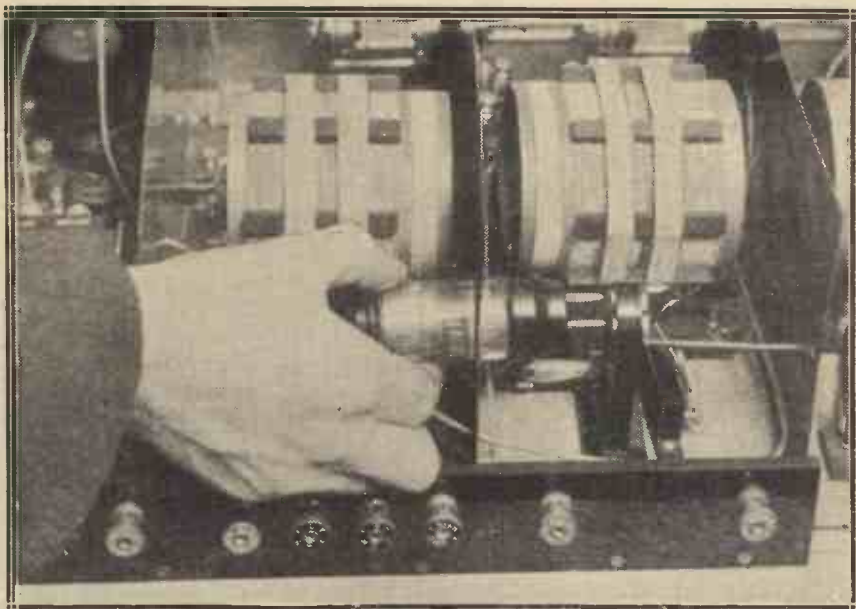

Be very careful when inserting the screened-grid valves to see that they go in straight, without straining the end caps or knocking the glass against the screen.

Just a little dimming, by the way, is likely to increase the life of the

valves, but prolonged running at excessively low temperatures is considered to impair the emission, and this point should be borne in mind when dealing with the local station. On distant ones the point is not likely to arise, but the magnification is so great that very drastic dimming would be needed on the local. I find a much better expedient is the very simple one of disconnecting the aerial when the local programme is required.

For the Local

The amount of energy picked up on the earth lead, etc., is quite sufficient at short ranges, and this gets over the difficulty completely.

Either this dodge or the use of a very small and inefficient indoor aerial (concealed in the picture rail, laid under the carpet, etc.) is my usual solution of the problem with any highly sensitive set. The difficulty always arises with such receivers, and I think it best to warn the reader frankly that he must be prepared to deal with it. At rather greater distances, of course, it may be enough to leave the aerial on, and keep the wave-trap permanently in circuit, this device giving a sufficient reduction of signals even when the station is fully tuned in, any final adjustment of volume being done on the master rheostat on the panel.

Before leaving this point it should perhaps be added that the use of a very small aerial in this way is very beneficial from the point of view of reducing the possibilities of interference from atmospheric, trams, and

(Continued on page 216.)

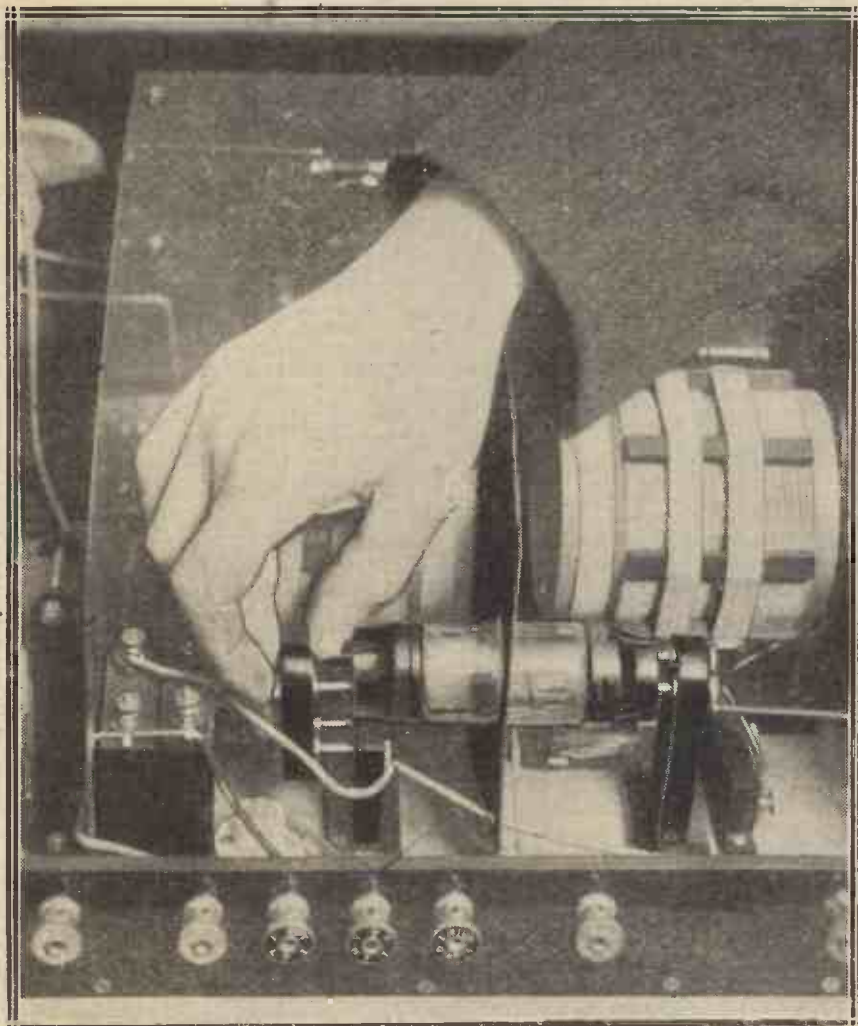

When fitting the anode cap portion of the Parex holder again exercise care against straining the valve. Don't forget to disconnect the H.T. while you are performing this operation!



KFI - GIANT OF THE WEST

A description of the new super-broadcaster at Los Angeles.

By a Special Correspondent.

quently K F I is able to offer to its listeners a transmission, the tonal qualities of which have been brought up to the utmost possible state of perfection.

Another result of the high-powered transmissions is their relative freedom from static disturbances; interferences which, as is well-known, cause much trouble in many of the American States.

Latest Type Transmitter

Normally operating on a wave-length of 468.5 metres, corresponding to a frequency of 640 kilocycles, the super-power station of Earle C. Anthony, Inc., has its aerial system erected between two steel lattice masts which are built on the concrete roof of one of the main factories of the firm. The masts allow the aerial, which is of the multi-strand type, to be raised to a height of some 225 feet above the level of the ground. The earthing arrangements are of the usual nature.

THERE is no doubting the fact that our American cousins across the herring-pond possess radio ideals and ambitions of a very tall order indeed. For a private firm to erect even a small broadcasting station for its own experimental use and for the benefit of outsiders would be quite a laudable accomplishment in most parts of the world. Not so in America, however. In that country nearly every commercial manufacturing concern has its own radio-transmitting plant and equipment, and therefore the erection of an extra station or two does not result in any thrills being given to the sophisticated radio "hams" in the land of Uncle Sam.

The new station, K F I, erected by Messrs. Earle C. Anthony, Inc., of Los Angeles, California, however, has certainly given rise to some amount of surprise in the minds of radio enthusiasts "over there." For one thing, the new station is equipped with absolutely the last thing in Western Electric transmitters, and its studios and transmitting rooms have been planned and erected in conformity with the most up-to-date refinements.

Quality First

Although Station K F I has not yet transmitted on its full power, the transmitter itself is rated at 5,000 watts, which fact, of course, indicates that not only is K F I the most powerful station on the American Pacific coast, but that the station's claim to be the most powerful industrial radio-transmitting station in the world is probably correct.

Although the output power of the station is so high, the founder of the firm, Mr. Earle C. Anthony, is no keen enthusiast on long-distance transmission. His object in equipping the station with a high-power transmitter is primarily to allow of an ample reserve of power in order that the transmitter may handle a much wider band of frequencies than is ordinarily the case. Conse-



This is the control panel in the transmitting room. An unusual view of the transmitter itself is given through the large window in the background. This window has the appearance of a mirror, at least it has in the photograph, as will be noticed.

To technical amateurs, the most interesting part of the present description will be that concerning the actual transmitter, which, as mentioned previously, is a product of the very latest Western Electric type. Station K F I has two entirely separate transmitters, the smaller one of which will not concern us here. The main transmitter, however, together with its immediate controls, occupy a floor-space of 16 ft. by 9 ft., whilst its height is approximately 7 ft.

This 5,000-watt transmitter is equipped with six panels which contain the aerial tuning inductances, the oscillating, modulating, amplifying and similar units of the plant. It is claimed, too, that the transmitter is more "fool-proof" than the average one is inclined to be, a strong network of wire being built around its most dangerous portions.

Tastefully Decorated Studio

The power required to actuate the transmitter is derived from the local mains, it being changed from alternating to direct current by means of a series of water-cooled valve rectifiers, the temperature of which is very accurately regulated by means of a thermostat device. After rectification, the current passes through a large step-up transformer before being conveyed to the transmitter.

The engineers of Station K F I make no secret about their methods, for a plate-glass partition is built into the wall of the main transmitting room (which, incidentally, is situated on the ground floor of the building) so that any of the public who are interested in matters radiotic can witness for themselves the method and general routine of an efficiently equipped radio transmitting room.



A cosy corner in K F I's smaller studio.

The two studios of Station K F I would require a more adequate description than the present writer is able to give them. The main studio, which is employed for the larger items of broadcast entertainment, has been tastefully finished in "period" fashion. It is free from draperies and other sound-deadening hangings, and (B.B.C. officials please note) it is *well-ventilated*. In a word, this super studio of K F I puts one in mind of a luxuriantly furnished drawing-room more than anything else.

The smaller studio is also built on similar lines, although its furnishings are of a more plain and severe nature.

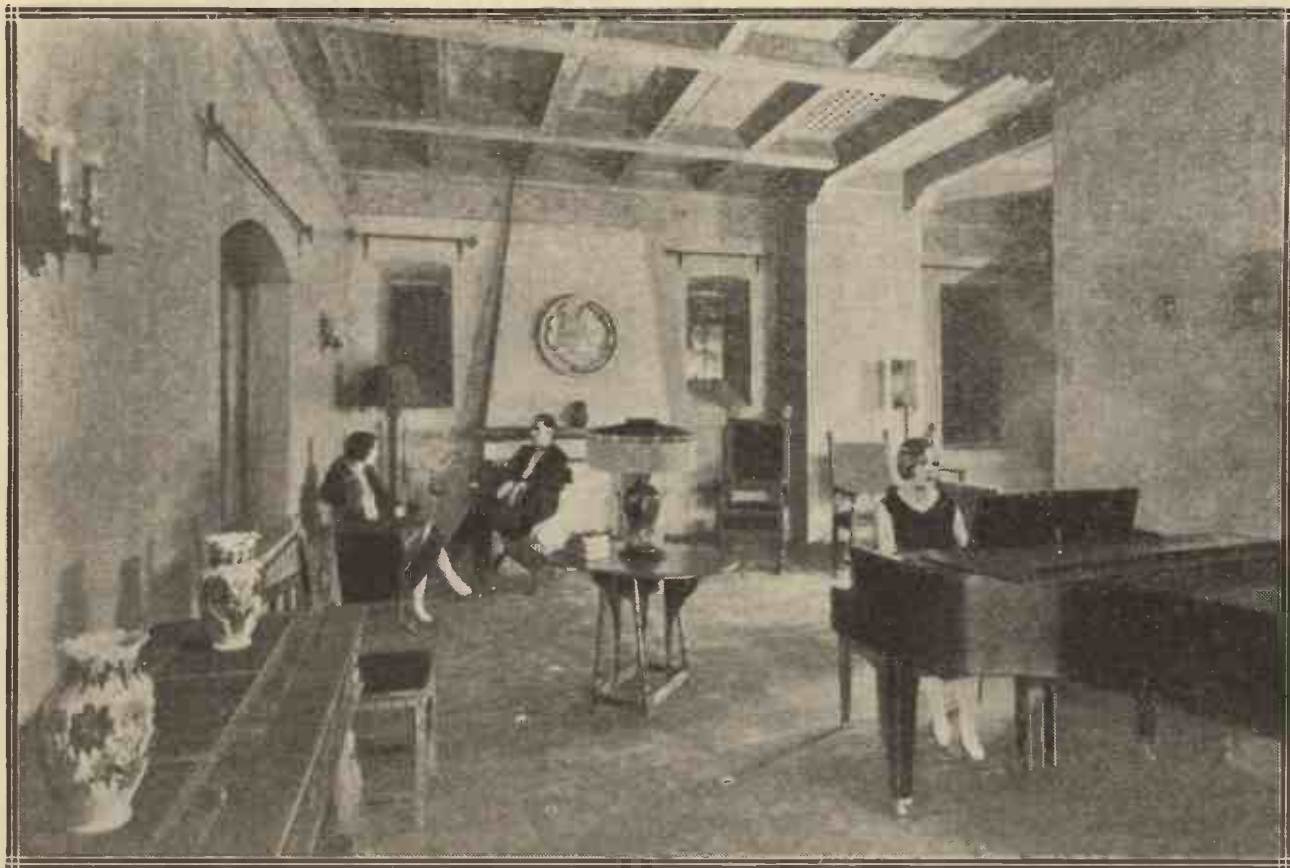

This studio at K F I is elaborately decorated and furnished in a "period" style. The modern note is, however, violently struck by the grand piano. The microphone, which can be seen just behind the pianiste, and projecting up well above her head, is to a certain extent camouflaged so that it shall harmonise with its surroundings.



Some New Rectifier Applications

An H.T. eliminator which does not employ fixed condensers is one of the interesting items discussed in this article.

By G. V. DOWDING, Grad.I.E.E.
(Technical Editor).

OF the various types of rectifiers in general use the majority of MODERN WIRELESS readers will be conversant, and will know that, for serious radio work, the valve type hitherto has been accepted as being the most practical. With the arrival of A.C.-operated valves the problem of the L.T. drive has been satisfactorily solved in the case of A.C. mains supplies; but rectification is still necessary when dealing with the H.T. supply, although in an all-from-the-mains-drive receiver all that is necessary is the inclusion of a full-wave rectifying valve and its necessary transformer and smoothing device.

An Attractive Device

Satisfactory though it is, however, the valve rectifier has now a serious rival in the new dry rectifier. The dry rectifier, of course, is not new to radio science—or, I should say, electrical science—but it is only comparatively recently that it has been put on the market in a practical form. The dry rectifier is a very attractive device, inasmuch as it does not necessitate the use of chemical

consumption of current; it does not need any attention in maintenance; and, finally, is of a very compact nature.

The construction of the Westinghouse dry rectifier, the original device of this type, and, we believe, the only one that is at present in commercial production in this country, is shown in Fig. 1. This is one complete element, and the drawing is near enough full size. The rectifying action does not take place between the oxidised copper washer and the lead washer; this latter is merely a means of making contact with the oxidised surface. Rectification actually occurs between the copper and its

paint. It is stated that their working lives run into years, and there is no reason why they should not. Providing they are not over-run in point of voltage, they do not tend to over-heat. In fact, they only become slightly warm.

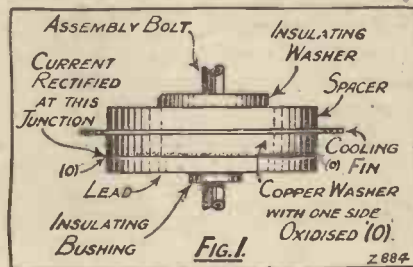

oxidised surface; the ratio of resistance from the copper to the oxide coating is very high compared with the resistance from the oxide coating to the copper.

High Efficiency

The efficiency of the Westinghouse metal rectifier unit averages over 60 per cent. How good this is will be appreciated when the figure is compared with that given by any other type—electrolytic, thermionic, or vibrating. These efficiencies, I believe, range from as low as 4 per cent or so up to about 40. The components of the Westinghouse rectifying elements are very tightly bolted together, and are coated with a protective

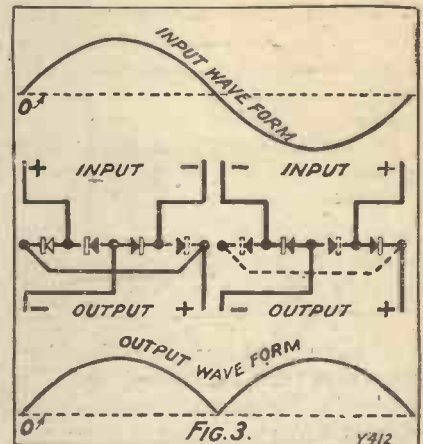

Several different types of elements are manufactured, a typical one taking anything up to about 3 volts pressure and about 5 ampere current. But these figures do not actually represent limitations, for the simple reason that, should greater current be desired, numbers of the elements can be paralleled, or should—as, of course, is often the case—greater voltages need to be handled

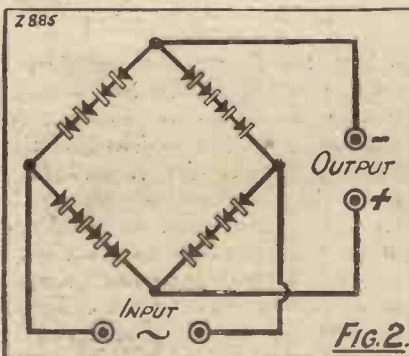

solutions in its operation; it does not necessitate the employment of a hot filament and the accompanying



A portable A.C. voltmeter which incorporates and makes novel use of a rectifier.

any number of these elements can be placed in series.

An arrangement of a device giving full-wave rectification for L.T. purposes is shown in Fig. 2. The manner in which full-wave rectification is carried out is indicated in Fig. 3 in a diagrammatical manner. But these and similar applications of rectifiers will be well-known to readers of MODERN WIRELESS, and have been covered very fully in articles which have appeared from time to time. The manufacturers of the new Westinghouse metal rectifiers, however, have indicated some rather novel but, at the same time, important applications.

A.C. Measuring Instruments

For instance, they have produced a number of A.C. meters embodying rectifiers. These are really D.C. instruments, but have rectifiers connected to them internally. Thus

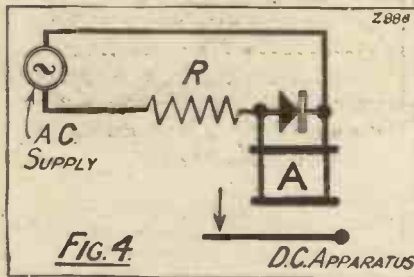

the high resistance and dead-beat action of the moving-coil type of measuring instrument is made applicable to A.C. work. One of these A.C. meters is no larger than an ordinary D.C. type of instrument, and, naturally, only the dry type of rectifier



A typical Westinghouse rectifier set. The input is 110 volts at 50 cycles, output being 60-75 volts D.C. and 1.5 amp.

has made this design possible. But of still greater interest to the radio enthusiast will be the Westinghouse H.T. eliminator scheme. The main feature of this is the entire elimination of fixed condensers for by-passing, and the substitution for these of a bank of dry rectifiers.

A Rectifier's Action

The simple circuit is shown in Fig. 5, where R is the usual arrangement of rectifiers giving full-wave rectification, A and B are L.F. chokes, and D are the by-pass rectifiers. Now this very simple little circuit is worth studying in detail, so that, first of all, we will get back to the rectifier and examine more closely its action.

Have a look at Fig. 6. Here you will see two curves. The lower curve refers to the resistance of a typical element in the forward direction, the resistances being shown on the

left. The upper curve gives the resistance of the element in the other direction for the same pressures.

Now in Fig. 5 the input is ordinary A.C. The output from the full-wave rectifier is, as the curve shows in the diagram, a fluctuating but unidirectional current. The function of the smoothing circuit necessary with H.T. eliminators is to smooth away those portions of the double-frequency curves above the mean value and fill in the space between the double-frequency curves below the mean value. If this is faithfully carried out the result is rippleless D.C., which can only be shown in diagrammatic form by means of a straight line, such as is given in Fig. 5 at the output end. This is illustrative of a perfect H.T. supply, which, by the way, seldom results; but of this more anon.

The By-Pass Elements

Now let us consider what the by-pass rectifiers do in this Fig. 5 circuit. These are shown as D, and are of a number in series capable of dealing with the necessary voltage. For

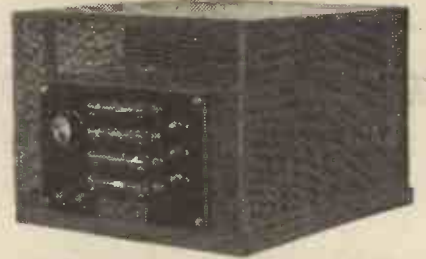

A rectifier unit, 3-phase type, having an output of 6 amperes at 110 volts.

the purposes of illustration, we have presumed that D consists of 120 rectifying elements clamped in series. This sounds a large number, but for such purposes a rather special element is used, and the whole assembly is surprisingly small, occupying but a matter of two or three cubic inches.

Novel "By-Passing"

Now the D group of rectifiers is only operating in this circuit in its reverse direction—its direction of greatest resistance. The junction between the chokes A and B is nearer to the negative pole of the rectifier. The bank of rectifying units is designed so that each has across it a mean D.C. voltage equal to the point X on the curve of Fig. 6. As the pulsating voltage of the output from the rectifier R rises above the mean D.C. voltage, the resistance of the by-pass units decreases; consequently these units shunt the

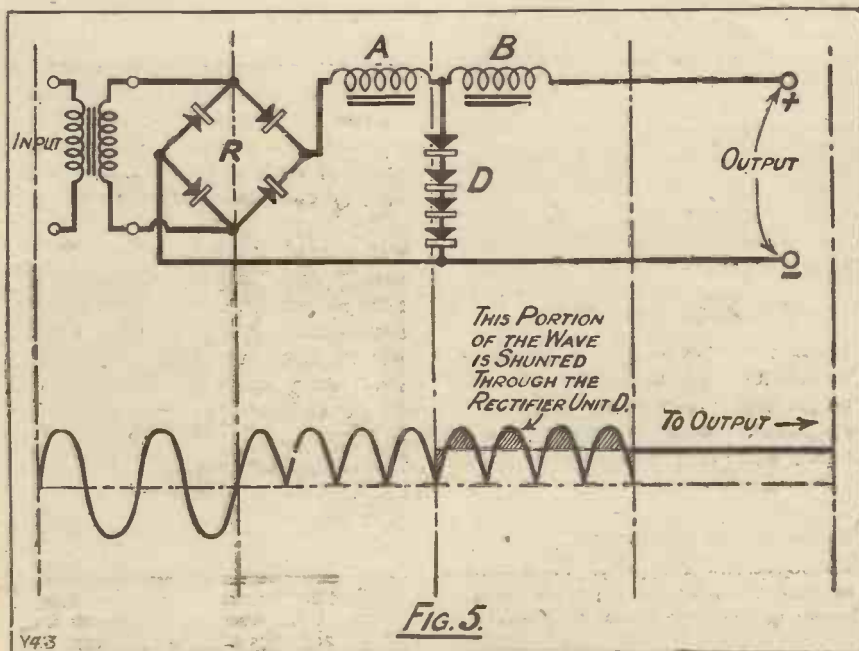

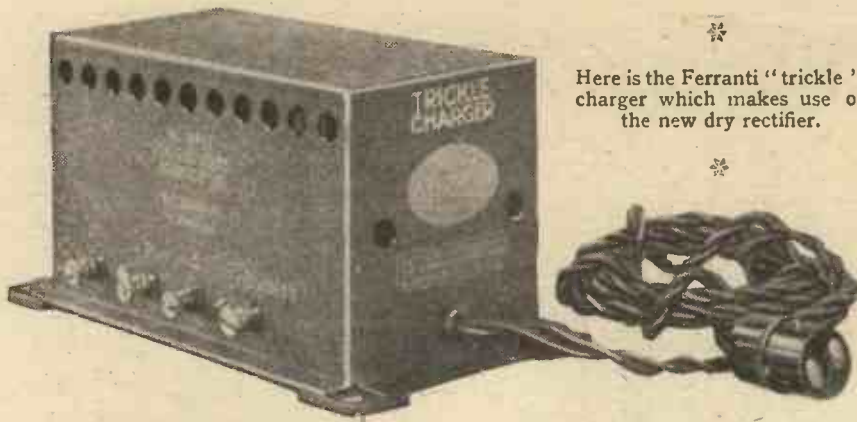

Here is the Ferranti "trickle" charger which makes use of the new dry rectifier.

greater proportion is allowed to pass through A, the D.C. device.

The resistance of the rectifier to a current flow in the reverse direction is very much lower, so that instead of flowing through A in this instance most of the current is efficiently "by-passed."

Quite Unconventional

This scheme should be more than interesting to the average reader inasmuch as it illustrates the use of a rectifier in quite a different manner to

increased output from R across to the negative pole.

The back E.M.F., due to the chokes A and B, supply the "filling" pressure, and the result is a pure D.C. output. We have heard an H.T. eliminator in use employing this scheme, and certainly the results were all that could be expected. Additionally the bank of rectifiers should

that it is possible to provide smooth direct current as required for radio purposes at very low voltages without relying on the usual filters of capacities and inductances.

An interesting application of the rectifier is illustrated in Fig. 4. Here the device is employed as a sort of by-pass valve in the operation from A.C. mains of something requiring a D.C. input. This last, A in the diagram, might be anything from an ordinary electric bell or relay to a small D.C. motor or other such article.



The type R.P.10d set which is used for charging accumulators and which delivers a D.C. output of 22-30 volts and anything up to 3 amperes.

A "Valve By-Pass"

Most of you will probably be able to see right away exactly how the scheme works, but for those who cannot a brief explanation should prove of interest. The rectifier is connected directly across the output (the bell, relay, or motor input). R is merely a resistance breaking down the current to the required value.

When the current flows in the one direction the rectifier offers a very high resistance to it, so that the

that when it is employed in an ordinary single-wave rectifier outfit. Here advantage is taken of the "one-way" action of the rectifier practically to stop current flowing in one direction. In the scheme just outlined the "forward" direction of the rectifier is used to stop the current flowing to the output instead of the "reverse" direction!

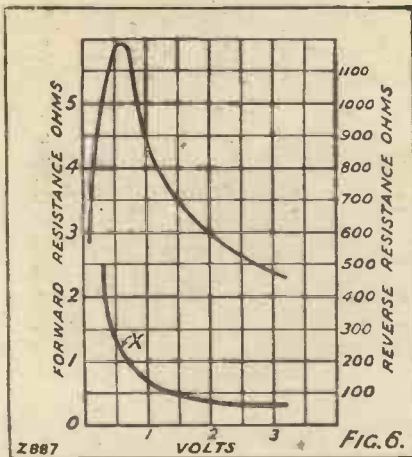

form an efficient by-pass to irregularities due to those superimposed frequencies which are liable to get through.

Its resistance at the most will be a mere 100 ohms or so in the so-called "forward" direction, while that of a fixed condenser of 2 mfd. capacity at a frequency of as low as 120 will be as much as 1,000 or so ohms. It is stated that the ripple voltage in the case of the Westinghouse scheme can be got down to as low as .05 volt, which is very satisfactory; .25 ripple would not worry the average listener.

Other Systems

It is interesting to note that the Westinghouse people have made the statement that the system of smoothing just described is by no means the only system the characteristics of the rectifier permit. Balanced ripple schemes and others have been carefully considered, and it is apparent

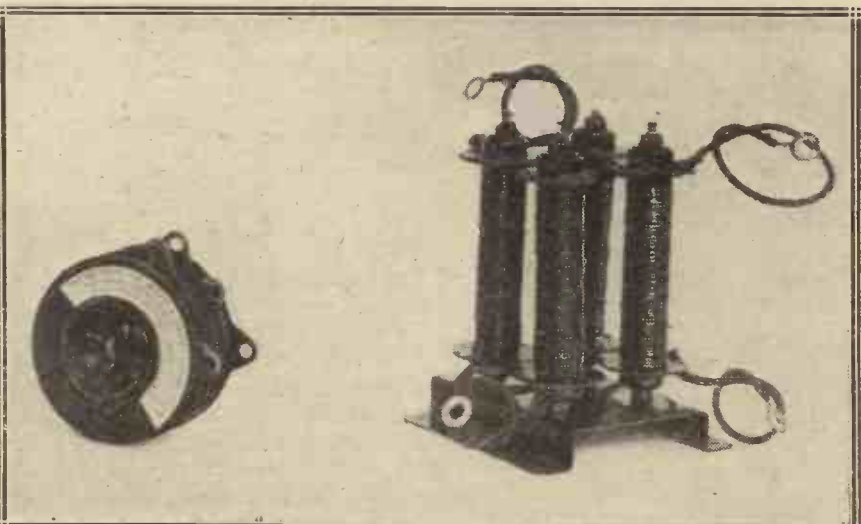

On the left is the small assembly of rectifying elements used for "trickle charging." They will handle up to 6 volts 1/2 amp. D.C. output. To the right is the assembly of elements for an H.T. battery eliminator capable of a D.C. output of 200 volts and 100 milliamps.



Questions Answered

Paralleling Valves

P. R. (Walsall).—"I have been given to understand that by placing two valves in parallel in the last stage of my set it will be able to handle a bigger volume without distortion. Is this correct?"

Placing two valves in parallel halves the valve impedance and increases the mutual conductance, hence for a given grid swing there is a bigger change in anode current, this resulting in an increase in signal strength. Owing to external circuit resistances, such as the D.C. voltage drop across an unsuitable output choke, there is sometimes very little apparent step-up in strength, but given a well-designed set the advantages of paralleling the valves are marked.

Placing valves in parallel does not increase the length of the grid base, and in consequence the maximum permissible grid swing is the same as for one valve.

Motor Generators

N. E. (Norwich).—"I have a 50-volt D.C. house-lighting plant, and I would like to obtain my H.T. supply from this source. Is there any way of increasing this voltage-to, say, 200 or 300 volts, for the purpose of operating a moving-coil loud speaker?"

The easiest method is to employ a small motor generator. This is really a combined motor and dynamo. The available supply is used to run the motor portion and windings could be obtained to give various terminal voltages on the dynamo or output side. You would, of course, need the usual smoothing chokes and condensers between the dynamo and the set, otherwise the H.T. supply would be noisy. If necessary, the output voltage could be broken down with the aid of resistances to give values suitable for

the H.F. and detector valves, in the same way as is usual in the case of a D.C. eliminator.

Controlling Oscillation

C. R. (Cheltenham).—"I have an old-type three-valve set which employs a non-neutralised tuned anode. It worked perfectly well with bright-emitter valves, but since I have changed over to dull-emitters the H.F. valve oscillates directly the aerial and anode circuits are brought

THE TECHNICAL QUERIES DEPARTMENT.

Are you in trouble with your set?

Have you any knotty little radio problems requiring solution?

The MODERN WIRELESS Technical Queries Department has been thoroughly reorganised and is now in a position to give an unrivalled service. The aim of the department is to furnish really helpful advice in connection with any radio problem, theoretical or practical.

Full details, including the revised and, in cases, considerably reduced scale of charges can be obtained direct from the Technical Queries Department, MODERN WIRELESS, Fleetway House, Farringdon Street, London, E.C.4.

A postcard will do: on receipt of this all the necessary literature will be sent to you free and post free, immediately. This application will place you under no obligation whatever. Every reader of MODERN WIRELESS should have these details by him. An application form is included which will enable you to ask your questions, so that we can deal with them expeditiously and with the minimum of delay. Having this form you will know exactly what information we require to have before us in order completely to solve your problems.

into tune. Can I stop the set from oscillating without using a neutralised circuit?"

The high mutual conductance of the modern H.F. valve renders it rather unsuitable for sets which have no means of stabilising. You might try a grid "losser" in the aerial circuit. Obtain a 400-ohm potentiometer and connect one end of the winding to the earth side of the winding to the aerial tuning coil and the slider to

the moving vanes of the aerial tuning condenser.

By increasing the value of the resistance you will be able to apply damping to the aerial circuit and by this means control oscillation. This scheme was used in the "B.B.C. Five," details of which were given in the June, 1927, issue of this journal.

H.F. Switching

H. A. (Norwich).—"I have a long-range receiver incorporating two screened split-primary H.F. stages.

The volume on the local station is terrific and I should like to cut out the two H.F. stages, employing the detector and L.F. side for local reception.

Could switching be introduced to enable the H.F. stages to be cut out?"

It is inadvisable to employ switching on the H.F. side, since this would in all probability produce instability, and you would find neutralisation impossible. Since the set incorporates split-primary transformers you could try the effect of connecting the aerial lead to the terminal which goes from the primary of the second H.F. transformer to the anode of the second H.F. valve. Connect in series with the aerial lead a .001 fixed condenser. The centre of the primary winding is, of course, joined to H.T.+, which is virtually at earth potential from the standpoint of H.F. currents.

The actual primary winding will now become the "aperiodic" aerial coil, and if the local station is within ten miles, signals will probably come in at good loud-speaker strength if the L.F. side is reasonably efficient.

Oscillator-Coupler

S. O. (Folkestone).—"Can you give me details of the short-wave oscillator-coupler used in the 'Experimental Eight' (described in the November, 1927, issue)?"

The oscillator-coupler is a standard Silver Marshall, No. 111C.

A number of turns is removed from the plate-grid windings, leaving three turns on each. The pick-up coil (rotor) is left untouched.

R.F. Chokes

J. K. (Maidstone).—"I have a quantity of plug-in coils which I used some years ago for Morse reception on the long-waves. Can I employ any of these as radio chokes?"

Yes, a No. 500- or 600-turn plug-in coil is very suitable for use as a choke on the Daventry wave-length, and a No. 250 on the ordinary 250-550-metre wave-band. On the very short-waves you might try a No. 50 coil if you have one available.

The "MERCURY" SEVEN

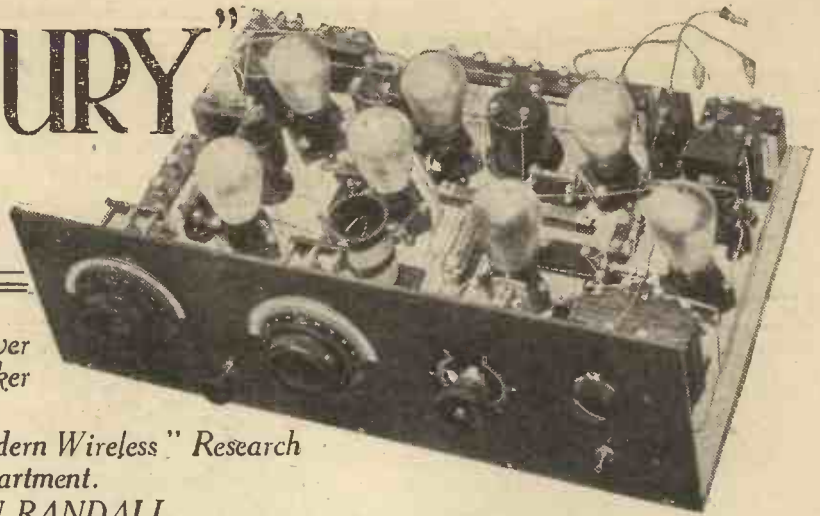

A seven-valve super-heterodyne receiver capable of very long-distance loud-speaker reception using only a frame aerial.

Designed and constructed by the "Modern Wireless" Research and Construction Department.

Described by A. JOHNSON-RANDALL.

THOSE who have never tried a super-heterodyne do not realise what a remarkable fascination such a receiver possesses. A super-het. will accomplish, on a small 2 ft. frame, results that only a good two high-frequency receiver, going all out, on an efficient outdoor aerial, can achieve. Moreover, these results can be obtained with an ease of tuning which is perfectly delightful.

This ease of tuning is enhanced by the fact that the selective properties of a good super-het. are something of the order of that obtained with four or five tuned stages in an ordinary

straight receiver. Since no outside aerial or earth is required, a super-heterodyne can be used in any room in a house, and is particularly suited to those who wish their receivers to have a certain degree of portability. Such a set is frequently invaluable to the flat-dweller.

Very Selective

Some readers are unfortunate enough to be within the shadow of a local station. That is to say, they are situated so close to their local broadcasting transmitter that they have the utmost difficulty in cutting

out this station and receiving distant stations working on wave-lengths fairly near to that of the local station. In most of these cases the construction of a super-het. will solve the problem.

With a receiver of this type, situated, say, within half a mile of a broadcasting station, it is possible to cut out the latter, and to receive other stations working on wave-lengths close to that of the local with a fair amount of ease. This is one of the factors which makes a super-heterodyne such a fascinating instrument to operate. "But," says the

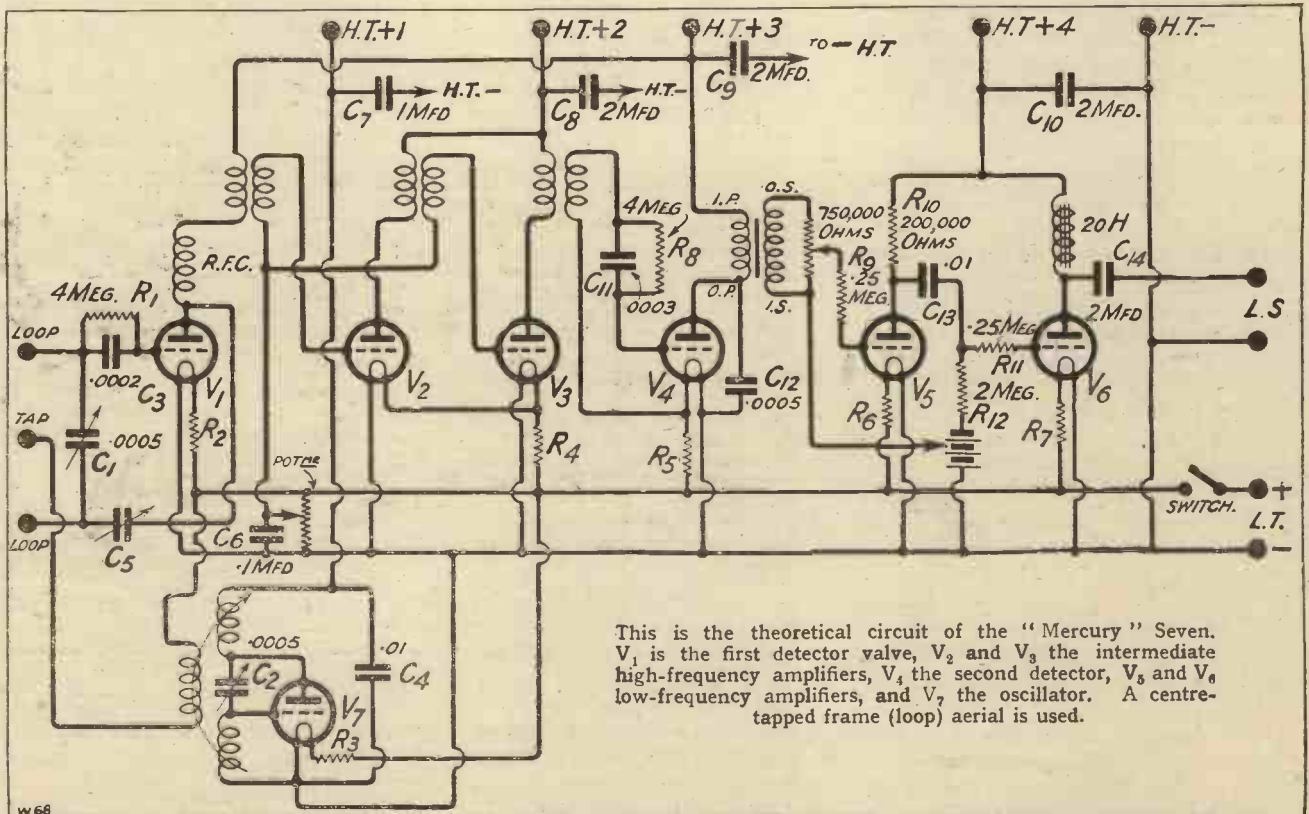

This is the theoretical circuit of the "Mercury" Seven. V₁ is the first detector valve, V₂ and V₃ the intermediate high-frequency amplifiers, V₄ the second detector, V₅ and V₆ low-frequency amplifiers, and V₇ the oscillator. A centre-tapped frame (loop) aerial is used.

critical reader, "in order to obtain these results you have to use seven valves. Think of the drain on the L.T. and H.T. battery."

H.T. Supply

It is quite true that seven valves are needed, but the modern valve requires such an astonishingly small current to heat the filament that the

accumulators, however, the problem is not very serious.

Since this is a constructional article, I do not propose to discuss the theory of the super-heterodyne, but speaking very broadly, the general scheme is as follows. The incoming oscillations are picked up by a small frame aerial which is tuned to the frequency of the station which it is destined to

one or two low-frequency stages which operate in a normal manner. A valve oscillating at any desired frequency is then arranged so that its oscillations can be superimposed upon the incoming signals in the circuit of the first detector valve. This separate oscillator has to be so adjusted that the difference in frequency between its own oscillations and the incoming

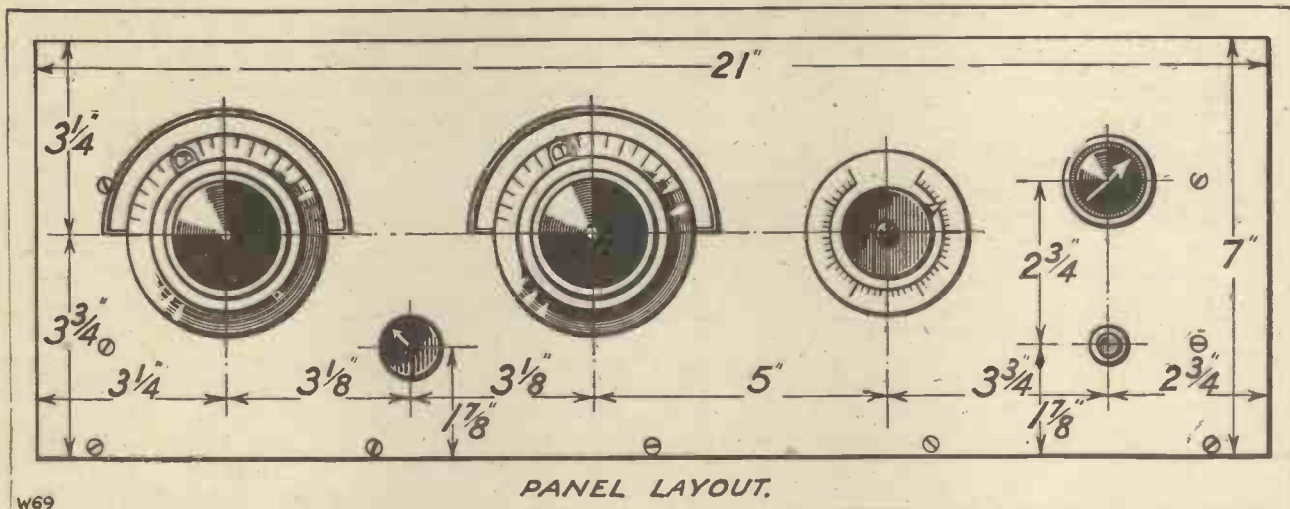

question of L.T. supply is scarcely worth considering. In fact, one could run the set on less current than that required by one bright-emitter valve. As regards H.T. it is certainly advisable to use accumulators or an H.T. battery eliminator. The anode current required is probably in the neighbourhood of twenty-five to thirty milliamps and this is rather a heavy drain for any but the very largest type of dry battery. With the increasing use of eliminators and H.T.

receive. Across this tuned circuit is connected an ordinary straightforward detector valve. Then follows a group of valves amplifying at what is called the intermediate frequency. This intermediate frequency may be anything between 3,000 and 6,000 metres according to the design of the coupling transformer.

How it Works

After this intermediate amplifier comes a second detector followed by

oscillations is equal to the wave-length, or frequency, to which the intermediate stages are tuned.

Since the satisfactory operation of a super-heterodyne depends upon this difference in frequency it will be seen that there are two positions for the oscillator tuning condenser for any given station. In practice either of these two positions can be employed, but the lower one is frequently more convenient. The oscillations at intermediate frequency are detected with

COMPONENTS REQUIRED

- 1 Ebonite panel, 21 x 7 x 1/4 in. (Any good branded material).
- 1 Cabinet, complete with baseboard 14 in. deep.
- 7 Anti-phonie valve holders (Ashley, Benjamin, Bowyer-Lowe, B.T.H., Burndept, Burne-Jones, C.A.V., Igranic, Lotus, Metro-Vick, Precision, Pye, W.B., etc.).
- 6 Filament resistances of the semi-fixed or interchangeable type (S. S. Bird, Bowyer-Lowe, Burndept, Burne-Jones, G.E.C., Igranic, Lissen, Peto-Scott, Precision, etc.).
- 3 Matched intermediate transformers (Marconiphone).
- 4 2-mfd. Mansbridge condensers (Dubilier, Ferranti, G.E.C., Lissen, Mullard, T.C.C., etc.).
- 1 1-mfd. Mansbridge condenser (see above).
- 1 Special oscillator coupler (Peto-Scott).
- 1 200,000 or 250,000-ohm wire-wound anode resistance (Dubilier, Mullard, R.I.-Varley, etc.).
- 1 L.F. transformer (Marconiphone 2-7 to 1, or other good make of low ratio).
- 2 .0005-mfd. variable condensers (Cyldon in set). (Any good make.)
- 1 L.T. on-off switch (Benjamin, Igranic, L. & P., Lissen, Lotus, etc.).
- 3 Grid-leak holders (Dubilier, Lissen, etc.).
- 1 L.F. choke, 20 henries inductance (Pye, R.I.-Varley, etc.).
- 1 Variable condenser of a capacity approx. .0001 mfd. (Cyldon, Igranic, Peto-Scott, etc.).
- 1 H.F. choke (Any good make).
- 1 Potentiometer, 400 to 800 ohms (Marconiphone in set). (Any good make.)
- 1 High-resistance potentiometer of approx. 500,000 to 750,000 ohms ("Centralab," R.A. Rothmel, Ltd.).
- 1 .1-mfd. mica condenser (Dubilier, T.C.C., etc.).
- 2 .01-mfd. mica condensers. (Clarke, Dubilier, Lissen, Mullard, T.C.C., Ward and Goldstone, etc.).
- 1 .0003 fixed condenser with grid-leak clips (Clarke, Dubilier, Lissen, Mullard, T.C.C., Ward and Goldstone, etc.).
- 1 .0002 fixed condenser with grid-leak clips (Clarke, Dubilier, Lissen, Mullard, T.C.C., Ward and Goldstone, etc.).
- 1 .0005 fixed condenser (Clarke, Dubilier, Lissen, Mullard, T.C.C., Ward and Goldstone, etc.).
- 2 .25-meg. grid leaks (Clarke, Dubilier, Lissen, Mullard, etc.).
- 1 2-meg. grid leaks (Clarke, Dubilier, Lissen, Mullard, etc.).
- 2 4-meg. grid leaks (these can be of lower value, but see text). (Clarke, Dubilier, Lissen, Mullard, etc.).
- 1 Terminal board complete with 7 terminals.
- 1 Terminal board complete with 3 terminals.
- 1 Terminal board complete with 2 terminals.
- 2 Panel brackets—either wood or aluminium.
- Quantity of wire, screws, nuts, etc.

the aid of the second rectifier, and amplified in a normal manner by means of a low-frequency amplifier, if it is desired to work a loud speaker. This, briefly, is the scheme employed in the receiver which I am about to describe.

Turning now to the theoretical diagram of the actual set, it will be seen that a centre-tapped frame aerial is employed, the high-frequency oscillations in the anode circuit of the detector valve being fed back on the ordinary Reinartz principle by means of a small variable condenser marked C_5 .

The Oscillator

This is an advantage, for it enables one to obtain the benefits of reaction in sharpening tuning, and improving signal strength, much in the same way as in the case of the ordinary straight single-valve receiver. The separate oscillator valve makes use of the Hartley method; that is to say, its tuning condenser is connected between the anode and grid of the valve. A small pick-up coil, free to rotate within the former upon which the main oscillator coils are wound, is

used to transfer the energy from the separate oscillator into the circuit of the first detector.

Intermediate Amplifier

The intermediate-frequency, or long-wave amplifier, consists of two stages coupled together by means of intermediate transformers. These transformers are interchangeable, since they are all matched up to give their maximum amplification at the same wave-length. Readers may wonder why the transformer-coupled low-frequency stage, has been placed first, since the more usual modern practice is to employ a resistance-coupled stage followed by a transformer.

With a super-heterodyne, however, there is a danger of the high-frequency oscillations at intermediate frequency passing into the low-frequency amplifier, and causing complete instability together with violent distortion. To stop these high-frequency oscillations with a high-frequency choke, as is the usual procedure with an ordinary straight receiver, becomes a most difficult matter in a super-het. because the

wave-length to which these intermediate stages are tuned may often be 6,000 metres, and, in consequence, an enormous choke would be necessary. By placing the low-frequency transformer first, however, and using a by-pass condenser having a value in the neighbourhood of .0005 mfd., it is possible to reduce the tendency for the high-frequency currents to be fed through into the L.F. side of the receiver.

As a further aid, .25-meg. grid leaks are placed in series with the grids of the two low-frequency valves.

Volume Control

A volume control is connected across the secondary of the low-frequency transformer, and by a simple adjustment of the rotating arm, any desired portion of the total voltage across the secondary winding can be tapped off and applied across the grid and filament of the succeeding valve. Since the reproduction largely depends upon the type of transformer used, it is essential that this component should have a primary inductance in the neighbourhood of 50 henries or more, and I would

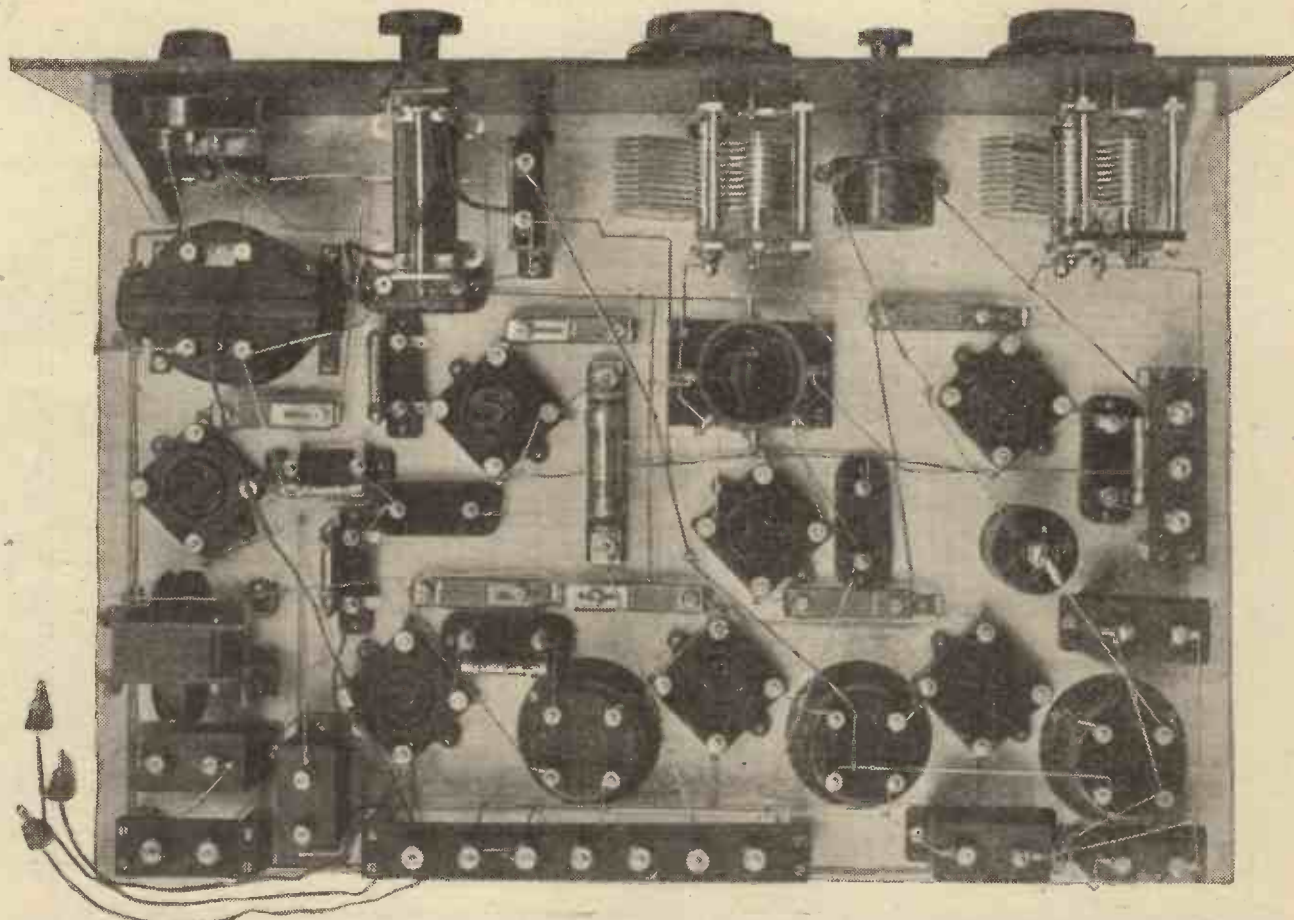

This very near view of the set removed from its cabinet will prove very useful to you during the wiring. The various components are arranged with a view to the greatest simplicity and efficiency in wiring. The latter is a very important factor in a powerful and sensitive set such as the "Mercury" Seven.

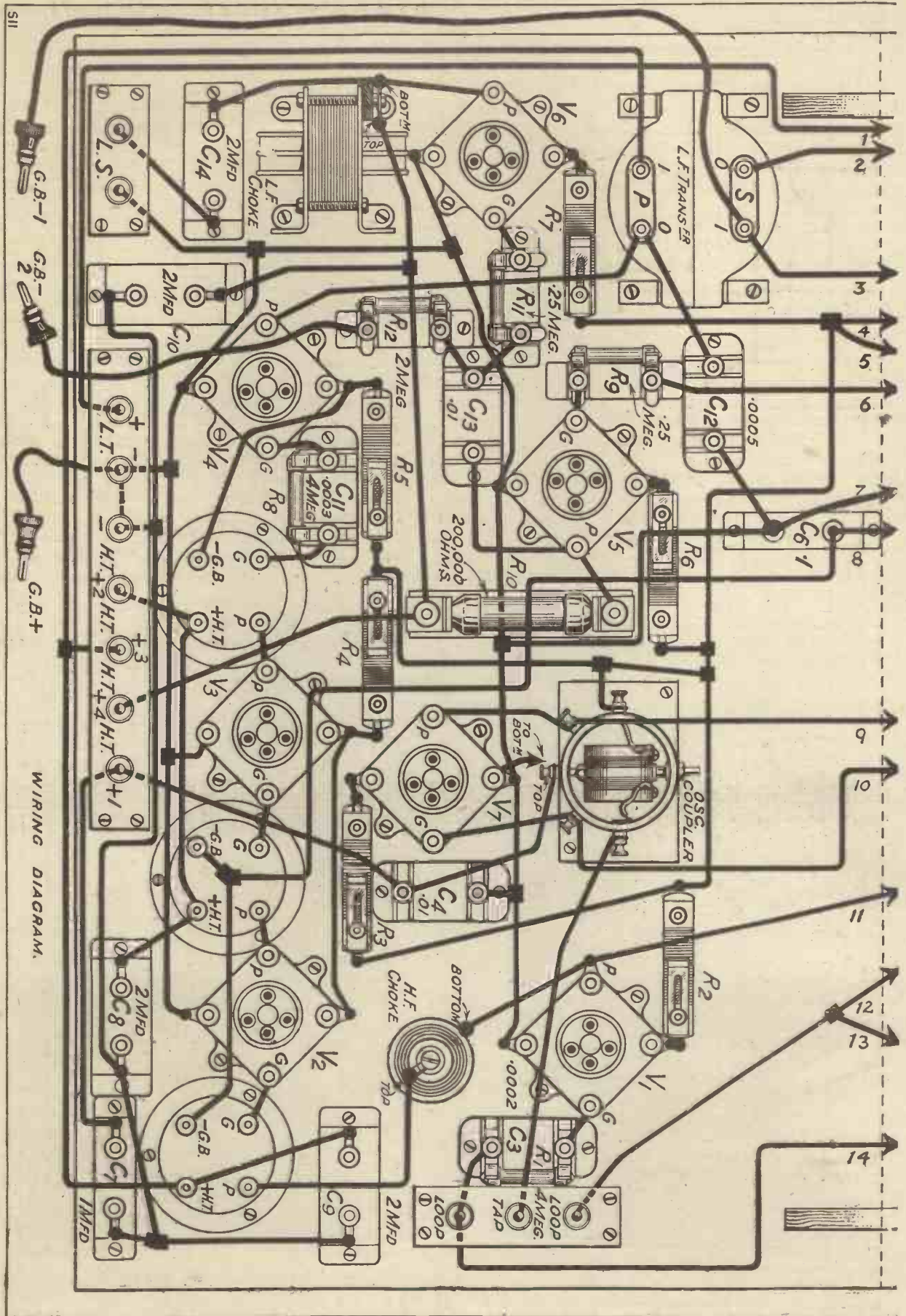

POINT-TO-POINT CONNECTIONS

One filament socket of the valve holder V_1 to one side of the filament resistance R_2 .
 One filament socket of each of the valve holders V_2 and V_3 joined together and to one side of R_1 .

One filament socket of V_4 to one side of R_2 and to the -G.B. terminal on the 3rd intermediate transformer.

One filament socket of V_5 to one side of R_2 .

One filament socket of V_6 to one side of R_2 .

L.T. + terminal to one side of the L.T. switch.

Other side of switch to one end of the first potentiometer winding, to the remaining sides of all the filament resistances and to one end of the pick-up coil (rotor) on the oscillator coupler.

L.T. - to H.T. - terminal, to the G.B. + plug via a flexible lead, to the remaining filament sockets of V_4 , V_5 , and V_6 to one L.S. terminal, to the remaining filament sockets of V_2 , V_3 , V_7 , V_1 to one side of the .01 fixed condenser C_4 to the bottom terminal on the bottom coil of the oscillator coupler (grid coil), to one side of each of the fixed condensers C_8 and C_{10} (.1 mfd. and .0005 mfd. respectively) and to the remaining end of the potentiometer winding.

One loop (frame aerial) terminal to one side of the grid leak R_3 and the grid condenser C_2 and to the fixed vanes of the variable condenser C_3 .

Moving vanes of C_3 to one terminal on the midjet condenser C_5 and to the remaining loop terminal.

"Tap" terminal for frame aerial to the remaining terminal of the pick-up coil (rotor) on the oscillator coupler.

Remaining sides of R_3 and C_3 to the grid of V_1 .

Plate of V_1 to the bottom contact on the high-frequency choke, and to the remaining side of the midjet condenser C_5 .

Top contact on high-frequency choke to the "P" terminal on the 1st intermediate transformer.

"G" terminal on same transformer to the grid of V_2 .

Grid of V_7 to the top terminal of the bottom coil (grid coil) of the oscillator coupler and to the fixed vanes of the variable condenser C_3 .

Plate of V_7 to the bottom terminal of the top coil (plate coil) of the oscillator coupler and to the moving vanes of the variable condenser C_3 .

Top terminal of top coil (plate coil) of the oscillator coupler to the remaining side of the .01 fixed condenser C_4 , to the H.T. + 1

terminal and to one side of the 1-mfd. Mansbridge condenser C_2 .
 Plate of V_2 to the "P" terminal on the 2nd intermediate transformer.
 "G" terminal on same transformer to the grid of V_2 .
 Plate of V_2 to the "P" terminal on the 3rd intermediate transformer.

"G" terminal on 3rd transformer to one side of the grid leak R_3 and the grid condenser C_1 .

Other sides of R_3 and C_1 to the grid of V_1 .

One tag of the 2-mfd. Mansbridge condenser C_2 to the "+H.T." terminal on the 1st intermediate transformer, to the H.T. + 8 terminal and to the I.P. of the low-frequency transformer.

One tag of the 2-mfd. Mansbridge condenser C_2 to the "+H.T." terminals on the 2nd and 3rd intermediate transformers and to the H.T. + 2 terminal.

Remaining tags of the Mansbridge condensers C_2 , C_7 , and C_8 joined together and to the H.T. - terminal.

Plate of V_1 to the O.P. of the low-frequency transformer and to the remaining side of the .0005 fixed condenser C_5 .

O.S. of the low-frequency transformer to one end of the H.R. potentiometer "winding" (Volume control).

Other end of the potentiometer "winding" to the I.S. of the low-frequency transformer and to the G.B. - 1 plug via a flexible lead.
 Arm of potentiometer to one side of the .25-meg. grid-leak holder, R_3 .

Remaining side of R_3 to the grid of V_2 .

"-G.B." terminals on the 1st and 2nd intermediate transformers joined together, to the remaining side of the 1-mfd. mica condenser C_6 and to the slider of the potentiometer controlling the intermediates.

Plate of V_7 to one side of the 200,000-ohm anode resistance R_{10} and to one side of the .01 fixed condenser C_3 .

Other side of C_3 to one side of each of the grid-leak holders R_{11} and R_{12} (.25 meg. and 2 megs. respectively).

Remaining side of the R_{11} holder to the grid of V_5 .

Remaining side of the R_{10} holder to the G.B. - 2 plug via a flexible lead.

Plate of V_6 to the bottom contact on the low-frequency choke and to one tag of the 2-mfd. Mansbridge condenser C_2 .

Other tag of C_2 to the remaining L.S. terminal.

Top contact on low-frequency choke to one tag of the 2-mfd. Mansbridge condenser C_2 to the remaining side of the anode resistance R_{10} and to the H.T. + 4 terminal.
 Remaining side of the Mansbridge condenser C_2 to the H.T. - terminal.

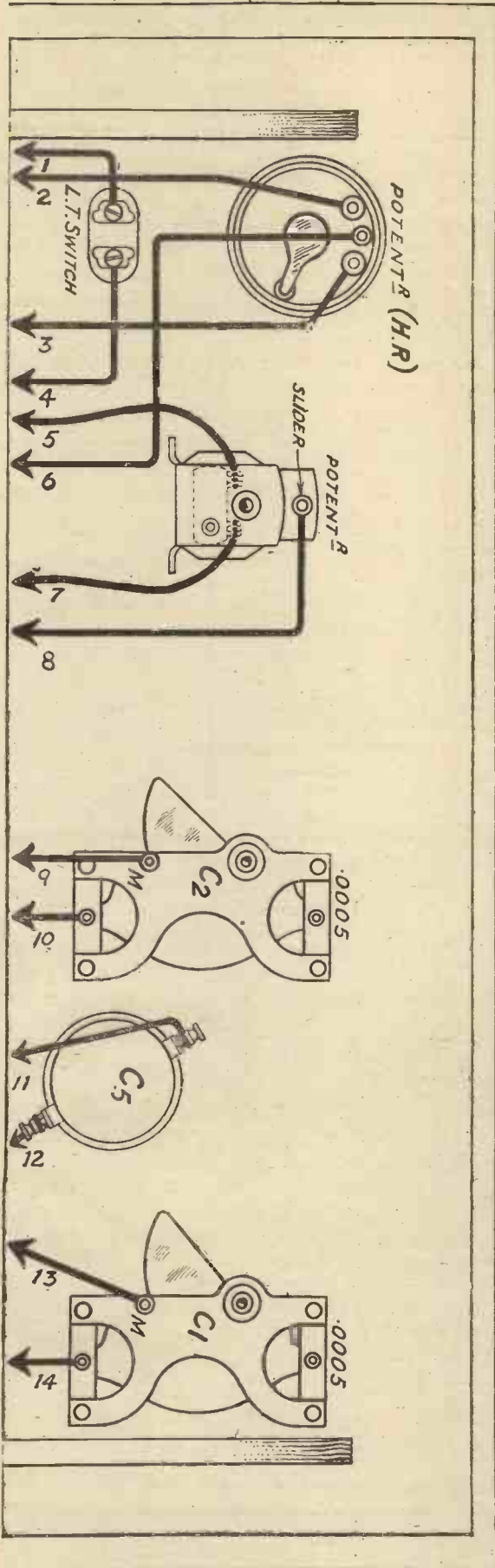

recommend a low-ratio instrument of first-class make. If the valve chosen for the output stage is of the super-power type, it is essential to choose an output choke of low D.C. resistance (about 300 ohms), and, in addition, one which will maintain a fairly high inductance value when a current of 25 milliamps is passed through its winding.

Turning now to the panel layout diagram, the order of the various controls reading from the left is: First the frame tuning condenser, then the oscillator tuning condenser, and between these two the small knob for the reaction control.

Sharp Tuning

Next comes the potentiometer for controlling the intermediate stages, then the volume control which is joined across the secondary of the low-frequency transformer, and underneath this the filament on-and-off switch. It will be noticed from the photograph that slow-motion dials have been incorporated for the two main tuning controls. These are essential in a super-heterodyne re-

holes will be reversed. That is to say, the hole for the frame tuning condenser will be on the right of the panel looking from the back.

A Useful Hint

I mention this because only the other day I came across a case where a beginner, in following out a diagram, had forgotten this point. In consequence his only alternative, apart from buying a new panel, was to use the back as the front, thus completely spoiling the appearance of the set owing to the fact that all the lines which he had so carefully scribed would appear on the front instead of on the back.

The variable condensers used in the set are of the three-point-suspension type, but this should be no more trouble than if they were of the single-hole-fixing variety, because with each condenser a metal template is provided, and this makes the work of fixing quite simple. It is only necessary to drill the holes in accordance with the template and the work is

bottom of the panel for the purpose of securing the panel to the baseboard. These five holes should be drilled at a distance of 3-16th to 1/4 in. from the edge, according to the thickness of the baseboard.

The slow-motion dials used are a type marketed by Messrs. Burndept and Bowyer-Lowe, and require some care in mounting. Full instructions are given with the carton in which the dials are packed, and there is therefore no need for me to describe the method of attaching these to the condensers. The layout of the components on the baseboard is clearly shown in the photographs, and there is little to be said respecting this part of the construction.

Wiring-Up

Super-heterodynes are not unduly critical as regards layout, but it is not advisable to deviate in any way from the general scheme shown, since the design has been under test for some considerable time with complete success, and by duplicating the scheme adopted the constructor can scarcely fail to obtain successful results.

If the wiring-up is carried out with bare wire, I would recommend a substantial gauge such as No. 16, but those who prefer an insulated wire can, of course, use one of the well-known types such as Glazite. With practically all of the components used, the various leads can be secured by means of terminals, and those who dislike soldering will no doubt prefer to do this.

When wiring up a receiver from a diagram or blue print there is really no hard and fast method to be followed in joining up the various leads to their respective terminals.

Preliminary Tests

It is always a sound plan, however, to wire up the filament fixed resistors, etc., first. These leads are usually nearest the baseboard and they are mostly somewhat difficult to insert at a later period.

If you have completed the wiring and checked it up very carefully with the wiring diagram, you will now be ready to conduct the preliminary tests. First, place a suitable valve in each of the seven valve holders. The valves I suggest are as follow: In the sockets V_1 , V_2 , V_3 , and V_4 four valves of the type usually sold for high-frequency amplifying purposes. Amongst such valves in the 6-volt class may be mentioned the Marconi or Osram D.E.L.610, the Mullard

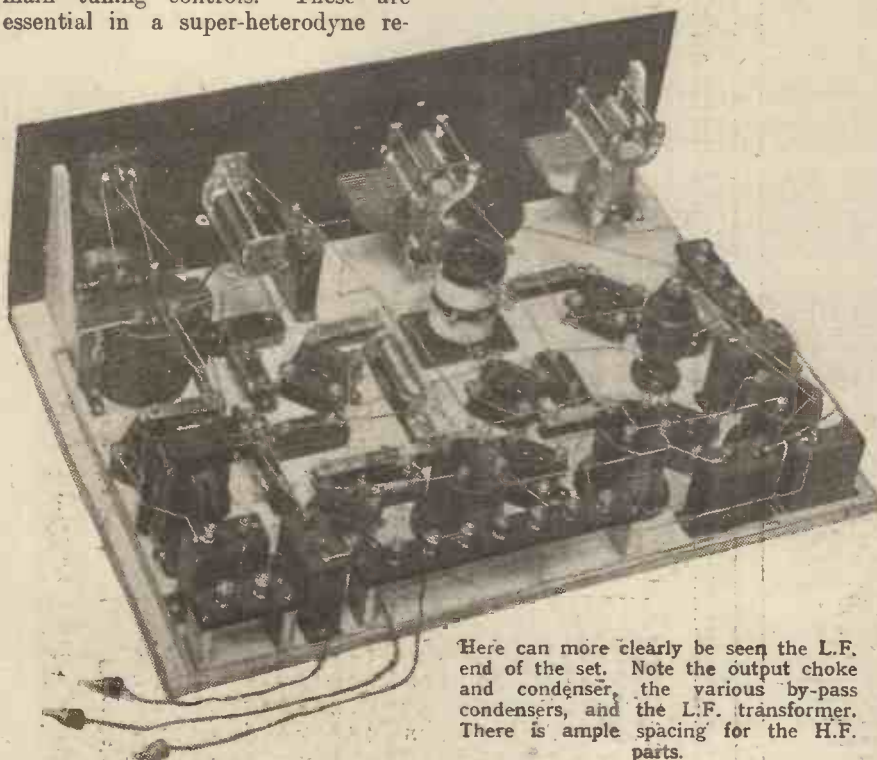

Here can more clearly be seen the L.F. end of the set. Note the output choke and condenser, the various by-pass condensers, and the L.F. transformer. There is ample spacing for the H.F. parts.

ceiver as the tuning, particularly that of the oscillator condenser, is extremely sharp.

We are now in a position to make a start upon the construction of the receiver. The first procedure is to mark off the panel to the dimensions given on the panel layout diagram. All lines should be scribed on the back of the panel, and it is as well to mention that the positions of the

done. The reaction condenser, volume controls and filament on-and-off switch require 3/8-in. holes, but the potentiometer requires the use of a template.

Here, again, one is supplied by the makers, and consequently the drilling is quite straightforward. In addition to the six holes for components, two screw holes are necessary for the angle brackets and five more along the

P.M.5X, the Cossor H.610, or, in fact, any valve having similar characteristics.

For V_5 I suggest another valve of the high-frequency type, since the use of one of the special R.C. valves in this case will be of little or no advantage owing to the fact that a 200,000-ohm anode resistance is used.

point the receiver will not work as a super-heterodyne, and if any difficulty is found in obtaining consistent oscillation with an ordinary high-frequency valve, then a small power valve should be tried.

It is more economical to use the high-frequency type on account of its lower H.T. current consumption.

types, the Mullard P.M.256, Burndept L.L.525, Cossor Stentor 6, Marconi or Osram D.E.5A, etc. I prefer the use of 6-volt valves in a receiver of this type, but the equivalents in the 2- or 4-volt classes can be employed. Having placed a suitable valve in this socket, connect up the L.T. battery, pull out the on-and-off switch, and note whether any of the valves light. With some types you will not be able to see whether they are alight or not, in which case you will have to carry on with the assumption that this part of the circuit is all correct, unless by any chance you have a voltmeter which you can place across each of the filaments in turn. Join a centre-tapped frame aerial between the points marked "loop," "tap," and "loop" on the diagram. The two ends of the frame go to those terminals marked "loop" and the centre point is connected to the terminal marked "tap."

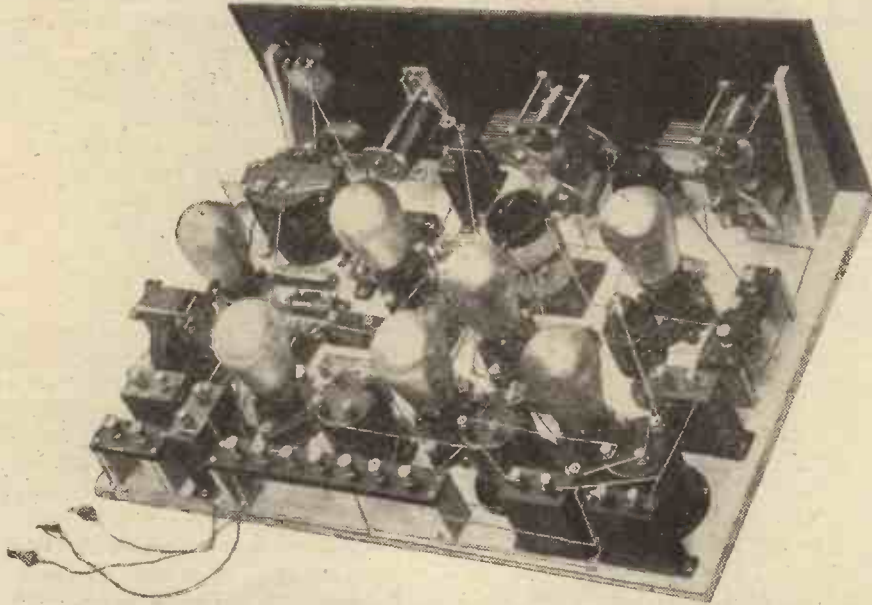

Here the valves are shown in position, the set being ready to place in operation. The grid-bias battery can be fixed to the inner side of the back of the cabinet.

Most of the special R.C. valves require an anode resistance having a value of 500,000 ohms or more.

It may be said fairly safely that in this particular instance a valve with a magnification of twenty will give just as much amplification as one of the special high "mu" types. In the last stage you may use either one of the ordinary small power valves or, alternatively, a super-power valve, with an impedance of 3,000 to 4,000 ohms.

The Last Valve

If considerable volume is to be handled then I would prefer to use the latter, but if the volume is only moderate then there is little to be gained in using a valve of the super-power type. For anything like full loud-speaker strength, however, I would strongly recommend the use of a super-power valve. In the oscillator socket V_7 , it is highly probable that a good high-frequency valve will be quite adequate, but in some cases a small power valve is desirable. A power valve usually tends to oscillate more freely on moderate anode voltages and it is, of course, essential that the oscillator should function over the whole wave-length range.

If the valve stops oscillating at any

Amongst the valves suitable for socket V_6 the following may be mentioned. In the small power class, the Marconi or Osram D.E.5, Ediswan P.V.5, Mullard P.M.6, B.T.H. B4, Cosmos S.P.55R, Cossor 610 L.F., Burndept L.525. In the super-power

Operation Notes

To commence with, try the following H.T. values. H.T.+1, about 75 volts; H.T.+2, 80 volts; H.T.+3, 60 to 75 volts; H.T.+4, at least 120 volts. Plug in the H.T. — wander plug and connect the loud speaker to the terminals marked L.S., and you are then ready for testing.

Search first for the local station. Place the reaction condenser C_5 at zero so that you are obtaining little or no reaction. Place the potentiometer so that the intermediate stages are not in an oscillating condition. Rotate

(Continued on page 208.)

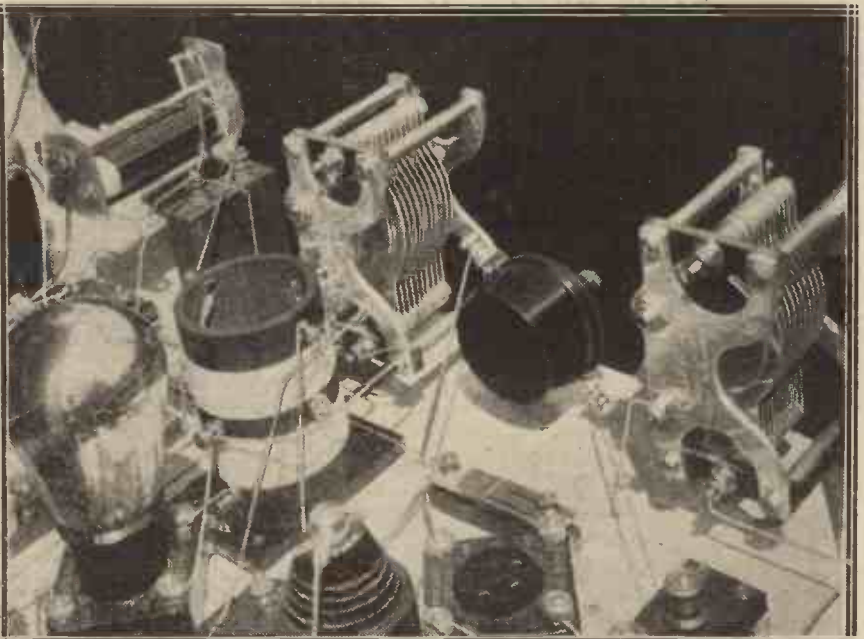

A "close-up" of the oscillator coupler, showing most of its connections. The potentiometer can also very clearly be seen in this photograph.

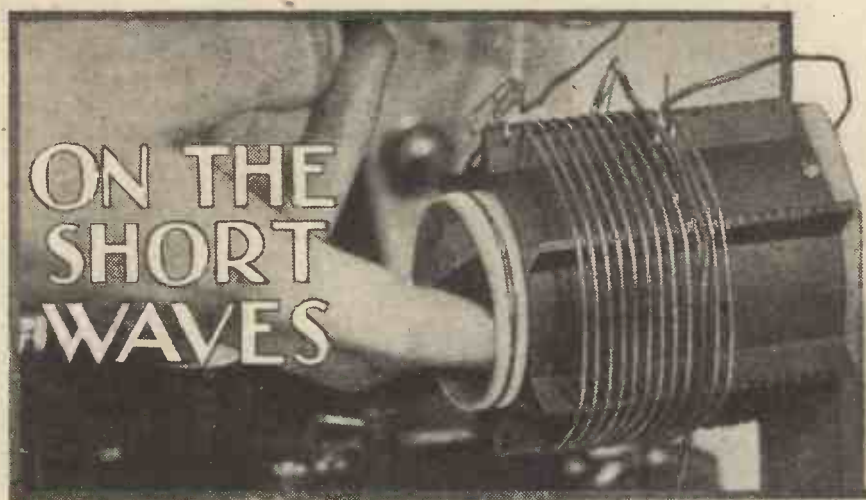

Notes of Interest on Short-Wave Receivers and Reception Conditions.

By W. L. S.

THE writer has recently been testing out and comparing the merits of several different types of short-wave receivers, some of commercial manufacture and others by amateur constructors. As regards the popularity of short-wave circuits, there is no doubt whatever that the Reinartz detector followed by either one or two stages of L.F. tops the list. With good reason, too, as far as the average listener is concerned, for its ease of handling is as great as that of any ordinary broadcast receiver, its sensitivity and selectivity being excellent.

Super-het. Advantages

There is a time, however, when one decides that something more pretentious in the way of short-wave receivers is to be desired, and the two alternatives are super-heterodynes and sets incorporating H.F. With regard to the former class, the super-het. is, in my opinion, much more suited to short-wave work than is the average super-het. that one hears on broadcast. It has, of course, rather gone "out of fashion" for broadcast reception, but for short-waves there is as yet nothing to surpass it for simplicity and *certainty*.

Reliability and Constancy

The amazing part of the super-heterodyne, when it is used on short waves, is that the varying "conditions" which are one of the usual bugbears of short-wave work apparently disappear! One hears the same stations coming in at the same strength night after night, while with

the very best of "two-valve low-lossers" one is forced to admit that consistency is not one of the great features.

I do not put this down to inherent troubles in the two-valver, but rather to the fact that the super-het. is so sensitive, and has so much extra "push" in reserve, that if stations are a little weaker than usual one doesn't notice it. We also have the great advantage of single-dial control

✱

The transmitting room at station KFI, the broadcaster known as the "Pacific Super-Power Station," owned by the Packard Motor Co., Los Angeles, U.S.A.

✱



with the super-het. Although many seem to fight shy even of making a super-het., the construction is simplicity itself, and once the few initial "knacks" of adjusting and operating it have been mastered, there is really nothing to do but turn the dial and listen!

The disadvantage of the "super" is, of course, the unavoidable one of "second channel interference." Every station is received both on an upper

and lower reading of the condenser dial and each station will, therefore, be found twice as you turn the dial. In the course of normal working these readings are usually separated by 20 degrees or so. On the crowded short-wave bands, of course, this is a real disadvantage, but in my opinion it is more than compensated for by the benefits derived from the circuit.

Success of H.F. Amplification

With regard to H.F. amplification, this type of short-wave set certainly seems to be coming into its own at last. I have tested one commercial receiver using a neutralised H.F. stage, and also two or three of the home-built variety, and they all work surprisingly well. The tuning is not so complicated as one would think, since when the set is correctly adjusted and neutralised (in which condition it is, by the way, absolutely stable), the main tuning control is the H.F. condenser, and the aerial condenser merely acts as a kind of volume control which has little or no effect upon the wave-length. Sets of parts for building a receiver with one neutralised H.F. stage are now available, and it is a line of experiment that is well worth following up.

Ideal for Telephony

Here, again, one notices greater "certainty" than is obtainable with

the average short-wave set, although the signals are apparently neither stronger nor more numerous.

For telephony reception, of course, one has to go a very long way to beat the super-het. and it is the receiver par excellence for the man who simply wants to listen to the American stations 2 X A D, 2 X A F, etc. He has no trouble with the "second channel interference" because he does not want to search.

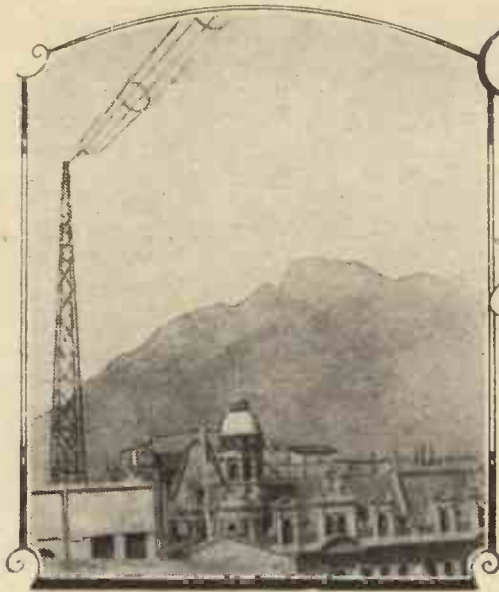

The CAPE TOWN Broadcasting Station

*The transmitter that
has no call sign.*

By
E. A. ANSON.

A SIX-KILOWATT Q-type Marconi transmitter, a four-wire cage-aerial and two masts erected on the roofs of two tall buildings. That is the business end of Cape Town's broadcasting station. The masts themselves are 46 ft. and 72 ft. high, steel girder type, situated on roofs themselves some 60 ft. high.

Behind them rises Table Mountain—sheer up into the clouds 4,000 ft. above. Curiously enough, Cape Town has no allotted call. Mr. R. S. Caprara, the station director, told me that just "Cape Town calling" was quite sufficient. Incidentally, Cape Town calls on 375 metres with some 12 amps. in the aerial.

Every care has been taken with the earth. The soil is very dry and rocky. The normal earth is a difficult proposition. The Cape Town engineers have solved the problem by carefully bonding all the iron roofs in the vicinity. In addition they have dug up the street below and laid stout copper wires underground parallel to the aerial. For a transmitter situated in the heart of a large town under these conditions a radiation as high as 12 amps. shows that the engineers have not worked in vain.

A Widespread Audience

Realise that here in South Africa they are up against problems never encountered in the thickly-populated areas of Great Britain. South Africa is a land of enormous distances and vast open spaces. Limitless plains, vast forests, stretch thousands and thousands of miles into the very heart of a gigantic country. The nearest broadcast station to Cape Town lies quite 600 miles away at

Durban, with Johannesburg a bad second at 900 miles.

Perhaps you can visualise this better if you imagine 2LO being expected to cover all England and the greater part of France. Surely a time for super-hets. and multi-valve sets, if ever there was a time!

Multi-Valvers Popular

The licences work on a zone system. Up to a radius of 50 miles the cost is 7s. 6d., collected by the Post Office in the Cape. Over 50 miles and up to 250 miles it is 35s.

In Cape Town itself there are a vast number of crystal sets, probably quite 50 per cent. However, there is a very ready demand for six-valve sets capable of reaching out and getting

"Auntie Lexus," the popular Cape Town announcer, preparing for the evening programme in one of the studios. The glass window looks into the control room.



some of those far-off lands beyond the seas. Probably 2 H.F., 2 L.F. is the favourite multi-valve set. Nearly all the radio dealers were displaying these types in their windows when I visited Cape Town.

It is interesting to note that British sets and components predominate. Not only was I told this by the station director and engineers but it was obvious in the shop-windows. However, the United States is slowly but surely getting the market. I give this as a word in time to our manufacturers.

The Programme Problem

The general opinion out there was that American sets gave just as good results. They were cheaper, and their service after purchase was beyond reproach. Spare parts could be obtained readily, and there was not that patient wait whilst some very special important component slowly drifted out by the next boat!

Surely it is worth while for our wonderful British sets to keep a very good market that at present is theirs for the trouble of keeping!

Another unique problem that would probably make the British programme staff turn grey prematurely is the language problem. All broadcast is bi-lingual in the Cape. News, talks, etc., have to be given twice, once in English and once in Afrikaans. The

Cape announcer must be expert in both these tongues. Naturally this repetition causes a certain monotony and waste of time.

In addition, the people that speak Afrikaans and a large proportion of

the coloured inhabitants may have very different ideas of the perfect programme compared to the white population. When compiling the programmes the station director and his staff have to weigh the two in the balance and strike instinctively the happy medium.

In Great Britain the problem of the perfect programme has yet to be settled. Introduce another language into this very controversial subject and—! Well!

The studios themselves are situated about a quarter of a mile from the transmitter, in the same building as the offices. They occupy the entire top floor of a tall, spacious building. In all there are two studios, placed one on either side of the control room. The control room is visibly connected with both studios through noise-proof glass panels.

Outside Broadcasts

No less than forty outside lines enter the well-equipped control room. These are all connected to the important churches, theatres, cinemas, music-halls, and other places of interest in the town. In addition, a portable transmitter can be brought into use at a moment's notice as connecting link when land-lines fail.

For instance, a ten-mile swim through shark-infested, dangerous currents in an icy-cold sea were successfully broadcast to an expectant public. The portable transmitter was installed on the launch. Loud speakers at busy centres in the town gave half-hourly reports of the swim, which was won by a young girl. Considering that this swim lasted from 7.30 a.m. to 8.5 p.m., it will be realised that this was an undertaking

requiring minute attention to the smallest detail to ensure success. In England it would be much the same as broadcasting a Channel swim.



A Cape Town celebrity, "Auntie Lexus."

Highly interesting programmes are compiled, thanks to the continuous flow of shipping into Cape Town. At some time or another most of the world's famous people visit South Africa, and the station director is not slow in getting in touch with them. The Prince of Wales has spoken over the wireless, so have Cobham, Galsworthy, Amery, Mason, Marion Crane, and Dr. Rendall. These are only a few taken at random.

In fact, Dr. Rendall received his microphone "baptism" at this station. In addition to visitors there is an ample supply of local talent, and the station director himself, besides being a keen wireless experimenter, is an expert musician. Probably he is one of the best clarinet players in the world. He was trained by Sir Charles Stanford.

Radio Jottings

Humming noises due to a battery eliminator may often be reduced by connecting a high resistance, such as an anode resistance, in series with the fixed smoothing condenser.

Big Ben has a microphone all to himself in the clock tower. (It is wrapped in cotton-wool, which is enclosed in a rubber football-bladder as a protection against bad weather.)

Contrary to a common belief, the secondary of a burnt-out transformer does NOT make a good choke for an output circuit.

When using a battery eliminator it is not advisable to switch the H.T. on or off when the valves are alight. (The H.T. should always be switched ON before the filament, and switched OFF after the filament.)

Faulty Phones

When scratching noises are heard in the telephones a good test is to connect them across a low-tension battery. If the terminals of the battery are clean and the noises are still heard it is a sure indication that the 'phones or 'phone leads are faulty.

The reproduction from a loud speaker is largely dependent upon its position in the room, i.e. it may be better in one corner than in another, and a position near the ceiling may give better results than one near the floor.

Condenser Connections

If the moving vanes of a variable condenser rely for contact upon a pressure or rubbing contact, it is often an advantage to solder a "pigtail" of flexible wire, to give a more definite connection.



Mr. R. S. Caprara, Station Director.

Very often pleasing echo effects heard during a transmission are not coming from the actual studio where the broadcasting is taking place, but the echo is being added artificially in a second studio.

The B.B.C. has one of the biggest collections of gramophone records in the world.

Valves, which were first developed for wireless work, are now used extensively to improve the working of telephones and cables.



The Assistant Engineer about to switch on the carrier.

Steering by RADIO



"An ingenious development . . . designed to give the pilot (of an aeroplane) an automatic and visible indication of his bearing from a particular beacon station without the necessity of manipulating any kind of wireless control."

By J. C. JEVONS.

THE application of directional effects in wireless still offers an interesting field of research to the experimenter gifted with a touch of inventive genius. For instance, the advantages to be gained by concentrating ether waves into a definitely directed path were fully realized for many years before Mr. Franklin succeeded in designing an aerial system capable of translating the idea into actual practice.

This inventive step has entirely revolutionized existing standards of wireless transmission, so that to-day the Beam system has out-distanced all its competitors for economical long-range working.

The various applications of the loop aerial in directional reception offer a similar field for experiment, full of interesting possibilities for those with original ideas.

Serious Screening Effects

At present direction-finding is chiefly confined to marine and aerial navigation, though there are interesting side-issues in connection with the automatic steering or control of ships and aeroplanes from a distance by directional wireless, and also in prospecting by radio for hidden or subterranean deposits of metals and mineral ores.

With existing types of D.F. apparatus a high degree of accuracy is only possible where there is reasonable freedom from screening effects and excessive noise. These ideal conditions do not exist on board ship,

chiefly owing to the effect of re-radiation from the funnels and other metal structures located near the receiving aerial.

Special Methods Necessary

This gives rise to "quadrantal error," as it is called, which although it can be allowed for, naturally complicates the taking of D.F. observations.

The position is still worse in the case of an aeroplane. Here, in addition to quadrantal error and vibration, the noise of the engine is all-pervading. Even if the aviator wears a "sound-proof" helmet he cannot secure as quiet a background as a ship's operator working in a special double-walled cabin.

Consequently the aviator cannot depend upon "minimum" or zero reception to indicate the direction

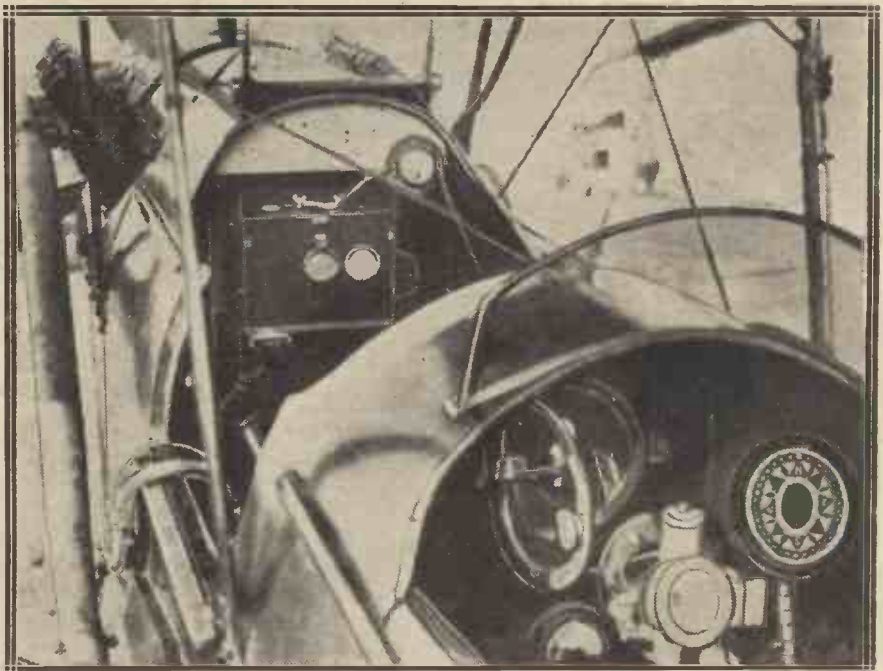

Above is illustrated a standard radio outfit installed in a service type of aeroplane. You will be able to see the transmitter fixed in the front cockpit. A pair of telephone receivers is resting on the side of the fuselage. The two circles on the front of the transmitter are valve inspection windows. An aerial current ammeter is fitted on the dashboard above the transmitter. The aerial, which cannot be seen, is a long wire which, having a weight on its end, is let out from the machine by means of a hand winch.

of the incoming wave. Instead he utilizes a double frame, setting one coil so that it receives at maximum strength, and using an auxiliary coil at right-angles to the first.

The critical point is determined by the particular setting of which there is no "pick-up" by the auxiliary coil, i.e. when it makes no difference to the signal strength when the auxiliary coil is switched into circuit with the main coil either in series or in opposition. In these circumstances the operator knows that the main coil is pointing directly towards the transmitting station.

An Alternative Method

The drawback to using the point of maximum signal strength instead of minimum or zero reception is that the former setting is not so sharply defined as the latter. In fact, it usually gives the same reading over several degrees of swing, and so gives rise to a corresponding margin of error.

In practice there is an alternative method used both by ships and aircraft. Instead of themselves carrying D.F. apparatus, the ship or aeroplane calls up the nearest land station where accurate equipment using the zero method is available, and asks

for the bearing of this calling signal relatively to the land station. It only takes a couple of minutes or so for the necessary information to be wirelessed back, and by taking two such bearings from two different land stations the inquirer is able to establish his precise location.

For the reasons above stated, the installation of D.F. apparatus is by no means general, especially on aero-

stallation is designed to give the pilot an automatic and visible indication of his bearing from a particular beacon station without the necessity of manipulating any kind of wireless control.

When a D.F. indication is desired, the loop aerial A shown in the diagram is connected by a clutch either to the main propeller shaft or to a separate wind screw so that it is slowly swung

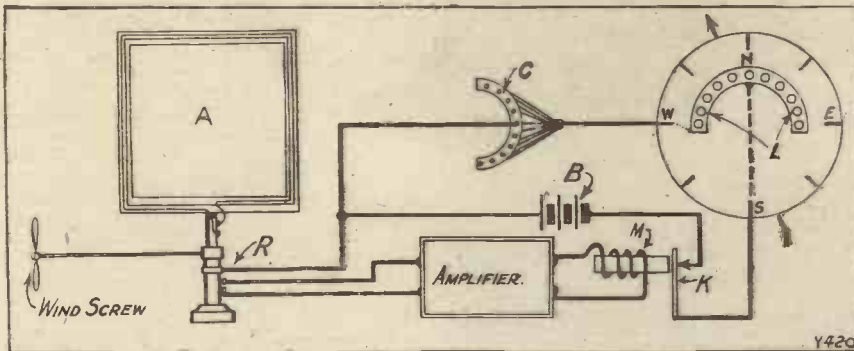

planes. The pilot has usually quite enough to do to supervise the flying controls, and in case of emergency he has less time than ever "to fiddle about with wireless gadgets."

The apparatus about to be described is an ingenious development due to the Telefunken Company. The in-

to and fro over an angle of 180 degrees.

Its movement is followed by an arm 'R', which brushes lightly over a series of contacts 'C'. These are in turn wired up to a corresponding number of flash lamps 'L', arranged in a circle so as to indicate the compass bearings relatively to the fore and aft line of the aeroplane and to true North.

The beacon signals received by the loop aerial 'A' are led to an amplifying set, an electro-magnet 'M' being arranged as shown in the output circuit of the last valve of the set.

So long as there is any "pick-up" voltage on the frame from the beacon station, the output current from the valve amplifier will be sufficient to enable the magnet 'M' to maintain the contacts 'K' open.

Automatic Signal

At the critical point of zero reception, however, the output current from the amplifier sinks to such a value that the contacts 'K' will close. Thereupon a battery 'B' in the relay circuit immediately lights up that particular lamp in the indicator 'L', which corresponds to the position of the arm 'R' on the contacts 'C'.

As the arm 'R' follows the movement of the loop 'A', the lamp so flashed at once enables the pilot to ascertain the required bearing. It will be noted that the flash depends upon the point of minimum or zero reception, which, as previously stated, gives a higher degree of accuracy than the maximum method usually employed on aeroplanes.



This is the aerial tuning coil used in connection with the new 50-kw. broadcasting plant at W E A F, Bellmore, L.I., N.Y. It is not unlike, in appearance at least, some of those plug-in coils used in short-wave receivers, and it serves a similar purpose. But there is a slight discrepancy in the similarity when it comes to a question of sizes.

THE "ALL-TURN" CRYSTAL SET

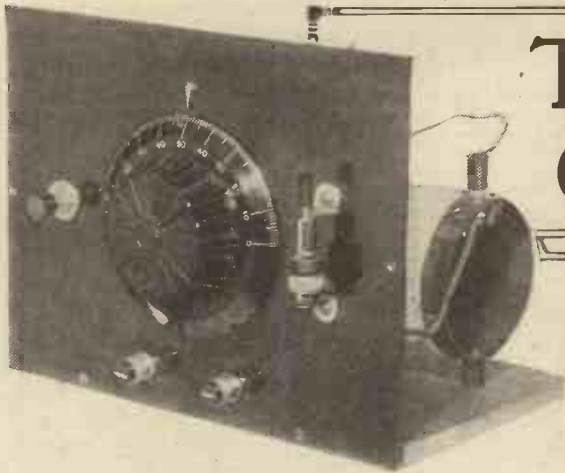

An easy-to-build receiver capable of providing the optimum degrees of sensitivity and selectivity. With the "All-Turn" you will be able to pick up alternative programmes with the greatest of ease.

By B. KINGSCOTE.

QUITE a fair proportion of the total number of listeners in this country have to use crystal sets, because receivers fitted with

valves are too expensive for them to buy and to maintain. A crystal set is most suitable for beginners, too, for they can very easily build one and later add a magnifier in order to raise the sound from headphone strength to a satisfactory loud-speaker volume.

considered quite the thing for good reproduction from the local station and Daventry. All sorts of strange crystal circuits have been devised; attempts have even been made to employ two detectors in an endeavour to increase the volume of sound. But the best all-round results are probably to be obtained from a simple straightforward circuit of proper construction.

is turned into sound. Now the amount of energy received depends on the effectiveness of the aerial as well as the design of the set. For a given position with respect to a broadcast station the listener can improve crystal reception in two ways, and the first and perhaps the one that should be more strongly emphasised is by paying attention to the aerial and earth.

Importance of Aerial

A crystal receiver contains nothing that can magnify the sound, and we have therefore so to arrange the circuit that the largest proportion of the total amount of energy available

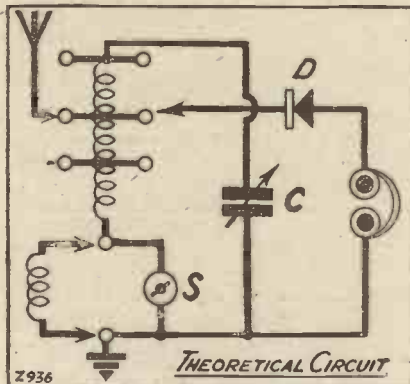

valves are too expensive for them to buy and to maintain. A crystal set is most suitable for beginners, too, for they can very easily build one and later add a magnifier in order to raise the sound from headphone strength to a satisfactory loud-speaker volume.

COMPONENTS USED.

- 1 Panel, 9 in. x 7 in. (American Hard Rubber Co.).
- 1 Baseboard, 9 in. x 5½ in. x ½ in.
- 1 .0005-mfd. tuning condenser, with dial.
- 1 Dial indicator.
- 1 "On" and "off" switch.
- 1 Crystal detector (Brownie).
- 4 Terminals.
- 1 Terminal strip, 4 in. x 1½ in.
- 1 Coil holder.
- 1 No. 200 plug-in coil.
- 1 Tube 3 in. diameter, 3¼ in. long.
- 6 Clix sockets.
- 2 Clix plugs.

Before valve detectors and low-frequency amplifiers were so well understood as they are to-day, one used often to hear the remark that crystal reception was better than valve reception. Indeed, a crystal detector with a valve magnifier was

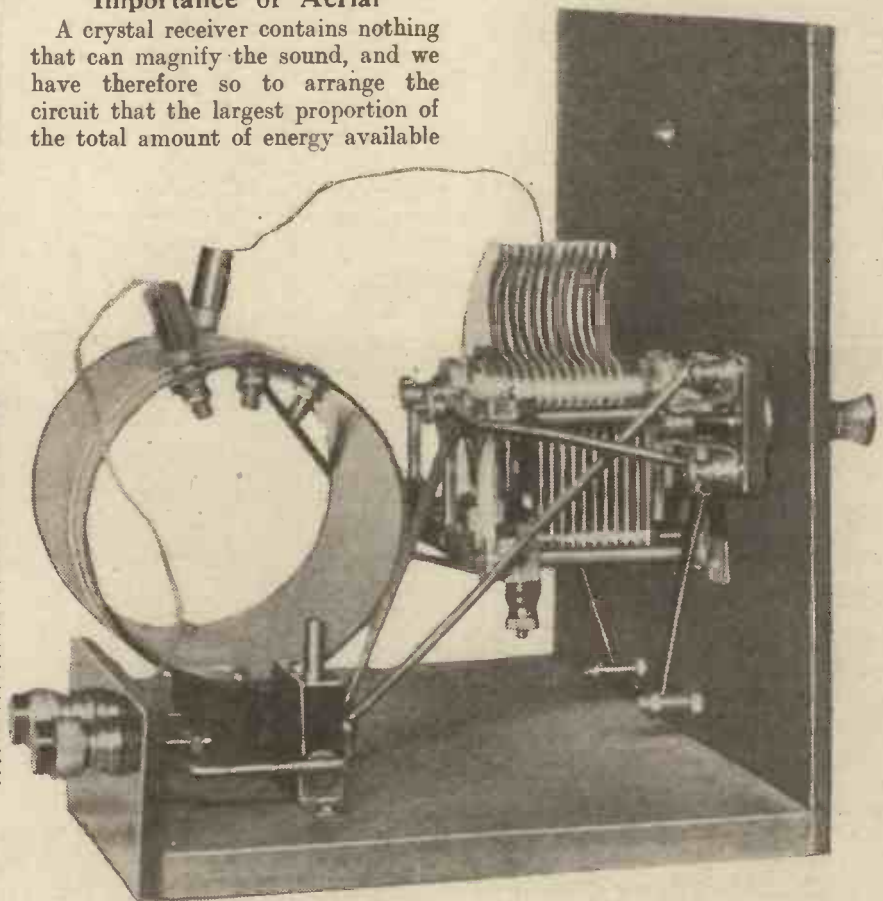

An ordinary plug-in coil is inserted in the coil holder, which can be seen in the foreground, and this coil is switched in from the front of panel when 5 X X is desired. The two terminals at the back of the set are for the aerial and earth, the latter being the nearer in the photo.

For crystal-set reception the largest and highest aerial should be used. Height is more important than length, and such things as aerial insulation, the continuity of the aerial wire, and the position of the aerial with regard to trees and buildings need attention. It is usually preferable to use a single wire in one length and to fit insulators of reasonable size. Signals will be weakened by allowing the aerial to run within a few inches of trees and the roofs of buildings, or other bodies.

An Effective Earth

A short lead-in is advised, and this should be carefully arranged. It is not good practice to fasten the lead-in to the wall of a passage or room, and it is better to put the set just where the aerial enters the house. A good earth is of great importance; sometimes there is a convenient water pipe to which a stout clip can be bolted, but often it is more convenient to run the earth wire to a point outside the house where a plate can be buried.

A buried plate makes an effective earth. It may be of copper or other suitable metal, two or three feet long by a foot or eighteen inches wide, to which the earth wire is soldered. This may be buried upright in the ground with the long edge arranged to be just below the surface.

The next point of importance is the tuner, for if this is inefficient there will be less energy available for

the crystal-'phone circuit. The tuner comprises a tapped coil and a plug-in coil, as shown in Fig. 1, with the

no effect on the tuning, and we are left with the single-layer coil and the tuning condenser.

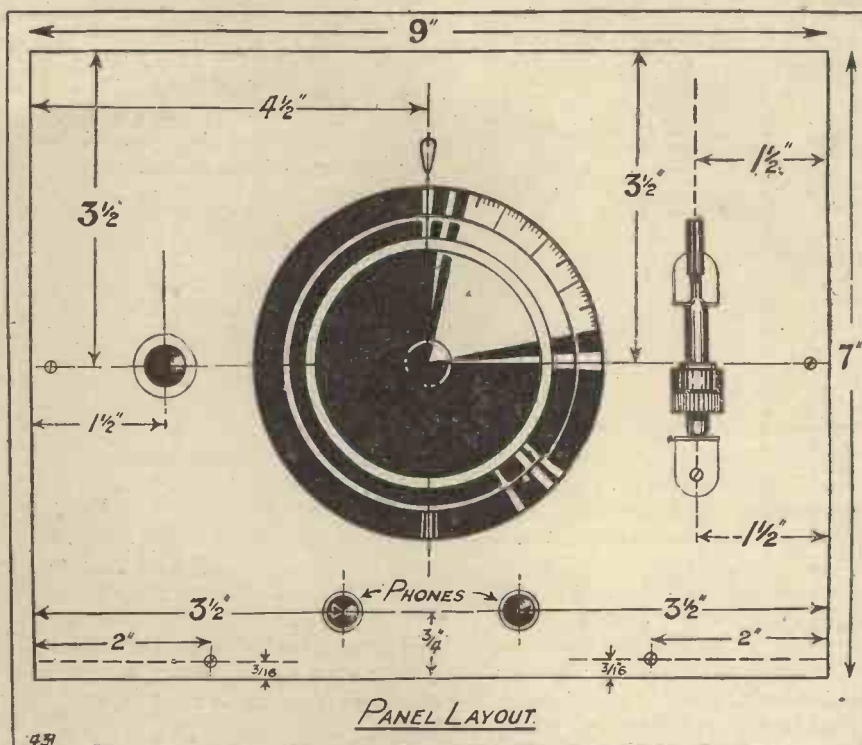

tuning condenser joined from the earth to the top end of the coil. The circuit shows that the plug-in coil can be short-circuited, and that the aerial can be connected to one of three points on the upper coil. This is a single-layer one, and is for the short wave-lengths. When the switch is "short-circuited" the plug-in coil has

This coil must be a good one and it is provided with tappings for two reasons. First, in order that the selectivity may be adjusted to suit any particular aerial; and, second, to provide an adjustment which will give a maximum signal strength. The single-layer coil for the broadcast band of wave-lengths can be made efficient by using a wire of reasonable gauge and a tube of good quality.

The tube should preferably be 3 in. in diameter and 3 1/2 in. long. It is wound with No. 20 D.S.C. and there are 60 turns. One of the tappings is at turn 20 and the other at turn 40.

Minimum Loss

By using a single-layer coil of this type we make sure that circuit losses will be a minimum, and it is very easy to change to the longer waves by removing the short circuit from the loading coil by pushing a switch.

It is probably better to use a multi-layer type of coil for loading, rather than a single-layer one wound with a fine wire, unless a coil of large diameter be used. A No. 200 coil was chosen for this part of the circuit.

The circuit tunes over the lower broadcast band of wave-lengths when the loading coil is short-circuited, and over the higher band when the short-

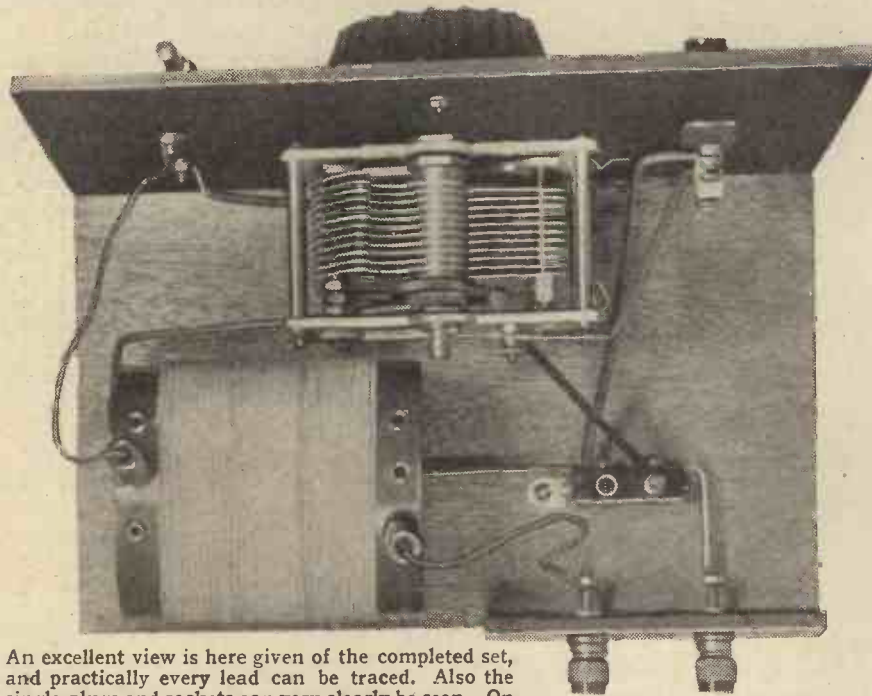

An excellent view is here given of the completed set, and practically every lead can be traced. Also the single plugs and sockets can very clearly be seen. On the right of the coil are the three aerial lead tappings, and on the left the crystal taps.

circuit is removed. On the lower band of wave-lengths a change is made when the aerial tapping position is altered. Thus, with the aerial connected to the top of the coil the circuit tunes to a higher wave-length and the minimum is not so low as when the aerial is connected to the first tapping, that is, the one nearest the earth end of the coil. This is because when the aerial is connected across the whole of the coil its capacity is added to that of the tuning condenser, while when the aerial is joined to the first tapping only a fraction of the aerial's capacity is, in effect, connected across the tuning condenser.

Many Variations Possible

Fig. 1 shows that the crystal detector and phones are joined between the earth and the point on the low-wave tuning coil. With the loading coil short-circuited the earth is, in effect, connected to the bottom of the short-wave coil. With the crystal detector joined to the first tapping, it is across one-third of the coil. When it is connected to the second tapping the crystal is connected across two-thirds of the full coil, and it is joined across the whole circuit when the plug is put into the socket joined to the top of the coil. One of these three positions will give louder signals than the other two. A good deal depends on the crystal detector. If this is of the wire contact type, the best results will usually be obtained when the detector is connected to the first tapping. When a high-resistance component is used, such as a perikon, it is usually best to connect the detector to the top of the coil.

The user will have to determine the best position for himself. He can make adjustments of the aerial tapping and the crystal tapping. With these two adjustments he can alter the selectivity of the set and the volume.

Winding the Coil

When receiving Daventry (5 XX) the loading coil is brought into circuit and the condenser is turned to tune it in the usual way. Experiments show that with the particular detector used there was no great advantage in tapping the long-wave coil, and, of course, when receiving long waves the effect of moving the detector tapping position on the short-wave coil will have hardly any effect at all.

The coil had better be wound first of all. Three holes should be drilled

at each end of the coil, $\frac{1}{4}$ in. in from the edge, and about $\frac{3}{8}$ in. apart, to take the three Clix sockets.

To wind the coil you will have to make a small hole in the former $\frac{1}{2}$ in. in from one end, and opposite one of the Clix as shown. Push one end of the wire through the hole and fasten it to this socket. Now wind on 20 turns of the No. 20 D.S.C., make another hole in the former and thread the wire through, and fasten it to the centre Clix socket.

Continue the winding by putting on another 20 turns, and again make a hole in the former, thread the wire through and join it to the remaining Clix socket. Now continue the winding by adding another 20 turns, drill

joined to the three sockets at the other end respectively.

The panel should be drilled to take the tuning condenser, "on" and "off" switch, crystal detector holder, and the two telephone terminals. These parts are shown in the diagram. On the baseboard fit the single-layer coil and the coil holder, remembering that the end of the single-layer coil having a wire projecting is nearest the coil holder.

Few Connections Required

Wiring is easy. There are no soldered joints. One wire passes from the earth terminal on the strip to one side of the coil holder to the tuning condenser, to one side of the switch,

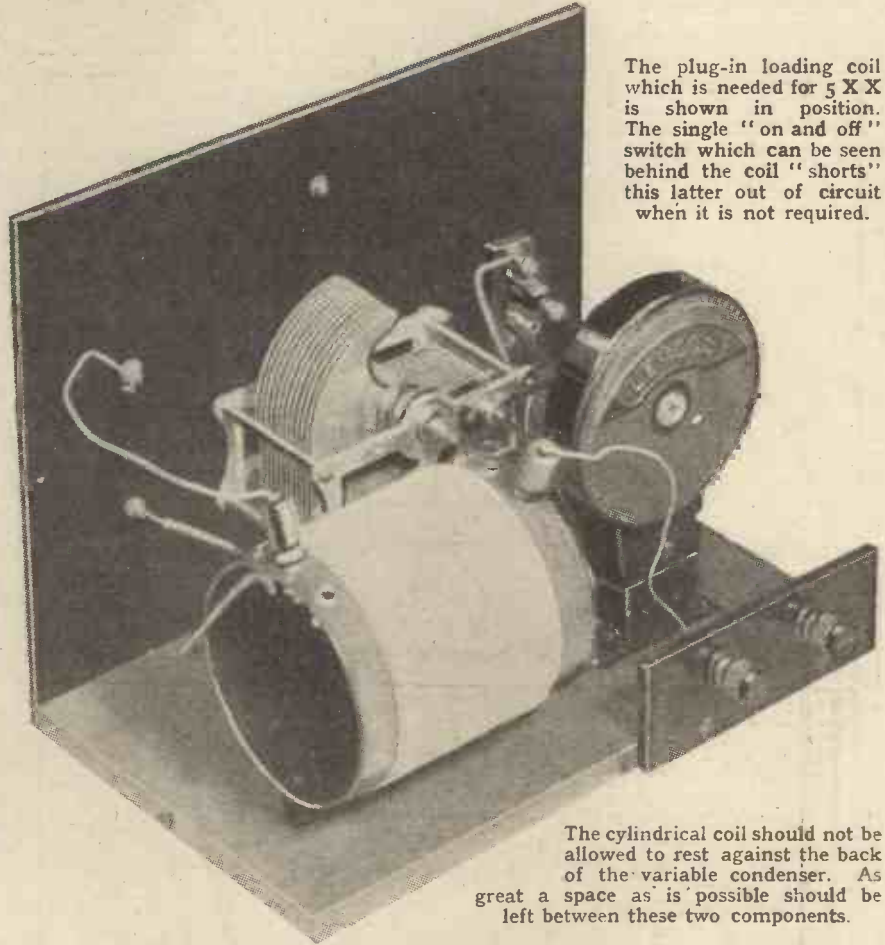

The plug-in loading coil which is needed for 5 XX is shown in position. The single "on and off" switch which can be seen behind the coil "shorts" this latter out of circuit when it is not required.

The cylindrical coil should not be allowed to rest against the back of the variable condenser. As great a space as is possible should be left between these two components.

two holes in the former, and thread the wire through, leaving an end about six inches long.

Simple to Construct

Two small feet of wood or ebonite, about $\frac{1}{2}$ in. thick, should be prepared and drilled to take a wood screw, but before the coil is finished a wire should be taken from a socket at one end of the coil to the socket that is opposite it at the other end. This means that the three sockets are

and to one telephone terminal. A flexible wire has to be connected to the aerial terminal, a plug being fitted to its free end.

Connect the wire that extends from the single-layer coil to the socket of the coil holder and one side of the switch. Now join the remaining telephone terminals to one side of the crystal detector, and run a wire from the tuning condenser to the coil, as shown in the diagram. There is only one more wire to put on, and that is

the flexible one. Fasten one end to the detector and put a Clix plug on the other end.

A pair of high-resistance telephones should be used. Connect them to the terminals on the front of the set, and to begin put both the plugs in centre sockets, pull out the switch to short-circuit the loading coil, and tune the local station. If by chance your best "local" station is 5 XX you will have to push in the switch.

Adjust the crystal detector very carefully and then when listening to a short-wave station try the effect of altering the position of the detector tapping for each position of the aerial tapping. You will find one combination which will give you loudest signals.

If your aerial is a good one, and you

are favourably situated, Daventry Experimental will be received quite well. In London, Daventry Experimental has been received at good telephone strength clear of the London station. On the long waves, Daventry 5 XX is heard and also a powerful foreign station.

A "ONE-HOLE-FIXING" TIP

"ONE-HOLE-FIXING" is an excellent scheme, which saves the constructor a lot of drilling and fitting when mounting components on the panel. Some variable con-

densers, however, do not seem to like having their end-plates drawn hard up against the panel with the fixing nut. The vanes get pulled out of alignment, or the spindle adjustment is upset, so that the component has to come out of the set again for repairs.

If you are unlucky enough to have a condenser which insists on behaving in this way, you can cure it of its bad habits in a simple manner. You will need a second nut for the spindle bush. Run this nut on to the bush, nearly, but not quite, down to the top end-plate of the condenser. Then clamp the condenser to the panel with the second nut in the usual way. The component is now held firmly by the two nuts, one on each side of the panel, and you need not be afraid of screwing the second nut down as tightly as you wish.

A. V. D. H.

STAINS FOR CABINETS

MANY amateur woodworkers find it decidedly economical to construct their own cabinets, with the additional advantage of enabling them to choose their own design. The process of finishing, however, presents the chief difficulty in most cases, particularly staining. I have always found that the simplest stains are the best. There are varnish stains—which are really varnish and stain mixed—which enable one to achieve two things in one operation, but it is not altogether satisfactory where really good results are desired.

The Best Method

Next, there is oil stain, that is, stain mixed in oil. This stain does not sink into the wood, but is more of a surface stain, and is somewhat messy in use. The best stain is undoubtedly plain water stain. In this case, the stain used is simply mixed with water to any desired shade or tint. Two of the best are logwood chips which are boiled down in water, and permanganate of potash, which is simply dissolved in water.

Both of these stains are obtainable from any good builders' ironmonger. It must be remembered when using stain, however, that the tint is much lighter when dry than when freshly applied. Two coats or more may, of course, be given to obtain the desired effect, or for purposes of matching. Water stain applied must be allowed to thoroughly dry before applying further coats.

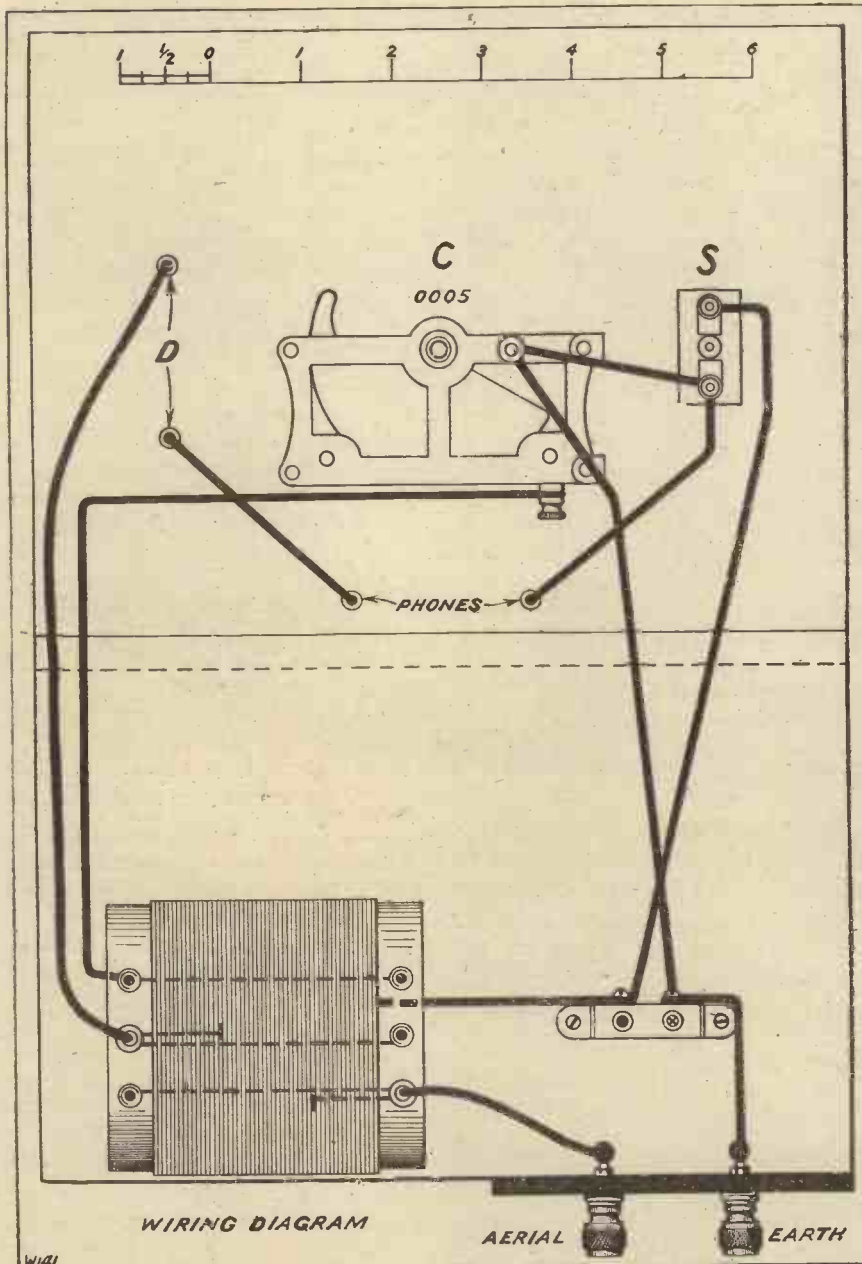

W44



Should the B.B.C. have a theatre, from which artistes can broadcast to a visible audience as well as to the microphone? This and many other interesting points are raised in this informative review.

By a Special Correspondent.

How broadcasting will develop in 1928 and whether it will retain its present degree of popularity depends almost entirely on the policy of the B.B.C. The B.B.C. stands very much in relation to the public as does a popular theatre. A theatre which continues to present to its patrons a type of entertainment which they like will, if its management is wise, continue to adhere to its policy until there are definite indications that its public has grown tired of that particular brand of entertainment. If it is not wise it will either alter or try to improve, one way or the other, something which does not immediately call for improvement and, in doing so, will experiment and take a risk in affecting public taste adversely.

On the other hand, it might continue a type of entertainment which, although greatly popular for a long period, at last begins to pall with theatre patrons. The management might then endeavour to revive interest in that particular brand of entertainment, and to succeed in adhering to a policy which, because it has been successful for so long, they consider should remain successful for some considerable time thereafter, despite the fact that there are indications of waning popularity.

Licences Still Increasing

That is more or less the position the B.B.C. is in. Despite adverse criticisms during 1927, and despite various agitations, for example, on talks or a lack of variety in the programmes, there can be no doubt that on the whole the vast majority of the B.B.C.'s listeners were sufficiently satisfied to continue remaining patrons. That is to say, they continued to pay their licence fees. The month of January proved this even more so, and there are to-day at least 2,300,000 listeners who have taken out licences.

There is no reason why at the end of 1928 that number should not have increased instead of decreased; but there again it all depends on the B.B.C. and the policy it has mapped out for 1928.

So far there are not many details to hand regarding the B.B.C.'s plans for 1928. A little information has come our way regarding the plans of the B.B.C.'s programme people with regard to women listeners. It was found some

time ago that, as the result of a vote among women listeners, a large majority were not keen on purely domestic subjects for talks and, according to the voting, women preferred talks on such subjects as music, literature, women's activities in politics, sport and travel, fashions, and such-like.

Afternoon Programmes

Later on, as the number of listeners increased and the feminine element became greater, it was found that a weekly chat on housekeeping subjects proved popular, and it is now one of the firmly established items in the B.B.C.'s policy of including talks, etc., of interest for women in programmes, and we understand that it will be continued throughout 1928.



Radio drama looks like developing by leaps and bounds in 1928. Above (left) is shown a producer discussing studio technique, whilst to the right is depicted a love scene in a broadcast drama.

An indication of the interest taken in these household talks is shown by the fact that when a B.B.C. lecture for women was broadcast giving a recipe for a Christmas cake, there were over eight hundred requests for further details, which were offered to those who wrote in and asked for them.

A series of talks down for 1928 is entitled: "Something new from something old." This is really the title of a series of talks on economical dressmaking, and there will be other talks on furniture and on bargain-hunting, also

on the making of cakes, jams, etc., etc. There is even a possibility of a series of catering talks which may be broadcast on Saturday afternoons.

Now this does not sound very interesting for the average reader of MODERN WIRELESS, but we think he ought to appreciate the information because it indicates that in one respect at any rate the B.B.C. is closely watching public taste as regards its feminine listeners, and there is every hope that it will do the same for the benefit of its male listeners.

There is a possibility, as is dealt with by the Editor in his editorial, that educational broadcasting may be rather overdone in 1928. It all turns on the report of the Advisory Committee appointed by the B.B.C. under the chairmanship of Sir Henry Hadow, and whether the B.B.C. adopts this report in its entirety. Sir Henry Hadow is an extremely clever man, but we very much doubt



A new metal rectifier, of the type now being applied to wireless reception, is here shown embodied in a sensitive meter applied to railway signalling. Such is its efficiency that it can detect and register minute alternating currents, even though the rail to which it is affixed is carrying, at the same time, the very heavy direct current required for electric locomotives.

whether his report will suggest to the B.B.C. that its broadcasting educational activities are even now being overdone. It is more than likely, indeed, that the report will suggest that these educational activities be even further increased. This will inevitably mean an encroachment on legitimate programme time, and entertainment will suffer a certain amount of curtailment.

However, there is one branch of the B.B.C.'s educational activities which nobody will grumble at, and that is in the formation of student circles and groups for the discussion of wireless topics and various aspects of the radio science. At the moment there are about forty such parties throughout the country working under the auspices of the Workers' Educational Association and the Co-operative Movement.

Last year the B.B.C. also appointed a small number of engineers whose job it was to visit schools, etc., and to

advise the teachers and pupils on wireless apparatus in use for reception. A propaganda campaign for the improvement in quality of reception among listeners is undoubtedly to be encouraged.

It will be interesting, by the way, to note the contents of the report which will shortly be published by the Kent Educational Authorities, who have been experimenting in a scientific way with the use of wireless in schools. At the moment there are 4,000 schools with sets.

Ambitious Drama Broadcasts

One thing the B.B.C. has always done well, and that is to arrange its Charity Appeals in an interesting and entertaining way. A charity appeal can be a dull and monotonous thing, but the B.B.C. has been careful to arrange for a very wide, varied, and interesting selection of speakers for the various parties on whose behalf it has broadcast appeals. The Appeals Committee of the B.B.C. has plans, we understand, which will probably make the 1928 charity appeals even more widely appreciated than before.

This article does not intend to deal with any possible technical changes or improvements, but in conclusion a word should be said about the possibilities of radio drama in 1928.

Mr. R. E. Jeffrey, who has retained the position of Dramatic Producer and Director at the B.B.C. with so much success, has some ambitious plans for radio drama in 1928. He stated the other day that he has four plays in hand of a type entirely new to broadcasting. One in particular is Ibsen's "Ghosts." Here we venture to suggest that this is not quite the type of play suitable for a large audience, especially as it contains so many young people. Ibsen's "Ghosts" is not a spook play, but a moral play, even more frightening than the word "Ghosts" suggests.

The recent production of Mr. Cecil Lewis's play, "Pursuit," was based on the idea of combining film and broadcasting methods, and it may be that if there are indications that Mr. Lewis's play has been successful, that ambitious efforts, based on this new idea, will be pursued as the year progresses.

The idea of having a hundred or more scenes in a radio play is novel, and the possibility of fading one scene into another in rapid succession, thus giving the effect of, say, a thrilling chase and its various aspects and incidents, is very good, but whether it lends itself to sufficient variation, and whether the interest offered will prove sustaining in future plays remains to be seen.

A Special Theatre?

Mr. Jeffrey has hopes of a theatre specially designed for wireless plays. In America there is a National Building in New York with an actual theatre from which plays are broadcast to listeners, at the same time satisfying an audience present in the theatre. Mr. Jeffrey has the idea that the B.B.C. should acquire some definite outside hall which should be used entirely for broadcasting plays, but at the same time providing a visual audience in order to obtain a psychological effect upon the players—that necessary atmosphere, applause, etc., which so enhances the realism of a broadcast play.

On the whole, radio drama looks like developing by leaps and bounds in 1928, and if only the B.B.C. keeps the essential ingredient—variety—in their programmes, there is every reason to suppose that the programmes for 1928 will continue to maintain satisfactory interest among listeners throughout the country.

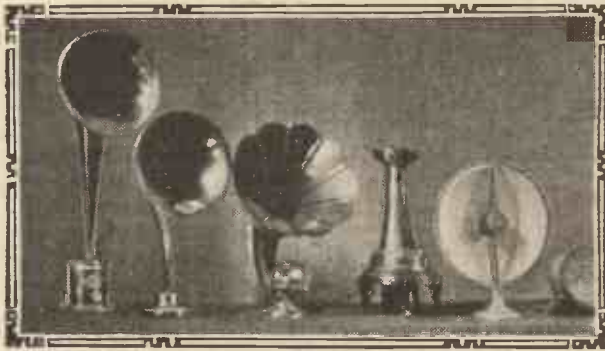

Remote Control and Loudspeaker Extensions

The Convenience of "Radio in Every Room."

By H. J. BARTON CHAPPLE, *Wh.Sch., B.Sc. (Hons.), A.C.G.I., D.I.C., A.M.I.E.E.*

THESE are, no doubt, numbers of wireless enthusiasts who revel in conversations about the "good old days" when wireless reception was a real achievement, necessitating untiring efforts on the part of the operator while searching after signals with the aid of inefficient coils, condensers, etc. The majority of people who possess wireless sets

or added amusement may be given to the children when they are kept in the nursery by wet weather. These are but a few of the cases which arise, and it is the purpose of the writer to consider in this article some of the ways and means which may be exploited in order to meet the problems presented by an issue of this character.

in a room in juxtaposition to the aerial system, and it is thus not a really practical proposition to arrange aerial and earth connections in the various rooms, owing to energy losses and tuning problems, this being quite

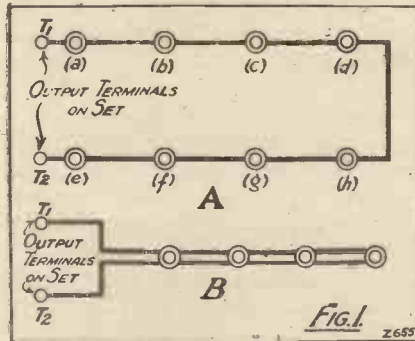

at the present time, however, are anxious to take full advantage of the extra benefits now conferred by broadcasting without the expenditure of a great amount of energy and the burning of midnight oil, and the trend towards simpler controls has done much to further this state of affairs. In the search after better and still better radio there is one aspect which does not appear to have been given the full attention it merits, and that is the possibility of enjoying the wireless programmes in any part of the house.

Ways and Means

For example, a sick person confined to the bedroom can while away the hours which otherwise would seem so endless; domestic problems are rendered less acute if the maid is provided with a small loud speaker in the kitchen so that she may listen in while at work; when retirement is made to the drawing-room after partaking of meals, the music, etc., can be transported (speaking metaphorically) from one room to another

A Partial Solution

On first thoughts it would appear that the simplest way is to acquire a portable or totally enclosed wireless receiver, with batteries, frame aerial, loud speaker, etc., housed in the one cabinet, so that it may be carried from room to room according to desire. This is only a partial solution, however, for it limits the entertainment to one particular room, and other members of the same household who may be situated in different parts of the house will not be able to enjoy the broadcast entertainment. We must look elsewhere for a complete solution of the problem.

Now, it is well known that when an outside aerial and earth are employed the wireless set is best accommodated

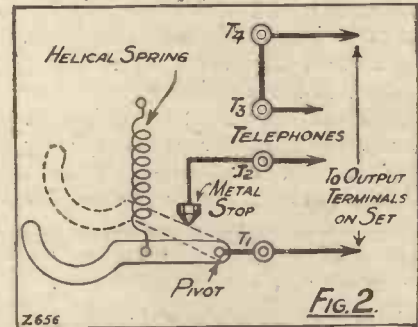

apart from the inconvenience of transporting the set with its associated batteries and equipment. The simpler solution obviously is to arrange for telephone or loud speaker positions in the rooms so that the required connections can be made with a plug and jack or terminals. The set itself can then be accommodated in the most convenient position in one room or even in a cupboard or attic



This photograph illustrates a well-known series and parallel wall-socket outfit for loud-speaker extensions.

out of sight, periodic examination being made to ensure that all is in order and for the purpose of battery renewals.

Many modern builders have recognised the fact that the provision of such an arrangement as this acts as an extra inducement to a would-be purchaser of a house, and frequently it can be seen in the advertised particulars of new houses that they are wired for broadcast reception. Of course, in the case of hospitals and similar institutions, the installation of wireless equipment includes this feature, telephone and loud speaker positions being distributed throughout the building and controlled from one point near the main receiving set.

The Points at Issue

Now let us examine carefully the points at issue, and see how easy it is to arrange for one's own wiring system, with the added advantage of remote control, when such is desired. Taking the simplest case first, namely that of loud speaker or telephone positions only, many possibilities lay

themselves open to the choice of the individual, and the final selection naturally will depend upon the person's taste, coupled with the convenience with which the resulting

is preferable, and with high-resistance windings the parallel system gives best results. With the series arrangement indicated diagrammatically in Fig. 1A, it is merely necessary to run

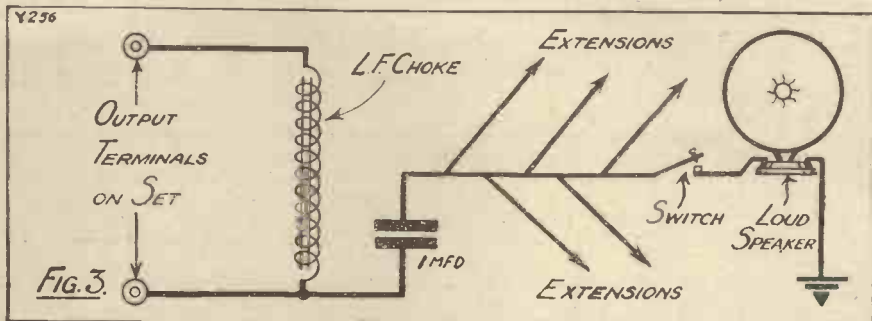

cable runs can be executed. Questions dealing with the actual location of the extension leads will be deferred to the end of the article, since they are common to all the systems.

Either series or parallel connections can be employed, and if, say, the constructor has a single-valve set, or even a crystal set capable of serving two or three pairs of 'phones, he will find generally that with low-resistance 'phones the series connection

a continuous lead from one output terminal of the set and link up the chosen "listening" positions in each room, and then return to the remaining output terminal. Now cut the wire at the points (a), (b), (c), (d), (e), (f), (g), (h) and insert the chosen connecting device. This may consist of a pair of terminals mounted on a small ebonite base which in turn is attached to the wall by wood screws.

The Series Connection

It will be appreciated readily that with this system the removal of one pair of telephones immediately renders the remainder inoperative, since the current is open. Consequently, a link must be provided to short-circuit each position when the phones are out of use. If preferred, advantage may be taken of special plugs and jacks which are on the market and perform this operation automatically. In the Crawford plug and jack, the jack, which normally has the telephones or loud speaker joined to the two terminals provided, embodies two pins, and, on insertion into the jack, these operate a spring holding two contacts together. When the plug is removed the same spring releases a plunger and once more short-circuits the jack terminals, thus re-establishing the series circuit.

Parallel Working

Another form, which is illustrated in one of the accompanying photographs, is the Deckorem wall-socket jack. This is similar in appearance to the standard electric-light switch, and can thus be screwed into place on the wall quite conveniently. The insertion of the plug into the series jack breaks a short-circuiting spring and places the loud speaker or head-phones between the broken contacts and on withdrawal the circuit is re-made automatically.

With the parallel arrangement of



A simple telephone terminal board for wall mounting.

Fig. 1B, a twin wire is run from the two output terminals of the receiver to link up the listening positions. In this case any short-circuiting of the points is not required, indeed, if it

ing condenser—and leads run as desired to the listening positions, where a tumbler switch and loud-speaker terminal block can be mounted.

circuit is thus established. This arrangement finds, perhaps, its greatest application where outdoor extensions are desired, owing to the convenience of the earth connection; but it is used frequently in large buildings. This method has the great advantage of isolating the loud speaker from any direct current flow, and is often more stable in operation where very long extension leads would be necessary, since undue lengths of twin wire cable are liable to produce howling owing to capacity and interaction effects.

A Great Boon

While the simple schemes just enunciated work admirably and give good service there is a disadvantage which might render them unsuitable in many cases. In order to switch on the set one must actually handle it, and therefore it would be better if some control could be incorporated which would enable this operation to be undertaken in any part of the house. Of course, actual tuning of the receiver for the reception of different stations must be carried out at the receiver itself, but for those who seldom listen to any transmission

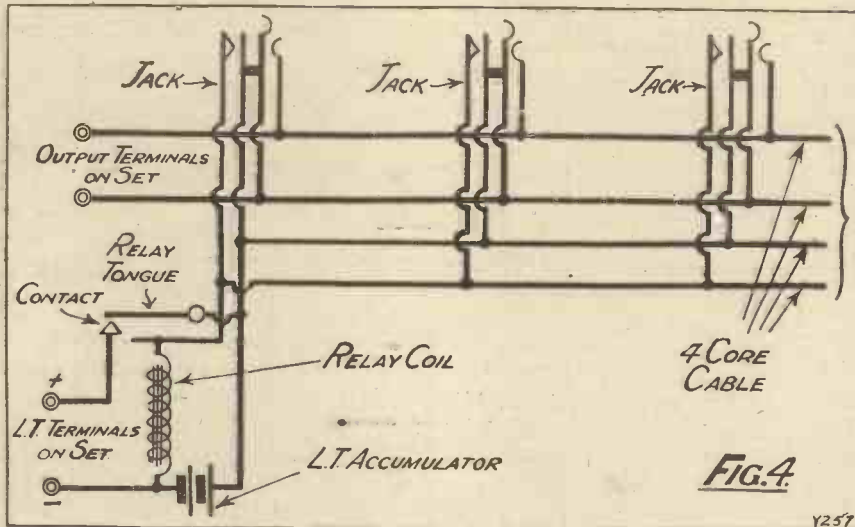

were done, signals would not be heard at the other positions. Terminals, as mentioned previously, or wall jacks, such as the parallel type illustrated, may be pressed into service as desired, but if no filter is used care must be taken that the same coloured wire is joined to corresponding contacts on the jacks so that the same polarity is maintained throughout. The current through the loud speaker or telephone windings then will be in the same direction on insertion of the jack.

It will be noticed that one terminal of the loud speaker is joined to earth, and the earth really forms the return medium to the set, since at the receiver itself the negative of the H.T. battery is earthed and a complete

A simple device such as that illustrated in Fig. 2 might appeal to some readers. Here we have a switch-arm operating in a similar manner to the Post Office telephone. With the headphones hung on the arm the circuit is broken, but on their removal the spring lifts the arm and metallic contact is made with a stop and the circuit established. This is a very convenient arrangement and has the advantage of being easy to construct. With the connections shown in Fig. 2 it is suitable only for the "parallel" wiring, and in the case of the series winding it must be arranged for the arm to short-circuit the 'phones when hung in position, and open-circuit them on removal.

Using One Extension Wire

It is quite conceivable that occasions may arise where it is desirable to employ only one extension wire and yet use the parallel system. This can be done in the manner shown in Fig. 3. A filter circuit is arranged across the receiver output terminals—the usual low-frequency choke and 1 mfd. block-



A popular outfit for providing extension leads and automatic remote control of the receiver's filament.

other than the local one, and consequently never have to alter the adjustments of the receiver, the fitting of a remote control device which makes it unnecessary to go to the set to switch on and off will be a great boon. The ingenuity of the serious experimenter will not be unduly taxed in devising a circuit which will enable this to be done, and the writer will content himself with explaining one or two systems which have been tried out and were found admirable.

Remote Control

In addition to the pair of wires from the output terminals two more wires must be run to the listening positions, and often the four wires are conveniently made up in one cable, different coloured braidings being used to distinguish the wires. The schematic diagram of Fig. 4 indicates one device using plugs and single filament control jacks, specially adapted for wall mounting, in conjunction with a sensitive relay. The relay can be mounted close to the set and the four-core cable run to the various chosen positions, the ends of one pair of wires being joined to the output terminals of the receiver and the ends of the remaining pair of leads to the appropriate relay terminals. The long and short springs respectively must be joined to the output wires, while the two filament springs of each jack are linked between the relay wires, a point which will be made quite clear by reference to Fig. 4.

On insertion of a plug into any one of the jacks the filament springs make contact and current can now flow from the L.T. battery through

the relay coil. This magnetises the coil and the relay tongue is pulled against a contact provided, thereby establishing the circuit from the accumulator to the L.T. terminals

this article. It is particularly simple and efficient in operation, and calls for little skill in wiring. Be careful to mount the Lotus relay on its level surface base, otherwise the tongue

A plan sketch showing how simple it is to wire the main rooms of a house with loud-speaker or telephone extension leads.

It will be seen that even for five rooms on two different floors the extension leads need not be excessively long.

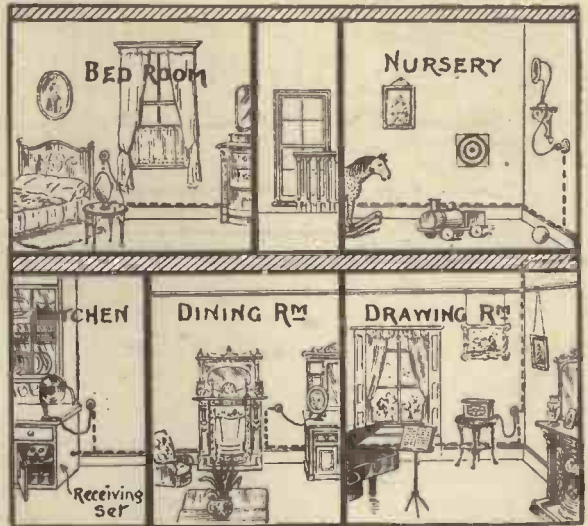

on the wireless set. The filaments are at once rendered operative and signals from the station tuned in on the receiver are heard at the position where the plug was inserted.

Simple in Operation

The insertion of further plugs into any of the jacks naturally does not affect the filament current which is already established, it being impossible for one listener to interfere with another. It should be noted also that the last plug to be withdrawn definitely cuts off the filament circuit so that there is no wastage of current. A commercial form of this scheme is marketed as the "Lotus" remote control and is illustrated in one of the photographs accompanying

might fail to function and cause current to be consumed even when the jacks are not in position. Six engraved terminals are arranged on the relay base so that no difficulty is experienced in making the necessary connections, and as the current consumption of the relay is only 20 milliamps on a two-volt battery there is very little extra drain on the L.T. accumulator.

A modification of this circuit is shown in Fig. 5. In this case a pair of leads run from the output terminals of the set to link up the chosen listening positions, while another pair run from the L.T. terminal of the accumulator and a tapping on the H.T. battery (the minimum value of this voltage being determined by experiment) to ordinary push-pull or bell switches close to the jacks or terminals. The relay is preferably of the sensitive high resistance type, such as the Weston or Siemens, and the magnet winding is connected between L.T. and H.T. The relay contact is joined to L.T. while the tongue is joined to the L.T. terminal of the set.

Economical Working

When it is desired to listen to the programme from the station normally tuned in on the set, connect up the loud speaker or telephones by means of the plug and jack or terminals, and depress the switch. Current will at once flow from the H.T. battery through the relay coil, energise the magnet, and operate the relay tongue.

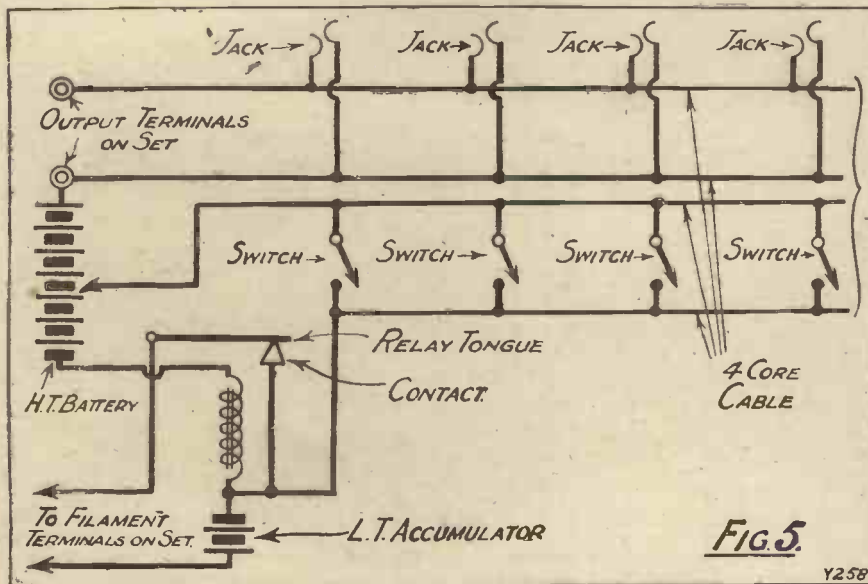

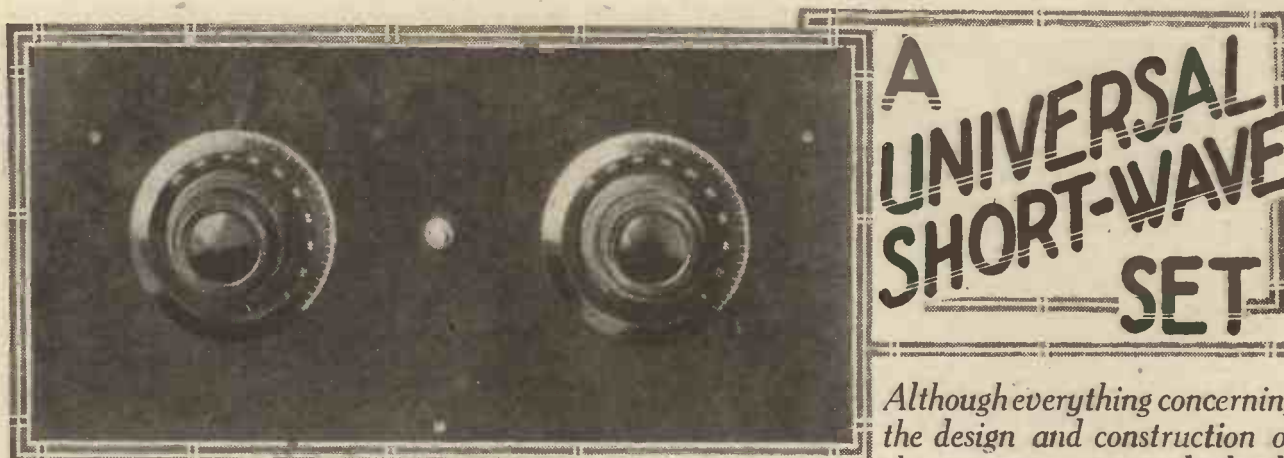

A UNIVERSAL SHORT-WAVE SET

Although everything concerning the design and construction of this receiver is absolutely straightforward, the results it gives are up to anything else obtained from any set of a similar nature in the author's possession.

By W. L. S.

IT has been the writer's opinion for a long time that a short-wave set, to be entirely successful, must not have anything with the slightest suspicion of "freakishness" about it. On the broadcast wavelengths, and higher, we often try out all manner of circuits, some of which would hardly be expected to give results at all, but they all seem to

which apparently work on the longer wave-lengths, are actually pretty inefficient, but it needs the extra test of short-wave work to prove how bad they really are.

In the receiver described in this article, the writer might almost be accused of having gone to the other extreme. Everything is so absolutely conventional; the circuit is perfectly "straight," and the layout is one that might be used for any general-purpose two-valver. Even the coil mountings are quite standard. The fact remains, however, that it works, and the results leave nothing to be desired when compared with those given by five or six other short-wave receivers of the writer's, with which this set has been carefully compared.

One is rather prone to give way to "fetishes" and fads in radio work;

this is very undesirable and often leads to many wrong impressions and misunderstandings. The writer does not make a fixed rule of adhering to any particular principles, and tries to avoid laying down the law, but this one thing is fairly definite—for short-wave work the reaction control must be accomplished by capacity means. Swinging (or "flopping") coil methods are very inefficient.

Easy Reaction Control

Probably we have many things to find out yet with regard to short-wave work, but it did not take us long to find this out! The whole secret of success lies in sufficiently taming the set to make it lie right on the very verge of oscillation, whether just below the oscillation point for telephony reception, or just above it for

COMPONENTS USED.

- Panel, 16 in. by 8 in. by $\frac{1}{4}$ in. with base-board 11 in. deep.
- 2 Spring valve holders (Ashley, Benjamin, Bowyer-Lowe, B.T.H., Burn-dept, Burne-Jones, Igranic, Lotus, W.B., etc.).
- 1 Slow-motion condenser, .00035 mfd. (J.B. in set. Any good make).
- 3 Fixed condensers, .0001 (Clarke, Dubilier, Goltone, Igranic, Lissen, Mullard, T.C.C., etc.).
- 1 Grid leak, 5-10 megohms (to suit valve used). (Dubilier, Igranic, Lissen, Mullard, etc.).
- 3 Base-mounting coil sockets (L. & P., Lotus, Peto-Scott, etc.).
- Set of "Atlas" short-wave coils.
- 1 On-off switch (Benjamin, L. & P., Lissen, Lotus, etc.).
- 1 Base-mounting rheostat (G.E.C., Igranic, Lissen, or similar type).
- 1 L.F. transformer (Ediswan in set. Any good make).
- 1 7-terminal strip and 1 2-terminal strip (Belling-Lee, Igranic, Eelex, etc.).
- 1 Clip-in condenser base and condenser of suitable size (.0005 to .001). (McMichael.)
- 1 Pair of panel brackets.

work somehow. Not so in the lower regions, however, for one has only to try a freak circuit or even a freak layout to find that this sort of thing does not pay.

Most probably the fact of the matter is that the so-called freak circuits,

As will be seen, the layout is absolutely conventional. The author points out that the construction might be that of an ordinary broadcast receiver.

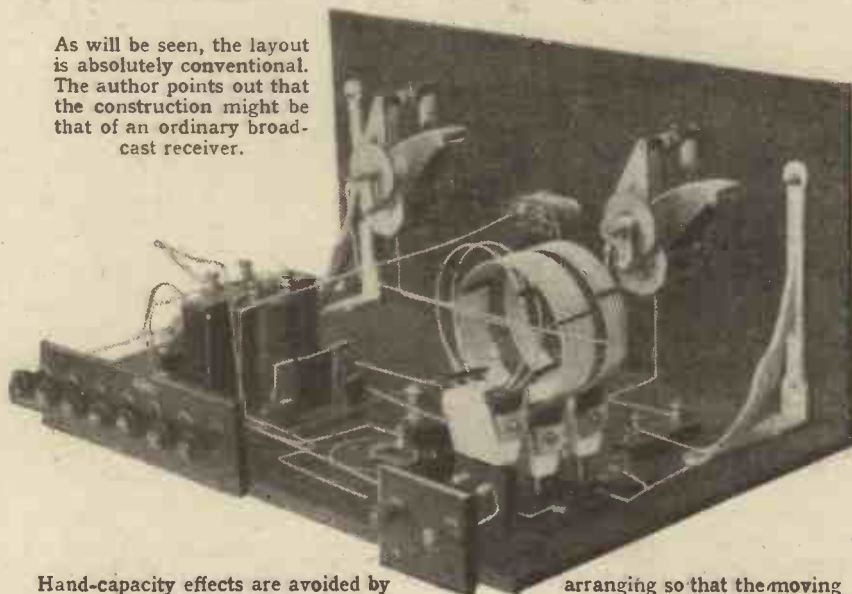

Hand-capacity effects are avoided by arranging so that the moving vanes of the variable condensers

are at earth potential.

C.W. work. It is quite impossible to do this with a coil holder of the floppy type, and even with a very small variable condenser controlling the reaction it is difficult enough to keep the set in its very most sensitive position.

Referring to the circuit diagram of this set in Fig. 1, it will be seen that the reaction control here is accomplished by a variable condenser connected from the "live" side of the transformer primary to the filament. In series with the variable, in keeping with the usual practice, is a small fixed condenser. This prevents the burning-out of the valves should the variable condenser accidentally develop a "short," and also prevents undesirable noises in the headphones should the plates of the variable get very dusty.

The Three Coils

The main tuning condenser also has a small fixed condenser connected in series, but here the object is to reduce the effective capacity of the variable and open out the tuning range. Both these fixed condensers are connected to the fixed plates of the variables, allowing both sets of moving plates to be earthed.

The aerial coil L_1 is untuned, and inductively coupled to the reaction coil L_3 , which in turn is coupled to the grid coil L_2 . The aerial circuit has a lesser effect upon the tuning of the set when it is coupled to the anode coil in this way, and this method has long been almost standard in America, which may be looked upon as the home of short waves!

The great advantage of using a loosely coupled aerial as opposed to taking the aerial on to the grid through a small condenser is that one can cover a much greater wave-length

This probably seems absurdly small, but with the coils used it covers all the short-wave bands without a single dead or "lost" spot. The coils used are the "Atlas" short-wave coils,

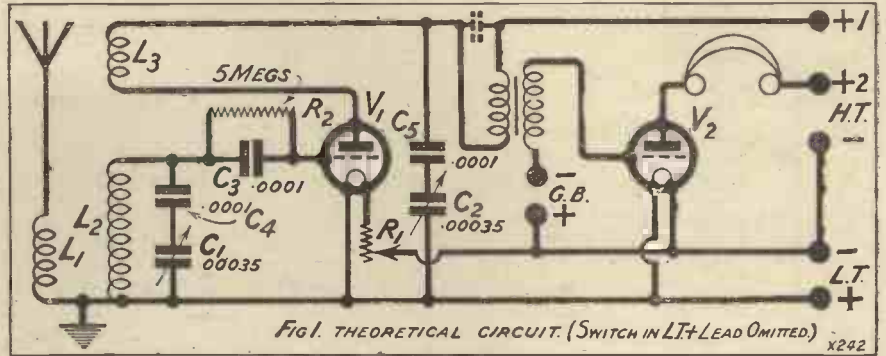

range on a small condenser, on account of the absence of damping introduced into the grid circuit. The writer has compiled some figures giving the wave-length ranges with the same coil and condenser with these two methods of aerial coupling, and the results are very surprising.

It is very inefficient to attempt to cover a huge range on one coil (some people apparently rush from 20 to 130 metres on a single coil with a .0005 condenser!), since the L/C ratio is so widely different at the top and bottom of the scale, and the set would be very inefficient at the top (long-wave) end. Accordingly the tuning condenser used for the grid circuit is of .00035 capacity with a .0001 in series with it, the actual effective capacity of the condenser thus being about .00007.

mounted on porcelain bases, and the following table shows roughly the wave-length ranges covered with the .00007 condenser:

Grid Coil.	Reaction.	Range.
2 turns	4 turns	16-23 metres
4 turns	6 turns	21.5-30 metres
6 turns	4 turns	28-46 metres
9 turns	6 turns	36-70 metres

The aerial coil is always the 2-turn or 4-turn coil, and it must be understood that these ranges will not be covered unless the aerial is loosely coupled to the set.

No serious losses apparently result from the use of standard plugs and sockets on the coils, and even if small losses are present one has the extra convenience of being able to use the same set for broadcast reception simply by changing the coils.

Suitable Grid Leaks

So much for the inductances. The next important point is the choice of values of the grid leak and condenser, and here one is governed to a certain extent by the valve it is desired to use as detector. The writer always uses a 6-volt high-impedance valve with an amplification factor of 20-30, the D.E.5b type being a good example. This type of valve works best with a grid condenser of .0001, or smaller, and a grid leak of about 8 or 10 megohms. The value of .0001 may be taken as correct for the grid condenser for most valves. The requirements for the grid leak will vary. The best leak is, of course, one with which the set will "slide" into oscillation with a gentle swish. Too low a value will give a "plop" on running into oscillation, and too high a value will give a hoot or howl. The correct value is one that comes between these two. Five megohms is a general figure.

Although a positive grid return is shown in the diagrams—i.e. the bottom of the grid coil is taken to the

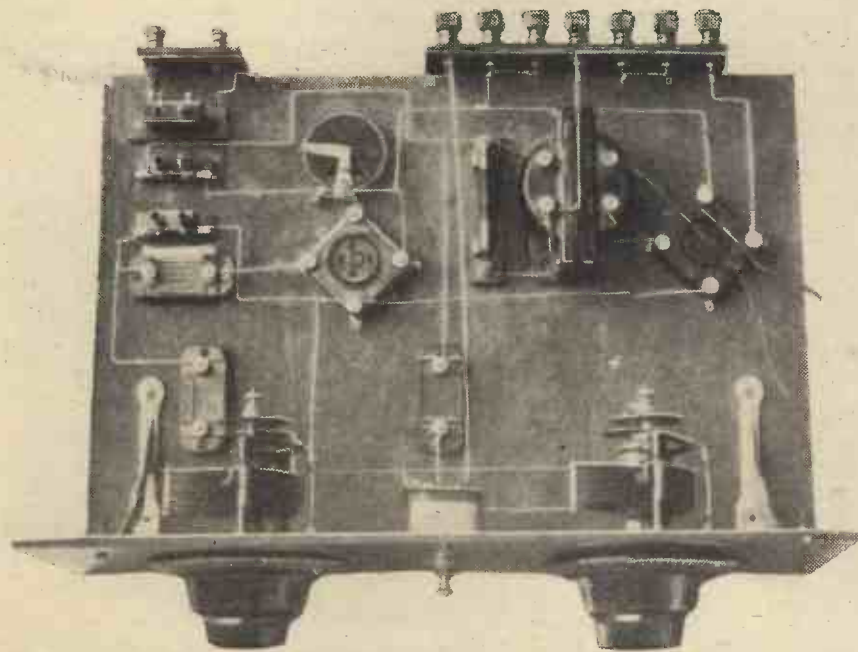

The components need to be fairly well spaced and the wiring must be moderately carefully arranged, but there is nothing complex or unorthodox about the receiver.

positive side of the L.T: it will sometimes be found that the set gives better results with this point taken to L.T.—. The positive return is, of course, correct theoretically.

tainly due to the aerial circuit. The set should, therefore, be tested for oscillation first of all with no coil in the aerial socket. If, with the 2-turn coil inserted and fairly loosely

G.B. lead from the transformer direct to the negative end of the filament.

With higher H.T. voltages on the L.F. valve about $4\frac{1}{2}$ volts negative bias will probably be necessary.

With regard to results, every short-wave set nowadays receives America and Australia on its first test, so that is not very much in the way of qualification. The ease of control is, probably, the most pleasing feature, and one is well rewarded for a little patience in choice of grid leak and adjustment of the H.T. and L.T. on the detector. The layout should be adhered to as closely as possible, as the grid and plate leads from the detector have been kept very short, and this is a desirable point.

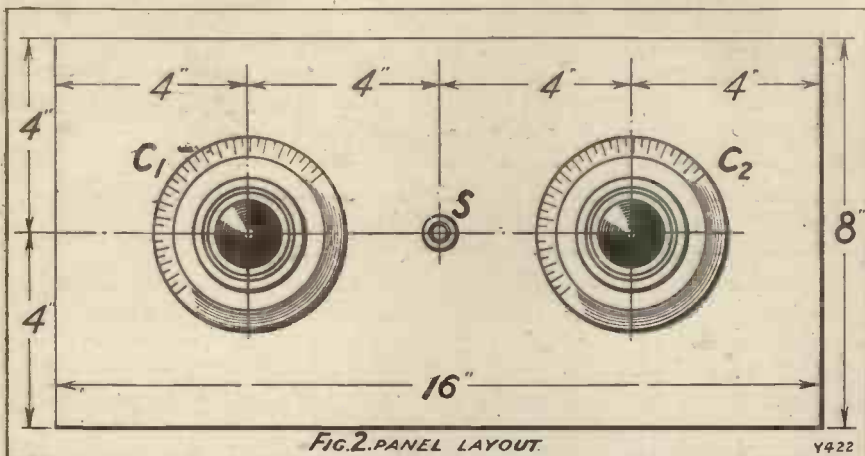

It is quite essential—this also is not a fetish!—to use a non-microphonic valve holder for the detector. The appalling ring on many short-wave sets which arises whenever the condenser dials are touched is simply due to the absence of this, and it is certainly “spoiling the set for a ha’porth of tar” to use an ordinary valve holder.

It will be noticed that a variable filament resistance has been provided for the detector valve, although none is included in the filament circuit of the note magnifier. The reason for this is apparent when one first uses the set. Sometimes one is unfortunate enough to meet a fearsome howl which persistently comes in whenever the set is just on the oscillation point. This is quite distinct from the howl that results when the set is oscillating too hard. The best method of curing this, in the writer’s experience, is simply to turn down the filament of the detector valve. This is apparently an infallible cure, and although there are numerous other ways of doing away with this trouble, this seems so simple a method that it is always used.

“Dead” Spots

The D.E.5b used is rated at 5.5 volts on the filament, but actually it is worked at less than 4 volts with no noticeable loss of signal strength.

No H.F. choke is used in this set. They are always sources of loss, and by using a “series-feed” circuit of this type, thus obviating the necessity for using a choke, a gain in efficiency is bound to result.

If, on testing the set, one finds dead spots on the dials over which it will not oscillate, these are almost cer-

coupled—the aerial socket has been mounted by one screw only to facilitate this—one of these dead spots appears, it is sure to be due to a harmonic of the aerial system, and the substitution of the 4-turn coil will cure the trouble—or, at any rate, shift the spot to another position, whence it can be moved by loosening coupling still more.

Ease of Control

The best H.T. voltage for the detector seems to be about 28-30 volts. With more than this the set oscillates too hard and “ploppy” reaction results. The note-magnifier should work well with 80-90 volts, since one does not want too much noise from a short-wave receiver. With this voltage it is often possible to do without a grid-bias battery, taking the

Interesting Tests

Clips have been provided across the transformer primary, so that a fixed by-pass condenser of .0005 or so may be inserted when the set is used for broadcast reception. A smaller reaction coil will then have to be used, or the set will oscillate even when the reaction condenser is set at zero.

Doubtless other modifications will be introduced by readers to suit their own requirements, but it is hoped that this outline of the general experiences of the writer with sets of this kind will prove useful to all “short-wavers.”

It may be of interest to some readers to note that this set was taken out in a car with the necessary batteries, a pair of ‘phones, and some rubber-covered wire, and tested at various spots in Surrey and Kent during the afternoons. The first fact disclosed by these tests was that the writer’s “home” aerial is almost useless, as far as short-wave reception is concerned!

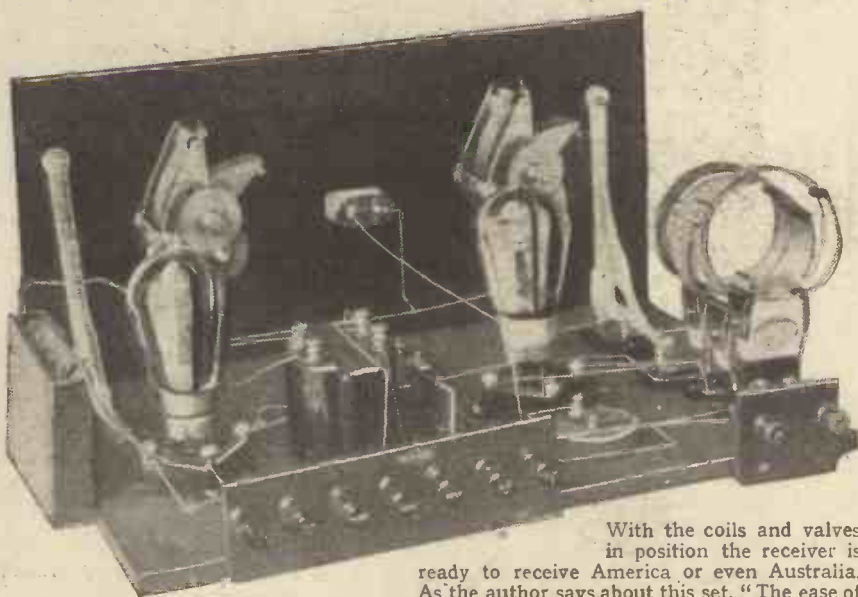

With the coils and valves in position the receiver is ready to receive America or even Australia. As the author says about this set, “The ease of control is, probably, the most pleasing feature.”

As soon as a high spot was found, the operators camped out and listened all round the dial, and signals of almost unbelievable strength were received from Germany, France, Belgium, and Sweden; the stations on whom the tests were carried out in every case being amateurs working on C.W. and telephony.

An R.A.F. station in Arabia was later received at good loud speaker

strength at the top of one of the Surrey commons, and this station had never once been heard at home!

Aerial Comparisons

This should not make the reader think that short-wave reception is hopeless with the average aerial, however, for the writer's is very badly screened.

It merely goes to show how im-

possible it is to erect anywhere in town an aerial which will give results comparable with those that might be obtained with less trouble in the country. Another interesting test revealed the fact that, while out with the set in "mobile form," signals were about 100 per cent weaker with the aerial removed, whereas at home the difference is more like 10 per cent!

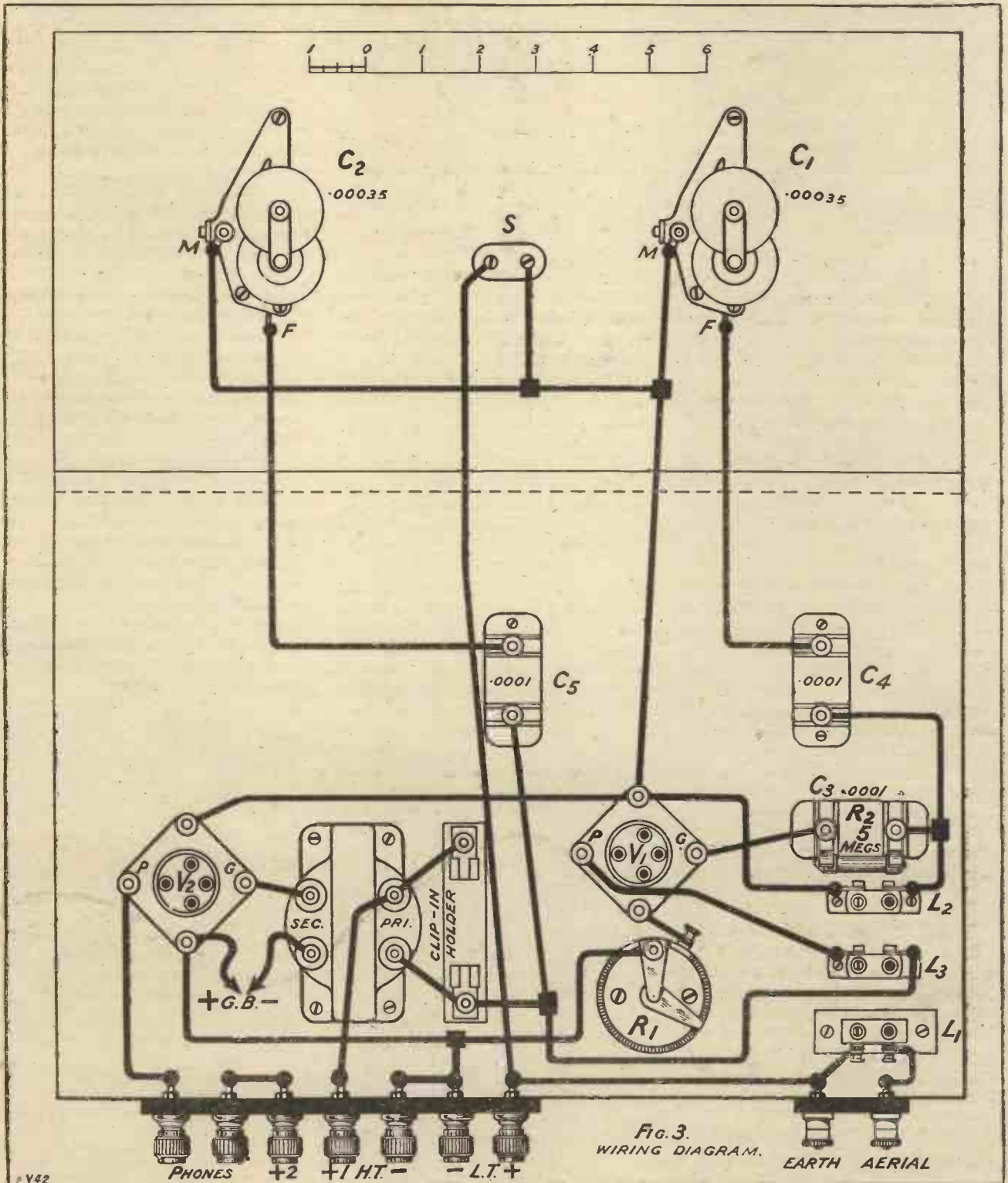

FIG. 3.
WIRING DIAGRAM.

INSULATION FACTS AND FANCIES

There is no such thing as a perfect insulator, but, on the other hand, a piece of material having a resistance of fifty thousand million megohms could hardly be called a good conductor!

By J. F. CORRIGAN, M.Sc., A.I.C.



CONTRARY to a very widely held opinion among wireless and electrical amateurs, an insulating material is not a substance which stops the passage of electricity, but, more strictly speaking, an insulator is a body which conducts an electric current badly. In other words, there is no such thing as a perfect insulator. All insulating materials conduct electricity to some degree, and although their conducting properties may, in some cases, be almost infinitesimal in extent, there is no gainsaying the fact that the term "electrical insulator" represents an ideal rather than an accomplished fact.

Dependent Upon Frequency

Naturally, the conducting properties of efficient insulating materials are extremely small in nature. In fact, a mass of good insulating substance may have a resistance as high as 50,000,000,000,000,000 ohms, a



Fig. 2.—The luminous discharge between two electrodes carrying high potential current and separated by air-space. This discharge occurs at voltages considerably below that required completely to break down the insulating powers of the air, and to allow the passage of a spark.

resistance which for almost any conceivable purpose would be entirely

satisfactory. Still, under certain conditions of potential, nature, and method of application of the current even the

Fig. 1.—Table showing the dielectric strengths of some common insulating materials.

Material.	Thickness.	Dielectric strength in volts.
Air	1 cm.	29,000
Mica	0.01 cm.	2,000,000
Ebonite	0.18 cm.	430,000
Paraffin oil	5 mm.	84,000
Olive oil	5 mm.	70,000
Dry paper	0.01 cm.	500,000
Glass (average)	0.1 cm.	270,000

insulating material mentioned above would allow a small residue of current to permeate it.

The degree of resistance to a current which any given insulating material affords depends fundamentally on two factors, viz., the voltage of the current, and its frequency. The higher the voltage of the current, the higher the resistance of the insulating medium must be in order to withstand its passage. If, also, the current is a direct one, it can be more easily insulated than an alternating or oscillating one. Such a fact is, of course, well known in practice to radio amateurs, who, from experience, are aware that radio currents, on account of their oscillatory nature, are much more difficult to handle than are currents which flow in one direction only. We learn, therefore, that the higher the frequency of a current the more difficult it becomes to insulate it adequately.

Take a practical example, for instance. Consider an insulator which would stand up to a direct current of 100,000 volts applied under given conditions. The same insulating

material, however, would probably break down under a current of 60,000 volts alternating at 60 cycles, whilst a current of 100,000 cycles per second frequency would suffice to break down the insulator at a potential of somewhere about 20,000 volts.

Dielectric Strength

Owing to the fact that an absolutely perfect insulating substance does not exist, the resistances of such materials are usually measured in megohms, one megohm being 1,000,000 ohms.

In considering the question of insulators and their properties we have still to deal with what is termed their "dielectric strength." Now, the dielectric strength of an insulator can most conveniently be defined as its ability to resist being broken down by an electric current. This factor is usually measured in terms of the number of the volts which are, under



Fig. 3.—An instantaneous photograph showing passage of a spark when the electrode potential has been raised above the dielectric strength of the insulating layer of air.

given conditions, required to puncture the insulating material. The dielectric strength of the insulating substance, however, is a factor which is extremely difficult to determine with any great degree of precision,

and this for the reason that it varies considerably under different conditions.

For instance, the dielectric strength of an insulator, besides being dependent upon the voltage of the current applied, and upon its frequency, is also governed by the thickness of the insulating medium, the length of time during which the current is applied, and upon the physical nature, size, and shape of the electrodes, and their distance apart.

Electrodes which are finely pointed are able to break down the resistance of an insulator at considerably lower voltages and frequencies than are electrodes which are rounded or flat. Such a fact is, of course, not difficult to appreciate, because when the applied electrodes are pointed the load is more greatly concentrated on a small area of the insulating medium than is the case when the electrodes are larger in size and possess a rounded or flat shape.

Leakage Before Breakdown

The table, Fig. 1, depicts some of the dielectric strengths of some of the more common insulating materials. It will be noticed that dry air has a dielectric or insulating strength of some 29,000 volts per centimetre thickness. At voltages below this, however, the insulating thickness of air between two electrodes begins to break down, with the result that some proportion of the current will be able to pass through it. Fig. 2, for instance, is a photograph showing the faintly luminous electric discharge passing between two pointed electrodes carrying a current considerably below the voltage necessary to overcome the dielectric strength



Fig. 4.—A broken portion of an "ebonised fibre" panel, showing its structure.

of the layer of air. Immediately, however, the current potential is brought up to that required to break down the dielectric strength of the insulating air space a spark passes through the two electrodes, as illustrated in the instantaneous photograph, Fig. 3.

Comparative Tests

Now, all other insulators act in precisely the same manner. Two electrodes carrying a current may be applied to a sheet of ebonite, mica, or glass, and although the current strength may not be sufficient to overcome the dielectric or insulating strength of the sheet, still, at the same time, a proportion of the current may pass, and thus take away considerably from the insulating properties of the material.

From the table of dielectric strengths it will be noted that ebonite possesses an insulating strength



The above is a photograph of a mass of crude mica.

of 430,000 volts, which figure compares very unfavourably with the 2,000,000 volts dielectric strength of mica, and the 500,000 volts of paper. One might say, therefore, that ebonite is not such an excellent insulator as it is supposed to be. Such a statement would be true, but only under a certain set of conditions. In a word, although the insulating properties of high-grade ebonite are excellent when the material is utilised in relatively thick sheets, the dielectric strength of the material deteriorates quite out of normal proportion when very thin sheets of ebonite are used.

Ordinary dry paper is a good insulator. However, such a material is of no practical value on account of its lack of physical strength, and, more especially, in consequence of its well-known moisture absorbing and retaining properties.

Mica is theoretically an extremely good insulator, but the unfortunate thing about this material is the

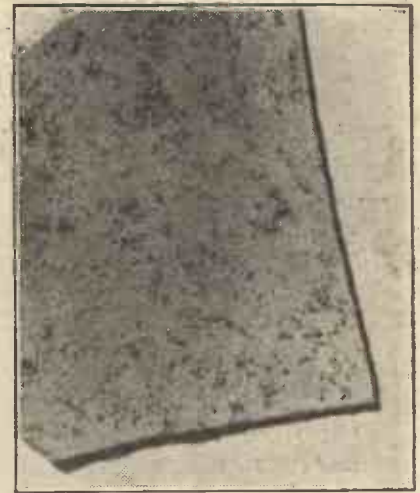

This is a photo-micrograph of a mica sheet showing minute impurities, some of which detract from its dielectric properties.

difficulty of procuring it in a pure condition and free from conducting flaws and other areas of relatively low resistance.

Quite a large number of radio experimental panels are composed of a material known as "ebonised fibre," an example of which is illustrated at Fig. 4. Such material is generally composed of layers of paraffin-impregnated paper pulp which are compressed together into a solid sheet. At first sight it might be thought that the insulating properties of such stuff would be very poor. As a matter of fact, however, the dielectric properties of this material are excellent so long as it is kept dry, a sheet of fibre panel of ordinary thickness being able to withstand a potential of anything between 40,000 and 50,000 volts. It is only when the material begins to absorb water (which it will do readily if kept in a damp place) that its insulating properties begin to deteriorate.

Variable Properties

It is a fallacy to think that because one sample of an insulating material has a certain dielectric strength another sample of the same variety of material will exhibit similar insulating properties. Such a second sample may or may not do so. In very many respects the efficiency of any given insulating material is dependent upon its degree of purity. Take water, for instance. Ordinary river water will conduct electricity fairly well. Water, on the other hand, which has been obtained in the highest state of purity and freedom from dissolved gases and salts is a very high insulator of electricity.



WHAT ARE VALVE CURVES?

Should characteristic curves be taken as accurate guides to a valve's behaviour? This article shows how misleading such data may be.

By KEITH D. ROGERS.

I MIGHT as well begin this short article by saying that although characteristic valve curves (especially those denoting change of anode current with change of grid volts, and used by all makers to denote the properties of their valves) are graphical representations of the physical properties of the valves concerned, they are *not* to be relied upon.

In case it be remarked that that is a wide statement and that I am inclined to be too dogmatic, let me remind my readers that the curves published are *static* curves. They are curves taken under non-working conditions, and may be very far from showing what really happens in a valve when it is operating in a set.

Static Curves

As a rule they are taken to denote an *average* valve's properties, and without any impedance in the plate circuit of the valve other than that of the milliammeter and the anode battery itself.

So far so good, we can realise then that the curve published by the

makers is taken under static (non-working) conditions. A certain voltage is applied to the anode (in some cases a resistance is inserted to somewhat imitate working conditions), and various fixed grid voltages are applied, and the corresponding anode-current values are taken.

"Average" Characteristics

But it is, of course, impossible for any manufacturer to take the curves of all his valves, so he takes a batch of curves and selects the average as denoting his average valve. And, furthermore, he does not take a huge series of readings from the meters and join each dot up—he takes an average of the dots, which results in a beautiful straight and smooth curve.

I do not blame him, what else could he do? If he were to show every little kink and irregularity for one valve he would find it did not occur in the same place (if at all) in the next, and so on. Therefore, he has to make a smooth curve of it and

call it "characteristic of average" so-and-so.

It is when it comes to operating the various valves that the whole joke of the characteristic curve dawns

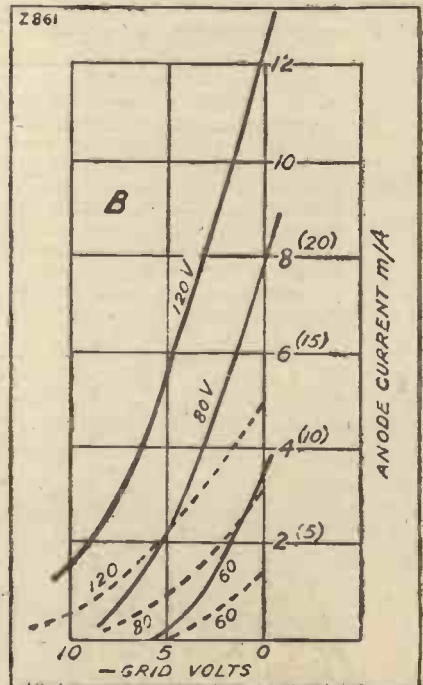

The same curves as at A, drawn to different scales, showing how the valve may be made to appear like an R.C. amplifier, or (as in dotted portion) like the ordinary L.F. valve it really is.

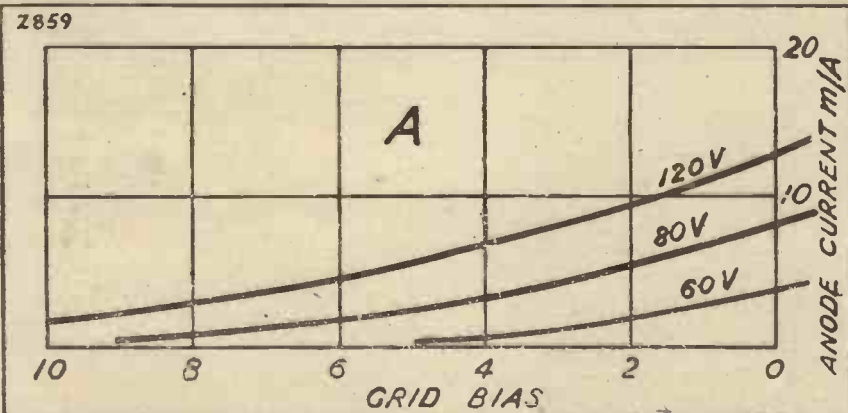

Accurately but deceptively drawn to an open grid-bias scale and a close anode-current scale this valve's characteristics make it look (at first glance) like a super-power valve with a long, even, "straight" curve. Compare this with "B".

upon one. They are like some medicines, taken in small quantities and with due regard to their uses they do good, but taken at random and without consideration they may cause a deal of trouble.

Let me explain.

Look at the curves marked A and B. They show three sets, taken at

120, 80, and 60 volts H.T., and at first glance appear to denote three different, totally different, valves. The series marked A shows a valve apparently without much magnification, its curve is very flat, not so "steep" as the dotted curve in B, and far from being as "steep" as the other curves in B. "No," says the man in the street, "of the three valves I prefer that, denoted by the heavy curves in B. It has a much 'steeper slope' and, therefore, as I am taught by manufacturers' advertisements, will give louder signals."

Misleading "Slopes"

So it would appear until the curves are examined, when it will be seen that they are all the same. They denote the same valve, but are plotted on different scales.

Now, I have done that to show how very misleading published curves can be. You take a catalogue of valves and glance through, and you will notice that some curves are steep, some flat and some medium, but if you look closely you find that

they do not differ so much as would appear at first sight.

Where curves have to be published the reducing of the original curve to fit any given space makes it necessary for different scales to be used, according to the shape of the curve. A long, flat curve needs a closer grid-voltage scale, and a steep slope needs a closer anode-voltage scale. Result—both appear almost the same. The former becomes steeper, and the latter less steep. All this has to be done to "make it fit" the page or carton slip. It is a great pity, because it means you cannot tell what a valve is likely to be, or compare it with others at a glance; you have to "work it out" before you know where you are.

In the curves shown on these pages all except one are taken on the average scheme, that is, the curves are taken with accuracy as regards the plotting of the points, and then the average curve between the points is plotted. The results, as will be seen, are good average curves denoting the rough characteristics of the valves in question.

But look at the super-power valve curve. This is taken with extreme accuracy on a large open scale, and though it has had to be reduced to

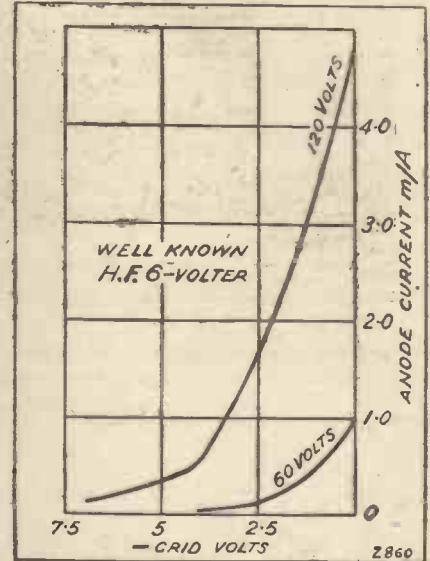

An example of "average curving"—the characteristics of a well-known and efficient H.F. valve. Note the good anode bend properties shown.

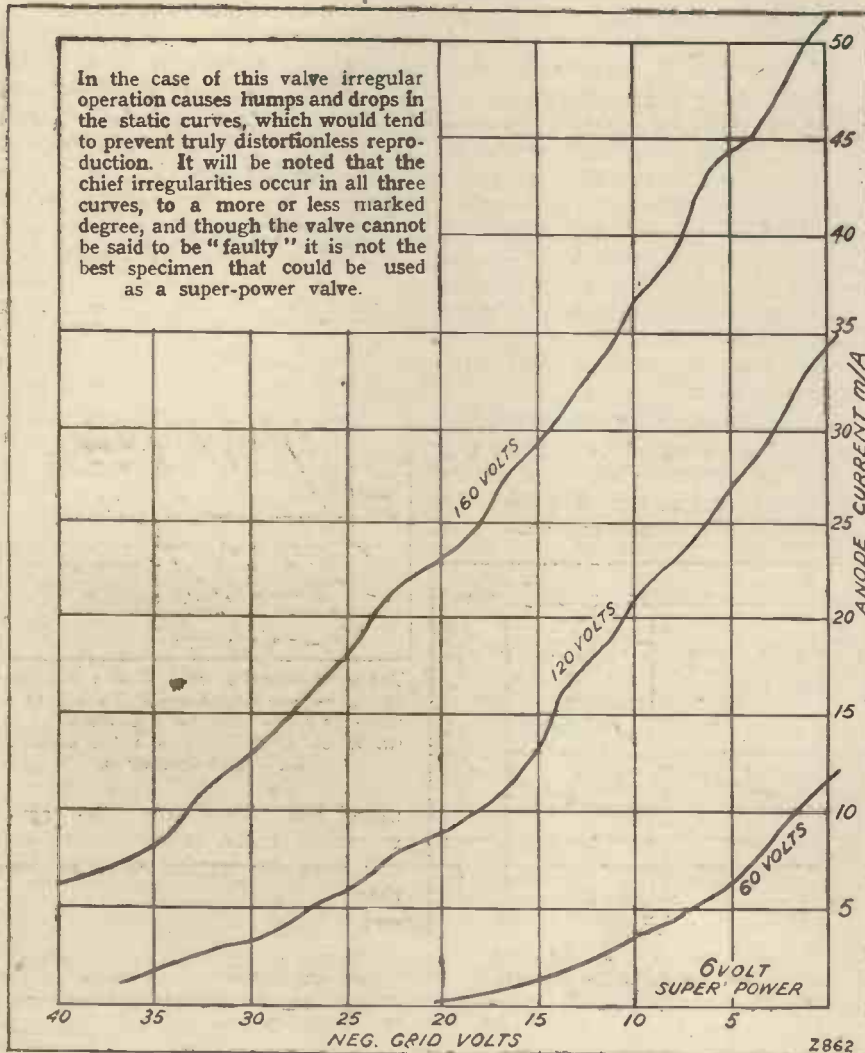

get it on the page, it will be seen that the kinks and humps are still clearly shown. Some of the smaller ones shown on the original have disappeared, but the main ones are still there.

That is an accurate curve of a large super-power valve, and yet (although we do not know what happens under working conditions) we use these valves and hope to keep our millimeter needles steady. What a hope!

Rough Guides Only

In practice, with the usual flattening of the curves under working conditions, the humps may disappear somewhat, but they may also increase; we do not know, so are really in the dark as to what is happening. It is interesting to note, however, that the irregularities shown in the valve whose curve is given are quite absent in another of the same type, while they reappear in different forms in still further specimens.

And so we are forced in answer to the question "What are valve curves?" to agree with the statement that they are graphical representations of the static character of an average valve of a certain type, and then to hope for the best.

As a rough guide as to whether such and such a valve is O.K. for H.F., L.F., etc., they are quite useful. They show a bit more than do mere figures, they give an idea of

(Continued on page 209.)



The "DX" FOUR

A tuned-anode receiver using standard components, and having two stages of H.F. amplification which,

although extremely simple to construct, is capable of really good loud-speaker results from a large number of broadcasting stations.

By L. H. THOMAS.

THIS article is, of course, no attempt to decry the obvious merits of the most up-to-date methods of arranging high-frequency amplification. No one can deny that the age of screening boxes and shield-grid valves has placed this branch of

the detector with the right hand without making the set burst into oscillation.

Taking the old original circuit into consideration, let us see what could be done to improve it (i.e. to stabilise it, for that is *always* necessary before it can be considered even a workable circuit). There were the alternatives of introducing a potentiometer—which means deliberately introducing losses into the circuit to “tie it down,” or we could neutralise it properly, in the usual way, with a split-anode coil.

condenser. If this latter condenser was made fairly small it had a stabilising effect, but here again the effect was more or less that of introducing inefficiency into the circuit so that it could be easily handled.

Final Arrangement

The writer, after some considerable experimental work on each of these methods, and also on various combinations of two of them, decided that there was apparently only one thing to do, and that was to use parallel feed *and* neutralise the circuit properly.

Furthermore, no attempt was made to stabilise the circuit by the expedient of using a small condenser between the anode and the coil, but one of quite a large value was used here.

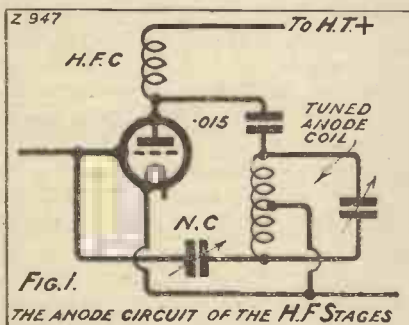

radio on a plane far above anything which it is possible to reach when one confines oneself to the older methods.

There is, however, a certain amount of satisfaction in seeing what can be done with the circuits that, not so very long ago, were almost universal, and it was a feeling of this kind that prompted the writer to perpetrate the receiver described in this article.

Improved Tuned-Anode

Many “old-stagers,” while having a soft spot for the well-known tuned-anode circuit, must also have bitter memories of long hours spent in attempting to tame a refractory specimen of it. Probably no type of receiver has given quite so much trouble to the world as this old friend. The writer was, therefore, more satisfied than surprised when he managed to produce a version of it that was so stable that one could touch the first H.F. valve with the left hand and

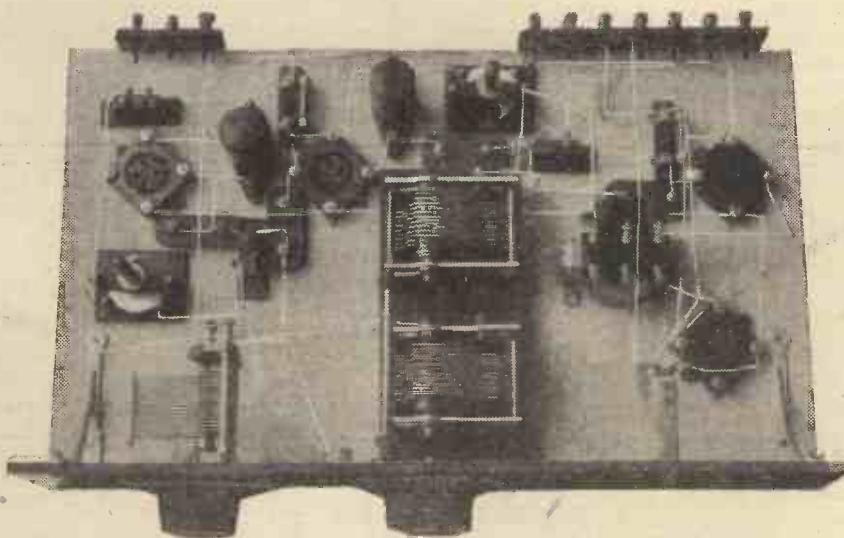

A view of the set taken before the wiring was completed. Standard components, even to the terminal strips, have been used, so the constructor will have no difficulty in obtaining the various parts. The last terminal on the large terminal strip is not used, as will be seen from the wiring diagram.

The arrangement of the anode circuit as finally decided on is shown in the small sketch, Fig. 1. It is, of course, simply a tuned-anode circuit neutralised in quite the ordinary way, but employing parallel feed for the H.T. supply.

Comparing this arrangement with an ordinary neutralised tuned-anode circuit with series feed, one important difference was noticed at once—the former would not neutralise at one setting for the whole of the wavelength range (i.e. if the set was stable at about 500 metres it would probably break into oscillation as the tuning capacity was reduced). The parallel-feed variety would, at one setting of the neutralising condenser, remain perfectly stable over the entire tuning range.

Stable Operation

No pretence is being made that this set was neutralising in the correct manner; it certainly was not, for the second neutralising condenser could be used very nicely as a reaction control! The fact remains, however, that the set can be adjusted to a point just below oscillation point, and it will remain at this point over the entire tuning range, giving all the advantages of a constant-reaction circuit.

In order to ascertain that this was not a mere freak, the whole set was dismantled and built up with entirely different components. As was hoped (but perhaps not entirely expected!) the new set gave results that were really indistinguishable from the old one.

It seems perfectly possible that three stages of this kind could be operated, the set still remaining stable. It will be seen, however, that the writer has confined himself to two, the two anode circuits being tuned by a double-gang condenser. As no

Fig. 2 shows the circuit diagram of the entire set. There is nothing at all unconventional about it, and it should be noted that the two tuned-anode stages are exactly similar in

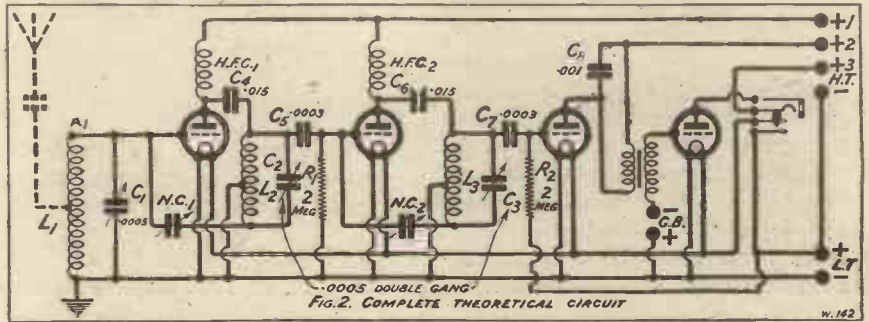

every way. This probably is responsible largely for the success of the arrangement. The H.F. chokes used in the plate circuits of the H.F. valves need not be of the same make as used by the author, but the two should be similar. The .015 stopping condensers should also be of the same manufacture, or, at any rate, precautions should be taken to see that the two really have the same capacity. If they are of the same manufacture one cannot really go far wrong.

Careful Layout Required

With reference to the mechanical and constructional part of the business, there is not much to be said. It will be seen that a fairly deep baseboard is necessary to accommodate the double-gang condenser, and for this reason the panel need not be extremely large. For a four-valver the set is reasonably compact when one realises that no screening of any kind is incorporated, and for this reason it is not possible to crowd the components together.

As will be seen from the photos, the panel layout consists of two dials and a jack. The latter switches on the filaments when the phones are

The layout of the components on the baseboard is also fairly simple, and consists chiefly of an attempt to avoid the gang condenser. The two H.F. valves and the detector

are placed "in line" across the baseboard, the L.F. stage being "curled round" towards the panel. By this means ample space is allowed

COMPONENTS NECESSARY.

- 1 Panel, 21 in. x 7 in. x 1/2 in. (Any good branded material).
- 1 Cabinet for same, with baseboard 12 in. deep (Artercraft, Camco, Caxton, Makerimport, Pickett, Raymond, etc.).
- 1 .0005 double-gang condenser (Cyldon in set). (Any good make.)
- 1 .0005 variable condenser (Ormond ebonite end-plate type). (Any good make.)
- 4 Non-microphonic valve holders (Ashley, Benjamin, Bowyer-Lowe, B.T.H., Burndept, Burne-Jones, G.E.C., Igranic, Lotus, Marconiphone, W.B., etc.).
- 2 H.F. chokes (Lissen in set). (Any standard make.)
- 2 Base-mounting neutralising condensers (Peto-Scott in set). (Any good make—Bowyer-Lowe, Burne-Jones, J.B., etc.).
- 2 Fixed condensers, .015 (Clarke, Dubilier, Igranic, Lissen, Mullard, T.C.C., etc.).
- 2 Fixed condensers, .0003 (Clarke, Dubilier, Igranic, Lissen, Mullard, T.C.C., etc.).
- 1 Fixed condenser, .001 (Clarke, Dubilier, Igranic, Lissen, Mullard, T.C.C., etc.).
- 1 Fixed condenser, .0001 (Clarke, Dubilier, Igranic, Lissen, Mullard, T.C.C., etc.).
- 2 Grid leaks, 2 megohms, with holders (Dubilier, Igranic, Lissen, Mullard, etc.).
- 1 L.F. transformer (Any good make).
- 3 Base-mounting coil sockets (Burne-Jones, L. & P., Lotus, Peto-Scott, etc.).
- 1 Single-circuit filament jack, with plug (Ashley, Bowyer-Lowe, Igranic, Lotus, etc.).
- 1 Seven-terminal strip, and 1 three-terminal strip.
- 1 Pair panel brackets.
- Glazite, or Junit, tinned copper for wiring; screws, terminals, bolts, etc.

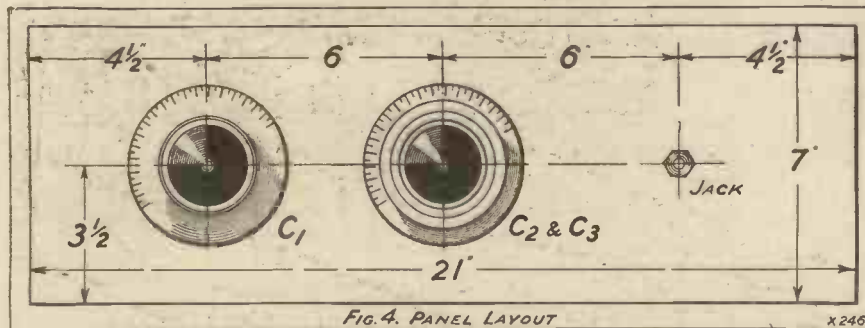

reaction control is necessary, we have only two controls to manipulate, and the set is so simple to handle that a third stage could certainly be used without introducing much extra trouble.

plugged in, and therefore no filament switch is necessary. No rheostats or even resistors have been incorporated, as all the modern 2-volt, 4-volt, or 6-volt valves seem to work well at these exact voltages.

for the H.F. stages. The grid-bias battery is normally placed in the space between the gang condenser

and the filament jack. All the other information may be gleaned from the back-of-panel wiring diagram. With regard to the wiring, there is no particular rule to follow. It is all quite simple, and there are no "awkward corners."

should be used; 2-volt, 4-volt, or 6-volt valves seemed to give equally good results.

With regard to H.T. voltages, about 80-100 volts was used on the anodes of the H.F. valves, 60 on the detector, and 80-100 again for

are within about 30 degrees of one another it will probably oscillate.

It is impracticable to neutralise in the usual way, but if the first neutralising condenser is set about one-third in and the second left all in, the band over which the set oscillates will be made considerably narrower. Now, by careful manipulation of the two condensers, it will be possible to make the set stop oscillating completely, and the position should be, roughly, the first condenser between one-third and one-half in and the second about half in. These, at any rate, were the writer's settings, almost irrespective of the types of valve in use.

The Best Adjustment

It will now be found that a slight increase in the capacity of the second neutralising condenser (the first should be left severely alone) will just bring the set to the oscillation point, though, of course, the farther the set is from oscillation the better the quality on strong signals. It will be working exactly as a capacity-reaction control. It should be left so that the set is just *below* this point. The oscillation point, of course, is not indicated by a squeal, but by a gentle hissing or rushing sound.

The two main condensers should be rotated slowly, keeping them as nearly as possible "in step." This does not necessarily mean that their readings will be the same, but it will have been seen from the first test when the two circuits are in tune by the readings of the two condensers when the set oscillates.

Incidentally, if a .0001 condenser is used in series with the aerial, as shown by the dotted line in the circuit diagram, a "C" centre-tapped coil (75 turns) may also be used for the coil L_1 , and the two condenser

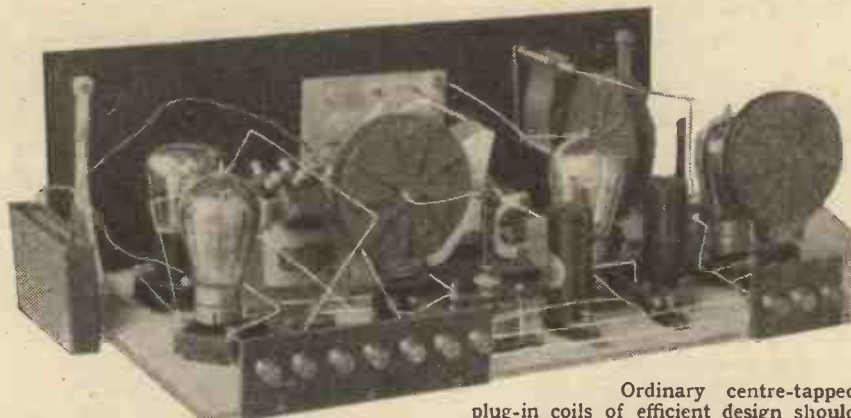

Ordinary centre-tapped plug-in coils of efficient design should be used in this set, and valves suitable for the various positions they will occupy must be chosen if the best results are to be obtained. When the set is in the cabinet the grid-bias battery stands between the last two valves and the side of the cabinet.

It will be noticed that in the theoretical diagram the aerial lead has been dotted in. It was found that the writer's aerial (rather short and fairly high) worked perfectly well when connected directly to the centre-tap of the coil L_1 . An "X" coil also gave good results. It is possible, however, that owners of long or low aerials will need to insert a small condenser between the aerial and the set. In the extreme case sufficient selectivity should be obtainable when the aerial is connected to the centre-tap via a condenser of .0001 capacity.

This point must, of course, be decided upon according to the dimensions of the reader's aerial, but as a general rule it should not be necessary.

Suitable Valves.

It is in the operation of the set that the reader is most likely to meet small difficulties at first, but these can all be easily overcome. Having completed and checked the wiring, the coils and valves should be inserted and the batteries connected up. The writer used valves of the very high "mu" type for the H.F. stages, i.e. valves designed for resistance-capacity amplification, with impedances of about 60,000 ohms. The ordinary H.F. valve also works perfectly well, however. Anything between 17,000 and 60,000 ohms should serve.

For the detector a small power valve or a general-purpose valve may be employed, and for the L.F. stage a power or super-power valve

the note-magnifier. This could probably with advantage be pushed up to 120 or more, but it is not strictly necessary.

Neutralising the Set

For the two tuned-anode coils "C" type centre-tapped (75 turns) were used, and a "B" (50 turns) centre-tapped for the aerial coil. A 50 or 60 "X" coil would also do.

Everything now being in readiness, the set may be put through its paces. The two halves of the gang condenser should be matched up equally (i.e. the edges of the sets of moving plates should be parallel). Do not connect the aerial up yet, but use the earth connection only. The set should now oscillate over a small band on the tuning range, i.e. when the settings of the .0005 and the gang condenser

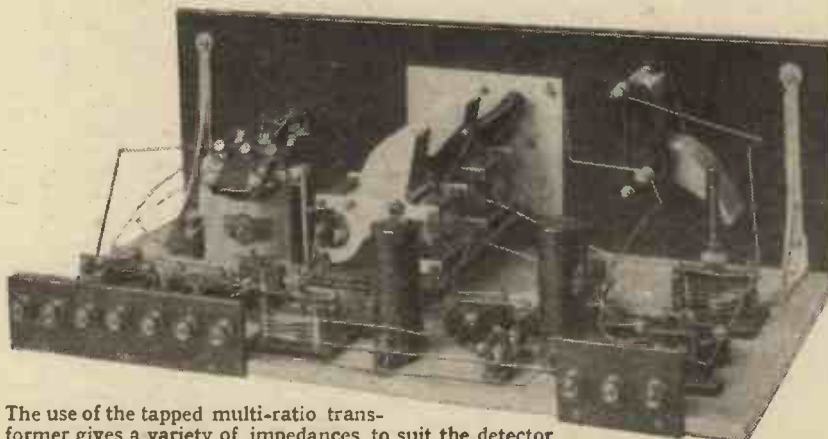

The use of the tapped multi-ratio transformer gives a variety of impedances to suit the detector valve, and enables the constructor to get the maximum performance from the set. The gang condenser can be fitted with a vernier dial if required, this assisting in the operation of the receiver when very weak signals are being received.

readings will then be roughly matched. If, at any rate, no amount of swinging about on the two condensers will produce any sign of oscillation, the set is stabilised correctly.

Results on Test

The aerial may now be connected. There should be no difficulty in telling when the circuits are in tune, for a gentle "mushy" noise, such as one always hears in the background when listening to a distant station, will be heard when the set is in its most sensitive state.

One soon acquires the knack of tuning the two circuits simultaneously, and if the reader has had any previous experience of H.F. receivers at all he has probably skipped this and is reading the end of the article. Suffice it to say that the two condensers should be rotated slowly, just keeping

the gentle mushy sound "within reach," so to speak.

The local station will, of course, be found without difficulty. For 2L0, with the coils mentioned, the readings are, roughly, 55 degrees on each condenser. 5 GB will be found at about 100 degrees, and just below him, at about 90 degrees, Langenberg should be heard at good strength.

On the first test of the set some twenty-two stations were logged on headphones, and on subsequent tests over twenty were identified using the loud speaker only.

These included Madrid (quite clear of London), Bilbao, Rome, and a station working between 5 GB and Langenberg, quite clear of them both. For selectivity this circuit seems to compare more than favourably with many so-called "modernised" receivers that the writer has

seen and heard. Several relay stations round about 300 metres were received on the loud speaker without difficulty.

Balancing the Tuning

The only other point requiring mention is the balancing of the two halves of the gang condenser. If coils of the same make and size are used in both anode circuits, the condenser should be perfectly balanced when bought.

It may be found, however, that independent rotation of one half will produce a slight increase in signal strength, and the only satisfactory method is to try this out on a fairly weak station; or, better still, on two, one at the top of the dial and the other at the bottom. No trouble should be experienced with this.

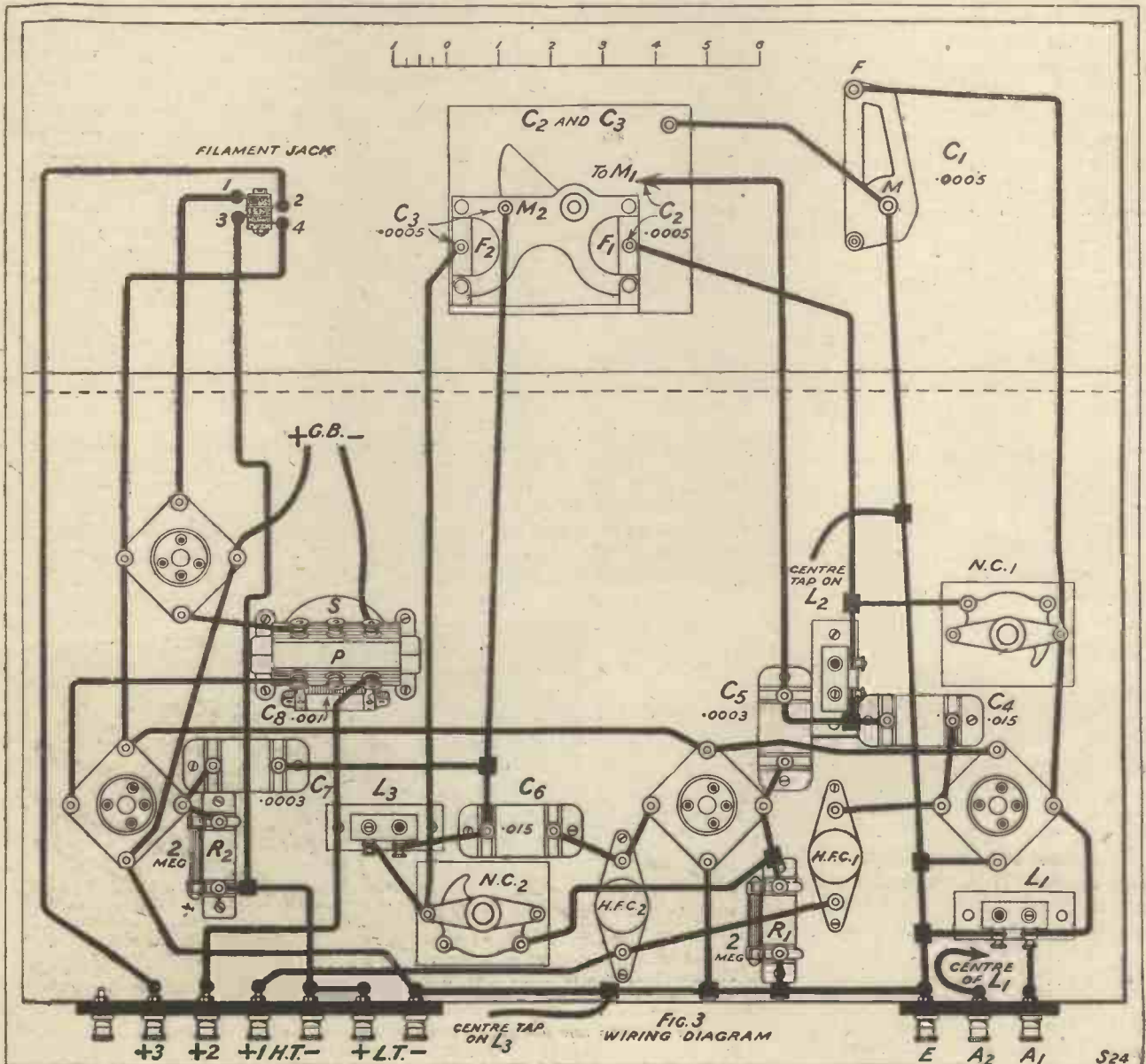

BLIND SPOTS

There has been a great deal of controversy on the subject of "dead" or "blind" spots and many experiments have been devised to discover the cause of these phenomena. It has also been found that many complaints of poor reception are due to faults in listeners' receiving installations, such as are explained in this article.

By A SPECIAL CORRESPONDENT:

IT is curious how the strength of reception from a broadcast station varies from place to place. You might reasonably expect that the strength of reception would simply become less the greater the distance from the station and that all places at the same distance would receive the same signal strength. If you took a map and drew a series of circles around the situation of the broadcast station you might expect that all the places on any circle would be places of equal strength.

Variable Reception

As a matter of fact, as every wireless experimenter knows full well, the actual facts are entirely different. Not only does the signal strength vary considerably at places equally distant from the broadcast station, but it may even increase as the distance from the station increases.

In some cases the localities of poor reception may be quite small and sharply defined. In extreme cases the signal strength may be practically nil. These areas are popularly known as "blind spots," but the designation "blind spot" is rather loosely applied to any area or locality where the reception is noticeably poorer than it ought to be for the distance from the station.

Noted "Blind" Areas

There has been a great deal of controversy on this question of blind spots. Some experts consider that a blind spot is due to the screening of the wireless waves by surrounding hills or mountains, and in support of this view it is noticeable that places in deep valleys are frequently places of poor reception.

For example, in some of the narrow valleys in South Wales the

transmission from the Cardiff station is not well received, although transmissions from certain other stations at greater distances than Cardiff are better received. It is probable that the direction of arrival of the waves from the Cardiff station is such that they are largely screened, whilst the directions of the waves from certain other stations are such that they are better able to gain entry into the valley.

Sheffield is another noted blind spot, and here it is thought that the poor reception of distant stations is due to the absorption of the waves by the enormous quantities of metal in and around Sheffield which, of course, act in the same way as innumerable aerials and cause the electro-magnetic energy to be dissipated. It was largely

for reasons such as these that it was found necessary to erect a relay station at Sheffield.

Tracing The Cause

Another curious thing about blind spots is that the degree of "blindness," so to speak, varies from time to time during the day or during the year. This, however, is only what might be expected, for if we assume that the blind spot is due to the screening or diverting of the waves owing to the conformation of the surrounding country, or owing to special conditions, such as those indicated above, it is only to be expected that variations in the mode of transmission, which undoubtedly occur between, for example, day and night conditions, should affect the problem,

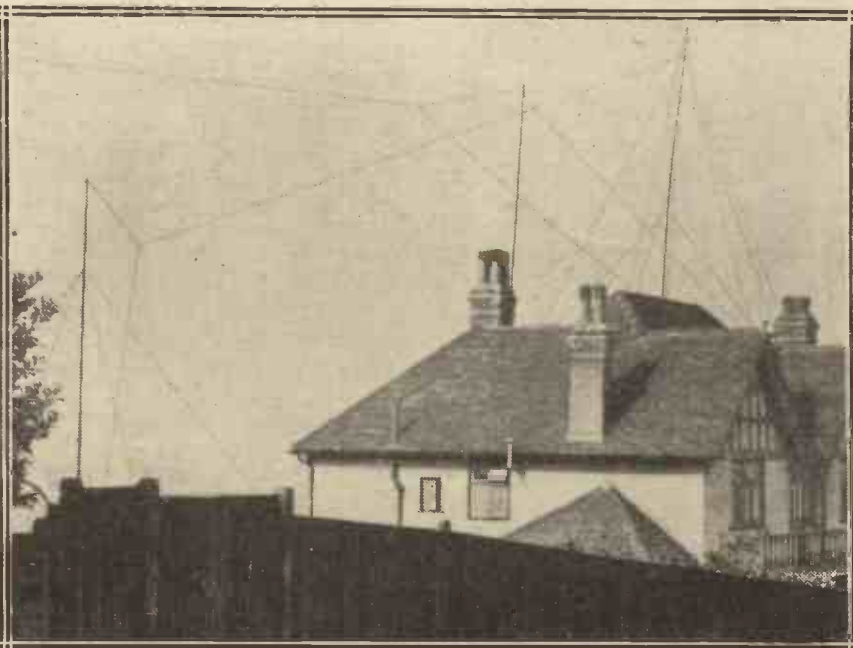

To avoid interaction and absorption troubles these two aerials have been erected at right angles to one another.

since the permanent conformation or conditions will then have a somewhat different influence.

In some cases blind spots are very troublesome and, if the situation is acute, there is nothing for the wireless listener to do but to give up hoping for the particular station to which his area is "blind," and to content himself with receiving other stations whose transmissions are better able to get through.

There is another side to the question of so-called blind areas, however. Frequently an amateur, especially a beginner, will report that reception is very poor in his locality, when, as a matter of fact, his experience is not shared by other people in the vicinity. It is very easy to make a first test on your conclusions as to the existence of a blind area by consulting your friends.

Is the Aerial O.K.?

If you find that practically no one else agrees with you as to the poor quality of reception, you may be sure at once that the fault lies in your receiver. If, however, you find a general consensus of agreement, then there is strong probability that the area is, in fact, definitely one of poor reception.

Assuming that you have met with little or no sympathy from your friends, the next thing is to look to your set with the idea that the fault is to be found there.

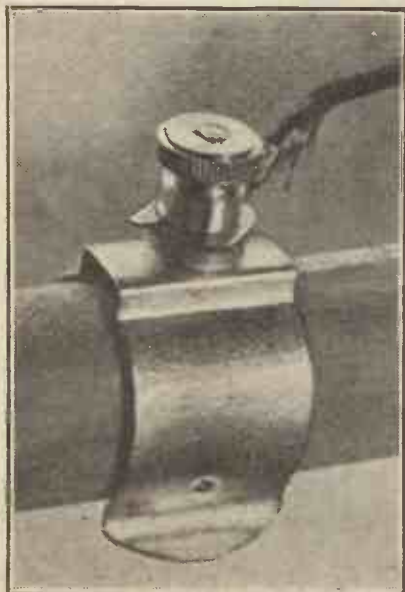

The clip type of earth connection is useless if it does not make really tight contact.

One of the first things to do is to examine the aerial and to make sure that the insulators are efficient—that they are not so covered with soot or

dirt as to have ceased to act as insulators; also that the aerial wire, particularly the down-lead, is not making contact with any object such as a wall; which would permit the signal currents to leak to earth.

Efficient Earth Essential

Improvement may also be made by varying the "bearing" of the aerial; for example, supposing it is lying east and west, you may, if you have space and facilities, try giving it a bearing north and south, or perhaps something between the two. It is often said that the aerial should point towards (or away from) the transmitting station which is to be received. But this is on the assumption that the waves from the transmitting station are arriving, so to speak, "as the crow flies."

It is important to bear in mind that, particularly in a locality such as a blind area or one which is in any way under suspicion, the waves may be arriving actually in a different direction from the "straight." What you want to do is to place your aerial so that it is parallel to the direction in which the waves actually arrive, and if, for reasons such as we have indicated in the foregoing, the direction of arrival should be different from the direction of the bearing of the broadcast station then you would be wrong in pointing your aerial straight towards the location of the broadcast station.

A much more important question is that of the efficiency of the earth connection. I do not know why it is, but although every amateur and experimenter is fully alive to the importance of a good, well-insulated and efficient aerial, many people seem to regard the earth connection as a "mere bagatelle." Now, in point of fact, the earth connection is not only just as important as the aerial, but it is actually *part of the aerial system*.

Of Equal Importance

For the aerial system is really a collector of the electro-magnetic waves, and the operation of the receiving set depends upon the passage of oscillatory currents from the aerial through the aerial coil of the set. For the proper setting up and maintaining of these oscillatory currents, connection to earth (or to a counterpoise) is very important. It is true there are other ways of achieving the desired result, but probably nothing equals in sensitivity and efficiency a good aerial as a collector and a good earth

as an outlet (and inlet) for the high-frequency currents.

Therefore, do not for a moment run away with the idea that if you have a good aerial the earth is of minor importance. Always keep it before



A bad method of making contact, which will corrode and cause trouble before long.

your mind that the *earth* is just as important as the *aerial*, and that a good aerial is of little use without a good earth, just as a good earth is of little use without a good aerial.

Keep Ground Moist

As to how to improve the earth connection, this depends on circumstances. A good soldered or screwed connection to a main waterpipe is a very suitable earth, but if this should not be convenient, the "earth" may be made by means of a buried metal plate, at least three or four feet deep, having a stout copper wire securely soldered to it, or, what is even preferable, a buried metal vessel, such as a disused canister or bucket, or something of that kind, placed with the open part upwards so as to retain any moisture which may percolate into it.

A stout metal rod or tube, say three or four feet long, driven into the ground will usually act as a fairly good "earth." But in all these cases it is important to remember that dry soil is a very poor electrical conductor, whilst wet soil is a good conductor.

Therefore, unless you use a connection to a waterpipe, you should always try to ensure that the buried plate, or whatever it may be which you are using as an "earth," is enclosed in ground which is likely to remain fairly moist.



A VARIABLE TONE CONTROL

This easily made instrument permits fixed-condenser capacities to be combined easily and effectively.

By E. CARTER.

IN making comparisons between various loud speakers, the writer experienced a series of petty annoyances in connecting different capacities across the windings. To simplify this experimental work the apparatus described below was designed and has now been incorporated in the output panel of the "family" set.

This useful gadget is a variable condenser with a maximum capacity of .011 mfd., varying in steps of .001 mfd. This range is obtained by using four fixed condensers of the following capacities: .001, .002, .003 and .005 mfd., connected to a special rotary switch. An extra condenser of value .0005 mfd. and a push-pull switch may also be included and so

length of 2 B.A. rod, 5 in. long; two W.O. terminals; four fixed condensers (capacities .001, .002, .003, .005); one piece of ebonite, $4\frac{1}{2}$ in. square, $\frac{1}{4}$ in. thick; one piece of ebonite, 4 in. by $3\frac{1}{2}$ in., $\frac{1}{4}$ in. thick; one piece of ebonite, $3\frac{1}{2}$ in. square, $\frac{3}{16}$ in. thick; twenty 2 B.A. nuts; two brass bushes;

marking off every 15 degrees. An old condenser dial marked 0-180 will do.

The Rotating Contact Plate

The contacts joined together as shown in diagram (Fig. 2) were connected by means of copper foil nipped under the contact fixing nuts during assembly. After the contacts

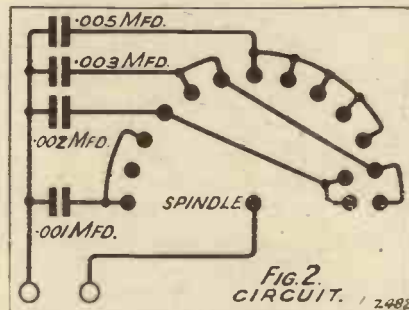
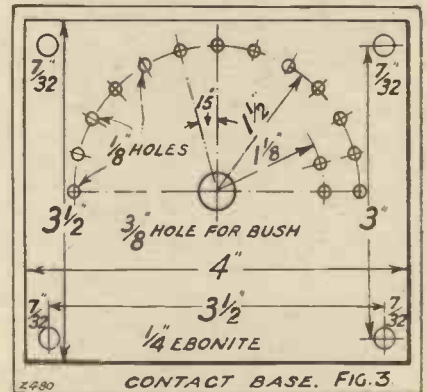

FIG. 2. CIRCUIT. 2482



CONTACT BASE. FIG. 3

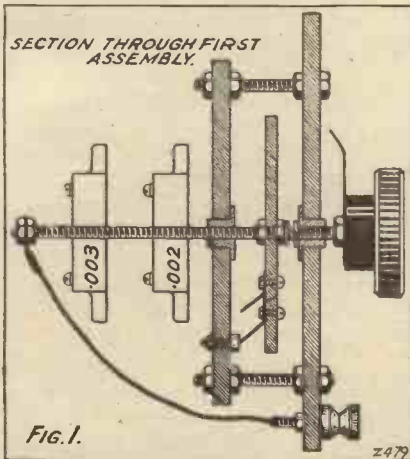

FIG. 1.

ebonite knob and pointer; six 4 B.A. bolts.

For the base of the rotary switch take a piece of $\frac{1}{4}$ -in. ebonite, $3\frac{1}{2}$ in. by 4 in., and mark off and drill as shown in Fig. 3. In dividing up the 3-in. circle into twenty-four sections, step round the circumference with the dividers set at about the radius, thus dividing it into six. It will then be found easy to divide each sixth into four. A protractor may also be used,

have been tightened up they should be faced up by rubbing face downwards on a piece of fine emery cloth laid on a flat board. This rubbing should be continued until all contact faces are dead level, after which the central brass bush may be fitted.

increase the steps to twenty-three and the maximum capacity to .0115 mfd. (This refinement has not been included in the apparatus described but if the constructor wishes to include same he can easily make allowances for it.) The following components will be required:

Few Parts Necessary

Fifteen standard contact studs; four lengths of 2 B.A. rod, $1\frac{1}{2}$ in. long; one

A comparison between this photograph and Fig. 1 will show how the main features of the Tone Control are arranged. The condensers are supported on their own wiring, which is carried out with No. 18 S.W.G. copper wire.

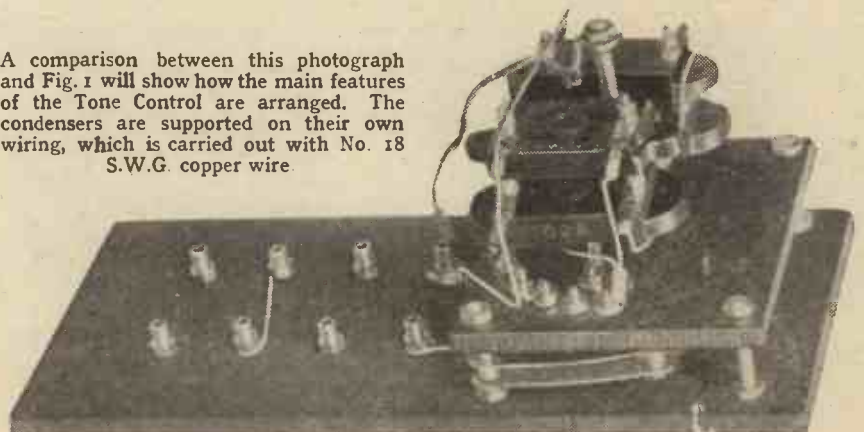

The next part to be constructed should be the rotating contact plate. This was made of $\frac{1}{8}$ -in. ebonite. Mark out as shown in Fig. 4, making

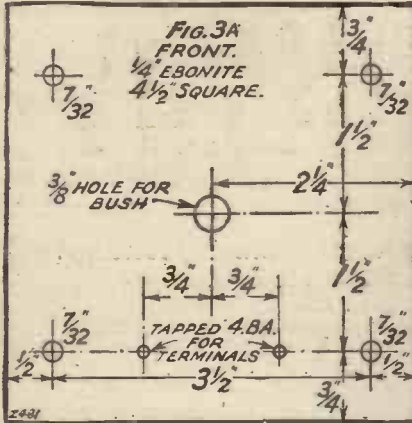

the notches round the edge by drilling $\frac{1}{4}$ -in. holes and trimming down after. These notches are cut to engage a roller arm and so give definite positions as on a tramway controller. The rubbing contacts should be made of springy phosphor-bronze sheet and bolted by means of 4 B.A. bolts to the contact plate.

Front Panel of Control

Of the three contacts two are single ones, but one needs to be a double one, as shown in Fig. 4. The drawing shows the side of plate opposite to that on which the contacts are mounted. Connection with the centre spindle should be made by means of copper wire or foil. The spindle should project $3\frac{1}{2}$ in. on contact side of ebonite and should be fixed by a 2 B.A. nut each side.

The front of the control should be made from a piece of $\frac{1}{4}$ -in. ebonite, $4\frac{1}{2}$ in. square, unless the unit is to be built into an existing panel. In Fig. 3 the four corner holes are shown as being $\frac{7}{32}$ in., but to avoid the nuts showing on the front of the panel these could be drilled from the back $\frac{5}{32}$ in., and tapped 2 B.A., taking care not to come right through the

panel. Mount a brass bush in the central hole and also fit the two terminals. Cut four pieces of 2 B.A. rod, $1\frac{1}{2}$ in. long, and fix them in the four holes, making them project from the back of panel.

Setting the Roller Catch

Put a spring washer on the short end of the spindle of the rotating contact plate and slip it into the brass bush in the front panel. Run a nut on to each corner stem and put on the fixed contact panel, following this by another nut, to lock it in position. By adjustment of these nuts the pressure between contacts can be regulated to a fine limit.

After this adjustment the central spindle can be cut off to length at the front and a knob and pointer fitted.

For the roller catch cut off a piece

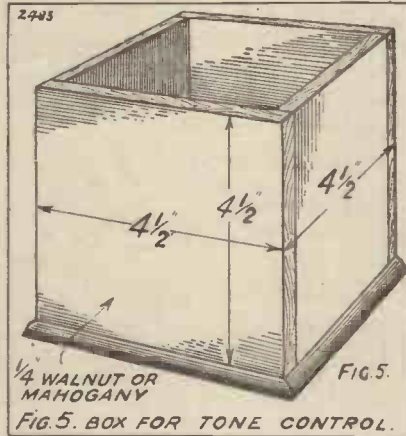

of $\frac{1}{4}$ -in. brass rod, $\frac{1}{4}$ in. long, and drill a hole through the centre. Cut two sheet brass links as shown, and bolt the roller between them, using a 4 B.A. bolt and lock-nut. Remove the bottom right-hand corner stem (looking at the back of panel), and slip this roller lever over it, using suitable distance-pieces on the stem to keep it opposite the contact plate. A light spring should be provided to keep it engaged in the notches. This

At the front of the panel a knob and pointer are arranged, as shown to the left of this photograph. The different capacities may be recorded on the panel, if desired.

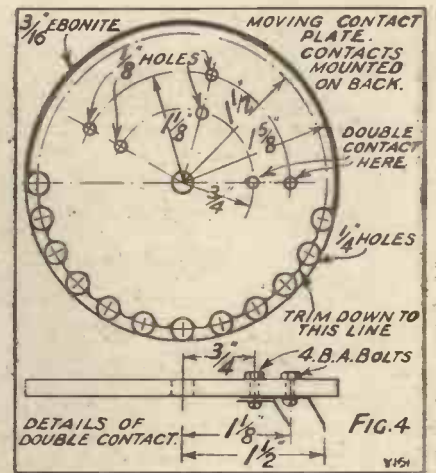
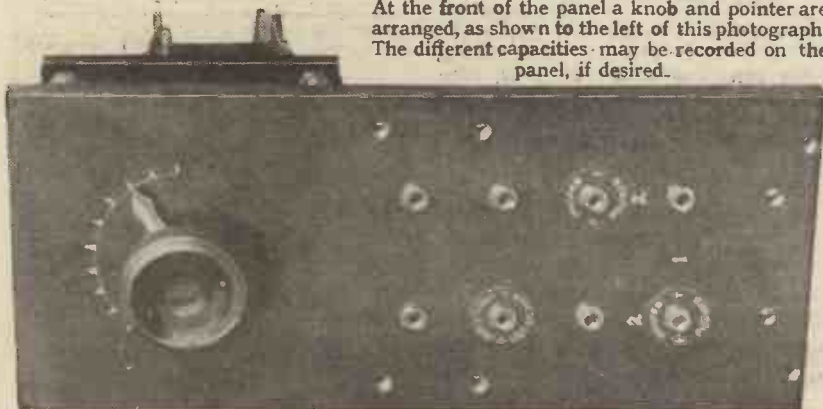

lever should be in the first notch (zero position of condenser) when the double contact is on contact No. 2, which has no connection on it.

The condensers can now be mounted, supporting them on the connections of stout copper wire—about 18 S.W.G. was used—to which they are soldered. All four condensers are connected one side to one terminal of the apparatus, and the other side to a fixed contact as shown in the wiring diagram, Fig. 2. A flexible lead should be taken from the spindle to the other terminal.

Alternative Values

All that now remains is to mark the front panel with the capacity values for each position of the pointer.

It is a simple matter to make a suitable box to dimensions given in Fig. 5.

If, instead of mounting the condensers direct, a set of clips be used,

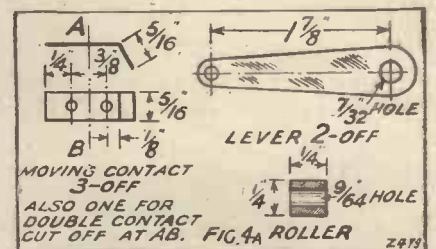

another set of condensers of values .0001, .0002, .0003 and .0005 can be substituted, and a range one-tenth of the previous one can be obtained.

Very often in constructional articles of new "hook-ups" the following phrase is used: "The best value of condenser to be used here should be found by experiment." Here is an opportunity to show the usefulness of the above apparatus outside its ordinary duties, although it is well worth making for a tone control alone.

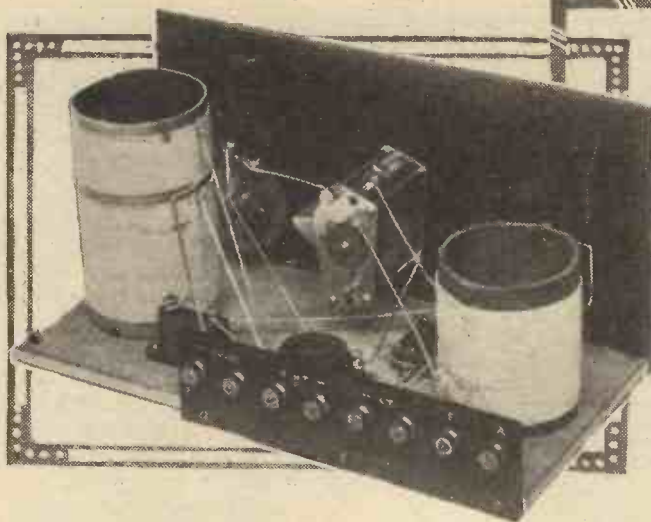

ANOTHER FILADYNE CIRCUIT

A novel L.F. addition to a conventional Filadyne detector circuit of a simple nature which Filadyne one-valver enthusiasts can very easily test.

By S. P. O'ROURKE.

THE interesting two-valve circuit which I am about to describe is one evolved while attempting to produce a Filadyne low-frequency amplifier.

It gives such remarkable results and is so simple that I can assure the numerous one-valve Filadyne enthu-

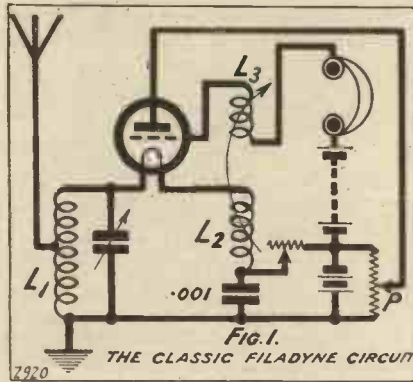

siasts that their time and money will not be wasted if they go to the slight trouble and expense of adding another valve in the manner briefly outlined below.

After all, if one can obtain greatly increased amplification with no disadvantages other than the expenditure of not more than 20s., then—why not?

A Curious Arrangement

It is perfectly well known that any ordinary amplifier, high- or low-frequency, may be added to the Filadyne detector in the usual manner; since, however, the valve used with filament input gives such a steeper characteristic curve than is usual, why not utilize the straight portion for amplification?

Accordingly, the circuit of Fig. 2 was evolved.

Certainly it looks rather doubtful on paper—L.F. impulses all over the filament battery circuit!

This, however, is unavoidable since a couple of L.F. filament chokes are obviously out of the question.

Any doubts were quickly dispelled within five minutes of testing out the hook-up, for I have never heard a two-valve deliver such "punch."

Thus it remained for a week or two, then in further experiments it was found that the circuit gave identical results with the transformer primary entirely out of circuit!

This discovery led to the final circuit of Fig. 3, which, by the way, is quite complete. It may look rather

scant and curious, but give it a trial and you will require no further introduction.

Some Interesting Deductions

Several important and interesting facts are revealed by this circuit. Firstly, and chiefly, is the fact that direct intervalve coupling is being obtained. Signals from the detector proceed from the plate direct to the filament of the amplifier; this fact can be demonstrated by placing an L.F. choke in series with the detector grid and its H.T. connection, when practically no change should result.

The advantages of direct intervalve

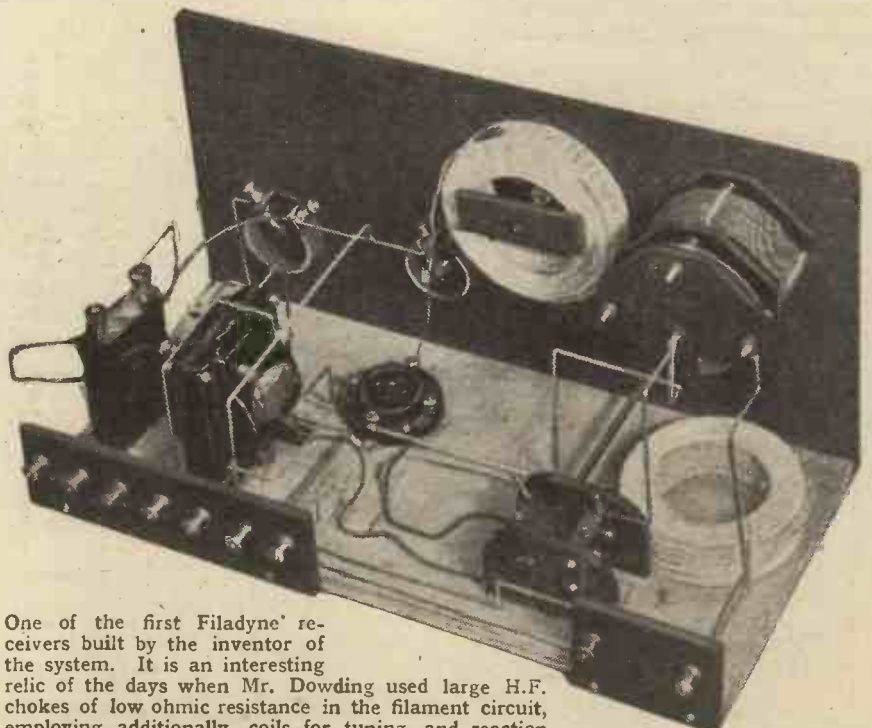

One of the first Filadyne receivers built by the inventor of the system. It is an interesting relic of the days when Mr. Dowding used large H.F. chokes of low ohmic resistance in the filament circuit, employing, additionally, coils for tuning and reaction of the ordinary plug-in type. In modern Filadynes (see Fig. 1) there are tuned chokes which operate also in combination for ordinary tuning purposes.

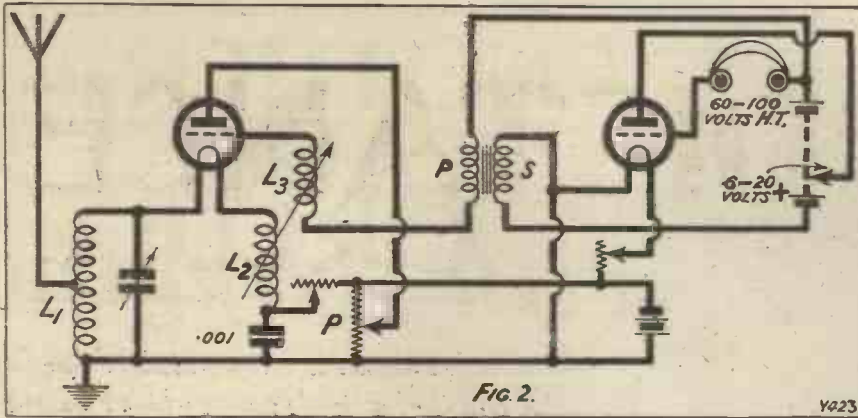

Fig. 2.

Y423

coupling need no enumeration here—they are obvious.

High Magnification

The amplification obtained by the amplifier valve is considerably more than theoretically the "mu" could provide, hence very probably there is some form of low-frequency regeneration taking place, and possibly some sort of reflex action. Whatever happens is in no way conducive to poor quality, the absence of coupling distortion being particularly noticeable.

Finally, a few practical points and details regarding Fig. 3. The first valve is simply an ordinary Filadyne detector with which most readers will be familiar. L_1 and L_2 are similar coils of 35-60 turns, not coupled, to one of which the reaction coil L_3 is permanently coupled. Reaction being controlled by the potentiometer P, of 400-1,200 ohms, shunted across the filament supply.

Component Details

The rheostat to each valve is of the usual type suitable for the valve and accumulator in use. L_4 is an L.F. choke; there is no critical value for this component and almost all reliable makes will be found quite suitable; alternatively, a converted transformer will also answer the purpose. It is usually advantageous to shunt the

choke with a condenser up to .001 mfd.; the best value can only be found by trial and is in no ways critical. In operation it is best, first of all, to get the Filadyne detector working well by itself, then the



A four-valve receiver employing a Filadyne detector circuit designed by Mr. J. English, who has carried out a great deal of research on the system, and to whom is due many notable developments. Our Technical Editor acknowledges the credit to this independent investigator for most of the latter work on the circuit which has made it famous as a serious and practical alternative to normal methods of detection.

amplifier valve may be turned full on, a tapping being taken to 6-20 volts positive on the H.T. battery; finally, the rheostat should be lowered until much greater volume is obtained, this point is very pronounced and cannot be missed.

The tapping and the rheostat should then be mutually adjusted

short broomstick, which can easily be suspended in the wireless cupboard to allow the whole stock of spare hanks of wire to be examined at a glance.

Centre-punches need sharpening occasionally with a file, or otherwise they will become blunt, and apt to wander from their correct position.

Acid from an old accumulator should not be poured down a drain, but should be disposed of by digging a hole in an unused corner of the garden, where it can be poured away without danger.

Insulators in a twin-wire aerial, if limited in number, should not be placed in the separate wires, where they are in parallel with one another, but they should be placed in the lead from the spreader to the mast, where they are in series with one another.

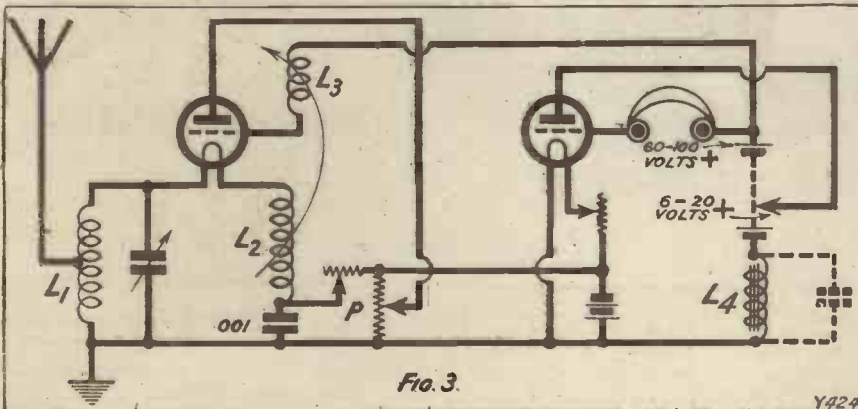

Fig. 3.

Y424

SPAN DISTANCE

with strength

From the void comes the tiny weak voice . . . Hamburg perhaps—or Rome . . . Tantalising, isn't it, that signals are not strong enough to be understood?

It is when you are trying for distant stations that you will appreciate the service Lissen transformers give you. Space-weakened signals are coaxed from minuteness to magnitude. Yet if you judged them from their purity and clarity you might imagine your foreign station in the next town.



Lissen transformers fully amplify every note, every tone, every over-tone, and every harmonic against a background of dead silence.

Test one for seven days against the most expensive transformer you can buy. If you do not definitely prefer the Lissen transformer in every respect, return it and your money will be refunded.

Turns ratio 3:1 Resistance ratio 4:1
Guaranteed 12 months.

LISSEN LIMITED, 20-24, Friars Lane,
Richmond, Surrey.

(Managing Director: Thomas N. Cole.)

LISSEN TRANSFORMER 8'6

you can use three Lissen Transformers in Cascade

RADIO ABROAD

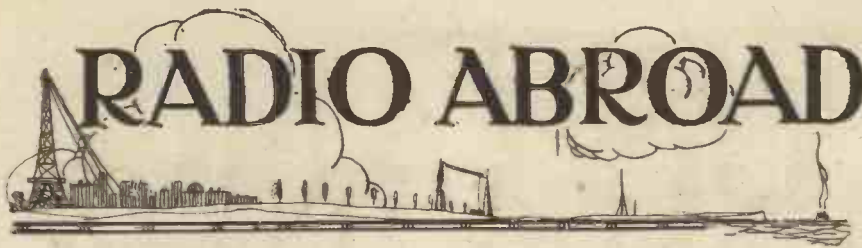

“On Approval”

A VERY useful system has been adopted in Germany by the Munich postal administration. Prospective customers are allowed to have a receiving set installed, by a responsible firm, and to use the same for a week without payment of the licence fee. This is in order to allow the prospective customer to make sure of the type of set he wants before he actually spends his money. This very kind action on the part of the authorities is, of course, with a view to encouraging business; but I should doubt whether it makes very much difference one way or the other, as I do not suppose the “pirate” is entirely unknown in Germany, and even there he is probably capable of taking “French leave.”

Broadcast in Australia

Some time ago a sub-committee of the New South Wales Cabinet was appointed to consider a proposal for the erection of a Government super-power station near Sydney, with six relay stations in different country areas. The committee, as a result of its investigations, favours the scheme, and the same is under the consideration of the Cabinet.

Japan

The Nippon Electric Company, which secured the order for three 15-kw. Geneva-rating transmitters from the Japanese Broadcasting Association, states that the Association aims at bringing the whole of Japan within the range of crystal sets. Six 15-kilowatt stations will be completed before very long at Tokyo, Hiroshima, Osaka, Sapporo, Sendai, and Kumamoto.

A Powerful Station

The Prime Minister of New Zealand, in opening 2 Y A, the Radio Broadcasting Company's new station at Wellington (which is the largest in the southern hemisphere, having 3 kilowatts of actual aerial power), stated that the station was ten times as powerful as the existing stations at

Auckland and Christchurch, and second only to Daventry in the Empire. Apart from the new station's value from the point of view of entertainment, it would communicate with all New Zealand by day or night, and it could speak easily each night to the Pacific Islands and to Australia. The Government has assisted in its establishment because New Zealand was thus assured of direct communication in the event of a national crisis.

India

The new programme of the Wireless Department in India embodies some extensive reconstruction. At Karachi

Radio Paris

The Compagnie Francaise de Radiophone, the proprietors of the Radio Paris station which is the nucleus of

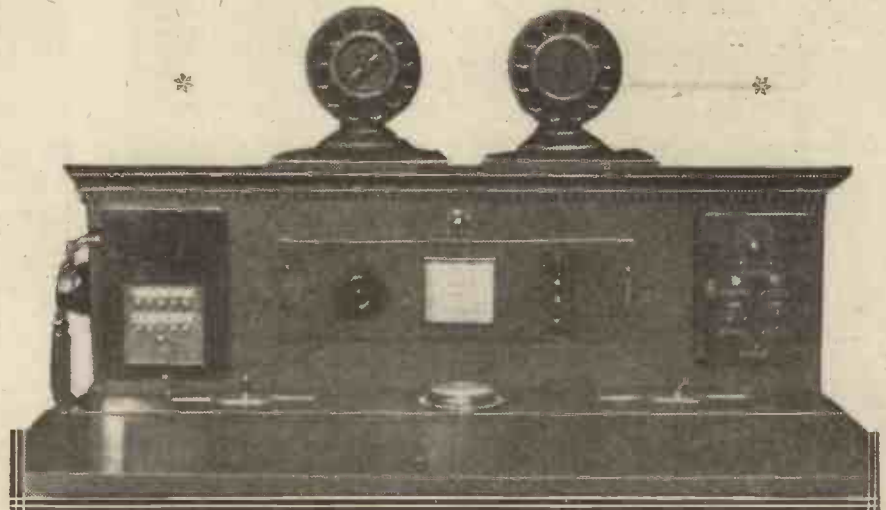

This big check receiver is used at the Prague broadcasting station to enable the station engineers to judge the quality of the transmissions.

the spark transmitter is being replaced by a 6-kw. valve set for C.W. and interrupted C.W. signalling and telephony, whilst a new receiving station will be erected at the aerodrome, including a direction-finding installation for ships and aircraft.

At Bombay the existing station at Butcher Island is being dismantled, and a new coast station erected at Santa Cruz. This latter will have a 6-kw. spark transmitter and a direction-finding receiver. Seven of the inland stations (Allahabad, Delhi, Lahore, Quetta, Peshawar, Mhow, and Nagpur) are being remodelled and equipped with C.W. transmitters.

the new “poste,” has assured listeners that no serious trouble will arise from the functioning of the new station. If any listeners prefer to receive foreign broadcast, notwithstanding the high quality of the programmes from the new station, they will easily be able to cut out the latter.

Interest in wireless in Paris was very well shown at the Wireless Salon, which lasted for sixteen days and brought considerably over 200,000 visitors. Wireless enthusiasts in France compared the number of visitors to the Paris exhibition with

(Continued on page 210.)

THREE WINNING LINES

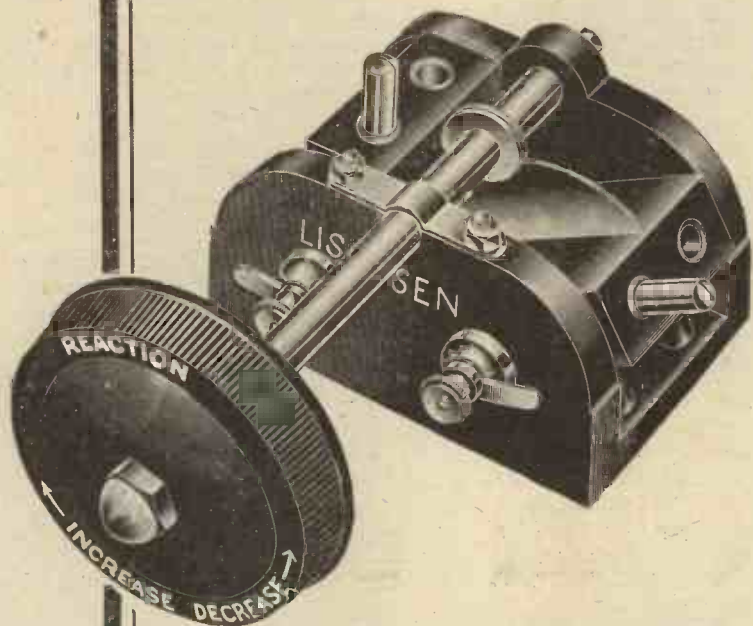

THE LISSEN COILHOLDER

Fine degree of control to permit of extremely selective tuning. Gear ratio selected as the best for all practical purposes. Big knob for comfortable finger grip and wide range of movement with one turn. No slip or backlash, coils will not move as the result of their own weight. No flexible connections to break. Moving block on the right-hand side, but may easily be changed over to left-hand side by following the simple instructions enclosed with each coil holder.

Model A. With 2 in. spindle (2 way) **4/6**

Model B. With 5 in. spindle (2 way) **5/6**

LISSEN HEADPHONES

Never before was it thought possible commercially to make headphones so light and at the same time so sensitive. These headphones are so light they may be worn throughout an evening without the wearer realising they are on the head. Cords will not twist or tangle but will always hang straight down no matter how the head may be turned, moved or twisted. The two earpieces are extremely sensitive and both are exactly matched in impedance. They settle at once into comfortable positions and may be secured there by the single movement of a special ball joint **8/6**



LISSEN RESISTANCE CAPACITY COUPLING

Provides a complete Resistance Capacity Coupling Unit. Includes two LISSEN Fixed Resistances and one LISSEN Mica Condenser. Values incorporated have been selected as the most suitable for general use, but the resistances are easily interchangeable. May be mounted upright or flat . . . **4/-**

LISSEN LIMITED
20-24, Friars Lane, Richmond,
Surrey

Managing Director: Thos. N. Cole



LISSEN LEADS IN RADIO PARTS

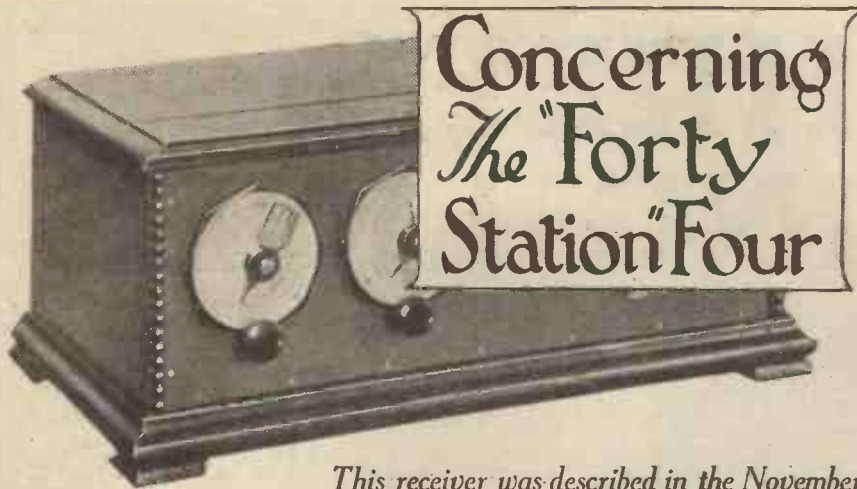

This receiver was described in the November, 1927, issue of "M. W.," and in response to many requests full details are given concerning its operation. As promised, the specifications of the long-wave coils are given.

By C. P. ALLINSON, A.M.I.R.E.

UNFORTUNATELY the further notes on the operation of the "Forty Station" Four receiver, with particular respect to the reception of the long waves, have been held up; but since the receiver does not present any marked peculiarities I do not suppose that this will have worried many constructors of this receiver.

I will first of all deal with the long-wave question and then go on to general operating notes, with a view to obtaining the very best performance from the receiver.

I would first of all like to emphasize that it is most important that the correct coils be used in this receiver. I have had several correspondents who, being in a hurry to get the receiver operating and not having the correct coils at hand, had employed other types thinking they would do. Naturally the results were disappointing, and a false impression of the set's capabilities resulted.

Perfectly Stable

When the long-wave coils for this receiver are plugged into position it should be found that the set is perfectly stable without any re-setting of the neutralising condenser. It may be found in some cases, however, owing to the aerial and earth system having some peculiar characteristic, that this condenser may need re-setting slightly, though this is extremely doubtful in view of the fact that the receiver is naturally more stable on the long wave-lengths.

It will be found on the long waves that the reaction control is not quite

so constant as on the short waves; it is extremely difficult to design a receiver for receiving both long and short waves which will have exactly the same characteristics on both wave-bands.

Stopping Parasitics

Should any instability be experienced on the long waves it may possibly be due to parasitic oscillations, which, as you know, generally give considerably more trouble when receiving long-wave transmissions than on the short wave-band. If this occurs it will be found that when the receiver oscillates the usual whistles or chirps are not heard when rotat-

ing the tuning condensers, and there is a peculiar feel about the receiver different from that obtained when it is oscillating normally.

Under these conditions all that it is necessary to do is to increase the value of the resistance R_5 , which is in the L.T. return of the high-frequency valve. Say, for instance, that it has been found that complete freedom from parasitics is obtained on the short broadcast waves with the slider a quarter the way round. Increase the value to half the way round, and if this does not give quite the desired results then increase it a little again.

Neutralising

I have constructed several experimental receivers of different types using the same high-frequency circuit as I have used in the "Forty Station" Four, and in no case have I found it necessary to use more than 300 ohms in order to obtain complete freedom from parasitic oscillation on the long-wave coils.

With regard to the neutralisation of this receiver, the best method to employ is by the use of a local modulated oscillator which is approximately calibrated. This should be connected up so as to induce a fairly average signal into the aerial and then adjusted so that its output is in the neighbourhood of 250 metres. The set is now neutralised by the familiar method of turning out the high-frequency valve and rotating the neutralising condenser until the silent point is found. In some cases it may be found that an absolute zero signal point is not obtained, but this does

(Continued on page 206.)

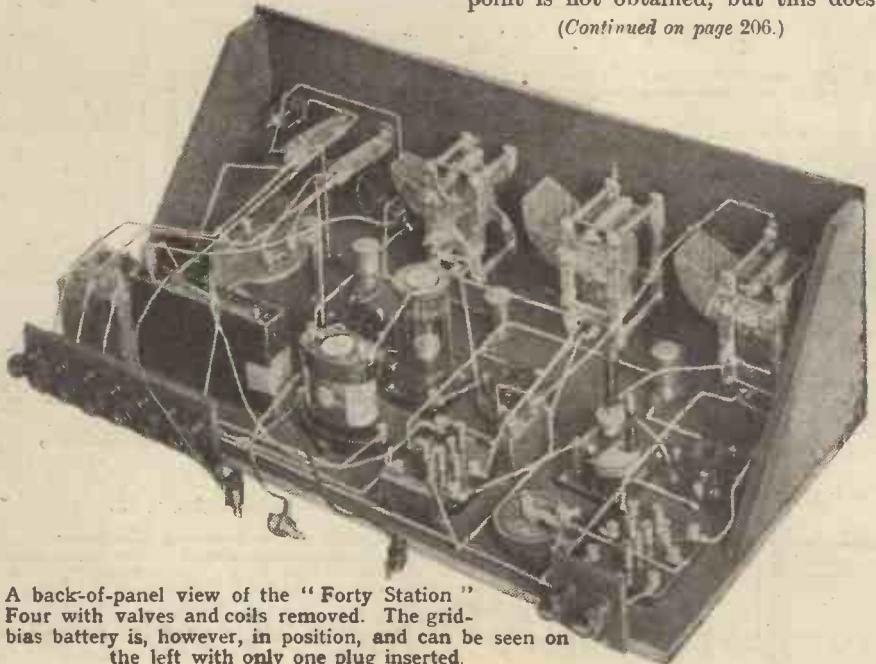

A back-of-panel view of the "Forty Station" Four with valves and coils removed. The grid-bias battery is, however, in position, and can be seen on the left with only one plug inserted.

TO ENSURE THE BEST REPRODUCTION. SPECIFY— **FERRANTI**

PUSH-PULL TRANSFORMERS



For providing large distortionless L.T. Amplification with moderate H.T. voltage.

The following types can be supplied from stock.

Audio Stage, type AF5c - - Price 32/6
 Output Stage, type OP3c - - Price 23/6
 (Ratio 1/1)

Audio Stage, type AF4c - - Price 19/-
 Output Stage, type OP6c - - Price 18/-
 (Ratio 1/1.)

Write for leaflet W4412 showing diagram of connections

OUTPUT TRANSFORMERS AND CHOKES

FOR
 LOUD SPEAKER
 FILTER
 CIRCUITS



Type OP1. Price 21/-, (Ratio 1/1.)
 Type OP2. Price 21/-, (Ratio 25/1.)



Type B1. Price 21/-

TRICKLE CHARGER

(Incorporating the Westinghouse Metal Rectifier and a Ferranti Transformer).

Will charge your L.T. Accumulator at Home from the Alternating Current Mains.

No renewals of any kind.

Simple and safe in operation, the Ferranti Trickle Charger will pay for itself over and over again. Ask your dealer to obtain one for you. Delivery from stock.

Price 55/-



FERRANTI LTD.

HOLLINWOOD

LANCASHIRE

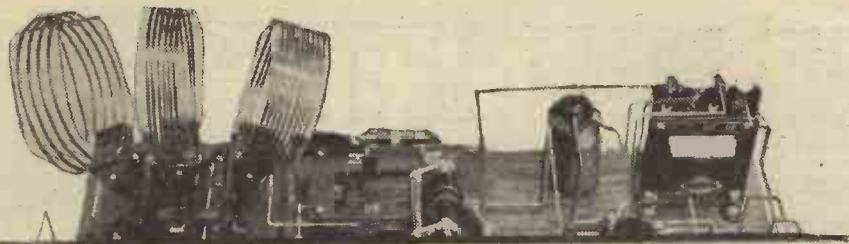

H.T. FOR SHORT-WAVE SETS

By P. R. BIRD.

Some Practical Hints.

MANY readers who have been tempted by the long-distance lure of short waves have experienced some difficulty with the high-tension supply. It frequently happens that arrangements for anode current which have proved quite satisfactory upon normal wave-lengths will not function smoothly when an attempt at reception upon the higher frequencies is made.

With an H.T. battery of the dry cell type there is very little likelihood of trouble arising, but even with this it will be found a good habit to adjust the wander plug frequently. Often a difficulty in making the set oscillate will disappear when the high-tension voltage has been properly readjusted.

Overcoming Humming

Apart from the foregoing there is generally little to be feared from H.T. trouble when using an H.T. dry battery and changing over to the short waves. But when an H.T. battery eliminator is used it is often found that a small hum which was not noticeable on ordinary reception will completely spoil the results on very short waves.

It is generally the H.T. supply to the detector valve which gives the trouble, and as such a valve takes only a little current it is very often possible to cure the trouble by the use of a small L.F. choke.

This should be inserted in series with the positive lead from the H.T. battery eliminator to the detector valve. Extra smoothing is obtained if a good quality fixed condenser of large or fairly large capacity is con-

nected between the earth or the filament-wiring and the respective H.T. positive terminal on the set.

In most cases it is not necessary to use an elaborate L.F. choke for final smoothing of the detector's H.T. supply. The current is generally of the order of only a few milliamps, so that the secondary winding of an L.F. transformer with "burnt-out" primary, or similar iron-core induc-

main eliminator, across the output of the rectifier section to the smoothing system.

This latter system generally consists of two L.F. chokes (one in the negative lead, and one in the positive), though in small eliminators one of the chokes is sometimes omitted. Large condensers, connected from the end of the choke to the opposite "main," complete the smoothing circuit.

To add a "centre-point" earth to such a system it is necessary to employ two fixed condensers across its input instead of one (see Fig. 1). This can be done by removing the condenser which is shown dotted, and replacing it by two condensers in series. The extra earth connection can then be taken from the junction of these two condensers.

As the placing of the condensers in series will reduce the effective capacity across the input to the smoothing system these two condensers should be as large as possible. For instance, if the condenser at the input of the

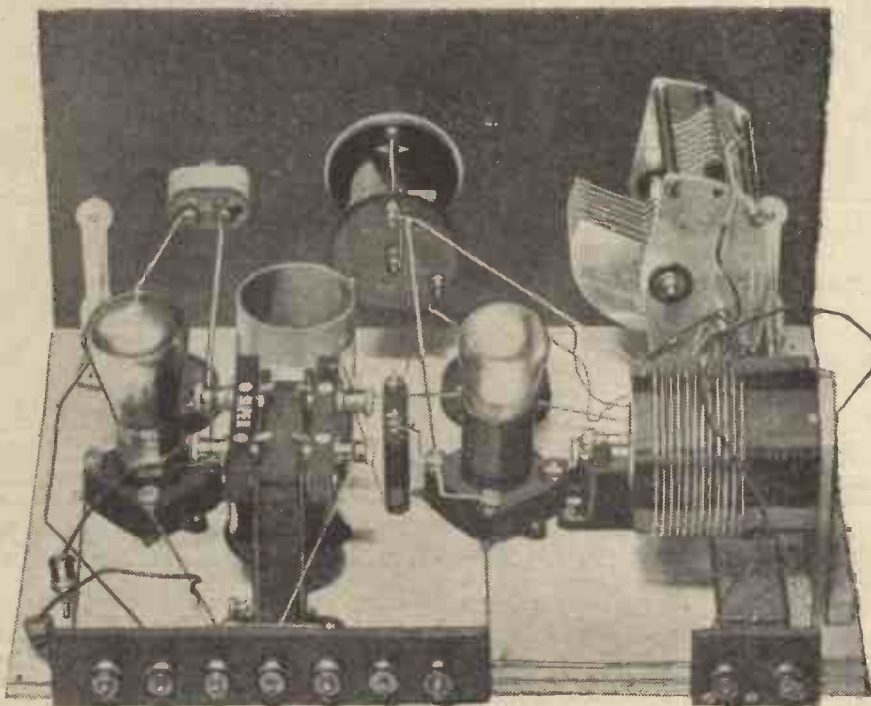

A back-of-panel view of "The Sydney Two"—a famous short-wave set that was specially designed to pick up the Sydney (New South Wales) programmes.

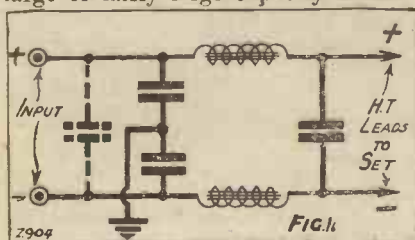

tance, will give sufficient smoothing in most instances.

Another good system which will often eliminate the last trace of hum in an eliminator is an extra earth connection to the smoothing system (see Fig. 1). An examination of the eliminator will generally show that a condenser of two or three microfarads has been shunted across its input, or, in the case of an A.C.

smoothing system was previously 1 mfd., it would be necessary to join two 2-mfd. condensers in series in order to get the same effective capacity. But very often it will be found that two condensers with their centre-point earthed will give better smoothing effects than the one condenser, even though the latter was of far larger capacity than is obtainable with two when joined in series.



My Broadcasting Diary

Under this heading month by month our Broadcasting Correspondent will record the news of the progress of the British Broadcasting Corporation, and will comment on the policies in force at B.B.C. headquarters.

An Empire Broadcasting Mystery

I WAS one of the earliest to recognise the supposed change of heart at Savoy Hill about Empire short-wave work. I carefully avoided any recriminations, and heartily applauded the B.B.C. on its new efforts. The Chelmsford "short-waver" has been on the air since October, and during the past two months has relayed London from 7 to close of programme five days a week. So far so good. But the fly in the ointment is the curious churlishness which has characterised the attitude of the B.B.C. towards the Dominion broadcasters; an attitude in startling contrast to their cordiality towards Americans.

At Christmas, for instance; there was a request from Australia for an exchange of programmes with the B.B.C. After much bickering, all the B.B.C. would do was a routine military band concert put on at the wrong time, and unaccompanied by any greeting or message to the eager listeners "down-under." Such an extraordinary omission of the customary courtesies caused widespread indignation throughout the Antipodes.

The "Perfection" Bogey

Then came the New Year with a chance to make amends. All the B.B.C. would do then was to put out the ordinary New Year's programme on 5 SW—merely relaying. Still not a sign of a cheery word for Britishers beyond the Seas. Officially, Savoy Hill justifies this amazing attitude by reviving the old "perfection" bogey. They will not undertake anything special for the Dominions because they cannot guarantee its perfect reception under present conditions! On such insecure ground they are ready to incur the odium of all the outer Empire. But there is another and more alarming side to the matter. I have heard privately, but on the best authority, that there are new influences at work at Savoy Hill definitely anti-British in spirit.

They disguise their designs on the pretence of carrying through the policy of the International Union at Geneva. From their angle almost any message of greeting from Britishers to Britishers is objectionable, because the Russians, the Turks, or the Bulgars might not like it! No one wants the ether used for inflaming international animosities, but this is a serious issue, and one which should claim the early attention of Lord Clarendon and his colleagues.

Programme Progress

The past two months have witnessed a more general and far-reaching improvement in programmes than has been recorded at any other similar period of British broad-

casting. Not only have "peaks" been restored, but the average has been lifted. Contrast between 5 GB and 5 XX is much more effective than formerly. There is a new spirit of professional "grip" in most of the programme work.

Things now are probably as well done as possible with an archaic system of distribution. Listeners are asking anxiously about the Regional Scheme. The Post Office is ominously quiet, but there is still a good chance of the London part of the new plan being in operation by the end of 1928.

To Controvert or Not?

Much doubt and perplexity have been caused by Lord Wolmer's cryptic answer to a question in the House of



This loud-speaker of "nightmare" dimensions and the switchboard are part of the Prague station's equipment. Note the multiplicity of plugs and leads at the switchboard, where the Prague programmes are linked up for S.B. (simultaneous broadcast) with Bratislava and other stations.

Commons about the admittance of controversy into programmes. It was suggested in this parliamentary exchange that the censorship provisions against political, industrial, or religious controversy, even in the so-called probationary period for the Corporation, were intended to apply only to talks and lectures.

“Ratting”

The inference is clear that the B.B.C. need apply only the tests of art to the entertainment parts of its programmes. Thus there was no valid objection to Captain Berkeley's play because it was not a talk or a lecture. The B.B.C. declares that the Post Office people have always intended these prohibitions of controversy to apply to the whole programme. But the Post Office will not support this view. It is either letting the B.B.C. down very badly, or the B.B.C. has completely failed to realise the extent of its freedom under the new conditions. I should think that the truth is between these two.

The Post Office is “ratting” under the pressure of public and Parliamentary opinion: the B.B.C. has been moving too cautiously. Anyway, whatever lay behind the Lord Wolmer incident, the listener should gain from an early enrichment of the programmes. I should imagine that Savoy Hill is really delighted: it should not

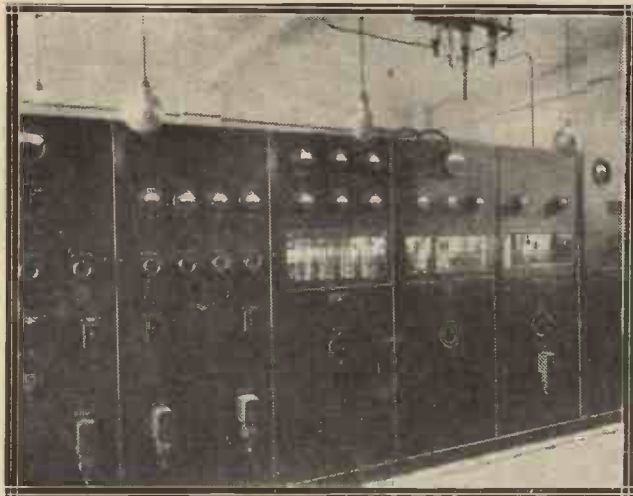

Behind these neat panels is the five-kilowatt Weston Electric transmitter of the broadcasting station at Prague, which works on a wave-length of 348.9 metres.

mind being let down in this way. It is now up to the bolder spirits among our broadcasters to take the initiative and press home the advantage gained—whether accidentally or on purpose.

Another Concert War

Before leaving for America with Sir Thomas Beecham, Mr. Lionel Powell let it be known that he now enter-

tained no hopes whatever of any kind of working arrangement between his interests and the B.B.C. He added the surprising intelligence that for the past nine months he had been in close touch with the B.B.C. and had exhausted every possible expedient to secure an agreement. But he had now given it up as a bad job.

From Mr. Powell's point of view the B.B.C. has no vision and no “instinct of generosity.” The B.B.C. disclaims all knowledge of the alleged negotiations, and offers no comment in reply to the criticism made by Mr. Powell. It is realised, however, in broadcasting and business circles that the B.B.C. is well-advised in waiting. Time is on its side, and its enemies are weakening year by year.

It should never get drawn into any arrangement which might be interpreted as having the effect of using listeners' money to subsidise commercial undertakings outside broadcasting without adequate return. It is not known yet what steps the concert industry will take in starting their next big attack on broadcasting.

The Local News Fiasco

The B.B.C. has not done anything about the local news troubles which have broken out in nearly every town (except London) where there is a station. The position is most acute in Belfast, Glasgow, and Newcastle, where local listeners are disgruntled about the absence of any account of local happenings. But I fear that this agitation will not succeed.

With something on its side in the argument, the B.B.C. is leaving local news alone until more is known of the changes that will be involved by the regional scheme of distribution. Under these circumstances it would be as well if the B.B.C. knocked out local news entirely and made no pretence at covering it. The occasional paragraphs that are now included only irritate listeners.

The Position at Belfast

Belfast has always provided the B.B.C. with strange and difficult situations; but the present is perhaps the “record.” All fair-minded listeners to Belfast station are agreed that Mr. Beadle and his staff have made remarkable improvements, and that, taken all in all, the programmes are exceptionally good and well-balanced. So hostile criticism is not directed at programme deficiencies.

It is concentrated on the composition of the station advisory committee. This appears to be called “The Sales Manager's Advisory Committee,” a title obviously inappropriate under the Corporation. The Wireless League has discovered the anomaly, and has tried to get the present sectional committee substituted by a representative listeners' committee, including the traders, but not dominated by them. However, B.B.C. headquarters is not ready to talk about the matter yet.

ANOTHER 1/- BLUEPRINT FREE NEXT MONTH!

WITH the March issue of “Modern Wireless” another magnificent blueprint will be presented free to readers. This will accompany the description of a three-valve SHORT-WAVE RECEIVER designed on entirely novel and highly efficient lines by Mr. C. P. Allinson, A.M.I.R.E. It is one of the easiest short-wavers to handle yet produced, but is not a difficult set to build. It is capable of loud-speaker reception of the most distant stations, and is a receiver which is sure to attain considerable popularity.

ORDER YOUR COPY OF THE MARCH “MODERN WIRELESS” NOW.

**almost
alive!**



If, to-night, at a friend's house, you were to hear the **BROWN Mascot Loud Speaker** without knowing you were listening to a loud speaker, you would be almost sure to ask who was his singing friend. Then when he replied that it was a loud speaker you heard, you would laugh and offer him the other leg. At that his eyes would sparkle, as he disillusioned you, and you would be quite astonished that a mere instrument could be so human. After that you would want a **BROWN Mascot Loud Speaker** for yourself, and when you had bought one you would say that in all the world there was no better place than your own fireside, in your old chair, with this almost-living loud speaker to thrill the evening hours.

The Wireless shop round the corner has the **BROWN Mascot Loud Speaker** Only 90/- is its price.

BROWN
LOUD SPEAKERS

S. G. BROWN, LTD.,
Western Avenue, North Acton,
London, W. 3.

CA 1430

**BEFORE YOU CONSTRUCT THE
1928 SOLODYNE**
WRITE FOR PARTICULARS OF THE NEW

CYLDON

**SHIELDED
TRIPLE GANG CONDENSER**

which has been specially designed for this Circuit, and on test in the actual Receiver has given unparalleled results.

By the time this advertisement appears, full particulars of this magnificent condenser will be ready for distribution in pamphlet form, complete with photographs, dimensions, etc.

The whole of this new component is one complete unit—there is no extra drum to buy. It includes complete three condenser assembly on aluminium chassis with control drums, four copper shields drilled where necessary. **PRICE £4.10.0**
Two screws only to fix.

We definitely claim the following advantages:
**SIMPLER AND MORE EFFICIENT
TUNING—EASIER ADJUSTMENT
—NO EXTRA DRUM CONTROL TO
BUY—GREATER SELECTIVITY**

*Fill in the Coupon Below NOW
for full particulars!*

**THE CYLDON BÉBÉ
REACTION CONDENSER**



This condenser was used and specified by the designer of the original 1928 Solodyne.

We can give **IMMEDIATE DELIVERIES** of the capacity required, viz. :—

***0001 PRICE 7/6**

Other capacities available :—

List No. **BB1** 0001 7/6
" " **BB15** 00015 8/-
" " **BB25** 00025 9/6
" " **BB3** 0003 11/-

SYDNEY S. BIRD & SONS, LTD.,
Cyldon Works,
SARNESFIELD RD., ENFIELD TOWN.

'Phone: Enfield 2071-2.

'Grams: "Capacity, Enfield."

Please send me particulars of the new **CYLDON** Shielded Triple Gang and Bébé Condensers for the 1928 Solodyne.

NAME.....
ADDRESS.....



BEAM RADIO

A brief account of recent developments.

THE South American beam services are entirely new services, and place Brazil and the Argentine in direct wireless communication with London for the first time. Having regard to the enormous amount of business conducted between London and South America the opening of this direct high-speed beam service is of the greatest importance to business organisations in all the countries concerned.

The beam service operates both to and from Rio de Janeiro, but at present Buenos Aires has no beam aerials, so that while messages are sent from London by beam to Buenos Aires, there is no beam in the reverse direction. It is expected, however, that this service will be made into a complete two-way beam service in the near future.

Operated From London

A good deal has been said recently with regard to the astonishing success of the beam services, which, on the authority of the Australian Prime Minister, are said to have attracted 45 per cent of the Pacific Cable Co.'s traffic from Australia alone, apart from the amount it has attracted from other

transmitting stations for the North and South American services are situated at Dorchester, and the receiving station at Somerton, about 30 miles from Dorchester. By means of a simple relay at the transmitting station the signals sent from London over the connecting land-line operate the wireless transmitter from which the signals are finally despatched through space to the distant receiving stations.

Great Speed Possible

Similarly, the signals received on the beam receiving aerials at Somerton are instantaneously conveyed by land-line to Radio House, where they are recorded on paper tape in the form of Morse signals, and then typed on to a telegraph form for delivery. These services are normally worked at between 100 and 200 words a minute, although much greater speeds are attainable and over 300 words a minute have been worked quite satisfactorily during tests. Over the wireless circuits alone—when signals have not to be relayed over land-lines—almost unlimited speeds are attainable. The only limit appears to be that introduced by the recording apparatus that is used.

cable routes. The immense strides that have been made and the large and increasing volume of traffic that is being carried by the beam will be realised from the fact that, during the week ending December 3rd, the total number of words carried over the four Empire circuits was at the rate of considerably more than 30,000,000 words a year.

These services are operated from Radio House by remote control, which means that the wireless transmitters are controlled from the signalling keys in London. The beam trans-

It is possible by electrical and engineering adjustments to vary the width of the wireless beam, and the beam transmitting aerials that have been built by the Marconi Company at Rio de Janeiro for communication with Europe have been so constructed that London, Paris, and Berlin are brought within the span of the beam when it reaches Europe. In this way the Rio stations can handle traffic for all these three capitals.

Beam receiving aerials are now being built near Paris for receiving from America, but none are yet in existence in Germany. It is not possible at present, therefore, to work with these capitals at as high a speed as can be worked with England, where the beam receiving aerials are in use.

New Stations

Beam stations are also being constructed at Dorchester for communication with Egypt, in Egypt for communication with England, and at Dorchester for communication with Japan and the Far East.

The Dorchester and Somerton stations are thus centres from which numerous services will be conducted. When the final arrangements are completed there will be seven Marconi beam services operated from these centres: one to Egypt, two to the United States of America, two to South America, and two to Japan and the Far East.

At Dorchester there is a row of five masts, so arranged that the great circle bearing on the North American and Egyptian stations is at right angles to the line of masts. Three bays on one side of the line of masts are used for transmission to North America and two bays on the other side will be used for working to Egypt, the Egyptian transmitter being arranged for working on two alternative wave-lengths.

Japanese Service

The two active aerials for the Egyptian service and two of the active aerials for the North American service are built with a reflector common to both and placed between them. There are two other masts, which are erected in a line at right-angles to the great circle to South America, and these carry the aerials and reflectors for the transmission of signals to Rio de Janeiro and the Argentine. Two more masts are in the course of erection, and will be used to suspend the aerials and reflectors for transmission to Japan.



I ALWAYS cherished a hankering to be a missionary. The idea I had formed out of the numerous lectures which dotted my boyhood was that you went at somebody else's expense to a glorious coral strand, populated by interesting heathen, with dinner-plates and tomato-cans in their woolly hair, and festooned with coconuts and monkeys; and then you shot lions, tigers and elephants. When I saw a stuffed lion for the first time I cooled off lions; when I saw a live lion I thought it was cruel to shoot lions, but when



... arbitrate in quarrels about brass pots ...

I heard one roar I cut the lion stuff clean out and substituted gazelle.

When I found that a missionary had to know Greek and perhaps fifteen dialects of Kaffir, milk cows, teach black babies the A B C, put drops into the sore eyes of spear-wielding warriors, and even cut off their arms and legs, grow corn, chase bad tribesmen, arbitrate in quarrels about brass pots, rebuke skinny black kids for leaving all their clothes behind in the mud hut, take quinine and grow bushy whiskers—well, I realised I had no heart in the matter. I applied for a job as a designer of solenoids to a firm of corkscrew manufacturers.

Complete Ignorance

Thereafter, although I certainly did attempt a little proselytising with reference to the Oxford and Cambridge boat-race, the idea of being a missionary did not occur to me till the day Grimes and I heard a man in a train say he did not know anything about radio, and did not wish to know.

Grimes looked at me over the top

of his paper, and I answered by turning an agonised look to the ceiling of the carriage. When the heathen had departed Grimes dashed his paper to the floor.

"Did you hear that?" he asked. "*He knows nothing about radio.*"

"Shocking!" I replied. "And how ghastly pleased with himself he seemed, too."

Very Sad Case

"It's very sad," replied Grimes, shaking his head slowly, "to think that in these days of 5 S W and 2 F C a bloke living in crystal range of London is in utter darkness. Can nothing be done? No doubt he has a lot of little brothers and sisters whom he will keep from the light. I daresay he has a wife. Oh, woe! Yoked to a man who never yet felt the caress of a pair of ear-phones or heard Daventry and said it was Sydney. I repeat, *can nothing be done?* Confound it! Jones, I've slapped my pocket too hard and I'll bet I've messed up that milliammeter."

We Commence Operations

Here was a genuine call to the field of missionary work at last. If one heathen, why should there not be thousands? And not a mish amongst them, sowing the jolly old golden grain or shoving the blighters' hands to the plough.

I became almost inspired as I walked home from the station, and old Mrs. Jeeble, who heard me muttering, dropped her umbrella, hanky, gloves, purse, doorkey, bag of peppermint drops, etc. and stood gaping so goldfishly that the local constable mistook her for a case of "fit," produced a grimy "first-aid" handbook and tried to treat her for drowning.

As Grimes and I thought further about the matter we realised that our missionary field lay at our very door. Was there not Figson, the Mincing Lane magnate who lived in the Manor House and was suspected of potting at all the aerial insulators in range of his air-gun? And Miss

Turquoise, at "Mon Repos," who sued Stalker for using her chestnut tree as an aerial support—a particularly anti-social act! And the Rev. J. Bonedrop, who took a cat's-whisker from a choirboy and threw it in the font.

Why, here in our midst were subjects ripe for our gospel, brands ready to be plucked from the burning. We thought we would begin to stop the rot in our own barns before bothering about a national crusade. So we formed the Radio Regeneration Trust, Ltd., with a paid-up capital of eight-pence, which was Grimes' fares to and from his brother's, who is a printer, and did the Articles of Association gratis.

A Question of Funds

I did not like this amalgamation of a high, noble object with the base symbols and ceremonials of the Capitalist System, but Grimes said it would give the show a solid foundation and would certainly appeal more to Figson and his like. Besides, as he pointed out, we could get Professor Muk on the Board, and that alone would secure us a hearing, he being the local celebrity, much sought after for *soirées* and lantern-lectures.

The question of funds was tackled



... mistook her for a case of "fit" ...

by Grimes in that inimitable manner of his which has whirled him from a position as Acting Sub-Inspector of Fire Hydrants to that of President of the Postponed Irish Stew Syndicate.

After explaining the project to seven dealers in radio apparatus, four accumulator-charging stations, four ironmongers who sold valves, a

fishmongeriser who put up poles while the haddocks were a'smoking, an undertaker's mute who rigged aeralis, and a tobacconist who stocked radio journals, he came away with guarantees of support to the tune of £4 17s. 3½d. a month, the 3½d. being the tail-end of 4s. 3½d. promised by the undertaker's mute, who had worked his whack out by a formula he had found in a cemetery, scribbled on the back of a moneylender's obituary card.

We selected as our first convert the Rev. J. Bonedrop, feeling that if we could pull the wool over the eyes of a man who crabbed radio on the highest ethical grounds the others would be easy meat.

Mr. Bonedrop was at his fretwork, making a beautiful letter-rack for his Christmas Bazaar in aid of Distressed Dentists. As we entered he rose, dusted his trousers and boomed:

"Ah, you have caught me in the midst of my lay-bahs, gentlemen!

Relaxation

Not always writing sermons or begging, you know! We clergy must relax on occasion. Yes, but even so, we try to use the Golden Hours to some purpose. Yes, a little trifle for the Bazz-zah. Here is a cheese-stand. There a potato-rack. And, again, a marrow-squeezer. All useful; all the fruit of my lee-sure. But pray be seated."

We sat. Grimes cocked his eye at the cheese-stand, while I took a closer view of the marrow-squeezer. We both confessed afterwards that a sort of hopeless feeling began to permeate us as we gazed at those *objets d'art*. We did not feel at home; we did not think we understood people who stood cheeses about and squeezed marrows

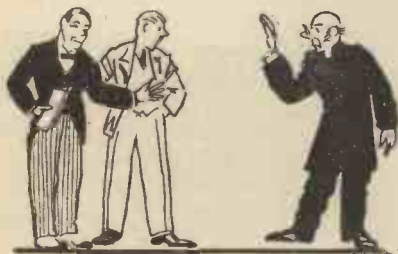

"It's like this, vicar," began Grimes, in a voice quite unlike that which had awed the maiden on the mat. "Mr. Jones and I have called to try and include you amongst a number of the most influential people round about here—Professor Muk, for one, is heart and soul with us—who are anxious to scare up—er—arouse in-

terest in music, science, education—er—and so forth."

"I am sure——" began Mr. Bonedrop; but I cut him short, as I said:

"And we, as representative men of the district—I am sure I may say that—feel that this can be implemented most effectively by the more widely spread use of the—ah—marvellous device which through the genius of Marconi——"

A Severe Setback

By gum! We thought he had got a sudden twinge of gout, he jumped so sharply.

"Gentlemen," he boomed, "I fear that I waste your time and mine. Any *respectable* amusement, yes! But this broadcasting—no! In fact—*Nu!* What is it? A sort of electrical phonograph affair, with the—really—the most terrible records. Vulgar! I hold strong views—I—ah—*never!* In point of fact—*Nu!*"

Grimes calmly produced a slip of paper. He rose to the emergency like a Napoleon.

"I have here, my dear vicar, a list of the people in this neighbourhood who use receivers. The Hon. Mrs. Gallumpzy, Sir Bloodsome Bleu, Dr. De Still, Professor Muk, Mr. Cure-smith, the solicitor, Mr. P. Pileworth, translator of the Rubaiyat of Hassan Yussuf, Miss Licker-pffrank, daughter of the Archdeacon of the same monicker—and many others."

"Ah—but *music-hall* pieces, godless dances!"

"I have here," went on Grimes, "a list of the talks delivered during the past month; the Good Causes, the services, the epilogues, the chunks of poetry, the church-bell ringings, etcetera. Cast your eye over them and see what you missed. Look at that! Good Cause of last Sunday—appeal on behalf of Vergers with Varicose Veins—almost the same as your Rheumatic Sexton racket."

I fear that Grimes' diction became rather colloquial as he warmed up.

We Persuade the Vicar

Mr. Bonedrop took the lists, wagged his pince-nez on to the tip of his nose—goodness knows how he kept 'em there—and began to read. He thawed almost at once. When he came to "Talk on Fretwork" he went up to 80 degrees in the shade.

"Mm! Ve-ry *interesting!* And do you assure me, Mr. Grimes, that there is no danger, moral or physical, in these machines—and no needles or records? Ree-markable! And Bishop Twentystone is to speak next month, eh? Well, *well, indeed.* Er—could

one have a demonstration—a fore-taste, as it were, so to speak, of one of these—what you said?"

Grimes got up.

"Whenever it is convenient to you, vicar. To-morrow? Good!"

We unloaded a £12 set on him. The undertaker's mute rigged up his aerial very solemnly, best black insulators and all, and the neighbourhood



He wanted nothing but rum. . . .

agreed generally that broadcasting put some zip into Mr. Bonedrop's ministrations.

Next we tackled Sir Humphrey Hoodle, but found that (a) he was stone-deaf; (b) he was impecunious, and (c) that he was completely under the thumb, right and left feet, and influence of Lady Hoodle, who was a FitzBattleaxe of the bluest blood, as Grimes put it.

An introduction from the vicar's wife got us past the bulldog at Figson's and into Figson's study. He appeared to study the "Drysalters' Gazette" and port wine mostly, but we succeeded in giving him a demonstration.

A Hard World

Unfortunately for us, however, the B.B.C. was off colour on that occasion and produced a talk on "Snails," a melancholy trio of woodwind tooters, and a poetry-reading by a soulful lady who had a devastating sniff. No takers! We killed a bottle of port between us and finished up with talk on dry-goods and complaints of the liver.

We tried the game on Admiral Bollard-Ratline. But there was nothing doing. He wanted nothing but rum and the "Army and Navy Gazette"—unless you except talk about how he bombarded Abu-al-Zabal in '69. When we showed him our demonstration set he bristled and said he did not ask for anything better than the old "Euryalus," 60-gun brig, a wet sheet, and the binnacle hard over—or some such rot.

I still think we did some good. The vicar is a shocking radio fan and gets Miami as easily as falling off a lectern. But the way of a missionary in his own country is deuced hard.

A Good Home for the 1928 "Solodyne"

Build this most modern set, build it of the finest components as it deserves to be built, and house it in a cabinet really worthy of its excellence.

The V.C. Bond Cabinet built specially to accommodate the 1928 "Solodyne" is a masterpiece of the cabinet maker's craft. It combines modern efficiency and ease of access with the craftsmanship which is the result of years of experience.

Neither of the above illustrations can do justice to the beauty of the workmanship. They serve respectively to show the actual compartment for the set and the generously proportioned battery cabinet, the neatness and accessibility of the terminals and battery leads.

Every V.C. Bond Cabinet is built individually and is a piece of craftsmanship worthy of the finest set.



PEDESTAL COMPLETE AS ILLUSTRATED.

In Oak, Polished **£5 10 0** each
 In Mahogany, Polished **£6 10 0** each
 Baseboards Free, Panels Extra.

Cabinet only :
 In Oak, Polished, **57/6.** In Mahogany, Polished, **67/6.**

Stand only :
 In Oak, Polished, **57/6.** In Mahogany, Polished, **67/6.**

Carriage Paid in England and Wales. Cabinets of all sizes and designs in stock or built to special requirements.

EVERY CABINET GUARANTEED SATISFACTORY.

Full particulars and price list from ACTUAL MANUFACTURERS

V. C. BOND & SONS, 61, THE GROVE, MARE ST., HACKNEY, LONDON, E.8. Est. 1899.
 'Phone : Clissold 0883. 'Grams : "VeeCeeBee," Hack, London.

WIRELESS CONSTRUCTOR ENVELOPES

No. 1. "The Radiano Three" Now on Sale Price 1/6 net.

Here is the first of a new series of Constructor Envelopes which thousands of amateurs have been in need of for many a long day. No. 1 is now on Sale—an envelope containing full instructions for building the famous P. W. Harris receiver

"THE RADIANO THREE"

In this envelope you will find every detail of the set simply explained; photographic reproductions and diagrams are included, as well as a

FULL-SIZE BLUE PRINT

"The Radiano Three" is a set you can build in an hour or two—no soldering necessary, and a wide choice of components and valves open to you.

Stop at the bookstall or newsagents and buy the first of the Wireless Constructor Envelopes, and remember—it is a Percy W. Harris Set.

Details of future Envelopes will be announced later

In Our Test Room



An Interesting Receiver

WE have recently had the opportunity of testing one of the new Ediswan "One-Der" single-valve loud-speaker receivers. This little set employs an E.S.220 valve, a special device in that it differs from the three-electrode type both in construction and its method of operation. It employs two anodes and two grids and one filament. This latter takes .2 amp. at 2 volts.



This is the Ediswan "One-Der" receiver and . . .

But it must be made clear that it is not of the "Loewe" variety, the afore-mentioned elements being all that is enclosed within the bulb. Each grid and plate is separated by the filament, the grids affecting the electron flow between the filament and the plates by what is known as the "robbing" effect. Crudely expressed, this means that the grid, under operating conditions, tends to diminish by attraction the number of electrons which reach the anodes from the one filament.

The circuit employed in the One-Der receiver corresponds to a detector stage and a stage of low-frequency amplification. Although regeneration is employed, a distinct advantage is that the set cannot re-radiate and cause interference; while another point strongly in its favour is that it is extremely economical to run, the

total H.T. consumption being of the order of 1 milliamp.

Two voltages of H.T. are necessary, one of about 100 volts and the other of 120. The two grid biases are $1\frac{1}{2}$ to 3 volts negative and $4\frac{1}{2}$ to 6 volts negative respectively. The set is contained in a neat wooden case, and on the front are the tuning and reaction controls and on-off switch.

The aerial and earth terminals and the loud-speaker terminals are at the side. A multiple battery cable is taken off from the back, and the battery connections are facilitated by the provision of suitable terminals on the ends of the distinctly coloured cords.

On test the set gave surprisingly good results. London, eight miles distant, came through on a medium-sized loud speaker with a volume approximately equivalent to that obtainable with a one-valve and crystal reflex set, but with a quality of reproduction seldom approachable by such an arrangement. 5 G B was not quite so loud, but was comfortably audible throughout a fair-size room. The One-Der is very selective, but the tuning is not over-critical. The price of the One-Der single-valve receiver, complete with valve, one set of coils, and H.T. and L.T. battery leads, is £9 10s., including all



. . . here is shown how the front panel can be pulled forwards and downwards to reveal the interior of the set.

royalties. The special One-Der valve can be obtained at 22s. 6d.

An Amplion Cone Loud Speaker

Variety, it is said, is the spice of life, and nowhere does this more strongly apply than to radio, the products of which, we fear, tend very frequently to develop along unin-



The Amplion "hanging-type" junior cone loud speaker.

teresting grooves of over-standardisation. Thus for years the loud speaker was a depressing trumpet. Not that any individual horn-type loud speaker deserves the term depressing, but no one can dispute the fact that ubiquitous sameness does eventually cast a gloom.

However, nowadays loud speakers assume all sorts of patterns. One novel departure is the Amplion hanging type junior cone speaker. This is an artistic production designed to hang on the wall from a picture hook or other such support. A photograph of the sample submitted to us for test appears on this page and it will be seen that it forms a sort of plaque and is suspended by cords of a heavy silk material.

H.T. FROM YOUR MAINS

FOR YOUR **COSSOR**
"MELODY MAKER"

If you have electric light you are wasting money every time you buy H.T. batteries. Start saving money—build an H.T. Eliminator and get current from your mains. Send the coupon for a book which shows you how to do it. "How to build your own H.T. Eliminator for A.C. or D.C." is written by an authority for the makers of T.C.C. Condensers. If you follow its concise instructions, clear photographs and simple diagrams you will have no difficulty in building an Eliminator which will give you constant H.T. from your electric light mains—for negligible cost. And, if you use T.C.C. 600 volt Condensers, you will build an Eliminator that is *utterly safe and reliable*. Send the coupon to-day. It will cost you nothing.

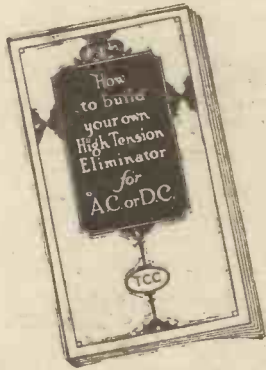

BE SURE TO USE

T.C.C. CONDENSERS

Telegraph Condenser Co., Ltd.,
Wales Farm Rd., N. Acton,
London, W.3.

I enclose 1d. stamp. Please send me your book, "How to build your own H.T. Eliminator for A.C. or D.C." M.W. Feb.

Name _____
Address _____

free!

CA 1510

REDUCED PRICES MAKE THIS VALUE UNPARALLELED

NEW REDUCED PRICES

•0003

7/6

•0005 **7/6**

(WITH 3" DIAL)
With "Two Speed" dial and Station Recorder.
•0003 ... 15/-
•0005 ... 15/6



Last year we concentrated our resources and experience to the production of a first-class precision condenser at a popular price.

Few wireless constructors have not heard of the wonderful success that followed its introduction. The experts described it as a condenser worth at least double its price. Constructors from all parts of the country have expressed their astonishment at finding such efficiency at so low a price.

Now this value is to be even greater. Our new factory, equipped for a far greater output, is able to produce these "Popular" Condensers still more inexpensively. We pass these economies in full to the public.

Every good dealer stocks Bowyer-Lowe quality components.

We shall be happy to send you our catalogues on request and to tell you where you can obtain our components in your district.

DETAILS

End plates are aluminium pressings. Rotor mounted on ball bearings. No "sloppy" bearings, springs or spring washers. Straight-line wave-length curve. Girder construction for strength. Perfect balance and dead accurate adjustment.



Popular Condenser

BOWYER-LOWE CO., LTD., LETCHWORTH

Also, despite its very reasonable price of £1 17s. 6d., this A.C.2 is an article of well-finished and refined appearance. There is nothing cheap-looking about it, and it would hang in an expensively furnished drawing-room without disgracing it.

Further, quite apart from its uses as a speaker, its presence might even occasion appreciative remarks for its qualities as an ornament. The cone itself, which is about 9 in. in diameter, is tastefully coloured with a fine old-gold tint, and this very nicely blends with the chocolate-coloured outer moulding. The terminals and the adjusting device are at the back.

We should certainly advise readers of MODERN WIRELESS, whether they possess a small or a multi-valve receiver, to hear one of these junior Amplions in operation. With memories of the performance of a five-guinea loud speaker of three or four years ago, the reproduction from this little Amplion comes as rather a revelation. Its projection is excellent, while its ample bass is not "base bass!" The A.C.2 is also quite sensitive and we cannot say more than that it appeals to us both in point of appearance and performance.

Sifam Pocket Voltmeter

We recently received a Sifam Pocket Voltmeter for test. It has two ranges, one from zero to 6, and the other from zero to 120 volts. The one range is scaled in red and the other in black, and the instrument is fitted with two selection contacts of the appropriate colours. It has a resistance of the useful order of 4,000 ohms. The scales, of course, are not large, but within their limitations fairly close readings can be taken, and this Sifam pocket voltmeter has a useful degree of accuracy for an



The "Sifam" pocket voltmeter.

article of its nature. If every one retailed is up to the sample submitted to us for examination, amateurs need have no hesitation in employing them for testing their batteries.

Tungstone Accumulators

The Tungstone Accumulator Company have adopted the slogan, "The plate is the nerve centre of any battery," and they quite justifiably claim that this statement is of vital importance to the user of wireless batteries. It is to be feared that only too few amateurs pay any attention to the "innards" of such accessories or components as accumulators. Electrical productions are far from being standard articles in point of quality. A saucepan or a kettle, or any other such common article of a certain make and selling at a certain price, will be much of a muchness with another similar article sold at a similar price, but this is far from being the case with an accumulator.

While that an accumulator should have a certain voltage and a certain ampere-hour capacity for a certain purpose is a primary requirement, that it should also be able to stand up to continual hard use and even a certain degree of disuse is almost as important. The case or container and the terminals of the accumulator are almost incidental and secondary items. The vital factors are the plates, their design and their construction, and the Tungstone Accumulator Company, Ltd., has done the right thing by bringing these facts forward.

In all their advertisements they make quite clear the vital advantages of their particular and originally efficient system of all-lead structure and the fact that the plates are perfectly balanced, a condition which, it is claimed, is only to be found in the Tungstone battery. But, nevertheless, it must not be thought that the Tungstone people have concentrated on the plates to the disadvantage of the remaining parts of construction.

The general design and assembly of their accumulators are most excellent. Some nine months or so ago we placed a Tungstone 60-volt accumulator into commission. It has been worked very much harder than any battery would be by an ordinary listener or amateur, and only those who have intimate knowledge of radio experimental laboratories can appreciate what it has had to stand up against.

To date it has shown not the



The Cosmos (Metro-Vick) L.T. eliminator, a report concerning which appeared on page 106 of the January issue of "M.W."

slightest signs of distress and is as clean and as fresh as during its first months of service. We do not think we should be exaggerating if we predicted for it an abnormal length of life even under the exacting conditions in which it operates. Discriminating radio amateurs who study the very interesting booklet issued by the Tungstone Accumulator Company will, we should imagine, rapidly become converts to the sentiment that "the plate is the nerve centre of any battery."

Radio in India

The A.J.S. people have made arrangements for the distribution of their products throughout India with Messrs. Bombay Radio Company, 73-75, Marine Lines, Queen's Road, Bombay, so that any of their products can now be obtained anywhere in India.

A New Rheostat

It has been left to the G.E.C., Ltd., one of the most progressive of the larger radio manufacturers, to produce (unconsciously, we believe!) a filament rheostat which can be mounted equally well either on the baseboard or panel. For this reason alone it is sure to achieve considerable popularity, but it has other attractive features in addition. For instance, when it is mounted on the baseboard, its moving parts and resistance element become completely dustproof, also it has a delightfully smooth action, which is obtained by the introduction of a plunger-type spring contact. It has a large milled adjusting knob which contributes in no small measure to its appearance.

Actually there are two types available. One is designed specifically for panel mounting and the other for

(Continued on page 207.)



A great little condenser!

THE Dubilier fixed condenser with its di-electric of best India Ruby Mica is hermetically sealed into its bakelite case to render it absolutely immune from the effects of damp or dust.

Before being sealed, however, the condenser element is subjected to enormous pressure, immersed in boiling wax, and kept so rigidly clamped when assembled that the excluded air can never regain entry.

Finally the excellent bakelite moulding acts as an extremely high resistance and prevents losses through current "creeping" across between the terminals.

Ye ars of experience and specialised craftsmanship go to the making of this great little condenser; see that it figures prominently in every set you build.

Dubilier Mica Condensers.	
Types 610 and 620 (vertical):	
0.00005 to 0.0009 mfd.	2/6
0.001 to 0.006 mfd.	3/-
0.007 to 0.009 mfd.	3/8
0.01 mfd.	4/-
0.015 mfd.	4/6



T.O.87.

Advt. of the Dubilier Condenser Co. (1925) Ltd., Ducon Works, Victoria Rd., North Acton, W3



IGRANIC POWER TRANSFORMER

IGRANIC SMOOTHING CHOKE

IGRANIC POTENTIOMETER

Use IGRANIC Power Components for an ample, silent supply

Being identical with those used in the IGRANIC H.T. SUPPLY UNITS, these components are designed to work together to give the most efficient power supply it is possible to obtain. They are supplied separately, each with full instructions for the construction of a H.T. SUPPLY UNIT of the special IGRANIC type, but may, of course, be used in any type of supply unit preferred by the constructor.

IGRANIC POWER TRANSFORMER

Designed for full-wave rectification. Separate winding gives 4 volts for filament of rectifying valve. Output 250 volts to each anode, 75 milliamperes.
 Type V208 T.A. 100/110 and 200/220 Volts A.C. 40-60 cycles.
 Type V208 T.B. 115/125 and 230/250 Volts A.C. 40-60 cycles.
 Price £2-5-0

IGRANIC SMOOTHING CHOKES

Really two chokes on one core providing the most effective system of smoothing. It has a very high inductance and is completely enclosed in metal case.

Type V208 C Price .. 25/-

IGRANIC POTENTIOMETER

Supplied with ten tappings to give equal steps of output voltage. Enclosed in metal shield. Ample current carrying capacity.

Type V208 P Price .. 12/6



IGRANIC FILAMENT TRANSFORMER

IGRANIC FILAMENT TRANSFORMER

This transformer supplies a steady current for the heater filament of A.C. Filament Valves. Gives ample current for up to four valves taking 2 amps. each at 3.5 volts, maintaining the output within 5 per cent. of this figure without the aid of a Rheostat. Three models for 100-110, 200-220, or 230-250 volt A.C. Mains.
 Price 30/-

List No. J441, giving full particulars, will gladly be sent on request.

IGranic components are always stocked by reputable dealers. All reports received by us of difficulty in obtaining them receive immediate attention.



149, Queen Victoria St., LONDON, E.C.4.

Works: BEDFORD.

Branches: BIRMINGHAM, BRISTOL, CARDIFF, LEEDS, MANCHESTER, NEWCASTLE, GLASGOW.

RADIO NOTES AND NEWS OF THE MONTH

A feature in which our Contributor brings to your notice some of the more interesting and important Radio news items.

Conducted by "G. B."

Banned Broadcast

ALL the fuss which Mrs. Snowden, one of the Governors of the B.B.C., has created is still talked about, and all the fuss which Captain Reginald Berkeley, author of "The White Chateau" and the banned radio play "Machines," has created is also discussed by students of broadcasting. It seems rather a storm in a teacup, but there is no doubt that the question of controversy does want ventilating.

As these words are written, the Governors of the B.B.C. are meeting in solemn conclave to debate this world-shaking problem.

"Nail That Up"

Captain Berkeley, writing in the "Daily News" on January 10th, seems chiefly concerned in criticising Sir John Reith, although his ostensible

object in writing for the "Daily News" was to criticise the censorship which resulted in a play of his being turned down by the B.B.C. because it contained elements of controversy.

One thing Captain Berkeley is undeniably right about, and that is when he says: "Sir John himself has laid down the prescription for securing the best services of broadcasting. It is to be done 'by keeping it in living contact with the human beings that it serves.' Nail that up, Sir John, in every studio in the Kingdom."

That's about the best advice Captain Berkeley has ever given the B.B.C.

Eiffel Tower to Remain

There appeared in the Press a few days ago an announcement that the famous Eiffel Tower, in Paris, was to be scrapped because it was showing

signs of senile decay. The Eiffel Tower was built for the great Paris Exhibition, but since then it has been used as the mast for the famous French wireless station, F.L. It has been periodically threatened with destruction because the steel framework constantly shows signs of decay and costs at least a thousand pounds a year to keep in repair.

But it appears the rumour is wrong, and F.L. and the famous tower are still remaining a feature of Paris.

Cheaper Valves

It was announced the other day that Professor Finch, Professor of Electro-Chemistry at the Imperial College of Science and Technology, South Kensington, has made a scientific discovery which, it is claimed, will greatly cheapen the production of electric-light bulbs, wireless valves and X-ray apparatus.

Professor Finch explained to a Pressman that it was because evacuation is such a troublesome and costly business that wireless valves, for instance, and X-ray tubes are so dear. "With my device it is a simple matter to secure a vacuum more perfect than has ever been attained and far more cheaply than hitherto."

(Continued on page 200.)

H.F. CHOKE



as used in the original 1928 "SOLODYNE" and "BUSINESS MAN'S FOUR."

7/6

H.T. AUTO FUSE



For the 1928 "SOLODYNE." A safety device for every valve set. A very small premium for a very big risk.

Including 0.5 amp. fuse bulb .. 1/6

Lists dealing with the 1928 "SOLODYNE," the "MUSIC MASTER" and other latest Receivers, including 36-page catalogue containing full constructional details of the Magnum Screened Receivers, will be sent on receipt of 1½d. stamp.

We Specialise in the 1928 "SOLODYNE"

As described in this and the January issue "Modern Wireless," and can supply the kit of parts price **£17 17s. 0d.**

or, if desired, the set ready wired and tested, price **£21 0s. 0d.**

plus Marconi Royalties .. **£3 2s. 6d.**
Any separate parts can be supplied as required.

THE MULLARD "MASTER THREE"

Complete kit of components **£5 15s. 0d.**

Or Ready Wired and Tested **£6 6s. 0d.**

Plus Marconi Royalties .. **£1 17s. 6d.**

BURNE-JONES & CO. LTD.,

MAGNUM HOUSE
TELEPHONE: HOP 6257
288, BOROUGH HIGH ST.
LONDON, S. E. 1

STANDARD WAVETRAP



As used in the original 1928 "SOLODYNE" and "BUSINESS MAN'S FOUR." **15/-**

Screening Box for the above .. **5/-**

This indispensable unit is suitable for use with any receiver and eliminates the unwanted station.

"SOLODYNE" COILS



as used in the original 1928 "SOLODYNE." Per Set of three including bases, B.B.C. waveband, **£2 5 0**

Set of 3 Coils for high waveband less bases **£2 5 0**

SPECIALLY DESIGNED FOR THE 1928 SOLODYNE

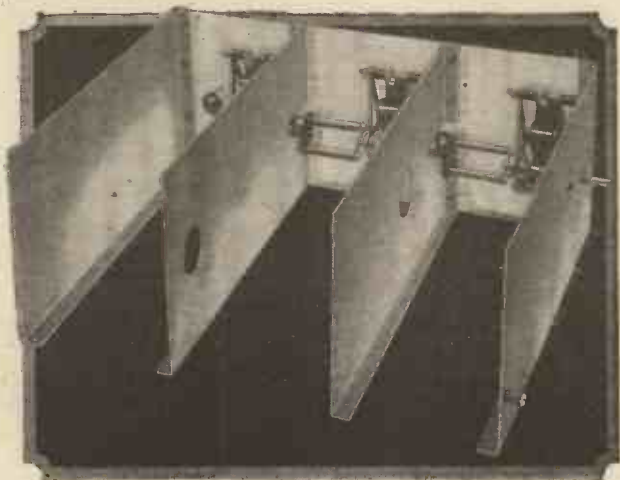

The entirely new J.B. Condenser, specially designed for, and used by, Mr. Kendall in the 1928 Solodyne Receiver, is the masterpiece of condenser design.

Three Logarithmic Condensers are mounted on a stiff aluminium panel, and between each of the units is positioned a copper screen. Each unit is adjustable without interference from, or with, the other two. The projecting spindle allows for the fitting of a Slow Motion Dial. The copper screens are detachable and the requisite screws for bolting them to the front panel are provided. The rotors of the Condensers are earthed to the screens and the insulating material is so placed as to be clear of the static field and thus reduce losses to an absolute minimum.

The J.B. Solodyne Condenser is sold complete with aluminium panel, copper screens with necessary holes bored, and bolts for mounting.

Price £3 17s. 6d.

JACKSON BROS.
8, POLAND ST.-OXFORD ST.
LONDON - W.1. Telephone:-
GERRARD 7414

A Wonderful Music Work

Edited by Sir HENRY J. WOOD.

MUSIC OF ALL NATIONS

To be Published in Fortnightly Parts. **1/3 Per Part.** A Collection of the World's Best Music.

FULL MUSIC SIZE FULL WORDS OF ALL SONGS

MUSIC OF ALL NATIONS breaks all records in music value! Good paper, clean printing, every piece complete—never before has such marvellous value been offered you! When complete it will constitute a superb library of the great music of every country—and all it will have cost you is just over a rd. a day. The first nine parts are still on sale at all Newsagents, Booksellers, and Music Dealers everywhere.

Buy them **TO-DAY!**

Part 7, Now on Sale, Contains:

- Polish*
ON THE RIVER *Eduard Parlovitz*
- Sea Shanty*
CAN'T YOU DANCE THE POLKA? *arr. Terry*
- German*
GAVOTTE IN G FROM THE 5th FRENCH SUITE *Bach*
- Hungarian*
CONSOLATIONS No. 1 *Liszt*
- Russian*
MAZURKA DE SALON *Tschaikowsky*
- Negro Spiritual*
DON'T YOU WEEP WHEN I'M GONE *arr. Burleigh*
- French*
VALE SEPTEMBRE *Felix Godlin*
- NATIONAL ANTHEMS OF THE WORLD (7) Welsh**
Land of My Fathers *James*

RADIO NOTES AND NEWS OF THE MONTH

—continued from page 198

Let's hope Professor Finch's discovery will result in the near future in cheaper electric-light bulbs and, more important to amateurs, cheaper valves.

What is a Professor?

In the "North Mail and Newcastle Chronicle," a few days ago, someone wrote as follows: "I met that modest inventor, Professor J. L. Baird . . ." This seems to be giving a title to Mr. Baird which, to the writer's knowledge, he has never claimed. It is interesting to remember that titles such as these can be used by people irrespective of whether they are entitled to them or not. A "professor" is really somebody who has been appointed to a Chair of some branch of scholastic work at a university. That is an example of bona fide use of the title "professor"; but, of course, as everybody knows, there are many other unofficial professors—even professors of chiropody and professors who read the bumps on one's head.

I don't think Mr. Baird has ever occupied a Chair at a university, but,

if he has, then certainly he is entitled to be called "Professor" Baird.

Wireless Wonders

A good many writers of wireless notes, have had an awful lot to say about the wireless wonders to come for 1928, but perhaps some of the most interesting remarks have been made by Thomas Alva Edison. "The outstanding development of the year coming," he has stated, "will be the solution of the problems associated with what we call television."

Mr. Edison seems to believe that before 1928 is over we shall televise individuals and their movements through space as easily as speech is now transmitted. "I can foresee such developments that the whole world will be linked up in an endless wireless chain," says Mr. Edison.

Sarcastic Optimism

I think Mr. Edison must have been indulging in a little sarcastic optimism when he said: "I expect that during the year it will be possible to so perfect transmission and receiving that it will be possible for any man to ring up his friend in the ether even though he may be ignorant of his whereabouts." This sounds a little too far-fetched and a little too fantastic,

especially when coming from the lips of one of the world's greatest inventors.

"The Times," in an article headed "The Progress of Science in 1927," states that a remarkable achievement in the practical application of physical science as regards television seems to be well on the way. Belin (in France), and Alexanderson and Jenkins (in America), have been able to submit somewhat crude shadowgraphs over the telephone line and, in the course of the year, Mr. J. L. Baird has given demonstrations which seem to show that he is well on his way to transmitting recognisable images of movable objects.

Almost Insurmountable Problems

This is a little more guarded than Mr. Edison's forecast, but anyone who read the Editor's article in last month's MODERN WIRELESS about "Television—Some Facts and Fancies" will realise that the expression "well on the way" with regard to television is again rather optimistic.

A certain degree of success has been achieved in television research, but it is rather like coming up against a blank wall; the problems in front which have to be scaled before

(Continued on page 202.)

No GLAZITE is genuine without this mark

If you want GLAZITE—the original coloured connecting wire which has given complete satisfaction to hundreds of thousands of constructors, insist upon seeing this label.

GLAZITE makes wiring simpler, quicker, more efficient and cheaper. It is flame-proof, dampproof, and does not deteriorate in use.

THE LONDON ELECTRIC WIRE CO. & SMITHS LTD.
PLAYHOUSE YARD, GOLDEN LANE . . . LONDON, E.C.1

GLAZITE
BRITISH MADE REGD

THE ORIGINAL COLOURED CONNECTING WIRE

Obtainable in six colours: Red, Yellow, Blue, Green, Black, and White.
Price 10d. per 10-ft. coil; 9d. per packet of four 2-ft. lengths (assorted colours).
From all good radio dealers.



MAGNAVOX

ELECTRO-DYNAMIC POWER SPEAKER UNIT

Manufactured under Magnavox British Patent No. 197,836 of May 24th, 1923.

R4 UNIT
£9.10.0



R4 UNIT
£9.10.0

The World's Finest Speakers by the oldest speaker manufacturers. A revelation in reproduction with results equal to moving coil speakers selling at five times the price. The field of the Magnavox Type R4 Unit is operated from a 6-volt accumulator or any standard trickle charger. Consumes 1 ampere. Resistance 12 ohms. This field current is easily available from the L.T. battery of your receiving set. The unit is supplied complete with attachment cords and built-in input transformer.

Permanent Magnet Type No. M7, 60/-
Write for full list

Our new 1928 Catalogue and circuit supplement is now ready. Send 9d. in stamps to cover cost of postage. It's the most instructive and interesting list available.

THE ROTHERMEL CORPORATION LTD.
24-26, MADDOX STREET, LONDON, W.1.
Telephone: Mayfair 0578, 0579.

REFUSE IMITATIONS



Make sure of having the prize-winning original Former by buying only Formers bearing the Trade Mark "Becon."

New Standard Sizes in three finishes. The guaranteed panels made by Ebonite experts at low prices.



THE BRITISH EBONITE COMPANY, LIMITED
HANWELL LONDON W.7.

GAMBRELL CENTRE-TAPPED COILS AND HOLDER



Prices quoted Standard Coil. Centre-tapped 6d. extra.

Universal Coils — use not being limited to centre-tapped circuits, fit any standard socket, easily interchangeable, and occupy minimum baseboard space.

Size.	Price.	Approx. No. of Turns.
a2	4/10	18
a	4/10	25
A	5/-	30
B1	5/3	40
B	5/6	50
C	5/9	75
D	6/3	100
E	6/9	150
F	7/9	200
G	8/6	300
	10/-	500

Coil Holder specially designed for centre-tapped coils



Price 1/9

GAMBRELL BROS., LTD.,
76, Victoria Street, London, S.W.1.

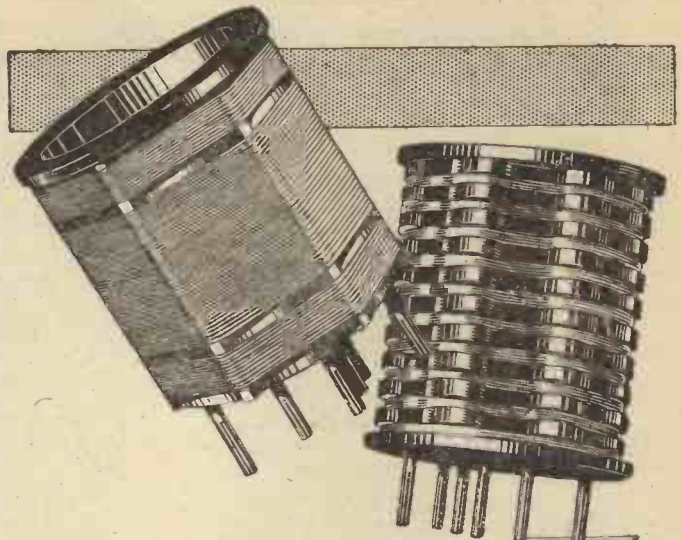

Mullard
The Master Three

INSIST UPON SPECIFIED COILS IF YOU WANT MAXIMUM EFFICIENCY

IF you are about to construct the Mullard Master Three Receiver you should remember that there is every reason why you should adhere to the author's specification.

SELECTIVITY to the desired degree is easily obtained with Colvern Coils. A few turns to requirement should be removed from the aerial winding and the end of the wire reconnected to Pin No.4.

RANGE depends to an extremely high degree upon efficient coils and it is very important that these should have a very low high-frequency resistance. To obtain this Colvern Coils are accurate space-wound. Experience proves that the use of Colvern Coils increases the range of a radio receiver. In the case of the Master Three Colvern Coils give maximum range.

VOLUME is similarly dependant upon the efficiency of coils. Logically, the signal strength of distant stations is greatly increased by Colvern Accurate Space-Wound Coils.

Therefore be advised—adhere strictly to the author's specification, you will be most satisfied.

Prices :—

Broadcast Wave.

Accurate Space-wound to give maximum efficiency.

7/6

Long Wave.

Sectional wound to give lowest high-frequency resistance.

8/6

Colvern Aluminium Panel.

is also specified for the Mullard Master Three Receiver 18" x 7"; 14 gauge; sprayed instrument black; drilled for variable condensers switch and panel brackets.

7/6

COLVERN

ACCURATE SPACE WOUND COILS

Colvern Ltd., Mawney's Road, Romford.

RADIO NOTES AND NEWS OF THE MONTH
—continued from page 200

television can be made a practical commercial proposition appear, in the present state of science, almost insurmountable.

Success of 5 S W

Advice from Australia indicates that the new Chelmsford Empire Broadcasting station, 5 S W, is now heard on most evenings in Australia. The B.B.C. has heard that 5 S W has been successfully picked up and relayed by the Cape Town broadcasting station, although, curiously enough, no reports of such similar success have been received, at the moment of writing, from Canada.

Birthday Wishes

Hundreds of listeners sent in wireless wishes for the first birthday of the British Broadcasting Corporation, and "The Evening News" has been offering prizes for the three best and most amusing wishes. One of the neatest and shortest good wishes was sent in by a reader as follows:

"Many happy relays of the turns." Another one read as follows:
"You squalling little brat, reared in the coarsest mode, I hope your code in life may be the Morsest code."

Steady Progress

The following figures show the growth in the number of receiving licences issued since the official opening of the B.B.C. in November, 1922:

Year ended:	Licences issued.
Sept., 1923	173,987
Dec., 1923	595,496
Dec., 1924	1,140,119
Dec., 1925	1,645,207
Dec., 1926	2,178,250
Nov., 1927	2,355,605

The last figure does not include 7,915 licences issued during the year to blind people free of charge.

It is considered that a conservative estimate is five listeners to every receiving set, so at present between ten and twelve million listeners exist in Great Britain. These figures undoubtedly show the steady progress of the popularity of broadcasting.

B.B.C.'s New Year Resolution

Mr. Cecil Lewis, who is contributing broadcasting criticisms to

"The Observer," writing in a recent issue in connection with broadcasting for 1928 says:

"It is seasonable, if nothing more, for us all to make at last one New Year's resolution, and I am sure the staff at Savoy Hill have made theirs. It is unlikely that they have sat round in solemn conclave deciding what it shall be, but I know, if asked, they would all reply without hesitation: 'Better Programmes.' Now, better programmes are like heaven—a pleasant place we intend ultimately to get to."

What a Hope!

This is rather a bad analogy because, unless we are very conceited, a good many of us must admit that we don't stand a very good chance of "getting there," and if our chances of getting better programmes are only as good as our chances of getting "there," well, I am afraid Mr. Cecil Lewis will be disappointed in the result for 1928!

Why not BUY THE BEST and get POPULAR WIRELESS?

Every Thursday—Threepence

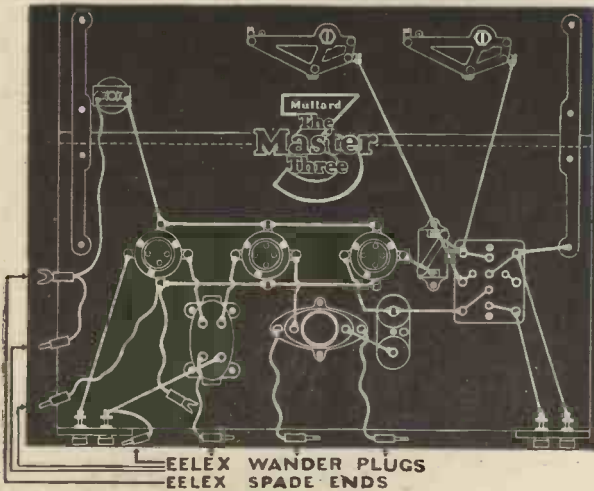

WIRELESS ACCESSORIES are chosen and recommended for the Mullard "Master Three," the Cosmor "Melody Maker," and "1928 Solodyne," also Eelex Treble-Duty Terminals. They are also used and specified for all the best sets to-day. This alone is sufficient testimony that Eelex Accessories are the best obtainable. Write for catalogue S44, which gives details of all the EELIX accessories. Complete set of EELIX Terminals, Plugs and Spades as required for: "Master Three," 2/10 (Plugs & Spades only, 1/4.) "Melody Maker," 3/4 "1928 Solodyne," 6/3 (Fuse-holder 4d. extra)

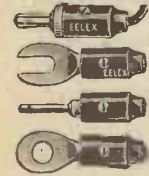

Coloured spades, plugs, pins and eyes, 1d. each, coloured flex 1d. 6d.

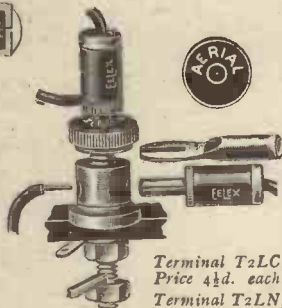

Terminal T2LC, Price 4d. each. Terminal T2LN, with Plain Top, Price 3d. each.

J. J. EASTICK & SONS,
Eelex House, Bunhill Row, Chiswell St., London, E.C.1

WALK UP! WALK UP! WALK UP!
NOW SHOWING

(IN OUR WINDOWS)

THE NEW 1928 SOLODYNE 5, undoubtedly one of the greatest achievements in wireless. Foreign stations received as loud and clear as 2 L O. NOW PREPARING. All parts for this wonderful circuit.

ALSO, all parts now in stock for the MOVING COIL LOUD SPEAKER. DO NOT FAIL to hear a demonstration of this wonderful adjunct to wireless.

SECURE AT ONCE THE NEW LIST OF PARTS FOR THE MOVING COIL LOUD SPEAKER, and special reference work on same, by C. P. ALLINSON, A.M.I.R.E., the well-known technical expert. 2s. 6d.

Every make of pick-up for use with the Gramophone in stock from 15s. upwards.

ONLY A FEW LEFT. AMPLIFEX LOOP AERIAL, the finest loop aerial yet devised, and the best for the reception of European Broadcasting. To clear, 30s.

ALL PARTS FOR MULLARD MASTER THREE NOW IN STOCK. FREE to all purchasers of a complete set of parts for the MULLARD MASTER THREE circuit, including Royalty, we OFFER TO WIRE THEIR SETS ENTIRELY FREE OF CHARGE.

OUR INTERNATIONAL RADIO CATALOGUE (3rd edition) will be sent to all enthusiasts sending 6d. to cover cost of postage and packing.

WILL DAY, LTD.

(The Best in the West)

19, Lisle Street, Leicester Square, London, W.C.2

Telephone (2 lines): Regent 0921 and 0922.

Telegrams: Titles, Westrand, London.

FOUR BLUE PRINTS Free!

A MAGNIFICENT 2/- GIFT FOR EVERY PURCHASER OF THE ISSUE OF "POPULAR WIRELESS," ON SALE THIS WEEK:—

"P.W." Blue Print No. 41. THIS YEAR'S CHITOS ONE-VALVER.—When originally introduced to the public through "P.W.," the "Chitos" scored a phenomenal success on account of its simplicity and sensitivity. Both these features have been improved in the modernised version now available for the first time.

"P.W." Blue Print No. 42. THE "Q. and A." THREE.—An ideal loud-speaker set for household use. The purity of reproduction is almost phenomenal, and to assist the veriest tyro in making the set it is described in the form of Questions and Answers. Easy to make, easy to operate, easy on the pocket!

"P.W." Blue Print No. 43. THE INEXPENSIVE FOUR.—Gives good long-range loud-speaker results at low cost. The circuit employed is a fast favourite: H.F. (neutralised), Detector, and 2 L.F. Amplifiers.

"P.W." Blue Print No. 44. THE ECONOMY FIVE.—Two high-frequency amplifying stages make this set exceedingly sensitive and selective, and two carefully designed L.F. stages give tremendous volume with great clarity of reproduction. (Even if you cannot build this set at the moment, *keep the Blue Print*—you will be sure to need it!)

BLUE PRINTS
ARE
THE BACKBONE
OF
THE RADIO
CONSTRUCTOR'S
HOBBY.

ADD FOUR MORE
TO YOUR COL-
LECTION FREE
OF CHARGE!

Don't Miss this Great Gift Number of "Popular Wireless." On Sale Everywhere from February 2nd, Price 3d.

**REMOTE CONTROL
AND LOUD-SPEAKER
EXTENSIONS**

—continued from page 162

This closes the filament circuit and the set is brought into commission. It will be noticed, however, that the plate current from the output circuit is now passing through the relay coil, and once this is established the switch can be broken at the listening position, since this plate current is of sufficient magnitude to hold the tongue down against its contact. Current consumption is thereby saved, since it is only the normal flow keeping the relay in action.

Switching Off

If reception is desired from any other point the loud speaker is joined up first to ascertain if the set is working, and if so the switch need not be touched. When no further listening is desired the loud speaker must be disconnected at each point, and the last one to break circuit will automatically cut off the current flow through the relay, and it will, in consequence, break the L.T. circuit.

It must be ascertained on test how much H.T. voltage is necessary to establish the relay in the initial instance, but once found the apparatus will function without further attention.

Several other schemes, simple and elaborate, will no doubt suggest themselves to the reader. In order to overcome the necessity of running four leads when wiring up these remote-control systems I understand one firm is shortly marketing a special relay device which will require only a pair of leads. It is an ingenious arrangement with a small time lag whereby the current from the H.T. battery operates the relay at the start, but during steady working conditions the clapper or tongue is held in position by the normal plate current similar to the arrangement just described.

Coming now to the general aspect of wiring, it will be appreciated that the actual method of leading the wires from room to room will vary with almost every house. The top of the skirting boards or along the picture rail are favourable places, but the final choice will depend upon whether the arrangement is to be of a permanent or semi-permanent character. If placed close to any electrical mains there is the liability of a hum

or buzz being produced in the wires by direct induction and this will evidence itself in the loud speaker. A little time spent in trying different routes generally will overcome this trouble, but as a last resort lead-sheathed cable can be run and the sheathing earthed. Be sure to use reliable and properly insulated wire, and be careful not to damage it when knocking in the staples, and above all see that the connections are both electrically and mechanically sound.

A Great Convenience

Failure to attend to these little details may necessitate the expenditure of time in tracing faults, so the care used in the first instance is amply repaid afterwards. The tuning of the receiver sometimes requires a slight adjustment to meet the new conditions, and it is advisable to test out each position in turn, to see that reception is quite satisfactory, by calling in the aid of another member of the family who can indicate with some prearranged signal how things are working in each room. When this is done complete satisfaction will be the reward, and the working of any of the schemes described cannot fail to give an added amount of pleasure.

IT is a recognised fact that first-class wireless sets must be constructed of the very best materials if perfect results are to be obtained. Perfect reception and tone depend entirely on the quality of the materials used for baseboards and panels.

CELASTOID

TRADE MARK

CELLASTINE

TRADE MARK

Wireless experts have used and tested these materials and report excellent results.

These materials have been used and tested by wireless experts, who report excellent results. Besides tending to give better reception, improved tone and high dielectric properties, these materials have absolute stability in quality. There is no discoloration with age or exposure. They can be worked with ease, no splintering or cracking when machining, tapping, drilling, etc., is experienced. They have deep, brilliant and lasting polish which does not affect surface resistibility.

CELASTOID

is obtainable in a realistic imitation of Tortoiseshell. It possesses the following characteristics: It is Transparent and can be supplied in both Transparent and Opaque colours. Wireless manufacturers have found numerous applications for the Fancy Patterns which include Tortoiseshell, Marble, Brocades, Moire, Nacre of Pearl.

CELLASTINE

is obtainable in Black, Opaque and Wood colours. Cellastine is also supplied as Cellastine Moulding Powders, which possess the same unique properties as sheets and are ideal powders for moulding components where quality is the main consideration.

PANELS CUT TO SIZE ARE SUPPLIED BY:—
Messrs. Rooke Bros., 55, Cardington Street, N.I.
Messrs. Roberts, Newton Street, Birmingham.
Messrs. Robert B. Clarke & Co., Eldon Street, Oxford Road, Manchester.

Sole Manufacturers: BRITISH CELANESE LTD., CELANESE HOUSE, HANOVER SQ., W.1.

The Greatest American RADIO MAGAZINE

free

RADIO NEWS, the largest radio magazine in the world, now publishes a DEALERS PERSONAL EDITION, which is included in the regular issue. Get a sample copy of this great, new American trade publication free! Over 150 pages, more than 200 illustrations—all the latest American wireless instruments and wireless receiving sets—Learn the money-making ideas now being used by the wireless business men of the United States.

350,000 radio enthusiasts depend upon RADIO NEWS—30,000 American dealers depend upon RADIO NEWS DEALERS PERSONAL EDITION—build your own business with RADIO NEWS ideas!



If you wish to subscribe to BOTH of these magazines, send 12/6 by British Postal Order.

RADIO NEWS

22nd FLOOR

230 Fifth Avenue, New York City, U.S.A.

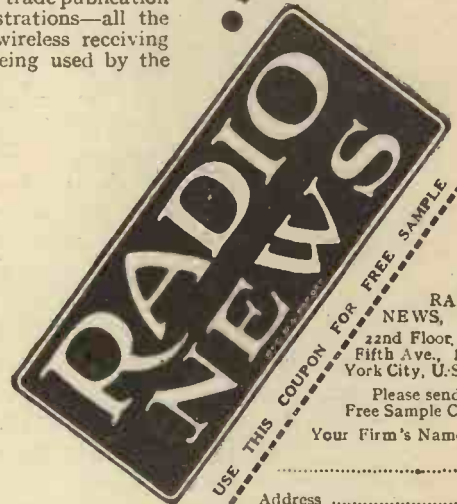

RADIO NEWS,
22nd Floor, 230
Fifth Ave., New
York City, U.S.A.

Please send me
Free Sample Copy.

Your Firm's Name.....

Address



LOG (or Mid-Line) CONDENSER

Mounts either Panel or Baseboard

*00035
*00025 10/6 each
*0005

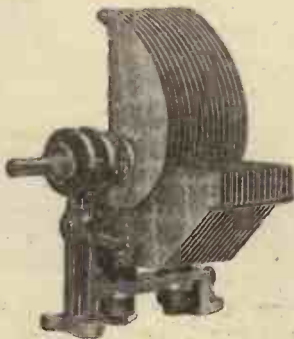

The most scientific Condenser yet produced. Perfect in every detail of construction and performance.



FORMO-DENSOR

A sound variable condenser which fills a long-felt want. Specially designed to take the place of the hitherto generally used Fixed Condenser.

Price from 2/6

For use as:—

Neutralising Condenser. Aerial Condenser. Grid Condenser. Reaction Condenser. Phasing Condenser. Tone Control Condenser. etc.

THE FORMO HANDBOOK

1/- post free. (Liberal Discount to Retailers).

A fully illustrated well-compiled work on the construction and uses of radio components, including Blue Prints Formo "True Scale" 3-valve Set and Formo "Two-Range" 2-valve Set.

CROWN WORKS, 22, CRICKLEWOOD LANE, N.W.2.
Telephone: Hampstead 1787.

Price Per Set
3/6
Highly Polished
4/6

THE "PAREX" VALVE HOLDERS

(Reg. Des.—Pat. Pend.)

THE ONLY PRACTICAL HOLDERS FOR SCREENED VALVES

as used in the

1928 SOLODYNE

"PAREX" SCREENS

for the SOLODYNE, as specified.

Back of Panel Screen of thick Al. 5/6

Copper Partitions. Per set of 4 17/8

Baseboard Copper Screen. 26" x 12" 7/6

Triple Gang Condensers on

Screens as specified, complete... 50/-

Set of 3 Coils, as specified 45/-

E. PAROUSSI, 10, Featherstone Buildings, High Holborn, London, W.C.1. Phone: Chancery 7010.



CABINETS

GIVE YOUR SET THE

PROFESSIONAL LOOK

Illustrated catalogue showing a complete range of Camco Cabinets, Panels, and Brackets free on request.



The best of sets looks amateurish in a makeshift cabinet. Install your set in a Camco cabinet and make it look as attractive as the dearest sets you can buy in the shop.

SEND A P.C. TO-DAY
CARRINGTON MANUFACTURING CO. LTD.

Camco Works, Sanderstead Rd., South Croydon
Telephone: Croydon 0623 (2 lines).

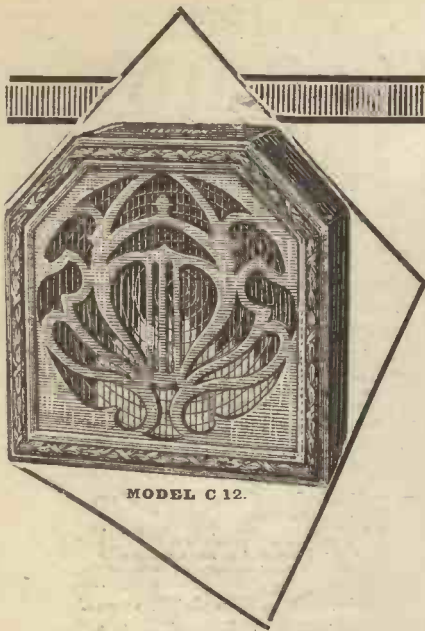

BRITISH FROM EVERY ANGLE

"Celestion" is the loud speaker so often imitated but never yet duplicated.

"Celestion" is "On demonstration—First on Merit."

Write for illustrated folder!

Models in oak or mahogany from £5. 10. 0. to £25. Showroom demonstrations without obligation.

CELESTION

The very soul of music.

THE CELESTION RADIO CO.,
Hampton Wick, Kingston-on-Thames.

Showrooms:
33-35, VILLIERS ST., STRAND, W.C.2.

French Agents:
Constable & Co. Paris.

CONCERNING THE "FORTY STATION" FOUR

—continued from page 184

not matter as long as a clearly defined point is found at which the signal strength becomes very small.

In cases where this form of wave-meter is not available, then a buzzer wave-meter may be used, and this will enable the neutralisation to be carried out with almost equal ease.

Failing these two a local powerful transmission may be employed. In cases, however, where this has a wavelength in the neighbourhood of 400 metres or more, the neutralising setting obtained will only be a preliminary one since this is not quite the correct setting for stability over the whole range.

High H.T. Better

It will be remembered that I stated that when correctly neutralised at 250 metres the set was slightly under-neutralised between 400 and 500 metres. If, therefore, the set is correctly neutralised between 400 and 500 metres it will be over-neutralised when you go down on the lower wave-lengths, and may, therefore, oscillate slightly.

If, therefore, neutralisation is carried out on a long wave-length, the values of the two tuning condensers should be reduced to about 60 or 70 degrees on the dials and such readjustments on the neutralising condenser made as may be found necessary. It will be found, however, that the procedure is much simpler to carry out than would appear at first sight, and no apprehension need be felt through any difficulty occurring in this respect.

The question of H.T. voltage is also an important one with regard to the stability of the high-frequency stage. It will frequently be found that reducing the H.T. voltage below a certain value will result in instability occurring where the set was previously stable, and the H.T. voltage has to be reduced considerably before another stable setting is found. I have myself found that a high-frequency valve is considerably more stable when using 120 volts H.T. than when using 80; while, at the same time, owing to the characteristics of the three-electrode valve a far greater efficiency is obtained by the use of a high plate voltage.

If, therefore, you have a high

voltage in the neighbourhood of 120 volts available, by all means use it.

The Aerial Coupler

Constructors of this receiver who are desirous of obtaining the utmost efficiency on the short broadcast wave-band may wish to make up their own aerial coupler, using Litz wire. In this case, it will be necessary to wind on 60 turns of 27/42, taking a tap at 15 turns from one end. The correct connections for the grid coil will be: Bottom of the coil to pin No. 2, then wind on 15 turns, take a tap, connect this to pin No. 3, then wind on the remaining 45 turns, and take the top end of the coil to pin No. 1. Considerable care will have to be taken in making the tap, and probably the best way of doing it will be to break the wire and finish off the two ends of the break and solder them together and connect to pin No. 3.

With a Litz coil and a suitably chosen aerial coil a marked increase in efficiency will result. The choice of the aerial coil, too, is by no means an unimportant matter, especially where the aerial and earth system is not an average one. The choice of the aerial coil is further governed by the degree of selectivity it is desired to obtain in some cases, especially where the set is used close to a broadcasting station it may be necessary to sacrifice a small amount of efficiency in order to obtain the desired selectivity.

Do not be afraid of using, say, a 5-turn aerial coil where you need a high degree of selectivity. I have myself experimented with this receiver, using only four or five turns in the aerial coil, and still found it capable of giving quite an excellent long-distance performance.

Long-Wave Coil

For long waves the aerial coil should be 75 turns and 250 to 275 for the grid coil, depending on the method of winding. Connections will be: Beginning of primary to pin No. 4, end to pin No. 5, beginning of secondary pin No. 1, wind on three-quarters of coil, take a tap to pin No. 3, and end of coil to pin No. 2.

To turn to the low-frequency side, I have been asked why a R.C. unit, with a low value of anode resistance, has been used. I have done this for several reasons. Firstly, it allows of a more certain control of reaction; secondly, a bigger grid base is available for the rectifier, thus enabling it to handle a larger signal, and last but not least, the use of a lower value of resistance is preferable if the utmost degree of purity is to be obtained.

IN OUR TEST ROOM
—continued from page 196

baseboard mounting, but through the two holes made in the panel mounting type for additional fixing purposes it is possible to fix the component on the baseboard by means of two long wood screws. It is possible that the makers are unconscious of this dual purpose of their rheostat, or it may be that they do not advocate this method of mounting for some reason or other, although we see no reason at all against it.

In any case, it is a point which will so attract the practical amateur that the G.E.C. people would be well advised to bring it forward. Apart from this, and in general, the G.E.C. plunger-type rheostat is a sound production. In each of the two types there are three models with resistances of 6, 12, and 30 ohms, any of which can be obtained at the one price of 2s. 9d.

Burgess H.T. Batteries

The modern multi-valve radio receiver demands a fairly heavy H.T. current. Where there are supply mains, eliminators can be used in order to obtain this, and if charging facilities are available high-tension accumulators can be used. Where neither is available the only alternative is the use of the primary type of battery, but the ordinary small-size H.T. dry battery is by no means an economical proposition if it is asked to deliver more than about five milliamps.

Where currents of the order of twenty or so milliamps. are desired an H.T. battery of the super-capacity type is necessary. One such was recently sent us for test by the Rothermel Radio Corporation of Great Britain, Ltd. It is a Burgess super H.T. battery (45 volts), a product of the well-known Burgess Battery Company of America, for whom the Rothermel people have made arrangements to be exclusive agents in the British Isles.

The battery has been in use for a period of about a month. During this time it has been used in conjunction with an accumulator supply to provide the heavy output of some 25 milliamps. It has been employed daily for periods of from two to three hours, but so far there has been but a slight drop in voltage. It appears to be almost abnormally robust and just the type of battery that country listeners will afford a hearty welcome.

There are to be very many other types of Burgess batteries available, from some even larger than the specimen referred to down to small batteries for grid-bias batteries, and if they are all up to the standard of the sample submitted to us they should tend to become as well known in this country as in that of their origin.

Lewcos "X" Coils

We recently received two "Lewcos" double-tapped coils. The one has sixty turns, and is tapped at the sixth and tenth turns, and the other is a 200-turn coil, tapped at the twentieth and fortieth turns. They are of the plug-in type, but their design is so original that they are worthy of special note for this reason. For instance, each is totally enclosed in a black casing, thus giving the article a considerable degree of robustness—a desirable quality for this type of component. The tappings are taken to two sockets, one in the centre of the device and the other at the top. A substantial plug terminal is provided for making contact.

Lewcos coils have gained a reputation for efficiency, and in the latest Lewcos productions little seems to have been lost by the additional complications in design. Tested in the aerial position of a normal type of receiver they gave results well up to standard.

In fact, taking advantage of one of the aerial tappings, the increased selectivity expected could be obtained with a sensitivity which did not drop below that provided by many coils the whole of the windings of which were included in the aerial circuit with the consequent loss in selectivity. Under modern ether conditions, selectivity is not only a desirability but a necessity, and those listeners using older types of sets and who have trouble in cutting out their local station, would be well advised to try the effect of replacing their present aerial coils for such as these new Lewcos "X" types.

NEXT MONTH

Another magnificent 1/- Blue Print will be presented free with every copy of "Modern Wireless." It accompanies a full description of a Three-Valve

SHORT-WAVE SET

Designed and described by C. P. Allinson, this receiver is of an extremely novel and efficient design and is certain to attain considerable popularity.

Order your copy of the March "Modern Wireless" now.

The 1928
"SOLODYNE"

HUNDREDS
ARE
BUILDING
IT

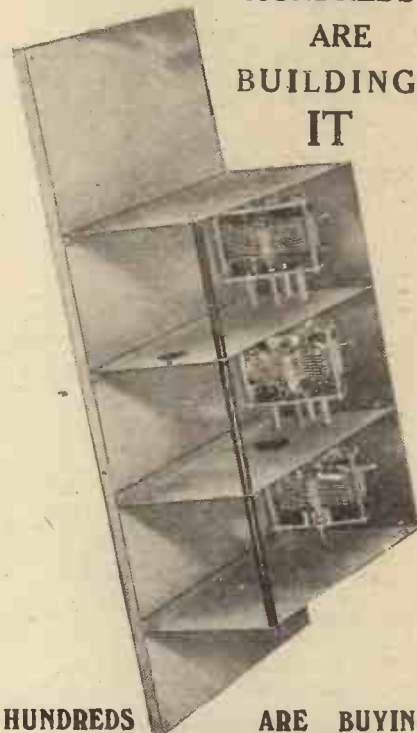

HUNDREDS ARE BUYING
**PETO-SCOTT
GANG CONDENSERS**

SHIELDED GANG CONDENSER as illustrated, complete, mounted on 26" x 12" Copper Covered Plywood Baseboard, Four Copper Screens, Front Screen. .0005 Log Mid-Line Triple Gang Condenser, instantly and independently adjusted, fitted with extra micrometer balancing adjustment ... **£4 10 0**
Silver Marshall Drum Drive 15/- extra.

SET OF SPECIAL COILS AND BASES, 250/550 metres, as specified, Laboratory Tested **£2 5 0**

Set of Long-Wave Coils **£2 5 0**

STANDARD M.W. WAVE-TRAP ... **15/-**

POLISHED MAHOGANY CABINET as supplied to "Modern Wireless" **£2 7 6**

Baseboard extra.

IF YOUR DEALER CANNOT
SUPPLY SEND FOR OUR COM-
PLETE LISTS OF PARTS.

PETO-SCOTT

COMPANY, LIMITED,
62, High Holborn, London, W.C.
77, City Road, London, E.C.1.

Makes ALL the difference



THE following Press opinions relating to Six-Sixty Cone Speaker Paper will indicate to everyone the startling difference this wonderful material makes to any Cone Speaker. These opinions come from the leading Wireless Journals of the day, and speak for themselves.

"Modern Wireless," January, 1928, "we must say that the results were most gratifying. Reproduction bright and pleasing."

"Popular Wireless," Dec. 31st, 1927, "a complete cone diaphragm equal in appearance and efficiency to a professional production. It is a most excellent material, and is better than anything of its kind that we have yet come across."

"Amateur Wireless," Dec. 24th, 1927, Mr. E. J. O'Connell, writing an article entitled "Make Your Own Loudspeaker," strongly recommends the exclusive use of Six-Sixty Cone Speaker Paper.

Six-Sixty Cone Speaker Paper is sold in two sizes, 12" diameter and 19" diameter. Full instructions for cutting and mounting are enclosed in an attractive envelope.

Prices 2/6 and 3/6
Brass Washers 3d. extra.

SIX-SIXTY

THE ELECTRON CO., LTD.,
122-124, Charing Cross Road,
LONDON, W.C.2.



LAKER STEEL MASTS

are 100 per cent. efficient—

They are made by engineers and supplied to H.M. Government, the B.B.C., and to Colonial and foreign stations throughout the world.

There are 50,000 "Laker" Masts in daily use.

By mass production we are able to offer a wonderfully efficient and handsome steel mast at the extraordinarily low price of

30 ft. 22/6

Complete as Illustrated.

Send 1/6 extra for part carriage. We pay the rest. Always bear in mind that an efficient aerial is the most important factor in good radio reception.

JAMES LAKER CO.
Engineers,
BECKENHAM, KENT

WHEN replying to advertisements, please mention "Modern Wireless" to ensure prompt attention. **THANKS!**

ARTCRAFT
RADIO CABINETS
BEST VALUE
New Catalogue Free
THE ARTCRAFT COMPANY
156 CHERRY ORCHARD ROAD, CROYDON

THE "MERCURY" SEVEN

—continued from page 147

the frame condenser and the oscillator condenser very slowly with the reading of the oscillator condenser slightly in advance of that of the frame condenser. You can usually tell when you have got the correct difference in the frequency between the two circuits by a very slight hiss in the background.

While the two dials are in the correct relationship to each other this hiss should be present. I am, of course, assuming that the intermediate stages are not oscillating and that the condenser C_5 is at zero. After a little perseverance you will probably hear the local station, although possibly quite faintly. Now try adjusting the potentiometer and you will note that signals will begin to increase in strength as the oscillation point is approached.

Results Obtainable

Now try adjusting the condenser C_5 , at the same time rotating the frame until the position for strongest signals is found. After a while you will find that this tuning operation is very simple since one soon learns the approximate average setting for the potentiometer and reaction controls. The variables then become the frame, the frame tuning condenser, and the oscillator condenser. Try various H.T. values and also different positions for the pick-up coil of the oscillator coupler. With regard to the latter I do not think you will find this critical. If very loud signals are being handled you may find it helpful to replace the 4-megohm grid leak on the second detector with one of 2 megohms. The 4-megohm leak, however, is a more sensitive arrangement.

It is impossible to predict the results obtainable from a receiver of this type since so much depends on the skill of the operator. It is perfectly safe to say, however, that it will receive the majority of the British and European broadcasting stations at loud-speaker strength. In London, at a distance of a quarter of a mile from 2 L O, the receiver will cut out this station with ease and receive a large number of other stations without interference. Although no very elaborate precautions have been taken to ensure abnormal selectivity, 2 L O only occupied about a quarter of each scale.

OPERATING LOUD SPEAKERS

—continued from page 121

from about 0.005 to 0.05 mfd. Hence by adopting the combined arrangement shown in Fig. 3 we can make the reproduction high- or low-pitched at will.

A Recommended System

It will be obvious that, in addition to tone correction, the above arrangement can be used as a volume control after a little skill has been acquired in reducing both the high and low notes in the same proportion.

So far we have shown the loud speaker connected directly across the anode impedance. Apart from the fact that the local circuit is thus at a high potential, this arrangement causes the audio-frequency variations to pass through the high-tension supply in order to reach the cathode. This may result in oscillation due to coupling effects with other valves, particularly if a battery eliminator is used.

There is, however, no reason why these audio-frequency variations should not be led direct to the cathode and the loud speaker kept at earth potential by connecting the latter to the low-tension negative terminal of the set as shown in Fig. 4.

The writer strongly recommends that the complete circuit of Fig. 4 should be adopted as a standard, because not only does it eliminate practically all the disadvantages of direct coupling enumerated at the beginning of this article, but it is the only satisfactory method for battery eliminator working—apart from a good transformer, which is, however, more expensive.

One-Wire Extensions

It may be pointed out that the method of connection shown in Fig. 4 allows of long loud-speaker extensions being made with only one wire. The L.T. negative is always earthed, and hence it is only necessary to earth the speaker at the distant end in order to provide a return path for the current as shown in Fig. 5.

In conclusion, it should be mentioned that no attempt to control the volume given by a loud speaker should be made by shunting across it a variable high-resistance. This method is often advocated, but there is a danger that the high notes will be by-passed.

THE GUARANTEE OF THE PERFECT TERMINAL

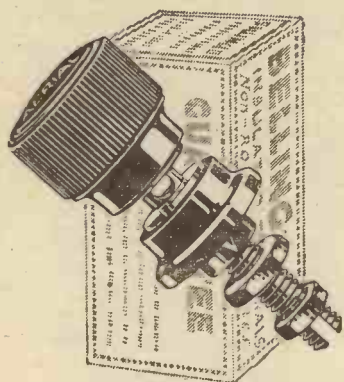

Every Belling-Lee terminal—the most perfect terminal in the world—is sold in an attractive Carton containing a year's guarantee.

All discriminating Wireless enthusiasts choose Belling-Lee terminals. Are you numbered amongst them?

PRICES.

Type "B." Bakelite insulated—9d. each.
Type "M." As type "B" but smaller, and non-insulated—6d. each.

Both types made with 39 different engravings.

BELLING-LEE TERMINALS

Belling & Lee, Ltd., Queensway Works, Ponders End, Middx.

For the 1928 Solodyne



Really good reception is dependent on efficient H.T. current supply. The Columbia Layerbilt is by far the best H.T. Battery to-day, and although the initial cost may slightly exceed that of other batteries, it is easily the most economical in the long run; in fact, it is the only H.T. Battery which will economically support the drain of the Solodyne for any length of time. On sets of four or more valves it will give the average user eight to twelve months' sterling service.

Price 25/-

No waste space.
No soldered connections.
Every inch a Battery.

Drop a card for literature.

J. R. MORRIS,
15, Kingsway, London, W.C.

Scotland: J. T. Cartwright, 3, Cadogan St., Glasgow.

WHAT ARE VALVE CURVES?

—continued from page 170

the amplification we ought to get, and of the grid bias and H.T. we should employ, but at the best they are only half-truths. If followed slavishly the curves may lead you right up the garden, especially where L.F. amplification is being undertaken and distortionless outputs are the aim of the constructor. To be more reliable each valve should have its individual curve taken, and as the makers cannot be expected to "take the temperature" of each individual valve, I would advise all really keen enthusiasts to take the curves of their own valves.

Tracking a "Dud"

It is a fascinating business, is not difficult, requires only a milliammeter, voltmeter, and the necessary batteries, and when they have taken the curves they will be more in a position to know how to treat the particular valves they have.

For instance, I had a very well-known power valve which gave peculiar distortion after it had been in the set a few minutes. I took its curve, and that showed what the trouble was. At 60 volts it behaved splendidly, at 100 it was quite good, but at 120 it rose a little at 20 volts-15 volts negative grid bias, and then went vertical. The valve was "soft," and was therefore of no use.

So if you have peculiar, or suspected, valves, take their "temperatures," so to speak, you may be surprised at what the milliammeter readings will tell you.

RADIO REMINDERS

Many valuable pigeons are lost annually through accidentally flying into aerial wires.

Corks placed at intervals along your aerial will prevent pigeons from flying into it, and will in no way impair the reception of wireless signals.

The use of a wrong type of jack for switching may result in the burning out of one or more valves, or in the ruination of an H.T. battery,

PROTECT YOUR VALVES!



If your reception is unsatisfactory, see that your Valve Holders are guaranteed to absorb shock and eliminate microphonic noises.

Only Valves efficiently protected by good valve holders give perfect results.

When the valve pins enter the valve sockets of the Lotus Valve Holder there is an immediate and lasting connection. The leg sockets expand and automatically lock, and the floating platform in which they are fixed is suspended by four phosphor-bronze springs. These springs have great mechanical strength, but are sufficiently resilient to absorb any external shock liable to damage the valve.

NOTE THE NEW PRICES:

Valve Holder without terminals - 1/6
Valve Holder with terminals - 1/9

All anti-microphonic type.

Lotus Valve Holders are used and recommended in the Mullard circuits in Radio for the Million, and are ideal for use in the Master Three and the Cossor Melody Maker. Use them in YOUR next set.

From all Radio Dealers.



Made by the makers of the famous Lotus Remote Control, Lotus Vernier Coil Holder, and Lotus Jacks, Switches and Plugs.

GARNETT, WHITELEY & CO., LTD.,
Lotus Works,
Broadgreen Road, Liverpool.



OUT-OF-DATE H-T BATTERIES are the source of continual expense and disappointment

How often have you experienced poor reception due to run-down batteries? Think of what a permanent H.T. supply at small cost would mean to you. This battery supplies a steady current ensuring pure, undistorted tone of consistently good strength. A current that can always be kept up to scratch and effect an enormous saving in cost.

Get this Free Book

Take the first step by sending for FREE Booklet describing every detail for installing and maintaining this super-efficient and money-saving battery.

2-VALVE SETS:	3-5 VALVE SETS:	SUPER SETS:
A. 4.90 volts. 25/1	D. 6.108 volts. 37/3	E. 6.126 volts. 69/6

DEFERRED TERMS. NO DEPOSIT.
 ORDERS OF 10/- OR OVER CARRIAGE PAID.
 Single Units of 1½ volts each from 4½d.
 Dept. (F), WET H.T. BATTERY CO.,
 12, Brownlow Street, London, W.C.1.
 STOCKED BY HALFORD'S CYCLE STORES.



Avoid all troubles & expense of H.T. supply by installing the

STANDARD

PERMANENT
H.T.
 SUPPLY

The Vital Power in Radio!

M.B.35

DIX-ONEMETERS
 are the best Bargain ever offered to radio users. £10 worth of precision, Multi-range Mirror scale, Jewelled knife-edge Instrument for 55/-

NEW A.C. MODEL "Onemeters"
 Now Ready. Ask for A.C. leaflet.

MELODY MAKER "VIOLINA"
 A cabinet loud speaker listed at £5 and worth it.
 Sale Price 25/-

ELECTRADIX RADIOS, 218, Upper Thames St. E.C.4

EVERYTHING RADIO ON EASY TERMS

WOOLDRIDGE RADIO CO. LTD.
 26 LISLE ST. LEICESTER SQUARE LONDON, W.C.2.

RADIO ABROAD
 —continued from page 182

the number who attended the exhibition in London, and consider the comparison very favourable. It is a sure sign of a healthy interest and activity in radio in France which, until comparatively recently, has rather lagged behind the United States and Great Britain.

High-Power Short-Waver

M. Descarsins, a French military radio engineer, has developed a circuit into which he can put as much as 20 kilowatts, using a 45-metre wave. His transmitter has been heard throughout Europe and the East, as well as in South America. He utilises a new type of Holweck demountable tube, which can easily be repaired if damaged.

H.F. Applications

Short waves, which have proved so extremely useful in radio communication, may possibly also perform valuable service in other directions, if the experiments which are being conducted with these waves at the Institute of Actinology, in Paris, are successful. Dr. Jean Saidman, the Director of the Institute, has installed many kinds of apparatus for the production and test of different kinds of radiation. He has obtained some very good results by means of 80-centimetre wireless waves produced by a small valve oscillator of the type used in short-wave transmission work. The output of this oscillator is discharged from a small loop of heavy copper tubing, and may be focussed upon the patient by a suitable reflector. If desired, the radio energy may be concentrated on a single part of the patient's body, such as an arm or a leg, by surrounding that member with a coil of wire like that used on the oscillator itself.

Whether or not these high-frequency currents have any special electric effects is not yet known with certainty, but they produce local heating effects in the affected tissues, and the good results which are already beginning to be obtained are ascribed by the doctors to this cause.

Wireless in the Fatherland

Wireless in Germany showed a curious lack of enterprise until perhaps a year or two ago—quite unlike most

technical industries in that country. But during 1926 and 1927 it has increased enormously in popularity. To-day Germany is second only to Great Britain amongst European countries in the number of wireless listeners. At the beginning of 1925 there were about half a million listeners in Germany, at the middle of 1925 over three-quarters of a million, and at the beginning of 1926 just over a million, at the middle of 1926 about one and a quarter millions, at the beginning of 1927 one and a half millions, and at the present time over two million, which reflects a very healthy progress in the industry!

Picture Transmission

Several demonstrations have taken place recently—one at Geneva, on December 9th—of a system for the reception of broadcast photographs, drawings, manuscripts and so on, by means of a new apparatus, stated to cost only about the same as a multi-valve receiver. At the time of writing, this particular apparatus, made by a Mr. Fulton, has not been publicly shown in England. It is a modification of a system used many years ago for the transmission of pictures by telephone wire. The Fulton system employs an electro-magnetic method of synchronization, whilst the images are recorded by electro-chemical action. It is claimed that the receiving apparatus is so simple that it can easily be manipulated by the average listener, whereas apparatus which has previously been produced for similar purposes has generally been much too complicated for the ordinary use.

"Rayfoto"

In this connection, the well-known Cooley "Rayfoto" picture-receiving system, which has been described during some months past in the American journals, is now on the U.S. market both as a completed receiver and also in the form of components for home construction. The Cooley apparatus was demonstrated in actual operation at the recent New York Radio Show, and attracted a great deal of interest. Pictures will be sent by certain broadcast stations in the United States, using their regular wave-length, and no tuning changes will be necessary in the ordinary wireless receivers.

Great interest is being displayed in the home construction of these photo-receivers and undoubtedly their introduction has given a valuable impetus to radio.

ISN'T IT GREAT!

Sifam control brings the true realisation of what perfectly balanced reception really means. "Isn't it great!" you'll say, as the undistorted beauty and naturalness of reception is borne upon you.

The popular-priced Sifam Meters have proved a great boon to thousands of enthusiasts who have learnt the value of testing their sets every night with these precision meters, and so avoiding expensive repairs to over-discharged batteries, and burnt-out valves.



NEW MODEL
Pocket Volt-
meter, High
resistance
4000 ohms.
Heavy nickel-
plated
case 9/6

Plate and filament current is controlled in exact proportions, and distortion is banished for ever!

All instruments unconditionally guaranteed; finished in heavy nickel plate and easily adaptable to panel mounting. Ask your dealer to show complete range.

SIFAM ELECTRICAL
INSTRUMENT Co., Ltd.
(Dept. M.W.), 11a, Page St.,
WESTMINSTER, S. W. 1.



M. B. 54.

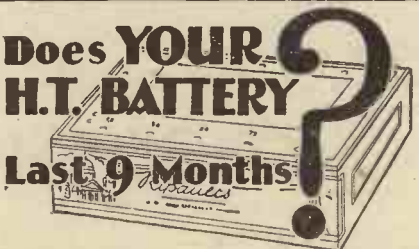

FREE: An interesting and instructive letter on H.T. Dry Batteries, which all readers will easily understand and fully appreciate. Sound advice on the way to choose the correct battery for your set. A "Life Chart" and "Right Choice" table of

RIPAULTS' SELF-REGENERATIVE H.T. DRY BATTERIES,
which give 50% longer life.

All sent Free to those who write for Folder MW/50.
RIPAULTS LIMITED,
Kings Road, London, N.W. 1.

INDICATING TERMINALS

BEFORE starting the construction of a new set, amateurs should take note as to where the receiver is to be used. The terminals of most modern sets are at the back of the cabinet and are thus tidily tucked away; but if the set is to be placed in a corner of the room close to a wall the terminals are not then going to be easy to get at. Not that it will be necessary frequently to refer to them, but occasions will arise when it will become necessary to disconnect one or other of the leads.

If one or both of the batteries are removed, the loose leads should not be left hanging down, and it is at such a time that it will be necessary to unscrew and subsequently re-screw the leads to the terminals. Such operations will be greatly facilitated if the terminals are of the coloured type. Then, even should the set be in a rather dark part of the room, there will be no difficulty in identifying the various points of connection.

ODD RADIO JOTTINGS

In pursuance of their policy to abandon spark transmitters, and thus reduce interference with broadcasting, the Post Office is reconditioning the British shore stations. Instead of spark apparatus the new Humber radio station is fitted with interrupted continuous wave (I.C.W.), and valve transmission has been introduced also at the Seaforth station at Liverpool.

The cost of the high-power station at Rugby, including the site, buildings, and plant, was approximately half a million pounds.

Many of the foreign stations are in the habit of relaying British programmes when conditions are good. This explains why it is sometimes possible to pick up Daventry (5 X X) upon a wave-length other than that on which the programme is supposed to be transmitted.

Time signals are now sent out from the Rugby high-power station on 18,740 metres, at 10 a.m. and 6 p.m. daily.



IT STANDS OUT

THE "PEERLESS" VARISTOR

In design the "Peerless" Varistor is recognised by the home constructor, the set manufacturer, and the expert designer as the neatest and most compact component in its class.

The reliability of its performance is assured by the high class quality of the materials used. Our many years specialised experience in resistance winding, guarantees efficient and lasting service.

Stocked in 3, 6, 10, 15, and 20 ohms.

SPECIALLY SUITABLE FOR THE COSSOR MELODY MAKER 1/3 each.

The BEDFORD ELECTRICAL AND RADIO CO., LTD.
22 Campbell Road, BEDFORD

LONDON:
21 Bartlett's Buildings, Holborn
Circus, E.C. 4
GLASGOW:
113 St. Vincent Street, C.2

PICKETT'S CABINETS

The RADIOLA BUREAU

Fully described in "POPULAR WIRELESS," page 416, Oct. 22nd, 1927:—

"... is a magnificent production dignified and graceful style... appeals strongly to us... worthy of the term 'de-luxe'... a good return for one's money."

"MODERN WIRELESS," page 511, Nov., 1927:—

"... modelled on Queen Anne lines... a very handsome piece of furniture—strongly constructed... beautifully polished... we consider it good value for money."



3 ft. high, Solid Oak, or Mahogany, beautifully finished. In many sizes.

From £5 5 0 to £15

Sent on Approval Direct from Factory.

No need to rebuild heaviest batteries. In sizes for every set and Full Lists FREE.

PICKETT'S CABINET WORKS (M.W.) Bexleyheath, Kent.

WET H.T. BATTERIES



Solve all H.T. troubles. SELF-CHARGING, SILENT, ECONOMICAL. JARS (waxed) 2 1/2 x 1 1/2 sq., 13 doz. Zincs New type, 11d. doz. SACS 1 2 doz. Sample doz. (18 volts), complete with bands and electrolyte, 4/3, post 9d. Sample unit, 6d. 16-page booklet free. Bargain list free.

AMPLIFIERS. 1-Valve 19s. 2-Valve 30s. 2-Valve All-Station Set 4s.

M. TAYLOR, 57, Studley Rd., Stockwell, London.

Self-Adjusting!

For best performance your valves require a variable filament control to supply the definite current they need, despite L. T. battery variations. AMPERITE is the only self-adjusting and automatic filament valve control that does this. Takes the "guess," inconvenience and unsightliness out of panel rheostats. Simplifies wiring, panel design, and tuning. Prolongs valve life. Order by name. Accept nothing else. For sale by all dealers. Price 5/-, with mounting. Write for FREE "AMPERITE BOOK" of season's best circuits and latest construction data.

Distributed by ROTHERMEL RAD. CO CORP. OF CT. BRITAIN LTD. 24, Maddox St. London, W.1

AMPERITE

REG. PAT. OFF.

The "SELF-ADJUSTING" Rheostat

Why buy Accumulators or Dry Batteries? — join our Service!

If your accumulators are serviceable let us correctly recharge them. If not, hire ours—High and Low Tension and both perfect, trouble-free services. Weekly, fortnightly or monthly deliveries anywhere within 12 miles of Charing Cross.

Particulars free on application. RADIO SERVICE (London) LTD., 105, Torriono Avenue, Camden Road, N.W.5.

Phone: North 0623, 0624, 0625.



TYPES OF MICROPHONES

THERE are three types of microphones in general use by broadcasting stations. There is, first of all, the carbon type, and this is nothing more or less than a variation of the microphone used in P.O. telephone installations. The principle upon which the carbon type operates is that the electrical resistance of pieces of carbon bunched together decreases when they are compacted more closely. The diaphragm actuated by the vibration due to sound waves subjects a mass of carbon particles to correspondingly varying degrees of pressure. This has the effect of varying the current flow through the carbon particles accordingly, and thus are sound waves transformed into electrical variations.

The Condenser Type

The condenser type of microphone has been used with great success by two or three continental broadcasting stations, and is being brought into considerable prominence in the United States. This variety is simplicity itself. In essentials, the instrument consists merely of two small metal sheets separated by air or some other elastic insulating material. These two plates form an electric condenser. One also functions as the microphone diaphragm, and as it is vibrated by sound waves so does the capacity of the condenser vary. These variations of capacity upset a tuned circuit accordingly, and in this manner, again, can sound waves be transformed into electric vibrations.

Magnetic Variety

The third type of microphone is the moving coil, and this is, perhaps, the most interesting because this device enables air waves directly to generate electric vibrations. In effect, it is a dynamo. The diaphragm of the device is attached to a small coil of wire. This coil is brought within the influence of a strong magnetic field. This latter is due to an electro-magnet, and as the coil vibrates with the diaphragm so it moves to and fro in the magnetic field, cutting the ubiquitous lines of force and therefore generating electricity which is taken from it through two leads.

Naturally the strength or intensity of the current electricity is in accordance with the strength or degree of vibration imparted to the coils by

the diaphragm. A moving-coil microphone is much the same thing as a moving-coil loud speaker, just as an electric motor can be said to be much the same thing as a dynamo. It may provide you with a few moments of amusing reflection in digging out the significance of that statement!

CAPACITIES MADE EASY

IT is sometimes convenient to make small condensers for special purposes, rather than to purchase them. We must have some means of ascertaining the dimensions of the condenser to obtain a given capacity. The well-known formula comes to our aid:

$$C = \frac{nKA}{11,304,000d}$$

where n is the number of sheets of dielectric under strain, K is the specific inductive capacity of the dielectric, A is the area of overlap in square cms. of the conducting plates of opposite polarity, and d is the thickness in cms. of the dielectric.

A "Good Working Value"

Now if we want to make a number of fixed condensers of small capacity values, it is useful to have a "good working value" for A. If, for example, we make A 4 sq. cms. and work out our calculations accordingly, we shall find that n comes out as anything but a whole number for most capacities. It is better, therefore, to start by assuming that n = 1 for a capacity of, say, .0001 mfd., and thus find A from the formula.

Here is a practical example, using mica sheets (S.I.C. = 6 is an average value) .0125 cms. thick, i.e. 80 to the centimetre. From the above formula,

$$A = \frac{11,304,000Cd}{Kn} = 2.355 \text{ sq. cms.}$$

Now if we use two sheets of conducting material with an overlap of 2.355 sq. cms. (i.e. 2.355 cms. long by 1 cm. wide) we shall get a capacity of .0001 mfd. With three sheets we shall get .0002, and so on. For much larger capacities it will, of course, be best to increase the area of overlap. Do not forget that the number of conducting sheets is always n + 1, since n represents the number of active sheets of dielectric only.

A. V. D. H.

"POPULAR WIRELESS" IS THE LEADING RADIO WEEKLY.

**A BATTERY LEAD
DANGER**

A WIRELESS friend of mine came to me in dire distress the other evening, for it appears that on my recommendation he had just bought a new high-capacity dry battery for use in his set to replace the old one which had worn out. From what I could gather he had put it into commission and initially noticed the revivifying effect always produced by the installation of new H.T. batteries. For some inexplicable reason, however, the volume given by the loud speaker soon began to reduce, and in a comparatively short space of time the set was quite lifeless.

Battery Right Down

I accordingly went along to see if I could discover what had happened, and strongly suspecting the valves thoroughly tested them first. My

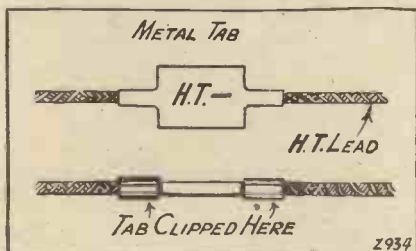

suspicions proved to be groundless, however, for there were no inter-electrode shorts, every filament was intact and consumed its rated current, while the emission was quite up to standard. The new H.T. battery was then tested with a voltmeter and found to register almost zero, pointing at once to some serious short-circuit which had to be traced if a repetition of the previous experience was to be avoided, for continual battery renewals is an expensive business under quite normal circumstances.

A Peculiar Fault

The various sources of possible short-circuit in the set itself, a well made four-valver, were examined with care, but in this particular instance all seemed in perfect order, and the trouble was traced finally to the high-tension battery leads themselves and proved to be the result of what can only be termed an unfortunate occurrence. These leads were of the usual rubber insulated type, but affixed to them were metal

(Continued on page 214.)



BENJAMIN Clearer-Tone Anti-Microphonic VALVE HOLDER

Make sure that the anti-microphonic valve holders you buy are Benjamin, because in these alone you get these 5 essential features:—

- (1) Valve sockets and springs are made in one piece with no joints or rivets to work loose and cause faulty connections.
- (2) Valves are free to float in every direction.
- (3) Valves can be inserted and removed easily and safely.
- (4) Valve legs cannot possibly foul the base-board.
- (5) Both terminals and soldering tags are provided.

Price 2/- each

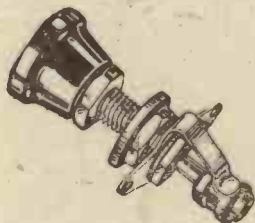

BENJAMIN BATTERY SWITCH

A sturdy positive action switch for high or low tension. It's OFF when it's IN, thus preventing the accidental turning on of current. Single contact. One-hole fixing.

Price 1/- each

There is a story told of a famous singer that he could sing a certain note into a wineglass and smash it into fragments by the vibration.

This is an extreme instance of the damage vibration can do. Nearer and dearer to you is the damage vibration does to the delicate filaments of your valves.

Every time a lorry rumbles past your house a wave of vibration travels to your radio set. Every time you walk across the floor another wave is sent.

The only way you can thoroughly stop vibration reaching the filaments is to fit Benjamin Anti-microphonic Valve Holders.

The smallest shock and vibration is quenched by the wonderful one-piece springs. Microphonic noises are entirely eliminated. The life of the valve is trebled at least.

BENJAMIN

ANTI-MICROPHONIC VALVE HOLDER

PRICE 2/- EACH

THE BENJAMIN ELECTRIC LTD.

Brantwood Works, Tariff Road, Tottenham, N.17.

A BATTERY LEAD DANGER

—continued from page 213

indicating tabs engraved with the familiar H.T. —, H.T. +1, etc.

As will be seen from the sketch they are kept in place by pressing over at each end of the tab small pieces of metal so that they grip on the circular rubber lead. In this instance, too much pressure had been applied with the pliers, with the result that the insulation of the leads had been punctured and the metal tabs were actually in electrical contact with the flexible wire inside. This in itself was not serious, but unfortunately one of the H.T. + leads had somehow got twisted together with the H.T. — lead during an adjustment of the wander plugs, and in consequence the two metal tabs had made contact, with the disastrous result that the battery was short-circuited and soon rendered useless.

If this type of H.T. lead indicator is adopted readers are warned to be very careful in securing them in position so as to ensure immunity from an occurrence similar to that quoted above—i.e. never press them on hard enough to break through the wire insulation.

"POPULAR WIRELESS"

Is the Leading Radio Weekly

Price 3d. Every Thursday

RADIO NOTES OF INTEREST

An American firm is now marketing an eliminator valve which, used with a proper circuit, produces from house electric lighting a constant noiseless flow of all the battery power required to run a receiving set.

Several scientific expedition ships have been wintering in the Arctic and Antarctic, and are keeping in touch

with civilisation through short-wave radio.

The famous Arctic exploration vessel, "Bowdoin" (call sign WNT), is wintering off the coast of Labrador, and uses a daylight wave-length of 20 metres, and an evening wave-length of 36 metres.

Signor Mussolini, the Italian Premier, has decreed that the English words "choke," "buzzer," "tuning" and other wireless terms shall not be used by Italian operators, who must employ instead the Italian equivalent of these terms.

TESTING YOUR H.T. BATTERY.

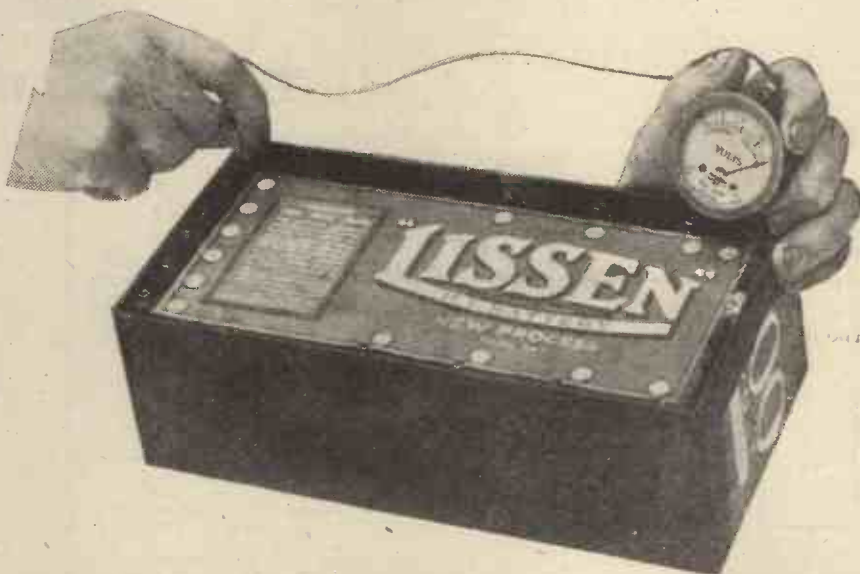

A good H.T. battery will give a long and honourable service, but eventually it will become exhausted. At this stage it can cause noises and distortion and should be replaced. Voltmeter tests at intervals are advisable, although you should use a high-resistance voltmeter. A low-resistance voltmeter may give fallacious readings and damage the battery.

An Essential for the 1928 "SOLODYNE"

"Utility" **TRIPLE GANG CONDENSER £4-0-0**

—if the limit of satisfaction is to be had! The "Utility" Triple Gang Condenser is spaced accurately, to accord with the Solodyne specification in "Modern Wireless," January issue, and is complete with four copper screens, aluminium panel and aluminium base screen.

The outstanding features of our popular ordinary-type Gang Condenser are embodied—variable, flexible coupling, total absence of torque, absolute rigidity. Individual units are securely attached to front panel, and the screens folded over to ensure straight edges. A thumb-control Micro Dial is fitted, with approx. ratio 90 to 1—facilitating fine tuning. Guaranteed.

DELIVERY EX STOCK.

Obtainable locally—or direct from the makers. Write for special leaflet.

WILKINS & WRIGHT LTD
KENYON ST. *Utility* BIRMINGHAM

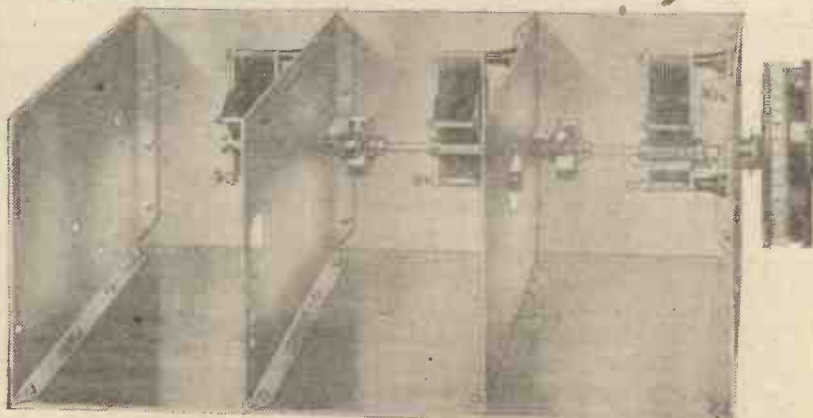

Triple Gang Condenser, complete with 4 Copper Screens and Aluminium Panel With Micro Dial, 10/6 extra. With Aluminium Base, 7/6 extra.

A PICTURE-RAIL-AERIAL MOUNT
By H. J. B. C.

No doubt there are many readers who from force of circumstances, or conditions of environment are compelled to work their receiving sets from indoor aerials, in lieu of those erected out-of-doors. When this is the case one of the most convenient ways of accomplishing this is to make use of the picture rail as a guide for the aerial wire. If the wire is cleated direct on to the top of the rail, however, there is likely to be a certain amount of leakage take place, and since under normal circumstances a loss of energy is not desired, a form of mount which gives a good measure of insulation, is not unsightly, and results in no damage to the room, will have a direct appeal.

Easily Constructed

The photograph accompanying this article shows the idea suggested; use being made of picture hooks, which can thus serve the double purpose of holding both the picture and the aerial wire. The number of hooks actually required will depend upon the size and shape of the room, but once this has been decided on by a rough calculation, the way to proceed is as follows:

Drill a $\frac{5}{16}$ -in. hole in the face of the hook, the exact position depending upon the angle it is desired to have

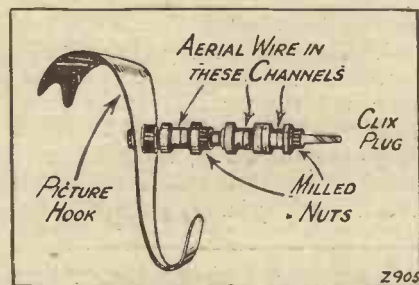

the insulators, and pass through this hole a Clix plug, with its usual insulating sleeve replaced with two Clix bushes, similar to those used for mounting under the Clix panel sockets. This will effectively insulate the metal portion of the plug from the brass hook, and after placing on the plug more of these bushes, arranged so that they make a channel for accommodating the aerial wire, screw home the milled nut and the whole will form a rigid projection from the hook face. When it is desired to run two or more wires round the

room it is a simple matter to insert another plug over the first one, securing to this second plug two pairs of the insulating bushes so that two more channels are made (see sketch), and so on, according to requirements.

Completely Removable

Furthermore, this scheme has the advantage that the down-lead end of the aerial wire can be fixed between the holding nut and plug, the insulating bush preventing electrical contact with the picture hook. Now connect one end of the down-lead to a plug, and it may be attached and detached from the hook position

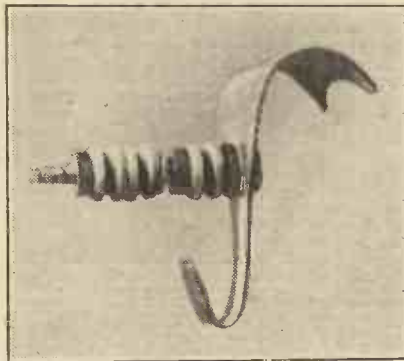

Here is a picture hook modified in accordance with the instructions given.

as occasion demands, thus avoiding the necessity for having the down-lead hanging permanently from the picture rail when not in use. The normal functions of the hooks, of course, are not interfered with in any way, and I have found the arrangement both convenient and handy. The aerial wire should be twisted once round each channel, this holding it secure for stretching the wire round the room.

"DUD" TRANSFORMERS

Do not throw away a "dud" or burnt-out transformer of the iron-core type, it is useful. First ascertain with a pocket battery and a pair of 'phones which winding has gone. To do this, place one of the battery tags on the input of the primary or secondary winding, the other battery tag connecting with one of the 'phone tags, and the remaining 'phone tag being taken to the output of the primary or secondary. In each case, if the winding is intact, a click will be heard. The sound winding may often be used as a low-frequency iron-core choke for experimental purposes.



Plantations and Panels.

5. The last lap in the long journey.

Now comes the last lap in the journey of the rubber which is to become a Resiston Panel. The long, thin sheets of pure rubber are now ready for ever to leave the land of their birth. The native tree tapper would see little resemblance in one of these sheets to the milky fluid he knew, but he would be more amazed to see what strength and what beauty is given to this self-same latex when, finally, it becomes a Resiston Panel.

Only the pick of the rubber ever finds its way to the Resiston factory. That is why Resiston has such sheer strength. Such lustrous beauty. Such perfect insulation. Why its colour is permanent. Why its dielectric constant is so low. If you want your Set to have the finest panel that ever was made, you will fit a Resiston Panel.

Resiston Panels come in 13 stock sizes in black and Mahogany-grained. From 6 in. x 9 in. in black, 3/5, to 8 in. x 30 in. Mahogany-grained 19/-.



"24 hours Cut Panel Service"

Advt. American Hard Rubber Co., Ltd., 13a, Fore St., E.C.

MORE ABOUT THIS YEAR'S "SOLODYNE"

—continued from page 134

so on. The general effect is to give a cleaner and quieter "background."

Next comes the question of valves. Since the screened-grid valves used in designing the Solodyne were of the 6-volt class (Marconi or Osram S.625) I propose to indicate in this article suitable combinations of other 6-volt types for the detector and L.F. stages. It is hoped at a later date to deal with the question of other types in the various stages.

For the detector and first L.F. stage you should use valves of the medium-impedance, medium-amplification factor types, rated as H.F. valves in most classifications. Here are a few examples in some of the leading makes: P.M.5X., D.E.L.610, Cossor 610 H.F., B.4H., S.S.6075 H.F., etc. For the last stage I would strongly urge the use of a really good super-power valve, and here there is a wide choice among the leading makes, any of which can, of course, be chosen.

H.T. Voltages

Turning to the question of H.T. voltages, it should be noted that one of these is a little critical and requires just a little care in making the first adjustment, after which it will be practically constant once found. I refer to the voltage on the-screening electrodes (terminal marked G2), and if the voltage on H.T. + 1 is between 100 and 120 volts (the usual working range) this one will be between 75 and 85 volts, and the adjustment should be carried out on as weak a distant station as you can find.

The voltage on H.T. + 2, which is the terminal which feeds the detector

valve, will usually be between 70 and 100 volts, a value which gives smooth reaction control being chosen in the usual manner. Terminal H.T. + 3 supplies the L.F. valves, and here it is recommended that as high a voltage as the valves will stand should be used.

G. P. K.

COIL DATA

Broadcast Waves

Formers:—3 in. diameter, 3 1/4 in. long, of any good insulating material.
 Bases and Sockets:—Standard "Special Flue" type (Peto-Scott, Burne-Jones, etc.). Dimensions of spacing strips (7 on each unit): 1/4 x 1/4 x 2 1/4 in. long.
 Secondary Windings:—80 turns in two halves wound in opposite directions, 9/38 Litz (silk). Same on all three units.
 Aerial Winding (i.e. Primary of Aerial Unit):—20 turns No. 32 D.S.C., tapped at 10 and 15.
 Transformer Primaries:—60 turns of No. 32 D.S.C. in two halves wound in opposite directions (each in same direction as half of secondary beneath).
 Reaction Winding:—45 turns of No. 36 D.S.C. in same direction as section of secondary against which it is placed.
 Spacing:—1/4 in. between halves of secondaries (i.e. in centre), 1/2 in. between reaction and secondary.
 Connections and General Arrangement:—See diagrams last month.
 Note:—Special article on the Solodyne on long waves next month.

TWO TIPS FOR CONSTRUCTORS

It often happens that when one has drilled a panel or strip of ebonite, as the case may be, it is desirable to drill another piece exactly similar. To do this, clamp the piece already drilled directly over the piece to be drilled, then drill one hole, using the drilled or upper piece as a guide. When this is done, insert a peg, as shown, in the hole thus drilled through the two pieces. Drill another hole in a like manner, and insert a further peg. The remainder of the holes may now be drilled without the slightest fear of the ebonite shifting.

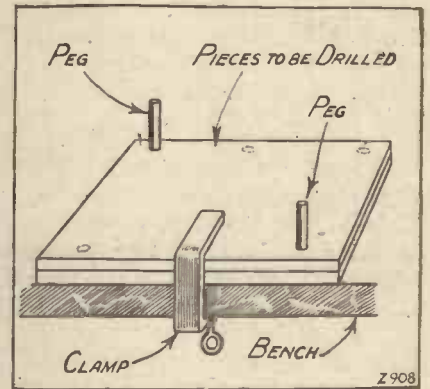

Forced Fits in Ebonite

I HAVE found from time to time that it is necessary to make forced fits in ebonite sheet. For example, it may be desirable to force a brass bar firmly into a hole previously drilled in ebonite sheet or rod. The simplest way of doing this is to warm the ebonite until it softens, then tap the material to be fitted lightly in the hole. It will be found to go in quite easily, without fear of breaking; but when the ebonite cools it sets hard again.

The HOME for your WIRELESS SET
 OUR STANDARD CABINETS
 are DUSTPROOF and house the whole apparatus, leaving no parts to be interfered with. All you do is UNLOCK AND TUNE IN. Made on mass production lines, hence the low price. Provision is made to take panel up to 30 in. wide and baseboard 20 in. deep. Carriage packed and packed free England and Wales. Thousands supplied with full satisfaction.
MAKERIMPORT Co.
 Dept. 2, 50a, Lord St., LIVERPOOL.
 From £4 15 0. Write to-day for descriptive pamphlet and suggestions for adapting your receiver or panel in our Standard Cabinets. Immediate Delivery.

The WHITELINE VALVE HOLDER
 "Mechanically and electrically perfect."
Bowyer-Lowe 2/3

INDEX TO ADVERTISERS

	Page
American Hard Rubber Co., Ltd.	215
Amperite Rheostat	212
Arcraft Company, The	208
Bedford Electrical & Radio Co., Ltd.	211
Benjamin Electric, Ltd.	213
Belling & Lee, Ltd.	209
Bird, Sydney S., & Sons, Ltd.	189
Bond, V. C., & Sons	193
Bowyer-Lowe Co., Ltd.	195 & 216
British Ebonite Co., Ltd.	201
Brown, S. G., Ltd.	189
Burne-Jones & Co., Ltd.	198
British Celanese, Ltd.	204
Carrington Manfg. Co., Ltd.	205
Celestion Radio Co., The	206
Cossor, A. C., Ltd.	114
Colvern, Ltd.	201

	Page
Day, Will, Ltd.	202
Dubilier Condenser Co. (1925), Ltd.	197
Eastick, J. J., & Sons	202
Electron Co., Ltd.	208
Electradix Radios	210
Ferranti, Ltd.	185
Forno Co.	205
Garnett, Whiteley & Co., Ltd.	209
Gambrell Bros., Ltd.	201
Igranic Electric Co., Ltd.	197
Jackson Bros.	199
Laker Co., James	208
Lissen, Ltd.	181 & 183
London Elec. Wire Co., & Smiths, Ltd.	200
Makerimport Co.	216
Metro-Vick Supplies, Ltd.	Cover iii
Morris, J. R.	209
Mullard Wireless Service Co., Ltd.	Cover ii
Music of All Nations	199
Paroussi, E.	205
Peto-Scott Co., Ltd.	207

	Page
Pickett's Cabinet Works	212
Portable Utilities Co., Ltd.	113
Popular Wireless	203
"Radio News," U.S.A.	205
Radio Service (London), Ltd.	212
R. I. & Varley, Ltd.	Cover iv
Rothermel Corp., Ltd.	201
Ripaults, Ltd.	211
Sifam Electrical Inst. Co., Ltd.	211
Taylor, M.	212
Telegraph Condenser Co., Ltd.	195
Wet H.T. Battery Co.	210
Wilkins & Wright, Ltd.	214
Woodlridge Radio Co., Ltd.	210
Wireless Constructor Envelopes	193

All communications concerning advertising in "Modern Wireless" must be made to John H. Lile, Ltd., 4, Ludgate Circus, London, E.C.4. Telephone: City 7261.

A Home-made Met-Vick Four

For working off the Electric Light Mains

The "Met-Vick" 4-Valve A.N.P. Set shown on this page can also be constructed for working direct from the electric light mains. This involves the use of "Cosmos" A.C. Valves and Battery Eliminators, and is fully described in the booklet 7117/4 obtainable from your wireless dealer complete with drilling template and wiring diagrams. The performance of the set is astonishingly good, giving great selectivity with a wide range, high quality of reproduction and simplicity of operation.

The cost of the necessary parts is low. Ask your dealer for the booklet or write to the makers.

METRO - VICK SUPPLIES LIMITED

(Proprietors: Metropolitan-Vickers Elec. Co. Ltd.)

155, Charing Cross Road,
LONDON, W.C.2

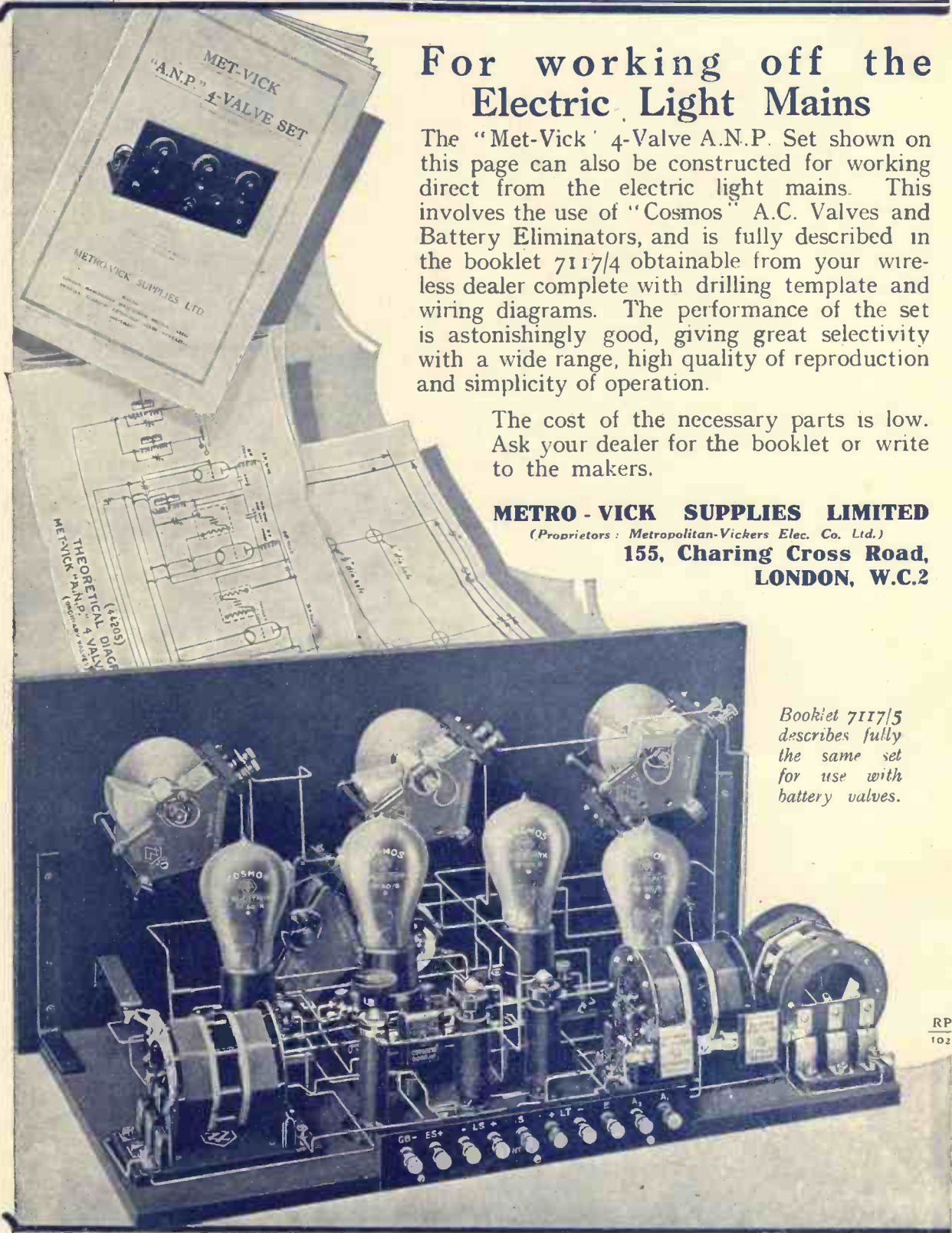

Booklet 7117/5 describes fully the same set for use with battery valves.

RP
102

FOR UP-TO-DATE RADIO

The remarkable popularity of

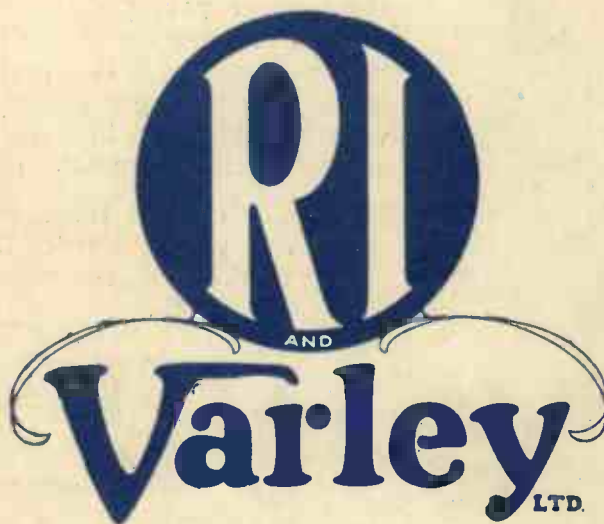

PRODUCTS IS THE RESULT OF
QUALITY

THE MARK OF



BETTER RADIO

Kingsway House, 103, Kingsway,



London W.C. 2 Telephone: Holborn 5303