

A MAGNIFICENT GIFT ISSUE

# MODERN WIRELESS

1/-  
MONTHLY

Edited by  
**NORMAN EDWARDS**  
M.I.R.E., M.R.S.L., F.R.G.S.

Vol. VIII. No. 11.

NOVEMBER, 1927.

*Free Booklet  
Inside!*

"THE  
COMPLETE  
TROUBLE  
TRACKER"



# Two Outstanding Mullard Achievements



Again Mullard takes the lead—'075 Valves and the New Model E Speaker. This new series of valves with the wonderful Mullard P.M. Filament consuming only '075 ampere makes all valves consuming 1/10 ampere extravagant. All the advantages of the wonderful Mullard P.M. Filament, great strength, long life, and copious emission are retained for the lowest available running cost.

## The Mullard Pure Music Speaker Model E

has solved the problem of Pure Music from a speaker of moderate price. Hear it and realise what amazing value it offers.



# Mullard

## MASTER · RADIO

Price  
£3 5 0

*Advt. The Mullard-Wireless Service Co., Ltd., Mullard House, Denmark Street, London, W.C.2.*

# CONTENTS

Vol. VIII. No. 11. MODERN WIRELESS NOVEMBER, 1927

	Page		Page
Editorial .....	437	Notes on a True Purity Circuit .....	481
Broadcasting Father Time .....	438	Questions Answered .....	484
A Day at Daventry .....	439	Sidelights on the B.B.C. ....	485
How Many Volts Do You Waste .....	441	The "Reactor" Short Waver .....	487
The "Experimental" Eight .....	443	Further Valve Developments .....	493
What Readers Think .....	452	L.T. Economy .....	495
The Interdyne Valve .....	453	Distortionless Volume Controls .....	497
Making Short-Wave Coils .....	456	3 L O of Melbourne .....	499
A de Luxe D.C. Unit .....	457	Radio Abroad .....	502
Some Readers' Results .....	460	My Broadcasting Diary .....	503
Round the Alps With a Portable .....	461	In Passing .....	506
Does Fading Trouble You? .....	463	In Our Test Room .....	511
The "Forty-Station" Four .....	467	How Much do You Amplify? .....	515
New Zealand Radio .....	473	A Standard Wave-Trap .....	520
Operating the "Super-Screen" Four .....	475	Radio Notes and News .....	526
Sources of H.T. Supply .....	477		

Edited by NORMAN EDWARDS, M.I.R.E., M.R.S.L., F.R.G.S.

Technical Editor: G. V. DOWDING, Grad.I.E.E.

Scientific Adviser: J. H. T. ROBERTS, D.Sc., F.Inst.P.

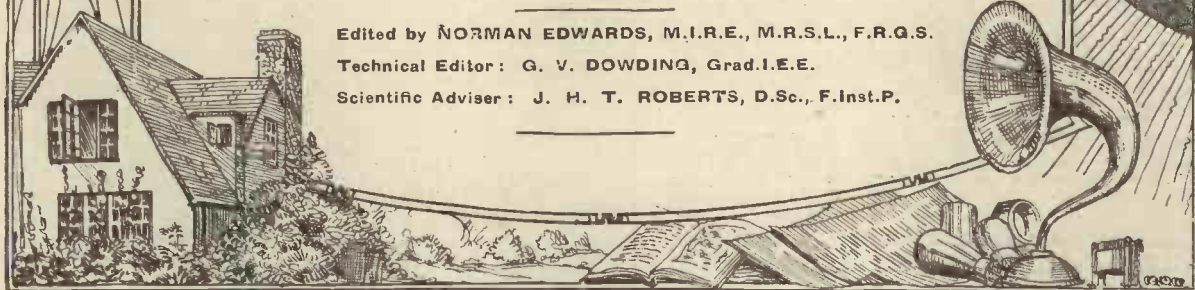

You can easily build a receiver like this from the clear instructions given in the FREE booklet. The set illustrated is the T-2, a 5-valve receiver, incorporating two Marconi S.625 Shielded Valves. It is a revelation in H.F. efficiency.

## Have you had your FREE circuit yet?

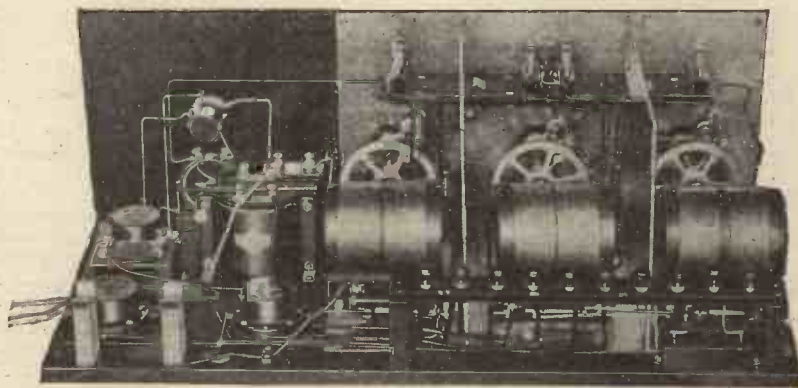

**SIX SPECIAL CIRCUITS** by the Marconiphone engineers are offered to the home constructor. Each one designed for a particular purpose, incorporates the very latest developments in radio. Four circuits are for receivers to operate direct from the mains; two show how to get the best results from the Marconi S.625 Shielded Valve.

**FREE CONSTRUCTIONAL BOOKLET**, including blue print and full details, will be supplied for any one of these receivers. Booklets (including blue print) of the other receivers 6d. each. Send a card now stating which booklet you require.

## MARCONIPHONE

The MARCONIPHONE CO., LTD. (AND REDUCED), 210-212, Tottenham Court Road, London, W.1.

Here are the circuits for operation

### ENTIRELY FROM THE MAINS.

- K.1 (for A.C. Mains). 3-valve receiver employing the famous K.L.I valves.
- K.2 (for A.C. Mains). Similar to K.1, but in addition incorporates an H.F. stage.
- D.P.1 (for D.C. Mains). 3-valve receiver—simple to construct.
- D.P.2 (for D.C. Mains). Similar to D.P.1, but gives greater range and selectivity by means of a neutralised H.F. Stage.

### DISTANCE WITH THE MARCONI S.625 SHIELDED VALVE

Achieved to perfection with these two circuits.

- T.1. 4-valve receiver, including 1 H.F. stage, with S.625 valve.
- T.2. 5-valve. Two H.F. stages, with S.625 valves. Stations hundreds of miles away can be tuned in with complete stability.

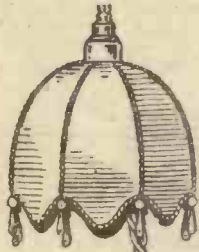

*For working  
entirely off the  
E.L. Mains*

The illustration shows the new Met-Vick 5 with the eliminators contained in the side cupboards. It can be plugged into a lighting circuit just like any other Electric appliance. If used with H.T. and L.T. batteries these can be accommodated in the cupboards. The circuit employs two phase-balanced and stabilized H.F. stages before the detector, and two resistance coupled L.F. stages.

Operation is extremely simple, the local station can be easily cut out and a wide range of alternative programmes obtained.

Special attention has been paid to running costs which are remarkably low.

The Met-Vick 5 is a really beautiful instrument and while a distinct advance on any 1926 model it still remains at a reasonable price. Obtain Leaflet 4117/9 for complete range of prices.

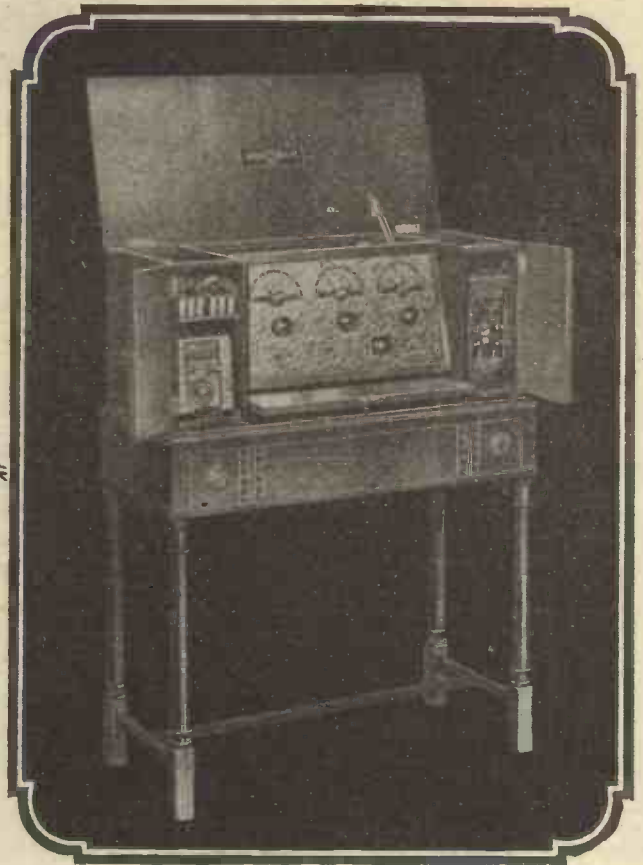

*Battery Eliminators*

Met-Vick Battery Eliminators are supplied in two models, one for providing filament current and the other for anode and grid currents, by plugging in on electric light mains. *The H.T.-G.B. Model* provides a high voltage (up to 250 V.) for the last valve (ensuring a large volume without distortion). It is fitted with a switch, a protective fuse and a distributor panel enabling it to be used on various supply voltages of 40-100 periods. Grid Bias tapings at 5, 10, 15 and 20 volts.

The smoothing system is of exceptional efficiency. The eliminator can therefore be used successfully with multi-valve and the most sensitive sets even in districts where there are considerable irregularities in the electrical supply.

*The L.T. Model* gives an output of 5 amperes at 4 volts and a potentiometer ensures complete absence of hum. Obtain copy of List 7117/8.



**MET-VICK**  
(COSMOS)

**METRO-VICK SUPPLIES LIMITED**

(Proprietors: Metropolitan-Vickers Elec. Co. Ltd.)

155 Charing Cross Road - LONDON, W.C. 2

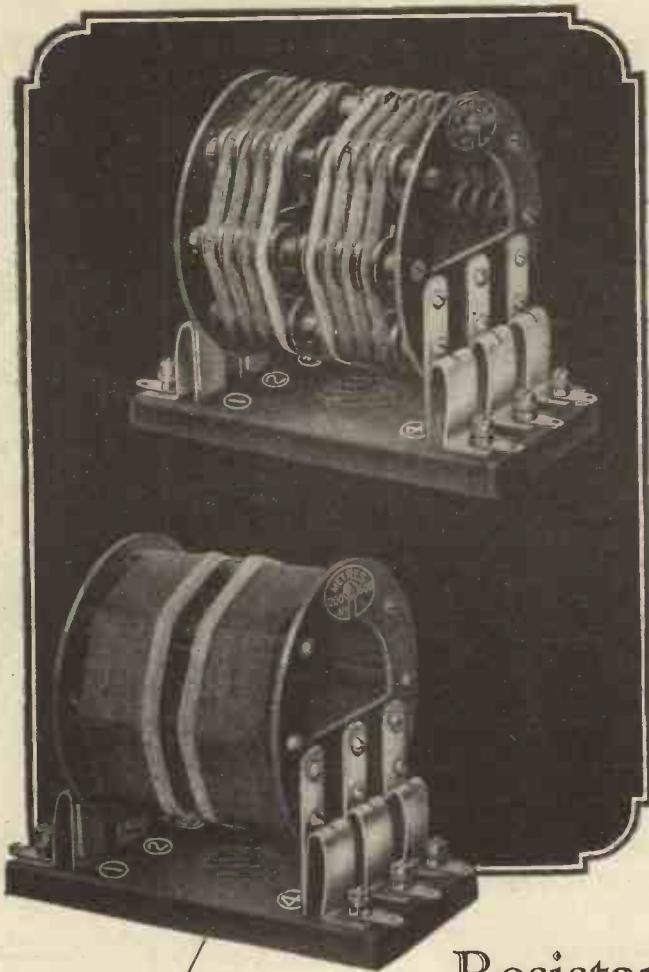

24

# A·N·P

(Astatic-Non-Parasitic)

# Coils

A CLEVER SOLUTION OF A DIFFICULT PROBLEM.

*Patents pending.*

Designed to overcome in a simple manner the three difficulties associated with high frequency amplification namely: Magnetic coupling between coils, Stabilisation, and Parasitic Oscillation. The first named is prevented by Astatic winding, obviating the necessity for metal screens with their disadvantages, the second is obtained by centre and quarter-tappings accommodating valves of various impedances, and the third is avoided by balanced self-damping windings, thus dispensing with the expensive double condenser and resistance method previously used.

*List 4117/8 gives full details and prices.*

## Resistance Coupling Units

Thousands of radio enthusiasts are loud in their praises of "Cosmos" (Met-Vick) Resistance Coupling Units. L.F. stages coupled by means of these Units result in clear Loud Speaker reproduction without distortion. The 'V' type unit can now be supplied fitted with the new 'Met-Vick' A.C. Valve Socket for use when building a set for working off the E.L. mains. The A.C. Valve-socket is also supplied separately for panel or baseboard mounting. Obtain List 7117/8 for full details and prices.



## MET-VICK

(COSMOS)

METRO-VICK SUPPLIES LIMITED

(Proprietors: Metropolitan-Vickers Elec. Co. Ltd.)

155 Charing Cross Road : : LONDON, W.C 2

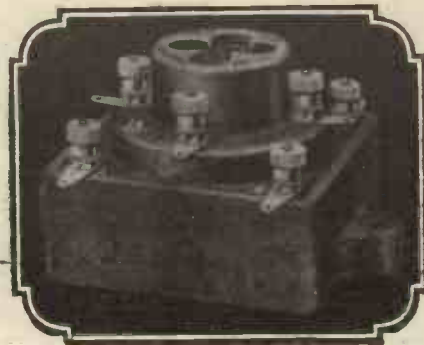

# free

Cossor's great scheme  
to bring Alternative  
programmes to all

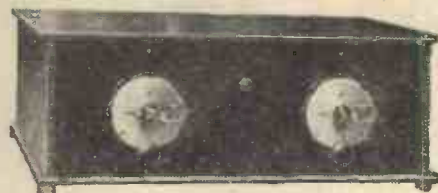

THE new B.B.C. Alternative programmes demand a new standard in Receiver performance. Only the Receiving Set which is 'Razor-sharp' in tuning will be sufficiently selective to tune out the unwanted local station in favour of the one which is required. Appreciating this the makers of Cossor Valves have made it easy for everyone to own a Receiving Set which has been specially designed to meet these new conditions of Radio. The wonderful new Cossor 'Melody Maker' is not only highly selective but, as its name implies, it gives amazingly clear and true to life reproduction. It is a real 'alternative programme' Receiver, for if its owner is dissatisfied with B.B.C. programmes a large number of Continental Stations in France, Holland, Germany, Italy, Spain and Switzerland are always available at full loud speaker strength.

## The wonderful Cossor "Melody Maker"

SOLDERING abolished—every step as clear as A.B.C.—failure is impossible. Here is the Set you'll be proud to own. Gives you all the best programmes from this country and abroad. Build it in one evening at the cost only of a few inexpensive components, which are stocked by every wireless dealer.

## As simple as a Meccano

HITHERTO only those technically inclined have been able to build Receiving Sets. But when A. C. Cossor Ltd. designed the Cossor "Melody Maker" they evolved a new constructional system so utterly simple that even the man who knows nothing about Radio is able to build it—and get results as perfect as with a factory-built Set.

*Build the  
wonderful*

# Cossor "Melody Maker"

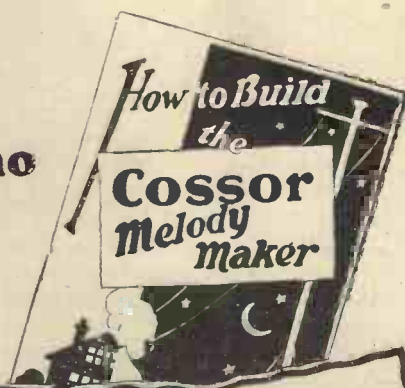

To A. C. Cossor Ltd., Highbury Grove, London, N. 5  
Please send me free of cost your constructional system  
"How to build the Cossor Melody Maker."

Name.....

Address.....

M.W. ....

# MODERN WIRELESS

Vol. VIII. No. 11.

November, 1927

## *The Lesson of Olympia—The King of Hobbies—The New Marconi Royalty Scheme—Alterations to 5 G B—An Improved Service.*

**B**y the time the Wireless Exhibition at Olympia came to a close it was very obvious that the hobby of Radio had once more demonstrated its agility in the matter of growth.

This year's exhibition resulted in a greater attendance than last year, and a corresponding increase in the interest in amateur radio work. Those who had any doubts about the permanency of radio as the premier hobby must have had them swept away by the evidence offered at Olympia this year. A good many hobbies have a transient popularity: a "craze" develops; thousands of people believe (for the time being) that they have found a hobby of eternal fascination. How often are they disappointed!

### Behind the Scenes

**B**UT with radio the interest seems to remain ever fresh and to secure added impetus as the years go by.

The reason is not difficult to seek. Wireless does not stand still: it personifies the spirit of progress, and constantly offers its devotees fresh developments and new fields to conquer. It is, indeed, the king of hobbies. As such we must pay it due respect—not forgetting those who gave it birth—Lodge, Marconi, Fleming, De Forest, and the broadcasting "stars" who, in this country at any rate, have done so much to forward the art of technical development from the transmission side—Captain Eckersley and his assistants, and the mysterious engineers of the Marconi Co., who, unknown by name, have done much sterling work without much public recognition.

But although unknown by name they are not forgotten. Their work bears fruit, and amateurs like Marcuse and Simmonds hold up the non-professional end in a way which does them high credit.

The moral of all this is—be thankful for a fascinating hobby which never grows stale.

**T**HE Marconi Co. announce its adoption of a new scheme in connection with royalties on receivers.

The effect is simple to understand. If you have purchased, for example, a three-valve set, on which you have paid a royalty of 12/6 per valve holder, but wish to discard it and buy instead a five-valve set, the royalty charged is only on the two extra valves. Instead of paying five times 12/6 (at the rate of 12/6 per valve holder), the royalty charge only amounts to 25/-, instead of 62/6.

This readjustment of royalty charges is very welcome indeed, and should do much to stimulate trade this season. An even greater stimulus would result if the 12/6 per valve royalty charge were reduced. A flat rate of 5/- per valve royalty would, we suggest, be more suitable in view of the fact that there has been an all-round reduction in prices of wireless manufactured goods. We trust that the Marconi Co. will give this question of a reduction in royalty charges very careful consideration.

**I**T was only to be expected that some alterations to 5 G B would have to be made, for, although an excellent service from that station was widely acclaimed, it was soon found that it was not entirely satisfactory, for two reasons. The first was that the transmissions suffered from directional effects attributable in large measure to the influence of the steel masts of 5 G B's big neighbour, 5 X X. The extent to which this screening effect took place was not dependent upon whether 5 X X's aerial was energised or not, but was mainly due to the metalwork in the mast system and the fact that energy was being dissipated in it by the 5 G B transmitter. The second was that a number of listeners still to be found in the Birmingham area had not adapted their sets to the conditions. These listeners lived under the shadow of the old 5 I T aerial and found no difficulty in receiving the Birmingham programmes on crude apparatus.

Eventually they realised that their sets needed considerable adaptation if they were to receive successful transmissions over a distance of 35 miles.

### Improved Reception

**T**HE B.B.C. recently carried out experiments in various parts of the Birmingham area with a seven-valve super-heterodyne receiver and a detector plate current meter, and it was established that the signal strength of 5 G B in that area was quite equal to that in the East End of London, where 5 G B is received at good strength. While advising Birmingham listeners to improve the selectivity of their sets, the B.B.C. promised to make every effort to assist by erecting a new and more permanent aerial consisting of one pair of masts 325 ft. high and 400 ft. apart. Further, the power of 5 G B is now likely to be from 25 to 30 kilowatts.

These alterations to 5 G B should now result in the elimination of the unsatisfactory state of affairs in the Birmingham districts and the conduct of a service meeting with widespread and general approval.

# BROADCASTING "FATHER TIME"



How the B.B.C.'s Time Signals are obtained.

By  
**J. F. CORRIGAN,**  
M.Sc., A.I.C.

ALTHOUGH time signals have been transmitted from the Eiffel Tower, Paris, since the year 1910, it is not to that station that the honour of being the first to transmit accurate time signals belongs. Five years before the Eiffel Tower commenced its famous time transmissions, the Naval Department of Washington, U.S.A., began a series of time-signal transmissions, such signals dating from the month of January, 1906.

In appearance this remarkable clock (a photograph of which appears at Fig. 1) puts one in mind of an ordinary grandfather's clock of the severely conventional type. Yet it is from this instrument that the world's time is obtained.

## The Mean Time Clock

Situated, along with several other duplicate clocks, in a small and entirely heat-insulated room to which access is obtained only by means of entry through three double doors, the Greenwich Standard Mean Time clock—the "World's Timekeeper"—carries out its vital function of measuring out accurate beats of time ceaselessly and in a perfectly constant and reliable manner.

The Standard Time clock is an instrument of the swinging pendulum type. A portion of its mechanism is sealed in an airtight case, and the entire clock is maintained at a constant temperature of 60 deg. Fahr. by means of a thermostat, or heat-regulating device, contained in the same room.

The pendulum of the clock consists of a light steel rod, which for part of its length is covered with a tube of a special alloy in order to compensate for any slight expansion or contraction of the rod which minor temperature changes might set up.

## "The Six Dot Seconds"

Fixed about half-way down the pendulum is a permanent horseshoe magnet, the poles of which swing slightly in front of the poles of an electromagnet in the manner indicated in the diagram, Fig. 2. By sending electrical impulses through the electromagnet the rate of the pendulum's swing can be controlled, and in this manner it is possible to adjust the clock to an accuracy amounting to 0.1 sec.

We have yet to learn, however, the manner in which the clock is able to transmit its time beats for broadcasting purposes. Such a procedure is not a difficult one to grasp. The clicks or "pips" audible to the listener during the time-signal trans-

missions are the result of the revolution of an escape wheel which, at a definitely pre-determined moment, is allowed to touch a spring with its teeth, and thus to set up a series of regular electrical contacts. The pulsations of current resulting from these contacts are conveyed by landline to the B.B.C. transmitter, amplified, and broadcast simultaneously.

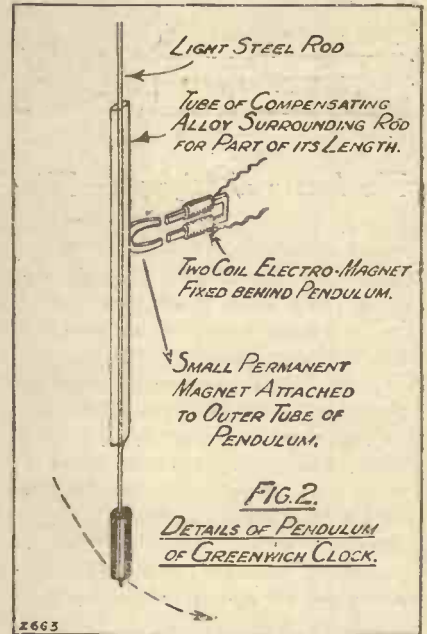

Thus, by switching into the clock circuit at the right moment, the B.B.C. engineers are able to broadcast the correct time instantaneously (for all practical purposes) to every listener.

In this connection it might also be mentioned for the benefit of those in doubt that it is the last of the series of six "pips," and not the first of the series, which indicates the correct time.

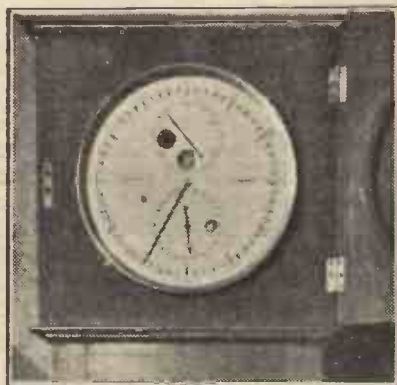
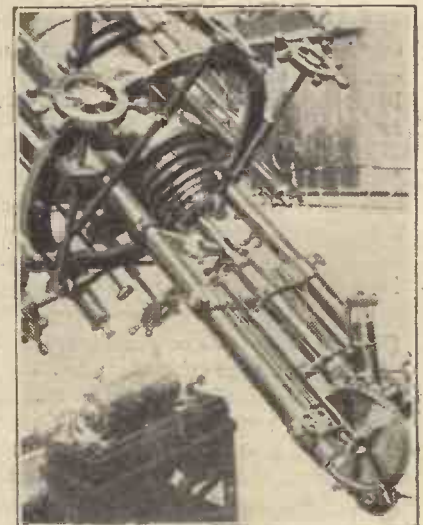

Fig. 1. The only existing photograph of the Standard Mean Time clock at Greenwich Observatory.

The B.B.C. people, however, are certainly the pioneers of "domestic" time-signal transmissions, if we may use that term, for before the Greenwich and Big Ben time signals were available for their use they relayed with wonderful accuracy the world-famous Eiffel Tower time transmissions. The rather complicated Eiffel Tower time transmissions are nowadays replaced by the simpler and still more accurate time signals from Greenwich, the famous "six pips" being derived from the Standard Mean Time clock at the Greenwich Observatory.



One of the large telescopes used for stellar and solar observations at Greenwich.





## A DAY AT DAVENTRY

*An interesting account of the routine tasks necessary at 5XX in order that the possibility of "shut-downs," the nightmare of the B.B.C. engineer, shall be reduced to a minimum.*

*By A DAVENTRY ENGINEER.*

**T**HE Daventry station is situated on Borough Hill, about one and a half miles from the town of Daventry itself. The hill is over 600 ft. above sea-level, and stands out well above the surrounding country. As might be expected, gales of wind are not an uncommon occurrence in winter; in fact, so strong is the wind at times that one wonders whether the two huge 500-ft. masts supporting the aerial are going to crash down and wreak destruction on the buildings beneath (to say nothing of the engineers inside).

Naturally, the masts have been designed to withstand such conditions with an adequate factor of safety, but it is a difficult matter to design an aerial system which has sufficient strength and at the same time is electrically efficient.

This brings us to one of the routine jobs that is carried out by Daventry engineers. It is not a daily job, but on certain days of the month the masts are climbed (by means of the iron ladders inside them), and submitted to a thorough inspection, together with the aerial, the halyards, pulleys, stay-ropes, mast-lighting equipment, etc. The climbing of a 500-ft. mast on a small (and slippery!) iron ladder is a task that calls for a clear head and a steady hand. A fall would certainly be fatal.

### A Daily Dust

Some of the engineers (the total staff of the station numbers fourteen, excluding the development engineers at 5GB) live in staff quarters on the site, and the work of the station is divided into shifts. Naturally, a man working till midnight could not be expected to be on duty again at 9.30 a.m. in the morning.

The work of the day begins at 8 a.m., when the night watchman "hands over" to the cleaners and mechanics. Apart from the question of appearance, it is essential that the

wireless apparatus and machines be kept scrupulously clean. Dealing with such high voltages, dust (not to mention moths, etc!) will easily cause a flash-over and shut down of the station, and that is to be avoided at all costs. The mechanic has to see that the machines are in order, and to repair any fault that may have occurred during the previous day.

### Warming Up!

At 9.30 two engineers report for duty, one for the control-room, and the other for the transmitter. The first duty of the former is to check with the London S.B. engineer the private lines between London and Daventry. They must be free from spurious noises and induction, and their frequency characteristics (which are obtained by means of a local oscillator in London, the output of which is put on to the line and measured at Daventry by means of a valve voltmeter) must be up to standard. If any of the lines fail in any respect, the faulty ones are handed back to Post Office trunk test for fault location or change.

All the control-room amplifiers have to be tested, batteries have to be charged, and everything must be in readiness for the weather forecast at 10.30 a.m.

Meanwhile, the transmitter engineer has been occupied with the starting of the pumps which circulate the cooling water through the jackets of the big water-cooled valves. It is important to see that each valve is getting its proper share of water. The machines are then started, and the valve filaments lighted at least fifteen minutes before power is switched on, so that the valve may be thoroughly warmed to avoid ionisation and softening.

### Valves at £80 a Time!

The correct adjustment of the filament voltage of each valve is extremely important; a voltage too high will mean a reduction in the life of the filament, and with valves at £80 a time this is a point to be watched. On the other hand, too low a voltage will reduce the emission so much that the valve will not operate on the correct part of its characteristic



Some of the transmitter panels at 5XX. The big water-cooled valves have to be carefully looked after, as they cost £80 each.

**A TWO-WAY COIL-HOLDER IMPROVEMENT**

ONE of the disadvantages of the ordinary two-way coil holder is that when using it in an experimental set, or in any way which necessitates the frequent changing over of the leads to the moving coil, the changing becomes exceedingly irksome. The ends of the flex leads often become frayed, and through the constant use of the screwdriver the screw heads get badly burred and sometimes need replacing.

A good many types of coil holder have 4 B.A. screws as the medium of contact, and, as a rule, these screws do not extend far into the ebonite before engaging the thread in the brass plug or socket. In this case the substitution of wander plugs for the screws is simplicity itself, the only proviso being that the plugs must be of the type which does not taper too finely, otherwise they will not make efficient contact.

**For Different Threads**

Should it happen that the plugs do not grip properly, and the contact is intermittent, the only remedy is to fit a couple of valve legs into the screw-holes.

The threaded shanks of the valve legs must be cut down to the length of the threaded portion of the screws, the cut ends filed flush, and if the length of the plugs which are to be used will allow it, about half the socket itself may be cut off and filed down in the same manner as the shanks.

There is a possibility that the threads in the coil holder may be 5 B.A. instead of 4 B.A., but this need be no deterrent, as valve legs are also made with similar threads.

**A MULTIPLE SPANNER**

During the course of the construction of wireless sets, erection of aeri-als, executing repairs, etc., there will be nuts of various sizes that need slackening or tightening with the aid of a spanner, and it is very annoying to find that the particular spanner sizes required are conspicuous by their absence. Some time ago I decided to remedy this by making up a multiple spanner.

Fig. 1 gives a rough idea of the scheme. The open jaws of a fairly

large spanner are about three-quarters filled with steel laminations,  $\frac{1}{16}$  in. thick. Fig. 2 (a), illustrates the shape of these laminations, and the

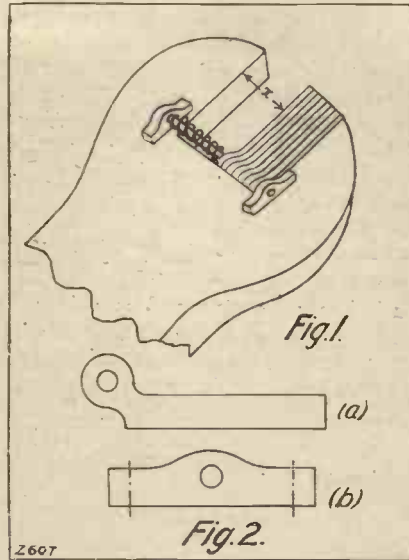

number required naturally will depend upon the size of the spanner chosen in the first place. They are held on a spindle passing through the hole indicated, while two supports, made similar to (b), are for the purpose of holding the spindle, which should be riveted over at each end. A small coiled spring should be slipped over the spindle before riveting so that the laminations are forced to one end, as shown in Fig. 1. By riveting the supports on to the spanner face, and letting the shaped edges of the laminations rest against the inner cheek of the spanner jaw, they serve to reduce the width "X" to a small amount.

To use the spanner on any nut it is merely necessary to lift over one or more of these laminations so that they lie along the spanner face, the whole being held quite rigidly by the helical spring. The spanner jaws can thus be made to accommodate nuts of varying sizes by turning the laminations through 180 degrees, and the tool proved very useful and effective in my own case, well repaying the little time spent on its construction.

H. J. B. C.

**A DAY AT DAVENTRY**  
—continued from page 439.

curve and will limit. The machines are now switched on to the set—one of 25 kw. to supply the drive-circuit high-tension, and the rectifier filaments, and two others of 70 kw.

each to supply the magnifier and modulator panels, the high D.C. voltages being obtained by means of suitable transformers and a full-wave rectifier system.

All machines are controlled by field rheostats centralised at one control table, and from this point the engineer is able to see the whole set and, if necessary, shut down everything by pressing a button.

At 10.30 a.m. the tuning note and weather forecast are given. Then follows a brief respite until 12 o'clock, when the morning concert begins. Except for an interval between two and three o'clock the transmitter is in practically continuous operation until close-down at midnight. Consequently, all repair work, aerial overhauls, and experimental work have to be carried out between midnight and 9.30 a.m., so that when the announcer bids you good-night it does not always mean that Daventry is really closing.

**The Check on Quality**

The transmission is constantly checked by the engineer on control. Not only does he check quality, but quantity as well, by means of a slide-back circuit and volume indicator which are calibrated against the transmitter at frequent intervals. The cause and probable duration of any breakdown are immediately telephoned to London, so that an announcement may be made from 2 L O. The breakdown percentage for last year was .09 per cent, representing only 162 minutes in the year!

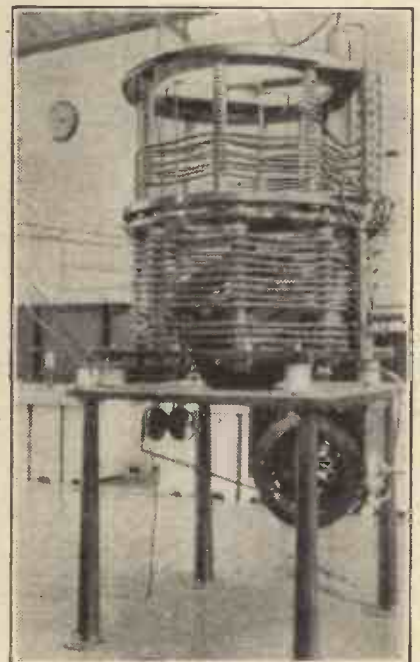

The aerial tuner at 5 X X, which, as in the case of all the gear, has to be kept free from dust and scrupulously clean.



This article deals with "an important and much neglected point which has a considerable bearing on the quality of reproduction that can be obtained from a given receiver."

By G. P. KENDALL, B.Sc.

I SUPPOSE that most readers on seeing the title of this article will expect to find it to contain a more or less useful but not particularly interesting dissertation upon some point in accumulator maintenance, tips for prolonging the life of H.T. batteries, or something of that kind. They may be surprised to find that it is actually dealing with a subject much nearer to their hearts, namely, that of the quality of reproduction which they get from their loud speakers. It may as well be confessed that the title was deliberately chosen to create such surprise, in order to direct the reader's attention as forcibly as possible to an important and much neglected point

voltage the longer becomes the useful part of the valve's characteristic curve, in other words, the less chance there is of over-loading, and the more perfect you make the rest of your set the more important does this become, because it is the main obstacle remaining between you and reasonably perfect reproduction.

**"Actual" Anode Voltage**

Now, I am afraid that what most people do to satisfy this requirement is to look up the maker's rating, and on finding it to be, say, 120 volts, they proceed to apply 120 volts to the H.T. terminal which feeds the valve in question. What I want such people to do is to ask themselves whether the 120 volts which their H.T. battery provides does really get to the anode of the valve, and if not, just how much voltage does actually reach the spot where it is wanted. As a matter of fact, the whole of it does NOT reach the anode, and the important point which is so often forgotten is that there is a voltage drop across the loud speaker, output filter, or whatever

it is that is included in the plate circuit. The extent of this drop depends upon the ratio of the "resistance" of the valve and resistance of the loud speaker, etc., and it

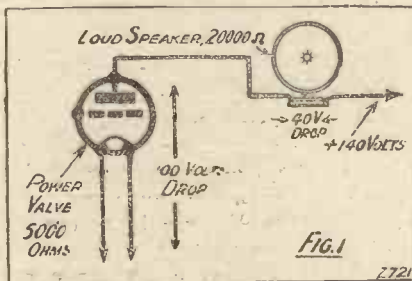
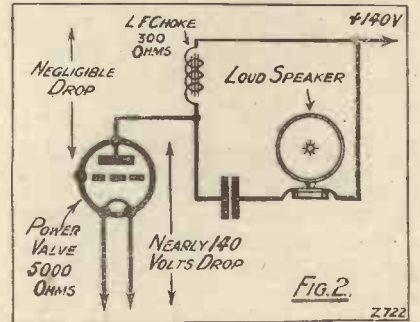

may be quite a large amount; it is always worth taking into consideration, and reducing as far as possible by a method which we shall be considering shortly.

**Effect of Resistance**

Let us first see just how serious the drop of voltage across the loud speaker may be. Suppose that a power valve is being used with a

which has a considerable bearing on the quality of reproduction than can be obtained from a given receiver and power valve.

**Overloading**

Most people by now realise that the first essential in getting really good quality is to see that the last valve in the set (the power valve, that is) is capable of handling the desired volume without being over-loaded and so introducing one of the worst of all kinds of distortion, and with any given valve this means that the full H.T. voltage permitted by the manufacturer must be applied to the anode. Remember that the higher the H.T.

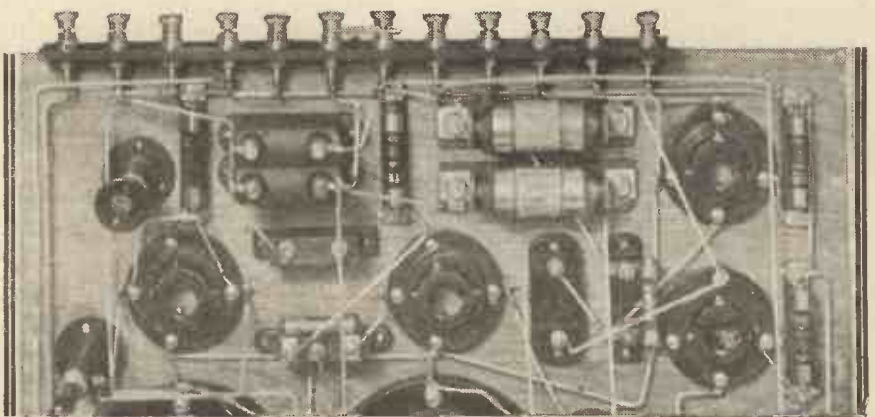

The total voltage of the H.T. Battery does not get to the anodes of the valves: there will be potential drops across the resistances in the anode circuits due to coupling resistances, loudspeaker, etc.

working "resistance" of 5,000 ohms, and that the loud-speaker resistance is 2,000 ohms. Further, assume that the proprietor of this valve is being, as he thinks, quite generous to it in providing an H.T. battery of no less than 140 volts; just how much is the valve really getting? The voltage drops across the valve and the speaker will be proportional to their resistances—i.e. five-sevenths of the total will be dropped across the valve, and two-sevenths across the loud speaker. In actual figures this is 100 volts and 40 volts respectively, and it means that the actual H.T. available to work the valve is only a meagre 100 volts, which is really something of a starvation ration for a full-grown power valve. The other 40 volts is simply wasted, and by now the reader will begin to appreciate the inwardness of the question contained in the title of this article! It will readily be seen, too, that things get worse the lower the impedance of the power valve, in other words, the better this valve is from the point of view of being able to handle strong signals without overloading.

**Advantages of Filter**

What then is to be done? We cannot alter the resistance of our loud speaker, and the only thing to do is to take it out of the anode

circuit altogether and use either an output transformer or an output filter. The latter is the usual expedient, and it will be seen that we are then concerned with the ohmic resistance of the choke employed, which in a good make will be quite low, of the order of a few hundred ohms. An output filter, then, is really extremely desirable if we are out for quality, since it cuts out almost entirely the waste of H.T., and permits a really useful voltage to reach the anode of the valve.

A word of warning, however; it does not do to use just any cheap choke, since many of these are of

quite high resistance, and defeat their own object. Similarly, it will not do to use one of the very high inductance chokes intended for intervalve coupling, these again being of high resistance. An inductance of 20 to 30 henries is sufficient for an output filter, and it is as well to choose only one of those makes of which the resistances are known. As an example, it may be mentioned that the choke in the set I am using at the moment is a certain 20-henry type, which has a resistance of only 250 ohms, and this forms a useful guide to the amount of resistance which may be regarded as permissible.

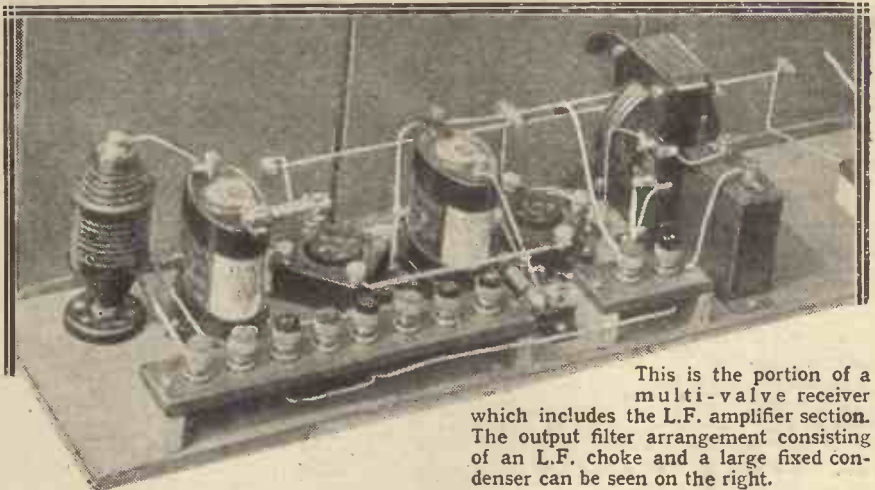

This is the portion of a multi-valve receiver which includes the L.F. amplifier section. The output filter arrangement consisting of an L.F. choke and a large fixed condenser can be seen on the right.

FOR the benefit of those readers who are primarily interested in the constructional articles which appear in MODERN WIRELESS, a small scale about 3 in. long will, in future, be incorporated with diagrams to which it can be properly applied.

The purpose of the scale is to supply readers with a means of ascertaining the position of any com-

**SIMPLIFYING THE "LAYOUT" OF YOUR SET**

ponent or drilling point which may not be clearly shown on the diagram.

It is probable in many cases that constructors will not want to cut the scale out of the paper in order to use it, and for obtaining small dimensions this would not be necessary if a pair of draughtsman's "dividers" are employed. In any case, the cutting of the paper can be obviated by either "tracing" the scale, that is, placing a piece of semi-transparent paper over it and making an exact copy, or by the alternative method shown in the illustration.

**Using the Scale**

Obtain a strip of fairly stiff white cardboard about the size of an ordinary 12-in. rule, and place this against the scale. Then carefully mark on the edge the necessary dimensions. This will give a 3-in. scale applicable to the drawing. If it is desired to make a 12-in. scale

move the cardboard 3 in. to the left, and repeat this until the scale is complete. By applying the scale to the diagram any required dimension can be found immediately.

It will, perhaps, simplify matters to give an actual example. Supposing we have a panel layout showing a drilling point, but no dimensional instructions for finding the position of the point on the panel.

The application of the scale rule along the edges of the panel in the manner shown will supply the necessary information. Two lines drawn at right angles to the panel edges will then provide the actual drilling point at the place where they cross.

It is probably unnecessary to emphasise that the scale rule is not applied to the actual panel or baseboard, as the case may be, but only to the diagram.

When the required dimensions have been found on the drawing, the scale rule is, of course, substituted for an ordinary rule, and actual inches are employed when ascertaining the drilling point on the panel itself.

H. A. D.

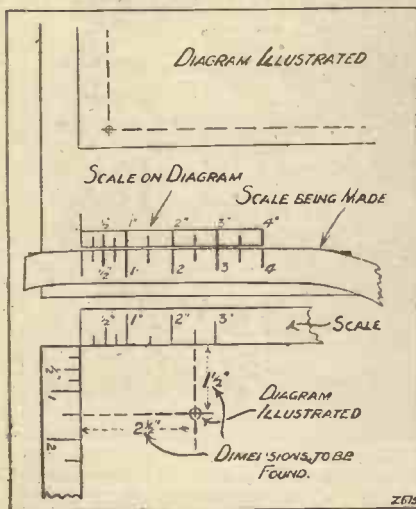

# The "EXPERIMENTAL" EIGHT



*A powerful eight-valve receiver suitable for use with either a frame or outdoor aerial, and covering an unusually wide series of wave-length bands.*

*Designed and Described by G. V. COLLE.*

**H**AVING constructed a large number of radio receivers, mostly of the multi-valve type, I have come to the conclusion that, apart from a good "straight" five-valve set, consisting of 2 H.F., detector, and 2 L.F., and gang control, there is little to equal a super-heterodyne for ease of operation, selectivity, and sensitivity.

Unfortunately, a set of the former type has rather a restricted wave-length range, especially if the H.F. valves are neutralised. In most cases

it is extremely difficult to go below 200 metres with two stages of H.F. amplification, and to tune to 2,000 metres or so generally requires the use of three new coils.

### Avoidable Faults

The super-heterodyne, on the other hand, will usually cover wave-lengths below 200 metres with a small outdoor aerial, but will not tune to the high wave-lengths so satisfactorily, owing in most cases to the smaller frequency difference which exists between the

incoming signal and that of the intermediates.

It also suffers from the disadvantage that initial adjustments are sometimes rather critical. Many a budding super-het enthusiast have I known who has had his enthusiasm sadly damped when it came to giving the set its primary test. Generally the trouble was not due to the fact that the set was not capable of giving the results claimed, but to the inexperience of the operator.

In the majority of cases which have

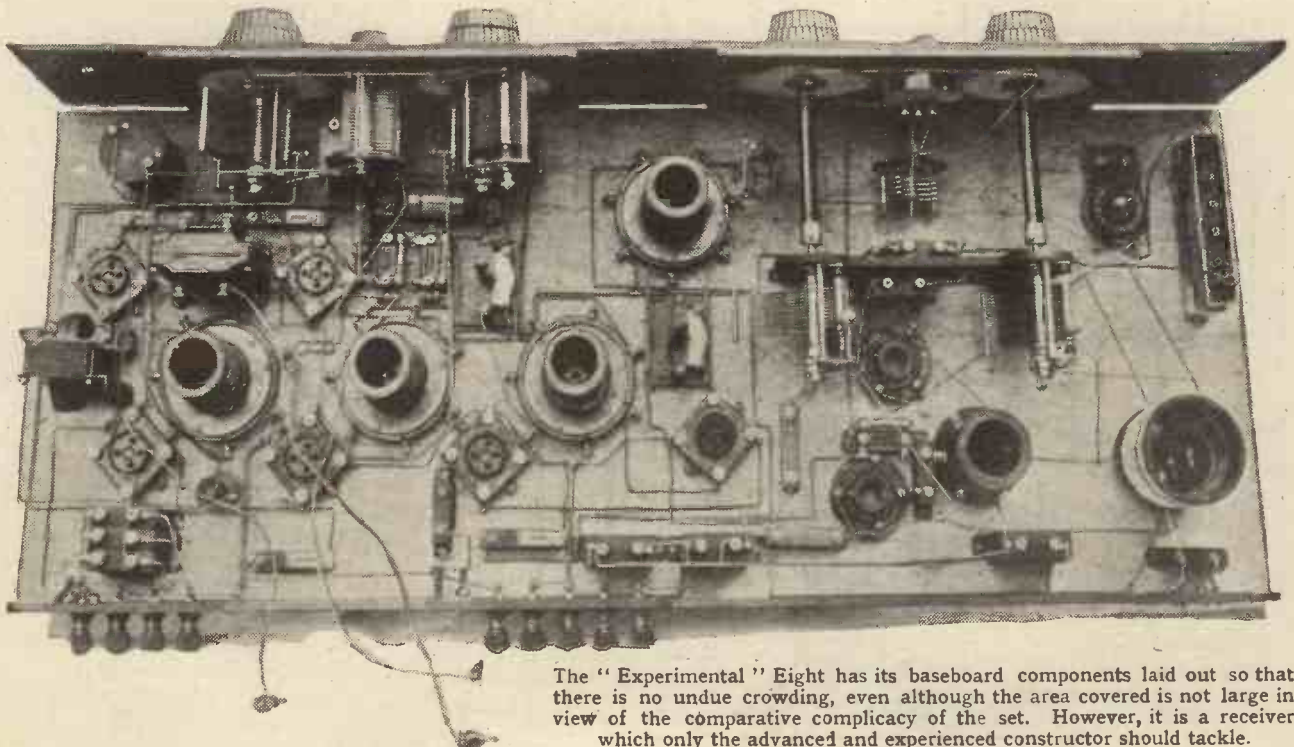

The "Experimental" Eight has its baseboard components laid out so that there is no undue crowding, even although the area covered is not large in view of the comparative complicacy of the set. However, it is a receiver which only the advanced and experienced constructor should tackle.

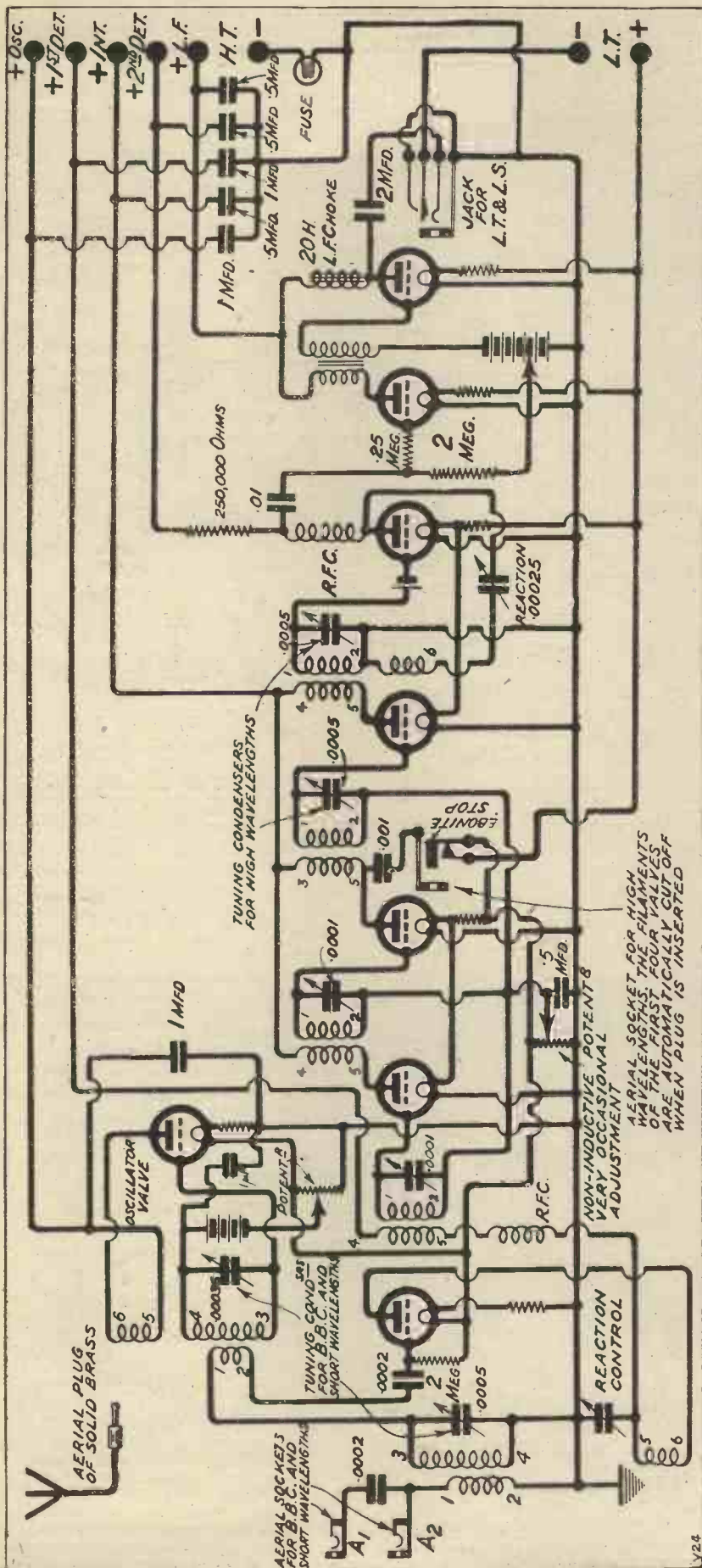

come to my notice, an insensitive condition of a receiver has followed the "mis-matching" of the intermediate transformers and the use of unsuitable valves, and sometimes poor oscillator-coupler arrangements. I have placed the intermediate transformers first, as these are the worst offenders.

However, my object in bringing the above faults to readers' notice was not to discourse on them, but to show that if they can be avoided the chief "snags" associated with super-hets are eradicated.

### Frame or Outdoor

The set about to be described represents the result of an attempt to eliminate them in a simple manner.

It will tune from approximately 190 to 550 metres with the aid of two variable condensers only, and will give loud-speaker results on nearly every station it receives. The six-socket base used for accommodating the aerial coupler is so wired that either an outdoor or a frame aerial can be used. To employ the latter it is only necessary to remove the aerial coupler and substitute a six-pin holder that is wired as per the diagram given on another page. The frame aerial is recommended for the broadcasting wave-lengths, as it avoids the risk of the oscillations from the oscillator valve getting into the outdoor aerial and so causing interference with neighbouring sets.

For other wave-length ranges up to 900 metres the outdoor aerial can be employed, unless the frame aerial is suitably wound for wave-lengths above 550 metres. Below 190 metres it is imperative that the outdoor aerial is utilised, or at least some system other than a frame. The same applies to wave-lengths between 900 and 2,000 metres, where the aerial lead is transferred to the high wave-length aerial socket.

### Long-Wave Reception

Here again, only two tuning controls are utilised, although a different pair is brought into use, the first being thrown out of action.

The idea of the set is to employ two of the intermediate-frequency couplings for the high wave-lengths with four valves, and all the valves for the broadcasting and low wave-lengths. In this way great amplification can be obtained on the higher frequencies (low wave-lengths), the high wave-lengths being left to look after themselves.

This does not mean "get-what-you-can" from the high wave-length

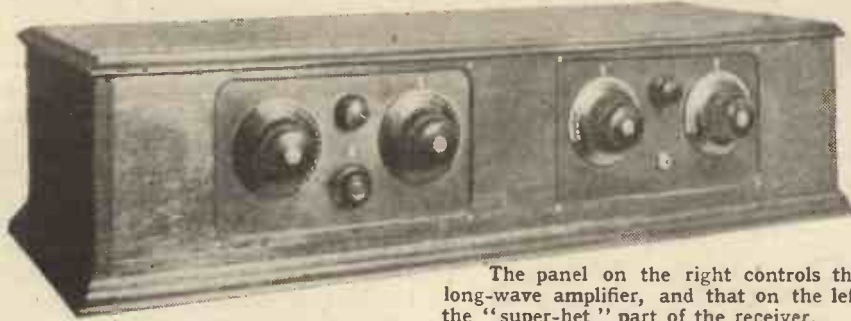

The panel on the right controls the long-wave amplifier, and that on the left the "super-het" part of the receiver.

can be removed simultaneously, an advantage which need not be extolled.

### Reaction Control

The oscillator coupler is also interchangeable, being fitted in a low self-capacity six-pin base, like the aerial coupler, both being suitably arranged for very low wave-lengths.

Reaction on the first detector valve is controlled by a miniature condenser,

portion of the receiver, since full loud-speaker volume can be had from 5 X X, Radiola, Hilversum, and in certain cases several German stations. I simply refer to the fact that, owing to the greater amplification generally obtainable from an H.F. amplifier operating on a high wave-length, only four valves are really necessary.

### The Aerial Coupler

There are several refinements included in the design of the receiver which should appeal to all set builders.

In the first place, the aerial coupler (that connected to the grid of the first detector) is constructed on a Collinson feather-weight former, the primary coil being interchangeable. The reaction coil is wound on the outside of the Collinson former alongside the secondary coil, so that the whole

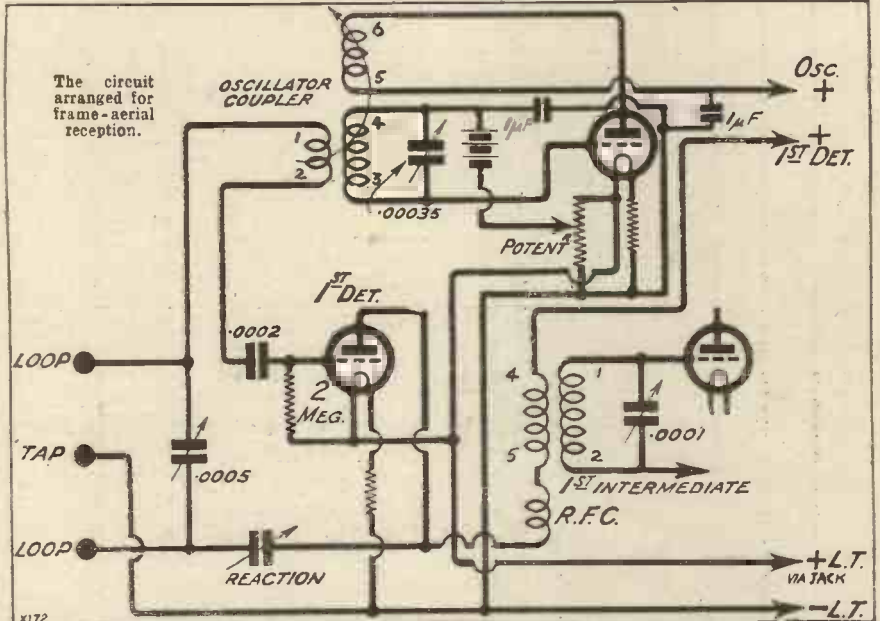

### COMPONENTS REQUIRED.

- 1 Cabinet, 36 in. x 7 in. x 14 in. deep (inside measurements), with front overlay and wood strip 2 in. wide x 36 in. long x 1/4 in. thick (V. C. Bond & Sons).
- 1 Baseboard 36 in. x 14 in. x 3/8 in. thick. (V. C. Bond & Sons).
- 2 Ebonite panels, 12 in. x 7 in. x 1/8 in. thick.
- 1 Piece of ebonite 8 1/2 in. x 4 1/2 in. x 1/4 in. for the sub-panel.
- 3 Terminal strips (ebonite), one 7 in. x 2 in. x 1/4 in., one 5 in. x 2 in. x 1/4 in., and one 3 in. x 2 in. x 1/4 in.
- 9 Terminals, markings as per diagram (Belling & Lee).
- 1 Piece of ebonite, 1 1/2 x 1 1/2 in. x 1/4 in. for supporting potentiometer on baseboard.
- 2 Low-loss anti-phonics valve-holders (ordinary type will serve).
- 2 Special aerial sockets (Wright & Weaire).
- 1 Special aerial socket with filament contacts (see above).
- 1 Special aerial plug of solid brass (see above).
- 1 Jack and plug for L.T. and loud-speaker (see above).
- 1 Six-socket base for aerial coupler (Collinson Precision Screw Co.).
- 1 Featherweight former with interchangeable primary former (Collinson Precision Screw Co.).
- 4 Six-pin bases with copper screens—any good make. Those used in set were Peto-Scott.
- 4 Split-primary H.F. transformers, 1,000-2,000 metres. (See article.)

- 6 Anti-phonics valve holders (Benjamin, Bowyer-Lowe, Igranic, Lotus, etc.).
- 1 Six-pin base for oscillator coupler (Rothermel Radio Corp.).
- 1 Oscillator coupler, type 111A. (Rothermel Radio Corp.).
- 1 Non-inductive Centralab potentiometer, 400 ohm (Rothermel Radio Corp.).
- 4 1-mfd. Mansbridge condensers (Dubilier, Lissen, Mullard, T.C.C., etc.).
- 1 2-mfd. Mansbridge condenser (see above).
- 4 5-mfd. Mansbridge condensers (see above).
- 1 0.01-mfd. mica condenser (Dubilier, Lissen, Mullard, T.C.C., etc.).
- 1 0.01-mfd. mica condenser (see above).
- 2 0.002-mfd. mica condensers (see above).
- 3 Grid leak holders (Dubilier, Lissen, etc.).
- 2 2-meg. grid leaks (Dubilier, Lissen, Mullard, etc.).
- 1 25-meg. grid leak (see above).
- 1 H.F. choke (any good make).
- 1 250,000-ohm anode resistance and holder (Dubilier, Mullard, R.I. Varley, etc.).
- 6 Fixed baseboard filament resistances to suit valves.
- 4 Dial indicators.
- 3 0.0005-mfd. S.L.F. or square-law variable condensers without verniers (Ormond Engineering Co.).
- 1 0.0035 mfd. (Ormond Engineering Co.).

- 2 Special extension spindles as per diagram (Ormond Engineering Co.).
- 4 Vernier dials, any good type (originals were Ormond).
- 1 Reaction condenser, 0.0005 mfd. This is a panel-mounting neutralising condenser (Peto-Scott).
- 1 0.0025-mfd. "Minator" reaction condenser (Peto-Scott).
- 1 400-ohm potentiometer for baseboard (see wiring diagram) (Lissen).
- 1 Flashlamp bulb and holder, for fuse.
- 1 L.F. transformer (any good make of fairly low ratio).
- 2 Baseboard-mounting 0.001-mfd. variable condensers (Peto-Scott).
- 1 L.F. choke, 20 henries inductance (heavy duty type).
- 1 9-volt grid-bias battery, tapped every 1 1/2 volts, for oscillator valve.
- 2 Grid-bias battery clips.
- 2 1 1/2-volt cells for grid bias on second detector (Siemens' type T cells) or tapped 4 1/2-volt battery.
- 6 packets (approximately) "Glazite," colours to suit circuits (London Electric Wire Co. & Smiths).
- 1/2 lb. No. 18 S.W.G. tinned copper wire for wiring short-wave-length side of receiver.
- Various screws, nuts, flex, etc.

Note: In the case of most of the main components in this set, parts of any good make may be used, and it is not possible to list all these. A few alternatives are given in alphabetical order.

having a capacity of, roughly, .00005 mfd. It will be noted the H.F. choke is connected in a manner which causes the condenser to take the character

the high wave-lengths, and naturally a larger winding is better in the aerial circuit, up to certain limits, than that which is needed for the

panels, and wooden overlay are procured. The latter is supplied with the cabinet, together with the baseboard and a polished strip of wood 2 in. wide, which is cut up into suitable lengths and fitted between the terminal boards situated at the back of the baseboard.

Two ebonite panels, each measuring 12 in. by 7 in. by  $\frac{3}{16}$  in., and drilled according to the drilling layouts given, are screwed to the baseboard. As the latter measures 36 in. by 14 in. by  $\frac{3}{8}$  in. thick, and as the panels are screwed 4 in. from each end, a space of 4 in. is left between the inside edges of the panels, so that the panels are equidistant from each end of the baseboard and from each other, this giving a symmetrical layout.

**Fitting the Panels**

The wooden overlay can next be screwed to the ebonite panels by means of  $\frac{7}{16}$  in. (approximately) countersunk 6 B.A. brass screws. This part of the assembling should not, however, be undertaken until the baseboard is fitted inside the cabinet with the ebonite panels in position, otherwise poor centralisation of the overlay will result.

When the baseboard and panels are in position in the cabinet it is only necessary to slide the wooden overlay in, the inside edges of the walls of the cabinet finding its position. Countersunk holes, clearance for 6 B.A., must be drilled in the overlay, so that when in position in the cabinet their positions can be marked on the faces of the ebonite panels with the clearance drill inserted through the holes. The points marked (A B C D) on the panels can then be drilled with a 6 B.A. tapping drill and the holes tapped with a 6 B.A. tap, after which the overlay can be fitted.

Should this appear difficult to the prospective constructor (although he can have the assurance of the writer

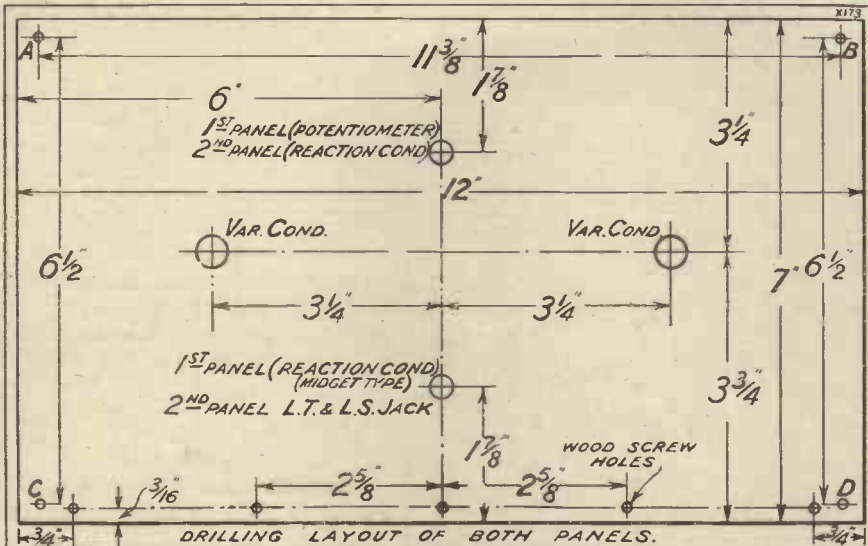

of a throttle control of oscillation, very little adjustment being required in order to keep the valve in a suitable state of regeneration over the entire band of wave-lengths. On the frame aerial it functions on the "Hartley" principle.

**Oscillator Circuits**

No less than nine oscillator-coupler circuits were tested during my experiments, and though one in particular gave good results, yet it proved rather troublesome on the local station, 2 LO coming in at several points on the oscillator-condenser dial.

The coupler finally chosen was a Silver-Marshall type 111A, and this, used with a positive grid bias of 6 to 7 1/2 volts, enabled me to eliminate practically all the harmonics and obtain one reading for the local station.

Those readers who are more fortunately situated, and who are well clear of powerful transmissions, should not experience this trouble. The exact adjustment of grid bias on the oscillator valve will be dealt with more fully when I describe the operation of the receiver.

The H.F. transformers for coupling the intermediate valves consist of the standard "split-primary" types as sold by most of the leading manufacturers. In the case of the first, second, and fourth intermediate transformers, only the primaries were utilised, connections being taken from the pins 4 and 5; both primary and neutralising windings were taken into account when connecting the third H.F. transformer, as the primary here is used for the aerial circuit on

H.F. transformers. I therefore suggest that connections be taken from pins Nos. 3 and 5, the latter going to the plate of the valve and 3 to + H.T.

Having briefly dealt with the theoretical considerations of the set, attention can now be turned to the

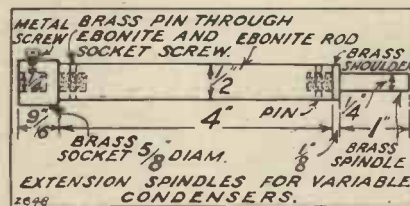

actual construction. The assembling of the receiver is quite a straightforward matter, although the making of one or two components calls for a little care.

**Commencing Construction**

It is not advisable to commence construction until the cabinet, ebonite

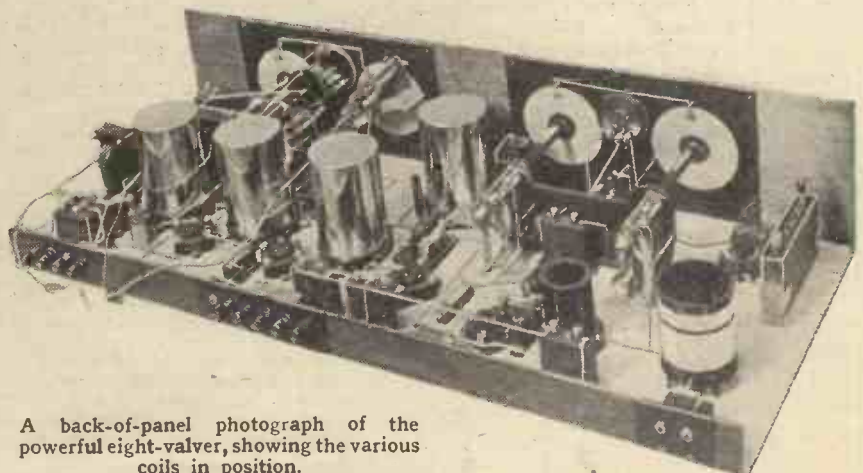

A back-of-panel photograph of the powerful eight-valve, showing the various coils in position.



that it is not so), the work may be undertaken by the makers of the cabinet, who can also supply the two Radion panels at extra cost.

The partitions avoid the necessity for screwing the terminal boards in exact positions, and thus assist in making construction easier.

casting and low wave-lengths (left-hand panel), as these are clamped to an ebonite sub-panel and made to engage with the vernier dials on the main panel by means of extension spindles. If true alignment is not obtained the vernier dials will be inclined to tilt and scrape the main

For the purpose of the "Experimental" Eight, The Ormond Engineering Co. supplied two sets of brass bushes for each of the above two condensers so as to allow them to be mounted on the sub-panel with the earthing plates and dials on the main panel. The extension spindles were also made for the same set, and consist of two ebonite rods  $\frac{1}{2}$  in. in diameter and 4 in. long, with brass sockets and set screws at one end (so as to engage with the spindles on the variable condensers), and  $\frac{1}{4}$  in. diameter brass spindles at the other, which pass through the bushes on the main panel and on which the vernier dials are screwed. A plan of these extension spindles is given on another page.

### Wiring Up

No mention has been made as yet of the screwing down to the baseboard of the sub-panel, because to complete the alignment of the dials the extension spindles should be pushed through the bushes on the main panel, the dials fitted, and the sub-panel moved about until the dials run parallel in all directions to the main panel, when the job can be completed.

The fitting of other components is quite a straightforward affair, and therefore does not call for any special mention. Wiring from the first intermediate transformer to the second L.F. is carried out with "Glazite" of any suitable colour. "Glazite" was chosen as being more suitable than bare wire owing to the fact that most of the leads, especially those for L.T. and H.T., are run close to the baseboard, which brings them very close together. Grid and plate leads are

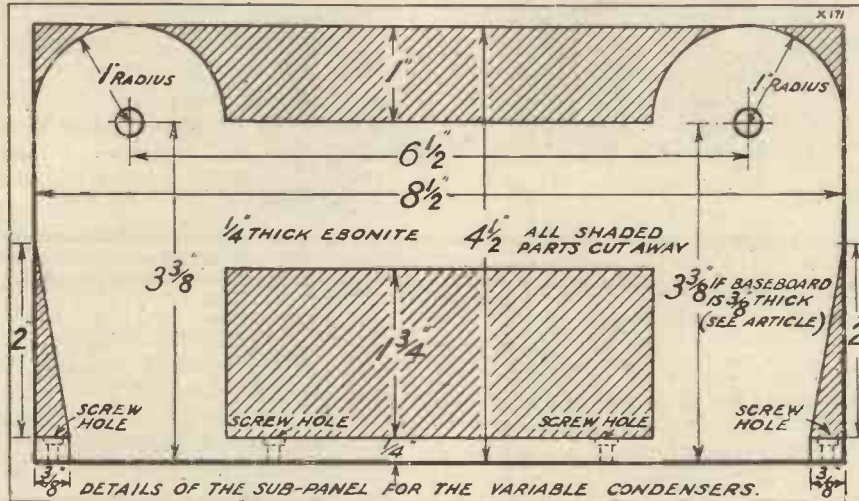

Constructors can commence the mounting of components with those on the panels. The two .0005 mfd. variable condensers for the high wave-lengths (right-hand panel looking at the front of the receiver) can be fitted, and also the combined L.T. and loud-speaker jack. Then, before mounting the .00025 mfd. "Minator" reaction condenser, the 2 mfd. Mansbridge, which connects in series with one loud-speaker lead, can be screwed to the baseboard near the jack.

### The Variable Condensers

A little care should be exercised in fitting the .0005 and .00035 mfd. variable condensers for the broad-

panel at some portion of their circumference.

A good plan is to drill the holes in the main panel (which probably has already been done), cut the sub-panel and trim it neatly, then bring it against the back of the main panel, keeping it firmly against the baseboard, and mark with a suitable drill or scriber corresponding points to those for the variable condensers through the holes in the main panel.

After drilling the sub-panel the variable condensers can be mounted on it at the angles shown in the photographs. Both the extension spindles can be fitted and firmly screwed in position.

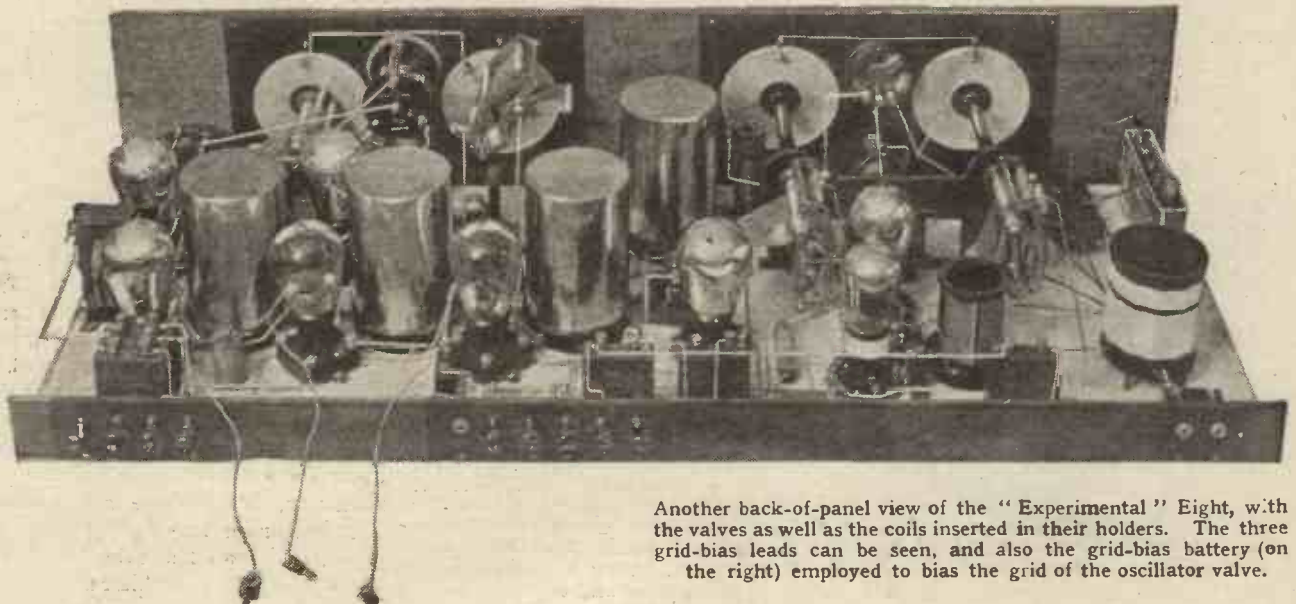

Another back-of-panel view of the "Experimental" Eight, with the valves as well as the coils inserted in their holders. The three grid-bias leads can be seen, and also the grid-bias battery (on the right) employed to bias the grid of the oscillator valve.

kept well apart and run where possible from point to point, right-angle bends being avoided.

The oscillator and first detector valves and their couplers are wired with No. 18 S.W.G. tinned copper wire, as it must be remembered they have to tune to very low wave-lengths. Readers should bear in mind that if they desire to receive down to 20 metres or less the wiring cannot be made too "low-loss." The importance of well separating the wires and using extension spindles and earthing plates under the condenser dials, cannot be exaggerated. Even so, tuning will be fairly critical on short wave-lengths.

### Intermediate Transformers

Naturally, the low-loss wiring on the first detector and oscillator side of the set results in a high degree of efficiency on the broadcasting band, assuming, of course, that the coils are also efficient.

Since the task of wiring the receiver is a rather lengthy one, a list of point-to-point connections is given, and every constructor is advised to check his connections from it.

One of the unique features of this "superhet." is the type of intermediate transformers employed. As mentioned in the first part of this article, they tune from 900 to about 2,000 metres, the intermediate wave-length being set just above 1,000 metres. During experiments with these coils it was found that removing the neutralising and reaction windings on the first, second, and fourth and the reaction winding on the third, did not improve results to the extent one would have expected. Any reader who wishes to make this set, and has some of these coils on hand, can therefore use them without the necessity

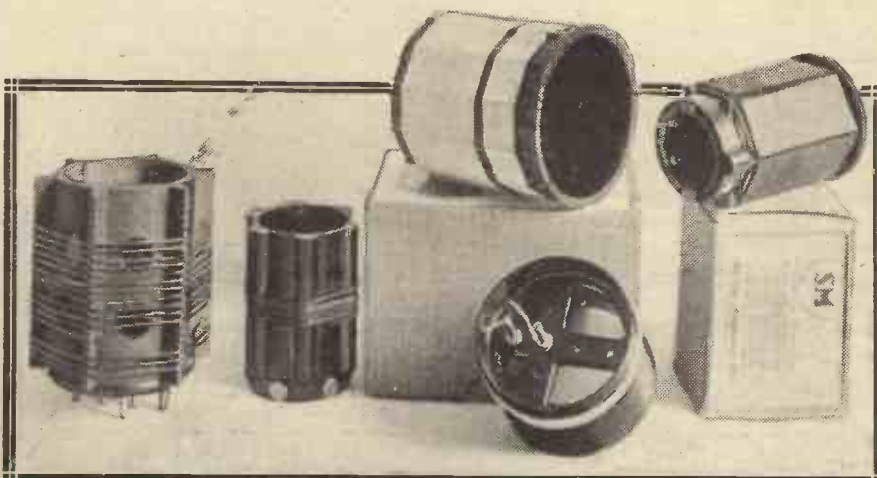

From left to right : The S.W. aerial coil ; S.W. oscillator coupler ; aerial coupler and primary band, and the oscillator coupler for the lower broadcast band.

of removing the windings not in use.

It would not be out of place to mention that Messrs. Peto-Scott's new barrel type of "split-primary H.F. transformer" tuning from 1,000 to 2,000 metres were used in the original receiver ; but while on the subject,

lengths and can operate efficiently when used in neutralised circuits. In certain cases it has been found the primary and neutralising windings have been too small, and in others the secondary had been wound with an unsuitable gauge of wire or does not cover the desired band of frequencies.

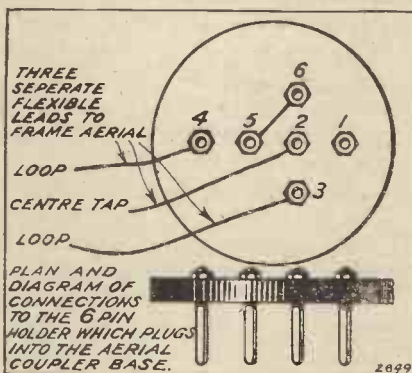

the writer would like to put on record that he can see no objection to any one of a majority of "split-primary H.F. transformers" now on the market being employed, providing they cover the specified band of wave-

### The Aerial Coupler

The aerial coupler for the broadcasting band of wave-lengths for an outdoor aerial is wound on a Collinson featherweight former, the secondary and reaction windings being on the outside and the primary winding on the interchangeable former which fits inside the main former. As supplied by the makers, three sockets are provided inside the main former ; but for the purpose of the "Experimental" Eight only two are utilised, and these are transferred to the pins Nos. 1 and 2, the pins on the smaller inside former being arranged to suit. The secondary winding consists of 60 turns of No. 26 S.W.G. D.C.C. wire, the coil being wound on the bottom end of the main former, with the end of the coil nearest the pins going to No. 3, and the far end to No. 4. Pins No. 2 and 4 are also joined together by a piece of copper wire.

For reaction, wind 40 turns of No. 30 S.W.G., S.S.C., or D.S.C. wire  $\frac{3}{16}$  in. away from the secondary and in the same direction. The end nearest the secondary take to pin No. 5, and the remaining end to No. 6.

Two interchangeable primaries are provided on the writer's set, one being suitable for a long aerial and the other for a short one. This is very necessary, because the set is often operated under varying conditions at different places. However, the reader can try various sizes himself so as to

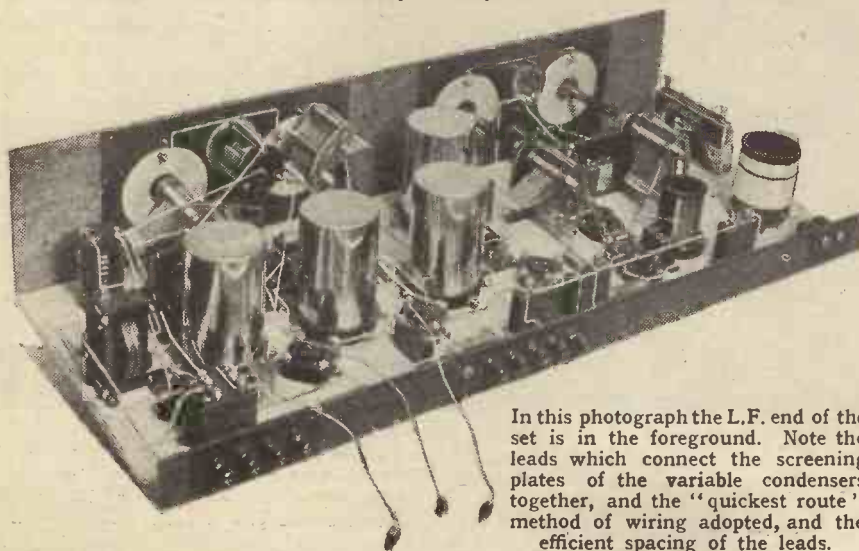

In this photograph the L.F. end of the set is in the foreground. Note the leads which connect the screening plates of the variable condensers together, and the "quickest route" method of wiring adopted, and the efficient spacing of the leads.

obtain the maximum pick-up consistent with selectivity.

As an approximate guide 3 to 10 turns can be employed for aeri-als averaging 70 to 100 ft. and 8 to 15 turns for those below 70 ft. It is im-material in what direction the pri-mary is wound, although the writer always endeavours to wind in the same direction as the secondary. The end farthest away from the pins can be joined to No. 2 and the other end to No. 1.

No mention will yet be made of the coil for very low wave-lengths, as experiments are still proceeding with various types. A short-wave coil is shown in one of the photographs; and while this has enabled the writer to receive several short-wave ama-teurs, 2 X A D, 2 X A F, and many Morse stations on the loud speaker, he does not feel justified in recommend-ing it until other coils have been tried.

Six-volt valves were the first types to be tried, and while these gave the

results one would naturally expect, the writer went to great trouble to compare them with 2-volt types, in

view of their large number of adherents. The results from the two-volters were very good. It was necessary to insert a

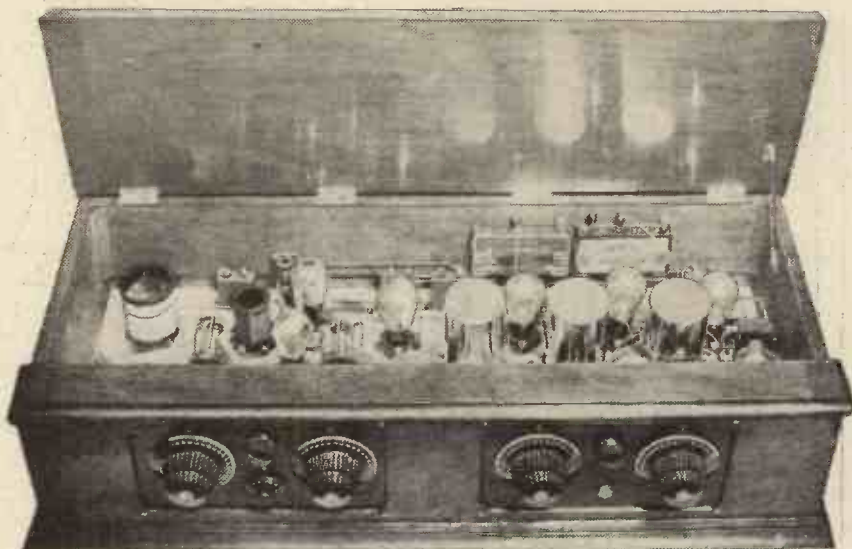

A photograph of the completed set which gives an excellent idea of its general appearance and assembly.

#### POINT-TO-POINT CONNECTIONS OF THE "EXPERIMENTAL" EIGHT.

One filament tag of each of the valve holders  $V_1$  and  $V_2$  to one side of the rheostats  $R_1$  and  $R_2$  respectively.

One filament tag of each of the valve holders  $V_3$  and  $V_4$  joined together and to one side of the rheostat  $R_3$ .

One filament tag of each of the valve holders  $V_5$  and  $V_6$  joined together and to one side of the rheostat  $R_4$ .

One filament tag of each of the valve holders  $V_7$  and  $V_8$  to one side of the rheostats  $R_5$  and  $R_6$  respectively.

+L.T. terminal to the inner filament contact of the high wave-length aerial socket, to the remaining side of the rheostat  $R_4$  and to the remaining sides of  $R_5$  and  $R_6$ .

Outer filament contact of the high wave-length aerial socket to the remaining side of the rheostat  $R_4$ , to the remaining filament tag of the valve holder  $V_1$ , to one side of the grid-leak holder  $G.L._1$ , to the remaining filament tag of valve holder  $V_2$ , and to the positive terminals of both potentiometers.

-L.T. terminal to the centre contact of the L.T. and L.S. jack (the contact arm has an ebonite endpiece fitted to it).

Left-hand contact and terminal on metal frame of the L.T. and L.S. jack, joined together, to the remaining filament tags of the valve holders  $V_7$ ,  $V_5$ ,  $V_3$ ,  $V_6$ ,  $V_4$ , and  $V_2$ . This lead also goes to all the "E" terminals on the six-pin screened bases, to the moving vanes of the fourth intermediate condenser, the earthing terminals and plates on all the condensers on the same panel, to the No. 2 terminal on the fourth six-pin base, to +G.B. for the L.F. valves, to one tag of each of the three 5-mfd. Mansbridge condensers in left-hand corner of baseboard, and to one side of the flash-lamp bulb fuse.

The lead then carries on from the negative filament tag of valve holder  $V_3$  to one tag of each of the 1-mfd. Mansbridge condensers situated at the back of the baseboard, to the remaining sides of the rheostats  $R_1$  and  $R_2$ , to socket No. 2 on the six-pin aerial coupler base, to the negative terminals on both potentiometers, to the earthing plates of the low wave-length variable condensers, and to one tag of each of the 1-mfd. and 5-mfd. Mansbridge condensers fitted to each side of the sub-panel.

$A_1$  aerial socket to one tag of the 0002-mfd. fixed condenser.

Other tag of this condenser to the  $A_2$  aerial socket and to the No. 1 socket on the six-pin aerial-coupler base.

No. 3 socket on same base to the No. 1 screw on the oscillator-coupler base and to the fixed vanes of the 0005-mfd. secondary variable condenser.

Moving vanes of same condenser to the moving vanes of the miniature reaction condenser and the socket No. 4 on the aerial-coupler base.

No. 5 socket on aerial-coupler base to the fixed vanes of the miniature reaction condenser and also to the top contact of the first H.F. choke.

Bottom contact of choke to the No. 5 terminal on the first intermediate base.

No. 6 socket on the aerial coupler base to the plate of valve holder  $V_1$ .

Grid of  $V_1$  to one tag of the second 0002-mfd. fixed condenser and to the remaining side of the grid-leak holder  $G.L._1$ .

Other tag of the second 0002 fixed condenser to screw No. 2 on the oscillator-coupler base.

Screw No. 3 on same base to the grid of the valve holder  $V_2$  and to the fixed vanes of the 00035-mfd. oscillator variable condenser. Moving vanes of same condenser to the screw No. 4 on the oscillator-coupler base, to the remaining tag of the 1-mfd. (Mansbridge) condenser close to the sub-panel, and to the +G.B. plug via a flexible lead for the oscillator bias.

No. 6 screw on the oscillator coupler base to the plate of valve holder  $V_2$ .

No. 5 screw on the oscillator-coupler base to the remaining tag of the 1-mfd. Mansbridge condenser No. 1, to the remaining tag of the 1-mfd. Mansbridge No. 3, and to +H.T. (oscillator) terminal.

Arm of the potentiometer on the base-board to the -G.B. plug via a flexible lead for the oscillator-valve bias.

Arm of the potentiometer on the panel to the remaining tag of the 5-mfd. Mansbridge condenser close to the sub-panel; to the moving vanes of the first 0001-mfd. variable condenser (first intermediate), to the fixed vanes of the second intermediate 0001-mfd. variable condenser, to the No. 2 terminals on the first, second, and third six-pin intermediate bases, and to the moving vanes of the third intermediate variable condenser (0005 mfd.).

No. 4 terminal on the first six-pin intermediate base to the remaining tag of the 1-mfd. Mansbridge condenser No. 2. and to +H.T. (first det.) terminal.

No. 1 terminal on the first six-pin intermediate base to the fixed vanes of the first 0001-mfd. variable condenser, and to the grid of valve holder  $V_3$ .

Plate of  $V_3$  to the No. 5 terminal on the second six-pin intermediate base.

No. 1 terminal on same base to the grid of valve holder  $V_4$  and to the moving vanes of the second 0001-mfd. intermediate variable condenser.

Plate of valve holder  $V_4$  to one tag of the 001-mfd. fixed condenser, and to the No. 5 terminal on the third six-pin intermediate base.

Other tag of the 001-mfd. fixed condenser to the remaining contact on the high wave-length aerial socket.

Grid of valve-holder  $V_5$  to the No. 1 terminal on the third six-pin intermediate base, and to the fixed vanes of the third intermediate variable condenser (0005 mfd.).

Plate of  $V_5$  to the No. 5 terminal on the fourth six-pin intermediate base.

No. 1 terminal on same base to the +G.B. plug for the second detector bias, and to the fixed vanes of the fourth intermediate variable condenser (0005 mfd.).

Grid of valve holder  $V_6$  to the -G.B. plug for the second detector bias.

+H.T. (inter.) terminal to the remaining tag of the first 5-mfd. Mansbridge condenser, to the No. 4 terminal on the fourth intermediate base, to the No. 3 terminal on the third intermediate base, and to the No. 4 terminal on the second intermediate base.

Plate of valve holder  $V_6$  to one side of the H.F. choke, and to the moving vanes of the 00025-mfd. "Minator" reaction condenser. Fixed vanes of this condenser to the No. 6 terminal on the fourth intermediate base.

Remaining side of the H.F. choke to one tag of the 01-mfd. fixed condenser, and to one side of the 250,000-ohm anode resistance.

Other side of the anode resistance to the remaining tag of the second 5-mfd. Mansbridge condenser and to the +H.T. (second det.) terminal.

Remaining tag of the 01-mfd. fixed condenser to one side of each of the grid-leak holders  $G.L._2$  and  $G.L._3$ .

Other side of  $G.L._3$  to the grid of the valve holder  $V_7$ .

Other side of  $G.L._2$  to the first -G.B. plug for the grid bias to the L.F. valves.

Plate of  $V_7$  to the "plate" terminal on the L.F. transformer.

+H.T. terminal on L.F. transformer to the top contact on the L.F. choke, to the remaining tag of the third 5-mfd. Mansbridge condenser, and to the +H.T. (L.F.) terminal.

Bottom contact on L.F. choke to the plate of  $V_8$  and to on the 2-mfd. Mansbridge condenser.

Other tag on the condenser to the right-hand contact of the L.T. and L.S. jack.

"Grid" terminal on the L.F. transformer to the grid of valve holder  $V_8$ .

"Grid bias" terminal on the L.F. transformer to the second -G.B. plug for the grid bias to the L.F. valves.

Remaining side of the flash-lamp bulb fuse to the -H.T. terminal.

NOTE.—The grid-bias cells for the second detector valve should be mounted close up to the valve holder  $V_6$ . The grid-bias batteries for the L.F. valves are mounted inside at the back of the cabinet.

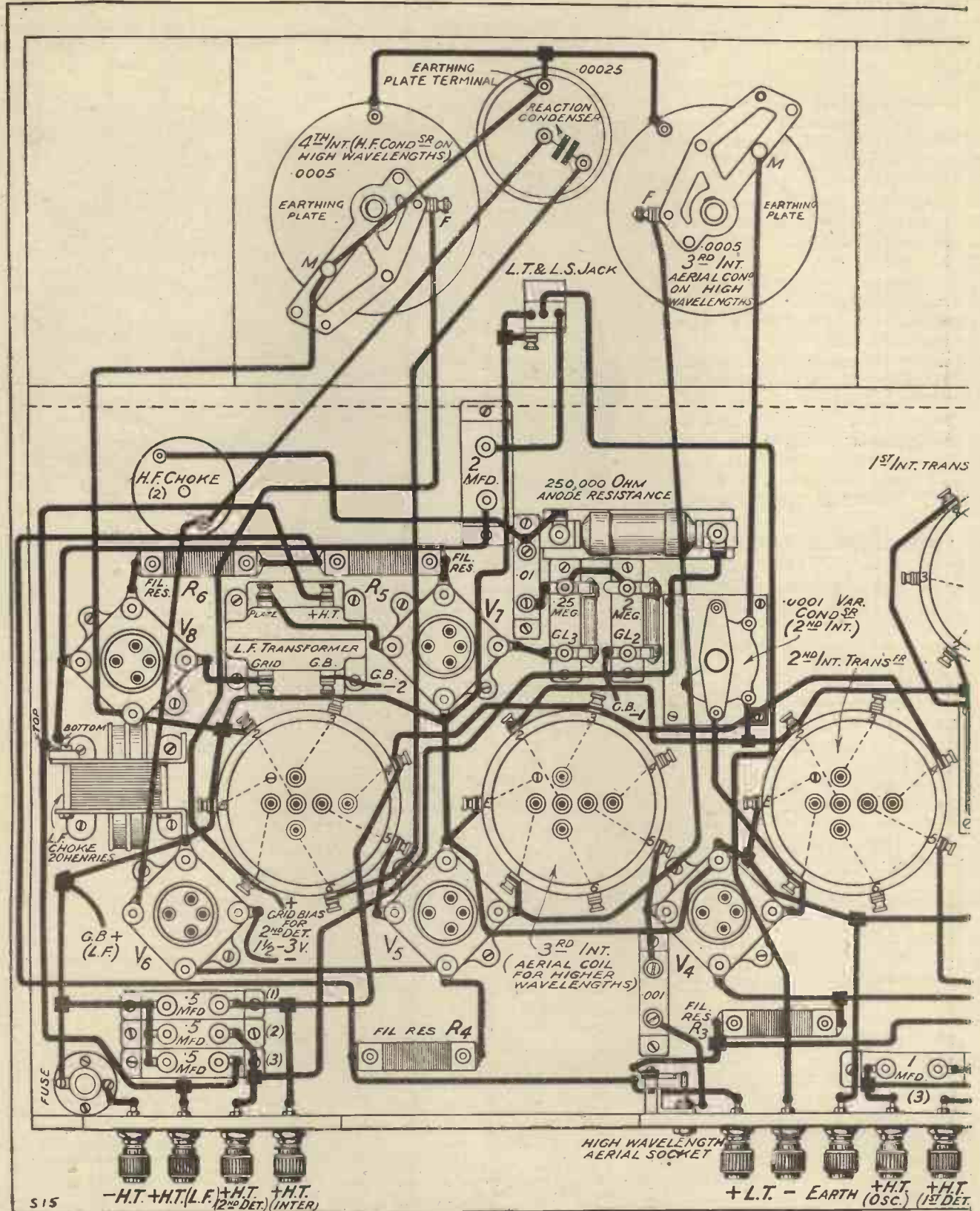

1½-volt grid battery in series with the arm of the potentiometer controlling the intermediates when using these valves so as to give them an adequate negative bias. Beyond this minor alteration they operated quite as well as the 6-volt valves, and they can be confidently recommended.

Valves of the 6-volt range employed in the original receiver are as follows: Oscillator, B.T.-H.B4; first detector, Mullard P.M.5X; intermediates, Marconi or Osram, D.E.H. 612; second detector, Cossor H.F. 610; first L.F., Marconi or Osram D.E.8H.F.; second L.F., Cossor

Super Power. Cossor H.F.610 and Marconi or Osram D.E.8H.F. also worked well in the intermediate stages in place of the D.E.H.612. In the 2-volt range the following combinations are recommended: Oscillator, Mullard P.M.2, Marconi or Osram D.E.6 or S.T.22; first detector,

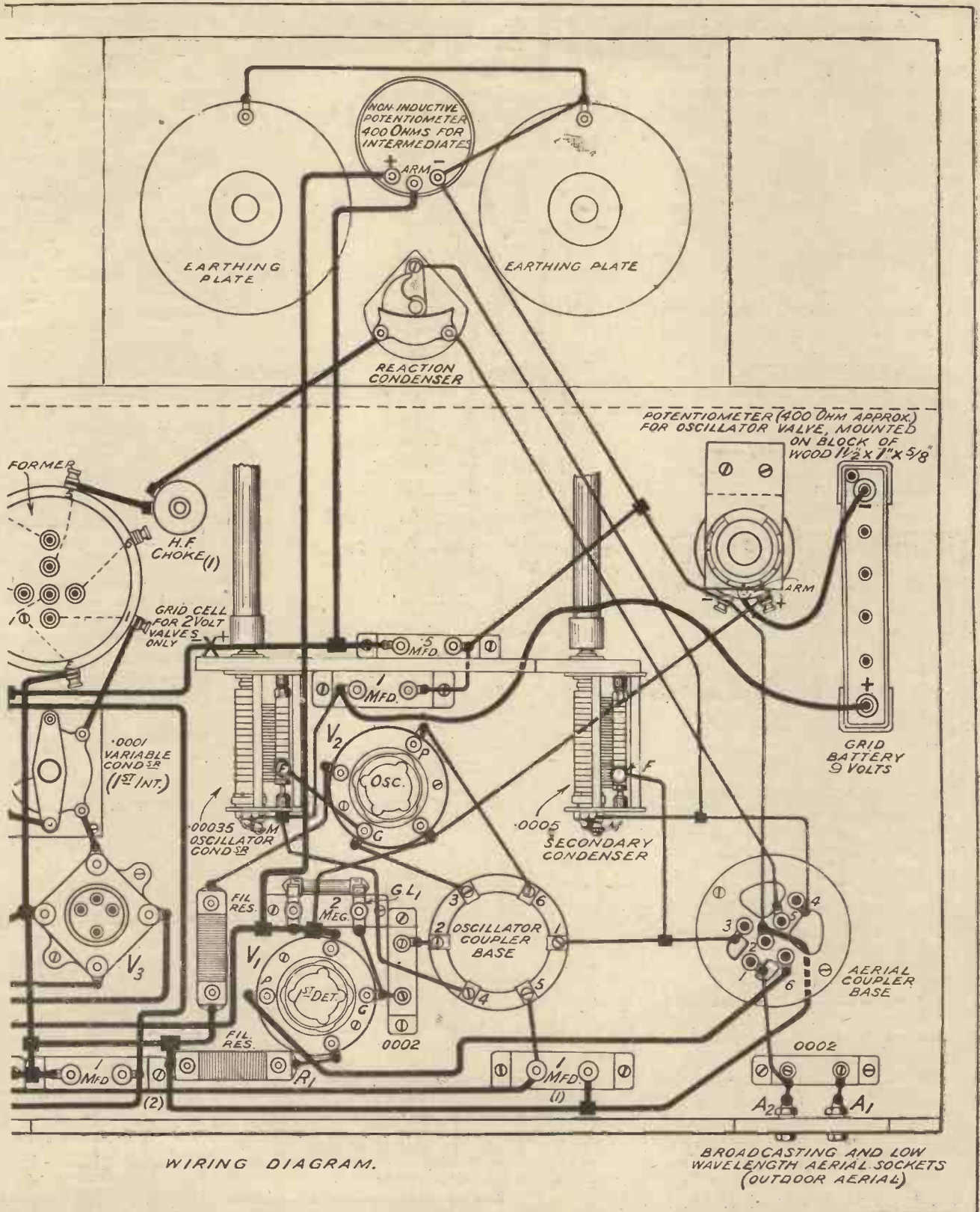

Cossor H.F.210 or Mullard P.M.1 H.F. ; intermediates, second detector and first L.F., Cossor H.F.210, S.T.21 or Mullard P.M.1 H.F. ; second L.F., Cossor Stentor Two, Marconi or Osram D.E.P.215 or Mullard 252.

A final word regarding the H.T. supply. Since the super-power valve in the

last L.F. stage takes approximately 17 milliamps. at 120 volts H.T. and a Pye 20-henry choke in its plate circuit, and the other seven valves 13 milliamps., an H.T. battery capable of supplying 30 milliamps. or more is essential.

The voltage should not be less than 120, as the full amount is very desir-

able on the super-power valve. For maximum purity of tone 150 volts can be employed.

Complete notes on the operation of the receiver, with details of the short-wave coil and other H.T. values, will be given in a later issue of MODERN WIRELESS.



# WHAT READERS THINK

## Loud Speaker Impedance

SIR,—Having read Mr. Gordon's very interesting letter in the September issue of MODERN WIRELESS may I point out what appears to be a misconception on his part.

In his letter he states that a Lissenola unit of 2,000 ohms D.C. resistance was found to have an impedance of 1,850 ohms, rough measurement, at a very low frequency. Evidently he is confusing his terms.

Impedance is equal to the square root of (resistance)<sup>2</sup> + (reactance)<sup>2</sup>. It follows therefore that at any frequency the impedance can never be less than the D.C. resistance. The reactance is equal to 2π times the frequency times the inductance.

Therefore, considering his last valve, which has an impedance of two to three thousand ohms, it is quite evident that to get maximum power in his output he should use a speaker with a D.C. resistance of much lower value than 2,000 ohms. A good value would be somewhere about 750 ohms resistance for a speaker used with a valve as described.

Yours faithfully,

LEON E. NEWNHAM,  
B.Sc., A.M.I.R.E.

Copnor, Portsmouth.

## Short-Wave Results

SIR,—Having built a modern short-wave receiver described by Mr. Simmonds in the February issue of MODERN WIRELESS, I should like to know whether other builders of this set have done better than the following:

On Sunday, September 4th, 1927, I picked up 2 ME (Sydney, Australia) on 32.5 metres at 6 p.m., and held this transmission until 7.40 p.m. G.M.T.; and on September 11th, 1927, I again picked up this station, transmitting on 28.5 metres to U.S.A. a programme for relaying. The strength of this transmission was R.5 to R.6. I have also received the following: KDKA on 14 metres, 2 X A F on 32.77 metres, 2 X G on

16.8 metres, W L W on 50.02 metres, 2 X A D on 22.02 metres. All these have been received at good strength on earphones.

Wishing MODERN WIRELESS every success.

Yours truly,

London, N.16. F. G. SYKES.

## "Four-Valve Filadyne"

SIR,—I have constructed and thoroughly tested the "Four-valve Filadyne" described by Mr. English in your July issue. I have tried several valves in the detector stage, and I find that the D.E.2 L.F. and S.T.22 both give excellent results. During the tests I used a S.T.21 as H.F., a D.E.2 L.F. or S.T.22 as detector, a S.T.23 as L.F. I may here state that I did not incorporate the last L.F. stage, as an ordinary three-valver gives good loud-speaker results.

I received the following stations in one evening:—Aberdeen, R.6-7; Glasgow, 5 SSC, R.5-6; Frankfurt, R.6; Hamburg, R.5-6; Oslo, R.5; London, R.4-5; Birmingham, R.5;

Langenberg, R.6; and 7 relays, R.3-4; also two unknown Germans; Harmonic of Vienna.

These results were obtained with 70 volts H.T. on H.F., 30 volts on detector, and 100 volts on L.F. The Brown cone speaker in union with the set yielded excellent purity.

I shunted the second variable condenser with one of the variable-fixed variety and adjusted it so that both condensers were in step at the middle of the tuning scale. This gadget greatly simplifies tuning. Hoping this will interest fellow constructors.

Yours faithfully,

A RECRUIT.

P.S.—This is the first set I have constructed.

Buckie, Banffshire, N.B.

## Resistance Coupling Problems

SIR,—Ref. your August number, page 183, enclosed may perhaps interest J. D. P., of Newton Abbot.

I have tried various values of valves, leaks, and condensers, etc., and have finally arrived at circuit below as most suitable.

I live 20 miles from 2 L O, and for this station use the 2 H.F., detector, and V.6. I can tune in Stuttgart and upwards, Barcelona downwards without noticing 2 L O.

Loud speaker—Toulouse upwards I need all valves; below London I very rarely use V.5. Tone and purity good.

Hoping this may interest your correspondent,

Yours faithfully,

Cobham, Surrey.

C. F. C.

## THE CIRCUIT USED BY C.F.C.

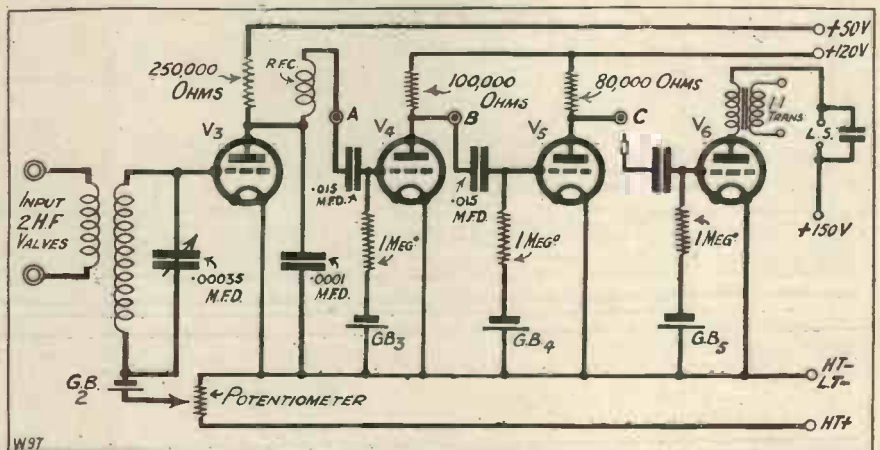

V3	S.T.61A. 70,000 ohms. 40μ	V4	C.T.25B. 20,000 ohms. 20μ	V5	C.T.25 10,000 ohms. 10μ	V6	S.T.63 4,000 ohms.
	G.B.2. 0 to 1½ v.		G.B.3. 1½ v.		G.B.4. 4½ v.		G.B.5. 22 v.

Anode-bend rectification. H.F. side—Silver Marshall inductances; .00035 condensers; two D.F.A.1 valves; H.T., 85 v.; G.B., combined through 100,000-ohm resistance, 1½ v.; variable 500,000-ohm resistance across grid of second H.F. valve. Igranic H.T. eliminator, 110v. A.C. H.T. voltages probably 5 to 10 volts below ostensible values. If detector voltage is increased, overloading will result when V4 is in circuit. V6 plugs into points A, B, or C (jacks) as required, lighting or extinguishing filaments of V4 and V5.

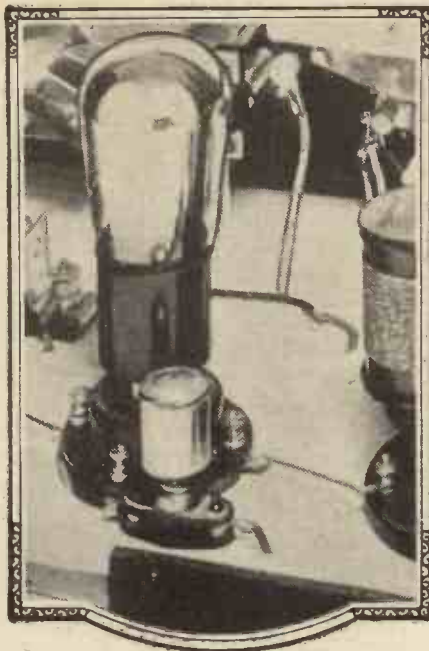

# The INTERDYNE VALVE

*An article fully describing the theory and operation of the new "self-neutralising" valve, written specially for "Modern Wireless" by the inventor.*

*By J. ROBINSON, M.B.E., D.Sc., Ph.D., M.I.E.E., F.Inst.P.*

THE ordinary three-electrode valve has had almost a complete monopoly of the public favour for a very long time, much to the disappointment of inventors. Various new types of valves have been proposed, and occasionally manufacturers have made some of them available, but they have received little support, the reasons apparently

introduce any disadvantage in other respects. Thus, for instance, we might easily improve the amplification factor, but this may introduce difficulties in preventing amplifiers from breaking into oscillation.

Again, we might obtain extra amplification with stability but at the expense of one or two added controls, and this would be absolutely fatal. One of the greatest requirements in present-day wireless is simplicity of operation, and any successful change of design of valves must have this condition that it does not add to complications of adjustment, and, if possible, it should make adjustments much easier.

In order to see how the new valves operate, we shall consider first an ordinary three-electrode valve used as a high-frequency amplifier (Fig. 1).  $L_1 C_1$  is the grid circuit, and  $L_2 C_2$  the anode circuit, the anode coil being connected to the anode at A and to the high-tension battery at its other end, B.

Incoming waves excite the grid circuit, and this applies a varying potential between the grid and the filament. This varying potential is shown in Fig. 2, where the anode current-grid volt characteristic of the valve is shown. The grid oscillations are shown as a, b, c, d, . . . , and they cause the grid potential to vary between p and q. This causes the anode current to vary between P and Q, and we have

## Causes of Instability

It is thus also highly desirable that new valves shall be suitable for use in the ordinary valve holder.

The new stable valves which are the subject of this article are designed with the definite object of allowing high-frequency amplification to be obtained without any fear of oscillations being produced, and, further, without any adjustments of apparatus being required. The valves which have so far been constructed give the ordinary performances of the well-known three-electrode valves—i.e. the same amplification factor and impedance, with the added advantage that stability is obtained.

It is important to observe that we are dealing only with the type of instability which is introduced by the ordinary valves themselves, for it is not to be expected that good results can be obtained by using a well-designed valve with slovenly wiring and disposition of parts.

Oscillations of amplifiers at present are introduced both by the valves and by the interaction between various coils and leads. The new valve obviously deals only with the oscillations produced in valves themselves.

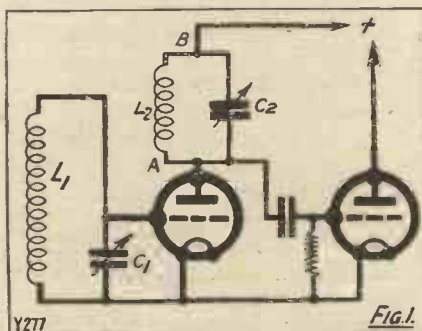

being that the efficiency of the ordinary type of valve is so good and, further, almost everyone understands how to handle them.

It is at last beginning to be realised that decided advantages can be obtained by departing from the standard design of the three-electrode valve, and thus we may now expect to see the supremacy of this type of valve challenged, at least for some purposes.

## Needed Improvements

Of the various properties of ordinary valves, there are the following in which decided improvements can be expected—amplification factor, impedance, rectification, and stability in amplification. Any improvements in one respect must, however, not



Robinson's new Interdyne valve fits the standard four-pin valve holder and is no larger than an ordinary receiving valve of average dimensions. The flexible lead that can be seen is the connection to the additional anode.

variations of anode current in the valve as shown at  $X_1, X_2, X_3, \dots$ . The magnitude of these anode current variations depends on the steepness of the characteristics, and are given by the amplification factor of the valve.

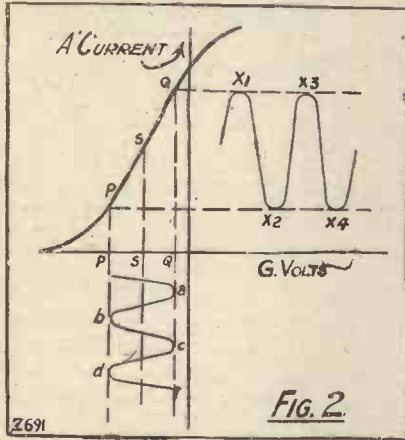

This varying anode current now becomes influenced by the tuning of the anode circuit, and we get an alternating potential in this circuit which is larger than that produced in the grid circuit by the incoming waves. In other words, instead of having now a steady anode voltage

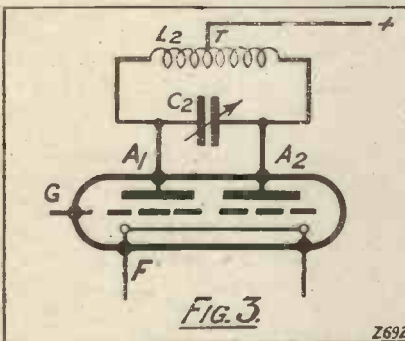

we have a varying anode voltage. This, in fact, is the desired function of an amplifying valve to produce a larger variation of voltage. It is, however, precisely these varying anode voltages which cause the valve to oscillate, for with the ordinary three-electrode valve it is not easy to prevent the varying anode current from reacting on the grid circuit.

**Early Stabilising Methods**

Referring to Fig. 1, we have variations of potential across the tuned circuit, and if the end B is attached to the positive of the high-tension battery, it is permanently at a constant potential provided there is no impedance in the anode battery and its associates. Thus the other end, A, of the coil has the full variations of potential, and in consequence

of the capacity between the anode and grid, part of these potential variations get through to the grid, thus in effect introducing reaction, which will produce oscillations under such favourable conditions as high enough amplification, or, again, if the grid circuit is in an efficient condition—i.e. with very small resistance so as to allow the full value of the voltage to be obtained on the grid.

The problem becomes one to obtain the desired varying anode voltage in such a manner that it will have no reaction back on the grid. One well-known method for preventing oscillations is apparent from the preceding, which is to prevent the full value of the induced voltage on the grid from being obtained, by making the grid circuit inefficient. This is usually accomplished by introducing resistance into the path between the grid and filament, which is obtained by the device of making the grid positive, a potentiometer usually being employed for the purpose.

**Automatic Neurodyning**

However, we wish to obtain our object without any such damping device, and we must now see how it is possible to obtain a valve which will first allow the efficient impulsing of the anode to obtain the varying anode potentials, and which will secondly prevent these varying anode potentials from affecting the grid in any way.

Consider in the first place a valve with two anodes, one grid and one filament, as shown in Fig. 3. In this case the two anodes are shown symmetrically disposed with regard to both the filament F and the grid G. The anode potential is introduced at the middle point T of the anode coil. Suppose that we have oscillations

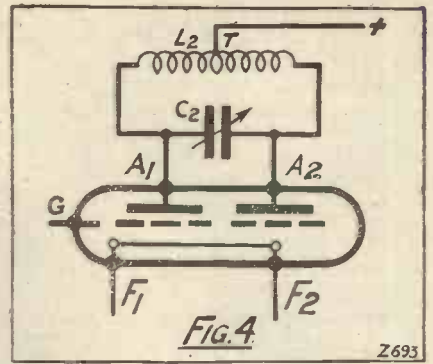

in the anode circuit  $L_2 C_2$ , the zero high-frequency potential is in this case at the point T, and when the anode A is made positive due to the oscillations, the anode  $A_2$  becomes negative from the same source, and any influence on the grid due to the two anodes is thus zero. However, although we in this manner prevent oscillations in the anode circuit from influencing the grid, we have not a very efficient valve, and in fact in most cases such a device would not operate as a valve.

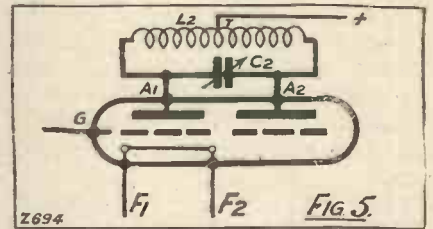

The reason for this can be readily understood from the foregoing description, for our chief object is to obtain differences of potential which are as large as possible between the ends of the coil  $A_1$  and  $A_2$ . The primary cause of such differences is in the impulsing effect on the anode due to the emission. In this case the impulsing is effected at both ends of the coil simultaneously, so that if the

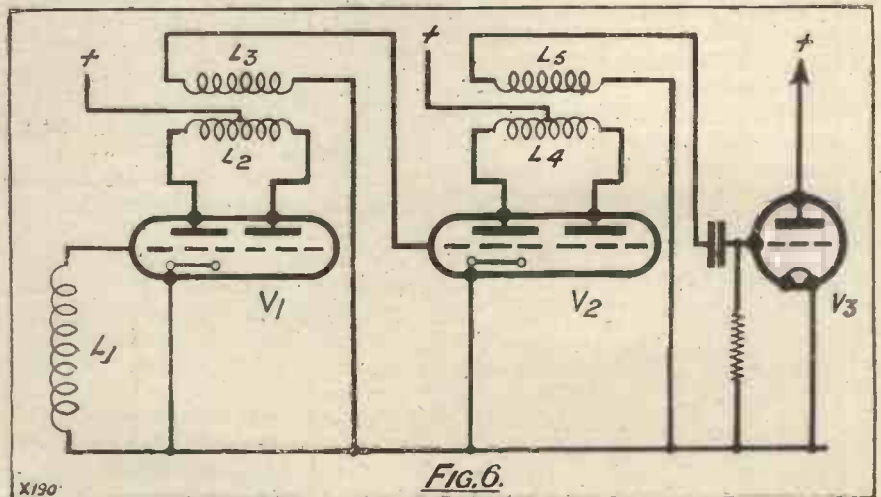



emission along the filament is uniform we should never succeed in exciting the anode coil.

This is the essential point, we must not impulse the two anodes equally,

valve is suitable for introduction into the ordinary valve holders.

Various types of centre-tapped coils are available, and, in fact, it is not difficult to arrange for a centre

more obvious because once these valves are inserted, no other operation is required to obtain stability, which is there permanently. The ordinary adjustments of the amplifier can be made without any fear of introducing instability. Again, when a valve has burnt out, all that is required is to insert another valve of the same type without any further adjustment.

**Circuit Applications**

Thus, by the introduction of an extra anode to the ordinary three-electrode valve in this way, we have obtained a very simple device which is as efficient as any present-day valve as regards amplification, etc., and which gives a stable form of amplification in an automatic manner, no extra adjustments of any type being required, i.e. we have combined efficiency of amplification with stability, and with the greatest possible simplicity of operation.

The circuits which can be employed with these new valves are innumerable. For cascade amplification, transformer coupling can be employed as shown in Fig. 6. In this case, the various coils are shown untuned, and such aperiodic amplifiers have still application, particularly if selectivity is introduced in some other device. Obviously, tuning of some of the coils can be introduced, such as on the coils  $L_1$ ,  $L_2$  and  $L_3$ , and this gives a very selective amplifier.

**Further Examples**

Another example of cascade amplification is shown in Fig. 7, whereby one connects one end of the anode coil through a condenser  $C_3$ , with a resistance  $R$ , to the grid of the next valve.

There is another important aspect of this new type of valve. So far, it has been described only with respect to its faculty for preventing an amplifier from oscillating. This other feature is also of great importance,

*(Continued on page 540.)*

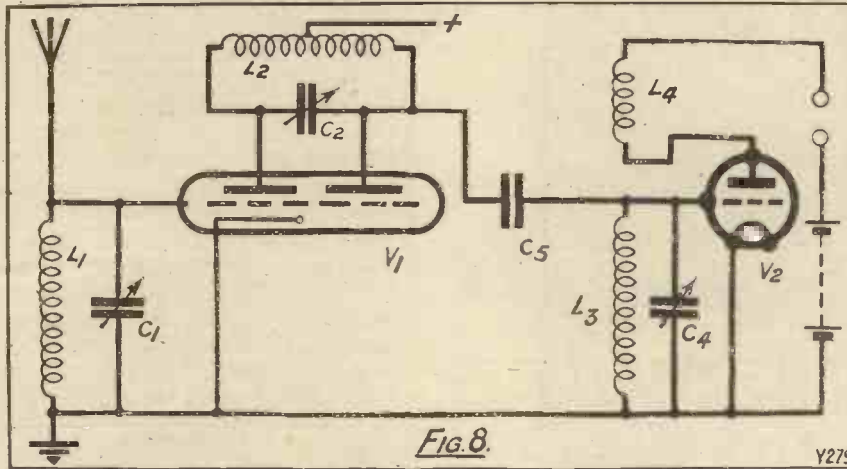

Fig. 8.

Y279

and we achieve this result in valves such as those shown in Figs. 3 and 4. In Fig. 4 the filament is effective for the whole of anode  $A_1$ , and is only partially effective for the anode  $A_2$ . In Fig. 5 the filament is effective only with respect to anode  $A_1$ . Thus valves constructed on these principles will allow the ordinary functions of a valve to be obtained and at the same time they will prevent the varying anode potential from reacting on the grid.

Thus we have a stable valve, which is no more difficult to insert in one's receiver than the ordinary three-electrode valve, if one uses an anode coil with a middle tapping.

**Practical Considerations**

For high-frequency amplification we must thus design the valve so that there is asymmetry of the anodes and grids as regards the anode currents to them, but that there shall be symmetry as regards the dimensions and disposition of the anodes and the grid. In the present-day methods of manufacture it is quite easy to obtain these conditions. The two anodes can be arranged quite easily so as to be symmetrical with respect to the grid. Again, the leads from the anodes inside the valve can be arranged easily in such a way that no asymmetry is introduced. The cap of the valve is also easily arranged to suit the present-day valve holders, for there is only one extra terminal for the second anode, and the ordinary four pins of the valve cap can be used in the ordinary way, merely introducing a terminal in a convenient position, for instance, in the cap, for the extra anode. Thus the new

tapping on some forms of ordinary anode coils. Thus there is no difficulty in introducing these new valves immediately into ordinary receivers. Once introduced, the advantage of stability is apparent. When the

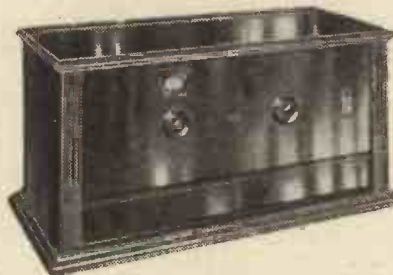

An R.I.-Varley "Interdyne" which uses the new Robinson valves in the H.F. positions.

anode coil is connected as shown in Fig. 5, there is complete stability. The valve will naturally operate as a valve if the connection to the second anode  $A_2$  is removed, but if this is done, oscillations are immediately introduced. The advantage is all the

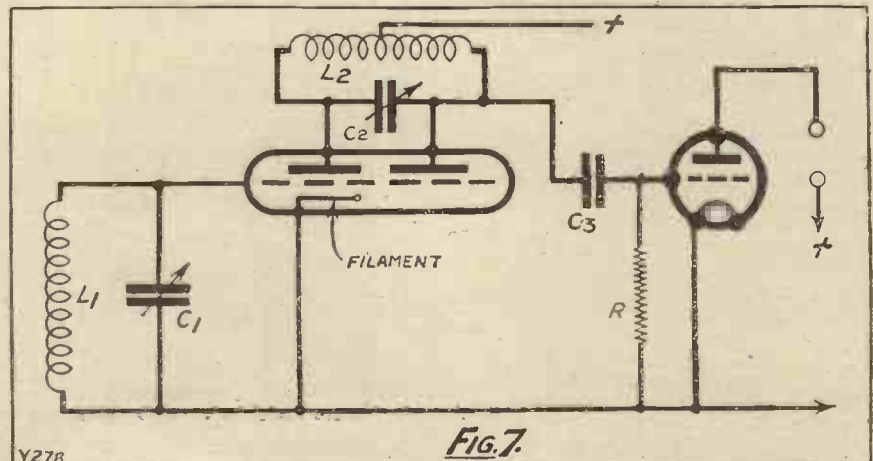

Fig. 7.

Y278



By A. T. WALLIS.

A NUMBER of methods have been devised by which the amateur can wind his own short-wave coils, but the majority of them involve the making of some kind of ebonite former to hold the coil rigid

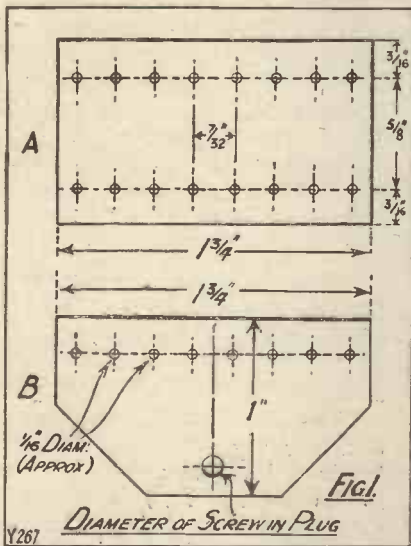

and to ensure correct spacing. The following method employs celluloid, which can be easily worked with a pen-knife or bradawl.

**The Materials Needed**

The materials required are:—16 S.W.G. bare copper wire (1 lb. will make about six eight-turn coils), several strips of celluloid 1 in. wide, such as sold by most radio dealers for ordinary coils, and best quality ebonite plugs.

The wire should be straightened (by holding one end in a vice and pulling the other end until all the kinks are out), and cleaned with a piece of emery cloth. Leave one end of the wire in the vice, and wind two more than the required number of

turns on a 3-in. former (a bottle will do, if there is nothing else at hand). Keep the wire pulled tight while winding; walking towards the vice as the wire is taken up. When the required number of turns have been wound the wire may be cut off and the coil laid on one side. It will be found that it springs to a larger diameter when released from the former, but this can be rectified when assembling

**Constructional Details**

The four celluloid plates will next be required:—two "A" and two "B," Fig. 1. The easiest way is to make one of each from the dimensions given, and use these as a template to mark off the others.

Fig. 2 shows the celluloid plates on the completed coil, which is assembled by the following procedure:

Take one plate "A" and thread the start of the coil through the first hole, follow with one "B" plate, the wire being threaded up through the first hole and down through the

opposite one; another "B" plate, and finally the other "A" plate are put on in the same manner.

Push the plates carefully round the coil until the starting point is reached again, which will now come opposite the second hole, the above procedure is then repeated until each hole contains its respective turn. The coil is, in fact, screwed into the plates. Continue until there is an extra turn each side of the plates, this may be cut to a suitable length for connecting to the plug. It will be found that the first and last turns lose their shape by constant handling during construction, so by winding two more than are required these may be cut off, leaving the completed coil of undamaged turns.

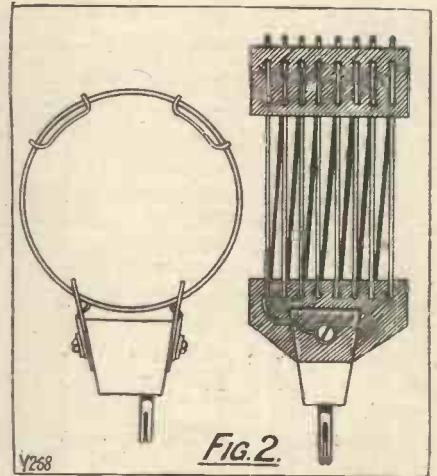

The coil may now be attached to the plug by the hole in lower edge of "B" plate, and the two ends of wire bent round the plate and anchored under the connecting screws. Straighten the coil if it is out of shape, and see that all turns are parallel.

The result should be a rigid coil of professional appearance.

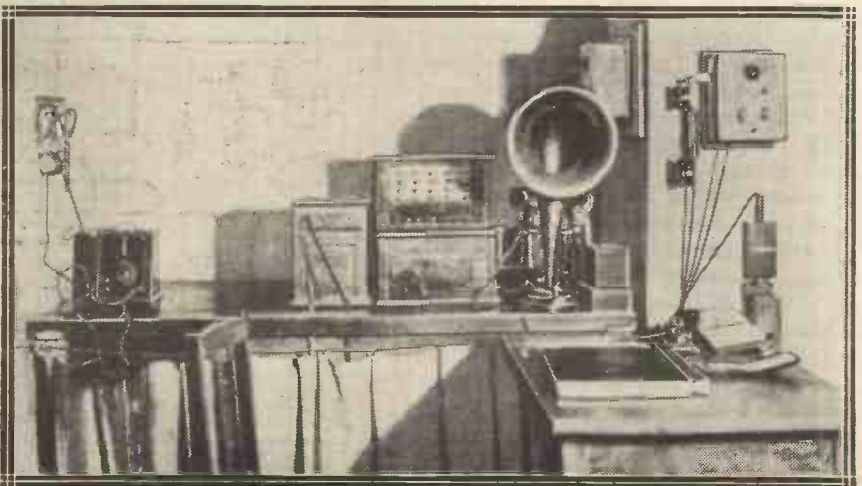

The control room at the Tokyo, J O A K, broadcasting station.

# A de Luxe D.C. Unit

A number of refinements and special smoothing arrangements are provided in this unit, giving a practically perfect H.T. supply, specially suitable for a large set.

Designed and described  
By G. P. KENDALL, B.Sc.

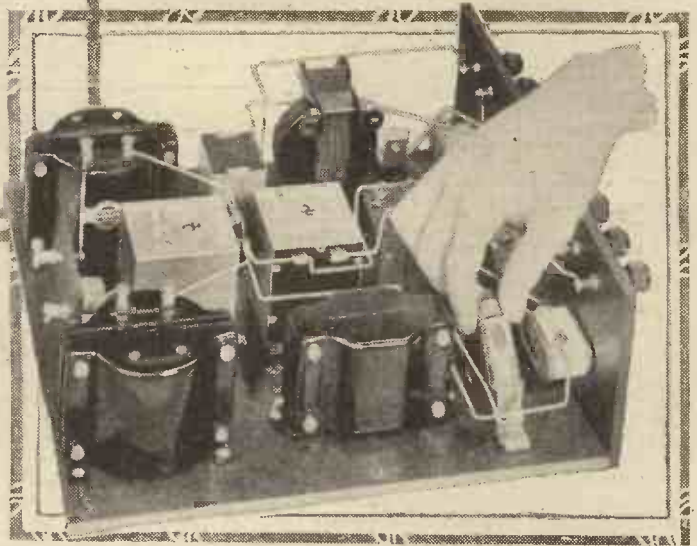

THIS unit has been produced to meet the needs of the man who has had a certain amount of experience with eliminators and who

mains, but in order to make the unit as universally useful as possible it was decided to adopt a very effective main smoothing circuit, and add to

this a supplementary one for the detector valve, since it is at this latter point that most of the trouble occurs with noisy mains. The fact that the main smoothing circuit contains a total inductance of 80 henries and a capacity of 4 mfd. will give an idea of the pains taken to secure really effective filtering.

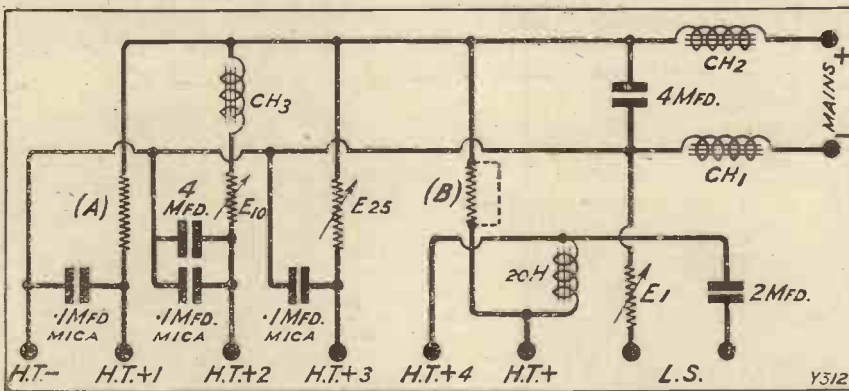

### Thorough Smoothing

This main filter circuit consists of, first, following immediately upon the input terminals, two 40-henry chokes, one in the positive and one in the negative lead, and across these again the 4-mfd. condenser. Following upon this smoothing circuit come the feeds to the various output

has realised that working a fair-sized set from the mains is decidedly one of those things which are worth doing well if they are done at all. Frankly, it is an expensive unit, with a number of special refinements intended to make it as widely useful as possible, and will appeal chiefly to owners of large sets who have direct-current mains and wish to obtain from them a practically perfect H.T. supply, without those difficulties from overloaded smoothing circuits, coupling effects due to unsatisfactory methods of voltage adjustment, and so on, which result from the use of a unit designed for small sets requiring only one or two different voltages and low currents.

Particular care has been devoted to the smoothing arrangements, and these will be found sufficiently thorough to give a really good and clean supply from even very bad and noisy mains. Actually, they are more elaborate than is necessary on good

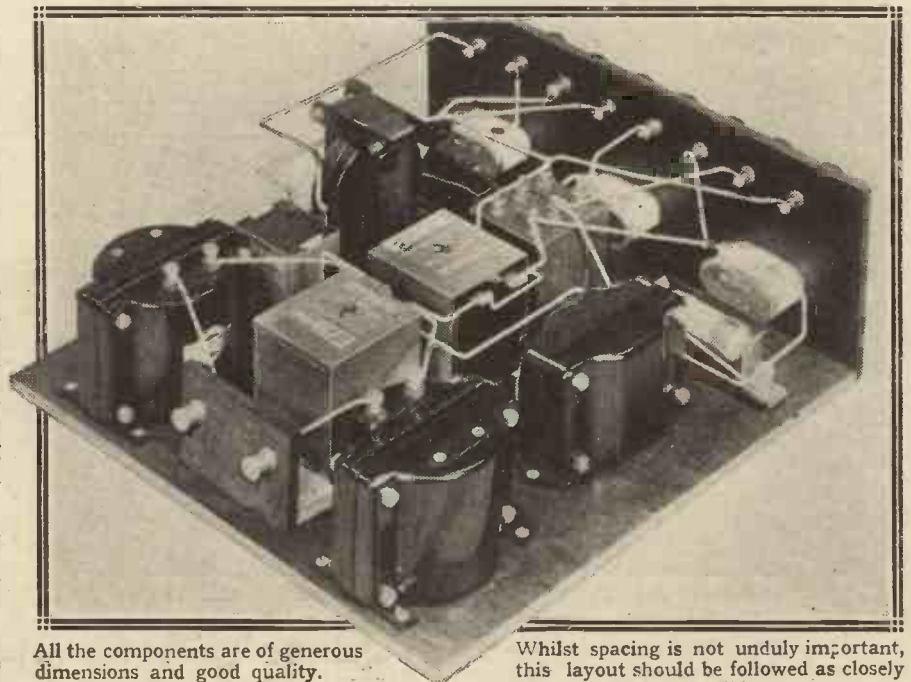

All the components are of generous dimensions and good quality.

Whilst spacing is not unduly important, this layout should be followed as closely as possible.

terminals, of which there are five positives, a common negative, and two loud-speaker terminals. In each of the positive leads is a means of adjusting the voltage, and reference

the terminal H.T. + 1 when a certain current is being drawn. Shunted from H.T. + 1 to H.T. - is a mica

the other H.T. terminals for the same reason. (That, of course, is why a .1 mica condenser is seen in parallel

**MATERIALS REQUIRED.**

- 1 panel,  $4\frac{1}{2} \times 12 \times \frac{1}{4}$  or  $\frac{3}{8}$  in. thick. (Radion, Ebonart, Pilot or other good branded material.)
- 1 baseboard,  $12 \times 12$  in.
- 1 cabinet to suit.
- 2 smoothing chokes (those used were the Marconiphone 40-henry type). Others of similar inductance and low d.c. resistance can, of course, be used.
- 1 small choke of about 30 henries. (Original was the Sterling 30-henry type, but others can be used if desired.)
- 2 anode resistances, wire-wound, with bases. (Originals were R.I.-Varley, but any standard make such as Mullard, Dubilier, etc., can be used if the required values are available. For resistance see text.)
- 3 "Bradleyohms," one No. E.25, one No. E.10, one No. E.1 (see note in text re this last). (R.A. Rothermel & Co., Ltd.)
- 2 4-mfd. condensers, Mansbridge or similar type. (High-voltage type essential. Those used were of "Hydra" make, 500 volts A.C. test. Other good standard makes, such as Mullard, T.C.C., Dubilier, etc., can, of course, be used, but alterations of layout will be needed if they are larger than those shown.)
- 2-mfd. condenser. (See above.)
- 3 .1-mfd. mica condensers. (Dubilier used, but numerous other makes, T.C.C., etc., are available and occupy practically the same space.)
- 1 20-henry L.F. choke. (Pye, R.I.-Varley, etc.)
- 8 engraved terminals, with insulated tops for preference. (Belling & Lee.)
- 2 plain terminals.
- 1 terminal strip,  $3 \times 1\frac{1}{2} \times \frac{1}{4}$  in.

should be made at this point to the circuit diagram. The terminal H.T. + 1 is intended to serve for high-frequency valves where these do not require a critically adjusted voltage, or for the first low-frequency

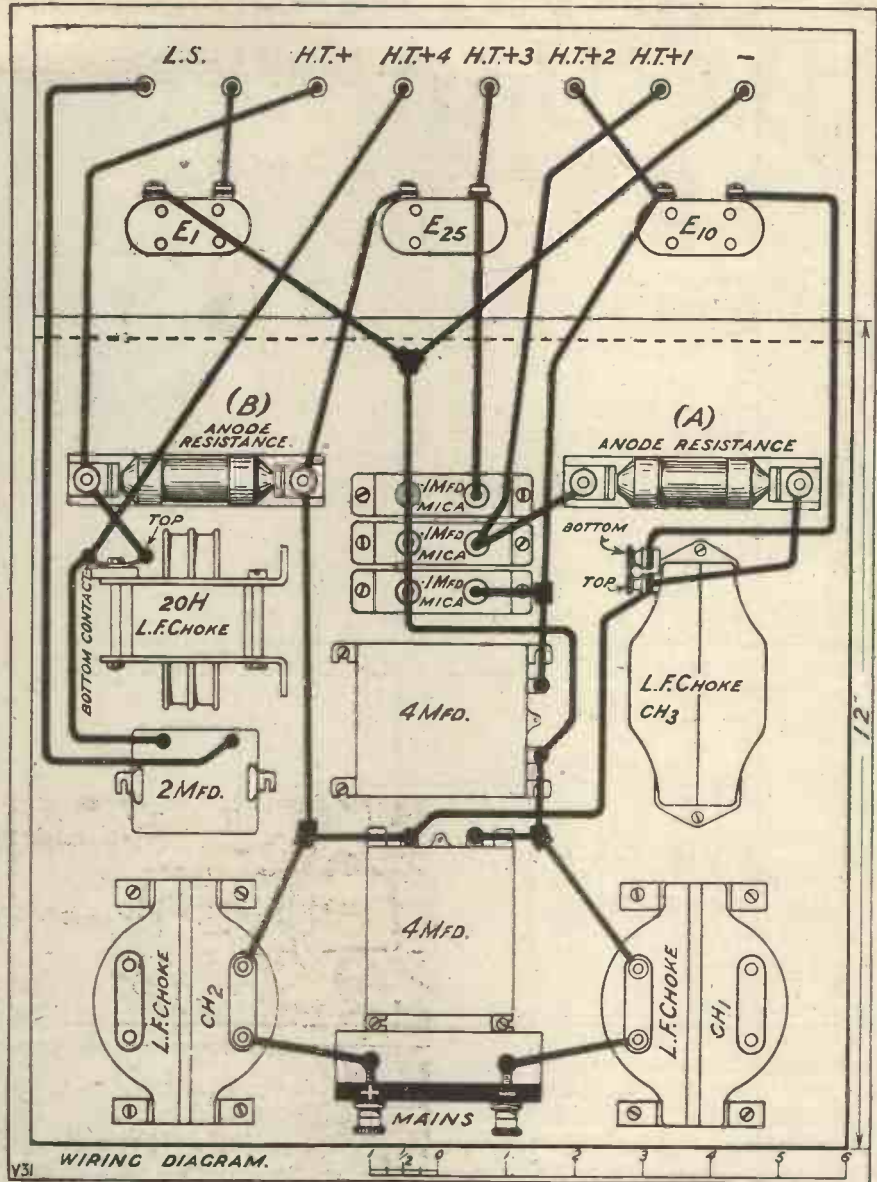

condenser of .1 mfd., and the function of this is to act as a very thorough by-pass and prevent any coupling

with a 4-mfd. Mansbridge type across H.T. + 2 and H.T. -.) If desired, both the high-frequency valve (or valves) and the first low-frequency stage can be run from this terminal, if a common voltage is suitable (it will be in many cases).

**Resistance Values**

To arrive at a suitable value for the resistance is a fairly simple matter. First decide what voltage you require; this will probably be between 100 and 120 volts. Then ascertain from the maker's curves what current will flow if that voltage is applied to the valve or valves fed by this terminal.

Now find out what voltage must be dropped in the resistance to give the desired output voltage. This, of



The knob on the extreme right controls the volume of the output, and the other controls give variations of voltage.

stage. It includes in series an anode resistance A, which can be chosen to give the desired fixed voltage upon

effects from being produced by the various resistances in the unit. Similar condensers are provided across two of

course, is simply the difference between the voltage across the main smoothing circuit and the required voltage. At this point it should be noted that the voltage across the smoothing circuit is not quite the

put device for the loud speaker is incorporated in the eliminator unit itself, thus simplifying the external connections considerably. Provision is made for using this device only when required, another terminal being

In many cases, of course, no extra resistance will be needed, the voltage drop in the smoothing chokes, output filter choke, etc., being sufficient to reduce the input to a suitable pressure. In such cases the holder for B will simply be shorted.

When the filter output circuit in the unit is to be employed, the loud speaker should be connected to the L.S. terminals, and a lead taken from H.T. + 4 to the L.S. terminal on the receiver which is wired internally to the anode of the last valve. No connection will then need to be made to the other L.S. terminal on the set.

Finally, the purpose of the variable resistance marked  $E_1$  must be explained. This is simply a volume-control device, but placed in a somewhat unusual position. Instead of the customary position in parallel with the loud speaker, which is undesirable with an output filter, it is connected in series, and to reduce volume this resistance must be *increased*, i.e. its control knob must be screwed outwards. When full volume is required it must be screwed inwards to the minimum resistance position, the actual amount of resistance then left in circuit being quite small.

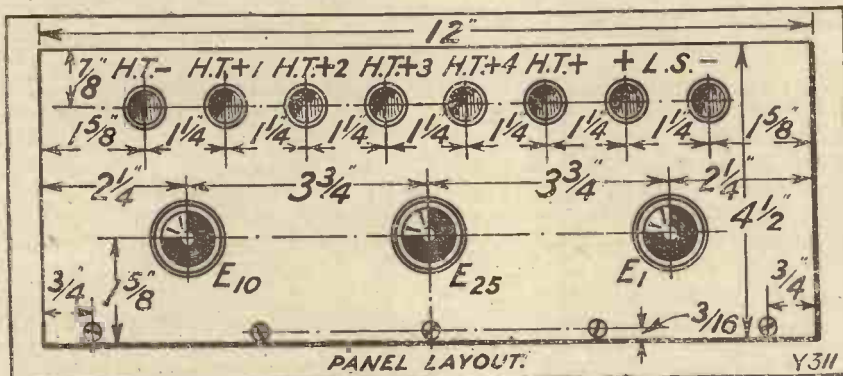

full voltage of the mains, since there is a small drop in the chokes. This is easily allowed for by estimating roughly the total current to be drawn from the eliminator, and assuming a drop of 8 volts per 10 milliamps flowing. Having found the voltage which must be dropped in the resistance A, multiply this by the current (in milliamps) which will be drawn from terminal H.T. + 1, and divide by 1,000. The result is the resistance required in ohms.

#### Detector and H.F.

Terminal H.T. + 2 is intended for the detector valve, and here there is an extra smoothing circuit, and a variable resistance for voltage adjustment. No calculations are needed here, since the voltage will be regulated experimentally to get the desired smooth reaction adjustment, etc.

Terminal H.T. + 3 is also provided with an adjustable series resistance, and this terminal is intended to supply H.F. values requiring a critically adjusted H.T. voltage. In particular, it will serve for the H.T. supply to the screening electrode in the newly introduced shielded valves, the variable resistance being of a high value to suit this purpose.

#### Output Circuit

The terminals H.T. + and H.T. + 4 are intended for the last stage of the receiver, and here a special scheme has been incorporated at the suggestion of the Technical Editor of this journal, who is now using this eliminator in conjunction with the "Super-Screen Four" (described in the last issue of "M.W."). Many receivers do not incorporate a filter output circuit, which involves the use of a separate unit. To meet such cases a filter out-

arranged to give a plain H.T. supply, cutting out the filter output circuit when it is not needed.

Thus, in a set already incorporating a filter output, terminal H.T. + is used in the ordinary way, provision being made for a rough adjustment of voltage by means of another anode resistance B, the value of which is obtained by a similar process to that adopted in the case of resistance A.

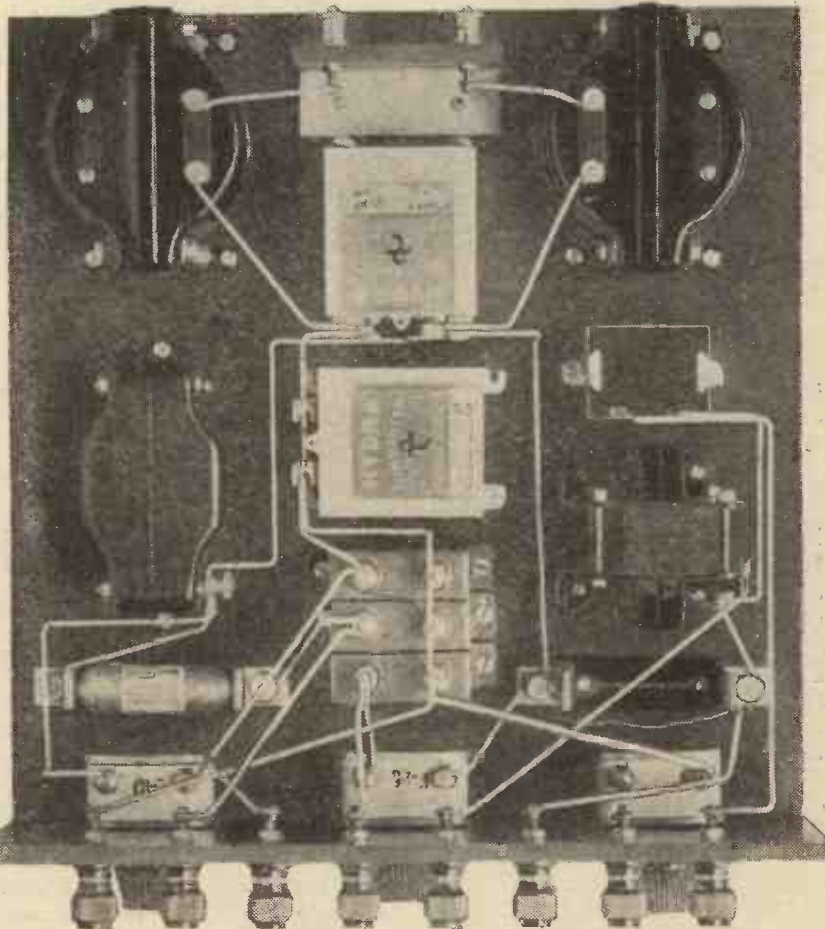

This plan view shows the layout and practically all the connections

# SOME READERS' RESULTS

*The One-Valve Filadyne—The World's Worst Blind Spot  
—Broadcasting And The Empire.*

SIR,—I have made up your latest one-valve Filadyne, and I thought you would like to hear of the rather unexpected results.

The set was tested three-quarters of a mile from 2 L O, indoor aerial at top of the house, main water pipe as earth within a few feet. On connecting up as indicated in the text of the article in July MODERN WIRELESS, I found signals good but tuning exceedingly flat, using a new D.E.R. valve and 30 to 60 volts H.T. Not being satisfied with the tuning after many trials, I reversed the L.T. leads, there-

I thought you would like to know my results in case they might help others of your readers.

Yours faithfully,  
R. E. TYLER.

Soho, London, W.1.

SIR,—The two letters which appeared in the May and September issues of MODERN WIRELESS respectively re the "World's Worst Blind Spot" are apt to be rather misleading.

The reason, in my opinion, why difficulty is experienced in receiving the Colombo Station (V P B), east of

These mountains act, I should say, as a reflector for Colombo in a westerly direction, because I have received time signals from this station at a distance of 2,000 miles west-north-west (approximately), and also as far south as the "Roaring Forties" on a one-valve three-circuit receiver.

So it would appear that the "blind spot" mentioned by your correspondents is only "blind" as regards the Colombo Station.

I have been a regular reader of your excellent paper since No. 1.

Yours faithfully,  
JOHN CROOK.

Roath Park, Cardiff.

SIR,—With reference to your most interesting article "Broadcasting and the Empire," by the Editor in your September issue, it would probably interest you to know that P C J J, of Holland, comes through here, loud-speaker strength, regularly every Tuesday and Thursday at 10.30 p.m. Ceylon time. These concerts are very much appreciated, in fact we look forward to listening-in, as they bring us into immediate touch with the Home side of the world.

I think it was September 6th that the Amsterdam chimes were broadcast, with beautiful effect. At the commencement of the programme a little fading was noticed, but as the night grew later the clearness of the reception was increased. The set used was 1 detector and two stages of low-frequency amplification, home-made. 2 X A F (Schenectady, U.S.A.) was picked up at dawn, telephone strength, on a short-wave receiver described by Mr. Simmonds in your February issue.

Last Sunday, 11.30 to 12.30 midnight, Mr. Gerald Marcuse was received out here. Although the hours are somewhat late to get these stations, it is well worth while sitting up to get them. This is a drawback that may possibly be overcome in time.

I hope this note will catch the eye of many listeners-in in the Dominions and Far East; that they will agitate strongly for the B.B.C. to really consider this matter and give us some Home music, if only twice a week to commence with. If this were done, I am sure our big stations out here would do its utmost to receive these programmes and relay them to users of crystal and multi-valve receivers.

Yours faithfully,  
J. S. H. JOLLIFFE.

Agalawatta, Ceylon.

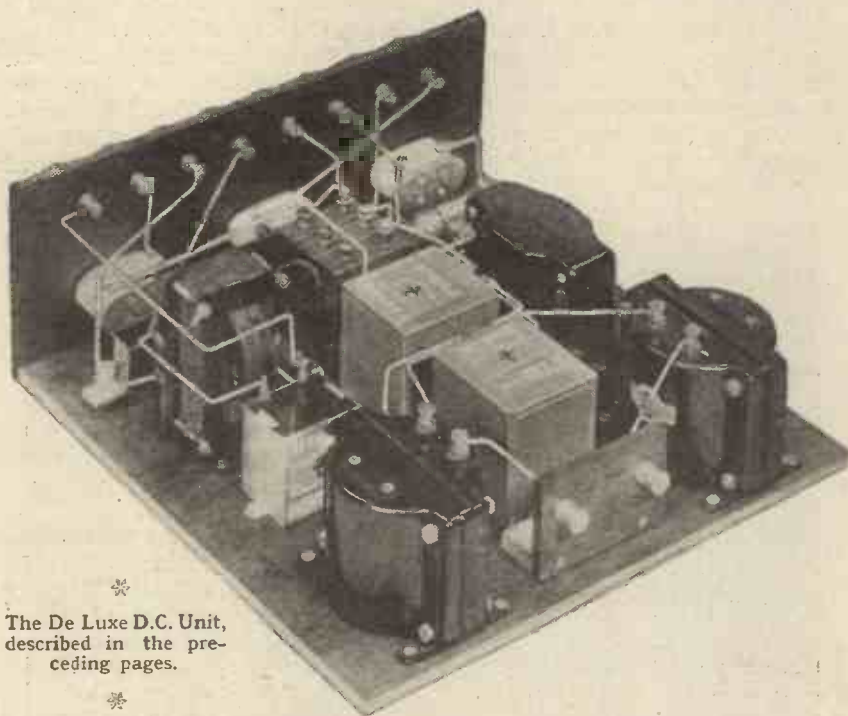

The De Luxe D.C. Unit, described in the preceding pages.

by placing a negative potential on the anode. Result—razor-sharp tuning and quality and strength just as good, the valve functioning in every way the same as before. Incidentally, I found the regulating of the potentiometer made only a slight difference in the strength of signals. (Burndept 1,200 ohms used.)

Of course, when one follows out the circuit from the theoretical diagram there is obviously a negative potential on the anode from the H.T. battery, but I conclude that with some valves the L.T. positive makes adjustment on the anode more easily regulated.

the eightieth meridian, is because this station is badly screened by the range of mountains which form the "backbone" of the island of Ceylon. The highest peak of these mountains, Pidirutalagala, 8,295 ft., lies practically due east of Colombo.

I have experienced no difficulty in receiving and working stations other than Colombo—e.g. Penang (V P X), Rangoon (V P T), and even Perth (V I P), while in the so-called "blind spot." Singapore (V P W) can be heard under favourable conditions at a distance of 800 miles in a north-westerly direction.



# ROUND THE ALPS WITH A PORTABLE

*Some experiences among the foreign stations during an extensive tour on the Continent.*

*By CECIL LEWIS*

(Late Director of Programmes of the B.B.C.).

IT was not only round the Alps either, as a matter of fact. When someone suggested a tour down the Rhine, over the Alps, on to Florence and Rome, it seemed too good to be true, and far too good to miss! A car was waiting, panting to be off, on the Dutch frontier. Would I come?

Could I come? That was the only question. Could I persuade the powers that be to release me from the sober duties of listening to London and Daventry? I could not.

It was at this moment that Mr. Scherf, of the Igramic Electric, turned up. He metaphorically produced a set from his waistcoat pocket and said with that for a talisman I could go. So I did.

Portable sets have always scared me. Technical staff at the B.B.C., to whose discussions I have often listened, worship quality. They set themselves a standard of perfection both for transmission and reception, and probably do not realise that a man with a non-technical ear is quite satisfied with something less than perfection. But I must hasten to add, that with the Neutrosonic Seven he gets about as near perfection as any human being has the right to expect.

## First Tests

To start with, the set is not exactly portable—transportable, the makers term it. A seven-valve set, with 150 volts of H.T., a frame, and a loud-speaker is bound to take space and weight for efficient operation.

It is fairly compact and consists of two units—the set itself being one, and the other being a cube cut into three slices: the centre slice batteries, on one side a frame (which detaches and fits into a swivel socket on the centre battery slice), on the other an excellent hornless loud speaker. To operate the set, unclip

the side pieces of the cube, join four leads—two frame and two loud speaker—connect all batteries with one irreversible five-point socket, switch on—and there you are! The whole thing can be done in under a minute.

The only trouble I had with the set over the whole tour was a couple of parted connections, one to a valve socket and one to a filament lead. Fractured soldered joints are very difficult to detect and need to be searched for systematically—I nearly died of heat trying to spot one in Como—but this is little discredit to the set, when you consider that it was banged and bumped over two thousand miles of continental roads—some of whose surfaces have to be driven over to be appreciated—in a small car. Not a single valve gave out over the whole trip, and the filament consumption was so low that the 4-volt battery was only charged once in six weeks, listening, on the average, five nights a week.

The first stop was Cologne, where, in a first-floor room, with trams just

round the corner, we tuned in all the German stations, Daventry, Paris, and London with no difficulty. The set was new to me. I was pleased; but this was soon to be destroyed by an ominous crackling when I touched the first detector valve. After a few perfunctory dots and dashes of music, came silence. Next morning we took the set to a radio shop, where they dismantled it, declared that the lead to the detector grid had been shorting, showed me that the crackling had gone, and we packed up and started south towards Darmstadt. But that night also there was utter silence.

## A Comparison

It was not until we got into Heidelberg next day and went to Telefunken's that we found out the Cologne people had *parted* the lead they said was shorting, entirely! No wonder the crackling had ceased! No wonder there was silence! In five minutes the joint was made good. Telefunken switched on their latest five-valve set with an outside aerial, I switched on mine with a foot frame.



The head of the Jaufen Joch Pass, 6,000 feet high, the way through to Italy from Innsbruck.

In a moment my loud speaker had flooded out the Telefunken, which was inaudible! The station was about fifty miles away. Telefunken—and indeed every radio manufacturer and agent on the Continent—were most impressed.

The two bugbears of long-distance summer reception on the Continent are thunder and overhead power wires. The former is always to be reckoned with; the latter only made listening impossible on one occasion, and that was in the marvellous old mediæval town of Rothenburg.

**Mains Interference**

It was there we had the second breakdown. Nothing to do with the set this time, only the operator! The cracklings of the mains was so curious—and I had no previous experience of it—that I took it for a breakdown in the H.T. batteries. Accordingly, I took them out, to see if changing their order would improve things. Unfortunately I put two back negative to negative without noticing it! Of course, there was no more crackle after that—and nothing else either! It took us quite a time to spot what we had done.

Soon we got down to the Oberbayern, on the edge of the Tyrol, in the northern folds of the Alps. The central position here, and the absence of thunder for some days, gave us a period of quite exceptional reception, both for lack of atmospherics and variety of programmes.

There was a fiddler on Daventry one night whose highest harmonics were perfect. Langenberg, Munich, Frankfurt, Vienna, Paris, Toulouse, Milan, besides a number of unidentified Spanish and Central European stations came in with great clarity and volume. We danced to the Savoy bands on the white scrubbed pinefloor of a little chalet, we joined in the choruses of cabby songs from Vienna, a famous German playwright helped out with his concertina. The whole party was converted to radio there and then!

**5 G B and 5 X X**

Reception does not seem to be altered by height above sea level to the extent one had imagined. The only time it was possible to get a sustained test of this was in the Haute Savoie at the height of 3,000 feet. The strength of continental stations was not noticeably different from that in the Tyrol. The only obvious improvement being the reception of Daventry at loud-speaker strength in the daytime.

It was in the Haute Savoie that the first experimental transmissions

on 5 G B were heard. The first evening was disappointing, the strength being no greater than that of Daventry; but the next night the radiation seemed stronger—or, in any event, 5 G B was about as loud again as 5 X X.

British stations are not international to the extent that some people seem to believe. All the German stations—whose programmes, by the way, are extremely good in execution, if not so in variety—are a great deal stronger than anything from across the Channel. The quality of their transmission also is very good; but they seem to know nothing of fading or control. The result is that singers and emotional actors often blast badly.

The three chief dishes in continental programmes when the plethora of jazz and café music has been

lack of an adequate programme time table. Night after night one listens to stations without having the least idea even of the style of programme they are going to put on. A continental Radio Bradshaw is necessary.

**Programme Guide Required**

But, as yet, the Continent is not sufficiently keen on Radio to have arrived at this. The organisation of such a Bradshaw over a large area would hardly be possible without united European control. The sort of function that the Geneva Radio Bureau might discharge, if international programme problems were considered as seriously as the technical problems are—and there is no reason why they should not be.

After all, one realises that British Radio will always be unique because it operates under almost ideal conditions in a "bright little, tight little island"—Europe, a wilderness of countries, states, languages, beliefs, and dissents, will have to make Radio an International House, and set that house in order before the continental listener can hope to get the service that the British organisation makes possible.

**A PANEL-DRILLING HINT**

CONSTRUCTORS who prefer to see a clean panel, unadorned by bolt heads and unnecessary holes, will find that, providing one is working on fairly substantial ebonite, a "blind" hole at the back of the panel, tapped to take the required screw or terminal, fills the bill.

The main difficulty is to know how deep to drill, and the following little device will be found to make a very useful stop:

Secure about three-quarters of an inch of stout ebonite tubing, having a bore of roughly quarter of an inch (an old lead-in tube is just the thing) at equal distances round the tube drill, and tap three holes to take 6 B.A. screws. Slip the stop over the drill to be used, and adjust for distance; thus, if quarter-inch ebonite is being used the point of the drill should protrude from the stop slightly over three-sixteenths of an inch. The three screws are then tightened.

The hole can now be drilled in the usual way, until the stop touches the panel. A refinement is to fix a further two screws at the opposite end of the stop, thus making the whole thing practically solid.



The famous gate tower at Rothenburg.

set aside, seem to be chamber music, choral singing, and declamatory poetry.

On one Saturday night, two stations had an hour each of almost unrelieved male-voice singing. How would that go down on 2 L O? On another night, out of six German stations, five had plays going on.

This tour has impressed two things on me. Firstly, the enormous advantages of alternative programmes when suitably controlled. It is an unbelievable relief to have the choice of half a dozen programmes. Usually it does not take above five minutes to find something to one's taste and settle down to listen. Secondly, the



# Does Fading Trouble You?

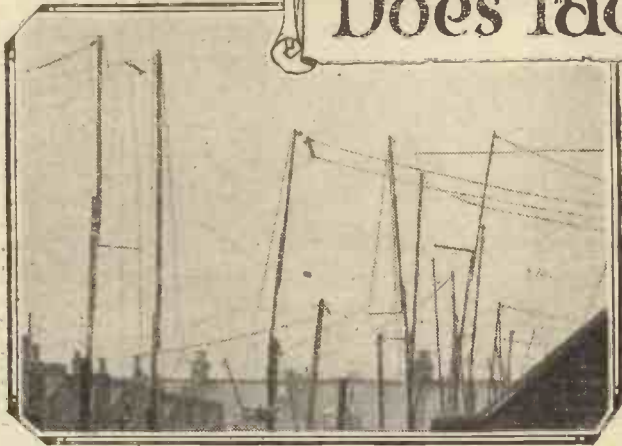

*This interesting article throws considerable light upon the phenomenon of "fading."*

By E. A. ANSON.

These measurements were made, using an outdoor aerial about 30 ft. long and 30 ft. high, and an earth of about 20 ohms to a lead pipe down a 20 ft. well. The aerial was stretched very tight in order to avoid swinging. In addition, it was made of finer wire than normal to avoid catching the wind.

## The Receiver Used

The receiver, a two-valve set—one H.F. and detector—had condenser reaction (see Fig. 2).

A valve voltmeter was connected across the anode coil. When the set was tuned in to the desired station, and reaction adjusted until it was sufficiently sensitive, although not oscillating, the valve voltmeter measured the amplified H.F. voltage. This measured H.F. voltage is a measure of the strength of the received station's carrier wave. It does not measure the audible strength of the signals, and is not affected by it.

SOME sixty miles above you at this very moment lurks a vast unexplored space where no man has ever been. Now high, now low, now conducting, now insulating, this weird, impenetrable region

region of the atmosphere kindly reflected these new man-made waves back to earth again.

So we have fading. For sometimes this region lets the waves through, and sometimes it reflects them; but the reflecting surface is ever changing. Sometimes the reflected wave hits our aerial, sometimes it flickers far beyond, sometimes the reflected waves co-mingle with the direct earth-bound wave. Then we get distortion, for the waves we receive by reflection are not in step with the other waves (see Fig. 1).

For the B.B.C. wave-lengths, this Heaviside Layer, as it is called, only reflects or bends the wireless waves back to earth at night-time. By day it is the earth-bound wave we receive. This earth-bound wave gets tired easily, gets lost by the way in tree and hill and smoke of cities; so it does not carry well.

By night sometimes the reflected wave helps, and sometimes it causes signals to disappear or fade away.

## "Restless" Stations

Have you ever heard that distant station come roaring in until your chest swelled with manly pride? Have you asked Brown to come next night to hear the far-off message come roaring in on two valves only? Have you? Did Brown believe your tale of yesterday, when nothing came but the distant murmur of far-off atmospherics? Not he! Despite the fact that fading had played a trick or two on him before.

Well, read on and see how measurements were made on fading. These measurements, perhaps, will open your eyes and show you how quickly signals drop from loud to weak; how some stations seem ever restless, never steady one second to another.

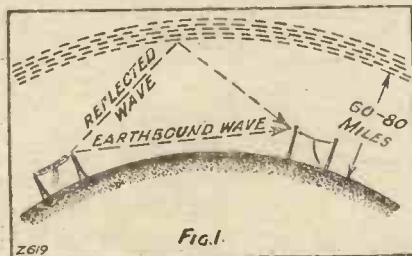

wraps up our spinning world as it were in an invisible covering.

Until man toyed with wireless sets this region of the world's atmosphere worried nobody.

## The Heaviside Layer

Then Senatore Marconi stated that he would send a wireless message across the Atlantic—some twenty years ago now. Wise men scoffed, saying that these wireless waves

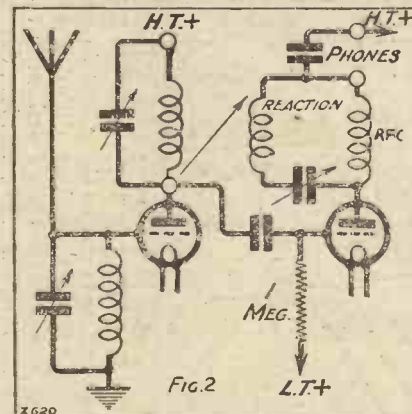

moved in straight lines. How, then, would they follow the circle of the globe—how?

But they did. For the upper



The B.B.C. test van and apparatus used for measuring the field strengths of the B.B.C. stations in different localities.

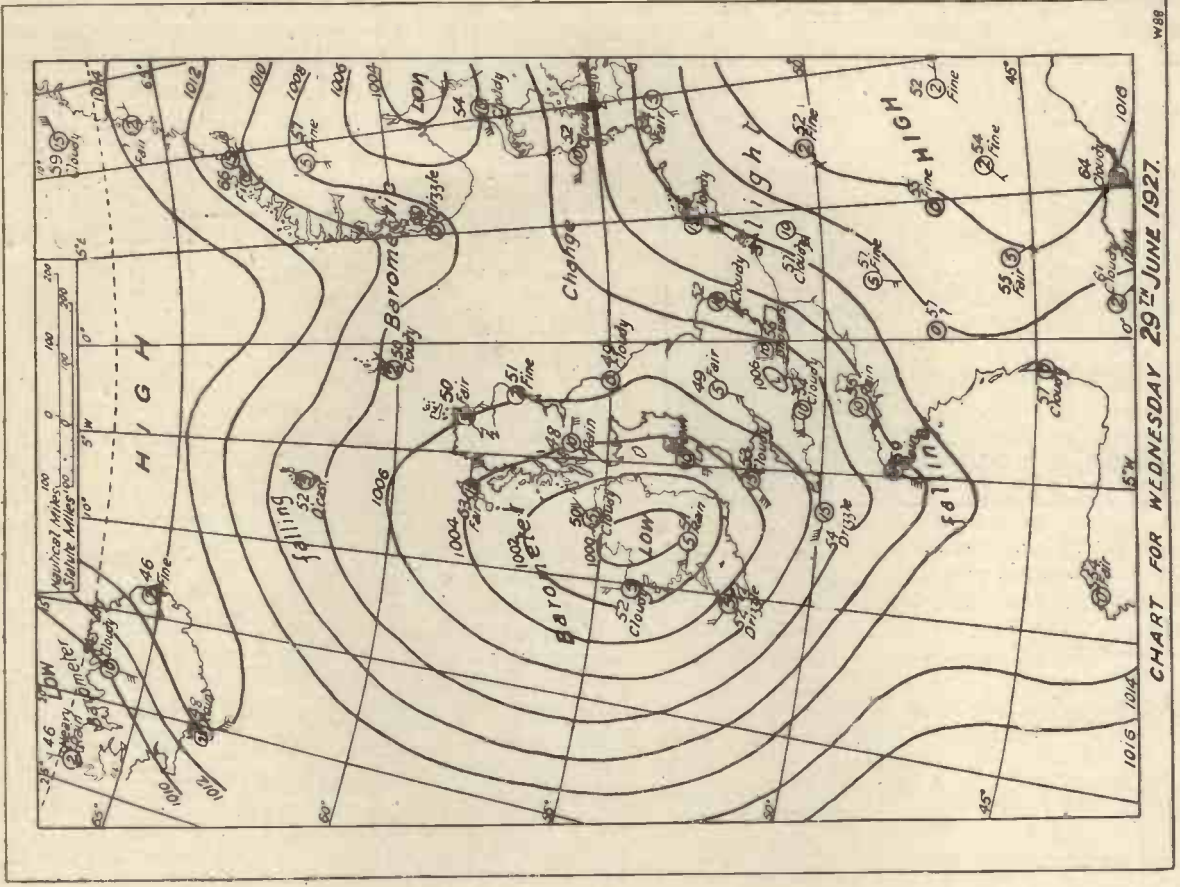
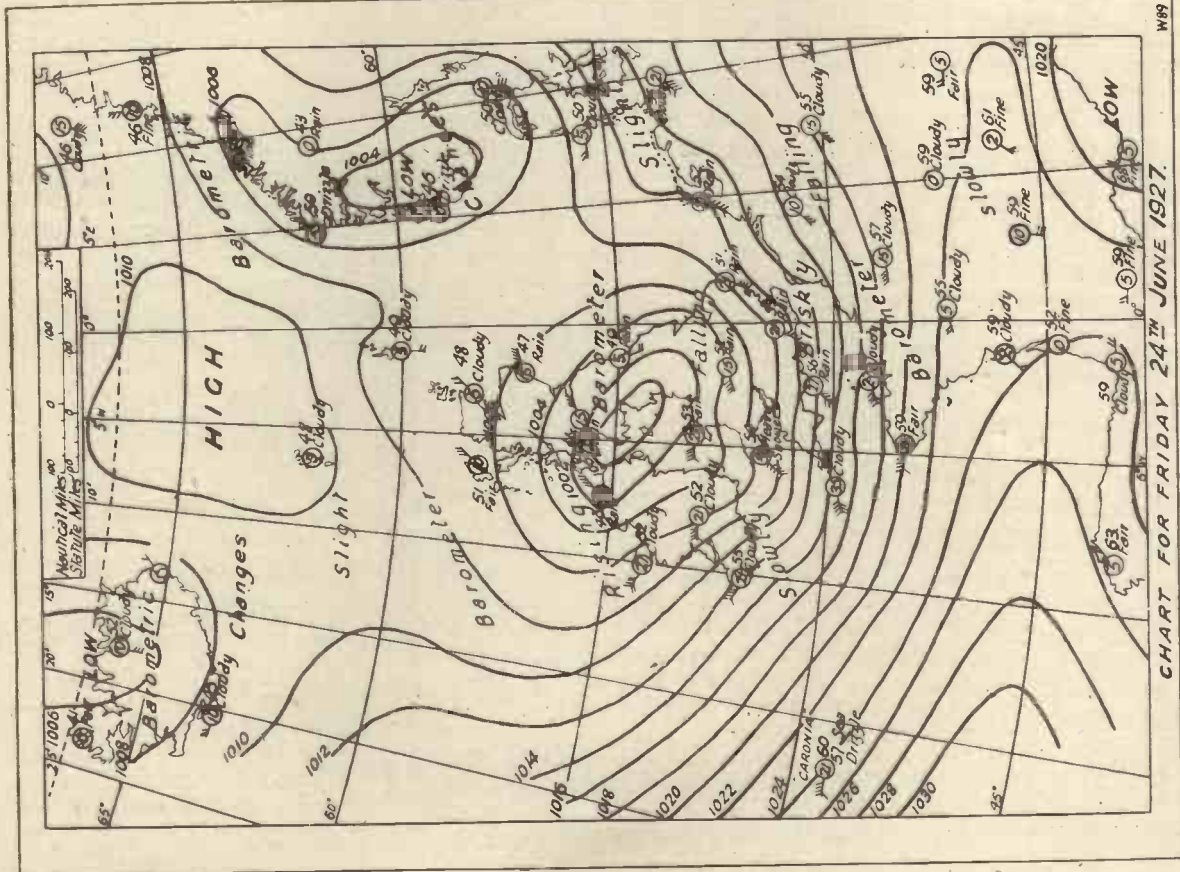

Above are the weather maps for Great Britain and its immediate vicinity for the Friday before the eclipse and the eclipse day itself. It will be seen that bad weather existed in this country on those days, with depressions approaching from the Atlantic. In the earlier map it will be seen that "heavy showers" were the order of the day in Pembrokehire, where the tests described in the article were made, while on the day of the eclipse the weather had "improved" to "cloudy" in the same area. In both cases the barometer was low, depression after depression coming in from the west, having their effects upon "fading" and reception generally.

After tuning in, the reading of the valve voltmeter was noted every 15 seconds, or more often if necessary; then the result was plotted in a curve, like Fig. 3. The valve voltmeter readings on the graph give a deflection of 24 for zero H.F. volts. The actual H.F. volts are marked to the right of the valve voltmeter readings. Roughly speaking, one H.F.—detector—one L.F. will give fair loud-speaker results with an H.F. voltage across the anode coil of anything above 5.

This will give you an idea of the actual practical signal strengths obtained by a normal set. But if the initial signal has been amplified considerably to get the H.F. volts up to 5, atmospherics and other noises may make the result unsatisfactory on a loud speaker.

Well, have a look at 5 W A's effort. This station is situated 70 miles away. It is a full-powered B.B.C. station.

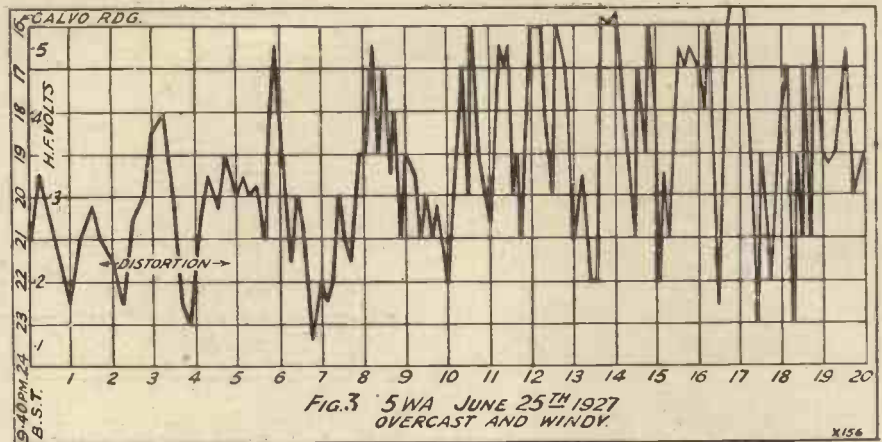

London's 2 L O is very difficult to receive in daylight. It does not come on the scene till the evening. Fig. 6 shows what happens. To be blunt, 2 L O fades abominably. Sometimes it roars in; at others its strength falls to 24, and is inaudible even on 'phones. Sometimes all that is audible is a mass of loud

Fig. 8 gives another sample of 2 L O's tricks for June 28th. Observe that although 2 L O fades badly, yet it is audible by night. By day the curve follows the 24 or 23.9 line, and the station is not audible.

### The Total Eclipse

This leads us to the day of days, June 29th, and the hour is 6 a.m. On this day the eclipse occurred. Fading measurements were made on 2 L O. Fig. 9 shows them. Until 6.22, 2 L O was behaving in her usual daylight manner; then came the moon and got in the way of the sun. The Heaviside Layer thought night had come, and got busy bending 2 L O back to earth. This occurred almost precisely at totality.

For wireless purposes the region of totality extended from South Pembrokeshire, where these measurements were made, to just north of the Wash. During totality there was bad distortion; notice that the signal strength rises abruptly from zero as totality occurred. After totality, on the other hand, it took no less than 18 minutes for normal daylight conditions to return. The Heaviside Layer seemed reluctant to give up reflecting and settle down into its normal daylight state.

Incidentally, these and other eclipse experiments tend to confirm the presence of this impalpable layer.

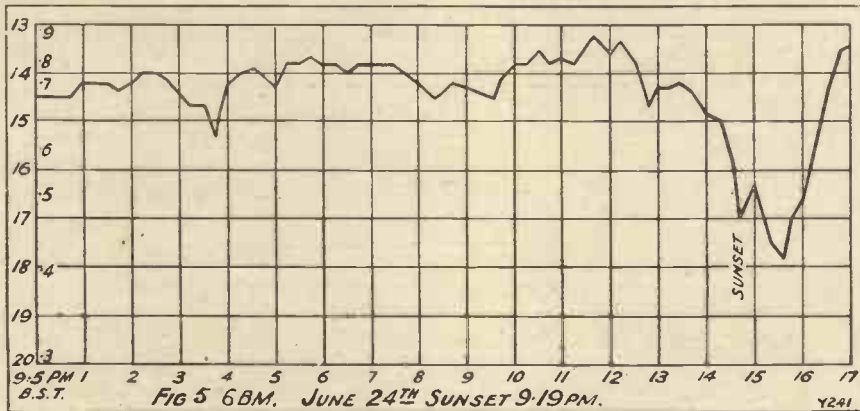

No wonder 5 W A is not much use here in Pembrokeshire. It is a restless station—one second loud, next second weak, tune you ever so wisely. It is not a station that can be tuned in and relied upon for consistent results. Results in Fig. 4 the next day are much the same.

but dreadful distortion. Some nights it is consistently weak, like Fig. 7; other nights it is fairly strong. No, 2 L O is not a station that can be relied upon here. If I asked Brown to come along and hear what I could do with 2 L O, it would surely let me down. It is noteworthy that 2 L O, like 6 B M, seems to be affected by sunset.

### Interesting Results

Now look at Fig. 5. This shows 6 B M (Bournemouth), 140 miles, for June 24th. It does not vary nearly so much, and signals are well up to loud-speaker work. In fact, 6 B M is our best station here in Pembrokeshire after 5 X X.

There is one curious point about 6 B M. This station fades abruptly for a minute or two at sunset precisely. This curve is typical, for this happens every day. After the sunset fade signals return to normal, gradually rising to 8 and 9 as darkness comes.

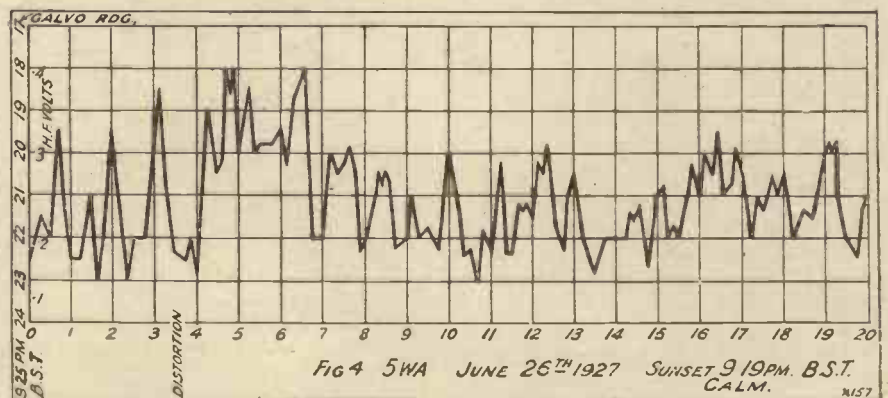

The weather charts will give you a good idea of the weather conditions round about June 24th-29th—if, indeed, you need reminding!

Roughly speaking, a series of depressions were pouring in from the Atlantic, as is usual in our English summer. One after another they came, causing rain, low clouds, and other forms of beastliness. These depressions do seem to affect fading and signal strength, but it is not

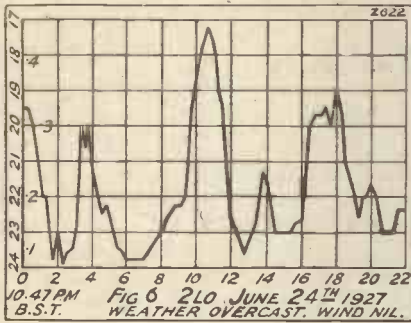

quite clear how. For instance, the front of a depression does seem to cause phenomenal atmospherics which pass off as the depression goes.

Perhaps a careful study of these curves will show you how impossible it is to guarantee reception over 40 or 50 miles, except on 5 X X.

**Short-Wave Fading**

A number of experiments have also been carried out with regard to the fading experienced at the high frequencies corresponding with 20-50

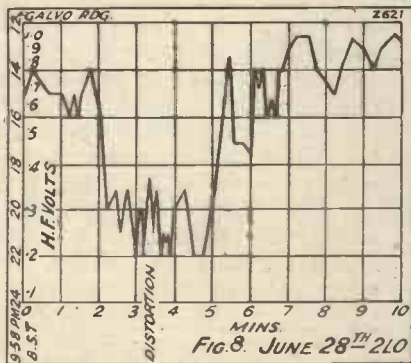

metres wave-length. Here it is a very difficult task to draw a graph because all sorts of peculiar effects take place. We have to deal with what is known as the "skip" effect, which often makes short-wave reception from new stations more or less impossible. The ground wave, apparently, quickly dies out, and when this has gone we are dependent upon the reflected wave which may penetrate the Heaviside Layer to a

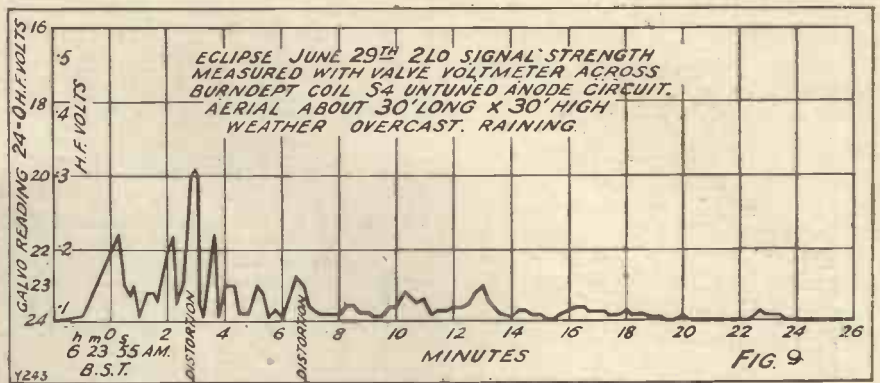

considerable degree—or it may not.

In any case, we find that reflection from this layer takes place at such an angle as to make short-wave reception best at hundreds, if not thousands, of miles from the transmitter.

Then there is the possibility of the waves becoming polarised—a sort of corkscrew action—which again pre-

cludes good reception except at those points where the wave is "straight" again. Dr. Alexanderson has carried out numerous tests on this point alone.

points comparatively only a few miles apart. Hence the scheme patented some years ago in this country by which "spaced" aerials are employed. Several aerials at different points in the country are used to pick up a transmission, the resultant signals being "pooled" as it were and brought to a common listening post. Thus fading at one

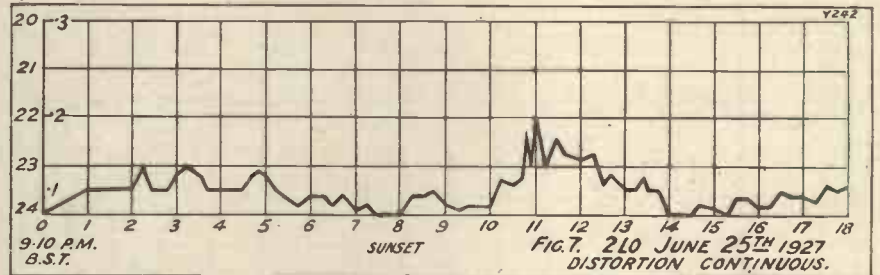

**"Spaced" Aerials**

The Heaviside Layer, however, plays the greatest part in short-wave fading and thus reception from a distant station may vary considerably at

point can be compensated by strong signals at another, and so on—the whole being carefully controlled before the final result is pushed through the 'phones or loud speaker—or in the case of the B.B.C.'s recent proposal, relayed. Much yet remains to be done with regard to the problem of fading, for until we find out exactly what happens we shall have difficulty in eradicating it.

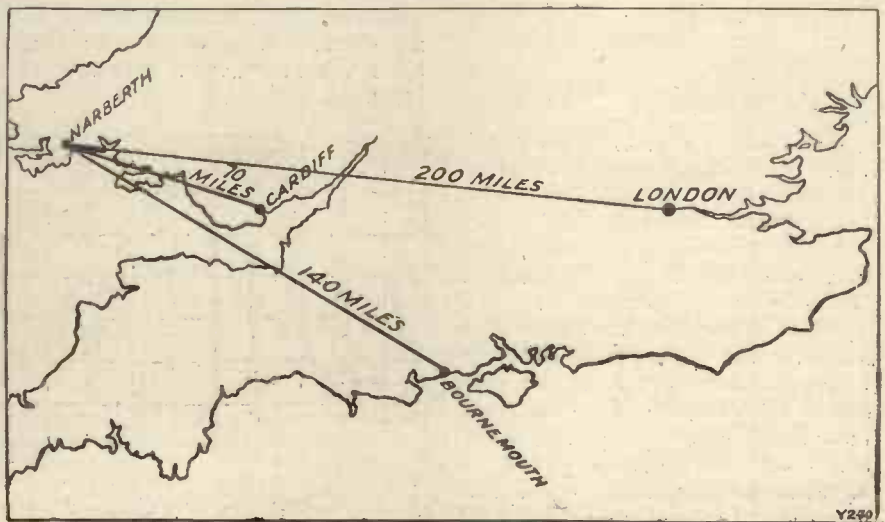

# The "Forty-Station" Four



An easily constructed four-valver capable of receiving a number of stations at loud-speaker strength.

Designed and described by C. P. ALLINSON, A.M.I.R.E.

I DO not know why, but I have always been a keen supporter of the split-secondary type of neutralised circuit, probably because I have done so much research work in connection with it, although I know that

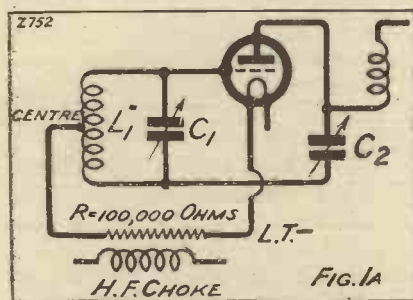

it is the generally accepted opinion that the amplification obtainable per stage with this system is not so great as that given by the split-primary on account of the fact that the full voltage which is developed across the tuned circuit is not applied between grid and filament.

I have, however, been conducting some experiments on this type of circuit for some time now with a view to improving its overall efficiency. A fairly detailed account of these experiments is given elsewhere, and I do not propose to deal with them here.

### Improved Efficiency

I may say that I have found, by making a very simple alteration to the usual split-secondary circuit, such as shown in Fig. 1A, that I have been able to improve its efficiency to a very marked extent without in any way sacrificing its stability. From this illustration of the conventional circuit it will be seen that an inductance  $L_1$ , tuned by a condenser  $C_1$ , is connected between the grid of the H.F.

valve and one side of the neutralising condenser  $C_2$ . A centre tap is taken through a high-resistance or H.F. choke to L.T. negative.

Briefly, I found that I could obtain far greater amplification per stage by shifting the centre tap down the coil to a position about a quarter of the way up from the bottom, and reducing the value of the resistance  $R$  in the L.T. negative return to a value only just great enough to stop parasitic oscillations from being generated at the lower readings of the tuning condenser  $C_1$ .

A skeleton diagram of the new form of the circuit is shown in Fig. 1B.

The immediate results are that a far greater proportion of the signal voltage generated across the coil  $L_1$  are applied between grid and filament of the valve, while owing to the asymmetry of the windings placed in the grid and plate circuits their liability to

generate parasitic oscillations is far less, so that a very small value of resistance in the neighbourhood of 200 to 400 ohms may be used in the L.T. return to damp them out in case there should be any tendency for them to be generated.

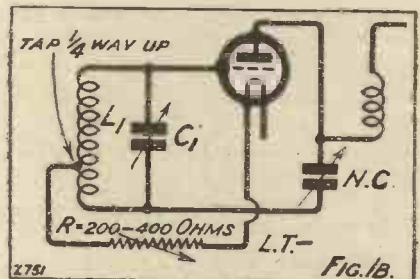

Further, by shifting the tap from the centre of the inductance to the point shown, a larger value of capacity is required to obtain neutralisation than is usually the case and this simplifies the stabilisation of an H.F.

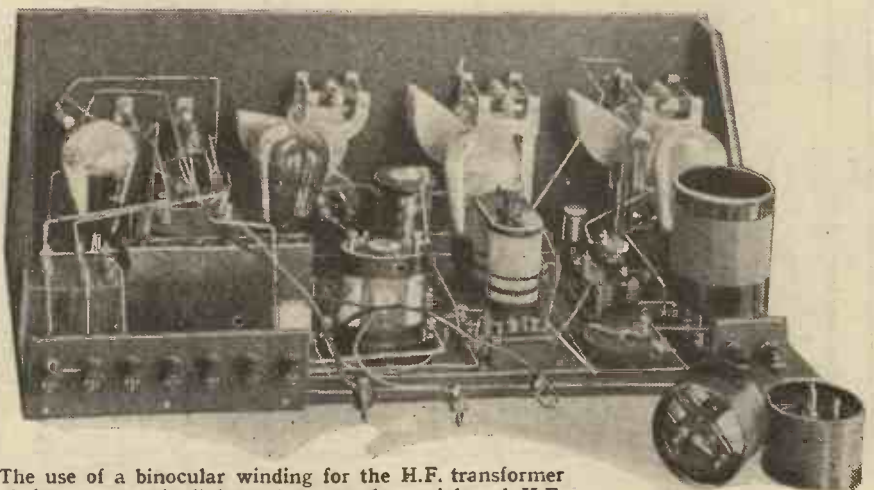

The use of a binocular winding for the H.F. transformer obviates magnetic linkage between the aerial and H.F. coupling stages. In the foreground are seen the interchangeable primary aerial windings  $L_1$ .

stage when using a valve with a very low internal capacity.

I also found when using the scheme outlined in Fig. 1B that, if the set

bourhood of 50 per cent to 70 per cent, as far as can be gauged from the approximate measurements which I have taken.

been received since then), and as a result of extensive tests which have been carried out both in my laboratory and under actual working con-

### COMPONENTS REQUIRED

- 1 ebonite panel, matt finish, 21 in. × 7 in. × 3/16 in.
- 1 baseboard, 10 1/2 in. deep.
- 1 cabinet to fit the above. Any suitable wood may, of course, be used, according to the surroundings with which you wish it to harmonise. (Pickett Bros.)
- 2 .0005 log mid-line variable condensers; and
- 1 .0003 square-law variable condenser. (Cyldon.)
- 2 slow-motion dials. (Ormond Eng.)
- 2 oblong 6-pin coil bases. (London Electric Wire Co.)
- 1 tapped-grid H.F. transformer. (Collinson Precision Screw Co.)
- 1 B.R.T. Reinartz transformer. (London Electric Wire Co.)
- 1 H.F. choke. (R.I.-Varley, Ltd.)
- 1 type A resistance-capacity coupler. (R.I.-Varley.)
- 1 L.F. transformer, ratio 6—1. (Marconi Ideal.)

- 4 non-vibrating valve holders. (Wearite.)
- 4 fixed resistors and screw holders. (Burndept Wireless Ltd.)
- 1 base-mounting Potentiometer. (Lissen Ltd.)
- 1 panel-mounting potentiometer. (Lissen Ltd.)
- 1 neutralising condenser. (Peto-Scott Co. Ltd.)
- 1 double-circuit jack; and
- 1 single-circuit single-flament control jack. (Ashley Wireless.)
- 1 fixed condenser, .002. (Dubilier Condenser Co.)
- 1 grid leak, .25 megohm. (Mullard.)
- 1 fixed condenser, .01. } T.C.C.
- 2 fixed condensers, 1 mfd. } or
- 1 fixed condenser, 2 mfd. } Mullard.
- 1 set of grid-bias battery clips.
- 1 on-off switch. (J. R. Wireless Co.)

- Indicating terminals bearing the following designations: Aerial, Earth, L.T.—, L.T.+, H.T.—, H.T.+1, H.T.+2, H.T.+3, and H.T.+4. (Belling Lee.)
- 2 pieces of ebonite, 2 in. wide and 1/4 in. thick, of suitable length for aerial and earth terminal strip and battery terminal strip.
- Quantity of Glazite wire for making the connections. (London Electric Wire Co.)
- A number of screws for fastening components to baseboard, and wander plugs for the grid-bias batteries.
- 1 small knob for the reaction condenser control. (I have used Igranite Indigraph dial, but any small knob or dial may be used, according to the constructor's inclination.) Any of the usual alternative makes of good quality can be substituted in the above list.

were correctly neutralised at a frequency representing 200-250 metres, where it is usually most liable to go into self-oscillation, when reaching the high wave-lengths in the neighbourhood of 450-500 metres the valve would actually be slightly under-neutralised, thus introducing a small amount of reaction at a point where the set is usually most stable naturally.

The actual increase in amplification obtainable per stage with this scheme over the older method is in the neigh-

This is a very large improvement and marks an important step forward in the development of a circuit which has hitherto been chiefly remarkable for its inherent stability and particular suitability for use in reflex circuits.

### Very Efficient Set

This is the circuit, therefore, that I have used in a set which I have named The "40-Station" Four (since 40 stations were received on the first night's test, though many more have

ditions, I can say unhesitatingly that this is one of the most efficient four-valve receivers which has passed through my hands.

As a rule, wireless receivers are not exactly decorative, but the photograph which shows this receiver in its cabinet does not give a real impression of its handsome appearance. The cabinet is made of dark oak highly polished, and this in conjunction with the marked contrast given by the frosted dials on the black panel give

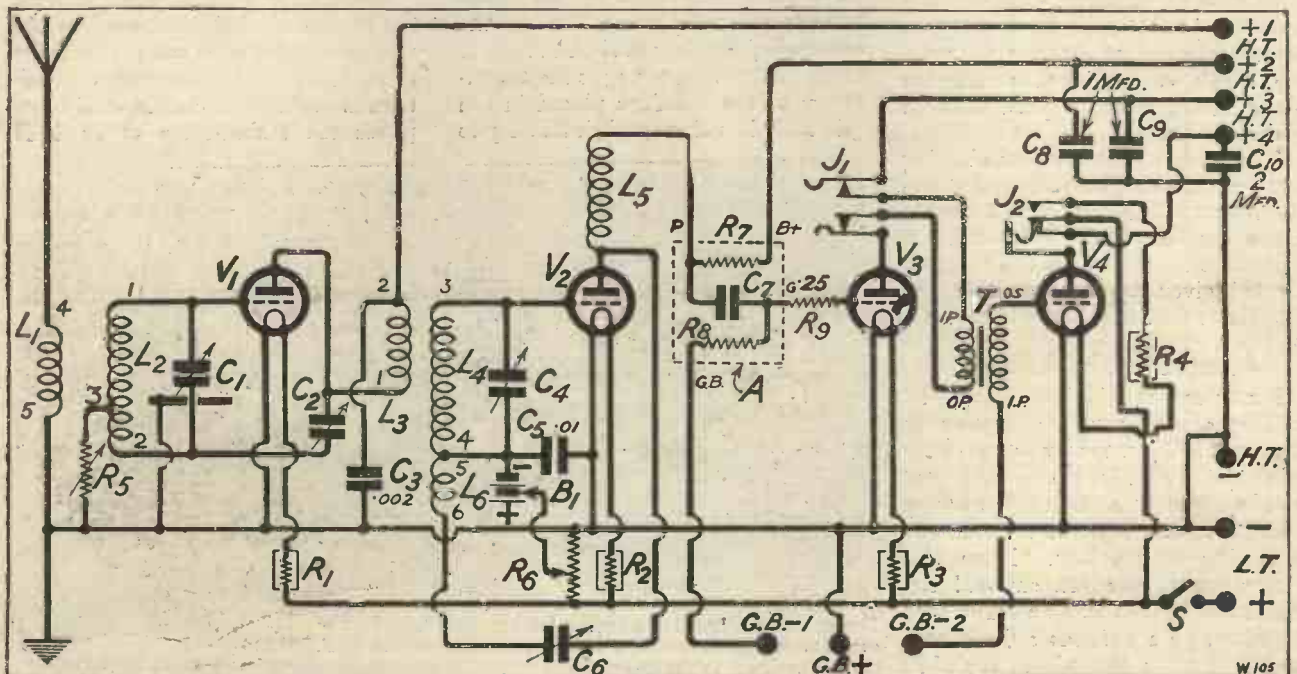

it a distinctive note that is not out of place in any surroundings.

In actual operation the receiver is easy to handle, there being but two tuning controls which tally very closely with each other over the major portion of the dials. Since the H.F.

H.F. grid coil, is a baseboard mounting potentiometer having a maximum resistance of 450 ohms, but in practice it will be found that only half this winding is required in order to prevent parasitic oscillations from being generated.

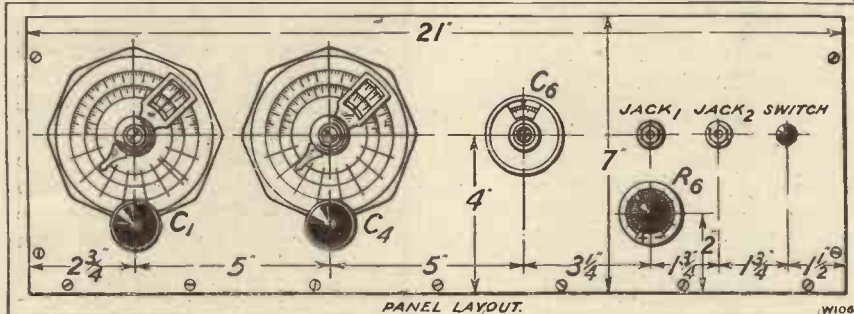

circuit is more or less a self-compensating one there is very little need to make use of the reaction control except on very weak transmissions, and this is further made possible by the high degree of amplification given by the H.F. stage.

Among the stations heard with this receiver were such transmissions as Bilbao, Copenhagen, Naples, Milan, Bordeaux, Juan les Pins, Kristinehamn, as well as the well-known powerful transmissions such as Toulouse, Berne, Langenberg, Hamburg, Glasgow, Muenster, Belfast, etc.

A full list of the stations together with dial readings will be given next month, and will serve as a guide to the constructor when first searching, while further information as to the operation of the receiver will be given, with special reference to long-wave work.

### Circuit Details

The H.F. transformer which is used to couple the aerial to the H.F. valve is provided with interchangeable primary windings so that different-sized windings can be used, either according to the wave-length range which you intend to receive, or else in order to control the selectivity of the receiver. By using a very small winding it is, of course, possible to get a very high degree of selectivity, which will be found of great assistance when the set is used close to a local broadcasting station. This, however, gives rise to a drop in efficiency, and I think by far the best method to employ is to use a really reliable wave-trap to cut out interference from the local transmission when receiving distant stations.

The variable resistance  $R_5$ , shown in the L.T. negative return of the

### Binocular Coils

The H.F. valve is coupled to the detector valve by means of a binocular transformer which is provided with a reaction winding so that Reinartz reaction may be applied to the detector circuit if desired.

Since only one stage of H.F. amplification is being employed, and one of the transformers used is practically fieldless, I have considered it unnecessary to screen either of the coils since the coupling between them is negligible.

The detector valve used anode-bend rectification, a small grid-bias battery being fastened to the baseboard behind the L.F. transformer, while the potentiometer is controlled from the front of the panel, and will be seen below the left-hand jack in the photograph.

### R.C. Coupling

Resistance-capacity coupling is used between the detector and the first L.F. valves, the anode resistance  $R_7$ , the coupling condenser  $C_7$ , and the grid leak  $R_8$  all being contained in a single unit, which is shown within the dotted line marked A in the theoretical diagram.

By means of jacks either three or four valves may be used at will, the first L.F. valve being coupled to the second L.F. valve by means of an L.F. transformer.

This enables very high-quality reproduction to be obtained on distant as well as on local stations, together with satisfactory volume. Since resistance-capacity coupling tends somewhat to reduce the amplification on the higher notes, and transformer coupling tends to do this on the lower notes we get a certain amount of compensation when using the two L.F. stages, and the output from this set is of an extremely high order of quality.

Notwithstanding that an H.F. choke is connected in the plate circuit of the detector valve, I have considered it advisable to be absolutely on the safe side and stop any possibility of H.F. potentials being applied to the grid of the L.F. valve. A high resistance of .25 megohm is therefore connected in the grid lead, as shown at  $R_9$ , to act as an H.F. stopper.

### Carefully Designed

When plugging the loud speaker into the second jack, so as to work with both stages of L.F. amplification,

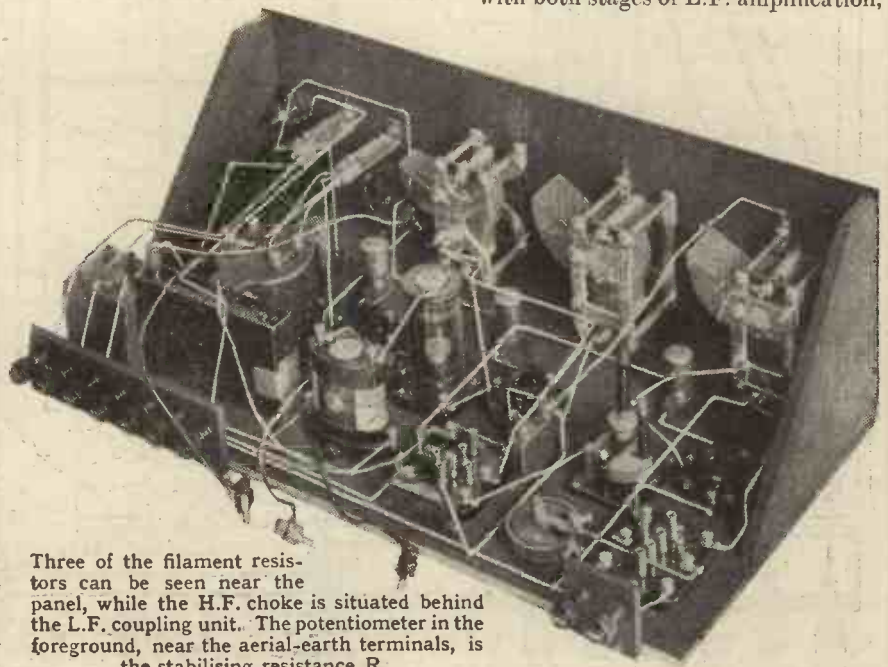

Three of the filament resistors can be seen near the panel, while the H.F. choke is situated behind the L.F. coupling unit. The potentiometer in the foreground, near the aerial-earth terminals, is the stabilising resistance  $R_5$ .

the filament of the last valve is automatically turned on, while a small switch in the L.T. positive lead serves to control the whole set.

In designing this receiver I have planned the layout as carefully as possible, not only with a view to its electrical efficiency, but also with a view to ease of construction, and I do not think that there is a single soldered joint which is difficult to get at in the whole of the receiver. Those who have not yet acquired skill with this implement will find that the greater part of the wiring can be done without a soldering iron.

The components which I have used in constructing this receiver are given in the preceding list, but providing that any other makes of components substituted are known to give a good performance there is no reason why they should not be used in place of the ones which I myself have found satisfactory.

The only point which I would ask you to bear in mind is that particular care should be taken in choosing your valve holders. Those which I have used are particularly satisfactory, since there is no solid dielectric present in the centre of the valve holder, which might give rise to undesirable dielectric losses and increase the capacity between adjacent valve pins unnecessarily.

### Panel Drilling

I usually commence the construction of my receivers by first mounting the components on the panel. The biggest holes you will have to drill are for the two output jacks, which both need a 7-16th-in. hole, whereas for the three condenser spindles  $\frac{3}{8}$ -in. holes will be required, and for the potentiometer 5-16th-in., and for the on-off switch  $\frac{1}{4}$ -in. hole. Besides these you will need to drill nine 4 B.A. clearance holes by means

of which the fixing screws for the variable condensers are put through the panel.

It should be noted that with the Cyldon condensers which I have used, drilling templates are provided, and care should be taken to see that you have them the right way up when drilling the holes. This will depend, of course, as to whether you are drilling your holes from the back or front of the panel. Some constructors prefer to drill from the front, since then if the panel chips at all when the drill breaks through the other side, no harm is done to the appearance of the receiver. Others prefer to work from the back of the panel since it can then be marked out with a scribe and square as the marks will not show.

This is the method I myself employ, and if there is any risk of the panel chipping away when the drill comes through, which is likely to occur when using a big drill, I put a small pilot

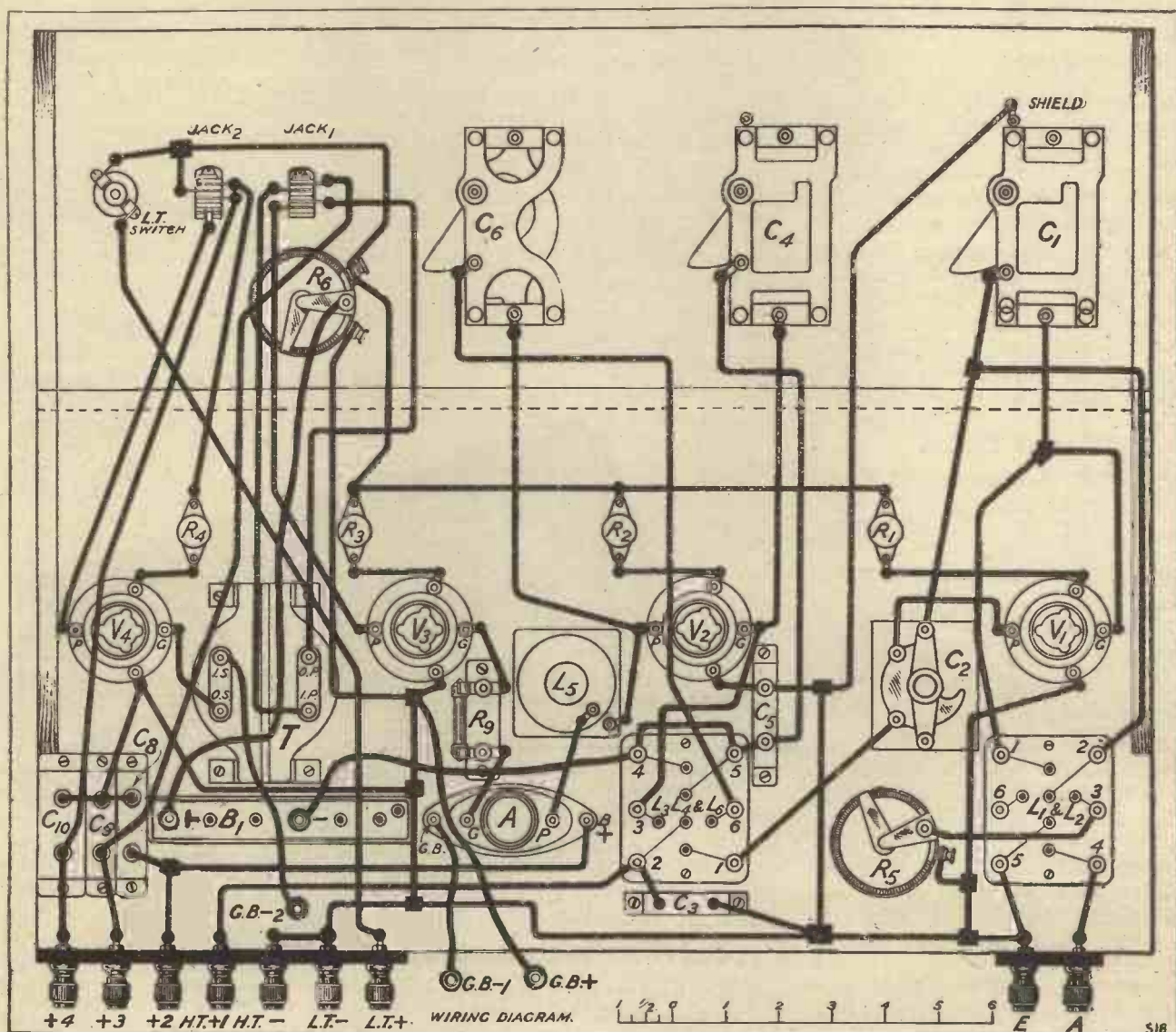



hole through first and then drill the big hole from the front of the panel so that any chipping that may occur will take place on the reverse side.

A dimensioned panel layout is given elsewhere, which will serve as a guide to doing this part of the work, and after all the components have been mounted on the panel this should be fixed to the baseboard.

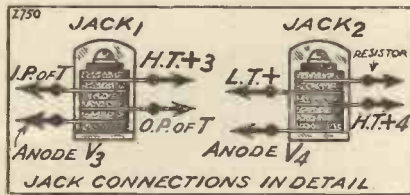

The components which go on the baseboard should now be placed in position and the wiring diagram, which is drawn to scale, will prove a very valuable guide in determining the exact positions at which to place the various components.

The wiring diagram shows the connections which have to be made, and the photographs which have been taken behind the panel will be of great assistance when doing the wiring up. Since ample room has been left to do the wiring there is no exact order in which the leads should be put in position, and provided that the following suggestions are followed in a general kind of a way, no difficulty should be experienced on this account at all.

I would suggest that you first of all put in the L.T. leads, both positive and negative, and after this I would suggest that you start at the aerial end of the receiver and wire up the circuits in order. Start with the aerial and earth connections, then go on to the tuned circuit connections to the grid of the H.F. valve, after which follow through to the anode circuit of this valve, and so on to the grid circuit of the detector.

Then follow through to the first and second L.F. valves in order, and it will be found that the various leads will fit into position without any difficulty.

### The Condenser Shields

It will be found that the Ormond slow-motion dials which I have used are provided with an earthing terminal by means of which the metal dial (which is not in contact with the spindle of the variable condenser) may be connected to earth, thus acting as a shield against hand-capacity effects.

Since it is only the spindle of the first tuning condenser  $C_1$  which is not

at earth potential it is only necessary to earth this shield, since no hand-capacity effects with the second condenser will be experienced.

One point which may give a little difficulty is the connections to the two jacks, and I therefore show these in detail, so that no trouble may be experienced on this score.

### The H.T. and L.T. Supply

Since many experimenters of today are using battery eliminators by means of which the H.T. supply is derived from the electric lighting mains, I have included extra smoothing condensers across the detector and L.F. H.T. tapplings. In the case of the H.F. valve I have not considered this necessary, though the usual H.F. by-pass condenser has been provided.

It will be noticed that I have used separate H.T. tapplings for the first and second L.F. valves. This, again, will be found to be of advantage when using a super-power valve in the last stage, since it will enable you to use the high-voltage terminal on your eliminator (which is usually provided for super-power valves) so that the maximum purity of tone may be obtained on very strong signals, such as from the local station. Most super valves are rated to stand 150 volts H.T., if not more, but this is a rather larger value than it is usually safe to apply to an ordinary power valve, such as is used in the first stage of an L.F. amplifier.

inside of the cabinet with a couple of drawing pins.

Where a super-power valve is going to be used with 120 volts H.T. two grid-bias batteries will be required, while if a larger value of H.T. than this is applied to the last valve a third bias battery will be needed, as otherwise the full benefit of the large value of H.T. will not be obtained.

The only point I have not yet dealt with is the value of the fixed resistances,  $R_1$ ,  $R_2$ ,  $R_3$ , and  $R_4$ , by means of which the filaments of the valves are controlled. These will depend, of course, on the type of valves which you employ, together with the battery you are using, and I will therefore discuss the question of valves to use in this receiver next.

For maximum power and amplification I certainly think that the 6-volt valve is by far the best. Since, however, we are using anode-bend rectification it can be shown from theoretical consideration that a 2-volt valve will give a sharper bend, and therefore more efficient rectification on account of the smaller potential drop across the filament.

### Suitable Valves

Many will, therefore, prefer to use a 2-volt valve as rectifier, a suitable valve being the Blue Spot Cosmos, which is well known for its efficiency in this position, or the P.M.21A, or a similar valve, and use 6-volt valves for the H.F. and L.F. stages.

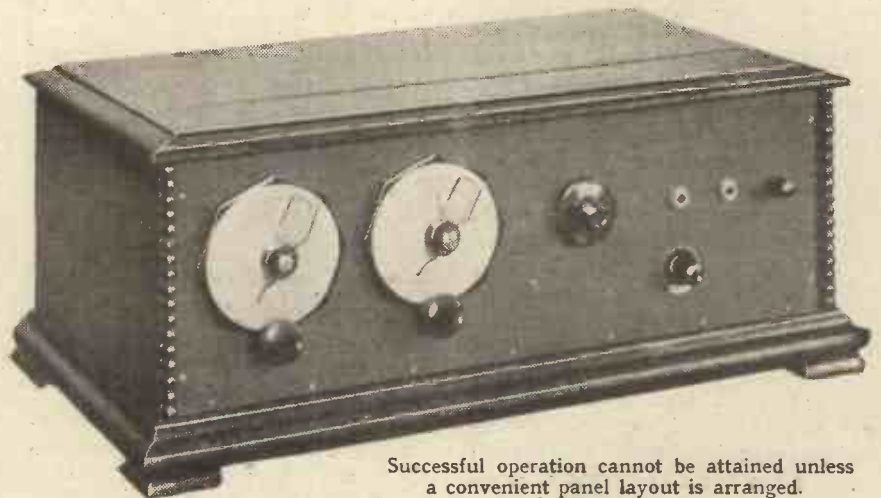

Successful operation cannot be attained unless a convenient panel layout is arranged.

The grid-bias batteries may be kept inside the cabinet on a little shelf, or else a battery of the type made by Siemens may be used. This is provided with a special cardboard flap, by means of which the grid-bias battery can be fixed to the

On the other hand, should you prefer to use 6-volt valves throughout then the right type of valve to use for the rectifier will be a high- $\mu$  valve, such as a 6-volt Blue Spot Cosmos, P.M.5B, or its equivalent in other makes

For the H.F. valve in the 6-volt class, the P.M.5X, B.4H, D.E.5B, ES5 H.F., or a similar valve may be employed, or the equivalent in the 2- or 4-volt classes, should you wish to use valves of this voltage rating.

For the first L.F. I certainly recommend a small power valve such as the B.4, D.E.5, P.M.6, or the like, while for the second L.F. valve, a super-power valve is advisable, unless the set is going to be used at a very great distance from a local broadcasting station, so that the actual power handled by the last valve is not excessive. Super-power valves in the 6-volt class are the Stentor 6, P.M.256, D.E.5A, LL.525, and their equivalents in other makes.

Having made your decision as to the valves you are going to use it is a simple matter now to find out what filament resistances you require.

After the completion of the receiver it is as well to check over the wiring carefully to make sure that no mistakes have been made, and then carry out the usual tests before connecting the H.T. battery, so as to avoid any possibility of burnt-out valves. If everything is all right the set may be connected up to the aerial and batteries and the valves inserted and the preliminary aerial tests carried out. These should be carried out with the neutralising condenser about a third the way in and the reaction condenser at zero.

### Neutralisation

The local station should be tuned in and the H.F. valve neutralised by one of the usual methods. Where the local station is fairly close the H.F. valve may be turned out and the neutralising point found by the usual zero signal adjustment of the neutralising condenser. If, however, no station is within sufficiently close range to allow of this being done, then the maximum reaction demand method, as described by Mr. Kendall, may be employed, or some other method of this description.

In some cases it may be found when using 6-volt valves having a rather high internal capacity that the maximum setting of the neutralising condenser is not quite great enough to give a well-defined point of minimum signal strength. In this case it is a simple matter to augment the neutralising condenser capacity by a couple of pieces of insulated wire twisted together and connected one under each of the terminals of the neutralising condenser. Care should be taken, of course, to see that the insulating material on the wires will

stand up to the H.T. voltage applied to the H.F. valve, since otherwise a short-circuit will occur.

### Stabilising Resistance

When carrying out the neutralising it should be remembered that the slider of the potentiometer, which is connected in the filament return of the H.F. valve, should be set about half-way round with the particular make which I have employed, so that about 200 ohms is included in the circuit.

Should it be found, however, that when the tuning condensers are reduced to a minimum parasitic oscillations are obtained, then the

conditions it is probably slightly under-neutralised, and a certain amount of natural reaction is therefore introduced into the H.F. circuits which are otherwise heavily damped by the aerial on one side and the rectifier on the other. This therefore increases the sensitivity and selectivity of the set.

### Setting the Detector

Where the set is used fairly close to a broadcasting station a point that is very important and that should always be remembered is that sometimes a different value of grid potential is required for maximum efficiency with the detector valve on the local station from that for a distant or weak station.

I have found for weak signals that the correct value of bias on the detector grid is from  $\frac{1}{2}$  volt to 1 volt negative. Thus, with the negative wander plug plugged into the  $4\frac{1}{2}$ -volt socket of the grid-bias battery, the slider of the potentiometer is a little more than half-way towards the positive side.

The best point for weak signals can easily be found by detuning the local station until it becomes very weak and finding the setting on the potentiometer which brings it in at its loudest strength at this setting.

### Results Obtained

Distant stations may then be searched for and the list of stations received will prove a very useful guide for this purpose.

It will be found that the set is sufficiently selective to bring in Langenberg free from all interference from the Daventry Junior transmission, and when using all four valves I do not think you will have any difficulty in equalling the results I have obtained on my aerial.

I may say that even using the set in conjunction with a frame aerial, for which it is not really designed, I have been very successful in receiving a number of transmissions at night at good loud-speaking strength, and no trouble from instability has been experienced with this set when once the correct adjustments have been made.

STATIONS HEARD.	
Munich.	Paris.
Riga.	Copenhagen.
Vienna.	Naples.
Brussels.	Königsberg.
Station on 513 metres.	Bournemouth.
Daventry Experimental.	Paris (Radio Vitus).
Berlin.	Dublin.
Lyons.	Milan.
Langenberg.	Newcastle.
Oslo.	Belfast.
Stockholm.	Nuremberg.
Rome.	Liverpool.
Brunn.	Innsbruck.
Bilbao.	Lyons.
Frankfurt-on-Main.	Dortmund.
Cracow.	Cassel.
Berne.	Lille.
Glasgow.	Malmö.
Hamburg.	Toulouse.
Toulouse.	Bremen.
Manchester.	Trondhjem.
Stuttgart.	Muenster.
Leipzig.	Stettin.
London.	Juan les Pins.
Cardiff.	Viborg.
Prague.	Gävle.
	Kristinehamn.
	Kariskrona.

slider of the potentiometer should be adjusted so as to put more resistance into circuit until these parasitic oscillations cease.

It may now be necessary to re-neutralise since the setting of the slider on the potentiometer has an effect on the value of capacity required to obtain neutralisation.

Having done this my procedure is to find out at which setting on the dials the receiver is most prone to go into oscillation, and with the dials set at this point I reduced the value of the neutralising condenser till the set is just stable. Under these con-

  
 NEXT MONTH  
**Special Christmas**  
**DOUBLE NUMBER**  
 Price 1/6 On Sale Dec. 1st



*A brief description of broadcasting conditions "down under."*  
By RALPH L. SANGSTER.

WHEN listeners in Britain are sleepily preparing to go about their allotted tasks, their fellows in New Zealand, away down at the bottom of the Pacific, are tuning in to the local broadcaster.

But although New Zealand is eleven and a half hours ahead of Britain in time, it was two or three years behind the Old Country in setting up its system of broadcasting. The enforced inaction through Government delay in coming to terms with a suitable company to control broadcasting has enabled very modern stations to be erected, and broadcasting in New Zealand is about to enjoy the boom which has been experienced in the older countries.

#### Four Large Broadcasting Stations

Four broadcasting stations, three of which are of the up-to-date Western Electric type, are now in operation

in the four principal cities of New Zealand, and there are privately-owned stations in smaller towns.

Owing to the long, narrow shape of Maoriland it is difficult to give a "crystal" service to listeners, but loud-speaker reception of any of the four stations may be obtained on the usual detector and two audio stages no matter in what part of the "Fernland" the listener lives.

#### An Added Pleasure to Those "Out Back"

Although New Zealand has only been colonised during the last eighty years, wonderful progress has been made in opening up the large unbroken tracts of bush country; and, strangely enough, it is doubtful whether our "cockies" (farmers) are any farther removed or isolated than are the farmers of rural England. Motor mail cars



One of the commodious and tastefully-decorated rooms at 2 Y A, the Wellington broadcasting station.

serve small settlements not yet dignified with a railway, and horses supply the rest.

Now broadcasting comes swiftly to the aid of those "out back," keeping them in touch with events of the



Through the window of the control room the engineers can see what is going on in the studio.

day, warning them of impending weather vagaries, and making enjoyable hours in the restful twilight following hard sunny days.

**Powerful New Station**

The latest station to be built was erected in the capital city, Wellington, a few weeks ago. It is conservatively rated at five kilowatts aerial power, and the input varies from twelve to fifteen kilowatts. Following modern practice, the transmitter proper is situated away from the centre of the city, being actually on the top of a hill about 1,000 feet high, the actual aerial towers adding 150 feet to this height.

Amplifiers are used with private lines to conduct the items from the luxurious studio in the heart of the business quarter; and there are also relays to about a dozen theatres, churches, and lecture halls, which supply varied and entertaining programmes.

A special feature of the transmitter is that faithful modulation can be obtained up to at least 80 per cent efficiency, and the new "condenser" type of microphones with a natural frequency of 7,000 cycles per second also

are noted for their faithful reproduction without the "hiss" so often noticeable with the ordinary carbon microphones.

As voltages up to 10,000 are used, the usual protective devices are necessary, and in this respect the equipment conforms to modern requirements.

**Short-Wave British Broadcasts**

It is generally held here that short-wave broadcasting from London to the Dominions should be quite feasible, and that it would be of tremendous value in fostering Empire unity, understanding, and goodwill.

The news that Mr. Gerald Marcuse, of station 2 N M, is about to step into the breach is very welcome. Listeners

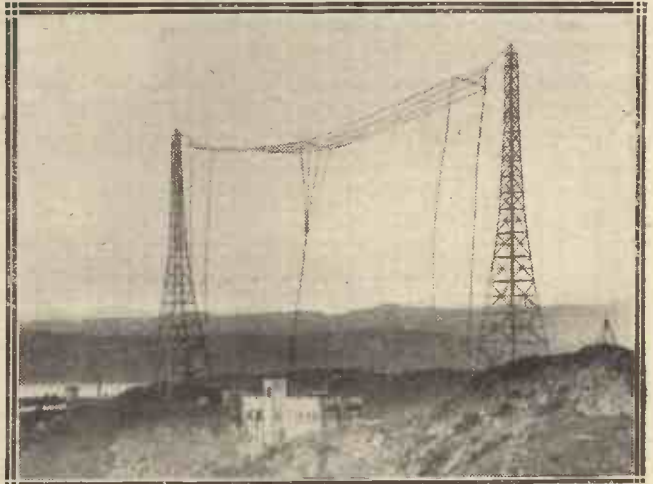

The Wellington station, 2 Y A, is situated some distance out of the city, and is 1,000 feet up.

here expect that programmes from 2 N M will soon rank amongst the most popular items out here.

England (or rather, Britain!) is still "home" to the "colonials, and programmes and news with the "home" touch will be eagerly sought after. More power to 2 N M—and it is "up to" British listeners to see that the powers that reign o'er British broadcasting realise of what very great value such efficient broadcasting station or stations will be to all who dwell in our vast Empire.

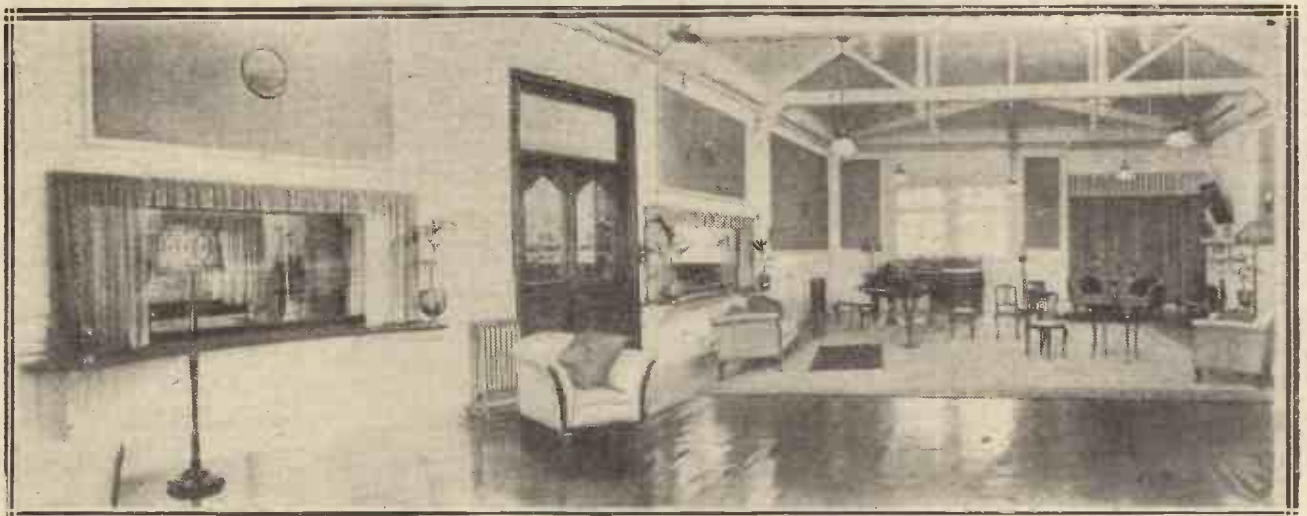

The Grand studio at 2 Y A is decorated with blue and gold, and very handsomely furnished.



*Hints on handling the already-famous receiver which was described last month.*

*By G. P. KENDALL, B.Sc.*

**T**o get the best possible results from any sensitive multi-valve receiver, one of the most important points is to see that each valve is working under as nearly ideal conditions as possible, and is, moreover, suited to the work it is called upon to do. These details, therefore, may well be the first to claim our attention in this month's notes on the "Super-Screen" Four.

The version of the screened-grid valve at present on the market (the D.E.S.625) is fitted with the D.E.5 type of filament, and it will be found that this is not at all critical as to temperature. So far as results are concerned, it is sufficient simply to turn it full on, but in order to prolong the life of the valve it is desirable to dim it slightly, and an adjustable baseboard rheostat was accordingly provided for in the design. You will find that if you adjust this so as to bring about two or three ohms resistance into circuit (this fraction is quite easily estimated with a rheostat of six or seven ohms total) you will not lose signal strength, and the valve will have an easier time of it.

#### H.T. Adjustment

The H.T. voltage on the anode of this valve in the "Super-Screen" Four is not critical, and the standard value of 120 volts or a little more can be adopted for general purposes without further experiment. The voltage on the screening electrode, however, requires a little adjustment for the best results, and this should be done

on the signals of the weakest distant station you can find. A few trials of various voltages between 70 and 85 will soon enable you to determine the best working point. The grid bias on this valve is not critical, and a value of  $1\frac{1}{2}$  volts (i.e. a single small dry cell) will serve all normal purposes here.

Turning now to the detector valve, it will be found that the strongest signals will be obtained with one of the

Failing these, good results can also be obtained with a valve of the H.F. type, such as the Cossor 610H.F., P.M.5X, B4H, D.E.5b, etc., equivalent types being available in all the well-known makes. Adjustment of H.T. and filament current for this valve should be made in the usual way to obtain smooth reaction control.

In the first L.F. socket we have a choice between two main types of valves, and the decision must be made

The two dials on the left are for tuning the "Super-Screen" Four, the third dial being for a wave-meter circuit. This can also be used as an absorption wave-trap, if desired, and it then provides quite a useful additional aid in sorting out a couple of distant stations which are interfering with each other. The set is a revelation of what four valves can do.



resistance-coupling type in this socket, a few examples of suitable kinds being these: P.M.5B, D.E.H. 610, Cossor R.C., S.S.610R.C., etc.

by the user according to whether he desires the greatest possible fidelity of reproduction on even very strong signals, or alternatively slightly greater amplification with a greater risk of overloading and consequent loss of

quality on powerful transmissions. In the former case, a medium-sized power or L.F. valve is the correct prescription, examples being these: P.M.6, D.E.5, B4, P.V.5, Cossor 610L.F., etc. If greater amplification is desired, the risk of overloading being understood and accepted, a valve of somewhat higher impedance and amplification factor may be used, such as the D.E.L610, P.M.5X, Cossor 610 H.F., S.S.610 H.F., and others.

decided by the maker's instructions, but do not make the mistake of using less than the full permissible amount.

### Little Reaction Needed

The actual operation of the "Super-Screen" Four is, fairly simple, since there are only two tuning controls, and probably very little explanation is needed. There is no need whatever to use enough reaction to make the set oscillate when searching; the

when the operator has realised its possibilities, and since it is not often met with some further notes on its use may be helpful. A brief explanation was given last month, from which it will have been gathered that the main purpose of the device is to provide a circuit actually in the set possessing a constant calibration which can be used for identifying stations. It acts on the absorption principle, that is to say, when it is brought into tune with the circuit to which it is coupled (the anode circuit in this set) it absorbs energy and causes an increase in damping.

### Using The Meter Circuit

If this is done when a station is being received it will be found that the signals of that station die down practically to vanishing-point, and reappear again sharply as the wave-meter circuit is detuned either way. This absorption effect will be found to cover a small band, say, two degrees for each station, and it is an easy matter to estimate the middle point of this band, and record this as the reading for that particular station. For example, if it is found that Langenberg disappears when the meter circuit reading is brought up to 70 degrees, and reappears again when 72 degrees is reached, the reading to record would be 71 degrees.

This is quite an easy process in practice, but it is also possible to narrow the indication down to about half a degree, if desired, by bringing up the reaction. If this is done when the meter circuit is set to produce absorption of the station, it will be found that the set will break into oscillation when the wave-meter is de-tuned very slightly either way. It will, of course, be desirable to draw up a calibration chart for this circuit as soon as a few stations of dependable wave-length (such as the British and German main stations) have been logged.

One or two final points. Coil sizes in this receiver are the conventional values of No. 25 or 35 in the aerial circuit, according to the degree of selectivity required, size of aerial, etc., and No. 60 in the secondary circuit. For the Daventry range of waves a No. 100 or 150 in the aerial and No. 250 in the secondary will be correct.

For the anode circuit on long waves it was not found necessary to use a special coil, a standard "split primary" transformer being employed. When this is used, of course, only the secondary and reaction windings are actually in circuit.

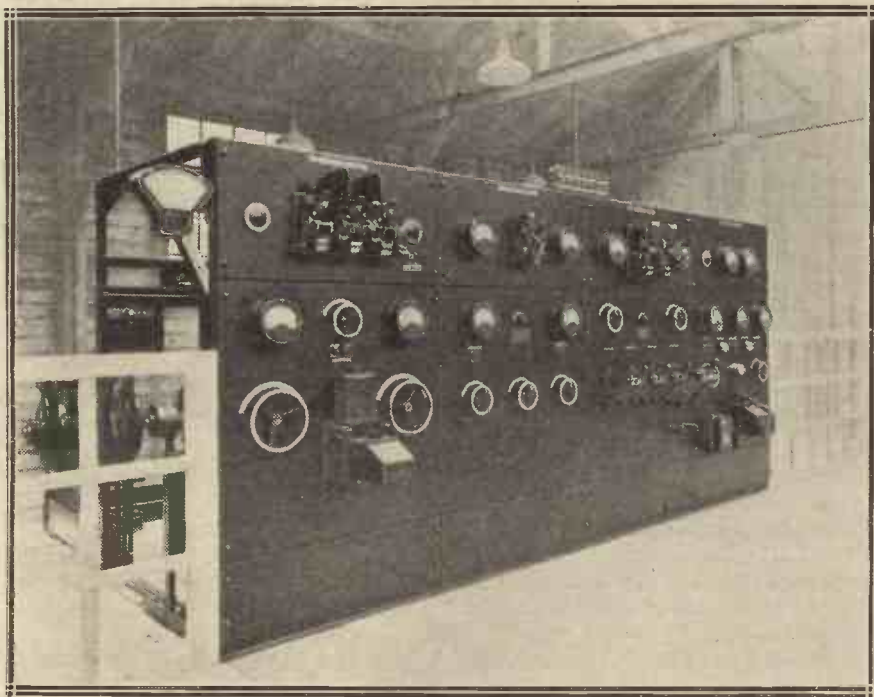

The power switchboard for a standard broadcasting equipment (45 kilowatts).

It is not well to go above about 25,000 ohms impedance, and it must be remembered that even within this limit the reproduction of the bass will not be quite so satisfactory as with the previous types.

### The Power Stage

When a power valve is used in this socket due care must be taken to use adequate grid bias, in order to keep the anode current within safe limits and so avoid risks of saturating the core of the L.F. transformer.

In the last stage a really good super-power valve is most desirable, since the set will give very full loud-speaking from a large number of stations, and there is no reason why the quality should not be of a very high order indeed if proper precautions to prevent overloading in the last stage are taken by using a large valve, plenty of H.T., and correct grid bias. Some examples of the type of valve required are these: Cosmos Red Spot, P.M.256, Stentor 6, D.E.5A, L.L.525, etc. Grid bias will, of course, be

sensitivity is quite high enough to enable stations to be picked up by varying the tuning controls in unison, keeping well clear of the oscillation point all the while. Then, when the station has been tuned in, reaction can be adjusted to give the desired volume. The knack of keeping the two circuits in step with each other as searching proceeds is easily acquired, since with a sensitive set like this there is always a faint sound of "liveliness" composed of atmospheric, stray Morse signals, and so on, when the circuits are in tune with each other, and one soon learns to turn the dials in such a way that this sound is maintained while the search for stations goes on. With the aid of this indication tuning becomes easy, and the user will probably be considerably surprised at the large number of transmissions which can be tuned-in in succession without touching the reaction control, which can be left set to a very moderate value.

The absorption wavemeter circuit will be found a very useful device

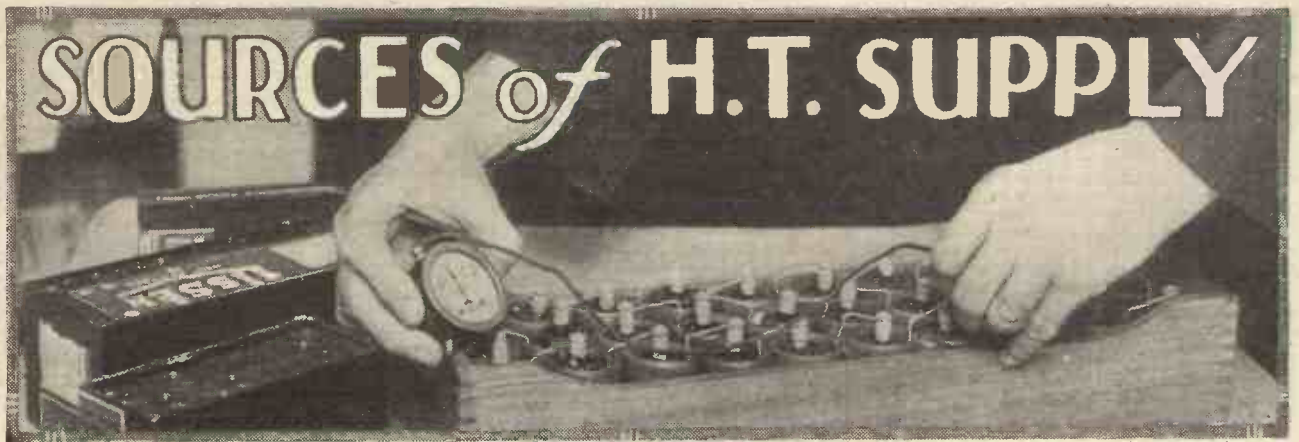

# SOURCES of H.T. SUPPLY

*In this article one of radio's biggest bugbears is dealt with helpfully and authoritatively.*

*By C. W. PEARSON.*

**Y**EARS ago the question of high-tension supply was a simple matter, as the only source open was the dry high-tension battery, as we know it to-day. The position which prevails now could not exist, as, there being no other developed variety, it was a case of "Hobson's choice"—have it or leave it. With the phenomenal and unexpected strides that radio science has made, the position is reversed, and whereas

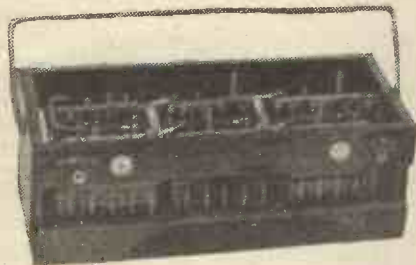

H.T. accumulators are generally put up in sections of convenient size for carrying to the charging station.

then makes of reliable batteries in England could easily be counted upon the fingers of one hand, manufacturers of reliable accumulators, and high-tension apparatus for the utilisation of mains electrical current now number scores.

## For Multi-Valvers

Unfortunately, the rapid perfection of radio apparatus has not been so marked in the dry battery trade, with the consequence that a large number of inferior batteries are being sold that are totally unsuited to the demands that a multi-valve set will impose. It must be remembered that where a man of moderate means possessed a crystal or one-valve set four years ago, he is now able to own a set of four or five valves, this, in the greater

number of cases, being due to trade competition, mass production, and foreign competition.

Sometimes his components are of the cheap imported variety, and his reception may be likened to the growl of an animal, but it is not quality that I wish to stress so much as the fact that with the multiple set a greater demand is made on the high-tension supply. The battery sold for this purpose to-day is not fitted for the task, as, with very few exceptions, the makers have not increased the capacity of the battery to meet the increased demand.

When the average individual asks himself what his source of current will be when next he is ready to replace his present system, there are four varieties to choose from—i.e. (1) dry primary battery, (2) wet primary battery, (3) secondary battery, and (4) H.T. supply apparatus for utilisation of mains electrical supply. Each has its advantages and disadvantages, and, in the writer's

opinion, all will remain on the market, for the simple reason that each has its own particular sphere. A brief survey of each will be treated in the order given.

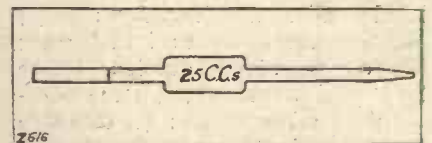

One of the best methods of pouring the sal-ammoniac into a wet H.T. battery is to use a chemist's pipette, of the type illustrated above.

## Dry Primary Cell Battery

The dry cell was first produced by one, Gassner, in the year 1888, and it is perfectly safe to state that very little improvement has taken place up to the present day. It was originally introduced to replace the standard Leclanché battery, and for some purposes there is no doubt but that it has succeeded admirably. The sale of the cell was originally so

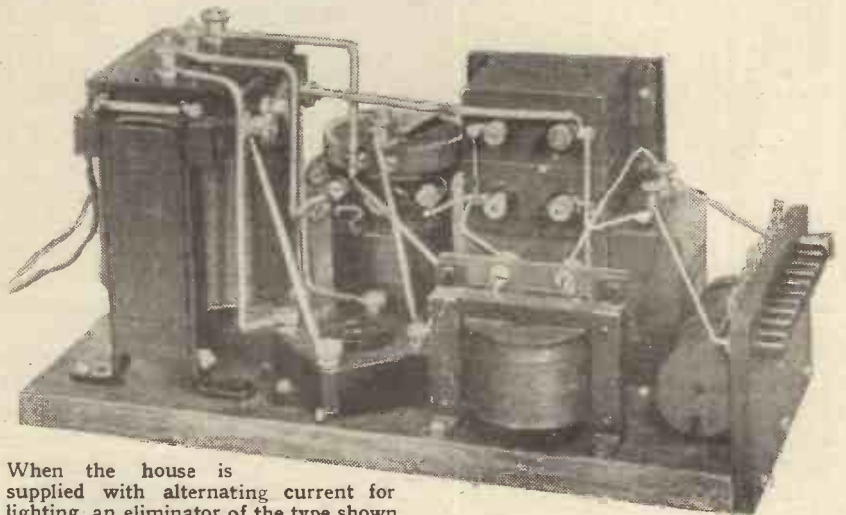

When the house is supplied with alternating current for lighting, an eliminator of the type shown above may effectively be employed.

small that public demand only permitted it to be made as a small side line.

These conditions prevailed until the motor industry used a battery of the cells to furnish the spark in the internal-combustion engine. This added impetus, caused manufacturers to visualise a future for the dry cell and increase production on old methods, still thinking improvements were hardly worth while troubling about.

### Disadvantages

The Englishman is rather conservative to improvements, unfortunately, but when roused he usually makes up for lost time. I believe that some English manufacturers now maintain research laboratories costing five figures per year to maintain. The consumer obviously bears this cost, but the actual service obtained far outweighs this.

Actual disadvantages of the dry high-tension battery may be tabulated under five headings: (1) Relative short life to initial cost; (2) noises which develop before battery is worn out; (3) inaccessibility for minor repair; (4) complete wastage of battery when run down; (5) age of battery being unknown when purchased.

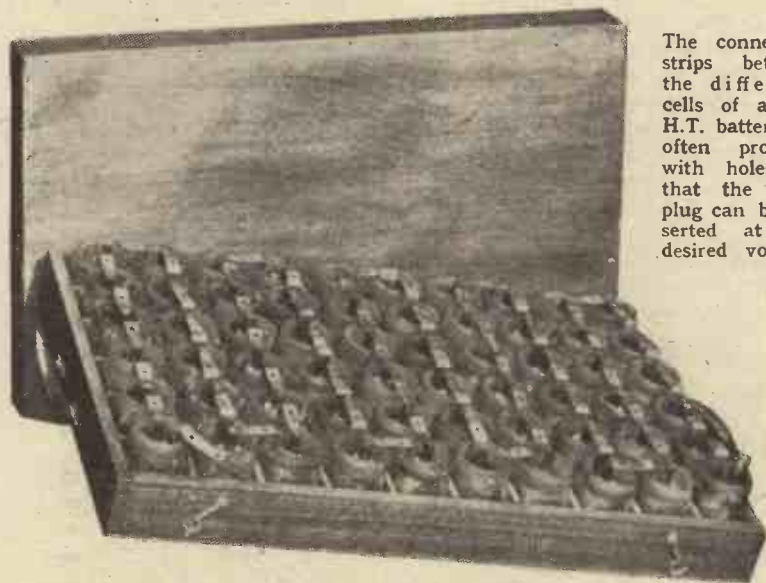

When purchasing a battery the initial purchase price is governed by one's pocket, and a 100-volt battery of English manufacture bearing a good name costs approximately 21s. If we are to get six months' service from this the cost is a shilling per week. Six months is a good period to take as an example, as the manufacturer's guarantee to the dealers becomes

void after this, so it is safe to assume that this is a useful life.

Again, assuming that the dealer has had the battery in stock three months, it means that it is nine months old before it wears out. To

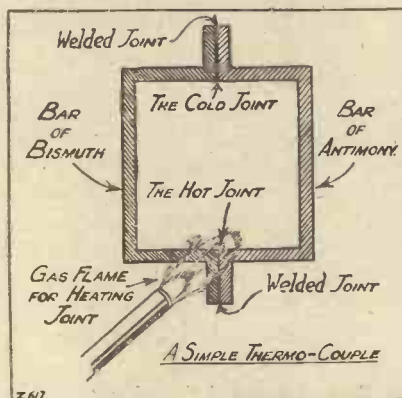

If the dissimilar metals are joined as shown and one joint is heated, current flows from the hot joint to the cold. Will this eventually be the method adopted for supplying H.T. current?

the individual who is paid highly for his services 21s. is a mere nothing, but to the average individual whose wage is approximately 60s. per week it is a serious amount, and often he skips the reliable English cell and resorts to the cheap and indifferent battery of 8s. or 9s. per 100 volts.

The connecting strips between the different cells of a wet H.T. battery are often provided with holes so that the H.T. plug can be inserted at any desired voltage.

Although he does not know it, he is spending more on his H.T. supply than the man who pays 21s. if service is to count, as the probable life of the cheap cell is only about six or eight weeks. The annual outlay on the 21s. battery is, in the majority of cases, two guineas, but on the 8s. to 9s. battery the outlay is in the region of 54s. The reader will probably

criticise these figures as extravagant, but it is an open question, governed by each individual's idea of when a battery is spent.

### A Guarantee Wanted

We are all, more or less, misled upon this, as depreciation is so very gradual that we miss it until very noisy reception is obtained, diminution of volume, or a sudden breakdown manifests itself. If the discarded battery could be taken into an electrical laboratory and carefully tested by an expert, this opinion would be that only about half of the actual battery has been consumed.

This other half (which means an outlay of 10s. 6d. on the 21s. basis) must be discarded because it has failed to give the faultless reception for which it was primarily designed but causes an abundance of "home-made" atmospherics. In all probability, could we open the battery and get down to the root of the trouble it would be found that one or two cells are all that are causing the breakdown. Some people advocate the cutting out of the faulty group on location, but in the writer's opinion, the advantage which accrues is questionable.

Upon the purchase of a battery, the dealer will be always very emphatic that it is quite fresh. The old story of such huge sales that the battery is in and out of the shop in a few days is not good enough. Clearly, some reform is needed, and the only person who can do this is the battery manufacturer. He should display clearly, and in a conspicuous place, when the battery was made and date of guarantee expiring, thus allaying suspicion as to the quality of his wares.

### The Wet H.T. Battery

To the person who lives away from town and experiences a difficulty in the charging of the accumulator high-tension battery, a very good substitute is presented by the Leclanché type. This is nothing more than the old style of Leclanché battery made in miniature form, and provided that the ingredients used are above question, all the reliability of the larger type is present in the smaller.

A battery of good merits may be made up from the small cells being marketed now at fivepence or sixpence per complete cell. There are two types to choose from, one has a sac-element and the other a small porous pot, but a



number of people favour the smaller type with porous pot, as it stands upright in the glass jar, equidistant from the zinc shell. Its chief defect lies in the fact that polarisation of the battery is very rapid, and it is for this reason that its scope as a source of current is limited.

Fortunately, the demands of current for a wireless set are small from an amperage point of view, and it will be found that, provided the porous pot is of large enough capacity, five or six hours' continuous service on a multiple valve set will make very little difference to it. After this use the battery will quickly depolarise itself and be found as good as new

After filling the cell with sal-ammoniac solution, a layer of light machine oil should be poured on to the electrolyte to a depth of about one-eighth of an inch. By doing this, we are eradicating another weakness that is ever present, known as "creeping." In simple terms, "creeping" is caused by the capillary attraction of the electrolyte by minute crystals of sal-ammoniac. This results in a continuous building up of minute crystals, and a neglected battery will quickly assume a frosted appearance, due to this creeping action.

### Filling the Cells

If the sal-ammoniac is carefully

The operation is simple and requires a little practice to perfect, but its usefulness will warrant the outlay. To use it, a vessel of sal-ammoniac solution is taken, and the pointed end of the pipette inserted under the surface, the open end being placed in the mouth. By drawing on this, the solution will pass up the tube and fill the bulb, the tongue being used to seal the tube and preventing the solution from running away when suction is released.

### A Useful Battery

If the tube is now sealed by a wet finger, the tube and contents can be transferred to any desired position. Upon releasing the finger and allowing a little air to pass into the pipette, a fine stream will flow from the pointed end, and will cease as soon as the finger is placed over the end again. This gives an exceedingly fine control, and the battery can be filled without any of the sal-ammoniac solution touching the sides, where it is not wanted.

Immediately after filling, the layer of oil should be poured in, but if it is effectively to prevent creeping, the sides above the electrolyte must be perfectly dry. Always remember that once a battery starts to creep, the only cure is to wash it out and start again.

Upon testing, the porous-pot type of battery shows an internal resistance slightly greater than the sac type, through polarisation. But, given further research, a very useful battery should result, as even at the present time maintenance costs are low in comparison with initial outlay.

### The H.T. Accumulator

On the introduction of the secondary battery as a supply of high tension,

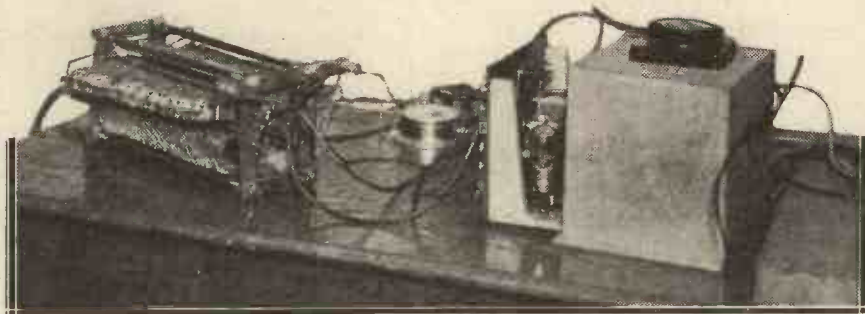

The thermo-pile shown to the left is a practical form of the thermo-coupler. The model shown was devised for the L.T. supply.

again. A few points are open to improvement, as the zinc element in a great number of batteries on the market is of builder's quality. This will be quite in order, provided that it is amalgamated.

### Amalgamating the Zinc

A very simple method of amalgamation is to procure a cold, saturated solution of mercury perchloride in water, about four fluid ounces being sufficient for the purpose. The zinc shell should be stood in the solution for a few minutes, when it will become covered with a grey deposit. If this is rubbed with the finger a mirror-like surface of mercury will be found. Care should be taken not to allow the mercury to come into contact with any wounds or broken skin, as it is very poisonous. Very small quantities will prove fatal if taken internally. Amalgamation forms a protective agency against wastage of the zinc, and its life will be prolonged threefold.

I have seen a number of people using the battery with just a solution of sal-ammoniac in the container. Thus, during the summer, or if the battery is kept in a warm room, evaporation losses will be serious, as only a very small quantity of electrolyte can be used in such a small cell.

poured into the dry battery, and none allowed to touch the parts of the cell which are out of the reach of the solution, and the oil poured on to its surface, it will be found that the small amount of trouble bestowed will be amply repaid by the trouble-free service obtained. For pouring the sal-ammoniac solution, I have successfully used a chemist's pipette. It may be purchased from any large chemical apparatus dealer for about a shilling.



One of the advantages of accumulators for H.T. supply is that the voltage is steady enough for laboratory tests.

we began to think that our troubles were at an end, as theoretically it has great possibilities. To the town dweller who can easily get the accumulator recharged, through a reliable service station, the claimed capacity is rather tempting. Noiseless, trouble-free service, a constant voltage, capability of heavy discharge, a life of six months on each charge, what could be more reliable and cheap to maintain?

Many of us purchased these batteries on advertised merits, but unfortunately practice proved an eye-opener. The Press has given frequent replies to users, and for each query reaching the Press there remain at least fifty other dissatisfied users, all complaining that instead of the claimed six months' capacity, that obtained is nearer to one month.

**Accumulator Capacity**

The capacity of an accumulator is governed purely from the amount of current that enters to a fixed specification, and the discharge relative to the amount of paste in the grid. The manufacturers claim six months' service to a charge, but this is really worthless, as no rate of discharge is given. Again, accumulators are being sold on a milli-ampere hour capacity, but nothing is said as to whether it is actual or intermittent capacity. There are very few makes obtainable that state the ability of a battery to stand a discharge at a definite rate, and, as we are all aware, this considerably influences the amount of current available from a charge.

Another nuisance with this type of battery lies in the fact that com-

paratively few stations are equipped to charge the battery according to makers' instructions. A great temptation to them is to increase the rate and decrease the period, thus unscrupulously making a great profit. The current per cell, if charged as designed, is extremely small, and takes a long time to thoroughly penetrate the plate.

**Keep Battery Clean**

Another difficulty lies in the fact that a rapid method of ascertaining the density of electrolyte during the charge is practically impossible, owing to the small amount of electrolyte that each cell contains. Also, the small plate that this battery contains means that only a very small amount of paste is possible in the plate, and as the amount of paste influences the capacity, the size of the plate is no indication of the actual service that we will receive.

The plate is made from anti-monious lead; from an electrical storage point of view it is inert; and from the writer's point of view deleterious, as it prevents the "growing" of the paste, thereby readily allowing sulphation to commence. Some manufacturers of accumulators use an adulterant in the paste which they call "a filler." The purpose of this is to assist the binding of the paste in the grid, but it effectively reduces the capacity of the cell, as only the actual paste present (in unison with the amount of sulphuric acid) can determine what the actual capacity of the cell will be.

It is possibly the presence of fillers and sulphation that give rise to the parasitic noises in our 'phones. Another prolific source of noise can easily be formed outside the battery, namely, the presence of acid on the

containers. They should be kept scrupulously clean and free from acid spray, as sulphuric acid, being strongly hygroscopic, or water-attracting, if left on the top of the cell, will quickly draw sufficient water from the atmosphere to form an easy path for the escape of current, and as the capacity of the H.T. accumulator cell is small, we naturally cannot afford to lose any. Remember that so long as this leakage is possible, the period of discharge is continuous, irrespective of the time that the accumulator is used.

It is very possible that a large number of criticisms that are hurled

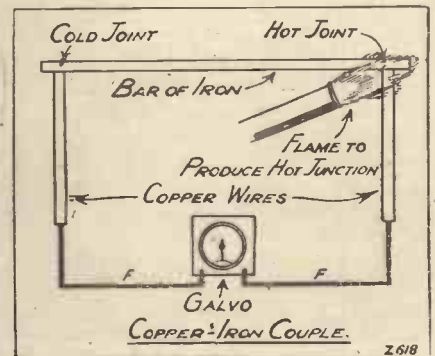

When the galvo is connected as shown it registers a current flow due to the heating of one of the junctions.

at the manufacturers are due purely to this carelessness. Conditionally that an accumulator is purchased from a well-known maker who will guarantee his product (not so much length of life of battery, as the actual capacity), and due care is exercised in its use, there is very great promise of good trouble-free service to be obtained, but use the same careful discretion on your purchase as you desire to be used on the purchase of your food.

**Careful Charging Essential**

If the makers cannot conveniently recharge it for you, be discreet as to whom you entrust it. Do not give it to the nearest garage man to charge because it is convenient. Ascertain first as to whether he has the technical knowledge to care for this delicate article, and then, whether he is equipped for its specialised charging, for although he may be able to charge a large-capacity cell successfully, remember that this is no criterion, as the larger cell will always stand a greater amount of abuse than the H.T. accumulator. Always use pure brimstone acid, and distilled water (not boiled water), and take particular care that the accumulator is not short-

(Continued on page 530.)

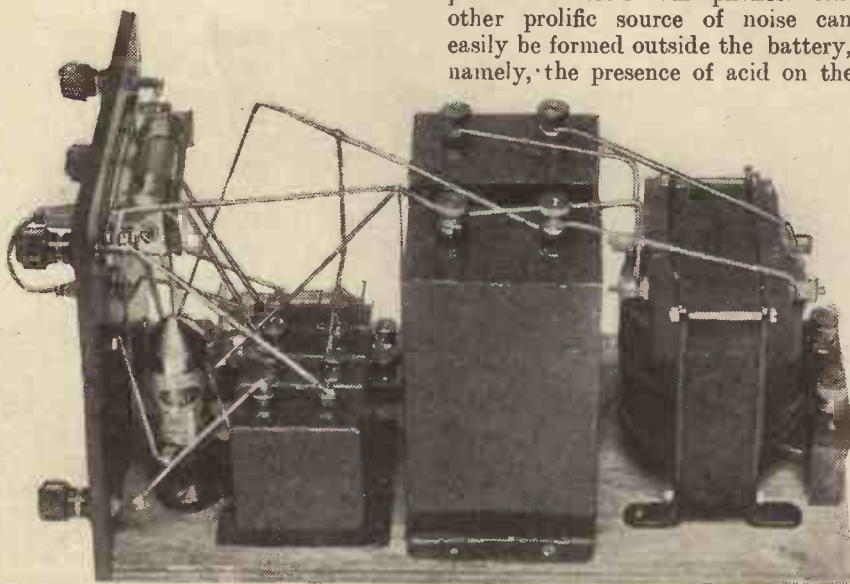

This type of H.T. battery eliminator is for use when the house is wired with a direct current (D.C.) electrical supply.



# NOTES ON A TRUE PURITY CIRCUIT

By C. P. ALLINSON, A.M.I.R.E.

I HAVE for some time been using a rectifying circuit of a novel description, which has specially recommended itself to me on account of the extraordinarily high quality of reproduction that is obtainable with it. We all know that both leaky-grid condenser rectification and anode bend introduce distortion, the latter less, of course, than the former.

In the case of anode bend, however, the distortion that is introduced is owing to the fact that non-linear rectification is obtained, since the bend on which we are working is not sufficiently sharp for anything like linear rectification to be given. This applies in particular to weak signals

theless I have found that the damping introduced is so low that this does not matter to any appreciable extent.

The chief reason for the success of this circuit in giving pure reproduction

first evolved it, and they agree with me that the improvement in quality resulting from the use of this circuit is extremely marked and well worth the slight drop in signal strength

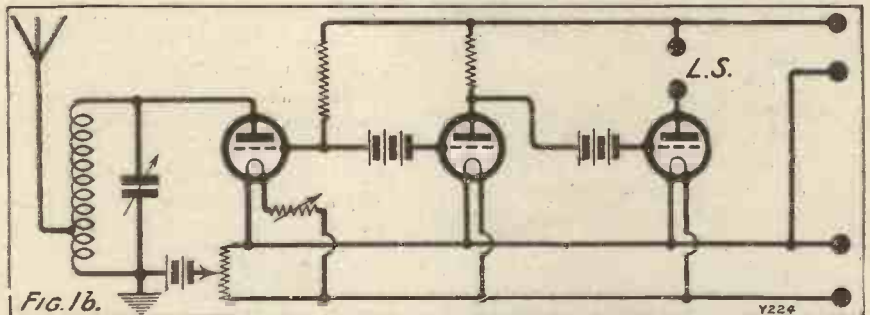

is owing to the characteristic curve which is shown in Fig. 2. Under practically all working conditions the bend in the grid-current curve at "A" is extremely sharp, so that not only is the efficiency of rectification high on weak signals but it is almost absolutely linear, thus giving a degree of purity of reproduction which is not given by any other system which I have previously tried.

which is actually experienced when using this scheme.

I have since then had a number of letters from amateurs who have tried out this system, and who have had a certain amount of difficulty in getting it to perform satisfactorily, and I have therefore carried out some further experiments with this method of rectification in order to make it

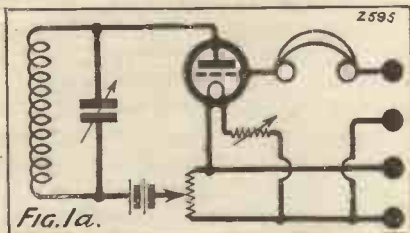

rather than to strong ones, for in the case of weak signals we do not get efficient rectification on account of the curvature of the bend.

### The Triode Rectifier

The circuit I am using is shown in Fig. 1, which is not new and has previously been published in one of the wireless papers. The skeleton scheme of the rectifier is shown at "a," while at "b" is the original circuit I used. It was a bit tricky in operation, however. I am using a circuit of this type at present for my local-station receiver, but actually it can be used following several stages of H.F. with every success for distant reception. Although, in its present form, using resistance-capacity coupling with a coupling resistance of the order of 1 or 2 megohms, it is not possible to get reaction with the circuit, never-

I am supported in this statement by several other experimenters to whom I showed the circuit after I



A receiver that has been experimentally adapted to Mr. Allinson's true purity circuit.

more easy to handle, and also to determine more accurately the conditions under which the valve is working.

**Three Variables**

For reference purposes the detector circuit is shown by itself in Fig. 1 at "a," and those who have read my previous article will remember that I pointed out that the question of the value of the filament resistance was a fairly important one in obtaining the maximum efficiency from this circuit. It therefore becomes clear that we have three variables which require adjustment before the best results are obtained with this triode method of rectification.

These are, of course, the plate voltage, the grid voltage, and the

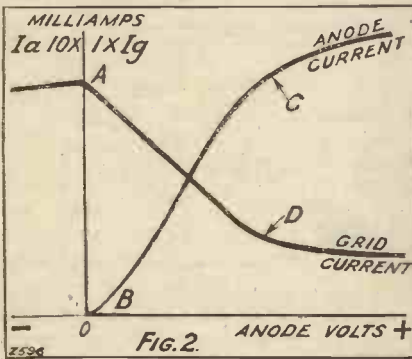

filament voltage, the latter usually being somewhat critical in adjustment.

The first thing to determine was what effect the filament voltage had on the characteristic curves obtained under the usual input-voltage-output-current conditions. In order to do this, therefore, the plate voltage was plotted against grid current, and against plate current at different values of filament potential.

A representative characteristic curve is shown in Fig. 2, in which anode current and grid current have both been plotted against anode volts at a given value of grid volts and filament potential.

**Grid Current Curve**

It is by no means unusual to find that in order to get both the characteristic curves on the same graph it is necessary to plot the anode current on a different scale to the grid current, and this has been done in this curve.

The portions of the curve which interest us chiefly are the bends at A and D on the grid-current curve, since it is these which we are utilising for rectification. It will be seen that we have two bends, an upper bend, A, and a lower bend,

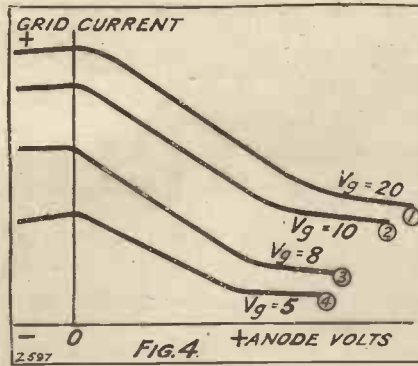

D, and we may therefore use upper bend or lower bend for rectification, whichever we find preferable.

It will be noticed that the grid-current curve drops again on the negative side of the anode-volts ordinate and at the same time we have a rather sharp bend at B in the anode-current curve at zero anode volts, and it would therefore appear when working on the upper grid-current bend that we shall also obtain anode-current rectification in a similar manner to which the grid-current rectification is obtained when using a valve in the more conventional manner.

**Best Conditions**

It has been found in many cases that the lower bend in the grid-current curve shown at D was obtained with the same value of anode

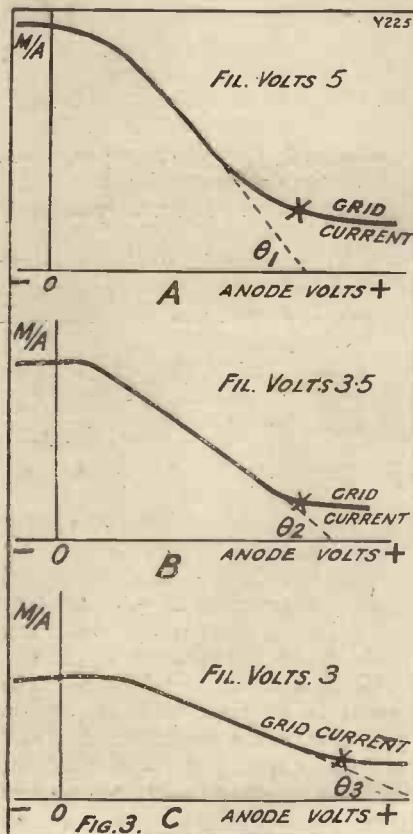

voltage as the upper bend in the anode-current curve as shown at C, and it was therefore preferable to work under conditions when the bend in the grid-current curve coincides with the straight-line portion of the anode-current curve, otherwise anode-current rectification will again be obtained.

**Steep Slope Essential**

Two other conditions which need to be observed for maximum efficiency when using the triode method of

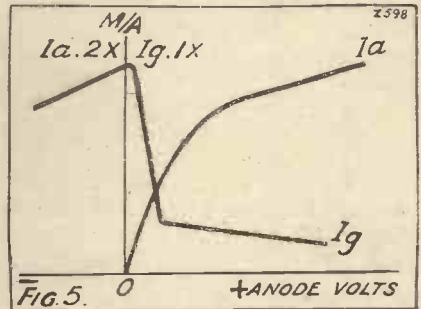

rectification are that the slope of the grid-current curve should be as steep as possible, and that the bend at the point marked A or D should be as sharp as possible.

In order to determine the most suitable conditions as regards filament potential for this to occur a very large number of readings was taken, and some of these are summarised in Fig. 3 at A, B, and C.

The figures show the variation of slope and sharpness of bend with variation of filament potential, and these curves definitely show that there is an optimum value of filament potential beyond which no improvement is obtained. Actually, it is found that even if a slight increase in slope results, the flattening of the bend is so marked as to make it clear that any advantage which may be gained from the steeper slope is more than counteracted by the flattening at the bend. Thus in A (Fig. 3) the angle of slope, as shown at  $\theta_1$ , is somewhat greater than that shown at  $\theta_2$  at B. Nevertheless, the bend of the curve, as marked with a cross, is much flatter than that in the latter figure. In the case of C,  $\theta_3$  is less than either  $\theta_1$  or  $\theta_2$ , but the sharpness of the bend at the point marked with a cross is not appreciably sharper than that obtained in Fig. A.

**Filament Control**

These readings, which were taken with a valve normally rated at 5.5 volts, show that no improvement is to be obtained when using it for triode rectification when running the

filament at a potential above 3.5 volts. In fact, the reverse is indicated by the curves obtained, and this point is borne out in actual practice, since it was definitely found that far greater signal strength is to be obtained by keeping the filament of the valve turned well down.

**Interesting Comparisons**

We now have to consider what the effect will be on the sharpness of the bend of the characteristic curve, when plotting grid current against anode volts, of raising or lowering the grid potential, and the results obtained with regard to this point are summarised in Fig. 4.

The four curves drawn there are taken at different values of grid potential, and it will be seen that in

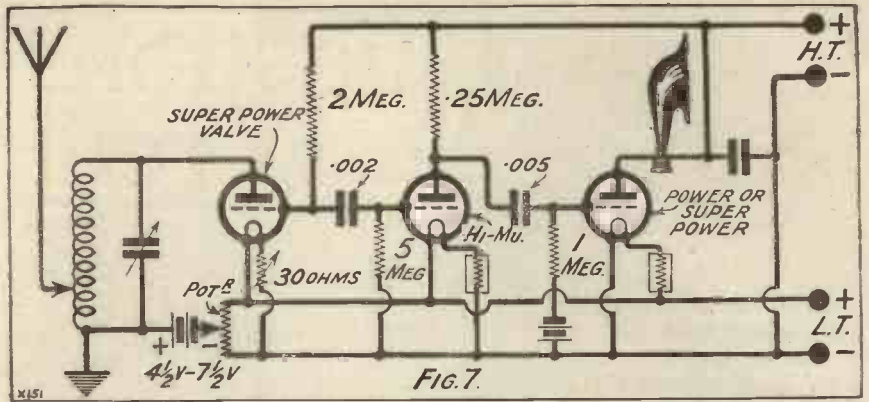

resulting when the grid voltage was cut down to 2 volts. This curve is not drawn to the same scale as that in Fig. 4, so that it does not actually give a measure of the slope of the curve, but it does show how the

current which results on the negative side of the anode-volts ordinate, and seems to indicate that bottom-bend rectification is the more efficient form with this system. In practice, however, I have found very little difference in efficiency between upper- and lower-bend rectification; if anything, indeed, slightly greater signal strength was given by the former.

**Two Useful Circuits**

It will be seen, therefore, that in order to obtain the very best results from this circuit a little practice and experimental work are required before success will be achieved. This is especially the case where battery coupling is used between the detector and the first low-frequency valve, since every adjustment of plate, filament, or grid potential on the detector valve will affect the adjustment of the coupling battery and thereby the potential of the low-frequency valve.

(Continued on page 538.)

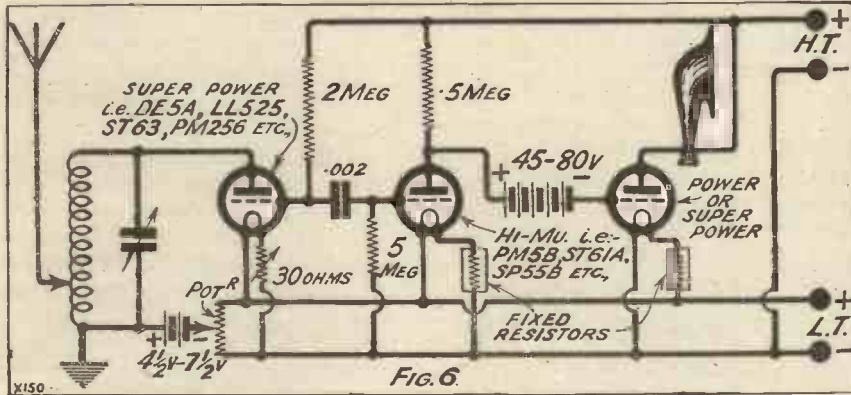

curve No. 1, in which a grid potential of 20 volts is employed, both bends of the curve are flat and very broadly distributed. When the grid potential was reduced to 10 volts somewhat sharper bends were obtained, and as the grid voltage was gradually cut down and down, so a sharper and sharper bend resulted, until when it was reduced to 5 volts it will be seen that quite sharp bends, as shown in the third and fourth curves, result.

curvature at the bottom bend is reduced to an almost negligible quantity so that a sharp angle results.

It also shows the drop in grid

**Best Grid Potential**

Curves 1, 2 and 3 vary very little in slope, and the actual figures obtained were 36 degrees for curve 1, 35 degrees for curve 2, and 34 degrees for curve 3. In the case of curve 4, however, the slope has been reduced to 25 degrees, and it would therefore appear that the optimum value of grid potential under the conditions obtaining when these curves were taken was in the neighbourhood of 8 volts, in which not only do we get a satisfactory slope but a satisfactorily sharp bend in the curve.

In order to give an idea of the extremely sharp bend that can be obtained, I give, in Fig. 5, the graph

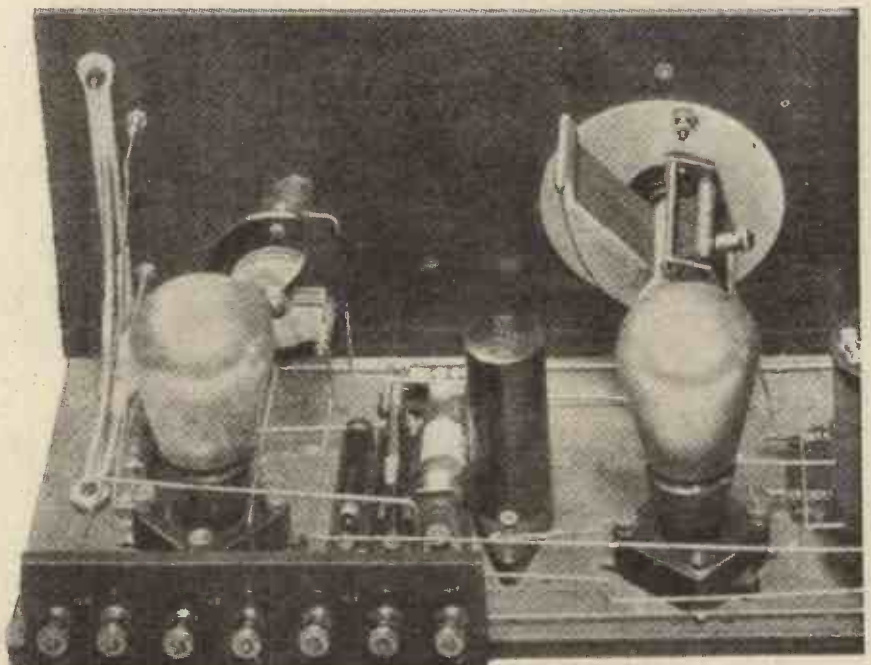

The "L.F. end" of a receiver employing the conventional resistance coupling on the lines of that included in the Fig. 7 circuit.



# Questions Answered

## Unsatisfactory Reaction

A. K. (Folkestone).—"I am using a .0005 reaction condenser in my receiver, which employs coils of the standard type normally used in conjunction with screens. A very small increase in the reaction setting causes the detector valve to oscillate and, in consequence, the best results are not being obtained on distant stations."

Experiment with small fixed condensers in series with the .0005 reaction control. You will probably find that the use of a .0003 series condenser will improve the control very considerably. In some cases a condenser as small as .0001 can be employed satisfactorily. Much depends upon the stability of the remainder of the circuit.

## Astatic Coils

C. R. (Cardiff).—"Can you give me the approximate number of turns required for a Litz-wound astatic coil, of the type requiring a single Paxolin or cardboard former?"

Using a 3-in. diameter former wind on 40 turns of 9-38 Litz wire, unspaced, in a clockwise direction. Then punch two holes in the former, thread the wire through and wind on another 40 turns in an anti-clockwise direction, thus making 80 turns in all. Alternatively you can wind as two separate coils, soldering the two ends in the centre of the coil together. As a tuned-anode coil in conjunction with a .0005 variable condenser this winding should be suitable for the ordinary B.B.C. band. A similar coil could be used in the aerial circuit, by taking the aerial through a small fixed condenser to the centre tap and tuning the whole winding with a .0005 condenser. The length of such a winding, allowing for a small space between the two halves, will be about 2½ in.

## Gramophone Pick-Ups

F. C. (Keighley).—"I am interested in electrical gramophone reproduction. Can I use my ordinary broadcast receiver for playing gramophone records?"

Yes. Obtain an electrical pick-up of which there are a variety of different types on the market. Place this on the tone arm of your gramophone in the place of existing reproducer.

## THE TECHNICAL QUERIES DEPARTMENT.

Are you in trouble with your set?

Have you any knotty little radio problems requiring solution?

The MODERN WIRELESS Technical Queries Department has been thoroughly reorganised and is now in a position to give an unrivalled service. The aim of the department is to furnish really helpful advice in connection with any radio problem, theoretical or practical. Full details, including the revised and, in cases, considerably reduced scale of charges can be obtained direct from the Technical Queries Department, MODERN WIRELESS, Fleetway House, Farringdon Street, London, E.C.4.

A postcard will do: on receipt of this all the necessary literature will be sent to you free and post free, immediately. This application will place you under no obligation whatever. Every reader of MODERN WIRELESS should have these details by him. An application form is included which will enable you to ask your questions, so that we can deal with them expeditiously and with the minimum of delay. Having this form you will know exactly what information we require to have before us in order completely to solve your problems.

Connect the two leads from the pick-up direct to the grid and filament of the first L.F. valve of your receiver and use the L.F. stages and loud speaker in the usual way. There are two main types of pick-up. One employs a high-resistance winding and is joined up as described above. The other utilises a low-resistance magnet winding and must be used in conjunction with a step-up transformer having a ratio in the neigh-

bourhood of 70-1, according to the design of the pick-up.

The two leads from the pick-up are connected to the primary winding whilst the secondary winding is joined between grid and filament of the L.F. valve. Grid bias is applied via the secondary winding and it is quite usual to shunt this winding with a .25-meg. resistance. It is a fairly simple matter to modify the receiver so that the gramophone may be employed when broadcasting is not required by the use of a double-pole change-over switch.

## Using a Milliammeter

P. R. (Stapleford).—"I wish to arrange my set so that I can use a milliammeter for the purpose of checking quality. Is there any method whereby the instrument can be inserted in circuit with either of the two L.F. valves when required?"

Yes, you can employ two double-circuit closed jacks. Connect the two inner contact tags together. Join H.T. + to one of the outside tongues and connect the other to the anode of the L.F. valve.

Join the two leads from the milliammeter to an ordinary telephone plug. Inserting the plug in the jack will place the instrument in series with the H.T. and the anode of the valve. Withdrawing the plug will connect the H.T. direct to the plate of the L.F. valve. Be careful to join the positive terminal of the milliammeter to the correct side on the telephone plug.

## Charging from Daniell Cells

L. B. (Sidmouth).—"I have endeavoured to charge my 4-volt accumulator from Daniell cells, but I find that these cells run down very quickly, and the cost of charging is rather higher than I anticipated. Can you give me any suggestions for improvement?"

It is essential to use at least six Daniell cells in series. Use large outer jars so that plenty of copper sulphate solution is present, and suspend near the surface cloth bags full of copper sulphate crystals in order to maintain the strength of the solution. Some readers have found that sulphuric acid is unnecessary and that a solution of Epsom salts or zinc sulphate is just as effective, giving an increase in the life of the zincs. Keep the cells in a cool, damp spot in order to minimise creeping and do not allow the zincs or copper foil to touch the porous pot.

It is essential to use heavy zincs, free from impurities.

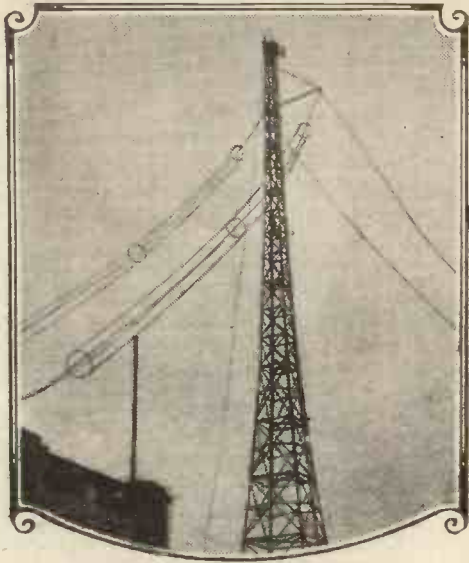

# Sidelights on the B.B.C.

*The Question of Controversy—Politics and Wireless  
—Progress of Short-Wave Broadcasting.*

By THE EDITOR.

“WE have sailed as close to the wind as we dared, and we are now engaged in making representation to the Postmaster-General.”

Thus Sir John Reith at the Radio Exhibition banquet. It is an admission of the fact that the B.B.C. is awake to the importance of controversy in its programmes, and it is also evidence that the P.M.G. still exercises a restraint over the B.B.C.'s activities which is a hindrance to progressive development.

Undoubtedly a greater freedom in the matter of controversial talks is desirable, and undoubtedly that freedom, if abused, can do incalculable harm. But when dealing with a corporation like the B.B.C.—which in the matter of treading warily is as careful as any government department tied up in red tape—it may be assumed that if the P.M.G. left the question of the quality and quantity of controversy in the programmes to the discretion of Sir John Reith that confidence would not be misplaced or in any way abused.

Writing with a personal knowledge as well as a public knowledge of the Director-General of the B.B.C., we might venture to say that a more discreet man than Sir John would be hard to find.

He is a man with a very shrewd knowledge of the legitimate possibilities of controversy.

## “Close to the Wind”

When Sir John said that “we have sailed as close to the wind as we dared,” it must be remembered that he was referring to the power of the P.M.G. to veto controversial broadcasts, and not to any suggestion that the B.B.C. had deliberately approached the boundary limits of discretion and good taste in the matter of controversial “talks,” etc.

To “sail close to the wind” is a metaphor which Sir John used to indicate that the B.B.C. had taken the fullest possible advantage of the controversial limits set by the P.M.G., and to indicate that those limits were unduly narrow.

Few people will disagree with Sir John's hint that the P.M.G.'s restriction is enforced to a degree which is not consistent with the English idea of free speech, or legitimate argument. The limits set by the P.M.G. are, in fact, narrow to an almost ludicrous degree, and are more reminiscent of Russian methods than British; and the knowledge that the B.B.C. is making representation to the P.M.G. (presumably with the intention of obtaining more latitude in the matter of controversial broadcasts) is very good news and, we hope, likely to reflect favourably on future B.B.C. programmes.

There are, of course, many subjects so acutely controversial that in view of the extraordinary variety of the B.B.C.'s audience, and the youthfulness of so many of its patrons, it would be safest to ignore them. For example, talks on a subject like birth control need not be dealt with by the B.B.C.; nor need acute religious matters of controversy come within the purview of Savoy Hill; but there are dozens of other subjects offering excellent debating qualities and possibilities—none more so than politics.



The beam system of transmission and reception might solve the problem of successful Empire broadcasting. This photograph shows a corner of the receiving-room at the Skegness beam station.

But here, again, there is need for discretion. People have their own ideas on politics, and their own pet political beliefs and prejudices. Impartiality and the scrupulous observation of the element "fair play" would be essential in introducing political controversy to the broadcasting programmes.

However, "Prejudice is the child of ignorance," according to Hazlitt, and there is a good deal of truth in his dictum. The B.B.C., by a tactful handling of the question of political broadcasting, could dispel a good deal of prejudice in many quarters where ignorance is certainly the basis for the prejudice, and incidentally provide a spice in many of their "talks," which would supply a long-felt want.

That the King has no politics is a well-known constitutional fact. The B.B.C. should have none. If political "talks" or debates are to be broadcast they will be successful and welcome, if all parties are given a fair chance of airing their views, and if a little showmanship is exercised the material will provide a good deal towards the success of the Brighter Broadcasting Movement.

### "Spaced Aerial" Tests

It may now be regarded as definite that the B.B.C. has plans in hand for the provision of a short-wave transmitting station, and that there is a good chance of the station being ready by the end of the year. The site of the B.B.C.'s short-wave station is still being kept a close secret at Savoy Hill, but it is more than probable that the station will be built within a radius of twenty miles of London.

Just lately the B.B.C. engineers have really been devoting a good deal of time to the various problems connected with Empire broadcasting.

Reception of 2 F C, the Sydney station, has been more or less regular, and it has been clearly shown that the best time for reception at this time of the year is between 6 p.m. and 7 p.m. (G.M.T.). This is a fairly suitable one from the point of view of listeners in this country, but when it is 6 p.m. here it is 3 a.m. the following morning in Australia!

Although signals from 2 F C have been regularly received reception from the quality point of view has not been good.

The B.B.C. continue, however, with the relay experi-

ments, especially in connection with the American station, and during the next few months the B.B.C. anticipates that American programmes will be received and relayed to listeners here at the same strength (and with as good quality) as from a B.B.C. local station.

B.B.C. plans with regard to short-wave reception are, in fact, well in hand. The idea is to erect ten receiving stations, all connected to one central station, giving a



Sir John C. W. Reith, speaking at a dinner given in connection with the birthday celebrations of one of the B.B.C. stations. Mr. Percy Edgar, director of G I T, is seen on Sir John's left.

combined effort of received signals for relaying purposes. The B.B.C. expects that by means of this plan the problem of fading of signals on the short waves will be solved.

It has already been proved, during a recent twenty-four hour test of reception from America, that when two distinct receivers were used at Keston for picking up two stations transmitting the same items on different wave-lengths, when reception faded on one wave-length the other was not affected. The combined effect resulted, in fact, in almost uninterrupted reception.

### A Beam Experiment

As these words are written, the Australian station, 3 L O, has informed the B.B.C. of a forthcoming beam Empire broadcast experiment, and the B.B.C. has offered almost enthusiastic help. This is a change of front, and shows that at last the B.B.C. has set out wholeheartedly to do its best for Empire broadcasting.

The Americans, by the way, are also continuing intensive short-wave experiments, and W G Y, the well-known station at Schenectady, recently started a series of five-metre test transmissions, using a power of 1 kilowatt. If, at some future date, reliable broadcasts can be carried out on wave-lengths between, say, four and five metres (or 75,000,000 and 60,000,000 cycles respectively), the problem of interference and over-crowded wave-bands would be solved.

With such a frequency separation between two stations, hundreds of transmitters could operate between four and five metres without mutual interference.

The B.B.C. has not as yet tackled such ultra-short waves, although I believe several amateurs, including E. J. Simmonds, have conducted some highly interesting experiments on ten metres.



The transmitting valves used by the high-power American station, W E A F.



# The "REACTOR" SHORT WAYER

The receiver described in this article was designed to operate on wave-lengths between 15 and 75 metres. It employs a special valve for reaction, thus obviating that bugbear of "threshold howl."

By J. ENGLISH.

THERE is no doubt that interest in short-wave transmission and reception is increasing very rapidly. The pioneer work of amateur transmitters first demonstrated the unique properties of short waves for long-distance communication on small power. After they had set up records the commercial people became interested, and now we have several foreign broadcasting stations putting out regular programmes on short waves.

#### COMPONENTS REQUIRED.

- 1 variable condenser, .00025. (Any good make, original was an Ormond.)
- 1 vernier dial.
- 1 small variable condenser, 0001. (Ormond, Peto-Scott, Igranic, etc.)
- 3 valve holders. (Benjamin, Lotus, Bowyer-Lowe, W.B., Precision, Igranic, etc.)
- 1 on-off switch.
- 3 .0001 fixed condensers } Dubilier,
- 1 .001 fixed condenser } Lissen,
- 1 .003 fixed condenser } Mullard,
- 1 .01 fixed condenser. } T.C.C., etc.
- 1 5-meg. fixed resistance } Mullard,
- 1 2-meg. fixed resistance } Lissen,
- 1 .5-meg. fixed resistance } Dubilier,
- 3 grid-leak attachments or holders. } etc.
- 2 spring clips.
- 1 rheostat, 30-ohm. (Igranic, Lissen, etc.)
- 1 two-way semi-fixed rheostat. (Loriotat, or two separate resistances of any good make.)
- Ebonite ribbed former, 3 in. by 3 in.
- 4 terminals.
- 1 panel, 15 in. by 8 in.
- 1 9-in. baseboard.
- 1 panel shield.
- Sundry wire, screws, etc.

Unfortunately, we have not a short-wave broadcasting station in the British Isles at present, but there is reason to believe that this deficiency will be remedied shortly. Then Empire broadcasting will at last become a reality. After this more short-wave stations in all countries will establish fresh lines of com-

munication, so that before very long we can look forward to the commencement of world broadcasting.

At the present time there are quite a number of interesting short-wave transmissions to be picked up with a simple receiver. There are the amateur telephony transmissions, most numerous during week-ends, several regular American programmes and numerous experimental transmissions from Continental stations. Interest is added to short-wave reception in that one never knows what will be picked up. Morse signals may be heard coming from all parts of the world.

The most interesting field lies below 75 metres and successful

reception on these wave-lengths does not call for a complicated set of excessive operative skill. With the right receiver and a little patience in tuning short-wave reception is no more difficult than ordinary DX work.

#### Simple and Efficient.

The receiver described in this article was designed with the view to providing a simple and efficient short-wave set for reception on wave-lengths between 15 and 75 metres, this band being at the present time the most interesting. The experiences of many amateurs show that the best results are obtained using a simple detector valve with reaction, followed by one or at most two L.F. valves.

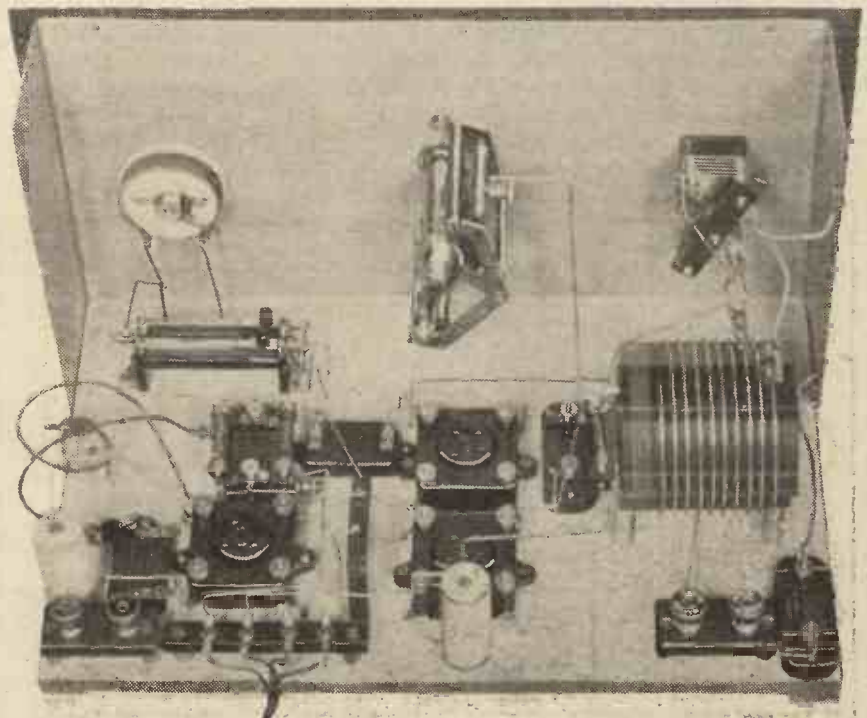

As will be seen from the photograph, the panel is completely shielded to obviate body-capacity effects.

Ordinary H.F. amplification on short waves gives extremely poor results, and for practical purposes is quite valueless.

In the operation of a detector-L.F. short-wave receiver the most important feature is an absolutely smooth control of reaction. Also such small variations of the capacity of the tuning condenser are required for accurate tuning that slow-motion dials are a necessity.

**Circuit Employed**

The receiver described below comprises essentially a detector valve followed by a stage of L.F. amplification. Resistance-capacity coupling between detector and L.F. amplifier was chosen in preference to the more usual transformer coupling because, with the latter, trouble is often experienced with L.F. howling when the set is on the verge of oscillation. This, as many short-wave enthusiasts have learnt by bitter experience, is a most annoying fault, often making reception impossible.

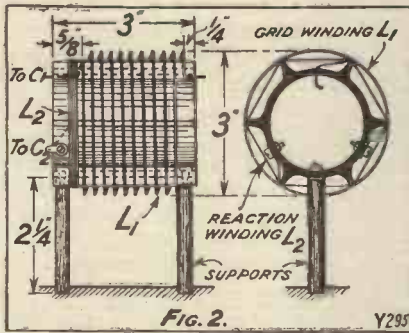

Any tendency towards howling when the set is on the threshold of oscillation either drowns out weak signals or distorts them very badly. The transformer-coupled detector is a

notorious offender in this respect. With R.C. coupling, however, a perfectly quiet background is more

well, so that there is really no question of extravagance in using another valve just for reaction. The separate

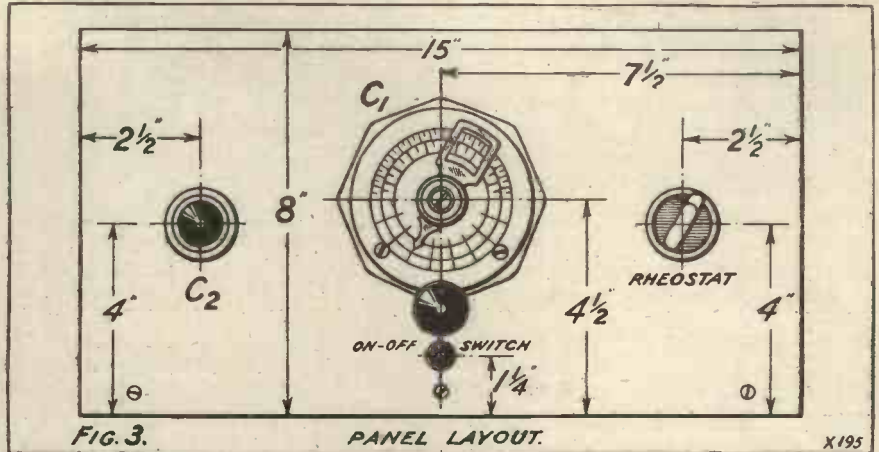

easily obtained when the circuit is brought to the sensitive state just prior to oscillation. By the use of suitable valves and components quite a good degree of amplification is obtainable.

**Separate Reaction Valve**

In this receiver a separate valve is used to supply the reaction effect. There are several advantages accruing from the use of this separate reactor. In the usual regenerative detector there is no one value of grid leak and grid bias which is best for both efficient rectification and smooth reaction, so that a compromise has always to be effected. With a separate reactor, however, detector efficiency can be increased, while it is easy enough to adjust the reactor for smooth reaction control.

This third valve need not be a special type, and most general-purpose valves with low H.T. work quite

reactor, besides giving that smooth control of reaction so indispensable in a short-wave set, makes it possible to use an R.C. coupling between detector and L.F. amplifier. With R.C. coupling and no separate reactor smooth reaction is not easily obtainable from the detector itself.

The theoretical circuit of the receiver is shown in Fig. 1. It will be seen that the tuning circuit  $L_1 C_1$  is common to both detector ( $V_2$ ) and reactor ( $V_1$ ). Reaction is obtained with the usual arrangement of choke ( $Ch_1$ ), series reaction coil ( $L_2$ ) and control condenser ( $C_2$ ). The grid coil  $L_1$  is wound with bare wire so that by means of tapping clips the number of turns in the grid circuit can be adjusted to cover a fairly wide wave-band, a second tapping clip enabling an auto-coupled aerial to be used. The small series condenser  $C$  serves to remove "dead spots" in tuning due to aerial damping. A spare variable condenser may be used externally to the set in place of  $C$  if you want to use up your old components.

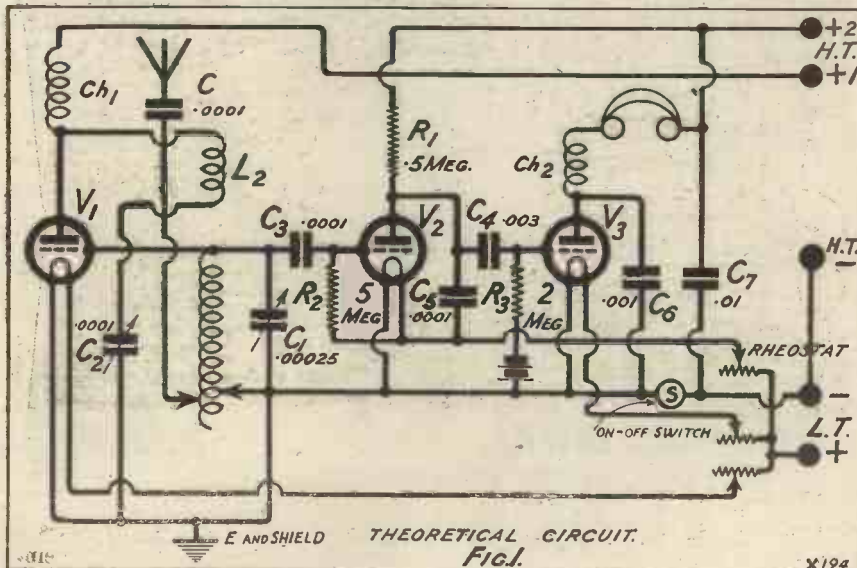

**High Degree of Amplification**

The detector operates as a grid condenser rectifier, a high-mu valve being used in this stage. This, in conjunction with the values specified for  $R_1$ ,  $C_4$ , and  $R_3$ , secures a high degree of amplification. The small-capacity condenser  $C_5$  serves the important function of shunting H.F. currents to earth. The rest of the circuit is quite straightforward, the choke  $Ch_2$  and condensers  $C_6$ ,  $C_7$  helping to eliminate body-capacity effects through the phones.

The question of capacity effects is rather important with short-wave receivers. If proper precautions are

not taken, hand capacity when tuning can be very troublesome, while any movement of the operator's body may cause variations in the tuning. Such troubles are avoided in the pre-

Ormond logarithmic condensers fitted with a slow-motion dial. The logarithmic form of condenser has several advantages from the point of view of spacing of stations and logging.

tinned wire supported on a 3-in. length of ribbed ebonite former. The low-loss design has been chosen more for convenience in making tappings to the coil than for greater efficiency. The coil is fashioned by tightly winding just over eight feet of wire on a cylinder  $2\frac{1}{2}$  inches in diameter. A suitable former having this diameter is an ordinary  $1\frac{1}{2}$ -volt large-size dry cell.

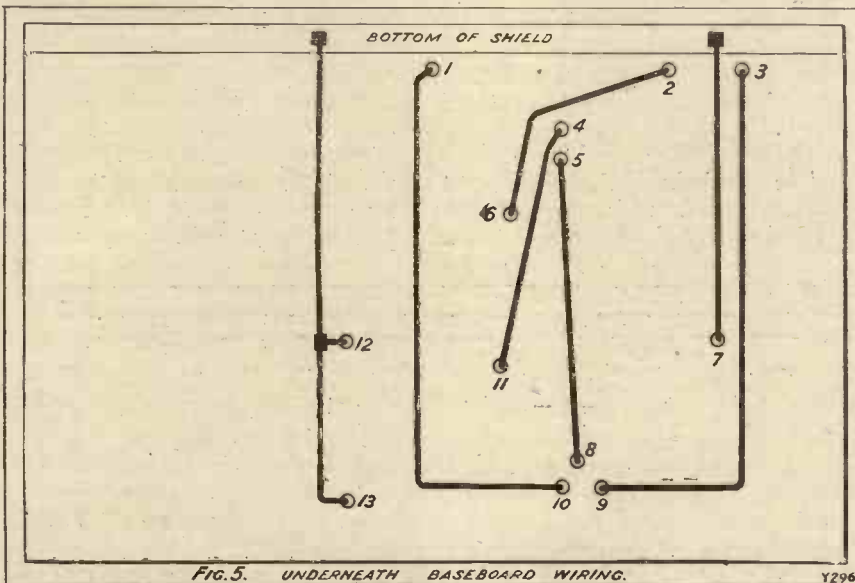

sent receiver by judicious use of metal screening. It would perhaps have been better to have enclosed the whole receiver in a sheet-metal box, but construction would then have been more difficult. The type of screening used here proved very successful, no trouble being experienced from hand capacity when tuning.

Except on the lower wave-length range body-capacity effects were not noticeable. An examination of the photographs will show the form of screening used. A metal sheet is placed against the back of a panel, the ends being bent in so that the receiver itself is partially screened at the sides. This screen, being earthed, also acts as a common busbar for several leads, thus shortening wiring, which is an important consideration in a set of this description.

For example, the screen serves as a common earth connection for each variable condenser and as a common negative filament connection for the on-off switch and parts of the filament wiring.

### The Tuning Control

The tuning condenser and its mechanical motion is also an important consideration in any short-wave receiver for the reasons outlined above. The capacity of this condenser should be less than .0003 mfd., of low-loss design, and fitted with a smooth-working slow-motion control. I have used here one of the new

The type of dial used is entirely satisfactory, while enhancing the appearance of the panel layout.

A slow-motion adjustment on the reaction condenser is not necessary, and practically any type of small-capacity condenser can be used here.

### Home-made Coils

When making up a short-wave receiver there are certain components which it is not usually necessary to buy. The components to be made up for this set are the short-wave coil, and two H.F. chokes. All these are of simple and easy construction.

### The H.F. Chokes

The coil is then removed, and gently eased on to the ebonite former, the ends being passed through holes drilled in the wall of the tube and then bent over inside. The turns are then spaced out equidistantly. The reaction winding consists of six turns of 42 D.S.C. wire wound on in the same direction as the bare wire coil, a distance of  $\frac{1}{4}$  inch separating the two.

The ends of this winding are secured to soldering tags bolted to the wall of the former, as in Fig. 2. The end of this winding nearest the grid end of the bare-wire coil goes to the anode of the reactor valve. The completed former is secured to the two wooden supports and the coil is then ready for mounting. When setting out the baseboard two blind holes  $\frac{3}{8}$  in. diameter and about  $\frac{1}{4}$  in. deep are drilled in the baseboard where the coil supports will come when mounted in position. The wooden legs are then fitted into these holes, a little Seccotine helping to make a thoroughly firm support for the coil.

Each H.F. choke consists of a simple single layer of No. 42 D.S.C. wire tightly wound on a 2-in.

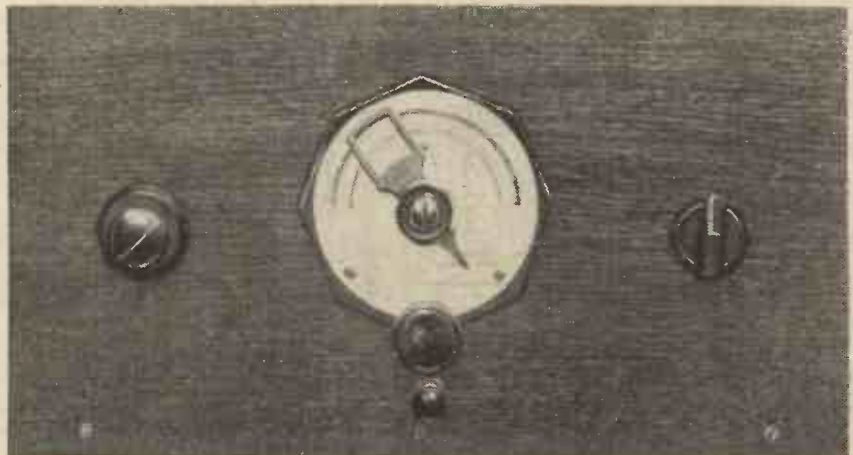

The panel contains the reaction control, tuning control, filament rheostat for detector valve and a filament on-off switch.

The design of the short-wave coil is shown in Fig. 2. It comprises a bare-wire coil, 10 turns of 18 S.W.G.

length of birch dowel,  $\frac{7}{8}$  in. in diameter. The winding occupies a length of  $1\frac{3}{4}$  inches, one end being

soldered to a small tag screwed to the top of one end of the former, the other end of the wire being anchored to a small screw driven in at the side of the former quite near its other end. These two chokes are identical in all respects. When mounting them a hole is drilled in the baseboard and the chokes screwed down from underneath by a  $\frac{3}{8}$ -in. brass screw.

A suitable material for the baseboard is a piece of six-ply measuring 14 by 9 inches. To the underside of this are screwed two battens  $\frac{1}{4}$  in.

thick. As no insulating properties are necessary in this panel there is no need to use a piece of ebonite. I have used here a piece of oak-faced three-ply, which, when coloured and polished, looks quite well. In combination with the metal shield the rigidity of the panel is even greater than that of an ebonite one, while the cost of construction is much reduced.

**Wooden Panel**

The panel should first be cut out, coloured, and polished. A good finish is obtained after rubbing down

with fine sandpaper by merely painting with some dark spirit stain. The metal screen is then fashioned and screwed to the rear side of the wooden panel. Holes can then be drilled through both in the correct alignment in one operation.

The metal screen can be either copper, aluminium or zinc sheet. I have used the latter material for this receiver, as it is readily obtainable and easy to work. The zinc sheet, which need only be about  $\frac{1}{32}$  in. thick, measures 20 by  $7\frac{3}{4}$  in. The side-pieces, bent at right angles, are 3 in.

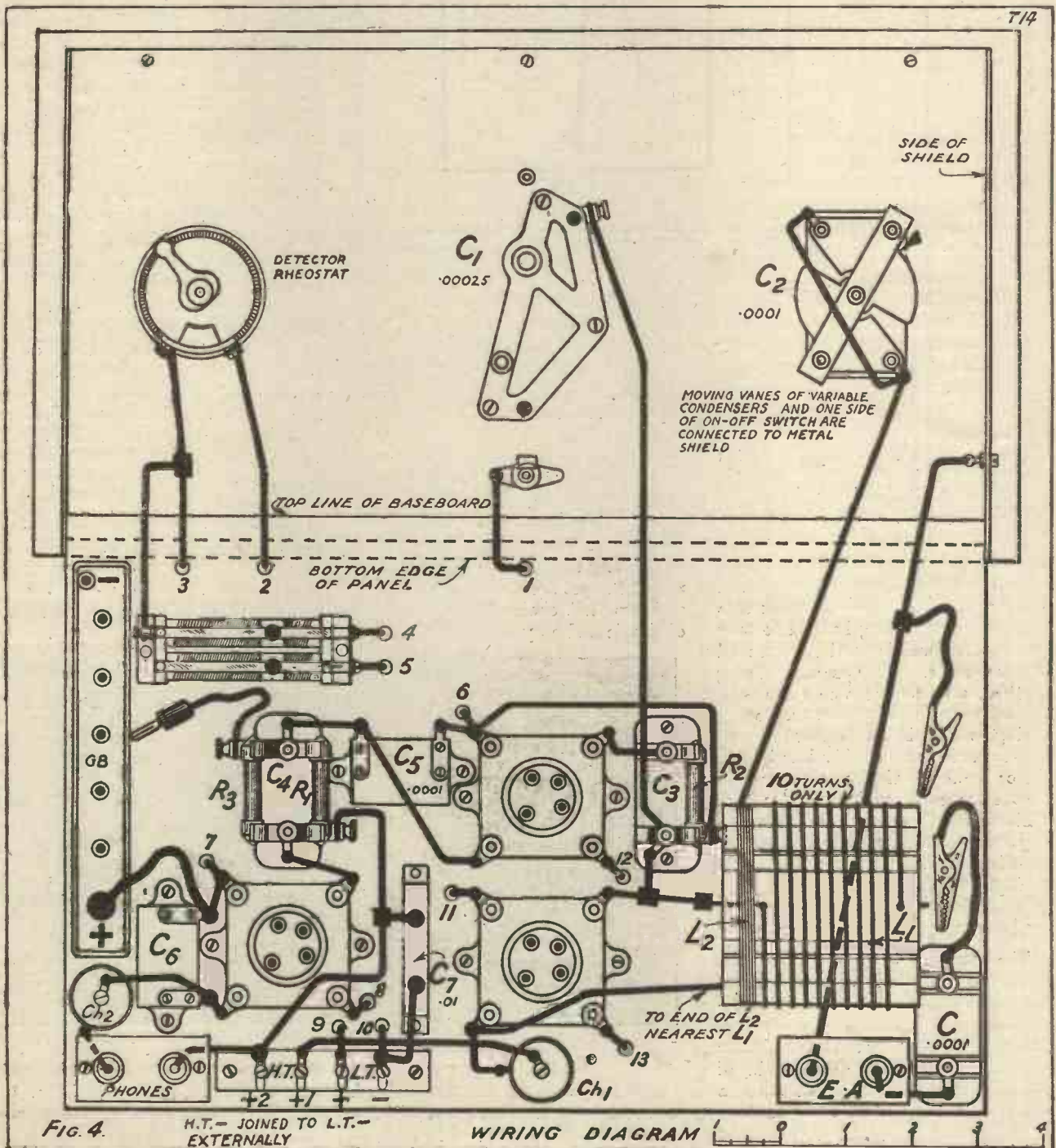

FIG. 4.

H.T. - JOINED TO L.T. - EXTERNALLY

WIRING DIAGRAM

long, a small hole being drilled in each at the bottom, so that they can later be screwed to the baseboard. These sidepieces also maintain the front panel rigidly at right angles with the baseboard.

### Mounting Components

Having drilled in the shield-cum-wood the necessary holes, as shown in Fig. 3, the panel can be screwed to the baseboard. When mounting the panel components, see that only the rotor of each variable condenser makes contact with the metal screen. The particular rheostat used here is so made that none of its working parts comes in contact with the panel. A  $\frac{3}{8}$ -in. hole should be drilled in the panel, so that the spindle clears the metal shield. If any other rheostat is used, care must be taken to insulate its working parts from the metal screen.

For the baseboard components practically any reliable makes can be used, provided they conform to the same specifications and approximately similar dimensions.

The mounting of components is quite straightforward. Notice that the four terminals and the four battery contacts are mounted on strips of ebonite screwed to the baseboard on little pillars of ebonite tube or wood rod. On the fixed condenser,  $C_1$ , a grid-leak clip and a Dumetohm insulated clip are mounted on each terminal in opposite positions. This makes a handy and com-

pact holder for the resistances  $R_1$  and  $R_3$ .

In the original receiver, the filament wiring is almost entirely carried out underneath the baseboard. Fig. 4 shows the main wiring, and Fig. 5 the under-baseboard wiring, the holes in the baseboard connecting the two being given the same numbers in both diagrams. If the filament wiring is carried out as shown in Fig. 5, bare wire can be used, as no leads cross at any point. It is advisable to carry out this part of the wiring first. Notice that the lead to the on-off switch is soldered to the insulated tag, and the lead from the earth terminal to a tag bolted to the earth screen, or simply soldered thereto.

### Preliminary Tests

The two clips making contact with the tuning coil are well soldered to short flexible leads, the aerial contact being joined to the free side of the series aerial condenser C. Two other flexible leads terminating in wander plugs are required for making connections to the  $4\frac{1}{2}$ -volt grid-bias battery.

When wiring-up has finished, and the usual tests made for correct connection of filament and H.T. leads, the receiver can be set up for testing. This is best done before placing the receiver in its cabinet.

The first thing to do is to test the reaction control, and for this the aerial clip should not be connected

to the coil. The earth clip is connected to about six or seven turns from the grid end and, with all valves turned on, the filament and anode voltages of the reactor valve are adjusted until reaction control is quite smooth. Reaction control should then be even and smooth with the earth clip on ten down to four turns.

### Choosing the Valves

With general-purpose valves in the reactor-stage filament current should be fairly generous, H.T. about 50, reducing if backlash is noticeable until this ceases. It should be quite an easy matter to obtain perfectly smooth reaction control without which successful reception will be difficult, if not impossible. When the original receiver was being tested the reactor passed into oscillation so smoothly that the transition from quiescence to oscillation was imperceptible. If the reaction condenser is rotated quickly, of course, a slight "plonk" is heard, but if rotated slowly the circuit should pass into oscillation without any such sound.

If several valves are available, they should be tried out in turn in the reactor stage until one is found giving the best results with the reaction control. While practically any general-purpose valve will do, there is often one in the stock that will function best. If you are buying valves for this receiver, the very best type for this stage is one having an impedance of about 20,000 ohms and a magnification factor of 15 to 20. If, after making proper adjustments, backlash should still be noticeable, due perhaps to an unsatisfactory type of reactor valve, a cure can nearly always be effected.

### Improving Reaction

Disconnect the lead of the detector grid leak from L.T. + and connect it by a flex lead to the bias battery. This changes the detector into an anode-bend rectifier with some slight loss of sensitivity. A small bias of zero or 1.5 volts negative will then make reaction control quite smooth, should other adjustments not have been successful, especially with low-impedance valves.

The detector should be a high-magnification valve, the L.F. amplifier being any first or second L.F. stage type, or even a good general-purpose valve. With this third valve, grid bias can be increased slightly beyond the normal value, thus reducing the H.T. current drain without sacrificing signal strength.

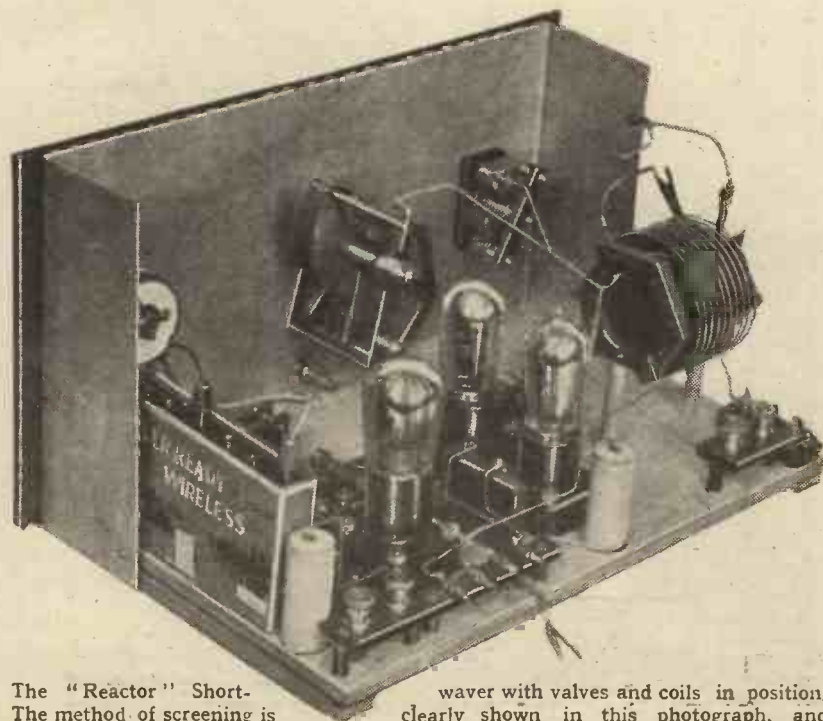

The "Reactor" Short-wave receiver. The method of screening is clearly shown in this photograph, and should be followed as closely as possible when constructing the set.

waver with valves and coils in position. clearly shown in this photograph, and should be followed as closely as possible when constructing the set.

It will be noticed that the setting of the detector rheostat has an effect on reaction. Thus with the set just oscillating an increase or decrease in the detector filament current will decrease or increase respectively the degree of reaction. This provides an additional fine control of reaction, very useful at times. The filament current for the detector can be reduced somewhat below normal without decreasing signal strength because this type of valve with resistance-capacity coupling actually works better with slightly less than the normal filament current.

**Preliminary Tests**

When the valve adjustments have been made, preliminary reception tests can be undertaken. It is a good idea to practice tuning-in the many commercial C.W. transmissions with the set just oscillating. These Morse signals can be heard at practically any time of the day, a good number being receivable without any aerial. These tests will demonstrate the fineness of tuning necessary on short wave-lengths, a fraction of a degree being sufficient to pass over a station. When you come to searching for telephony, you will realise the necessity for varying the tuning condenser very slowly, otherwise it is easy enough to miss the station you are after.

For wave-lengths below 50 metres the earth clip is connected to some point along the coil and the aerial clip to a point one or two turns farther on nearer the free end, the best tapping for the aerial clip being found by experiment. The shorter the wave-length, the smaller the number of turns required between the aerial and earth clips. For wave-lengths above 50 metres the earth clip is connected to the extreme free end and the aerial clip to a point one or two turns up from the earth-clip.

**American Stations**

The 45-metre amateur transmissions are found between 70 and 90 degrees, the earth clip being on the ninth turn and the aerial clip on the tenth. When searching for these transmissions you should be careful to decrease reaction beyond the point of oscillation as quickly as possible after finding a carrier-wave, otherwise you may interfere with the reception of these signals by the man who is conducting tests with the transmitter. The phenomenon of skip distance on short waves is often noticed, amateurs in Scotland being received in London much louder than transmissions on

the same power from nearer stations.

Of the American stations, 2 X A D (22.02 metres) is, perhaps, the most popular, and when it is putting out a transmission this station has been received very strongly in the evening about 9 o'clock, G.M.T. This station is tuned-in at about 16 degrees with the earth clip on five turns counted from the grid end, and the aerial clip about one turn lower, the best point for this clip being found by experiment.

With the earth clip on six turns other American stations which have been received are 2 X A F (32.77 metres) on about 32 degrees, and a harmonic of K D K A on approximately 80 degrees. The aerial tap in each case will be between one and two turns lower, one turn being required if perchance the set will not oscillate with two turns. The 63.6-metre transmission from K D K A is found with the tuning condenser set to about 120 degrees, the earth clip being on the extreme end of the coil, and the aerial clip one or two turns up.

At times one can pick up telephony transmissions of an experimental nature from Continental stations, while the number of C.W. Morse transmissions is legion. These are of great interest if you know the code.

When using a short-wave receiver it is of great practical interest to notice the relative strengths of atmospherics on different wave-lengths. I have experienced conditions when reception on wave-lengths above 35 metres was almost

impossible owing to heavy static, while below about 30 metres interference from atmospherics was almost negligible. "Home-made" atmospherics can also ruin the reception of weak signals if the H.T. battery is an old stager. Therefore, you should use a fairly new H.T. battery for short-wave work, as this will give you a nice silent background.

**SPADE CONNECTIONS**

SIR,—So much has been said about how to prevent flex from fraying that I feel I ought also have a say without offending anyone. I have just been over an article "Fixing Flex Leads"

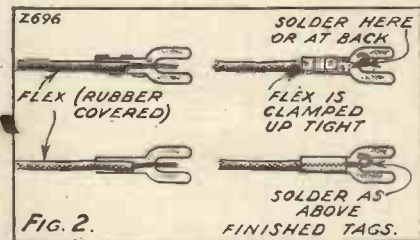

in a recent issue of your paper, and it seems to have lost the easy way.

We will take the usual small stamping. My method of fixing is shown above, and it saves lots of golf language!

W. H. A.



Mr. Mayer, the well-known Essex amateur, with his apparatus. The call sign of Mr. Mayer's station is G 2 L Z.

# Further Valve Developments

Several striking departures in valve design have been announced during the past month and are discussed below

By KEITH D. ROGERS.



WITH the end of the Radio Show constructors are once more settling down to a season's set building. A multitude of new things has been set before them and the "season" now opening holds more promise than any of its predecessors.

But the show did not put all the new developments before us. Some were not ready in time and many more will probably make their appearance during the next few months.

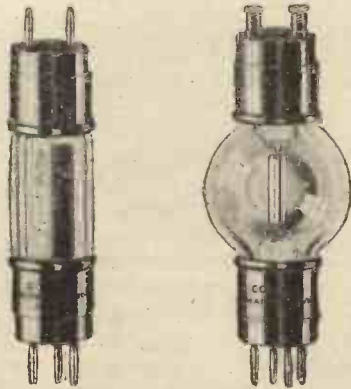

The Cossor screened valve and the new Cossor A.C. valve. This latter has two terminals on the top for connection to the mains supply unit.

Among the new valves which were hinted at during the show (some few models indeed were on view), but which are not yet released, are the screened-grid valves made by Mullards, B.T.-H., and those being turned out by A.C. Cossor, Ltd.

## Different Mounting Scheme

In the former case, I have only been able to obtain a couple for inspection and test, and up to the time of writing have been unable to

give them a thorough test. They are unlike the S.625 type of valve made by Marconi and Osram, in that they employ a greater degree of shielding, and the second grid, the shield, instead of being brought out to a pin at the opposite end of the valve to the main grid, is brought to a pin exactly corresponding to the anode pin of the ordinary three-electrode valve. So we have the valve base the same to look at as the ordinary three-electrode, the grid and filament pins are the same with the "anode" pin making connection with the screening grid. The true anode is taken to a little terminal at the far end of the valve, which is somewhat like the Loewe multiple valve in dimensions, though it is not quite so fat.

The characteristics of the Mullard screened valve are different from those of the S.625 in that the filament consumption of the 6-volter is .075 amp. and the impedance is 275,000 ohms, or thereabouts. The magnification factor is given as 200—a wonderfully high figure.

From the point of view of the constructor, however, I cannot so far see any advantage in making the valve of the four-pin type—to be mounted in an ordinary holder, for, if easy and adequate screening is to be adopted the valve will have to be horizontal. If mounted vertically the screening will be rendered much more difficult. Furthermore, the arrangement of the pins makes it difficult to be changed for either the Marconi, Osram or Cossor types without alteration in the wiring. Why the makers have branched off on their own, so to speak, I fail to see, unless some patent problems confront them. If it were a choice between their valves and one other make, each being different and requiring different mounting, it might be argued that once you have started with Mullards you'll keep to that type. But, if one can build a

set and use certain mountings and then have a choice of at least three makes of valves as against one only of another make, I know which type of mounting I would use. If it is not too late, I should feel inclined to reconsider that design if I were the firm concerned. It seems a pity to cramp what appears to be an excellent valve by making it different from all the rest as regards its "housing" requirements. I have a shrewd idea that that was why the old Myers valve failed to "take on" in the old days. Standardisation in wireless is difficult, but one should, in my opinion, have as much as possible.

## New B.T.-H. Valves

The B.T.-H. screened valve is of different internal design, and employs a 4-pin base with extra terminal for the fourth electrode. As yet it is not on the market, and I understand no release date is fixed. It will have the peculiar filament characteristics of 1 volt and .1 amp. The other characteristics and reasons for the unusual filament voltage chosen are not yet to hand.

The new Cosmos AC/R (red spot) A.C. mains valve. It employs the well-known short-path construction and a special adaptor is supplied to enable it to be used in any circuit



Other new B.T.-H. valves include the B.12, a "Rice-Kellogg" super-power valve not yet on the open market. This was designed for use with the coil-driven loud speaker, and is a

king among super-power valves. It also has an unusual filament voltage (7.5) and takes 1.2 amps. It is designed for operation from the mains, but is not of the indirectly heated cathode type.

Those using A.C. H.T. eliminators will welcome the B.T.-H. R.H.1, a really good half-wave rectifier, giving a D.C. load of 65 m.a. with an A.C. anode potential of 550 volts.

### The Cossor "S" Series

The Cossor people have sent me a few "advance copies" of their screened valve which follows a similar design (externally) to that of the Marconi and Osram valve. Its characteristics are different and it employs the kalenised filament, having a consumption of .1 amp. Both 2- and 6-volters are to be made. Impedance = 120,000 ohms in each case, while the 2-volter has a mag. of 60 and the 6-volter one of 100.

On the face of it, this valve should be quite useful, its mutual conductance is not high, but it should work quite well. It costs 22s. 6d. More of this and the Mullard valves when I have given them thorough tests.

Apparently, on raising the H.T., a secondary emission is liable to take place, and this can only be obviated by careful alteration of bias. This adjustment must be carried out with the H.T. off, or the secondary emission will start while the grid plug is being moved from one tapping to another. As a matter of interest the milliammeter reads, normally, about 10 milliamps, but when the "fireworks" begin it goes over to over 100 m.a. For normal operation the valve is quite good. It will not stand much input; up to five volts either way is the maximum. It is not a super-power valve and has a steep slope. But its magnification factor enables beefy signals to be obtained with a moderate input. In the experiments being discussed, four valves were used in parallel in an endeavour to obtain sufficient power to operate a Rice-Kellogg speaker really well. All valves were inclined to blue glow even at moderate anode pressures, but this was not serious until the voltage reached 200, when careful watching was necessary to see that this peculiar secondary emission, or so I put it down to be, did not take place.

plug them in, short the L.T.+ and L.T.- terminals on the set and connect the output of the special A.C. mains unit supplied by Cossors to the terminals on the tops of the valves. The mains unit costs 45s. and has tapings so that the correct current and pressure is given for any number of valves. These valves should be really useful and I like the idea of the "interchangeableness," for it means that none of the components, such as L.F. anode resistance or transformer, needs to be altered to match the valve impedances when a change over from battery to mains is effected. If the valves act up to their characteristics they should have a ready sale. As yet I have not been able to test them and at the time of writing they are not available to the public.

### Two-Volt "Supers"

Following on the heels of the Mullard 252 super-power 2-volter come the Marconi and the Osram D.E.P.240. These are good little valves (price 20s.), and are really useful super-powers. They will handle about 10-12 volts either way, quite a useful voltage. The characteristics are:

Fil. volts. . . . .	2
Fil. amp. . . . .	0.4
Anode volts. . . . .	120 (max.)
Amp. fac. . . . .	3.5
Impedance . . . . .	3,000

Thus the valve has a mutual conductance of 1.16—a very creditable figure.

The valve should sell well, for it certainly is an advance and is a very useful addition to the "stable" of 2-volters. It is claimed that this new valve, with a W filament, has the largest emission surface of any 2-volt valve. It is unnecessary to say any more, except that I can recommend it without reservation to all who require good volume with purity on 2-volters.

Another very interesting valve is the new Ediswan—which has been developed in connection with a new receiver placed on the market by that firm. The valve has two grids and two plates, with a single filament. It will thus act as a detector and 1 L.F. valve, for which purpose it is used in the receiver mentioned. The circuit employed makes use of a high-value anode resistance, and a useful loud-speaker range is claimed with the circuit employed. Reinartz reaction on the aerial is employed, though the set is said not to cause interference.

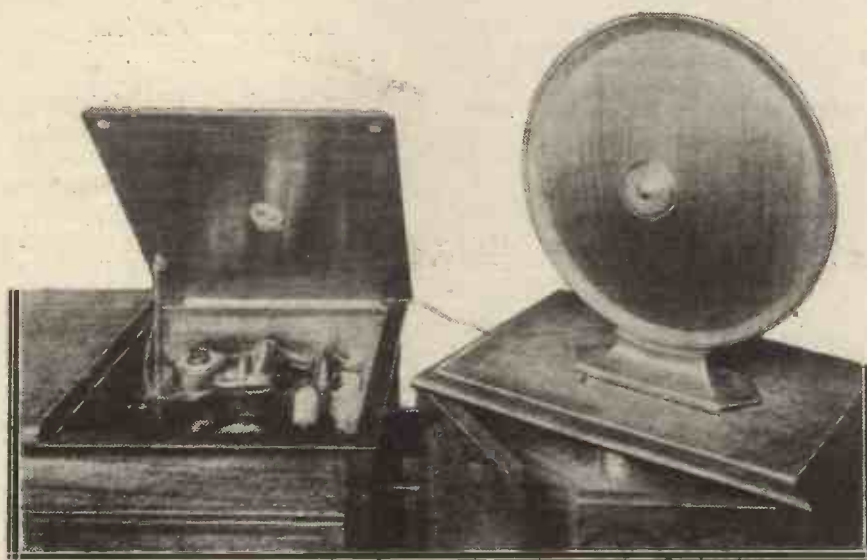

The gramophone "pick-up" is becoming exceedingly popular in this country and owners of receivers with efficient loudspeakers and good L.F. amplifiers will find that the use of a pick-up with their gramophone makes all the difference in the tonal quality of the reproduction from that instrument.

Talking about thorough tests, I have been very interested in the antics some A.C. valves have been playing.

These valves behave quite well if moderate H.T. is used, say, 160 volts, and plenty of grid bias, but if you raise the H.T. and do not carefully rearrange the grid bias all sorts of things happen. Above 220 volts H.T. these things occur with extreme suddenness.

By the way, the Cossor A.C. valve range is quite different from those of other manufacturers. It is so arranged that the valves shall be quite interchangeable with ordinary existing types of Cossor valves. Thus four A.C. valves are to be marketed: H.F., Det. and L.F., R.C., and Super-power, having the same characteristics as the 6-volt Cossor valves of those types.

The A.C. valves can be placed in any set. All that has to be done is to





*Unless one has supply mains available there is no practical solution to the problem of L.T. battery elimination, but considerable economies can generally be effected in the charging and maintenance of the necessary accumulators.*

*By G. V. DOWDING, Grad. I.E.E.  
(Technical Editor.)*

A GREAT deal has been said about the elimination of H.T., but in these days it is probable that people having D.C. mains would much rather be able to eliminate the L.T. battery. Units for deriving "H.T." current from D.C. mains can be perfectly satisfactory. A scientifically

freedom from "background" when the mains are "tapped" for H.T., even with the majority of commercial units. My own local mains are very "rough." They carry a so-called D.C. of 150 volts and a whole horde of audio and H.F. frequencies, gathered, I should imagine, from every corner of the earth! But by adding a couple of H.F. chokes to a unit something on the lines of the one mentioned above, it is possible to filter out all the electrical "dross," and a very decent H.T. supply becomes available.

one's requirements and from which one can extract a full evening's enjoyment. It is a simple matter to do this with the "Super-Screen."

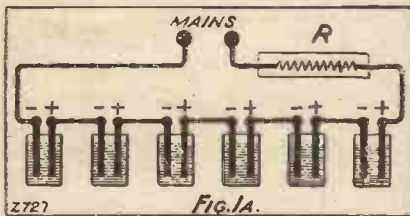

designed unit of the nature of the one described elsewhere in this issue, using first-class chokes, etc., is almost as silent as an accumulator H.T. supply and is much cheaper to maintain. Also, once put into service, such a unit is practically everlasting and will continue to deliver a smooth current just as long as the power station which supplies the local "juice" keeps on working.

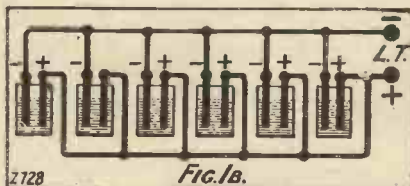

Mains units of earlier days, with their inefficient chokes, crude designs and current limitations, were worse than cheap dry batteries, but it is now possible to obtain an absolute

**Slight Voltage Drop**

One has to drop a few volts, but I find 120 or so quite sufficient for a first-class household set. It will be appreciated that while I have to do quite a lot of experimenting at home, there are people in the house who desire to listen to the programmes of the various broadcasting stations now and then. For them is arranged the so-called household set.

**The "Household" Equipment**

My "household" set varies from time to time; at present it is the "Super-Screen" Four, which is ideal for the purpose. Of such a receiver I demand that it shall tune in at least four stations moderately free from that horrible background of Morse and static at full loud-speaker strength. To do this, the set should be capable of smoothly tuning in quite loudly at least thirty stations. One can then roam round the ether when one feels so inclined and choose from the many radio babblings a quartet which fulfils

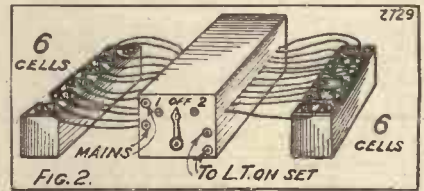

Six of the rooms in my house are fitted with loud speakers. I had wires "built-in" as the various rooms were decorated. A switchboard in my study enables me to switch on any one or more of these speakers. Two of the speakers are "Cones" and one is a



A 6-volt accumulator can be charged in its normal form and its cells connected in parallel for running 2-volt valves.

"coil-driven" "Cone." For some time I had been using accumulators to supply the H.T. for this "household" system as I had my doubts as to whether or not the various sets which from time to time were placed in use would work properly with any other form of H.T. supply.

Not only had I to cater for super-power valves with their heavy anode consumptions, but also for different types of H.F. circuits. But, gradually, we have been able to make our receivers more or less independent of their battery supplies by the use of efficient "by-passing," and our H.T. units can now be made to operate efficiently with any existing type of set, even including one using the new shielded-grid valve.

### Satisfactory H.T.

And so my "household" set now derives its H.T. from the mains and loses none of its stability or its D.X. qualities in so doing. But there remains the L.T. One cannot design a D.C. unit that will supply smooth L.T. current for any sort of set using any sort of combination of valves, so for the L.T. I have to use accumulators. But I was left with two first-class 120-volt H.T. accumulators on my hands additionally to those set aside for laboratory work. And as I sorrow-

for charging, I would have a very cheap source of L.T. supply available.

### A 60-Cell Six-Volter!

When one charges a 6-volt accumulator of 20 ampere hours capacity, one requires about two amperes of current, and this from 150-volt mains means 300 watts. Now, each of the cells of those two H.T. accumulator batteries has a capacity of 1 actual ampere hour. Grouping the 60 cells of one battery into three paralleled banks of 20 cells each, and placing these banks in series, gives one the equivalent of a 6-volt battery of 20 actual ampere hours capacity—enough to run a multi-valver for some time, using modern economical dull-emitters.

With the 60 cells in series the charging would only have to be at the rate of about 100 milliamps, and only 15 watts of electrical power would be consumed. Home charging would then become quite a practical proposition in the case of D.C. mains. And with one battery on charge and the other in service one could have L.T. for as long as the cells lasted for much less than the cost of running one electric light.

But there is a snag quite apart from the initial expense of the batteries were they to be bought for

would quite automatically switch one set of cells on to the receiver in the 6-volt form, and at the same time switch the other set on to the mains in series for charging, and reverse the condition whenever necessary. But anyone could see right away that

A large 2-volt accumulator is not necessarily as economical to use for running 2-volt valves as a 6-volt battery with its cells connected in parallel.

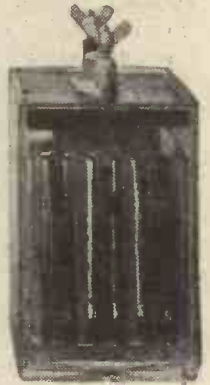

this would be no ordinary switch. It is asking far too much for any simple arrangement of studs and contacts. There is, of course, no really practical solution to the problem, and the scheme I am going to outline will be of purely theoretical interest to my readers—or, at least, to the majority of them.

### The Switch Required

It is not a difficult task to design a switch which would take about two months to make and about a month to wire up!

Let me outline what has to be done. The mains have to be connected to one pair of terminals on the switch and the receiver to another pair. The sixty cells of the one H.T. battery would have to be connected to sixty more pairs of terminals, and, similarly, the other sixty cells joined to the switch. A control arm would have to move to three positions. One, an "off" position, at which nothing at all is going on, and both the mains and the batteries are entirely disconnected; and the two remaining positions would each place one set of cells in series with the mains and a charging resistance, and the other set of cells in a 6-volt "hook-up" in series with the L.T. system of the receiver.

### Very Complicated

Thus one group of cells would always be on charge while the other was in use. Sounds quite simple, does it not? And it can be done, but, as far as I can see, only by the most complicated switching. Let me take two groups of six cells which are only required to be either in series or

(Continued on page 534.)

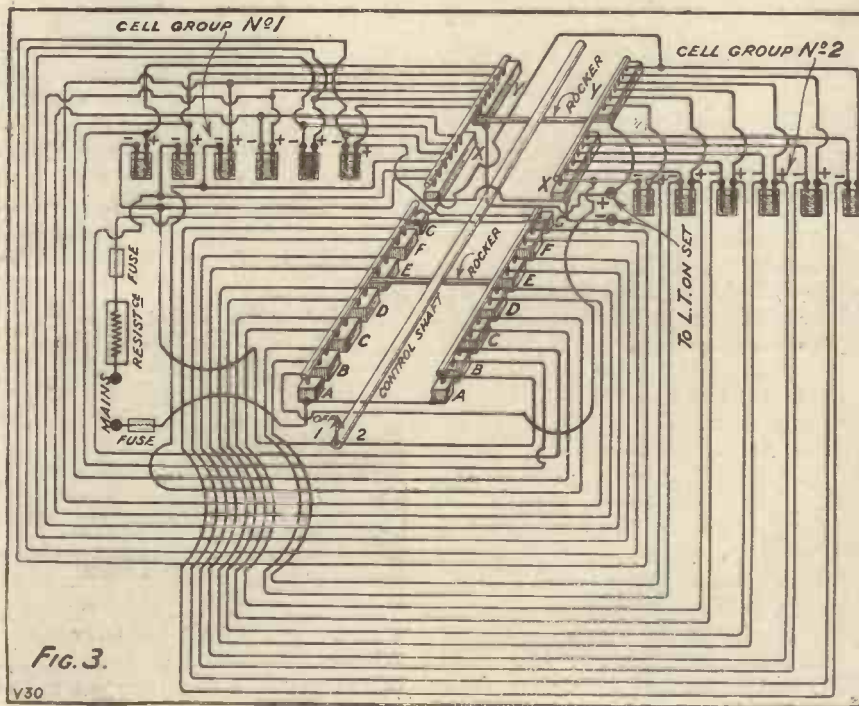
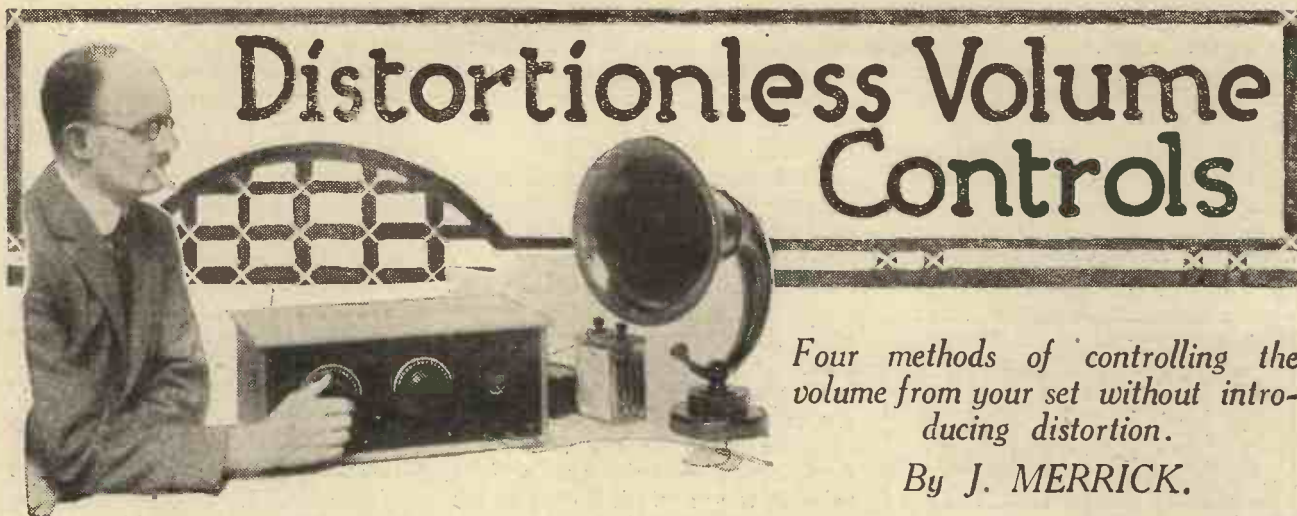

FIG. 3.

fully contemplated them one evening, the thought occurred to me that could each be grouped into a 6-volt series-parallel arrangement for supplying L.T., and re-grouped into a straightforward series arrangement

the purpose. And this is the re-shuffling of the connections of all the cells subsequent to every change-over. A very tedious task indeed, and one that would try the patience of anyone.

What is required is a switch that



# Distortionless Volume Controls

Four methods of controlling the volume from your set without introducing distortion.

By J. MERRICK.

THE tendency nowadays is to install in the home a really powerful broadcast receiver giving good quality. Frequently it happens that only occasionally during an evening's reception is the whole of the output used in order to take

is altering the anode voltage. Sometimes it is recommended to join a variable resistance across one of the intervalve transformers, but this method, although having the advantages of simplicity and cheapness, is not always productive of the best results.

I illustrate four sound methods, all of which have been used at one time or another by the writer. The first is applicable to a resistance amplifier. A tapped anode resistance is connected as indicated in Fig. 1, and the grid circuit of valve  $V_2$  is joined to it through a switch arm which passes over the contacts connected to the tapings. This is a simple volume control, and tapped wire-wound resistances are readily obtained.

### Tapped Grid Leak

In Fig. 2 we show a choke-coupled stage which is similar to the resistance stage of Fig. 1, the choke taking the place of the anode resistance, of course. Good-quality choke coils already provided with four or five tapings can be purchased.

As a variation we have in Fig. 3 a tapped grid leak. This is also wire wound, and as it may have a relatively high capacity as compared with a normal grid leak, it is advisable to use a low value with a correspondingly large coupling condenser. A shunting grid leak may be used, as shown in the diagram, to reduce the loudness of the clicks produced when the switch arm passes from stud to stud.

Several ordinary grid leaks may be connected in series when these are available, and the studs of the tapping switch connected to the connections between each pair of grid leaks. If these have equal resistance values

the voltage drop across each is identical, but when they have different values the voltage drop across one will depend upon its value as com-

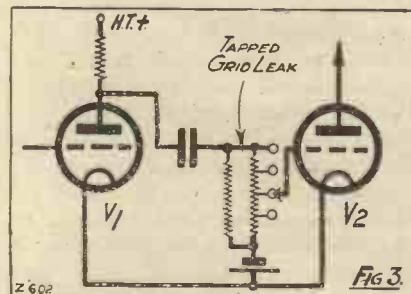
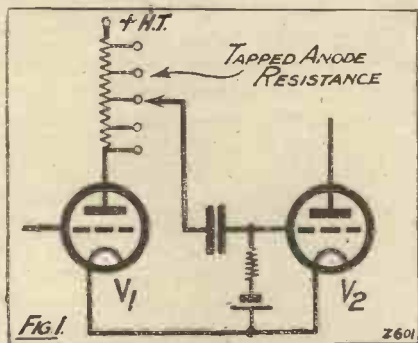

full advantage of a particular item which makes a special appeal. At other times it is preferred to receive quite softly, without altering the tonal qualities of the reception. Occasionally the loud speaker may be taken to a different room from that customarily used, when, without a doubt, a different output from the receiver will be required in order to raise the volume of sound to the desired level.

Clearly some simple volume control is required. Dimming the filaments

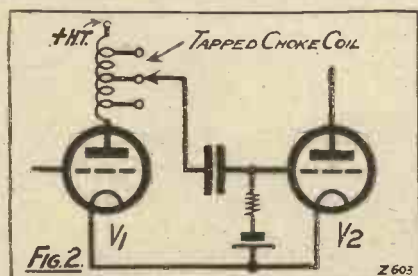

of low-frequency amplifying valves is strongly to be condemned, and so



A tapped L.F. transformer which enables a number of different impedances to be obtained.

The final arrangement, which is illustrated in Fig. 4, is the tapped transformer. These are obtainable complete with a tapping switch, and provide a ready means for varying the volume without materially affecting the quality. Transformers having a tapped primary are not recommended, because when the amount of the primary winding connected to the anode of the valve is varied the

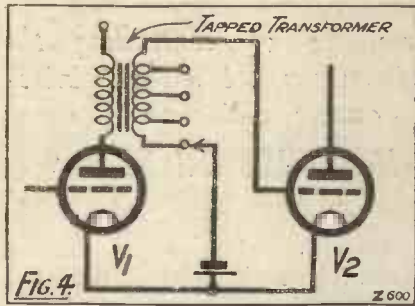

quality changes because of the different primary impedance of the transformer.

In all methods described, the fraction of the full voltage passed to the grid of the next valve is practically proportional to the position of the tapping. Thus, if the anode resistance, grid leak, or choke, is tapped at its mid-point, one half of the full voltage will be delivered to the next grid, and so on.

We have, of course, to bear in mind that when a portion of the full voltage is used, the capacity of the next valve is connected across a portion of the circuit instead of the whole circuit as when the full volume is used. But this is not likely to have the slightest effect on the faithfulness of the amplification, and need not worry us very much.

\*\*\*\*\*  
**WAVELENGTHS—KILO-**  
**CYCLES—OCTAVES**  
 \*\*\*\*\*

As with other new arrivals with adoring parents, there is much argument about the name wireless waves shall bear, or, to be more exact, the way in which they are to be designated.

Ether shakers of the old school have a sentimental hankering after the old pet name, wave-length. The younger uncles want kilocycles; and now other relatives, musically inclined, have thought of octaves.

Why octaves, you ask? Is this the encroachment of the musical atmosphere on the engineering mind due to broadcasting?

First of all, what exactly is meant by wave-length, kilocycle, and octave?

To tell again the old, old story—a wireless wave, like a sound or water wave, consists of a series of ripples or pulses moving along one after another, and the wave-length is the distance from the crest of one wave to the crest of another measured in a straight line. Thus the wave-length of 361.4 metres, which is the wave-length of the London station, means that the distance between each succeeding wave-crest is 361.4 metres.

That portion of the wave between one crest and the next crest is one complete wave or cycle, and the number of these which pass a given point in one second is known as the frequency. Thus London's transmitter has a frequency of 830,000 cycles. A kilocycle is, of course, 1,000 cycles; thus, London's frequency is 830 kilocycles. Actually, the kilocycle is the unit of frequency, just as the metre is the unit of wave-length.

**Octave Measurements**

An octave is a musical term to express all the waves between one given frequency and a frequency twice as great. If the lowest note of the piano has a frequency of 50 cycles, the first octave consists of the notes ranging between 50 and 100 cycles; the second octave between 100 and 200 cycles, and so on. A full compass piano has usually seven octaves.

If we take round figures and say that wireless waves occupy a band of wave-lengths from 100 metres to 10,000 metres, this is expressed in frequency as from 3,000 kilocycles to 30 kilocycles or musically covering 6-7 octaves.

Now it is suggested that the beginning of a series of octaves be set by mutual agreement at 1 cycle a second. And if each octave above this be numbered in sequence, a wireless wave of, say, 600 metres or 500 kilocycles will occur at the beginning of the 9th octave and will be designated as 18-932 octaves, while a wave-length of 5 metres will occur on the 25th octave.

**Extremely High Frequencies**

It is claimed that all the waves from Gamma rays, X-rays, light and heat, short electric, radio waves and sound waves could be measured by the same unit more conveniently than at the moment.

For instance, heat, light, X-rays and Gamma rays are measured in Angstrom units, the frequency of gamma rays running into millions of kilo-

cycles; while to express the wave-lengths of these rays in metres requires a host of nothings before the 1.

Whereas, if octaves were used, the figures of all waves would be more reasonable. In radio, calculation with regard to modulation would be easier, and the relation between waves with regard to harmonics and interference would be more easily discernible.

\*\*\*\*\*  
**A PANEL-MARKING**  
**HINT**  
 By C. A. J.  
 \*\*\*\*\*

MARKING out a panel is not at all a difficult operation, but it is one which nevertheless needs a certain amount of care and attention.

A pair of odd-leg calipers, having one curved and one straight leg, with the straight leg ground to a point, will prove by far the best means of marking out any panel, whatever the size or surface. There will be no unsightly marks left to disfigure the panel, and at the same time there should be no difficulty experienced in handling the calipers.

Suppose, for example, that on a line three inches from the top of the panel there are to be two holes for the variable condensers, and the holes are to be three inches from either edge. Open the legs of the calipers until the distance between the points is three inches, checking them against the rule; place the point of the curved leg against the top edge of the panel with the point of the straight leg swung over the face.

**Easily Accomplished**

Hold the rule on the panel, a little lower than the point of the calipers, and then make a short line, about three inches in from the edge. Repeat this at the other edge; then from either edge strike across these short lines at right angles. As the calipers were set at three inches the point at which the lines cross will be the centre for the hole to be drilled. Should the distances be more or less than the measurements stated, which are only intended as an illustration, the different measurements should be read instead of those given here.

A pair of dividers will serve if a pair of odd-leg calipers cannot be obtained, but more care will be needed in their manipulation.



*Some interesting details of one of Australia's leading broadcasting stations.*

**T**HE average broadcasting studio nowadays is not an apartment which contains many novel properties.

One broadcasting studio is very much like another one in general principle, although, of course, modifications of design occur in every individual case, in accordance with the particular requirements of that studio.

A permanent "broadcasting hall" in lieu of the conventional studio, however, is a matter of interest, and it is from such a novel enclosure that the whole of the regular programmes of the Australian broadcasting station, 3 L O, of Melbourne, Victoria, are transmitted.

3 L O, like its English relative, 2 L O, is, of course, a pioneer broadcasting station. Its technical equipment is of the conventional order, and therefore a description of it will need only a few words in passing.

Transmitting on 5 kilowatts, the Melbourne station, 3 L O, derives its power supply from the mains of the

Victoria State Electricity Commission. For the plate supply, this current is transformed by means of an auto-transformer, having a 20,000-volt step-up. The transformer secondaries are split, and rectifying valves are connected to each end of the transformer, thus effecting double-wave rectification.

Current for filament heating in the transmitter is drawn from a 240-volt alternating current which is rectified, and smoothed in the usual manner by means of a series of condensers and chokes. The oscillator unit of the transmitter contains two valves, utilising a common H.T. supply. The well-known Meissner circuit is used. Ten modulator valves are employed, and a like number of the power amplifying panels.

3 L O's aerial is a 4-wire "cage" which is 150 feet long, and is suspended a little over 150 feet high between two 200-ft. steel lattice masts. A counterpoise earthing



This photograph shows the station orchestra assembled on the broadcasting platform. The microphone can be seen in the centre of the picture.

arrangement is used. This latter may be seen on the photograph below. It consists of an 8-stranded wire carried in a circular fashion around the aerial masts on steel poles, each 15 feet in height.

There is no doubt, however, that the actual transmitting



The main broadcasting hall, looking towards the platform.

studio is the most interesting portion of the broadcasting equipment at 3 L O. Situated in the heart of the city of Melbourne—some seven miles distant from the actual transmitter—the 3 L O studio constitutes a concert hall more than anything else. The main studio is 32 feet long by 25 feet wide. Its walls, floor and ceiling have been specially treated with chemical agents in order to render the apartment more or less sound-proof, and to damp out any objectionable echo effects.

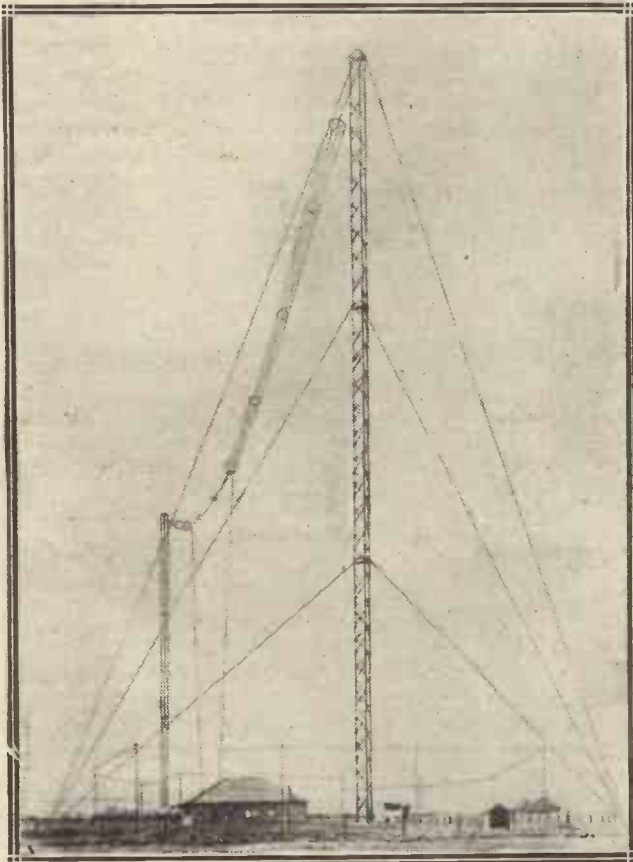

The four-wire cage aerial and counterpoise used at the Melbourne Station.

Apart from the actual broadcast performers, the studio possesses a seating accommodation for about 200 people. It is, in fact, a well-appointed enclosure, one which is adequately ventilated (B.B.C. provincial studios, please note!), and one in which the broadcast artistes do not experience that peculiar sense of confinement and isolation from the rest of the world which is so often stated to be the case in other studios.

### 3 L O's Novel Studio Illumination

There is a platform at one end of the 3 L O studio, and for most purposes this is utilised by the broadcasting artistes. Immediately behind the platform is situated a large sound-proof double window, behind which is the control room of the studio. The control room is fitted up with the usual array of instruments, together with a relay board for outside broadcasts. A complete receiving set and loud speaker is provided so that the control operator in charge is enabled to hear the actual transmissions, and to signal any instructions concerning it through the control-room window on the broadcasting platform.



The control room at 3 L O. The window at the end of the room looks into the main studio.

Weston Electric microphones are employed for broadcast purposes in the studio, and are of the "double-button" type.

Another noteworthy feature of 3 L O's studio is its system of lighting which, although it is as yet in an experimental stage, is sufficient to indicate the fact that our Australian broadcasting cousins have really come to grips with the problem of making an up-to-date broadcasting studio comfortable to artiste and listener alike. Visitors to the 3 L O broadcasting hall often express surprise at the novel lighting system. The broadcasting platform is brilliantly lit with white reflected light. On the other hand, the body of the broadcasting hall is continually submerged in a pure red glow, contrasting in a most effective manner with the platform lighting.

Australia's station, 3 L O, transmits on a wave-length of 371 metres (809 kilocycles—to satisfy the frequency fans). It is owned and controlled by the Broadcasting Company of Australia Proprietary, Limited, and it is heard regularly in all the States of the Australian Commonwealth, and in New Zealand and Tasmania. Reports have also been received of its clear reception by broadcast "fans" in the Pacific Islands, America, Canada, and even in far-away Alaska.

# NEW LISSEN LINES

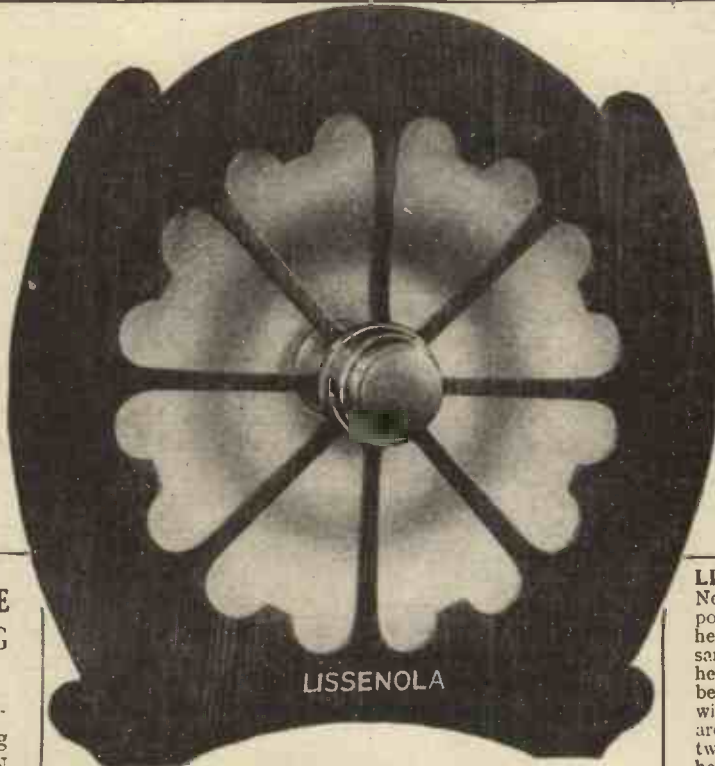

LISSENOLA

## LISSEN REVOLUTIONISING CONE

A combination of horn and cone in the same loud speaker.

**29/6**

*Fills in the missing note.*

## LISSEN RESISTANCE CAPACITY COUPLING UNIT

Provides a complete Resistance Capacity Coupling Unit. Includes two LISSEN Fixed Resistances and one LISSEN Mica Condenser. Values incorporated have been selected as the most suitable for general use, but the resistances are easily interchangeable. May be mounted upright or flat.

**4/-**



## LISSEN COILHOLDER

Fine degree of control to permit of extremely selective tuning. Gear ratio selected as the best for all practical purposes. Big knob for comfortable finger grip and wide range of movement with one turn. No slip or backlash, coils will not move as the result of their own weight. No flexible connections to break. Moving block on the right-hand side, but may easily be changed over to left-hand side by following the simple instructions enclosed with each coil holder.

Model A. With 2 in. spindle (2 way) .. **4/6** Model B. With 5 in. spindle (2 way) .. **5/6**

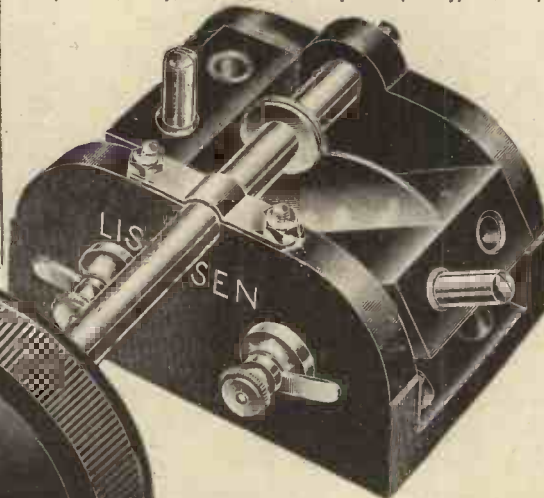

## LISSEN HEADPHONES

Never before was it thought possible commercially to make headphones so light and at the same time so sensitive. These headphones are so light they may be worn throughout an evening without the wearer realising they are on the head. Cords will not twist or tangle but will always hang straight down no matter how the head may be turned, moved or twisted. The two ear-pieces are extremely sensitive and both are exactly matched in impedance. They settle at once into comfortable positions and may be secured there by the single movement of a special ball joint .. **8/6**



LISSEN LIMITED,  
20-24, FRIARS LANE,  
RICHMOND,  
SURREY.

Managing Director : Thos. N. Cole.

LISSEN

LEADS IN RADIO PARTS

# RADIO ABROAD

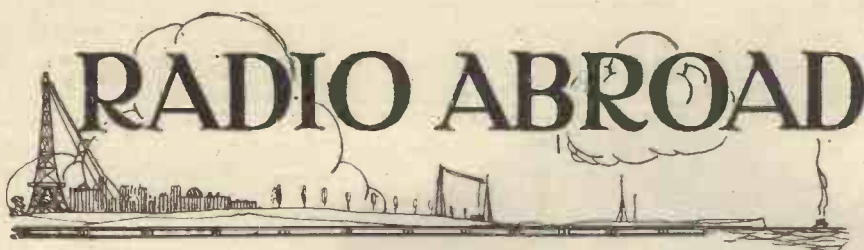

## Radio in the Future

**D**R. LEE DE FOREST, the famous American scientist, has been indulging in some predictions as to radio in fifty years' time. He promises all kinds of wonderful advances. First of all, he thinks that there is every likelihood that before long we will be able to draw electricity from the upper air in sufficient amount to drive machinery in the home and in the factory. For this purpose conductors will be built ten miles high, connected with a series of aerials which will gather in and store up the vast amount of energy that exists in the shape of the enormous potential differences between the upper atmosphere and the surface of the earth. Problems of warmth, lighting, and transportation will cease to exist, and we shall be bothered no longer with anxious speculations as to our reserves of coal and oil.

## Power to Aeroplanes

In the same way, energy will be transmitted by wireless to aeroplanes, so that a machine crossing the Atlantic, for example, may do so without the need for carrying an enormous weight of fuel; in fact, it will not carry any fuel at all, for it will be automatically supplied with energy whilst in the air. A very important feature here is the fact that the aeroplane would be able to rise far above the storm belt. "And how long will international boundaries be regarded as important," asks Dr. de Forest, "when London is practically in New York's front yard and San Francisco out by the garage?"

## Cosmic Rays

Dr. de Forest is greatly interested also in the new cosmic rays discovered by Dr. Millikan, which have a frequency ten million times as great as that of the most rapid light rays.

It is likely that "atmospheric" troubles may be overcome by means of short-wave transmission.

Dr. de Forest believes that, before long, clocks and watches will be arranged to be automatically driven and regulated by means of radio impulses internationally transmitted.

It is possible even at the present day to use a simple receiving set in conjunction with a relay which corrects itself once or twice a day, or to adjust the escapement in a watch or clock so that it will register an impulse from a master station every second or two. This is actually little more than the Western Union Telegraph Company is doing now with a myriad clocks that are electrically operated and regulated. There is no reason why the desk clock in one's office should not be thus kept accurately on the second with Greenwich time.

## An Awkward Situation

In the United States the number of patents taken out in connection with various wireless subjects has increased

between all the principal manufacturers each has the right, on terms, to make use of the patents belonging to the others.

As the principal of the National Electric Light Manufacturers' Association recently said in New York, referring to the problems and difficulties confronting the manufacturer: "Heaven and the Patent Office alone know how many obstructions of this nature still lie in our path."

## Cone Speakers

Talking of United States patents, the original patents on the cone loud speaker are held by the Lektophone Corporation, and licences were issued to various large concerns, including the Radio Corporation of America. In an action for infringement a decision was given adverse to the Lektophone Corporation, and a very peculiar situation was thereby created. On appeal, however, this decision has been reversed, and the patents held by the Lektophone Corporation are therefore upheld. In particular, it had been argued with the Hopkins Patent No. 1,271,529



There is still sunshine at Deauville and the above two late holiday makers are seen enjoying this with the aid of a portable radio set.

to such an enormous extent that radio manufacturers are finding themselves seriously embarrassed by the complicated patent position. They say that it is almost impossible for them to move hand or foot without finding themselves up against somebody or other's patent. They are endeavouring to cope with the very difficult situation by pooling their patent interests so that by an arrangement

was anticipated by Lumière and others. However, the Lektophone Corporation, controlling and operating the Hopkins patents, has now vindicated its legal rights.

## The Innsbruck Relay

The new broadcast station at Innsbruck, in the Tyrol, relays Vienna programmes on 294 metres. This

(Continued on page 542.)





# My Broadcasting Diary

*Under this heading month by month our Broadcasting Correspondent will record the news of the progress of the British Broadcasting Corporation, and will comment on the policies in force at B.B.C. headquarters.*

## The Awakening of Parliament

THE reassembly of the House will be marked by an unprecedented rush of questions about broadcasting. Colonel Day, the holder of the world's record for questions in the House, has already got a good few down. It is understood that one member has given notice of a question about the probable opening date of 5 G B, and its probable cost.

With the House of Commons meeting in November, and 5 G B starting on August 21st, one gets a fair idea of a delightful detachment from the realities of broadcasting. Nevertheless members have discovered in their constituencies for the first time that broadcasting counts: that it is indeed of much more general interest and concern than Mr. Lloyd George's land policy, Peace in Industry, or the League of Nations.

Eighteen months ago, when the future constitution of the B.B.C. was being decided, not more than fifty members of a House of more than 600 took the slightest interest. It is probable that as many as 150 members of Parliament are now aware that broadcasting in this country is really a matter of governmental responsibility.

An inevitable result of this discovery will be more acute questioning of the P.M.G. The latter has offered less information about the Corporation and its work than he was ready to do in the old days about the Company. But he is not likely to be worried very seriously during the life of the present Parliament. It will take some years before the Mother of Parliaments overcomes the time-lag in regard to broadcasting. Really, the member who asks in November when an event is to happen, which is already four months old, is getting quite close-up to realities. There should be some pertinent questions about the Regional Scheme, say within six weeks of its completion.

## Overdoing a Theory

The B.B.C. outdid itself with the blare of trumpets that accompanied the opening of 5 G B. Things were so organised at Savoy Hill that the Press heralded the event as one of as great importance

as the passing of an age-long dynasty. There was rapturous acclamation of the statesman-like syntheses poured out from across the Strand. High-brows and low-brows were both buried.

The new principle was contrast by degree of concentration. One programme was to be acceptable for the reason that one could do something else at the same time; whereas the other programme was to gratify the mood when one wished to concentrate on listening. There is something in this principle; but like all principles it defeats itself when applied literally and without reasonable modification.

## At Long Last

Without thinking much of any principle at the beginning, the programme builders naturally evolved light characteristics for 5 G B and mixed characteristics for 5 X X and 2 L O. There was no hard and fast application of rules beyond this general understanding. And the results were excellent. What a sigh of relief went up from millions of homes when a really decent entertainment programme was made available at long last.

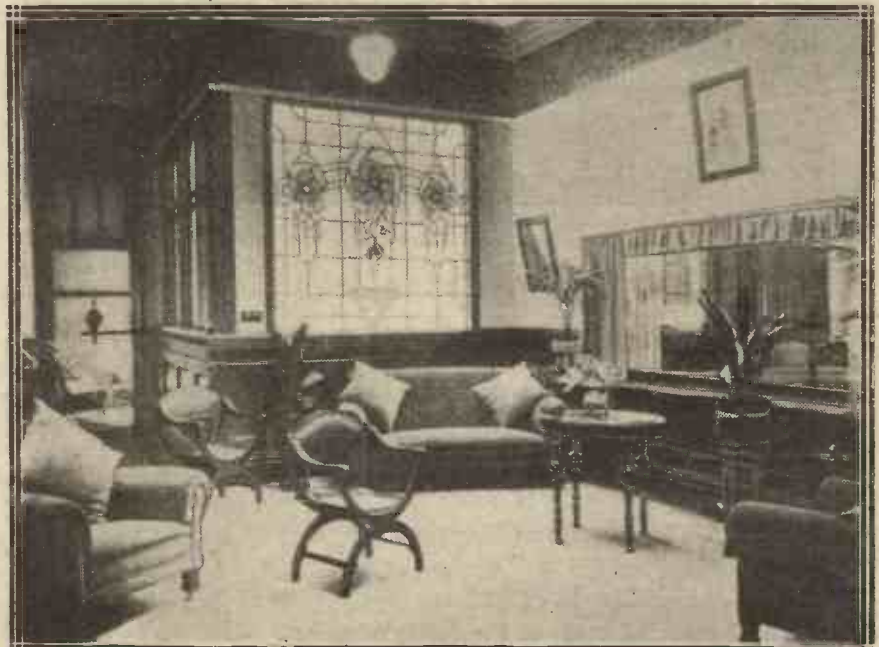

The new broadcasting station at Wellington, New Zealand, is luxuriously equipped and above is shown the comfortable smoke-room. An article on this New Zealand station appears on another page in this issue.

And then the theorists got busy, with the result that efficiency was soon compromised for consistency. First, two half-hours of adult education crept into 5 G B, then some rather dreary debates were intruded, then some uplift stuff was dumped. It is true that simultaneously the other programme was lightened; but the resultant was much less pleasing than the first essays at popular alternatives.

Savoy Hill must realise that in its own interests 5 G B must remain solely entertainment and news; no uplift or educational muck whatever. That is what listeners want, and that is what will push licences up rapidly. Surely the B.B.C. realises that the rate of increase of licences is disgracefully slow, and reveals failure to cater to popular tastes.

If there had been a ready responsiveness to entertainment needs and less humbug about uplift, there would have been four million licences to-day. And now that there is a good chance to meet entertainment demands, and still "save faces," Savoy Hill must not let it slip through blind adherence to an alleged "principle."

### Programme Research and Development

It is common knowledge that the engineering development section of the B.B.C. is beyond praise. It is far and away the most efficient organisation of its kind in

it not only desirable but necessary to constitute a regular research branch of their programme organisations.

I put it quite seriously to the B.B.C. that the one serious hole in its organisation to-day is the absence of this research and development section on the programme side. There is no longer the excuse that Savoy Hill cannot look far ahead, and must live from hand to mouth. A nine years' run is a reasonable period to get on with the new art in a thoroughly scientific way. The incidence of pioneering responsibility is now shifting from the engineering to the programme side.

### B.B.C. Short-Wave Station

Captain Eckersley took clever advantage of his visit to America to talk about great new experiments coming to a head in co-operation with the United States broadcasting engineers. Arising out of these there was a promise that the B.B.C. would begin its "next series of experiments in Empire broadcasting" in October.

Confident but vague messages have come from Captain Eckersley since he reached the other side of the "herring pond," but there is still no sign of the promised short-wave experimental transmitter. It is profoundly to be hoped that work is really going on, and that all the talk from Savoy Hill is not one vast bluff. If there is an element of bluff in it, the public recoil will be terrific, and the consequences for senior officials at the B.B.C. will undoubtedly be serious.

As against this diagnosis is the comforting consideration that the B.B.C. is nothing if not shrewd, and have probably envisaged all the practical possibilities. It is for this reason that I am optimistic that the Empire broadcasting will soon be solved satisfactorily. When this has come about, we can all afford to stop thinking about the amazing truculence of the B.B.C. last summer. In political circles it is rumoured that the P.M.G. was much upset by the obstructionist attitude of Savoy Hill. The settlement of the difficulty has a political as well as a wireless interest.

### The Governors

Three months ago I reported that the Governors had been doing a good deal of useful work unobtrusively. They had readily sub-

mitted themselves to the same rules of anonymity that have been applied to the staff. It would appear that in the interval there is "no change" to report.

Despite the alarming prognostications of conflict, and public scandals, the new B.B.C. Board appears to be pursuing an unusually smooth and amicable course. Of course, things are so safeguarded at Savoy Hill that not a whisper about the Governors ever trickles through even the back door.

In fact, the only source of information on this subject is the occasional unguarded remark of a Governor at dinner or lunch, with a disguised sleuth in the offing. Even a piecing together of all the things that this produces does not provide any material worth the name of snappy gossip. The real danger appears to be "over-amicability." An occasional row is healthy!

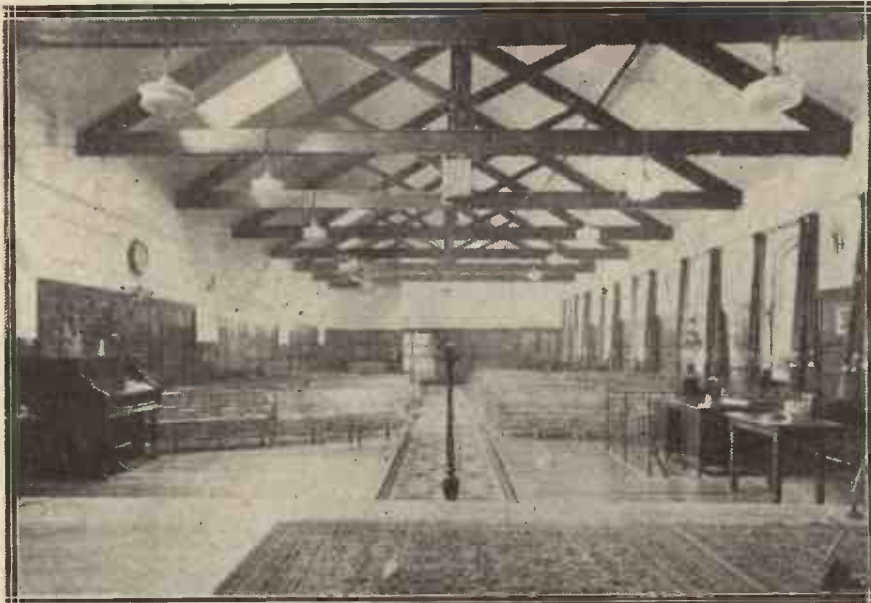

The main studio at 3 L O, the Melbourne broadcasting station. As will be noted, it is provided with a large auditorium and resembles a concert hall.

the world. Knowing the orderly methods of the Director-General of the B.B.C., one would expect that Captain Eckersley's development section would have an equally efficient counterpart in the Programme Department.

Indeed, one would imagine that now that the art of the business is getting so particularised such a development section would be indispensable. Inquiries at Savoy Hill on this subject produced the answer that the research and development side of programme work is undertaken by the various executive sections, that is, music, drama, and talks.

### Foreign Success

It was added that the needs of the different sections are so specialised that research and development must be devolved. The reply does not satisfy me when I know that both the Germans and the Americans have found



# BE A RADIO MISER

THE IMPULSES your aerial receives from foreign stations are doubly precious because of their weakness. You must arrange your receiver so that none of the energy is lost. You must guard against leakage. You must be miserly in the way you save each minute portion. This means more than using good radio parts—it means using the one make of parts that have been conspicuously notable for their low loss qualities for many years—LISSEN.

## ECONOMISES H.T.

By putting a Lissen 2 mfd. Mansbridge Condenser across your H.T. Battery (1 mfd. will do, but larger size is better) you will lengthen its life by 10 per cent.



### LISSEN Mansbridge Type Condensers

2 mfd. 3/6	1 mfd. 2/6
Other capacities:	
.01 .. .. 1/9	.25 .. .. 2/-
.05 .. .. 1/9	1 .. .. 1/9
.025 .. .. 1/9	5 .. .. 2/3

A specially moulded solid insulating case totally encloses each Lissen Mansbridge Condenser.

## NEVER LEAK OR VARY

Lissen fixed condensers are accurate to within 5 per cent. of their marked capacities. They never leak, they never vary. Less than a year ago they were being sold at twice the price—and since then they have been still further improved. You can't buy a finer condenser.



### LISSEN Fixed Mica Condensers

.0001 to .001, 1/- each (much reduced)
.002 to .006, 1/6 " " "

A pair of clips is included free with every grid condenser.

## NOW COSTS 1/- LESS

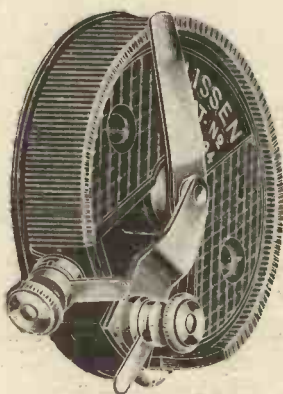

The baseboard type of Lissen Resistor is now reduced from 2/6 to 1/6. This type has, of course, no knob, dial or pointer, but is provided with 2 holes for screwing to baseboard. 7 ohms Rheostats: 400 ohms Potentiometer, previously 2/6, NOW 1/6

## ALSO REDUCED

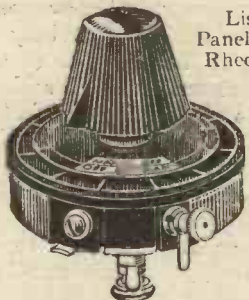

Lissen Panel Type Rheostats

The wires do not loosen, the arm keeps in perfect contact—nothing ever goes wrong.

Rheostats 7 and 35 ohms .. NOW 2/6	(Previously 4/-)
Potentiometer 400 ohms .. " 2/6	(Previously 4/8)
Dual Rheostat 35 ohms .. " 4/6	(Previously 6/-)

## SAVE CURRENT

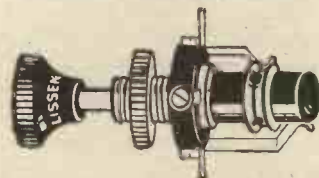

Energy is often lost at the switch points. These Lissen SWITCHES are designed to prevent energy leaking away while they do their work efficiently. There is one for every switching need—each one is very neat.

LISSEN TWO-WAY SWITCH	1/6
(Previously 2/9)	
LISSEN KEY SWITCH .. ..	1/6
(Previously 2/8)	
LISSEN REVERSING SWITCH	2/6
(Previously 4/-)	
LISSEN SERIES PARALLEL SWITCH .. .. .	2/6
(Previously 3/9)	
LISSEN FIVE-POINT SWITCH	2/6
(Previously 4/-)	
LISSEN D.P.D.T. SWITCH ..	2/6
(Previously 4/-)	

## STRONGER SIGNALS



There is not a square inch of superfluous ebonite in this Lissen Valve Holder. That means low capacity, and therefore stronger, clearer signals. Shown ready for baseboard mounting, but can also be used for panel mounting by bending springs straight. Patented. Previously 1/8. NOW 1/-.

## ABSOLUTELY SILENT



Lissen Leaks are absolutely silent in use; their resistances never alter. This was proved some time ago by exposing them to the rain and sun on our factory roof. All resistances. Previously 1/8. NOW 1/-.

**WHENEVER RADIO PARTS ARE WANTED USE LISSEN**  
**LISSEN LIMITED, 20-24, FRIARS LANE, RICHMOND, SURREY.**

Managing Director: THOMAS N. COLE.

L.259a



THIS brief history has to do with the theory of Mr. Harold Snacks, known to his intimates as "Snacks at the Bar"—a form of refreshment peculiar to the denizens of Fleet Street. Snacks had a theory which was known in every bar from the King Lud to the Coal Hole—and it was none the worse for that, except that it generally cost his cronies from 1s. to 10s. per demonstration. I



"She turned and glared back at Snacks."

estimate that his theory has cost, in liquid measure, some forty gallons, or, commercially, one barrel. Which is more than it is worth to a mere chronicler.

### Snacks' Theory

Mind you, a theory like the great Snacks' Theory is of no common order like those of the late-lamented Mr. Darwin. It ranks among those such as that, if the air only contained 5·7 per cent more helium than it does, it would be possible for a human eye situated on the Monument, London, England, to see lighthouses in New Zealand.

Snacks had studied the ether from the ground up, and had come to the conclusion that it was vilely neglected. Too many blank spaces, in his opinion. He had the mind of a mere estate agent, I fear. Nevertheless, as he argued—doubtless with reason—the unexplored parts of the spectrum are bound to have some function or other. He was wont to add, with less reason, that the paucity of data about the mechanism of telepathy is a

strong point in favour of the (i.e. his) belief that the job is done somewhere in those unexplored kilocycles.

"Only sound, with a suitable receiver, those regions of the ether," he said, "and you tap the real world, the world of thought. There you will gather up the unpublished thoughts of Homer and Shakespeare, and the—"

"Yes," I replied, "and the unprintable thoughts of a lot of other people. Tap that policeman on the nose, Snacks, and see what thoughts you will receive from him."

### A Demonstration

"Misguided friend of my college days," he rejoined, "you scoff because you are an ignorant unbeliever. But you will weep tears of remorse when the revelation bursts upon you. Let us step into yonder hostelry, where perchance I may demonstrate."

"Quite," I answered. "I know what you will demonstrate, and that the bill will be the revelation that will burst upon me."

Ten minutes later he reminded me of the well-known phenomenon of two people thinking precisely the same thing at the moment.

"Yes, just one more," I said, and signalled to the serving-wench."

"That's telepathy," he chuckled. "But I can do much better. See that girl over there? I'll make her turn round."

Whereupon he proceeded to concentrate his glare, and presumably the force of his mind, upon the back of the hapless victim, a lady who was being refreshed with coffee and flattery.

Snacks concentrated till his neck grew red and his eyes glazed, but the "subject" exhibited no cognisance of the etheric oscillations with which he was supposed to be inundating her. Rather did she draw the nearer to her companion and begin her tale afresh. "And so I said—well, I said, just as I might to you here, Harry. I said, *you cat*, I said," etc., etc., *ad nauseam*.

"Stick it, Snacks," I remarked; "she's weakening."

So he concentrated some more; indeed, so intense did he become that I was easily able to flick a crumb of biscuit at the lady's cup and saucer without his knowledge.

### "A Magnificent Reaction"

Then she turned and glared back at Snacks, who, by reason of the fixity of his gaze and his high colour, looked about as guilty as a man could.

"I beg your pardon, but were you aiming at me?" quoth the lady in a tone of what she intended to be exquisite sarcasm.

Snacks beamed.

"A little experiment, madam—merely a little experiment."

"Well, you can keep your tricks for them that want 'em! The *idea!* Harry!"

I could not care for Harry. Judged by his looks, he could neither contribute usefully to the demonstration nor add to the gaiety of the commonwealth. Probably he was an efficient ironmonger's assistant, but I opined that he lacked the spirit of scientific inquiry. Therefore I took Snacks out into the great open air forthwith, while he gloated freely.

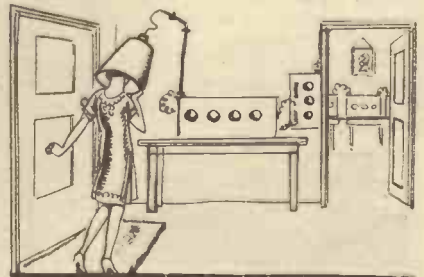

"Mrs. Snacks plunged head first into the transmitter."

"A magnificent reaction," he chimed, "a most convincing demonstration. That encourages me to divulge the fact that I have designed and made the world's first telepathic transmitter and receiver. Only one-way working. I shall devise the duplex arrangement later."

*Six-Sixty "every time!"  
say the Constructor*



"I want certain results," says the constructor, "and I know that with Six-Sixty I shall get them. Firstly, it is a well-known fact that each Six-Sixty Valve is tested under actual broadcasting conditions before being passed on to the public. This is the most exacting test that any valve can undergo. Then, again, what further proof of the excellence of Six-Sixty Valves do I need, when I know that most of the leading Set Manufacturers in the country standardise Six-Sixty in their Receivers? A.J.S., The Langham Portable, General Radio Company's Receivers, McMichael, Truphonic, are but a few of those universally known Receivers in which Six-Sixty are standardised. Manufacturers know the best valve, and their choice is mine. They are the experts, and what they select is bound to be the best, so I say 'Six-Sixty every time.'"

"Then remember that eight of the famous range of Six-Sixty valves consume only '075 amp. filament current.

"I recommend fellow constructors to write for the most attractive booklet describing in detail the full range of Six-Sixty Valves. (They range in price from 10/6.) It is sent post free on receipt of a post card."

**SIX-SIXTY**  
GLOWLESS VALVES

THE ELECTRON CO. LTD. 122-124, CHARING CROSS ROAD, LONDON, W.C.2

In spite of the autumnal chill in the air I broke out into a fine but well-distributed perspiration. This was getting serious.

**A Reverse "Super-het."**

"You will readily grasp," continued Snacks, "that in an artificial system of thought transmission, whether by broadcast or 'beam,' we cannot in our present state of knowledge manipulate electro-magnetic waves of an order of magnitude such as those which lie in the unexplored parts of the invisible spectrum. Hem! Waves much shorter than X-rays and so forth. You follow me?"

"Oh, quate."

"Very good! Now suppose the thought waves emitted were to be super-heterodyned, eh? Suppose they were to be worked up from 'beat' to 'beat' until they became of a negotiable length. They could then be radiated or preferably transmitted by the 'beam' system. How's that?"

"Go on," I faltered, wiping my forehead.

"Right. We now come to the receiver. If—"

"But where, may I inquire, is the receiver? Is it the ear or the pituitary gland, the vermiform appendix or the funny-bone?"

"If the transmitter is in the brain," replied Snacks, "so also must be the receiver. I propose to subject the amplified brain-waves, when they arrive, to a reverse super-heterodyne process; to increase their frequency, stage by stage, to the original."

"But how on earth—" I interposed.

"Oh, that's easy. You duplicate the super-het. apparatus and simply reverse all the connections. That's logic, ain't it?"

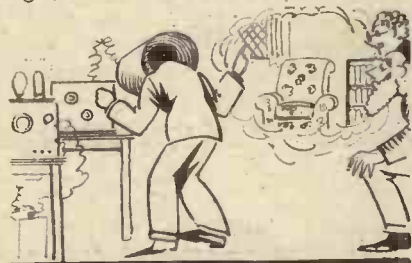

"And now I get a sense of things: a thing with legs."

"Very much so. Just like the old syllogistic trap for schoolboys: 'Every fool is a human being; Snacks is a human being; therefore Snacks is a fool.' Go on, but go slowly."

"Well, really, that's all, you know. The waves, having got down to

thought-frequency, are bound to affect the natural organ of thought reception situated, one supposes, somewhere in the nervous system, and so be brought to the consciousness of the person concerned."

"But what about 'jamming'? Do you imagine that every person thinks on a different wave-length? If so, you will require a universe of ether entirely to yourself, and even that will be congested. The Post Office won't allow it."

"My dear fellow, it is a trite saying, though none the less true, that no two persons are exactly alike. Hence no two can possibly think in the same cycle; the differences may be small, but the receivers must be correspondingly selective."

"Well," I said, "proceed! Though if I were you, I'd stick to 2 L O; it's low-brow, but healthy-with the rude, glowing health and balanced mentality of the peasant."

**The First Test**

"There's nothing more. The theory is propounded, the apparatus made and the trial is to-morrow at seven p.m. I invite you, knowing well that your facile pen may be relied upon to delineate the truth as you see it."

"You are partly right," I groaned, "but I warn you that my Editor is not at all facile. His directors sternly forbid anything of the sort, as witness my collection of rejection slips. Still, I will come, and I will bring my wife. She has a knack of keeping my grip on the realities."

And so we parted. Thereafter I did a deal of heavy thinking. Some Greek philosopher, through whose dreary pages I had been driven at school, is alleged to have advised his disciples to endeavour to turn every untoward circumstance to their own advantage. This gag had always stuck in my mind, because I thought it particularly fat-headed. But no doubt the old stiff had the right idea. For example, a man may have married a wife, but to compensate him he gets an allowance off his Income Tax on her account. Just so has English law absorbed something of the Stoic philosophy and I am all for the teaching of Greek in the elementary schools, from which I suppose our future legislators will spring. Is this politics? No! Fate, and Mr. Thomas and his like.

All right-minded men will agree with me that the proper position for an armchair is "back to the light," so that one can read by daylight

without endangering Heaven's precious gift of sight. But my wife, from reasons purely æsthetic and decorative, wanted the bally thing—oh, well, I don't wish to intrude a petty domestic problem upon an enlightened public gasping for super-heterodyned telepathy.

Muriel consented to come to the demonstration because she wanted to tell Mrs. Snacks about Mrs. Glarper's mother, who had a terrific row with the laundry people over a pair of curtains. For reasons which will appear later I prevailed upon her to



"Snacks was clean delirious with triumph."

take early tea with Mrs. Snacks instead of waiting for me to return from town and accompany her to the Snackses.

I found the layout of the demonstration to be as follows: The transmitter began on the front door mat with a huge copper-gauze funnel, into which the sender poked his (or her) head; it then led by a series of some fifty super-het. units through the lounge hall, the drawing-room, the dining-room, a passage, the kitchen, the scullery and the boot-hole, and ended in the conservatory, from which the aerial was erected. The receiver started on the first landing, climbed past four bedrooms, wound its reversed super-het. way up three flights and terminated triumphantly in another copper-gauze funnel situated in the box-room. A duplex line-telephone connected the upper and lower funnels.

**Well Under Way**

Mrs. Snacks plunged head first into the transmitter and Snacks into the receiver. I supported Snacks. At the word "go," Mrs. Snacks began to think. That alone was an achievement, I thought. Snacks adjusted the knobs like a handbell ringer playing "Tannhäuser," telephoning the while to his wife.

"I don't quite get you, Alice! Is it something green?"

The answer was evidently in the negative.

(Continued on page 536.)

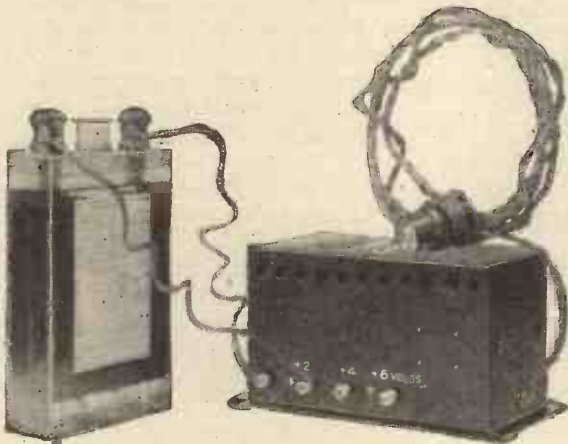

**PRICE 55/-**

DIMENSIONS:  $7\frac{1}{2}'' \times 4\frac{1}{2}'' \times 4''$

# THE FERRANTI PERMANENT TRICKLE CHARGER

*(Incorporating the Westinghouse Patent Metal Rectifier)*

For charging accumulators at home from the Alternating Current Mains. Suitable for use on voltages from 200 to 250 and 40 to 60 cycles.

**NO** VALVES TO BURN OUT  
MOVING PARTS TO GET OUT OF ORDER  
CHEMICALS TO RENEW

## NO MAINTENANCE COSTS

**OUTPUT:** The Charger will supply  $\frac{1}{2}$  ampere continuously to 2-volt, 4-volt, or 6-volt cells

The FERRANTI Trickle Charger consists of a step-down Transformer designed for operation from Alternating Current Mains having any voltage from 200 to 250, and frequencies from 40 to 60 cycles, feeding a Westinghouse patent metal rectifier. The Unit is silent in operation and will last indefinitely.

### The Charger is Simple and Safe

The FERRANTI Trickle Charger takes 12 watts from the Alternating Current Lighting Circuit and gives  $\frac{1}{2}$  an ampere Direct Current to the Low-tension Accumulator, or during 83 hours' use the Charger will consume one Unit of Electricity from the A.C. Mains.

FERRANTI ELECTRIC  
LIMITED  
Toronto, Canada

FERRANTI LTD.  
Hollinwood, Lancashire

FERRANTI INC.  
130, West 42nd Street,  
New York, U.S.A.

# Not Necessary to buy a TUNGSTONE TWICE IN A LIFE TIME

FIRST CHARGING RISKS ENTIRELY ELIMINATED.

*Battery Troubles Solved*

**10 HORSE POWER STARTER KICK.**

The ONLY Car Starting Portable Storage Battery in the World

**TUNGSTONE**

With Plate Grids and Paste made of Pure Lead

*Accumulator*

Telephone Central Office  
2, ST. BRIDE'S HOUSE, SALISBURY SQ. FLEET ST. LONDON E.C.4

*Revolution*

after **50 years** *Signation*

OF THE  
*World's Battery Practices*

NO SULPHATION. All Parts Replaceable

FIRST CHARGE ONLY

*Four Hours*

For any STORAGE BATTERY from 6 to 5,000 amps.

Because Standardised and Interchangeable renewable Die Cast and Machine Pasted Plates PERPETUALLY replace a Set of Used Plates. Dry Plates partially first charged are ready for immediate use. Can be stocked for unlimited period in dry place. Spare Plates sold at reasonable prices with allowance of 4d. per lb. for returned disused plates. Anyone can quickly and easily slip a Set of New Plates into the Indestructible Guaranteed Metal Containers in use.

## FREE for the ASKING

*Illustrated Battery Pocket Guide  
containing Special Articles on*

## MODERN BATTERY FAILURES

### HIGH TENSION PLATES. EXCLUSIVE FEATURES NEVER BEFORE ACHIEVED BY ANY OTHER MAKER

Tungstone, with its two Perfectly Scientifically Balanced H.T. Plates, without Wood Separators, is far more efficient and steadier in working with assured longer life than when three unbalanced Plates are used necessitating Wood Separators.

All Tungstone High Tension Plates are SCIENTIFICALLY BALANCED in correct weight proportions of the Grid and Pure Lead Paste, so that the Ampere Hour Capacity is evenly used up by an automatic proportional discharge of current from Positive and Negative Plates securing steady voltage. No abrupt changes in the potential. The drop slow and imperceptible. No Wood Separators prevent Voltage fluctuations due to polarization and internal resistance which is negligible. No frothing or foaming. No Sulphation. No Parasitical Noises in Phones or Loud Speaker. No sudden Plate failure at a critical moment demanding Voltage adjustments. The respective Plates are Certain to get their required proportionate charge of current. If correctly first charged is a guarantee against uneven strain and irregular drain on Plates on Charge and Discharge, and there is no chance of a separate Cell discharging and reversing long before the others. The loss of charge on standing is low and the local action small.

The open Circuit Voltage will give due warning of the approach of the Battery to a discharged state. As H.T. Cells are small it is difficult to test the Specific Gravity. Balanced Plates allow greater dependability to be placed on voltage readings. Cells are not permanently ruined by being left standing for months.

### A FULL CHARGE IS ALWAYS SECURED IN SHORTER TIME AT LESS COST

All De Luxe H.T. 3 a.h. Tungstone Accumulators from 12 to any Volts are fitted with a Patent Charging Equipment whereby each series of 12 Volts can be coupled in parallel so that they can be charged to the full on a 12-16 Volt Charging Plant.

EASY TERMS OF PAYMENT.—Sold in U.K. on Monthly Payments extended over a period. Apply for particulars.

TUNGSTONE ACCUMULATOR CO., LTD., The Independent Battery of the British Empire,  
3, St. Bride's House, Salisbury Square, London, E.C.4.

G



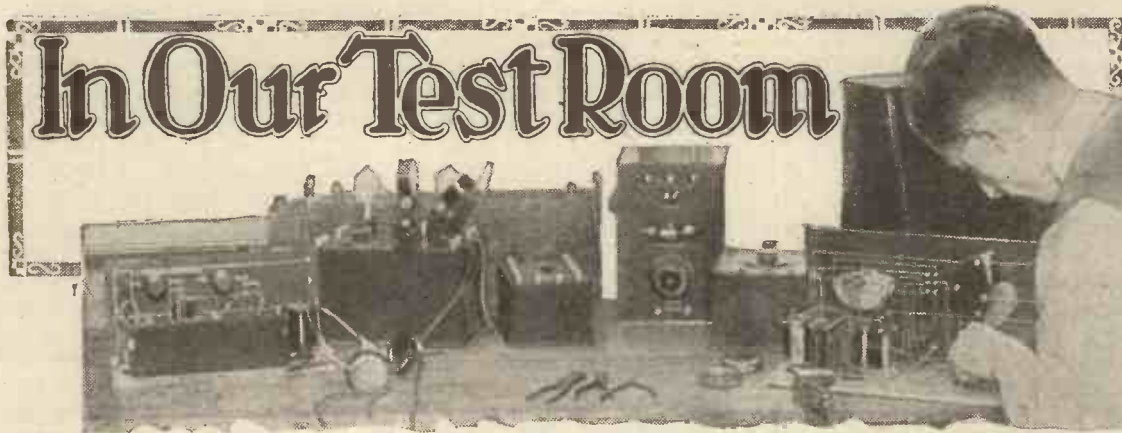

### L. & P. Coil Holder

**T**HE LONDON AND PROVINCIAL RADIO COMPANY, LTD., recently sent us one of their two-way coil holders. It is provided with a scaled indicator similar in appearance to a variable condenser dial and of much the same size. The indicator is permanently geared to the control and provides a very close reading of adjustments. The component is well made and is compact and easily fitted behind the panel of a receiver. The movement



This L. and P. coil holder has a scaled adjustment indicator.

is quite positive and is smooth and free from looseness or harshness. Undoubtedly the scaled indicator is a very valuable feature and one that the constructor will appreciate. It enables a reaction adjustment, when the coil holder is used for such, to be accurately calibrated as well as the variable condensers. This two-way coil holder sells at 10s. 6d.

The L. & P. people also sent us some of their push-pull switches and baseboard coil mounts. The former retail at the moderate price of 1s. 3d., and are in every way satisfactory. The coil holders are priced at 10d. each, and appear to us to represent excellent value for money.

### Lissen Baseboard-Mounting Rheostat

We recently received one of the type BB 35-ohm Lissen rheostats. And as are all the other Lissen com-

ponents it is a well-designed and well-made component. It may be that Lissens have the machines, or it may be due to skilful workmanship, but Lissens manage to give their products a finish which must be the despair of many of their friendly rivals. This new rheostat, for instance, is really a first-class piece of work, and gives one a pleasure to handle as well as to use. It is circular in shape and a small contact revolves round the edge of the resistance winding smoothly, but will retain any position against vibration or accidental knocks of a light nature. The component is very easily mountable, and cannot but satisfy the most critical of constructors in all respects.

### Siemens' "Power" H.T. Batteries

The ordinary small-cell H.T. battery has a very short life when it is used with power valves which might consume anything up to 15 milliamps. each, or even more than this, but Messrs. Siemens have recently placed on the market large-capacity dry H.T. batteries at very attractive prices. These are styled "Power" batteries, and are available in two types, one of 60 volts, which retails at 17s. 6d., and the other of 100 volts, and this sells at 29s. It will be agreed that these prices are in the circumstances distinctly reasonable. The 100-volter weighs 20 lb., and this will form some guide as to the size of the cells employed.

Both types are, of course, tapped. The sample 60-volter which we were sent for test has been in use on a five-valve set for two or three weeks, the periods of continuous activity running into three and even four hours, and while it is early yet to say anything about the battery's reliability, it is significant that so far there has not been the slightest voltage drop. Further, we have had one

of the smaller Siemens' H.T. batteries in use doing light work for nearly nine months, so that we have something of a guide as to the possibilities of a battery nearly three times the size but of the same make.

Even in the case of a one- or two-valver it was always worth while purchasing an H.T. battery of large capacity, and now that one is available at such a low price it becomes doubly advisable.

### A "Radiola" Cabinet

We recently had the opportunity of examining a cabinet of the bureau type made by Messrs. Pickett Bros. of Bexley Heath. It was drawn from



The "Radiola" wireless bureau, made by Messrs. Pickett Bros.

a large stock of many types ranging from single box patterns to very expensive models.

As will be seen by the accompanying photograph, it is modelled on

Queen Anne lines and is a very handsome piece of furniture. The front of the top compartment falls forward to disclose a space large enough to take a multi-valver and a baseboard is provided. The top of the cabinet is hinged.

The lower compartment is very roomy, and will take the largest of batteries or eliminators. The two doors fit very snugly and are reinforced to prevent warping.

The design of this "Radiola" cabinet is excellent and it is very soundly constructed. The particular model which is in front of us as we write is made of oak and it is beautifully polished. The price is £7 15s., and we consider it good value for money. Messrs. Pickett Bros. have a very wide range of cabinets in stock in all sorts of woods and patterns, and they make special types to individual requirements.

### Novel Tuning Unit

Messrs. S. A. Lamplugh, Ltd., of King's Road, Tyseley, Birmingham, recently sent us one of their new Panel Plate Tuner Units. This is a most interesting article. It consists of an engraved metal panel, finished in black and gold, upon which are mounted a slow-motion variable condenser, a coil tuner with a reaction adjustment, and a switch for changing from low to high wave-length ranges. These components are arranged very neatly and symmetrically. The object of the unit is to enable constructors to assemble sets having a professional appearance. Very clear instructions for mounting the unit are provided, as well as directions for assembling either a two- or three-valve receiver. The unit tunes from approximately 200 to 2,000 metres. The variable condenser has an excellent movement and operates smoothly and positively. It is provided with a "knife-edge" pointer and very close dial readings can be taken.

On test, the unit gave better results than we had anticipated, as the coil unit does not appear to be of a particularly efficient design, although it is compact and neatly enclosed. The constructor whose aim it is to build a broadcast receiver capable of receiving the nearer stations either on 'phones or loud speaker, and who requires neatness of appearance, compactness, and simple controls, will find this Lamplugh product of great interest, and, considering its scope, we do not consider it unreasonably priced at 35s.

Messrs. Lamplugh also sent us some of their new Vario-Fix Rheostats. These are neat little components and are designed for baseboard mounting. They are available in 6, 15, and 30 ohm maximum values at the low price of 1s. 2d. each. Their resistance elements are easily removable, and are in the form of small fibre strips, on which are wound resistance wire. These can be obtained separately at 6d. each. The Vario-Fixes are small in size but are robust and well made.

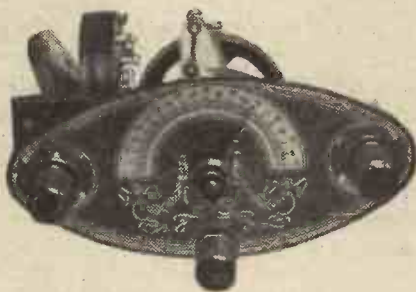

The Lamplugh panel plate-tuning unit.

And the fact that they not only provide resistance variations but also that their ranges are easily changed, should make them attractive propositions to constructors.

### Some Goltone Items

Messrs. Ward & Goldstone, of Pendleton, Manchester, recently sent us a small sample of their "Goltone Negrolac Aerial" wire. This consists of 49 strands of enamelled wire covered with a glossy fabric material which is claimed to be able to stand up against the severest atmospheric conditions. The wire should have a good "pick up" considering its extremely large combined surface area, and it is excellent stuff to handle and does not tend to kink. It also has considerable mechanical strength and should be able to resist many times the strain imposed upon the average aerial. "Negrolac" is obtainable in 80-ft. and 100-ft. lengths at 15s. and 18s. respectively.

We also received from the same source a sample "Quickgrip" connector. This is a spring clip provided with a fork terminal contact. It can be fixed to the end of a lead, and enables connections to be instantly made to any other lead or to a terminal. The experimenter especially should find this device extremely useful. It retails at 2d. Larger "Quickgrips," suitable for accumulator connections, are available at 5½d. and 7½d. each. These are lead coated in order to protect them against acid.

### Peerless "Varistor"

The variable resistor for baseboard mounting, that compromise between the panel-mounting rheostat and a fixed resistance, seems to have definitely settled itself in the constructor's favour. And the Bedford Electrical Radio Co., Ltd., whose "Peerless" rheostats gained deserved high orders of popularity, have now produced the "Peerless" "Varistor." This deserves special mention inasmuch as it has a really good mechanical movement; one comparable with that of a first-class rheostat. Hitherto but small attention appeared to have been paid to the movements of our "variable resistors," but the Bedford people have given a definite lead in this direction, and one that will no doubt be followed by other manufacturers. The "Varistor" has a resistance element in the form of a half circle, and this is mounted upon an aluminium base having one terminal at each end. A small contact arm smoothly runs over the wire, and a definite "off" position is provided. This last is another attractive feature and one we should like to see universally adopted. The "Varistor" is obtainable with maximums of 3, 6, 15, and 20 ohms at the very reasonable retail price of 1s. 3d.

### A Cheap Valve Holder

One of the cheapest valve holders that has come to our notice is the anti-capacity type made by Messrs. Cason Mouldings, of Lower Edmonton, London, N.9. It retails at 6d., and is of novel design. Four springs are mounted in four slots arranged round a central insulating moulding, and the pins of the valve slide down in these slots over the springs. An excellent contact is made and the valve held quite as firmly as in the more conventional type of holder. The springs continue at right angles at the bottom to form soldering tags. The holder is mounted on a baseboard by one screw and this passes through the base and a rubber pad which is provided. The centre of the moulding is cut away. This Cason holder provides good insulation, has a low capacity between its contacts, and is a neatly produced little article.

The Cason people are also making a "Toggle" switch for panel mounting. The feature of this is a very positive "snap" action. It is a nice little switch. It has a small red lever and "on" and "off" are clearly marked in red letters. It retails at 1s. 3d.



**Great!**

**L**ISTEN just once to the Mullard Pure Music Speaker with the wonderful harmonic response, and you too will find yourself saying "GREAT!" and deciding that you must have one.

*Mullard P.M. Speaker Model "D"*  
in Red and Black . . . . . **£5.5.0**

*Mullard P.M. Speaker Model "E"*  
in all Black . . . . . **£3.5.0**



*Mullard P.M. L.T.  
Battery Charger (for  
A.C. Mains).*

*Price* **£4.0.0**

# **Mullard**

## **MASTER · RADIO**

*Mullard Wireless Service Co., Ltd., Mullard House, Denmark Street, London, W.C.2.*

*Arks.*

# EFESCA

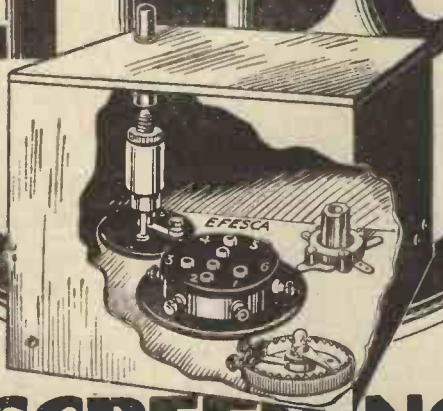

## SCREENING CUBE

THE EFESCA Screening Cube is designed in accordance with standard specification, constructed of solid copper with a rigid baseboard. EFESCA components are embodied in the complete unit, and comprise—standard six-pin base, neutralising condenser with long handle projecting through the lid, anti-microphonic valve holder and adjustable fixed resistor. The screen is drilled and fitted with earthing terminal.

**PRICE COMPLETE**  
As Above, 25/- Each

Copper Screening box with lid and baseboard only, 12/6 each.

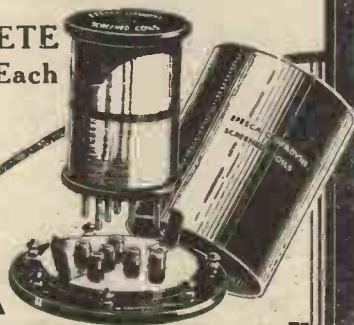

## EFESCA "CENTADYNE" Screened Coils

Are wound in accordance with standard specification, and can be relied upon to give the best results possible in their respective applications.

WRITE FOR COMPLETE CATALOGUE SHOWING FULL RANGE OF EFESCA COMPONENTS.

**FALK, STADELMANN & CO., LTD.,**  
83/93, Farringdon Road, LONDON, E.C.  
And at Glasgow, Manchester, Birmingham, Dublin, Newcastle, and Cardiff.

# Buy Best Batteries

"Cordesia" Pocket Lamp and High Tension Batteries are specially manufactured for the purpose for which they are required.

In the Composition of the Mixture and Electrolite, the greatest possible care is taken to obtain the MAXIMUM STORAGE CAPACITY. In this—their own PATENTED MIXTURE OF MANGANIT—plays an important part.

Result . . . Under strict Union Tests "Cordesia" Batteries have proved "THE BEST." An EIGHT WEEKS OLD Battery, under continuous test of 6,000 Ohms, having given 390 Hours Effective Power equivalent to 296 m.a.h.

### MAINTAINED PRICES

4.5 Pocket Lamp Battery  
5d. each 4/6 dozen

### HIGH TENSION

	each
Grid Bias ..	1/3
S.T. 60 volt ..	7/3
S.T. 100 volt ..	12/-
—	
T.C. 60 volt ..	7/6
—	
C.S. 60 volt ..	8/6
C.S. 90 volt ..	12/-
C.S. 100 volt ..	13/6
—	
S.C. 60 volt ..	14/6
S.C. 72 volt ..	17/-

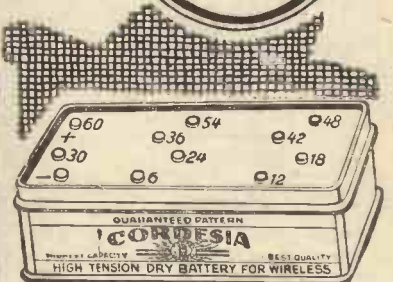

# BUY BEST BATTERIES CORDESIA



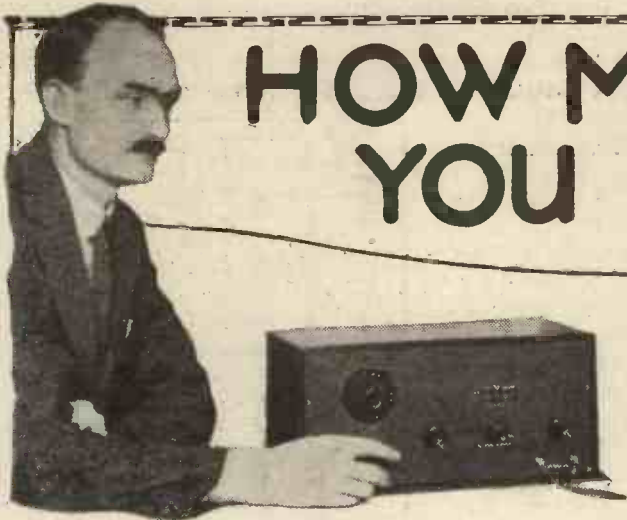

# HOW MUCH DO YOU AMPLIFY?

*The results of a series of interesting tests.*

*By A. EMERSON.*

UNTIL the valve arrived on the scene nobody amplified at all in wireless. There was no broadcasting of speech. Spark transmitters sent out messages by brute force and the receiver did its best with the minute bit of H.F. energy that found its way there from the rending spark of the not very distant transmitter. Our modern crystal sets still rely on this brute-force method to-day; in fact, they are very little improved when compared to a 1913 crystal set. The amplification obtained with a crystal is nil; rather do we cherish every

purser the result. From a purity point of view it is better to start with virile, robust signals from a good aerial and earth rather than set out to amplify anæmic, weakly signals with a multitude of valves. We have the choice of doing either nowadays.

## Valve Amplification

In a valve receiver the H.F. volts across grid and L.T. minus compared with the H.F. volts across the plate and L.T. minus gives us a measure of the actual amplification taking place. The theoretical amplification of a valve is obtained generally from an inspection of the static curves showing grid volts and plate current. For instance, suppose at negative 1 grid volts the plate current is 1 milliampere. At negative 2 grid volts less plate current will flow. Now we can make the plate current return to its original value of 1 milliampere by increasing the H.T. Suppose we have to increase the H.T. by 20 volts to do this. Well, in that case the amplification or "mu" of that particular

valve would be 20 divided by 1 (the amount the grid volts were altered).

In practice it is not possible to make full use of the theoretical "mu" of a valve. We can only use a portion of it. It is possible mathematically to cover many pages with figures and

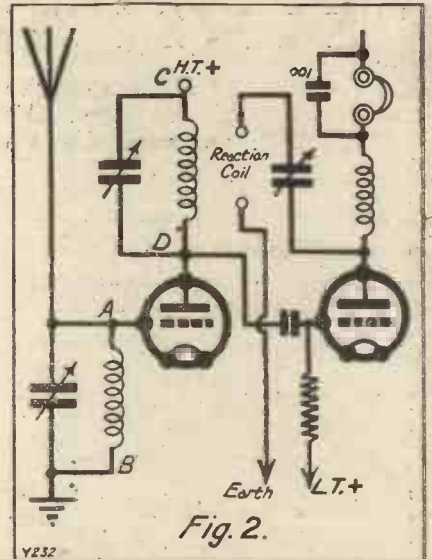

eventually arrive at an answer that shows what a particular circuit should do, but sometimes the answer is wrong.

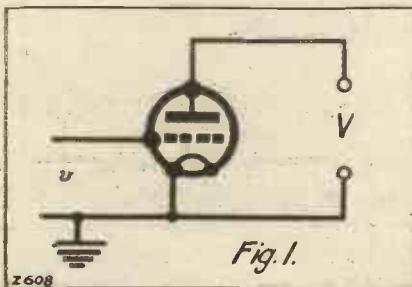

little fraction of H.F. energy so that we may hear what is being said.

## Introducing Distortion

Now we use the valve. With it we can receive the smallest fraction of an H.F. volt, pass it from valve to valve, and build it up into output voltages of a hundred or so, capable of being heard several miles. But the less you have to resort to the valve for amplification the purer will be your result. Particularly does this refer to L.F. amplification, for when a valve passes on a bit of mangled music, the next valve takes it to itself and multiplies the mangled portion into horrible, strange sounds. So it is well to remember that the fewer L.F. valves for a given result, the

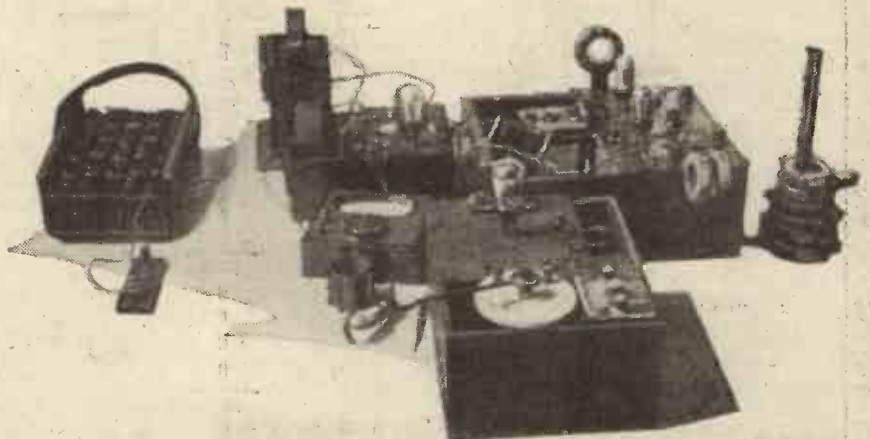

A section of the apparatus used for measuring the efficiency of various stages of amplification

Anyhow, a few practical measurements will give us a good idea as to what is actually occurring in our receivers as regards amplification,

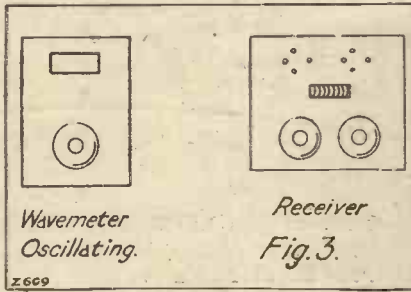

even if our results are only comparative. In these measurements the actual H.F. voltage at the grid of the valve was compared with the H.F. voltage at the anode, in both cases with respect to L.T. minus. The loud speaker, headphones, and any other components normal to the circuit were included in every case.

**H.F. Amplification**

The H.F. or L.F. voltages were measured by a valve voltmeter. This voltmeter throws a small load on the circuit under test, and hence the results must be accepted with some slight reserve. They at least form a basis for comparison.

Investigations were made first of all on a perfectly simple 1 H.F. and Det. receiver, connected up as in Fig. 2.

The valves were both D.E.2H.F.'s, with a theoretical "mu" of 12. The receiver was tuned to 400 metres and a wavemeter coupled to the aerial coil inductively. As a matter of fact, the wavemeter was some two feet away from the coil. Normal aerials and earths were connected up

in order to copy actual receiving conditions as much as possible. The H.F. voltmeter was then connected across A-B with the reaction coil removed. The wavemeter was moved away until the valve voltmeter read .1 H.F. volts.

Then the valve voltmeter was connected across C-D in the tuned-anode circuit. It was necessary to retune both circuits before taking a reading, as the valve voltmeter had a small capacity, about 15  $\mu\mu$  F. The H.F. volts in the anode circuit were .3. This gives us an apparent H.F. amplification of 3 at 400 metres, but this, of course, is partly made up of reaction effects through the plate-to-grid capacity of the H.F. valve.

**Effect of Reaction**

Reaction was then increased until rushing sounds were just not audible. Keeping the aerial coil H.F. volts still at .1 the anode H.F. volts had risen to 1.6. This gives an amplification of 16. Thus the amplification due to deliberate reaction appeared to be just over 5.

We may therefore expect this type of receiver, which used Burndept

coils, to give us actual amplifications of 3 to 16 with full reaction. It is possible to increase reaction further, but distortion results on telephony.

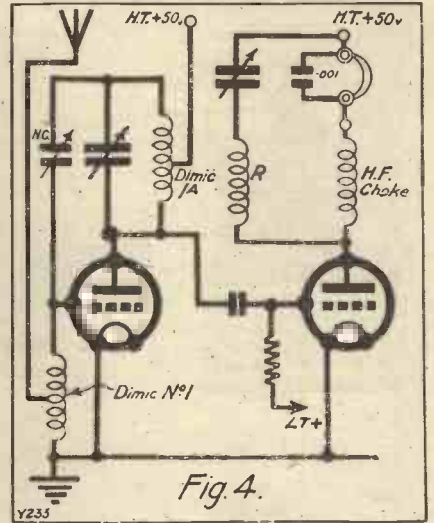

Compare these results with a modern up-to-date receiver that has been neutralised. The H.F. valve was a D.E.H.210, with a theoretical "mu" of 35. Low-loss Dimic coils were used, with centre feed, as in Fig. 4.

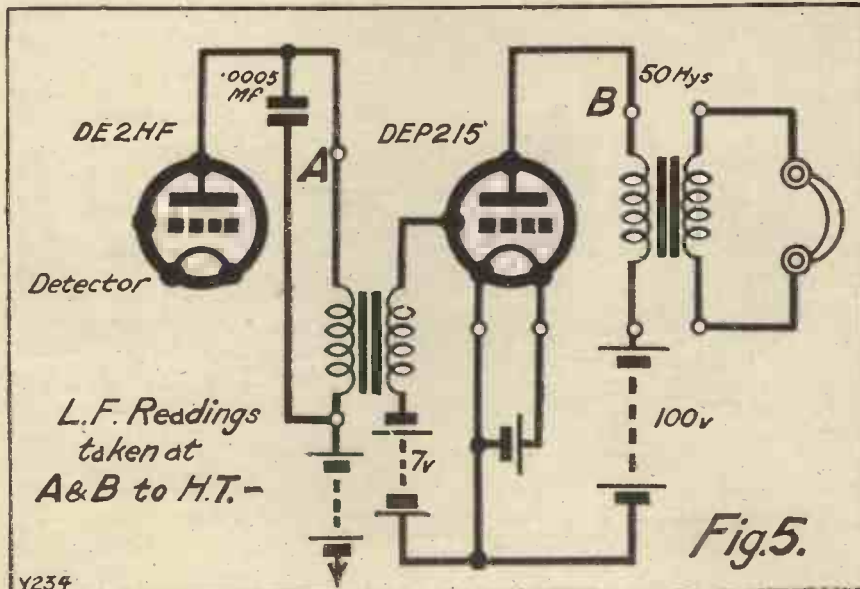
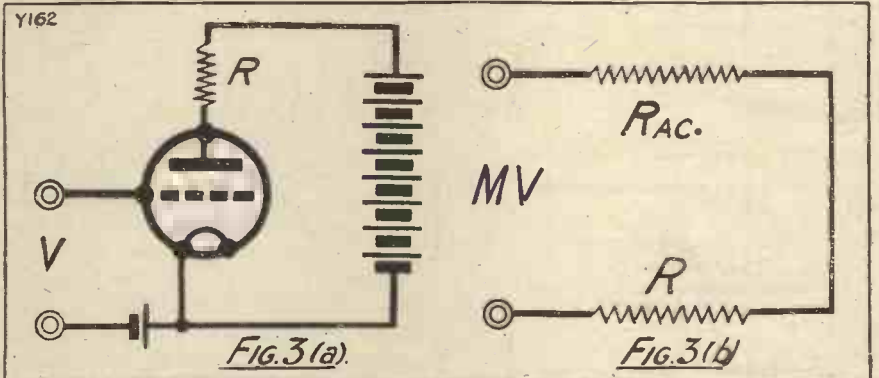

With an input voltage of .1 an output H.F. voltage of 1.6 was received, using no extra reaction. Thus we were getting an actual amplification of 16, assuming that the valve was correctly neutralised. Compared to the theoretical amplification now of 35, our actual amplification is over a half that of the valve. In the first case it was as low as a quarter.

**Result of Modern Design**

Reaction had slightly less effect on this last circuit, giving an additional amplification of 3, possibly because the resistance in the circuit was low already and there was not so much for reaction to do.

These tests prove that our modern valves used with good coils in modern circuits are a step in the right direction. Neutralisation itself does not make a set sensitive. All neutralisation does

**CYLDON THUMB CONTROL CONDENSERS**

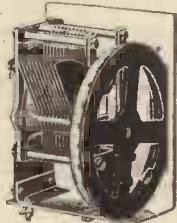

Semi-Shielded Models (as illus.).

Single :

·0005	...	£1 2 0
·0003	...	1 1 0
·00025	...	1 0 6
·0002	...	1 0 0

Also Two-, Three-, and Four-Gang.

Twin and Triple Semi-Shielded Models (as illus.).

	Twin	Triple
·0005	£2 7 0	£3 9 6
·0003	2 5 0	3 6 6
·00025	2 4 0	3 5 0
·0002	2 3 0	3 3 6



**CYLDON BEBE CONDENSER**



·0001	...	7/6
·00015	...	8/-
·0002	...	8/6
·00025	...	9/6
·0003	...	10/6

Prices include small graduated Bakelite Knob dial, 2" in diameter.

**CYLDON STRAIGHT LINE FREQUENCY CONDENSER**

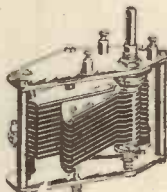

·0005	...	15/6
·00035	...	15/-
·00025	...	14/6

With large 4" Dial, 2" extra.

**CYLDON STRAIGHT LINE WAVELENGTH SQUARE LAW VARIABLE CONDENSER**



·001	...	19/-
·0005	...	15/6
·0003	...	14/6
·00025	...	14/-
·0002	...	13/6

Large 4" Dial, 2" extra

**CYLDON SHORT-WAVE CONDENSER**

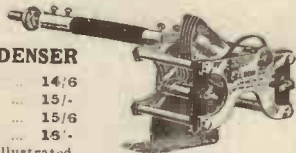

·0001	...	14/6
·00015	...	15/-
·0002	...	15/6
·00025	...	15/-

Complete as illustrated.



**CYLDON TEMPRYTES**

Temprytes	...	1/6
Mounts	...	1/-
Shorting Plugs	...	6d.

**CYLDON GANG CONDENSERS**

	Two-Gang	Three-Gang	Four-Gang
·0005	£2 10 0	£3 10 0	£4 10 0
·0003	2 2 6	3 2 6	4 2 6
·00025	2 0 0	3 0 0	4 0 0

Dial extra.

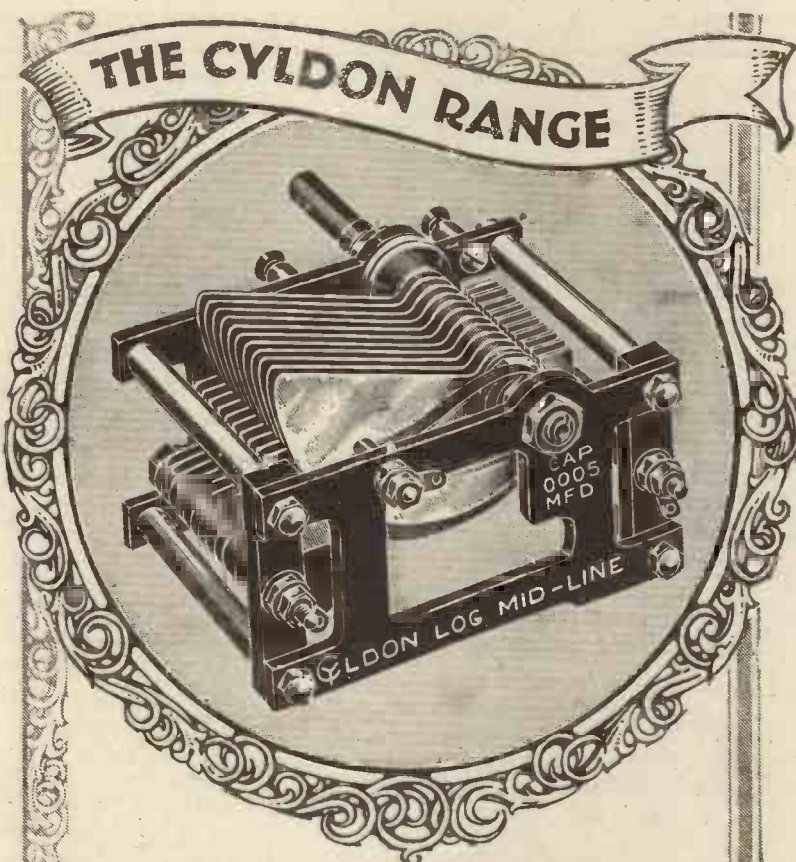
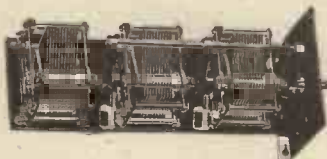

**CYLDON LOG MID-LINE CONDENSERS**

(1) Spread all stations evenly over whole dial. (2) Prevent stations "falling out of step". (3) Dial readings in multi-tuned circuits using individual condensers made the same. (4) Thick aluminium plates. (5) Large, adjustable, non-wearing bearings. (6) Pig-tail connection to rotor. (7) Extremely well made; electrically efficient; precision movement.

**PRICES :**

·001 : 19/-	·0005 : 15/6	·0003 : 14/6
·00025 : 14/-	·0002 : 13/6	

With 4-in. Knob Dial, 2"-extra. In the case of gang condensers, Log Mid-line condensers are a necessity, not a luxury.

Every genuine "Cyldon" product bears the registered trade mark, a guarantee that the world's best brains and manufacturing resources have gone to its making.

**EVERY "CYLDON" CONDENSER IS GUARANTEED UNCONDITIONALLY**

See us at Stand No. 5, Manchester Wireless Exhibition, October 24 to November 5.

Write for our latest interesting publication—"Concerning Variable Condensers"—our latest illustrated Catalogue and the Tempryte chart **FREE AND POST FREE**

**SYDNEY S. BIRD & SONS, LTD.**

CYLDON WORKS,

SARNESFIELD RD., ENFIELD TOWN, MIDDLESEX

Contractors to the B.B.C., H.M.R.A.F., H.M.O.W., and all the leading manufacturers of quality receivers.

Sole Australian Agent : E. V. Hudson, 55-7, Charlotte Street, Brisbane, Queensland.

is to permit high "mu" valves and efficient coils and circuits to be employed. It is the latter that give the results.

The intervalve transformer was a Sullivan some four or five years old. On an organ the output voltages in both cases flickered up to a maxi-

second to 6,000 p.p.s. The frequency was measured with the aid of a Campbell frequency meter. With the help of these instruments I was able to put the L.F. valves and their couplings through their paces. The actual L.F. output of the last valve does not, of course, represent what the valve is doing by itself, for the 50-henry 'phone transformer has a say in the matter. However, there is always some sort of inductance in any case, and the results give an idea as to what the average set does with the L.F. notes. However, the performance of the first transformer-coupled valve does give a very good idea of what resistance coupling can do.

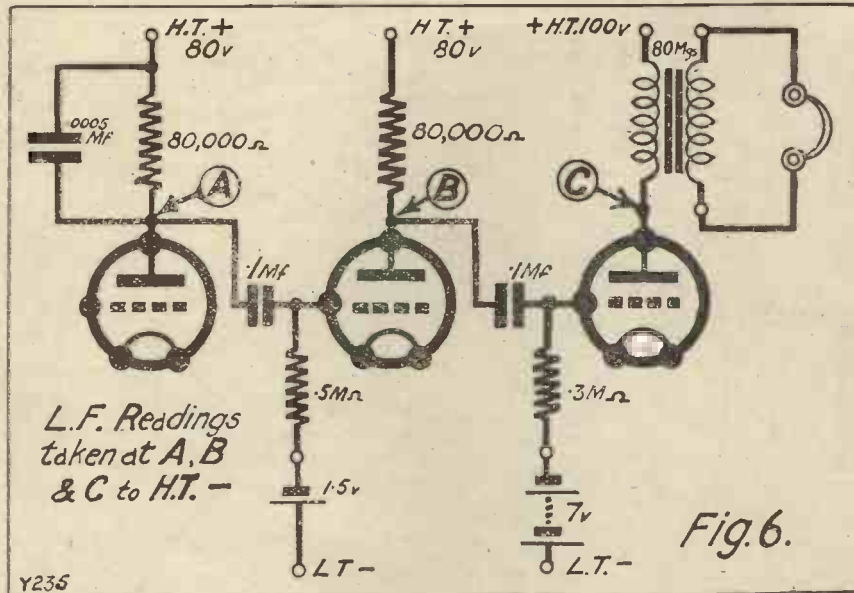

A complete test was made with the first circuit on 5 X X from the H.F. volts on the aerial coil to the L.F. volts on the last valve, using transformer coupling and resistance coupling. With an H.F. voltage on the aerial coil of .05 there was .65 H.F. volts across the anode coil. Reaction had to be used a little, so results cannot be compared with the other tests. The H.F. voltage of .65 was impressed on the grid of the detector valve. This valve sorted out the modulated L.F. components and on the tuning note passed on .18 L.F. volts to the first L.F. resistance valve. This valve amplified the .18 up to 1.0 volts and passed it on via a .125 mica condenser to the last valve. In the plate circuit of this valve, a D.E.P. 215, there was a telephone transformer with an inductance of about 50 henries. The L.F. voltage across this transformer was 9 volts for the tuning note. This works out at a total amplification of  $\times 50$  for the low frequencies.

**Further Results**

Using an intervalve transformer, an input of .38 L.F. volts on the tuning note was amplified to 8 volts across the last valve connected as before. This gives an overall amplification of only  $\times 21$ .

The accompanying diagrams show the circuits used and values of the components. Mica condensers made by Dubilier were used for the L.F. couplings, .125 mfd. The resistance amplifier was not of the high "mu"

type. The intervalve transformer was a Sullivan some four or five years old. On an organ the output voltages in both cases flickered up to a maximum of 25 volts to 27 volts. Thus, if the last valve was amplifying about 9 times the input voltage to its grid would have been about 3 volts, and grid bias used of 7 volts would only just be sufficient. For really safe results making sure of not running into grid current a bias of 10 or 12 volts and an H.T. of 150 would have been better. As it was, it was possible to obtain sufficient strength to fill a normal-sized room on a loud speaker.

**The Method Employed**

Perhaps a description of how these tests were made will help us to understand more about them. Although I have seen beautiful amplification curves that go in a dead straight line, yet I have never seen the result of testing a receiver from H.F. to L.F., making every valve do its job, so I have attempted to do this, injecting modulated H.F., making the detector detect it, and then measuring the amplification on the L.F. side.

The first instrument required was an oscillating wavemeter. This was adjusted to 1,400 metres. The H.F. circuits of the receiver were carefully tuned to it. Then the Cambridge L.F. oscillator was coupled into the plate circuit of the wave-meter, into which it injected a volt or two of the desired frequency.

The modulated H.F. was amplified

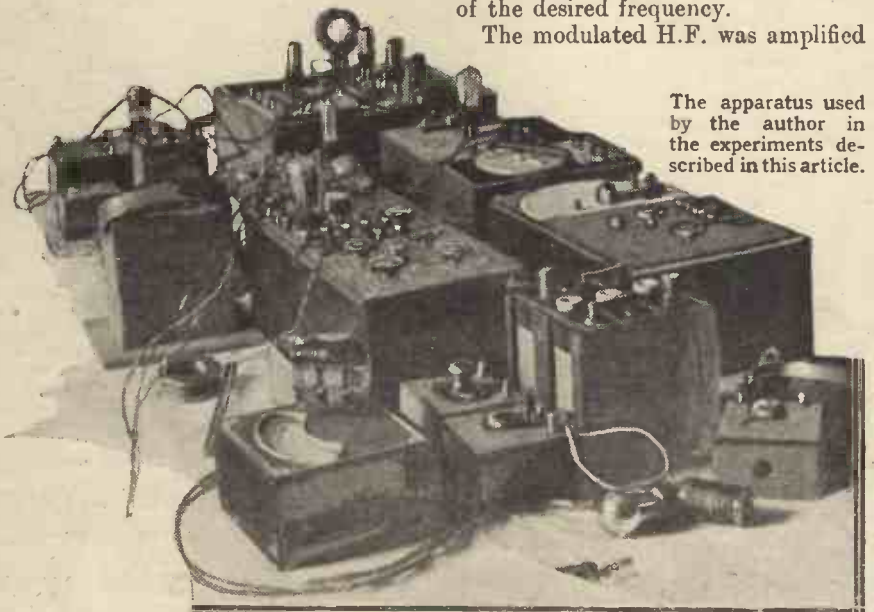

The apparatus used by the author in the experiments described in this article.

Thanks to the kindness of the Cambridge Instrument Co. I was able to obtain an L.F. oscillator capable of giving a pure sine wave output from about 60 periods per

and detected by the receiver in the ordinary way, the detector then sorted out the L.F. components, and they were passed on to be amplified.

(Continued on page 538.)



**ONLY 90!**

now is all you need pay for a handsome Hornless Loud Speaker

THERE'S no need now to pay a high price for your Loud Speaker. Only ninety shillings will buy an instrument which will satisfy the most discriminating ear and the most fastidious eye. The BROWN Mascot Loud Speaker is unrivalled at its price both in performance and appearance. It will give you—now and always—a reproduction that is so true that it can only be compared with the original. That is

unmatched, in its class, in the purity of its tone, and unequalled in the majesty of its volume.

The reproduction you hear when first you listen to the Mascot is the reproduction you will hear after years of use. That is a guarantee upon which the world-famous BROWN reputation is staked. Hear the Mascot at your Dealer's, or, better still, get him to demonstrate it in your own home. Price 90/-.

Hear also the new BROWN UNIVERSAL Loud Speaker Price £6

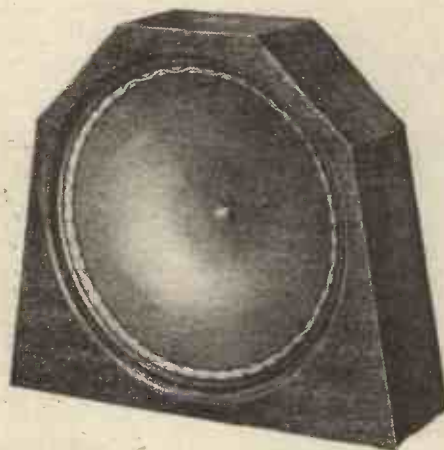

Unrivalled, at its price, for Performance and Appearance

# Brown Mascot Loud Speaker

S. G. Brown, Ltd., Western Avenue, North Acton, London, W.3.

# A STANDARD WAVE TRAP

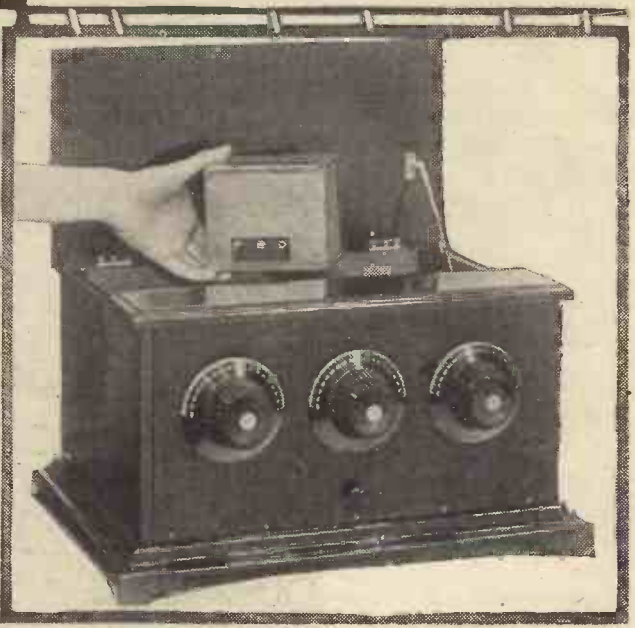

*This cheap and efficient little instrument for cutting out the local station is easily and quickly made, and can be used with any existing set. It is being adopted as a standard accessory for incorporation in future receivers.*

*Designed and Described by  
G. P. KENDALL, B.Sc.*

UNTIL recently there was somewhat of a tendency to regard the wave-trap as a device for the novice, which the experienced constructor was a little ashamed to use, since it seemed to cast aspersions, by its very presence, upon the selectivity of his set.

The general feeling seemed to be that wave-traps were all very well for the man who was not capable of handling a really selective and sharp-tuning receiver, but that even he would do better to build himself a decent set and learn to operate it as soon as possible.



The wave-trap can be totally screened to prevent interaction with the receiver.

No doubt part of this anti-trap prejudice was due to a lingering suspicion, dating from the earlier days when only crude forms were available, that traps were unreliable, but this particular objection was gradually disappearing as the merits of the reliable series auto-coupled type were discovered. Now, however, the trap is undergoing a rapid rise in

popularity, for two main reasons. The first is the arrival of Daventry Junior, which has led a large pro-

**COMPONENTS REQUIRED.**

- 1 baseboard, 3½ in. × 3½ in. × 5/16 in.
- 1 three-ply strip, 1 in. × 3½ in.
- 1 terminal strip, 2½ in. × 1½ in.
- 1 terminal.
- 2 sockets and 1 plug. (Clix or similar type.)
- 1 piece ebonite, Pirtold or similar tubing, 2 in. diameter and 2½ in. long.
- 1 compression-type variable condenser (see text for capacity). (Formodenser or similar type.)
- Wire for coil (see text).

portion of those people who previously were content to listen to one

programme to desire to cut out their local station and receive the alternative transmission. It is obviously useless to urge listeners of this type to scrap perfectly good sets of the "local" type and build selective receivers with neutralised H.F. stages and efficient screening arrangements, since the expense is clearly not justified for the sake of receiving one extra station.

This reason alone is sufficient to cause a much more widespread use of traps, but there is another one which is likely to have a strong influence on the man who uses more elaborate long-range receivers, and that is the introduction of the screened-grid valve for H.F. amplification.

The extreme simplicity of the instrument will be apparent from this view.

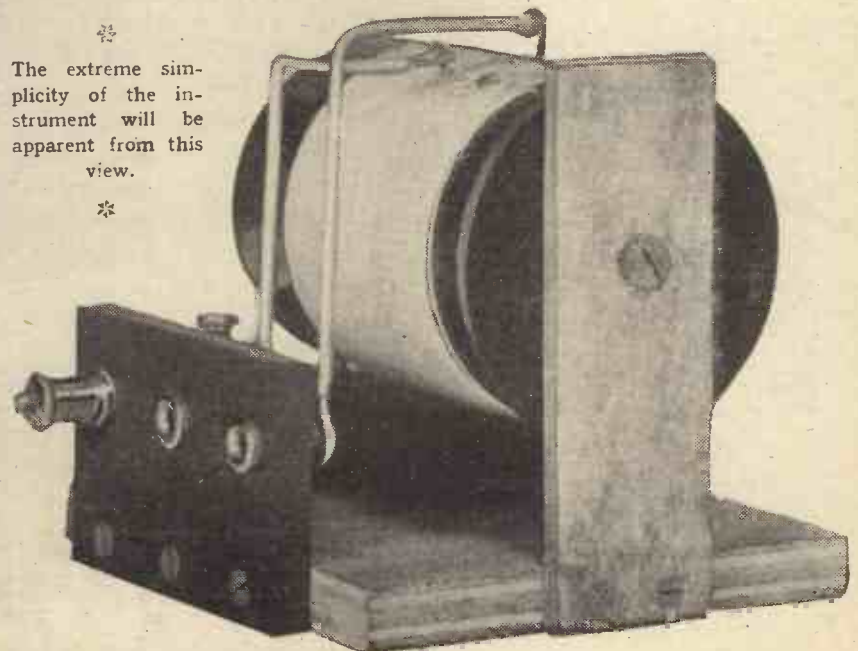

# THE REAL SOLUTION



## TO THE BATTERY CHARGING PROBLEM

Philips Battery Charger Type No. 1009 ensures accumulators being maintained at full capacity from the electric light mains.

There is no complicated mechanism. A small control in the output lead enables either H.T. or L.T. accumulators to be charged.

The Unit is quite simple to use, reliable and there is no fear of over-charging with the consequent damage to the plates. Philips Battery Charger Type No. 1009 is supplied for any voltages from 100 to 260.

*See Stand No. 24 at the Manchester Radio Exhibition.*

# PHILIPS

## For Radio

*Advt. Philips Lamp, Ltd., Philips House, 145, Charing Cross Road, London, W.C.2.*

One of the standard methods of using this valve is with a plain tuned-anode circuit, and the selectivity of such a scheme is not particularly high, as most experimenters know. When only a single stage is used, employing tuned-anode coupling to the detector valve, the selectivity obtained is only moderate. By using reasonably good tuning circuits and a coupled aerial system an adequate degree of selectivity for general purposes can be got, but there is likely to be some little difficulty in cutting out the local station at the shorter distances, and here again a trap will prove extremely useful.

**Interaction Difficulties**

It is considered, therefore, that considerable use is likely to be made of traps in the future, and a review of the position has been undertaken by the "M.W." Research Dept., with a view to ascertaining whether a standard type of trap could be devised which could be applied to practically any type of set. It was considered that such a universal trap should be capable of actual incorporation in the set to which it is added, and experiments showed that this was not a very easy matter, since interaction between the trap and other circuits in the set was very prone to produce undesirable effects. The trouble was less pronounced with the more modern types of sets using fairly complete shielding, but even here care was needed in some cases.

**A Reliable Type**

The circuit to adopt was easily decided upon, since the series auto-coupled type has so many advantages,

decided to make provision for screening the trap when necessary, such provision to be arranged in such a way that the screen can be omitted

construction without producing too inefficient a coil. The unit finally adopted contains a coil of two inches diameter, and the tuning device

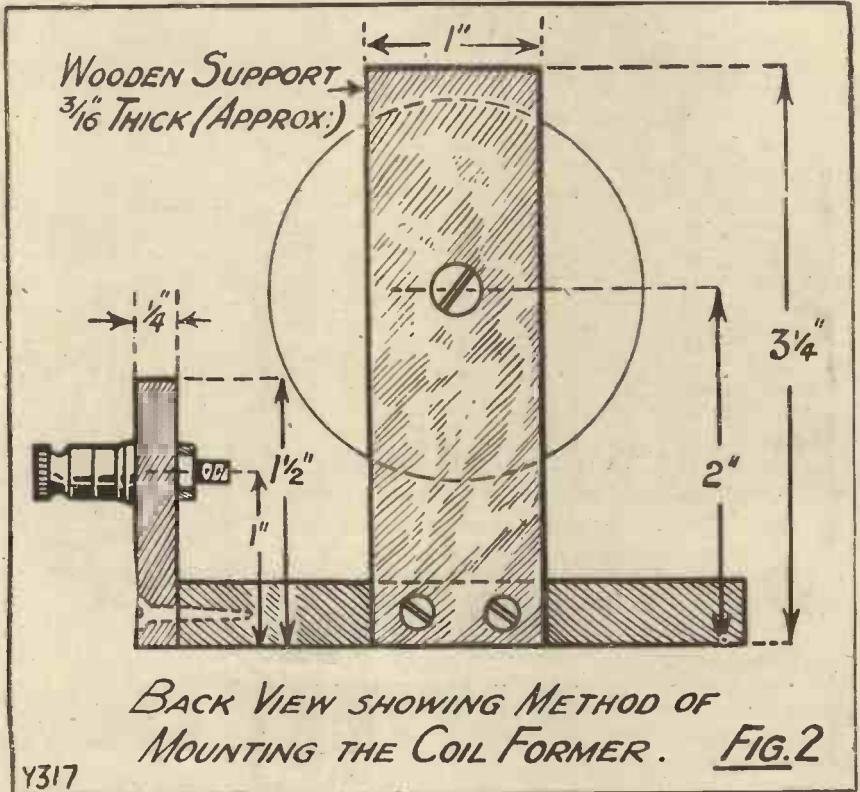

when desired. In very difficult cases it would then be possible to screen the trap completely, in others only a partial screening scheme could be adopted, and in others again the trap could be used without shielding, the essential parts being so arranged that these points could be left to the discretion of the set designer.

To conform effectively with these requirements it was found that a

is one of the small variable condensers of the compact compression type which is now becoming popular for work of this kind. Provision is made for varying the position of the aerial tap along the coil to suit different requirements, a small strip of ebonite being used to carry a terminal for one connection to the trap, and two "Clix" sockets. The other connection to the trap is provided with a "Clix" plug, and this is inserted in one or other of the sockets, so varying the number of turns used for coupling. The whole assembly is mounted on a small wooden baseboard, which can be screwed down in a suitable position in the set.

Complete details of the trap will be given here, and the constructor is advised to keep them at hand for future reference, since in forthcoming sets it will be found that the specification may in some instances call for "one standard wave-trap," without repeating the data given here.

The baseboard is  $3\frac{1}{4}$  in. wide,  $3\frac{3}{4}$  in. long, and about  $\frac{5}{16}$  in. thick. The coil is wound upon a tube 2 in. in diameter and  $2\frac{3}{4}$  in. long, the method of mounting being well seen in the photographs. This is done by means of a strip of three-ply or other thin wood of the width given in one of

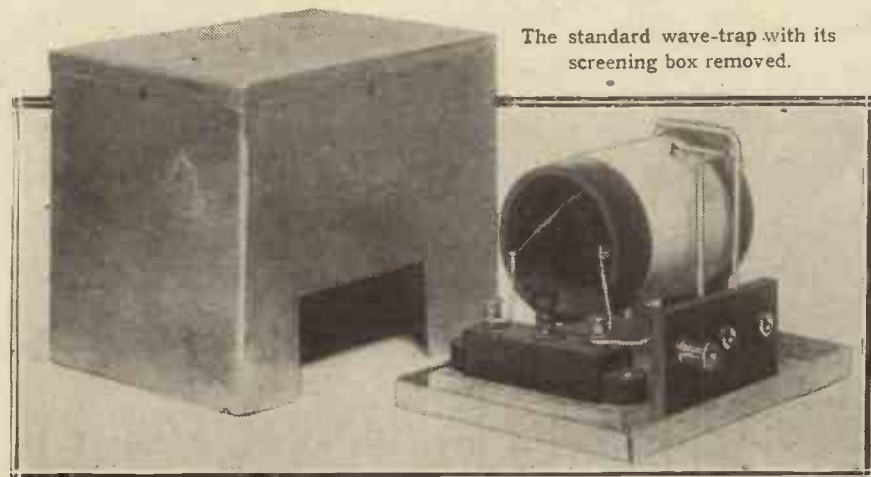

both as a trap and from the point of view of simplicity of construction and operation. The interaction problem is more difficult, and it was finally

trap coil of fairly small dimensions was necessary, and the one finally adopted was about as small as is possible with ordinary methods of



**MAINS  
POWER  
AT A  
TOUCH**  
FROM THE NEW

**“EKCO”**

**ONLY 17'6**

**M.1 H.T. ADAPTOR**  
FOR D.C. MAINS - 17/6 Complete

The cheapest, most compact and handiest—although thoroughly reliable—form of H.T. supply. Provides one tapping of 60 or 90 or 120 volts at 10 milliamps. In the form of an enlarged adaptor, 3" x 2" diameter, fitting direct into the lamp-socket. Suitable for 1 to 3 valve sets only.



**M.2 H.T. MODEL**  
FOR  
D.C. MAINS  
29/6 Complete

Provides two tappings of 60 and 120 volts at 10 milliamps. Suitable for 1 to 3 valves only.



Write for new "EKCO" folders giving full details of the new 1927-28 "EKCO" Units!

*Safe! Silent! Sound!*

**E.K. COLE LTD** DEPT. M.W., "EKCO" WORKS,  
LONDON RD., LEIGH-ON-SEA

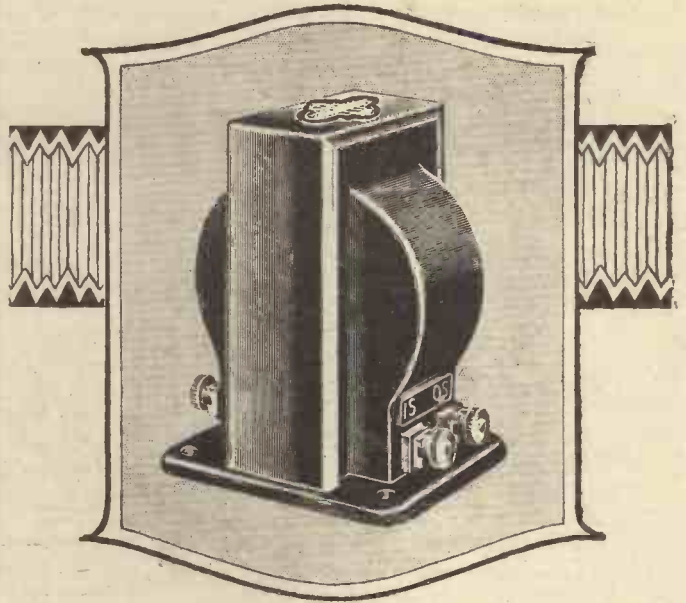

**All L.F. Transformers  
yield first place to this!**

It is Igranitic "G" Type L.F. Transformer—the latest product of Igranitic research. For high amplification and faithful reproduction of all audible frequencies it is unapproached by any other instrument at present obtainable. Whenever L.F. Transformers are needed, use Igranitic "G" Type. Totally enclosed to prevent interaction, and wound to entirely eliminate breakdowns.

It is made in two ratios—3.6 to 1 for use in first and single stages, and 7.2 to 1 for second stages and for use with low impedance valves.

Price  
30/-

Write for publication J322 which describes this and all the recent Igranitic developments.



149, Queen Victoria Street, London  
WORKS: BEDFORD  
BRANCHES: BIRMINGHAM, BRISTOL, CARDIFF, GLASGOW,  
LEEDS, MANCHESTER, NEWCASTLE

the drawings. One end of this strip is screwed to the edge of the baseboard, and the upper end carries the coil former. This can be attached with screws by fitting either a wooden disc or a simple crosspiece of wood inside the end of the ebonite tube, this being held in place by screws passing through the tube. Any other convenient method of mounting can, of course, be adopted, provided that it does not involve the use of large pieces of metal, and also that it supports the coil at the correct height. (This is important, to conform with the screening arrangements.)

The coil consists of 68 turns of either No. 28 double cotton covered wire or the same number of turns of 9/38 Litz wire. The latter material gives a better coil for this purpose, and is advised where the constructor is sufficiently experienced to be able to deal with it properly. It is important, when using Litz, to clean thoroughly the end of every strand and see that a perfect soldered joint

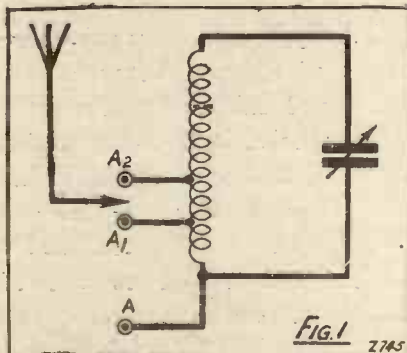

is made to each strand. The only way to be sure of this is to tin each strand separately, then twist them together and dip them in a bead of molten solder on the end of the iron before attempting to solder the Litz to the point to which it is wired in the trap. Tappings are made at the sixteenth and twenty-second turns, connections being taken off to the sockets on the terminal strip.

**The Condenser**

The capacity of the variable condenser will be either .0003 (or .00025; of course, if no .0003 is available in the make chosen) or .0005, and the decision will depend upon the wave of the local station which it is desired to cut out. If this is under 400 metres, a capacity of .0003 is required, while if it is of 400 metres or over, .0005 is desirable. This is important, and care should be taken in ordering to specify the correct capacity.

Screening arrangements will usually be dealt with in describing sets incorporating the trap, but it may be mentioned that where complete

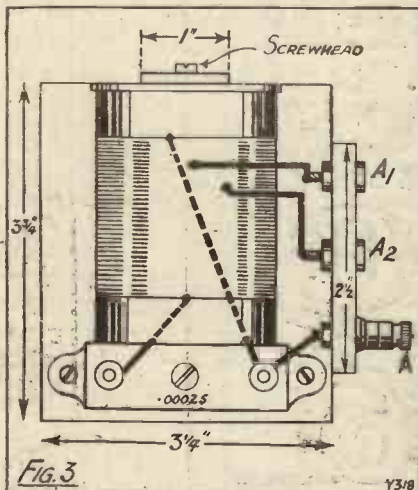

shielding is required good results can be obtained by using one of the rectangular boxes produced by Messrs. Leslie McMichael for use with their "Dinic" coils, the method being shown in one of the photographs. Note that part of one side of this box must be cut away to clear the terminal and sockets, as shown, and that a hole must be drilled in the upper side of the box through which a screwdriver can be inserted for the purpose of adjusting the condenser. (This must be done with the box closed, if one is used.)

Various methods of using the trap

will occur to the reader, but a detailed consideration of the practical points arising in its use must be left for future occasions when sets incorporating the component are described. Just one point must be made clear, however, and that is that this trap (in common with all others of this general type) is not intended to cut out Morse, interference from tramcars, atmospherics, or any other flatly-tuned or aperiodic interference.

It should perhaps be pointed out that it has been borne in mind in producing this trap that the complete tuned circuit which it incorporates forms a useful unit for odd jobs, and the connections, etc., were accordingly arranged to permit it to be used in a variety of ways. For example, it can be used as a stand-by crystal set in an emergency by mounting a crystal detector on the baseboard alongside the coil, on the side away from the terminal strip, where there is just room for a fairly compact one.

One side of the detector is then wired to the condenser terminal farthest from the earth terminal, one 'phone tag being attached to the other detector terminal. The remaining 'phone tag is next screwed down under the terminal on the terminal strip. The aerial will then be plugged into one of the sockets, and the earth attached to the terminal.



The connections to the coil and condenser are clearly shown above.



### For R·C Circuits

THE fixed Mica Condenser (Type B775) shown here is designed for use in Resistance Capacity amplifiers and in other circuits where condensers of large capacity are required to withstand potentials of several hundred volts.

They are tested during manufacture at a potential of 500 volts D.C. and are hermetically sealed in handsome black bakelite cases carrying screw terminals and solder tags.

Standard capacities and prices are as follows:—

Capacities	Prices	Capacities	Prices
0.02 mfd.	5/6	0.09 mfd.	8/-
0.03 "	5/6	0.1 "	8.6
0.04 "	5/6	0.125 "	10/-
0.05 "	5/6	0.15 "	12/-
0.06 "	6/6	0.2 "	15.6
0.07 "	7/-	0.25 "	19/-
0.08 "	7/6	0.3 "	22.6



Advt. of the Dubilier Condenser Co. (1925), Ltd.,  
 Ducon Works, Victoria Road, North Acton, W.3

T.C.54

WE DO NOT TALK ABOUT SUCCESS—WE GUARANTEE IT.

# Guarantee

I hereby guarantee that I will provide each Student of The Bennett College with tuition until he has passed the examination for which he has enrolled.  
 I further guarantee to provide all the necessary books free of charge and undertake that no further fees will be required other than those stated on the form of enrolment.

WE GIVE A WRITTEN COPY OF THIS GUARANTEE TO EVERY STUDENT.

*J. Bennett* F.R.S.A., M.I.Mar.F., A.I.Struct.E.,  
 M.B.I.P.S., etc.  
 (GOVERNOR), THE BENNETT COLLEGE,  
 SHEFFIELD.

Having helped thousands of others to achieve success and advancement, it may be possible that we can help YOU.

I am assisted by a large and expert staff, and the advice we give is sound. If we cannot help you we will say so; if we can we will tell you how.

We have FREE booklets setting out the possibilities in connection with each of the subjects shown in the lists; send for the one in which you are interested, or ask for MY PRIVATE ADVICE, which also is free. You incur no obligation.



Most Moderate Charges, Payable Monthly.

EXPERT TUTORS FOR EVERY DEPARTMENT.

Have You ANY Ambition?

### WE TEACH ALL THE FOLLOWING SUBJECTS:

COMMERCIAL.	TECHNICAL—Con.	TECHNICAL—Con.
Accountancy	Secretaryship	Internal Combustion Engines
Advert. Writing	Workshop Organisation	Marine Eng. B.O.T.
Salesmanship		Mathematics
Army Certifc. Courses	TECHNICAL.	Matriculation
Auctioneering and Estate Agency	Applied Mechanics	Metallurgy
Auditing	Architectural Drawing	Mining
Banking	Building Construction	Mine Surveying
Book-keeping	Clerk of Works' Duties	Motor Engineering
Civil Service	Boiler Engineering	Naval Architecture
College of Preceptors	Boiler Making	Pattern Making
Commercial Arithmetic	Chemistry	Post Office Examinations
Commercial Law	Civil Engineering	Quantity Surveying
Company Law	Concrete and Steel	Road Making and Maintenance
Costing	Draughtsmanship	Sanitation
Economics	Electrical Engineering	Shipbuilding
English and French	Practical Mechanical Engineering	Structural Engineering
Executorship Law	Engineering Costing,	Surveying and Levelling
Foreign Exchange	Quantities and Specifications	Surveyors of Works, R.E.
General Education	Foundry Work	Telegraphy and Telephony
Modern Business Methods	Heat Engines	Town Planning
Police Entrance and Promotion Courses		Wireless Telegraphy
		Works Managers' Course

WE SPECIALISE IN PREPARATION FOR ALL EXAMINATIONS.  
 WE TEACH BY POST IN ALL PARTS OF THE WORLD.

Note Address: THE BENNETT COLLEGE, DEPT. 134, SHEFFIELD.



## Advertisements

As far as possible all advertisements appearing in "M.W." are subjected to careful scrutiny before publication, but should any reader experience delay or difficulty in getting orders fulfilled, or should the goods supplied not be as advertised, information should be sent to the Advertisement Manager, "Modern Wireless," 4, Ludgate Circus, London, E.C.4.

### REFUSE IMITATIONS



Make sure of having the prize-winning original Former by buying only Formers bearing the Trade Mark "Becol."



THE BRITISH EBONITE COMPANY, LIMITED.  
 HANWELL LONDON W.7.

# RADIO NOTES AND NEWS OF THE MONTH

A feature in which our Contributor brings to your notice some of the more interesting and important Radio news items.

Conducted by P. R. BIRD.

### B.B.C.'s New Short-Wave Station

At last there is definite progress to report in connection with B.B.C. Short-wave Empire broadcasting. A recently issued statement says that an experimental transmitting station is now in course of erection at Chelmsford, from where it will carry out tests on 24 metres. (Chelmsford, it will be remembered, was the birthplace of the first "5 X X.")

### Plenty of Power

The call-sign of this new station is to be 5 SW, and the power to be employed will eventually be the same as 5 GB's (about 25 kw.), though no doubt it will start off with less, and progressively increase as results permit.

The aerial is to utilise the masts

at the Marconi Co.'s Chelmsford works, these being 480 feet in height. Unless the initial tests are unexpectedly successful, there will be no attempt at prolonged programmes at first, but the B.B.C. hopes that Empire programmes may be a really practicable proposition next year.

### The Exhibition Attendance

As I anticipated, the National Radio Exhibition was a huge success at Olympia this year. On opening day 13,347 people paid for admission, and this total was beaten during the week, Wednesday's figures being 15,195. The grand total for the seven days was 78,886.

### Long-Distance Crystal Set

Arising out of my recent remarks about crystal sets that can pick up foreign programmes without the help

of re-radiation, a Newcastle reader has kindly sent me a list of stations heard during September that will be hard to beat.

His aerial is within two miles of 5 N O, so he listened to that station on a loud speaker. If he didn't like the programme he tried for either Daventry or Hilversum, either of which could be heard when 5 N O was going full tilt!

After 11 p.m., when the local had gone to bed, Hamburg, Frankfurt, Langenberg, Vienna, and 5 G B were tuned in. And this same crystal set provided the Sunday lunch-time music from Radio Paris! Can anybody beat that string, without the aid of a valve?

### PCJJ Programmes on Short Waves

As many short-wave enthusiasts have inquired at what times the Eindhoven station transmits, I have been trying to get details of the hours of service. But owing to the experimental nature of the Phillips short-wave station, and to the fact that it is moving to Hilversum, its programmes cannot be fixed up in advance. It is anticipated that the transmitter will be off the air for about six weeks in all.

(Continued on page 528.)

## The Latest Radio Development



### GRAMOPHONE ELECTRICAL PICK-UP



The Magnum is the latest and easily the lowest-priced Pick-up. One of its unique features is its volume control. You can regulate its amazingly pure reproduction from a faint whisper to the maximum volume your wireless amplifier can give.

Adapted to any gramophone instantly. You have merely to fit the Magnum Pick-up on to the tone-arm and connect to the amplifying side of your wireless set. Uses all types of needles.

# 35/-

SEND STAMP FOR PARTICULARS

## BURNE-JONES & CO. LTD., MAGNUM HOUSE TELEPHONE: HOP 6257

288, BOROUGH HIGH ST., LONDON, S.E.1

## CONSTRUCT THE "40-STATION" FOUR

as described in this issue.

	£	s.	d.
1 Mahogany Cabinet with baseboard	1	15	0
1 Ebonite Panel, matt finish, 21 x 7 1/2 in.	0	8	0
2 Cylton Log Mid Line Condensers, '0005	1	15	0
1 Cylton sq. law Condenser, '0003	0	16	6
2 Ormond Slow-motion Dials	0	10	0
2 Lewcos 6-pin Bases	0	5	6
1 Collinson Tapped Grid H.F. Transformer	0	9	6
1 Lewcos Binocular Reinartz Transformer	0	10	0
1 R.I.-Varley H.F. Choke	0	9	6
1 R.I.-Varley type "A" R.C. Coupler	1	0	0
1 Marconiphone Transformer, 6 to 1	1	5	0
4 Vibro Valve Holders	0	10	0
4 Burndy Fixed Resistors and Screw Holders	0	10	0
1 Lissen Baseboard Potentiometer	0	1	6
1 Lissen Panel Potentiometer	0	2	6
1 Neutralising Condenser	0	5	0
1 Double Circuit Jack	0	2	6
1 Single Circuit Single Fil. Jack	0	2	6
1 Dubilier Fixed Condenser, '002	0	3	0
1 Dubilier Grid Leak, '25 meg.	0	2	6
1 T.C.C. Fixed Condenser, '01	0	2	4
2 T.C.C. Fixed Condensers, 1 mfd.	0	5	8
1 T.C.C. Fixed Condenser, 2 mfd.	0	3	10
1 Set G.B. Battery Clips	0	1	0
1 On and Off Switch	0	1	6
7 Belling-Lee Terminals, as described	0	5	3
1 Terminal Panel for seven terminals drilled	0	0	9
1 Terminal Panel for two terminals drilled	0	0	3
1 Small Knob for reaction condenser	0	0	9
Glazite, assorted screws, and wander plugs	0	5	2
			£12 10 0

NOTE.—Where a complete set of components is purchased together Marconi Royalties at the rate of 12/6 per valve holder are payable. Any of the above components supplied separately as desired. Components supplied for all sets described herein. Send Stamp for 36 page Catalogue and Lists.



**THE GUARANTEE OF THE PERFECT TERMINAL**

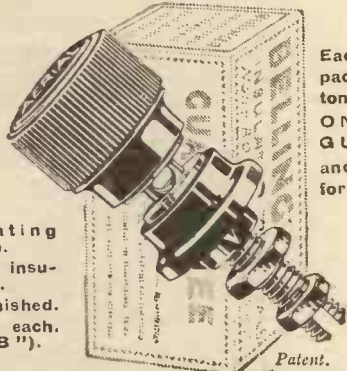

Each terminal packed in a carton with a printed ONE YEAR'S GUARANTEE and instructions for mounting.

Non-rotating name.  
Bakelite insulated.  
Highly finished.  
Price 9d. each.  
(Type "B").

Patent.

**THE BEST DESIGNED TERMINAL IN THE WORLD.**

Other types available—

- Type M. Nickel-plated Metal with non-rotating name 6d.
- Type R. Small with insulated head and rotating name 3d.

ALL TYPES SUPPLIED IN 30 DIFFERENT LETTERINGS.



Obtainable from all Dealers, or in case of difficulty send your order to us, enclosing your Dealer's name and address.  
**BELLING & LEE, Ltd., Queensway Works, PONDERS END, MIDDLESEX.**

**Made with the accuracy of a Gun !!**

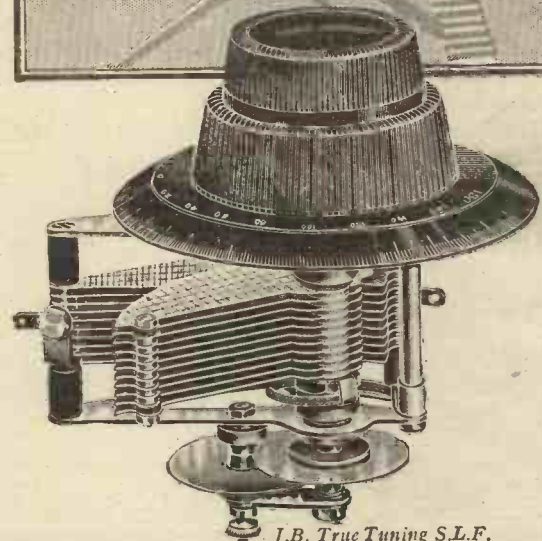
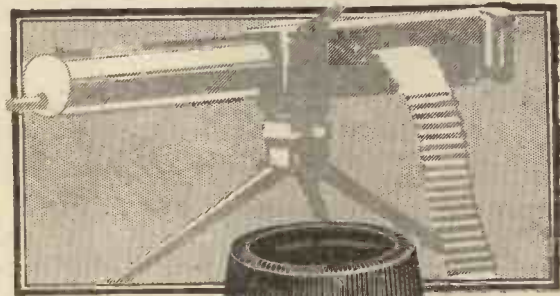

J.B. True Tuning S.L.F.

The same care and attention which are exercised in the design and construction of the most delicate mechanism of a gun are displayed in all J.B. Condensers.

Accurate to the finest point, and perfectly finished, J.B. Condensers can be well compared to the finest gun ever made.

There is no sign of backlash in the J.B. models. The dial is turned and the stations come in with unflinching regularity.

**THE PERFECT FIVE.**

1. J.B. S.L.F., Slow Motion. (J.B. True Tuning S.L.F.) Double Reduction Friction Drive. Ratio 60-1. Prices, complete with 4-in. Bakelite Dial for coarse tuning and 2-in. Bakelite knob for Slow Motion Device. '0005 mfd. 16/6; '00035 mfd. 15/6; '00025 mfd. 15/-; '00015 mfd. 15/-
2. J.B., S.L.F. Prices, complete with 4-in. Bakelite Dial. '0005 mfd. 11/6; '00035 mfd. 10/6; '00025 mfd. 10/-; '00015 mfd. 10/-
3. J.B. Log Plain. Prices, complete with 4-in. Bakelite Dial. '0005 mfd. 11/6; '0003 mfd. 10/6; '00025 mfd. 10/-; '00015 mfd. 10/-
4. J.B. Log. Slow Motion. Double Reduction Friction Drive Ratio 60-1. Prices, complete with 2-in. Bakelite knob for vernier control and 4-in. Bakelite Dial for main control. '0005 mfd. 16/6; '0003 mfd. 15/6; '00025 mfd. 15/-; '00015 15/-
5. J.B. Neutralising Condenser. Price 3/6.

**JACKSON BROS.**  
8, POLAND ST- OXFORD ST  
LONDON - W.1. Telephone - GERRARD 7414

**A RADIO BOOK EVERY ENTHUSIAST SHOULD HAVE**

SET BUILDERS. THE WORLD'S GREATEST RADIO PUBLICATION IS HERE!

EUROPEAN EDITION OF CITIZENS RADIO CALL BOOK.

Contains full details of very latest American Circuits and Receivers. Graphic illustrations and diagrams, constructional data and other information enabling the novice to construct the World's finest sets.

Full list of Broadcasting Stations, helpful hints and tips. Unquestionably the finest value and most useful book of the day. Over 200 pages, size 9" by 12", crammed full of information and hundreds of illustrations. September issue is now Ready—Secure your copy at once and get to know about the most up-to-date developments in Radio.

The European Edition of the Citizens' Radio Call Book is on sale at all W. H. Smith and Son's Bookstalls and can be obtained also from THE ROTHERMEL RADIO CORPORATION OF GREAT BRITAIN, LTD., OF 24, MADDOX ST., W.1. In France, Brentanos Ltd. Price 3/- per copy. Send P.O. to-day

Published by  
**THE CITIZENS' RADIO SERVICE BUREAU,**  
Chicago, Illinois, United States of America.

The component parts for making these sets are distributed throughout Great Britain by the Rothermel Radio Corporation, of 24, Maddox St., W.1, and may be obtained from all high-class dealers.



**RADIO NOTES AND NEWS OF THE MONTH**  
*—continued from page 526—*

**A Mystery Solved**

The call-signs 2OB and 5EZ have been puzzling Lancashire listeners for a long time. And they puzzled the Postmaster-General, too, for he hadn't granted either of these stations a licence to transmit!

Eventually the radio detectives got on the job, and finally the originator of 2EZ and 5OB was fined four guineas at the Eccles police-court. (The authorities caught him through the large number of flash-lamp batteries he had been buying!)

**Regional Scheme Going Forward**

Towards the end of November the B.B.C. is celebrating its fifth birthday, but apparently nothing startling in the way of special occasions is being planned. There is, however, a rumour going round that the Corporation, less fettered by the Post Office than the old Company,

is now getting on unexpectedly well with its plans for regional-scheme stations. Generally big innovations are made in midsummer (when alterations are more favourably received than at any other time), so it seems likely that there will be some definite news before Christmas about one or more of the new stations opening up in the early summer.

**Design of H.F. Amplifiers**

In the article on this subject in last month's MODERN WIRELESS, the wrong photograph was used to illustrate the "tuned-anode receiver," the set shown being the famous "Radiano Three," which comprises a detector and 2 L.F. amplifying stages.

**One for Glasgow!**

Everybody likes to grumble at the broadcasting sometimes. But not many people can do it as neatly as the correspondent who wrote up to the "Glasgow Herald" and said:

"It is perhaps just as well that Schubert did not add anything more to his Unfinished Symphony; 5SC does not even play all the notes he did write!"

**Valve Colour-Scheme**

To help in distinguishing the various types of valves, a colour-scheme has now been recommended by the U.S. National Electrical Manufacturers' Association. The Standards Committee has advised the radio division of the association to mark general-purpose valves with dark red, L.F. amplifying valves with orange, and detectors with green and so on.

Apparently this is because listeners who have taken home the wrong type of valve have complained of feeling "So Blue."

**Two-Way Wave-Length for Trans-Ocean 'Phone**

When the New York-London radio 'phone service was first opened, experiments were conducted to find which wave-lengths were best for Rugby and for Rocky Point. After much juggling an ingenious system has been worked out, by means of which both stations work on a common wave-length of about 5,600 metres.

It will be recalled that neither station sends a carrier wave, but only "single side-band" transmission is employed. In addition to its other advantages this method now proves capable of two-way working on one wave-band, thus economising elbow-room in the ether.

**REVOLUTIONARY DRY RECTIFICATION**

**Kuprox. Ratheon.**



Type "C" 2 1/2 amp. Kuprox. Replaces Bulbs 25/-



2 amp. bulbs, now obsolete.



Ratheon "A" 2 1/2 amp. cartridge. 22/6



Type "A" Kuprox Trickle Charger, for 220 V., 50 cycle A.C., gives 8 to 1 amp. charge for 4 or 6 V. batteries 3/6

Kuprox and Ratheon Revolutionary Dry Rectifying Units, Eliminators and Chargers, as fully described by Dr. Roberts in the October issue of "Modern Wireless" and November issue of the "Wireless Constructor," are handled exclusively throughout Great Britain by The Rothermel Radio Corporation of Great Britain, Ltd., 24-26, Maddox St., London, W.1. Send immediately for our new 1928 Supplementary Catalogue, for full details of—

**KUPROX DRY RECTIFYING UNITS.  
 KUPROX TRICKLE CHARGERS.  
 KUPROX L.T. ELIMINATORS.**

*Kuprox is as Dry as a Bone, Noiseless in Operation, and will last indefinitely.*

We also carry a full range of H.T. Eliminators and combined H.T., L.T., and G.B. Eliminators, suited to all needs, and giving outputs up to 100 M.A., at 180 V.

**Dry Rectifiers are Radio's Greatest Need. We have them.**

Ask for details of Ratheon Filamentless Rectifying Tubes.			
Type "B"	60 mils.	150 V.	32/6 each
"BH"	85 "	200 V.	32/6 "
"BA"	350 "	200 V.	50/- "
Special Valve Sockets			2/6 "

**THE ROTHERMEL**

**RADIO CORPORATION OF GT. BRITAIN, Ltd.,**  
 24-26, Maddox Street, London, W.1.

'Phone: Mayfair 578-9. Telegrams: "Rothermel, Wesdo, London."



Type "A" Kuprox, 8 to 1 amp. Replaces vibrators 25/-



Vibrators, now obsolete.



Type "G" Kuprox, 3 to 5 amp. 25/-

*Components of Distinction & Quality*

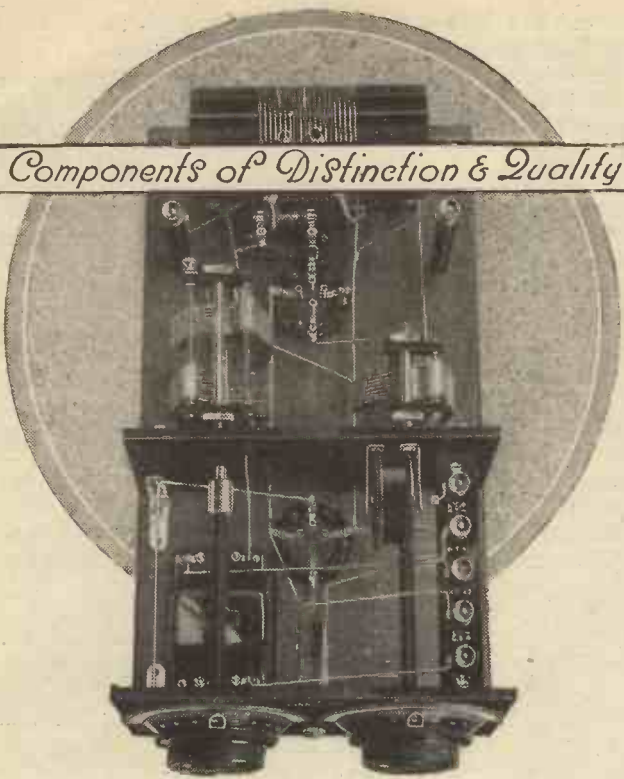

## Short Wave Receivers

The Bowyer-Lowe Short Wave Receiver marks a great advance in receiver design and successfully receives short-wave broadcast transmissions (20 to 200 metres) at distances of 4,000, 5,000 and 6,000 miles with the ease of tuning associated with the ordinary 250 to 550-metre transmissions.

Letters on our files from many different countries testify to this fact.

A booklet describing the construction, together with full-size blue print, can be obtained 1/- post free.



**INTERCHANGEABLE H.F. CHOKE**  
Made in six sizes.  
2/-



**"POPULAR" CONDENSER**  
"0003 .. 10/-  
"0005 .. 10/6

WRITE TO-DAY FOR A COMPLETE LIST OF OUR PRODUCTIONS



BOWYER-LOWE CO., LTD., LETCHWORTH

A BOOK THAT EVERY EXPERIMENTER SHOULD HAVE:  
"The Bowyer-Lowe Standard 7 and 8-valve Super-Heterodyne"  
How to Build and Operate. By A. E. BOWYER-LOWE.  
**PRICE - - - 2/-**

Send your remittance for a copy to-day.



## RECUPERATING AGENT IN THE HELLESEN DRY BATTERIES.

It is the price you pay per hour of enjoyable radio reception that matters, not the price you pay for your dry battery.

Helleesen Dry Batteries have been known for over forty years as the best in the world. The No. 7 recuperating agent marks a development to meet a new need; the old Helleesen standard of construction, the best material in the hands of expert workmen, remains.

With a quadruple insulation and sealed cover, buy a Helleesen for safety and satisfaction.

60-volt "WIRIN" 12/6  
99-volt "WIRUP" 21/-  
(Postage Extra.)

All types, voltages, etc., in Double and Treble capacities for H.T. and L.T. Supply. Ask your dealer for the type to suit your set and get the maximum service, or write us for full particulars.

Obtainable at all Radio, Electrical and General Stores, Harrods, Selfridges, etc., or direct from

A. H. HUNT, Ltd. (Dept. 5), CROYDON, SURREY.



**SOURCES OF H.T. SUPPLY**  
*—continued from page 480*

circuited, or its life will be materially shortened.

**Apparatus for Utilisation of Mains Current**

To those of us who have mains electric current at our disposal, there is no better source of H.T. supply, and provided that a sound apparatus is purchased, it is reliable, cheap, trouble-free, and silent, and although its first cost is large, it is quickly saved, as it means that first cost is final. The current consumption is negligible, the convenience is unequalled, as all that it requires is to plug it into any convenient lighting socket. The voltage, being constant, adds greatly to volume and purity of reception.

With a carefully designed set, the current consumption of the valves makes very small demands from the H.T. battery, and were it not for the power valve, it is doubtful whether one would purchase an eliminator, but in nearly every set the final stage is either a power valve, or in the bigger sets, a super-power valve.

This is necessary if reception is to be pure and undistorted, but from the H.T. current aspect an evil, as the milliamperage necessary is alarming, giving the H.T. battery nearly the maximum amount of work it is capable of. The life of the battery being definitely limited, it very quickly ceases to function unless it is of a large capacity, which also means a large price. It is here that the eliminator is advantageous, as an adequate number of milliamps can be taken with no apparent rise in cost.

**Good Apparatus Essential**

Indifferent apparatus of doubtful origin will produce parasitic noises, which, during the silent passages, are apt to irritate one. By careful selection of apparatus possessing a "name," this nuisance is absent. With the increased use of the eliminators amongst amateurs, the negligible running cost is apt to induce them to discard the grid-bias battery. This is a grave mistake, as the battery is as important here for pure reproduction as it was when used with the dry battery, the only difference being that the economical saving of the H.T. current in the case of the battery does not manifest itself in the eliminator.

**Possibilities of Thermo-Electricity**

In the near future another source of high-tension supply may be introduced to us through the medium of a battery of thermo-couples, and should prove a very reliable means of feeding the valve. To the man in the street who is not very well acquainted with electric technique, a brief description will suffice to explain what this really is, but it can only be an outline, as the study of thermo-electricity is very complex and detailed.

If two pieces of different metallic wires of equal length are welded together at one end, and the junction heated, whilst the other end is kept cold, a current will flow from the hot joint to the cold. This effect is known as a thermo-electric current. The actual strength of the current is very small, but to the owner of a very sensitive galvanometer, the presence may be easily detected by a simple experiment. A small piece of iron rod is taken of  $\frac{1}{8}$  in. diameter and about 12 in. long.

Two pieces of bare copper wire about 22 gauge and 42 in. long are tightly fastened to the iron rod at each end, leaving an end of each copper wire loose. These loose ends are then

*(Continued on page 532.)*

**THE BEST IN THE WEST**

Do not fail to call at our showrooms to hear a demonstration of the MOVING COIL LOUD SPEAKER.

All parts in stock. Complete set. - £6 16 3

It also will pay you to hear a demonstration of the marvellous apparatus for electrical Gramophone reproduction.

Every type of pick-up can be demonstrated upon request. Brown, Igranic, Marconi, Celestion, etc.

**NEW LINES IN STOCK.**

THE NEW DUBILIER K.C. CONDENSER 12/-

THE NEW BURTON S.L.F. CONDENSER  
 .0005 6/- .0003 5/9

SPECIAL BURTON VERNIER DIAL - 5/-

SPECIAL TYPE PAREX VALVE HOLDERS FOR CAPT. ROUND'S SCREENED VALVE - 4/6

A FEW ONLY LEFT. AMPLIFEX AERIAL LOOPS.  
 The finest Loop Aerial ever devised, originally £3 10 0,  
 To clear 30/-

**WILL DAY LTD. (Dept. M.W.)**

19, Lisle Street, Leicester Square, LONDON, W.C.2  
 Telephone: Regent 4577. Telegrams: "Titles, Westrand, London."

**WATES UNIVERSAL TEST METER**

Milliammeter 0-36 milliamps.  
 Voltmeter 0-6 volts.  
 do. 120 volts.

Accuracy guaranteed.

Dependable.

The voltmeter is High Resistance 3600 ohms.

Think of the advantage of this instrument.

You can test your receiver for distortion.

You can find the drain in milliamps from H.T.

Test voltage of H.T. supply.

Test L.T. Battery.

**8/6**

Post free 8/9.  
 or C.O.D.

Send for our 20-page booklet of the Standard Sac Leclanche Wet Batteries.

**THE WET H.T. BATTERY CO.,**  
 12-13, Brownlow Street,  
 High Holborn, London, W.C.



# Have you tried this new Lewcos Coil?

The range of LEWCOS Centre Tapped Coils—already popular among experienced constructors for their high efficiency—has now been completed. Wound with Litz wire, they give greatest selectivity at a moderate price. All coils are identical in external measurements. Obtainable from radio dealers everywhere.

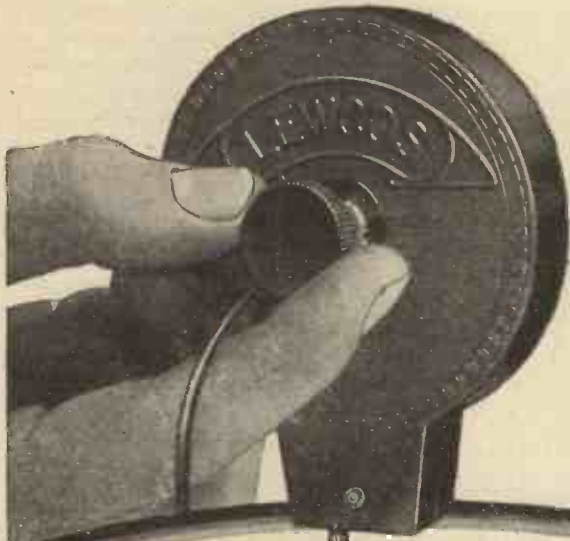

LEWCOS CENTRE TAPPED COILS (Protected Type).											LEWCOS "X" COILS Double Tapped		
Coil No. . . . .	25	35	40	50	60	75	100	125	150	200	300	X100	X200
.00003 mfd. . . . .	75	90	126	151	188	231	297	408	565	805	942	188	505
.00025 mfd. . . . .	160	225	283	316	391	500	652	905	1184	1416	2005	391	1410
.00095 mfd. . . . .	225	300	386	432	555	680	885	1330	1625	1960	2755	555	1960
Price . . . . .	3/6						5/3			4/9	7/-		

THE LONDON ELECTRIC WIRE CO. & SMITHS, LIMITED  
PLAYHOUSE YARD, GOLDEN LANE, LONDON, E.C.1.

## LEWCOS CENTRE TAPPED COIL

Registered Trade Mark. (Protected Type) Patent No. 271384

You must have a precision instrument



for sharp tuning

Modern radio circuits call for critical tuning—critical tuning demands precision condensers—precision condensers means Pye condensers for accuracy and reliability. Pye precision condensers are scientific instruments made one at a time with great care. You need them to get the best from your set.

PRICES—'0001, '0002, '0003 Mfd. 17/6 each.  
'0005 Mfd. 18/6 "  
'00075 Mfd. 22/6 "

Illustrated leaflets of components and sets on application (post free).

**W. G. PYE & Co.,**  
"Granta Works," Montague Rd.,  
**CAMBRIDGE.**



Don't Spoil Your Garden Use "TURRET" MASTS.  
30 ft. Turret Junr. £1 19 6 | 40 ft. Turret Three £2 18 9 | Phone:  
27 ft. Turret Two £2 4 6 | 58 ft. Turret Super £6 19 6 | GERRARD 2650  
SIMPSON & BLYTHE, 22, Gt. Windmill St., Piccadilly, W.

### CUT THIS OUT FOR CABINETS

and post to us for new FREE list illustrating Cabinets as shown in "Modern Wireless," etc., etc.

NAME .....

ADDRESS .....



(Write in block letters, please.)  
**CARRINGTON Mfg. Co. Ltd.,**  
CAMCO WORKS, SANDERSTEAD ROAD,  
SOUTH CROYDON.

Telephone: Croydon 0623 (2 lines)

**SOURCES OF H.T. SUPPLY**

—continued from page 530

connected to a sensitive low-resistance galvanometer. A Bunsen-burner or spirit lamp is then used to heat one of the copper-iron junctions. The assembly for the experiment is shown in Fig. 7. It will be found that as the temperature of the junction is increased, a deflection of the galvanometer needle will take place, increasing as the temperature rises, until it reaches a maximum point when, although the temperature is increasing all the time, the deflection of the needle decreases, until ultimately it goes back to zero, even though the temperature of the junction is much greater than the temperature required to give maximum deflection of the galvanometer needle.

**Small Voltage**

The degree of temperature required to give maximum deflection of the galvanometer is known as the neutral temperature, which in the case of the copper-iron couple is round about 275° centigrade. The E.M.F. from heating a single junction is very

small, and in the case of our iron-copper couple the current generated is approximately 15 micro-volts for each 1°C. difference in temperature between the hot and cold junctions of the couple. (A micro-volt is one-millionth of a volt.)

Thus, assuming that the cold side of the couple is normal, i.e. 15° C., and the hot side is maximum, 275° C., the difference in temperature is 275° - 15° = 260°. Each degree is responsible for 15 micro-volts, consequently, the E.M.F. of the couple at neutral temperature is  $2.60 \times 15 = 3.900$  micro-volts, or .0039 volts. This seems very small, but when it is explained that different metals generate different currents, the outlook is much better. In the case of a bismuth-antimony couple the E.M.F. is approximately six times as strong as a copper-iron couple, for each 1° C. difference in temperature of the ends of the couples. Although some metals and alloys have a greater value than the bismuth-antimony couple, the current in all cases is small when compared with the current obtained by mechanical or chemical means.

The reliability of the current is unquestionable, as use is made of this thermo-electricity as an accurate

indicator of temperature. It will be clearly seen that if a battery of these couples are connected in series, a definite current will be generated at a certain temperature. Inversely, the current generated by the couple will (always being constant) represent a definite temperature. Therefore, each degree on the galvanometer will be a degree or number of degrees of temperature. A commercialised apparatus, consisting of a battery of thermocouples (thermopile) connected to a galvanometer, is sold under the name of pyrometer, and finds extensive use in manufacturing processes, as an accurate temperature indicator, especially where temperature is critical to certain substances. Glass manufacturers are using them very extensively since the glass industry changed to the highly scientific study that it has assumed at the present day.

**Sensitive Arrangement**

An example, showing the sensitiveness of the effect of a change in temperature, is furnished by the pyrometer used as a temperature indicator on a glass furnace. In the melting of the glass constituents, the temperature reaches 1,400° C., and the instrument will show a change of 2° C. The current generated by

(Continued on page 534.)

**The "Experimental Eight"**

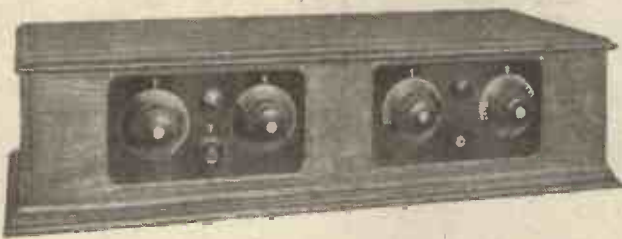

The Cabinet for the set described in this issue was made by V. C. Bond & Sons

In its sound construction and beautiful finish it is typical of the cabinets of all sizes made in our workshops.

Oak Pol. . . . £9/10/0  
Mahogany Pol. £4/10/0  
Baseboard Free.  
Carriage Paid.



The Bedroom Chair and Trousers Press illustrated on the left is another example of expert craftsmanship which is both a piece of artistic furniture and a personal servant.

Illustrated folder giving full particulars of cabinets and chairs free on application to

Actual Manufacturers:  
**V. C. BOND & SONS,**  
61, The Grove, Mare Street, Hackney, E.8.  
Phone: Clissold 0883. Grams: "Veeceebec"  
Established 1899. Hack. London.



**You can't burn off the tinning!**



Impossible, you say! Well, take your "Peerpoint" Soldering Iron and place it in the gas flame or fire, and then leave it as long as you like! When you take it out red hot the tinning will be intact. Why? The tinned portion of this wonderful iron is not inserted in the flame at all. The Junit "Peerpoint" Soldering Iron is fitted with a sheath which is well-tinned, and which is removed when the bit is placed in the flame, and then replaced for the actual soldering operation, the heat travelling from the copper bit to the tinned sheath instantaneously. Thus you have the Fool-proof soldering iron which is always clean and well-tinned, and which makes all types of soldering the easiest thing in the world.

Price 3/6  
(Patent).

Junit Self-Soldering Wire is specified in every circuit in the famous P.M. publication, "Radio for the Million." Is your set wired with it? If not, you have wasted unnecessary energy, time and temper in the wiring of your set.

Sold in attractive packets each containing five 2-foot straight lengths.

1/- PER PACKET

Ask your dealer for these Junit Products, and if he is unwisely enough not to stock them, write direct to us.

**The Junit Manufacturing Co., Ltd.**  
NAPIER HOUSE, 24-27, HIGH HOLBORN, LONDON, W.C.1.

# £300 A YEAR FOR YOUR SPARE TIME!

Wonderful New Invention YOU can Make and Sell under My Patent!

REALLY, genuinely, you can make at home and in your spare time a sum of extra money up to £300 per year. The work is of fascinating interest. It will open up to you new ideas, new vistas of money-making; provide many of those luxuries and necessities which you have so long wished for, and give you occupation just at those hours when time is apt to hang heavily on the hands.

to manufacture under my Royal Letters Patent, in order to ensure unrestricted marketing. Let me hear from you NOW before somebody else is granted the licence and the extra income that can so easily become yours.

Simply forward the coupon and, by return of post, I will send you every part.



IN THE COMFORT OF YOUR OWN HOME YOU CAN DOUBLE YOUR INCOME. The work is a delight. You can keep at it just as long as you like each day or week. No "plant" or machinery is needed. A spare room or even the kitchen table can serve as your profit-making "factory"—and the children can help too!

particular with which you may wish to be acquainted. It is those who

seize opportunities who succeed. Take this opportunity NOW.

Others are doing this by working my enormously successful patents. Why not you? It costs you nothing to write for full particulars, and you can then see for yourself exactly what you can do.

My patents are in very great demand in the field of wireless and electricity—so much so that

## I GUARANTEE

your profits, and further guarantee to protect you against any infringement or interference with your market. Only one person in 50,000 of the population is allowed

### "MAKE-MONEY-AT-HOME" COUPON.

TO THE ENGLAND-RICHARDS CO.,  
103, King's Lynn, Norfolk.

Sirs.—Please send me at once, and FREE, full details as to how I can Make Money at Home in my spare time. I enclose 2d. stamps for postage.

Print your name and address boldly in capital letters on a plain sheet of paper and pin this coupon to it.  
Modern Wireless, November, 1927.



## LOG (or Mid-Line) CONDENSER

Mounts either Panel or Baseboard

•00035  
•00025 10/6 each  
•0005

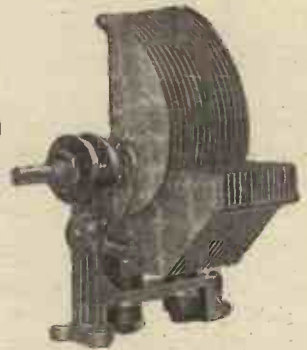

The most scientific Condenser yet produced. Perfect in every detail of construction and performance.

Full Catalogue Free on Request.

## THE FORMO HANDBOOK

1/- post free.  
(Liberal Discount to Retailers.)

A fully illustrated well-compiled work on the construction and uses of radio components including Blue Prints

Formo "True Scale" 3-valve Set and  
Formo "Two-Range" 2-valve Set.

THE FORMO CO.,  
CROWN WORKS, 22, CRICKLEWOOD LANE, N.W.2

Telephone: Hampstead 1787.

## DEAD SILENT!!!

GRAHAM-



FARISH  
New Process

# Ohmite RESISTANCES

Patent Regd. Design.

Even if you need them to carry 10 milliamperes we positively guarantee these new Anode Resistances to be absolutely silent, fieldless and

### BETTER THAN WIRE WOUND

because:—They are hermetically sealed in a Bakelite case and are made under a new process—they cannot vary even if you boil them in water or connect them across the electric mains.

Get them at your Dealers.

### PRICE

All sizes from 10,000 ohms

**2/3** Each up to 1/2 meg.

Advert. of The Graham-Farish Mfg. Co.,  
17 Masons Hill, Bromley, Kent.

## The World's Best Stories



An Argosy story is always a good story. The policy of this brilliant magazine is to print only those stories which are indisputably great, and written by the acknowledged master writers of the past and the present day.

# The ARGOSY

Monthly - - 1/-



Tested on 500 volts D.C., or if you wish to pay a few shillings more, Tested on 750 volts D.C., it offers you the best value for money ever given in Wireless. And . . . there never was a more dependable condenser.



Prices : Tested on 500 volts D.C.  
1 mfd. - 2/6 2 mfd. - 3/6 4 mfd. - 5/3  
Prices : Tested on 750 volts D.C. equal to 500 volts A.C.  
1 mfd. - 3/- 2 mfd. - 4/- 4 mfd. - 6/9

From all good dealers or direct—  
**LOUIS HOLZMAN**  
109, Kingsway, London, W.C.2.  
Telephone: Holborn 6209.  
Irish Free State Distributors: Briscoe Importing Co.,  
9, Astons Quay, Dublin

**SOURCES OF H.T. SUPPLY**  
*—continued from page 532*

the couple at 1,400° C. is 25 milli-volts, and a temperature variation of 2° means that it is representative of one seven-hundredth part of twenty-five milli-volts, which is .035 milli-volt.

**“Very Great Promise”**

The couple used in this case consists of a wire of Platinum and a wire made of an alloy of either Platinum 90%, Iridium 10%; or Platinum 90%, Rhodium 10%; these wires being used owing to the fact that they are capable of withstanding a high temperature without melting. In the case of a furnace not using such a high temperature, an Iron Constantan Couple is used. This consists of a combination of two wires, one of Pure Iron, and the other Constantan Wire, which is an alloy of Copper 60% and Nickel 40%.

The current generated at 420° C. is 22 milli-volts, but the combination cannot be used at a temperature exceeding 900° C. Another common couple is the Chromal Alumel, and is effective to 1,100° C. In this case,

one wire is Nichrome, or an alloy of Nickel 90%, and Chromium 10%; the other one being Nickel Aluminium—Nickel 98% and Chromium 2%.

The possibilities of these minute currents generated by Thermal effects may not appear of very great promise to a person lacking in imagination, but given sufficient scientific research on a definite plan, and taking into consideration that experiments on the Continent and in America have produced currents far in excess of the quoted Bismuth-Antimony couple, the writer is very strongly impressed with the possibilities. Experimental work with different alloys so as to produce as high a current possible at an economic temperature will be the seed from which the unit will be evolved.

A great advantage that will manifest itself from an apparatus of this description lies in the fact that the E.M.F. control will be almost microscopical, as it will be realised from the brief description given above that, to increase or decrease the current, all that is required is to increase or decrease the temperature as conditions demand. Again, owing to the constancy and regularity of the current, our visionary unit of the future should appear foolproof.

**L.T. ECONOMY**  
*—continued from page 496*

parallel, as in Fig. 1. At Fig. 1a one set is in series and connected to the mains for charging, and at Fig. 1b the other lot are paralleled and taken to two L.T. terminals. Fig. 2 shows an arrangement in a “practical” form which would do the necessary work.

Within the switchbox is a control shaft, to which are permanently and immovably fixed two rocker arms, carrying at their extremities groups of metal contacts which dip, as the control shaft is moved, into numbers of small mercury baths. The front rocker (see Fig. 3) carries the contacts which bring the cells into series and connect them to the mains, and the back-rocker contacts place them in parallel and connect them to the receiving set.

When the indicator is at “off,” none of the contacts are touching the mercury, and everything is disconnected. When the indicator is at “1” number one cell group is in use and number two is on charge.

*(Continued on page 536.)*

**CARBORUNDUM IN RADIO**

**Perfection in R.C. Coupling**

**THE CARBORUNDUM RESISTANCE CAPACITY COUPLING UNIT**

is quite different from any other at present on the market, presenting as it does many distinct advantages over Units employing ordinary Grid Leaks and Anode Resistances. The Resistances used in the Carborundum Resistance Capacity Coupling Unit are solid rods of unbreakable Carborundum, which is created in the largest electric furnaces in the world, at the terrific temperature of 4060° F. They cannot burn out, present no capacity effects, and are absolutely non-microphonic. The Unit takes up far less room than the smallest L.F. transformer, and the complete absence of background noises enhances the already great possibilities of R.C. Coupling. Not being dependent on a metallic film, the resistances will not disintegrate and are unaffected by atmospheric changes.

No. 73. Price 8/6.

**CARBORUNDUM ANODE RESISTANCES AND GRID LEAKS** in all standard values. Price - each 2/6.

**CARBORUNDUM STABILISING DETECTOR UNIT.** The most satisfactory method of crystal detection. Price 12/6 (Dry Cell 5d. extra).

Send for new 24-page Book containing circuits and much useful information. All Carborundum Radio Products are sold under our complete guarantee that they will operate satisfactorily in properly designed circuits.

**THE CARBORUNDUM CO., LTD.,**  
**TRAFFORD PARK :: :: MANCHESTER.**







**As precise  
as the  
Standard Measure**

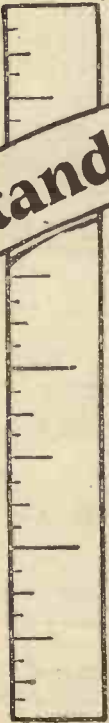

**T**HE Standard Measure never varies. Its inch is an inch—always. It is precisely accurate.

The T.C.C. Condenser, also, is precisely accurate. Its capacity never varies. If '001 is stamped on the side of its green case, its capacity is '001—always. That is one reason why T.C.C. Condensers are regularly used by all the leading Radio technicians. They know its capacity is accurate. And they know its insulation is perfect. They know, in short, that T.C.C. Condensers will never let them down.

Follow their lead. Use T.C.C. Mica Condensers in your next Set. All capacities—from '0001 mfd. price 2/4.

**T.C.C.  
Condensers**  
**Always dependable**

Advt. Telegraph Condenser Co., Ltd., Wales Farm Rd., N. Acton, W. 3.

97C5

**WESTON**

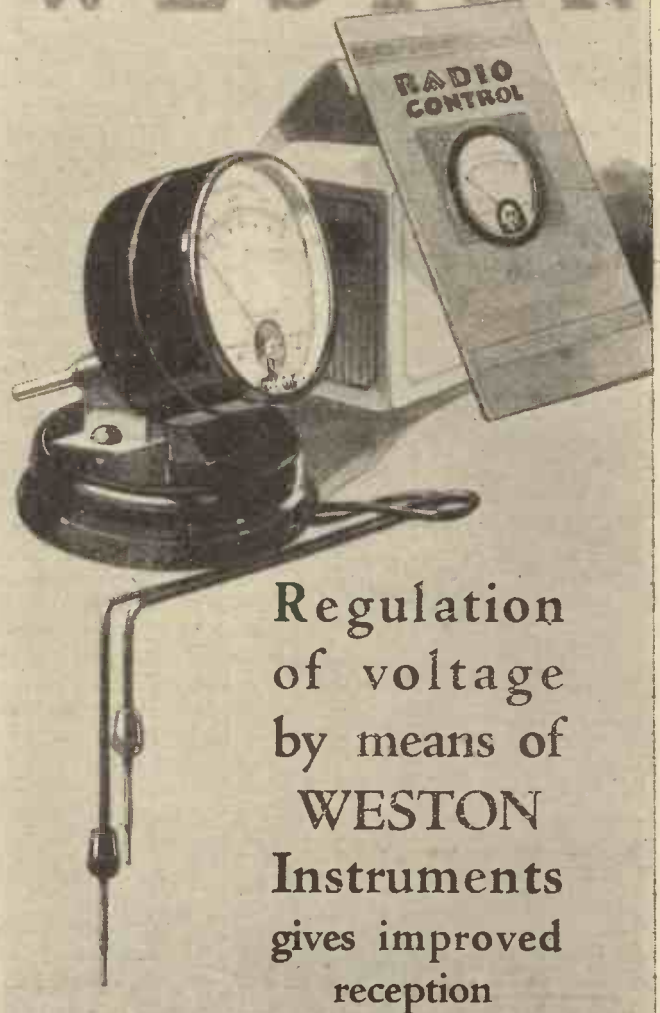

**Regulation  
of voltage  
by means of  
WESTON  
Instruments  
gives improved  
reception**

To obtain maximum results from your receiver you must be sure that the H.T., L.T. and G.B. voltages are regulated correctly. For an exact measurement of these variable voltages use a Weston Pin-Jack Voltmeter with high-range stand. Only the Weston standard of accuracy and reliability is sufficiently fine to be of any use for such measurements.

The Weston free booklet "Radio Control" explains the necessity for accurate electrical control of your radio receiver and gives much helpful advice. Let us have your name and address.

MODEL 506 Pin-Jack Voltmeter complete with high range stand and testing cables £2:10:0

**WESTON**

STANDARD THE WORLD OVER

Pioneers since 1888

Weston Electrical Instrument Co. Ltd.

15, Gt. Saffron Hill,  
London, E.C. 1

# Each side of the panel—

On the under side—the business side—as well as the top side of the panel, fit “Utility” Components—the proved best for design, material, and finish. “Utility” high quality is no criterion of price—“Utility” cost no more than the average, so insist on them at your local dealers.

—incorporate

## Utility GUARANTEED COMPONENTS



**“Utility”  
ON and OFF  
SWITCH**  
An efficient main switch for cutting off L.T. supply. Push-pull design, and 12-point contact to minimise resistance. One-hole fixing. N.P. finish. Price 2/-

**“Utility”  
NEUTRODYNE  
CONDENSER**  
Mounts above or below baseboard. Rigidly made—ball-bearing spindle, and sufficient tension to avoid accidental misadjustment. Price 5/- each.

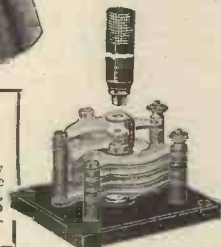

**“Utility”  
MICRO-DIAL**  
A new model, improved for easier reading by the inclusion of an aluminium dial and aluminium cursor. Reads half-line cursor. Reads clockwise or anti-clockwise. Price. 7/6 each. N.B.—Our popular plain model is still listed.

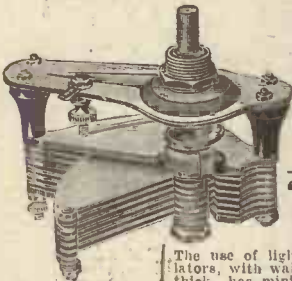

**YOUR  
LOCAL  
DEALER  
STOCKS  
“Utility”**

**“Utility”  
LOCARITHMIC  
CONDENSER**  
The use of light thimble insulators, with walls only 1/32 in. thick, has minimised the solid dielectric. Ball-bearing spindle. Pigtail connections. Capacities from .0002 to .0005 at prices from 7/6 up.

WRITE FOR  
LISTS

**WILKINS & WRIGHT Ltd.**  
“Utility” Works, Kenyon St.,  
**BIRMINGHAM.**

## L.T. ECONOMY

—continued from page 534

From Fig. 3 you will be able to judge the complexity of such an arrangement when two groups of sixty cells are involved and it is necessary to introduce the complication of having series-parallel grouping. Many of the connections will be between the contacts on the rockers, and would not be straying all over the place, as in Fig. 3. However, the scheme is quite fantastic, although you may find it diverting to work out for yourselves a switch that will do the work with the minimum of contacts and the minimum of wiring.

### Halving Charging Costs

But those people who do charge their own accumulators on D.C. mains should remember that when they halve the charging rate they halve the cost. Supposing six volts L.T. is required, then my advice is, buy two small 6-volt accumulators rather than one large one. Instead of having a 6-volt 30-a.h. purchase two 6-volt 15-a.h. Placed in parallel these will be the equivalent of the 6-volt 30, but when joined in series for charging they will save half the cost of this. A 6-volt 30, charged at 3 amperes on 200-volt mains, and consuming in the process 600 watts, will not give any more current return than two 6-volt 15's placed in series for the purpose of charging and consuming but 300 watts.

### Practical Examples

And charging stations, too, generally charge much less for a higher-voltage, smaller-capacity battery. A garage in my neighbourhood asks 9d. for replenishing a 2-volt accumulator having a capacity of 20 ampere hours, and only 10d. for a 4-volter of the same rating! Amateurs who use 2-volt valves especially should bear this in mind, that it is not the volts that cost the money so much as the amperes! Were I a listener using 2-volt valves, the accumulator I would be handing over to the charging station every now and then would be a very small 6-volter, consisting of separate cells, which would be joined again in parallel after being charged. It is a fact, though, that some small cells do not stand up to hard work as well as those of larger capacities, but providing the small accumulator is of good make such as an Oldham, Exide, etc., its life will be a long one if it is carefully maintained.

## IN PASSING

—continued from page 508

“I get an impression of foxes smiling through curtains of pink tissue-paper,” said Snacks.

“Good lor’!” he said, aside to me. “She says she’s thinking of puce-coloured boots in boxes at Bargains and Smithgroves, Regent Street.”

There was no rapport between the Snackses. He never had the sympathetic mind. But I let the play go on, for the good of his inflated ego.

“What’s that?” he shouted. “Thinking of Uncle Rexine? I say, Alice! I got a perfectly clear reception of the woman at Bexhill who fell off the breakwater. Are you really trying?”

Then I came forward, ostensibly as the saviour of a situation—for the place was crammed with scientific nobs of all kinds—but in reality as a common, low-down, husband.

“Let Muriel get on,” I said, “and let me receive her thought.”

“Hello, Snuffler!” I cried through the ‘phone. Snuffler is her pet name *en famille*. “This is Snorter. Think hard!”

### An Impression

I waited a few moments. Then I ‘phoned, “I seem to get an impression—I am not sure—but are you thinking of—er—Light?”

“More or less,” came the reply, which I passed on to Snacks, who was recording.

“Er—now I get a sense of things—a thing with legs; I’m not sure how many, probably four?”

“Well, I was!” came the answer.

“And now it’s all hazy—a pattern, like birds and flowers; what you call cretonne.”

“Just that,” replied Muriel, and Snacks danced for joy.

“And now,” I went on, “I seem to see a sort of question—a big query mark; is it *wonder*?”

“Very much so,” said Muriel.

“Now I see—that is, I think, a bookcase.”

“Absolutely right,” came the answer.

“It is moving. Moving to the left,” I added.

“It is—that is—er—it will do so,” replied my wife.

“Now I get an impression of two birds—doves, I think. A sense of peace.”

“Oh, Bill!” came the voice.

(Continued on page 538.)

A New Music Work edited by SIR HENRY J. WOOD

# MUSIC OF ALL NATIONS

A Collection of the World's Best Music. Published in Fortnightly Parts.

**10 COMPLETE PIECES  
FULL MUSIC SIZE**

with Full Words of ALL Songs

FOR **1/3** ONLY

This new Fortnightly Part Work breaks all records in music value! Good paper, clean printing, every piece complete and articles written by outstanding musical celebrities—never before has such marvellous value been offered to you! When complete MUSIC OF ALL NATIONS will constitute a superb library of the great music of every country—and all it will have cost you is just over 1d. a day.

Part 1 will be on sale at all Newsagents, Bookstalls and Music dealers on Thursday, Nov. 3rd. If you have any difficulty in obtaining a copy send 1/6 direct to the Publishers, The Amalgamated Press, Ltd., Fleetway House, London, E.C.4. This work may only be exported to the British Dominions (excluding Canada) and possessions overseas, including Egypt and mandated territories.

**ORDER Part 1  
TO-DAY**

**Part 1, on sale Thurs., Nov. 3rd**

will contain

**LES MILLIONS D'ARLEQUIN**

*Italian* *Drigo*

**SWING LOW, SWEET CHARIOT**

*Negro Spiritual* *Arr. by Burleigh*

**MINUET IN G**

*German* *Beethoven*

**SHENANDOAH**

*Sea Shanty* *Arr. by Sir Richard Terry*

**COME, ALL YE ROVING  
BACHELORS**

**SEVENTEEN COME SUNDAY**

*Two English Folk Songs*

**BLUE DANUBE WALTZ**

*Austrian* *Strauss*

**LA PALOMA**

*Spanish* *Yradier*

**HYMN TO THE SUN**

*Russian* *Rimsky-Korsakov*

**National Anthems of the World**

*(1) God Save the King* *John Bull*

## LES MILLIONS D'ARLEQUIN

R DRIGO

SERENADE  
Allegretto cantabile (♩ = 144)  
pp leggiero  
p cantabile

This piece alone is worth more than the cost of the entire part. You probably know it well. Try it over on the piano.



## TREBLE-DUTY TERMINALS

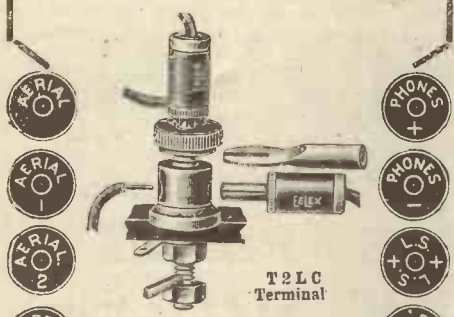

- AERIAL 0
- AERIAL 1
- AERIAL 2
- EARTH
- A.T.
- L.T.
- L.T.
- H.T.
- H.T.

- PHONES +
- PHONES -
- L.S.
- L.S.
- GRID +
- GRID -
- GRID -
- GRID 2
- OUTPUT +

Of exceptional value to the wireless constructor as they provide facilities for connecting securely—spade plugs, pin, or wire—and being slotted, internal joints need not be soldered. Each terminal is nickel plated and can be obtained with any of 36 variations of indicating tabs.

Price 4/- each.  
Plain Top 3d. each.

By far  
the best  
earth  
yet.



The EEX Moisture Retaining Earth Bowl is far superior to a spike or mat, and to obtain the best from your set your earth should be as perfect as humanly possible. 9" in diameter. Supplied with 6-ft. copper wire and brass connector to fix to your existing earth lead from set.

4/- each. Postage 9d.

### ELECTRIC SOLDERING IRON



The very latest and most efficient soldering iron obtainable. Every constructor should possess one. Complete with flex and adaptor to plug into ordinary lamp holder. As illustrated 21/- each. Lighter model 13/6. Please state voltage when ordering.

Drop a Postcard NOW or 'phone your name and address for List S41 which gives full details of all EEX Wireless Accessories to:



EEX HOUSE, BUNHILL ROW,  
CHISWELL STREET, E.C.1.  
Phone: Clerkenwell 9282-4

## IN PASSING

—continued from page 536

"What a dear ass you are!" This message I reserved to myself.

By this time the scientists were almost beside themselves with excitement, and Snacks was clean delirious with triumph. So was I. For before I left home I had moved the beastly armchair to where the wife wanted it, and won the right to have the bookcase where I always said it should be. All this without patent surrender. Moreover, I knew by her tone that by losing—I had won.

So the Greek bloke did some good after all those centuries, though unfortunately for "Snacks at the Bar" his gadget never worked so well again and he is now devoted to short waves—not quite so short as those which shifted the bookcase.

Now, *there's* a nice story to tell to the next man who tries to talk telepathy to you.

## NOTES ON A TRUE PURITY CIRCUIT

—continued from page 483

Under these circumstances, I found that the simplest form of the circuit was to use straight resistance-capacity coupling between the detector and the first low-frequency valve, so that the adjustment of the rectifier for most efficient working might be obtained without upsetting the adjustment of the low-frequency valve in any way.

The coupling between the first and second low frequency may then be of the resistance-battery type, and the circuit shown in Fig. 6 is one which I have found very efficient in actual use and in giving amplification practically up to normal three-valve strength.

I have indicated suitable valves and suitable values for the coupling resistances, condensers, and so on, to use with the valves specified, while those who do not think that sufficient advantage is obtained by using battery coupling in the second stage to justify its expense will find that in Fig. 7 I have shown ordinary resistance-capacity coupling in both stages, suitable valves and values being indicated as before.

## HOW MUCH DO YOU AMPLIFY?

—continued from page 518

The valve voltmeter measured the L.F. voltages at various stages of amplification. In every case the output from the plate of the power valve was adjusted to give 8 volts by moving the wave-meter backwards and forwards. Then the input frequency was measured by the frequency meter. This instrument works on the no-signal system, an indicating hand pointing to the frequency of the note under these conditions. It gave quite sharp and definite results.

### Amplification Curves

The transformer used had a ratio of about 3 to 1 and was a good modern component made by a maker of repute. Remember that the results do not give the performance of the transformer itself but of the set as a whole. To get the actual performance of the transformer it would have been necessary to subtract the effect of 'phone inductance and other factors.

A curve was then plotted for each method of coupling, and it was found that the first stage gave substantially even amplification from about 80 p.p.s. to 6,000 p.p.s. (the upper limit of measurement). The resistance-coupled second stage gave a curve not quite so good, falling somewhat from about 3,000 p.p.s., but still reasonably good.

The transformer in the second stage was markedly deficient in amplification of the frequencies below about 300 per second, and fell away sharply on the really low notes. Its amplification of the higher frequencies, on the other hand, was somewhat better, but the curve as a whole was much less even.

### "Acute Controversy"

When we start to compare resistance coupling with transformer coupling we find ourselves surrounded by acute controversy, each side bringing forth the badly designed sets of the other side and holding them up to scorn and publicity. Many output curves are plotted on the log principle in order to smooth out the curves and make them look pretty. The plain curves made on ordinary squared paper do not do this. The slightest lapse from the straight line shows up glaringly. Why not?

(Continued on page 539.)



## Plantations and Panels.

2. The Sap from the tree is now taken by the oxen-carts to the tanks.

**W**AY back in a Malay rubber plantation our tree is giving forth its latex. This latex, or sap, is now collected in pails by the native and transferred to an oxen-drawn cart. This takes it to the factory where is begun the long process of transformation from a milky fluid into a Resiston Panel.

Only the pick of the rubber is used to make Resiston Panels. The slightest flaw which has crept in during the many stages of manufacture bars a piece of rubber from ever becoming a Resiston Panel. Utter purity is the Resiston Standard.

That is one of the reasons why the Resiston Panel is famed for its sheer beauty. Why Resiston has such amazing strength. Why Resiston's insulation is 100% efficient. Why Resiston's dielectric constant is so low. Why Resiston's colour is permanent. Why, in short, Resiston will give you that satisfaction which comes from knowing that the panel in your set is efficient. Ask your Dealer for Resiston.

Resiston Panels come in 13 stock sizes in black and Mahogany-grained. From 6 in. x 9 in. in black, 3/5, to 8 in. x 30 in. Mahogany-grained 19/.



**"24 hours Cut Panel Service"**

A. v. American Hard Rubber Co., Ltd., 13a, Fore St. E. C.

9713

## HOW MUCH DO YOU AMPLIFY?

—continued from page 538

From all this there do seem to emerge one or two definite facts. Transformer coupling was weak on the low notes below about middle C or about 270 p.p.s. The exact point where this falling off begins depends on the actual transformer, valves used, etc., and may be a good deal lower than the example given. But it must be realised that this method of coupling is cheap and easily installed and has certain circuit advantages.

Resistance coupling, on the other hand, is a dainty feeder; it will not smooth over distortion or "overloads" but tends to pass on what it gets in an amplified form. It is susceptible to teething troubles that at times are quite exasperating. Parasitical oscillations and H.F. currents upset its inside dreadfully.

### An Important Point

In fact, resistance coupling needs pampering and nursing for good results—everything must be just so. Most certainly it is not a circuit that a beginner can string together in a slap-dash manner and expect things to work at their best. It does not amplify so much as a transformer unless high "mu" valves are used with high anode resistances. Unfortunately this sacrifices a certain amount of quality.

Provided you are willing to take trouble with a resistance-coupled set it certainly does seem possible to get reasonably even amplification from below 50 p.p.s. to 6,000 p.p.s., but to enjoy this method of coupling to the full it is vitally important to use a good-moving coil or cone loud speaker capable of using properly those low notes that this method of coupling provides.

## "Popular Wireless"

The Leading Radio  
Weekly with the  
Largest Circulation

ON SALE EVERY THURSDAY  
PRICE - - 3d.

# Keystone Components

are used in this month's 8-valve Set

Minator Condenser as used .. ..	10 6
Copex Split Primary Transformer ..	10/-
Keystone Panel Mounting Neutralising Condenser .. ..	6 3
Keystone Board Mounting Condenser .. ..	5 6
Use also Red Triangle Polished Panels, 12" x 7" x 1/8", drilled free ..	5 3



### COPEX SCREEN AND BASE

This screen and base is made from high-grade copper—the best metal for screening coils. Terminals are arranged in such a manner that it is impossible to "short" them when replacing screen. Perfect electrical and self-cleaning contact. Screen and interchangeable 6-pin base. (Patent No. 259459).

9/6

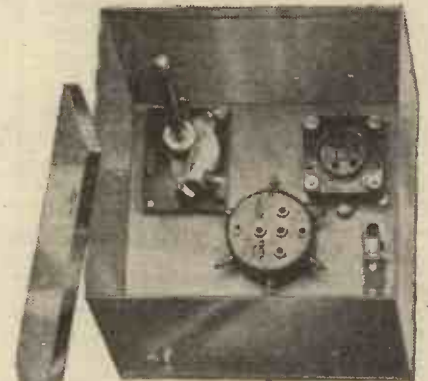

Standard Screening Boxes, 6 1/2" x 6 1/2" x 6" .. ..	12 6
Ready wired and assembled as illustration .. ..	25/-

### THE KEYSTONE MELODY COILS

Ensure success. Ready wound to specification .. ..

7/6

We can give prompt delivery of the **MELODY MAKER PARTS**

1 "Red Triangle" Ebonite Panel, 21" x 7" x 1/4", polished and drilled .. ..	9/6
1 Polished Oak Cabinet .. ..	£1 10s.
1 Baseboard .. ..	2/-
Extra for engraving terminal strip .. ..	2/-
1 Terminal Strip drilled and cut to size .. ..	2/3
All goods post free or C.O.D.	

**PETO-SCOTT CO., Ltd.**  
77, CITY ROAD, E.C.1

Branches at 62, High Holborn, LONDON, W.C.1 and LIVERPOOL. P.S.9703



**LAKER STEEL MASTS**  
are 100 % efficient—

They are made by engineers and supplied to H.M. Government, the B.B.C., and to Colonial and foreign stations throughout the world.

There are 50,000 "Laker" Masts in daily use.

By mass production we are able to offer a wonderfully efficient and handsome steel mast at the extraordinarily low price of

**30 ft. 22/6**

Complete as Illustrated.

Send 1/- extra for part carriage. We pay the rest. Always bear in mind that an efficient aerial is the most important factor in good radio reception.

**JAMES LAKER CO.**  
Engineers,  
**BECKENHAM, KENT**

**DIGBY'S CABINETS**  
WRITE FOR NEW  
16 PAGE CATALOGUE  
F. DIGBY, 9, BANBURY ROAD,  
SOUTH HACKNEY, LONDON E.9.  
PHONE: CLISSOLD 5458.

**BUILD ONE OF THE SETS—**  
DESCRIBED IN THIS ISSUE

A P.C. will bring you price lists of components for Sets described in this Magazine, viz.:

(1) THE "FORTY-STATION" FOUR  
(2) THE "EXPERIMENTAL" EIGHT  
(3) THE "REACTOR" SHORT-WAVER

We specialise in radio components for all "Modern Wireless" Circuits and supply to Exact Specification.

The City & General Radio Co. Ltd.  
79, CANNON STREET, LONDON, E.C.4  
Phone: City 9280.

**Free!**  
**ENGINEERS**  
Here is a  
Wonderful Opportunity

A book that will throw a new and startling light on the possibilities within your grasp—will show you how you can prepare for the A.M.I.E.E., A.M.I.Mech.E., A.M.I.Struck.E., A.M.Inst.C.E., A.M.I.A.E. and any other engineering qualification quickly, and in the privacy of your own home. 60 engineering Diploma (A.M.Tech.I.) courses are described—44 pages of vitally interesting matter to the ambitious engineer.

The book is FREE.  
Write for your copy at once, stating branch of Eng. or Exam. which interests you.  
The Technological Institute of Great Britain, 204, Thanet House, Strand, London, W.C.2.

WHEN replying to advertisements please mention "MODERN WIRELESS" to ensure prompt attention. THANKS!

**EVERYTHING RADIO**  
**EASY ON TERMS**

WOOLBRIDGE  
RADIO CO. LTD.  
16 LISLE STREET,  
LEICESTER SQ., LONDON, W.C.2

**THE INTERDYNE VALVE**  
—continued from page 455.

because if oscillations are produced deliberately at any stage of an amplifier, such as, for instance, in a supersonic receiver, these oscillations cannot pass back to the earlier stages of the amplifier. Again, if it is desired to employ an oscillating valve for purposes of searching for distant stations, by the well-known and popular device of searching first for the carrier wave, one of these new valves can be employed in front of the valve which has reaction, and the oscillations in this second valve cannot reach the aerial. Thus, with one stage of amplification of the type here described, the second valve can be made to oscillate without causing radiation from the aerial, and thus

**ROBINSON INTERDYNE VALVE.**

A Robinson Interdyne Valve made by the Mullard Company has the following characteristics:

Maximum filament voltage	6 volts
Filament current	0.75 amps
Maximum anode volts	150 volts
Impedance	19,000 ohms
Amplification factor	17.5
Mutual conductance	94

without causing any annoyance to neighbours. One method for doing this is shown in Fig. 8, but various other methods will readily suggest themselves. In this case, valve V<sub>1</sub>, with its associated circuits L<sub>3</sub>, C<sub>4</sub>, L<sub>4</sub>, represents one's ordinary detecting valve with reaction, and the valve V<sub>2</sub>, with its circuits L<sub>1</sub>, C<sub>1</sub>, L<sub>2</sub>, C<sub>2</sub>, the anti-radiation and amplifying device.

There remains only the necessity to emphasise once again that this new valve has eliminated one very important source of oscillations in amplifiers, and it will give excellent results provided only the usual precautions are taken to avoid direct interaction between various parts of the receiver.

Excellent amplifiers can be constructed with these new valves. One well-known firm, Radio Instruments, is supplying a five-valve receiver

**LONDON LISTENERS!**  
—improved reception ensured

If you have your accumulators correctly charged by our skilled maintenance service. We collect weekly, fortnightly or monthly within 12 miles of Charing Cross, and exchange your accumulator (H.T. or L.T.) for one fully charged. If yours are not serviceable, you can hire ours. Both trouble-free, money-saving services. Terms—weekly, fortnightly or monthly—no deposit required.

And you can depend on our service for a solution in every wireless trouble.

Our service—the speciality of experts  
Write for full details and terms:  
**RADIO SERVICE (London) Ltd.**  
105, Torrington Avenue, Camden Rd., N.W. 5. Phone: North 0523 (3 lines)



which consists of two high-frequency stages using the Interdyne valves, a rectifying valve, and two L.F. stages. A reaction control is provided in the rectifying circuit to facilitate searching and to improve amplification when required. Actually this reaction control is rarely needed, for a very large number of stations can be obtained without employing it. However, this receiver illustrates admirably the principles of the new valve, for stability is obtained without any trouble, and, again, the rectifying valve can be made to oscillate without any radiation from the aerial.

The receiver, further, has only one tuning control, so that it is actually a very simple receiver which can be operated by people with little knowledge of wireless, and allows a large number of stations to be received under these conditions.

**THE PORTABLE SUPER-HET.**

SIR,—I wish to give my appreciation of the six-valve portable super-heterodyne by Mr Kendall, in the May, 1926, issue of MODERN WIRELESS. I made this set up about three weeks ago, and the first night I tried it I tuned in 32 different stations on a large Audivox loud speaker. On Saturday, Sept. 18th, from 9 p.m. onwards, I received 46 stations on the loud speaker, including Budapest, Madrid, Vienna, Copenhagen, Breslau, Oslo, Zurich, and a large number of German, French, Spanish and Italian stations, also most of the British and Free State stations. I consider this a very good performance for a portable set or even an ordinary set. I also tried a rather interesting experiment with the set about a week ago. I was travelling from Oxford to Guildford by the express train, and I connected the set up in the carriage, and managed to tune in 2 L.O., 5 G.B., 2 German stations and Bournemouth on a medium-sized Amplion speaker. Of course, there was a certain amount of crackling going on, which was probably due to the dynamos, etc., under the carriage. At any rate, it certainly demonstrated very well the portability of the set. The two other passengers in the carriage were rather amazed when I tuned in some German stations while travelling at about 65 miles per hour.

Wishing MODERN WIRELESS and WIRELESS CONSTRUCTOR every success, and hoping that this may be of interest to you and your readers.

Yours truly,  
Surrey. R.G.N.

**A CURIOUS AND PUZZLING FAULT**

WHENEVER the home constructor undertakes to wind his own coils, generally of the solenoidal type, according to the instructions issued by the designer of the particular set he is making, he will notice that there is always a warning that unless meticulous care is taken in the process the results may prove to be disappointing. While on the surface an easy task, the winding and mounting of coils calls for skill in the operation, and too often the poor performance of a receiver can be traced to inefficient coils. As an indication that even in a coil-winding shop faults occur, I felt the following incident, which was related to me recently, would be of interest to readers of this journal.

**Carefully Tested**

A number of coils had been ordered for inclusion in a quantity of valve oscillators, and these were wound according to specification as far as wire gauge, diameter of former, and number of turns were concerned. They were then given a D C. resistance test, and the inductance was measured at low frequency (of the order of 1,000 cycles per second). Since the test figures secured fell within the specified margins the coils were connected up in one of the oscillator sets, the L.T. and H.T. battery sources switched on and tests for oscillation at once made.

The instrument refused to function, however, and, after a thorough overhaul of every connection and an endeavour made to locate possible faults, a further trial was executed with the same negative results. This appeared puzzling, since individual component tests had revealed no errors, so the coils were removed, and two or three very carefully unwound turn by turn to see if they had got damaged or a partial short-circuit was taking place due to bad insulation, but still no apparent trouble could be traced.

The test engineer was rather non-plussed, and decided to go to the winding shop and investigate the conditions under which the coils had been made. It was ascertained that the particular girl who had been told off to make the coils had executed previous commissions of a similar character without any trouble, but another girl was made to wind one

(Continued on page 542.)



*The*  
**Benjamin Standard**

The Benjamin Standard is known throughout the Radio trade. It stands for a greater efficiency, a far higher degree of excellence and an unequalled value. Every component that is stamped with the name of "Benjamin" is the very best of its class.

**THE BENJAMIN RHEOSTAT**

has its windings protected inside the dial. Three windings—6, 15 and 30 ohms. Price 2/9.

**THE BENJAMIN IMPROVED EARTHING DEVICE.**

Twelve feet of one inch copper in 11½" x 1½" giving 288 sq. in. of surface area. The inclined plane of the plates ensures perfect contact. Price 5/9.

**THE BENJAMIN BATTERY SWITCH.**

Simplest and most efficient switch. It's OFF when it's IN. Single contact, one hole fixing. Price 1/-.

**THE BENJAMIN BATTERY ELIMINATOR**

for Alternating Current 200-240 v. 50 cycles. Delivers current for loads up to twelve valves, giving 180 volts for power valve. A really dry eliminator. No acids, no liquids, no hum. £7 15 0.

**THE BENJAMIN VALVE-HOLDER.**

No other valve-holder so efficiently disperses microphonic noises and absorbs shocks so thoroughly. Valves free to float in any direction. Price 2/-.

**BENJAMIN**  
**THE BENJAMIN ELECTRIC LTD.**

Brantwood Works, Tariff Road,  
Tottenham, N.17.

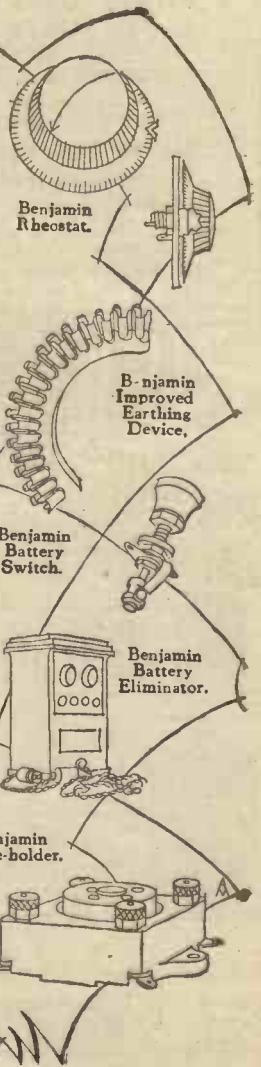

CW

**4½d.**



**EEXLEX**  
**TREBLE DUTY**  
**TERMINAL**

Adaptors 36 DIFFERENT TOPS  
(Eye, Pin, or Spade) 1d. each.



**T14 Plug 3d.**

This Treble Duty Terminal is a Unit in the Eelex System of standardised Plugs and Sockets.

Write for List. M.W. 10



**J. J. EASTICK & SONS**  
Eelex House, 118, Bunhill Row, London, E.C.1.

**CABINETS**  
OF DISTINCTION.  
Send your requirements to—  
**H. CATTERMOLLE, 227 Anlaby Road, HULL**

**READY RADIO SUPPLY CO.**  
41, NEWCOMEN STREET,  
LONDON BRIDGE, S.E.1.  
**PROMPT & RELIABLE.**

Write to-day for price lists of components for circuits described in this issue.

- (1) The "Forty-Station" Four
- (2) The "Experimental" Eight
- (3) The "Reactor" Short-Waver

**A BOON TO INVALIDS**  
**THE RADIO CONTROL CLOCK**  
Price 10/6 post free.

**PICKETT'S**  
**CABINETS**

USED BY BRITAIN'S BEST  
S. W. Emerson,  
S. H. Anspach, WORLD'S PRIZE WINNERS

Standard De Luxe  
Elstree Solodyne 65/- 95/-  
Mt. Queen Anne Model £5-5-0 £9-9-1  
(Rivals 250 to £150 Receivers).

**GUARANTEED AND SENT ON APPROVAL.**  
Estimates and Lists Free.  
**PICKETT'S CABINET (M.W.)**  
WORMS, BEXLEYHEATH.



**THE TAYLEX**  
**WET H.T. BATTERIES**

Solve all H.T. troubles.  
Self-charging, silent, economical.  
**JARS (Waxed) ZINCS SACS**  
2 1/2 doz. 1/3 doz. (new type) 1/2 doz. 1/6 doz.  
Sample dozen (18 volts), 3/6, post 9d.,  
sample 6d.

**BARGAIN LIST FREE.**  
Amplifiers: 1-valve, 19/-, 2-valve, 30/-,  
2-valve all-station set, £4. Approval  
willingly.

**M. TAYLOR, 57, Studley Rd.,**  
**Stockholm, London.**



**A CURIOUS AND PUZZLING FAULT**  
—continued from page 541

or two identical coils for comparison purposes.

Routine tests on these new coils proved that they fell within specification limits, so they were included in the oscillator, and it immediately functioned perfectly. Wire from the same reel and similar formers had been used; where could the fault have been? Since the D.C. resistance test had been O.K., it was diagnosed as being due to a leakage across the turns, which only evidenced itself at the high frequencies at which the oscillator normally worked.

**The Trouble Traced**

During the course of a further investigation the workgirl who had wound the coils which proved defective was interrogated, and the conversation revealed the fact that she had just started a course of medicine, some of the doses having been taken during work hours. The medicine in question was a well-known proprietary article, which contained a large percentage of iron, and it had got on to her fingers, and thence on to the silk insulation of the wire during the coil-winding process!

Although only a very small quantity of the fluid could have been absorbed under circumstances such as this, the amount of iron was sufficient to cause a high-frequency leakage between coil turns, the D.C. resistance and low-frequency inductance test being unaffected.

The moral of this interesting investigation is quite plain. Be sure your hands are clean and free from anything of a metallic nature when coil winding, otherwise the foreign matter may be taken up by the wire insulation and cause curious effects which may prove difficult to trace.

In the case of L.F. transformer winding the acid from moist hands is quite sufficient to cause an ultimate breakdown if it comes into contact with the fine enamelled wire used for such instruments. It is amazing what apparently small and unimportant things have large effects where radio is concerned.

H. J. B. C.

**RADIO ABROAD**  
—continued from page 502

station is linked with the studio by 450 miles of landline. Of this distance a considerable portion is covered by power lines over which the programmes are sent at radio frequency. They are again stepped down at Worgl, 45 miles from Innsbruck, and complete the journey by ordinary telephone cable.

**Portugal**

The Colonial Empire of Portugal is linked with Lisbon by a chain of stations, the latest of which was recently opened at Lourenço Marques, on the African coast. Other stations are Madeira, Cape Verde, and Loanda.

**India**

Elaborate plans for covering India with a chain of high-power stations, making reception possible to millions of inexpensive receiving sets, are now beginning to show tangible results with the completion of a 12-kilowatt station at Bombay on the west coast

**NEXT MONTH**

The December issue of MODERN WIRELESS will be a

**SPECIAL XMAS DOUBLE NUMBER**

and will include many special constructional and other articles of interest to all classes of radio enthusiasts.

Price 1/6. On Sale Dec. 1st

of the peninsula of Hindustan. This is in a time zone five and a half hours east of London.

**Silence is Golden!**

In the United States, where wireless broadcast is entirely free from the restrictions and control which exist in this country, all kinds of curious arrangements are made with broadcasting stations for transmitting matter of various kinds, usually of an advertising nature. A new system of "selling radio" commercially has been inaugurated by the apparent possessor of a contract with station WHN, New York, for one hour eight times per month. Solicitors are offering merchants one minute of this time eight times a month for 45 dollars. It is guaranteed that the name and address of the firm "buying the time" shall be mentioned four times within each of the 60-second periods. Sellers of the time by the minute are allowed 25 per cent of their sales. One solicitor said he sold thirty-five prospects in one day.

(Continued on page 543.)

**Don't Save up —**



PUT a small sum down and buy one of our Sets. We have a wonderful range of instruments. All accessories sold on instalment system, too. A Postcard to Desk "M." will bring you our Brochure. **New Times Sales Co., 77, City Rd., London, E.C.1.**



**TROUBLE-FREE BATTERY SERVICE**



Heat your valve filaments with Columbia Dry Cells.

Using '06-075 or 1 amp. valves you will get months and months of trouble-free service. Trouble-free service means—No weekly journeys to charging stations—No re-charging costs—No risks from acids spilling. Dry-cell service is so simple as compared to the continual nursing positively demanded by accumulators; but use good dry cells—

**Columbia**

Radio "A" Dry Cells.

Drop a card for full information.

**J. R. MORRIS,**  
15, KINGSWAY, LONDON, W.C.

Scotland - **J. T. CARTWRIGHT,**  
3, Cadogan Street, Glasgow.

*The HOME for your*  
**WIRELESS SET**

**OUR STANDARD CABINETS**

are **DUSTPROOF** and house the whole apparatus, leaving no parts to be interfered with. Beautiful in Design and Finish. Made on mass production lines, hence the low price. Provision is made to take panels up to 30" and base-board 20" deep. Special Cabinets for the Solodyne, New Family Four, Long Range Five, "M.W." Five, A "Three" for the New Valve, All-British Six, etc., now ready.



MODEL 'D.'

From £4 : 15 : 0

Write for full particulars **FREE**—

**MAKERIMPORT CO.,**

(Dept. 2) 50a, Lord Street, LIVERPOOL.

WHEN REPLYING TO ADVERTISEMENTS  
KINDLY MENTION "MODERN WIRELESS"

**REPAIRS**

to HEADPHONES, LOUDSPEAKERS, TRANSFORMERS, COILS.

First-class workmanship only. This is just the vital difference. We are specialists with almost 30 years' experience in every form of intricate and accurate coil winding, and we guarantee that work entrusted to us will be returned to you as good as new, if not better. This is no idle claim, but the unsolicited opinion of scores of satisfied clients.

**THE VARLEY MAGNET COMPANY**  
(Proprietors: Oliver Pell Control, Ltd.)  
BLOOMFIELD ROAD WOOLWICH, S.E.18.

Telephone: Woolwich 0888.



**RADIO ABROAD**  
—continued from page 542

**Canada**

The number of broadcasting stations in Canada has decreased, there being now only 75 stations listed, as against 80 last autumn. Of the present number listed as possessing licences, 16 operate under what are called "phantom" licences. Such a licence will allow a firm to have a call but no station of its own, the programmes being transmitted from another station with the call letters of the phantom licence. In this way there are many more calls than stations. Eleven of the listed calls are owned by the Canadian National Railways, which operate a chain of stations from coast to coast. Ten are operated by newspapers, while one station is under consideration for a liquor firm in Toronto.

In a number of Canadian cities, bi-lingual programmes are broadcast—Ottawa, Montreal, and Quebec. Announcements are made usually first in English and then in French, while certain speakers will address both audiences in their own language, a feature which makes broadcasts from parts of the Dominion especially interesting.

**"Ohm-spun"**

A curious new type of resistance wire which is very handy for some purposes is now manufactured in New York and is known as "Ohm-spun." It consists of a very coarse woven "fabric" in which the "threads" in one direction are resistance wires, while those in the direction at right angles are asbestos string. In this way a kind of coarse matting is made, carrying the resistance wires separated at regular distances in the asbestos. The resistance wires may be suitably connected together and used for general purposes, whilst the asbestos insulates them and is incapable of catching fire, even though the resistance wires may run red-hot. The "ohm-spun" mat may be conveniently mounted on a vertical frame or rack, or may be hung up like a curtain or tapestry.

**Selectivity Urgent**

Selectivity is the most urgent need in wireless to-day, according to Admiral W. H. G. Bullard, Chairman of the Federal Radio Commission, U.S.A. He continues: "There seems

(Continued on page 544.)



**BRIGHT OR DULL—**  
*The* **PEERLESS DUAL RHEOSTAT AFFORDS PERFECT CONTROL!**

The Peerless Dual Rheostat is specially made to meet the demand for a Rheostat covering needs of both bright and dull emitter valves. Has two windings, a resistance of 6 ohms, with a continuation on to a 30-ohm strip winding. Resistance wire wound on hard fibre strip under great tension and immune from damage. One-hole fixing, terminals conveniently placed. Contact arm has smooth, silky action. All metal parts nickel-plated. Complete with ebonite combined knob and dial.

**PRICE 3/-**

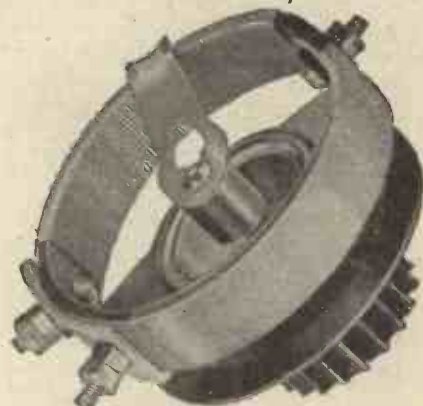

**THE BEDFORD ELECTRICAL AND RADIO CO., LTD.,**  
22 Campbell Rd., Bedford.

LONDON: 21, Bartlett's Buildings, Holborn Circus, E.C.4.

GLASGOW: 113, St. Vincent Street, O.2.



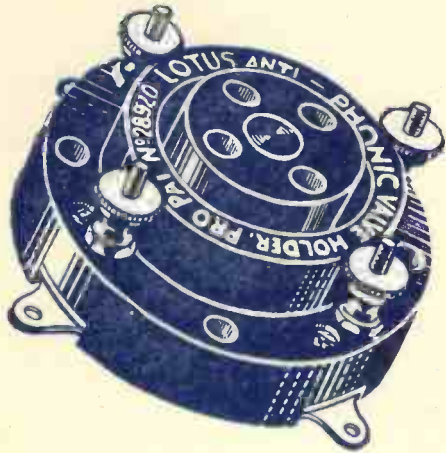

*Prices :*

Without Terminals	2/3
With Terminals	2/6
Combined Grid Leak and Terminal Valve Holder	3/9

## Look to your Valve Holders !

**I**F your reception is unsatisfactory or weak, if it is spoiled by constant irritating noises, look to your Valve Holders.

See that they are guaranteed to absorb shock and eliminate all microphonic noises, because that IS where the fault lies.

The Lotus Valve Holder is constructed to give immediate and lasting connection when the valve pins enter the valve sockets. The leg sockets expand and automatically lock, and the floating platform in which they are fixed is suspended by four phosphor bronze springs, which have great mechanical strength and at the same time are sufficiently resilient to absorb any external shock that would cause damage to the valve.

Carefully made from the finest bakelite mouldings, with phosphor bronze leg sockets, every Lotus Valve Holder undergoes strict tests before leaving the factory, and can be relied on to withstand a great deal of rough usage.

**LOTUS**  
BUOYANCY  
**VALVE HOLDER**  
ANTI-MICROPHONIC

Made by the makers of the famous Lotus Remote Control, Vernier Coil Holders, Jacks, Switches and Plugs.

GARNETT, WHITELEY & CO., LTD.  
"Lotus Works" - Broadgreen Road, Liverpool

**ABSORBS SHOCK—ELIMINATES MICROPHONIC NOISES**

CAUSTON

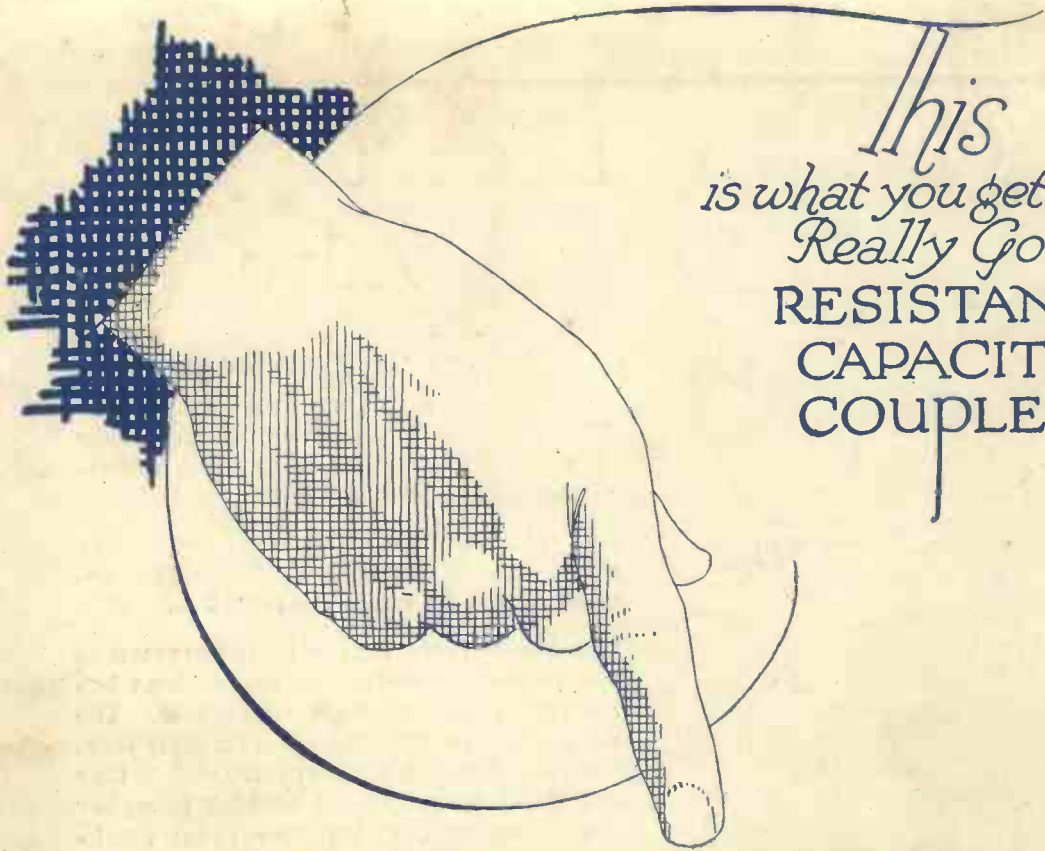

*This*  
*is what you get with a*  
*Really Good*  
**RESISTANCE**  
**CAPACITY**  
**COUPLER**



**Type A.** Suitable for use after Valves with A.C. Resistance (Impedance) of 15,000 - 40,000 ohms .. **20/-**  
**Type B.** Suitable for use after Valves with A.C. Resistance (Impedance) of 30,000 - 100,000 ohms .. **22/6**

*If you are seriously interested in L.F. amplification and in getting the purest results from your loud speaker, our new Booklet "Low Frequency Amplification" (Price 1/-) contains in simple language the fullest details of Transformer, Resistance Capacity and Choke Coupling. The information is absolutely reliable, and confirmed by independent tests made by the National Physical Laboratory.*

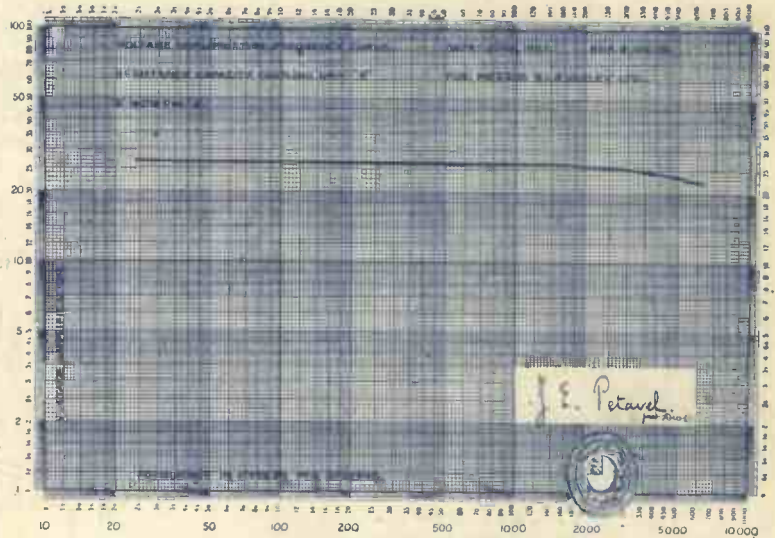

VOLTAGE AMPLIFICATION-FREQUENCY CURVE

**Uniform Amplification at all frequencies**

The efficiency of this perfectly designed component is backed by the authoritative seal of the National Physical Laboratory.

The new R.I. and Varley Resistance Capacity Coupler is beautifully finished, and every detail is perfectly matched and accurately balanced.

*We have specialised in every form of L.F. Amplification and invite you to write for our leaflet "L.F. Transformers" (free), giving particulars of our new Straight Line Super Transformer.*



**THE MARK OF BETTER RADIO**

Kingsway House, 103, Kingsway, London, W.C.2.

Telephone: Holborn 5303