

FREE WITH THIS ISSUE

THE "MODERN WIRELESS"  
RAPID STATION GUIDE

# MODERN WIRELESS

1/4  
MONTHLY



Vol. VI. No. 5.

Edited by  
**J. H. REYNER**  
B.Sc. (Hons.), A.M.I.E.E.

P. O. V. Code. D. 211  
len. 2/10 20 100/101  
2/x 1926

OCTOBER, 1926.

## *How to make* A SCREENED-COIL SUPERHETERODYNE

By  
**G.P. KENDALL, B.Sc.**





# 400 P.M. filaments will lift a man!



## CONSIDER THE FACTS

*The life of a valve is not one minute longer than the life of its filament.*

Therefore, for real value, see that your valves have **STRONG FILAMENTS.**

The wonderful P.M. Filament offers you three times more for your money. It is so tough that even after 1,000 hours' life it can be tied in knots and cannot be broken except by the very roughest handling—*result, safety against accidents.*

There is more than strength in the P.M. Filament. It has up to 3 times greater length and up to 5½ times greater emission than an ordinary filament. This is where the P.M. Filament gives you real value.

Another big point, the P.M. Filament requires only one-tenth ampere giving 7 times the life to each of your accumulator charges.

For great economy, great life and great results secure the valves with

**THE WONDERFUL P.M. FILAMENT**

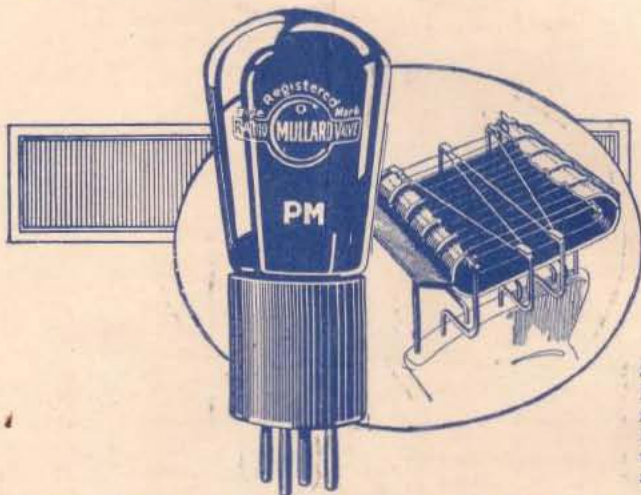

Sectional view of the P.M.5 showing the great length of the P.M. Filament and its resilient hook suspension.

### NEW REDUCED PRICES

For 4-volt accumulator or 3 dry cells

THE P.M.3 (General Purpose) 0'1 amp. 14/-

THE P.M.4 (Power) 0'1 amp. 1s/6

For 6-volt accumulator or 4 dry cells

THE P.M.5 (General Purpose) 0'1 amp. 18/6

THE P.M.6 (Power) 0'1 amp. 18/6

For 2-volt accumulator

THE P.M.1 H.F. 0'1 amp. 14/-

THE P.M.1 L.F. 0'1 amp. 14/-

THE P.M.2 (Power) 0'15 amp. 18/6

*These prices do not apply in Irish Free State.*

ASK YOUR DEALER FOR P.M. VALVES

# Mullard

**THE MASTER VALVE**

British Made  
in a  
British Factory

# CONTENTS

VOL. VI. MODERN WIRELESS No. 5

	PAGE		PAGE
A Screened-Coil Superheterodyne ... ..	435	Operating the Elstree "Solodyne" ... ..	471
By G. P. KENDALL, B.Sc.		By J. H. REYNER, B.Sc. (Hons.), A.M.I.E.E.	
In Passing ... ..	442	An H.T. Charging Unit for Home Use ... ..	479
Modern Design in Simple Sets ... ..	444	By THE STAFF OF THE ELSTREE LABORATORIES.	
By J. H. REYNER, B.Sc. (Hons.), A.M.I.E.E.		The Mewflex ... ..	488
A "Four" for Range and Selectivity ... ..	448	Described by J. H. REYNER, B.Sc. (Hons.), A.M.I.E.E.	
By W. Q. KAY.		An "Easy-to-Make" Single Valve Set ... ..	494
More "Elstree Six" Successes ... ..	453	By JOHN PUGH-PRICE.	
Off the Beaten Track ... ..	454	The Design of Loud-Speaker Horns ... ..	501
Press-Men Test the "Solodyne" ... ..	456	By H. J. ROUND, M.I.E.E.	
A Three-Valve Trap Receiver ... ..	459	Some Problems in "Gang" Control ... ..	508
By C. P. ALLINSON, A.M.I.R.E.		Tested by Ourselves ... ..	516
The "Elstree Six" ... ..	468	Tracing Trouble ... ..	525
		By JOHN UNDERDOWN.	

Edited by J. H. REYNER, B.Sc. (Hons.), A.M.I.E.E.

RADIO PRESS LTD., BUSH HOUSE, STRAND, LONDON, W.C.2.

Telephone: City 9911

Nothing contained herein is to be regarded as permission or encouragement to infringe any patent rights.

## MAGNUM RESISTORS

No. 1059.

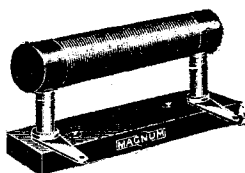

Supplied in ranges to suit all types of Valves.  
NOTE.—When ordering, state make and type of Valve used and voltage of accumulator.  
Magnum Resistors eliminate unsightly knobs, ensure correct filament temperature, and prevent overrunning.

PRICE.

Resistor on Base .. ..	2 6
Resistor only .. ..	1 9
Shorting Plug .. ..	1 0

Recommended for the Elstree Six, Elstree Solodyne 8-Valve Super-Het., and all sets employing fixed resistances.

## Construct the CHARGING UNIT

(as described in this issue).

	£	s.	d.
1 Mahogany Cabinet with Baseboard .. ..		18	0
1 Ebonite Panel, 9 in. x 6 in. x 1/4 in., ready drilled .. ..		5	6
1 Sifam Milliammeter, 0—150 .. ..		10	0
1 Hot-Wire Ammeter, 0—5 .. ..		12	6
1 R.I. Dual Rheostat .. ..		7	6
1 Utility 2-Pole C.O. Switch .. ..		4	0
1 Magnum Special Filament Transformer .. ..		1	5
2 Lotus Valve Holders .. ..		4	6
2 Magnum Terminals .. ..		6	6
1 Adaptor with Flex .. ..		2	0
2 U.4. Valves .. ..		1	10
Connecting Wire .. ..		6	6
		<b>£6</b>	<b>0 0</b>

We specialise in and can supply Components for all Sets described in this and all Radio Press publications, including—

- THE ELSTREE SIX.
- THE ELSTREE SOLODYNE.
- THE MEWFLEX THREE.
- THE NIGHT HAWK.
- THE DISTAFLEX TWO, Etc., etc.

Lists on receipt of stamp.

## CONSTRUCT THE

# 8-VALVE SUPER HET.

(as described in this issue by Mr. G. P. KENDALL).

	£	s.	d.
1 Mahogany Cabinet with drop-front and baseboard as described .. ..		5	10 0
1 Ebonite Panel, 21 in. x 7 in. x 1/8 in., ready drilled .. ..		10	6
2 Angle Brackets .. ..		2	6
5 Magnum Screens and Bases .. ..		3	15 0
3 Magnum Intermediate Transformers .. ..		3	0 0
1 Magnum Filter .. ..		1	0 0
1 Magnum Oscillator .. ..		15	0 0
8 Magnum Resistors .. ..		1	0 0
8 Lotus Valve Holders .. ..		18	0 0
3 Varley Chokes .. ..		1	8 6
1 Varley 100,000 ohm Resistance and Base .. ..		7	6
1 Igranite L.F. Transformer, 5/1 ratio .. ..		16	0
2 Igranite Potentiometers .. ..		13	0
5 Dubilier Fixed Condensers, .015 type 610 .. ..		1	2 6
1 Dubilier Fixed Condenser, .001 .. ..		3	6
2 Dubilier Fixed Condensers, .0003 .. ..		6	0
1 Dubilier Leak, 2 meg. .. ..		2	6
1 Dubilier Leak, .5 meg. .. ..		2	6
1 T.C.C. Condenser, 1 mfd. .. ..		3	10
1 T.C.C. Condenser, 2 mfd. .. ..		4	8
1 Baseboard Balancing Condenser .. ..		7	6
1 Baseboard Neutralising Condenser .. ..		5	0
2 Eureka S.L.F. Condensers, .0005 .. ..		1	11 0
2 Clearton Selector Dials .. ..		1	1 0
1 Single Telephone Jack .. ..		2	0
1 Plug .. ..		1	6
2 Belling-Lee Terminals .. ..		1	6
5 Plugs for G.B. Battery .. ..		10	0
Glazite .. ..		4	0
Connecting Flex .. ..		2	0
		<b>£25</b>	<b>16 0</b>

Any of above parts supplied separately as desired.

## BURNE-JONES & CO., LTD.,

Manufacturing Radio Engineers,

MAGNUM HOUSE,

296, Borough High St., London, S.E.1

Telephone: Hop 6257.  
Telegrams: "Burjomag, Sedist, London."  
Cables: "Burjomag, London."

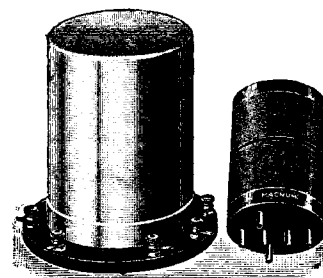

No. 1053.

## MAGNUM SCREENED COILS

NEW STANDARD COILS AND PRICES.

	£	s.	d.
Magnum Screening-box, complete with 6-Pin base (Standard spacing and cross formation) .. ..		15	0
Split Primary Aerial Coil, 250/550 .. ..		6	0
Split Primary H.F. Transformer, 250/550 .. ..		10	0
Split Primary Aerial Coil, 1000/2000 .. ..		6	0
Split Primary H.F. Transformer, 1000/2000 .. ..		10	0
Split Secondary H.F. Transformer, 250/550 .. ..		10	0
Split Secondary H.F. Transformer, 1000/2000 .. ..		14	0
Reinartz Coil, 250/550 .. ..		10	0
Reinartz Coil, 1000/2000 .. ..		14	0
Price per set of 3 Screens and Coils, 250/550, for the Elstree Solodyne .. ..		<b>£3</b>	<b>11 0</b>
Set of Screens and Bases I.F. Transformers, Filter and Oscillator for the 8-Valve Super-Het. described herein .. ..		<b>£8</b>	<b>10 0</b>

NOTE.—Where a complete set of Components, together with a drilled panel, is purchased, Royalties at the rate of 12s. 6d. per valve holder are payable.

The following Sets ready wired and tested:—

ELSTREE SIX .. ..	£29	0 0
ELSTREE SOLODYNE .. ..	£25	0 0
Plus Marconi Royalties at 12/6 per valve holder.		

FILAMENT TRANSFORMER AS USED IN THE CHARGING UNIT DESCRIBED HEREIN OPERATING FROM 200/240 VOLTS A.C. TO 3, 5 OR 8 VOLTS. 25/-



Be sure to see  
**SIR OLIVER LODGE'S**  
 newest and greatest Wireless achievement — the  
**LODGE 'N' CIRCUIT**

This circuit does what no other circuit has done before. Without the use of reaction, and with a perfectly simple straightforward circuit, it gives as much volume as one with a large amount of reaction. It cannot interfere with other people's reception. It has a purity of tone far superior to that of a "reactive" circuit and needs only one control. CLEARTRON have secured the world rights of the Lodge "N" Circuit, which is embodied in 2-valve (and 3-valve) sets. *Explanatory booklet, with "Foreword" by Sir Oliver Lodge, sent on request.*

Complete Specification

Two CLEARTRON Valves, C.T. .08 Standard, C.T. .08 Plus; 4-Volt Accumulator 40 amp; 100-volt H.T.; 9-volt Grid Bias Battery; CLEARTRON SPECIAL Loud Speaker, full Flare; CLEARTRON Condenser, and Micro Station Selector; Marconi "Ideal" Transformer; Local and Daventry Coils (four in number). Patent Nos.: 238003, 223625 and patents pending. In CLEARTRON Special Honduras Mahogany Cabinet, complete

**£15.15.0**

including all Royalties  
 Installation included (except Aerial and erection.)

or 20/- cash and easy  
 monthly payments.

ASK ABOUT  
 CLEARTRON'S  
 NOVEL  
 SERVICE  
 PLAN



SINGLE  
 DIAL  
 CONTROL

Non-interfering  
 Non-radiating  
 Great volume  
 Extreme purity  
 Keenly selective  
 Highly sensitive

Ask or send for the 1926-7 Catalogue of  
**CLEARTRON NEW MODEL VALVES**

**14/-**

Standard Prices

**18/6**

America's foremost Valve, made in Britain's newest factory.



**CLEARTRON RADIO LIMITED**

ONE, CHARING CROSS, LONDON, S.W.1. Works: Birmingham.  
 Telephone: Regent 2231/2. Telegrams: "Cleartron, Westrand, London."

CT.



# A SCREENED-COIL SUPERHETERODYNE

By G. P. Kendall, B. Sc.

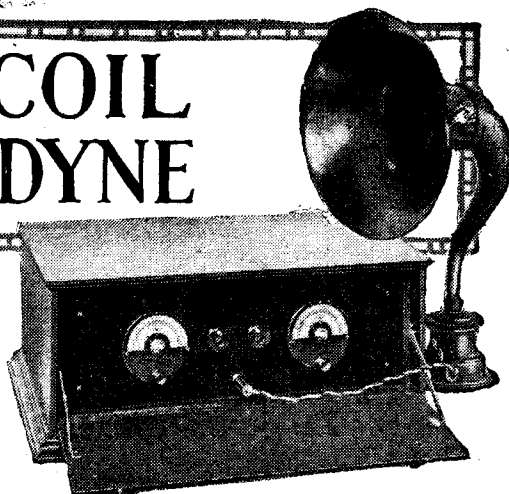

*This eight-valve superheterodyne illustrates an interesting application of the newly introduced screening boxes. Each of the principal units of the circuit is separately screened and the intermediate frequency transformers are mounted on the standard six-pin bases so that different makes can be tried.*



one of the most important problems in their construction is to arrange that each individual section of the receiver does its own job, does not interfere with the functioning of some other part of the circuit, and does not take on some job

FAIRLY long and at times rather bitter experience of superheterodynes and their ways has convinced me that

I will quote the case of a certain super-heterodyne made by a constructor who has had a long experience of straight receivers, but has not done very much with supers. When I was invited to hear his new instrument it was grunting and squawking in a most objectionable manner when any attempt was made to bring the potentiometer controlling the long-wave side round towards the most sensitive position (with the long wave amplifiers somewhere near

### The Solution

I suggested that the constructor should take the appropriate steps, and he proceeded to try shunting condensers acting as by-passes in various parts of the circuit, chiefly across the low frequency inter-valve coupling units and across the loud-speaker terminals, and he very soon got rid of the trouble in this way.

This is but one example of misbehaviour upon the part of one section of a super-heterodyne receiver, and there are various other

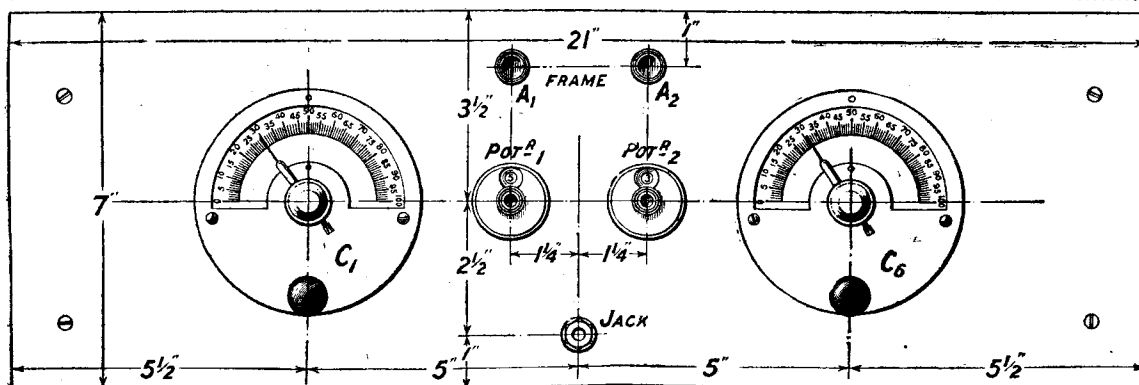

Fig. 1.—The panel drilling is quite simple, the condensers and potentiometers being on the same centre line. Blueprint No. 182a (free).

which should be done by another part of the set. As a matter of fact, this sort of thing is quite common in the average superheterodyne, and really satisfactory working is impossible so long as it goes on.

### An Example

As an example of the kind of trouble to which I am referring,

the verge of oscillation). Furthermore, the adjustment of the long-wave potentiometer did not hold good for the different wavelengths being received, and altogether it was behaving in a way which convinced me that the trouble was that high-frequency currents were getting through into the low-frequency amplifying circuits.

ways in which trouble may occur. The long-wave transformers, for example, may start picking up signals on their own, instead of leaving that duty to the frame aerial, and such signals will not as a rule be the ones it is desired to hear again; the oscillator valve, instead of sticking to its job of generating oscillations and feeding

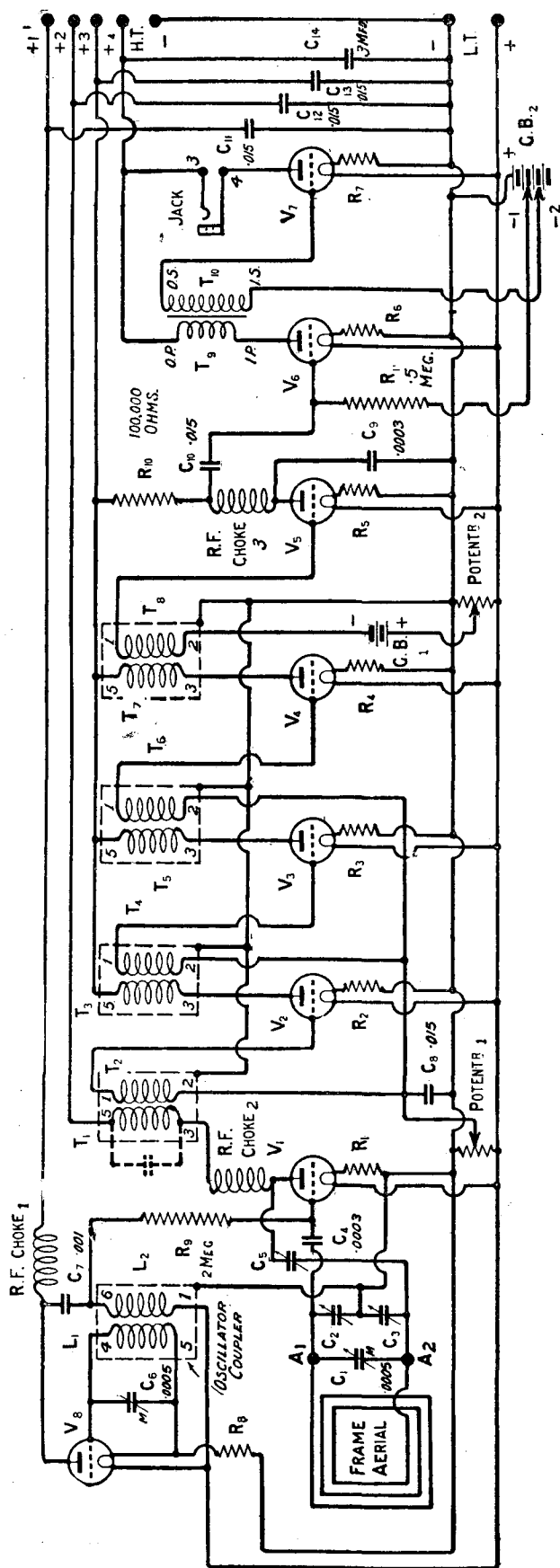

Fig. 2.—The simplified circuit diagram. The filament connections to the jack are omitted in order to retain simplicity. Note that H.T. — is joined to L.T. —

## A Screened-Coil Superheterodyne

(Continued)

them to the grid of the first detector valve, may start inducing high-frequency currents into places where they may do more harm than good; and it will be understood that these high-frequency currents may be not merely of the fundamental frequency which is being generated but of all sorts of harmonic and overtone frequencies which may cause much annoyance.

### The Circuit

Before proceeding to describe the various measures which have been taken to make all the different sections of the circuit behave themselves in a proper manner, let us take a look at the circuit adopted. This is illustrated in one of the diagrams accompanying this article, and it will be seen that a separate oscillator valve is provided, instead of the combined oscillator-detector which is something of a weakness of mine. The reason why a separate oscillator was adopted in this case was to enable reaction upon the frame circuit to be used from the first detector, which is not readily achieved if that valve is also the oscillator.

### The Oscillator

The oscillator employs a parallel feed circuit, with a high-frequency choke in the anode circuit of the valve, a by-pass condenser conducting the high-frequency impulses through a shunting coil to the filament circuit. The grid circuit of this valve is tuned in the ordinary way, and it is found to be a very stable and convenient oscillator, with certain advantages upon short waves which will be found beneficial when the receiver comes to be used for such stations as KDKA, in a manner which I hope to describe at a later date.

In order to avoid the difficulties arising from the use of magnetic coupling between the oscillator circuit and the frame aerial circuit, a special method of feeding the local oscillations on to the grid of the detector valve has been adopted. This is quite simple, and consists merely in taking the bottom end of the grid leak of the detector valve, instead of directly to filament positive, to that point by way of the anode



## AN EFFICIENT EIGHT-VALVE RECEIVER

circuit coupling coil of the oscillator valve. In other words, the lower end of the grid leak is connected to the upper end of the oscillator coupling coil, whose lower end is wired to filament positive.

### Oscillator Coils

There are thus no special couplings to arrange, which makes it easier to prevent the straying of the local oscillations about in different parts of the set, and is also convenient when working on short waves. There being no variable couplings or other difficulties of this sort to arrange. All the local oscillator coils are wound upon a single former, and the whole is placed inside a standard screening box, so that one can be fairly sure that the local oscillations are fed only to the one place they are required—namely, the grid of the first detector valve.

### The Centre Point

The first detector rectifies by means of the leaky grid condenser method, and reaction is taken

from this valve by the scheme usually known as the Hartley arrangement, with a slight modification. This scheme, it may be remembered, usually requires the use of a centre-tapped frame aerial, which is not always available. To remove this necessity, I have incorporated the split-condenser method of obtaining a centre

mediate value at the outset and tuning is done by a separate .0005 condenser connected across the ends of the frame.

### Reaction Control

The reaction effect itself is obtained by means of a small variable condenser, this being of the baseboard mounting neutrodyne type, but of special capacity, connected between the end of the frame aerial, remote from the grid of the valve, to the anode of the valve itself, a high-frequency choke being connected in the anode circuit to ensure the best results.

### Intermediate Amplifier

Following the first detector

point, so that the ordinary frame aerial without a centre tap may be employed. The split condenser is simply a small balancing condenser made by Messrs. Peto-Scott, connected directly across the ends of the frame aerial, the centre point being connected to filament negative in the ordinary manner. This condenser may be set to its inter-

mediate-frequency amplifier, which consists of three valves, arranged in a perfectly normal fashion. Each of the intermediate transformers, and, of course, the input filter, is contained in one of the standard screening boxes introduced for the shielding of coils by the Elstree laboratories. The idea is to mount each of these units

### STATIONS RECEIVED

Pending the publication of a fully detailed test report next month, the following list of stations heard during a short test will give an idea of the capabilities of the receiver. All these stations were heard on the loud-speaker, and only those which could be identified definitely by the announcer's words are included in the list. Numerous other transmissions were heard, but were either not identified or were not capable of being received clearly because they were being heterodyned or otherwise interfered with:—

Aberdeen.	Glasgow.	Newcastle.
Belfast.	Dublin.	Manchester.
Birmingham.	Stoke-on-Trent.	Bournemouth.
Brussels.	Munster.	Berne.
Rome.	San Sebastian	Toulouse.
Frankfurt.	Hamburg.	

## COMPONENTS REQUIRED

Cabinet, baseboard and brackets (Camco).  
 Panel,  $21 \times 7 \times \frac{3}{16}$  (Camco).  
 Two S.L.F. variable condensers, capacity .0005 (Portable Utilities, Ltd.).  
 Two slow motion dials (Cleartron Radio, Ltd.).  
 Two high resistance potentiometers (Igranic Electric Ltd.).  
 One single filament control jack (Igranic Electric Ltd.).  
 One low-frequency transformer, 5:1 ratio. (Igranic Electric, Ltd.).  
 One balancing condenser, base-board mounting (Peto-Scott Co., Ltd.).  
 One neutrodyne-type condenser of special capacity, base-board mounting (Peto-Scott Co., Ltd.).  
 Three H.F. chokes (Varley Magnet Co., Ltd.).  
 Five fixed condensers, type 610, capacity .015 (Dubilier Condenser Co., Ltd.).  
 Two fixed condensers, type 610, capacity .0003 (Dubilier Condenser Co., Ltd.).  
 One fixed condenser, type 610, capacity .001 (Dubilier Condenser Co., Ltd.).  
 One grid-leak, 2 meg. (Dubilier Condenser Co., Ltd.).  
 One grid-leak,  $\frac{1}{2}$  meg. (Dubilier Condenser Co., Ltd.).  
 Two grid-leak holders (Dubilier Condenser Co., Ltd.).

One wire-wound anode resistance 100,000 ohms (Varley Magnet Co., Ltd.).  
 Eight spring valve sockets (Garnett, Whiteley & Co., Ltd.).  
 One Mansbridge-type condenser, capacity 1 microfarad (Telegraph Condenser Co., Ltd.).  
 One Mansbridge-type condenser, capacity 2 microfarads (Telegraph Condenser Co., Ltd.).  
 Two ebonite-topped terminals (Belling-Lee & Co., Ltd.).  
 Five H.T. battery plugs, 2 red, 3 black, for grid-bias connections.  
 Eight fixed resistors and sockets (Burne-Jones & Co., Ltd.).  
 Five "screened-coil" boxes and bases (Burne-Jones & Co., Ltd.).  
 One special oscillator-coupler (Burne-Jones & Co. Ltd.).  
 One input filter unit, mounted on standard "screened coil" base (Burne-Jones & Co., Ltd.).  
 Three intermediate frequency transformers, mounted on standard "screened-coil" bases (Burne-Jones & Co., Ltd.).  
 Glazite wire.

## A SCREENED-COIL SUPERHETERODYNE—(Cont.)

upon a standard base of the type normally used for the coils which are used inside these screening boxes, and to plug it into position inside the box.

A very useful measure of screening of the intermediate frequency amplifying circuit is obtained in that way, and a notable freedom from direct pick-up of long-wave interference, mush, and so on is achieved.

### L.F. Couplings

Following the second detector there are two stages of low-frequency amplification, the first being resistance-coupled and the second transformer-coupled, an arrangement which is found particularly suitable in view of the fact that the second detector operates on the anode bend principle, which means that this valve has a very high impedance under normal conditions.

### A Safety Device

The expedient adopted in this set is to connect also a high-frequency choke in the anode circuit of the detector, and to place a by-pass condenser directly between the anode of the valve and the filament circuit to exclude these high-frequency currents as far as possible from the low-frequency coupling unit. The value of the by-pass condenser will, in some cases, re-

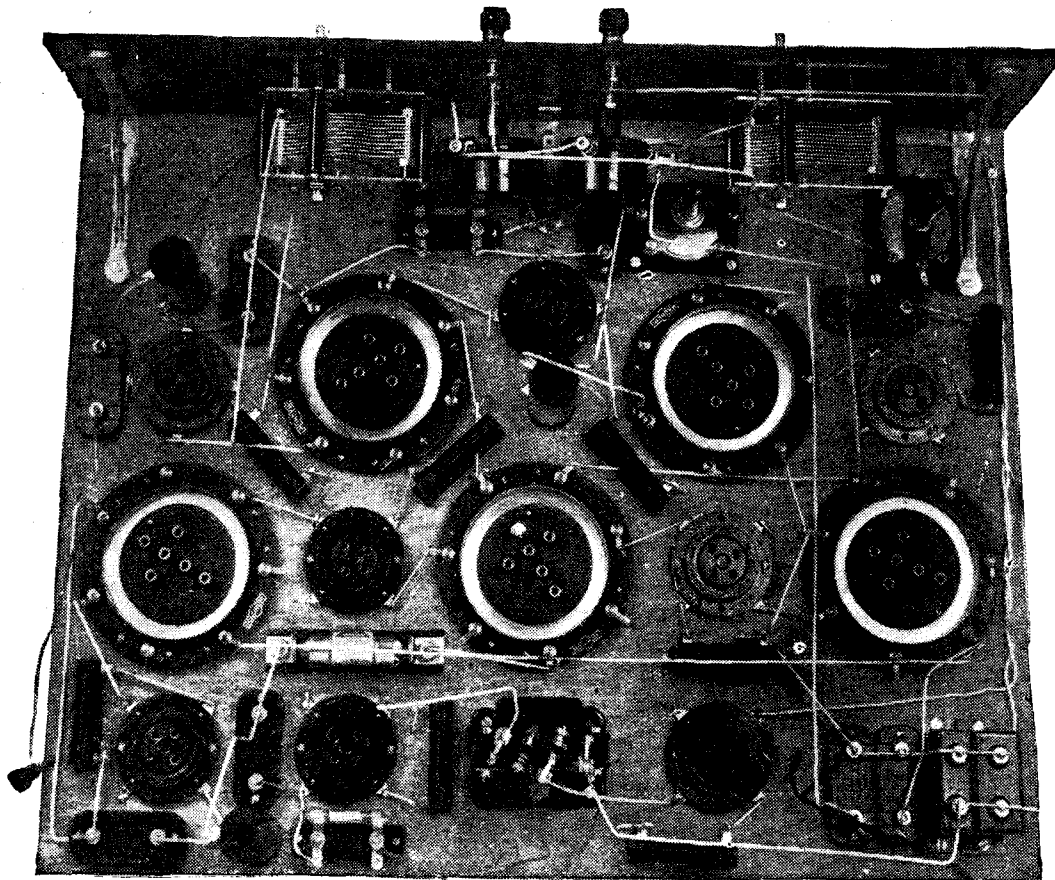

The loud-speaker leads from H.T. +4 and the anode of  $V_7$  to the jack are twisted together.

### Second Detector

The second detector operates on the anode bend principle, a special small grid-bias battery being fitted to provide the desired negative bias upon its grid. The exact adjustment of the negative potential of the grid of this valve is done by means of a second potentiometer, the connections of this potentiometer and grid-bias battery being shown in the circuit diagram.

This arrangement is particularly suitable when the detector valve is worked in such a way as to have a very high impedance, but it must be remembered that a resistance in the anode circuit of the detector valve will also act as a high-frequency coupling unit, and therefore some steps should be taken to prevent the high-frequency currents being passed on into the low-frequency circuits where they may cause trouble.

quire a little experimenting, although a value of  $\cdot 0003$  is found suitable in my set. This may be increased to  $\cdot 0005$  if troubles are experienced from high-frequency currents getting through to the low-frequency circuits.

### Practical Details

Turning to the actual lay-out and arrangement of the practical details of the receiver, it will be seen that a very simple panel



A SCREENED-COIL SUPERHETERODYNE—(Cont.)

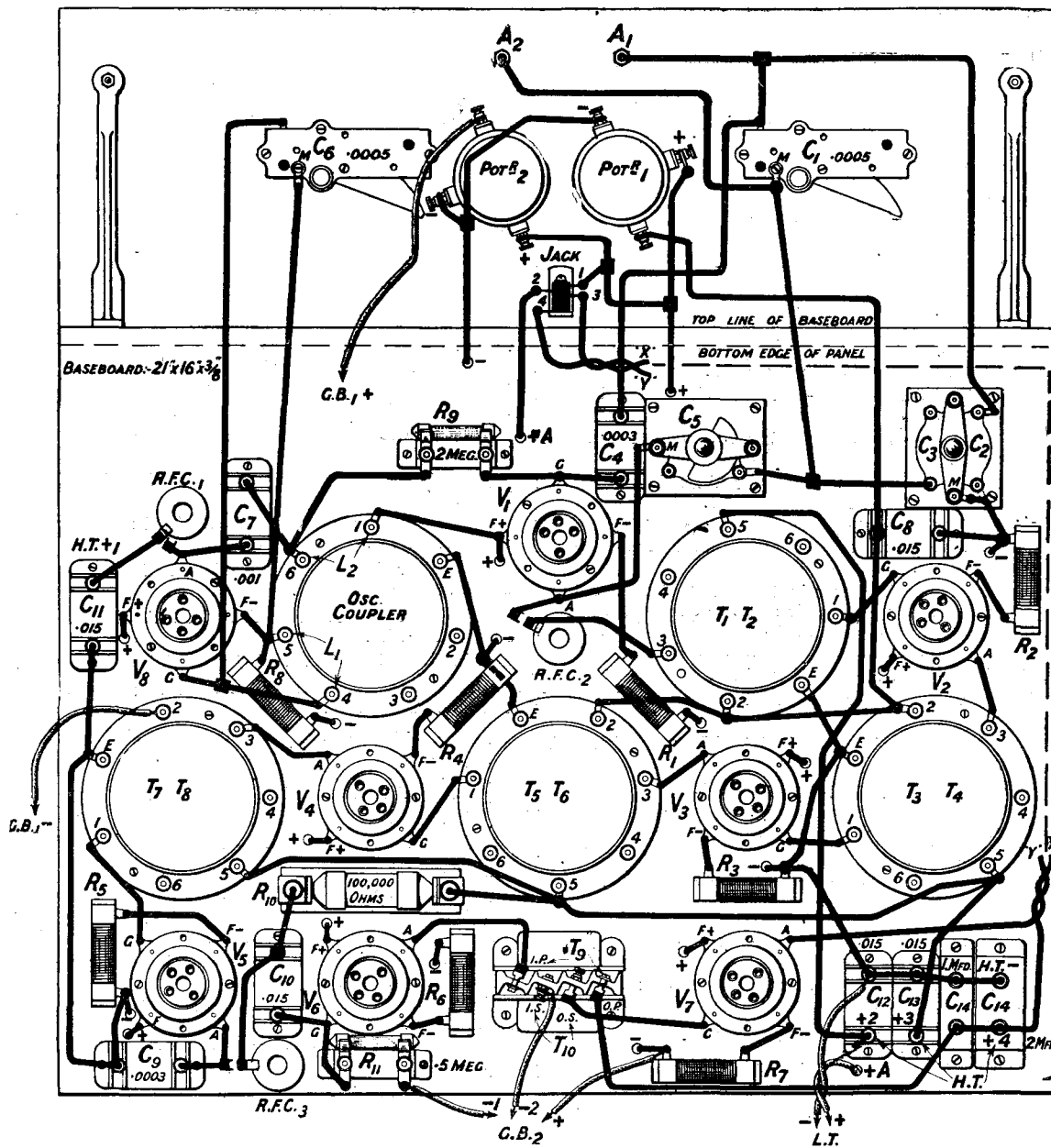

Fig. 3.—The connections to the filament tags of the valve holders are carried beneath the baseboard. Blueprint No. 182b (free).

lay-out has been used. Looking at the panel from the front, the two variable condensers will be seen, each with its slow-motion dial, the left-hand one controlling the tuning of the frame circuit, and that on the right the frequency of the local oscillations. Between them are the two potentiometers, one of these controlling the intermediate-frequency amplifier, and the other the exact amount of bias upon the grid of the second detector.

Above the two potentiometers are the frame aerial terminals, and below them is the loud-speaker jack, which, it should be explained, is also the on and off switch for the filaments of the valves.

All the other components are mounted upon the baseboard of the receiver, and a careful examination of the wiring diagram will provide all the necessary information. One or two points here, however, call

for a word of explanation, as to the uses of the various devices.

**Battery Leads**

Take first the question of the battery connections. It will be seen that no terminal strip is used, connection for the battery leads being made direct to various components which bear terminals. All the H.T. leads are connected to terminals upon the various shunting

## AN EFFICIENT EIGHT-VALVE RECEIVER

### WIRING INSTRUCTIONS

Join long lengths of wire to contact 3 and contact 4 of Jack, twist these together and join wire from contact 4 of Jack to A of V7, and wire from contact 3 of Jack to one side of both parts of C14; same side of C14 to OP of T9T10.

Join contact 1 of Jack to + of Potentiometer 1; + of Potentiometer 1 to + of Potentiometer 2; continue wire from + of Potentiometer 2 through baseboard.

Join wire to contact 2 of Jack and take end through baseboard.

Join - of Potentiometer 1 to - of Potentiometer 2; continue wire from - of Potentiometer 2 through baseboard.

Join flex lead to remaining terminal of Potentiometer 2 for + of G.B.1.

Join A1 to fixed plates of C2, and fixed plates of C1; fixed plates of C1 to one side of C4.

Join A2 to moving plates of C1; moving plates of C1 to fixed plates of C5; fixed plates of C5 to fixed plates of C3.

Join remaining terminal of Potentiometer 1 to one side of C8; same side of C8 to terminal 2 of T3 T4; terminal 2 of T3 T4 to terminal 2 of T1 T2; terminal 2 of T1 T2 to terminal 2 of T5 T6.

Join F- of V1 to one side of R1.

Join wire to other side of R1 and take end through baseboard.

Join F+ of V1 to terminal 1 of L2; continue wire from terminal 1 of L2 through baseboard.

Join F- of V2 to one side of R2.

Join other side of R2 to moving plates of C2 and C3; moving plates of C2 and C3 to remaining side of C8; continue wire from same side of C8 through baseboard.

Join wire to F+ of V2 and take end through baseboard.

Join F- of V3 to one side of R3.

Join other side of R3 to E of T3 T4; E of T3 T4 to E of T1 T2. Also join same side of R3 to one side of C12; same side of C12 to one side of C13; same side of C13 to remaining terminals of both parts of C14.

Join flex lead to terminal of C12 which is connected to E of T3 T4.

Join wire to side of R3 which is connected to E of T3 T4 and take end through baseboard.

Join wire to F+ of V3 and take end through baseboard.

Join F- of V4 to one side of R4.

Join other side of R4 to E of Oscillator Coupler and to E of T5 T6, also join wire to same side of R4 and take end through baseboard.

Join wire to F+ of V4 and take end through baseboard.

Join F- of V5 to one side of R5.

Join other side of R5 one side of C9; join same side of C9 to E of T7 T8; join E of T7 T8 to one side of C11.

Join wire to side of R5 which goes to C9 and take end through baseboard.

Join wire to F+ of V5 and take end through baseboard.

Join F- of V6 to one side of R6.

Join wire to other side of R6 and take end through baseboard.

Join wire to F+ of V6 and take end through baseboard.

Join F- of V7 to one side of R7.

Join wire to other side of R7 and take end through baseboard, also join flex lead for GB2+ to this side of R7.

Join wire to F+ of V7 and take end through baseboard.

Join F- of V8 one side of R8; same side of R8 to terminal 5 of Oscillator Coupler; terminal 5 of Oscillator Coupler to moving plates of C6.

Join wire to other side of R8 and take end through baseboard.

Join wire to F+ of V8 and take end through baseboard.

Join remaining side of C4 to G of V1; G of V1 to one side of R9.

Join other side of R9 to terminal 6 of L2; terminal 6 of L2 to one side of C7.

Join other side of C7 to A of V8; A of V8 to one side of R.F.C.1.

Join other side of R.F.C.1 to remaining side of C11.

Join moving plates of C5 to A of V1; A of V1 to one side of R.F.C.2.

Join other side of R.F.C.2 to terminal 3 of T1T2.

Join G of V2 to terminal 1 of T1T2.

Join A of V2 to terminal 3 of T3T4.

Join G of V3 to terminal 1 of T3T4.

Join A of V3 to terminal 3 of T5T6.

Join G of V4 to terminal 1 of T5T6.

Join A of V4 to terminal 3 of T7T8.

Join G of V5 to terminal 1 of T7T8.

Join A of V5 to one side of R.F.C.3; same side of R.F.C.3 to remaining side of C9.

Join other side of R.F.C.3 to one side of C10; same side of C10 to one side of R10.

Join other side of C10 to G of V6; G of V6 to one side of R11.

Join flex lead for G.B.2-1 to other side of R11.

Join A of V6 to 1P of T9T10.

Join G of V7 to OS of T9T10.

Join flex lead for GB2-2 to 1S of T9T10.

Join G of V8 to terminal 4 of L1, and to fixed plates of C6.

Join terminal 5 of T1T2 to remaining side of C12.

Join terminal 5 of T7T8 to remaining side of R10; same side of R10 to terminal 5 of T5T6; terminal 5 of T5T6 to terminal 5 of T3T4; terminal 5 of T3T4 to remaining side of C13.

Join flex wire to terminal 2 of T7 T8 for GB1-.

#### *Connections under baseboard.*

Join + A to flex lead for LT+.

Join all wires going through baseboard with - against them in wiring diagram together.

Join all wires going through baseboard with + against them in wiring diagram together.



## A SCREENED-COIL SUPERHETERODYNE—(Cont.)

condensers, one of these condensers being provided across each H.T. tapping. It will be seen that there are five of these condensers, three of them being Dubilier condensers of the Type 610 variety, of .015 capacity, these being for theappings for the oscillator, the first detector, and the intermediate frequency amplifiers and second detector. Two T.C.C. Mansbridge-type condensers are provided to form the shunt for the low-fre-

the flexible lead which goes off to the H.T. battery tapping point. H.T. negative is connected to one of the terminals upon the opposite side of the bank of condensers, which of course, are all connected together on this side. This point is also L.T. negative, a pair of flexible leads being provided for connection to the accumulator. L.T. positive is soldered directly on to the wiring under the baseboard so that this pair of leads is more or less per-

this particular tapping should only be fastened in position after the various connections have been made to the oscillator valve.

The only other point in the construction or wiring of the receiver which seems to call for comment concerns the connection between two of the high frequency chokes and the anode points upon the appropriate valve sockets. The chokes are fastened in position quite close to the sockets, and unless you

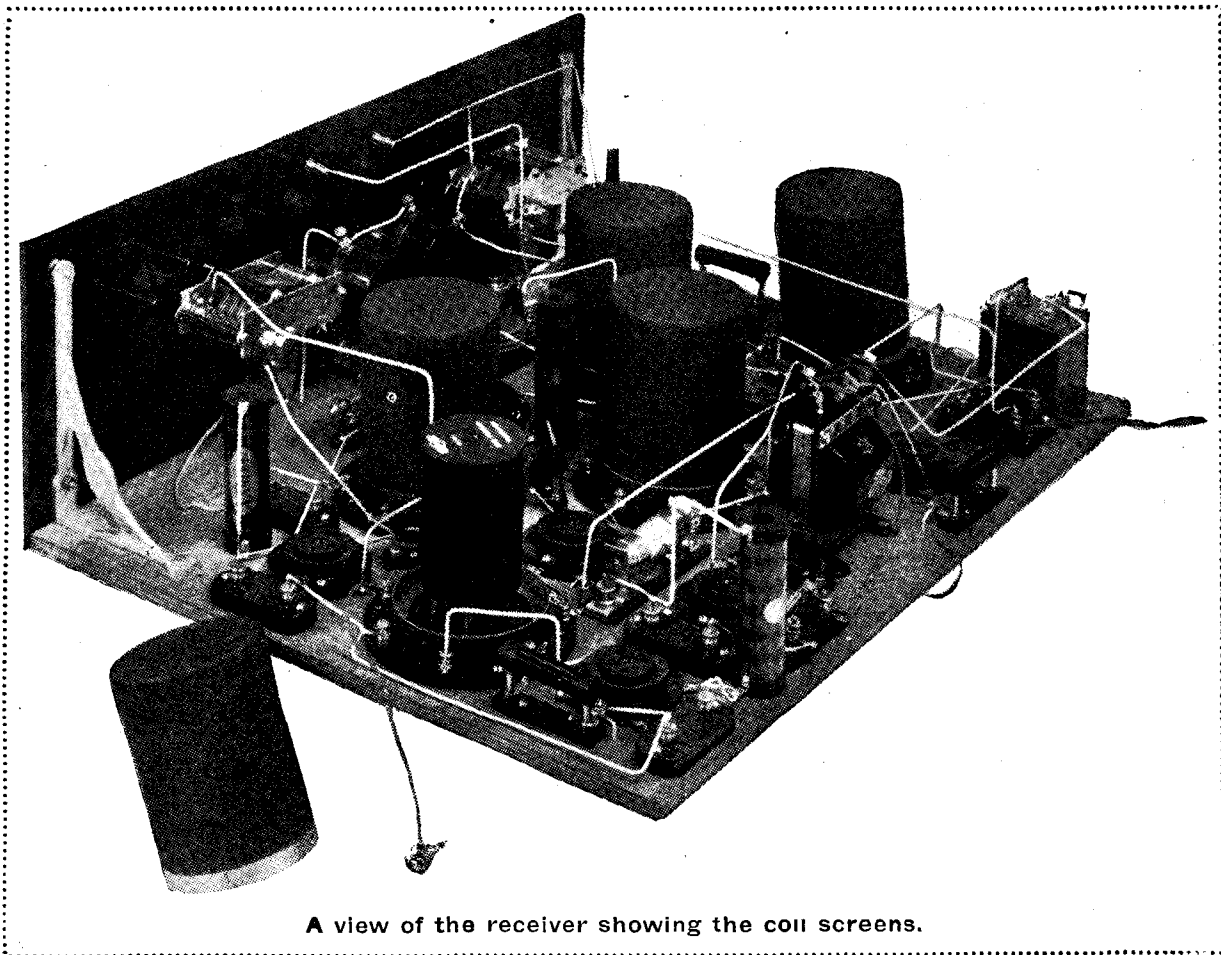

A view of the receiver showing the coil screens.

quency tapping. One of these is of two microfarads and the other of one microfarad, the two being connected in parallel to give a total capacity of three microfarads, which can of course be provided by means of a single condenser if such is available.

### Terminals

These condensers are all fitted with terminals, and under the appropriate one can be connected

manently connected to the set. All the leads, it will be understood, are taken out through holes in the back of the cabinet.

### Oscillator Tapping

It will be noted that the high tension connection point for the oscillator valve is at the opposite side of the receiver from the group of shunting condensers for the otherappings, and it should be explained that the shunting condenser for

possess a fairly small soldering iron you may find it difficult to operate in the limited space available.

### A Warning

Due care should be taken here, because the chokes are covered with what appears to be celluloid, so that if they are touched with the soldering iron fireworks may result. If any difficulty is experienced,

(Continued on page 523.)

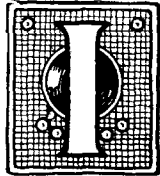

**I** WAS a little shy at first about Professor Goop's suggestion that he and I should start a wireless service station together. Somehow the word "service" has a nasty suggestion of work about it, and even on the hottest day the very thought of work gives me cold shivers

going on frequently prod me in the ribs and ask me to stop snoring. Poddleby, who is a rude fellow, has been known to refer to my periods of absorption as nasal-organising. This just shows how easy it is for brilliant people like myself to be misunderstood by their so-called friends.

**The Scheme**

Professor Goop's idea was that a service station run by him and me would be a positive godsend to the inhabitants of Little Puddleton. "You know what it is," he said; "all wireless men are the same. When a high-tension lead comes adrift from its moorings they say 'Oh, I'll re-solder that tomorrow.' Then they twist it up

was that at a jumble sale last week I picked up for a mere song a tradesman's delivery tricycle."

**The Mechanic**

I was preparing to walk out of the room, for I have never really enjoyed tricycling as a pastime, when the Professor hastened to add that he had already engaged young Edward Bugsnip to provide the motive power. "Anyhow," I said, "I refuse to spend my whole time soldering. I hate soldering; it makes one's waistcoat so greasy and the frizzling noise always makes me think of sausages." The Professor calmed my fears by saying that besides propelling his quaint vehicle young Bugsnip would also act as mechanic; all that he and I would have to do would be to direct operations and to divide the cash.

**We Decide**

That sounded better; in fact, for many years I have been looking for a job demanding exertions of this kind. In a moment my mind was made up. "Professor . . ." I cried, striding across the room with outstretched hand, tripping over little Bingo and landing face

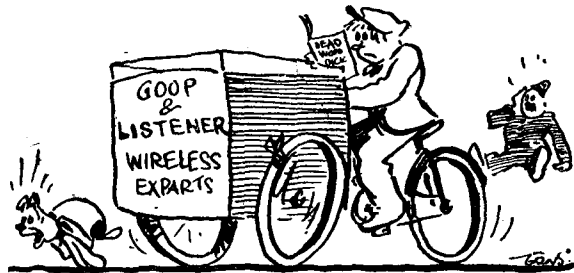

... Edward Bugsnip to provide the motive power.

right down the spine. It is not, mark you, that I am a slacker; few people, in fact, have put in more accumulator-ton-miles than I have, whilst an eminent mathematician has calculated that the energy expended by me during the last five years in twiddling condenser knobs would be sufficient to drive all London's 'buses at sixty miles an hour for a week—in which case it is highly improbable that there would be many Londoners left.

**Organisation**

It is rather that, having been provided by nature with an outside in brains, which becomes most active when the rest of me is quiescent, I find that my strong suit lies in organisation rather than in mere manual labour. Give me a comfortable chair, beneath the shade in summer or before a cosy fire in winter, and I have few rivals as an organiser. Such, in fact, is my concentration when I am organising that people who do not understand the process that is

somehow and every day they keep on reminding themselves that they really must get out the soldering iron. One evening it comes adrift again and clings like the tendril of a vine to a low-tension wire. Up goes anything from one to nine valves and then the job really does get done. If my idea materialises those who have small defects of this kind in their sets will merely ring up on the telephone or send us a post-card. We will then collect the set and deliver it in a few hours in perfect



"I've just fished young Bugsnip out of the 'orsepond."

condition." "I suppose," I said, "that you are not suggesting that I should spend all my time running round Little Puddleton and bringing dud sets for you to tinker with?" "Far from it," cried Professor Goop. "What really gave me the idea

downwards on the hearth-rug. Really I think those woolly sheepskin hearth-rugs ought to be forbidden by law. For some little time my speech, like that of some loud-speakers, was distinctly woolly, but eventually I managed to make

## IN PASSING — (Continued)

the Professor understand that I was enthusiastically accepting his offer and not hurling reproaches at him, as he had at first supposed. We resolved to start business upon the very next day. We therefore sped to the *Gazette* office bidding them put through a rush order for business cards. They undertook delivery at breakfast time the next morning, provided that we would leave the proof reading to them. This we naturally agreed to, for the *Gazette*, like everything else in Little Puddleton, is nothing if not efficient. You will, I think, agree

would refer to Edward Bugsnip as a dove, I saw at once what he meant. We had not long to wait, for almost instantly the telephone bell rang clamorously. I leaped to the instrument. Professor Goop leaped at the same time, but I got there first. "P.C. Bottlesworth speaking," said the well-known voice of our local guardian of law and order. "I 'ave just fished young Bugsnip out of the 'orsepond with an 'ay rake, and if you want that there three-wheeled bicycle 'e was ridin' you 'ad better put on a bathin' suit and come and get it."

superheterodyne receiver is in that Noah's Ark of yours at the bottom of the water? What on earth do you mean by it?" "That," I said sweetly, "is quite in order; we make a point of washing sets that come from certain houses before we handle them. Meantime, had you not better go to the rescue of our van driver and head mechanic who seems to be in difficulties?" Snaggsby turned round to look in the direction in which I was pointing, but it was the push administered by me and not his own nobler feelings

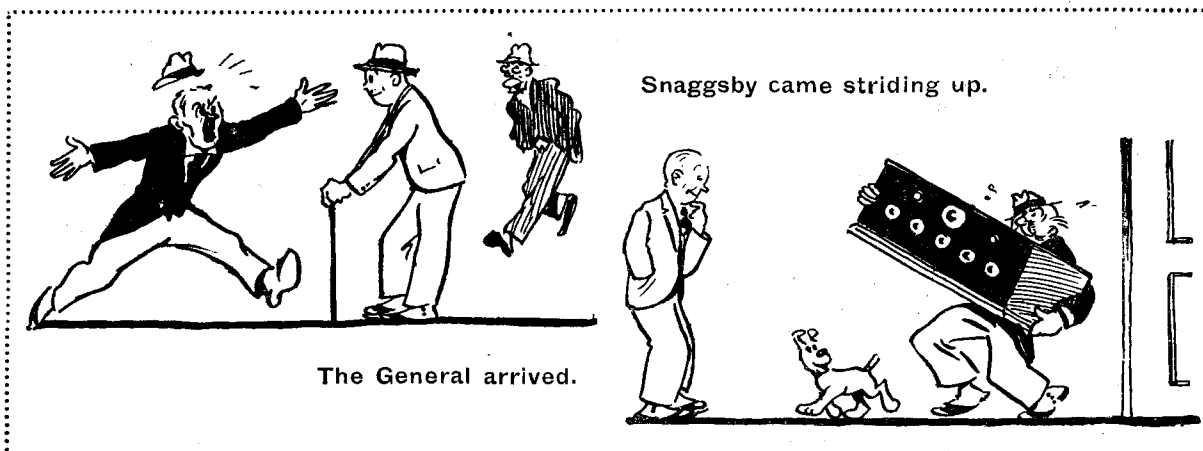

with me that the business card reproduced herewith is almost beyond criticism.

MEssrs.

**GOOP AND LeSsenEr,**

Wireless experts.

Repairs executed at  
SHORTEST NOTICE

### We Start

We agreed that the Professor should be on duty in the morning, for that is the time I usually devote to the beauty sleep which prepares me for the real labours of the day. Professor Goop is generally up and about quite early, because he so frequently forgets to go to bed. When I called round at "The Microfarads" shortly after mid-day I found the Professor in a great state of excitement. "I have launched our dove from the ark," he said, "and now we must wait to see what he brings back." Though no one in the ordinary way

### Slightly Annoyed

The lad Bugsnip, I elicited by inquiry, had spent half the morning in giving his little friends rides down the steep hill at the far end of the Goop Boulevard. Eventually, whilst conveying a round half-dozen of them he had attained such a velocity that he had been unable to round the bend at the bottom and had gone, like a Brooklands racer, over the banking and into the pond. When the Professor and I reached the scene of the catastrophe we found that quite a crowd had collected, amongst them Admiral Whiskerton Cuttle and Snaggsby, both of whom seemed to be slightly annoyed about something. The Admiral was simply keeping his mouth open and letting words pour forth in a torrent. Snaggsby was holding young Bugsnip by the scruff of the neck and shaking him violently.

### A Catastrophe

Directly he saw me Snaggsby let the lad drop into the pond and came striding up. "Do you know," he roared, "that my new

that prompted him to make his first attempt at life-saving. As he struggled towards the bank with young Bugsnip clinging to his coat-tails the Admiral, true to the fine traditions of the Senior Service, leaned down and stretched out a helping hand. At that moment Snaggsby fell over something and the Admiral joined them with a graceful if unpremeditated dive. "Since you are all on the spot," I shouted, "you might as well fish out our delivery van." It took quite a little persuasion to make them do it.

### Progress

We had quite an unpleasant time with Snaggsby and the Admiral over their sets, for neither of them would be convinced that such an immersion was an essential part of the process of bringing them to a state of perfect efficiency. The Admiral actually brought round in a bottle a tadpole which he had found in one of his H.F. transformers and threatened to make Professor Goop eat it. So many  
(Concluded on page 507.)

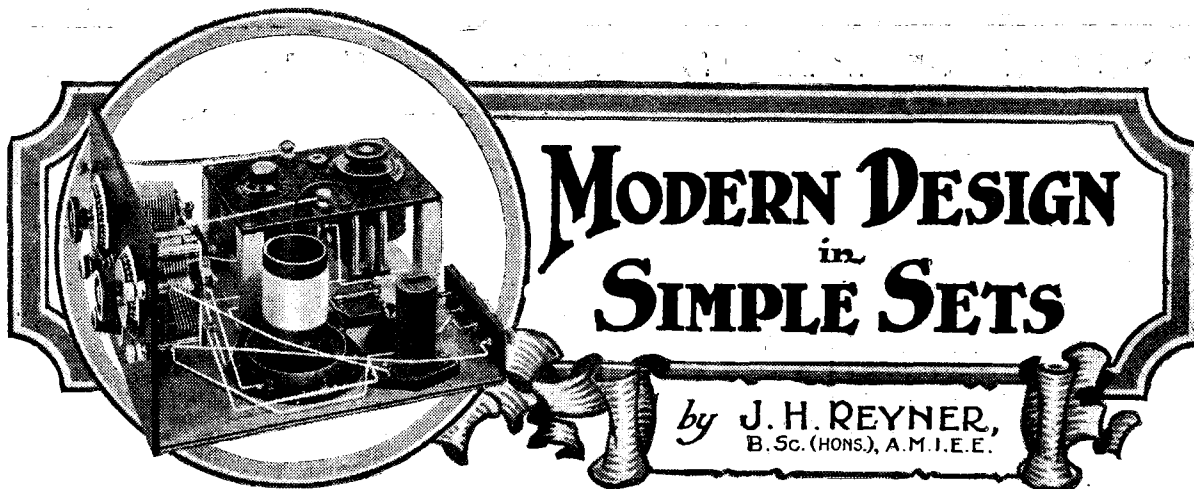

*The recent great improvements that have taken place in the design of multi-valve sets apply equally to small simple receivers. A modern small set must be selective and the reaction effect must be easily controllable, as Mr. Reyner shows in this interesting article.*



We have recently made some very rapid strides in the science of radio. We have had, for example, such receivers as the "Elstree Six," which succeeded in receiving in daylight a considerable number of stations at loud-speaker strength. In fact, the daylight performance of this receiver would have constituted a good test report during the hours of darkness for the type of set which used to be produced only a few years ago.

**Daylight Range**

This daylight range is only made possible by the fact that we have definitely obtained methods of high-frequency amplification which are thoroughly efficient. During the daytime the wireless waves travel over the surface of the ground. Owing to the ionisation of the atmosphere these waves are more or less rapidly absorbed, with the result that after a comparatively short distance the waves practically cease to exist. At certain times of the day, for example, it is impossible, even on the "Elstree Six," to hear the carrier waves of certain distant stations only 300 or 400 miles away, let alone any satisfactory telephony.

**Night Effects**

At night time, on the other hand, we have this direct wave which, incidentally, is not absorbed to the same extent, and we also have an indirect or reflected wave which travels to the higher regions of the

atmosphere and is reflected down to earth again by a layer of electrified particles which acts as a mirror. This will result in stations being received at ranges which are absolutely impossible during the daytime, and such short distances as 300 or 400 miles become, comparatively speaking, child's play.

**Defeating America**

In another direction I set myself the problem of defeating one of the best American designs, and moreover achieving this result before the

obtained definite data concerning the laws which govern the various actions.

**Smaller Sets**

The receivers which I have just mentioned are large and comparatively expensive. Have we, then, neglected the smaller types of sets employing two or three valves only? I think not, and a glance through the pages of MODERN WIRELESS for the past few months will show a tendency to change the design of these

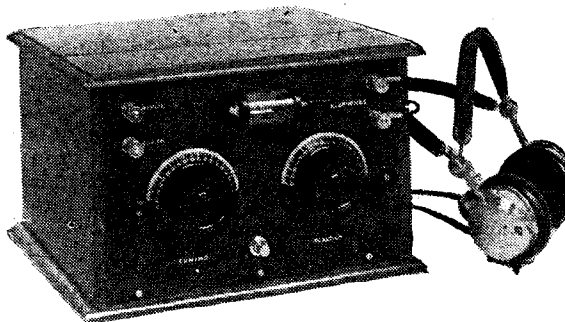

A compact small set embodying modern practice — the "Midget Reflex Receiver" described in the free gift envelope included with every copy of the November "Wireless Constructor."

original American design could be considered obsolete. This I ultimately succeeded in doing in the "Magic Five," and, following it one stage further, came the "Solodyne," which was described in last month's issue.

All these achievements have been rendered possible by the fact that we have tackled the problem of radio reception, and particularly high-frequency amplification, in a scientific manner, and we have

simple sets and to bring them into line with the latest practice. Let us consider some of the ways in which these recent developments have affected the design of small and simple receivers.

Considering the case of a single-valve receiver, this is becoming of use principally for local station work. The man who wants distant reception, as we shall see shortly, will add one or more stages of high-frequency amplification.



## MODERN DESIGN IN SIMPLE SETS—(Continued)

### Single-Valve Range

"Local-station reception" is a phrase which is often used without due thought. One naturally thinks of the man situated 10 or 20 miles

the value being varied in order to control the amount of current which is permitted to flow through the circuit. Alternatively, we may change a circuit providing two

crease the by-pass effect so we starve the reaction coil proper and the reaction effect is reduced.

### Distant Reception

With the increased number of stations operating on the Continent, many of them working with considerable power, it is quite possible to receive several of these stations also on a suitably designed single-valve receiver. There are, however, two objections to this process, as a result of which there is an increasing tendency to the use of one or more high-frequency stages.

### Selectivity

In the first place, if any satisfactory distant reception is to be achieved a certain measure of selectivity is necessary. It is by now common knowledge that adequate selectivity consistent with good quality cannot be obtained with only one tuned circuit. If the experimenter is situated close to a local station (by close I mean anything from 10 to 15 miles), then the reception of stations operating quite near in wavelength to the local station is completely out of the question with only one circuit. Granted that it can be done, but the quality is poor, and even with two circuits quality suffers on some stations.

For the man who lives in the country the problem is not so acute, but, even so, in order to separate some of the distant stations and still retain satisfactory quality more than one tuned circuit is desirable.

There are now so many stations working simultaneously that unless a reasonably selective circuit is available they interfere with each other, and for this reason more than one tuned circuit is desirable.

### H.F. Amplification

The second reason for the use of the high-frequency valve lies in the fact that the selection of these stations is made many times easier by the use of such an accessory. The present high-frequency valve really does amplify.

The amplification obtainable from an H.F. valve is nearly as good as that from a low-frequency valve in a correctly designed receiver. The modern detector does not obey a linear law, so that if we double the voltage applied to the detector valve we obtain distinctly more than twice

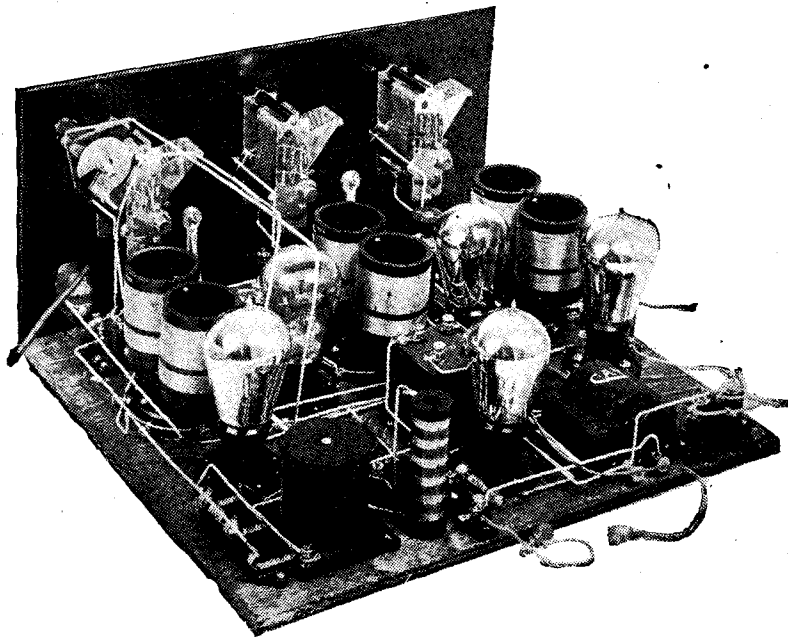

Binocular coils are eminently suited to small or large sets. The photograph shows these coils in the "Night Hawk," a Radio Press Star design.

away from the local station when the term "local station" is used. What of the man, however, whose nearest station is 50 or 60 miles away? For him a single valve receiver is quite satisfactory provided it is efficient, and it is in rendering the single-valve receiver capable of receiving signals 50 to 100 miles away with ease, and without danger of inadvertent oscillation, that modern design is different from older types of construction.

### Reaction

The principal development, therefore, in single-valve reception has been in the direction of improving reaction control. The modern tendency is to use some variation of the Reinartz principle. The older system in which a fairly large coil is connected in the anode circuit of the detector valve and is variably coupled to the grid circuit is considered to be obsolescent.

It may be that a series condenser is inserted in the reaction circuit,

paths for the reaction currents, one of which shall definitely produce

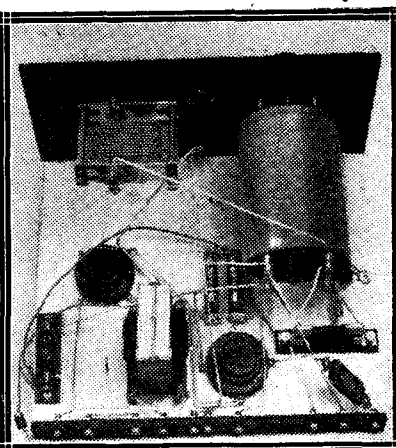

Fixed resistors for filament control are tending to replace rheostats, thereby simplifying the panel layout.

reaction, and the other serve merely as a by-pass. As we in-

**MODERN DESIGN IN SIMPLE SETS—(Continued)**

the output. This being so, it pays very definitely to use a high-frequency valve in front of the detector valve. Moreover, with a high-frequency valve the reaction control is not so critical, and also can be placed on the second tuned circuit. Such an arrangement minimises considerably the risk of interference with one's neighbours. Everyone knows that he ought not to howl, yet, for a real treat, one has only to listen-in after the B.B.C. stations have closed down! The frenzied whistling and howling that takes place in the frantic search for distant stations is pitiful. All this trouble would be obviated by the use of a correctly operated high-frequency valve. Even one valve would bring in the distant stations, and at any rate would render possible the use of non-radiating circuits.

be neutralised, tune the receiver to the local station, and then adjust the neutralising condenser until no signals are heard. In this position the energy which is passed through the valve capacity is cancelled out by the energy passing through the neutralising condenser, and the result is that no signals are heard.

Conversely, if the second circuit (that associated with the detector valve) is allowed to oscillate, then, obviously, any energy from these oscillations which feeds back through the valve will immediately be cancelled out by an equal and opposite amount of energy fed through the neutralising condenser. The receiver is therefore definitely non-radiating, and tests have shown conclusively that this is no mere theory but an actual established fact.

In the case of an H.F. amplifier the

the most serious being that there is a possibility of dead spots occurring at some point, or points, in the tuning range, and to avoid these it is necessary to make provision for changing the tapping point on the coil or the number of turns in the aerial coil. Possibly other methods will be devised in time which do not suffer from this disadvantage, but for the present this method of so-called "aperiodic" aerial coupling is very convenient.

**Valve Damping**

A question on which considerable light has been thrown during the past year is the effect of the valve on the tuned circuit. The purpose of a valve is to amplify, and if it were a perfect amplifier it would not have any deleterious effect upon the circuits associated with it. Careful application of theory to the



The modern tendency is towards the use of capacity controlled reaction of the Reinartz type. This permits a very accurate adjustment to be made.

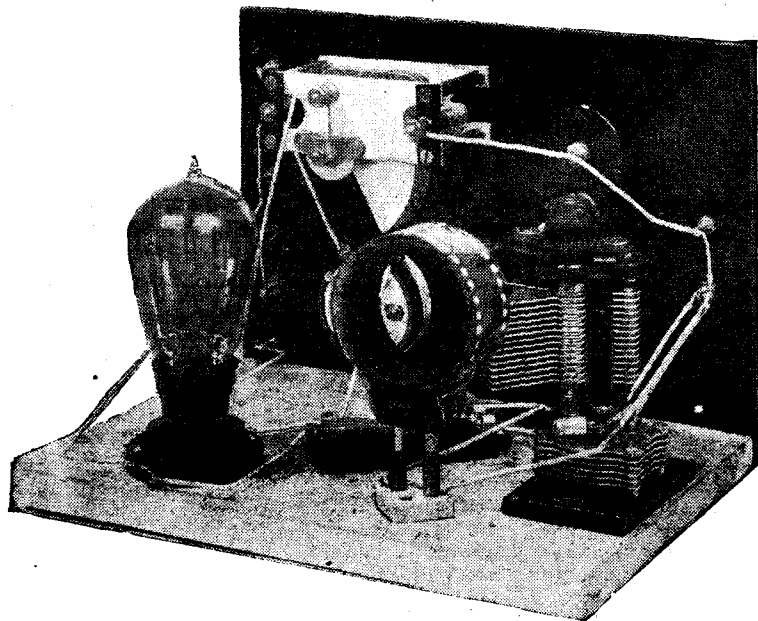

**Neutralising Receivers**

From the point of view of non-radiating, a neutralised receiver is unquestionably the best. With the modern bridge methods of neutralising, it is possible to obtain a definite balance between the capacity feed-back of the valve and the capacity feed-back through the neutralising condenser. In fact, one of the most common methods of neutralising a circuit, and one which I always use myself whenever practicable, is to turn out the valve to

question of selectivity is of considerable importance. The object of adding high-frequency valves is to enable distant stations to be received, so that some measure of selectivity is essential.

**Aerial Damping**

The aerial damping is one of the most fruitful sources of loss, and this is minimised by the use of a tapped aerial coil or a tight-coupled aerial circuit. There are one or two disadvantages to this arrangement,

actual results obtained in practice, however, showed that the selectivity obtainable with various types of circuits was very definitely below what would theoretically be expected.

Further investigations showed that this was due to damping arising from the presence of the valve. In a tuned-anode circuit, for example, the valve is virtually across the tuned circuit, so acting as a leak shunted across the whole. Obviously, this will result in an

**MODERN DESIGN IN SIMPLE SETS—(Concluded)**

increase in the effective resistance of the circuit itself, and consequently it will give poor selectivity.

**Centre-Tapped Circuits**

These difficulties are overcome in two ways. First of all we can arrange to tap the anode of the valve across a part of the tuned circuit only. If the valve is only tapped across half of the coil, then the extra damping introduced into the circuit is reduced to one quarter of what it would be if the valve were connected across the whole of the coil.

This has given rise to a series of centre-tapped circuits. By connecting the high-tension battery to the middle of the coil instead of the end we obtain a zero-potential point in the middle of the coil, so that the remote end of the coil is at the

anode, and who cannot be bothered with neutralising! If they would only try it, they would be astounded at the increase in efficiency.

**Transformer Coupling**

The other method of achieving similar results is by the use of transformer coupling. If instead of tapping the anode of the valve across a portion of the coil we connect the anode circuit through a small primary and couple it to the secondary we obtain an effect which is electrically very similar. In order that the effect shall be practically identical it is necessary to have a tight coupling between the primary and the secondary. The actual number of turns on the primary may be only quite small, but the two windings must be close together in order to obtain a tight coupling.

These types of coils are excellently suited for use in simple circuits. Although in some cases slightly better results could be obtained by designing a special transformer to suit the individual case, yet these standard transformers which are produced comparatively cheaply enable satisfactory results to be obtained from the general class of valve, and the results obtained will be markedly superior to those obtainable with the older types of non-scientific circuit.

**Screening**

The question of screening is interesting if we consider these simple circuits. Screening is principally useful in reducing interaction between the various stages of a multi-valve receiver. On the other hand it also has very considerable effect in reducing the direct pick-up on the local station. I was experimenting the other day with a "Magic Five" receiver on which I had made slight modifications. I had the receiver tuned to Cardiff while London was operating, but there was still a faint background of London.

**An Interesting Example**

Now the presence of the screens increases the resistance of the coils very slightly, the theory upon which I have based my design being that this increase in resistance is more than compensated for by savings in other directions. I thought that it would be interesting to observe whether the removal of the last screen would reduce the resistance sufficiently to enable Cardiff to be received quite clear of London.

I removed the screen, therefore, from the last tuned circuit, *i.e.*, the one connected to the detector valve. On re-tuning the circuit to allow for the change in inductance caused by the removal of the screen I could only hear London! Cardiff was faintly audible in the distance when London stopped working. No amount of re-tuning or re-adjustment made any difference, and this afforded a striking proof of the correctness of my theories. The combined effects of direct pick-up and stray energy losses were sufficient to destroy the fine selectivity previously possible.

For simple circuits, however, there is no reason why these transformers should not be used without their screens.



**Wireless in the Army. A portable field set in use during the recent manœuvres.**

opposite potential to the anode, and can therefore be used as a source of neutralising voltage.

Using such a circuit therefore we have at once reduced the effect of the valve to one-quarter, and provided ourselves with a ready method of neutralising the circuit. This method is both convenient and easy to put into operation, yet there are many people who are still using the straight-forward tuned-

**Binocular Coils**

Now these various methods have been developed for the larger sets, and definite and standard types of coil have been designed. We have the screened coils, which are made in a variety of different patterns. We have the binocular coils, which have been developed and used by Mr. Allinson for some time past, and which were used by Mr. Harris in the "Night Hawk."

# A "FOUR" FOR RANGE AND SELECTIVITY

By W. Q. KAY

*This useful four-valve receiver is capable of receiving many British and Continental broadcasting stations on the loud-speaker. At a distance of twelve miles from 2LO it will eliminate this station and bring in Manchester.*

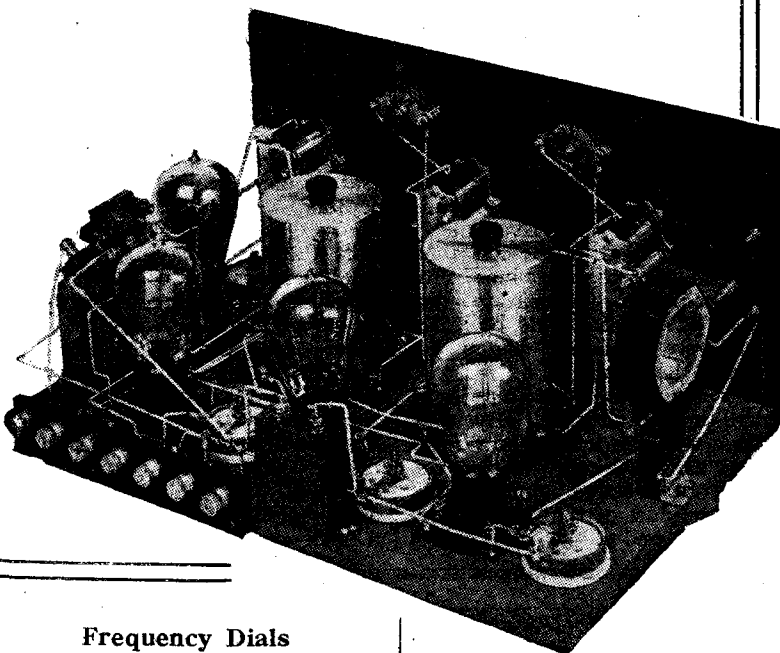

As all the European stations are being allocated on a fresh basis, amateurs are attacking the problem of distant reception with renewed zest owing to the greater freedom from interference which is expected to result when the system has got into proper working order. The present receiver is one which was constructed recently with the object of providing ready reception of the various distant stations while giving comfortable loud-speaker reception on the local station when desired.

### Frequency Dials

Since the new scheme makes use of the 10 kilocycle method of separation, straight-line frequency condensers have been employed in this receiver. As the capacity is reduced so the frequency is increased in proportion, and with the plates all out the dial reading is 180. Thus the dial readings are the reverse of what is usually found to be the case, but any difficulty which may be experienced in this direction will soon be overcome after a little practice.

### The Circuit

For the receiver a straight-forward H.F. circuit has been em-

ployed, utilising one of the standard patterns of screened transformer now on the market. The actual circuit is shown in Fig. 1, and will be seen to include two high-frequency stages, a detector, and a low-frequency amplifier. The aerial circuit is a simple tapped coil, which has not been enclosed in a screening case, being one of the various makes of tapped coils on the market. The high-frequency transformers are of the split-primary type, one half of the primary being in the anode circuit of the preceding valve, the other portion being utilised as a neutralising winding.

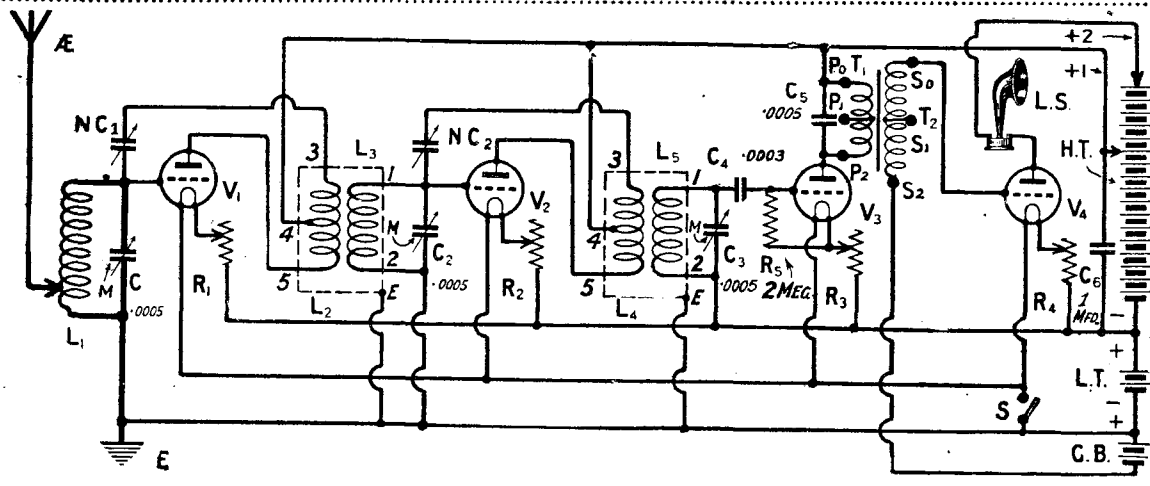

Fig. 1.—The theoretical circuit. The coil L<sub>1</sub> is an ordinary X coil.



A "FOUR" FOR RANGE AND SELECTIVITY—(Continued)

Panel Layout

The grid circuits of the various valves are tuned by the three condensers, which are placed symmetrically upon the panel, and in this case the two neutralising condensers have been mounted on the panel as well. The first of these needs adjusting to the correct neutralising point and is left in position. The second condenser is made rather larger and is utilised to provide a reaction effect by increasing its capacity beyond the neutralising point.

with comparative ease. The provision of the two tappings on the aerial coil can be utilised to assist in obtaining any special degree of selectivity required, the use of the smaller tapping generally giving a higher selectivity unless it so happens that this corresponds

fixed. By this means we obtain all the advantages of fixed resistors, without the lack of flexibility which is their principal disadvantage.

A Novel Device

Grid rectification has been employed for the sake of simplicity, and in this case only a grid condenser is required external to the valve holder, the grid leak being incorporated as part of the valve holder. The unit, which is similar in appearance to the ordinary type of valve holder,

STATIONS RECEIVED on the LOUD-SPEAKER

DIAL READING.	STATION.	DIAL READING.	STATION.
25 .. ..	Birmingham.	62 .. ..	London.
28 .. ..	Frankfurt.	72 .. ..	San Sebastian
37 .. ..	Berne.	82 .. ..	Hull.
41 .. ..	Rome.	86 .. ..	Nottingham.
42 .. ..	Glasgow.	88 .. ..	Barcelona.
45 .. ..	Münster.	94 .. ..	Stoke.
48 .. ..	Newcastle.	100 .. ..	Hanover.
50 .. ..	Dublin.	105 .. ..	Dortmund.
52 .. ..	Hamburg.	124 .. ..	Elberfeld.
55 .. ..	Bournemouth	145 .. ..	Kiel.

Reaction Control

This method of producing reaction is a reasonably satisfactory one, and has the merit of cheapness. Moreover, it enables the receiver to be maintained in a sensitive condition without much variation

with a "flat-spot" on the aerial in use.

Filament Resistances

"Variable" fixed-resistors are incorporated in the set, these being a baseboard mounting model of the ordinary type of filament

provides a neat method of supplying the necessary leak from grid to filament.

Compact Layout

Space has been economised in this receiver to a large extent, and in fact the receiver has been

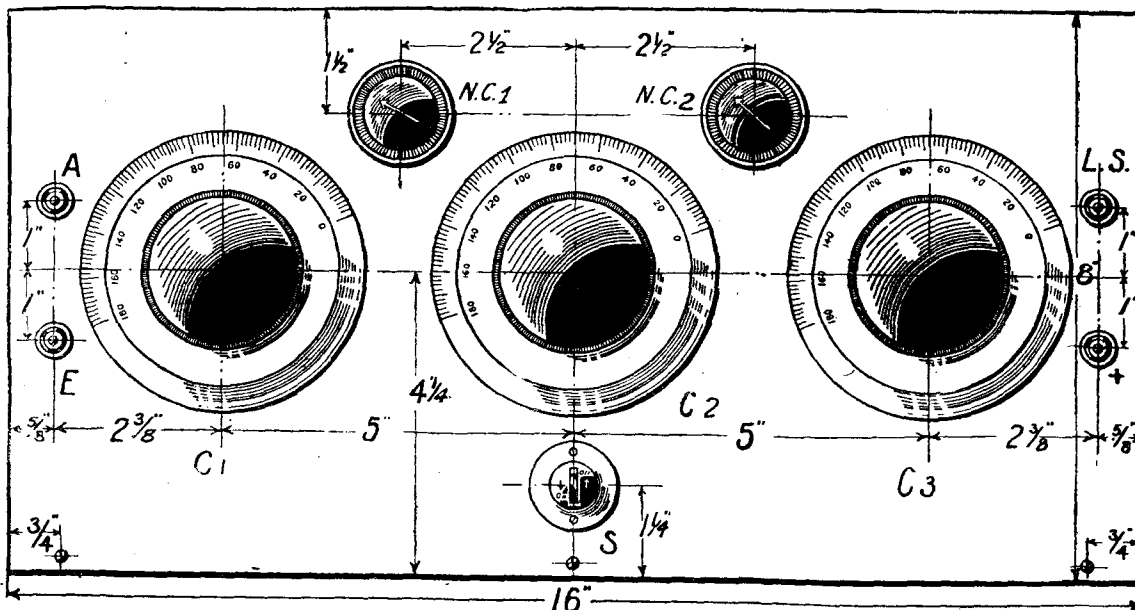

Fig. 2.—This drilling diagram may be obtained free. Ask for Blueprint 181a, free.

of the reaction setting from time to time, so that the principal tuning is carried out upon the three main dials. The selectivity is good, it being possible to cut out the local station in a very short space and to receive distant stations

rheostat. In this case they have been made of 30 ohms resistance, so enabling practically any type of valve to be used in the circuit. They are adjusted to the correct point when the set is first tested out, and are afterwards left

designed to fit inside a fairly small cabinet. The actual size of the panel is 16 in. by 8 in., and there are many people who already possess cabinets of this size. In this set the baseboard is required to be 10 in. deep, which is a little

## A "FOUR" FOR RANGE AND SELECTIVITY—(Continued)

deeper than the normal, but it does not require a special double-depth cabinet.

If necessary the baseboard could be made 9 in. deep by placing the components carefully.

### Constructional Details

The first operation is the marking out and drilling of the panel. The panel should be marked out in accordance with the front-of-panel diagram supplied with this article, after which the condensers may be mounted in the positions shown. Details of the actual position of the holes can easily be obtained from the templates supplied with the condensers.

The mounting of the two neutralising condensers requires no comment save a note that the larger condenser is that marked N.C.<sub>2</sub> on the drilling diagram. The four terminals and the on-off switch may then be mounted, and this completes the layout.

temporarily in position in order to make sure that ample space is left round all the components, and that none of the condensers or other components on the panel foul any of the baseboard components. When the various parts have been correctly spaced they may be screwed down and the

the second all out. With average valves this will be found satisfactory, and no further adjustment is required.

If desired, of course, the first valve may definitely be neutralised by the usual methods, but the circuit is stable over a wide band of the neutralising condenser setting, and is thus not critical of adjustment. The second valve, of course, is deliberately over-neutralised to provide reaction.

### Dial Settings

Other stations may readily be tuned in by setting the three dials approximately to the positions given in the test report. Tuning is somewhat sharp, so that difficulty may be experienced at first

until the actual dial settings for the various stations have been logged.

The reaction condenser does not produce any increase in strength until the last two circuits are in tune. It is advisable, therefore, to move the condenser a little at a

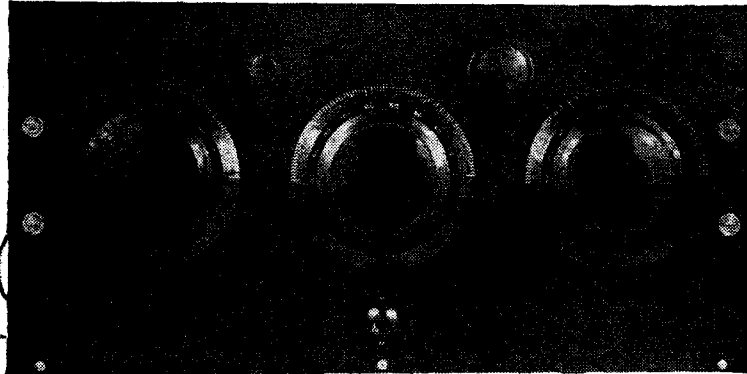

The layout of the panel is neat and symmetrical.

wiring up commenced in accordance with the blueprint and wiring instructions.

### Testing Out

The receiver is then ready for testing out. Carefully check over

## COMPONENTS REQUIRED

- One panel, 16 in. by 8 in. by  $\frac{1}{4}$  in. (Ebonart.)
- One cabinet to suit, with baseboard, 16 in. by 10 in. by  $\frac{5}{8}$  in. (W. H. Agar.)
- Three .0005 straight-line frequency condensers. (Eureka, Ormond or other suitable S.L.F. condensers.)
- Two coil screens. (Bowyer-Lowe, Efesca, Lewcos, Magnum or Peto-Scott.)
- Two split-primary transformers. (Ditto.)
- One tapped coil. (I have used here a Lissen 60X, which approximately matches the screened coils in inductance, and so gives similar dial readings.)
- One L.F. transformer. (R.I. multi-ratio.)
- Three vibratory valve holders. (Lotus.)
- One vibratory valve holder with 2 megohm grid leak incorporated. (Lotus.)

- Four baseboard mounting filament resistances, 30 ohms. (A. F. Bulgin.)
- One .0003 fixed condenser. (Finston.)
- One .0005 fixed condenser. (Finston.)
- One 1 mfd. fixed condenser. (T.C.C.)
- One Marco three-plate neutralising condenser. (R. A. Rothermel.)
- One Marco seven-plate neutralising condenser. (R. A. Rothermel.)
- One coil mount. (Burne-Jones and Co., Ltd.)
- One terminal strip, carrying seven terminals, 7 in. by  $1\frac{1}{4}$  in. by  $\frac{1}{4}$  in.
- Four 4 B.A. terminals.
- One Frost toggle on-off switch. (R. A. Rothermel.)
- Glazite wire.
- Radio Press panel transfers.

### Baseboard Components

The remainder of the components may then be placed on the baseboard, and in view of the remarks which have already been made little comment is necessary at this stage. It is advisable to place the panel

the connections and ensure that they are in accordance with the diagram given. Then tune in to the local station, the approximate setting being obtained from the test report given with this article.

Place the first neutralising condenser about half-way round, and

time and to re-tune on each occasion, as otherwise the set may burst into oscillation unexpectedly.

### Valves

The first three valves should be of the high-impedance type usually employed for high-frequency work,

## A "FOUR" FOR RANGE AND SELECTIVITY—(Continued)

## WIRING INSTRUCTIONS

Join one side of R1 to one side of R2 and thence to one side of C6, one side of R3, H.T.—, L.T.+ , one side of R4, moving plates of C3 and terminal 2 of L5.

Join remaining sides of R1, R2, R3 and R4 to F+ contacts of V1, V2, V3 and V4 respectively.

Join L.T.— to G.B. + and thence to one side of S, the two E terminals of screened coil bases, terminal 2 of L3, moving plates of C2, moving plates of C1, earth terminal, and pin connection of L1.

Join remaining side of S to F—contacts of V4, V3, V2 and V1.

Join other side of L1 to G of V1 and to remaining side of C1, and thence to moving plates of N.C.1.

Join A of V1 to terminal 5 of L2.

Join terminal 3 of L2 to remaining side of N.C.1.

Join terminal 1 of L3 to G of V2 and to remaining side of C2 and thence to moving plates of N.C.2.

Join A of V2 to terminal 5 of L4.

Join terminal 3 of L4 to remaining side of N.C.2.

Join terminal 1 of L5 to one side of C4 and to remaining side of C3.

Join other side of C4 to G of V3 (The gridleak R5 is already incorporated and connected in the valve-holder, V3.)

Join A of V3 to terminal P2 of transformer primary T1, and thence to one side of C5.

Join terminal Po of T1 to other side of C5 and to H.T.+1, and thence to remaining side of C6 and the No. 4 terminals of L2 and L4 respectively.

Join terminal S0 of transformer secondary T2 to G of V4.

Join S2 of T2 to G.B. —

Join A of V4 to top L.S. terminal.

Join L.S.+ to H.T.+2.

Join L1 tap lead to aerial terminal with flexible wire.

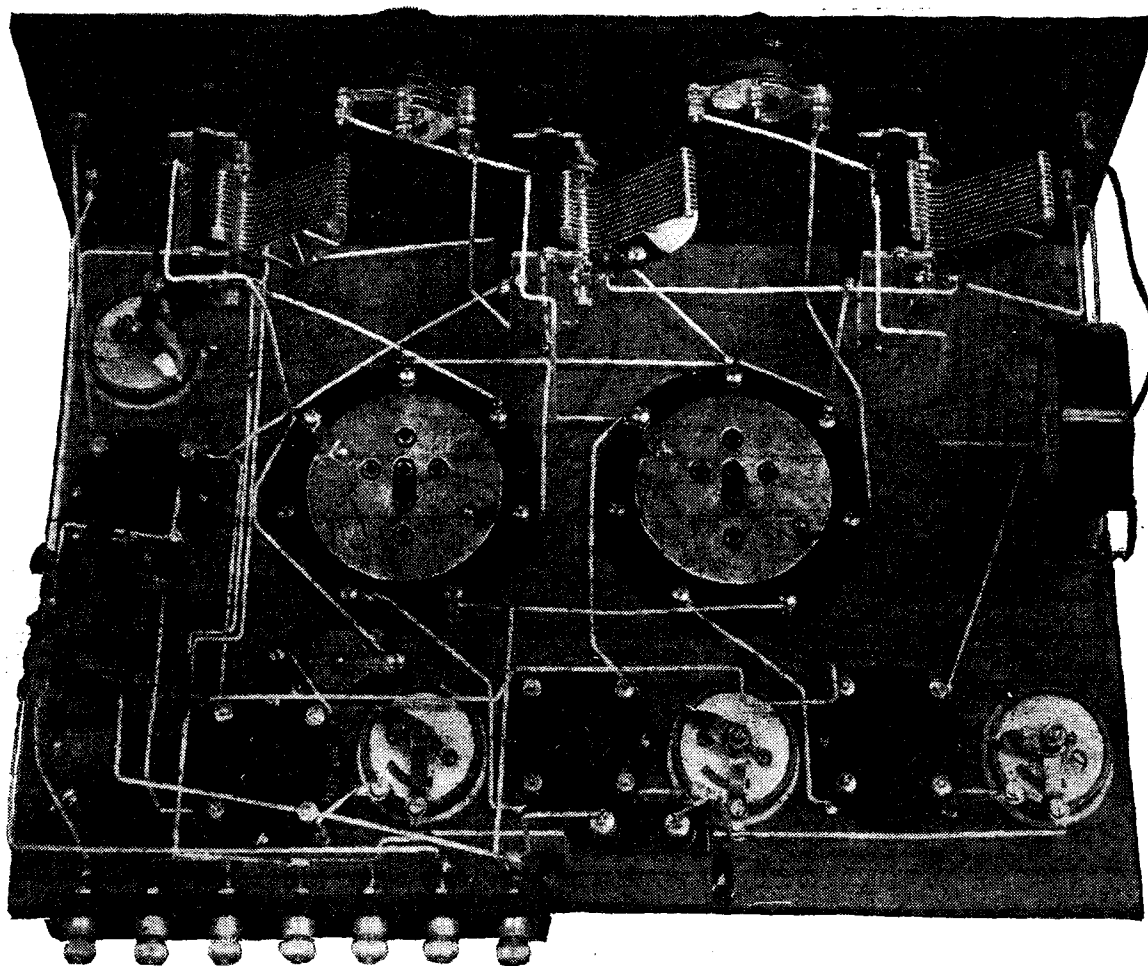

The H.F. stages incorporate screened coils, but the first grid circuit employs a tapped plug-in coil.

A "FOUR" FOR RANGE AND SELECTIVITY—(Concluded)

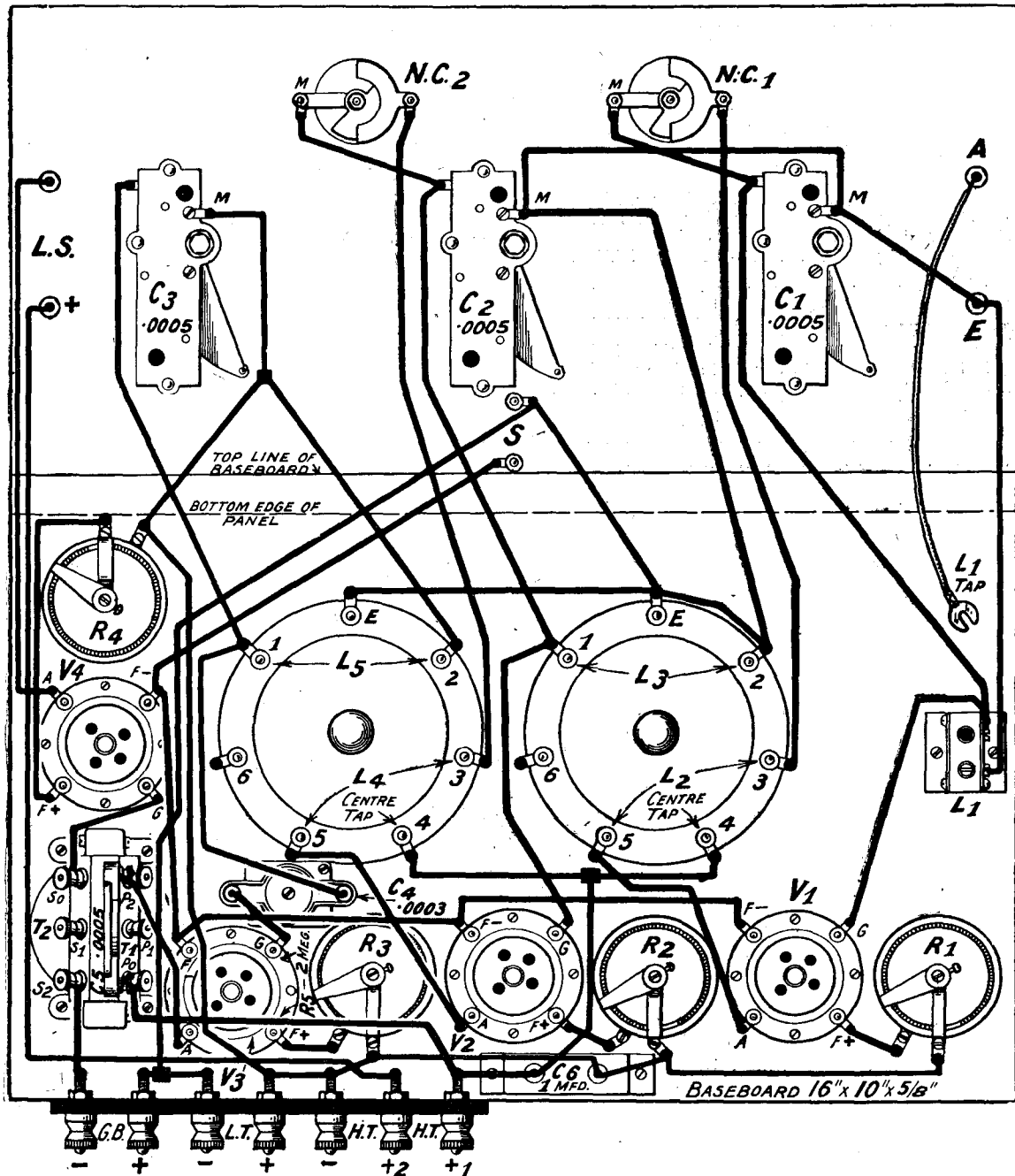

Fig. 3.—The condenser N.C.2 enables a reaction effect to be obtained. Blueprint 181b may be obtained free.

The last valve may be a low-impedance power-valve.

The H.T. voltages may be for H.T. +1 about 60-80 volts, and for H.T. +2 about 120 volts.

The set generally is not critical as regards valves, provided that the

types specified are employed. With regard to the grid bias, this, of course, will depend upon the L.F. valve and the H.T. voltage. With the ordinary small power-valve working on an H.T. voltage of 120, the grid-bias may be from 6-7½ volts.

It will be noticed that the L.F. transformer used in the set is one with tapped windings. With the aid of these tapings various ratios can be tried and the best arrangement found by experiment to suit the particular detector valve used.



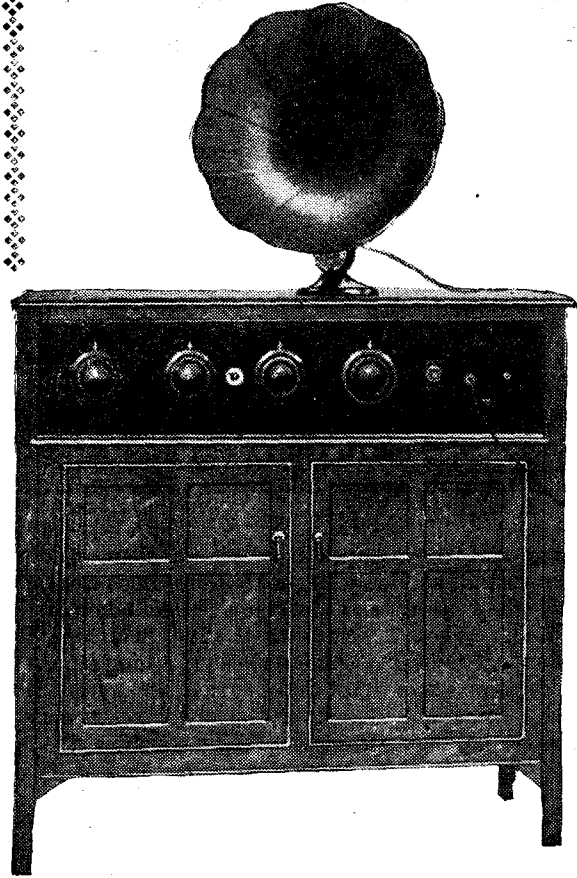

The "Elstree Six" built by Mr. Stafford.

# MORE "ELSTREE SIX" SUCCESSSES

## "No Trouble"

SIR,—I have very great pleasure indeed in telling you that I completed the "Elstree Six," early last month. I had no trouble of any kind, and really cannot say how grateful and pleased I was. For the past three years I have tried various hook ups, spending much time and money, but I never even approached the results that the "Elstree Six" gave so easily; indeed, the results seemed too good to be true. I have sent the set to my brother at Travancore, South India, and hope in due course to receive a delighted report from him,—Yours truly,

C. W. STANDEN.

S.W. II.

## "A Lovely Set"

SIR,—Since the advent of wireless I have constructed innumerable sets of all descriptions, and have also heard the majority of the best proprietary brand sets that have been placed on the market.

I can conscientiously say that there is nothing to compare with the

enthusiast who requires to receive all stations within a radius of 500 miles at full loud-speaker strength.

I shall be only too pleased to demonstrate it to anyone living within the neighbourhood of Wendover.

Thanking you for placing such a lovely set before the public.—Yours truly,

H. STAFFORD.

"Huntly," Victory Road,  
Wendover.

## "Super-sensitive"

SIR,—I have much pleasure in informing you that I have completed the "Elstree Six" with entirely satisfactory results. Using the coils for range 2 I have tuned in most of the B.B.C. stations and a fair number of the Continentals for which readings were given in the June issue of MODERN WIRELESS. These stations were received at good strength and without the least interference from the local station, which is about one mile distant.

The set is super-sensitive and yet ridiculously easy to control. I have tuned in three stations

within the limits of one degree of the dial without the slightest overlapping or interference. In conclusion, may I thank you and your staff for such a design "par excellence" as the "Elstree Six."  
—Yours truly,

S. H. F. WILLIAMS.

Devonport.

## Immediate Results

SIR,—Our Bristol office has asked the writer to report on the result of the "Elstree Six," which he has made up to test. He must congratulate your Elstree staff on their success. After completing and placing the dials in position for Cardiff, as given in the MODERN WIRELESS that station came in at loud-speaker strength immediately, and since then the set has been successful in bringing in all the B.B.C. stations on the loud-speaker, and the writer can well recommend this receiver to any keen listener who delights in getting all stations on the loud-speaker.—Yours truly, Pp. Automobile Accessories (Bristol), Ltd.,

F. NEWCOMBE,  
Director.

Exeter.

## Valves for the "Elstree Six."

As many readers are anxious to know whether 2-volt valves work satisfactorily in the "Elstree Six," a number of tests of these valves have been made at our Elstree Laboratories. Although our tests are not yet completed with all makes, we are in the position to say that Cossor Point One H.F. in the first three sockets, and Cossor Stentor Two in the last three are quite satisfactory.

# OFF THE BEATEN TRACK

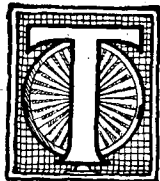
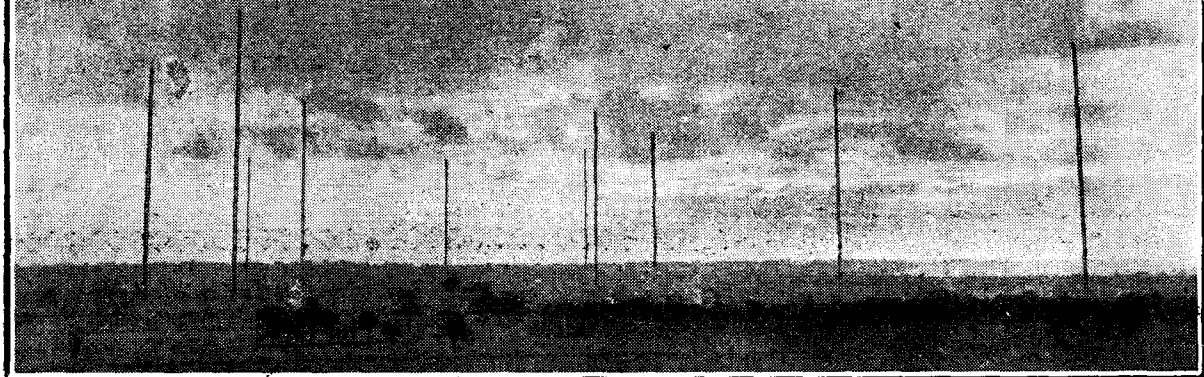

**T**ELEPHONY is apparently destined to "rule the waves" as far as wireless is concerned. One can no longer escape from it by ascending into the heights or descending to the depths! Rugby has been rampant on several

different wavelengths between 4,000 and 8,000 metres, especially on Saturdays and Sundays, during the last month, and Nauen has started telephony transmissions on about 39 metres. The latter station has been received in London with a detector and one stage of L.F. at the same strength as 2LO, and with a superheterodyne adapted for working on wavelengths down to 20 metres he seemed as if he would burn out the loud-speaker. The station is also very sharply tuned, and really causes remarkably little interference.

### Higher Up

**N**OTHING startling has been heard on the longer waves for some time now. From 600 metres up one seems to know just about what may be expected to happen, which certainly cannot be said about the shorter waves, extremely erratic in their performance as a rule. Probably the fact of the matter is that I have become "hardened" to the short

waves, and the manner in which stations 5,000 miles distant suddenly begin to come in as clearly as if they were next door has been taken for granted. When I return to the longer waves, I half expect to hear a Chinese station lurking among the ships on 600 metres, and begin to feel hurt if it doesn't come off! However, the longer waves may certainly lay claim to much greater constancy.

### Short or Long

**I**VERY much doubt whether the long-wave C.W. stations will ever be superseded by short-wave stations working on lower power. To start with, "local" conditions have a much greater effect "down below," and fading and atmospheric also take their toll. Then there is the difficulty that crops up when high power is used on waves round about 40 metres. The range of the station is so tremendous that, according to reports of tests carried out by the American Government stations, the waves continue to chase one another round the earth, not being content to travel to their intended destination and stop there. The result is that when the transmitting station sends one dot, a station at the Antipodes would receive this, followed very closely by a weaker one, and possibly a few more!

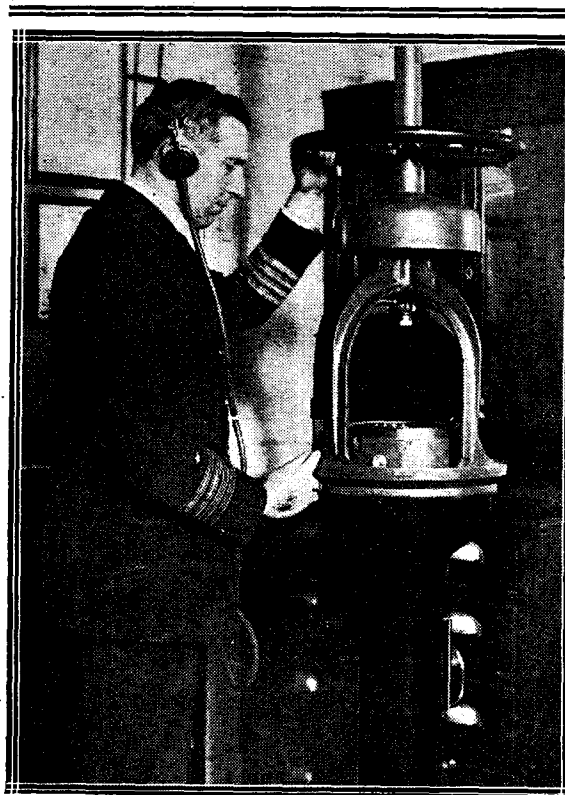

The dangers of fog at sea have been greatly reduced by the use of direction-finding apparatus. Here we see a bearing being taken on board the s.s. "Leviathan."



# PRESS-MEN TEST THE "SOLODYNE"

## An Interesting Demonstration at Elstree



IN accordance with the declared policy of Radio Press, Limited, of giving regular demonstrations of its new Star receivers, the remarkable Elstree "Solodyne" was demonstrated to a gathering of Press representatives at the Elstree Laboratories on Tuesday, August 31, last. Among those present were representatives of the following newspapers: *Morning Post*, *Daily Express*, *Daily Telegraph*, the *Scotsman and Dispatch*, *Daily News*, the Press Association and the Exchange Telegraph Co.

### One Dial Control

Mr. J. H. Reyner, in charge of the demonstration, began by explaining to the visitors the difficulties that had to be overcome in designing a set in which one dial control was to be obtained without sacrificing efficiency. The set was thereupon connected to a small aerial—not a large and highly efficient aerial which might give misleading results, but a small affair comparable with that used by the average listener. One after another British and Continental stations were tuned in on the loud-speaker, the stations being so numerous that in many cases two or three stations were found within a couple of degrees on the dial.

### Trying It Themselves

To prove that there was "no deception," as the conjurers will have it, each Press representative was invited to take charge of the instrument and turn the dial backwards and forwards to see how simple it was to pick up the stations. Although no member of the audience had previously handled

a set, everyone agreed it was exceedingly simple to work.

### Opinions

Among the numerous complimentary expressions of opinion published subsequently in the journals, we may give the following:—

#### MORNING POST

"A set that in actual test has received 50 Continental stations by merely turning one knob instead of endless fiddling with two or more controls, usual with such selective reception, was demonstrated to the Press last night. The set, which is called the 'Solodyne,' has been designed by the technical staff of Radio Press, Ltd., and the tests were held at the firm's laboratories at Elstree. By slowly rotating a large knob in the centre of the set, the loud-speaker responded to one station after another with a clarity and precision that was almost uncanny."

#### DAILY NEWS

"Universal reception made easy. . . . Last night I picked up a dozen stations in as many seconds by turning the dial a few fractions of an inch. Frankfurt, Munster, Bournemouth, San Sebastian, London, Cassel and Dresden tumbled over each other as I turned the dial slowly round."

#### DAILY EXPRESS

"A wireless receiver which is the last word in simplicity, and on which all Europe can be heard by rotating a single dial, was demonstrated to a 'Daily Express' representative last night. The set has five valves, and as the single dial was rotated,

(Concluded on page 486.)

## COMPONENTS FOR THE ELSTREE "SOLODYNE"

The Elstree "Solodyne" has achieved a popularity only equalled by the well-known "Elstree Six." Within a fortnight of the first details being published in the September issue of MODERN WIRELESS, applications were received for over two thousand wiring blueprints. At the National Radio Exhibition at Olympia the Solodyne was the centre of attraction. In view of this widespread interest, will readers please note that in addition to the Lewcos screened coils mentioned in the list of components, the following alternative makes will give satisfactory results: Bowyer-Lowe, Burhe-Jones, Efesca and Peto-Scott.

While approved components can be substituted for many others named in the original article, a mere claim that such-and-such a component is recommended by its maker as suitable for the "Elstree Solodyne" is no indication that it has been approved by the Elstree laboratories for the purpose. It is necessary to emphasise this point as several triple condensers in which the spindle is common to all three condensers are being erroneously recommended for this receiver. It should be noted that the three spindles must all be insulated from one another, and independent adjustment provided for each.



Here is absolute uniformity—  
longer life—increased sensitivity  
—incredible economy of opera-  
tion—a shockproof filament—Co-  
axial mounting system—the same  
Cossor unblemished standard of  
excellence.

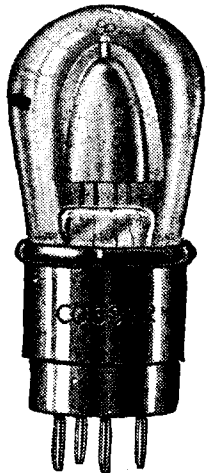

**COSSOR POINT ONE**  
[Red Top]

For H.F. Amplification and Re-  
sistance Capacity Coupling

Normal filament voltage 1.8  
Filament current 1 amp.  
Maximum anode voltage 120 volts.  
Impedance 42,000 ohms.  
Amplification factor 13.

14/-

[Plain Top]

For Detector and L.F. use.

Normal filament voltage 1.8  
Filament current 1 amp.  
Maximum anode voltage 120 volts.  
Impedance 22,000 ohms.  
Amplification factor 9.

14/-

PERIODICALLY Cossor has inaugurated improve-  
ments in valve design so far reaching in effect as to  
be hailed as milestones in the progress of the industry.  
The first self-supporting unsprung filament was in the  
Cossor P1—still regarded as the standard British bright  
emitter. The first triple-coated filament to work at a  
really low temperature was to be found in the Wuncell  
Dull Emitter.

And now Cossor has aroused universal interest among  
all radio enthusiasts with the wonderful new Cossor  
Point One—the first Valve ever to utilise successfully  
Co-axial Mounting.

Already eager thousands have discovered in this new Dull  
Emitter a standard of performance which has never be-  
fore been available in any valve. They have revelled in  
a super sensitivity which has enabled them to smash  
with ease their own records for long distance reception,  
and with the Stentor Two in the power stage they have  
been dumbfounded at the superb fulness of tone from the  
Loud Speaker.

Yet sensitivity and tonal purity are but two of the outstanding features  
of this new valve. Co-axial mounting permits the use of a shockproof  
filament suspension system which assures an abnormally long life. A  
new method of filament manufacture cuts current consumption to one  
tenth of an ampere. A new grid of exceptional rigidity banished for  
ever the bugbear of microphonic noises.

Obtain some of these wonderful new Cossor Valves without delay—  
they will set you a-tingling with enthusiasm and awake your admiration  
for the British research workers who have made such remarkable  
results possible.

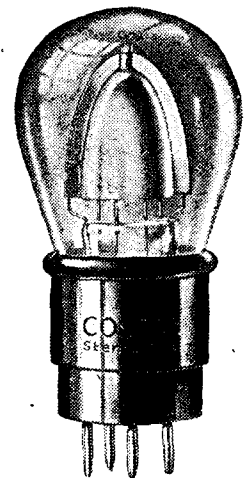

**STENTOR TWO**  
**POWER VALVE.**

Normal filament voltage 1.8.  
Filament current 1.5 amp.  
Maximum anode voltage 150 volts.  
Impedance 8,000 ohms.  
Amplification factor 8.

18/6

Ask your Dealer for the new  
Cossor Folder which fully ex-  
plains the new system of Co-  
axial mounting.

*The new and amazing*  
**Cossor Point One**

  
**USE FOR**  
**YOUR "SOLODYNE" RECEIVER.**

**IGRANIC-PACENT TRIPLE GANG CONDENSERS**

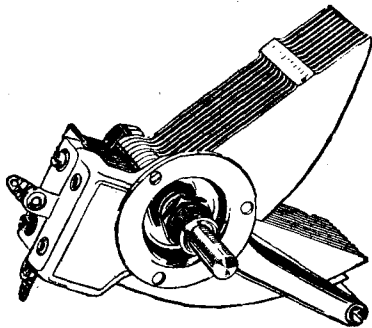

Obtain the utmost efficiency from your "Solo-dyne" Receiver by using Igranic-Pacent British-made Straight Line Frequency Variable Condensers. These condensers give accurate straight line frequency tuning and have extremely low losses with negligible minimum capacity. The plates are of brass riveted and soldered together, thus maintaining perfect conductivity, permanent alignment and absolutely uniform variation.

The substantial dust-proof bearings ensure very smooth movement, which greatly facilitates accuracy of adjustment.

Single pattern—'00035 mfd. .... **14/6**  
 '0005 mfd. .... **18/6**

Triple Gang Pattern, complete with supporting brackets (3 sections each of '0005 mfd.) price complete **£3 10 0**

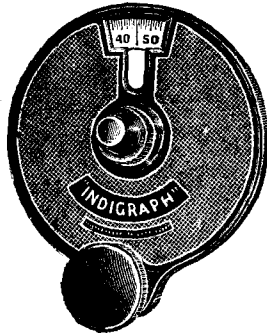

For accurate adjustment of your variable condensers use the **IGRANIC INDIGRAPH VERNIER KNOBS AND DIALS.** Extremely smooth movement, entirely free from backlash and a reduction ratio of approximately 8:1. Station settings can be recorded on the dial opposite the scale readings. Extremely handsome appearance.

Price .. .. **7/6**

**IGRANIC MICRO CONDENSER**

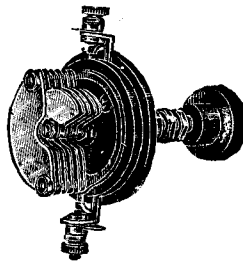

A miniature condenser for use in all cases where extremely fine variations of capacity are required. Ample spacing between the vanes and knob eliminates hand capacity effects.

Price complete with Knob and moulded Bakelite cover **5/6**

**BASE MOUNTING BRACKET**

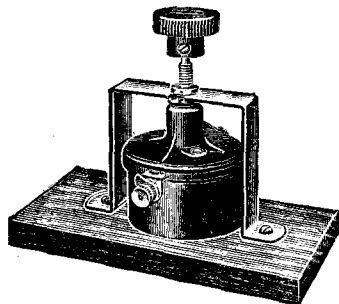

Specially designed for baseboard mounting of the Igranic Micro and Vernier Balancing Condensers, Variable Grid Leaks, Tone Controls and High Resistance Potentiometers.

Price .. .. **6d.**

**IGRANIC TONE CONTROL**

Gives smooth control of volume and removes the harshness so often experienced with very loud signals.

Price .. .. **5/6**

*Send for new Igranic Catalogue No. J.121, containing particulars of the components you need for building Receivers of the highest possible efficiency.*

**IGRANIC ELECTRIC CO., LTD.**

**149, Queen Victoria St., London.**

**Works: Bedford.**

# A THREE-VALVE TRAP RECEIVER

By C.P. Allinson, A.M.I.R.E.



*This selective receiver is of particular interest to the listener residing within the shadow of the local station, since at a distance of 1½ miles from 2LO it has been found possible to cut out this station and to receive Manchester free from interference.*

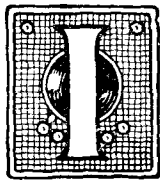

**I** WAS chatting to a friend of mine the other day who lives within two miles of 2LO. "I'm very keen to search round and listen to other stations," he said, "only I find it practically impossible to cut London out. I can't afford to make a big multi-valve set (I haven't got room for

Living as I do about a mile and a half from 2LO the question of selectivity has always been one of special interest to me, and the set to be described in the following article is the outcome of much work done in this connection. I have endeavoured to make the control and handling of the set as simple as possible, while at the same time no special coils need to be made up. All the components used are

astounding. With the aerial connected direct to terminal 3 of the screened coil Birmingham cannot be received owing to swamping from 2LO. With the second circuit in use however and the neutralising condenser about half way in, Bournemouth can be received without interference from the local station, while with a slight reduction in the coupling capacity and care in tuning it has been found possible

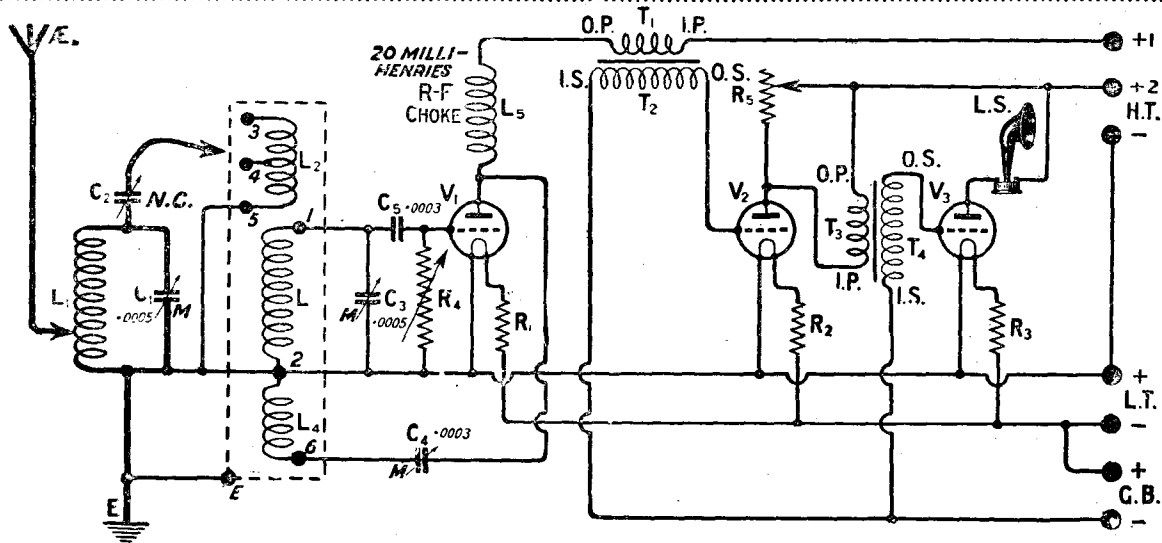

Fig. 1.—The simplified theoretical circuit. The jack connections are shown separately in Fig. 2.

it if I could) with numerous H.F. stages, special coils, extra valves, etc. Isn't there a set reasonably easy to control and not using more than three valves which will cut out 2LO and let me get something else?"

standard parts and easily procurable.

### Selectivity

With this set in use at about a mile and a half from 2LO the difference in selectivity is little short of

to eliminate the local transmission on Manchester and receive this station quite clear though somewhat reduced in strength.

On the higher wavelengths it will be found an advantage to increase the value of the coupling con-

# A THREE-VALVE TRAP RECEIVER—(Continued)

denser to obtain the best signal strength, while for the shorter wavelengths the reverse will generally be found the case.

### Results

When tested out on a short aerial at a mile and a half from

chester was extremely weak but could be tuned in nearly free of 2LO. At night this station could be received quite clear of interference and a number of British and Continental stations were received. Among these were Elberfeld, San Sebastian, a couple of

fied. Some of these were received on the loud-speaker with three valves, others were received on the phones with only two of the valves in use.

### The Circuit

The theoretical circuit diagram is shown in simplified form in Fig. 1, and a brief consideration of the principles involved may be of interest.

The aerial is auto-coupled to a tuned circuit  $L_1 C_1$ ; this circuit comprises the right-hand tuning condenser (as seen from the back of the panel) and the tapped plug-in coil seen in the single holder on the right-hand edge of the baseboard. This circuit is coupled to the detector grid circuit, and since it is not only important to have this coupling absolutely under control but also to eliminate direct pick-up in the grid circuit, this has been done by using a screened coil as shown in the views of the interior of the set.

The arrangement actually employed gives a very flexible scheme by means of which various degrees of coupling can be obtained. The screened coil used is the tapped primary H.F. transformer, which is provided with a reaction winding.

### Coupling

The coupling between the two circuits  $L_1 C_1$  and  $L_3 C_3$  is obtained by means of a small variable condenser  $C_2$ . This is actually a neutralising condenser. One side is connected to the top of the circuit  $L_1 C_1$  while a flexible lead on the other side enables it to be con-

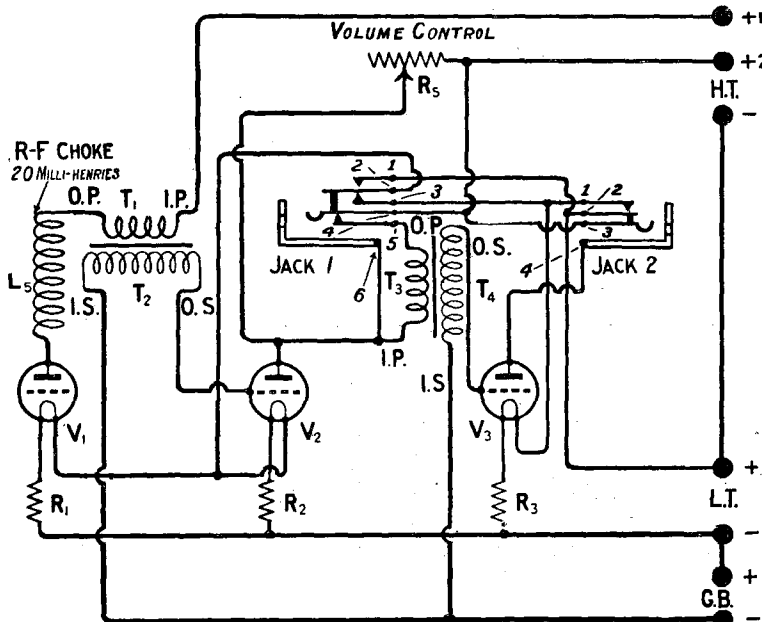

Fig. 2.—The jack switching permits two or three valves to be used as desired.

2LO it was found possible to receive one or two stations beside the local one on the loud-speaker in daylight, the two best being Bournemouth and Birmingham. Man-

relays, Union Radio Madrid, Manchester, Oslo, Bournemouth, Radio Toulouse, Hamburg, Dublin, Newcastle, Münster, Rome, Frankfurt, Birmingham, and others not identi-

## COMPONENTS REQUIRED

- One ebonite panel, matt finish, 20 by 8 by  $\frac{1}{4}$  in. (Paragon.)
- One cabinet for same with loose baseboard  $8\frac{1}{2}$  in. deep. (Peto-Scott Co., Ltd.)
- One screened coil with screen and base. Type tapped primary H.F. transformer with reaction winding. (Bowyer-Lowe, Efesca, Lewcos, Magnum, or Peto-Scott.)
- Two .0005 variable S.L.F. condensers and
- One .0003 variable S.L.F. condenser. (The Formo Co., Ltd.)
- Two L.F. transformers, first and second stages. (Cambrell Bros.)
- One 20 millihenry H.F. choke. (Bowyer-Lowe Co.)
- Three fixed filament resistances. (Bowyer, Lowe Co.)
- One double circuit double filament control jack. (Bowyer-Lowe Co.)
- One single circuit single filament control jack. (Bowyer-Lowe Co.)
- One plug. (Bowyer-Lowe Co.)
- One baseboard mounting neutralising condenser. (Peto Scott Co., Ltd.)
- One baseboard mounting single coil socket and
- One variable grid leak. (Beard and Fitch, Ltd.)
- 3 anti-microphonic valve holders. (Etherplus.)
- Two National Velvet Vernier dials. (Rothermel Radio Corporation of Great Britain, Ltd.)
- One volume control. (Burne Jones, Ltd.)
- One .0003 fixed grid condenser type 600A. (Dubilier Condenser Co., Ltd.)
- Nine terminals.
- Three or four packets of Glazite. (London Electric Wire Co., Ltd.)
- Strip of ebonite 7 by 2 by  $\frac{1}{4}$  for terminal panel.
- One dial and knob for reaction condenser. The ones used were obtained from Messrs. Burne Jones, Ltd., but an ordinary dial may be used here if desired.
- Two spring clips.

# Don't throw your Fountain Pen away every time it runs dry!

NO fountain pen user would think of throwing his pen away whenever it ran dry. Yet that is exactly what thousands of wireless users are continually doing—whenever their H.T. Dry Battery “runs out” they are obliged to scrap it and buy a new one. But those who have discovered Oldham are more fortunate; they just charge their H.T. Accumulators whenever they run down (four times a year) and forget them! Thus has the Oldham High Tension Accumulator solved the vexed question of H.T. Supply. There are so many improvements embodied in this latest Oldham triumph that it is difficult to imagine anyone ignoring it for one of different make. The refinements which the Oldham includes have long been eagerly looked for by all who deplored the inefficiency of the old dry battery. Think what it means to have an Accumulator which gives the many following advantages:

A glance at the illustration will show it is built on the unit system—like an expanding bookcase. You can start with, say, 60 volts, and then add to it in 20 volt units as the need arises; 80, 100, 120 volts—just as you will.

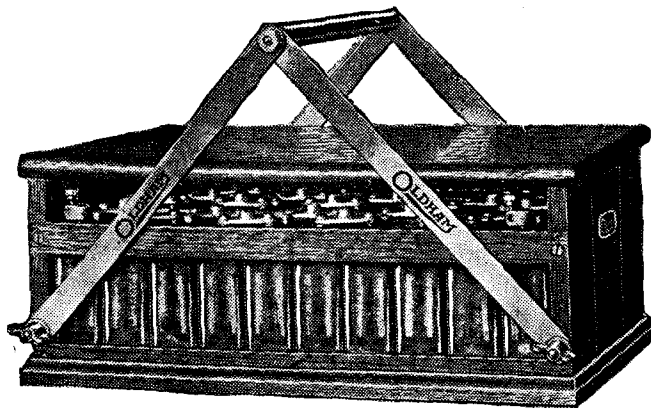

### 10d. per volt

60 volts £2 10 0, 100 volts £4 3 4  
80 volts £3 6 8, 120 volts £5 0 0

Complete with lid and handles  
Solid Oak Base, 3/6 extra.

The Accumulator is always neat and tidy—fit to take its place in any room. Acid can't be spilt, and when it needs recharging a convenient carrying handle is available. Each of its big capacity cells is a miniature Oldham accumulator capable of holding its charge for months on end. Each plate is made under the same Special Activation Process which has made the name Oldham famous throughout the world.

Which do you prefer—the ordinary dry H.T. Battery with its consequent noises and cracklings—after some of the cells have become weak

—its distortion, lack of volume and constant expense for renewals; or the Oldham H.T. Accumulator which will give a new lease of life to your set, more volume, greater sensitivity, and the utmost economy in operation? Once a man chooses this Oldham he never

goes back to expensive dry batteries.

Ask your dealer to show you one of these handsome H.T. Accumulators—don't be put off with a substitute. Nothing can take its place for none other can give you the same steady flow of power—the same freedom from sulphation and the same generous length of service.

**OLDHAM & SON, Ltd.,** Head Office & Works:  
Denton, MANCHESTER.

London Office and Service Depot: 6, Eccleston Place,  
S.W.1. (Phone: Vict. 0286).



Gilbert A-1, 5816

Tell the Advertiser you saw it in "MODERN WIRELESS."



# Here are the N.P.L. figures

—now you can judge for yourself!

TABLE 1			TABLE 2			
Coil	Inductance in microhenries	Self-capacity in micro-microfarads	Coil	Parallel capacity in micro-microfarads	Wave-lengths in metres	Effective resistance in ohms
35	61	15	35	300	264	2.8
40	90	15	40	"	318	2.9
50	150	9	50	"	406	3.3
60	200	13	60	"	472	4.4
75	295	12	75	"	573	5.3
100	540	11	100	"	774	6.6
150	1,410	12	150	"	1,250	15.8
200	2,220	17	200	"	1,580	19.7
250	3,070	17	250	"	1,860	24.9
300	4,800	14	300	"	2,320	28.2

**I**N the design of radio inductances it is a well-established fact that the smaller the R/L value for any circuit the greater is the selectivity and signal strength.

Because this fact predominated in the design of the LEWCOS Coil we can publish without fear the R/L values obtained in independent tests by the National Physical Laboratory.

**Why the wave-length is given.**

We would draw the attention of readers to the wave-length at which the measurements were made. This is a most important point which is often overlooked by amateurs and sometimes even by manufacturers when

quoting the H.F. resistance figures for their coils. Resistance in high frequency varies with the frequency and to give a figure for H.F. resistance without the wave-length at which that resistance was measured is valueless.

**Try this better coil yourself!**

You will be delighted at the improvement in reception when you use Lewcos Coils. Besides being highly efficient they are strongly constructed and of good appearance. Try Lewcos Coils in your set—they make *all* the difference! Your wireless dealer stocks or can obtain Lewcos Coils for you. Write for descriptive leaflet.



## LEWCOS Inductance Coil

No.	25	35	40	50	60	75	100	150	200	250	300
Price	4/6	4/6	4/6	5/-	5/6	5/6	6/9	7/6	8/6	9/-	10/-

**THE LONDON ELECTRIC WIRE COMPANY & SMITHS, LTD.**  
 Playhouse Yard, Golden Lane, London, E.C.1

Phone: Clerkenwell 1388

[Telegrams: Electric, London

# CUTS OUT 2LO AT 1 1/2 MILES

connected to various points. By connecting it to terminals 3 and 4 a combination of capacity and magnetic coupling is obtained. By connecting it direct to the grid of the detector valve (terminal 1 on the screened coil) capacity coupling only is employed.

and the use of the screened coil enables this to be accomplished.

A note of warning may be sounded here. The coupling between the two circuits must be loose if satisfactory results are to be obtained. If it is too tight the two tuning controls will not be in-

geared dials have been fitted to the tuning condensers for this purpose.

### The L.F. Stages

The two stages of low-frequency amplification are quite straightforward and jack switching is employed to enable either two or

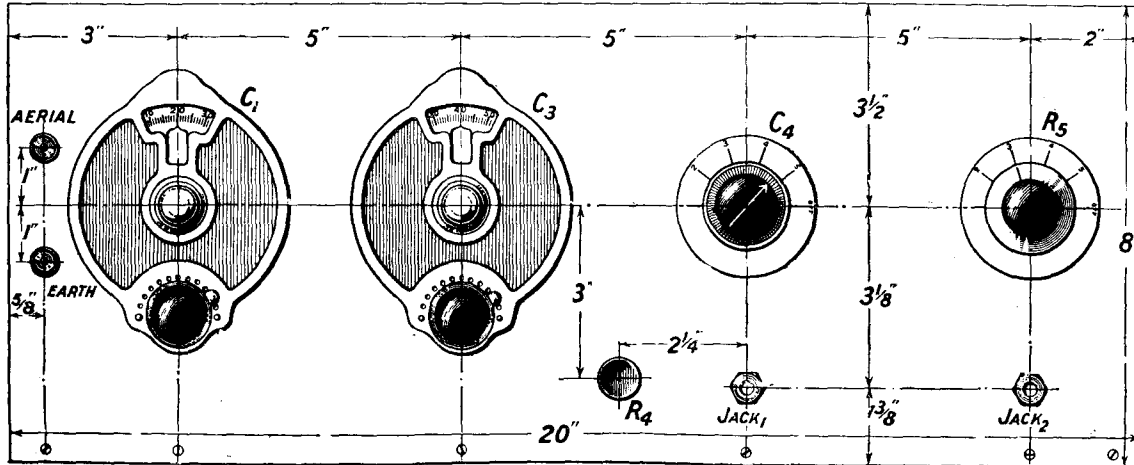
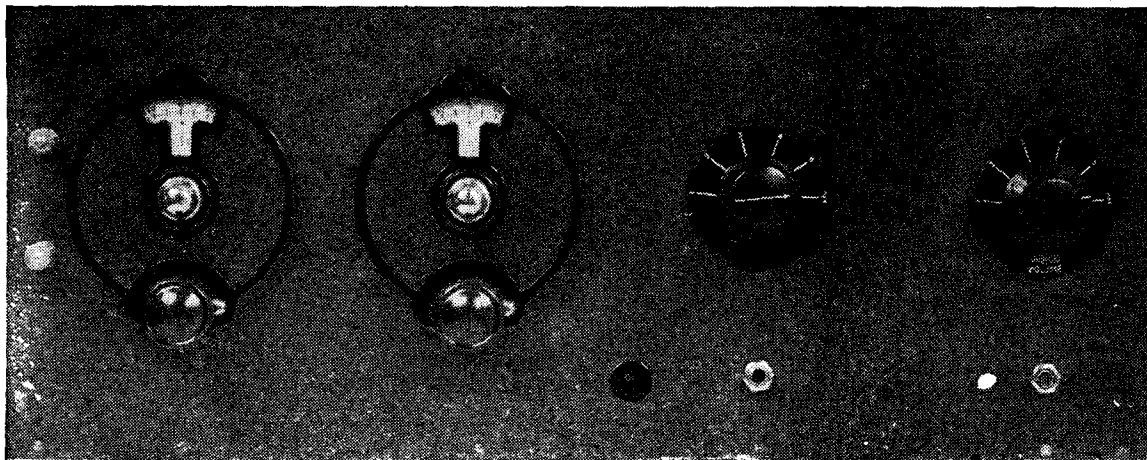

Fig. 3.—The slow motion dials have a fine and coarse adjustment incorporated. Blueprint No. 180a may be obtained free of charge.

The last method appears to give somewhat tighter coupling, in fact under some circumstances it may be too tight, and the first method

dependent, but the interaction between them will make it practically impossible to handle the set, while the effect on reaction, too,

three valves to be used at will. Filament control jacks have been used so that inserting the phone or loud-speaker plug in either jack



The knob on the extreme right is a volume control which enables very strong signals to be adjusted to a pleasant strength.

is frequently to be preferred. It will be seen then how important it is that no stray coupling be present between the two circuits,

is disastrous. In order to facilitate the tuning of this receiver the use of some form of vernier control is most certainly desirable and

lights up the correct number of valves. The connections for this are shown in a separate diagram in Fig. 2 for the sake of clearness, and

**A THREE-VALVE TRAP RECEIVER—(Continued)**

the contacts have been numbered so as to simplify reference to it in conjunction with the wiring diagram for making the connections in the set itself.

It should be noted that the primary connections of the second L.F. transformer are reversed to those of the first one, and this must be followed if the same transformers are used as are in the set.

**Resistances**

Before going on to the constructional work we have yet to decide what value filament resistances to use. If 5 volt valves of the  $\frac{1}{4}$  ampere type are to be employed then the correct values for these resistances when a 6 volt battery is used will be 4 ohms. Of course where 2 or 4 volt valves are used throughout with 2 or 4 volt

.06 valves for the first two and a four volt accumulator is employed then the first two resistances will be 17 ohms and no resistance is needed for the last valve.

These figures are merely to serve as a general indication of some of the more usual values—it is obviously impossible to give a full list of the various types of valves and the values of the

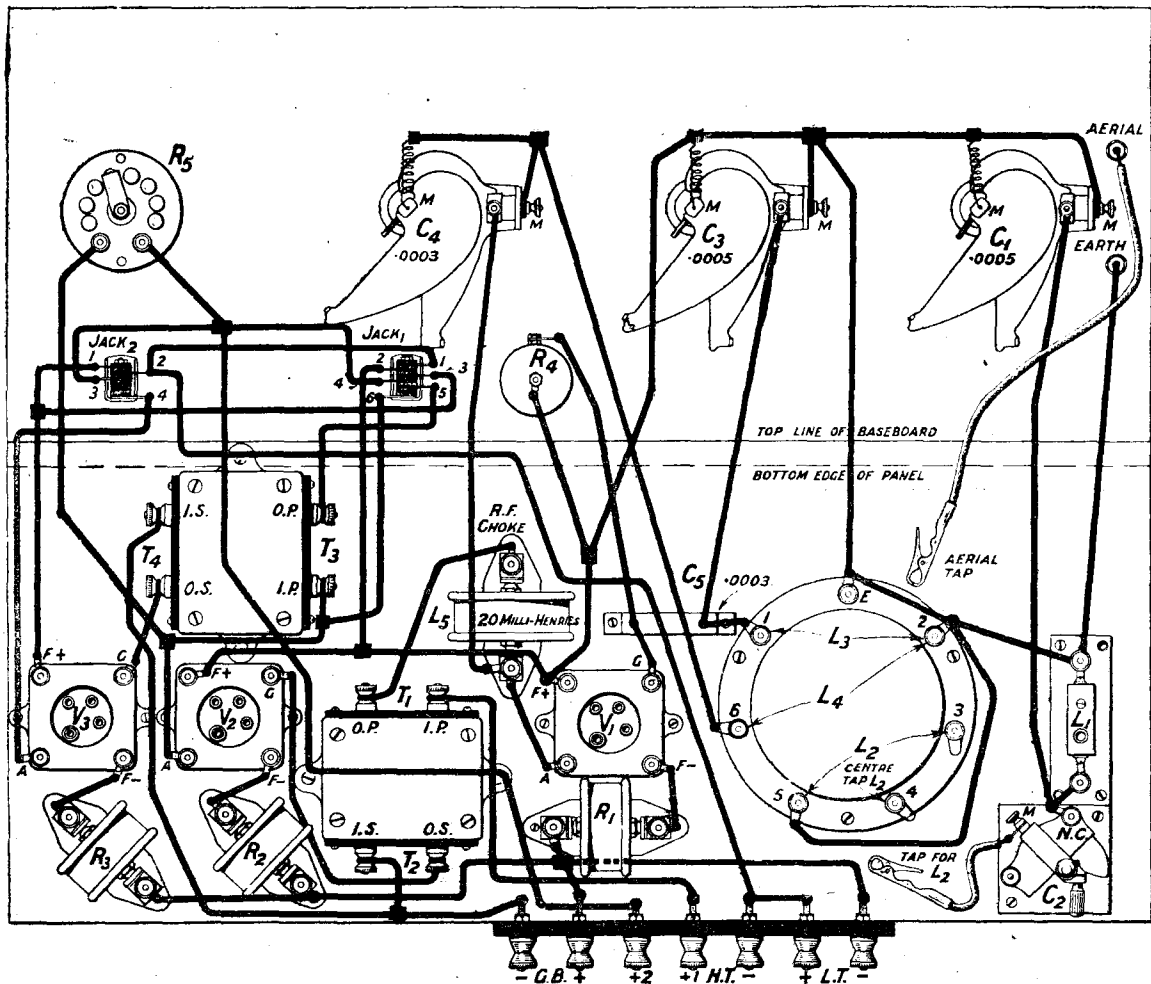

Fig. 4.—The connections to the L.F. transformer primary windings should be followed with care. Blueprint No. 180b is available free.

**Components**

A complete list of the components required to construct this receiver is given herewith, but it should be borne in mind that the particular makes mentioned are not indispensable to the working of the receiver provided that any parts substituted are of reliable make.

batteries respectively no resistances need be used at all. If it is intended to use two .06 valves for the detector and first L.F. followed by a five volt power valve, then the first two resistances will need to be 50 ohms each and the last one 4 ohms as before. If the last valve is to be a 4 volt valve with the

resistances that would be required since the large varieties of types of valves with different voltages and ratings would require a few pages being devoted to this alone.

**Construction**

The first stage of the constructional work is to prepare the panel

# Clothed in Metal

—the wonderful new idea in Wireless



**Note:**  
Only copper can give the perfect self-cleaning contact so essential for perfect shielding.

## The great Revival in long distance reception

### Prices for Copex Shields & Coils

Copex Copper Shield (patent applied for) complete with six pin base ... .. 15 0

### INTERCHANGEABLE COILS.

	B.B.C.	5XX.
	250-500 mtrs.	1900-2000 mtrs.
Tapped Primary Aerial Coils ...	6/- each	6/- each.
H.F. Transformers (Split Primary & Reaction) ...	10/-	10/-
Split Secondary H.F. Transformers	10/-	10/-
Reinartz Transformers ...	10/-	10/-

### Pilot Manual (new Edition)

Send a postcard for a free copy of the "Pilot Manual" giving complete specifications and details of many of the new Radio Press Receivers. Several pages are devoted to useful constructional hints. Fully illustrated.

**PETO - SCOTT CO., Ltd.**  
(Sole Makers of Copex Coils).  
77 City Rd., London, E.C. 1.

Branches:  
LONDON, 62, High Holborn, W.C.1.  
WALTHAMSTOW, 230, Wood Street.  
PLYMOUTH, 4, Bank of England Place.  
LIVERPOOL, 4, Manchester Street.

EVERY keen wireless enthusiast must be thrilled at the immediate prospect of being able to build Sets which will definitely tune out powerful near-by transmission and pick up distant broadcasting upon a complete background of silence. Such selectivity has at last been rendered possible by the development of shielded coils. In the new Radio Press Sets, shielded coils are used to eliminate "direct pick up" and to ensure absolute stability by abolishing interaction.

One of the first shielded coils — if not the first—to be developed in conjunction with the Radio Press Laboratories at Elstree was the Copex. This highly efficient Coil and Shield has been approved by Radio Press and since used by them in a number

of their most recent Receivers.

**Q** In order that the quality of Copex Coils — and in fact all Keystone products — shall be fully safeguarded, the services of Capt. W. R. Tingey, the well-known wireless authority, have been retained by Peto-Scott Co. Ltd. as Technical Adviser.

The Copex Shielded Coil possesses valuable exclusive features. Its shield is made of copper — thus ensuring perfect electrical contact between the detachable top and its base. Aluminium tends to oxidise and particles flake off — this prevents a really good contact being maintained and negatives much of the advantage of shielding. Within the shield is the standard six-pin base which permits the use of interchangeable coils and H.F. transformers. All Copex coils are accurately wound on genuine ebonite tube. Only silk covered copper wire of the highest conductivity is used and all H.F. Transformers are accurately matched to ensure the highest degree of selectivity being obtained.

### For the Elstree SOLODYNE

Complete Set of Copex coils and copper shrouds including 2 split primary H.F. Transformers and one aerial coil ...	£3 11 0
Full kit of other components as specified by author	£10 17 6
Red Triangle Ebonite Panel drilled and engraved	£0 11 6
High grade polished mahogany cabinet ...	£5 10 0
Finished instrument aerial tested and fully guaranteed. All Royalties paid...	£23 12 6

# COPEX COPPER SHIELDED COILS

Gilbert Ad. 5821



**What are the  
ideal conditions for  
DISTANT RECEPTION?**

**A** DARK night with rain pouring in torrents and the wind whistling through the trees. A good receiver, well charged batteries, and a stage or so of H.F. amplification incorporating **MH** BARREL TYPE TRANSFORMERS:— these are the ideal conditions for long distance reception.

But whether the moon shines or the rain pours— whether there are howling winds or balmy breezes, the performance of **MH** TRANSFORMERS remains at maximum—ALWAYS!

Whatever the conditions—if the signal is there, **MH** Components will bring it in.

*Demand of your dealer **MH** Components—*  
**they're British.**

**L.M<sup>c</sup> MICHAEL LTD**  
Manufacturers of Wireless and Scientific Apparatus  
**WEXHAM ROAD, SLOUGH, BUCKS:**

Telephone:  
SLCUG 4 441-442.
Telegrams:  
Rad'ether, Slough.

**NEW**



**COMPONENTS OF  
EXTREME INTEREST**

**MH Unimic Coil.**  
Its special base mounting is electrically and mechanically perfect, and allows of variable coupling.  
**Price 5/-**  
Base 2/6 extra.

**MH Dimic Coil No. 1.**  
Taken at the Middle frequency it has a resistance of 5.25 ohms at a frequency corresponding to 400m., i.e., 0.26 ohms per uH.  
**Price 10/-**  
Base 2/6 extra.

**MH Balancing Condenser.**  
The growing need for precise balancing encouraged us to produce a component which you will find essential.  
**Price 4.9**



## A THREE-VALVE TRAP RECEIVER—(Continued)

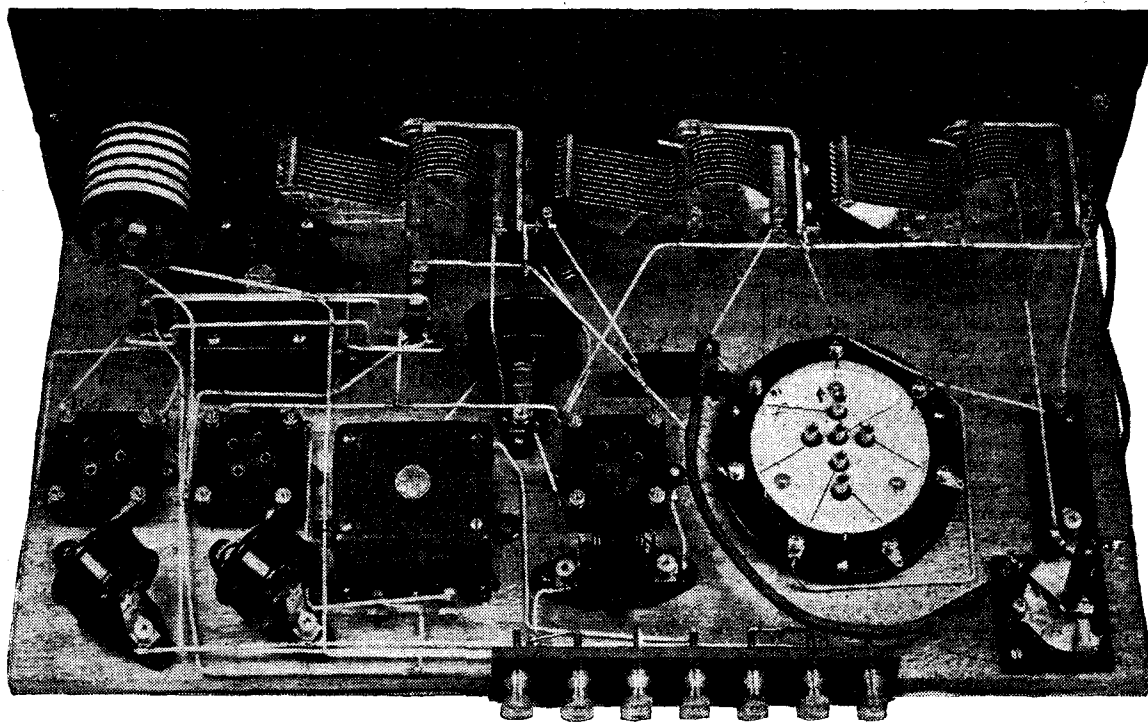

The small neutralising condenser on the right-hand edge of the baseboard is the coupling condenser C2.

for mounting the components on it. For this purpose the panel lay-out shown in Fig. 3 should be consulted. Not only does this give the various dimensions, but it is drawn to scale. It will be found of great help in marking out the panel. The holes for the variable con-

densers, volume control and jacks may all be  $\frac{3}{8}$  in., while 5-16 in. will serve for the variable grid leak. The holes for the two terminals and the fixing screws by means of which the panel is fixed to the baseboard will depend on the terminals and screws actually used.

The components are now mounted on the panel and this is fixed to the baseboard, and the components which go thereon may be placed in position. The wiring may then be carried out in accordance with the instructions and blueprint. (Concluded on page 462.)

### WIRING INSTRUCTIONS

Join IS of T4 to IS of T2: IS of T2 to GB—.  
 Join OS of T4 to G of V3.  
 Join OP of T3 to Contact 5 of Jack 1.  
 Join Contact 6 of Jack 1 to IP of T3: IP of T3 to A of V2: A of V2 to one side of R5.  
 Join A of V3 to Contact 4 of Jack 2.  
 Join Contact 4 of Jack 1 to remaining side of R5, Contact 3 of Jack 2, and H.T.+2.  
 Join Contact 3 of Jack 1 to Contact 1 of Jack 2: Contact 1 of Jack 2 to F+ of V3.  
 Join Contact 1 of Jack 1 to Contact 2 of Jack 2: Contact 2 of Jack 2 to H.T.—: H.T.— to L.T.+.  
 Join Contact 2 of Jack 1 to F+ of V2 and F+ of V1: F+ of V1 to one side of R4 and to moving plate contacts of C3: moving plate contacts of C3 to moving plate contacts of C1 and E of coil screen base: E of coil screen base to terminal 2 of L3: terminal 2 of L3 to terminal 5 of L2 and pin of holder for L1: pin of holder for L1 to earth.  
 Join L.T.— to GB+: GB+ to one side of

R1: same side of R1 to one side of R2: same side of R2 to one side of R3.  
 Join remaining side of R1 to F— of V1.  
 Join remaining side of R2 to F— of V2.  
 Join remaining side of R3 to F— of V3.  
 Join OP of T1 to one side of L5.  
 Join IP of T1 to H.T.+1.  
 Join OS of T2 to G of V2.  
 Join flex lead with spring clip on end to aerial terminal.  
 Join fixed plates of C1 to socket of holder for L1: socket of holder for L1 to fixed plates of C2.  
 Join flex lead with spring clip on end to moving plates of C2.  
 Join fixed plates of C3 to one side of C5: same side of C5 to terminal 1 of L3.  
 Join remaining side of R4 to remaining side of C5: same side of C5 to G of V1.  
 Join A of V1 to remaining side of L5: same side of L5 to fixed plates of C4.  
 Join terminal 6 of L4 to moving contacts of C4.

# THE "ELSTREE SIX"

*Further Letters from Readers who have tried this remarkable Receiver for themselves.*

## "Surpasses all Others"

SIR,—I was agreeably surprised with the results I heard during the demonstration of the "Elstree Six." I have tried and had the handling of numerous different types of sets and circuits in the last six years, and the "Elstree Six" certainly surpasses all others with regard to selectivity and the elimination of interference, in my estimation.

I would like to take this opportunity of thanking you and your staff for the cordial way in which we were received at your laboratories; everything possible being done to make us comfortable, and no pains spared to demonstrate and explain any query that was asked.—Yours truly,

L. A. GREENWOOD.

N.4.

Some of the giant masts which support the aerials of NAA, the United States Navy Department Station, situated at Arlington, U.S.A.

## "Selectivity Remarkable"

SIR,—It is with much pleasure that I give you my opinion of the "Elstree Six." The evening that I heard this set I think atmospheric conditions were very bad. This speaks all the more for the set, as at that time I could hardly get any distance on my own set. Nevertheless, that evening I heard every B.B.C. station, including relays, using the "Elstree Six." The selectivity of the set was remarkable; but more surprising still was the simplicity of tuning, although four tuning dials were used. Later on in the evening, about 10 o'clock, the different stations came in at tremendous strength.

Before I close I take this opportunity of congratulating you on the production of this remarkable set.—Yours truly,

W. BARROW.

S.W.II.

## "Truly Wonderful"

SIR,—Re the demonstration of the "Elstree Six," I consider that it is a truly wonderful receiver. The stability and selectivity are all that could be desired.

The way one can go from one station to another, only one degree or so apart on the dials, without a sign of self-oscillation or inter-

ference from other stations is had the good fortune to witness before. There is no doubt that the "Elstree Six" marks a big step forward in radio science. On working the set myself, I found it as easy to handle as a one-valve reaction receiver, while its selectivity and range were all that could be desired. It was demonstrated in my presence on the whole broadcasting band, and reception in all cases was pure and distortionless, while the neutralisation was complete over the entire range, thus making the receiver quite stable.—Yours truly,

S. KINGHAM HERBERT.

London.

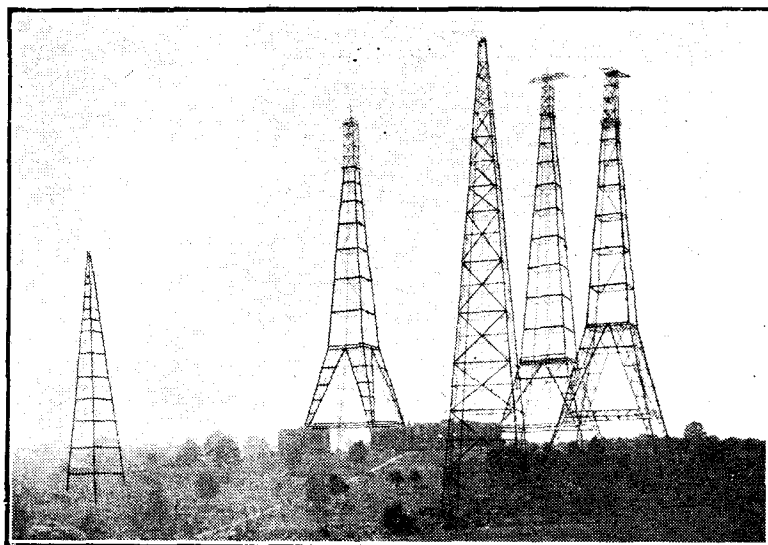

ference from other stations is wonderful.

Wishing you every success with all your publications.—Yours, etc.,

G. SMITH.

Reading.

## "Easy to Handle"

SIR,—I was very much impressed, during my visit to your laboratories, by the efficiency of the "Elstree Six," and in the three hours or so I spent at Elstree was given a demonstration such as I had not

## "Wonderful Achievement"

SIR,—I am writing to thank you for the privilege of seeing and trying for myself the "Elstree Six." I think it a most wonderful receiving set, and I was amazed at the selectivity and ease with which one could tune in station after station.

I should like to compliment your engineers on their wonderful achievement.—Yours truly,

A. WATERS.

Surbiton.

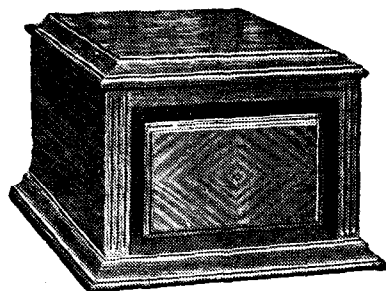
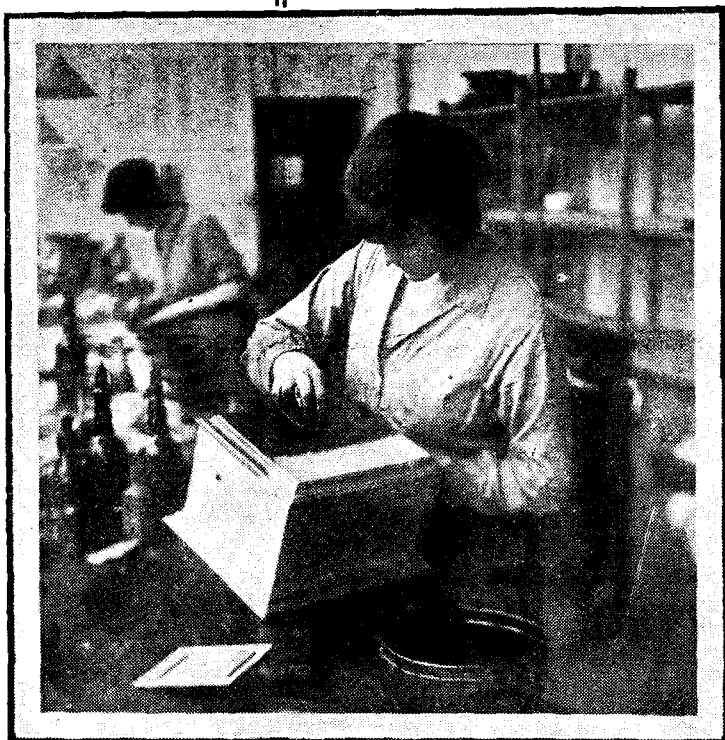

ART and Science go hand in hand in the **Brown** Cabinet Loud Speaker. Beautifully finished in rich Mahogany or Oak, it will harmonise with the setting of any room, while in purity of tone and adequacy of volume it stands alone among Loud Speakers of this type. In resistances of 2,000 or 4,000 ohms. **£6.6.0**

Conscientiously made—for you

The careful, conscientious workmanship—the almost loving care with which **Brown** workers tend the instruments they make is almost akin to the pride with which the Craftsmen of old fashioned their work. This pride of work is distinctly reflected in the finished product—it will be obvious to you the moment you see a **Brown** Loud Speaker or Headphone.

Each **Brown** Instrument is conscientiously made; we, its sponsors, know that in it we have designed

a Loud Speaker which will give the most faithful rendering of the Broadcast it is possible to imagine; one that, in purity of tone and adequacy of volume, sets a standard in reproduction unequalled throughout the World. Because we want to pass this on to you, we are determined that not by the slightest deviation from the high standard of workmanship, nor by a moment's relaxing in the discernment with which only the finest quality materials are chosen, shall the astounding fidelity of **Brown** reproduction be prejudiced.

# Brown

S. G. BROWN, LTD., Western Avenue, North Acton, W.3

Retail Showrooms: 19, Mortimer Street, W.1; 15, Moorfields, Liverpool; 67, High Street, Southampton.

Wholesale Depots:—2, Lansdown Place West, Bath; Cross House, Westgate Road, Newcastle; 120, Wellington St., Glasgow; 5-7, Godwin St., Bradford; Howard S. Cooke & Co., 59, Caroline St., Birmingham. N. Ireland: Robert Garmany, Union Chambers, 1, Union St., Belfast.

Q

In addition to the Cabinet, there are eight other **Brown** Loud Speakers—a type for everyone from 30/- to £15 15 0.

Gilbert Ad. 5804.

Tell the Advertiser you saw it in "MODERN WIRELESS."

# MORE FACTS ABOUT AUDIO FREQUENCY TRANSFORMERS

The simplified expression giving the amplification ratio of valve and L.F. transformer is—

$$\mu \times \sqrt{\frac{Z^2}{R^2 + Z^2}}$$

where  $\mu$  is the amplification factor of the valve.

"Z" is the impedance of the transformer.

"R" is the impedance of the valve.

If, at a given frequency, the valve impedance "R" equals the transformer impedance "Z," the expression becomes  $\mu \times \sqrt{\frac{1}{2}}$  or  $\mu \times 0.7$ .

On the other hand, the greater the transformer impedance "Z" the more nearly does the expression become equal to  $\mu \times \sqrt{1}$  or  $\mu \times 1$ .

Thus, the greater the transformer impedance the greater the amplification ratio, and to choose a transformer of lower impedance to match the impedance of the valve merely results in impairing the amplification.

Therefore, to obtain the best results choose a transformer of very high impedance, and, seeing that transformer impedance varies with frequency whilst valve impedance is practically unaffected by frequency, choose a transformer which has high impedance at low frequency, say 100 otherwise, low notes will not be reproduced satisfactorily.



## BRITISH MADE AUDIO FREQUENCY TRANSFORMERS TYPE AF3

HAVE THE FOLLOWING IMPEDANCES

At 100 Periods - - - 50,000 OHMS  
At 500 Periods - - - 410,000 OHMS

**NO BETTER TRANSFORMER  
IS AVAILABLE AT ANY PRICE**

Ask your Dealer for Leaflet W 401



**FERRANTI Ltd., HOLLINWOOD,  
LANCASHIRE.**



**25/-**

**RATIO 3.5 to 1  
FOR USE IN BOTH  
FIRST AND SECOND  
STAGES.**

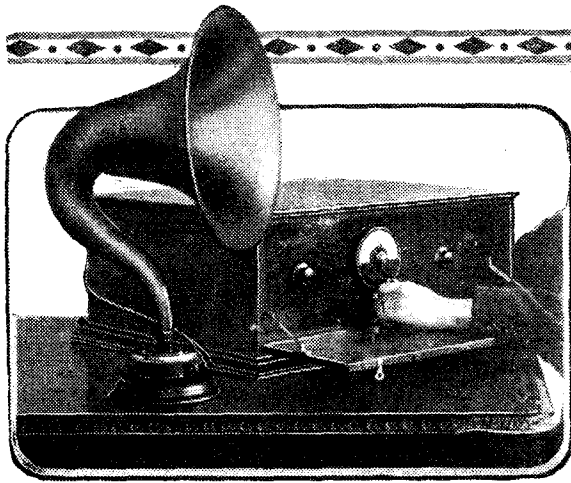

## OPERATING THE ELSTREE "SOLODYNE"

By J.H. REYNER B.Sc.(Hons.) A.M.I.E.E.

### THE SENSATION OF THE SHOW

#### Single-Dial-Operated Long Distance Set makes History at the Radio Exhibition

"The very set I have been waiting for!" Thus exclaimed almost every member of the large crowd who jostled one another to inspect the "Solodyne" at the Olympia Wireless Exhibition. This article tells you how to make those essential adjustments which, once performed, enable you to equal the wonderful results already publicly demonstrated at Elstree. Thousands of readers are already building the set from the constructional details given last month.

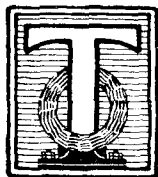

THE instructions for making and wiring up this receiver were given last month, and the receiver is so simple in operation that I have no doubt that many constructors have already obtained good results on their own receivers. There are however, one or two points upon which the actual methods adopted at Elstree will be of interest.

Before passing on to these, however, reference should be made to the fact that the slow-motion dial employed on this receiver was inadvertently omitted from the list of components. As the photographs and diagrams, however, indicated fairly clearly this was one of Messrs. Cleartron's Micro-Selector dials. Those readers who prefer to use the dial supplied with the condenser can of course do so, but I have found that a slow motion dial is of distinct advantage.

We will assume that the receiver has been satisfactorily made up in accordance with the instructions

given last month, and that the usual preliminary tests have indicated that the wiring is correct.

#### Balancing

The first step is now the balancing of the triple condenser. First roughly neutralise the receiver by placing the neutralising condensers about one quarter of the way round, that is to say very nearly at the minimum capacity. Now tune in to the local station, the approximate position of which may be obtained from the test report given last month. The aerial should be connected either to  $A_1$  or  $A_2$  according to the actual size of the aerial. If a large aerial is being employed then the smaller tapping, *i.e.*,  $A_2$  should be employed. If a small aerial is used, then the larger tapping  $A_1$  should be chosen.

#### The Aerial Condenser

Having chosen the aerial tapping required, the set is then tuned in to the local station as just mentioned. Now unscrew the small locking screw in the universal joint between the aerial condenser

(the condenser farthest away from the panel) and the remainder of the triple condenser. When this screw is loosened it will be found possible to rotate the aerial condenser independently of the other two. By this means the aerial circuit may be brought approximately into tune. An accurate balance cannot quite be obtained by this method because tuning on the local station at first will be found a little bit broad. This serves, however, for a preliminary balance, and the screw may then be tightened up again.

#### Neutralising

The receiver should now be neutralised correctly. Leave the receiver tuned to the local station, and remove the fixed resistor for the first high-frequency valve. This is the one on the right hand side of the set at the rear of the baseboard. Signals will still be heard in all probability, and the neutralising condenser should be adjusted until a silent point is obtained. The neutralising condenser may then be locked in position.



**OPERATING THE ELSTREE "SOLODYNE"—(Contd.)**

The fixed resistor is now re-inserted, and the resistor for the second valve is removed. The process of neutralising is then repeated for this valve, the neutralising condenser being fixed once again in the position of zero signal strength.

It is important to remember that the reaction condenser should be set at zero during the neutralising operations.

**Final Adjustments**

After the receiver has been neutralised in this manner the

increase the strength a little by means of the reaction adjustment on the right hand side of the panel. Now undo the locking screw on the coupling between the second and third condensers, that is to say the middle condenser, and the condenser nearest the panel. These condensers control the second and third high-frequency circuits respectively.

Now rotate the last two condensers (that is to say the aerial and the middle condenser) together until the distant station is at its loudest. Having tuned on

same as that previously described, except that the tuning will now be found to be sharper than it was in the first rough adjustment. When the three circuits are all correctly balanced up, it will be found that the increase of the reaction condenser causes a progressive increase in strength up to the oscillation point. If the receiver does oscillate, no radiation will be caused, but of course the quality of reproduction will suffer if the reaction is pushed too far towards the oscillation point.

It is as well to summarise the

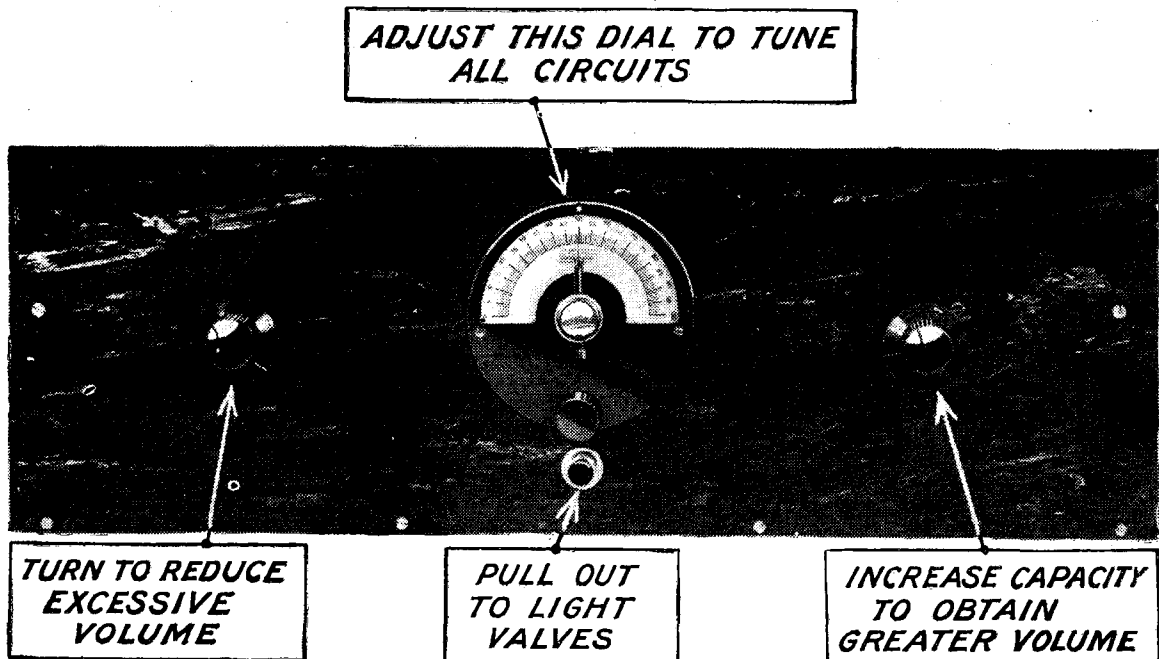

The Elstree "Solodyne"—a Radio Press Star set—has received over fifty stations on the loud-speaker. There is only one dial to adjust.

final balance-up on the triple condenser may be carried out. This should be done on a distant station, and it will be found that even with the crude adjustment already obtained, several distant stations can quite easily be received. Tune in to some distant station approximately in the middle of the dial. For example at Elstree the final balancing up is usually carried out on Bournemouth, a distant station which comes in at or around 46 degrees.

Tune in therefore to a suitable distant station, and if necessary

these two condensers you should then tune-in on the third condenser (nearest the panel), by utilising the dial on the front of the receiver. When this has been completed the second and third circuits will have been adjusted to tune together. It now remains to make a final adjustment of the aerial condenser, which should be done while the set is still tuned to the particular station chosen.

**Reaction**

The method of adjusting the aerial condenser is exactly the

several points in their correct sequence as shown in the table.

It will now be found that it is possible to run from bottom to top of the scale, and the stations will come in one after the other in a most surprising manner. The reaction condenser should be practically all out at the bottom of the scale and be found to require a slight increase as the dial reading increases. Thus very little reaction would be required on Cassel or Hanover while on Birmingham or Zurich an appreciable amount of reaction is desirable. Apart from this, however, no other adjust-

# FIT BENJAMIN COMPONENTS.

### BENJAMIN VALVE HOLDER

complete with Dublier Fixed Condenser (0003) and Dumetohm Grid Leak (2 megohms)—series or parallel.  
Price 7/- each

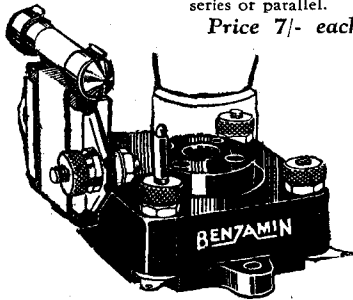

### BENJAMIN VALVE HOLDER

complete with Dumetohm Grid Leak (2 megohms).  
Price 5/3 each

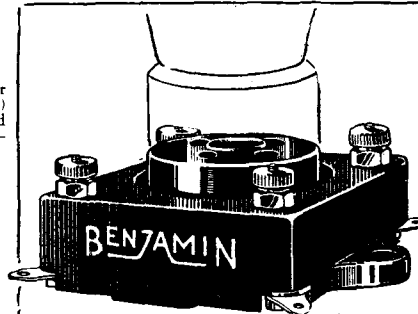
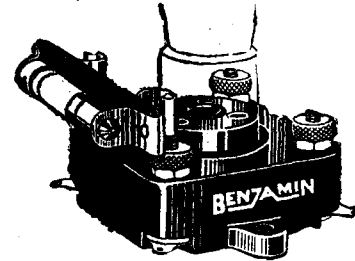

### BENJAMIN Clearer-Tone Anti-Microphonic VALVE HOLDER

Price 2/9 each

#### FIVE EXCLUSIVE FEATURES:—

- (1) Valve sockets and springs are made in one piece, with no joints or rivets to work loose and cause faulty connections.
- (2) Valves are free to float in every direction.
- (3) Valves can be inserted and removed easily and safely.
- (4) Valve legs cannot possibly foul the base-board.
- (5) Both terminals and soldering tags are provided.

Patent Nos. 222986—1923, 250431—1925. Registered Design No. 714847.

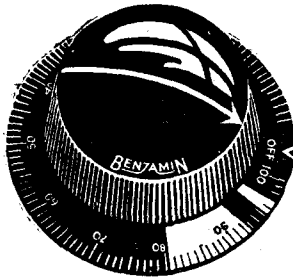

### BENJAMIN Self-Contained RHEOSTAT

The resistance is *inside* the dial. Nothing behind the panel except lock-nut and soldering tags. Panel space saved, wiring and mounting simplified and the appearance of the panel improved.

Made of genuine Bakelite. Three windings as standard—6, 15 and 30 ohms.

Price 2/9 each

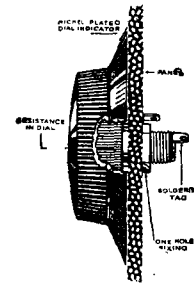

### BENJAMIN BATTERY SWITCH

A sturdy, positive action switch for high or low tension. It's OFF when it's IN, thus preventing the accidental turning

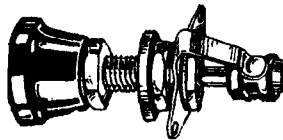

on of current. Single contact, one-hole fixing.

Price 1/3 each

Ask your dealer or write for particulars

## THE BENJAMIN ELECTRIC LIMITED

Brantwood Works, Tottenham, London, N.17

# MAKERS OF THINGS MORE USEFUL

# The World's Greatest Radio Products

The New  
**NEUTRON**  
**CHEMICAL EARTH COMPOUND**  
 (Prov. Pat.)

A highly concentrated preparation, when poured into EARTH increases the area to approximately ONE to TWO CUBIC YARDS. An extremely efficient conductor of Electricity. The earth resistance is reduced to a minimum.

**50% Increased Efficiency in your Earth.**  
 Ask your dealer for descriptive leaflet

**3/6**

The  
**NEUTRON**  
**"MAGNUM"**  
**Permanent Detector**  
**5/6**

**Pantector, Panel Type, 3/6. Crystastat, 4/6**

The best series of Permanent Detectors.  
 Each Detector is tested in actual broadcast 130 miles from Daventry.

### NEUTRON VALVES

<p><b>POWER GREAT VOLUME</b></p> <p>4 volt P.430 (for Loud Speaker).</p> <p>5/6 volt P.525 (for Loud Speaker).</p> <p>5/6 volt P.525A (for Hornless).</p> <p>5/6 volt P.525B (for Resistance).</p> <p><b>15/6</b> each</p> <p><small>Sole Distributors for U.K. and Ireland, NEUTRON DISTRIBUTORS, 144, Theobalds Road, London, W.C.1.</small></p>		<p><b>D. EMITTERS</b>  <b>ECONOMICAL, NON-MICROPHONIC.</b></p> <p>Absolute purity of TONE. Plenty of volume.</p> <p>2 volt. 2 amps. H.F. and L.F. types.</p> <p>4 volt. .06 amps. H.F. and L.F. types.</p> <p><b>12/6</b> each</p> <p><small>All Export enquiries for Continent and Australasia to PETTIGREW &amp; MERRIMAN LTD., 2 &amp; 4, Bucknall Street, Oxford Street, W.1.</small></p>
--	---	---

# The World's Greatest Radio Crystal



# NEUTRON

TRADE MARK

NEUTRON, LTD *Sentinel House, Southampton Row London, W.C.1.*

---



---

**OPERATING THE ELSTREE "SOLODYNE"—(Contd.)**

---



---

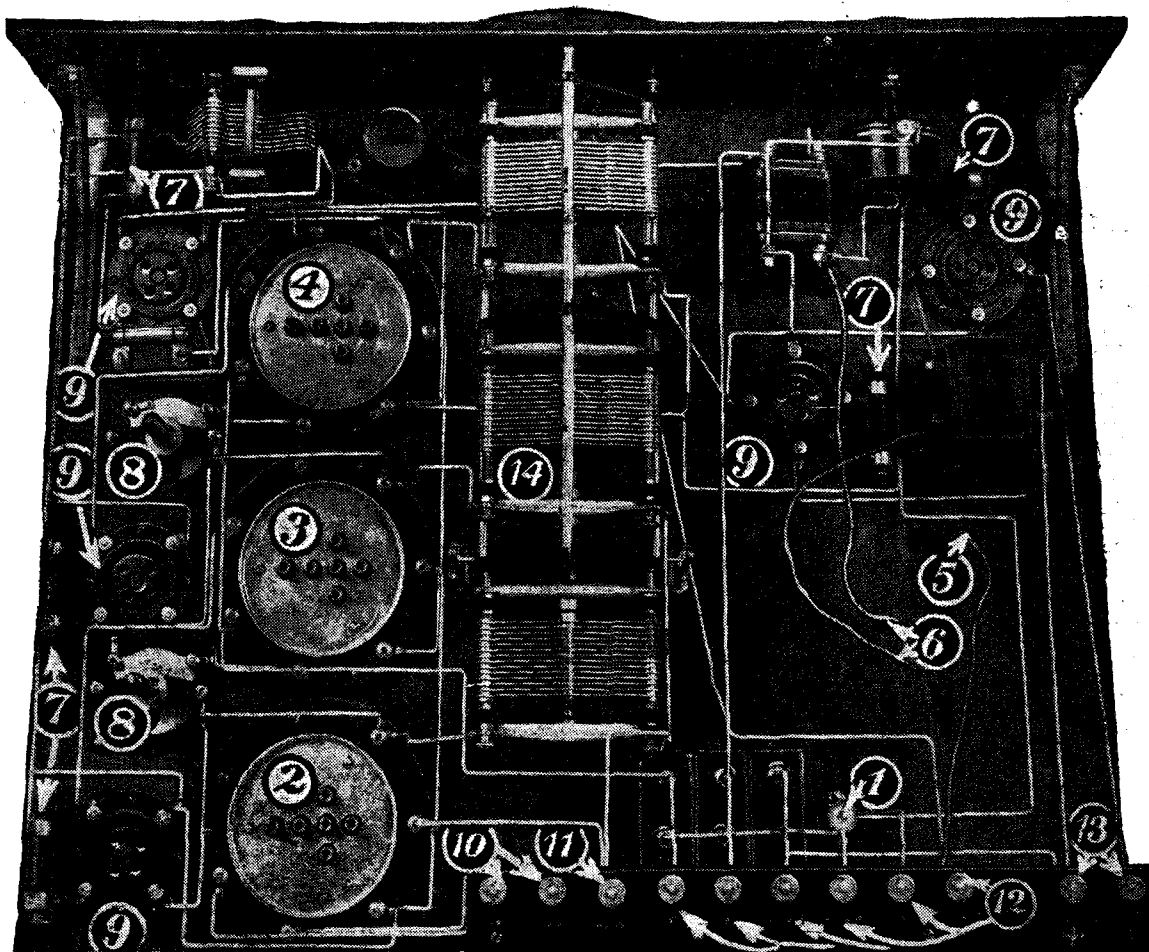

### NOTE THESE POINTS

- 1.—Flash lamp bulb will burn out if H.T. "shorts" across L.T. battery.
- 2.—Insert aerial coil here.
- 3.—Insert standard split-primary coil here.
- 4.—Insert standard split-primary coil with Reinartz winding here.
- 5.—Plug-in to + socket of grid bias battery.
- 6.—Plug-in to grid-battery at voltages to suit valves used. Maker's pamphlet will give suitable values to be employed.
- 7.—The values for the fixed resistors will depend upon the types of valves used and upon the voltage of the L.T. battery. These resistors can be changed in a moment, and are made to suit all valves.
- 8.—Adjust neutralising condensers as instructed in this article.
- 9.—Insert valves of types suggested.
- 10.—Try both aerial taps ( $A_1$  and  $A_2$ ) in order to find out which suits your aerial best.
- 11.—Attach earth lead to this terminal.
- 12.—Take particular care in connecting up the high-tension and low-tension batteries. H.T. + 1 requires the highest voltage, generally about 120 volts. H.T. + 2 goes to the detector, and a value of 30-40 volts is required. H.T. + 3 feeds the two high-frequency valves, and a value of between 60 and 90 volts is suitable.
- 13.—Join the two ends of the loudspeaker flexible lead to these terminals, connecting the positive tag (usually marked red) to the L.S. + terminal shown in the wiring blue print.
- 14.—Follow out the instructions given on page 471 regarding the adjustment of the triple condenser.

**OPERATING THE "SOLODYNE"—(Concluded)**

ment is required except the simple rotation of the main dial.

**Volume Control**

Should any station be over loud, it is quite easy to cut down the strength by use of the volume control on the left hand side of the front panel.

**Valves**

A most important point is that of the valves and voltages to employ. A fairly wide choice is available in this connection. For the high-frequency valves and the detector valve we require a type having a fairly high impedance. I say fairly high deliberately, because there are several types of valve having impedances of the order of 60,000 ohms or more, and this value is too high. A valve having an impedance of the order of 25,000 to 30,000 ohms with an amplification ratio of the order of 15 to 20 is what is required. If lower impedance valves than this are used the selectivity will be impaired, while if higher values are used, the signal strength will fall off. The

be of very low impedance in order to handle large volume, something of the order of 4,000 ohms. If desired an ordinary low-impedance power valve may be employed in the last stage, but the quality will be found not to be quite as good.

**Voltages**

These few remarks will serve to give some indication to intending constructors as to the type of

**H.T. Current**

The question of high-tension battery consumption is of considerable importance, and the choice of voltages is to some extent connected with this problem. By using high impedance valves in the high-frequency stages, apart from the other desirable features which accrue from this proceeding, we obtain a distinctly minimised high-tension consumption. At the same time the voltage applied to the high-frequency valves should be as low as possible consistent with good signal strength. It will be found that up to a point the voltage may be reduced without any considerable loss of signal strength, and the more this can be

done the less will be the consumption of the two valves in question.

**Long Wave Reception**

One of the most interesting features about the receiver is the considerable efficiency on the higher ranges. If it is desired to receive Daventry, Radio-Paris, Konigs-

**LONG WAVE STATIONS RECEIVED ON THE LOUD-SPEAKER**

Dial Setting.	Station.	Wavelength.
11.5 ..	Croydon and French Aircraft ..	900
14 ..	Dutch Aircraft Stations ..	950
22.5 ..	Hilversum .. .. .	1,050
37 ..	Hjerring .. .. .	1,250
40 ..	Königswusterhausen .. ..	1,300
44 ..	Karlsborg .. .. .	1,350
63 ..	Daventry .. .. .	1,600
77 ..	Radio-Paris .. .. .	1,750
97 ..	Amsterdam .. .. .	2,150

valves which may be employed in the various stages. The best results both as regards signal strength and quality of reproduction cannot be expected unless these remarks as to choice of valves are borne in mind when selecting. Any makes, however, may be employed, provided they have impedances of the order specified. **It should be noted that the fixed resistors used**

**ADJUST YOUR "SOLODYNE" AS FOLLOWS :**

- 1.—Choose aerial tap according to size of aerial.
- 2.—Set neutralising condensers about one quarter of the way round.
- 3.—Tune the receiver to the local station.
- 4.—Adjust aerial condenser (that farthest away from panel) until the aerial circuit is approximately in tune.
- 5.—Neutralise first valve.
- 6.—Neutralise second valve.
- 7.—Tune in to a distant station.
- 8.—Balance up second and third circuits by uncoupling connections between the respective condensers. This involves altering the aerial condenser and the second condenser together so that it is finally necessary to
- 9.—Balance the aerial condenser on the distant station.

circuit, in fact, has been designed to suit the particular types of valve specified because extended research has indicated that this is the best characteristic for modern types of high-frequency circuit.

**L.F. Valves**

The first low-frequency valve should be of medium to low impedance, anything from 7,000 to 15,000 ohms, while the last valve should

**depend on the valves employed and it is absolutely essential in ordering these components to state the valves with which they are to be used.**

As far as high-tension voltages are concerned from 60 to 90 volts should be used on the H.F. valves, about 40 volts on the detector valve, and the maximum permissible on the two L.F. valves. Something of the order of 120 volts is satisfactory in this last case.

wusterhausen, etc., it is only necessary to obtain the equivalent aerial coil and split primary H.F. transformers for the Daventry range, and to replace the existing coils with the longer range pattern. No alteration of the neutralising setting is required, and it will be found in the majority of cases that the balancing of the condensers also remains unaffected on these longer waves.





*A Notable & Popular Broadcaster's  
opinion of*

# HART BATTERIES

**'MEET EVERY NEED  
OF EXACTING  
WIRELESS USERS'**

*says*

## J. H. Squire

OF THE CELEBRATED  
J. H. SQUIRE CELESTE OCTET



91, Templars Avenue,  
Golders Green,  
London, N.W.11

Messrs. Hart Accumulator Co. Ltd.,  
Stratford, London. E.15.

Dear Sirs,

There is no doubt, in my opinion, that the "HART" High Tension Batteries and Low Tension Accumulators will meet every need of the most exacting "Wireless enthusiast" - whether for transmission of reception. The absence of noise in operation is only equalled by their strong construction and attractive appearance, whilst the additional guarantee for a full year makes me feel sure that all who try them will agree with me in testifying to their undeniable merits.

Yours very truly,

*J. H. Squire*  
THE J. H. SQUIRE CELESTE OCTET.

June 22nd, 1926.

# HART

**THE BATTERY OF QUALITY**

There are models of "HART" BATTERIES for all wireless circuits. Write to-day to Department M.W.2 for illustrated leaflets and full particulars.

**HART ACCUMULATOR CO.LTD. STRATFORD LONDON E.15**



*The*  
*Best in the World*  
**HELLESEN**  
**DRY BATTERIES**

Switch off your set and you switch on the No. 7 Recuperating Agent in your HELLESEN H.T. Battery.

This is the secret of the remarkable efficiency and long life of the Helleesen Dry Batteries, and to-day when radio is just a matter of switching on and off, the H.T. Battery which possesses this power to the greatest extent is absolutely necessary.

You now have the opportunity of buying at a competitive price dry batteries which have always sold on quality—not on price. With quadruple insulation and sealed cover the GENUINE HELLESEN IS THE GENUINE ARTICLE.

**AT HUNTS' NEW PRICES** you pay no more, but you get the **BEST IN THE WORLD.**

60 volt "WIRIN" 12/6. 99 volt "WIRUP" 21/-  
(Postage extra.)

All types, voltages, etc., in Double and Treble Capacities Dry Batteries for Low Tension Hand and Pocket Lamps.

*From all Radio, Electrical and General Stores, Harrods, Selfridges, Barkers, Whiteleys, etc., or direct from*

**A. H. HUNT LTD. (Dept. 5), Croydon, Surrey.**

Write for leaflet No. 155a.



The New Combination  
**Lotus Grid Leak**  
and Buoyancy  
**Valve Holder**

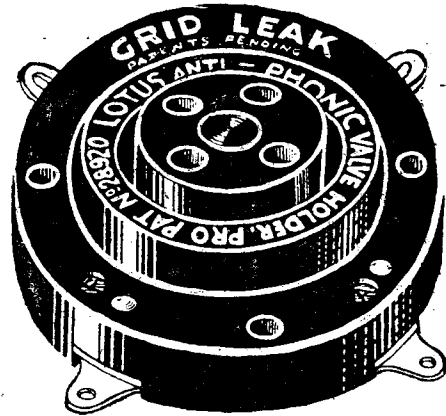

Patent No.: 256833.  
Pro. Pat. No. 20339.

The Grid Leak is not discernible, being totally enclosed in Bakelite-Valve Holder Base.

Yet Another  
**LOTUS triumph**  
in Component design

Like all other Lotus components, the new Combination Grid Leak and Valve Holder is guaranteed efficient in construction and design. It eliminates unnecessary wiring and soldering, and makes for economy in cost and space.

*PRICES:*

Ordinary Terminal Valve Holder 2/6	Combination Grid Leak and Terminal Valve Holder, 3/9. All Anti-Microphonic Type.
Without terminals 2/3	

**LOTUS**  
COMBINATION  
**GRID LEAK**  
and Buoyancy  
**VALVE HOLDER**

From all Radio Dealers.

Garnett, Whiteley & Co., Ltd.,  
Lotus Works,  
Broadgreen Road, Liverpool.

# AN H.T. CHARGING UNIT

## FOR HOME USE



By the Staff of the  
Elstree Laboratories

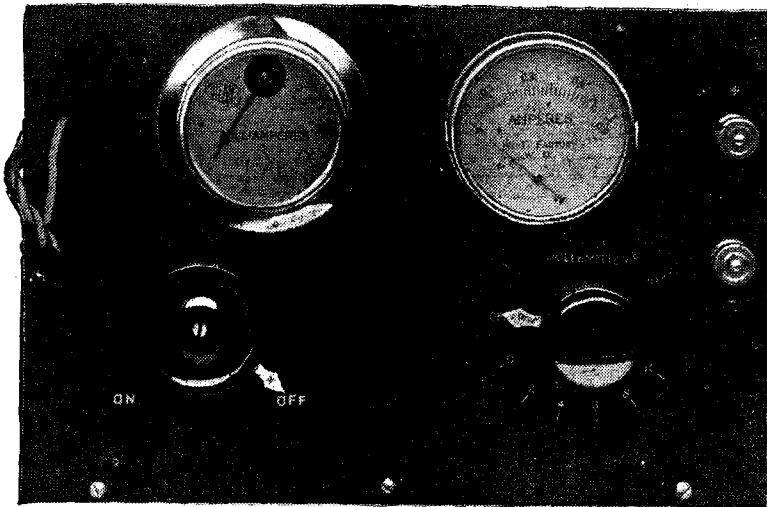

*With the increasing popularity of multi-valve receivers, H.T. accumulators are rapidly finding favour. Many readers have asked us how they may charge batteries of this type from the A.C. mains, and it is to fulfil the needs of such that this neat and efficient little unit has been designed.*

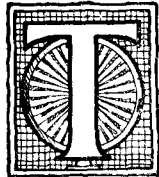

THE high-tension accumulator is rapidly coming into favour owing to the increasing demand for high-tension supply of 20 milliamps or more, which is beyond the capacity of the average dry battery.

The principal difficulty about high-tension accumulators lies in the charging. Where a source of D.C. is available, the problem is comparatively simple, and has already been discussed on various occasions. The problem of A.C. supply is rather more difficult because it is necessary to rectify the current before it can be utilised to charge the accumulators.

### Charging from A.C. Mains

The unit to be described herewith has been designed to enable charging to be carried out with a minimum of trouble from the ordinary A.C. mains. For this purpose special rectifying valves are employed, made up by the Osram Lamp Works.

These valves, which are known as the U.4 type, are similar in general construction to the D.E.5 type of valve, with the exception that the grid is omitted altogether, and one pin on the base is therefore cut off. The filament is of the usual

5 volt  $\frac{1}{4}$  ampere dull emitter type, and the total emission when the filament is being run at its correct current is of the order of 15 to 20 milliamps.

### Saturation

This, of course, is the saturation value, and is obtained when the

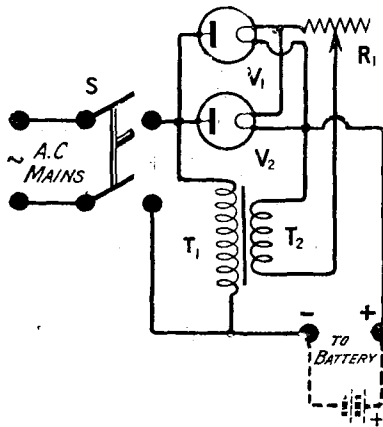

Fig. 1.—The simplified theoretical circuit of the charging unit.

anode voltage is of the order of 60 to 80 volts or more.

This saturation at comparatively low voltage is of considerable assistance in making up a charging

unit of this type, because it renders the device self regulating. The actual circuit adopted is shown in Fig. 1. It will be seen that the A.C. mains are connected direct to the battery to be charged through two of these rectifying valves in parallel. Thus only the positive half of the wave is allowed to pass, so that the current which flows through the battery is uni-directional, and thus charging takes place.

### Single Wave Rectification

Single-wave rectification has been adopted for simplicity. Double-wave rectification requires the use of special centre-tapped transformers, and this tends to introduce extra complications. In the present case, therefore, two valves have been utilised in parallel in order that currents of the order of 30 milliamps may be passed to the battery. If necessary, of course, a single valve only can be employed, in which case the charging current is 15 milliamps instead of 30.

The advantage of the saturation of the valves previously referred to will readily be seen by reference to this circuit. We have a certain alternating voltage applied across the unit from the mains, while in opposition to this we have the voltage of the high-tension battery which has to be charged.

# AN H.T. CHARGING UNIT FOR HOME USE—(Contd.)

## General Principles

Now the alternating voltage is constantly varying in value, rising from zero to a maximum and then falling away to zero again.

When this point is reached the current through the valve saturates, so that however much the voltage increases no further increase in the charging current will result.

The diagram in Fig. 2 indicates

no charging current will flow through the valves and battery until the voltage on the mains has risen above that of the battery. In the figure therefore, when the curve rises above the horizontal line

## COMPONENTS REQUIRED

- One ebonite panel 9 in. by 6 in. by  $\frac{1}{4}$  in. (any good make).
- One baseboard 9 in. by  $6\frac{3}{4}$  in.
- One milliammeter 0 to 150 (Sifam). (See the remarks below).
- One hot wire ammeter 0 to .5 (Leslie Dixon and Co.)
- One dual filament rheostat (Radio Instruments).
- One Utility 2-way dual change-over switch (Wilkins and Wright).
- One filament transformer, stepping down the voltage of the mains to 5 volts. The actual instrument used was obtained from Messrs.

- Burne-Jones and Co., and was equipped with a primary voltage of 200 to 240 and gave three secondary voltages of 3, 5 and 8 respectively. Similar instruments can be obtained from the same source to suit other main voltages.
- Two Lotus vibratory valve holders. (Garnett Whiteley and Co.)
- Two terminals.
- One length of flex with a suitable plug or adapter.
- One or two U.4 valves as required.
- The whole unit may be housed in a cabinet if required.

At the next half-cycle, of course, the voltage rises to a maximum in the opposite direction, but during this cycle no current is passed through the rectifying valve, so that we are not interested in this portion of the operation.

Now as long as the voltage on the mains is below that of the battery to be charged, the anode of the rectifying valve will be negative with respect to the filament, and no current can pass. When the voltage rises above that of the battery, current commences to flow and increases in strength until the voltage on the mains is more than 60 to 80 volts greater than that of the battery.

the state of affairs. The full line indicates the manner in which the voltage on the mains is varying. The horizontal line at a definite

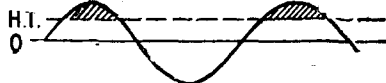

Fig. 2.—The dotted line indicates the voltage of the H.T. battery to be charged.

height above the zero point represents the voltage of the high-tension battery which is to be charged.

### Charging Conditions

As has just been explained,

representing the battery voltage charging current will flow, so that the portion of the cycle during which the valve is operating is illustrated by the shaded portion in the diagram. Consequently, provided this condition is complied with, the battery will be charged, and the charging current will be practically independent of the actual voltage of the high-tension voltage itself because of the saturation effect which has previously been referred to.

In this connection it should be remembered that the maximum voltage with an A.C. supply is nearly 50 per cent. greater than the rated value. With an alternating voltage like this it is necessary to choose some mean value of the voltage, because the actual voltage is varying from moment to moment. In practice the actual mean value is chosen in a slightly complicated manner, but is so chosen that the effect of, say, 100 volts D.C. and 100 volts A.C. upon certain types of apparatus, such as lamps or heaters, etc., shall be the same.

Actually, however, since in the case of alternating current this is only a mean value, the maximum value is somewhat higher, and in practice is between 40 per cent. and 50 per cent. higher. It is therefore possible to obtain satisfactory charging by means of this unit even when the voltage of the high-tension battery is only some 20 or 30 volts below the rated voltage of the A.C. supply mains.

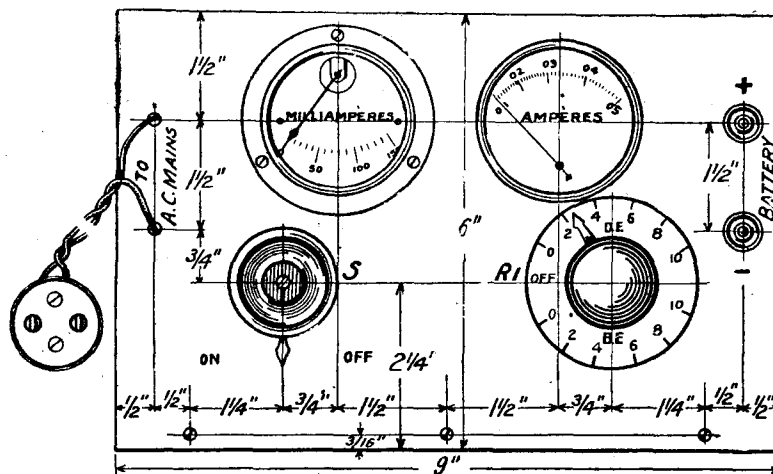



Fig. 3.—The ammeter seen on the right is secured to the panel by means of its two terminal screws.

# For High Efficiency Sets

To obtain that high efficiency of an experimental set, the experimenter must ascertain that each individual component of the set will not have a deteriorating effect on the remaining parts. This efficiency can only be obtained by having guaranteed and tested components of a reputable firm. Bowyer-Lowe fulfil these qualifications, and their guarantee protects you against damage by careless handling after leaving the factory, since every article bought from Bowyer-Lowe, if found faulty within twelve months of purchase, will be replaced free of charge.

**COIL SCREENING BOXES**



These Screening Boxes screw into the base shield and provide a perfect electrostatic screen. Sockets and terminals are to Radio Press standards. Finished in highly polished aluminium and ebonite.

Price, 15/-.

**POPULAR CONDENSER**



Electrically and mechanically sound in design, the Bowyer-Lowe Condenser ensures perfect results.

Price, with dial .0003, 10/-  
Price, with dial .0005, 10/6.

**NEUTRALISING CONDENSERS**



These Condensers have been specially designed and provide a high-class component for use in Radio Press Circuits. The minimum capacity is .000002  $\mu$ F., while the maximum capacity is .000025  $\mu$ F.

Price (Board or Panel Mounting), 7/-.

**JACKS**

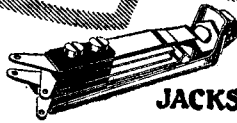

Bowyer-Lowe Jacks mark a great advance in design.

Single Circuit, open ..	2/8
Single Circuit, closed ..	2/7
Double Circuit ..	3/-
Filament, Single Control ..	2/9
Filament, Double Control ..	2/8

**SUPER HETERODYNE TRANSFORMERS**



Thousands of amateurs have built Super Heterodyne Sets, using these transformers, with perfect success.

Set of 4 Transformers, 24 0 0  
Interchangeable Oscillator Couplers, 300-600 metres, 21/-  
Interchangeable Oscillator Couplers, 500-2,000 metres, 21/-  
Base for same, 4/-.

**ANTIPONG VALVE HOLDERS**



The only Valve Holder with such a low capacity combined with the cushioning necessary for preventing interphonetic noises in your valves. Universal fitting. Baseboard mounting. Complete.

Price, 3/- complete.

# BOWYER-LOWE

THE SPEED RADIO APPARATUS

ANNOUNCEMENT BY BOWYER-LOWE CO. LTD., LETCHWORTH, HERTS.

Tell the Advertiser you saw it in "MODERN WIRELESS."

# A SIMPLE H.T. CHARGING UNIT

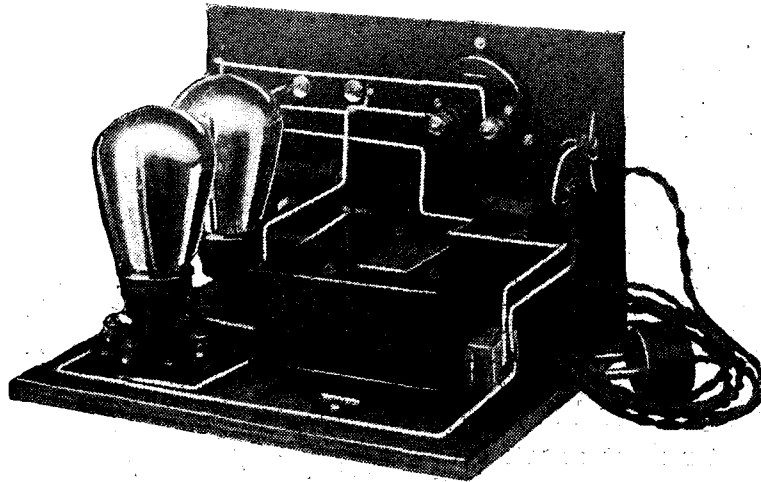

The wall plug on the right may be inserted into the standard house lighting wall socket.

In practice, therefore, it will be found that the unit gives practically a uniform current of 15 milliamps per valve on any high-tension accumulator of which the voltage is 60 volts or more below that of the mains.

### Voltages

For example, working on 240 volt mains an accumulator of 180 volts can be charged satisfactorily. On 200 volt mains, then 140 is about the limit, while if the supply is only 110 then a 60 volt accumulator is all that can be charged. Since the majority of A.C. mains, however, are of the order of 240, the average 120 volt H.T. battery can be charged without any difficulty whatever, and without the necessity for the introduction of any series resistance.

Turning our attention, therefore, to the actual construction of the unit, the components listed will be required.

### Instruments

The milliammeter requires some comment. It may be wondered why 0 to 150 milliammeter has been utilised to read a current of 15 or 30 milliamps only. Actually this has been done because the particular type used is a cheap pattern costing only 10s. It is not possible to make this pattern reading below 150 milliamps in inexpensive form.

Vibratory valve holders have

been used merely to protect the valves from accidental damage, and of course are not essential, since there is no question of microphonic noise in a unit of this type.

### Construction

The actual constructional work is so simple as to require no explanation at all. It will be necessary to cut holes in the panel in order to accommodate the two meters. A large hole will have to be cut on the left hand top corner for the milliammeter, and two smaller holes for the terminals of the hot wire current meter which then becomes a surface mounting instrument. This instrument has

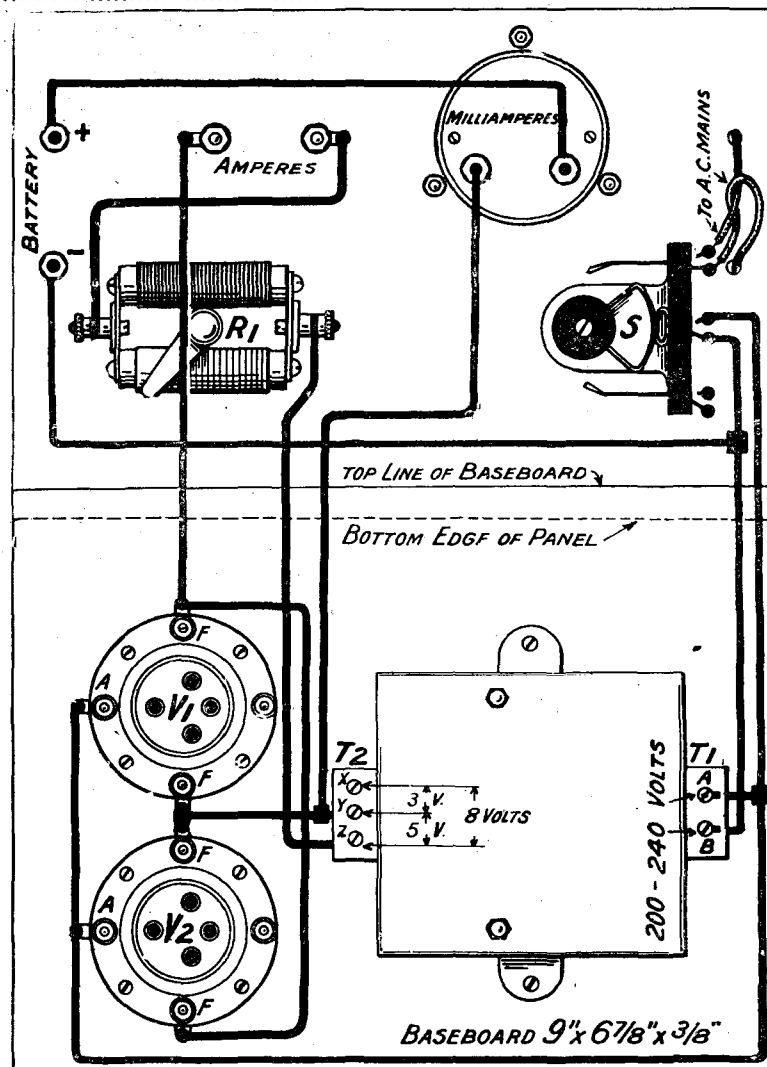

Fig. 4.—The H.T. accumulator to be charged should be joined to the two terminals on the panel marked "battery."



ALL PARTS STOCKED. LEADING DISTRIBUTOR OF—

Ormond Products. SQUARE LAW LOW-LOSS. .0005, 9/8. .0003, 8/6 1/8 each (less no vernier). FRICTION GEARED. .0005, 15/6. .0003, 14/8. .0002, 12/6. TRAJIGHT LINE FREQUENCY FRICTION GEARED. .0005, 20/-. .0003, 19/6. S.L.F. .0005, 12/-. .0002, 11/-. S.Q. LAW LOW LOSS DUAL, .0005, for Extra Sir. 12/11 each. ORMOND FRICTION DIAL, 10/6. FILAMENT REOSTATS DUAL 2/6; 6 ohms or 30 ohms, 2/-. POTENTIOMETER, 400 ohms, 2/6. L.F. SHEROODED. latest model, 17/6.

HEADPHONES

All 4,000 ohms. N. & K. STANDARD PATTERN PHONES, large size ebonite earcups, double leather headbands, Superior Tone, 4,000 ohms. Special Price, 7/11 pair. N. & K. GENUINE. See name in full on outside cases, new light-weights, 11/6. Extra quality, do., 13/6. DR. NESPHER, unapproachable value, adjustable wonderful tone, 7/11. D.G. TELEFUNKEN (20/- model), limited number at 14/11. Adjustable, genuine. "BRUNET," stood the test of years, need no boosting, 11/6. 12/11. 14/6. models. KRISOMBY CONTINENTAL, still as good as ever, exquisite tone, sample pair, 8/1. BRITISH HEADPHONES. BROWN'S FEATHERWEIGHT. 20/-. BROWN'S A TELE. (Red), 30/-. B.T.H. (22/-). STERLING, 20/-. 22/6. WEST-ERN ELECTRIC, 20/-. All makes stocked.

FIXED CONDENSERS.—Dublier. .0001 2, 3, 4, 5, each 2/6. .001 2, 3, 4, 5, 6, each 8/6. Grid Leak, 2/6. Edison Bell, .001, .0001, 2, 3, 4, 5, 1 1/2; .002, 3, 4, 5, 6, 1/6. .0005 grid leak, 2/6. McMichael with clips. .0001 to .0005, 2/6 each. .001 to .006, 3/6 each.

Grand value in NON-MICRO-FRIGIC V. L.V. COL. Eds., Bound Mounting 1/6.

McMICHAEL Dionic Coils, 10/- each. Bases, 2/6. LISSE H.F. or L.F. Choke 10/-. R.I. 10/-. Success, 10/-. Ditto, Super, 18/6. Watnal Audio, 18/6. R.C.C. Polar R.C. Unit, 10/6 and 12/6. AMPLIFER Loop Aerial, 70/-. BROWN'S No. 2 Receiver 10/6. Post extra. Valve Holders, anti-micro, Burned, 2/6. Lottus, 2/6 and 2/8. Magnam, 2/6, 5/-. Benjamin, 2/8.

ACCUMULATORS.—2 v. 40. 7/11. 2 v. 60. 9/6. 2 v. 80. 12/6. 2 v. 100. 15/6. 4 v. 60. 17/11. 4 v. 80. 22/6. 6 v. 60. 26/6. 6 v. 80. 35/6. ALSO another good make, 1/6 extra on each of above. Post 1/6.

OLDHAM'S STOCKED.

VARIABLE CONDENSERS.—Polar Standard, 10/6. Junior, 5/6 each. Bowyer-Lowe Popular, 10/6. Igranite, 24/-. 21/-. Collinson's Low Loss, 21/-. 20/-. Utility, 8/6. 10/6. Vernier, 2/6 extra. Utility Low Loss, stocked .0003 and .0005. J.B. (Jackson Bros.), Square Law, .001, 9/6; .0005, 8/6; .0003, 7/6 with vernier, 4/6 each extra. Geared, .0005, 15/6; .0003, 13/6. Low Loss, 10/6, 9/6.

H.T. BATTERIES. EVEREADY 66. 12/6; 108 v. 21/-. L.T. 3 for D.E. Valves, 7/6. SIEMENS H.T. 60 v. 12/6. Hellesen's 60 v. 14/6. Various 1.5 D.E. Batteries, 1/6 to 2/6. BROWNE.—Grade A, 1/- each while you wait, 3/16 at half-penny per sq. inch. 1 in. at three farthings.

ASHLEY PLUGS AND JACKS. These jacks are made of non-ferrous brass, genuine bakelite, nickel silver, pure silver contacts. Fit panels 1/4 to 3/4 thick, one hole fixing. S.C.O. 1/3. S.C.G. 1/6. D.C. 1/9. F.S.C. 1/9. F.D.C. 2/3. 1/9. Phone Plugs, 1/6. Post Extra.

"ESSANCO" MOUNTED COILS.—Made under Burndett Licence Patent No. 168249. No. 25, 35, 50, each 2/6; 75, 2/6; 100, 3/6; 150, 3/6; 200, 250, 300, each 4/6.

ORDERS BY POST MUST BE ACCOMPANIED BY SUFFICIENT TO PAY POSTAL CHARGES.

IGRANIC'S BIG PRICE REDUCTIONS. IGRANIC TRIPLE-HONEY-COMB INDUCTANCE COILS. 30, 2/9; 40, 2/9; 50, 2/9; 60, 3/1; 75, 3/3; 100, 3/6; 150, 5/9; 200, 4/1; 250, 4/6; 300, 4/9; 400, 5/6; 500, 7/6; 750, 9/6; 1,250, 14/6; 1,800, 16/6. Voltage Ap. P. Converter. 250/500 M.A. Patent S.L.F. .0003, 14/6. .0005, 18/6. Low Loss Dual. .0005, 27/6. Micro Condenser. .0004, 5/6. Dial. 1/- extra. Vernier Balancing Do. 5/6. Indiaragm Vernier Knob and Dial, 7/6. Microvern. 8/6. "E" Type L.F. Transformers latest shrouded model 3/-, 15/6; 5-1, 16/6.

MARCONI PHONE.—Auto Series Par. Variometer, 16/-. Sterling Non Pong V.H.I., 2/8. Velvact Potentiometer, 2/6. Ideal L.F. Transformer, 25/- (2-7-1, 4-1, 5-1, 8-1). Ideal Junior L.F., 18/6. Var. Res. 40,000 ohms, 8/6; H.F. Choke up to 4,000 metres, 10/6; Sterling Baby L.S., 5/6. Sterling Linkie, 20/-. "Miniless" S.L.V., Condenser, .00025, 21/-. .0005, 24/-. .001, 30/6.

WARNING. SEE K. RAYMOND'S NAME ON PREMISES. THIS WILL ASSURE YOU GETTING THE GOODS I ADVERTISE. PLEASE ASK FOR THIS SIGN. K. RAYMOND'S RECOGNISED WEST END DISTRIBUTOR

of the Manufactures of Edison Bell, Jackson's (J.B.) Polar, Igranite, Peerless, Bureka, Magnam, Burnard, Lottus, Dubliner, Marconi, Dorwood, Sterling, Success, B.T.H., McMichael, Lissen, Utility, R.I., Bowyer-Lowe, Forno, Brunet, Ormond, Newey, P. and M., etc., etc.

ORDERS BY POST MUST BE ACCOMPANIED BY SUFFICIENT TO PAY POSTAL CHARGES.

COIL STANDS.—Lottus 2 wire, 7/6. 3-way, 10/6; (extension handles extra). Polar 2-way, 6/6. 3-way, 9/6. Sterling Triple, 21/6. Ray Ray, geared 2-way, 3/11. 3-way, geared, 6/11.

WEST END DEPOT FOR "MAGNUM" (Rune Jones).

IN STOCK ALL NEWEST MAKES OF VALVES. We give you immediate benefit of makers' reductions in price. VALVES.—Cosmos S.P. 18. Led or Green, 14/6. New Blue Spot, 14/6. All Mullard, Ediswan, Ostram, Marconi, Concor stocked. Bright D.E. and Power, 3/6; 14/6, 16/6, 18/6, 19/6, 22/6, 24/6, 26/6, 28/6, Mullard F.M. 4, 22/6, Do. F.M. 3, 18/6. 1 burnt-out valve taken in part exchange for any of above. Offer subject to withdrawal without notice.

WATNOL PRODUCTS. .0005 or .0006 and Grid Leak, 2/6. Fixed Condenser, all caps, 2/6. Variable G.L. 2/6 (3 to 6 meg.). Anode, 50,000 to 100,000, 3/6. Ditto, 10,000 to 75,000, 3/6. Auto L.F. Coupling, 18/6. Post extra.

SUBSIDIES. New 2-way geared coil-stand, 6/6. 4 point condenser, 17/6. 15/6. "R.I." New Type Aerial Tuner, 30/6. Gambrell Neutrovernia, 8/6. Seasmart Commode, 19/6. U.S. Super. L.F., 15/6. Voltmeter, P'lio, rde, 7/8. E.F. Transformers all wave-lengths. Magnam, 7/6. Stradia 6/6. Bowyer-Lowe, 7/6. McMichael, 10/6. (A. 7, 12/6). For Grid Leaks, Burnard, 3/6. Watnal, 2/6. Anodes B., 3/6. W., 3/6.

L.F. TRANSFORMERS.—Ferranti A.F. 3, 25/6; A.F. 4, 17/6; Bureka Concert, 25/6; 2nd Stage 21/6; Baby list or 2nd, 15/6; Reflex, 15/6. Forno shrouded, 10/6. Success (Black), 21/6. Royal, 30/6. Ormond newest model, 15/6. Wates' Supra, 10/6. Croix 5-1, 3-1, 4/6. Marconi "Ideal", all stages, 25/6 each. C.A.V., 15/6. Pyc, 22/6. Gambrell, 2 stages, 25/6. Ideal Junior, 29/6.

IGRANIC FACENT. Potentiometer, 2/6; 0 or 30 ohms Res, 2/6. LISSEOLA LOUD-SPEAKER UNIT, 13/6.



LOW LOSS including knob and dial as sketch

Unsolicited Testimonial. 382, Cranbrook Road, Ilford, Essex. Messrs. Raymond.

I am writing to let you know the wonderful change your new type condenser has made in my one-valve Straight set. On Sunday evening (with 2L0 working) I was successful in receiving Radio Berner, Dublin, Hamburg and Newcastle at excellent phone strength. All these stations had previously passed me by. I can only say that if there is a 100 per cent. increase on the market, yours is IT. Harry L. Prockter.

WONDERFUL LOW-LOSS STRAIGHT LINE FREQUENCY ALL STATIONS CONDENSER No. 4 Supreme SELECTIVITY. Each station has a CLEAR TUNING SPACE. CROWDING ENTIRELY ELIMINATED. SIMPLIFIED TUNING. DISTINCT AND DEFINITE Radio reception. PRECISION workmanship. Solid Brass vanes (a very important factor). Compact position of rotor INSURES MINIMUM panel space. ONE-HOLE FIXING. Rigital connection to rotor gives silent working. Special Spring top Bush gives a firm but easy movement. LOW LOSS SELECTION ENDS. ALL HIGHEST possible QUALITY. Everyone AMAZED at the beauty and finish of these Condensers, and to compete with the OUT-OF-DATE AMERICAN CONDENSERS now on the market, we ask you to try the BRITISH ARTICLE. .0003 . . . . . 6/11 .0005 . . . . . 7/11

WITH VERNIER 1/- EACH EXTRA. POST 6d. SET. ALSO LOW LOSS FRICTION GEARED. 10/6 POST 6d. PER SET.

IMPORTANT! These condensers are planned with central shaft and specially curved vanes, and therefore only take up the same amount of room as the standard type. The wide sweep of the ordinary type S.L.F. needs much more room on panel. Please note Test Report, Feb. 27/26 Am. Wireless.

ELSTREE SIX POST EXTRA

SETS OF PARTS FROM £12.

SOLOQUY PARTS Send for Lists,

QUOTATIONS GIVEN for sets of parts. Please write plainly.

RADIO MICRO. DUTCH. Power 5 v. 8/11. 25 v. 5/11. 25 v. 5/11. Power 3 v. 7/6. Power 1 v. 9/11. (Power are 3-4 volts.) Philips 4 Electrode. 4 in for Unidyne, 8/11.

SETS FOR THE MILLION

Long distance 2-valve L.F. and Detector Receiver in handsome polished cabinet; includes set as shown, 1 power, 1.06 D.E. valve, tuning coils, H.T. 100 volt, L.T. 3, Aerial Equipment, H.T. and L.T. Leads, 2 pairs of 4,000 ohms phone, or LOUD SPEAKER (Marconi Tax Paid), 24 17s. 6d.

Also new circuit specially adapted for use with indoor aerials. Specification as above, 25 10s. Carriage and Packing 5/- set.

BEFORE YOU PURCHASE ELSEWHERE CALL AND LET ME QUOTE YOU I can offer you 20 per cent. discount on many lines (except price maintained). Cheapest House in London. WE HAVE THE GOODS! BE SURE IT'S RAYMOND'S!

OPEN. 9 to 8 Daily 9 to 9 Saturday. 11 to 1 Sunday. Phone: GERRARD 4637. K. RAYMOND 27 & 28a, LISLE STREET, LEICESTER SQUARE, W.C.2. 1 MIN. LEICESTER SQUARE TUBE. OPPOSITE DALY'S GALLERY DOOR.

SPECIAL!! ALL POST EXTRA.

OUR NOTED ONE VALVE and CRYSTAL SET, in solid polished cabinet, complete with valves, phones, H.T. and L.T. Units. Aerial Equipment, Daventry Coil. Extraordinary value, 45/11. Carriage, 2/-. ASTOUNDING 2 Valve Am- plifier, 25/11. Amplifiers in or COMPLETE handsomely with valves, polished box, H.T. and L.T. Units, 44/8. Carriage 1/6.

LOW LOSS SQUARE LAW

This variable Condenser is simply marvelous value. It can be equalled in price or quality.

.0005 .. 4/11 .0003 .. 4/9 Post 6d. set. Vernier 1/- each extra

CHOKES.—Cosmos H.F. 6/6; Lissen H.F. or L.F. 10/- each; A.J.S. 15/6, with unit 20/-. R.I. Multi Ratio, L.F. 27/6. Standard Model, 25/6.

SPECIALS!

LOUD SPEAKERS.—Radio Micro "SAFIR," 22/6, worth 50/-. TELEFUNKEN MODEL, generous size, 19/11. DR. NESPHER DE LUXE, grand tone, 27/6, worth 37/6. CLARITONE, fine value (in great demand) 50/-. Post extra.

"SUPER" ONE VALVE SET. works loud-speaker fine; demonstration free; Set, including Tax, 49/6. Complete with valve, batteries, coils, aerial and phones, 79/6. (Loudspeaker extra). Carriage 5/-. WONDERFUL 3-VALVE SETS.—Reinartz circuit. In handsome American Cabinet; Royalty paid, all complete including Aerial, Coils, Batteries, grand Loudspeaker, Valves .06 1 Power, ready to fix, £7/17/6. Everything of the very best. Carriage 7/6 extra.

ADICO BATTERIES (H.T.). Highest award this Month's Trade Test, 60 volt, 6/11; post 1/6; 100 volt, 12/11; post 1/6. The 100 volt is specially suitable for Loud Speaker work. This brand personally recommended.

PLACE OF PAYMENT 27, Lisle St., W.C.2.

CALLER'S COLUMN.

NOT SENT BY POST. Switch Spade Terminals for H.T. L.T., etc., 1/6 pair. Spade tags, 6 a id. Stud screws, 3 for 1 id. Red or Black, 3d. pair. Ins. staples, 5 a id. Ormond screws and nuts, 2 a id. Switch arms and studs, 1/6. Nickel, 1/4. Wander Plugs, 2d., 3d., 4d. pair. Plug and socket red, 2 a id. 3d. to 1/- pair. Twin Flex, red and black, 12 yds., 1/6. Miniature Silk, 6 yds., 6d. Ins. hooks or egg insulators, 2 for 1 id. Aerial wire, 7/22. 100 yd., 1/11. Extra heavy weight, 2/3. Stranded aerial, 100 ft. (49 strands), 1/3. D.C.C. wire per lb. reel 20 s., 2d. 2 g., 10d., 24 g., 11d., 26 g., 1/4; 25 g., 1/1. Fused copper, 1/16 sq. Bus bar, 12 feet, 6d. (Impure tape, 12 yds., 6d. Earth Tubes, Copper, good value, 1/11. Chaux, 2/3, 5/6. SPECIAL OFFER in Oak, American Type, Hinged lid, 2 feet, 6d. with baseboard for 12 x 7 panel. 8 in. back to front, 9/6. Also 12 x 9, 10/11; 18 x 8, 16/11.

INDOOR AERIALS.

(Total length, 100 ft.)—Wire 49 strands. Length, 12 ft. width 4 1/2 in. Ebonite Insulators, complete with rubber rings, ready to fix up, 4/6. VARIOMETERS FOR B.B.C. (Handsome Model), Ball Rotar, Ebonite. Former wound silk, 3/11. Our famous wound D.C.C. Grand Value, 1/9. Both with knob. SWITCHES.—D.P.D.T. panel 1/-, S.P.D.T. panel, 3d. On switch, 1/1. Tumbler, 1/6. Push and Pull 1/6. CRYSTAL SETS.—Handsome design, for local or Daventry Station. Everything complete, ready to go, 15/11. Complies Set, Coils, Head-phones, Aerial Equipment. BATTERY BOXES 63 v.—Metal, take 14 batteries, 3/6. Fitted Chins, 1/6. Battery Testers, 4d. Bulseye Dials, 3d. 6 FOR 1.3. BROWNIE PANELS 3/6.—For Crystal Sets, 6x6, 1/6; 7x5, 1/2; 8x6, 1/6; 9x6, 1/6. BROWNIE NO. 2.—Latest model, 10/6. Complete with pair of high-class phones, 4,000 ohms, value 8/11. Aerial wire, lead-in, Daventry Coil, the lot, 15/11. SUNDRIES.—Adhesive Tape (black), 4jd. Sets of 8 Drills, 1/3. Set of 5 Spanners, 6d. Set of Tape, 1/11. (O.B.A. 2, 4, 6 B.A.). Screwdrivers, 8d., Soldering-iron, 1d., 2 B.A. Rod, 2jd. Wander Plugs, pr. 2jd. Extra quality pr. 4jd. and 6d. Valve windows, 4d. Basket Holders, 10jd. Extra quality, 1/6. D.P.D.T. on china base, 1/6. S.P.D.T. on china base, 9d. and 1/6. 6-ft. Phone Cords, 1/8. Loud-Speaker Cords 1/9 and 1/11. 4.5 Flash Lamp Batteries, 6d. Line, 6 for 2/6. "A.B." 3 for 1/6. 4 for 1/3. Various per dozen, 3/6, 3/8, 3/11, 4/3.

DETECTORS on base, En- closed Brass, 1/6; 1/3. Do. Nickel, 1/6. 1/3. 1/9. Micrometer 1/9, 1/11. "Key Ray". H.T. BATTERIES.—Crown Polo 60 v. 6/11. Grid Bias v. valve tapped 1/6, 1/3, 1/6. All well-known makes stocked. 2 B.A. L.F. TRANSFORMERS.—Standard Ormond, 13/11. "Key Ray," 5-1, 7/11. Croix, 5-1, 4/6. Wates Super Pattern, 7/11. BRASS PARTS, ETC.—Terminal, nut and washer, W. O. Piler, phone, doz., 1/4. Nickel Ditto, doz., 1/4. Studs complete, 1/2 by 3, doz., 6d.

BARGAIN DEPT. Huge quantities of unwound coils and goods which have been taken in exchange for sale at ridiculous prices. BARGAINS NOT SENT BY POST. ABOVE CALLERS ONLY.

## AN H.T. CHARGING UNIT FOR HOME USE—(Contd.)

been secured in position by these terminals.

The only other components mounted on the panel are the "On-off" switch on the left, and the filament rheostat on the right,

### A Warning

If for example the voltage of the H.T. battery was too high for the A.C. mains with which the unit was being employed, then with the filament at or around its normal

adjusted in order to give the stated current, provided that any variation necessary is within the limits of accuracy of a hot wire ammeter. With the 5 volt tapping it may prove impossible to obtain the required current, in which case the 8 volt tapping should be used.

In operating this receiver a word of warning may be given concerning switching on and off. It is necessary when starting up to switch on the mains before the filament is switched on, that is to say, place the mains switch to "on," and then bring up the current to the required value with the filament rheostat as previously described. Conversely, when cutting out the unit do not switch the set off with the filament still running, but turn the filament rheostat to the "off" position before throwing the mains switch to the "off" position.

It should be observed, that since the mains are connected direct

### WIRING INSTRUCTIONS

- Join battery + terminal to one side of milliammeter.
- Join other side of milliammeter to terminal Y of transformer secondary T2, and thence to one filament contact of V1 and V2.
- Join remaining filament contacts of V1 and V2 to one side of ammeter.
- Join other side of ammeter to one side of R1.
- Join other side of R1 to terminal Z of T2.
- Join battery-terminal to middle near-side contact of S and thence to terminal B of transformer primary T1.
- Join anode contacts of V1 and V2 together, and thence to remaining side of T1, and remaining middle contact of S.
- Join top contacts of S to A.C. mains plug through the two holes in panel (flexible wires).

and the two terminals on the right hand side to which the battery to be charged is connected.

### Testing

Having carefully checked the wiring to ensure that no mistake has been made, connect the high-tension battery to be charged on to the two terminal on the right hand side, taking care that the positive terminal of the battery goes to the correct terminal on the charging unit. Next plug the adapter into the lamp socket or heating plug, whichever is used. Place the filament rheostat in the "off" position, and then place the two-way switch to "on."

Now gradually increase the filament brilliancy until the correct current is registered. The milliammeter should then show a charging current of the order of 15 milliamps.

This value of charging current should not be exceeded, as if any heavier current is taken there is a possibility of the valves being softened and consequently damaged. It may be that the hot wire type of ammeter in use is slightly inaccurate to perhaps .1 or .2 of an ampere, and it is as well to check this instrument against a standard D.C. instrument if possible.

In any case, the milliammeter registering the charging current is the best guide to the correct adjustment of the unit. The filament current of the valve can safely be adjusted until the unit is passing its correct 15 milliamps per valve (i.e., 30 milliamps with the two valves in use), provided that this only requires a small modification of the filament brilliancy.

brilliancy, nothing like 15 milliamps would be passed. In such circumstances it would be possible, by increasing the brilliancy of the filament considerably beyond the

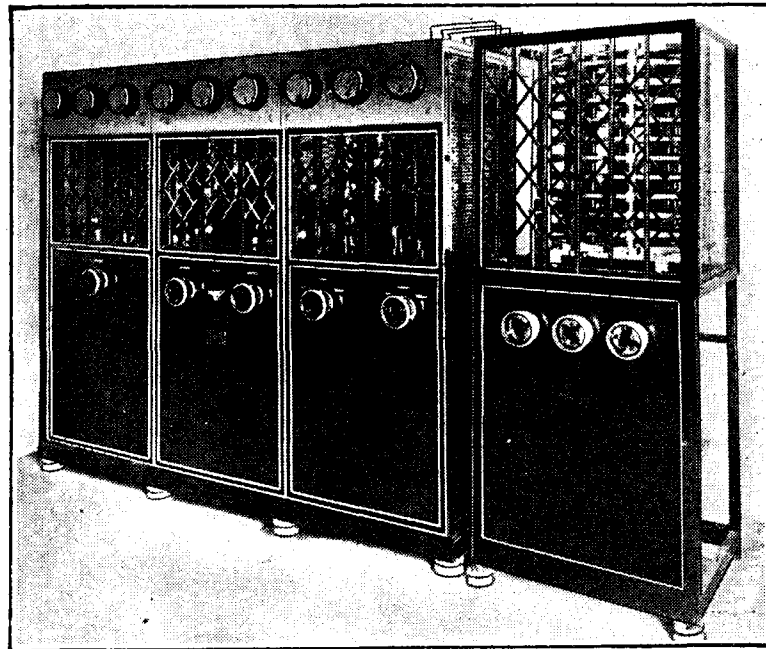

The valve panels at the French "Radio Electrique" station.

normal point, to pass 15 milliamps per valve, or even more, but such an effect would be extremely dangerous and would result in the valve burning out within a very short time.

Under normal conditions, however, the filament brilliancy may be

to the high-tension battery, the latter must be completely isolated when placed on charge. That is to say, it must not be left connected to the receiver or in such a position that one side of the battery is earthed.

# Utility

**G U A R A N T E E D**

## COMPONENTS

The recent National Radio Exhibition fully demonstrated the outstanding supremacy of British design and manufacture in Wireless Components and Instruments—and productions of "Utility" origin there displayed received the highest commendation from Wireless Enthusiasts and Dealers alike for their efficiency, precision and care to detail. Although "Utility" Components have been greatly reduced in price, their high standard of quality and our guarantee to replace or repair defective parts free of charge is maintained.

### "Utility"

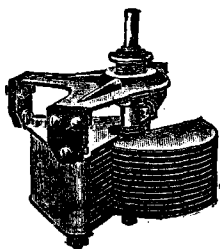

**Low Loss Condensers.**  
This famous "Utility" Component has been improved. All brass parts are nickel plated, pigtail connections from moving plates, terminals and soldering tags are fitted, and the centre spindle rotates on ball bearings. The Vernier pattern is fitted with a Micro-Dial as illustrated below.  
Prices from 13/-.

### "Utility"



**No Capacity Change-over Switch.**  
Made to change over any number of contacts. Design ensures that self-capacity is negligible. Contacts are self-cleaning.  
Prices from:  
Knob Pattern, 2-pole change over, 3/6.  
Lever Pattern, 2-pole Change Over, 4/-.  
"Utility" Push-Pull Type Switch. Price 4/6.

### "Utility"

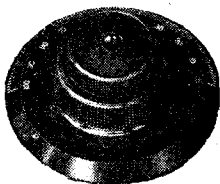

**Micro Dial.**  
A handsome 4 in. Dial in which is incorporated Slow Motion Mechanism for obtaining the finest tuning of the Condenser. The dial itself gives coarse adjustment, the Knob fine adjustment and the gear ratio is 70:1. Movement is unlimited. Backlash is entirely eliminated. It can be fitted to all makes of condensers.  
Price 7/6.

### "Utility"



**Jack and Plug.**  
A Jack designed on the same principles as our well-known "Utility" Switch, and similar to our Push-Pull Switch in size. Has many advantages over the ordinary type of Jack. Perfect rubbing contact and low self capacity.  
Prices: Jack, 4/6. Plug, 2/6.

Your local dealer stocks "Utility," if he is an up-to-date man. Ask him for details.

**WILKINS & WRIGHT LTD**

**KENYON ST.**

**Utility**  
WORKS

**BIRMINGHAM**

# A New Dubilier Product

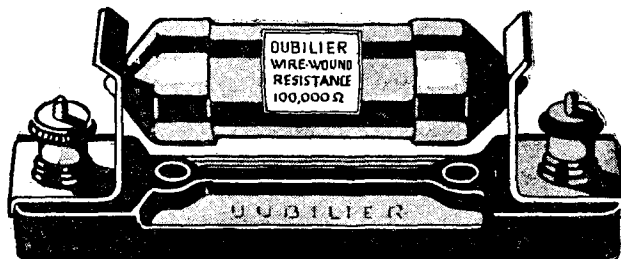

## The Dubilier wire-wound resistance

No new Dubilier Product is placed on the market until it has undergone prolonged tests under working conditions.

In this manner you can always be assured of the perfect reliability of any product bearing the Dubilier name.

The new Dubilier Wire-wound Anode Resistances will be found to be ideal for resistance capacity circuits.

Self-induction and self-capacity effects are virtually non-existent, and the resistance values remain constant throughout all variations of climatic conditions.

20, 30, 40, 50, 60, 70, 80, 90 and  
100 thousand ohms .... 5/- each  
200 thousand ohms .... 8/- each  
HOLDERS (as shown, extra) 1/6 each

**Specify Dubilier.**

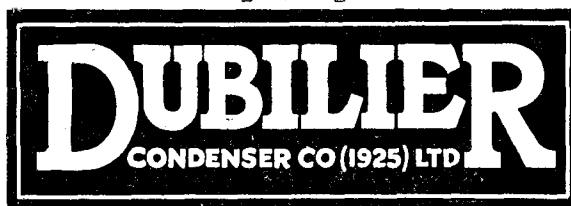

ADVT. OF THE DUBILIER CONDENSER CO. (1925) LTD., DUCON WORKS, VICTORIA ROAD, N. ACTON, LONDON, W.3.  
TELEPHONE: GUSWICK 2241-2-3. E.P.S.212

Tell the Advertiser you saw it in "MODERN WIRELESS."

EXPERTS IN RADIO ACOUSTICS SINCE 1908

## TWO NEW CONE SPEAKERS

THE Ellipticon has been described as "the best loudspeaker on the market" by one who is fully qualified to judge, and who has no personal interest in our success. And we honestly consider that it is one of the best instruments we have ever turned out. The Tablecone, too, can really be said to be superior to similarly priced Cones.

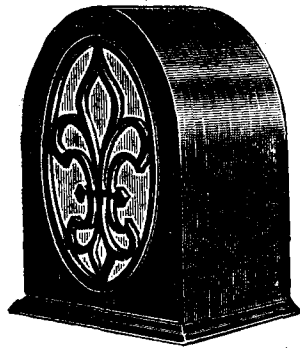

### THE ELLIPTICON

(Registered Trade Mark)

The new Brandes Cone. Undoubtedly the best loudspeaker produced, it brings tone of great depth and sweetness. The cone has a large vibrating area and a driving unit of special design. The magnets in the unit are unusually large. There is no diaphragm but a small arma-

ture which, actuated on the "push-pull" principle, reacts to the faintest impulse. The specially designed cabinet "reflects" the sound in rich and mellowed tones.  
Height .. 13½ ins.  
Depth .. 7½ ins. **£5 10**  
Width .. 10½ ins.

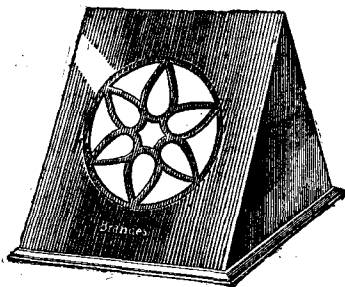

### THE TABLECONE

Attractive cabinet of unique design, finished in dark walnut. The cone unit is fitted with a large magnet and the circular diaphragm has an extremely sensitive driving unit which provides plenty of volume with unblemished tone.

Supplied complete with cord connection. It has a genuine claim to be superior to any similarly priced cone speaker.  
Height .. 10 ins.  
Depth (at base) 11½ ins. **£2 15**  
Breadth .. 9½ ins.

# Brandes

From any reputable Dealer.

BRANDES LIMITED • 296 REGENT ST. • W.1

62

Service Advertising

## PRESS-MEN TEST THE "SOLODYNE"

(Concluded from page 456).

items in every language and snatches of music of every type were picked up on a loudspeaker."

### DAILY TELEGRAPH

"A remarkable wireless receiving set with an all-Europe range controlled by a single dial was demonstrated to a party of Press representatives at a demonstration at Elstree last night. . . . It is a five-valve set, and simply by the manipulation of this one dial I heard at least a dozen Continental stations as well as the main British stations. . . . The problem of simple control has thus been practically solved, and, moreover, the set is so constructed that it can be made up by any amateur from components obtainable on the ordinary market."

### Triple Condensers

Our readers will be interested to learn that the following well-known manufacturers are producing a triple "gang" condenser for use in the Elstree "Solodyne" receiver.

- Igranic Electric Co., Ltd.
- Ormond Engineering Co., Ltd.
- Jackson Bros.
- Collinson Precision Screw Co., Ltd.
- Wilkins and Wright, Ltd.
- Sidney S. Bird and Sons.

In Messrs. Burne-Jones' advertisement of the Elstree "Solodyne" components in last month's issue, the price of B.T.H. Transformers was given as 25/-. This should have read 17/6 each.

*It will be of interest to our friends to know that the Ormond Gauged Triple Condenser for the Elstree Solydyne is now in active preparation and will shortly be available.*

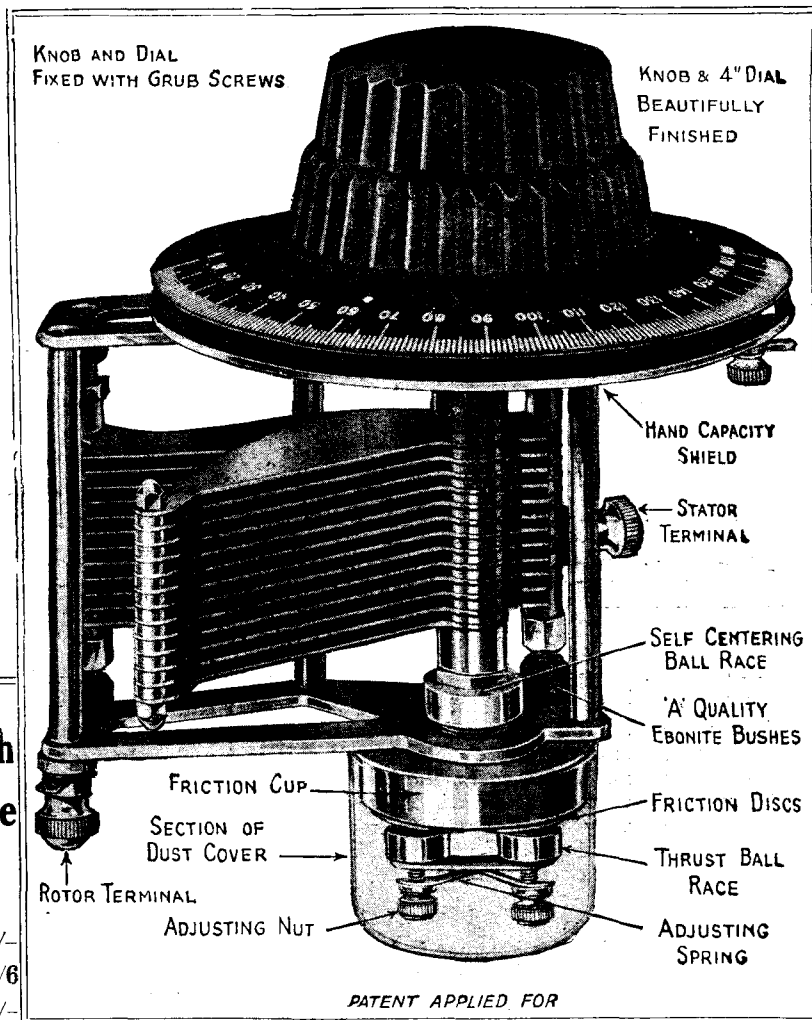

# The Ormond S.L.F. Condenser

**Prices : With 4in. Bakelite Knob :—**

.0005 microfarad	20/-
.00035 "	19/6
.00025 "	19/-

**Prices : With Dual Indicator Dial :—**

.0005 microfarad	21/6
.00035 "	21/-
.00025 "	20/6

RATIO 55-1

## S.L.F. Condensers are now essential !

This new "Geneva Plan" only hastens your final choice of a condenser. Thousands of listeners daily, even under the wavelength system, had been changing over to ORMOND CONDENSERS, owing to their remarkable precision and extraordinarily low price. And now that station selection is to be determined by frequency separation, and everyone should use S.L.F. condensers, the value to your set of this latest ORMOND S.L.F. Condenser is greater than ever. The marking of the Ormond dial enables listeners to

pick up any station with the minimum of trouble and without any unnecessary calculations. Moreover, the general sound construction of the ORMOND S.L.F. facilitates precise tuning adjustments and noiseless operation. The famous ORMOND SLOW MOTION FRICTION DRIVE (55-1) is incorporated and special ball bearings give liquid-like movement to every turn of the knob. This world-famous component is easy to mount, having one and three-hole fixings with both terminals and soldering tags for connections.

**Ask any dealer to show you an Ormond model.**

199-205 PENTONVILLE RD.,      KING'S CROSS LONDON, N.1.

Telephone: Clerkenwell 9344-5-6.      Telegrams: "Ormondengi Kincross"

Factory: Whiskin Street and Hardwick Street, Clerkenwell, E.C.1.

Continental Agents: Messrs. Pettigrew & Merriman, Ltd., "Phonos House" 2 & 4 Bucknall Street, New Oxford Street, W.C.1.

Tell the Advertiser you saw it in "MODERN WIRELESS."

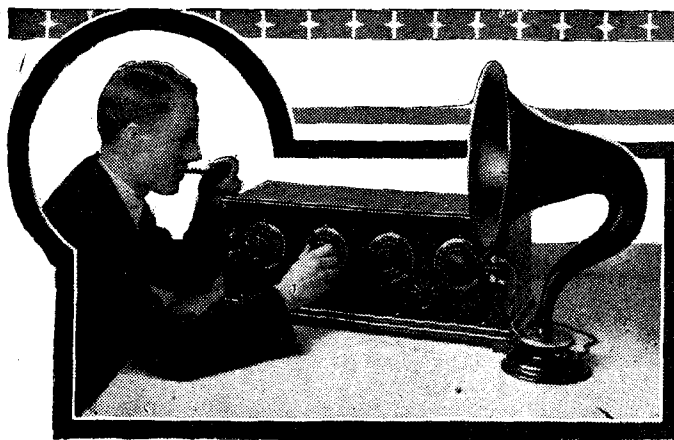

# The MEWFLEX

*Described by*  
J.H. REYNER, B.Sc., A.M.I.E.E.

## FURTHER HINTS ON OPERATING Adjustments for Daventry and the Long-wave Stations



ULL constructional details of this receiver were given last month, and also details as to how to operate the receiver. Some few further notes will possibly be of interest. The receiver is really very simple to handle, and the principal difficulty lies in getting used to the tuning controls.

### Uniform Tuning

There are three tuned circuits, and although the tuning on each one is not too critical, yet they must all be adjusted together in order to obtain the best results. The conditions of affairs is somewhat similar to a combination lock, and until all dials have been set approximately to the right positions no signals will be heard. For this reason the question of searching when the receiver is first constructed is a matter of a little difficulty, and the following method is best adopted.

### How to Tune

Tune in to the local station, and generally make any adjustments which are necessary at this stage. Then move all the dials two or three degrees. Even if no station is heard, the fact that the receiver is in tune will be indicated by a

gentle rushing noise. It may be that further stations will be heard at this point, and in fact this is extremely probable, but if this is not found to be the case continue to move the dials one at a time a very small amount, keeping the rushing noise which indicates that the circuits are in tune.

### Logging the Stations

In this manner it is possible to go right to the end of the scale, and on the way station after station will be found and can definitely be

that nothing but the local station can be heard, when the whole time the receiver is in perfect condition, and only requires to be properly handled. At the same time, provided a little care is taken, there is nothing whatever difficult about the operation, but the process is one which takes a little getting used to, and results cannot be expected immediately.

### A Common Difficulty

Similar difficulties were encountered with the "Elstree Six." Many readers who have constructed this receiver have had difficulty at first in finding distant stations. They have succeeded in tuning-in to the local station, and have tackled the question of distant reception in a haphazard manner without any success at

### LONG-WAVE STATIONS RECEIVED ON THE LOUD-SPEAKER.

Station.	Dial Setting.
Hilversum .. .. .	28
Soro .. .. .	42
Koenigswusterhausen .. .. .	50
Daventry .. .. .	72
Radio-Paris .. .. .	81

tuned in and logged. It is advisable at first to log the actual setting of each condenser until the receiver has been thoroughly mastered. It is then a comparatively simple matter to return to the settings for any given station, and no difficulty will be experienced in selecting any required station.

### Method Required

It cannot be too strongly emphasised that any haphazard method of tuning is quite unsatisfactory and will give very disappointing results. Complaints are often made

all. The result is that they hastily misjudge the receiver and go about broadcasting their dissatisfaction. I have personally encountered many such readers who were surprised when I suggested that at least a week was required to get used to the tuning of a modern high-frequency receiver.

### Take your Time

My counsel, therefore, is: Do not be in too much of a hurry. Tune-in to the local station, and then very gradually work your way up and down the scale as the case may be,



**S.P. 18 RED.**

A real two volt power valve. Designed specially for low frequency amplification. Should always be used in last stage for operating loud speaker. It is also suitable as a detector.

Fil. Volts: 1'6.  
Amps.: '3.

PRICE 14/-

**S.P. 18 GREEN.**

A high amplification valve having a moderate impedance. Designed as a high frequency amplifier and as a detector. Also suitable for resistance, choke and transformer coupling (except last stage, where an S.P. 18 Red should always be used.)

Fil. Volts: 1'6.  
Amps.: '3.

PRICE 14/-

**S.18 BLUE.**

Extra high amplification valve. Designed for resistance capacity, choke and early stages of transformer coupling. Excellent as a detector or tuned anode H.F. amplifier.

Fil. Volts: 1'6.  
Amps.: '09.

PRICE 14/-

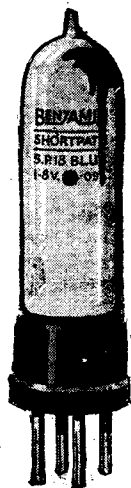

## Smith asked for the circuit

SMITH, curious to know if Brown's 3-valve set equalled his own 3-valve neutrodyne, paid him a visit. A surprise awaited him. Not only did Brown's set bring in many more stations than his; it also reproduced everything clearer and louder.

Smith asked what freak circuit was being used. He had another surprise. It was an absolutely straightforward H.F. and L.F. Circuit. Puzzled, he asked what made Brown's reception so perfect. He was told in four words—

# BENJAMIN SHORTPATH RADIO VALVES

Greater amplification, greater output, less distortion, exceptionally good rectification, and extremely low filament consumption are among the more important features of BENJAMIN VALVES. Better results can be obtained from any receiving set if they are fitted.

Ask your dealer about them—or send to us for leaflet giving full particulars.

THE BENJAMIN ELECTRIC LTD.,  
Brantwood Works, Tottenham, N. 17.

**D.E. 55.**

A very economical general purpose valve. For high frequency, detector and low frequency (except last stage when the S.P. 55 Red should always be used.)

Fil. Volts: 5'5.  
Amps.: '09.

PRICE 18/6

**S.P. 55 BLUE.**

Extra high amplification valve. Designed for resistance capacity, choke and early stage transformer coupling. Also excellent as a rectifier or high frequency amplifier.

Fil. Volts: 5'5.  
Amps.: '09.

PRICE 18/6

**S.P. 55 RED**

Super power valve specially designed as a last stage power amplifier. Will give great power without distortion. Also suitable for detector or H.F. amplifier.

Fil. Volts: 5'5.  
Amps.: '25.

PRICE 22/6



**FURTHER HINTS ON THE "MEWFLEX"—(Continued)**

and keep in tune with the rushing noise which will be heard to indicate that the receiver is correctly adjusted. In this manner several distant stations can be picked up straight away. Log their positions definitely, so that you can return to those points.

Then, having obtained a setting for a dozen stations all over the dial, you can proceed to look for other stations in between those you have already found, and by this means you will gradually find all the stations which were put in the original test report, if not more.

**Neutralising**

The neutralising on this receiver is not difficult. The first valve can

well-defined point in the middle of the neutralising condenser setting at which signals die almost if not completely away. This is the neutralising setting, and the condenser may then be left in that position and the fixed resistor replaced. The valve must of course be left in its socket during this operation.

**The Second Condenser**

The setting of the second neutrodyne condenser is a little more difficult, owing to the fact that the balance method cannot be adopted on the second valve, which is the reflex valve. Consequently if this valve is turned out the low-frequency currents are also cut off. If the neutralising condenser, however, is set at approximately the

will cause the circuit to burst into oscillation. This can very often be checked by reducing the reaction condenser, and it does not follow that the first neutralising condenser is incorrectly adjusted. If you obtain this phenomenon, therefore, do not immediately rush to your neutralising condenser and alter, as you may obtain a worse condition of affairs than before. Try, first of all, the effect of reducing the reaction condenser on the last valve, that is to say, the fourth dial on the receiver, and this will usually be found to maintain the receiver stable.

**A Peculiar Effect**

If the first neutralising condenser has been adjusted in accordance with the instructions given, it may

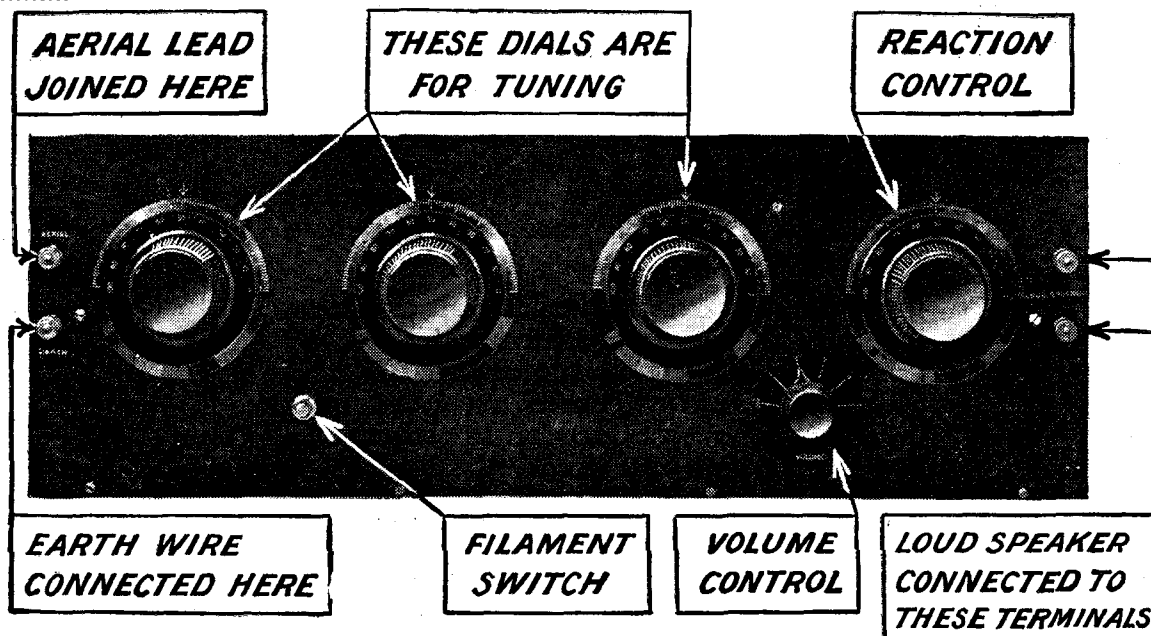

The front of panel of the "Mewflex," a highly efficient Radio Press Star Set described last month. A reflex circuit is employed, and the receiver is completely stable over a very wide band of wavelengths

definitely be neutralised by the usual balancing method. For the benefit of those readers who are not familiar with this method, it is best carried out as follows. Tune-in the receiver to the local station, and then remove the fixed resistor controlling the first valve. Set the neutralising condenser either at the minimum or maximum point, and then retune on the first two circuits to the local station.

Now adjust the neutralising condenser until the signals vanish. It will be found that there is a fairly

same position as the first one, then it will be somewhere near the correct adjustment, and should the receiver burst into oscillation in the meantime during the tuning-in, this condenser may be slightly adjusted.

**Reaction Control**

It should be observed, however, that the Reinartz reaction on the last valve will cause the whole of the circuit to become lively. It may be found that when tuning-in a movement of the first condenser

be taken as correctly set, and should not be altered under normal conditions.

It should not be thought that because the first dial causes the set to oscillate the first circuit is necessarily oscillating. This is not necessarily the case, because it is found that with a neutralised circuit a reaction adjustment on the last valve will liven up the whole of the receiver. If, on the other hand, it is found that with the reaction condenser all out the cir-

*(Continued on page 515.)*

# THE Newey "4 Point" Condenser

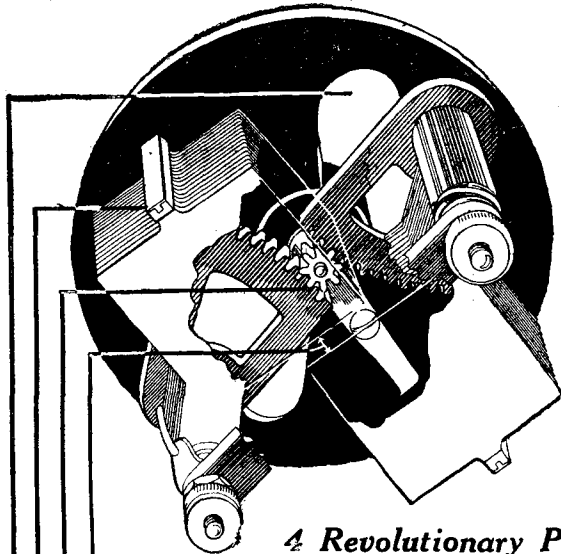

### 4 Revolutionary Points

- ① **NO HAND CAPACITY.** The Bakelite plate on which the Condenser is mounted is specially designed to minimise self-capacity, eliminate dielectric losses, and isolate the vanes from the control knob.
- ② **ZERO LOSS.** All plates are bonded into a slotted equaliser bar to ensure true zero loss conditions. No rubbing contact is employed.
- ③ **360° CONTROL.** No Vernier is necessary, since the condenser drive is calibrated over a range of 360°.
- ④ **NEGLIGIBLE ZERO CAPACITY:—** The capacity at zero reading as certified by the National Physical Laboratory gives only .000003 mfd.

The Condenser operates on the square law principle, is beautifully finished and made by all-British Labour in all-British Factories from the finest material available.

Price complete with knob and dial.  
 .0005 mfd. .. 17/6 .. .0003 mfd. .. 15/-

### THE NEWEY VERNIER COIL HOLDER

A perfectly constructed coil holder, designed for Back of Panel One-Hole fixing, and in addition provided with lugs for fixing in any position on panel. Bakelite moulding throughout. Worm geared by means of metal segment and worm, and fitted with patent stop plate to prevent overwinding in extreme positions—gearing ratio 8—1 giving fine critical tuning and permitting the use of the heaviest coil. PRICE 7/6

Ask your nearest dealer for the Newey Catalogue of Radio Components. If you have any difficulty, write direct. Sole distributors:

**PETTIGREW & MERRIMAN (1925) Ltd.,** Phonos House, 2 & 4, Bucknall Street, New Oxford Street, London, W.C.1  
 Telephone: Gerrard 4248-49. Telegrams: Merrigrew, Westcent, London

# Increased Electronic emission.

length of filament about twice that in the usual type.

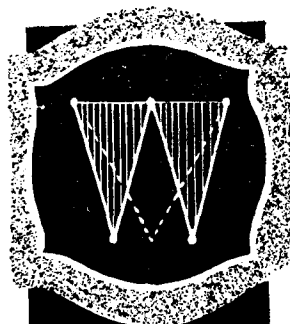

Comparative Diagram  
SIX-SIXTY



Duo-triangular filament suspension



**S**EEING is believing. It is obvious from the construction of the Six-Sixty Duo-Triangular system of suspension that the length of filament employed is almost twice that in the usual type of design, represented by broken lines. Now this increased length of filament must result in a corresponding increase in electronic emission, and if in turn all this valuable electron stream is utilised, then greater efficiency must ensue.

In the early days of the radio valve, the length of filament in the old type of cylindrical construction may have been relatively great, but a very large proportion of the electron stream was lost. The design of the new Six-Sixty Point One Valves is such that the entire filament is wholly enclosed within the grid and anode, and therefore all the electron stream is utilised.

And, remember, the special Six-Sixty filament itself is wonderfully economical. Its current consumption is barely .1 amp., and when operating at the rated voltage there is absolutely no sign of "glow."

The new Six-Sixty Point One Valves—embodying all the advantages of Duo-Triangular Filament Suspension—are suitable for operation in all stages of a receiver, whether the L.T. supply be 2, 4 or 6 volts.

Descriptive leaflet S.S.9-26 with particulars of complete range free on application.

After exacting and exhaustive tests, Messrs. A. J. Stevens (1914) Ltd. have decided to standardise 'SIX-SIXTY' Valves in their famous "Symphony" Range of Receivers.

- S.S.2A, H.F. & L.F.
- D.E. 1.8 volts, .1 amp., H.F., L.F., and Detector .. 14/-
- S.S.10.
- D.E. 2 volts, .15 amp., Power Amplifier .. 18/6
- S.S.7.
- D.E. 3.7 volts, .1 amp. Power Amplifier .. 18/6
- S.S.8.
- D.E. 3.4 volts, .1 amp., General Purpose .. 14/-

These Prices do not apply in the Irish Free State.

## SIX-SIXTY VALVES Better by Six times Sixty

The Electron Co. Ltd., Triumph House, 189, Regent St., London, W.1. 2A

Tell the Advertiser you saw it in "MODERN WIRELESS."

# A THREE-VALVE TRAP RECEIVER

(Concluded from page 467).

## Testing Out

For preliminary tests the aerial may be connected to terminal No. 3 or 4 on the screened coil. First insert the valves in their respective holders with the correct filament resistances inserted in the clips. Then connect the L.T. battery and place the plug in jack No. 1. The first two valves should light up, and when the plug is transferred to jack No. 2 all three valves should light. When the plug is withdrawn all valves should be out.

With the valves alight apply a small value of H.T. voltage to both H.T. terminals, and if all is well the correct working values may be used. No difficulty will be found in receiving the local station and the correct value of grid bias may then be found.

## Aerial Connection

Now transfer the aerial lead to one of the taps on a Lissen X coil or a similar inductance which is plugged into the coil holder and connect the flexible lead from the neutralising condenser to terminal 3 or 1 on the screened coil. Place

the neutralising condenser about half way in. It will now be found that the tuning is ever so much sharper and the local station will only come in over a narrow range on the dials, and it is probable that a little reaction will be required to bring it up to strength. A little practice in the handling of the set is preferably obtained out of broadcasting hours.

For this purpose increase reaction till the set is oscillating gently; it will then be found that when the aerial coupling circuit  $L_1, C_1$  is brought into tune with the grid circuit the set will stop oscillating. Reaction is again increased a trifle and a readjustment of the aerial tuning condenser will again result in the set stopping oscillating. If this stopping of the oscillation is accompanied by a rather loud click it is probable that the coupling is too tight between the two circuits and the value of the coupling condenser should be decreased.

It will now be found that as the two condensers are rotated together the set can be kept in a stable condition. As soon however

as one of the circuits gets out of tune with the other the set will oscillate. Since the circuits are out of tune it is probable that little if any energy is radiated, nevertheless care should be taken during broadcasting hours lest interference be caused.

By keeping the two circuits in tune however it will be found that other stations will come in at various settings on the dials and with a suitable degree of coupling they will be received with only a little diminution in signal strength notwithstanding the extra tuned circuit and the loose coupling between the two.

## Coils

The best size coil for  $L_1$  was found to be a Lissen No. 60 for all round work, and this also had the advantage of giving nearly the same dial readings as the screened coil, though, on such wavelengths as it was found possible to use a 75, an increase in signal strength was observed as well as rather better selectivity when this coil was employed.

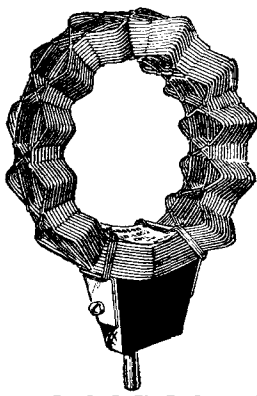

## LO-LOSS COILS

Strongly constructed. Special thumb grip moulded into the Bakelite mounting enables coils to be plugged-in or removed without fear of damaging windings. High inductance and low self capacity. Maximum air spacing.

Coil No.	Price
25	1/3
35	1/6
50	1/9
75	2/-
100	2/6
150	2/9
175	3/3
200	3/6
250	3/9
300	4/-



## WIRELESS COMPONENTS

have a splendid reputation for all-round quality and efficiency, and can be obtained from all dealers.

### MICRO VERNIER DIAL

This dial can be used with all types of variable condensers and it gives perfect control. Coarse and fine tuning.

Ratio 80 to 1. Price 6/6.

### FILAMENT RESISTANCES

(on Bakelite moulding.)

Well designed and constructed. Of nice appearance and smooth in action.

Prices :-

7 ohms	...	2/3
15 or 30 ohms	...	2/6
Dual 6 and 30 ohms	...	3/3

### FIXED CONDENSERS

Accurate and efficient. Finest materials only used in their construction.

·001, ·0001, ·0002, ·0003, ·0004, ·0005, ·0006	each	1/-
·002, ·003, ·004, ·005, ·006	...	1/9

### VALVE HOLDER

This "Puratone" valve holder is anti-microphonic. Cuts out all vibration interferences. An ideal holder for perfect reception.

Price 2/-

### COIL PLUG

Made of Bakelite. Coils can be either sewn or bound, as special holes and grooves are provided. Superior in finish. Nickel parts.

Price 10d.

**FINSTON MANUFACTURING CO., LTD.,**  
45, Horseferry Road, WESTMINSTER, LONDON, S.W.1.



## SUPER COILS

Totally enclosed in moulded Bakelite cases giving great mechanical strength, without impairing their efficiency.

All connections are soldered.

A loose plug is provided for reversing windings of coils.

Nos. 25, 35, 40	2/6 each
" 50, 60	3/- "
" 75, 100, 150	3/6 "
" 175, 200	4/- "
" 250, 300	4/6 "

# There are three kinds of Variable Condensers

—here are the results you'll get from each

## No. 1 Ordinary Condenser

(Straight line capacity)

The ordinary Variable Condenser as used in the vast majority of Wireless sets jumbles together no less than 51 wavelengths (of 10 kilocycles separation) in the first 15 degrees of dial setting; while the remaining 85 degrees of the dial cover only 49 wavelengths. This might have been good enough in the early days when any sort of reception was gratefully received. But science has moved since then and there is no longer any need for your set to remain an obsolete jumble of conflicting and jamming stations.

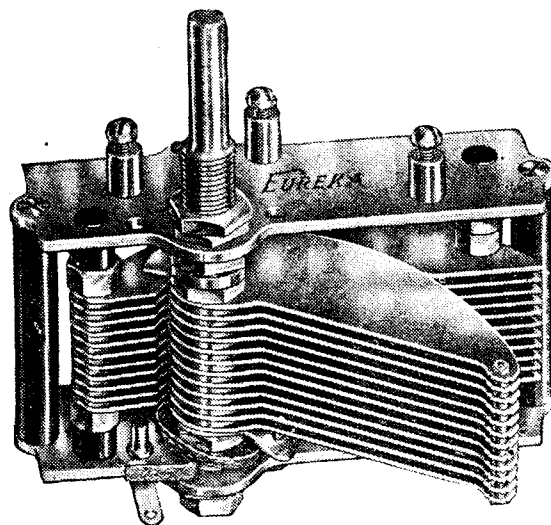

## No. 2 Square Law Condenser

(Straight line Wave-length)

The square law condenser made a serious—if not very successful—attempt to overcome this aerial traffic tangle. But even this type of condenser bundles together into the first 15 degrees no less than 30 wave lengths (nearly 2½ stations to every degree of dial setting) and thus falls far short of solving the tuning riddle with which every ambitious Set user is confronted. As a proof of this it should not be forgotten that square law condensers have been available on the market for more than a year—yet selection has been just as difficult to obtain.

## —and the Eureka Ortho-cyclic

**N**OW comes the new principle of tuning by which, with the Eureka Ortho-cyclic Condenser, a definite separation of wavelengths evenly and exactly over the whole scale is accomplished. By this new principle of design each movement of one degree of dial setting (with 100° dial)

gives a definite separation of ten kilocycles over the whole scale.

Thus, instead of 51 conflicting wavelengths in the first 15 degrees, you get exactly 15 wave lengths in 15 degrees. And so on, right through the scale, the same exactitude of station separation is maintained

In this way scrambling and crowding of stations is entirely eliminated; tuning is made easier, more regular and more certain. Vernier plates are rendered obsolete and the danger of stations heterodyning each other at the cost of purity in your reception is materially reduced.

## Which kind does your Set deserve?

**I**F you possess a Set capable of receiving distant stations, that Set deserves Eureka Ortho-cyclics. The true pleasures of distant reception are only possible where the Ortho-cyclic principle of tuning is employed. Take out your obsolete Condensers and replace them with these beautifully made Eureka Ortho-cyclics.

Owing to their compactness they require

only a panel depth of 2 inches—they can be fitted in a few minutes by either one-hole fixing or four-point mounting, whichever method you prefer. Ball-bearing—superbly finished—they represent a standard of efficiency far in advance of present-day levels. Ask your Dealer to show you one—you'll be proud to see such an outstanding example of British workmanship.

### Prices:

- 0003 mfd 14/6
- 0005 mfd 15/5

# EUREKA

## ORTHO-CYCLIC

Equip your Set also with Eureka Transformers and Coils.

Manufactured only by Portable Utilities Co. Ltd. (Eureka Radio Products) 8 Fisher Street, W.C.1

Tell the Advertiser you saw it in "MODERN WIRELESS."

# AN "EASY TO MAKE" SINGLE-VALVE SET

By JOHN PUGH-PRICE

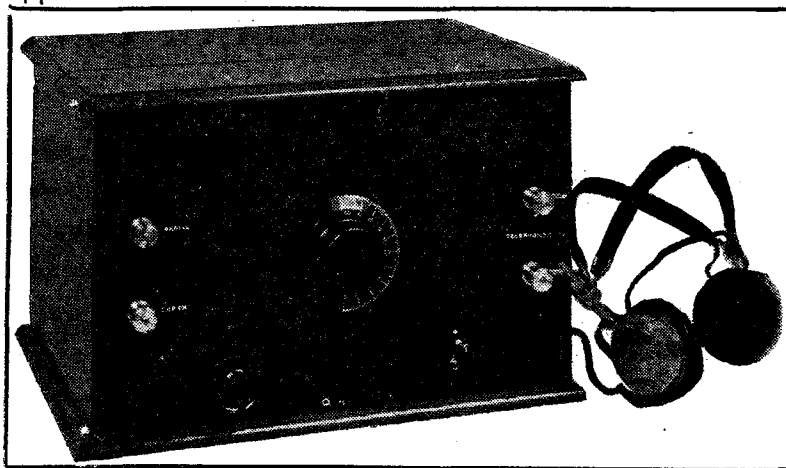

*A simple and efficient little set, specially suitable for the beginner in valve reception. It is easy to construct and to operate, and will receive, in addition to the local station and Daventry, other British and Continental stations in favourable conditions.*



To begin with a crystal set and progress later to a single-valve receiver," is my advice to the beginner who wishes to make wireless reception his hobby. Do not attempt to run before you can walk is a very sound axiom, and any time spent in constructing and handling a single-valve receiver is time well spent, should time and circumstances later allow of a multi-valve receiver being constructed. With a crystal receiver the listener is tied to reception from the local station, and perhaps Daventry, and inevitably there comes a time when it is desired to reach further afield.

### Reaction Control

Ordinary magnetic reaction, obtained by means of a coil in the plate circuit of a valve coupled directly to the grid coil, and employing a swinging arrangement, is now losing its old popularity and the modern tendency is to use some form of Reinartz reaction, obtained by means of a variable condenser. In practice, I have found a modification of this arrangement to give very satisfactory reaction control, adopting a fixed condenser in series with a moving reaction coil, instead

of a fixed reaction coil and a variable condenser, the usual choke, of course, being included in the plate circuit. Inspection of the theoretical circuit diagram will make this clear.  $L_1$  is an untuned aerial coil, tightly coupled to the grid coil  $L_2$  of the detector, which latter is tuned by a straight-line frequency condenser of  $\cdot 0005$  micro-

$\cdot 0003$  will be required for Daventry reception. In the plate circuit of the detector valve, the usual radio-frequency choke required with the Reinartz reaction system is incorporated, and this takes the form of a plug-in coil, allowing various sizes of chokes to be tried in order that the best results may be obtained.

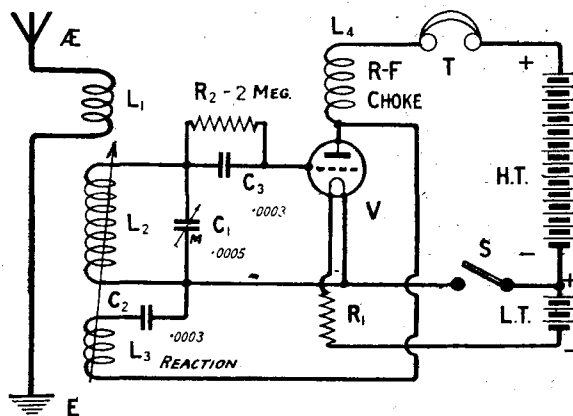

Fig. 1.—The theoretical circuit.  $L_1$  is a plug-in coil of suitable size.

farad. The size of the fixed condenser  $C_2$  will depend upon the characteristics of the valve and the aerial system and to some extent upon the coils employed. One of  $\cdot 0003$  has been found satisfactory in my case, but where the set tends to oscillate too readily the capacity may be decreased to  $\cdot 0002$  or even to  $\cdot 0001$ . Generally

fied being Nottingham, Frankfurt, Aberdeen, Birmingham, Rome, Newcastle, Dublin, Petit-Parisien, Liege, Toulouse and Hamburg. Signals from 2LO were sufficiently strong to work a loud-speaker at fair strength.

Upon changing coils for the Daventry wavelength, this station was obtained at uncomfortable

### Test Report

On test, upon a good high aerial, about twelve miles south-east of 2LO, the set showed up very well indeed, and was extraordinarily easy to handle. Although only a fixed condenser is employed in the modification of the Reinartz reaction system, the characteristics of this latter were preserved to a pronounced extent, one setting of the reaction coil holding for the major part of the range. Using a resistance-coupling valve with 60 volts H.T., sixteen stations were heard at good telephone strength during an hour's search, among those identi-



REDFERN'S  
**Ebonart**  
 NON-METALLIC SURFACE  
 RADIO PANELS

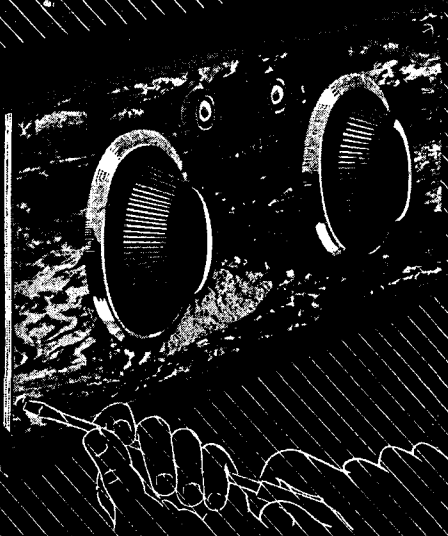

Ebonart has high insulating properties and a leak-free surface. It's highly polished surface, never touched by metal foil, has a sheen like satin, in black or mahogany. Fine S.B. matt is also available.

The homogeneous structure of Ebonart ensures accurate cutting and drilling, with ease of manipulation.

Ebonart, in the 21 standardised panel sizes, is sold in attractive cartons which protect its beautiful surface.

REDFERN'S RUBBER WORKS LTD.  
 Hyde, Cheshire

Send for Folder 262A

# EFESCA

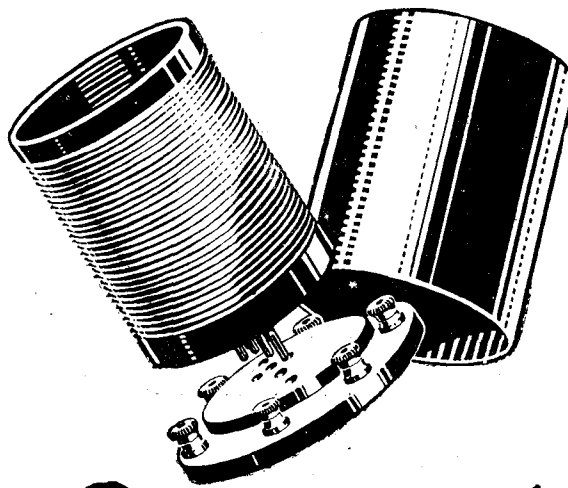

## Screened Coils - FOR NEUTRALISED CIRCUITS

Made to Elstree Laboratories specification and officially approved.

**T**HE Range of Efesca Screened Coil Units includes H.F. Transformers, Anode Coil, Aerial and Reinartz Coils in two sizes to cover Broadcast and Daventry wavelengths for Radio Press screened coil circuits.

Mounted with 6 pin plugs, designed to be interchangeable, enabling varying coils to be used with the same base and screen.

Other Efesca Components for Neutralised Circuits include Neutralising and Balancing Condensers, Double Condensers and Centre-tapped Coils.

H.F. TRANSFORMERS      AERIAL COIL  
 Price 7/6 each              Price 4/6 each

BASE and SCREEN 15/-  
 Ask your Retailer, or write for complete catalogue 573/2  
 WHOLESALE ONLY.

FALK STADELMANN & CO., LTD.,  
 83/93, FARRINGTON ROAD, LONDON, E.C.1  
 And at Glasgow, Manchester, Birmingham,  
 Newcastle and Dublin.

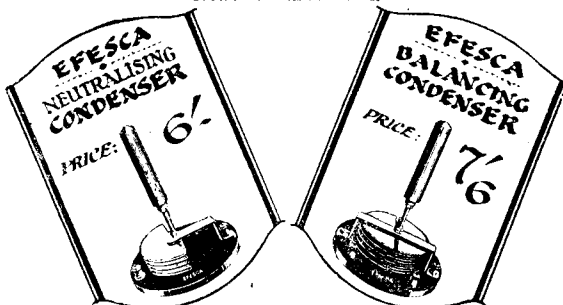

*If you are thinking of buying a finished Set, hear a demonstration of Efescaphone Sets at our Showrooms*

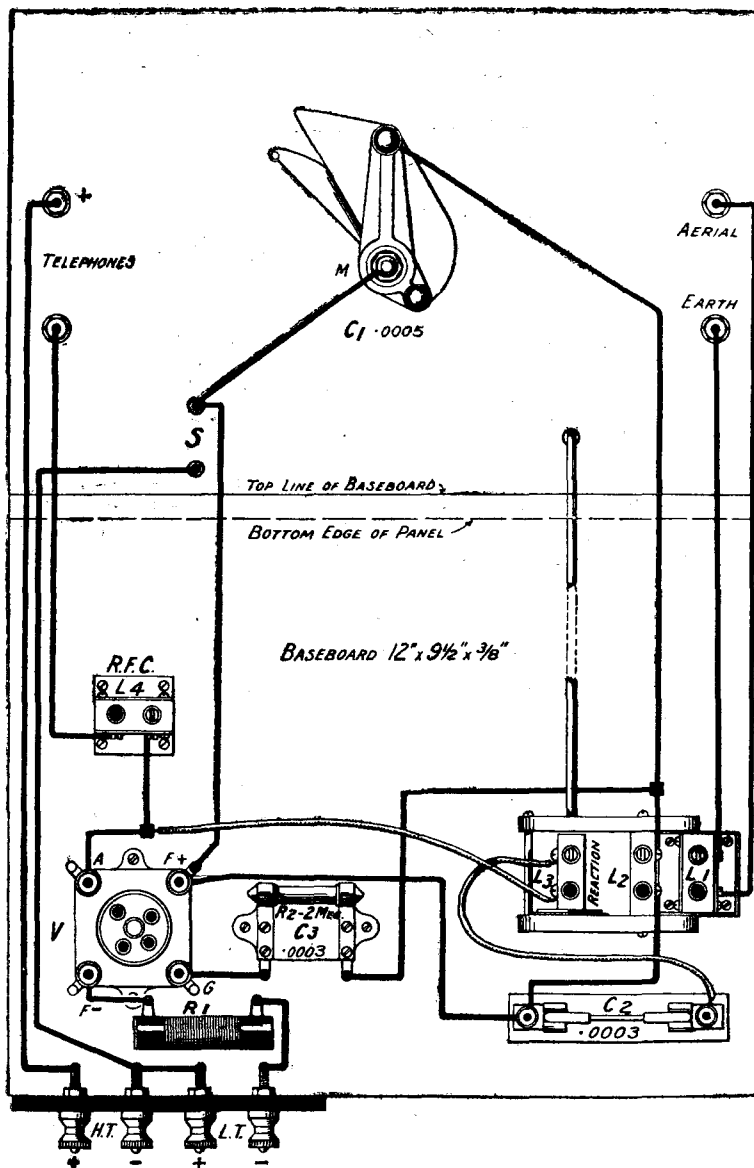

Fig. 2.— $L_3$  should be kept as small as possible consistent with adequate reaction control. Free Blueprint, No. 179b.

telephone strength and Radio-Paris, completely free from any interference from the former station, was heard at good telephone strength.

**Construction and Wiring**

The constructional work is so extremely simple that it may be dismissed with a few words. The variable condenser employed is mounted by one-hole fixing, and the only other holes on the panel are those required for the four terminals, filament "on-and-off" switch and one to allow the 2-coil holder handle to pass through. The panel itself is affixed to the base-

**AN "EASY TO MAKE" SINGLE-VALVE SET (Continued)**

board by means of three wood screws, no brackets being required since the panel is held in position by wooden fillets. The single coil holder, mounted near the fixed block of the two coil holder must be raised to the same height as this latter, which is easily effected by placing a suitable thickness piece of wood underneath the coil block, before this latter is screwed into position.

Excepting in the case of the two leads to the reaction coil, all wiring is carried out with Glazite, but for the two reaction leads flexible wire must be employed.

**Testing**

Having wired the receiver the first step is to carry out a preliminary test to ascertain that all is correct. Connect aerial and earth in the normal manner, and in the  $L_1$  coil socket place a small coil, that is, if you wish to listen to a station on the lower broadcast band. Here a number 25 or a Gambrell "a" proves suitable. For  $L_2$  a number

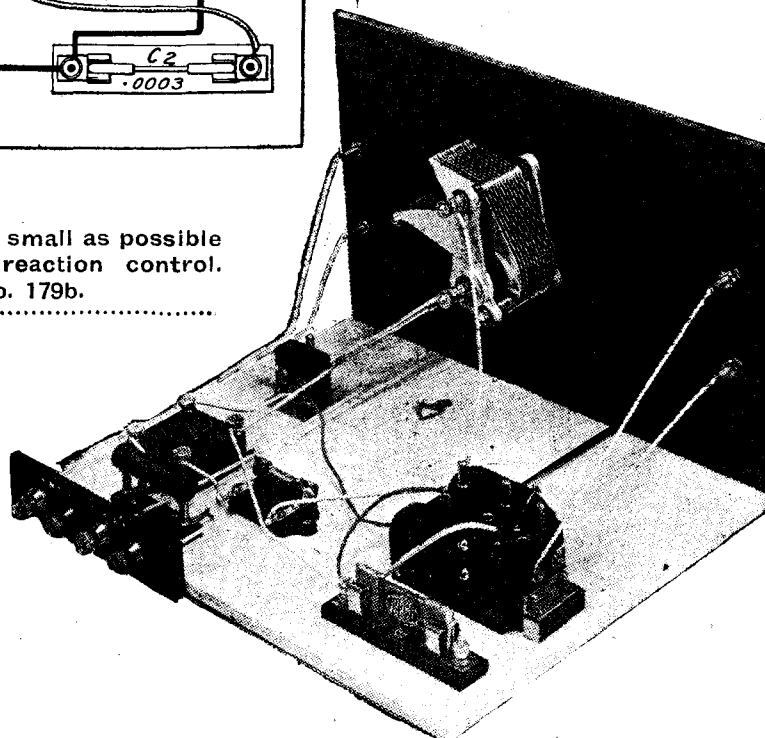

The components are well spaced and the set is extremely simple to construct.

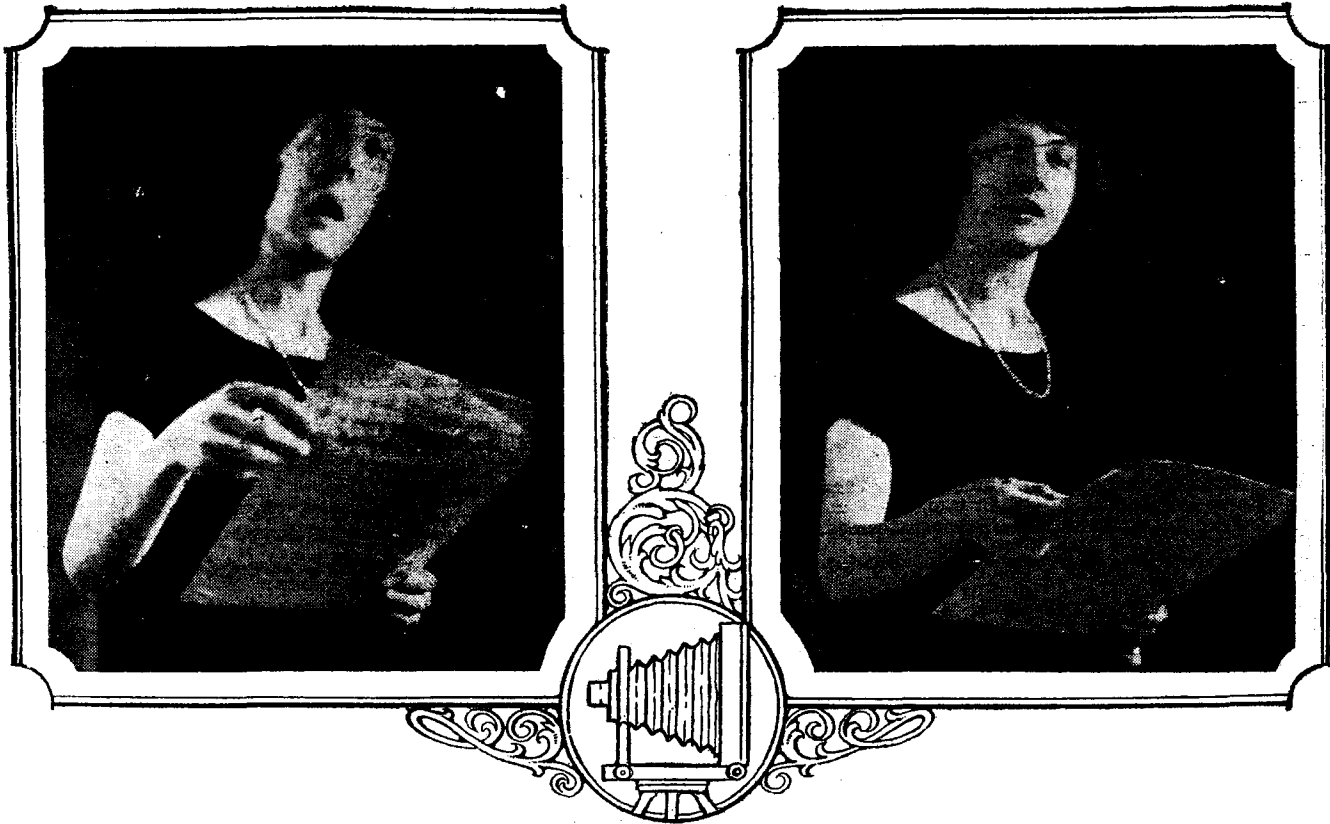

Just as an inferior lens will create distortion so an inefficient Transformer will distort a voice

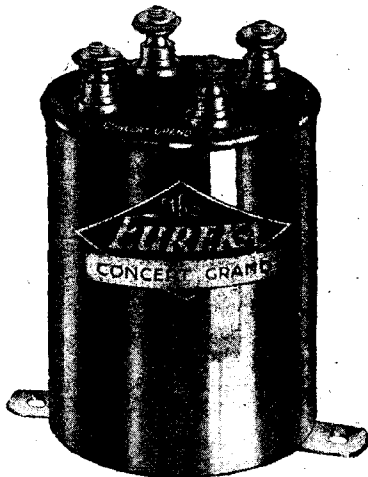

The new Eureka Concert Grand

ALMOST any kind of lens will serve to produce an image on a sensitive photographic plate. But no one expects that a simple uncorrected achromatic lens will give such faithful reproduction as an anastigmat. Exactly the same principles apply in wireless. Practically any L.F. Transformer will amplify and give some kind of results.

But if you want to hear the rippling notes of the soprano you must use a Transformer scientifically corrected against distortion. Every Eureka has been scientifically designed by specialists in the science of sound reproduction to give an even amplification throughout its entire frequency range. It does not amplify some notes at the

expense of others, but is, in fact, fully corrected against distortion.

And now, through an improved method of "stratum-winding," the efficiency of Eureka Transformers has been still further increased. At no extra cost to you there is now available greater volume and sweeter tone, whilst the possibility of breakdown has been eliminated by the use of interspaced insulation between windings.

These new and exclusive features will place the Eureka again ahead of possible competition. For your next Set, therefore, be sure to use a Eureka—"the Transformer which re-creates the living Artiste."

Types and Prices

- Concert Grand . . . 25/-
- Ditto for 2nd stage . . . 21/-
- Baby Grand (1st or 2nd) 15/-
- Eureka Reflex . . . 15/-
- Eureka L.F. Choke Unit 25/-

Re-creates the **EUREKA** Living Artiste

Portable Utilities Co., Ltd.,  
Fisher St., W.C.1.

Gilbert Ad. 581L

AN "EASY TO MAKE" SINGLE-VALVE SET (Concluded)

COMPONENTS REQUIRED

One matted ebonite panel 12 in. by 8 in. by 1/4 in. thick.  
 One mahogany cabinet to take above panel and baseboard, 9 1/2 in. deep.  
 One ebonite terminal strip, 5 in. long by 1 1/4 in. by 1/4 in. thick. (The cabinet and panel used are those catalogued as for the New S.T. 100.) (Peto-Scott Co., Ltd.)  
 One .0005 S.L.F. variable condenser. (K. Raymond.)  
 One Lotus two-coil holder for baseboard mounting. (Garnett, Whiteley and Co., Ltd.)  
 One Frost toggle on-and-off switch. (The Rothermel Radio Corporation of Gt. Britain, Ltd.)  
 Four 2 B.A. terminals. (Burne-Jones and Co., Ltd.)

One Clearer-tone valve socket. (Benjamin Electric, Ltd.)  
 One .0003 clip-in condenser and base. (L. McMichael Ltd.)  
 One .0003 type 600 fixed condenser and 2 megohm grid leak. (Dubilier Condenser Co. (1925), Ltd.)  
 One fixed resistor and base. The particular resistance will have to be chosen to suit the valve used. (Burne-Jones and Co., Ltd.)  
 Two single coil mounts. (Burne-Jones and Co., Ltd.)  
 Four 4 B.A. terminals.  
 Quantity of Glazite wire and rubber covered flex.  
 Radio Press panel transfers.

50, Gambrell "B" or its equivalent should be used, whilst for the reaction coil L3 a coil should be chosen by experiment. Here I have

of 250 size or bigger will be necessary. Here for both the lower broadcast range and for Daventry I employ a Gambrell "I" coil.

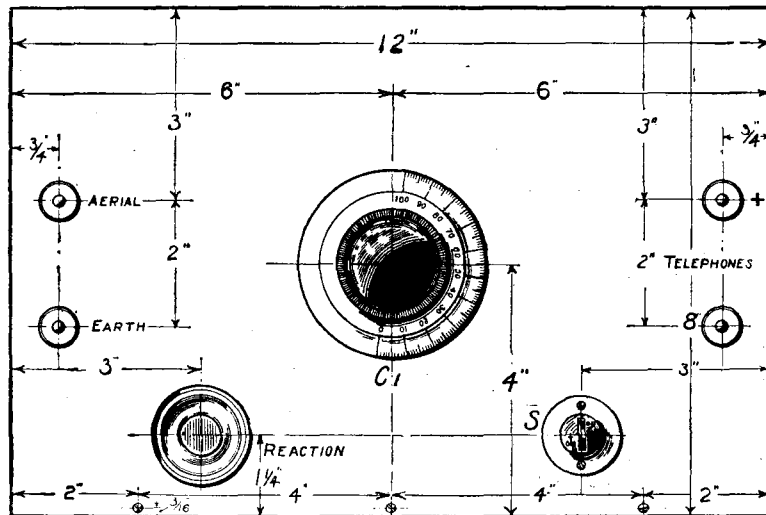

Fig. 3.—A free full-sized Blueprint, No. 179a, of this drilling diagram may be obtained on application.

utilised a Gambrell "A," but in numbered makes a 35 or 50 should prove suitable. For the radio-frequency choke RFC a large coil

Having connected telephones in circuit place the valve in position and connect up the L.T. battery only. If when the filament switch

is placed in the "on" position the valve lights in the normal way connect a lead from the negative terminal of the high tension battery to the H.T. negative terminal of the set and take a lead from the H.T. positive terminal and tap into a very low voltage of the H.T. battery, for example, 4 1/2 volts, noting whether the brilliancy of the valve is increased. If it is not, increase high-tension and you may proceed to tune in the usual way. Place L2 and L3 as far apart as possible and rotate the grid tuning condenser C1 until the local station is heard. Now bring L3 towards L2, re-tuning slightly upon C1 when signals should increase in strength.

Daventry

If testing upon 5XX L1 should be a number 75 or 100 or a Gambrell "D," L2 a number 250 or Gambrell "F," and L3 should be of the order of a number 200 coil or a Gambrell "D" or "E1." The choke should be a number 300 or 400 coil.

Almost any type of general purpose valve will work well in a set of this type, but I personally prefer a high impedance type. With most valves suitable H.T. voltages are of the order of 50 and 70.

WIRING INSTRUCTIONS

Join H.T.— to L.T.+, L.T.+ to one side of S.  
 Join pin of holder for L4 to A of V. Also join pin of holder for L4 to socket of holder for L3 with a flex lead.  
 Join L.T.— to one side of R1, other side of R1 to F— of V.  
 Join moving plates of C1 to remaining side of S, same side of S to F+ of V, F+ of V to one side of C2, same side of C2 to socket of holder for L2.  
 Join one side of C3 and R2 to G of V.

Join other side of C3 and R2 to pin of holder for L2, pin of holder for L2 to fixed plates of C1.  
 Join remaining side of C2 to pin of holder for L3 with a flex lead.  
 Join earth to pin of holder for L1.  
 Join aerial to socket of holder for L1.  
 Join telephone+ terminal to H.T.+.  
 Join other telephone terminal to socket of holder for L4.

**ASK YOUR DEALER**

for the  
new



**S.L.F.**

The New J.B., S.L.F. Condenser is made on lines similar to our Low Loss Type (Pat. No. 241805). In addition, its many excellent new features include Special Bearings Top and Bottom which eliminate springs. Side and End play in the centre spindle is impossible. The Top Bearing is of large diameter and friction-lined, which ensures an absolutely smooth movement. The brass vanes are supported at tips to ensure accurate spacing. End plates are highly polished and all fittings are heavily nickel-plated.

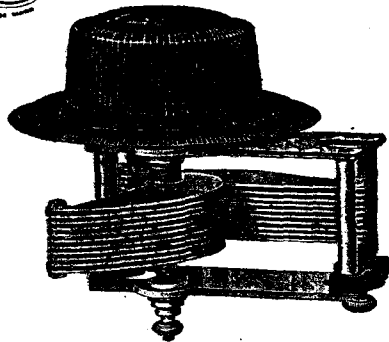

Fitted with 1/4" shaft, sold complete with 4" Dial and is more compact than most S.L.F. Condensers.

Condensers.	Retail Prices:
.0005 mfd	11/6
.00035 mfd	10/6
.00025 mfd	10/-

The J.B. Gang Control Triple Condenser for the Elstree Solodyne .. 47/6

**JACKSON BROS**  
B. POLAND ST - OXFORD ST  
LONDON - W.1.  
(First Floor)  
Telephone: - GEFARAD 7414

Agents for Holland: Radio Beurs, Papenstraat 8, Sg. v.enhage, Hague, Holland

**H.T. BATTERIES That You Can Depend Upon.**

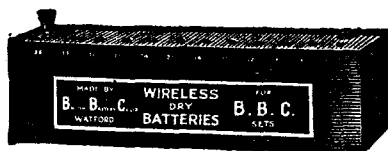

- No. 4w. 36 Volts. 6/6
- No. 5w. 60 Volts. 11/-
- No. 6w. 9 Grid Bias 2/-
- No. 10w. 4 1/2 " " 1/-

No. 4w. and 5w. 3 volt tappings.  
No. 6w. and 10w. 1 1/2 volt tappings.

PRICES INCLUDE WANDER PLUG CARRIAGE PAID.

**No. 1w. 4 1/2 Volts. Standard Pocket Lamp Size;** with patent spiral wire terminals and plug sockets to take Wander Plugs. Used Units replaced easily.

To connect in series types 1w. and 8w., insert straight Terminal in Spiral of next battery. Bend spiral and thus ensure permanent electrical connection without soldering. Note:—1 doz. = 54 volts. PRICE 7/- PER DOZ. with Plug, car. paid.

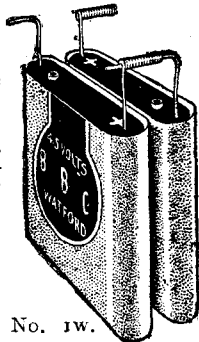

No. 1w.

**No. 8w 4 1/2 volts Super. Capacity.**

Extra Large size Unit with Patent Spiral Wire Terminal and Plug Socket to take Wander Plug. Capacity four times that of No. 1w.

Size 3 1/2 x 1 1/8 x 3 inches.  
PRICE 18/- PER DOZ.  
CARRIAGE PAID.

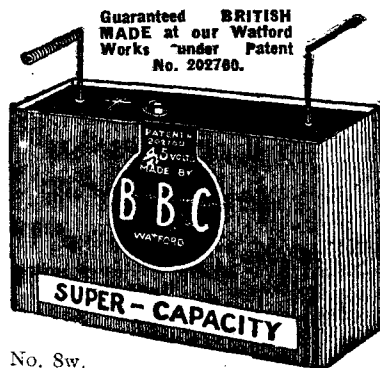

No. 8w.

Guaranteed BRITISH MADE at our Watford Works under Patent No. 202700.

To be obtained from your local dealer or direct from the

**BRITISH BATTERY CO., LTD.,** WATFORD, HERTS.

PHONE: WATFORD 617  
CLARENDON RD., WATFORD, HERTS.

Paris Ad.

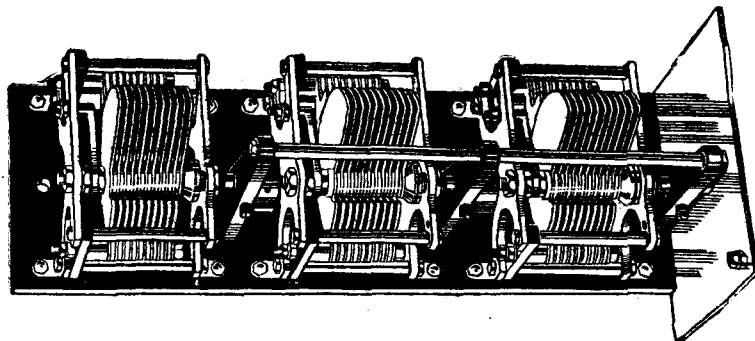

CONSTRUCTORS are giving this handsome new model a most enthusiastic welcome because of (1) Its absolute freedom from whip. (2) Independent adjustment of each Condenser by novel means, completely eliminating hand capacity.

OTHER attractive features are—each Condenser electrically separated. Anti-capacity plate supplied. Operation of all three condensers as "silky" as if only one was used. Whole instrument perfectly rigid. Supplied ready for immediate fitting. Construction and finish are well up to the fine Cyldon standard.

Send for particulars of the Cyldon WAVEMETER—it identifies unknown stations and makes searching and testing out simplicity itself.

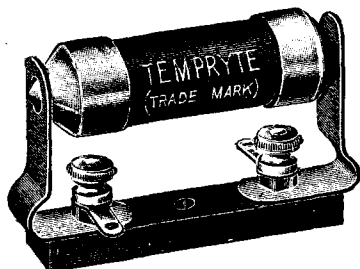

**Cyldon TEMPRYTES.**

The best means of valve control. British-made and delivered from stock immediately. Can be supplied in correct resistance for any Valve. State resistance (ohms) required, when buying, or be sure to give name of valve and voltage of accumulator supplying current to the valve.

- Cyldon Temprytes .. 2/8 each.
- Holder Mountings .. 1/6 each.

The **CYLDON**  
(pronounced Sil-don)

**TRIPLE GANG CONDENSER**

for the new  
Five Valve "Elstree  
Solodyne"

Price £3:10:0 (without Dial)

Get full particulars of all Cyldon Products from your dealer or write direct to the makers. Other Cyldon Condensers comprise Square Law, Square Law Dual Pattern, and the S.L.F. 4-lu. Knob Dial, supplied free with Square Law and Dual Models, and 2/- extra with S.L.F. or Triple Gang.

**SYDNEY S. BIRD & SONS,**

"Cyldon" Works, Sarnesfield Road, Enfield Town, Middlesex.

Telephone: Enfield 0672.

Tell the Advertiser you saw it in "MODERN WIRELESS."

£1,000  
MUST BE  
WON

12 FEET

2/-

POST FREE.

Any length obtainable.

ON SALE  
EVERYWHERE.

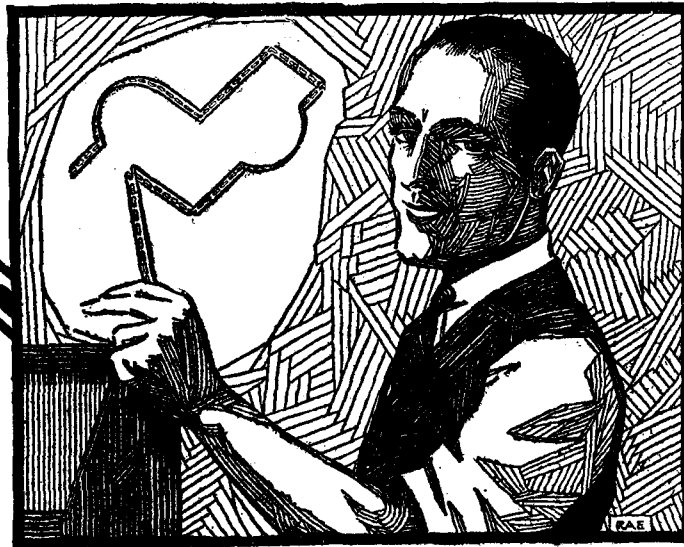

NO  
ENTRANCE  
FEE

SHARPER TUNING.  
MORE POWERFUL  
SIGNALS.

Entirely  
British Manufacture.

100% EFFICIENCY.

DELIGHTFUL TO USE.

SUPERIAL  
**SIMPLE-STRIP**

"SIMPLE-STRIP" is made of the finest hard-drawn copper—heavily tinned—perforated to take 4B.A. connections, and will stay put without solder. No need for bits and pieces. One length of "Simple-Strip" will cover several connections. And between these connections it will turn and twist as you will.

The most complicated circuit can now be wired by any amateur without difficulty and without waste.

Simple-Strip may be cut with an ordinary pair of scissors, bends and twists can be made with the fingers to any angle.

Simple-Strip must be included in the kit of every wireless enthusiast. It has many uses: A spade terminal with one snip of the scissors: A battery or accumulator connection: An excellent earth clip for gas or water pipe—and for other uses.



- CLUES DOWN.**
1. Hinder, to obstruct.
  2. Exclamation.
  3. Over.
  4. Large inns.
  5. Level.
  6. Cross Gallows.
  7. Consumed.
  8. Help.
  9. Sharp, tapering body.
  10. Enclosure.
  15. Islands.
  17. Edge.
  18. Dye.
  21. Cease.
  23. Warbles.
  25. Turkish institution.
  27. Former Russian Parliament.
  28. Impaired by surroundings.
  30. Meals.
  31. Omit.
  34. Certain.
  37. Evil.
  38. Perform.
  39. Preposition.
  41. Part of the verb to be.
  45. Spike of corn.
  47. The ocean.
  49. Abyss.
  50. To navigate.
  51. Measure.
  53. Lively.
  54. Narrow openings.
  55. Protuberance.
  56. Outlet.
  60. Small ocean.
  61. Animal.
  63. Denial.
  64. Father.
  67. Doctor (abbreviated).

WORK OUT THIS CROSS-WORD  
**THEN** \_\_\_\_\_  
ASK YOUR WIRELESS SHOP  
HOW YOU MAY WIN £500  
WITH YOUR SOLUTION

or write direct to  
**The NEW LONDON ELECTRON WORKS Ltd.,**  
EAST HAM M.W. Dept. 99. LONDON, E.6

- CLUES ACROSS.**
1. Pacify.
  6. Acid.
  8. Serpent.
  11. The definite article.
  12. Open, public.
  13. Fit for use.
  14. Religious act.
  16. Fish.
  19. Violent noise.
  20. Understanding.
  22. It is.
  24. Tug.
  26. Matched.
  29. Exercises.
  32. At home.
  33. Employ.
  35. On high.
  36. Sphere of influence.
  40. Total.
  41. To feel pain.
  42. Seat.
  43. Conveyance.
  44. Colour.
  46. Scriptural pronoun.
  47. Myself.
  48. Recess.
  52. Animal.
  57. Exists.
  58. Cultivates.
  59. Custom.
  62. Conclusion.
  65. Persons.
  66. Widely, expansively.
  68. Lover of own land.
  69. Pulls along.

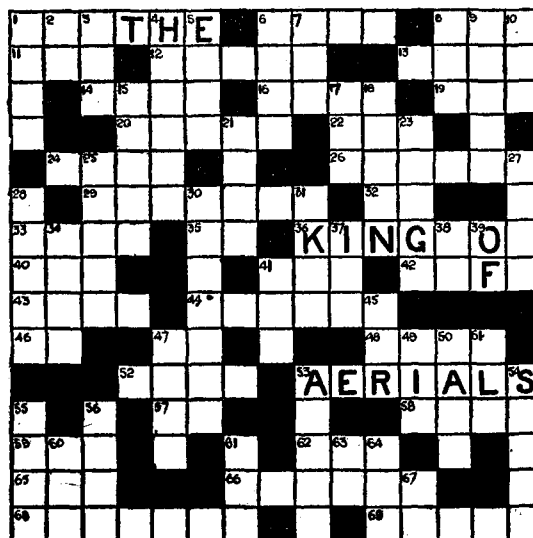

SAVE THE  
2/-  
DISC

ONE ENTRY  
FOR EVERY  
1/- SPENT



# :: THE DESIGN OF :: LOUD-SPEAKER HORNS

By *CAPTAIN H. J. ROUND, M.I.E.E.*

In this valuable contribution the author gives some very useful information concerning the shape and dimensions of horns for loud-speakers. It is written in a manner which makes it easily understandable by the non-mathematical reader.

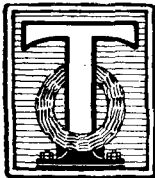

THE development of horn loud-speakers and gramophones has brought to light the basic principles on which the horn works, and has enabled designers very greatly to improve apparatus using horns.

I will run through the general ideas governing the design of these horns before giving some detail figures which will enable design to be carried out.

If we have an oscillatory circuit LC (Fig. 1), and we introduce a voltage in it, a resulting curve of current at all frequencies can be obtained which is called the resonance curve.

By placing resistance in the circuit we can absorb energy, and can produce a more damped resonance curve—the more the resistance the more the damping, until the resonance curve becomes nearly flat.

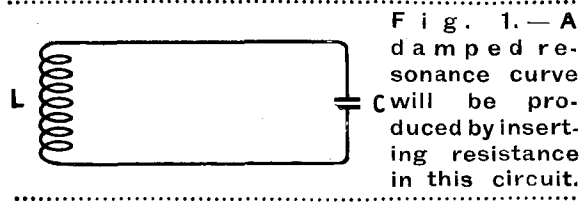

Fig. 1.—A damped resonance curve will be produced by inserting resistance in this circuit.

### Diaphragms

Now, a diaphragm is very similar. Its weight and flexibility give it a resonance curve if forces at different frequencies are applied to it, and any friction will act the same as resistance to damp it down, and by damping it down sufficiently its response can be made fairly uniform to all frequencies.

Obviously, we do not want to do this damping by a wasteful means, as we require the vibration to produce sound, so that the more we can apply the damping usefully, the better.

A very long tube attached to a diaphragm, as shown in Fig. 2a, takes energy away from the diaphragm, and the smaller the tube the greater the energy taken away—that is, the more the resistance applied to the diaphragm. Fig. 2b shows how a small tube is attached to a diaphragm.

The reason for this application of greater damping by the smaller tube lies in the ratio between the diaphragm diameter and the tube diameter.

If the same vibration of the diaphragm is considered in the cases of both large and small tubes, the same quantity of air is moved; but, of course, it moves faster in the small tube, and the energy

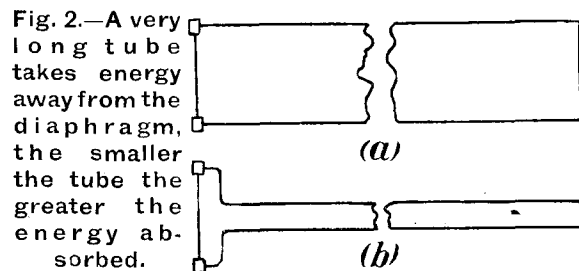

required for the extra speed represents a higher resistance value applied to the diaphragm.

Of course, if the tube is made too small, friction on the side of the tube will enter and waste the energy we wish to send along the tube; but theoretically by altering the size of this tube we can damp the diaphragm just as much as we please.

A long straight tube will act just the same for one frequency as for another one, and this is almost obvious, as there is nothing to differentiate between frequencies.

### Reflection

Of course, this long straight tube is of little use to us practically, and to get the energy out into the air we have to end the tube somewhere. If

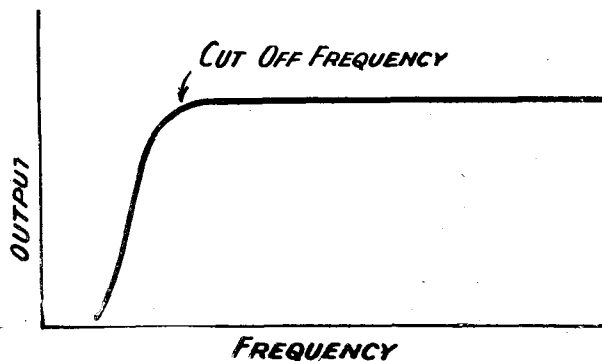

Fig. 3.—The output curve for a percentage horn.

**THE DESIGN OF LOUD-SPEAKER HORNS—(Continued)**

the end is a small one the energy refuses to come out and is reflected backwards, thus thwarting the two objects we are aiming at—

- (1) To damp or load the diaphragm ;
- (2) To radiate the sound out into the room.

It has been found that if the tube is gradually opened out to a large orifice, this reflection does not take place until a certain low frequency is reached. The slower the opening out and the

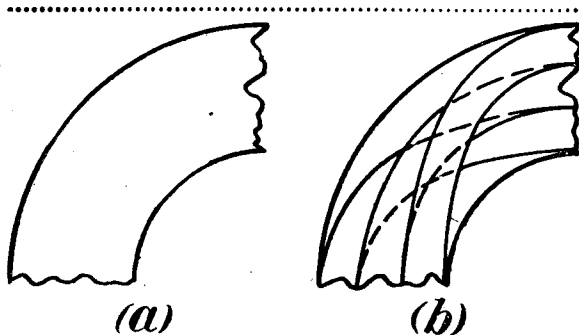

**Fig. 4.—How the wide tube may be split up into a number of small tubes with the same length of path for each tube.**

larger the orifice, the lower this limiting frequency is.

This opening out has been determined to be best done on a percentage or logarithmic basis. Every inch the increase of diameter is in the same proportion.

Fig. 3 shows the output curve of such a horn.

Any other way of opening out a horn is likely to produce unexpected results, except possibly the straight cone, which has been fairly well tested out and its properties determined.

**Size of Opening**

The final size of the opening is a matter of great difficulty to contend with. This opening can hardly ever be made big enough if we want to get the very low tones out properly.

In general we can say that to get all we want with a horn—

- (1) Its input orifice must be small unless the diaphragm is a specially large one of small weight ;
- (2) The length of the horn must be great ;
- (3) The open end of the horn must be large.

**Length of Path**

Long horns will be unpractical to have in a house, and recent work has indicated how they can be confined into a small space.

Imagine a sound wave having to go round a bend in a tube like horses round a race track.

If the tube is of narrow diameter there is not much trouble, because there is not much difference

in the length of path the wave has to travel between the inside and the outside of the track, but in the big tube the difference of length of path is considerable (Fig. 4a), which will result in a considerable mixing up of effects at the bend—the outside horses have little chance—but if we split up the wide tube into a lot of small tubes, providing we make the length of path the same for each tube, the effects will not be mixed. Fig. 4b shows how this might be done at any one bend.

Various methods of doing this in a partially effective way have been adopted in gramophones. Where the horn is still small it is bent about as required—when it gets fairly big it is split into two or sometimes four sections, each section wrapped up as required and keeping each section the same length. They are then all joined up into the final orifice.

Fig. 5 shows one means which has been adopted of carrying this process out.

**Diagram of Horn Shape**

The diagram in Fig. 6 will give all the necessary dimensions for constructing various horns.

I have neglected entirely the question of whether the horn is square in section or circular, as it will not be of great importance.

From this table you can choose a horn which is convenient in both length and diameter of orifice, and which will give a suitable curve of frequency.

Then a scale drawing can be made from the

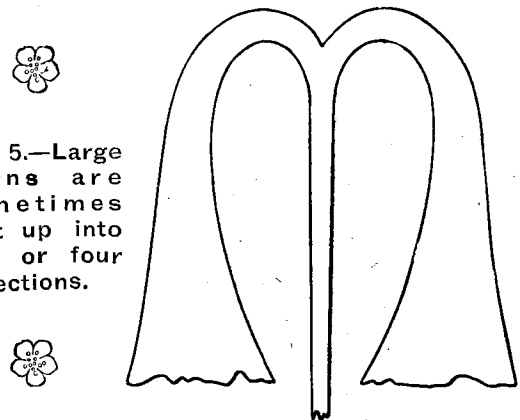

**Fig. 5.—Large horns are sometimes split up into two or four sections.**

figures given, and the horn constructed of wood or metal.

The top line of figures gives the diameter of the horn at the distances from the small end read off from the chosen scale below.

**An Example**

For instance, we want to construct a horn which reproduces well down to 200 frequency. The

# A Straight-line Frequency Condenser with 10:1 ratio Vernier Dial 17/6

## THE "CAPACIGRAD"

The "CAPACIGRAD" is a remarkably efficient straight-line Frequency Condenser. Its plates are made of hard brass, accurately mounted. The rotor is "grounded" and fitted with "pigtail" connection. Frames of Aluminium. Spindle runs in special adjustable bearings with a velvet-smooth action entirely free from "chatter." Electrically and mechanically it is a sound and work-a-like piece of apparatus.

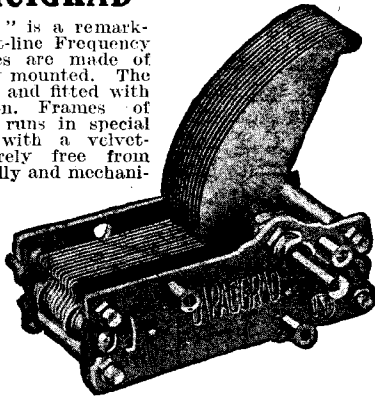

**PRICES :**

Cap. .0005 ... 12/6  
 " .00038 ... 11/6

Complete with drilling template and soldering tags. Overall length with plates all out 4 1/2 in.

## THE "KILOGRAD" VERNIER DIAL

The "KILOGRAD" VERNIER DIAL. Ratio 10 : 1. Fit the "Kilograd" Vernier Dial to the "Capacigrad" Condenser and you have an ideal combination. The Dial is beautifully moulded in Bakelite and will enhance the appearance of your set.

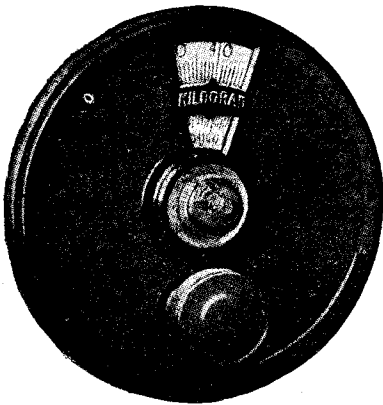

Diameter 4 in. Ratio 10 : 1.  
 Fits any condenser with 1/4 in. shaft.  
 Supplied either zero right or zero left.

PRICE 5/-

Profusely illustrated 48 - page list of American Apparatus and 26-page Supplement, free and post free on request.

### :: OTHER SPECIALITIES ::

BREMER TULLY SHORT-WAVE COILS AND COUPLER. See August "Wireless Constructor"—"Australia on Two Valves."  
 LONG-WAVE TRANSFORMERS for the "All Europe on a Frame." Super-heterodyne Receiver. Also "Bodine" Loop. See July "Modern Wireless."

# Hamleys

Estd 1760  
**HAMLEY BROS. LTD.**

200-202, REGENT ST., LONDON, W.1.

Telegrams: "Pleasingly, Piccy."  
 Telephone: Regent 3760 (6 lines.)



No. 1

Things are not always what they seem.

## "The Cowl does not make the Monk"

"THINGS are not always what they seem," says the old adage. A man may wear cloak and cowl, yet who can tell he is of the Monastery—until he probes beneath. Who knows but that the sacred cowl may be but the shield of an impostor? Is there a "Judas" in your Wireless Set? Those constant cracklings and that worrying weakening of your signals—where do you suspect, lies the culprit? You examine the components, check over the wiring—everything seems correct. Are you sure of the fixed Condenser? Of all the faults in a Receiver more are traceable to the fixed condenser than to any other component. Yet you buy it on faith: you may have the choice of two Condensers—alike in outward appearance, except that one bears the name "T.C.C." stamped upon its case. The unnamed condenser may be nothing but a case shielding inferior materials and bad workmanship—an impostor. To buy such is false economy.

Although to buy T.C.C. may cost a few pence more in the first place, it will assuredly save you time, money and temper, for when you buy a T.C.C. Mica or Mansbridge Condenser you obtain a product behind which is the experience of England's Condenser pioneers. Because only the finest materials available are used, by men with more-than-a-score years' experience in Condenser manufacturing, you know you are buying a Component whose capacity is guaranteed to be within an ace of accuracy, and that your set will be entirely free from leakage and all other condenser-troubles.

**T.C.C. Mansbridge Condensers are priced from 2s. 0d. upwards; Mica are from 2s. 4d.**

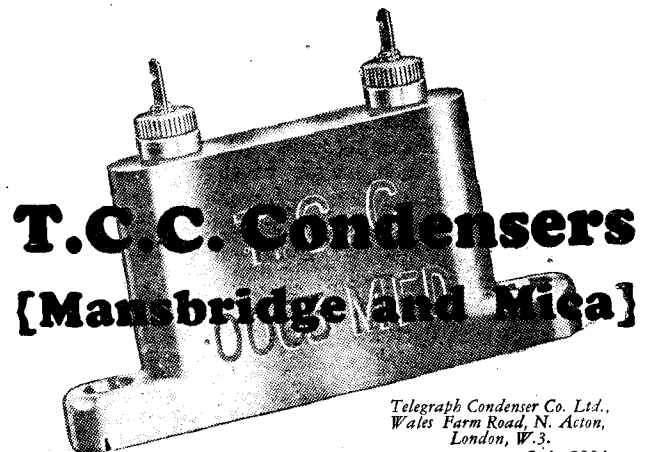

## T.C.C. Condensers

### [Mansbridge and Mica]

Telegraph Condenser Co. Ltd.,  
 Wales Farm Road, N. Acton,  
 London, W.3.  
 G.A. 5824

**THE DESIGN OF LOUD-SPEAKER HORNS—(Concluded)**

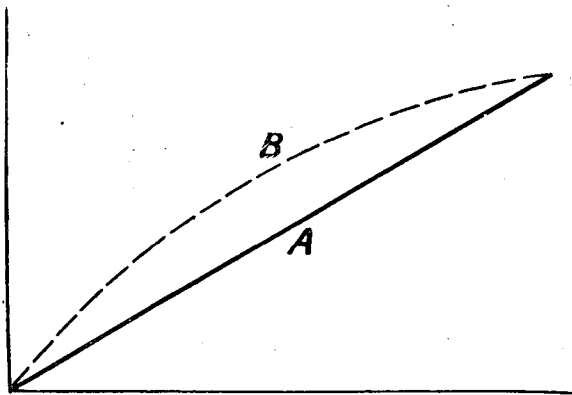

Fig. 7.—The curves for straight horns with large and small input orifices.

scale of lengths is read off opposite the left vertical scale marked "Frequency, etc.," The diameters of the horn at different distances along can be read off from the extreme top scale. Thus, at 100 cms. from the small end the diameter is 10.9 cms.

The curved line represents the full length of the horn, which in this particular case will be 160 cms., and the right-hand vertical scale indicates the open end orifice will be 42 cms.

A 50-cycle cut-off horn will be very large; thus its length is 850 cms. (28 ft.) and its big diameter 168 cms. (5½ ft.).

**The Small End**

If the small orifice is kept at about 1-5th of the diaphragm diameter, a practical limit is reached in the amount of damping that can be usefully applied to it. Special light diaphragms have been constructed to avoid this small horn opening, but they have not been generally used yet.

In making up these horns it is rather wise to make the narrow end in short lengths, which can be moved to test the effect of a shorter horn with a larger input orifice on one diaphragm. The smaller the orifice the better the damping, but other considerations, such as air friction and the depth of the compression chamber, also enter, and these effects are usually too complicated to work out other than experimentally.

The output orifice is very difficult to contend with, and in the diagram I give the output diameter necessary to give not more than 35 per cent. reflection at the cut-off frequency.

To those experimenters building horns I suggest that they build them

of square section of thin wood. I find 3- or 5-ply useful for this purpose, but sheet iron is quite satisfactory, and of course much easier to make wrapped-up horns with.

The influence of the material of the horn has been very much exaggerated.

**Straight Cones**

Straight cone horns are peculiar in their properties.

If the input orifice is considered to be very small, then the curve of the straight model horn is like Fig. 7a, but if the input orifice is large the curve tends to be like Fig. 7b—never quite as level as the percentage horn.

Many engineers are of the opinion that the straight-sided horn gives better effects

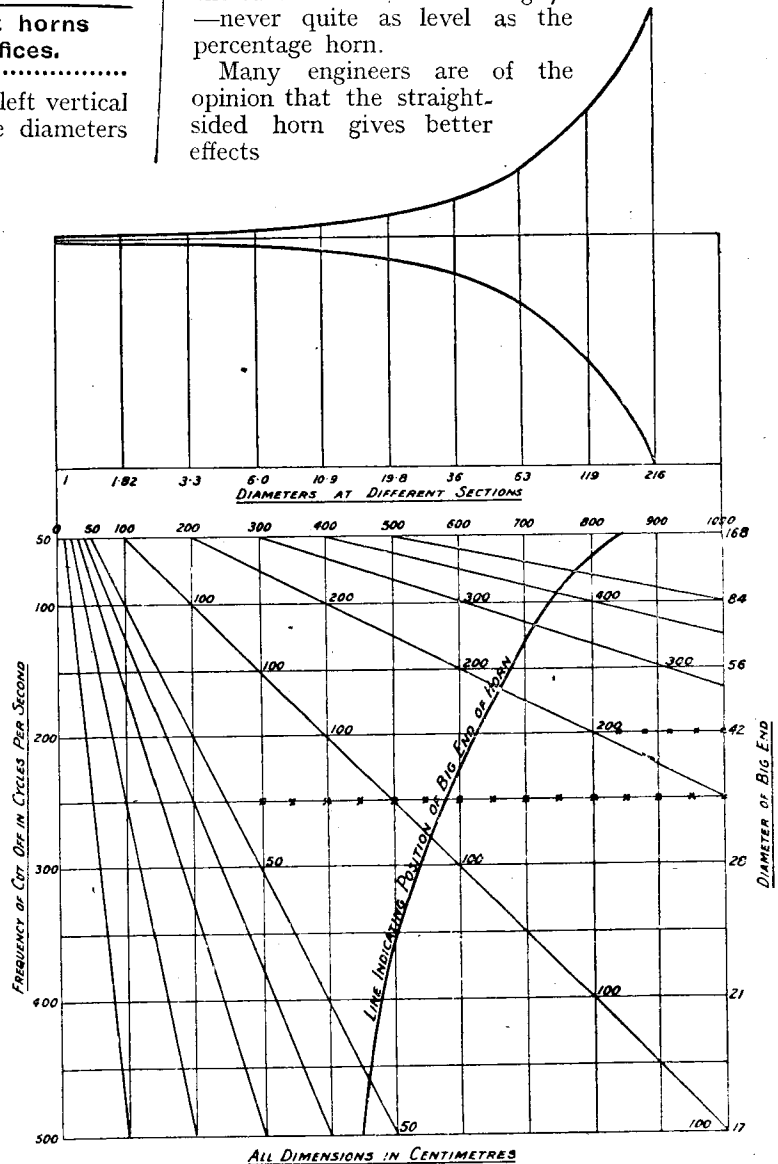

Fig. 6.—A useful set of curves from which it is a simple matter to obtain the necessary details for the construction of a horn.

## News from Advertisements

A NEW Dubilier product in the form of a wire wound resistance has now been placed on the market.

The London and Provincial Radio Co., Ltd., are advertising an indicating dial for fitment to their well-known universal coil-holder.

A Lotus Grid-Leak and buoyancy Valve Holder is advertised by Garnett Whiteley, Ltd.

The Igranic - Patent Triple Gang Condenser is announced by Messrs. P. Igranic Electric Co., Ltd.

Readers with A.C. current in their houses will note with interest the "Z" Filamentless Vacuum Tube Rectifier, marketed by Economic Electric, Ltd.

Crossword enthusiasts should turn to the advertisement of Messrs. The New London Electron Co.

### "Elstree Six" or "Solodyne"?

We have received many queries as to which of the two sets, the "Elstree Six" or the "Solodyne" is the better. Some readers are apparently delaying building one or the other of these receivers because they are of the opinion that one of the designs must be superior to the other. The truth is that neither set is better than the other. The "Elstree Six" employs six valves and has three stages of high-frequency amplification as against the two stages used in the "Solodyne." For this reason the "Elstree Six" may be made to give longer range and a little more selectivity. On the other hand, there are four controls against the one control of the "Solodyne," which, in addition, utilises screened coils. The selectivity of the "Elstree Six" may be enhanced by the use of smaller anode coils when close in to a broadcasting station. Alternatively its sensitivity, at the expense of selectivity, may be increased by the use of larger anode coils. Numerous other examples could be taken and we would impress on readers that the matter is one solely for individual choice. Each is a Radio Press Star set and is the best of its class.



## Columbia

### DRY BATTERIES FOR ECONOMY

DEPRECIATION of cell life and power is actually much less on sets operated and maintained by COLUMBIA Batteries. Initial cost on dry batteries is moderate, they give long service and eliminate the expense of frequent and troublesome accumulator renewals. There is a COLUMBIA Battery for every purpose—use them for every radio battery need. Safe, clean and easily handled, long and inexpensive service and amazing efficiency.

The right battery in the right place naturally means a great deal to your reception. Therefore "How to get the most out of your radio batteries" is a little book which will be most useful to you. It is packed full of really practical and interesting information. These booklets are sent free on request.

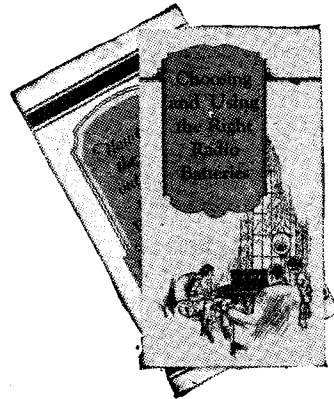

Send for "How to get the most out of your radio batteries" and "Choosing and using the right radio batteries." It is astonishing what will result in marked economy in operation and improved quality of reception when you have a little definite knowledge as to the correct use of your radio batteries.

Ask your dealer for Columbia High Tension Battery No. 4780 60 volts, a special size with extra large radio cells. Or Columbia High Tension Battery No. 4770 45 volts (extra heavy duty), for long service and economy. Columbia "A" Dry Cell Battery for Dull Emitter valves will meet heavy current demands and give much longer service than other batteries. All Columbia Batteries are fitted with spring clip terminals to ensure quick and secure connections.

ASK ANY GOOD DEALER FOR COLUMBIA.

## J. R. MORRIS,

15-19, KINGSWAY, LONDON, W.C.2

Telegrams: Colcarprod, London. Telephone: Gerrard 3038.

Scottish Representative:

John T. Cartwright, 3, Cadogan Street, GLASGOW.

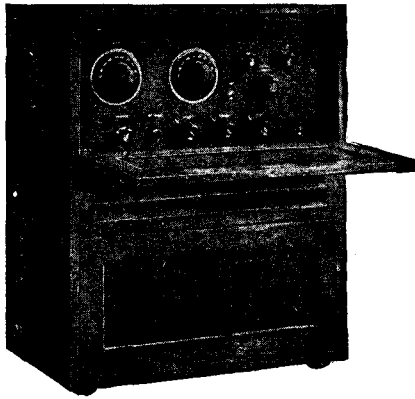

*A New Model*  
*at the urgent request of Public & Trade*

**The CURTIS DOUBLE CIRCUIT SUPERHET 6**

**SELF CONTAINED PORTABLE RECEIVER**

**GUARANTEED FULL LOUD SPEAKER RANGE**  
**ON SELF CONTAINED AERIAL**

Local Station 150 miles.      Daventry 500 miles.

There is no Six Valve Receiver or circuit on any market which will excel

**The CURTIS DOUBLE CIRCUIT SUPERHET 6**

for range selectivity, volume or the perfect purity of tonal reproduction.

**Price £40**

Including Self-contained Aerial, loud speaker, all batteries and valves; royalties £5 extra.

**1926-1927**      Illustrated Catalogue of Instruments and Components. **FREE ON REQUEST**

**PETER CURTIS LIMITED,**  
**11, RED LION SQUARE, LONDON, W.C.1**

Telephones : Chancery 7543

Telegrams : "Paracurtez, Holb."

MANCHESTER      -      -      312, DEANS GATE

**Did you visit the Radio Exhibition?**

Considerable interest was displayed, in the series of

**DUCO "KNOCK-DOWN" CABINETS**



Constructors and Experimenters appreciated the advantage of securing a cabinet in separate sections. The Duco series permits of building up as you go along, thus facilitating the mounting and wiring of components. All sections are of solid mahogany, tongued and grooved ready for assembling. The "A" Type illustrated is one of three types supplied.

We shall be pleased to send you Particulars of the full range.

**TYPE A (AMERICAN) CABINET.**

RC121/60.	9in. x 6in.	£0 19 9
RC121/61.	9in. x 7in.	1 0 0
RC121/66.	12in. x 7in.	1 3 0
RC121/69.	12in. x 9in.	1 4 0
RC121/75.	14in. x 7in.	1 4 6
RC121/80.	18in. x 7in.	1 6 9
RC121/85.	18in. x 9in.	1 8 9
RC121/90.	18in. x 10in.	1 10 0
RC121/92.	21in. x 7in.	1 10 0
RC121/95.	24in. x 10in.	1 14 9

**Brown Brothers Limited**

*Allied Companies*  
**THOMSON AND BROWN BROTHERS LTD**  
**BROWN BROTHERS (IRELAND) LTD**

*WHOLESALE ONLY*  
**GREAT EASTERN STREET, LONDON, E.C.2**  
**126, George St., Edinburgh, and Branches.**

Please order from your usual Wireless Dealer.

**8/6 and better COLVERN SCREENED COILS**

Mechanically and Electrically highly efficient, the Colvern Screened Coils are better and considerably lower in price. Made of copper. The screen together with the Colvern low-loss Inductance Former complete with Standard 6 pin Base can be obtained for 12/6.

**Collinson Precision Screw Co., Ltd.**  
 Walthamstow, London, E.17.  
 Provost Works, Macdonald Road.

Telephone—Walthamstow 532.  
 Also at 150, King's Cross Road, N.W.1.

Former and Base, 5/-

Constructed of the highest quality bakelite.

Single Formers, 4/-

Copper Screen, 8/6

Complete with base.

**Full of useful information**

**The SIFAM Book of RADIO MEASURING INSTRUMENTS**

Send for **FREE** Copy to-day.

**SIFAM ELECTRICAL CO. INSTRUMENT CO.**

Dept. M.W., 95, Queen Victoria St., London, E.C.4

**IN PASSING**

(Concluded from page 443.)

unkind things were said about us by our first two customers that for a time our new venture languished. It must not, however, be imagined that business was completely at a standstill. Far from it; one day we sold a 4BA nut to Bumbleby Brown, and on the very next day Gubbsworthy paid us threepence in hard cash for half-an-hour's hire of a pair of wire cutters which we had borrowed from Dippleswade. Then one fine day things began really to look up. The General arrived staggering under the weight of his five-valve set. He had heard, he said, that our repairing department was not prospering as it deserved; so to give a helping hand he had brought a job for us to do. There was one little nut in an obscure corner which required to be tightened down and he had no spanner that would reach it.

**The Job**

It was a jolly awkward little nut to get at; in fact, to do so we found it necessary to remove both the wiring and the components of the high-frequency circuits. This enabled us to examine the set thoroughly, and we found that there were quite a lot of things that wanted doing. In a week's time it went back to the General accompanied by a bill neatly written out by the Professor.

	£	s.	d.
To tightening up loose nut	0	0	1
To re-wiring H.F. circuits	1	2	6
To re-designing and improving ditto ...	3	11	1
To replacing faulty valve-holder ...	0	6	6
To re-winding coils ...	0	17	4
To adjusting variable condensers ...	0	9	8
To cleaning gridleak ...	0	0	4
To renewing worn-out power-valve ...	1	2	6
To re-soldering 86 joints at 6d. ...	2	3	0
To removing beer stains from cabinet ...	0	7	6
To supplying and fitting 5 fixed resistors ...	2	10	0
<b>Total ...</b>	<b>£12</b>	<b>10</b>	<b>6</b>

We added that an early settlement would oblige. So far, I regret to say, it has not. Some people are very hard to please.

EXPERTS IN RADIO ACOUSTICS SINCE 1908

**SEE FOR YOURSELF....**

SEE and hear for yourself. Go to a Brandes Dealer and look over the Brandes range. Get him to demonstrate, and make your own comparisons. Not many instruments of such good class are so reasonably priced. Observe that the cost of the Brandola is considerably reduced.



**THE BRANDOLA**

Specially built to bring greater volume with minimum current input and exceptional clarity over the full frequency range. A large diaphragm gives new rounded fulness to the low registers and new clarified lightness to the high. Reproduction controlled by a thumb screw on the base. Polished walnut plinth with electro-plated fittings. Height 26 ins., bell 12 ins. **75/-**



**THE TABLE-TALKER**

The new goose-neck design is the result of research in radio-acoustics, which definitely establishes its value in relation to the diaphragm fitted. Patent material used in the construction of the horn eliminates metallic harshness. Volume and sensitivity controlled with small lever located at the rear of the base. Elegantly shaped, tasteful neutral brown finish, felt-padded base. Height 18 ins., bell 10 ins. **30/-**

**Brandes**

*From any reputable Dealer.*

BRANDES LIMITED · 296 REGENT ST. · W·1

*Service Advertising*

Tell the Advertiser you saw it in "MODERN WIRELESS."



# SOME PROBLEMS IN "GANG"

## :: CONTROL ::

*Some of the Difficulties encountered in Designing the ELSTREE "SOLODYNE"*

**F**ROM a mechanical point of view, it is a comparatively simple matter to construct a receiver having three tuned circuits, and to arrange to operate all the tuning condensers from the same control. Moreover, when such an arrangement is first connected up, the local station is usually received quite well, and possibly one or two other stations may force their way through.

### Matching

The best results, however, obviously cannot be obtained until some definite method of matching up the various circuits has been incorporated. There are several methods whereby this may be done, some of which are not satisfactory, while others can be used with success. It is proposed in this article

### The First Method

During the first preliminary experiments small neutralising condensers were connected in parallel with each of the three variable condensers. The skeleton circuit

In some cases neutralising condensers are useful where the correction required is very small.

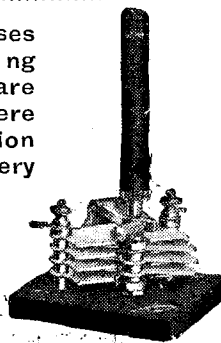

(omitting such things as batteries and other details unnecessary to the present discussion) is shown in Fig. 1. The three coils,  $L_1$ ,  $L_3$ ,  $L_5$

With similar coils like this the settings of the last two condensers are reasonably similar, but of course the reading of the aerial dial is considerably different unless special precautions are taken.

### The Aerial Circuit

With the aerial circuit we have the difficulty of the aerial capacity to contend with. If the aerial circuit were connected across the whole of the first coil, then we should have a capacity of the order of .0002 permanently connected across this coil. Obviously, therefore, some special arrangement must be made in this case if the aerial tuning condenser is to be controlled on the same knob as the other two.

### Tight Coupling

The effect of the aerial may be considerably diminished and also the selectivity of the whole arrange-

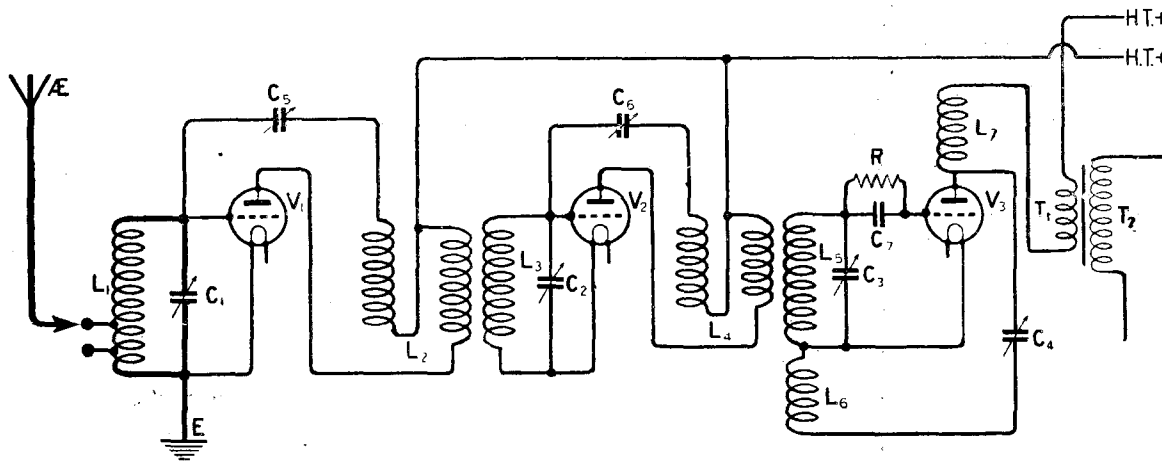

Fig. 1.—In the Elstree "Solodyne" the three circuits controlled by one adjustment are  $L_1$ ,  $L_3$  and  $L_5$ .

to discuss some of the methods which were tried in evolving the Elstree "Solo-dyne" and to explain some of the difficulties which were encountered in the process.

and  $L_5$  are all wound to the same dimensions, so that they can be considered as commercially matched although actually they were not quite of the same inductance.

ment enhanced, by utilising the common form of t-tapped aerial circuit. The aerial is connected across a small portion at the earth end of the coil only, so that the

We are thanked daily for making

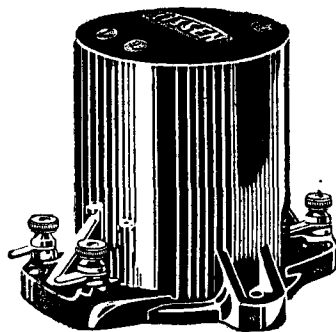

**this new Transformer!**

During the recent National Radio Exhibition at Olympia not one, but dozens, of delighted users of our new 8/6 Transformer came to our stand and actually thanked us for placing on the market such a superb instrument at so incredibly low a price. For—price quite apart—the new Lissen 8/6 Transformer is without superior on the market.

So good is the new LISSEN Transformer that all the previous higher priced models have been withdrawn in its favour. Compare it against its higher-priced rivals for tone purity and volume—every note, every harmonic, every overtone is amplified.

Get a new LISSEN Transformer from your dealer or direct from us if any difficulty.

Test it—compare it—the higher the price of the Transformer you compare it against the better we shall be pleased and the higher you will think of it yourself.

URNS RATIO .. 3 : 1  
RESISTANCE RATIO 4 : 1

**PRICE 8/6**

—and guaranteed for 12 months

Use it for 1, 2 or 3 Stages L.F. Include no postage if sent direct but mention dealer's name.

**LISSEN LIMITED,**  
20-24, Friars Lane,  
Richmond, Surrey.

Managing Director : T. N. Cole.  
L65

**SOME PROBLEMS**  
:: IN ::  
**"GANG" CONTROL**  
(Continued)

secondary circuit proper which is tuned with a condenser is really tightly coupled to the aerial circuit.

This is quite a common form of aerial circuit, and if this method is adopted, the effective capacity across the secondary circuit is very considerably reduced. Experiments showed that with the order of tapping which is usually employed in such circuits, the effective capacity across the secondary was reduced to something of the order of 50 micro-micro-farads or less.

**Two Methods**

We now have two alternatives. Either we can connect a similar

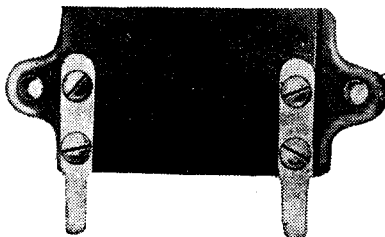

Connecting a small fixed condenser across two of the tuned circuits is one method of balancing out the effect of the aerial.

fixed condenser across both the other two tuning condensers, so that they also have a small parallel capacity of about 50 micro-micro-farads, or we can reduce the inductance of the aerial circuit until it tunes at the same point on the tuning condenser as the other two circuits. It is interesting to examine these two methods in a little greater detail.

The frequency to which any particular circuit will tune depends upon the product of the inductance and the capacity. For any given setting of the triple condenser, the capacities of the three individual condensers will be approximately the same. Let us assume that at one point the capacity of each condenser is 100 micro-micro-farads, (.0001). Let us also assume that

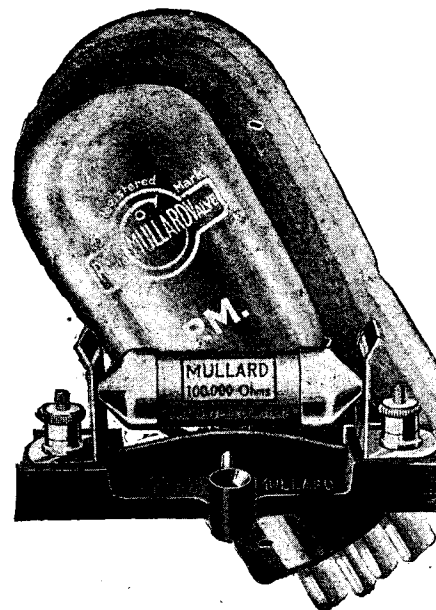

The Research behind the finest Valve behind a wire wound Anode Resistance

When one research organisation controls several products, it follows that the same standard of efficiency must be applicable to each product marketed. The costly patient research which has resulted in the finest valve, lies behind THE MULLARD WIRE WOUND ANODE RESISTANCE, and it is placed on the market with the certain knowledge that its efficiency is the efficiency of the finest valve.

A resistance wound on a textile fibre core perfectly covered, and interlayered with the same material, ensuring the elimination of all self-capacity, and also that the fine metallic wire is rendered absolutely free from every particle of mechanical shock.

The temperature co-efficient is negligible, since the resistance is not set in wax but only covered with a thin layer of wax to allow a perfect dissipation of heat.

Mullard EVER-REST Wire Wound Anode Resistance (80,000 and 100,000 ohms) ... 5/-  
Complete with Holder ... 6/8

Also supplied in our intermediate values. Other values to specification.

Mullard Grid Leaks and Condensers, ...  
Type Grid B 0.5 to 5.0 megohms ... 2/6  
Type Grid B combined with .0003 mfd. Condenser Type MA ... 5/-  
Type MA Condenser .0001 to .0009 mfd. ... 2/6  
Type MB Condenser .001 to .01 mfd. ... 3/-

Leaflet M.W. free on request.



**WIRE WOUND ANODE RESISTANCE**  
The MULLARD WIRELESS SERVICE Co., Ltd.  
Mullard House, Denmark St., London, W.C.2.

Tell the Advertiser you saw it in "MODERN WIRELESS."

## SOME PROBLEMS IN "GANG" CONTROL—(Contd.)

the inductance of the last two coils is 200 micro-henries.

### Reducing the Inductance

In the case of the last two circuits therefore the product of L and C is  $200 \times 100 = 20,000$ . In the first circuit, however, we have a fixed capacity of 50 micro-micro-farads connected across the tuning condenser due to the effect of the aerial. Our total capacity here, therefore, is 150 micro-micro-farads, and we must reduce the inductance of the first coil accordingly, so that its product with this value of capacity is also 20,000. This requires a value of approximately 133 micro-henries.

Let us now consider a point further up the scale where the tuning

two, because the small parallel capacity is only a small proportion of the total capacity in circuit, whereas down towards the bottom of the scale the effect of the parallel capacity becomes very important, and the inductance has to be altered to a considerable extent.

### Fixed Condenser Method

This leaves the other alternative which is that of connecting a small fixed condenser in parallel with the other two condensers and adjusting this until a satisfactory balance of all three condensers is obtained. This method has the advantage that it may also be utilised to correct minor variations existing in the condensers themselves.

slight difference between two of the coils we cannot correct for this by connecting a small parallel capacity across one of the circuits, because the value of this small correcting capacity would have to increase as we increased the total capacity in use. Due to this effect, therefore, it was found that the minor corrections which had to be made in the experimental model of the receiver did not hold good over the whole of the scale and some slight re-correction was necessary at different points of the scale. This of course defeated the whole object of the receiver, and other methods were therefore attempted.

The difficulty was due to minor variations in the inductances of

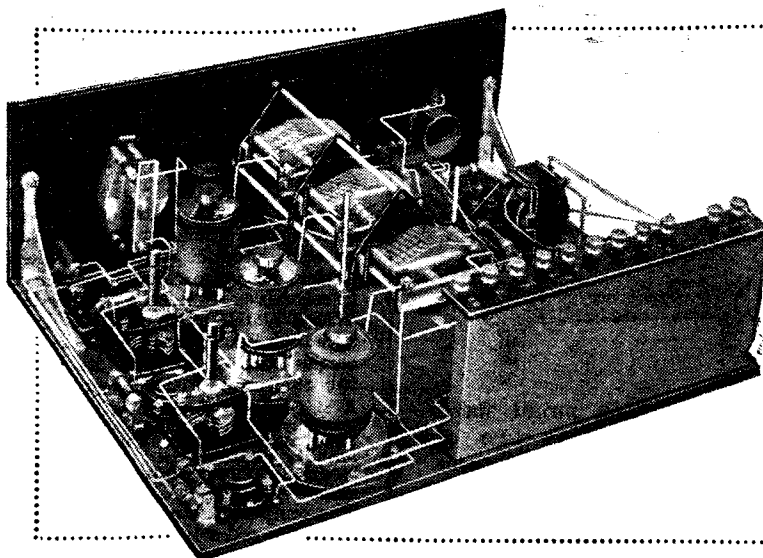

In the Elstree "Solo-dyne" a special triple condenser is employed, which utilises a method of coupling whereby the relative positions of the moving vanes may be varied.

capacity is, say, 250 micro-micro-farads. The product of L and C in the last two circuits is then 50,000. The tuning capacity in the first circuit is 250 plus the 50 micro-micro-farads in parallel, which makes a total of 300 micro-micro-farads, and if the product of L and C is again to equal 50,000 we then require an inductance of 166 micro-henries.

It will be clear from this that the method of reducing the value of the first inductance coil in order to compensate for the aerial capacity is not a practicable one, because the value of inductance required is different at different points of the condenser scale. At the top of the scale the inductance requires to be practically the same as the other

We have just considered an extreme case where the capacity of one condenser differed by a fixed amount from that of the others. We saw that in order to correct for this it was necessary to vary the inductance by an amount depending upon the actual value of the capacity in circuit. It will readily be seen that in accordance with this principle, that if we vary the inductance of the circuit by a fixed amount, then we can correct for this by a variation in the capacity, but, as in the previous case, the correction required will depend upon the total amount of capacity in circuit.

### Other Methods Tried

This means that if we have a

the various coils, and the next step therefore was to attempt to alter the inductances within a small amount so that they could be balanced up at will to equal values.

### Variometers

The next step in the development, therefore, was the inclusion of small variometers in series with the tuning coils, with the idea of enabling the inductances of the various circuits to be balanced up within a small amount. The variometers themselves consisted of small 2 in. diameter tubes containing three turns only, with similar rotors of slightly smaller diameter inside them, and for convenience these were mounted

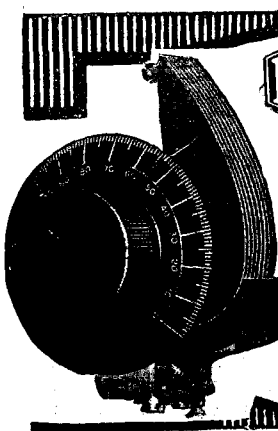

**FORMO**  
CENTRUM PRELTA CO. LTD.

**ULTRA LOW LOSS**  
Straight Line Frequency Condenser  
Cone Bearings, Braced Vanes, Positive  
Collector. A real precision job.  
Condenser only 000 mfd. 0005 mfd. .... 9/-  
Condenser with plain Dial. Standard 1" 10/6  
dia. Shaft

SEND FOR CATALOGUE AND DESCRIPTIVE  
LITERATURE OF COMPLETE FORMO RANGE.

**THE FORMO COMPANY,**  
Crown Works, Cricklewood, N.W.2  
Phone: Hamp. 1797.  
Manchester: Mr. J. E. Leves,  
23, Bartley St., Levenshulme,  
Phone: Heaton Moor 475.

See page 517 for  
Formo Transformer.

**HIGH-CLASS COMPONENTS  
FOR "MODERN WIRELESS" SETS**



**Royal-Frost  
Bakelite Toggle  
Switch.**  
As specified in  
"Modern Wireless"  
Receivers.  
List Price  
2/6 each.



**MARTIN COPELAND  
VERNIER AND  
NEUTRALISING  
CONDENSER**  
Radion insulated, wide-  
ly spaced terminals,  
genuine bakelite knob.  
As used in a "FOUR"  
for Range and  
Selectivity.  
(see this issue).  
3-plate, List Price 5/- each  
7-plate, List Price 7/- each

**THE NATIONAL VELVET VERNIER  
DIAL**  
A variable Ratio dial from 6:1 to 22:1 as  
used in the "DOUBLE CIRCUIT THREE  
VALVE RECEIVER" described in this  
issue.  
4in. Velvet Dial, Type "B," 15/-

**ROTHERMEL RADIO CORPORATION  
OF GREAT BRITAIN LTD.,  
24-26, Maddox St., Regent St., London, W.1.**  
Phone: Mayfair 578 and 579.  
Grams: Rothermel, Wesdo, London.

**Safeguard  
Your set!**

Install the Etherplus  
+ combined Aerial-  
earth, lead-in Tube  
and Switch. It is a  
permanent lightning  
conductor whether  
the set is on or off.

Every Etherplus + Light-  
ning Shunt carries a £100  
Free Insurance against  
lightning damage.

Stock size lead-in tube  
6 1/2" (9 1/2" lead in tube  
6d. extra). From your  
dealer  
**3/9**

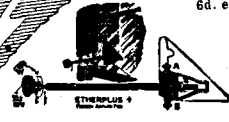

**ETHERPLUS**

**M. & A. WOLFF,**  
9-15, Whitecross Street, London, E.C.1.

**RADIO ACCESSORIES  
= ENSURE PERFECT  
RECEPTION**

**The famous**



**BECOL** LOW LOSS FORMER

**BECOL**  
REGISTERED TRADE MARK

**Low Loss Former**

3 in. Diameter overall.  
6 in. length 3/-  
4 in. " 2/-  
3 in. " 1/6

Made from the famous "EECOL"  
genuine ebonite. Large air space  
between wings. Easy winding.  
Thoroughly dependable and British  
made.

Also supplied in lengths  
up to 36 in.

**RADIO PANELS IN STAND-  
ARD SIZES, PACKED IN  
CARTONS READY FOR USE.**

**THE BRITISH EBONITE CO. LTD.,**  
Nightingale Road, Hanwell, London, W.7.

**CUT THIS OUT  
FOR CABINETS**



Send for FREE list illustrating Cabinets as shown  
in "Modern Wireless," etc., etc.

NAME .....

ADDRESS .....

(Write in block letters please.)  
**CARRINGTON Mfg. Co., Ltd.**  
18-20, Normans Buildings, Central  
St., London, E.C.1.  
Trade enquiries especially invited.  
Telephone: Clerkenwell 6903.



**EELEX**

**Treble Duty  
Terminals**

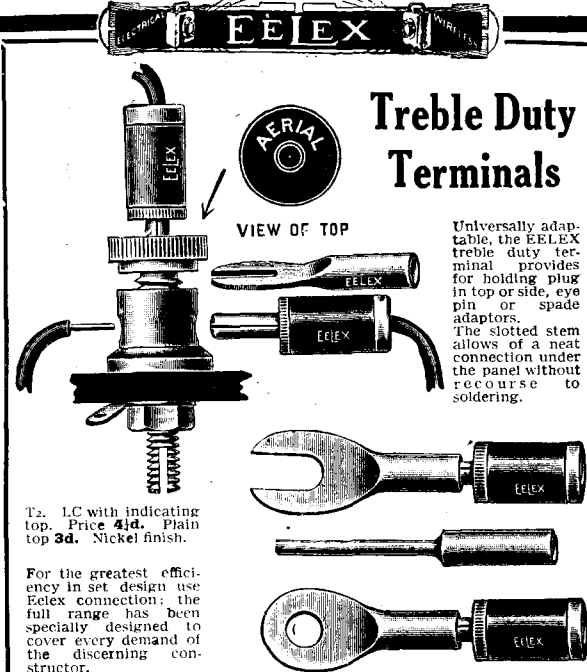

**AERIAL**

VIEW OF TOP

Universally adap-  
table, the EELEX  
treble duty ter-  
minal provides  
for holding plug  
in top or side, eye  
pin or spade  
adaptors.  
The slotted stem  
allows of a neat  
connection under  
the panel without  
recourse to  
soldering.

T2. LC with indicating  
top. Price 4/6. Plain  
top 3/6. Nickel finish.

For the greatest effi-  
ciency in set design use  
Eelex connection: the  
full range has been  
specially designed to  
cover every demand of  
the discerning con-  
structor.

T14. Eye, Pin and Spade Adaptors.  
Plug only 3/6. Pin eye or spade 1/6.

Write to-day for free  
illustrated list of com-  
plete Eelex range.

**J. J. EASTICK & SONS**

**EELEX HOUSE, 118, Bunhill Row, E.C.1**

Tell the Advertiser you saw it in "MODERN WIRELESS."

**SOME PROBLEMS IN "GANG" CONTROL—(Contd.)**

on the baseboard outside the screens.

The amount of coupling which would exist between such very small inductances would not be thought to be appreciable at first sight. Yet it was found in practice that the circuit became completely out of control when these variometers were incorporated. It was quite impossible to balance up the inductances of the various circuits because any alteration to the variometers simply varied the coupling between the circuits and either threw them into oscillation or introduced other undesirable effects.

**A Vital Point**

If this method is to be used therefore it is essential that the variations of inductance shall be carried out on the

actual coil itself, inside its screening case. The question of making small variometers as part of the coils themselves was considered, and discarded as being too complicated and only to be adopted as a last resource.

The question was then tackled from another angle. By investigating the problem of the amount of correction necessary in the various circuits from a mathematical standpoint, it can easily be

shown that in order to compensate for slight differences between the various circuits it is necessary to have a correction which increases directly as the capacity itself increases. In other words we must link up some small correcting condenser on the same spindle as the actual tuning condensers themselves.

**Rocking the Rotor**

On looking into the matter further, however, it was found that the same effect as this could be obtained by altering the settings of the various condensers relative to each other, provided

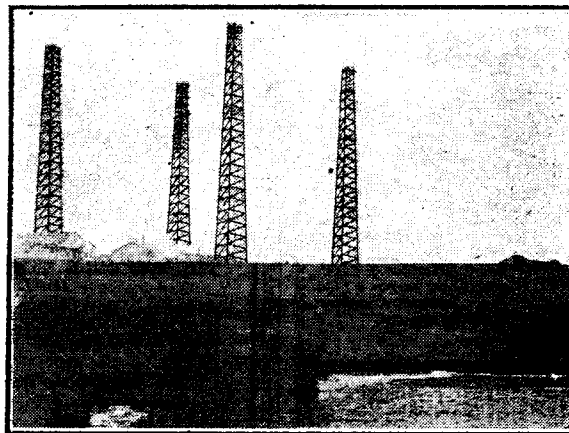

The masts of the Marconi high-power station at Newfoundland. The reception of this station was the amateur's ambition in the crystal days.



Patent No. 244,251

**The Moving Block Cannot Fall**

The vernier movement comprises three sets of enclosed precision machine-cut gears, and reduces the speed of the moving block by eight times.

Side plates, coil blocks, and knobs in artistic bakelite mouldings. All metal parts heavily nickel plated. Made for left as well as right hand.

**LOTUS**  
VERNIER  
**COIL HOLDERS**

**PRICES :**

Two Types :	
For outside panel mounting :—	
Two-way ...	7/-
Three-way ...	10/6
For inside baseboard mounting, with 6-in. handle :	
Two-way ...	8/-
Three-way ...	12/6

Made by the makers of the famous Lotus Buoyancy Valve Holder.

**GARNETT, WHITELEY & CO., LTD.,**  
LOTUS WORKS, BROADGREEN RD., LIVERPOOL.

**THE ESSENCE OF RADIATION IN RADIO.**

ONCE again we have scored a signal success by having on view in our Showroom Windows the new Elstree

**:: SOLODYNE ::  
RECEIVING SET**

the marvellous long-range circuit with the single control.

Join the ranks of the many who take it for granted that our Windows always contain the latest and best apparatus in the Wireless Trade.

We have complete units for making up this marvellous set now in stock.

Send 6d. for our massive International Radio Catalogue. Callers free.

**WILL DAY, LTD.,**  
19, Lisle Street, Leicester Square,  
LONDON, W.C.2.

Telephone:  
Regent 4577.

Telegrams:  
Titles, Westrand, London.

**SOME PROBLEMS**

∴ IN ∴

**"GANG" CONTROL**

*(Concluded)*

a certain type of condenser was employed.

**The Method Adopted**

This is the method which has actually been adopted in balancing up the Elstree "Solodyne."

Similar results could, of course, be obtained with a condenser in which arrangements were made to vary the position of the stator or fixed plates instead of adjusting the moving plates. Which of the two methods is adopted is immaterial, but in the particular case of the Elstree "Solodyne" the adjustment was obtained by a relative movement of the rotors of the condensers.

**Aerial Capacity**

This method therefore is satisfactory for balancing up individual discrepancies, but there still remains the question of the aerial capacity. It will be remembered that this problem was overcome previously by connecting a small fixed capacity across each of the remaining two condensers. This, however, necessitates two extra adjustments which have to be balanced up when the set is first installed. If we are arranging for independent variation of the several condensers, it would be very desirable if we could make this method suffice for correcting the aerial capacity also.

**Experimental Results**

Experiments were therefore tried with a view to accomplishing this. Instead of connecting small parallel capacities across the remaining two condensers, the rotor of the aerial condenser was retarded so that the first circuit came into tune with the others at some given point.

Actually a point in the middle of the condenser range was chosen, and the last two circuits were tuned accurately to this frequency. The aerial condenser was then tuned independently to the same frequency and the three condensers finally locked in position. It was found that this method succeeded in correcting the aerial capacity to a satisfactory degree.

EXPERTS IN RADIO ACOUSTICS SINCE 1908

**IS THIS WHAT YOU'RE LOOKING FOR ?**

TESTING the new 2-valve receiver at our Works at Slough, on a standard P.M.G. aerial, we tuned in the two Paris stations, London, Daventry, Bournemouth, Birmingham and Newcastle on the loudspeaker. This despite bad screening set up by a large power station not more than 50 yards from the vicinity of the laboratory. We were testing on 66 volts only. You can expect even better from the 3-valve Brandeset.

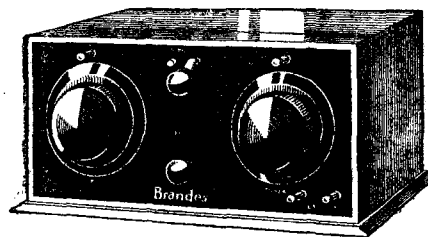

**THE BRANDESET II.**

The new Brandes 2-valve set features simplicity of control and ingenious compactness. Condenser dial, filament rheostat, reaction dial and "throw-over" switch for long or short wave tuning complete the panel controls. Straight line frequency condenser tuning and grid-bias

is employed. The standard coil is suitable for Daventry and no "plug-in" coils need be purchased. The L.T., H.T., and grid-bias leads are plated into one cable from rear of set.

**£6 10**

*(Exclusive of Marconi Royalty and Accessories.)*



**THE BRANDESET III.**

The new Brandes 3-valve receiver employs the same ingenious characteristics as the Brandeset II, except that an extra stage of Audio Frequency is employed. It has straight line frequency condenser tuning, grid-bias, and is adapted to long and

short wave tuning. Both receivers give most excellent loudspeaker reproduction on a number of stations, and are specially designed for this purpose.

**£8 10**

*(Exclusive of Marconi Royalty and Accessories.)*

**Brandes**

*From any reputable Dealer.*

BRANDES LIMITED · 296 REGENT ST. · W.1

# The "All-Europe" Loud Speaker set

The wonderful results obtained with this set are possible only with "Powquip" Components.

**COILS ("POWQUIP").** These are uniquely constructed, and form an unusual and highly efficient means of coupling. "Powquip" Coils simplify tuning, and are infinitely more selective than the usual coils.

**TRANSFORMERS ("POWQUIP").** The "Orchestral" and "Manchester" Transformers used in this set are the result of many years' research, and reproduce the high and low tones of both music and speech with absolute fidelity.

## - POWQUIP - COMPONENTS

A new folder which gives all details of this set, and the Powquip "Coil" and "Wireless" booklets which will give you extra help, can be obtained free of charge on application to your dealer or to

**THE POWER EQUIPMENT CO., LTD.,**  
Kingsbury Works, The Hyde, Hendon, N.W.9

Phone: Colindale 6196-7-

Grams: "Powquip, Hyde, London."

# SUCCESS

## RADIO PRODUCTS

For perfect Radio Reception

### "SUCCESS" SUPER CONDENSER

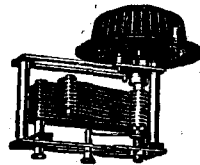

#### ULTRA LOW LOSS S.L.F.

Minimum Dielectric Loss. Skeleton End Plates. Grounded Rotor. Spring Pigtail. Ball Bearing. 100 to 1 Slow Motion. Provision for quick searching. No Pack-lash. Lacquered Brass Throughout.

.0005 mfd. Complete 18/6!

.0003 - - 18/-!

Write for illustrated list of "Success" Radio Products.

**BEARD & FITCH LTD.,**  
34, Aylesbury St.,  
London, E.C.1.



# "Silvertown" WIRELESS ACCESSORIES

Quality guaranteed by over 50 years electrical manufacturing experience.

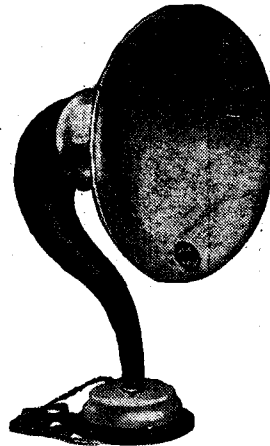

## The SILVERVOX

The "Silvervox" Loud-speaker will reproduce both speech and music without the loss of its original tone and quality. Coils wound to either 120 or 2,000 ohms. The tone arm is a heavy aluminium casting. Total height 20 inches. Size of trumpet 12 1/2 inches diameter.

Price £3 - 0 - 0 each.

B. 599.

### FILAMENT RHEOSTAT. O E HOLE FIXING.

Circular pattern, on ebonite former, complete with knob, pointer, black celluloid scale engraved in white and two terminals for connections. The resistance wire is wound on an insulating rod, thereby giving a perfectly smooth adjustment. B. 599 — Wound to approximately 5 ohms resistance.

Price 3/- each.

B.—600—Wound to approximately 30 ohms resistance.

Price 3/6 each.

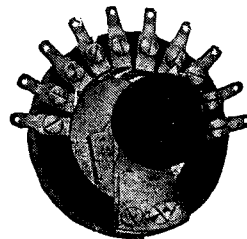
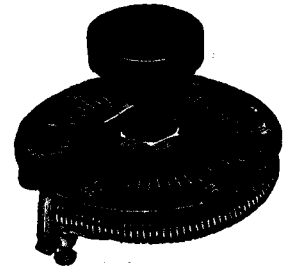

B. 570.

### 10-WAY INDUCTANCE OR CAPACITY SWITCH.

(Patent 226245.)

This switch is of the under panel mounting type, and is fitted to the panel by means of the two counter-sunk head screws supplied. It enables the experimenter to build up large capacitor, and is an invaluable addition to any set. Price 5/6 each.

#### AN AID TO ENTHUSIASTS.

We have prepared a logging chart for recording wavelengths, condenser settings, etc., of those stations which require careful calibration to tune in. A copy of this chart, printed on stiff card with hanger, can be obtained free of charge at any of our Branches or from any high-class dealer.

Makers:

**THE SILVERTOWN COMPANY,**  
106, Cannon St., London, E.C.4. Works: Silvertown, E.16.

BELFAST.  
BIRMINGHAM.  
BRISTOL.  
CARDIFF.

DUBLIN.  
GLASGOW.  
LEEDS.  
LIVERPOOL.  
LONDON.

MANCHESTER.  
NEWCASTLE-ON-TYNE.  
PORTSMOUTH.  
SHEFFIELD.





# The latest in Jacks & Plugs

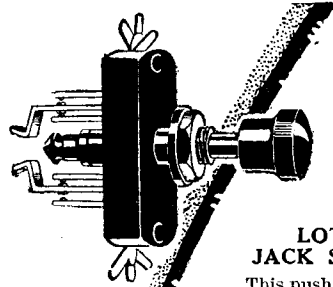

### LOTUS JACK SWITCH

This push-pull switch is designed to occupy the minimum space, being only 1 1/4 in. deep. Of the finest Bakelite, it has nickel silver springs and contacts of pure silver. Soldering contacts can be made to suit any wiring.

#### Prices

No. 9, as illustrated, 4/-

Others from 2/9

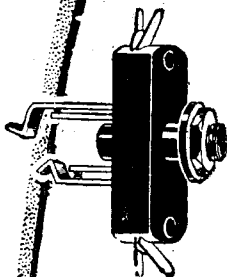

### LOTUS JACK

Designed to take up the least space, the depth back of panel being 1 1/4 in. Made from best Bakelite mouldings, with nickel silver springs and pure silver contacts. One-hole fixing. Soldering contacts can be brought into any position.

#### Prices

No. 3, as illustrated, 2/6

Others from 2/- to 3/-

### LOTUS JACK PLUG

Designed for use with Lotus Jacks. Made from best Bakelite mouldings and nickel plated brass. To fix, the wires are placed in slots and gripped in position by a turn of the screw cams.

#### Price 2/-

Made by the makers of the famed 'LOTUS' Vernier Coil Holders and 'LOTUS' Buoyancy Valve Holders.

# LOTUS

## JACKS-SWITCHES-PLUGS

GARNETT, WHITELEY & CO., LTD.,  
LOTUS WORKS, BROADGREEN RD., LIVERPOOL.

## FURTHER HINTS

### :: ON THE :: "MEWFLEX"

(Continued from page 490.)

cuit still oscillates, then it is probably the second neutralising condenser which is causing the trouble, and a slight readjustment at this point will probably cure the trouble.

### Capacity Coupling

A difficulty which is experienced in this type of circuit is due to the fact that there is capacity coupling existing between the primary and secondary of the transformers. This usually manifests itself by causing the neutralising points to be very sharp and critical. The ideal arrangement, of course, is for the circuit to be stable over a fairly wide band of the neutralising condenser, so that if some slight error or misadjustment is made, the receiver is still stable. With this particular circuit the neutralising condenser is somewhat critical of adjustment, and consequently a little care is required at first when the receiver is being tested out.

### Long-Wave Coils

Reception on the longer wavelengths can be accomplished quite easily by merely removing the screens from their sockets, replacing the low wave coils by the long wave coils, and reinserting the screen. It will be found that no readjustment of the neutralising condensers is normally necessary, and all that is required is to tune the circuits in exactly the same manner as is adopted on the lower wavelengths. The test report which is given on page 488 shows the approximate settings obtained on several of the stations in this wavelength band, and this will serve as a guide in tuning.

These coils, however, differ slightly, according to the make, so that the figures given should not be taken as necessarily correct to one or two degrees. They will serve, however, to show the approximate positions at which the stations may be expected on the dial. As long as the condensers are tuned together in a similar manner to that adopted on the lower ranges no difficulty will be experienced in picking up the various stations.



This loudspeaker is designed on quite new and original acoustic lines. It is possible on this to get the lowest bass notes as well as the highest treble notes in a perfect form of reproduction.

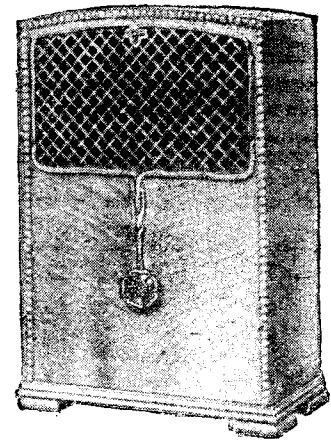

For distinction of design and construction it stands alone, the attractive cabinet harmonises with any furniture. Over four feet of curving flute lies in the Touchtone cabinet to preserve the overtones of perfect rendering.

Price in Oak.....£6 : 6 : 0

Mahogany.....£7 : 0 : 0

Write for full illustrated leaflet 141 giving all particulars.

London:  
25, Victoria  
Street,  
S.W.1.



Newcastle/Tyne:  
Tangent House,  
Blackett St.,

**GENT & CO., LTD.,**  
FARADAY WORKS, LEICESTER

Tell the Advertiser you saw it in "MODERN WIRELESS."

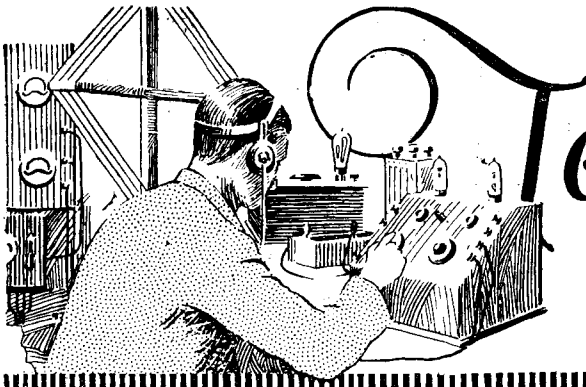

# Tested by Ourselves



**SAMPLE** of their Acton Glass case accumulator has been submitted by Messrs. C. A. Vandervell and Co. The unit supplied was a 6 volt 48 ampere hour battery, each of the cells being provided with

.....

## Plugs and Jacks

**WE** have received several of their Plugs and Jacks from Messrs. Bowyer-Lowe Co., Ltd., for test.

The jacks are constructed on the girder principle, and the soldering tags to the spring contacts are set

matter what thickness panel is employed.

These jacks are made in various types both for single and double circuits and for filament control. They are robustly constructed and are efficient in use, while the insulation between adjacent contacts was found to be infinity.

The plug for use with these jacks is constructed throughout of brass as regards the metal portion, while the fixing screws provided allow either of round tags or flexible wire being fastened. The insulated cover is highly polished, and the component has a neat appearance.

We can recommend these plugs and jacks for all wireless purposes.

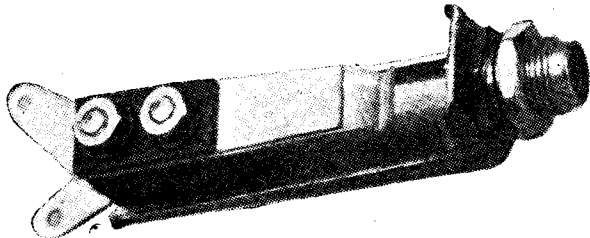

An example of the Bowyer-Lowe jack.

## Low Loss Coil Former

**WE** have received a Low Loss Coil Former from Messrs. The Jewel Pen Co., for test and report.

This former is of the skeleton type

a glass container in place of the usual celluloid or ebonite. The three cells were mounted in a stout carrying case provided with a leather strap.

No separators were provided between the plates, the glass of the cells being moulded to keep the plates apart. By this construction it is claimed that any undue internal resistance in the battery is completely eliminated, that the battery will maintain its charge even when it is not used for some period, and will stand up to rougher treatment than normal.

We have had the battery in intermittent use now for over two months. During the majority of the time it was used for about two hours a week at the end of which it was put on a steady discharge at a current of 1.5 amperes, and was found in all to give well over its rated capacity.

Despite the extremely irregular use of this unit, therefore, it gave a full discharge, and the plates were in a thoroughly healthy and free condition at the end. There was an entire absence of any sediment at the bottom of the cells, due to disintegration, and as far as can be seen, the battery should give excellent service under rough conditions. We can thoroughly recommend it to our readers.

to either side so as to facilitate soldering connections to them. An excellent feature is applied in the method of fixing, which is of the usual one hole type. The bush

**The coil former submitted by Messrs. The Jewel Pen Co. is provided with plugs and sockets for mounting purposes.**

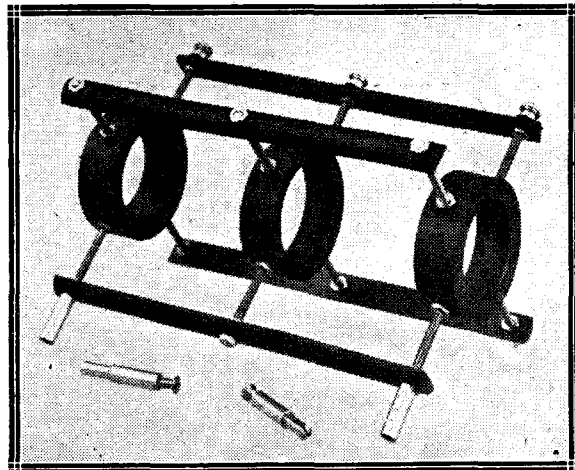

.....

itself is fixed, and a nut is employed to fasten this component on the panel. This obviates the need for any special spacing washers, and makes sure that the reach of the plug be correctly set, no

and consists of three ebonite rings to which four lengths of threaded rods are fitted. The four ends of these threaded rods carry strips of ebonite which are threaded so as to allow the windings of the coil

Charge your H. T. Accumulators with  
the new  
"Z"  
FILAMENTLESS VACUUM TUBE RECTIFIER

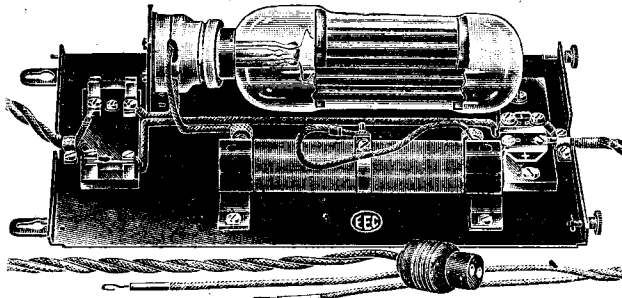

EXTRAORDINARILY EFFICIENT.  
Consumption 1 unit in 50 hours!  
SILENT. SAFE. SURE.  
Practically indestructible.

Operates on 200-220 volt A.C. mains  
of any periodicity. D.C. output ap-  
proximately 100 volts 80 milliamperes.

PRICE complete with input and  
output leads, variable  
resistance and fuses. **£3 - 0 - 0**

**Economic Electric Ltd** 10, FITZROY Sq.  
LONDON W.1.

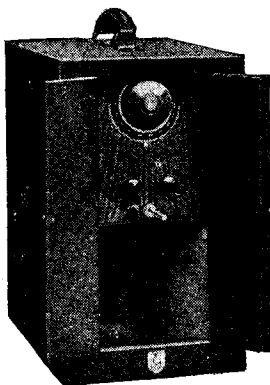

Phone - Museum 9236.

**PELICAN  
SELF-CONTAINED SETS**

The two-valve set illustrated gives good  
loud-speaker strength and pure repro-  
duction up to 20 miles, without either  
aerial or earth.

Plug-in terminals are fitted so that  
existing aerial and earth may be used  
if desired. Provision is made for use  
of headphones when you wish to tune  
in other stations.

Loud Speaker, Valves, Batteries, etc.,  
all contained in cabinet.

PRICE COMPLETE and including  
royalties ... .. **£19 5 0**

Write for Illustrated Folder giving  
further details and prices of  
Pelican 1, 3, and 5 Value Sets.

**CAHILL & CO., LTD.,**  
64, Newman Street, London, W.1.

Paras. Ad.

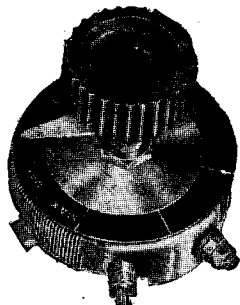

The "PEERLESS"  
JUNIOR RHEOSTAT

**2/6**

**Short Circuit  
impossible if**

you use the "Peerless" Junior Rheostat.  
Their amazing popularity can be judged  
from the fact that the sales have already  
passed the HALF MILLION figure.  
An OFF position is provided, while  
definite stops make short circuit im-  
possible. Resistance element immune  
from damage. Safely carries current of  
two valves. Complete with nickelled  
dial and one hole fixing. Three types:  
Size 1 1/2 in. diam., 1/2 in. high, 6, 7, 15 or  
30 ohms.

From all dealers or direct.

**The BEDFORD ELECTRICAL  
& RADIO COMPANY, LIMITED,**  
22, Campbell Road, Bedford.



This is the Glory Corner at The Bennett College. We give it that name because it contains in bundles about One Hundredweight of letters which we have received from Grateful and Successful Students. We keep all these thousands of unsolicited testimonials as a fountain of inspiration and because we are really proud of them. Having helped thousands of others to achieve success and advancement, it may be possible that we can help YOU.

I am assisted by a large and expert staff, and the advice we give is sound. If we cannot help you we will say so; if we can we will tell you how.

We have FREE booklets setting out the possibilities in connection with each of the subjects shown in the lists. Send for the one in which you are interested, or ask for MY PRIVATE ADDRESS, which also is free. You incur no obligation.

- COMMERCIAL**
- Accountancy
  - Advert. Writing
  - Salesmanship
  - Army Certif. Courses
  - Accounting & Estate Agency
  - Auditing
  - Banking
  - Book-keeping
  - Commercial Arithmetic
  - Commercial Law
  - Company Law
  - Costing
  - Economics
  - English and French
  - Executive Law
  - Foreign Exchange
  - General Education
  - Modern Business Methods
  - Police Entrance and Promotion Courses
  - Secretariats
  - Workshop Organisation

**GOOD REASONS  
why you should join  
The Bennett College.**

1. We give a written guarantee of success.

2. We supply all the necessary books FREE.

3. We have expert tutors for every Department.

4. We teach by post - you study in your spare time.



Yours sincerely,  
*J. Bennett*

**Have You ANY Ambition?**

Most moderate charges,  
payable monthly.  
No extra fees.

**WE SPECIALISE IN PREPARATION FOR ALL EXAMINATIONS  
IN CONNECTION WITH THE ABOVE SUBJECTS.**

**WE TEACH BY POST  
In All Parts of the World**

Note Address -  
The BENNETT COLLEGE  
Dept. 134, Sheffield.

**The Bennett College**  
SHEFFIELD  
Dept. 134.



**100% EFFICIENCY H.T. BATTERY**

Constructors' Ideals realised. As tested "Modern Wireless," April, 1924, etc. Brass Terminalled Giant Unit Dry Cells (compare standard cell), 300 per cent. capacity, 1 1/2 volts, 60-volt, in polished Oak Case, as tested, 19/6 carriage 1/9. In usual card cases, 14/6, carriage 1/6. Replacement cells, 4/- doz. Every cell replaceable. Sample cell, 6d. Lists free. Prompt delivery. Direct only from maker, saving 50 per cent.

**C. A. FINCHETT, Old Armoury, Osvestry.**

**FORMO**  
A MONUMENT IN THE MARCH OF PROGRESS

The Formo Shrouded Transformer is the universal favourite  
**10/6 Made in ratios 1-1, 1-2, 1-3, 1-4 & 1-5. 1-3 & 1-5 for first and second stages.**  
Send for catalogue and descriptive literature of complete Formo range.

**THE FORMO COMPANY, Crown Works**  
Cricklewood, N.W. 2. Phone: Haupp. 1787.  
Manchester - Mr. J. B. Leves, 23, Hartley St., Levenshulme. Phone: Heaton Moor 475. See p. 511 for Formo S.L.F. condenser.

TRADE MARK **FINEST QUALITY**  
**RED DIAMOND** RADIO COMPONENTS  
 Every Component is perfect.  
 REGISTERED  
**R.D. 40 Perm. Detector 2/- each.**  
  
 Of all high-class Radio Dealers or sole makers  
**JEWEL PEN CO. LTD. Radio Dept. 40,**  
 21-2, Great Sutton Street, E.C.1.

# REPAIRS

By specialists skilled in every form of accurate and intricate coil winding.

Headphones, Loud Speakers and Transformers rewound, remagnetised, and reconditioned **EQUAL TO NEW** and returned the same day on C.O.D. system. The unsolicited opinion of one of our many satisfied clients "—all I can say is, they are better than when new!"

**VARLEY Magnet Co**  
 Renewal Dept.  
 Woolwich.  
 S.E.18.



Proprietors  
 Oliver Pell  
 Control Ltd

### STERLING RECEIVERS SENSATIONAL OFFER

Having purchased a large number of Sterling 2-Valve Loud Speaker Sets, we are offering them to the public on Unprecedented Terms.

A Genuine Sterling 2-Valve Loud Speaker Set. Complete, Ready for Immediate Use, with D.E. 06 Valves, H.T. and L.T. Accumulator, Aerial Equipment and one of our world-famed De Luxe Excellence Loud Speakers. Price £15 15s. Royalties paid.

Terms, 15s. deposit and 15 monthly payments of 20s. Send for one of these Superb Sets at once, as the Number for Sale is limited, and when sold cannot be repeated under double the price.



15/- deposit.

Free Catalogue on Application.  
**THE WIRELESS DISTRIBUTING CO., LTD.,**  
 (Dept. M.W.)  
 Wireless House, Stoke Newington, N.16.

## BROKEN CHINA

glass, wood, etc. can be permanently mended with Durofix which makes water and heat-proof repairs of tremendous strength.

### RAWPLUG DUROFIX

Sold by Ironmongers, etc. in tubes 6d. and 1/- each.  
 The Rawplug Co., Ltd.  
 London, S.W. 7.

# COMPONENTS

ENORMOUS STOCKS TO CLEAR.

Send for Bargain Price List.  
 Laurie & McConal Ltd., Fitzroy St., Cambridge

## TESTED BY OURSELVES—(Contd.)

to be spaced. Two plugs and sockets are provided, one to each end of the former for mounting purposes. By this means it is possible to wind different coils for different purposes, and to change them as desired, an advantage over the usual low loss former which is generally a fixture in the set in which it is used. Three terminals and soldering tags are provided to enable connections to be made with the winding.

This former is well constructed and strongly made, being able to stand up to a considerable amount of rough usage, and can be recommended for use.

**Emerald Wavemeter**  
 WE have received an Emerald Wavemeter for test and report from Messrs. Heath & Co., Ltd., of New Eltham.

The Emerald wavemeter gives direct dial readings in metres. The small operating dial is divided into metre divisions, whilst the larger dial is marked off at every 50 metres.



This instrument is housed in a handsome mahogany box, clearly marked terminals being provided for connecting the batteries. The valve, which is carried within the wavemeter itself, is sunk below the panel so as to protect it from injury. The range of this instrument is from 200 to 600 metres, the main dial being divided in 50 metre divisions, and the smaller dial, which is geared to the main dial and actuated by the operating knob itself, is divided into metre divisions. It is claimed that this instrument is accurate within one metre, and when checked against our standard

instrument the largest discrepancy obtained was .07 of a metre.

The instrument is so designed that a variation in high-tension potential of five volts either side of the recommended value will not affect the calibration.

We can thoroughly recommend this wavemeter. It is simple to use, gives accurate results, and the workmanship of the whole instrument is exceedingly good. The

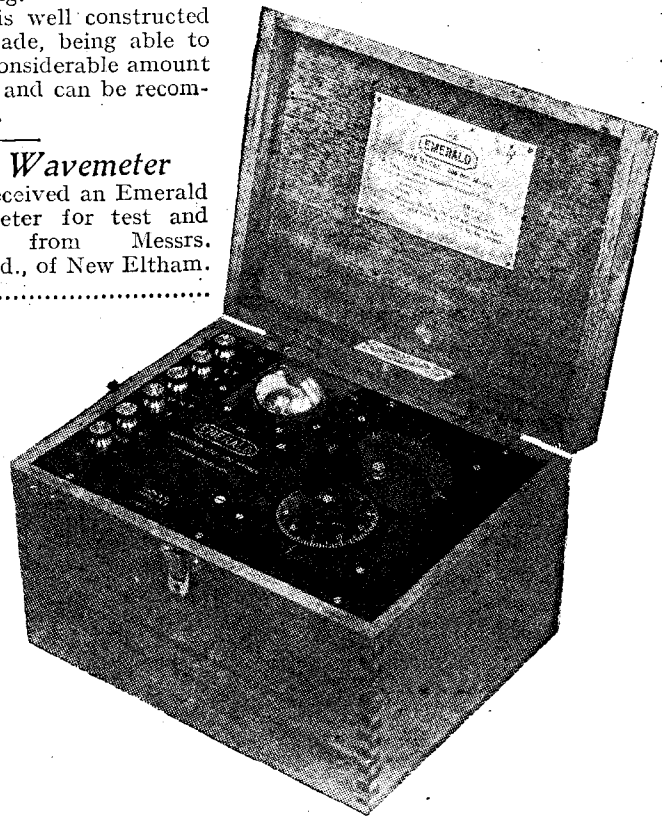

price, including valve, is only £7 4s.

### Safety Lead-in

MESSRS. PRESSLAND have sent us one of their Safety Lead-in tubes for test. This component is intended to provide a lightning arrester device which is permanently connected to earth, so that the disconnection of the aerial to the set and the earthing of the set inside the room are thus made unnecessary.

The lead-in of the aerial is attached beneath a heavy terminal, fixed at one end of a length of brass

# TRIUMPH

CUSHION  
ANTI-MICROPHONIC  
**VALVE-HOLDER**

HEIGHT OF  
PERFECTION  
IN VALVE  
SEATING.

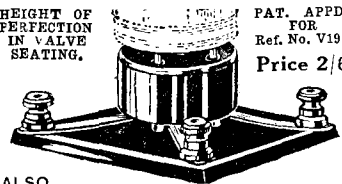

PAT. APPD  
FOR  
Ref. No. V190  
Price 2/6

ALSO  
**TRIUMPH RHEOSTAT &  
TRIUMPH 2 COIL STAND**

*Ask your dealer for free list of*

**TRIUMPH** GUARANTEED  
COMPONENTS & SETS  
*or send p.c. mentioning Modern Wireless, to:*  
**A. H. CLACKSON, LTD.,  
WHITE HART WORKS, LONDON, N.22.**

**A HOME FOR YOUR WIRELESS SET**

**OUR STANDARD  
CABINETS**  
are DUSTPROOF  
and house the whole  
apparatus, leaving no  
parts to be interfered  
with. All you do is  
**UNLOCK and TUNE  
IN.** Made on mass  
production lines,  
hence the low price.  
Provision is made to  
take panels from 16  
by 7 up to 30 by  
18 in.



From 44 15 0  
Write to-day for descriptive  
pamphlet and suggestions  
Carriage paid and packed free England and Wales, for adapting your receiver  
free panel in our Standard  
Money returned if not  
satisfied. Immediate Delivery.

**MAKERIMPORT Co.** Dept. 2, Melville Chambers,  
50a, Lord St., LIVERPOOL.

## CONSTRUCTORS, Just a Postal Order

to us with details of components  
you require ensures delivery  
by return.

We specialise in supplying Complete  
Sets of Parts and Cabinets for all Radio  
Press Sets and Envelopes.

All leading makes of Valves and  
Components in stock.

**ORDERS FOR 10s. AND OVER  
POST FREE:**

Postage must accompany overseas  
orders and all orders of less than 10/-

**Goods carefully packed  
—Valves at buyer's risk**

Let us supply you at once with your  
requirements for that new set or that  
component which will improve your  
present set.

**WILDER, DEVLIN & CO.,**  
10, Forest Rise, London, E.17.

**Valves Repaired**  
AS GOOD AS NEW!!

**HALF  
LIST  
PRICE**

(except Weeco, S.P.'s and low capacity  
types.) Minimum D.E. Current 0-15  
amps when repaired.  
All Bright and Dull Emitters.  
Listed at less than 10/-.  
Minimum charge 5/-.  
**VALCO LTD.** Dept. M. W. Tabor  
Grove Wimbledo. SW

## TESTED BY OURSELVES (Continued)

screwed rod. This rod passes through  
the centre of a small brass ring to  
which an earth external to the  
building is connected. There is only  
a small gap between the screwed  
rod and this brass ring, so that in  
the event of a high static charge  
collecting on the aerial it is claimed  
that it will discharge straight to the  
earth across this gap rather than go  
through the set. The rest of the  
brass rod passes through an ebonite  
tube, provided at one end with a  
hole for ventilation purposes, and  
a stout terminal at the far end is  
provided for connecting the lead in  
to the set itself. The safety gap is

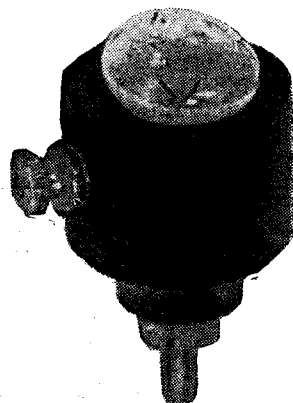

The Hunt safety wander  
plug incorporates a small  
flash lamp bulb.

totally enclosed so as to prevent  
leakage occurring owing to rain.

When placed on test it was found  
that the insulation resistance was  
infinity, while the capacity between  
the lead in and the earth ring was  
found to be negligible. An insur-  
ance guarantee is supplied with each  
of these components, under which  
damage to personal property or third  
party will be paid up to £100.

### Safety Wander Plug

**M**ESSRS. A. H. HUNT, Ltd.,  
have sent us one of their  
safety wander plugs for test.  
This wander plug consists of a small  
screw lamp holder which is provided  
with a plug fitting to enable it to be  
inserted in the usual high-tension  
battery. On the side is a small  
terminal under which the lead itself

## Cheaper and Better Jacks

Ashley Radio Jacks are made  
of nickel silver springs, with  
pure silver contact and Bake-  
lite insulation throughout. Tags  
are tinned and spread fan wise  
for easy soldering.

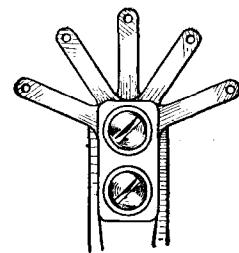

**Note  
the  
Prices  
below :**

Showing how tags are fanned.



JACK No. 1. Single Circuit (Open) 1/3

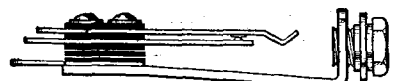

JACK No. 2. Single Circuit (Closed) 1/6



JACK No. 3. Double Circuit. 1/9

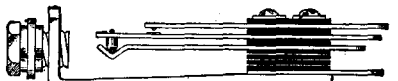

JACK No. 4. Filament Single Control 1/9

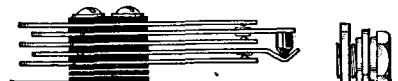

JACK No. 5. Filament Dbl. Control. 2/3

## Telephone Plug



Price 1/6

Occupies less space than any other Plug. Metal  
parts highly nickelled and polished. Bakelite insu-  
lation throughout, suitable for spade or pin tags,  
and any type of flexible or solid wire connection.

*Ashley Radio*

Ashley Wireless Telephone Co. (1925) Ltd.  
Finch Place, London Road, Liverpool.

TESTED BY OURSELVES — (Continued)

may be fixed. A small flash lamp screws into the holder and acts as a fuse, thus preventing the valve from burning out should a short take place.

When placed on test it was found that when this wander plug was placed in series with the H.T. lead and the battery then shorted across a .06 valve, the safety lamp burnt out without the valve being damaged in any way.

This is a well-finished and useful accessory which commends itself to many amateurs as a simple means of protecting valves from being burnt out.

Anti-Microphonic Valve Holder

MESSRS. HARLIE have sent us one of their anti-microphonic valve holders for test. This component is built on anti-capacity lines, the valve legs all being spaced apart, while each is surrounded by a thin sheath of insulating material. The metal parts of the sockets are sunk beneath the

top of these insulating sheaths, so as to safeguard the valve if any attempt is made to insert it incorrectly. In order to obviate even that, the anode pin is marked with

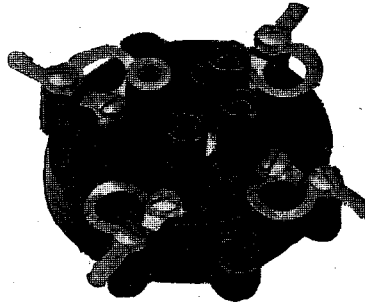

The Harlie anti-microphonic valve holder.

a red ring so that no mistake shall be made.

The valve legs are carried on a round disc of insulating material, a hole being drilled through the centre of this still further to reduce the capacity of the valve holder. This

base is supported by means of flat leaf springs on a thin shell of insulating material which may be fixed to the baseboard, and it has a definite limit to its travel either upwards or downwards. Connections may be made by means of screws or soldering tags, and the general finish of the component is good, although the construction is somewhat on the light side.

Several valves were tried in the holder, and all were found to be a good tight fit, assuring that good electrical contact be made to each of the pins. The insulation resistance between pin to pin was found to be infinity in each case, and it is clear that considerable care and thought have been expended on its construction. We have no hesitation in recommending this component for use.

High-tension Accumulator

MESSRS. THE TUNGSTONE ACCUMULATOR CO., LTD., have sent to us one of their standard 60-volt 3-

**The L. & P. Indicating Dial**

The whole wireless world knows that the "L. & P." Universal Coil Holder gives the finest control of coupling ever achieved. Thanks to the new L. & P. Indicating Dial you can now keep a record of the exact degree of coupling between the two coils from 0 to 90 degs.

The dial is easily fitted to any L. & P. Coil Holder—without even the need of drilling a hole. It is an accurate scientific instrument, beautifully made and working without a trace of backlash. The one thing needed by the experimenter who believes in keeping a log of all stations received.

**L. & P. Indicating Dial - 5/6 each.**

The L. & P. Universal Two-Coil Holder is a marvel of value at 8/6.

FROM GOOD DEALERS EVERYWHERE.

Manufacturers:  
**LONDON & PROVINCIAL RADIO CO. LTD.,**  
COLNE, LANCs.

Telephone: 94. Telegrams: "Reception"

<p><b>JACKS, 4-POINT.</b></p> <p>1-HOLE FIXING. 1/9</p>	<p><b>IZION, HAND DRILL.</b></p> <p>Only TAKES DRILLS 3/6 UP TO 5/16 in. SIX DRILLS - - 1/-</p>	<p><b>RELIABILITY CONDENSERS.</b></p> <p>Only Mansbridge Mid. Type. 25, 1/8, 1/4, 1/2, 3/4, 1, 1 1/2, 2, 3/2</p>	<p><b>WIRELESS CABINETS.</b></p> <p>For Panels, 7 in. high—Width 8". Hinged Lid Oak 12", 14", 16", 18", 20", 24", 28", 32", 36", 40", 44", 48", 52", 56", 60", 64", 68", 72", 76", 80", 84", 88", 92", 96", 100". Mabogany, 1/- extra.</p>	<p><b>DEWAR SWITCH.</b></p> <p>12-CONTACT. 2/6.</p>
---	---	--	--	---

**READ THIS LIST AND SAVE MONEY ON COMPONENTS.**

**ACCUMULATORS.**—Exide—D.T.G. 4/6, D.P.G. 8/6, W.J. 20v. H.T. type 15/-, Oldham H.T. 10d. per volt. Duroc 20v. 12/-, 10v. 6/-. Repairing Outfit 2/6. Hart, Oldham and Exide stocked.

**AERIALS.**—100 ft. in. Copper Tape 1/6, G.C. British 2/6, Enamelled 3/6, Electron 1/8, Superlat 2/6, Mars 8/6, O.V. complete 2/6, Ashton Spreaders 12/- per pair.

**INSULATORS.**—Large Shell 3d., Reel or Egg 1d., Climax 3d., do. with Shock Absorbers 3/- pair. Gal. Pulleys 4d., 100 ft. Gal. Straining Wire 1/6, Straining Bolts 6d., Spreader Ends 7d.

**HEADPHONES.**—Reliability 90v. 11/-, 60v. 7/6, 36v. 4/6, 15v. 1/10, Ever Ready, Siemens, Helicon, 108v. 2/-, 66v. 12/6, 36v. 7/6, Flashlight Battery Cases 14 Batteries 3/9, 4lv. Batteries 2/6.

**ERONITE.**—Any size cut, Clayton brand, 1 in. 9 in. by 6 in. 2/2, 12 in. by 9 in. 4/6, 15 in. by 9 in. 5/6, 3/16 in. 25 per cent. less. Paragon and Radion 1d. per sq. inch.

**CONDENSERS.**—Low Loss, Square Law, with knob and dial, .0005 5/-, .0003 4/6, with Vernier Blade 1/4 extra, Twin .0005 for Elstree Six, unequalled value, 9/6. Cydon Twin for do. 27/6. Ormond, J.B. Utility, Sterling, Polar, Formo, Irganic, G.E.C. Variable, and all capacities.

**FIXED CONDENSERS.**—Dubbler, Edison, Lissen, Watmel, Mullard, McMichael, at advertised prices. Special Reliability Fallon .0003, 2-meg. Leak, 1/3. Cases only 4d.

**L.F. TRANSFORMERS.**—R.I. Multi Ratio 27/6, Marconi Ideal 30/6, Junior 18/6, Ferranti A.P.3 25/-, A.P.4 17/6, Formo 10/6, H.T.C. Empire 7/6, Croix 5 to 1 4/-, Lissen New Type 8/6, Irganic 16/6, Eureka Concert Grand 21/5/-, No. 2 21/-, Baby Grand 15/-, Ormond 15/-, Royal 20/-, Success AH Black 21/-, Silvertown 21/-, G.R.C. 15/-, Brandes 17/6, Burndep 16/6, Special Value 7/6, R.A.P. Ex. Gvt. Transformers, Modulation or Telephone types 7/6.

**VALVE HOLDERS.**—Antiphonic Benjamin 2/9, Lotus 2/3, with terminals 2/6, Burndep 2/6, Harlie 1/6, Reliability unequalled 2/-, all baseboard types, ordinary do. 6d., N.P. Valve Sockets flush fitting 1d., Superior All Ebonite Panel Type 10d., Open Type 6d.

**HEADPHONES.**—B.T.H. 15/-, Browns F, Type 20/-, Reliability 7/6, Adjustable 8/-, Dr. Nesper 12/11, T.M.C. 17/6, Western Electric 20/-, all 4,000 ohms, Sullivan 120 ohm, Double Ex. Gvt. New 4/6, 120 ohm. Single Phone 2/6, Long Phone Cord 1/-, Odd New Samples, 4,000 ohms, 10/-.

**DETECTORS.**—R.I. 6/6 and 6/-, Liberty 3/6, Cat's Eye 2/6, all permanently set, also good glass enclosed 1/-, 5 Tested Crystals 1/-, Neutron 1/6, Hertzite 6d., Tungstallite 6d. and 1/6.

**COIL HOLDERS 2-WAY.**—Lotus 7/-, with long handle 8/-, Penton geared 6/-, Polar Cam Vernier Blade 6/-, Newey 6/6, Woodall 10/6, Reliability Geared 3/6, Good Quality 2/6, Unequalled Value 6/-, Verrier Friction Drive Type 3/6, Single Moving Holder 1/6, Anode Holder 9d.

**COIL MOUNTS.**—Honeycomb type Reversible Pins 6d. Solid Ebonite, do 8d., Basket Coil holder 8d., Horned Coil Plug 8d., Narrow Ebonite 5d., Shorting Plug 7d., Reversing Plug 1/3 pair.

**UNEQUALLED VALUES.**—Twin Red and Black Plex 2d. yd., 46 Pin Collformer and instructions 1/-, with handle 1/3, 30 ohm. Resistance 1/6 N. Plated Valve Windows 3d., 1lb. Round 1/18s or 1/16s Tinned Copper Wire 7d., Square 24 in. by 1/16 in. Tinned Copper Busbar 1d., Coil Back Tape 6d., 12 yds. 1 in. Empire Tape 6d., Box assorted B.A. Screws and Nuts 1/-, Ex. Gvt. Standard Telephone Plugs 1/3, New Ebonite Sheet Cutting, Useful Pieces 1/6 lb., 2 Coils for 9d.

**EXPERIMENTERS' PARCELS.**—Containing Accessories of Various Types worth 20/-, post paid 5/6. VALVES.—Radion, all Types, Frelat 2-volt 3 amp. 4/11. All Advertised Makes Stocked.

Send for RELIABILITY WIRELESS GUIDE No. 2. Free on Request.

**J.H. TAYLOR & CO.**  
6, RADIO HOUSE, MACAULAY ST., HUDDERSFIELD  
Tel. 341 Grams: THOROUGH HUDDERSFIELD

Order 5/6 Value Carriage Paid. Under 5/6 2d. per 1/- for Packing &c.



**TESTED BY OURSELVES—(Concluded)**

ampere-hour high-tension batteries. This battery is contained in a polished teak box. Considering the capacity of this accumulator, it is not only reasonable in its dimensions, but also in its weight. The size of the container is 5 in. high, 9½ in. wide and 12 in. long, while the weight of the complete battery with acid is just under 26 lb.

The battery is sent out with its first charge, but in a dry condition. On receipt the battery was filled with acid, and given a further charge, and then left to stand for two months, after which the voltage was found to be 63 volts. It was then put into use, and a heavy current taken from it, and it was also short-circuited on several occasions. It was then kept in use for about two months, current being taken from it at rates varying from 12 to 30 milliamps. At the end of this period it showed a voltage of 53 volts overall, and even then did not show any serious voltage drop when under load.

This battery is of robust construction and reliable in use, while a great convenience is afforded by the provision of inter-cell tapings, by means of which it can be tapped off every 2 volts. Further,

.....  
 .....  
 .....  
 .....  
 .....  
 .....

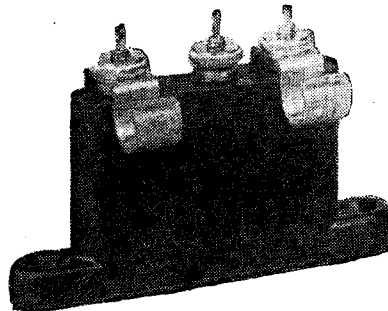

The T.C.C. grid condenser enables two different arrangements of the grid leak to be employed.

.....  
 .....  
 .....  
 .....  
 .....  
 .....

**Grid Condenser**

WE have received a grid condenser for test from Messrs. The Telegraph Condenser Co. Ltd.

This is similar in construction to their well-known components, a different terminal arrangement, however, being provided.

Instead of this component being provided with only two terminals, three are provided, which in conjunction with their grid leak clips enables it to be used either for series or parallel arrangement of the grid leak. Each condenser is accompanied by an explanatory leaflet showing how the desired connections can be obtained.

Rated at a capacity of .0002, its actual value was found to be .000193, giving an accuracy within less than 5 per cent.

The arrangement provided widens the scope of this component, which can, apart from its general utility, be recommended for its accuracy.

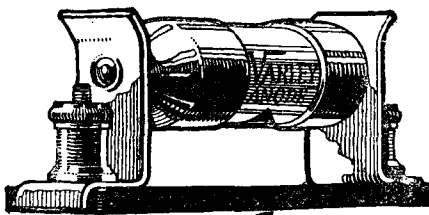

**The Varley Constant Bi-duplex Wire-wound ANODE RESISTANCE**

Non-inductively wire-wound on the famous Varley Bi-Duplex system, with turns of bare wire silk separated, the Varley Anode Resistances have a factor of safety in current carrying capacity greater than that of any other resistance on the market. Absolutely constant and unaffected by atmospheric conditions, the Varley Anode Resistances ensure that real purity of tone obtainable only with this form of intervalve coupling.

Complete range of sizes up to 250,000 ohms. Descriptive leaflet giving full particulars, on application.

The Varley Anode Resistance has figured in all the big sets of 1926 including the "Elstree Six," while the Varley Multi-cellular H.F. Choke has already been chosen for "The Night Hawk," and also for the 8-Valve Superheterodyne described in this issue of MODERN WIRELESS.



The Varley Magnet Co.

(Proprietors: Oliver & Co. Ltd.)  
 Granville House,  
 Arundel Street, London, W.C.2.

Phone: City 3393.

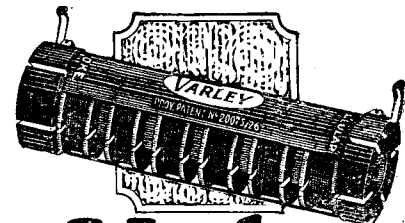

**The Varley Multi-cellular HIGH FREQUENCY CHOKE**

The remarkable efficiency of this new product—wire-wound on the famous Varley Bi-Duplex system—opens up new possibilities in Radio Science. In the Varley Multi-cellular H.F. Choke, not only are the bare turns of wire silk separated, but the winding itself has its individual turns and layers air spaced in a special manner, the winding on each cell being completed before passing to the next.

Price, complete 9/6.

Descriptive leaflet giving full particulars, on application.

LITTLE WIRELESS GADGETS

**MAP**

Small Parts to the Trade.

MAP Co. 246 Gt. Lister St. Birmingham.

**CASTLE RADIO CABINETS**

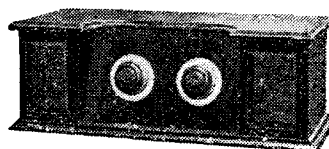

Send for our illustrated List No. 35N., post free. E. FARNELL & SONS, Birkenshaw, r. Bradford.

**Valves Batteries**

Radio Micro .06 .. 7-	Zeal 80v., tapped every 3
Do Power Lamp 10 9	Guaranteed Battery ... 7/9
Fama 4v. .06 .. 5-9	Fama 2v. 2, .. 4/-
Fama 2v. .06 .. 6-3	Fama Power 4v. 2 8/6

Write for list all Wireless Components. Trade enquiries invited. Phone: Av. 1452. S. D. ZEALANDER & CO., 124, Markie, London, E.



**YOU WOULD NOT TRY  
TO CARRY WATER IN A SIEVE  
THEN WHY MOUNT YOUR COMPONENTS  
ON A LEAKY PANEL? THE EFFECT IS  
THE SAME.**



**PANELS ARE GUARANTEED  
LEAK PROOF**

Insulation Resistance ... Virtual Infinity.  
Surface Resistivity ... Virtual Infinity.  
Electric Strength to Admiralty Specification.

**YOUR DEALER WILL SECURE THEM FOR YOU.  
TRY OUR RENOWNED FIXED CONDENSERS.**

*Sole Manufacturers:*

**THE PARAGON RUBBER MFG. CO., LD.,**  
86, GRAYS INN ROAD, LONDON, W.C.  
Holb. 1856.

*Special Wireless  
Cabinets  
to Customer's orders*

*Cabinets that at any time  
are illustrated or described  
by the Editor of this Journal  
we can make to order.  
Ask for prices. Delivered  
free anywhere in the  
United Kingdom.*

*Hundreds of readers of this  
Journal have expressed their  
satisfaction with workmanship  
and price of our cabinets*

*Specialist makers of Wireless Cabinets  
Caxton Wood Turnery Co  
Market Harborough*

Patent No. 248921.  
Registered Design No. 715424.  
Beautifully finished in genuine Bakelite, the Belling-Lee Terminal eliminates soldering, is completely insulated, and made in 28 different engravings.

Standard Model (Bakelite-Insulated) Type B 9d. each.  
Popular Model (Non-Insulated) ... Type M 6d. each.

Solid cast metal Dial Indicators, with white polished letters on a black background. One-hole fixing. 8 different letterings. 6d. each.

Ask your dealer for them, but if he cannot supply, send your order to us enclosing his name and address. Catalogue free on request.

**BELLING-LEE  
PANEL FITTINGS**

Advertisement of BELLING & LEE, Ltd.,  
Queensway Works, Ponders End, Middlesex. E.P.S. 12

**Convenience  
for 1<sup>d</sup>**

Newey Snap Terminals, Studs, Adapters, 'Phone Connectors, and Multi-Connectors—each one of these an added convenience and improvement to your wireless set—can now be bought for—  
**1d.** (Nickel-plated 1½d.).

For this trifling sum you can have all the 'phones your set will stand from two terminals only. There is no unscrewing of nuts and twisting of wires round the screws; just press the connector on to the stud and the connection is complete and perfect. You can switch over from 'phones to loud-speaker at a moment's notice. Battery connections are perfectly simple; and for experimental circuit work Newey Snap Terminals will save the constructor precious hours.

Experimental Sets in Boxes ... (Brass) 1/6 (Nickel-plated) 2/-  
Sole Distributors: PETTIGREW & MERRIMAN (1925), LTD.  
Phonos House, 2 & 4, Bucknall St., New Oxford St., London, W.C.1.  
Telephone: Gerrard 4248/49. Telegrams: Merrigrew, Westcent, London.

**Newey SNAP  
TERMINALS**

# A SCREENED-COIL SUPER-HETERODYNE

(Continued from page 441.)

remove the chokes, solder one end of the wire to the appropriate point upon the valve socket, replace the choke and make the other joint.

Just one other point in connection with the wiring should perhaps be mentioned. It will be observed that there is a twin twisted lead for the connections between the anode of the last valve and H.T. plus, through the appropriate contacts upon the jack. This is a rather important point, and some care should be taken to run the lead exactly as seen in the wiring diagram and photographs.

### Operating Details

Full operating details, notes on how to get the best from the receiver, and so on, will appear next month. Meanwhile it may be desirable to give a little information as to valves and voltages, etc.,

in order that those who have not had much previous experience of super-heterodynes may be in a position to get the instrument working satisfactorily.

As regards valves, it will be found that the high-impedance, high-amplification-ratio types originally intended for resistance-capacity low-frequency amplification will give particularly good results in all positions in the set except the two low-frequency amplifiers, which should be of the low-impedance power type. For the oscillator, almost any type of valve will do, one of the fairly freely oscillating type being perhaps slightly preferable.

As a general guide, it will be found that about 40 volts upon the H.T. + 1 terminal, 60 upon H.T. + 2, 80 or 90 on H.T. + 3, and about 100 or 120 upon H.T. + 4 will give good results.

### Operating Hints on the Elstree Solodyne

(See page 471)

## There's proof positive in the N.P.L. Curve

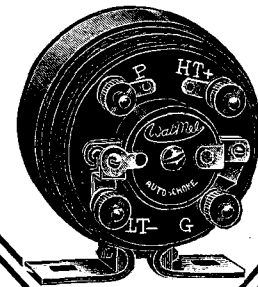

### THE WATMEL AUTO-CHOKE

has won immense popularity among constructors because of its ability to amplify without coarsening TONE. The N.P.L. Curve of this ingenious component is "as straight as a die." N.P.L. Curve 103/9 and Booklet on request.

# Watmel

### The WATMEL WIRELESS COMPANY, LTD.

332a, Goswell Rd., London, E.C.1

Telephone: Clerkenwell 7990.

Lancashire and Cheshire Representatives:

MR. J. B. LEVIER,

23, Hartley Street, Levenshulme,  
Manchester.

TELEPHONE: 475 HEATON MOOR

# BUSH HOUSE

The Largest Wireless House outside London.  
CALL IN AND SEE US.

PARTS FOR  
**ELSTREE SIX; SOLODYNE**  
and all other POPULAR CIRCUITS.

Do not fail to write for it—it is sure to be in stock.

SEND FOR LIST NOW.

60 Volt Sure Life Batteries - 7/6 *Guaranteed*  
100 " " " - 12/6 *and post free*  
9 Volt Grid Bias - - - 1/- *over 5/-*

All makes of Valves in Stock.

**35, SHUDEHILL, MANCHESTER**

## COUPON.

### QUESTIONS & ANSWERS.

In future this coupon must be accompanied by a P.O. for 2/6 for each question and a stamped addressed envelope.

**"MODERN WIRELESS"**

OCTOBER, 1926.

## FREE BLUEPRINT SERVICE COUPON.

Modern Wireless Vol. VI. No. 5. Oct., 1926

This coupon entitles the reader to one blueprint of any set described in the above issue, and must accompany each postal application.

**"YOU'LL CONVERT  
YOUR  
RIGID  
HOLDERS  
NOW."**



Fig. 975.  
Code Word  
"WOBBLERS"

**JUST PLUG  
THEM IN!**

Per 1/6 Set of  
4 (3 black,  
1 red)

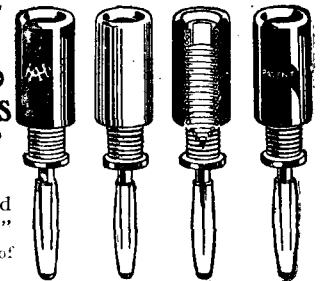

Full Size Illustration.

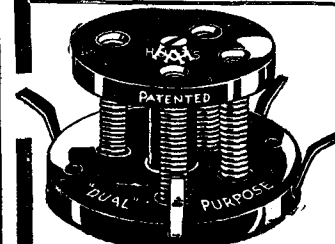

Full Size Illustration.

Code "DUAL" Word.  
**PURPOSE**

DOUBLE ENDED. Price 1/9 each  
**THE FOOL-PROOF HOLDER**  
FOR BASE OR PANEL FITTING  
OR IN ANY OTHER POSITION.  
The smallest and neatest combined  
holder on the market. No joints  
because the soldering tag is the  
same piece of wire as the spring.  
Show cards and display cards free.

Code "WOBBLY" Word.  
PRICE 2/3 each.  
THE IDEAL  
EXPERIMENTER'S HOLDER  
TOO SIMPLE TO IMPROVE

For the genuine experimenter who must have a holder without capacity and perfectly sprung, Hunt's "WOBBLY" is ideal. It is impossible to have fewer parts, or to better insulate, separate or spring them. Separately sprung legs are far more effective than a closed-in solid spring top.

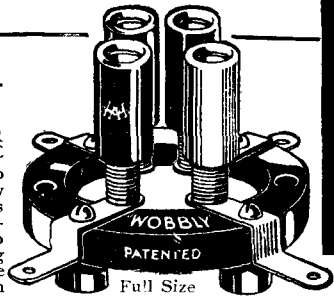

Full Size Illustration

Made under Patent 242057/24, Prov. Pats. 30670/25 and 40/26, by:—  
**A. H. HUNT, Ltd. (Dept. 5), Croydon, Surrey.**

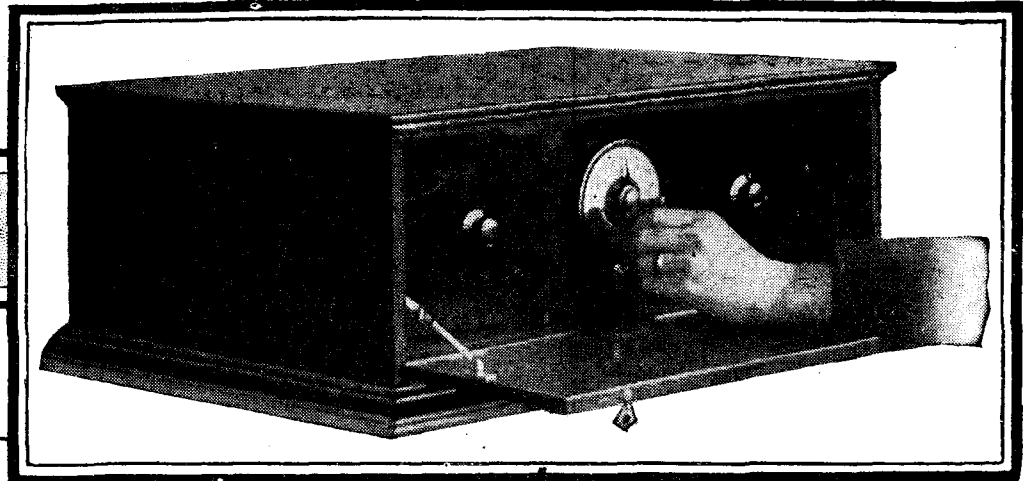

# YOU MAY WIN THIS WONDERFUL FIRST PRIZE

## A COMPLETE ELSTREE SOLODYNE

**SECOND PRIZE: A Complete Elstreflex Receiver**

**THIRD PRIZE: A Complete Razor-Sharp Wavemeter**

THE Mystery Number of WIRELESS, on sale Tuesday next, will give every reader the wonderful opportunity of winning an equally wonderful receiver—the Elstree “Solodyne.”

So great was the enthusiasm shown for this receiver at the recent Exhibition held at Olympia, that we have every reason to believe this issue will have record sales.

Copies of the Mystery Number may be difficult to obtain except on the day of publication. You may avoid any disappointment by giving your newsagent instructions *to-day* to deliver your copy.



Obtainable from all Newsagents, Bookstalls and Booksellers, or direct from the Publishers, Radio Press, Ltd., Bush House, Strand, London, W.C.2. Subscription Rates, 13/- per annum throughout the world.

EVERY reader and each of his friends should try to be the fortunate winner of one of these wonderful prizes. Full details of the conditions of entry will be published in the issue of WIRELESS dated October 9th, on sale Tuesday next.

The Elstree “SOLODYNE”—the first prize—is the famous Five-Valve Receiver on which no fewer than fifty stations were received on the loud-speaker on one dial.

Buy your copy of WIRELESS early.

In addition this issue will contain many interesting articles:—

**MYSTERY ARTICLE** by a well-known *Radio Personality.*

**ATMOSPHERICS AND THEIR PREVENTION.** By *Captain H. J. Round, M.I.E.E.*

**SECRETS OF MODERN RADIO EFFICIENCY (Part IV).** By *J. H. Reyner, B.Sc. (Hons.), A.C.G.I., D.I.C., A.M.I.E.E.*

**WHAT THE NEW WAVELENGTHS MEAN TO YOU.** By *G. P. Kendall, B.Sc.*



*Buy "Wireless" on the way home*



# Tracing Trouble

By JOHN UNDERDOWN

*Some helpful hints on diagnosing faults in H.F. circuits of the neutralised split-secondary type.*

**I**T is intended, from time to time under this heading, to review various faults, in order that the symptoms may be recognised by readers in trouble, and remedies may be available. This month, it is thought by the writer that faults in a particular arrangement rather than general troubles will be of interest, and an account will be given of symptoms

layout or to insufficient attention being paid to published instructions.

### The "Elstree Six"

The H.F. and detector circuit arrangement of the receiver is reproduced in the figure for the purposes of reference, the actual components being lettered as in the original set. Combinations of Dimic coils and of ordinary plug-in coils are utilised to form neutralised transformer couplings, and here it is specially important to

of signal strength may be noticeable. The primary coils  $L_3$ ,  $L_5$  and  $L_7$  should be Nos. 50 or 60, the former giving the higher selectivity and the latter slightly better signal strength, although there is not a great deal to choose. Types of coils, which approximate in diameter to the Dimics used, are to be preferred here, although most makes of plug-in coils function satisfactorily. There is, however, upon the market at least one make with which the sense of the winding is

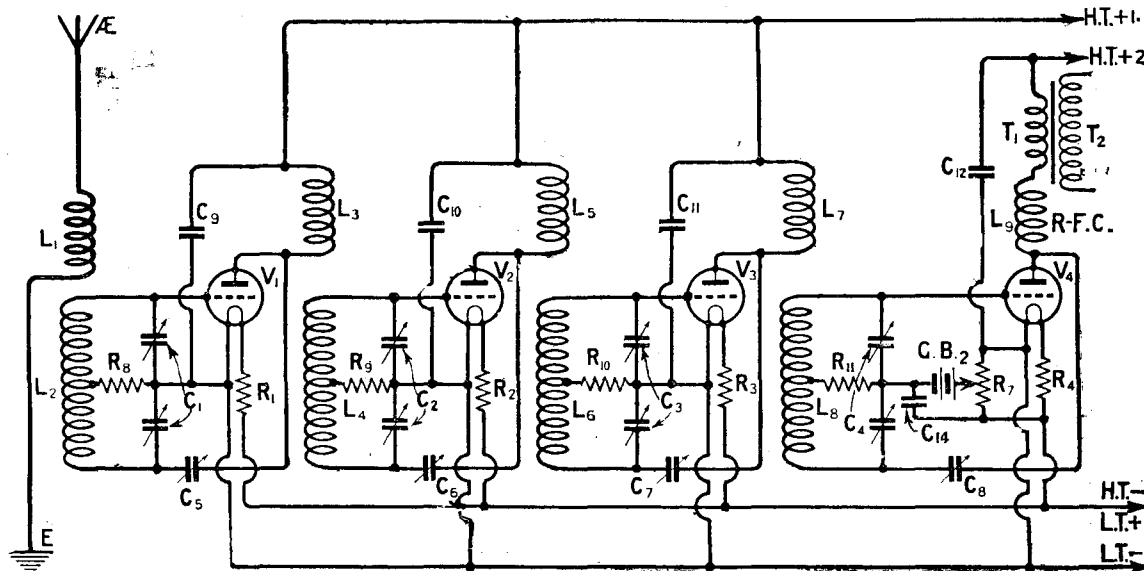

In a circuit of this type, if the primary coils  $L_3$ ,  $L_5$  and  $L_7$  are too large, some little difficulty may be experienced in obtaining stability.

observed when deliberate faults were placed upon an "Elstree-Six" type set. This particular receiver has been chosen, since it has made an extraordinary appeal to the listener, and as with every popular receiver a few readers are bound to experience difficulty, owing to various reasons such as alterations to components and

preserve the spacing between primaries and secondaries, if the results given in the article are to be duplicated. Tight coupling between the primaries and secondaries is necessary if the full signal strength of which the set is capable is to be obtained, and the spacing given on the blueprint must be followed exactly. If this is not done lack

reversed to that normally considered standard, and if such coils are employed it will be necessary to reverse the leads to the primary coil blocks.

If coils which are too large are employed for the transformer primaries, some little difficulty may be experienced in stabilising the receiver, and in such cases it is to

Another  
**FREE  
GIFT**  
for every  
reader

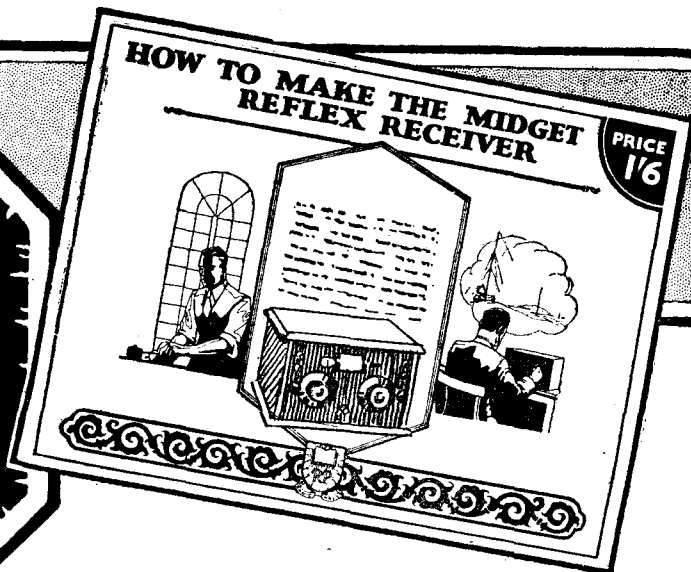

*J. H. REYNER, B.Sc. (Hons.), A.M.I.E.E.,  
who describes the "Invalid's Three."*

Other contents of this issue include :

**A STABLE TWO-VALVE SET**  
by G. P. Kendall, B.Sc.

A further article on the "DISTAFLEX TWO," one of the Radio Press Star Sets described in the October issue.

Notes on the "NIGHT HAWK," another Radio Press Star Set,  
by Percy W. Harris, M.I.R.E.

Also many other interesting articles by well-known writers.

**R**EADERS of "THE WIRELESS CONSTRUCTOR" will receive with the November issue another wonderful FREE GIFT, "How to build the Midget Reflex Receiver."

This will take the form of a constructional envelope, the contents of which will be similar to that of the famous Radio Press Envelopes, known to every home constructor.

Since this issue of "THE WIRELESS CONSTRUCTOR" will also be a Special Birthday Number you will be best advised to place an order with your newsagent to-day, otherwise you may have great difficulty in securing your copy.

*November Issue on Sale October 15*

# The Wireless Constructor

SIXPENCE MONTHLY

From all Newsagents, Bookstalls and Booksellers, or direct from the Publishers, Radio Press, Ltd., Bush House, Strand, London, W.C.2.  
Subscription Rates, 8/6 per annum United Kingdom, 7/6 per annum Canada and Newfoundland, and Other Countries 8/6 per annum.  
*Less periods pro rata.*

*From the nearest newsagent*

## TRACING TROUBLE—(Concluded)

be advised that one of the primary coils be decreased in size, preferably the centre one, namely  $L_3$ .

### The Anode Resistances

The effect of a broken down anode resistance, that is  $R_8$ ,  $R_9$ ,  $R_{10}$  or  $R_{11}$ , is a problem which I have investigated, by substituting a defective resistance which on a megger gave an infinity reading in each of these positions in turn. The symptom obtained with this defective component in the  $R_8$  position was a high pitched continuous whistle, whilst in the  $R_{11}$  position, that is in the grid circuit of the detector valve, the familiar bubble, bubble, bubble usually obtained with a break in a grid circuit, was present. In the  $R_{10}$  position the defective anode resistance merely gave rise to distortion and loss of signal strength.



In split-secondary circuits it is important to use anode resistances of reliable make.

### A Useful Test

It will be gathered from these experiments that a break in an anode resistance in the various positions may give rise to somewhat differing symptoms and it is worth while, when trouble is experienced, to roughly test these components with telephones and a dry cell for continuity.

### Detector Grid Bias

Correct adjustment of the grid bias to the detector valve has considerable bearing on the stable working of the L.F. side, and here with  $\frac{1}{2}$ -ampere type valves,  $1\frac{1}{2}$  or 3 volts with 60 volts H.T. generally proves satisfactory, and the adjustment of the potentiometer is found to be fairly sharp. With incorrect adjustment a note howl or whistle may be obtained.

### Neutralising

With  $\frac{1}{2}$ -ampere type valves and certain H.F. types in the H.F. stages the receiver is particularly easy to neutralise, and it is generally found that a setting which will give stability is with the neutralising condensers moving vanes about one third in. I have come

into contact, however, with a number of cases where complaints have been made that the set could not be neutralised, and in all cases this has been due to inattention being paid to the published instructions and not to an actual fault. A few words therefore on the subject of neutralising should prove helpful.

### A Simple Method

The simplest method to adopt is to set the reaction condenser at zero and all four tuning condensers to the setting for the local station, which may be obtained from the tuning chart given in a previous article, and to extinguish the first valve by removing the first Amperite, or fixed resistor. When this is done the first neutralising condenser,  $C_5$ , may be adjusted until the signals completely disappear or are reduced to minimum strength. It is essential when this is done that the tuned circuits on either side of the valve concerned are correctly adjusted for the reception of the given station, e.g., in the case of  $V_1$ ,  $C_1$ ,  $L_2$  and  $C_2$ ,  $L_4$ , although if a silent minimum point cannot be found when adjusting the neutralising condenser, one of the other circuits may be detuned until the desired silent point is obtained. Unless the adjacent tuned circuits are correctly adjusted, the neutralising will not be exact.

When the first valve has been correctly neutralised the procedure to adopt is to replace the first filament resistor or Amperite,  $R_1$ , and to remove  $R_2$ , the neutralising process then being carried out on  $C_6$ . This process should be carried out until all valves are stabilised.

With  $\frac{1}{2}$ -ampere type valves, or others with similar characteristics, it will be found that the neutralising setting is not particularly critical and a few degrees on either side of the correct point will still allow the receiver to remain stable.

### Other Valves

Should 60 milliamper type valves be employed in the H.F. stages, some little difficulty may be experienced in neutralising, since the capacity of these types between plate and grid is much less than that of the others previously mentioned, and it may be found that the plates of the neutralising condensers will have to be all out or near this position before the set is stabilised.

## RADIAX H.F. COUPLINGS

for all Modern Circuit

These splendid new coils are made in 8 series with 4 wavelength ranges to cover practically all circuits up to date.

The T.A. TRANSFORMER AND A.A. AERIAL coils are special for ELSTREE SIX with split secondaries and dual condenser tuning. The separate coil is thus avoided and a neat efficient unit results.

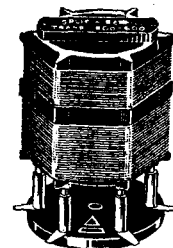

T.A. Transformer (3 required) each 10/6  
A.A. Aerial Transformer (1 required) ... 10/6  
6 Leg Bases for above .. 2/6  
Dual-Condenser, .0005 .. 17/-

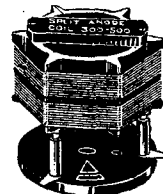

Split Single Coils for Anode tuning, etc., this is an almost universal type and will be in large demand this season whenever a single split low loss coil is needed.

150/400 6/8, 600/1200 8/3  
300/600 6/8, 1200/2000 9/-

### S.L.F. Low Loss Condenser

A splendid Precision Condenser at a moderate price. Has real straight line frequency characteristic; low loss, negligible minimum capacity and is remarkably rigid.  
Single .0003 10/6, .0005 11/6  
Dual for Elstree Six .0005 17/-

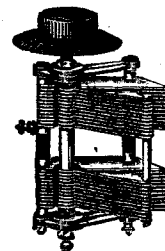

### H.F. Choke

150/4000 metres ... 8/-  
Send Id. stamp for lists of above, or 3d. for full illustrated catalogue of Modern Radio Components.

RADIAX Ltd. 40, Accessory Hse., Palmer Place, Holloway, London, N.7.

Farrs Ad.

## TRIUMPH

### 2-COIL STAND

Ref. No. C.169  
PRICE 5/9

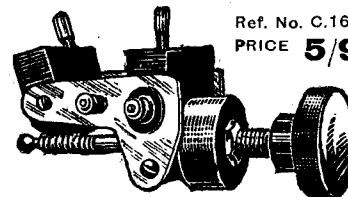

THE LATEST SUCCESS  
VELVET VERNIER ACTION

Also  
TRIUMPH VALVE-HOLDER  
[Anti-Microphonic] &  
TRIUMPH RHEOSTAT.

ASK YOUR DEALER FOR ILLUSTRATED LISTS,  
and send p.c. mentioning "Modern Wireless" to  
A. H. CLACKSON, LTD.,  
HART WORKS, LONDON, N.22

## TRIX

COIL HOLDER  
Back of Panel, one-hole fixing, vernier action: Geared pointer.  
Pat. app. for. 5/6

ERIC J. LEVER  
33, Clerkenwell Green,  
London, E.C.1  
and Branches.

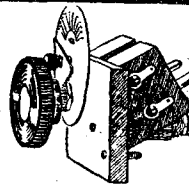

## AGAR for HIGH CLASS RADIO CABINETS.

A "Four" for Range and Selectivity.  
As described in this issue. Cabinet 37/3 carriage free. Panel-Radion 16x8x10, 3/19, WHITECROSS PLACE, E.C.2.

Index to Advertisers

	PAGE
Agar, W. H. . . . .	527
American Hard Rubber Co. (Britain) Ltd. . . . .	528
Ashley Wireless Telephone Co. . . . .	515
Beard and Fitch . . . . .	514
Bedford Electrical Co. . . . .	517
Belling and Lee . . . . .	522
Benjamin Electric, Ltd. . . . .	473, 489
Bennett College . . . . .	517
Bird (Sydney S.) . . . . .	499
Black, A. . . . .	528
Bowyer-Lowe Co., Ltd. . . . .	481
Brandes, Ltd. . . . .	486, 507, 513
British Battery Co. . . . .	499
British Ebonite Co., Ltd. . . . .	511
Brown Brothers, Ltd. . . . .	506
Brown (S. G.), Ltd. . . . .	469
Burne-Jones and Co., Ltd. . . . .	433
Bush House . . . . .	523
Cahill and Co., Ltd. . . . .	517
Carrington Mfg. Co., Ltd. . . . .	511
Caxton Wood Turnery Co. . . . .	522
Clackson (A. H.), Ltd. . . . .	519, 527
Cleartron Radio, Ltd. . . . .	434
Collinson Precision Screw Co., Ltd. . . . .	506
Cossor (A. C.), Ltd. . . . .	457
Coventry Direct Supplies, Ltd. . . . .	528
Curtis (Peter), Ltd. . . . .	506
Day (Will), Ltd. . . . .	512
Dubilier Condenser Co. (1925), Ltd. . . . .	485
Eastick (J. J.) and Sons . . . . .	511
Economic Electric, Ltd. . . . .	517
Electron Co., Ltd. . . . .	491
Falk, Stadelmann and Co., Ltd. . . . .	495
Farnell (E.) and Sons . . . . .	521
Ferranti, Ltd. . . . .	470
Finchett (C. A.) . . . . .	517
Pinston Mfg. Co., Ltd. . . . .	492

	PAGE
Forno Co. . . . .	511, 517
Garnett, Whiteley and Co., Ltd. . . . .	478, 512, 519
Gent and Co., Ltd. . . . .	515
Hamley Bros, Ltd. . . . .	503
Hart Accumulator Co., Ltd. . . . .	477
Hunt (A. H.), Ltd. . . . .	478, 523
Igranic Electric Co., Ltd. . . . .	458
Jackson Bros. . . . .	499
Jewel Pen Co. . . . .	518
Laurie and McConnell, Ltd. . . . .	518
Lever (E. J.) . . . . .	527, 528
Lissen, Ltd. . . . .	509
London Electric Wire Co. . . . .	462
London and Prov. Radio Co., Ltd. . . . .	520
London Radio Supply Co. . . . .	528
Makerimport Co. . . . .	519
M.A.P. Co. . . . .	521
McMichael (L.), Ltd. . . . .	466
Morris (J. R.) . . . . .	505
Mullard Wireless Service Co., Ltd. . . . .	Cover ii, 509
Neutron Distributors, Ltd. . . . .	474
New London Electron Works, Ltd. . . . .	509
Oldham Accumulators . . . . .	461
Ormonde Eng. Co., Ltd. . . . .	487
Paragon Rubber Mfg. Co., Ltd. . . . .	522
Peto-Scott Co., Ltd. . . . .	465
Pettigrew and Merriman (1925), Ltd. . . . .	491, 522
Picketts . . . . .	528
Portable Utilities Co., Ltd. . . . .	492, 497
Power Equipment Co., Ltd. . . . .	514
Radiax, Ltd. . . . .	527
Radio Instruments, Ltd. . . . .	Cover iv
Rawplug Co. . . . .	518
Raymond (K.) . . . . .	483
Redferns Rubber Works, Ltd. . . . .	495

	PAGE
Rothermel Radio Corporation of Great Britain, Ltd. . . . .	511
Sculthorps . . . . .	528
Sifam Electrical Instrument Co. . . . .	506
Silvertown Co. (The) . . . . .	514
Taylor (J. H.) and Co. . . . .	520
Telegraph Condenser Co., Ltd. . . . .	503
Valco, Ltd. . . . .	519
Varley Magnet Co. . . . .	518, 521
Watmel Wireless Co., Ltd. . . . .	523
Wildor Devlin and Co. . . . .	519
Wilkins and Wright . . . . .	485
Wireless Distributing Co., Ltd. . . . .	518
Wolff (M. and A.) . . . . .	511
Zealander and Co. . . . .	521

**ACCUMULATORS ON EASY PAYMENTS**

High Tension Accumulators built up from 20 Volt sections (15/- each). Example: 60 Volt H.T. 45/- CASH, or 12/6 DOWN and 6 monthly payments of 6/- Carriage Paid. Satisfaction or money back. Write for Lists to DEPT. 12, Coventry Direct Supplies, Ltd., Warwick Row, Coventry. Any Wireless Goods supplied on easy payments.



**5/- TYPEWRITERS 5/-**

A WEEK. ANY MAKE. A WEEK. Earns the Money before Payment. Standard Keyboard Machines. Yost, Remington, Smith Premier, £2 10s. 0d. Visibles, Underwood, Remington, Royal, from £7 15s. 0d. Yosts, Empires, Barlocks, Monarch, Oliviers, Hammonds, etc., £4 to £6. Portables from £6 6s. 0d. Terms: Cash Deposit and Monthly Payments. Full Particulars Free, and Local Agents Address: SCULTHORPS, 138a, West Nile Street, Glasgow.

**TRIX**  
Lever Pattern Switch  
is one-hole fixing, and it has an on-off indicating plate. No. 26a. 1/6. Also push-pull switches, one, two, and five way.  
**ERIC J. LEVER**  
33, Clarendon Gr., London, E.C.1 and Branches.

**PICKETT'S CABINETS**  
for every Constructor.  
"Daylow" Model from 30/-  
"Eletree Solodyne" } from 45/-  
"Eletree Rev. Reflex" } each.  
"The Night Hawk" }  
And many NEW Cabinet Designs.  
LISTS and Estimates—P.E.B. RETURN!  
**PICKETT'S CABINET (M.W.) WORKS, Bexleyheath.**

**SOLODYNE built for 12.6**  
We construct any Radio Press set at the price of the components plus 2/6 per valve only. First-class workmanship.—LONDON RADIO SUPPLY Co., 11, Oat Lane, London, E.C.2.  
Phone: City 1977.

**THE WIRELESS DOCTOR**  
will call (London and Home Counties) and put you right, if your set is troublesome. No cure, no charge. Sets installed, maintained and brought up to date.  
**ALEXANDER LACK, 2a, Woodville Grouv., N.16. Clissold 3687.**

Panel Talks: No. 1.

Should a panel be a looking-glass?

Is a mirror-like finish desirable on a panel? This is a question which has troubled the minds of most constructors. Here, then, is the answer: It is common knowledge that, after ebonite has been vulcanized, a metallic deposit is left on the panel's surface. This would cause serious leakage and the ebonite is, therefore, sandpapered to remove it. The rough "Matt" surface thus left is well known to ebonite-users. Look at such a panel under a microscope and it will be seen that there are in-

numerable tiny valleys and crevices—each one a "pocket" ready for a dust particle or speck of moisture, so making leakage an easy matter. It is on this account that the new Resiston Panels (like the famous Radion) are supplied ready for use with a highly polished, mirror-like surface, not produced by metallic rolling, but by an exclusive process which seals up the pores of the ebonite and thus provides a hundred-per-cent. insulating material. It's necessary to handle a Resiston panel to appreciate its superfine finish.



Look for the name

on every panel

Made by American Hard Rubber Co., Ltd., 132, Fore St., E.C.2

Made by the Makers of Radion Panels

G.A. 5820