

MODERN WIRELESS



March

1/6

Vol. IV. No. 2.

Edited by JOHN SCOTT-TAGGART, F.Inst.P., A.M.I.E.E.

March, 1925.



SPRING

"HOW TO MAKE"

DOUBLE

NUMBER

1/6

with free Blueprint



KARSAY

HOW TO MAKE:—

- THE SIMPLIFIED "THREE-VALVE DUAL" RECEIVER.** By John Scott-Taggart, F.Inst.P., A.M.I.E.E.
THE "NEUTRODYNE JUNIOR" CABINET SET. By Percy W. Harris, M.I.R.E.
THE "RESISTANCE FOUR." By A. Johnson-Randall.
A TRI-COIL TWO VALVE RECEIVER. By John W. Barber.
A SINGLE VALVE SET FOR KDKA. By Stanley G. Rattee, M.I.R.E.
A USEFUL CRYSTAL SET. By John Underdown.

CHOKE AND TRANSFORMER AMPLIFIERS.
By H. J. Round, M.I.E.E.

FRAME AERIAL EXPERIMENTS.
By A. D. Cowper, M.Sc.

POST-BAG PUZZLES.

By A. R. Burrows (Uncle Arthur).

A VISIT TO THE EIFFEL TOWER.

By Capt. L. F. Plugge, B.Sc.

Build with Burndept Components to get the best results

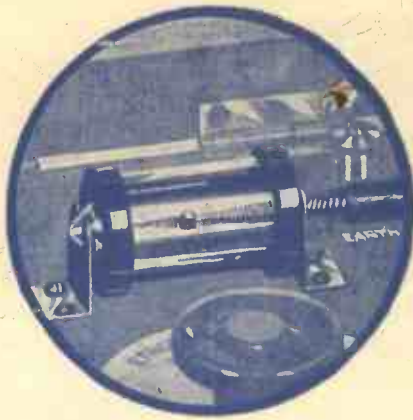

No. 215.—Crystal Detector, for panel mounting, as illustrated, in carton with screws and drilling template. 4s.

No. 216.—Crystal Detector, for experimental use, mounted on an engraved ebonite panel, fitted with terminals, the whole mounted on a polished walnut base. 11s. 6d.



Set of 4 Extra Short Wave Coils (80-150 metres), 16s.

Set of 4 Concert Coils (150-800 metres), 16s.

Set of 9 Coils, S₅ to 1,000 (750-20,000 metres), £3 16s. 6d.

Prices of single coils sent on application

WHEN you build a set with Burndept Components for the first time, you will be amazed at the difference in power and sensitivity of the apparatus in which they are used. Many keen and critical constructors testify to their great efficiency. You can be sure of good results when you build with Burndept Components which are fully guaranteed.

Crystal rectification in its most efficient form is well represented by the **Burndept Crystal Detector**, a very popular component recently reduced in price. In this Detector, the cat-whisker is controlled by a micrometer screw working through a ball-joint, the movement providing delicate adjustment. Frequent re-setting is not required. The sensitive synthetic crystal and all moving parts are enclosed in a glass tube, protected from dust. This component is very neat in appearance.

The use of **Burndept Coils** is a distinct factor in securing good reception on all wave-lengths between 80 and 25,000 metres. These Coils have extremely low self-capacity and high-frequency resistance, due to the patented method of construction. Each Coil is mounted on a non-reversible plug with spring contact pins. Write for Publication No. 44, which gives full particulars and prices, together with an interesting chart showing the wave-length range of the Coils.

The **Anti-Phonic Valve Holder** eliminates microphonic noises in dull-emitter valves and will prolong the life of any type of valve. As the illustration shows, the valve holder proper is slung on springs which absorb mechanical shocks and so protect the valve. The valve sockets are countersunk and thus the risk of short-circuits is eliminated.

Latest Catalogue sent FREE

Write for a free copy of the latest Burndept Catalogue, which gives full particulars and prices of the whole range of Burndept components, accessories, auxiliary apparatus, complete receivers and receivers for home assembly.

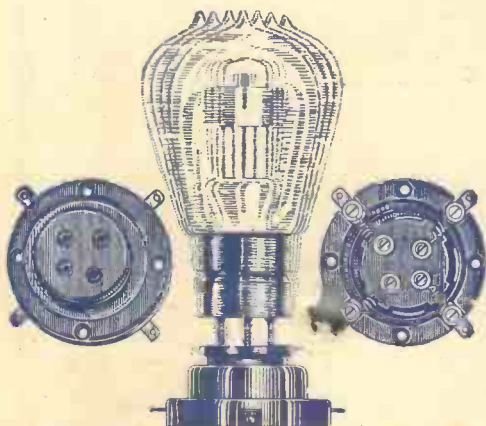

No. 401.—Anti-Phonic Valve Holder, for panel or base mounting, in carton with screws, 5s.

BURNDEPT

WIRELESS APPARATUS

BURNDEPT LTD., Aldine House, Bedford Street, Strand, London, W.C.2

Telephone: Gerrard 9077. Telegrams: Burndept, Westrand, London.

LEEDS: 12, Basinghall Street (near City Square).

CARDIFF: 67, Queen Street. NORTHAMPTON: 10, The Drapery.

Purchase Burndept by its name—substitutes are not the same



Editor:

JOHN SCOTT-TAGGART,
F.Inst.P., A.M.I.E.E.

Assistant Editor:

PERCY W. HARRIS, M.I.R.E.

Staff Editors:

E. H. CHAPMAN,
M.A., D.Sc.

A. D. COWPER, M.Sc.

G. P. KENDALL, B.Sc.

R. W. HALLOWS, M.A.

S. G. RATTEE, M.I.R.E.

Radio Press, Ltd.,

'Publishers of "Wireless Weekly" and "The
Wireless Constructor,"

Bush House, Strand, W.C.2.

Telephone.—City 9911.

Contents

	PAGE
A Simplified Three-Valve Dual Receiver ...	135
By JOHN SCOTT-TAGGART, F.Inst.P., A.M.I.E.E.	
The Eiffel Tower. By CAPTAIN L. F. PLUGGE, B.Sc.	144
The Neutrodyne Junior ...	148
By PERCY W. HARRIS, M.I.R.E.	
Postbag Puzzles. By A. R. BURROWS ...	154
The Resistance Four. By A. JOHNSON-RANDALL	158
The Crystal Analysed ...	165
By J. F. CORRIGAN, M.Sc., A.I.O.	
A Single Valve Receiver for KDKA ...	168
By STANLEY G. RATTEE, M.I.R.E.	
The Super-Negadyne. By A. D. COWPER, M.Sc....	172
A Plug-in Coil for "Untuned Aerial" Circuits...	174
By G. P. KENDALL, B.Sc.	
More T.A.T. Circuits ...	184
By JOHN SCOTT-TAGGART, F.Inst.P., A.M.I.E.E.	
An Adaptable Two-Valve Receiver ...	191
By JOHN W. BARBER.	
Low-Resistance Frame Aerials and Distant Reception. By A. D. COWPER, M.Sc. ...	200
Regular Programmes from Continental Broad- casting Stations ...	208
Choke and Transformer Amplification ...	216
By H. J. ROUND, M.I.E.E.	
An "Auto-Coupled" Crystal Set ...	222
By JOHN UNDERDOWN.	
Regular Programmes from American Broadcasting Stations ... Tested by Ourselves 252 ...	247



Scientific Adviser:

Prof. G. W. O. HOWE,
D.Sc., M.I.E.E.

Advisory Editors:

Prof. R. WHIDDINGTON,
M.A., D.Sc.

Prof. C. L. FORTESCUE,
M.A., M.I.E.E.

Advertisement Managers:

BARCLAYS
ADVERTISING LTD.,

Bush House, Strand, W.C.2
Tel.—City 9911.

All correspondence relating to contributions is to be
addressed to the Editor of "Modern Wireless."

Nothing contained herein is to be regarded as permission
or encouragement to infringe any patent rights.



3 Personally Guarantee

THE consistent efficiency and reliability of the Famous Formo Components, which are universally recognised alike by the more advanced experimenter and the home constructor. This latter, while not a scientific enthusiast, demands and rightly expects that his home constructed receiver should yield results which shall be the envy of his friends. These envied results, however, are often an adventure—made the more speculative by the employment of such apparatus as is neither used nor recommended by technical authorities. The Famous Formo Components—The Formo L.F. Transformer and Formo Variable Condensers, for example—designed with fearless originality to give unexcelled results and tested exhaustively in our own research laboratory for mechanical and electrical fault, preclude any speculative adventure.

Experimenters who build the Famous Formo Components into their sets—incorporate gilded securities with the assurance that they will yield the good dividend of highest efficiency.

ARTHUR PREEN, A.M.I.E.E.

The Guarantee

by reason of the high standard of efficiency of the Famous Formo Components, the rigorous methods employed in our test department, and the equally stringent choice of raw materials, enabled us to be the first manufacturers to back our products by an unconditional guarantee.

The reflection of our confidence in the Famous Formo Components is epitomised in this our guarantee: that these are guaranteed unconditionally to perform satisfactorily, to be highly efficient and to give results unexcelled.

Formo Company



THE FORMO COMPANY

(ARTHUR PREEN & Co., Ltd.),
Contractors to the Admiralty, War Office, India
Office, Air Ministry, and Post Office.

Chief Office and Works:
CROWN WORKS, CRICKLEWOOD LANE, N.W.2.

Resident Representatives:
Scotland: Mr. Miller, 22, York Place, Edinburgh.
Manchester: Mr. J. B. Levee, 23, Hartley Street,
Levenshulme.
Birmingham: Mr. H. E. Crocker, 134, Reservoir Road,
Edlington.

POLAR BLOK

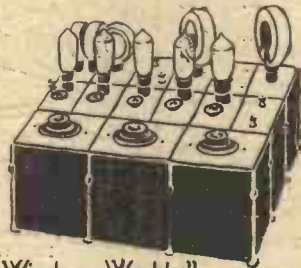

The "Wireless Weekly"
5 Valve Supersonic



A 4 Valve Set

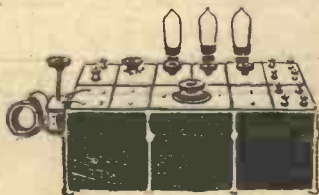

A 3 Valve Set



A Single Valve Set

Old Method

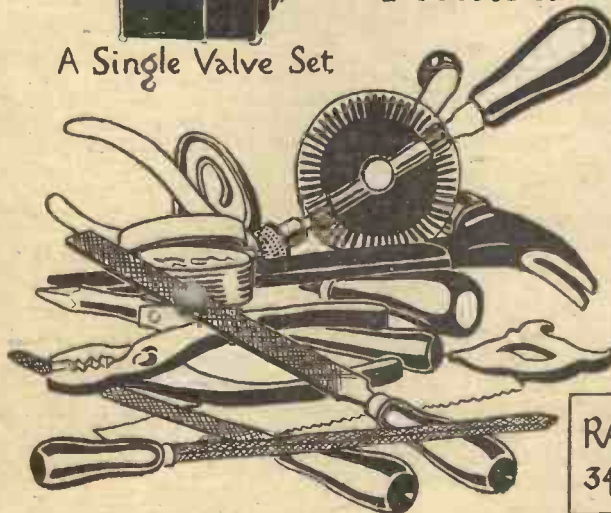

Polar Blok Method



There is an art in acquiring knowledge. In order to become acquainted with wireless phenomena, an experimenter should not content himself merely with investigating a few circuits haphazardly. He should study carefully every circuit which involves a new principle.

This necessitates rapid experimenting in order to keep abreast of developments, and for this purpose a number of components and the ability to arrange them quickly in any desired order is necessary. The drilling of panels, soldering of connections and construction of wooden boxes is sheer waste of time from the point of view of the experimenter, and tends to divert his efforts from the main channel of experimental work to that of proficiency in mere mechanical labour.

Effective experimenting is facilitated by methodical working. The scientific method is

THE POLAR BLOK METHOD.

Unit panels each carrying a first-class component and the necessary terminals can be rigidly but temporarily fixed in any desired order, on an extensible frame. No soldering is necessary, and it is possible to wire up almost any circuit efficiently in a few hours. The finished instrument can then be fixed into an extensible box. The initial outlay is low and the only tools required are a screw-driver and a pair of pliers. Just think of it! No waste of time or material—an inexpensive hobby with unlimited possibilities! Your existing components can be mounted once and for all on blank Polar Blok panels.

As an example of economy—the Polar Twin Receiver—the most efficient Two-Valve Dull Emitter, Dry Battery, Loud-speaker Set on the market to-day—is constructed entirely of Polar Blok parts. Its performance is better than that of many a four-valve set and its cost is only £5 10s., plus royalty, £1 5s.

RADIO COMMUNICATION CO LTD
34-35 NORFOLK ST, STRAND W.C. 2

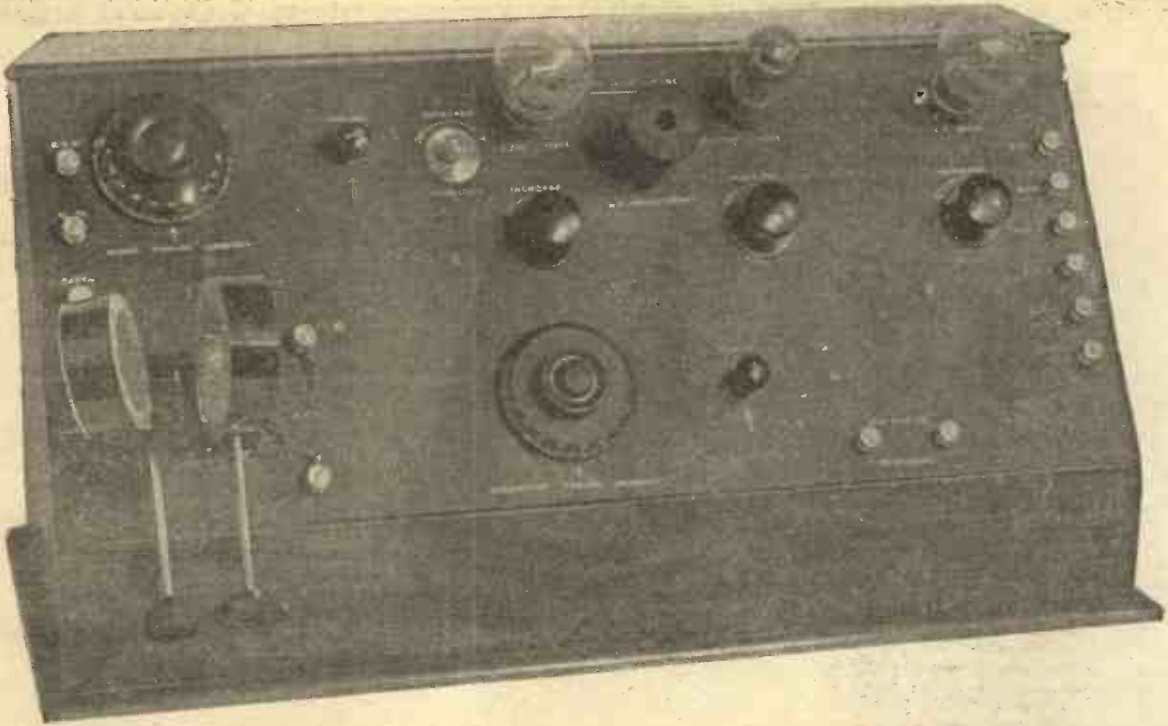

The appearance of the receiver when completed is very pleasing, as shown by the above photograph.

A Simplified Three-Valve Dual Receiver

Designed by JOHN SCOTT-TAGGART, F.Inst.P., A.M.I.E.E.

This article describes a simplified form of the "3-valve dual" described in "Modern Wireless" of April, 1924, by the Editor, who has now introduced the modifications given below. The components are almost entirely the same, but "switching" to try different arrangements is cut out, so that satisfactory results can only be guaranteed if the low frequency transformers specified are used and the general design closely followed. The results are equal to those of the original set. The reports from readers who have built the former receiver have frequently been published.

WIRELESS receivers employing the dual, or reflex, principle seem to present a strange fascination to the average wireless man. This, of course, is not unnatural when it is remembered that in sets of this type one valve is made to do the work normally accomplished by two. Although this is the one and only advantage obtained by using a dual circuit, it will be agreed that the saving of the extra valve, and the consequent economy in current for filament heating, constitute a very important advantage where it is desired to keep running costs as low as possible.

General Design

The receiver shown in the photographs employs three valves, the first working in the dual capacity of high and low-frequency amplifier, the second as a detector, and the last as a plain low-frequency amplifier. Many readers will

remember the description of a 3-Valve Dual Receiver in the issue of MODERN WIRELESS for April last year, and it was the great popularity attained by this set which led to the production of the present instrument, which is built on somewhat similar lines.

Modifications have been made, however, with a view to simplifying the original model, which contained a somewhat complex arrangement of terminals on the front of the panel for the purpose of changing the circuit to "straight" or "dual" as required. The present instrument is essentially a three-valve receiver, the elimination of provision for circuit changing resulting in considerably greater ease of construction and operation.

Extreme simplicity is not claimed in connection with the operation of the set, but once it is mastered, excellent results are possible. To those who desire great volume from the nearest station and very

commendable range, the receiver should make a special appeal.

Panel Lay-out

A photograph of the receiver in readiness for work is seen above, a handsome appearance as well as maximum efficiency being obtained by the lay-out of the components on the panel. The aerial circuit terminals (three in number) are seen on the left hand side of the panel, and reading from the top, are marked C.A.T., Aerial and Earth. The purpose of these terminals is discussed later. To the right of the aerial circuit terminals is the dial controlling the aerial tuning condenser, while immediately below the latter is a vernier two-coil holder with coils inserted. The two terminals to the right of the coil-holder permit a reversal of the connections to the right-hand socket. A small knob will be observed to the right of the aerial tuning condenser this controlling a two-plate vernier

condenser for fine tuning of the aerial circuit.

Battery Connections

Still further to the right is another small knob marked stabiliser, this controlling the value of a 100,000 ohm resistance for stabilising purposes. The three

arranged in a row on the right hand side of the panel, and reading from the top are marked H.T. 1, H.T. 2, H.T. —, L.T. +, L.T.— G.B. + and G.B.—. The two terminals for the telephones or loud speaker are placed slightly to the left of the battery terminals, near the lower edge of the panel.

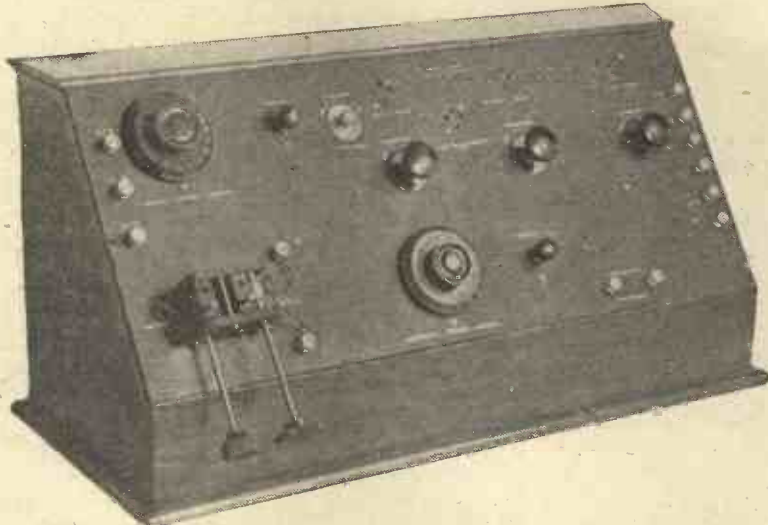

A general view of the receiver showing the simplicity of the lay-out.

valves are arranged in a row near the top edge of the panel, with their respective rheostats immediately below. A high-frequency transformer is inserted in a socket between the first and second valves.

Below the filament rheostat of the first valve is a knob and dial marked Secondary Tuning Condenser, while another two-plate vernier condenser is controlled by the small knob further to the right.

The six battery terminals are

Aerial Tuning Arrangements

Since the keynote of the receiver is simplicity combined with efficiency, provision has been made only for two forms of aerial tuning, namely, ordinary parallel tuning and constant aerial tuning. The former is obtained by connecting the aerial lead-in to the terminal marked Aerial, and the latter by joining the lead-in to terminal C.A.T. The earth wire is connected to the terminal marked Earth in each case.

The Circuit of the Receiver

A diagram of the circuit arrangement of the receiver is given in Fig. 1.

The aerial circuit comprises the coil L_1 tuned by the variable condenser C_2 of $.0005\mu F$ and also by the vernier condenser C_3 , the by-pass condenser C_4 of $.001\mu F$, and, if constant aerial tuning is employed, the condenser C_1 of $.0001\mu F$. The incoming high-frequency oscillations are communicated direct to the grid of the first valve V_1 , which amplifies at high-frequency, the magnified impulses in the anode circuit of the valve passing through the primary winding L_2 of the H.F. transformer L_2L_3 , and also through the fixed by-pass condenser C_5 of $.001\mu F$.

Further Details

The varying H.F. potentials across L_3 are communicated to L_4 , tuned by C_6 of $.0003\mu F$ and the vernier C_7 , and to the grid of the second valve V_2 through the grid condenser C_8 of $.0003\mu F$. The latter condenser, in conjunction with the leak R_5 of two megohms resistance, results in rectification by V_2 , in whose plate circuit is the reaction coil L_1 coupled to L_2 , and the primary T_1 of the low-frequency transformer T_1T_2 . The L.F. impulses in T_1 are induced into T_2 , connected between the grid and filament of the first valve, which consequently amplifies at low-frequency. Considerably magnified low-frequency impulses result in the anode circuit of this valve, and these are communicated to the grid of the last valve V_3 , via the low-frequency transformer T_3T_4 . The greatly amplified currents in the anode circuit

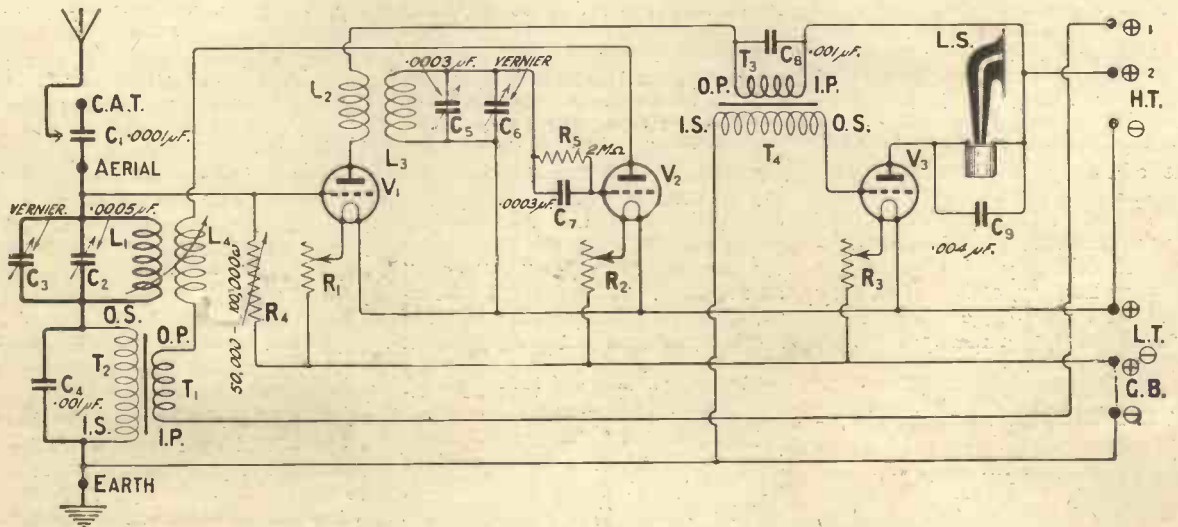

Fig. 1.—The theoretical circuit, with values indicated.

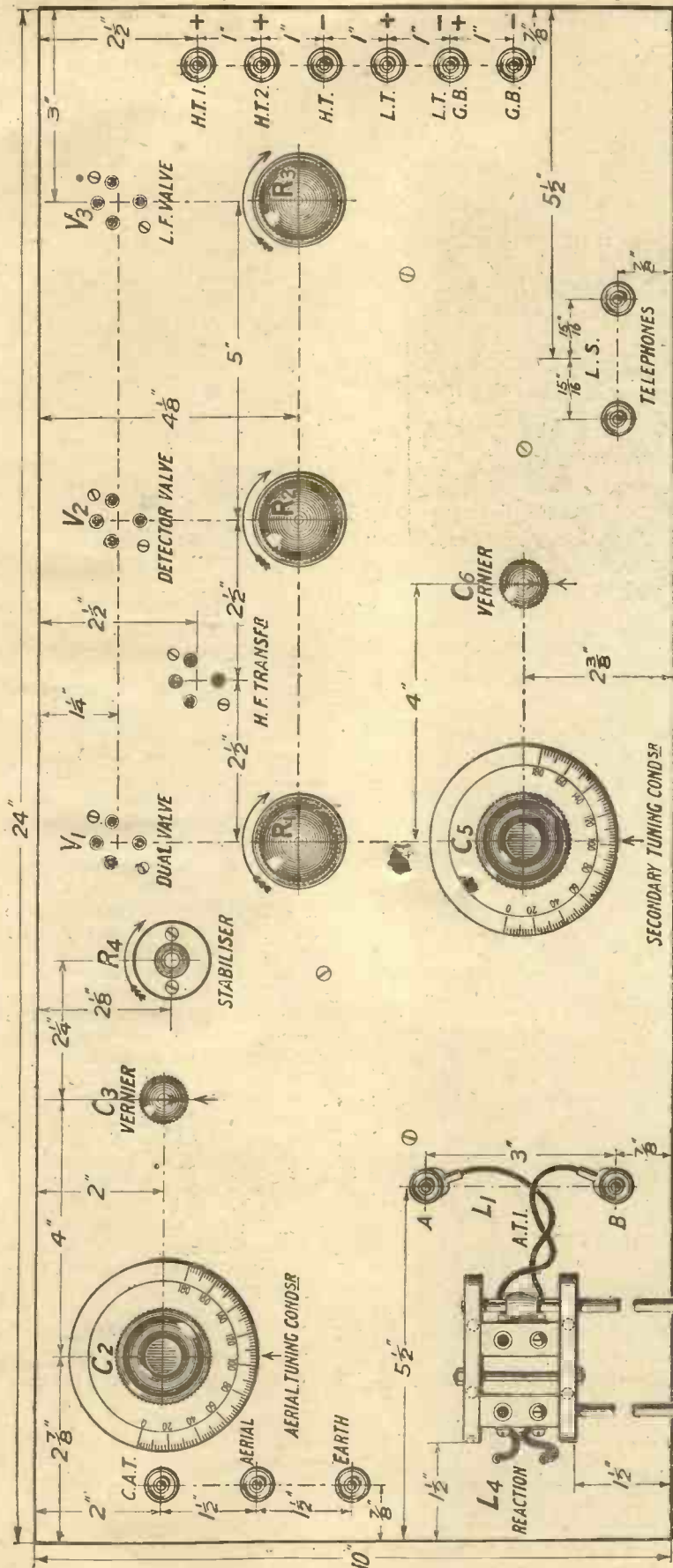

Fig. 2.—The lay-out of the panel Blue Print No. 99a.

operate the loud-speaker L.S., across which is connected the condenser C_c of .004 μ F.

H. T. Voltage and Grid Bias

The terminal H.T. 1 allows a separate anode potential to be applied to the detector valve—a very important factor in a circuit of this type. Excellent results are obtained by applying similar voltages to the first and last valves, but the detector will generally operate with maximum efficiency on a much lower anode voltage than that which is suitable for the amplifiers.

The value of the H.T. offered to H.T.1 governs very largely the tendency of the circuit to buzz.

By means of the terminals L.T.—G.B. +, and G.B.—, V_1 and V_3 may be given suitable negative grid potentials to ensure pure reception with maximum volume.

The Constructional Work

It is probable that many would-be constructors of the receiver feel some qualms as to their abilities to carry out all the constructional work successfully, due in most cases to the size of the set. To any such, it should be pointed out that the constructional work is considerably simpler than that encountered in many smaller sets, owing to the easy accessibility of all points to which it is necessary to make connections.

Components Required

The following list contains every component required for the construction of the set, and also, in the majority of cases, the name of the manufacturer. The latter will enable the reader to make an exact copy of the actual set described should he desire this.

The actual components employed are:

- Ebonite panel 24 in. by 10 in. by 1/4 in. ("Paragon," Peter Curtis).
- Cabinet of suitable size for above panel (that used is of the sloping front type).
- Cam-vernier 2-coil holder (Coswell Engineering Co.).
- 3 dual rheostats (Burndept, Ltd.).
- Low-frequency transformer (Woodhall Wireless Co.).
- Eureka Concert Grand L.F. Transformer (The Portable Utilities Co., Ltd.).
- 1 .0005 μ F variable condenser (K. Raymond).
- 1 .0003 μ F variable condenser (K. Raymond).

"MODERN WIRELESS" NEUTRODYNE JUNIOR THREE VALVE SET. Blue print No. 97 B. Price 1/6

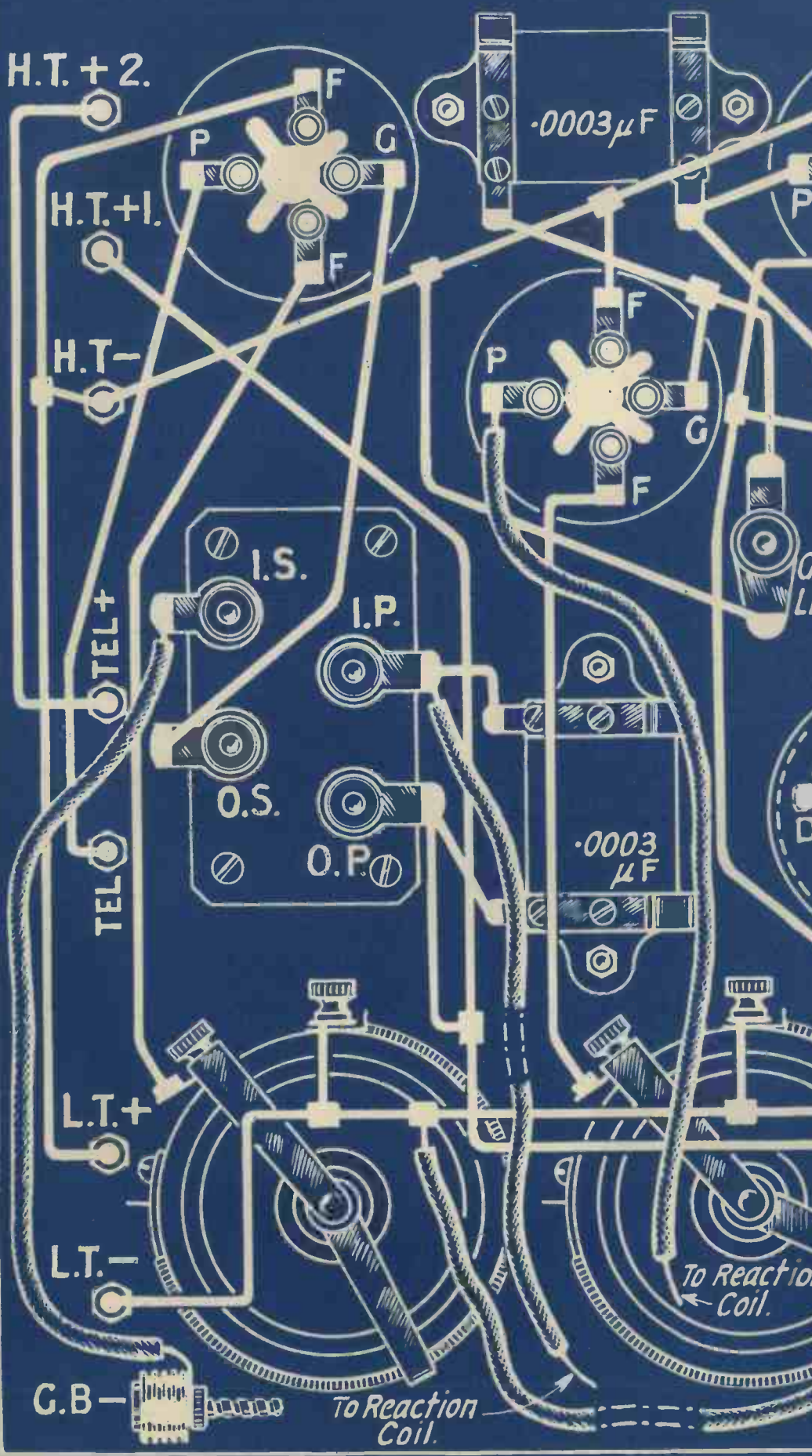

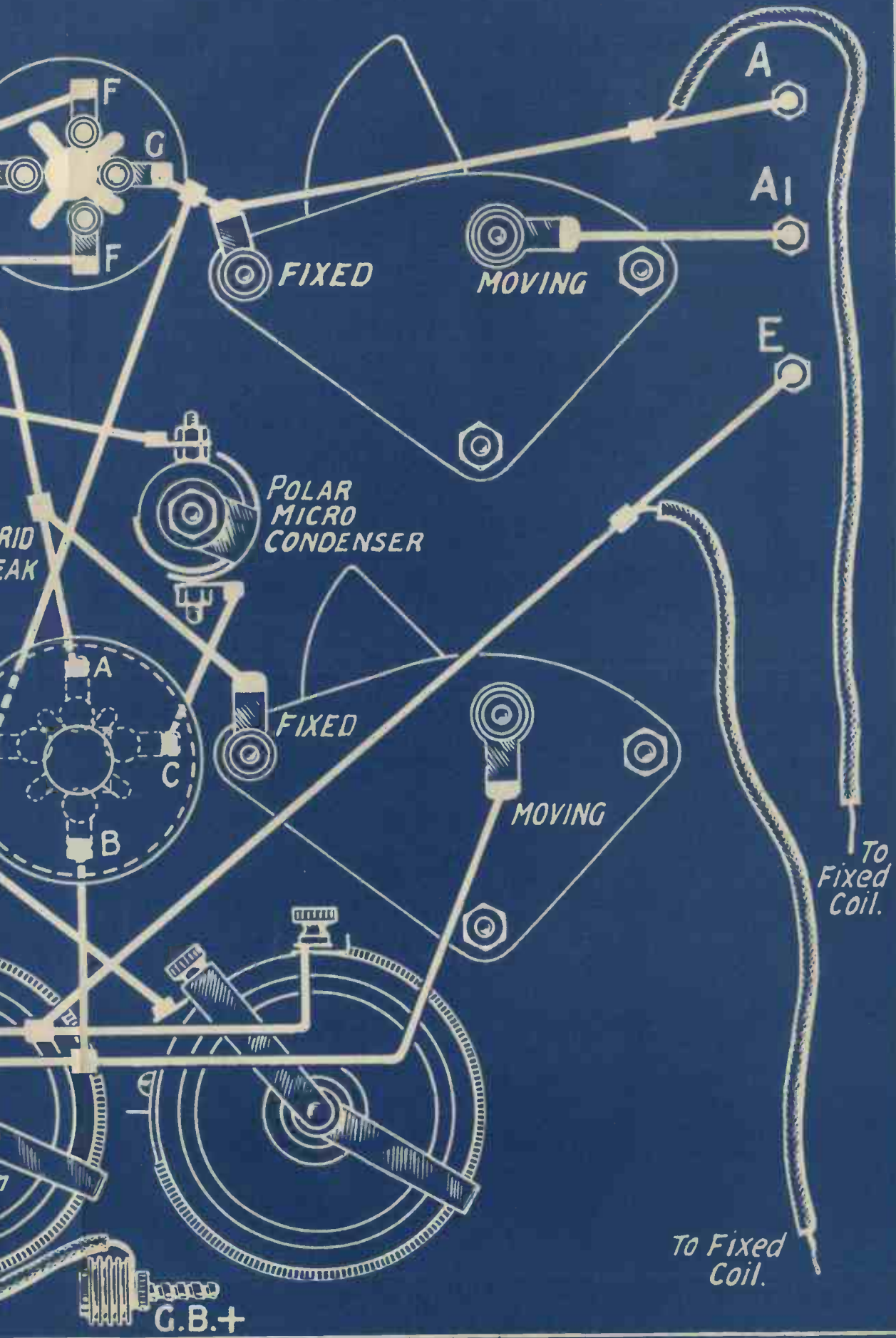

RADIO PRESS LTD, BUSH HOUSE, STRAND W.C.2.

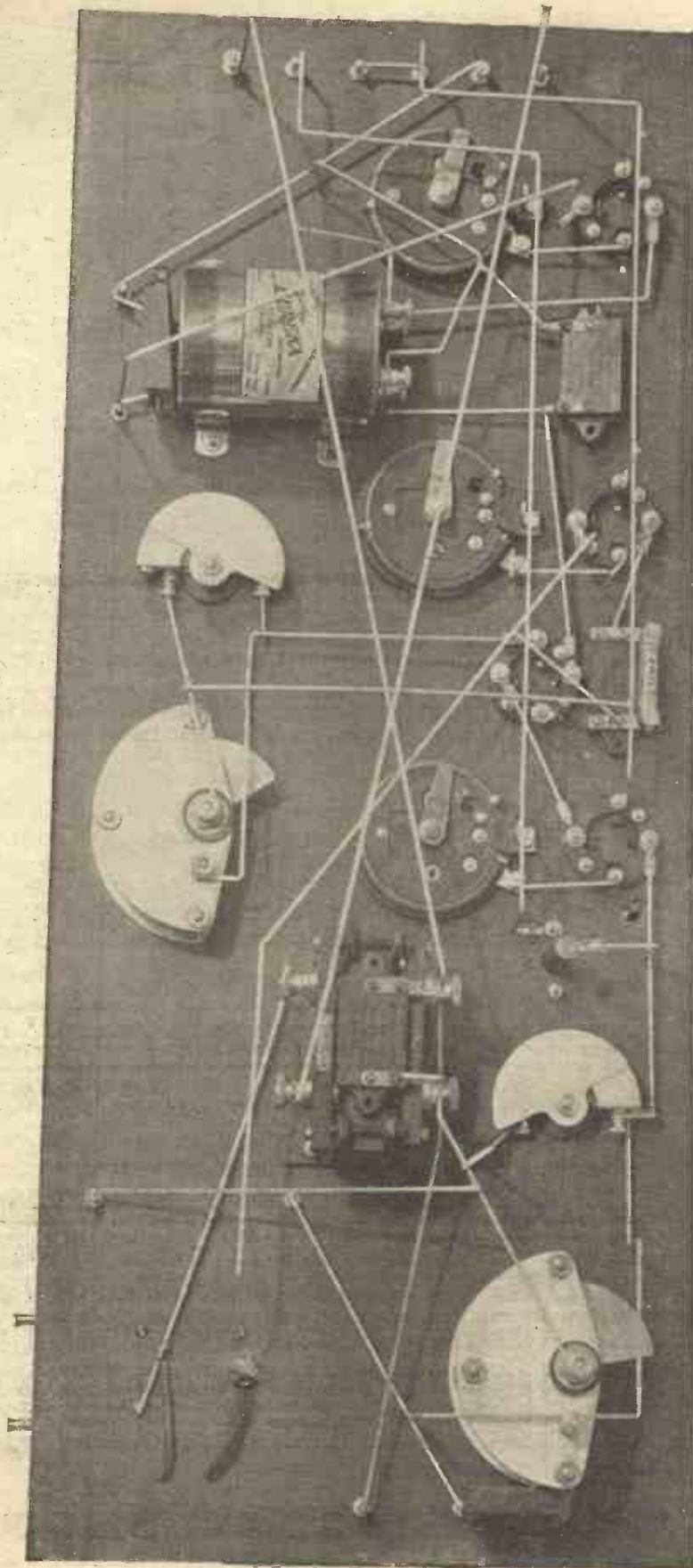

A complete plan view, which should be used in conjunction with the wiring diagram in Fig. 3.

- 4 H.T.C. type C valve holders (H.T.C. Electrical Co., Ltd.)
- 2 "Colvern" vernier condensers (Collinsons Precision Screw Co., Ltd.)

- 1 .0001 μ F fixed condenser
- 1 .004 μ F fixed condenser
- 2 .001 μ F fixed condensers
- 1 .0003 μ F fixed condenser with clips

Dubilier

- 1 2 megohm grid leak
- Variable anode resistance (Wattell Wireless Co.).

- 1 High-frequency transformer to cover desired wavelengths.

- Square tinned copper for wiring.
- 2 ft. of rubber covered flexible wire.

- 13 W.O. type terminals.
- Packet of Radio Press Panel Transfers.

The dual rheostats mentioned allow the use of either bright or dull emitter valves, the first half turn of the control knob being for use with dull emitters, and the second half turn for bright emitters.

Fine reaction adjustment is permitted by the cam-vernier arrangement fitted to the coil holder, and fine tuning (chiefly for use on distant reception) is obtained by the use of the two plate vernier condensers.

Drilling the Panel

This is a simple matter, the positions for the holes being shown in the drilling diagram, Fig. 2. This part of the constructional work is considerably facilitated if a point is made of having all components at hand so that suitable sizes for the various holes may be easily determined.

A few screw heads are shown in undimensioned positions, the reason for this being that the components they hold behind the panel may vary a trifle in size or shape even though the same makes be purchased as those utilised in the present case. No difficulty should be experienced in fixing the coil holder to the panel, its correct position being clearly shown in the diagram. Two holes are drilled to the left of the coil holder to allow flexible leads from the moving socket to pass through the panel.

Mounting the Components

Having completed the drilling of the panel the various components may be assembled. The diagrams and photographs allow no doubts concerning the correct positions of the various parts. Two screws secure each valve holder at the back of the panel in a manner which becomes quite obvious upon referring to the photographs. The

two L.F. transformers are each attached by two screws, the heads of which are visible on the front of the panel (Fig 2). It is, of course, impossible to mistake which is which of the two transformers, the wiring diagram, Fig. 3, showing the Eureka transformer on the left and the Woodhall on the right of the panel.

The five fixed condensers are not included at this stage, being secured later by means of the stiff wire employed for wiring the receiver.

Connecting Up

Care in making the various connections is the chief requisite upon reaching the wiring stage. It should be possible to make all the necessary connections by referring to the wiring diagram, Fig. 3, but should doubt arise upon any point, the photographs giving views of the back of the panel may be relied upon to clear the matter.

As indicated previously, the fixed condensers are secured in position during the process of wiring, Fig. 3 showing how this is done in each case; the different values, which are clearly marked, should be noted carefully. For the sake of clarity the two lower terminals (O.P. and O.S.) of the Eureka transformer have been slightly displaced in the wiring diagram. Care should be taken to make the connections to the transformer (and incidentally all other connections) correctly.

To ensure rigidity of the two stiff wire connections to the reaction coil socket, the ends of these are soldered to the two right-hand screws (X X in the wiring diagram) of the four which secure the coil holder to the panel. A flexible lead is then soldered to each of the two wires as shown, these passing through the two holes drilled in the panel and connecting to the screw terminals of the reaction coil socket.

Aerial Coil Connections

After completing the wiring on the back of the panel, the two flexible leads seen on the drilling diagram should be included, this completing the wiring of the set. To avoid all possibility of confusion it should be pointed out that the two flexible leads are joined to the screw terminals of the aerial coil socket at one end and to the terminals A and B at the other end, spade terminals being fitted to the latter ends of the wires for the sake of convenience in changing over the connections.

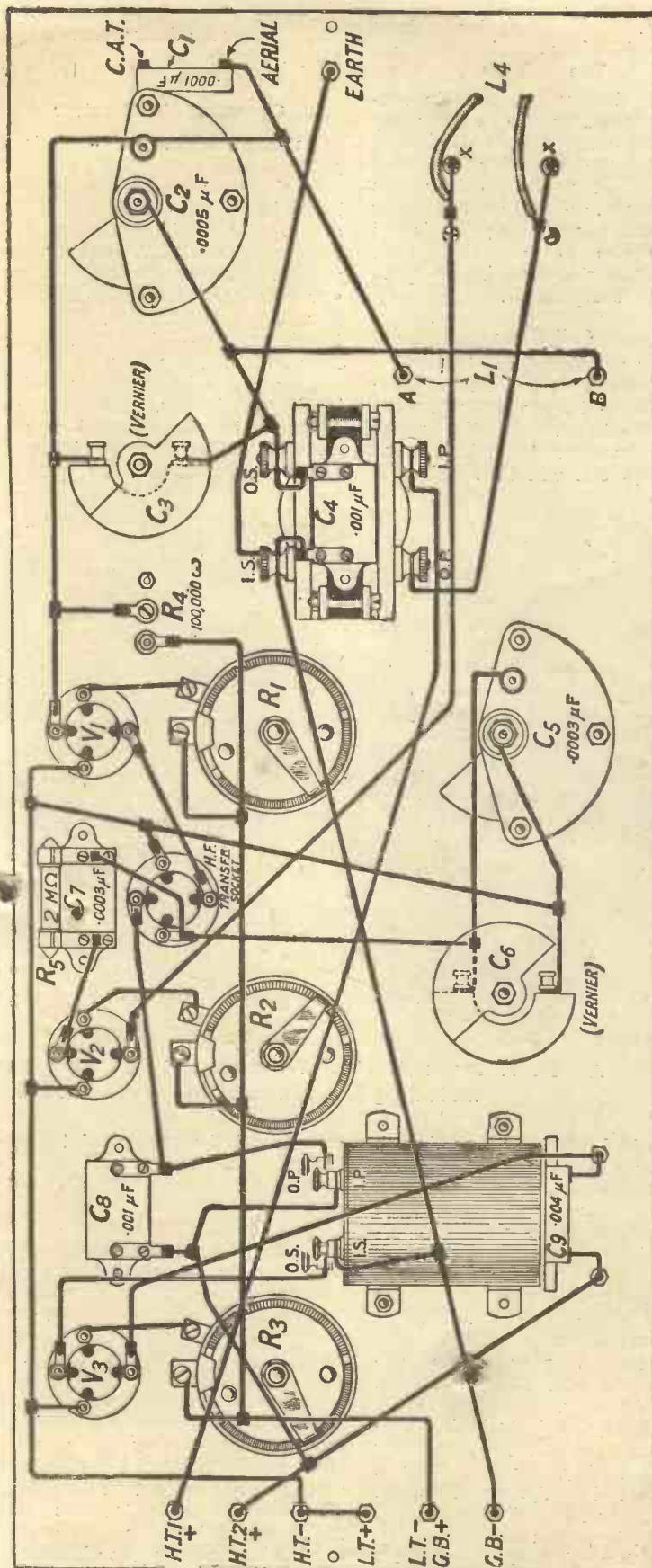

Fig. 3.—The wiring diagram, which should be followed carefully in connecting up the components. Blue Print No. 99b.

Finally, the inclusion of the grid leak R_3 in the clips of C, must not be forgotten.

The Cabinet

Many dealers specialise in providing cabinets to any given specification, and it is considered that in the majority of cases readers will prefer to buy this ready made. Any type of cabinet is suitable providing it is of correct size to take the panel, and allows adequate inside space for the components.

Coil Sizes

Using constant aerial tuning the following coil sizes will be suitable for the 300 to 500 metre broadcast waveband. In the aerial socket (marked A.T.1 in Fig. 2) a No. 50 coil will be required if

The high-frequency transformer must, of course, be of a suitable size to cover the desired wavelength range.

Operating the Receiver

As a preliminary test it is a good plan to apply equal voltages to the anodes of the three valves by joining the terminals H.T.1 and 2 with a piece of wire, and connecting the H.T. battery (the voltage will depend upon the type of valves used) to H.T.1 and H.T.—. For the present, also, the two terminals L.T.—G.B.+ and G.B.— may be joined together.

Now, with suitable coils mounted in the coil holder, the batteries attached to the set and valves and H.F. transformer inserted (these latter should be pushed

results are poorer than before, reverse the leads to the aerial coil by means of the flexible aerial coil leads and terminals A and B on the front of the panel.

Maximum results will be obtained when the coils are adjusted so that the set is just off the oscillation point. If any difficulty is experienced in working at this point due to low frequency oscillation in the form of a growling note or a howl, the stabiliser may be brought into operation by screwing down the 100,000 ohm resistance knob until stability is obtained.

There may be a normal tendency towards self oscillation even with a small reaction coil. In this case use a shorting plug instead of the reaction coil, and use the stabilising resistance if necessary.

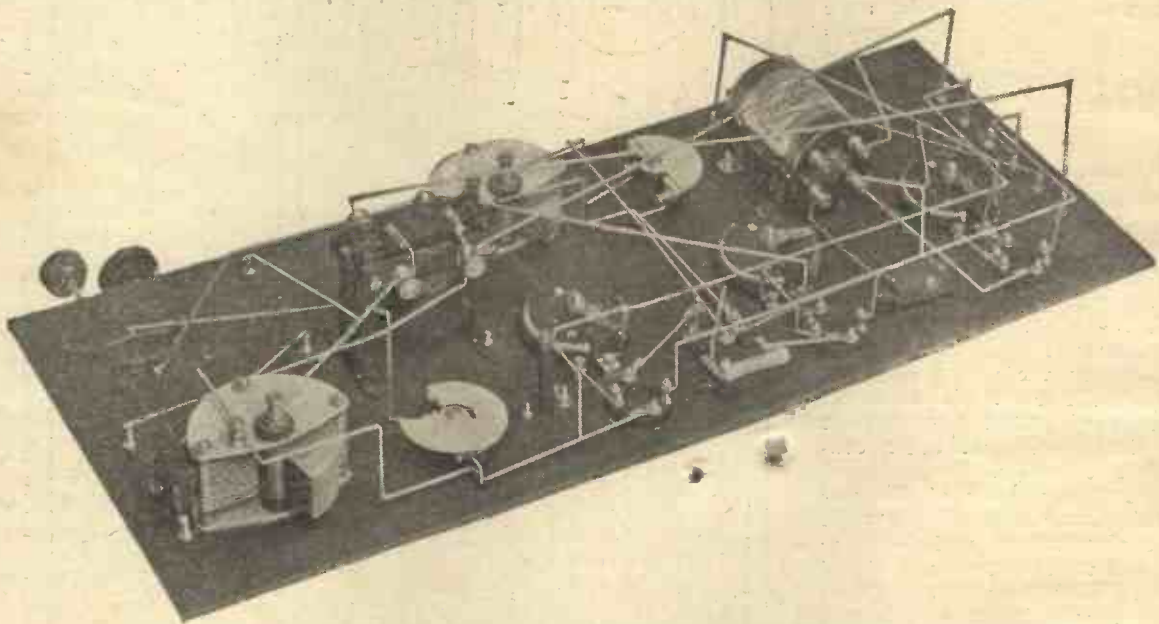

A view of the underside of the panel taken from another angle and clearly indicating the connections to the second transformer.

the desired station's wavelength is below 420 metres, or, if above this wavelength, a No. 75 coil. A No. 25 or 35 coil should be plugged into the reaction socket. If ordinary parallel tuning is employed, a suitable size of coil for the aerial socket cannot be stated definitely; Nos. 25, 35, and 50 should be tried. A larger reaction coil may prove advantageous when using this form of aerial tuning.

The Chelmsford station's wavelength is obtained with ordinary parallel tuning, by inserting a No. 150 coil in the aerial socket. A No. 75 or 100 coil may be used for reaction, but experimenting with other sizes may produce better results.

well home) the process of tuning-in may be commenced. The stabiliser knob should be unscrewed to cut the resistance out of circuit, and after placing the two coils at right angles to each other tuning may be carried out by rotation of the aerial and secondary tuning condensers. If you are not proficient in tuning two circuits simultaneously, the best method to adopt is to vary the aerial condenser in small stages with complete rotations of the secondary condenser after each small movement, until the desired station is picked up. Now bring the reaction coil towards the aerial coil and retune on the two condensers, noting the difference in the strength of signals. If

Valves

Having obtained results, a great improvement may be effected by the application of separate high tension voltages and negative grid bias. No definite figures can be given as being suitable, as these depend upon the valves used. It may be mentioned here that very good results can be obtained using three general purpose valves for this set, though a small power valve in the last socket is an advantage.

The grid battery may conveniently consist of a small battery of about 9 volts tapped at every 1.5 volts, and is joined to the terminals L.T.—G.B.+ and G.B.—, the bridging wire of course being removed. The

detector valve is given a separate anode potential in a very simple manner. The negative terminal of the H.T. battery is connected to the H.T.— terminal, and after removing the wire between H.T.1 and H.T.2, a point on the battery of, say, 100 volts or over, is joined

Distant Reception

On distant working, tuning will often be found very sharp and consequently somewhat critical. The two vernier tuning condensers prove of considerable value under these conditions, and full use should be made of them.

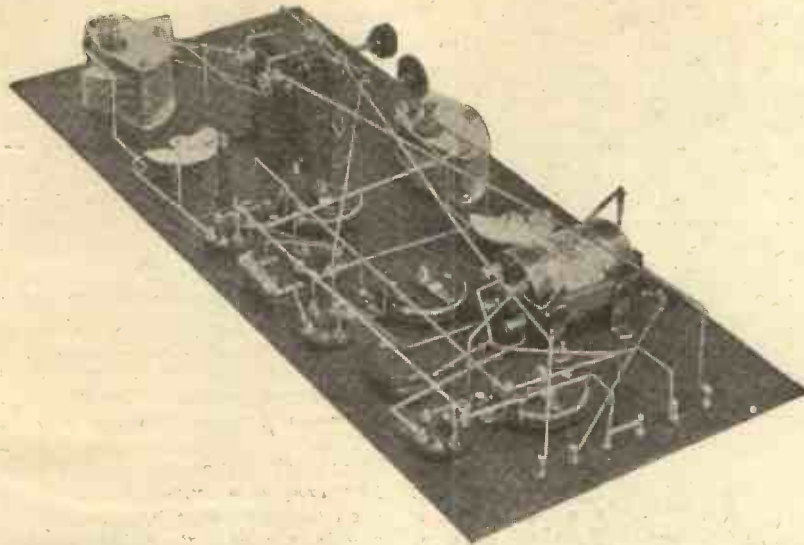

This photograph will be an additional help in wiring up,

to H.T.2 and a point of considerably lower voltage to H.T.1.

Although neither the grid nor anode voltages are likely to be critical, it is certainly worth while to experiment a little in this direction if it is intended to obtain maximum purity and volume from the receiver.

Finally, do not be disappointed if you do not get the expected results upon first connecting up.

A little experimenting on the lines suggested sometimes makes all the difference between good and mediocre reception.

A Reader's Results with the Original Three-Valve Dual

SIR,—I have been greatly interested in the various letters published in MODERN WIRELESS regarding the above set, and herewith quote a few particulars which may be of interest to others. I built a 3-valve dual set last June—minus adjustments for 2-valve dual and straight circuits. The place where I live is situated at the bottom and between a group of mountains about 2,000 ft. high, and is screened by these mountains on all sides.

Cardiff is about 40 miles away and was the only station I expected to hear owing to screening effect. When the set was first connected

up to aerial, etc., for test, I received the Big Ben time signal quite good on 'phones, via Glasgow, which is about 300 miles away. Cardiff, Birmingham, Bournemouth, London 2LO, Chelmsford, Manchester, Paris and Iberica, Madrid come in regularly on loud-speaker, and occasionally Glasgow.

Other B.B.C. and Continental stations come in at various strengths on 'phones—on one occasion, I disconnected the aerial and connected the earth lead to aerial terminal and got Newcastle at good 'phone strength, a distance of over 200 miles. These results are exceptionally good considering the hilly

locality in which I am situated, and far exceeded my expectations. The only occasional spark signals I hear are on 450 metres, which is the wavelength used by some British and French stations for commercial work.

The set is very selective, and although I am not using vernier condensers I can cut out the 450 metres spark, and tune in stations broadcasting on other wavelengths without interference. The normal ship working on 600 metres is never heard.

I use series fixed condenser in primary circuit, constant aerial tuning, and two No. 50 honeycomb coils for all reception except Chelmsford. For Chelmsford I use constant aerial tuning, 150 and 200 turn coils (150 for reaction). Variable and fixed condensers in primary circuit in parallel. Aerial is single wire about 25 ft. high, suspended between two trees. Earth consists of three feet of bare wire pushed into the ground. There are no soldered connections in any part of the circuit. As the set gave such good results I decided to test it away from the hills, so I took it across the Atlantic and I got London 2LO, Birmingham, Bournemouth, Cardiff and Manchester at good loud-speaker strength up to 1,400 miles, and same stations good 'phone strength up to 1,900 miles, also Cleveland, Ohio, on loud-speaker up to 1,900 miles and on 'phones 2,300 miles (including numerous intermediate American and Canadian broadcasting stations at good loud-speaker and 'phone strength). Very strong crashing atmospherics prevailed during the whole of my long-distance tests, but the broadcasting came in at sufficient volume to make both speech and music quite clear from B.B.C., U.S.A. and Canadian stations.

The set brings in signals at great volume (especially away from the hills), and I have not yet heard any other 3-valve set which can produce such volume and combined clarity, and I am sure that greater distances could be received under more favourable conditions. An "All Concert de luxe" set was tested at same time as I had the 3-valve dual under test, but the latter holds the ribbon for volume and easy control, while my friend with the "All Concert de luxe," picked up the same stations at same times and distances at reduced strength.

Thanking you for publishing such a good circuit as the "3-valve dual."—Yours truly,

"MOUNTAINEER."



Beautiful Spring

THE weather forecasts are full of dark talk of gales, snowstorms, of thunderstorms, of fogs, of tempests, of depressions, of secondaries and other things of that kind. These are infallible signs that the glad spring is approaching our shores. A little later there will be rumours of snow and hail and sleet and floods (or

rotten kind of wind that blows nobody any good had the true prophetic eye, though it is doubtful whether he foresaw the coming of wireless as a national pastime. Anyhow, spring is here, or very nearly so, and we must make the best of it. Unless we take very special precautions we shall find that our wireless dens are ruthlessly tidied up with dire results, for

it is at this season of the year that the female of the human species, no matter what may be her age or position in life, is seized with a wild desire to fill the passages with pails and brooms, the air with dust, and the soul of the male with discomfort and and bacon. Having fortified myself with an early but sound meal at the club, I was able to announce truthfully on my return in the evening that I could not look at any dinner. I spoke of headaches and shivers down the back and all sorts of things of that kind. When the zero day arrived I was far too ill to get up. Like the doormouse, I looked forward to passing away in comfort and content the darkest hours of the year. But did I succeed? I did not. To begin with, my better half decided that my case was one which demanded the lightest possible diet; and no expostulations of mine on the score that I must keep up my strength were of the slightest avail. I endured two days of toast and beef-tea. I think that possibly I might have stood a third if I had been left in peace.

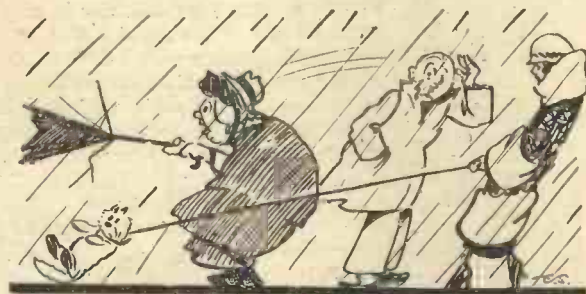

Summer is coming.

possibly droughts) and we shall know that summer is with us once more. In the matter of weather, I think that we are very badly treated. Possibly you notice that we do not produce our own particular brand at all; we simply take what is handed out to us by other countries. Anti-cyclones and sometimes cyclones without the anti, gather their forces over the Azores and then descend upon us. Depressions form in Continental areas, and set out once their preparations are complete for these happy Isles. Secondaries we seem to import from Iceland or Spain or the Faroes, or from any other place that has no particular use for them itself.

Signs of Spring

As an ordinary human being I can complain bitterly about all this, but as a wirelessman I am duly thankful, since for the purpose of long distance reception there is nothing to beat the wildest, wettest and altogether beastliest of weather. The man who invented the proverb to the effect that it must be a pretty

black despair. Probably you are going through it now. I see you in my mind's eye eating as you read this, the breakfast that is laid for you upon a packing-case in the bathroom.

Grinning and Bearing

The only thing for us to do—I refer now to the sterner sex—is to grin and bear it as best we may. It is no good striving to avoid the discomfort. Two or three springs ago I tried out a little scheme which had occurred to me as offering a way out of all trouble. Having ascertained upon which day the annual raid would begin I prepared for it by developing as many as possible of the outward signs of approaching indisposition. I toyed with my breakfast, looking with well simulated loathing at eggs

The Limit

But I was not. That day it appeared had been set aside for turning my bedroom into a devastated area. Quite early my wife, accompanied by her two accomplices, entered my room, and without a word the trio seized the bed and trundled it with me on board into the box-room. I decided that I felt better. I would get up. I called for my clothes. I was told that I could not have them because they were all covered up by dust sheets and things. However, the box-room provided some ancient garments, and in these I descended. Anyhow, I



Breakfast in the Bathroom.

could pass the day in my wireless room. I opened the door and fell back, feeling really ill this time. They had been there. The worst had happened. There was an acid smell in the room which I tracked down to the accumulator around whose terminals the metal headbands of a pair of phones were neatly arranged. One glance at its tortured platés was enough.

Prevention Better than Cure

But this was only the beginning

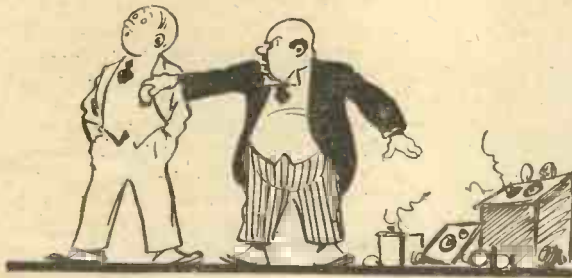

He drew forth a valve.

of my troubles. The leads from the high-tension battery had been neatly rolled up with their ends together. All my odd valves had been bundled into a cardboard box, which appeared to have fallen off something with its precious cargo inside, to judge by the casualties amongst filaments and even bulbs. And I could find nothing. Everything was so neat, so tidy and so disgustingly clean that it was impossible to do any proper work.

Reader, if you think to circumvent the spring-cleaners by locking up your wireless room when the dreadful period arrives, take my tip and wear the key on a string round your neck, whether walking or sleeping.

Poddleby Sees it Through

Poddleby I found had been through it too. His plan had been to lay in a store of food and drink and a camp bed with the intention of holding the fort by eating and sleeping in his den until conditions became normal once more. But they had outwitted him, too. As the result of what they described as an accident, though we knew it to be part of their Machiavellian ingenuity, one of them had been careless (careful) enough to let go his aerial halliards whilst attaching one end of a clothes line to the mast. When Poddleby left the fortress for a few moments to put things right the invaders marched in and occupied it. It was some consolation to find that his gear had sustained even more damage than mine. He complained that he had

lost six brand new valves, and I was able to repair some of my own loss by finding them whilst his back was turned. "Home," I said to Poddleby, when I had got the swag stowed away, "home is no place for us at this time. Let us go to some place where we can find peace." Poddleby turned round, glanced sharply at my top left-hand waistcoat pocket, advanced his hand and drew forth a valve as a conjurer produces a rabbit. He laid it upon the mantelpiece without a word. Then with a sigh he said, "You are quite right, my dear fellow, let us go down to the wireless club."

I would like to have made a facetious remark about his skill as an exponent of legerdemain, but fearing that he might probe into other pockets I refrained. Instead I seconded heartily his proposal to go to the club, where, at any rate, we should find things untouched. We went. As we approached we noticed that the door was open and that clouds of dust were issuing from it. Fighting our way in we found Mrs. Bugsnipp with a duster round her head having the time of her life in our sacred hut. Though her business is simply to come in in the mornings to remove the paper with which untidy fellows like Snaggsby and Bumbleby Brown litter the floor during our meetings, she had been seized with the spring-cleaning feeling and was fairly at it.

As we stood we were joined by General Blood Thunderby, Admiral Whiskerton-Cuttle, and Gubbsworthy, who, like ourselves, had strolled down to escape the horrors of home. It was decided by a majority of four to one (the one being the warrior himself) that General Blood Thunderby should enter in an endeavour to dislodge Mrs. Bugsnipp. The lady, however, was quite ready for him. As he approached the door a cloud of dust flew out causing him to retire blinded and sneezing to the base. Poddleby now volunteered to attempt an entry through

one of the windows, which was open.

Mrs. Bugsnipp Stands Firm

Standing upon the General's back he inserted his face in order to reconnoitre. The next moment it reappeared in close contact with the head of a wet mop which was twirled vigorously over the General and himself. Mrs. Bugsnipp held her ground until the worst had happened. If only any of us had the courage to do so we would dismiss her and give the job to one of our own sex, for men, even those who grow side whiskers and wear bobbed hair, seem to be immune from the attacks of the germ which produces spring-cleanitis.

The Super-Earth

Did I tell you that Professor Goop, the world renowned inventor had recently celebrated his silver wedding with Mrs. Goop?

It was decided that a subscription list should be opened forthwith, and that the moneys offered by the members should be expended upon an imposing piece of silverware for the Professor's sideboard. At a special meeting of the club it was handed over by the General, who made a neat little speech in doing so. The Professor was so overcome with emotion that he could scarcely find a word to say. However, during the next meeting a letter from him was handed in which the General opened and read aloud.

"I hardly know how to apologise," it ran, "for my failure to find words the other night to express my gratitude for the beautiful

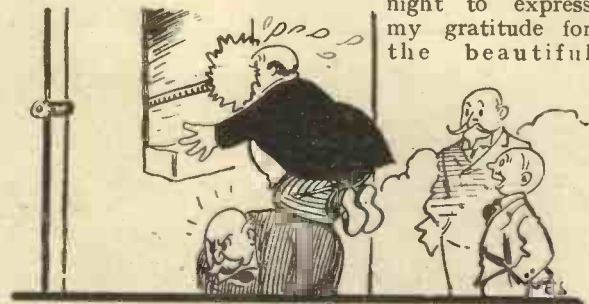

In close contact with a wet mop.

present with which I had been honoured by members of the Little Puddleton Wireless Club. Thanks to you and to it my reception has been enormously improved, for it makes the finest earth that I have ever had, silver being as you know, the best of conductors. All I can say is thank you and thank you yet again." All that we could say was —? but I think that I may safely leave them to your imagination. THE LISTENER-IN.

The Eiffel Tower

Its Transmissions on
Telephony

by

Capt. L. F. PLUGGE,
B.Sc., F.R.Ae.S., F.R.Met.S.

THE transmitting gear at the Eiffel Tower is essentially an experimental one. A circuit which might be described to-day may no longer be in use to-morrow. However, I propose to give an idea of the installation as I saw it during a visit paid a few weeks ago. The diagram of this arrangement is shown on Fig. 2.

The Telephony Transmitter

Following this diagram, it will be seen that the microphonic current controlled at M_1 by the modulations of the voice or of the music is amplified by a one-stage L.F. amplifier in which two ordinary R valves V are used in parallel. The H.T. applied to the plates has a value of 120 volts. This amplifier is installed in a room next to the studio. The current is then taken along a land line to the transmitting station some 1,000 yards from the studio. On arrival there it is again amplified by means of a

In this article our Continental Broadcasting Correspondent gives an interesting description of a visit, at our request, to the celebrated Eiffel Tower Station at Paris.

second one-stage L.F. amplifier using two "Horn" valves IV., also coupled in parallel. These two valves can be seen in the foreground of Fig. 1, and a diagram showing one of them can be seen in Fig. 4. They are low capacity valves, and some 1,000 volts are applied to the plates.

Wavelength

The microphonic currents thus amplified are transformer-coupled to the grids of the modulating valves III. These are six in number and are parallel coupled.

Also two "Neuvron" valves II, coupled in parallel on the plates of which 5,000 volts are applied, maintain an oscillating circuit formed by L_4 and its parallel condenser. The frequency is so arranged as to give the wavelength required. These oscillations are transferred to the grid of the Holweck valve I by the coupling L_5 and the plate of this valve,



A view of the famous Eiffel Tower, Paris, which is used for supporting the aerial of the wireless station, a description of which appears in this article.

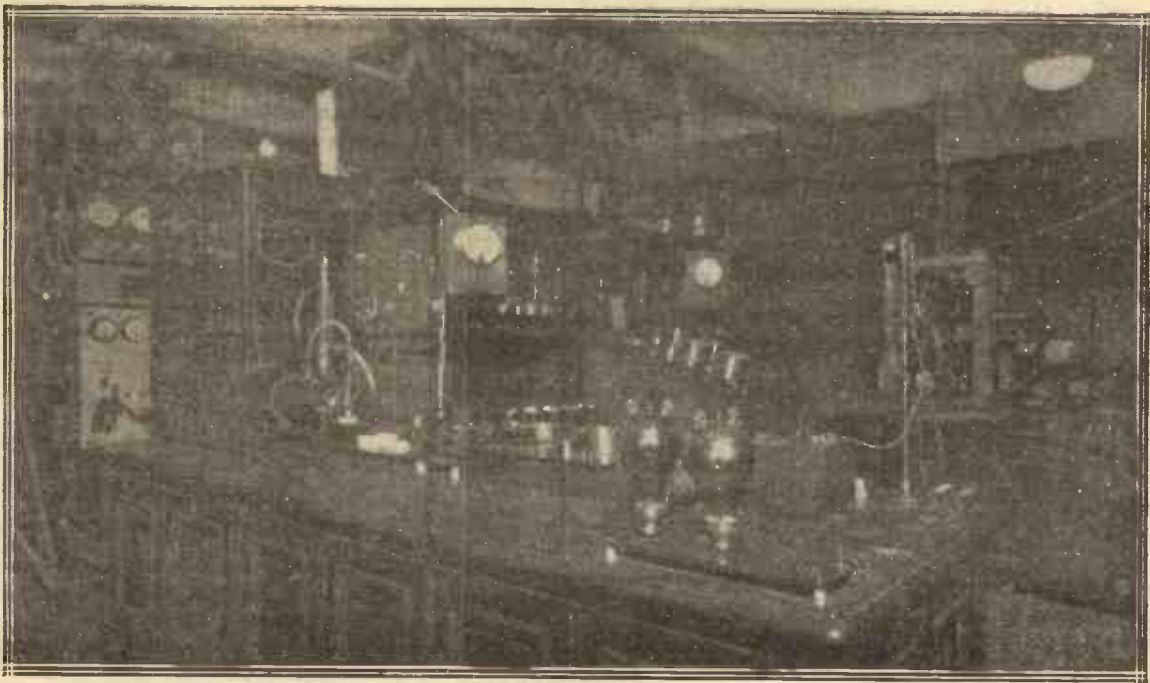

Fig. 1.—A general view of the transmitting room. The two valves in the foreground are the "Horn" valves used in the last stage of L.F. amplification, while on the left may be seen a spare Holweck valve for 2,650 metres transmission.

to which 5,000 volts are also applied, is connected to the aerial of the station.

In this manner the Holweck valve plays theoretically the part of amplifier, and any slight variation of the natural wavelengths of the aerial which might occur owing to its motion or any other cause does not affect the transmitting wavelength to any appreciable degree.

The oscillating system, two "Neuvron" valves and one Holweck valve, is duplicated. Either group can be used, and the spare set is shown on the left of Fig. 1.

The table given on the following page gives an idea of the current, voltage and power which is applied to the transmitting gear when modulation takes place as compared to the same circuit when in state of oscillation without modulation.

The Holweck Valve

The Holweck valve, the main transmitting valve, has several special features which warrant my saying a few words about it. A point which makes it very different to other transmitting valves at present in use is that it is what one might call "capable of being stripped." The valve can be taken to pieces in the workshop and any adjustment performed upon it, such as the filament being changed, experimental grids tested, etc. This is rendered possible by the fact that the valve, when at rest, is not under vacuum, but the interior is at normal atmospheric pressure. A special vacuum pump forms part of the valve itself, and is driven by

a specially designed electric motor which is set in action when the valve is about to be used and is kept running during the transmission. This pump, which maintains a high degree of vacuum within the valve, is of a very special design and the invention of a Mr. Holweck, from whom the valve takes its name.

The novelty resides, perhaps, more in the pump than in the valve itself. A photograph of this valve

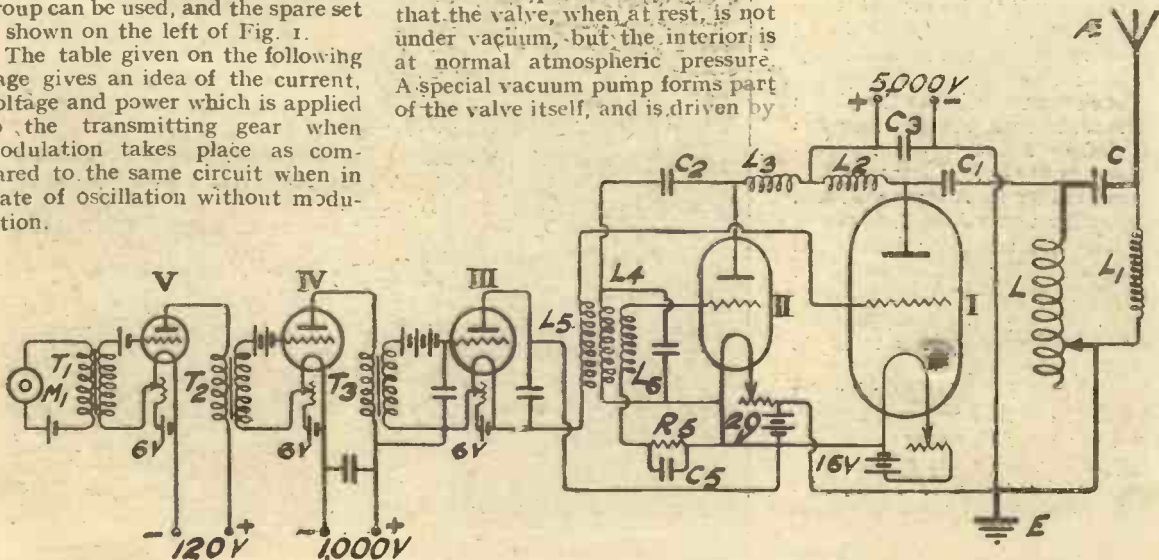

Fig. 2.—The circuit used for the telephony transmissions.

Some figures—

Parts of gear to which readings refer.	Units indicated.	Values with oscillation but without modulation.	Values corresponding to max. current intensity in aerial during modulation.	
Current in aerial	amps	22.0	32.0	
Input in the aerial	watts	3150.0	6650.0	
Value of high tension applied to plates of Neuvron and Holweck valves	volts	4500.0	4500.0	
Holweck valves {	Mean current on the plate	amps	.930	1.82
	Power applied to the valve	watts	4500.0	8200.0
Holweck valves {	Efficiency factor	—	.75	.81
	Mean grid current	amps	.080	.150
	Mean grid tension	volts	850.0	600.0
	Filament current	amps	35.0	35.0
Neuvron valves {	Do. do.	volts	16.0	16.0
	Mean current on the plates	amps	.075	.100
	Power applied to valves	watts	340.0	450.0
	Filament lighting	volts	20.0	20.0

may be seen in Fig. 3, which also shows the preparatory pump which is used to exhaust the greater part of air before starting, leaving the Holweck pump to produce and maintain the high vacuum already referred to. The valve is cooled by means of a circulating water-jacket, and the inlet and outlet of the water can be seen, together with a vacuum gauge and other special features which this valve incorporates.

Although only eight kilowatts are at present applied to the valve, I was told by the officer in charge that it could easily stand an input of 25 kilowatts without any ill-effect, and probably a good deal more.

A section through the valve itself is shown on Fig. 5, where it will be seen that the removable filament is "V" shaped and kept in position by a reed made of molybdenum and stretched by means of a spring.

The current applied to the plates of the oscillating group of valves is supplied by a D.C. generator producing 5,000 volts. Filament lighting current for these same valves is supplied by a 20-volt D.C. dynamo, and the L.F. amplifier valves are lit by a battery of accumulators. The H.T. applied to the last stage of L.F. amplification is supplied by a separate dynamo with an output of 1,500 volts D.C.

The station is entirely under the control of the military authorities, and the officer in charge is Capt. Bourgeron, who is the officer commanding the "Centre Radiotélégraphique de Paris."

The weather report is given out by M. Trocmé, sapeur of the French Engineers, Signal Corps,

from one of the cabins, of which there are two in the station, just next to the transmitting room. M. Trocmé, it might be interesting

to mention, took a three years' engineering course at Nottingham University College, and speaks English fluently.

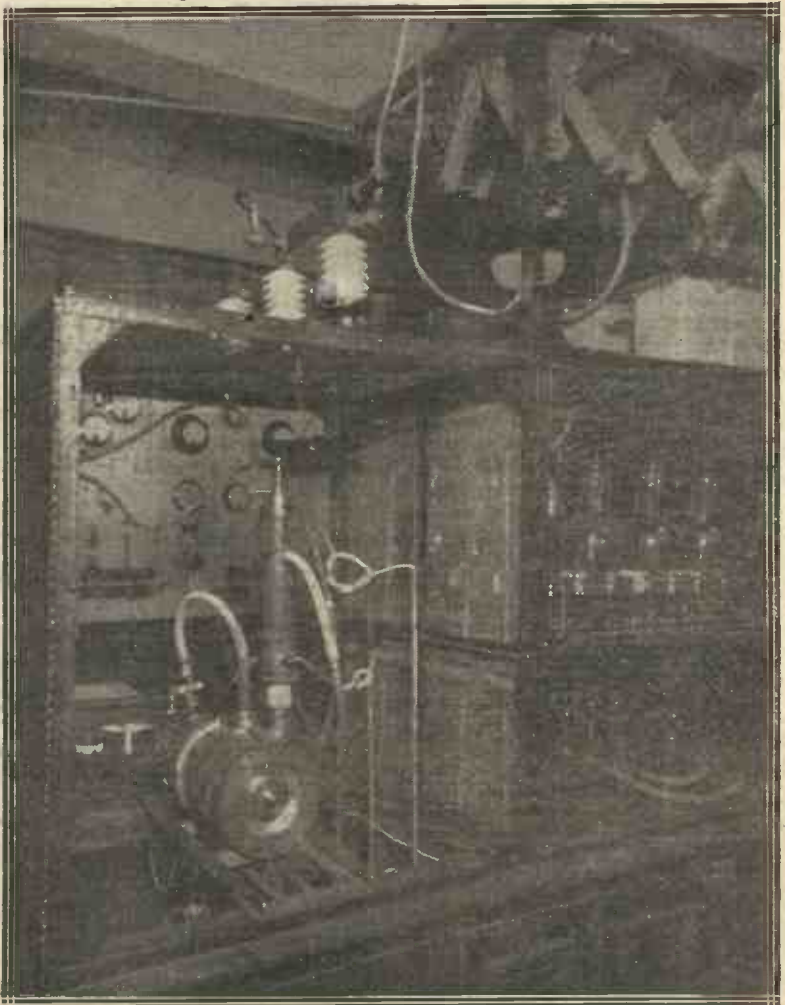

Fig. 3.—The Holweck water-cooled valve used for telephony transmission on 2,650 metres. This valve is capable of being loaded up to 25 kw.

Transmissions

At present the studio, situated in the north-western foot of the Tower, is lent for an hour a day to the "Société des Amis des Concerts Artistiques de la Tour Eiffel." M. Privat, who is the director of the society, and with whose voice many of my readers are no doubt familiar, was asked by M. Poincaré, of whom he is a personal friend, to take over the direction of these afternoon transmissions. A good deal of criticism had appeared for some time about the Eiffel Tower transmissions, and the latter were rather scorned by the French amateurs before M. Privat took over their direction.

The numerous listeners to the Tower, both in England and in the various parts of Europe, owe their thanks to M. Privat for the high artistic quality which his transmissions have now reached. All French papers, and even those which were the most bitter critics, are now unanimous in agreeing to this.

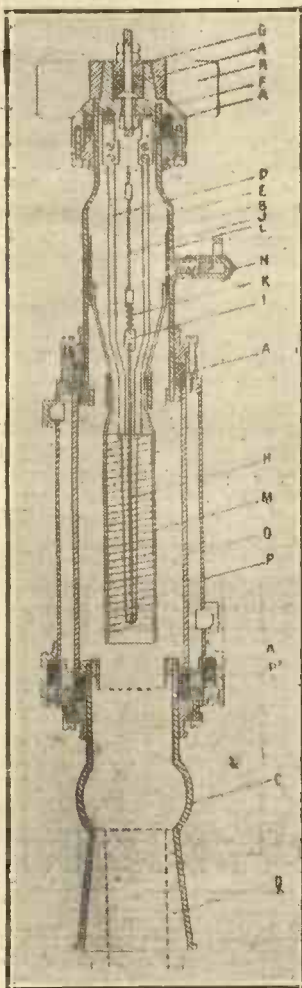

Fig. 5.—A section through the Holweck-valve.

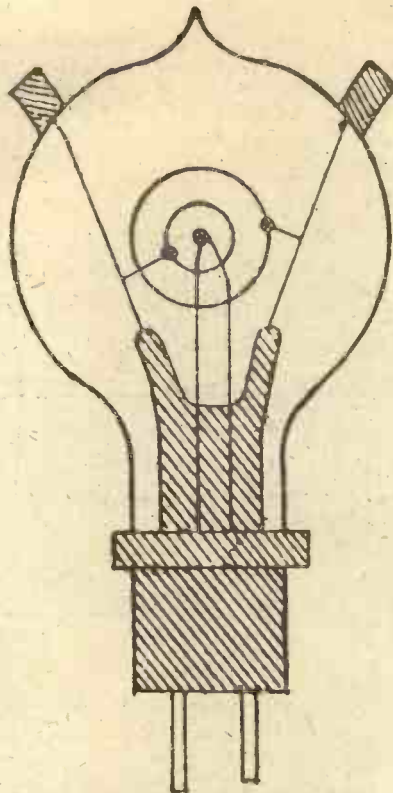

Fig. 4.—A "Horn" valve used by the French for resistance-capacity amplification.

Before M. Privat undertook the task, he was, and is still to-day, director of a paper called *Le Journal Pa*. This "spoken newspaper," as the title implies, is not a printed one. People interested in literature, science and art gather together at a "salon," and there M. Privat, surrounded by eminent men, discoursed to them on subjects of actuality. These subjects, exposed by personalities of recognised authority on the matter dealt with, are considered to be of greater interest to those present than if they were read in print by them. No better man, therefore, could have been chosen than M. Privat to take over the direction of the Eiffel Tower concerts. Apart from music, what is a wireless transmission but a spoken newspaper? News is given out, and when special subjects are treated, they are usually dealt with by men who are considered an authority on that particular subject.

Conclusion

Those listeners who have been tuning in the Eiffel Tower of late will have noticed that announcing is not done in the usual curt manner adopted by many other Continental stations. The speaker indulges in some interesting remarks on what is

about to be played or sung or with regard to topical subjects. I think this is of interest, especially to the distant and foreign listeners. It brings home to him the romance of wireless, that is able to pull down the barriers that separate countries and to carry beyond those barriers the ideas and thoughts of other nations and other civilisations.

*Excellent Results
with the
Three-Valve Dual.*

SIR,—Regarding the 3-Valve "Dual" set of your last April issue, doubtless you and perhaps some of your readers will be interested in the results I have obtained with this set. I can get at least one American station every night after 11 p.m. The extent of audibility depends not so much upon the state of the atmospherics as upon the local oscillating fends, who, unfortunately, are very many. I have had both WGY and WBZ on the loud speaker, which is a "Baby Sterling." Madrid, several German and French, and Brussels quite good on the loud speaker. I am less than one mile from 5IT, and yet I can pick up all the B.B.C. stations whose wavelengths are below Newcastle's on the loud speaker while 5IT is transmitting, without any interference. I have noticed one peculiarity about this set. Although it is so selective on the B.B.C. band, I cannot tune out 5IT when working on the higher wavelengths. There is no doubt in my mind that it is a most wonderful circuit. The main thing is to use only the best L.F. transformers. With regard to valves, I am using ordinary bright emitters. I have tried Cossor, B.T.H., Ediswan, Marconi-Osram, Dutch and some of the cheaper valves. There is little to choose between the well known makes mentioned, but the cheaper makes are hopeless. The conclusion I have come to is that if you want the best from a set, you must use the best components. I have built several valve sets, but in my opinion this set is equal to the best 4-valve set yet known. I think it will beat your splendid staff to devise a better circuit. Wishing you and your papers every success.—Yours truly,

W. T. PARKER.
Birmingham.

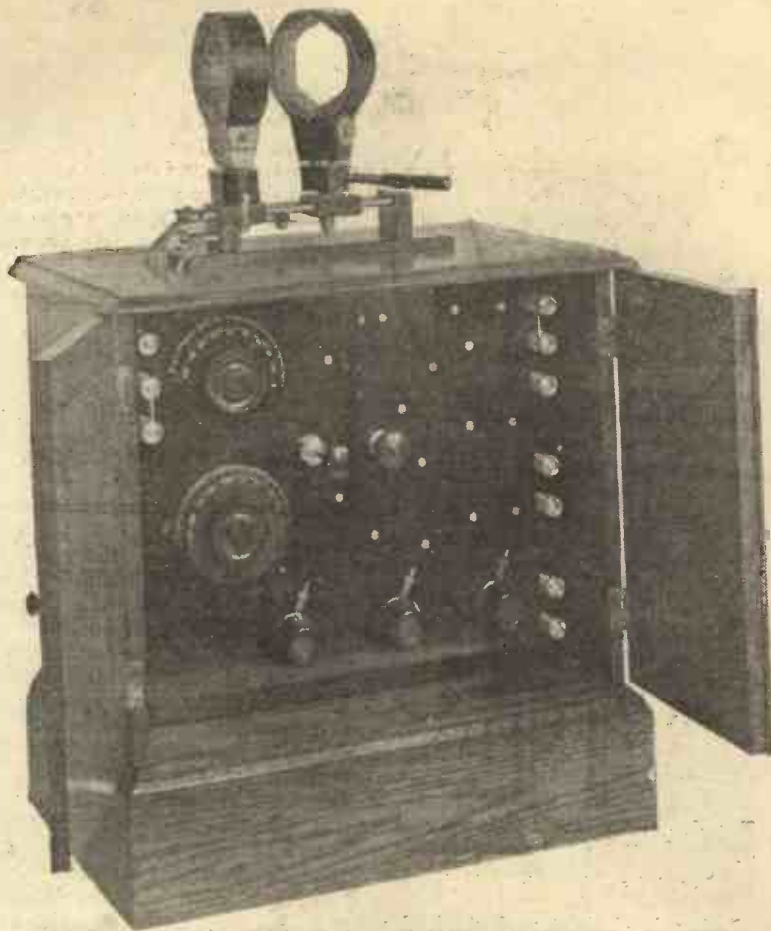

The
Neutrodyne
Junior :
A Three-Valve
Cabinet Receiver
for General Work.

By
PERCY W. HARRIS,
M.I.R.E.,
Assistant Editor.

coupling can be extremely loose without any instability in the receiver such as is occasioned by the use of loose coupling in the conventional tuned anode or tuned transformer receiver. The disadvantage of loose coupling is the multiplicity of controls involved and the skill in handling to get the best results.

A Special Form of Coil

Recently there have appeared on the market plug-in coils with one or more tappings taken to them, or else with a semi-aperiodic aerial winding closely coupled, the idea being to give the advantage of selectivity possessed by loose coupling without the necessity of a multiplicity of adjustments. Unfortunately a semi-aperiodic aerial circuit, while giving much greater selectivity, reduced the

The finished receiver strikes a distinctive note. The doors on the front of the cabinet may be closed when the set is not in use.

THE other day I received a post-card written in a strong feminine hand and worded as follows :

"SIR,—For heaven's sake don't write any more articles telling your readers how to build wireless sets.

Yours indignantly,
"WIRELESS WIDOW."

As a married man I can appreciate her point of view, but I am afraid it would take more than a post-card to abate my interest in the development of the wireless art. For this reason I venture to describe still another set, the justification being that I think it embodies certain features in simplicity and efficiency which will appeal to a wide circle. The Cowper method of neutralising the reaction feed-back between valves, with my modification of it, in which the two windings of a plug-in transformer are utilised, is well known to readers of MODERN WIRELESS, and constructional details of such sets have already appeared in MODERN WIRELESS and THE WIRELESS CONSTRUCTOR. The sets previously described,

however, have been of rather an elaborate nature, due on the one hand to the use of loose coupled tuning and on the other to more than one stage of high frequency amplification. Loose coupled tuning enables a much greater selectivity to be obtained, and in the neutrodyne method such

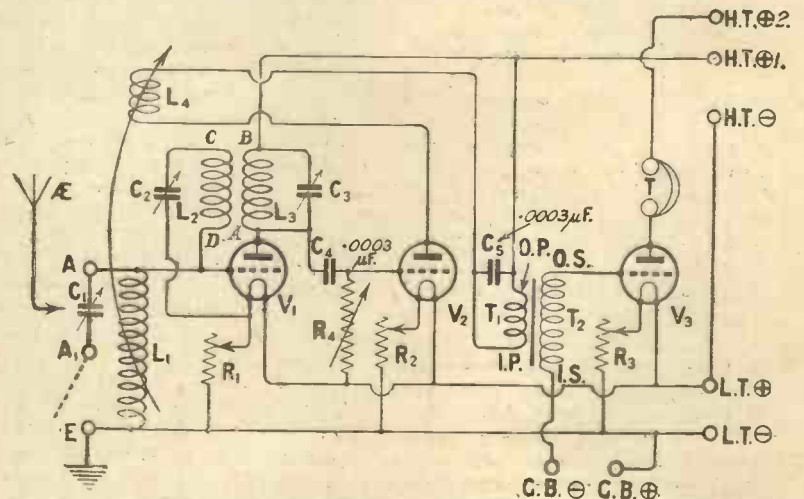

Fig. 1.—The theoretical circuit. The connection from C₂ to the filament of V₁ is of interest.

In this interesting receiver the Neutrodyne principle is applied in the simplest possible fashion, making the set as easy to handle as any tuned anode receiver. Used as described the selectivity of the instrument is unusually high and far exceeds that of the average three-valve tuned anode receiver.

stability of the tuned anode or tuned transformer set very considerably and generally a positive bias on the grid of the high frequency valve is necessary in order to "hold the set down." If, however, we apply this semi-aperiodic coupling method to a suitably designed neutrodyne receiver, we can obtain excellent results, as you will see if you build the instrument about to be described.

The Circuit

If you examine the theoretical circuit diagram in Fig. 1 you will see the circuit is made up of one high frequency valve, with tuned anode coupling to the detector valve, this being followed by one stage of transformer-coupled note magnification. Coupled to the tuned anode coil is a winding joined at one end to the grid of the valve and at the other to one side of a neutrodyne condenser, the other side of which is connected to the filament of the valve. A convenient form of these two windings is the well known plug-in transformer, a winding of which can be used as the anode coil and the other as neutralising winding. I found soon after beginning experiments with such transformers that the ordinary 300-600 metre transformer did not tune sufficiently low to embrace the 300 metre wavelength when used in this fashion, and at my suggestion the firms making these transformers built "neutrodyne units," the windings being so adjusted as to bring within their range the 300-600 metre band when tuned with a .0003 or .00025 μF condenser.

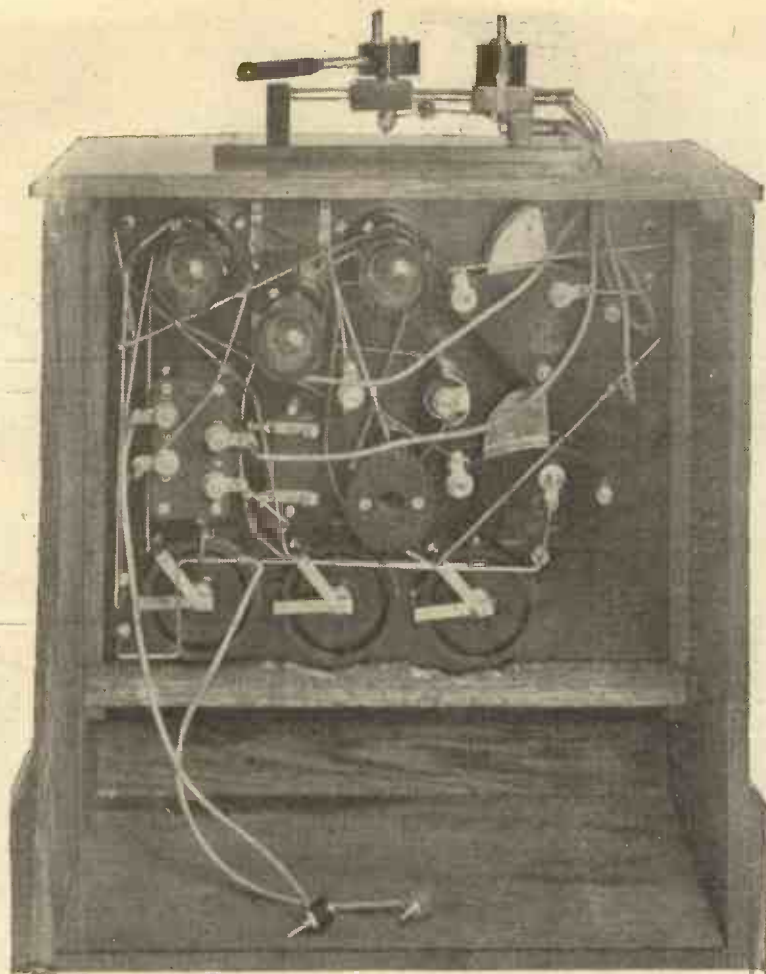

From this photograph the compact arrangement of the components, together with accessibility, will be appreciated.

Good Selectivity

In the circuit diagram I have shown the ordinary direct coupled aerial circuit in which form I suggest you first of all try out the instrument. You can then substitute the special coils to be described and obtain far greater selectivity. However, if you keep to the ordinary plug-in coils the selectivity is higher than is generally obtainable with a tuned anode set, as there is no special damping introduced into the first valve circuit to obtain stability and thus flatten the tuning.

The make-up of the receiver is somewhat different from that generally given for three valve sets, and in the present instrument I have utilised a cabinet with swing doors which serve to protect the instrument from dust. With the exception of the two-coil holder which is mounted on the top of the cabinet, all parts are carried on one ebonite panel, 12 by 10 in. by $\frac{1}{4}$ in. and following the practice that is becoming general, the valves are placed

behind the panel out of harm's way. The neutrodyne unit is also placed behind, so that when the doors are open we see only the tuning dials, the knob of the neutrodyne condenser, the knob of the variable grid leak and the three filament resistance controls. Terminals are arranged in convenient fashion, with on the left the well known three-terminal method of obtaining series or parallel connection of the aerial condenser. On the right are terminals for high tension (with provision for a separate tapping to the last valve) telephones and low tension. Grid bias is provided for by two flexible leads terminating in Clix sockets behind the panel. In many cases the addition of grid bias will not be found to give any improvement in signals as with bright emitters working from a six volt accumulator and with four volts on the filaments there will be a drop in voltage in the filament resistance of two volts, and this can be applied to the grid of the last valve by the simple expedient of connecting

the I.S. end of the secondary winding to the negative L.T. For this reason the two Clix sockets can be connected together for all preliminary trials and, in most cases where the two volt grid bias is provided as described, can be left in position. If required, of course, a power valve can be placed in the last socket and a much higher plate voltage applied to it, in which case suitable grid bias will need to be given. Suitable

every copy of this issue. You will have a wide choice of component parts. As is customary in Radio Press publications, I am giving the names of the actual makes I have used in this set, but it must not be thought that the choice of these particular parts is an indication that these only are suitable. In a few cases where adherence to a particular style is suggested, the reason for this will be given.

Three filament resistances. (Rothermel.)

Four valve sockets for panel mounting (Burne Jones). As the valve sockets must be mounted behind the panel, there are relatively few patterns suitable. The best kind to use here is one which is really made for mounting flat on a wooden baseboard. Notice that those illustrated are held to the back of the panel by two screws which are passed through from the front.

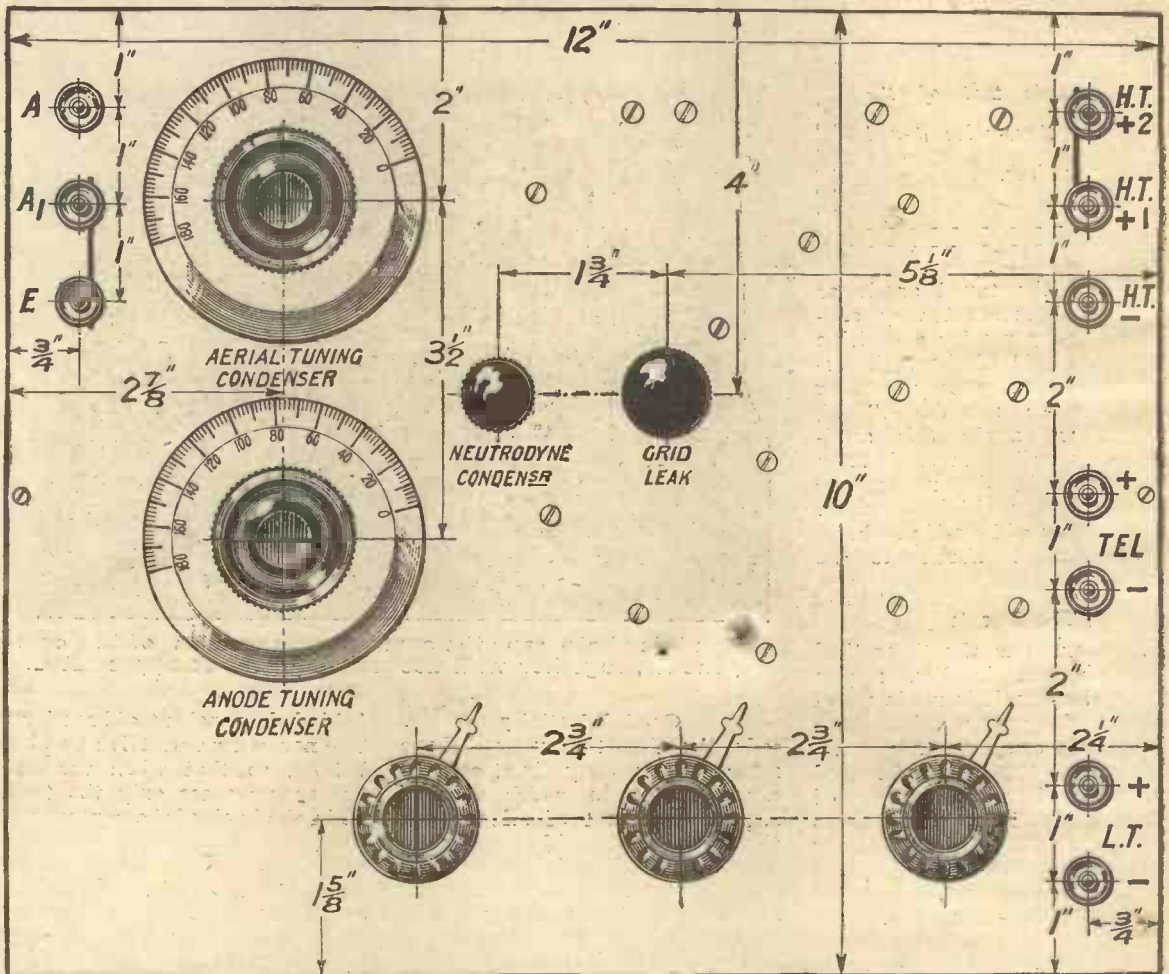

Fig. 2.—The layout of the front of the panel. Constructors may obtain the full-sized Blue Print No. 97a.

values of grid bias for power valves can be ascertained from the makers' lists, or from particulars furnished in the valve box by the maker.

To use a grid bias battery, plug the black or negative Clix into the negative socket of the battery and the red or positive Clix into the value of bias chosen.

Construction

Constructional details are given both in the photographs and in the free blue print enclosed in

Here, then, is the list of components required :

One ebonite panel 12 by 10 by 1/4 in. Whatever ebonite you use make sure that you use one of the guaranteed kinds and free from surface leakage.

One cabinet with folding doors to take the panel described. (That shown is a standard "Camco.")

One square law variable condenser .0005 µF. (Jackson Brothers.)

One square law variable condenser .0003 µF. (Jackson Brothers.)

One variable grid leak (Bretwood). You can use the conventional fixed leak of two megohms if you so desire. You will find very little difference using a variable grid leak here, but the particular pattern shown is convenient for mounting and occupies but a small space.

Two .0003 µF fixed condensers (Dubilier).

One Polar Micrometer Condenser. (Radio Communication Co.) Any of the well-known makes of neutrodyne condenser will do here.

Ten terminals.

One intervalve transformer of good make. That shown is a C.A.V. As now marketed this transformer is cased in a metal shield and therefore will not have quite the same appearance as that shown. Electrically, however, the transformer is the same. Any good make of intervalve transformer will do here, but as there is comparatively limited space available on this panel I advise you to choose one which occupies not too great an area.

ponents and lay them out on the back of the panel, to make quite sure that they will fit. In disposing the parts I suggest that you place valves and the neutrodyne unit in their particular sockets, as it will be necessary to see that the valves have room and proper clearance. The wiring has been very carefully worked out and I advise you to adhere to it as closely as possible. When wiring up have your valves at hand (preferably burnt out valves which you will not injure if they are

the panel will ultimately be screwed. There will be no special difficulty in mounting the components, but I would particularly urge you to read very carefully the mounting instructions issued with the Polar Micrometer condenser. The Micrometer condenser is an excellent instrument admirably suited for the purpose described, but it is very easily spoiled if mishandled in mounting. The makers have wisely given very clear instructions and you cannot go wrong if you follow them, but

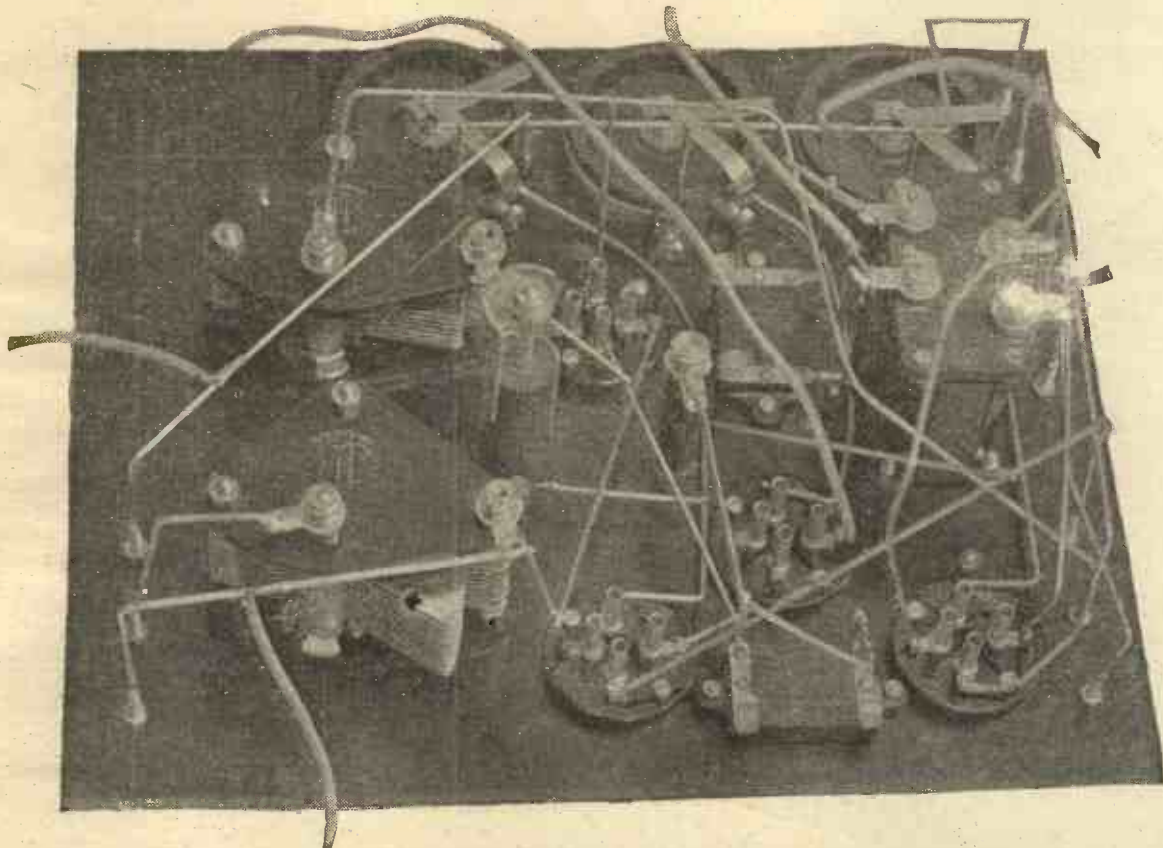

The underside of the panel, showing the wiring. This photograph will be of great assistance if used in conjunction with the Blue Print No. 97b, given free with this issue.

Two "Clix," one red and one black.

Neutrodyne Unit for the broadcast band (McMichael, Bowyer-Lowe, Magnum, and Peto-Scott are four makes which work successfully here. There may be others which I have not yet had an opportunity of trying).

One two-coil holder. That shown is a McMichael "Reversine." It has a particularly fine adjustment and enables reaction to be reversed without altering any connections.

One packet Radio Press panel transfers.

The Layout Needs Care

Before you drill your panel I advise you to obtain all the com-

ponents and frequently place them in their sockets to see that the wires are not in the way.

Wiring up

Points to watch carefully in marking out your panel and wiring up the receiver are—to see that there is room for the moving plates when they are at their maximum distance away from the fixed plates, that the sockets for the valves and neutrodyne unit are the correct way round and give plenty of room for the valves, that the wires do not touch one another at the crossing points, (save where specially indicated) and that you make proper allowance for the fillet of wood to which

I have already seen one neutrodyne set which failed to work for no other reason than an injury to this condenser when assembling. This would have been avoided had the builder read the leaflet enclosed in the box.

Mounting the Coil Holder

Wiring is done with No. 16 tinned square section wire, except for the leads which go to the coil holder and to the Clix. These are rubber covered flexible wire, as shown. When soldering these wires in place leave ample length, as you can cut them to the correct length in the final stage of joining up. The coil holder is fastened to the top of the cabinet by four

screws through the corners, and four holes are drilled in the top for the flexible leads from the panel below. When everything has been mounted on the panel it can be slipped into place, secured to the fillets of wood by two screws, and the flexible leads threaded through the top. Now cut off at suitable lengths and join to the four terminals of the coil holder. In deciding the length of each of these leads be sure that you have disposed them inside the cabinet in such a way that they do not foul the valves or moving vanes of the variable condensers.

one for the aerial tuning and the other for reaction. The reaction coil will be smaller than is generally the case and can well be one size smaller than that used for aerial tuning. Dealing first of all with the ordinary direct coupled method of tuning, we can place in the aerial socket the coil which we have previously found suitable for the broadcast wavelength with our own aerial. This means, of course, that according to the size of the aerial, we shall need a 25 and a 35, or a 35 and a 50 to cover the whole broadcast band. Larger aeriels will require the 25

joined by a wire, thus giving the parallel arrangement of aerial tuning. $H.T_1$ and $H.T_2$ can be joined by a wire for simplicity, thus giving the same voltage on all three valves. The grid bias terminals can be joined together.

Now place a number 75 coil in the aerial (fixed) socket and short circuit the moving socket, either by putting a short circuiting plug in it (if you have one) or by the simple expedient of joining the two terminals of the moving coil socket with a piece of wire. Set the aerial tuning condenser about half way, light your valves, use say 50 or 60 volts high tension and, put your neutrodyne condenser at its minimum position (in the case of the Polar this means pushing the knob in and turning it so that the moving plates are farthest away from the fixed plates). In the case of the other makes of neutrodyne condensers it means screwing the knob upwards so that the moving plate is as far as possible from the fixed plate. Now with the neutrodyne unit in its socket turn the knob of the anode tuning condenser backwards and forwards, and you will soon find that the set will oscillate over quite a considerable portion of the dial readings. This oscillation

will be indicated by a "plop" when it starts and by a slight rushing noise in the telephones. You can check if the set is actually oscillating by wetting your forefinger and touching the aerial terminal of the set, when you will hear a loud "plop" both when you touch it and when you withdraw your finger. Now

slowly adjust the neutroding condenser, and you will find that as you alter it the width of the band over which the anode condenser will oscillate will be narrowed. Thus, if previously it has oscillated between 40 and 80 degrees on the scale, it will now oscillate between 50 and 70. Continue this adjustment until you have narrowed the band down to such a point that there will only be oscillation over the smallest portion of the dial. When you find that the set will oscillate only over a tiny fraction of the scale, say one degree, make a further adjustment very delicately and carefully. The receiver will now be quite stable, i.e., it will not oscillate at all whichever setting you make of the anode or aerial condenser. This position of the neutrodyne condenser will remain for the whole of the wavelength bank covered by your neutrodyne unit, and you should leave the

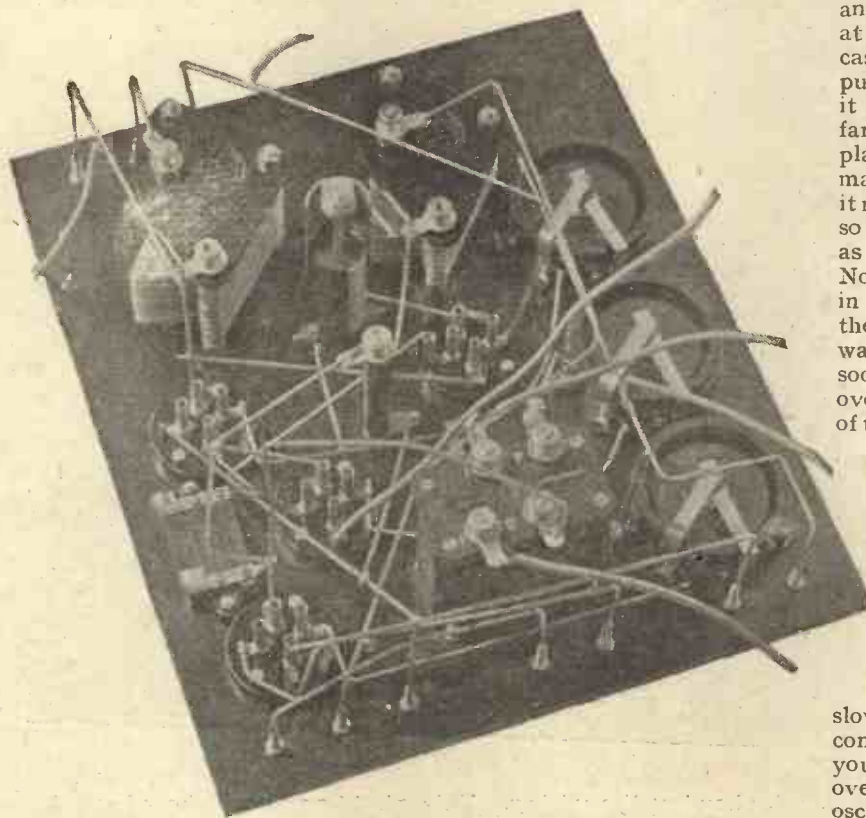

A view of the wiring which clearly indicates the connections to the battery and telephone terminals.

One further point should be mentioned, as it is somewhat of a departure from current practice. You will see that I have used a .0003 μF fixed condenser across the primary of the intervalve transformer, in place of the more general .001 μF . My experiments have shown that .0003 μF is amply large enough for the purpose, and there are theoretical reasons why too large a value should not be placed across the primary winding.

Choice of Coils

As you will observe there are two coils used in this instrument,

and the 35, smaller the 35 and the 50. It will also be convenient to have a 75 coil for the preliminary adjustment of the instrument, with which I will next deal. Before leaving the coil number, I will mention that a number 150 will be required if you wish to receive Chelmsford and Radiola. The 50 will serve for reaction with this.

Adjusting the Neutrodyne Condenser

The simplest way to make the preliminary adjustment is to join up the batteries and telephones, but not the aerial and earth. The terminals A_1 and E should be

condenser so set for all your work. The adjustment will only vary if you change the kind of valve or else substantially alter the high tension voltage.

Reaction

Now remove the short circuiting plug or the wire from the moving socket, plug in a size of coil one smaller than the aerial coil you will use; remove the No. 75 coil and plug in your usual aerial coil (say a number 35). Adjust the coil holder so that the reaction coil is at right angles to the aerial coil and tune with your aerial and anode condensers until you pick up the station you require at the best strength. Now move the reaction coil slightly one way or the other (if you are using a Reversine Coil Holder) and notice the reaction effects—a very slight movement of the coil will suffice to increase the strength of signals and bring the set towards oscillation. If you are using another kind of coil holder which does not permit of the reversing of the coil without alteration of leads, then make sure that approaching the moving coil towards the fixed gives the necessary reaction effects. If not reverse the leads to this coil.

When you have become accustomed to handling the set as an ordinary direct coupled receiver, you can carry out some exceedingly interesting experiments with semi-aperiodic aerial coupling, using for this purpose an Igranic "Unitune" coil, a Lissen X coil, or some of the special coils which Mr. G. P. Kendall, B.Sc., is describing on another page.

Semi-Aperiodic Coupling

In using the "Unitune" coil you will leave the connections to the coil holder just the same, but instead of connecting the aerial to the aerial terminal and the earth to the earth terminal, you should connect them to the two exterior terminals of the special coil. You will then find that with the one coil you can cover the whole broadcast band easily, but with a far greater selectivity than before. When using the Lissen X coil you will leave the earth wire on the earth terminal but connect the aerial terminal to one or the other of the projecting terminals of the Lissen coil. Notice that the Lissen and Igranic coils are not the same. On the Igranic coil you have two separate windings, one the aperiodic aerial winding and the other the normal winding connected to the plug and socket. In the case of

the Lissen X coil you have one winding only, with tappings taken at the 6th and the 10th turns. Which of these two tappings is the better in your case you will have to decide by experiment, but notice particularly that the beginning of the coil is connected to the socket and not to the pin, and this means that the socket should be connected to the earth side. Notice that the coil holder into which this is plugged *must have its pin connected to the earth side*, and therefore if your coil holder is not so joined up, make the necessary alteration by reversing the leads to it. This, of course, will also mean the reversing of the reaction leads if these are already the right way round. With the Igranic coil it does not matter which side is connected to earth (either pin or socket), but there will be a better way round for the aerial and earth connection through the exterior terminals.

With the Lissen coil you will arrange that the pin of your coil holder is connected to the earth side and you will connect the aerial wire to the 6th or the 10th turn whichever gives the better results. Tuning will be carried out exactly as before, but, as indicated, you will get much sharper tuning and less reaction will be required to make it oscillate.

Test Report

On repeated tests with this instrument no difficulty whatever was found in getting excellent

strength from all the British broadcasting stations and at night time several were of full loud speaker strength, although the volume from the distant stations varies considerably with the varying night conditions of different evenings. Romé, Madrid, Hamburg, Berlin and a number of other German stations came in at sufficient strength to operate a number of pairs of telephones, and occasionally at loud speaker strength. The set has already been tested by a number of members of the Radio Press staff on different aerials; their reports being the same as my own, gives me full confidence to recommend this set as a good general-purpose receiver for those who wish to listen to the distant stations as well as to operate a loud speaker on their local broadcasting station. Good loud-speaker strength can be obtained up to 20 or 30 miles from the nearest station with the greatest ease.

We would remind readers that in all our circuits where .0003 μ F variable condensers are specified for tuned anodes or transformers, a .00025 μ F will be equally suitable, provided it is of good make and up to its stated capacity.

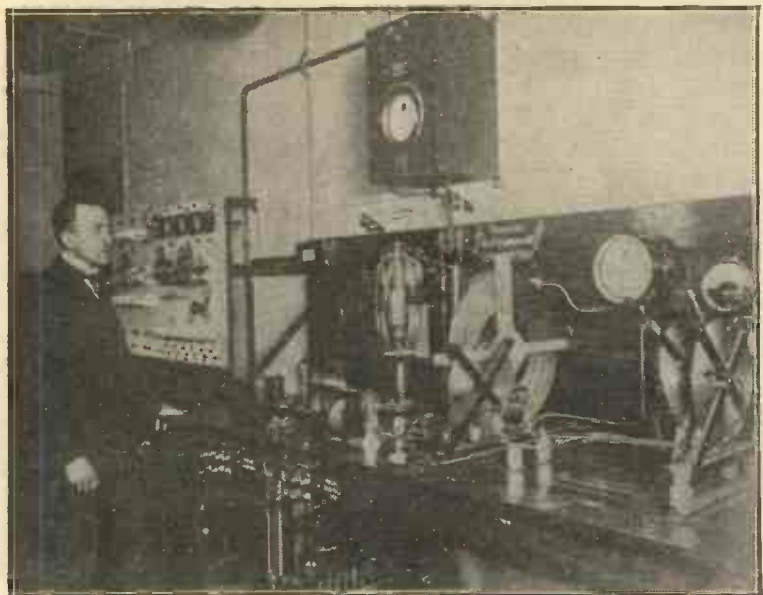

A view of the interior of the Hamburg broadcasting station which transmits on a wavelength of 395 metres.



Mr. A. R. Burrows, of the B.B.C.

Postbag Puzzles

By A. R. BURROWS

An amusing chat by the well-known Director of Programmes of the British Broadcasting Company concerning some of the difficulties encountered by the company's correspondence staff. Mr. Burrows is well known to the children as "Uncle Arthur."

THERE is a story told by a dear friend of mine (I trust he is not reading this article) of a Scotchman who, visiting Australia, expressed to his host surprise at meeting so many of his fellow-countrymen.

"Are there many Scots in the Commonwealth?" he enquired.

"Thousands," was the reply; "but the real trouble out here is rabbits."

The real trouble in broadcasting is to keep pace with the correspondence; to find time to answer

adequately the thousand-and-one reasonable questions (often quite incidental to the main questions), and, particularly, to solve the postbag puzzles.

Curious Addresses

If only one letter a year was to reach the B.B.C. from each home licensed to receive the broadcast programmes, then our incoming mail would average between three and four thousand letters a day, Saturdays and Sundays included. To answer even ten per cent. would entail an annual bill for postage stamps alone of £750.

Some of the puzzles are intended for the postmen. We have received

letters from foreign countries addressed simply "2LO." In Britain such an address would afford no difficulty, but the fact that this letter came halfway across Europe without delay, judging by the date stamp, may be regarded, we think, as an indication of the interest taken on the Continent in British broadcasting. Somehow, perhaps, we are a little too self-satisfied, for another letter, also from the Continent, was delivered with equal promptness. This was addressed simply "London Broadcastigation." Early in February this year the postman delivered correctly an envelope covered with an ingenious cartoon framed around the

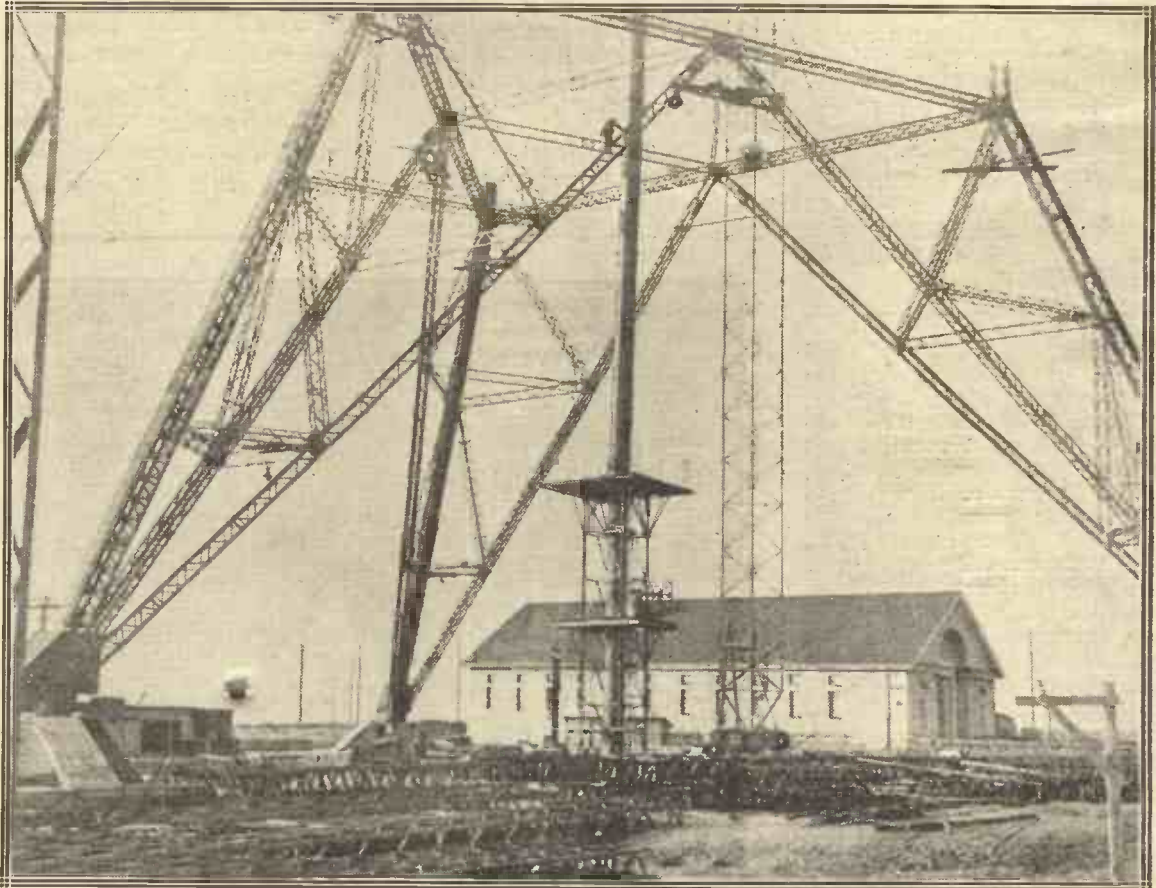

The giant 780-foot mast at Königswusterhausen in the course of erection. When completed this station will be one of the largest in the world.

postage stamp. The letter was from a scenic artist so alive to the possibilities of wireless that he was asking that he might be commissioned to paint the scenery used in the first experiment in broadcast wireless television.

A Listener's Problem

There follows sometimes a difficulty in deciding for which department a letter is actually intended.

I remember one from Hertfordshire in the early days of broadcasting addressed to the Director of Programmes which, at first sight, struck me as being essentially an engineer's matter. It was from a young listener who, together with another fellow older than himself, was making common use of a tall pole which stood at the end of their gardens. The method of hoisting the aerial appeared to consist of fastening one end to half a brick and throwing the half brick neatly over the top of the pole, but the successful "pitcher" invariably brought down the aerial already in position. The "ups and downs" of these aeriols were so frequent that relations eventually became strained. It was the smaller listener who wrote to 2, Savoy Hill, hoping, we presume, that the Director of Programmes would exercise his function to the extent of directing who should throw the next half brick.

There is one class of listener, quite an extensive class, who appears to think that the B.B.C. has a staff situated in some lonely spot well away from interference by the British stations, listening and logging all the transmissions in Europe and America. The letter

usually runs something like this: "Dear Sir,—Listening at 1.15 a.m. on Tuesday morning on about 300 metres, I heard a violin playing 'Caprice Viennois.' Can you tell me which station, etc., etc." Needless to say, we are rarely able to do so, though it does happen that our engineers occasionally find rest after a strenuous afternoon and evening by listening at home to "the other fellows" across the water.

stoop so long as they can injure another's career. Incidentally it may interest readers of MODERN WIRELESS to hear that the writer of anonymous letters regarding the broadcast programmes has almost died out. We have not heard for a long time from the young gentleman of fortune who was prepared to slit the throats of the whole of the Savoy Band for the sum of fourpence.

Lengthy Epistles

Broadcasting must be wonderfully stimulating to those with literary propensities, for it is astonishing how lengthy and even how bulky some of our letters are. One arrived the other day written on the back and front of a sheet of paper four times foolscap size. It contained, besides a simple question, what I should imagine to be the complete life history of its author. Another one before me at the moment consists of nine and a half neatly typewritten pages, about 1,000 words in all. This one we excuse because it displays an unusual sense of humour on the part of its author. Replying to my query whether we should transmit on Christmas Day or give the staff a holiday, this happy correspondent replies: "We had. Our accumulator ran down on Christmas Eve; the



Many enthusiasts in America have miniature broadcasting stations of their own. The above photograph shows the 200 watt transmitter owned by Mr. E. W. Edwards, of Cincinnati.

Whitechapel waits finished it." He then passes on to that eternal question, the identity of the announcers. Here he says: "There is a little bet you might settle for us. It is about the Pronouncer. I think you call him Announcer. We call him the Pronouncer, because Decima says, 'There! Did you hear him pronounce that? I told you so.' Of course, he says 'Pew-

Whitechapel waits finished it." He then passes on to that eternal question, the identity of the announcers. Here he says: "There is a little bet you might settle for us. It is about the Pronouncer. I think you call him Announcer. We call him the Pronouncer, because Decima says, 'There! Did you hear him pronounce that? I told you so.' Of course, he says 'Pew-

sheeny' when I say 'Puckinny.' But I have my reasons. If I say to my friend, 'That's a lovely piece by Pewshceny,' he just looks puzzled and says, 'Sheeny who?'; whereas if I say 'Puckinny' he looks enlightened and replies, 'Yes, those foreign johnnies are pretty good.'" We are also asked by the same correspondent to settle two other bets: "Whether Capt. Eckersley bobs up through a hatch into the studio wiping his face on cotton waste as do the engineers on tugboats, and also which finger our beloved Chief Engineer used in his recent piano solo as an illustration to his technical talk."

Such a letter in lighter vein comes as a relief to those obviously intended to be taken seriously, which must be answered fairly and in good temper. Amongst these, for instance, are those, happily not numerous, demanding why we should abuse our licence and damage the health of the rising generation by transmitting after 10 p.m., at which hour all the workers should be in bed. Alongside such letters as these will come others demanding that unless we transmit until 2 a.m. for the benefit of those engaged in the entertainment industry and do not arrive home until after midnight, we may expect 125 fewer listeners in a single locality next year. Well, we endeavour to give even minorities a good programme for their licence fee, but it would require many thousands of extra licences to pay the fares of sixty engineers returning home every morning when all public conveyances have ceased to run. Besides, loud-speakers at work until 2 a.m. would not be calculated

to create amongst flat-dwellers that desirable amity which should exist between neighbours.

It is good that experimenters should know that the B.B.C. is frequently being asked to continue its transmissions nightly to a later hour than at present. One of the reasons why late transmissions are confined to three nights of the week is the desire to give the British experimenter an opportunity for

and unpatriotic of the B.B.C. to broadcast the announcement that, according to French dressmakers, evening skirts are to be shorter. It's on a par with your German concert on Thursday."

Finally, here is a puzzle of the "cross word" order—but nicely put. It is a "round robin" from a number of workers at Smithfield Meat Market, and runs:—

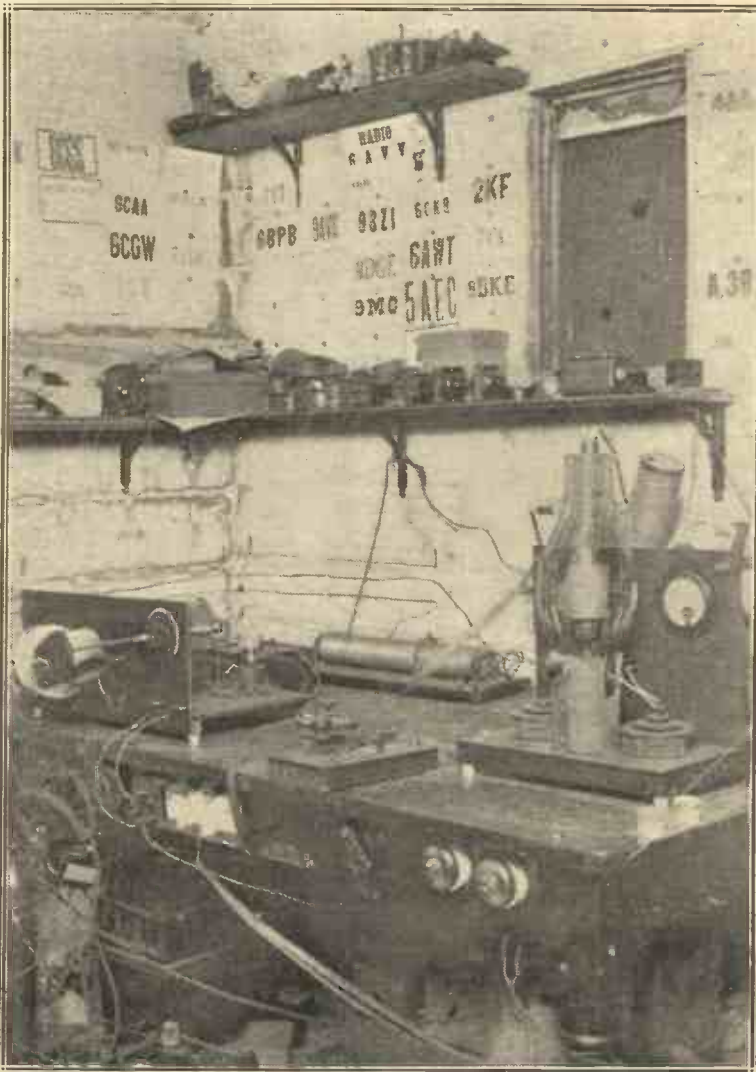

Two-way telephony communication with Australia an accomplished fact. The above photograph shows 3BQ, the experimental station owned by Mr. Max Howden, an Australian amateur who has worked with 20D, Mr. E. J. Simmonds of Gerrards Cross and others.

continuing research free from interference by the broadcasting stations.

The correspondent whom, I fear, we fail to convince is the one who labours under the impression that we are the originators of certain types of news. Here, for instance, is a letter which followed closely on a talk on forthcoming fashions: "Dear Sirs,—How thoughtless

"Sir,—It has been brought to our notice that a new fox-trot entitled 'Eat More Fruit,' containing the most insulting reference to lamb, pork, beef and ham as articles of diet, is now being broadcast as a song and dance number nightly by the Savoy Orpheans Band, and we beg to protest on behalf of our trade.

"This song, we understand, extols fruit eating in the interests of economy, longevity, fertility and temperance, and, worst of all, Britain's supremacy in sport; whereas history shows that the British butcher is unquestionably one of the most sporting, prolific and jovial of men. Naturally, therefore, we resent being 'danced on.'

"It was beef, not apples, that sent our men over the top in Flanders, and we therefore ask you, not out of malice, but in the interests of truth and fair play, to discontinue forthwith the broadcasting of this most insidious ditty.—Yours faithfully."

Our solution lies in the suggestion that the signatories should advertise for a fox-trot on "The Roast Beef of Old England." I think they will find that one actually exists.



Further Reports from Readers using the T.A.T. System



Good Results with a T.A.T. circuit

SIR,—May I add my word of praise for your T.A.T. system of H.F. amplification and tuning.

Using 2. v. 1 in the early hours of this morning, WGY, Schenectady, N.Y., came in at full 'phone strength—audible with the 'phones off the head.

With 2. v. 0 German stations are very loud, but on using 3 v. 0 very little increase of signal strength is noticed.

I have found that for wavelengths below 400 the choke on the first plate must be 200 instead of 250. The choke coils I use are not identically alike. Would this account for the fact that signals are not much stronger with 3. v. 0 than with 2. v. 0. In other words, is it essential to have identical chokes in multi-stages of H.F.?

After testing for U.S. stations all last winter with multi-stages of H.F.—and poor results—I can only say how delighted I am with your new method. There should be no limit to the number of H.F.s used with such a perfectly stable circuit. I propose continuing until I have U.S. at full loud-speaker strength without using any L.F. side at all.

Heartiest congrats. and the best of luck.—Yours truly,

P. VERNON-ANDERSON,
M.D., B.A.

Durham.

[There appears to be no reason why the chokes should be different.—Ed.]

The Seven Valve T.A.T.

SIR,—I have built the Seven Valve "T.A.T." Receiver, given in the January issue of MODERN WIRELESS, and I have very good results. I get nearly all the English B.B.C. stations on loud-speaker with six valves, 3 H.F. and 2 L.F., and with five valves I can get all the

German, French, Suisse stations and the Italian one (Rome) on loud-speaker too.

I have used all the four H.F. valves, but with them it is impossible to use the reaction and the strength does not increase very much, but instead I have more selectivity.

I am sending you a photograph, showing you my set.

Please note an extra valve (L.F. resistance capacity coupled), which can be switched off.

Wishing you every success.—

Yours truly,

GAETANO LANFRANCHI.

Milan.

Another Seven Valve T.A.T.

SIR,—I have constructed in detail, the 7-valve T.A.T. receiver, described in the January MODERN WIRELESS, and generally speaking,

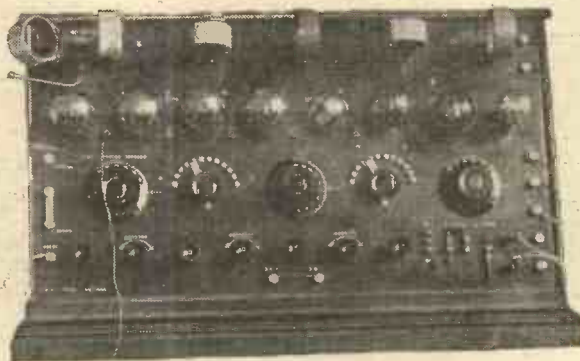

Mr. Lanfranchi's Seven Valve T.A.T. with an extra L.F. stage.

the results are very satisfactory indeed.

Using the five valves it is possible to receive all the B.B.C. stations at moderate loud-speaker strength (excepting Birmingham, which for some reason or other, can never be tuned in here) and of course most of the stations in Germany and France. Chelmsford is very good

loud-speaker strength here on four valves (distance 230 miles), and also Cardiff (50 miles).

As you suggest though, in your test report, it is not possible to do much with seven valves whilst the local station is working (in this case Cardiff) owing to the choking effect, although no actual signals are received from Cardiff.

On the night of January 20, using seven valves, KDKA, WGY and WBZ were tuned in, and at times were at uncomfortable loud-speaker strength! But unfortunately living right on the sea coast, Morse interference is very excessive.

Excepting for being rather unselective, I am very pleased with the set indeed, and I consider your "T.A.T." method of handling H.F. is excellent both for stability and ease of manipulation.—Yours truly,

RICHARD C. J. SANDERS.

Woolacombe, North Devon.

A Four Valve T.A.T.

SIR,—I tried your T.A.T. 4-valve receiver and I am glad to state that this is the best 4-valve receiver I have experienced for long distance receiving. I think that this receiver covers practically all broadcasting stations in Europe. I have located in a short time, fourteen stations situated in Norway, Sweden, Denmark, England, Germany, France, Holland and Switzerland. For the reception of 5XX the circuit proves really perfect, this station, as well as Radio-Paris, coming in at a very good loud-speaker strength.

I wish foreign readers of your very interesting review, who are dependent on H.F. amplification, to reach the best broadcasting stations in Europe would try your T.A.T. circuit; they will certainly be satisfied with the results.—Yours truly,

EMILE DE COEN.

Stockholm.

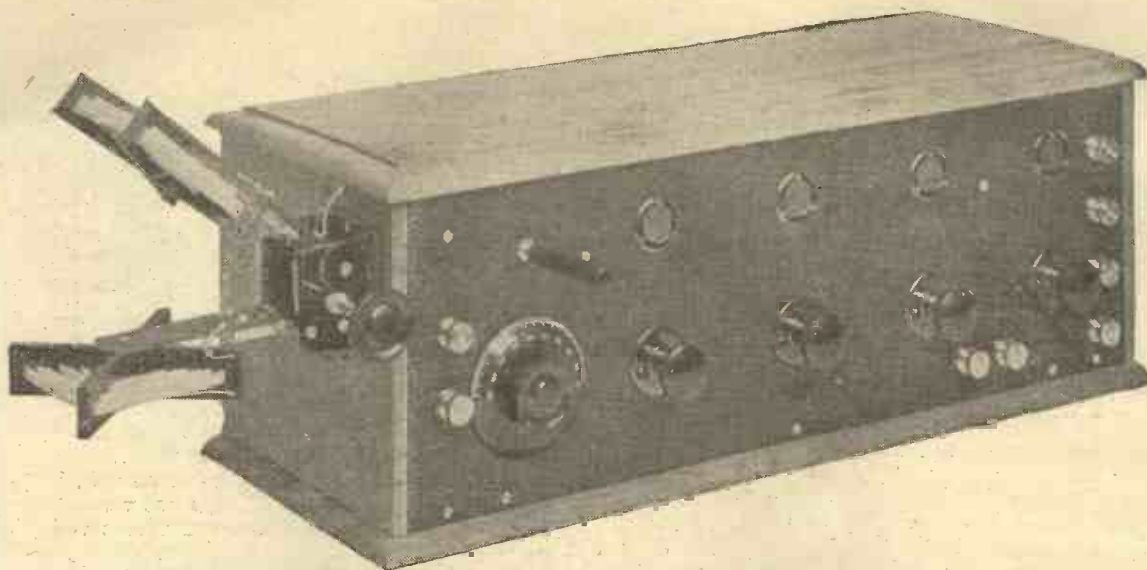

The handsome and well balanced appearance of the finished instrument is distinctly pleasing. Home-made coils are shown in the sockets.

The "Resistance Four"

A Four-Valve Receiver with Three Amplifying Stages

By A. JOHNSON-RANDALL.

An efficient four-valve receiver, simple to construct and easy to operate, capable of giving faithful loud-speaker reproduction in great volume up to distances of 20 miles from the local station.

TO the music lover and to the "listener-in," as distinct from the experimenter, the wireless receiver is regarded merely as a convenient apparatus by means of which may be rendered audible in the home the music and voices of artistes famous in their profession, and, in addition, lectures and "talks" by great men who before the advent of broadcasting were but names to the "man in the street."

To be of any real value as such the receiver must be as nearly distortionless as possible, in order that the reception may be a faithful reproduction of the original.

In many cases the poor reproduction often heard is due not to the loud speaker but to distortion actually in the set itself.

A Popular Method

There are several methods of amplifying the received signals in such a manner as to be capable of operating a loud speaker, and the most popular of all is without doubt that method of low frequency amplification in which the amplifying valves are coupled by means of low frequency transformers. Now, unless the transformers are

of first class make and unless certain rules known only to the more experienced enthusiast are followed, in nine cases out of ten some distortion will be present. This applies in particular to cases where two stages are employed, and to work a loud speaker efficiently it is often essential that this should be so.

It is recognised that the simplest

and most successful method of obtaining faithful amplification is by means of resistance capacity coupling. I do not mean that it is not possible, using this method, to have distortion present, as other factors must be taken into consideration, but if an efficient design is followed, and if the set is used intelligently with a minimum of

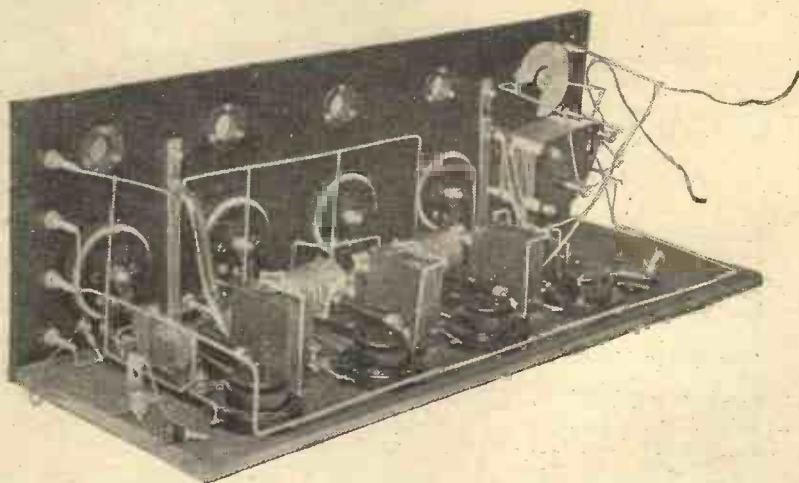

The small brass angle piece seen to the front on the left is for the purpose of holding the grid battery in position against the side of the case.

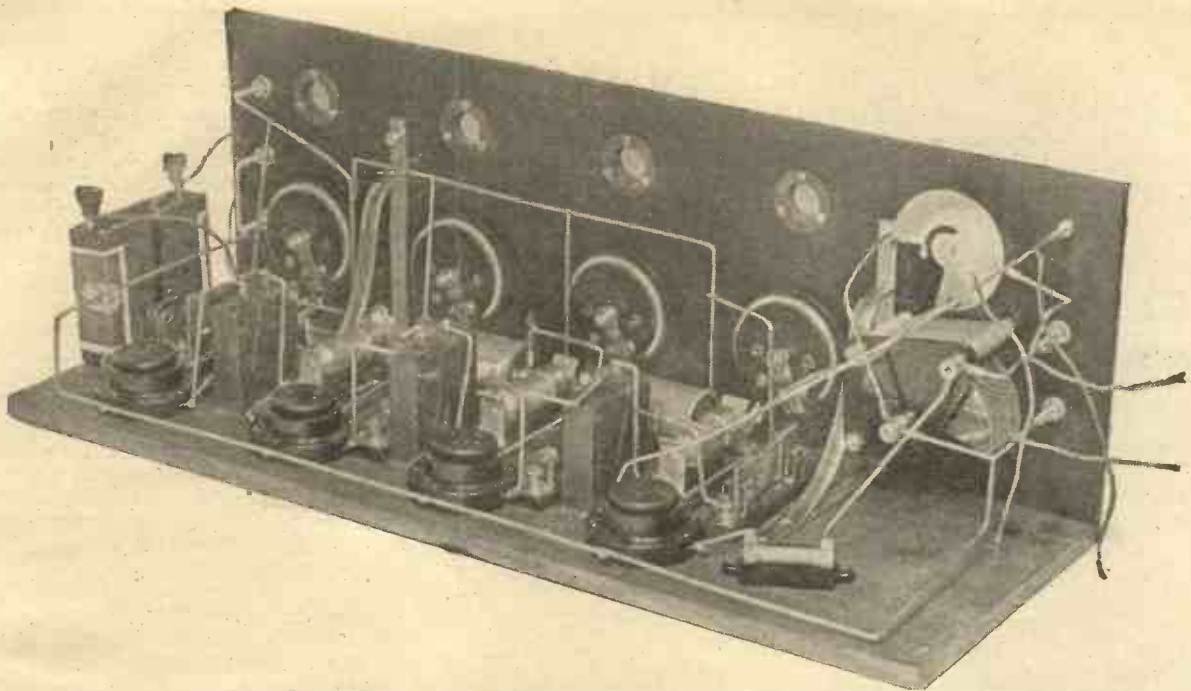

A view of the wiring with the grid battery for the last valve in position. This battery is held between the side of the case and the small brass clip.

reaction, then it is possible to obtain reproduction of such quality as to satisfy the "music lover" and do justice to the broadcast.

Resistance Coupling

Until recently the great disadvantage of resistance-capacity amplification was the fact that three stages were necessary to obtain the efficiency of two stages with transformer coupling, and also that very high anode voltages were essential if the amplifying

valves were to be operated at the correct working points on the characteristic curve, owing to the drop in voltage across the anode resistances decreasing the effective plate voltage. It is now possible however to purchase valves especially designed for resistance coupling giving a high amplification factor in the neighbourhood of twenty, thus bringing the effective amplification per stage much closer to that obtained by using ordinary valves

and transformer coupling. Moreover, these valves are dull emitters consuming only .25 ampere and the plate voltage necessary for efficient operation is only 100-120 volts. It is a receiver using this type of valve and employing resistance capacity coupling that I am about to describe.

The Circuit

The circuit is a simple straightforward circuit consisting of a valve detector followed by three stages of

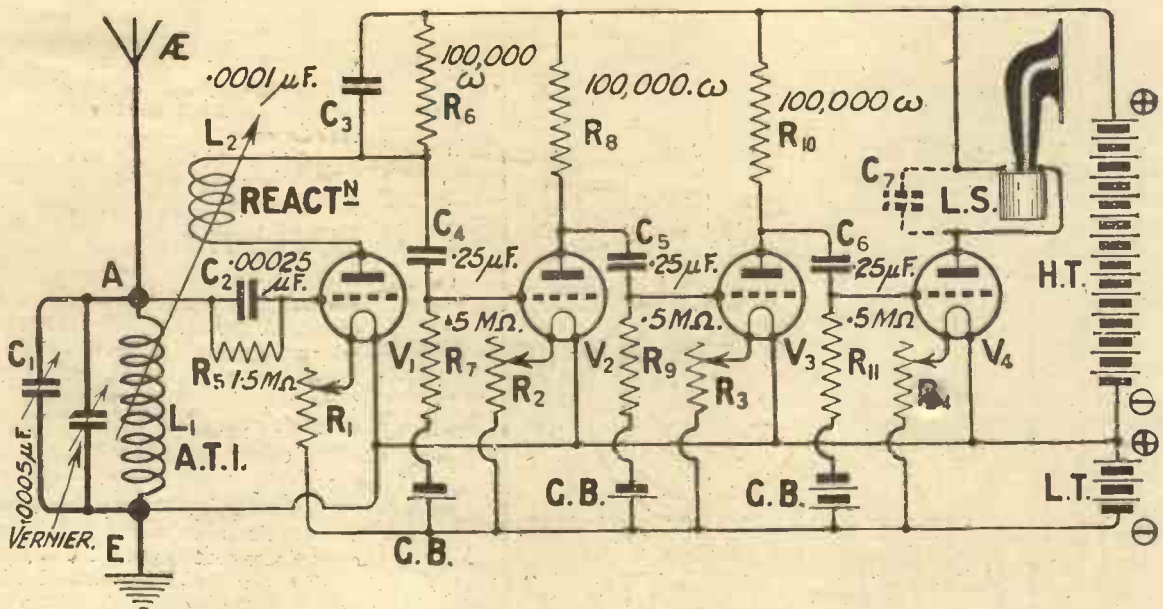

Fig. 1.—The theoretical circuit diagram. The best value for the condenser C7 shown dotted must be determined by experiment.

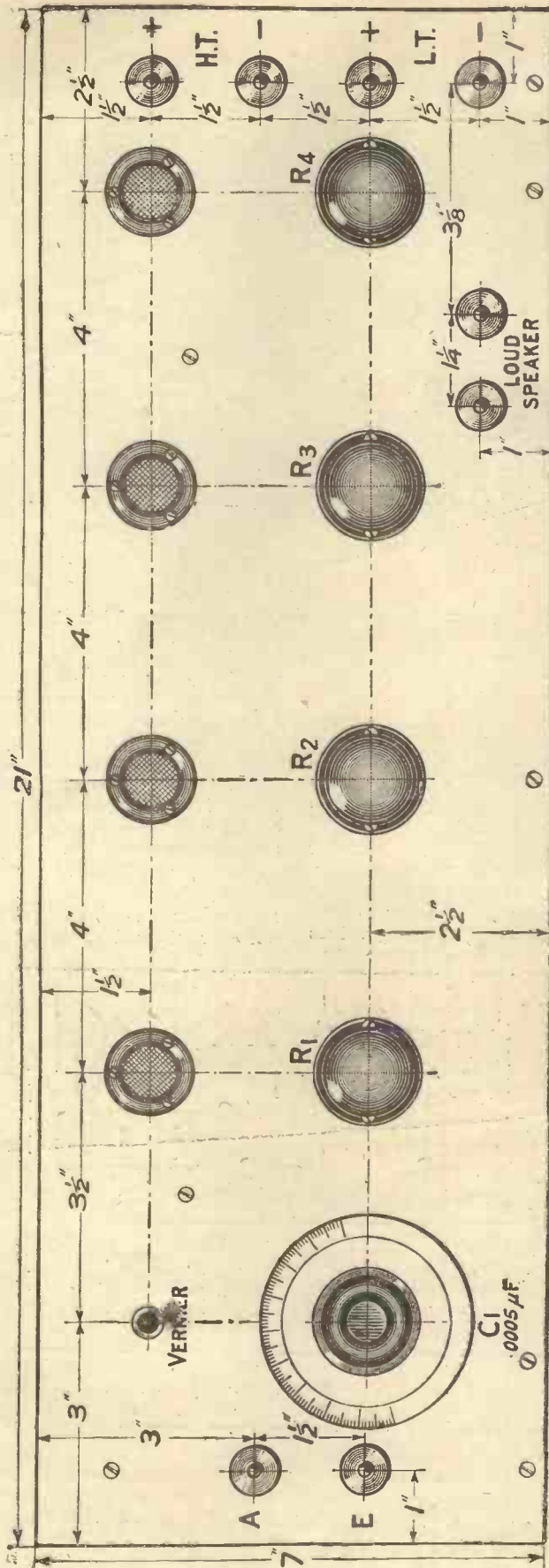

Fig. 2—The layout of the front of the panel. Blue Print No. 100a may be obtained from our Sales Dept.

low frequency amplification resistance coupled. The receiver is designed essentially for those who require pure reproduction and who desire to operate a loud speaker at full strength at distances up to 20 miles from the local main B.B.C. station. It has been deliberately kept as simple as possible in every detail consistent with efficient working. The aerial circuit consists simply of a plug-in coil tuned by a .0005 square law pattern variable condenser connected in parallel. Only two terminals are therefore necessary, one for the aerial lead and one for the earth connection. A small vernier condenser is connected in parallel with the main tuning condenser for fine adjustment. It will be noticed that no separate H.T. tappings are provided for in the design. The reason for this is as follows:

Only one H.T. tapping

The detector valve has a resistance of 100,000 ohms connected in series between the plate of this valve and the H.T. positive lead to it. The value of this resistance has been chosen such that the drop in volts across it ensures that the effective applied potential on the plate of the detector valve is approximately correct for valves of the general purpose type. As the remainder of the valves used are only suitable for six volt accumulators I would suggest that an ordinary bright emitter be used as a rectifier.

Value of H.T.

The two valves used in the first two stages of amplification are of the D.E.5b type and require a high tension voltage of 100-120 volts when used in conjunction with 100,000 ohm anode resistances. The last stage has no anode resistance and a low impedance valve of the B.T.H. B4 or similar type is suggested here. Using 100-120 volts on the plate of this type of valve a permissible total grid swing of 10-12 volts is possible without distortion, hence faithful loud speaker reproduction can be obtained. It will now be seen why a common high tension voltage of 100-120 may be used, at the same time working each valve at its efficient operating point.

Controlling the Tone

No condenser is shown connected across the H.T. battery, as I consider this should be considered essentially part of the H.T. battery itself and should be treated with this battery as a separate unit, as was suggested by Mr. Percy W. Harris recently in *Wireless Weekly*. A small clip-in type condenser is

connected across the loud speaker terminals, shown dotted in Fig. 1.

The tone of any loud speaker may to a certain extent be controlled by varying the size of this condenser and also the correct value varies with the input. Too small a value will make the tone "thin" and too large a value will "muffle" and speech will be "full." There is therefore an optimum value, which must be found by experiment; hence the reason for using the clip-in type of condenser. Grid bias is provided for each valve and separate grid

3 Coupling condensers .25 μ F (T.C.C.).

4 Anti-phonic valve holders (Burndept).

1 .0001 μ F clip in fixed condenser on base (McMichael).

1 Condenser on base for loud speaker (McMichael). The value may be between .001 and .01 μ F, or perhaps more in some cases and must be found by experiment. A good general value is .005, but this will not suit some instruments.

3 Anode resistances, 100,000 ohms (Dubilier).

2 1.5 volt grid bias cells (Ever-

to panel and one for soldering to reaction lead.

1 packet of Radio Press panel transfers.

Panel Layout

The layout of the panel is very simple, as will be seen from Fig. 2. Commencing from the left the terminals are: Left hand upper terminal is for aerial lead and the one underneath is for the earth connection. On the right of the panel, arranged vertically, are four terminals, the top one being H.T. positive, next below H.T. negative, and then L.T. positive and L.T. negative. At the bottom are the two loud speaker terminal, and the one on the right looking at the front of the panel should be joined to the positive terminal on the loud speaker, or, in the case of telephones, to the tag connection usually marked red. Turning to the back of the panel and the baseboard, the simplicity of the layout will be further noticed, and it will be seen that all the components are suitable for baseboard mounting and may be fitted simply by screwing direct to the baseboard itself. One point should be noted and that is the small brass angle piece shown on the right-hand side of the base. This is merely a small brass clip for securing the grid battery in position against the case and it serves no other purpose. A small piece of wood would be

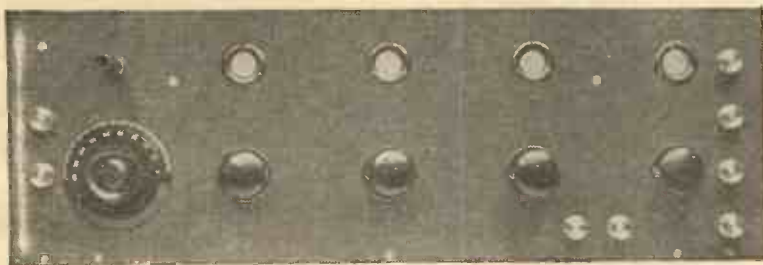

The symmetrical layout will be appreciated when marking out the panel.

batteries are used. As it is intended that valves of the D.E.5b type shall be used with a fixed plate voltage of 100-120 volts the correct grid bias may be obtained from two small 1.5 volts dry cells, one for each valve. In the case of the last valve a small tapped battery of 6 volts is suggested, although there is room in the case for one of 9 volts.

Grid leaks of .5 megohm are used in conjunction with .25 μ F coupling condensers, these values being very suitable for efficient working. This deals with the main points in the design.

Components Required

1 Mahogany case, complete with sub-base, suitable for a 21 in. by 7 in. panel and 8 in. deep. (That illustrated was made by W. H. Agar.)

1 21 in. by 7 in. by 1/4 in. ebonite panel free from surface leakage (Peter Curtis).

1 .0005 μ F sq. law condenser (Jackson Bros.).

1 Two-coil holder (Peto-Scott).

1 Vernier condenser (Colvern).

4 Filament rheostats 7 ohm (Burndept).

4 Valve windows, black nickel (Grafton Electric).

8 Terminals (those used are Burndept).

1 Grid condenser, .00025- μ F or .0003 μ F (Dubilier).

1 Grid leak, 1.5 megohms (Dubilier). 2 meg. will also be suitable.

3 .5 meg. grid leaks, complete with bases (McMichael).

Ready U.W.1 or similar type).

1 6 or 9 volt tapped grid battery (that used is an Ever-Ready 6 volt battery with 1.5 volt tappings, but any good make will be quite suitable).

2 Brass brackets for fixing panel to sub-base, obtainable from any ironmonger. The method of

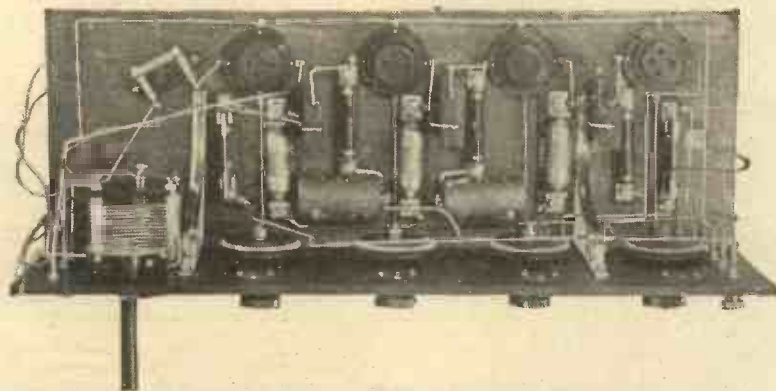

This photograph, together with the other views of the wiring, makes the construction exceedingly simple. It is possible to remove the resistances and clip-in condensers without disturbing the wiring.

fixing and type of bracket is not important.

Square section wire and soldering tags (Sparks Radio).

2 plugs for grid battery, one red and one black.

Some flexible rubber covered wire, a number of small wood screws, and three 4 B.A. screws and nuts, two for fixing brackets

just as suitable, but the clip used happened to be handy at the time.

Marking out the Panel

The first thing to do is to mark out the panel to the dimensions shown in the blue print or in Fig. 2. A small scriber and 12 in. steel rule should be used. Having marked out, mark the centres ready for drilling the holes by means of a

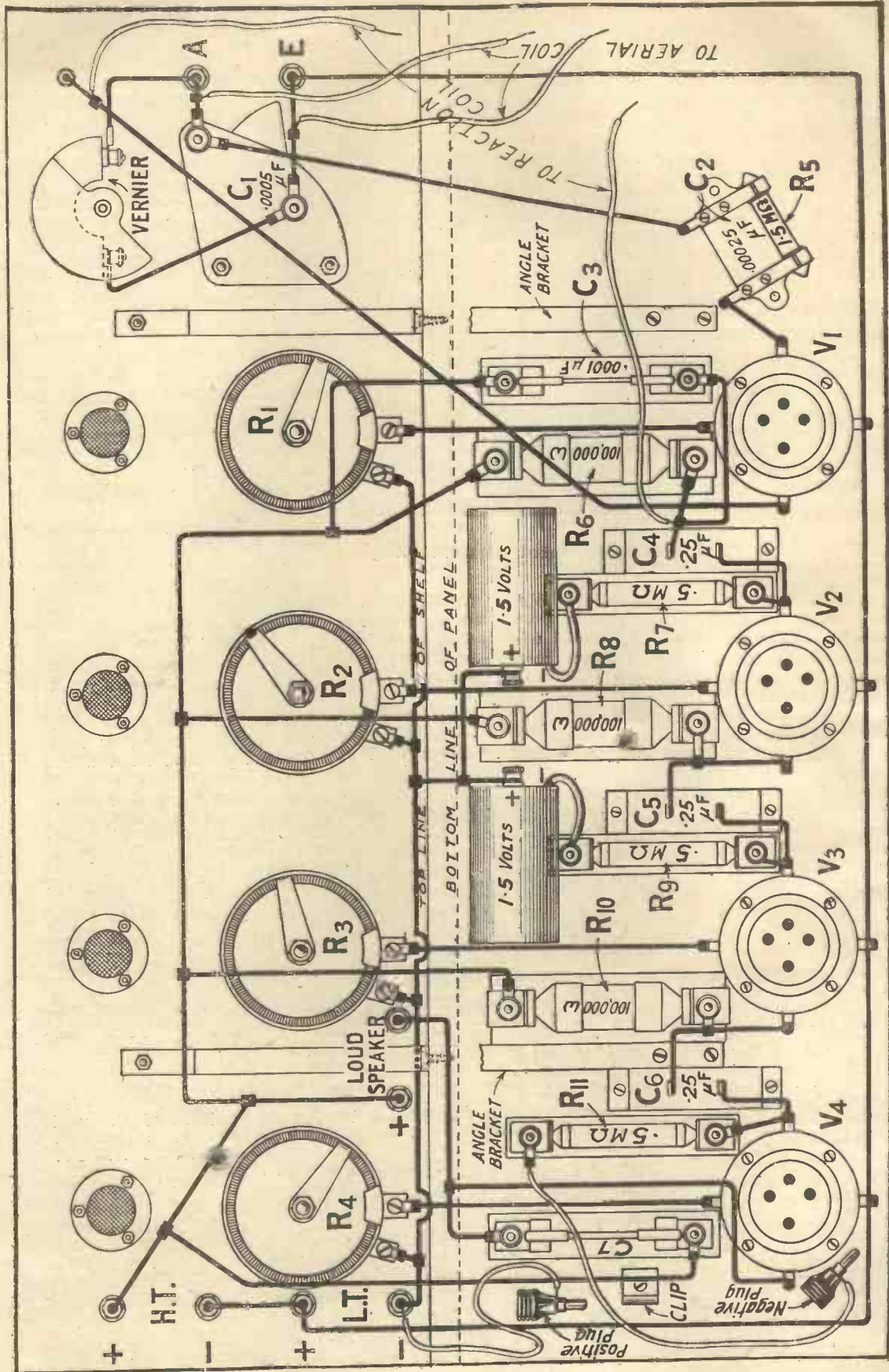

Fig. 3.—No difficulties will be encountered if the wiring diagram is followed exactly. The two plugs mark d positive and negative on the left are for the grid battery used for the last valve. A full-sized Blue Print No. 100b is available.

centre punch. The holes for the valve windows were drilled with a Clarke's expanding bit and are $\frac{3}{8}$ in. diameter. A template is supplied with each filament rheostat and will greatly facilitate mounting. The Colvern condenser and aerial tuning condenser are of the single hole fixing type, and a $\frac{3}{8}$ in. hole will do for both, although the Colvern really requires a slightly smaller one. The terminals have 2 B.A. shanks and a 2 B.A. clearing drill should be used. As these terminals are somewhat expensive, however, the constructor may decide to use others which may have 4 B.A. shanks.

Wiring

The wiring up of the filament rheostats should first be done, and a small pointed soldering iron should be used. Before mounting all the components on the base-board, solder the straight leads from the rheostats to the negative filaments on the valve holders. There are no special difficulties in the wiring except perhaps the connection from the two grid cells to the L.T. negative. The common wire from the two terminals on the grid cells should first of all be bent to shape and soldered to two small tags. The cells should then be removed, and the wire connecting the grid cells to the L.T. negative should be soldered. Then replace the cells in position, connecting their two centre terminals by means of the piece of wire already bent to fit; bend the wire from the L.T. negative bus-bar until it touches the wire on the grid cells, and solder. Be careful not to break the soldered joint on the L.T. negative bus-bar. I found the soldering tags supplied by Messrs. Sparks Radio very useful for connecting up. It will be observed that the reaction lead from the plate of the detector valve is soldered to a 4 B.A. screw in the panel and that a flexible lead is taken from it to the coil-holder. The other reaction lead is simply twisted round the stiff wire connection. This serves the purpose of keeping both leads well away from the other wiring. The leads to the coil holder are simply taken through two small holes in the case.

Operation

The operation of this receiver is exceedingly simple and the set is very suitable for general home use. Connect the aerial and earth leads to their respective terminals and also the loud speaker and L.T. battery. Turn on the filament rheostats and note whether the valves light. All being well, con-

nect the H.T. battery and adjust the H.T. voltage to 100-120 volts, using about 5-6 volts grid bias on the last valve. Place a 25 or 35 coil in the aerial socket for wavelengths between 300 and 400 metres and a 50 for wavelengths between 400 and 500 metres. Place a No. 50 or 75 in the reaction socket, although this value should be found by experiment. Keep the reaction coil well away from the aerial coil and turn the condenser knob slowly. When the desired signals are heard, bring up the reaction coil closer to the aerial coil. Again adjust the aerial condenser. If the signal strength does not increase reverse the reaction leads on the coil holder. Do not use extreme

reaction or you will get distortion. For 5XX and Radio Paris a No. 150 coil is correct for the aerial and a No. 100 for reaction. Experiment with the value of the loud speaker shunt condenser C7.

Results

I do not intend to make any claims as regards long distance loud-speaker results, as I do not intend the receiver to be used for this purpose. Whilst it is always possible to get other stations on the loud speaker at night and under favourable conditions, these results are never consistent, neither are they free from distortion and mush. My object is to describe a set which I know will give good quality and loud signals on the local station,



M. Trocmé, of the French Engineers, giving out the weather forecast from the Eiffel Tower Station. The power used for this transmission is 5 kw.

and in which there are no complications. On a good aerial, 40 feet high, 15½ miles from 2LO, the input into a large Brown loud speaker is sufficient to overload it, and this with the reaction coil short circuited. On a small indoor aerial consisting of two 26 s.w.g. wires stretched across the room, still *without* reaction, the weak signals received are amplified sufficiently to operate the loud speaker at fair strength considering the conditions. Using a small Ultra hornless type of loud speaker the reproduction is very pleasant to listen to, but the volume is less than that obtained with the Brown.

Valves Used

During test the actual valves used in the set were a D.E. 5B as detector, two D.E. 5B's in the first two stages and a B4 in the last stage. An ordinary general purpose valve also makes a good detector. 120 volts H.T. is normally used with 6 volts grid bias on the last valve. Under these conditions reproduction is quite pure. With a set of this description I recommend an H.T. battery containing larger units than the usual standard size sold in most shops. The actual measured filament current consumption of the four valves mentioned above is

slightly under 1 ampere at 6 volts and the measured plate current with the grid bias specified is 6 milliamperes.

Home-made Coils

It will be seen from the photographs that a type of coil designed by Mr. G. P. Kendall, B.Sc., is used. The results *without* reaction were obtained with one of these coils in the aerial socket, and I have found them to be superior to any others in my possession at the moment. The aerial coil shown has 32 turns and just tunes in 2LO, using a 100 feet long P.M.G. aerial. It covers practically the whole B.B.C. waveband on this aerial with a .0005 condenser (actual) in parallel.

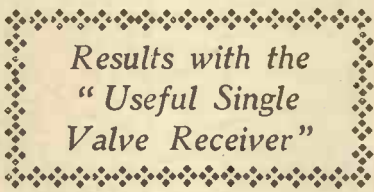

SIR,—In reference to the "Useful Single Valve Receiver" described by Mr. John Underdown in the February MODERN WIRELESS, I wish to say how pleased I am with the results. The curious part is that I very seldom solder my con-

nections from one terminal to another, simply using ordinary nuts and washers.

Firstly, on deciding to assemble this set I wired up according to plan, using a plug-in coil for the wave trap. I also tried an Edison Bell variometer with .0003 variable condenser across and this gave excellent results. I can completely tune out Chelmsford (small loud-speaker strength) and obtain very good reception of 2LO, Radio-Paris, Ecole Sup. (FPTT) and Madrid. Last Saturday night, after Chelmsford had finished broadcasting KDKA, I placed a .50 coil in the aerial and a .75 in the reaction and received rather faintly a station up to about 1 a.m. playing orchestral selections and a woman singing but I could not catch the language spoken.

My valve is an Ediswan A.R.D.E. 2 v., high tension about 60 v. The position of my aerial, which is about 50 feet (twin) compels me to have a lead-in of about 30 feet, and on this lead-in I can get Radio-Paris, 2LO and 5XX. I must repeat that the reception of 5XX is very good and in my opinion could not be improved for quality of tone (coils 150 and 250).—Yours truly,

T. W. HOLLIDAY.
Palmer's Green, N. 13.

WIRELESS WEEKLY

Remarkable New Regular Feature!

"Wireless Weekly," the first journal to publish accurate and detailed times of Continental and American Broadcasting, has now concluded elaborate arrangements by which it will in future publish

A FREE SUPPLEMENT of Detailed Programmes of CONTINENTAL and AMERICAN STATIONS

for the coming week, giving times, names of artists, the songs and music rendered, and other fascinating particulars. First Programmes in the 4th March issue.

Price 6d. Everywhere.

Order at once!



The Crystal Analysed

By J. F. CORRIGAN, M.Sc., A.I.C.

A little talk on the nature and composition of various rectifying minerals and crystals.

IT is not twenty years since the first inorganic rectifier of high-frequency radio impulses was put to a practical use by General Dunwoody, of the United States Army. The property of unilateral conductivity upon which the rectifying action of all radio-sensitive minerals and crystals depends was first seriously considered and examined by the above-named experimenter in 1906, and during the early summer months of that year Dunwoody produced his world-famous carborundum detector, a form of rectifying device which has now been granted an almost classical position in the annals of radio science.

Galena

At the present time the amateur crystal enthusiast has a considerable number of rectifying minerals and crystalline materials to choose from. Although the most popular rectifier for general amateur reception at the present time is undoubtedly the ever-present galena, there is nevertheless quite a fair number of other minerals of both a natural and a synthetic variety which are capable of acting as very good rectifiers of radio impulses, provided that they are employed under the necessary conditions.



A Bornite Crystal magnified two diameters.

Conducting Properties

It is rather a surprising fact, in view of the great popularity which has now overtaken the formerly despised crystal detector, that the number of minerals which has been added to the list of radio-sensitive materials within recent years is remarkably small. Indeed, all the natural mineral products which possess well-marked unilateral conducting properties seem to have been discovered very soon after the introduction of the carborundum detector to the radio world, and the rectifying and unilateral conducting properties of many minerals were known for a considerable time before Dunwoody perfected his form of rectifying device.

Classification

However, the purpose of this article is not to present a history of crystal rectification to the reader, but to put forward a number of facts concerning the chemical nature and composition of the more commonly employed rectifying substances which may be of some interest to the more seriously-minded radio amateur.

Although the minerals which are now known to be endowed with rectifying properties to a greater or less degree are very considerable in number, they may nevertheless be classified, for all ordinary purposes, into not more than three or four different groups. Such a classification of mineral rectifiers, of course, is based upon considerations of a

chemical nature only. Other classifications of radio-sensitive minerals have been put forward from time to time, and these have been based upon the type of contact required for rectification, the direction of the current at the point of contact, the mechanism



A Hertzite Crystal much magnified. The degree of magnification may be judged by comparison with the pin's head.

of the rectification which is believed to be carried out by these crystals, and upon many other considerations. However, the most concise and succinct classification of crystal rectifiers which can be made is one which is founded upon a consideration of their intrinsic chemical composition only.

Grouping

Adopting this method of classifying the crystals and minerals which are employed for the purpose of radio rectification, we may at once divide up all the more common substances of this description into three main groups or categories, viz., the elementary group of crystal rectifiers, the sulphide group, and the oxide group. There are other smaller groups, or sub-groups, but as the minerals which are included in

these are considerably rare and are not in common use at the present day, the reader may take it for granted that practically every specimen of radio-sensitive crystal or mineral which may come into his possession through the ordinary commercial channels may be relegated to one of the three main crystal groups mentioned above.

Chemical Composition

Let us now deal for a short time with a consideration of the nature and properties of these three great mineral groupings, and see how the rectifying powers of any given mineral or crystal are determined by its chemical nature and the grouping to which it properly belongs.

Most of the crystal rectifying substances which are in common use nowadays are set forth in the accompanying table. This table indicates the chemical name and composition of each of the common crystal rectifiers, and in addition to this it will enable the reader to determine at a glance the group to which any particular rectifying crystal may belong.

Lead Sulphides

It must, of course, be remembered that when dealing with these minerals and crystals we are not faced with absolutely pure chemical compounds. To take a concrete example, for instance: galena, which is a natural sulphide of lead, and which belongs to the sulphide group of rectifiers, is never found naturally occurring in an absolutely pure state. Most of the galena crystals which are marketed at the present day contain other chemical compounds besides the basic lead sulphide. Traces of silver sulphide, arsenic sulphide, antimony sulphide, lead sulphate, and carbonate, and a number of other compounds are always to be found in natural galena. Nevertheless, the basic constituent of natural galena is lead sulphide, and for this reason the mineral is placed in the sulphide group of rectifiers.

Silicon

The elementary group of rectifiers is not a very large one. It contains those elements which are set forth in the table, and also a number of special alloys which have been

observed to possess slight, yet definite, rectifying properties.

Probably the best known rectifier belonging to this group is the element silicon, which is very widely distributed in nature.

Silicon occurs in a very large number of rocks, but for commercial purposes it is obtained from sand, this material being heated to a very high temperature in an electric furnace along with a number of other substances.

Silicon makes a very good rectifier. It is not quite so sensitive as galena, but it has the advantage



A Crystal of Iron Pyrites.

over the latter mineral in that it retains its sensitivity over very long periods, and also that it is not generally sensitive to the effects of heat.

Périkon

Tellurium and graphite (which is a form of carbon) are not generally used for purposes of rectification with metallic contacts. They are



A Zincite Crystal.

best employed as one of the elements of a perikon detector, tellurium giving especially good and efficient results when it is used in conjunction with zincite. Graphite is at its best when it is used in light contact with ordinary galena. Nevertheless, both these elements will rectify when they are used alone in contact with an ordinary piece of fine wire.

Composition of Crystal "ites"

The sulphide group of rectifying minerals includes all the best known and the most widely used substances of this description. Galena is, of course, the most prominent member of this category, for this material, in a natural or a synthetic state, forms the basis of practically all the numerous proprietary crystal and rectifying substances. All the crystal "ites" are composed of galena in one form or another, and they give good results because for ordinary short distance reception of telephony galena is the most efficient mineral to use in a simple metallic contact detector. Furthermore, by incorporating small but definite traces of other mineral sulphides with galena, the sensitivity of the resulting product can be very considerably increased. Galena is the commonest and also the least expensive of all rectifying minerals, and this fact accounts in some respects for the many different forms and varieties of this material which are to be seen on the market nowadays.

More Complex Cases

Molybdenite, stibnite and iron pyrites are simple sulphides like galena, but the remainder of the sulphide group of minerals consists of sulphides of more complex composition.

Take the very well-known bornite, for instance. This mineral contains copper, iron and sulphur. It is a "double sulphide," not a mere mechanical mixture of copper and iron sulphides, but a definite chemical compound containing copper, iron and sulphur in constant proportions.

Sub-members

There are a number of rare minerals which can be employed as rectifiers and which, although they are not sulphides, are very much akin in chemical composition to the members of this group. Such minerals are the arsenides, tellurides, and selenides of certain metals. That is to say, they consist of combinations of these metals with arsenic, tellurium, and selenium respectively. In chemical properties, however, they are very similar to the metallic sulphides, and therefore they may be considered as sub-members of the sulphide group of rectifying minerals

Table showing the chemical composition of a number of the more commonly employed mineral rectifiers.

Mineral or Rectifying Substance.	Chemical Composition.	Formula.	Class or Group.
Silicon	Element	Si	Elementary group of rectifiers.
Tellurium	Do.	Te	
Graphite	Do. (Carbon)	C	
Arsenic	Do.	As	
Antimony	Do.	Sb	
Molybdenite	Molybdenum sulphide	MoS ₂	Sulphide group.
Galena	Lead sulphide	PbS	
Bornite	Double sulphide of copper and iron	Cu ₅ FeS ₄	
Bournonite	Double sulphide of lead, copper and antimony	—	
Stibnite	Antimony sulphide	Sb ₂ S ₃	(Tellurides, selenides, and arsenides may be included in this group).
Mispickel	Sulphide of iron and arsenic	FeAsS	
Copper pyrites	Double sulphide of copper and iron	Cu ₂ Fe ₂ S ₄	
Iron pyrites	Iron sulphide	FeS ₂	
Marcasite	Similar to iron pyrites, but contains small percentage of arsenic	—	
Zincite	Impure zinc oxide	ZnO	Oxide group.
Cuprite	Copper oxide	Cu ₂ O	
Brookite	Titanium dioxide	TiO ₂	
Ilmenite	Oxide of titanium and iron	TiFeO ₃	
Tellurite	Tellurium dioxide	TeO ₂	
Magnetite	Magnetic iron oxide	Fe ₃ O ₄	
Psilomelane	Manganese oxides	Mn ₂ O ₃	
Pyrolusite		MnO ₂	
Cassiterite	Tin dioxide	SnO ₂	

Hessite, for example, which is a naturally occurring telluride of silver, Ag₂Te, is an excellent rectifier when used in conjunction with zincite. Nagyagite, a telluride of gold and lead, gives still better results when used under the same conditions. Both these minerals, however, are extremely rare.

The Oxide Group

Coming, finally, to the third group of crystal rectifiers, the oxide group, we notice that the best known member of this group is zincite, which is an impure oxide of zinc. Zinc oxide, in its pure state, is almost perfectly white in colour, and the natural oxide of that metal, zincite, derives its characteristic ruby red colour from traces of manganese, which are always present in it to a greater or less extent.

If we include in the oxide category of rectifiers all the oxides which give only slight rectification we shall find that this group of rectifiers is the largest of the three. Practically any metallic oxide is capable of functioning as a rectifier provided it is used with a very light contact.

Synthetic Zincite

With the exception of zincite, the members of the oxide group of rectifiers are not very much used for rectification purposes on account of the much greater superiority and ease of working of the materials comprising the sulphide group.

Zincite, however, is a very important rectifier, and on account of this fact, successful attempts have been made to produce it artificially, with the result that "synthetic yellow oxide" is now rapidly gaining favour with many crystal experimenters as an effective substitute for the more expensive natural zincite.

There are one or two rectifying minerals which have not been

included in the above classification. Carborundum is the most prominent member of these. This material, however, cannot properly be termed a mineral, because it is not found in a natural state. Carborundum is essentially an artificial product.

Cerussite, another rarely used rectifier, is a carbonate of lead which is found naturally occurring in various parts of the world.



Mr. J. L. Baird, a pioneer of Television, at work in his laboratory. He has been successful in transmitting pictures of movement by wireless.



Successful tuning upon the wavelengths for which this receiver is designed can only be accomplished by the use of extension handles fitted to the condenser and reaction controls.

A Single Valve Receiver for KDKA

By STANLEY G. RATTEE, M.I.R.E.,
Staff Editor.

By building this simple little set much of the interesting reception which is beyond the scope of the average broadcast receiver may be enjoyed. Full constructional details are given, and since there are only two tuning controls the successful operation of the set may be carried out even by a newcomer to wireless.

THERE is so much of interest to be heard on the wavelengths below 100 metres that the construction of a special receiver designed to cover those wavelengths is a labour which quickly brings its reward. Whereas not so very long ago the wavelengths around 200 metres were crowded with amateur transmissions, there is now a relative quiet due to the fact that the transmitters concerned have concentrated their efforts to wavelengths below 100 metres. In addition to these transmissions the well-known station at Pittsburg, Pennsylvania, whose call signal KDKA is almost as commonly spoken of as those used by the stations of the B.B.C., also transmits on these short wavelengths, a fact which is making them increasingly popular.

Short-Waves

Though the receiver under description is but a humble single valve set, and the reception with it of a station some three thousand miles away sounds rather boastful, KDKA on 68 metres is nevertheless received at good strength without difficulty any evening when conditions are normal. To those readers who are already familiar with short-waves, the reason for this seemingly "freakish" reception will at once make itself apparent in the knowledge that these short wavelengths are particularly efficient and possessed of a carrying power entirely their own; facts which are very aptly demonstrated by the amateur two-way communications between this country

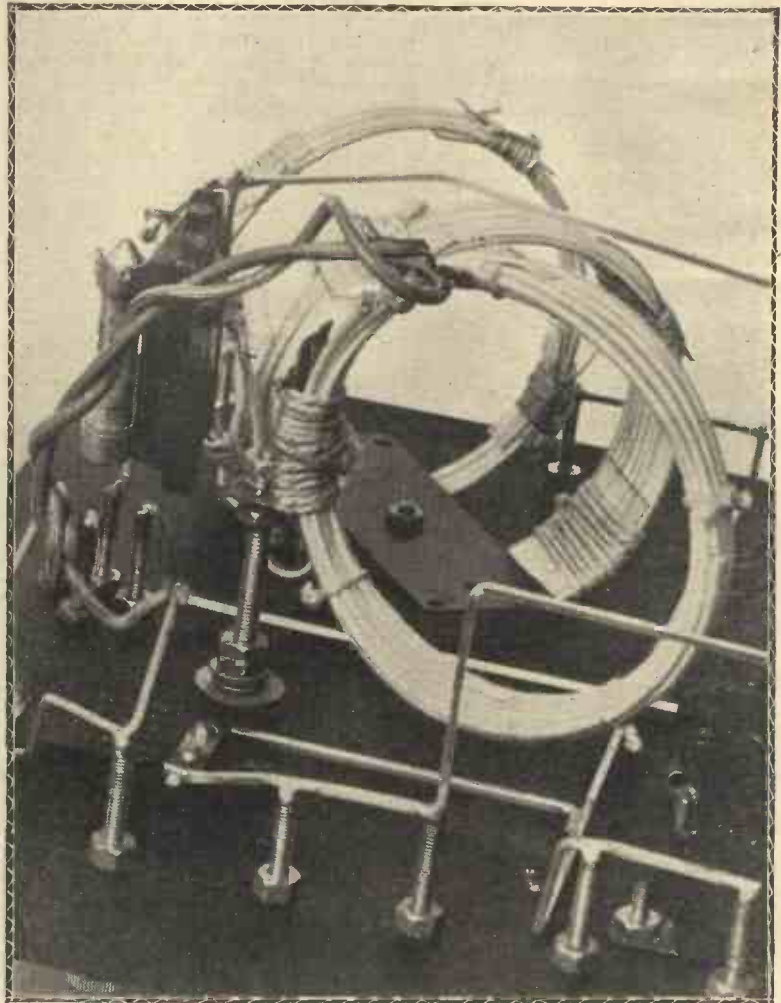

A close-up photograph showing how the coils are made. This illustration, besides showing how the reaction coil is mounted upon the improvised shaft, also indicates the method of securing the grid-leak and condenser.

and New Zealand, Australia and Brazil.

Considerations in Design

For the successful reception of stations upon these short wavelengths the main consideration in the design of a receiver is simplicity of tuning; further, with our present knowledge of the subject, it has not yet been found a simple proposition to obtain any satisfactory high-frequency amplification on these short wavelengths consistent with even difficult tuning. Such is the sharpness of tuning with wavelengths below 100 metres that the only feasible arrangements at the present time lie in a simple circuit constituting an aperiodic aerial, coupled to a single valve reaction circuit, with or without L.F. stages as desired.

Low Loss Coils

Another point which calls for particular emphasis is that the coils used must be of the "low-loss" type, the presence of solid dielectric in the fields of these coils resulting in losses on these short wavelengths. In this connection there is considerable scope for the experimenter, and it is interesting to note that in *Wireless Weekly* for November 19, 1924, Mr. Percy W. Harris described "A Low-Loss Tuner for Short Waves," in which his well-known "Harris"

coil was given prominence, and which has proved immensely popular. The coils in the present receiver are cylindrical in shape, and have no former, the coil being held together by string and supported by means of an ebonite

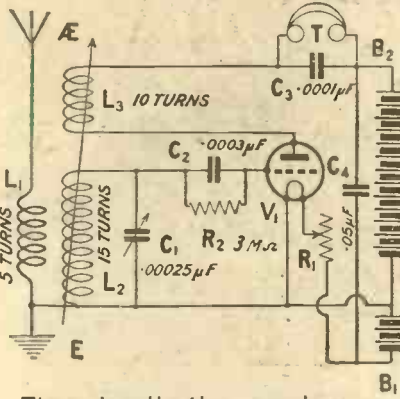

The circuit, the number or turns in the different coils being indicated.

clamp. The construction of these coils is both easy and quickly done, the three coils illustrated having taken the writer no longer than fifty minutes to make, from start to finish.

The Circuit

The circuit embodied in this receiver is shown in the theoretical circuit diagram, wherein it will be seen that simplicity of control has been maintained to the best ability.

The aerial coil, L_1 , which is untuned, is coupled by means of a fixed coupling to the secondary or grid coil L_2 , which is tuned by a $.00025 \mu F$ variable condenser. The reaction coil L_3 is variably coupled to the secondary coil, and a fixed condenser of $.05 \mu F$ is shunted across both L.T. and H.T. batteries; the remainder of the circuit is similar to any other single valve reaction arrangement, and calls for no comment.

Components Required

In the matter of components readers should pay particular attention to the values given and must, to get satisfactory results, use parts of reputable manufacture.

In the receiver illustrated the components incorporated are given below, together with the names of their manufacturers, and though these makes may not necessarily be adhered to, the parts chosen must be good, particularly the variable condenser, as otherwise, assuming that results are obtained, they will in all probability be noisy and disappointing.

1 Ebonite panel measuring 10 in. by 9 in. by $\frac{1}{4}$ in. (Britannia Rubber Co.).

2 Ebonite extension handles (Beldam Rubber Co.).

1 short piece of ebonite measuring 3 in. by $1\frac{1}{4}$ in. by $\frac{1}{4}$ in.

1 Filament resistance with suitable bobbin for the valve chosen (Radio Communication Co.).

1 Variable condenser, $.00025 \mu F$ square-law (Sterling).

$\frac{3}{4}$ lb. No. 16 S.W.G. d.c.c. copper wire (Burne-Jones).

1 Fixed condenser, $.0003 \mu F$ (Dubilier).

1 Fixed condenser, $.0001 \mu F$ (Dubilier).

1 Grid-leak, 3 megohms (Dubilier).

1 Fixed condenser, $.05 \mu F$ (T.C.C.).

8 Terminals.

4 Valve socket pins or one complete valve socket.

Some 2 B.A. studding and four nuts.

1 Ebonite knob, tapped, 2 B.A. Small quantity of celluloid sheet (6 square inches).

Quantity of square tinned copper wire.

1 Containing box to suit personal tastes (that in the photograph is a Camco cabinet).

Set of Radio Press panel transfers.

Constructing the Coils

In order to facilitate the winding of the three coils, it is necessary to procure either a cardboard or ebonite former 3 in. in diameter of any convenient length. Through the interior of the former thread

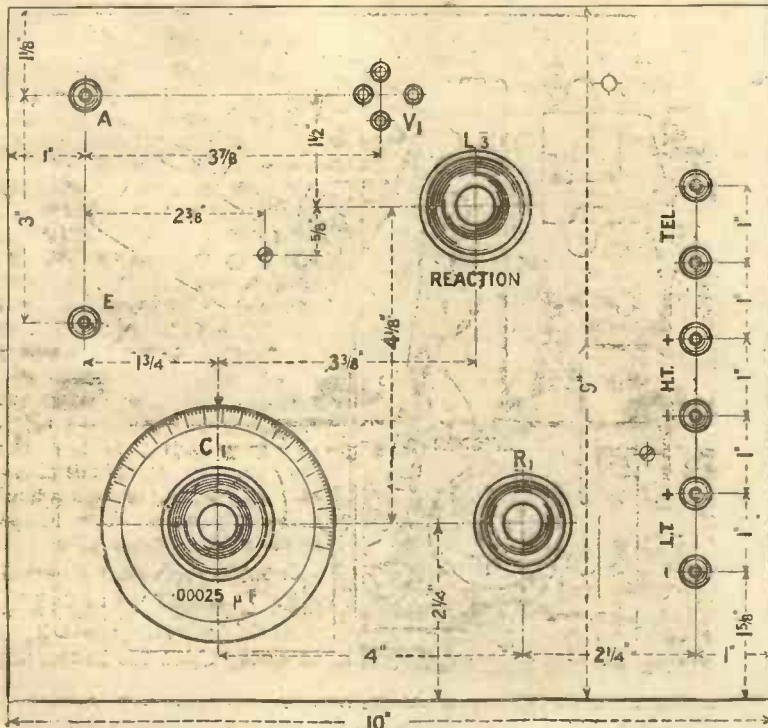

The lay-out of the panel and drilling dimensions. Blueprint No. 98a.

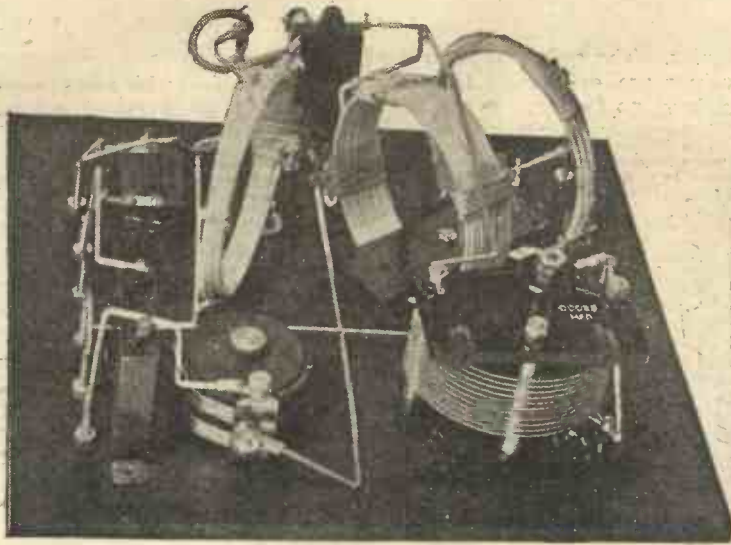

A photograph of the underside of the panel showing the coupling between primary and secondary coils. This illustration shows the components in much the same manner as is indicated in the wiring diagram below.

arrangement seen in the photographs was devised. This consists of an L-shaped copper strip, 2 in. long, by about $\frac{1}{2}$ -inch wide, bound to the reaction coil, a 2 B.A. clearance hole being drilled in that portion which projects at right angles to the coil. Through this hole is secured by means of lock-nuts a short length of 2 B.A. studding, which is projected through the panel and fitted with an ebonite knob for turning purposes.

The 2 B.A. studding itself is secured to the panel by means of two washers, a spring, and two nuts on the underside, with two nuts and a washer above the panel; a detailed drawing of this fitting is given among the working drawings of the set.

The Panel

The panel for this instrument must be made from one of the high-grade ebonites which are now procurable, and must be kept free from flux and other greasy substances which may accidentally become adhered to it during the course of construction. The disposition of the components is given in the panel lay-out, together with the dimensions, and readers are warned that they should not vary this lay-out in any way if it is their desire to receive long distance signals on the wavelengths the set is designed to cover. The

four pieces of strong but thin string and secure each one tightly along the length of the former by tying a bow on the outside. Move the strings to such a position that each is equi-distant from the other; bore into the right-hand edge of the former a hole sufficiently large to take the No. 16 wire, and after threading the wire through, bend the end projecting through to the inside of the former, at right-angles. Hold the former in both hands and with someone holding the coil of wire, turn the former anti-clockwise, keeping a good tension on the wire. With one turn made force a square inch of celluloid between each piece of string and the wire and continue the winding until five complete turns have been wound, then cut the wire, leaving about three spare inches.

Securing Pieces

Immediately on top of the wire and above the celluloid pieces already in position place four other pieces of celluloid, tying each "pair" tightly by means of its respective string. With the coil secured in this way the whole winding may be forced off the former by gentle pressure, and when removed the celluloid pieces and string ends may be trimmed by means of a pair of scissors.

The Secondary and Reaction Coils

The secondary coil is wound in precisely the same way as the primary, save that fifteen turns are wound instead of five. In the case of the reaction coil, this has ten turns and does not require the

celluloid pieces, the turns being bound together by means of the string.

In order to show more clearly precisely how these coils are made, a close-up photograph of them is reproduced.

The Reaction Coil

The reaction coil mounting in this receiver appeared at first to present some difficulty until the

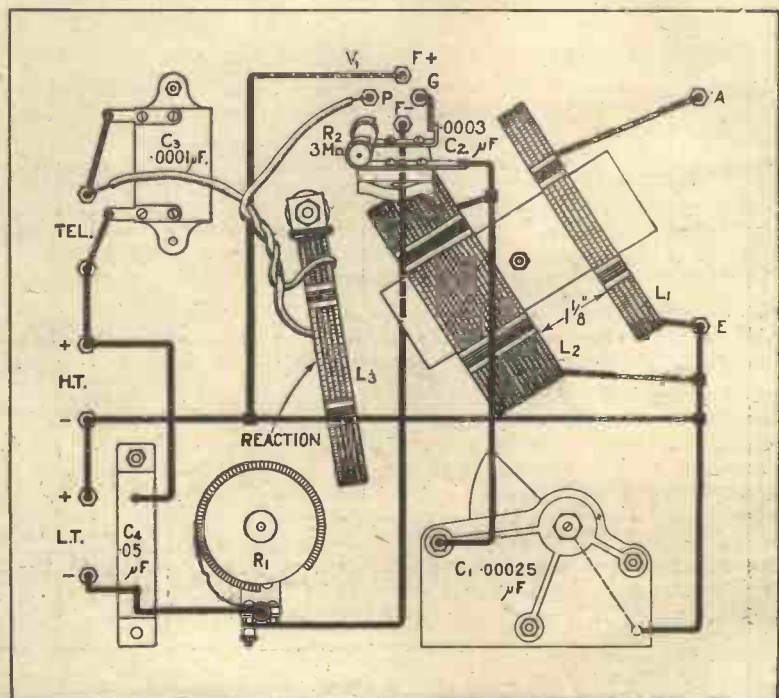

Practical back of panel wiring diagram showing distance of coupling between the primary and secondary coils. Blueprint No. 98b.

lay-out given is the result of much experimenting to give the best results and should be respected if similar results are desired by the constructor.

Mounting the Coils

The practical wiring diagram of the receiver shows also how the primary and secondary coils are mounted. The two coils should be placed in their approximate positions *after* the short length of ebonite which holds them to the panel has been loosely fitted. The secondary coil should then be moved so that it lies parallel with the reaction coil when that latter coil is at its maximum coupling. The primary coil should then be spaced to the distance indicated in the wiring diagram and set parallel to the secondary coil, when the ebonite securing piece should be tightened permanently.

The Grid Condenser and Leak

Differing from normal practice, the grid condenser and leak are not secured to the panel, but held rigid by the connections which go to that component as indicated in the wiring diagram; to make this point clearer readers are referred to the photographs showing the underside of the panel. The connections to the grid, in addition to all others, should be kept as short as possible, and the connections should be soldered with well-made joints.

Operating the Receiver

With receiver completed and before attempting to receive signals, connect the L.T. battery and note whether the filament lights, after which connect the H.T. battery and telephones to their respective terminals, and test the connections to the reaction coil by attempting to cause the set to oscillate by moving the coil near to the secondary. It will be observed that the set gives a very smooth control of reaction, the number of turns in the reaction coil being just sufficient to make the set oscillate over the whole scale of the condenser. During this test it should be noted that only a *very faint* rushing is heard when oscillation is taking place, whilst nothing will be heard if the reaction coil is wrongly connected; the remedy in

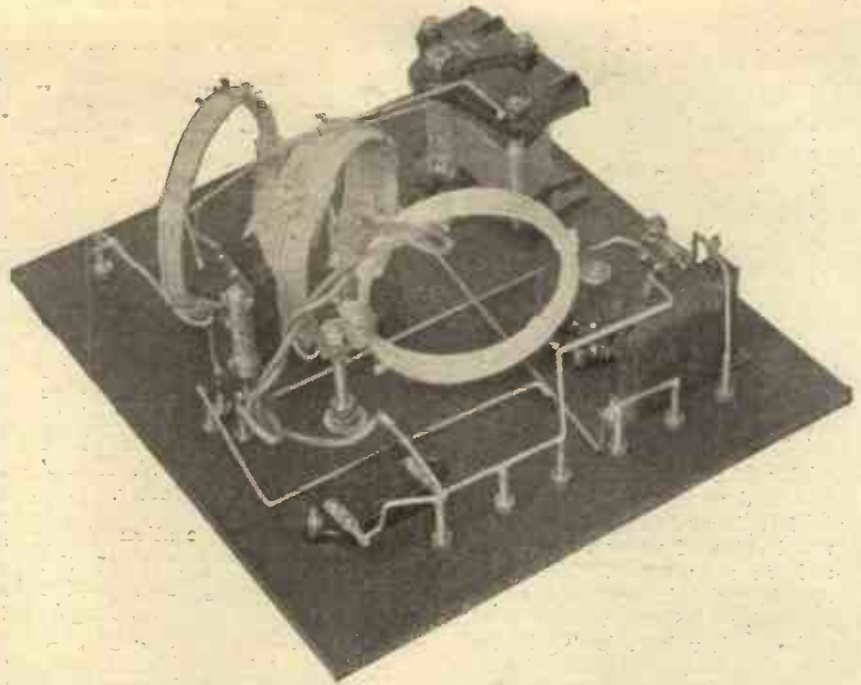

This photograph of the wiring shows how the coils are situated in relation to each other, and also indicates how the grid leak and condenser are secured.

this latter case is to reverse the connections to the reaction coil. Should there be no audible indication of oscillation either way, connect the aerial and earth, when with the coil correctly connected a very slow movement of the variable

condenser, together with a change in the position of the reaction coil, will bring in some sort of signal even though it may be too sharp to tune.

To operate the receiver after these tests have been made, fit the extension handles to the variable condenser and reaction coil, and proceed to tune as in the case of an ordinary single valve receiver, remembering that tuning on short wavelengths is exceedingly sharp and tricky.

It may be found in the course of tuning that there is one spot at which the set will not oscillate, which is indicative of the fact that the secondary circuit is tuned to the natural wavelength of the aerial circuit. Should this occur at a position on the condenser dial where one wishes to work, then a small fixed condenser should be added in series with the aerial, when the difficulty will at once be solved.

Results Obtained

Using the receiver in S.E. London, and connected to an indoor aerial, excellent reception of American, Dan'sh, Swedish, French and British experimenters (Continued on page 228.)

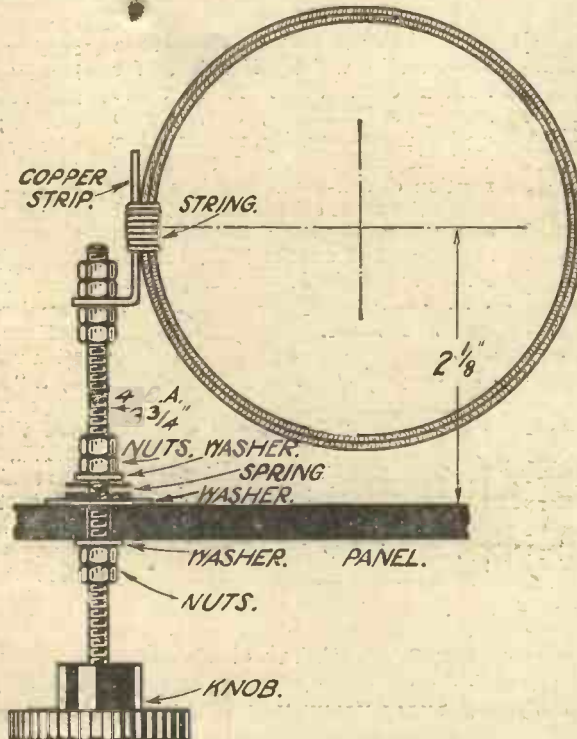

Details of the mounting for the reaction coil, the position of various nuts and washers being indicated.

The Super-Negadyne

By A. D. COWPER, M.Sc., Staff Editor.

An interesting modification of the Negadyne circuit recently described in these pages.

"Grid-Leak Howls"

WHENEVER excessive reaction is applied to a detector-valve operating with grid condenser and grid leak, if the damping in the circuit is fairly light and the grid leak of the usual value of around 2 megohms, a howl may result. This is, of course, quite independent of any heterodyne effects with received signals, though this "grid-leak howl" is often confused with the familiar heterodyne shriek resulting from clumsy attempts at tuning-in with an oscillating valve.

Overlap

The explanation of this effect has often been given. It is based on the phenomenon of "oscillation hysteresis," or overlap, whereby a valve will only start oscillating (other things being favourable) when the grid has reached a potential which is appreciably higher than that negative potential which, if applied, will just stop self-oscillation under the same circumstances. As the valve oscillates violently, the grid becomes rapidly more and more negative (by attracting negative electrons from the filament in the positive half of its voltage swing); and if the grid leak is not low enough in value to allow these electrons to escape at an adequate rate, the grid will rapidly reach the critical negative potential at which self-oscillation is no longer possible. There will be a short pause, therefore, whilst the accumulated negative charge is escaping; then when the potential has risen to the critical value for starting oscillation it will commence again, and so on. There will be a periodic interruption of the oscillation, at a rate determined by the reaction effect, the degree of damping, the size of the grid condenser, and the value of the grid leak as principal factors. The phenomenon has actually been pressed into service to give a rough indication of the resistance of an unknown grid leak, and is invaluable as an indication of the insulation resistance of a radio-receiver. The least trace of flux,

e.g., left on the panel between the valve sockets will altogether prevent the development of a howl in this manner. It has also been utilised in Mr. Percy W. Harris' "Buzzerdyne" wave-meter.

Super-Regeneration

By varying any one of the several controlling factors the

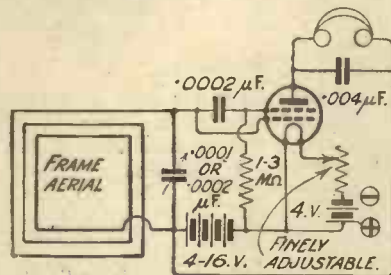

Fig. 1.—A Negadyne frame aerial circuit.

frequency of the interruptions can be controlled, and can be adjusted from one or two a second up to a super-audio whistle inaudible for human ears. Since it is quite readily adjusted to, say, 10,000 cycles frequency, by means of a variable grid leak, and the interruption of self-oscillation has very much the same effects as the tuned quenching-frequency oscillation superimposed on the H.F. oscillation in the original Armstrong super-

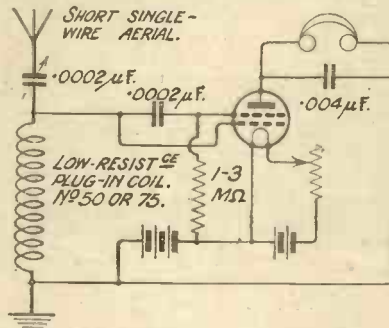

Fig. 2.—A similar circuit to Fig. 1 shown attached to a short aerial and earth.

regenerative circuit, the phenomenon has been utilised in the different types of "super" developed by Flewelling, in which

arrangements of variable grid leaks and large condensers, together with excessive reaction effect produced by large reaction coils (sometimes tuned in addition), give a controllable "grid-leak howl" of use as a quenching whistle in a frame aerial or otherwise lightly damped circuit. (Forms of alleged Flewelling circuits have appeared from time to time in which fairly close coupling is shown to a full-sized outside aerial, and in which the whistle has naturally disappeared. These are merely critical reaction circuits, sometimes operating in a dangerous manner by the "homodyne" method, and liable to produce intense interference. There is no super-regenerative action possible with such circuits.)

Control

The present writer has shown that special arrangements of large condensers, variable resistances, etc., are wholly unnecessary for setting up an effective "grid-leak howl" "super," the only requirement being, first, a lightly damped circuit; second, powerful reaction of some type; and, third, controllable variation and adjustment of any one of the factors which determine the frequency of the whistle by some device. The latter device is generally a variable grid leak or grid condenser in ordinary circuits, but not necessarily. An ordinary parallel tuned single valve, with reaction, receiver will operate as a "grid-leak howl" "super" if the aerial is disconnected, a larger coil than usual is inserted for the A.T.I., and only .0001 μF. or so of the tuning condenser is used. With efficient coils and good panel insulation a howl should be obtained by swinging up a large reaction coil, the note being adjustable by swinging the coil, and distant stations should be readable with a little practice in tuning on a short earth lead alone. The tuning is rather peculiar, as each powerful station's wave is accompanied by a series of belts which each give the familiar heterodyne wail on crossing them whilst searching. These are produced by complex re-heterodyning

effects, and they sometimes interfere with one another in the most curious way. The point for best reception lies between the largest and noisiest of the belts. In general, as with all "supers," the tuning is rather flat, so that it is difficult to isolate feeble stations, and much mush comes in.

"Numan's" Circuit

The extremely powerful direct reaction effect in the "Numan's Oscillator" four electrode valve circuit renders it a matter of great ease to obtain a "grid-leak howl," with quite ordinary values of grid leak, grid condenser, and with moderately damped oscillating circuits. As developed into a practical receiving circuit by the writer, control over self-oscillation is obtained by fine adjustment of the filament resistance, as that ordinary single-valve reception is possible with the use of an outside aerial. If now a small series condenser be used on a comparatively small single-wire aerial, or alternatively a small frame aerial (or even a simple low-resistance tuning coil with earth lead or short indoor aerial attached), then on slowly raising the filament temperature with the aid of a finely adjustable filament resistance of the carbon compression type, whilst having some 4-16 volts applied to plate and inner grid alike after the fashion of the "Negadyne" (Figs. 1 and 2), we observe the following sequence of phenomena: First, with filament yellow hot, ordinary single-valve reception, with increasing reaction effects; then a "plop" into oscillation with the usual accompaniment of heterodyne wails, etc.; with filament approaching a white heat a whistle starts of a pitch which depends on the various factors indicated above, and with increase of filament temperature this sometimes alters slightly in note, and may become a shriek. Then with very hot filament (4 volts across the ordinary Dutch type of four electrode valve rated at 3.5 volts) the whistle and self-oscillation alike cease, and ordinary reception is possible with but poor efficiency. The explanation of these effects is clear from a study of the characteristics at different filament temperatures. The "negative resistance" part which produces self-oscillation shifts and flattens out with increasing temperature. This makes possible the very simple control over self-oscillation and reaction of the "Negadyne," and can be utilised also for controlling the super-regenerative action in a "grid-leak howl" type of "Super-Negadyne" circuit; operat-

ing here exclusively in the region of the shrill whistle.

Simple to Control

This super-regenerative circuit works out in the simplest possible way, and of all the many different types of super-regenerative receivers experimented with by the writer in the course of the last two years, this is undoubtedly the simplest to control and the easiest to set up; whilst the results compare quite well with the Armstrong type, though a little less powerful on loud signals. With the Dutch type of valve the circuit will sometimes operate well with but four volts H.T. (a single flash-lamp battery), whilst the reception is remarkably free from body capacity effects with a small frame aerial in use, and is as stable as one could wish when the L.T. battery is in good order.

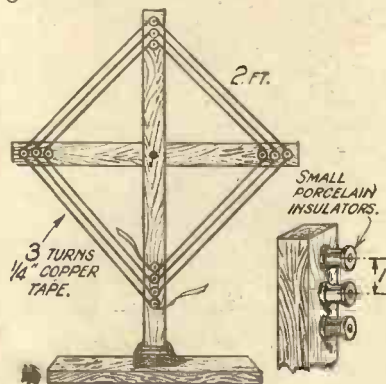

Fig 3.—A low-loss frame aerial suitable for use on 60 metres.

Constructional Details

An ordinary type of valve panel can be used, the fifth connection to the inner grid being usually made to a small terminal on the side of the base of the valve by a short length of flex to the outer side of the grid condenser. There is no occasion to use a variable grid leak, but one should be chosen, by trial, which gives an extremely high; almost super-audio, frequency whistle. About 1 to 3 megohms is indicated. A large blocking condenser across the phones of .004μF. or so is absolutely essential for the circuit to operate steadily, and almost completely absorbs the high whistle in practice. The tuning condensers should not be larger than the sizes specified, and should be of the low minimum ebonite-end type if possible. With a frame aerial the wavelength scale will then be almost linear.

Results

With the circuit of Fig. 2, on a small single-wire outside aerial,

Paris FPTT came in particularly clearly amongst several distant stations. With a 2 ft. square frame aerial of No. 22 S.W.G. d.c.c. wire spaced at 1/4 in., tapped at several points, London was clearly audible across a quiet, small room on the loud-speaker, with 18 or 20 turns on the frame, 12 volts H.T., and at 35 miles in a first-floor room in daylight. He would also give excellent signals with 4 volts H.T. (Fig. 1). He was steady and clear on the headphones with only a small plug-in coil and casual "capacity" aerial at the same point. Both Birmingham (some 80 or 90 miles away) on 20 turns, and Petit Parisien (Paris) on 11 turns; were easily readable on the loud-speaker with 8 volts H.T.

Short Waves

Fig. 3 shows a suitable low-loss frame aerial, consisting of three turns of 1/4 in. copper tape (that sold for aërials), arranged well spaced on small porcelain insulators on a wooden cross 2 ft. square, for reception of the very short wave transmissions from about 60 to just over 100 metres when used with a .0002μF. tuning condenser. With this quite a babel of amateur short-wave Morse came in, sometimes at L.S. strength, late at night and at a point well away from London. These were mainly slow transmissions with an ugly raw 60-cycle A.C. note. Some extremely powerful signals, calling "C.Q." for a long time, were well down to the lower limit of wavelength. It will be noted that all super-regenerative circuits operate with greatly increased efficiency on short waves, from the nature of the processes involved. However, really long-distance reception on the short waves by this method proves to be elusive, on account of the amount of mush and casual interference which even the smallest frame aerial will bring in.

**FOR YOURSELF,
AND FOR YOUR
FRIENDS JUST
BEGINNING RADIO!**

"The Wireless Constructor"
monthly.

Sixpence Everywhere.

Order your April issue now.

Out 14th March.

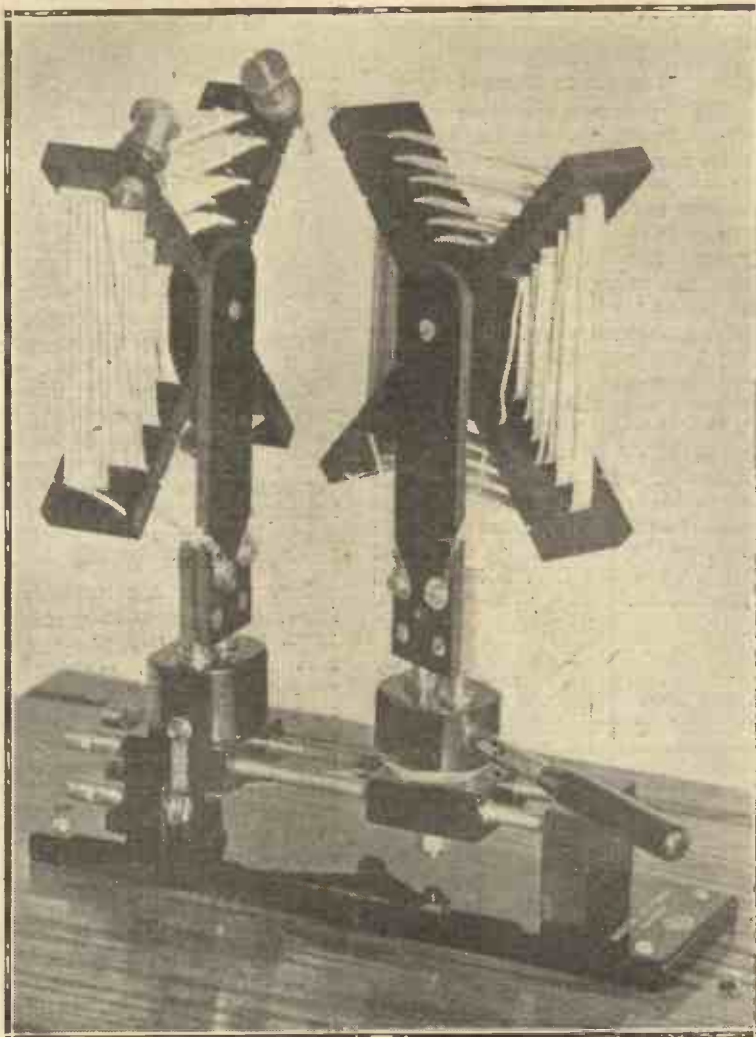

Fig. 1.—The coil in use in the Neutrodyne receiver described in this issue by Mr. Harris.

A Plug-in Coil for "Untuned Aerial" Circuits

By

G. P. KENDALL,
B.Sc., Staff Editor.

every pair of coils and wavelength, that it is necessary to retune both primary and secondary upon any change of the coupling, and that the reaction control of any circuit employing more than one high-frequency valve is profoundly modified by the use of a secondary circuit. Is it any wonder, then, that having had a wide experience of readers' difficulties, I should strongly deprecate the wholesale recommendation of loose-coupled circuits to beginner and expert alike?

Other methods

Some method of increasing selectivity is unquestionably one of the crying needs of the moment, and attention may profitably be directed to other methods of doing so than the loose-coupled circuit, which it seems should definitely be regarded as the appliance of the more skilled operator.

Use of a plug-in unit

The coil which forms the subject of this article is the result of a considerable amount of experimental work, and is intended to form a plug-in unit which can be inserted in practically any set, with a view to increasing selectivity by means of the now fairly well-known "untuned aerial" circuit. In this arrangement we have a tuned "secondary" circuit, across which the first valve of the set is connected, and to which the aerial circuit is coupled, either by means of, say, 10 or 12 turns inter-woven with the secondary winding, or by the aerial circuit being led through a few turns of the secondary winding itself on its way to earth. No actual tuning arrangements are provided for the aerial circuit, and a certain amount of disagreement exists as to the exact action of the circuit, which, however, does not affect the user of this particular

ONE hears frequent exhortations at the present time to use loose-coupled tuning circuits, and there seems to be an impression in some quarters that such circuits are a veritable panacea for all ills. As a matter of sober fact, I wonder how many of those who make this recommendation so freely have any conception of the difficulties which are experienced by the ordinary unskilled, or semi-skilled, user of a broadcast receiving set when he first operates a loose-coupled circuit? Very few. I should imagine, since most of those whom I have met who make this recommendation have been fairly expert operators. Actually, to get anything like the results which are promised us by the advocates of loose-coupled circuits, a far higher degree of skill is necessary upon the part of the operator than it is reasonable to expect in the home constructor of to-day, who has not

had the necessary years of experience of operating complicated receivers, and who very naturally demands that his set shall be simple and straightforward to handle, maintaining, and no doubt rightly from his point of view, that there is little pleasure in operating an instrument which requires hours of tedious practice.

Drawbacks of loose coupling

It cannot be too definitely stated that unless such skill be present, the results obtained will be nothing like so good as with ordinary single circuit tuning, whether as regards signal strength, ease of control, or even the vexed question of selectivity. It must be remembered that to obtain the full possible degree of signal strength and selectivity with a loose coupler, whatever its design, one must obtain the correct degree of coupling between the coils, which varies for

This coil provides a very effective method of increasing the selectivity of practically any receiver, and was specially designed for use in the "Neutrodyne Junior" set described elsewhere in this issue.

coil. The effect is, when the coil has been properly designed, to give a considerably increased degree of selectivity with only a trifling loss of signal strength, these advantages being conferred, moreover, without appreciably complicating the working of the set.

An efficient type

The inductance illustrated in the photograph is of the multi-layer cross-coil type, which I described in *Wireless Weekly* for February 11th of this year, this system of winding being one which I have found to be of extremely high efficiency, and which is, in addition, well fitted to this particular purpose. The foundation of the coil is a cross-shaped ebonite former, composed of two strips 5 in. long and 1 in. wide, halved together at the middle, each carrying a series of saw-cuts. The exact details and dimensions, etc., can be obtained from one of the illustrations accompanying this article, so that the former can be made for oneself, or it can be purchased from certain of the advertisers in MODERN WIRELESS, if reference is made to the advertisement section of this or a recent issue.

The coil itself consists of two windings, one containing 54 turns and the other 18, the two being wound on at the same time, as will be explained a little further on. A tapping is also taken out from the 18th turn of the 54 turn winding, and the inner ends of both windings are connected together. There is thus a choice of three possible arrangements, so that different aerial and earth conditions, different receivers, and so on, can be suited.

The exact method of winding the coil was given in great detail in the issue of *Wireless Weekly* to which I

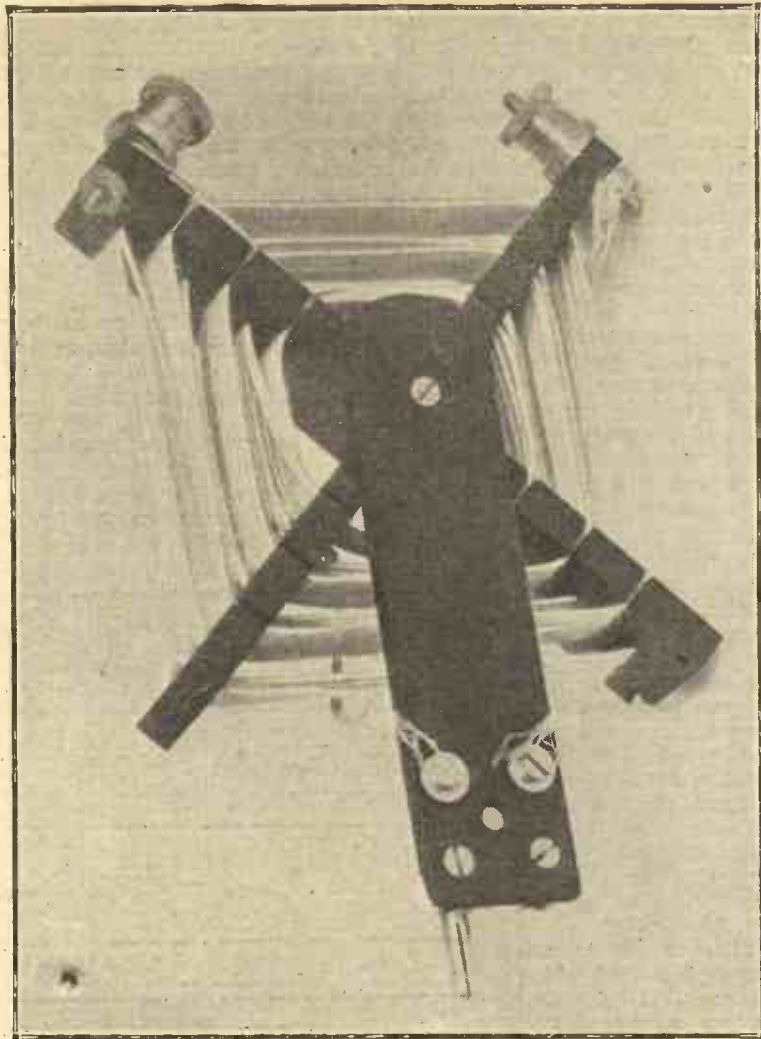

Fig. 2.—The coil is mounted upon a standard basket coil holder.

have referred, but it may be as well to repeat a sufficient part of this description to enable the winding of this particular coil to be performed.

Having assembled the former, the method of winding is as follows: Having obtained, say, a half-pound bobbin of No. 22 double cotton covered wire, run off about 12 ft. (actually, 9 or 10 feet will probably prove sufficient) on to a separate bobbin. Bire the ends of the wires from the two bobbins and twist them together. Place the two ends side by side in the slot marked 1 upon the diagram, and proceed to wind on the first layer in the equivalent slots all the way round the former. Push in the two wires side by side until 6 turns of each have been wound on, which will just about fill the first set of slots if the wire is wound in tightly and evenly. It is to be noted that

the best method is to slip the wire into the saw-cuts and then pull it tight rather than to keep it tight as it is slipped into each slot. Now cross over to the other side of the former to the set of slots, of which one is marked "2" upon the diagram, and wind on a further 6 turns of each wire, slipping them in two turns at a time, one of each. Having put 6 turns of each into this layer, cross over to the third layer and again wind in 6 turns of each, which completes the double winding. Now cut off the wire coming from the 12 ft. bobbin, leaving again about 4 in. surplus, and also twist up a loop about 3 in. long in the other wire. Now wind in each of the remaining layers 12 turns, this, of course, being the continuation of the winding in which the loop was made at 18 turns. This will fill the former, giving a total of 54 turns in the continuous winding.



The Piano

The reproduction of the rich volume and subtle overtones produced by a fine piano represents one of the most critical tests for a loud speaker. The agile touch of the musician—one moment hovering over the keyboard with elfin lightness, the next descending with tremendous energy—calls for the most exacting design and workmanship if it is to be faithfully reproduced.

GECOPHONE Loud Speakers will give a perfect reproduction of pianoforte music with a naturalness and quality that attract the most discriminating music lover.

This is why your

ultimate choice will be a

GECOPHONE

Loud Speaker

The experience and world-wide reputation of the G.E.C. are behind all GECOPHONE Wireless products.

GECOPHONE Loud Speakers represent the highest standard of design and workmanship, and are as near perfection as specialised knowledge, experience and exceptional manufacturing facilities can make them.

**SOLD BY GECOPHONE SERVICE DEPOTS,
ELECTRICAL AND WIRELESS DEALERS, STORES, ETC.**

(Manufacturers and Wholesale only)

The General Electric Co., Ltd. Head Office: Magnet House, Kingsway, W.C.

GECOPHONE

20!

**REDUCED
PRICE**

You are now able to buy the most reliable and efficient British Headphones at greatly reduced price. But the class of material used remains unaltered, and still the highest manufacturing ideals control the quality of the product. You simply get the same value for less money.

Matched Tone means that both your ears hear exactly the same sound at the same instant and you learn a new beauty of tone. Ask your dealer for Brandes.

**British Manufacture
(B.B.C. Stamped).**

Brandes

The name to know in Radio

Brandes Ltd., 296, Regent St., W.1

Works: : - Slough, Bucks

Superior "Matched Tone" Headphones

TRADE MARK

BUY : THE : BEST : FOR : LESS

Modern Tendencies in Design

By R. W. HALLOWS, M.A., Staff Editor.

It is of course impossible to make one design, one set or one method applicable to all persons and circumstances. Many considerations govern the actual form a design may take. In this article the author deals with modern tendencies from the point of view of the more experienced amateur, who is prepared to take extra trouble to get the best results with a set which is needed for a wide range of usage.

THAT we have learnt a very great deal during the last few years about both the theoretical and the practical sides of wireless reception is at once made evident by a comparison of the circuits and the complete sets of 1923 with those of to day. Take for instance the two theoretical circuits shown in Figs. 1 and 2. That in Fig. 1 represents a typical four valve set two years ago. The tuner is of the single circuit type with a .001 μ F variable condenser in parallel with the inductance. V_1 , a high frequency amplifier, is coupled to the rectifier V_2 by the tuned anode method, and to produce some kind of stability a potentiometer is employed so that the grid circuit of the valve may be damped sufficiently to hold the set down. V_3 and V_4 are note magnifiers, both transformer coupled. All valves are of the general purpose type, and all, whatever their function, receive the same anode voltage from the high tension battery.

In Fig. 2 we see a modern receiver of quite a different type. To obtain selectivity a loose coupled double circuit tuner is used, the aerial being tuned by a variable condenser with a maximum capacity of .0005 μ F. The large aerial tuning condenser has given place to one of half the

capacity very largely on account of the increasing popularity of plug-in coils now available for amateur use and the concentration of interest on a narrower band of wave-lengths. The good quality inductance now available is so carefully designed and so well made

justments which it allows. In the up-to-date tuner provision is usually made for placing the aerial condenser in series or in parallel, the former position being preferable for short wave reception whilst the latter is more convenient for working

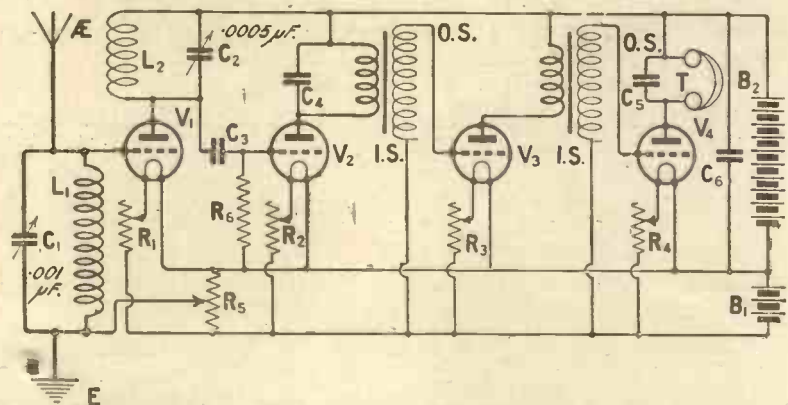

Fig. 1.—A receiver of two years ago. No grid battery was used and the same H.T. was applied to each valve.

that its self capacity has been brought down to a very small amount indeed. With coils of this type a large range can be covered, and the smaller condenser does all that is necessary, besides making tuning much easier owing to the finer ad-

justments upon the longer waves. The closed circuit is usually earthed to produce stability and freedom from parasitic noises, and the parallel condenser has a capacity not exceeding .0003 μ F. The double circuit tuner was in use two years ago, though not to the extent that it is now. In those days the closed circuit condenser had seldom a maximum capacity smaller than .0005 μ F.

Neutrodyne Method

We no longer rely entirely upon the potentiometer to give stability on the high frequency side of the set. Properly used the potentiometer is a sound enough fitting, but when, as was frequently the case in days when good design was the exception, a positive grid bias of 3 or 4 volts is employed for stabilising purposes it produces great inefficiency and renders the receiving set extremely unselective. In one modern circuit

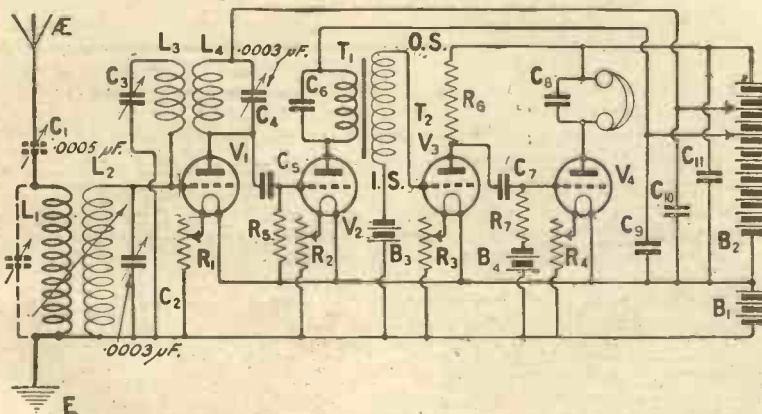

Fig. 2.—A modern receiver incorporating the neutrodyne principle, and capable of pure reproduction.

seen in Fig. 2, the potentiometer is dispensed with and stability is obtained by the use of the very efficient Neutrodyne method, the coupling being by tuned anode as before. A set stabilised in this way does not suffer as regards either efficiency or stability. So effective is the Neutrodyne method that as many as three stages of high frequency amplification may be used without the sets becoming too difficult to handle. The Neutrodyne is only one of the excellent

curve that distortion cannot occur owing to a flow of grid current.

Separate H.T. Tappings

One of the most important improvements of all is the provision of three separate tappings from the high tension battery, for this allows the anode potential of valves of each class to be adjusted to the proper figure. With general purpose valves very fair results were obtainable by the use of the single high tension positive busbar seen in Fig. 1, but the tendency now-

V_3 again will be a valve designed particularly for resistance capacity coupling, and V_4 will be a power amplifier such as the D.F.A.O. or L.S. 5 or similar type of valve. In the case of the last two valves the plate potential will be a high one in order to throw the characteristic curve well over to the left and to enable the valve to be worked efficiently.

Variable Condensers

Many of the components, besides the valves used in the 1923 set, will

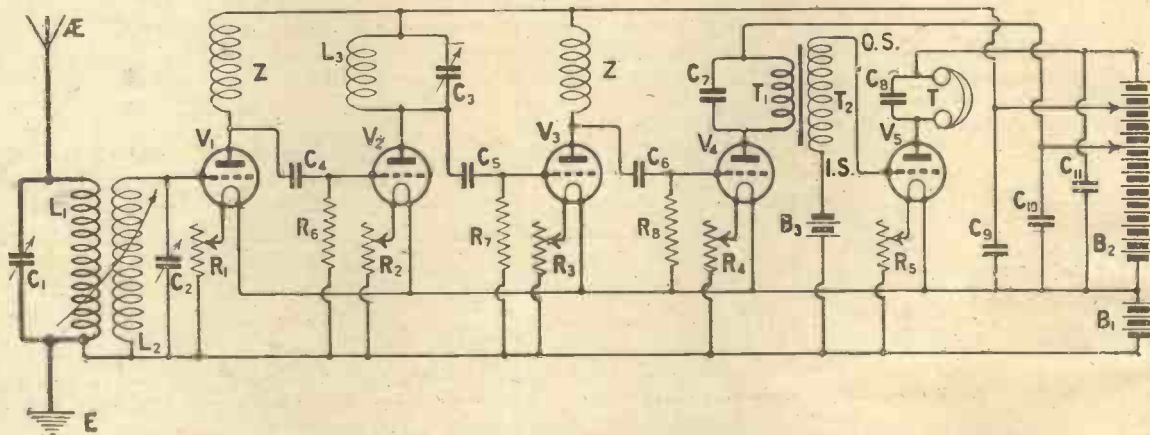

Fig. 3.—A five-valve circuit utilising the T.A.T. system of H.F. amplification.

stabilising systems in use at the present time. Amongst others, special mention should be made of the T.A.T. method due to Mr. John Scott-Taggart, in which tuned and aperiodic couplings alternate. Fig. 3 shows a five valve circuit with three stages of high frequency amplification arranged on T.A.T. lines.

Low Frequency Amplification

Reverting again to the circuit of Fig. 2, we find that whilst the low frequency transformer is retained as the coupling between the rectifier and the first note amplifier, the second transformer between V_3 and V_4 is replaced by resistance-capacity coupling. The reason for this is that practical experience has shown that no matter how good transformers may be, or how carefully shielded, interaction may occur to some extent if two or more are used in the same receiving set. Further, resistance capacity coupling does not respond unduly to certain frequencies, and therefore makes for purer reception, though it does not give quite the same degree of amplification as the transformer. We notice, too, that a negative bias is applied to the grid of each of the low frequency valves in order to bring the working point so low down on the characteristic

days on the part of both valve manufacturers and of wireless enthusiasts is to prefer the special purpose valve to the general. Thus in Fig. 2, V_1 will be a valve designed particularly for high frequency work, and the potential supplied

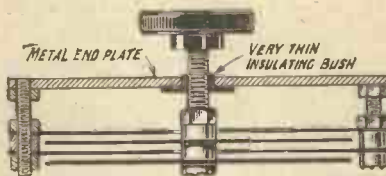

Fig. 4.—Some condensers of this type are not efficient.

to its anode will be that required to enable it to do its work best. The rectifier V_2 will be one of a large number of valves which do well in this position and it will be enabled to work efficiently if having a much lower anode voltage than that supplied to the high-frequency valve or note amplifiers.

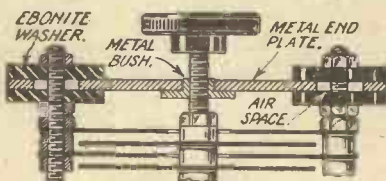

Fig. 5.—A low-loss type of condenser with metal end-plates.

be replaced in the up-to-date model by others of far greater efficiency. Of inductances we have already spoken, and mention has been made of the capacity of the variable condensers, though nothing has been said so far as to their design. Though really good variable condensers were made two years ago, they were as a rule rather expensive and the average amateur inclined rather to go in for cheaper models, with which he obtained very fair results upon the broadcast wave-band and upon the higher wavelengths. He did not as a matter of fact pay a very great deal of attention to variable condenser design until reception upon the ultra-short waves became popular. Then we discovered by practical experience how wrong we were in thinking that any kind of variable condenser would do so long as its maximum capacity was roughly what it was reputed to be. Many readers must have made up sets designed for short wave work only to find that, owing to the use of unsuitable variable condensers such as the type seen in Fig. 4, they could not be made to oscillate on wavelengths below about 150 metres. Short wave reception showed up defects in design that had hitherto been unsuspected. It was found that several kinds of variable condenser

LISSENIUM

INTRODUCING AN "X" COIL—

WE are introducing an additional range of "LISSENAGON" coils. To distinguish the series from the well-known and standard "LISSENAGON" coils, we are calling this new series of coils "LISSENAGON X" coils. The first number to be put on the market, and now ready, is a No. 60 coil.



This "LISSENAGON X" coil has two tappings. The tappings are nearer that end of the winding which is connected to the socket, "A" tapping being nearer to the end than "B" tapping. In all circuits where one of the tappings on

this coil is used, connections should be tried to both terminals separately to see which tapping gives the best results.

SELECTIVITY.

Great selectivity is a noticeable feature of this new "LISSENAGON X" coil. There is now a use for a tapped plug-in coil which will provide the user with the means of alternative connections called for to keep pace with the development in radio circuits.

USES OF THE NEW COIL.

Aperiodic Aerial Tuning.

You can adopt this method of tuning with your existing receiver by simply taking your aerial off its present terminal and connecting it to either of the two terminals on the "LISSENAGON X" coil. Best

results are usually obtained when the tapping point on the coil is nearest the earth terminal.

Neutrodyne Circuits.

This new "LISSENAGON X" coil is the only coil which can be used in "Neutral-Grid" circuits similar to that described by Mr. Cowper. The H.F. amplification obtained with this new "LISSENAGON X" coil is remarkably stable, because the coil is so designed that on one or other of the tapping points a neutral point is provided which balances out the unwanted capacities.

Reaction.

It will be noticed that in all circuits in which this new coil is used, reaction control is exceptionally smooth, and is very much finer than usually obtained.

WHY WE FIRST MADE a No. 60 COIL.

A No. 60 coil in the new series has a very wide application. For instance, this coil can be used in aerial, anode, and reaction circuits. That is, in a one H.F. tuned anode receiver to cover broadcast wavelength, the three coils necessary could all be No. 60 "LISSENAGON X." This coil is interchangeable with any make of coil, and in addition to its many special uses can be employed in the same way as any standard plug-in coil—you only use the tappings when you want to.

OTHER NUMBERS WILL BE INTRODUCED.

Price of this new "LISSENAGON X" No. 60 coil — — — — — 6/4

USE THE COILS WHICH INTENSIFY TUNING—

Adv. of LISSEN Ltd., 20-24, Woodger Road, Goldhawk Road, London, W.12.

POLAR RADIO

CLIMB TO THE
TOP
OF THE LADDER

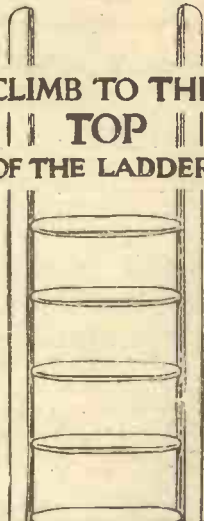

WIRELESS OPERATORS STILL WANTED

There are now vacancies on our Seagoing Staff for Junior Wireless Operators trained on our apparatus. Youths of good education, preferably between 17 and 25 years of age, wishing to enter the Wireless Profession, should communicate with the Managing Director, London Radio College, 82, 83, High Street, Brentford, Middlesex, who will be pleased to furnish particulars of the training course necessary to qualify for our service. Excellent shore positions are open to selected operators from our seagoing staff.

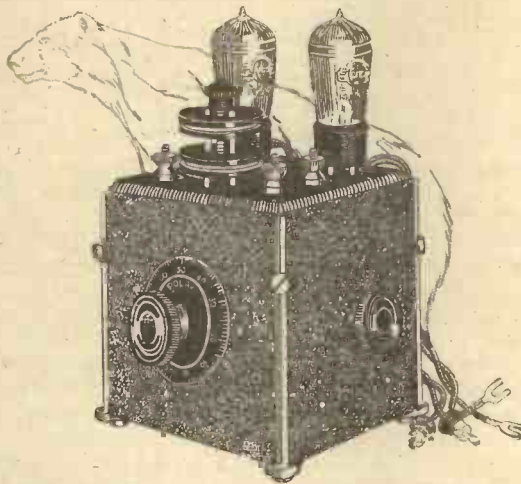
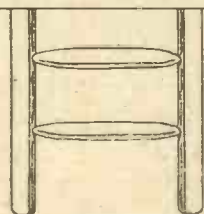

TO PIONEER EXPERIMENTERS

This is addressed to you because you are often called upon to act in an advisory capacity by friends who have no knowledge of wireless.

A question frequently asked is: "What is the best set I can buy?"

Being conscientious you will go to some trouble to avoid disappointing your friends. You want to avoid adverse comments on the set you consider to be a good one.

It is wise to exercise a little caution.

Go to your dealer and ask him to demonstrate the "POLAR TWIN." Test it out against any other set in stock.

Search for distant stations. Criticise tone and Clarity.

Examine the set in the light of your experience. Don't be afraid of giving too much trouble to the dealer. He is enthusiastic about this set.

We can tell you what others have written to us about this set, but we prefer that you should test it yourself.

One thing we will tell you. After finishing these tests, you will say to your friends: "Buy the 'POLAR TWIN' Set, it's the best I've ever heard."

Price: £5 10s. (Royalty, £1 5s.). Chelmsford Coils, 7s. 6d.

Write for the free "POLAR TWIN" Booklet to-day.



RADIO COMMUNICATION Co. LTD, 34-35 Norfolk St, Strand, W.C. 2.

BRANCHES :

GLASGOW 125, Hope Street.
NEWCASTLE 23, Collingwood Street.
LIVERPOOL South East Corner, Princes Dock.

BRANCHES :

MANCHESTER 66, Oxford Road.
CARDIFF Atlantic House, St. Mary Street.
SOUTHAMPTON 19, Queen's Terrace.

with metal end plates were inefficient when it came to very high frequencies. Arguing from the particular to the general, many wireless men leaped to the conclusion that all metal ended condensers must be bad and condemned them in the most sweeping manner. Such a wide assertion is very far from the truth, for if it is well designed the metal ended condenser is a thoroughly efficient component, which will give good results even upon the very low wavelengths.

Good Designs

Those designed on the lines shown in Fig. 5 are usually satisfactory. The kind of variable condenser to avoid, if efficiency is desired, is that in which the fixed vanes are electrically connected to metal end plates; through very thin insulating bushes in which passes the spindle that bears the moving vanes; and matters are made far worse if, as is sometimes the case, fibre or very poor ebonite is used for the bushes. The variable condensers in the up-to-date set are all so well designed that their minimum capacity is only a tiny fraction of the maximum. Further, they are generally of the Square Law type, which greatly facilitates tuning since it gives practically a straight line increase in wavelength, and not in capacity, as the moving vanes are turned further and further into mesh with the fixed.

L.F. Transformers

Very great strides have been made in the design and construction of low frequency intervalve transformers, as anyone will discover who cares to compare their performances. One of the most difficult problems that faces the designer of low frequency transformers, is that of obtaining anything like an equal response to all audio frequencies. This did not matter at all when the wireless set was used entirely for the reception of Morse signals, for if distortion took place it produced no unpleasant results. When broadcasting became an established fact our low frequency transformers had not advanced very much beyond the standard required for the reception of telegraphy. Most of them showed quite a marked "peak" effect, giving undue and distressing emphasis to frequencies in certain parts of the scale. But a very great deal of good work has been done since then, and the low frequency transformer as we know it to-day is a very different thing.

The Best Types

Those of the best types have reached such a state of perfection that they produce no noticeable distortion even when dealing with the complex frequencies of orchestral music.

Filament Resistances

Another component which has received a great deal of attention

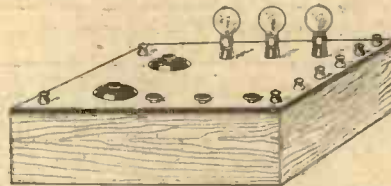

Fig. 5.—The horizontal panel type of receiver.

from designers is the rheostat. Those available two years ago at a moderate price were not usually satisfactory. Their open resistance spirals were very easily crushed or deformed, the brushing contact was often harsh, and in many types the rotating arm had an annoying way of working loose. Further, practically every kind of rheostat was designed for use with a valve requiring a filament potential of round about 4 volts and worked from a 6-volt battery. It was probably the coming of the dull emitter that influenced more than anything else the improvement that has taken place in rheostat design. To work these valves from the 6-volt filament battery,

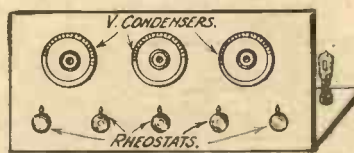

Fig. 6.—The vertical panel which is becoming very popular.

which was then practically universal, it was necessary to be able to throw a large amount of resistance into the low tension circuits. This meant that fine wire must be employed for their windings and led to the development of the rheostat whose resistance element is wound upon a solid core, though the contact is so "velvety" that no harshness occurs. In many modern sets the dual rheostat is used, the first half of the windings being of very fine wire with a total resistance of from 20 to 30 ohms, whilst the second half is of heavier gauge and has a resistance from 4 to 6 ohms.

Narrow Panels

The main panel of a certain type of modern set is very narrow in proportion to its length and it is arranged vertically. Upon it are mounted only the tuning condensers, rheostats, and, in some cases, the coil holder. All other components are fixed to a horizontal sub-panel secured to the lower edge of the main panel. The sub-panel is usually of wood, components such as transformers, coil holders and ebonite fixed condensers which do not require an insulated mounting being fixed to it directly, whilst those which need to be insulated are arranged upon small stands or shelves of ebonite. There can be no doubt whatever that this kind of set design (Fig. 6) is very much more effective in certain special circumstances than the other, but not necessarily so in all cases. To begin with, owing to the greater space given by the two panels to the constructor, he is able to avoid crowding and to keep all his components well separated.

Short Leads

The fact that the panels are at right angles to one another enables leads to be kept short and avoids undesirable parallelism. Last, but by no means least, the main panel, which is the only one visible to the eye when the set is in its cabinet, is much more pleasing to look at since it contains so few excrescences in the form of knobs and the like.

Efficiency the Aim

The whole tendency of design to-day is in the direction of increased efficiency. The main objects which the designer and the constructor have set themselves to achieve are to obtain sensitiveness and selectivity coupled with reasonable stability; to provide easy tuning, and to ensure the best possible quality in the reproduction of speech and music, sacrificing, if necessary, a certain amount of signal strength in order to obtain purity. Now that the broadcast band is so crowded with transmissions from both home and foreign stations an unselective receiver is of little use, though it might answer quite well a couple of years ago when few stations were transmitting and there were wide gaps between their wavelengths. And the wireless man of to-day is a connoisseur of quality. He no longer boasts that his loud-speaker reproductions can be heard a hundred yards away; he prides himself rather upon the fact that his wireless set brings in music that really is music.

More T.A.T. Circuits

Arranged by

JOHN SCOTT - TAGGART,
F.Inst.P., A.M.I.E.E.

This article contains a brief summary of the development of the T.A.T. method of H.F. coupling, together with modifications utilising the new "Trap" method of tuning.

THE first constructional article dealing with a receiver employing the T.A.T. (tuned-aperiodic-tuned) principle was published in the December, 1924, issue of MODERN WIRELESS. Four valves were employed, and the circuit was that shown in Fig. 1. This shows two stages of high-frequency amplification, followed by a detector valve and one stage of low-frequency amplification. The first stage of H.F. is aperiodic, the second being tuned. By this means great stability is obtained together with greater ease in hand-

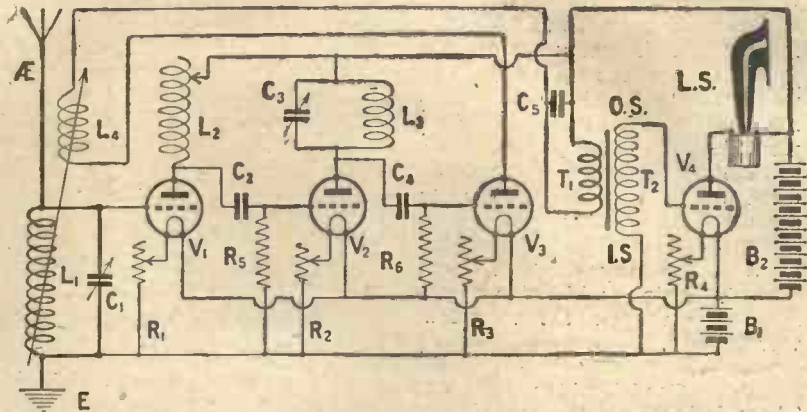

Fig. 1.—The original four-valve receiver incorporating the T.A.T. principle.

ling and controlling the receiver, especially as the variable condenser, which would otherwise be needed to tune the first stage of H.F., is eliminated. This receiver will generally be found to be so stable that reaction will be required, as shown in the theoretical diagram, to bring the set near to the oscillation point.

Values

Fig. 2 shows a five-valve receiver, the circuit of which is similar to that shown in the first figure, except that two stages of low-frequency amplification are employed.

The values for the various components will be the same as for the corresponding ones in the Fig. 1 circuit, and may be as follows:— L_1 for 200–500 metre broadcast transmissions may be a 35 or 50, according to whether the higher or lower wavelength transmis-

sions are desired. C_1 can be a variable condenser of $.0005 \mu\text{F}$, while C_3 can with advantage be a smaller one of $.0003 \mu\text{F}$ capacity, L_3 being a 50 or 75 coil depending on the wavelength being received. L_2 is a tapped reactance coil, similar to that employed in the "Simplicity Three" receiver, and consists of 150 turns of No. 40 s.s.c. resistance wire wound in a single layer on a former $2\frac{1}{2}$ in. in diameter. Tappings are taken at the 50th turn, then every 10 turns up to the 120th turn. Thus with the two ends of the coil there are 10 points which may be connected to the studs of a point switch.

C_2 and C_4 are grid condensers of the usual value of $.0003 \mu\text{F}$ and R_4 and R_7 2 megohm grid leaks; R_4 goes to L.T. — and R_7 to L.T. +. The reaction coil L_4 will usually be a 35 or 50 turn coil coupled variably to the aerial coil L_1 .

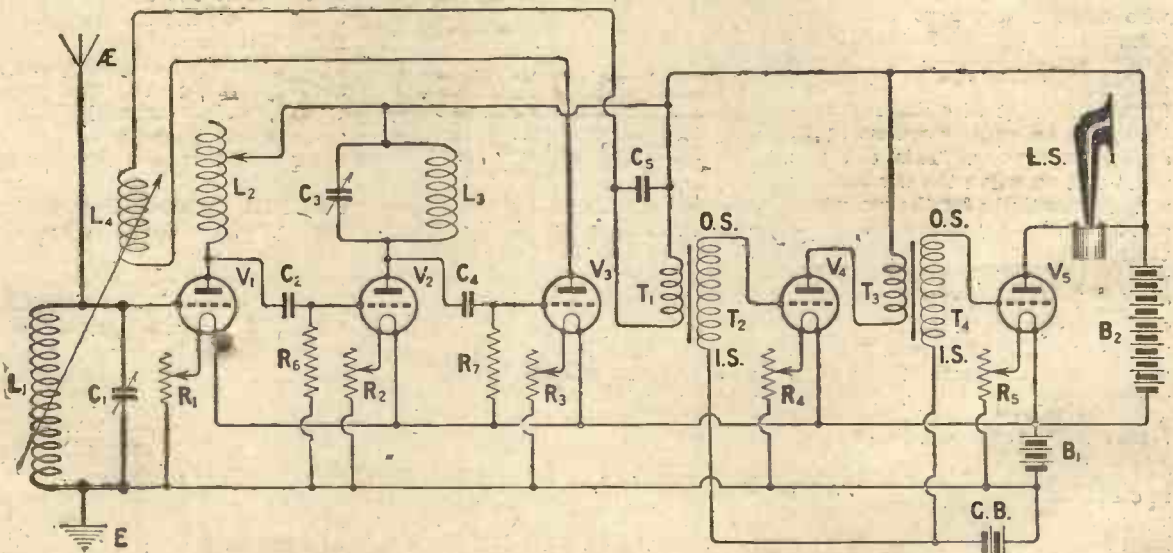
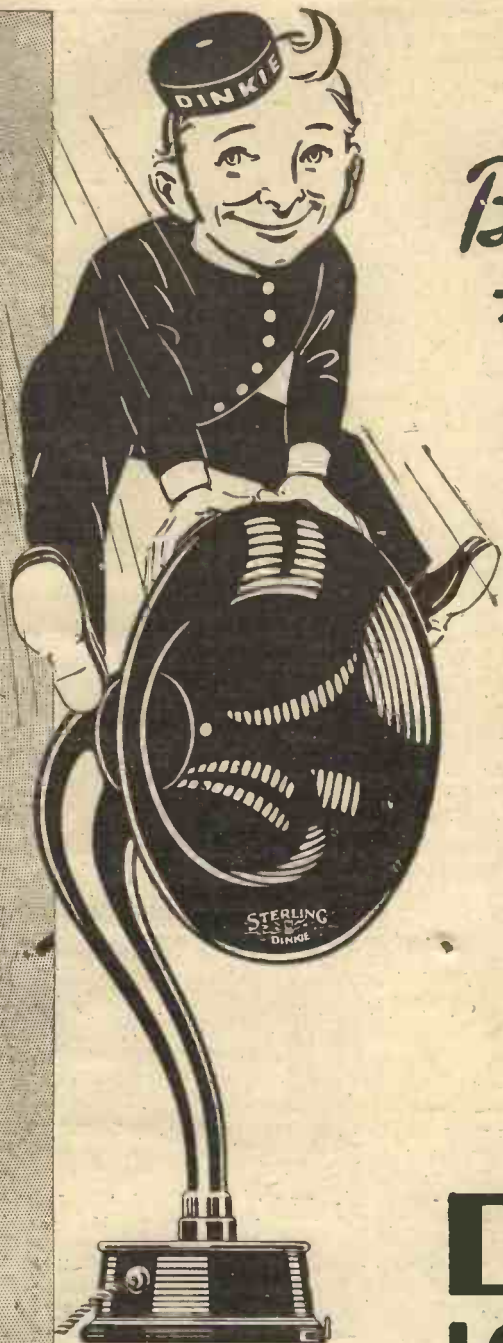

Fig. 2.—A five-valve T.A.T. receiver in which two stages of L.F. amplification are used.



*By Leaps & Bounds
to Record Sales*

"Dinkie"—the little fellow with the loud voice! A loud speaker without equal in its class. Small in size but big in volume. Small in price but big in value. "Dinkie" reproduces clearly, loudly, and in perfect tone all that is broadcast. Your radio dealer will willingly demonstrate Dinkie's powers before purchase.

The Sterling "Dinkie" Loud Speaker is supplied in a brown-tinted finish complete with flexible cord. Dimensions: Height overall, 13 in.; diameter of flare, 7 in.; diameter of base, 4 in.

PRICE
30/-

STERLING DINKIE LOUD SPEAKER

At your Radio Dealers

30/-

Advt. of
STERLING TELEPHONE & ELECTRIC COMPANY, LTD.
Manufacturers of Telephones and Radio Apparatus, etc.
210-212, TOTTENHAM COURT RD., LONDON, W.1
Works: DAGENHAM, ESSEX.



FALLON SQUARE LAW CONDENSERS



Features include:
One hole fixing,
tag connections,
heavy aluminium
top and bottom
plates. Metal to metal
adjustable
bearings, stout
well-cut aluminium
vanes. Complete as
illustration.

The New Fallon Square Law Condenser is absolutely the last word in perfect condenser construction. Extremely handsome appearance, all parts being heavily plated; .068 spacing (the closest possible). In the new model the overall length of the .001 condenser is only 4 1/8 in. as against 5 1/2 in. in the old model, and by a new idea in spacing washers, rigidity of construction, never before achieved in any make of condenser, has been obtained.

SQUARE LAW TYPE			
(As illustrated.)			
Price.		Price	
.001 ..	9/6	.00025 ..	6/9
.0005 ..	8/6	.0002 ..	6/-
.0003 ..	7/-	Vernier, 3 or 5 4/6	

STANDARD TYPE			
With Ordinary Vanes.			
Price		Price	
.001 ..	8/9	.00025 ..	6/-
.0005 ..	7/-	.0002 ..	5/6
.0003 ..	6/6	Vernier, 3 or 5 4/-	

FALLON FIXED Condensers

—improve re-
sults in all Sets

Made of the highest quality mica and copper foil; each one tested and guaranteed. FALLON Fixed Condensers are right up to FALLON standard. Fitted with soldering tags and nuts for making clean connections. **British Reputation.**—Your Condensers are not FALLON'S unless the name FALLON appears on same.



FALLON Fixed Condensers.

Capacities up to .001,
1/3 each. Capacities up
to .004, 2/- each.

Fixed Condenser and Grid
Leak COMBINED.
(As Illustrated.) 2 or 3
megohms, 2/6 each.

FALLON'S —The PREMIER Variometer

Inside winding, suitable for broadcast reception on any P.M.G. Aerial, extraordinary close coupling ensuring large tuning range. Inductance, the highest possible—9.5 to 1. Metal feet can be adjusted to four different positions. As used in the Single Valve receiver for all wavelengths, described and illustrated in "Modern Wireless," July issue.

PRICE 10/-
Postage 6d.

All Post Orders, Correspondence
and Applications for Trade
Terms to:

FALLON CONDENSER CO., Ltd.

White Ribbon Works, Broad Lane, Tottenham, N.15.

BRANCHES: 3, King's Street West, Deansgate, Manchester; 120, Wellington Street, Glasgow.

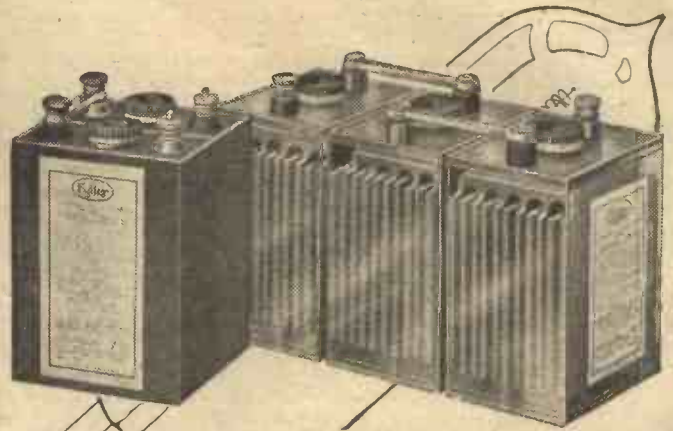

Getting the best
from your
valves.

Note the special ebonite case shown in the illustration of the smaller accumulator.

The efficient working of your valves depends in no small measure upon the reliability of your accumulator—the power unit of the receiver. Fuller's Standard Plate Type Accumulators, specially designed for wireless work, solve all your battery problems. Sturdily built, trouble-proof and highly efficient, they look good and they are just as good as they look.

All cells are fitted with non-corroding grease-cup terminals and are assembled in either strong, transparent celluloid cases or specially constructed ebonite cases (as shown in the illustration of the smaller battery). The ebonite cases are fireproof and are thoroughly recommended.

Made in 2, 4 and 6 volts and many different capacities, they are stocked by all reputable dealers.

PLATE TYPE ACCUMULATORS

The Cheapest H.T. Battery in the World

The H.T. Accumulator has been introduced to replace Dry Batteries for the anode circuit. Though it is more expensive in its initial cost, it is rechargeable and will be found to effect a considerable saving in the long run. One charge gives six months' service, re-charging cost is very trifling and with ordinary care the battery will last for ten years.

H.T. 30 volts, 30/-.

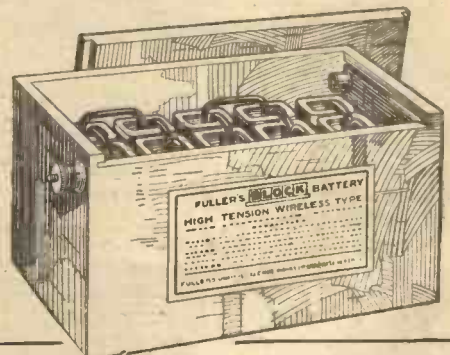

Advt. of Fuller's United Electric Works, Ltd., Woodland Works, Chadwell Heath, Essex.

The use of a grid bias battery is shown in the two stages of L.F. in order to give pure reproduction.

Increasing Selectivity

Fig. 3 shows a modification of the T.A.T. system in which double reaction is used. Two reaction coils L_3 and L_4 are placed in series in the anode circuit of the detector valve. One is variably coupled to the tuned anode coil and the other to the aerial; selectivity is therefore improved, as also is the sensitivity of the receiver.

The tuning of receivers employing the T.A.T. method of H.F. amplification is sometimes found to be rather flat, and therefore the application of "Trap" tuning will be of great value. The February issue of MODERN WIRELESS saw the development of this new principle, showing how selectivity could be greatly improved by the "Trap"

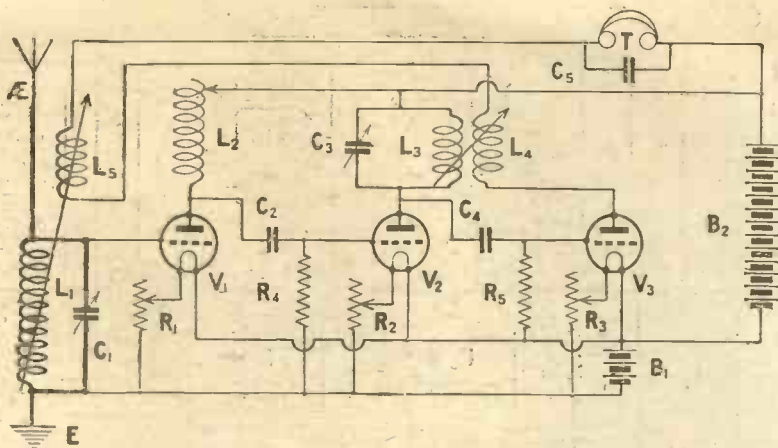

Fig. 3.—A T.A.T. circuit which includes double reaction.

frequency of the incoming oscillations the coil L_3 becomes equivalent to a tuned anode coil. This is due to the tight coupling existing between

entials across L_3 which are rectified by V_3 .

As soon, however, as L_4 C_4 is detuned, the coil L_3 reverts to its original condition of a small coil having a very small impedance, which acts as a virtual short-circuit to oscillations amplified by V_2 , and therefore no potentials are applied to the grid of the detector valve V_3 and no signals are received.

The "Trap" Coils

The two coils L_3 and L_4 may be plug-in coils, suitable values being 25 and 50, or 25 and 75, according to the wavelength it is desired to receive. If L_3 is made larger a slight increase in signal strength may result, but selectivity will not be so good.

An efficient scheme is to wind L_3 over L_4 . L_4 may be 50 or 60 turns of wire on a 3-in. former with 20 turns wound over it, with a layer of empire cloth in between L_4 and L_3 . This gives a very tight coupling between the coils, and good results have been obtained thus with as few as 10 turns for L_3 .

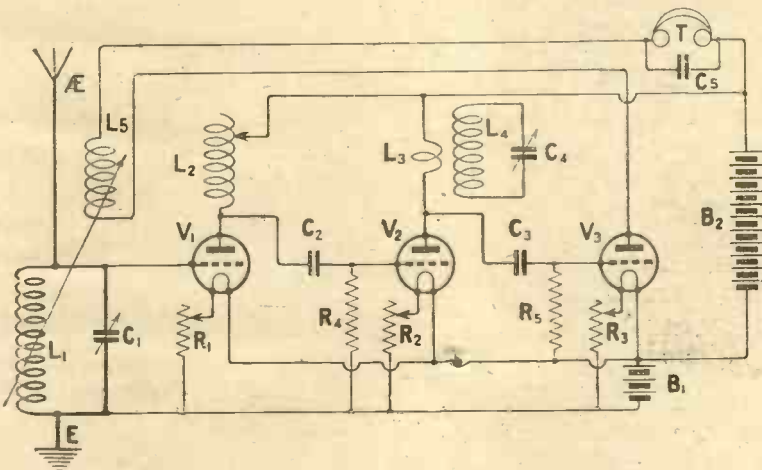

Fig. 4.—A three-valve circuit incorporating the "Trap" method of H.F. coupling.

method of coupling. This form of coupling can be applied to either high-frequency or aerial coupling, giving a great increase of selectivity. Its application to the T.A.T. system is shown in Fig. 4. Three valves are shown, the first two being H.F. amplifiers and the third the detector. The circuit L_1 C_1 is tuned to the incoming oscillations, which are amplified by the valve V_1 , and varying potentials are generated across the reactance L_2 and thus applied through the grid condenser to the grid of V_2 . The coil L_3 in the anode circuit of this valve consists of a comparatively small number of turns. Coupled tightly to L_3 is another coil L_4 , which has the number of turns required to tune to the desired wavelength. This inductance is tuned by a variable condenser C_4 . When the circuit L_4 C_4 is exactly tuned to the

L_3 and L_4 , and the amplified oscillations in the anode circuit of V_2 set up large varying poten-

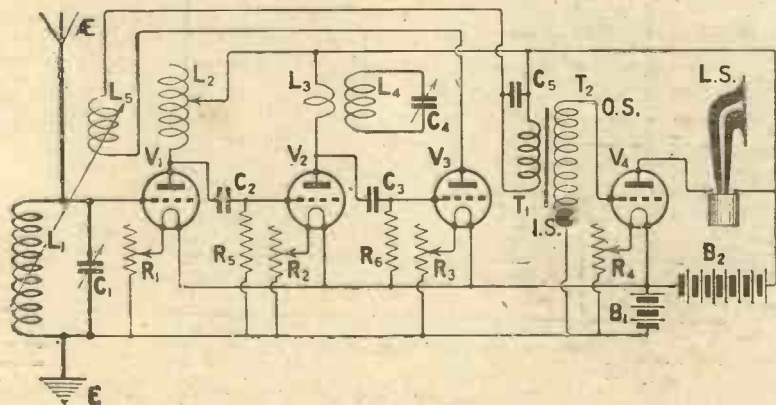

Fig. 5.—A similar circuit to that shown in Fig. 4, but with a stage of L.F. amplification added.

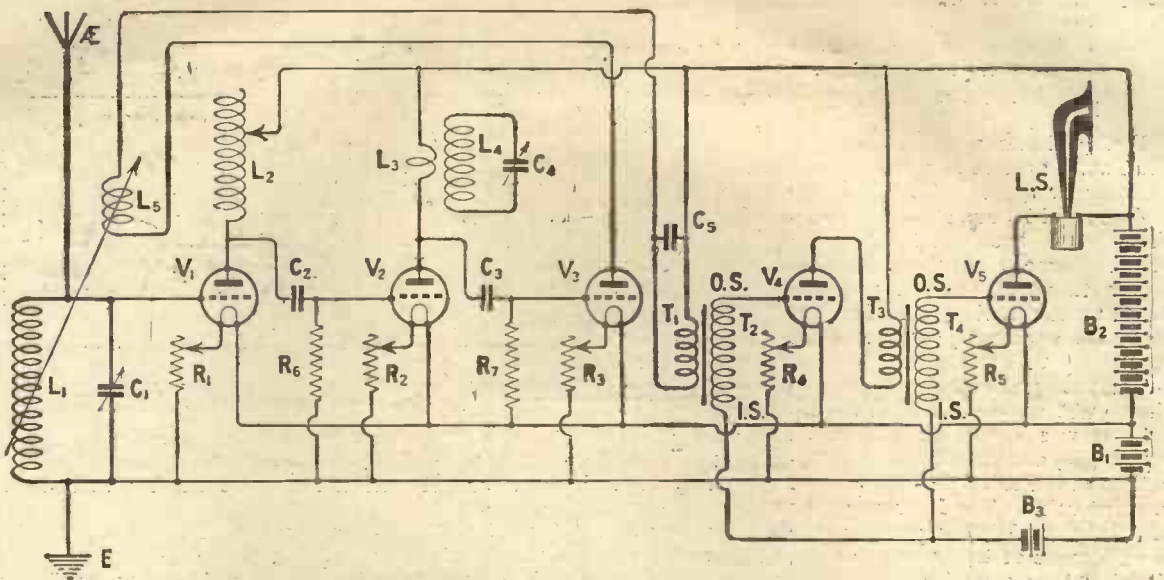

Fig. 6.—Sharper tuning is obtained with this five-valve circuit, due to the use of "Trap" tuning.

Fig. 5 shows the use of "Trap" coupling in a four-valve set. The circuit is identical with that of Fig. 4, except that a stage of L.F. is included.

Reaction is applied to the aerial coil in both the Fig. 4 and Fig. 5 circuits, which further helps to increase selectivity, as well as increasing the sensitivity of the receiver.

Similar to Fig. 5 is the Fig. 6 circuit, in which two stages of L.F. are employed, and the inclusion of a grid battery is shown.

The circuit given in Fig. 7 uses a "Trap" circuit in the aerial circuit as well as in the anode of V_2 . In the aerial circuit L_1 is a

small coil consisting of, say, 25 turns, while L_2 , which is coupled tightly to it, may be 50 or 75 turns and is tuned by a variable condenser C_1 . This arrangement gives another increase in selectivity to the receiver. Reaction may be applied by means of L_6 , which is in the anode circuit of the detector valve, either to L_1 or L_2 . The tuning on this receiver is very fine; it will be found necessary to use vernier condensers. The employment of the T.A.T. system further ensures excellent stability. Two stages of L.F. amplification are shown with the use of a grid battery.

Conclusion

In all the foregoing circuits the

L.T. negative has been shown connected to earth. Should any excessive tendency to oscillate be shown, however, the L.T. positive lead may instead be earthed. In any case both connections should be tried so as to determine which system gives the best results.

Although a common H.T. + lead has been shown in these circuits, the experimenter may desire to try the effect of different anode voltages on different valves. In general (with the five-valve circuits) three tapplings will be found sufficient: one for the two stages of H.F., one for the detector, and a third for the two stages of L.F.

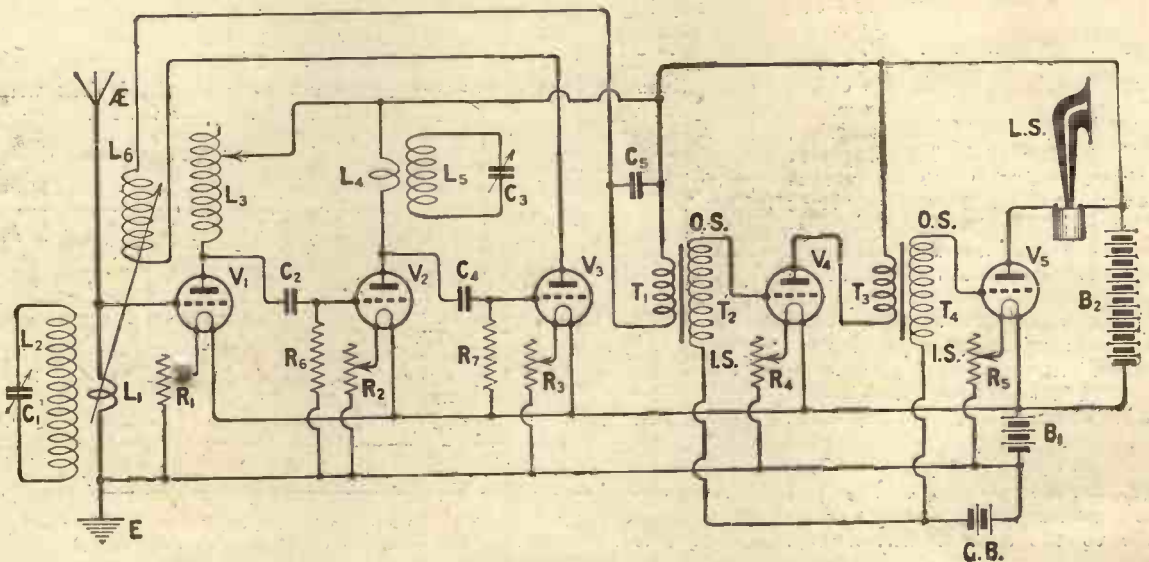

Fig. 7.—A highly selective five-valve receiver. "Trap" tuning is employed both in the aerial and tuned anode circuits.

Then your tuning troubles end



With such condensers—whose name is legion—as are only known by their initials, your tuning troubles have only begun. You cannot be certain that some mysterious agency will not have caused an equally mysterious short between the two sets of plates—an evening's broadcast spoilt by a faulty condenser.

Easily remedied, however—incorporate J.B. Variable Condensers; peerless among the popularly priced. Adjustment remains permanent, capacity remains constant, and one-hole fixing. Purchase J.B.—then your tuning troubles end.

Fit Condensers only as accurate as a delicate scientific instrument—buy these by name, J.B. They are a pleasure to use and to own.

SQUARE LAW			
.001	9/6	.00025	6/9
.00075	8/-	.0002	5/6
.0005	8/-	.0001	5/3
.0003	6/9	Vernier	4/6
STANDARD			
.001	8/6	.00025	5/9
.00075	8/-	.0002	5/-
.0005	7/-	.0001	4/9
.0003	5/9	Vernier	4/-

J.B. Condensers are obtainable throughout the world. In cases of difficulty, send direct to the manufacturers. Post: One, 6d.; two, 9d.; three, 1/-.

JACKSON BROS.
8, POLAND ST-OXFORD ST
LONDON - W.1. Telephone: GERRARD 7414.
(First Floor)

Barclays 639

AVOID DISTORTION OBTAIN SELECTIVITY

INSIST ON HAVING

TANGENT FITMENTS

"TANGENT" TUNING COILS.
Guaranteed for Low Self Capacity by the N.P.L.

"TANGENT" HEAD PHONES.
The Head Phone with a tradition.

"TANGENT" LOUD SPEAKERS
"Concert Model," "Tangent Tall Boy" and "Baby Tangent."

"TANGENT" L.F. TRANSFORMERS
Large and Small.

"TANGENT DISCOIL" H.F. "TRANSFORMERS."

All Wavelengths from 80 to 4,000.

Obtainable from all good Dealers, but in case of difficulty write us.



Selectivity and Sharp Tuning depend on the Tuning Coils. Efficiency and Purity on the Components.

GENT & CO. LTD. Est. 1872.
"Faraday Works," LEICESTER.

London: 25, Victoria Street, S.W.1.
Newcastle-on-Tyne: "Tangent House," Blackett Street.

CRYSTAL SET USERS

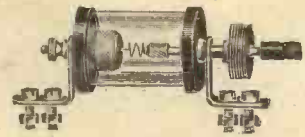

DUCO

MICROMETER ADJUSTMENT.

Micrometer movement ensures very fine adjustment. See that you get "DUCO" Quote number when ordering from your dealer.

CRYSTAL DETECTOR. Enclosed horizontal type for panel mounting. Splendidly constructed of nickel-plated brass and ebonite, and rendered perfectly dust proof by means of close-fitting glass cylinder. A really finished job, which gives "tone" to any crystal set. Supplied less crystal. No. RC95/1 3/9 each. Delivery ex-stock.

Brown Brothers Limited

— Allied Companies —
THOMSON AND BROWN BROTHERS LTD
BROWN BROTHERS (IRELAND) LTD

Wholesale only. Head Offices and Warehouses:
GREAT EASTERN STREET, LONDON, E.C.2.
118, George St., EDINBURGH, and Branches.

Please order from your Wireless Dealer. We cannot supply direct.

IMPROVE YOUR RECEPTION

if it's Sharp tuning—

The efficiency of the tuning coils you use has a far-reaching effect upon the power and range of your receiver. Flat tuning—the great barrier to long-distant work—encouraged by the inefficient coil, deprives your set of its potential power. Try the difference Diamond Sunflower Coils make. Note how sharp the tuning becomes. Diamond Sunflower Coils give razor-sharp tuning—their self-capacity is low and H.F. resistance is low. They oscillate easily—a very desirable feature when on long-distant experiments.

No. of Coil.	Approx. Wavelength in metres .001 Condr. in Shunt.	Price per Coil.
25	100—290	4/6
*30	142—377	4/8
35	185—465	4/9
*40	215—561	4/11
50	245—658	5/-
*65	370—820	5/3
75	395—1,090	5/6
*85	500—1,350	5/9
100	619—1,495	6/-
*125	671—1,720	6/6
150	720—2,000	7/-
*175	850—2,400	7/3
200	980—2,780	7/6
*225	1,010—3,160	7/9
250	1,240—3,520	8/-

No. 5 Swivel Mounting.

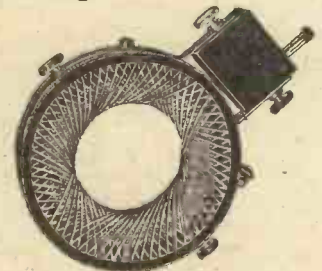

From all Dealers.



PLUG-IN COILS

DIAMOND WIRELESS, LTD., 184a, OXFORD STREET, LONDON, W.1.
Telephone: Museum 1389. Entrance Gt. Titchfield Street.

Barclays 776



A flick of the finger finds a new sensitive spot

OFTEN you must have wished for a sensitive Crystal Detector that did not require an infinite amount of patience in selecting a sensitive spot at just the right pressure. Often you must have spent valuable minutes in setting your Detector to a nicety only to find that an extra loud signal or atmospheric compelled you to start all over again.

We sympathised with all Crystal users and after months of experimental work have now placed on the market the new and improved Gravity Detector. This is the instrument that was so favourably commented upon by Mr. Percy W. Harris in *Wireless Weekly*, and was indeed used by him as the basis of a special Set described in the *Wireless Constructor*.

The Gravity Detector is cartridge-shaped and fits between a pair of spring clips. It must not be confused with a permanent detector in which the cats-

whisker is sealed in contact with the crystal.

The Gravity Detector consists of two cones separated by an ebonite ring. One holds the Crystal in position and the other contains around its internal periphery a row of metal points, each one of which is loaded at the head. As the Gravity is rotated these pins fall down upon the crystal and make contact with it just the right pressure.

It is delightfully simple to use. Merely rotate it slowly and a continuous series of contacts is made. All that you have to do is to give it a turn until you receive the loudest signals.

And, remember, the Eureka Gravity can be instantly removed from its clips and a new crystal inserted. No soldering or even screwing together. It will last a lifetime, for there are no parts to wear out. Read some of the advantages given here and order one from your Dealer at once.

Exclusive Advantages.

1. The Crystal is firmly held in a spring cup and the moving points fall to make contact with it as the holder is rotated.
2. When the Gravity Detector is in use the Crystal is fully enclosed.
3. The Gravity Detector can be re-loaded with a new crystal in a moment. Nothing to unscrew or solder.

6/6

Complete with tested Crystal

Exclusive Advantages.

4. The slightest turn of the Detector automatically brings into use a new spot on the crystal and a new contact point.
5. Nothing to wear out—the Gravity Detector will last a lifetime.
6. Stout plated spring clips are supplied and the base can be removed for fitting the Detector direct to the panel.

Portable Utilities Co., Ltd., Makers of the Eureka Transformer, Fisher St., London, W.C.1

Gilbert Ad. 2282

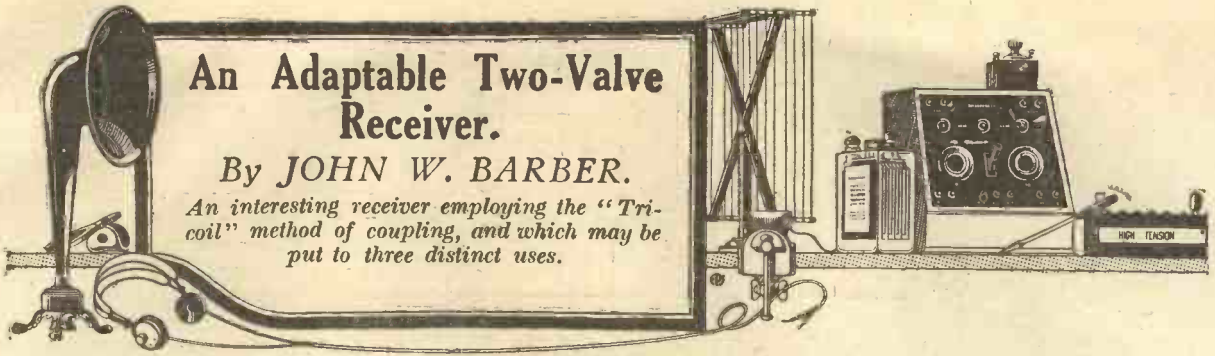

MANY readers, who have the problem of accumulator charging to consider, prefer to effect rectification of their wireless signals by a crystal detector, in preference to a valve, thereby economising in battery current. A further consideration is the purity of signals always given by a crystal detector, but seldom obtained when a valve is used for rectification. So much for the advantages of crystal rectification. There are disadvantages, chiefly in respect to the damping introduced by the crystal across a tuned circuit, necessary adjustment of cat-whisker, and so on, but where current must be considered, the balance goes in favour of the crystal.

In the receiver to be described, a high-frequency amplifying valve V_1 is employed, the amplified currents then being rectified by the crystal, and finally the second valve magnifies the low-frequency currents, which are then passed through the telephones.

The method of coupling is that described by Mr. John Scott-Taggart in MODERN WIRELESS for September, 1924, and called by him the "Tri-coil" method. A few notes on this principle may be of assistance to those who have not seen the article referred to. Consider the circuit diagram Fig. 1. Here the aerial circuit comprises the coil L_1 and condenser C_1 ,

the potentials across this circuit being applied to the grid and filament of the first valve. In the anode circuit of V_1 is a coil L_2 which is untuned, and coupled to L_1 in order that a reaction effect may be obtained. Loosely coupled to L_2 is a third coil L_3 , which is tuned by the variable condenser C_2 of .0005 μF , and which has the crystal detector D and primary winding of a low-frequency trans-

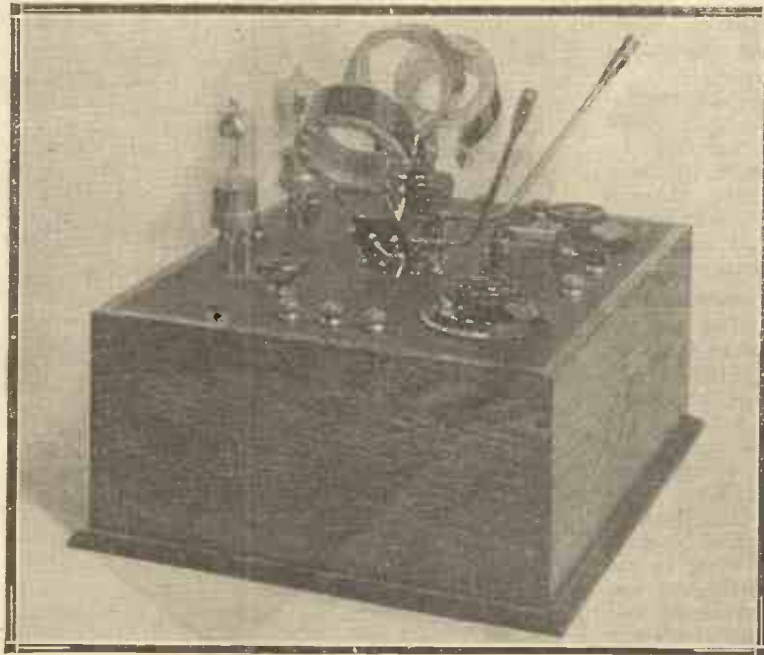

This photograph of the complete set shows the convenient arrangement of the controls.

former connected across it. The secondary winding of the transformer is joined across grid and negative filament of the second valve V_2 .

A very selective circuit is the result, while a fine control of reaction is possible. Unwanted signals may be considerably reduced in volume by loosening the coupling between L_3 and L_2 , while at the same time the reaction effect is controllable by the coupling

between these two coils, provided that the aerial and anode coils are sufficiently close together.

Crystal Circuits

By the simple expedient of turning out the filament of the first valve and removing the anode coil L_2 , the set may be operated as a loosely coupled crystal circuit, followed by one stage of low-frequency amplification. In this

case the coil L_1 and condenser C_1 still form the aerial oscillatory circuit, while the secondary or closed circuit is formed by the coil L_3 , variable condenser C_2 , crystal detector and primary winding of the low-frequency transformer, shunted by C_3 of .001 μF . When operating such a circuit it is often advisable to connect one end of the secondary circuit to earth, and in this case may be effected by joining the terminals E and E_1 together. Tuning is now effected by

means of the two variable condensers, which should be varied simultaneously, and by the variation of coupling between the two movable coils, the centre or fixed coil being removed and the socket left open.

This circuit will be found very helpful in certain districts within, say, ten miles of a main broadcasting station, and where spark or other forms of interference are experienced.

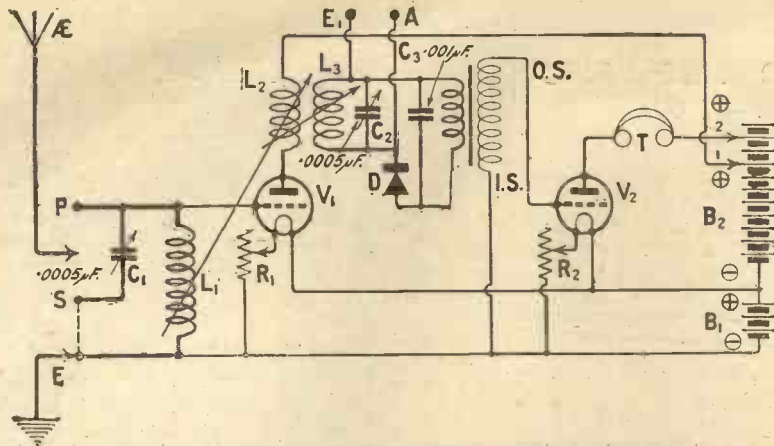

Fig. 1.—The theoretical diagram of the receiver.

The Third Circuit

The loosely coupled crystal circuit may be dispensed with and a direct coupled circuit substituted by removing the aerial and earth leads from the terminals P or S, and E (whose purposes are discussed later), and by joining the aerial lead to the terminal A₁ and the earth lead to terminal E₁, these latter terminals being situated in the front of the panel.

Tuning is now effected by variation of the right-hand variable condenser C₂ only; the coils L₁ and L₂ are not in circuit, and may be removed from their sockets. Alternatively, L₃ should be swung at right-angles to L₂, if the other coils are left in position.

The Completed Instrument

The photographs show the receiver as it appears when made up according to the details to be given. The controls are all readily to hand, while the central location of the three-way coil-holder makes for balanced short leads to all three circuits, as will be seen later. The valves are situated behind the coil-holder, and the respective filament controls will be found close to the valves. The three left-hand terminals are in the aerial circuit, and by their use the variable condenser C₁ may be placed either in series or parallel with the aerial inductance L₁. The low-tension (accumulator)

terminals are found at the back of the panel, out of the way, it thus being possible to drop two wires from these terminals down to the

accumulator, which will usually stand on the floor, without the risk of the wires being accidentally pulled away from the set.

The use of the two front terminals has already been described, while on the right of the set are the telephone and high-tension terminals.

Components Needed

For the guidance of those readers whose intention it is to construct this receiver, a complete list of the necessary components is given, and for their information the manufacturers' names are included. This latter information is, however, only intended to serve as a guide, and any suitable make of component may be substituted if of good quality.

- 1 Ebonite panel, 12 in. by 10 in. by ½ in. (Britannia Rubber Co.).

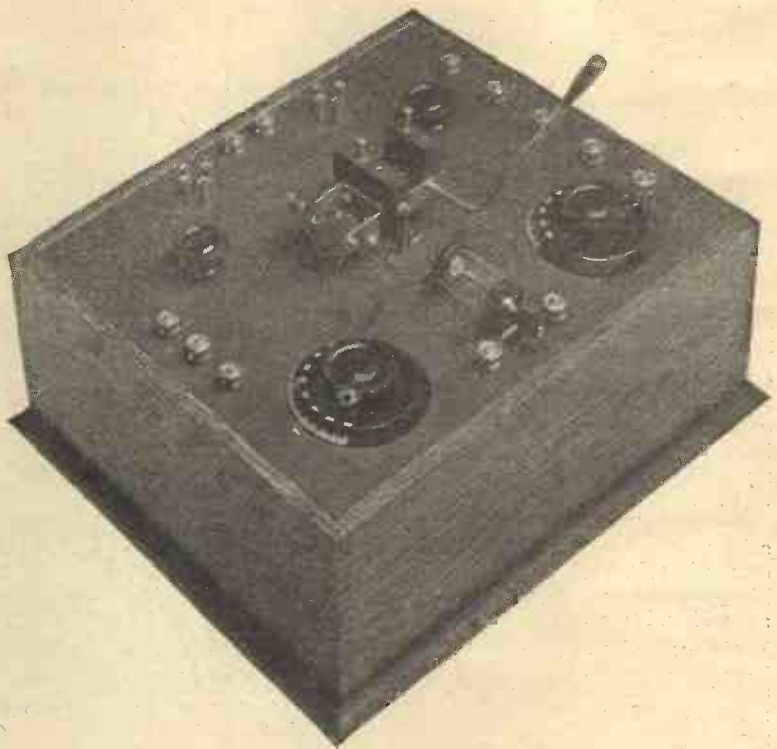

Another view of the set, which shows the neat lay-out.

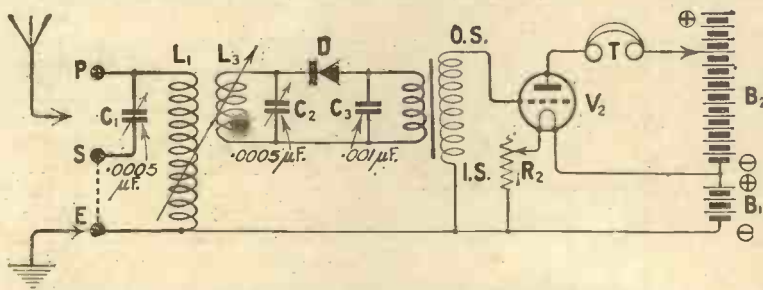
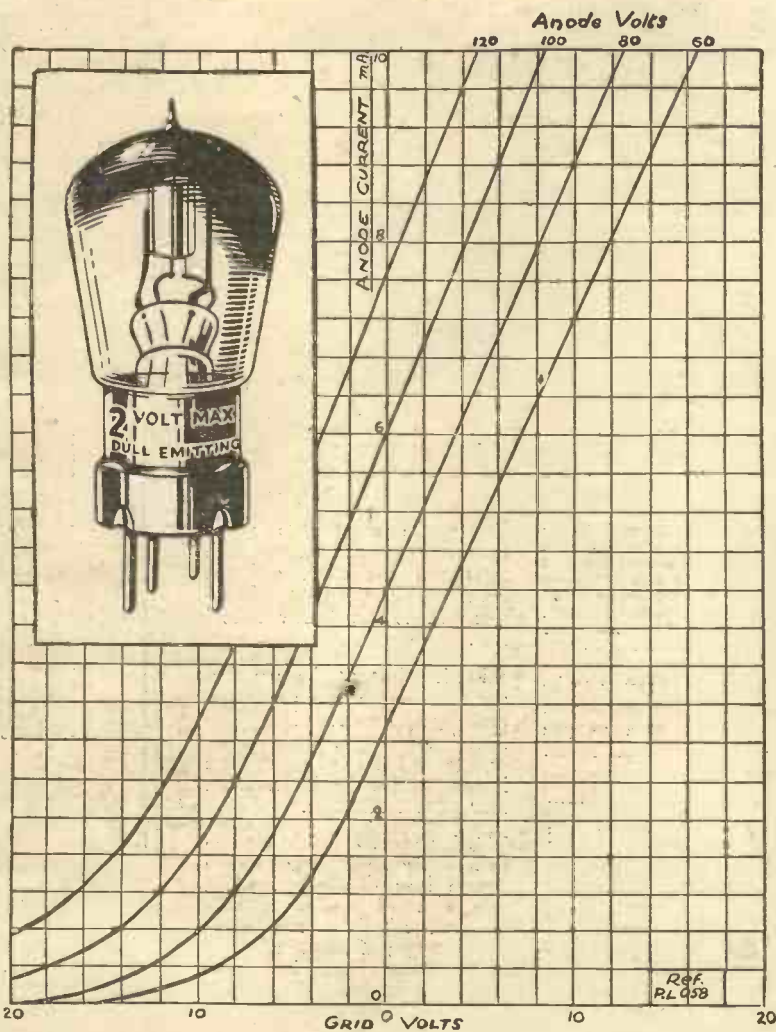

Fig. 2.—How the receiver may be employed as a loose-coupled crystal receiver followed by a stage of L.F. amplification.

- 1 Three-way coil-holder (Magnum).
- 2 Variable square-law condensers, 0.0005 μF (Jackson Bros.).
- 2 Filament resistances (Polar).
- 1 Crystal detector (Burndept).
- 1 Low-frequency transformer (Radio Instruments, Ltd.).
- 1 0.001 μF condenser with clips (McMichael clip-in type).
- 8 Valve sockets, nickel-plated (Magnum).
- 12 Terminals, nickel-plated (Magnum).

The handwriting of a valve



EDISWAN'S LATEST VALVE

These four curves illustrate the amplification given by the latest Edison-Swan Valve, the P.V.6D.E. for four different anode voltages. The abrupt climb to the point of saturation indicates in each case the high amplifying power obtained.

P. V. 6 D. E.

The characteristic curves shown are those of the Valve illustrated—Edison-Swan type P.V.6D.E., which has been especially designed for use with standard dull emitter valves and batteries.

Filament Volts 1.8—2.0
 Filament Amps. 0.4
 Amplification factor 6.0
 Anode Volts 60—120
 Price 22s. 6d.

A CHARACTERISTIC CURVE is the handwriting which shows the "character" of a valve. It tells more than many pages of print.

Every amateur knows that the addition of each volt to the grid potential increases the flow of current from the anode. After a point the increase of anode current becomes relatively large and remains steady until the second or saturation point is reached.

The amplifying capacity of the valve lies between these two points. The degree of amplification produced is indicated by the steepness of the curve lying between them.

EDISWAN VALVES

THE EDISON-SWAN ELECTRIC CO., LTD., Queen Victoria Street, London, E.C.4



The Bowyer-Lowe Square Law Condenser is the only one giving the square law effect with a wave-length range and capacity ratio **GREATER** than that of an ordinary condenser. Single, double and triple types supplied, with or without vernier.

SINGLE .0003 ...	16/-
DITTO with Vernier ...	19/-
SINGLE .0005 ...	17/-
DITTO with Vernier ...	20/-
DOUBLE .00025 ...	28/-
.. .0003 ...	29/-

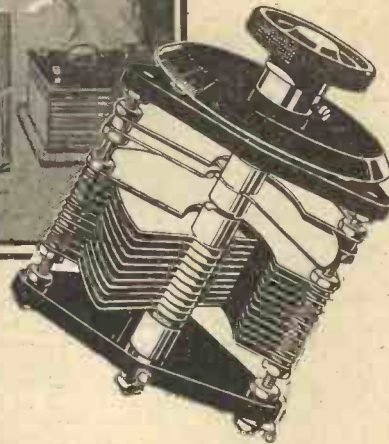

Every Set will be more efficient when "Low Loss" is understood

HAVE you ever wondered why it is that two wireless sets apparently alike in design, layout and wiring may be totally dissimilar in performance? One will yield signals of surprising musical quality over a wide range; the other will in every sense be disappointing. The "Low Loss" principle affords the answer.

In every receiver, and every component, there are places where a dissipation of electrical energy occurs. Dirty condenser washers will cause this loss of power, so will faulty joints; poor quality ebonite is not a perfect insulator; through it energy is wasted. Thus and thus, in a hundred ways, tiny leakages of power accumulate and in the aggregate seriously affect the quality of the final reception.

These minute leakages are called "Losses."

It has not been sufficiently realised that it is the business of every manufacturer of wireless parts to so design and assemble his products that their construction reduces these losses to a minimum, for "Low Loss" components mean highly responsive sets.

Whenever you have reason to be dissatisfied with the quality of reception afforded by a set you make, be suspicious of losses.

SEND FOR THIS BOOK.
It contains 36 pages of useful information about all Bowyer-Lowe Tested Components, with blank pages for your own notes. It is FREE on application. Enclose 1/4d. stamp for postage.

Locate the components which cause them, rebuild your set with parts you can trust, and the tremendous improvement will convert you to the "Low Loss" idea.

But it is better to be sure than sorry. Every single component made by Bowyer-Lowe is a "Low Loss" component, designed by experts and built by engineers in such fashion that its losses are reduced to a minimum.

This fact accounts for the extreme responsiveness of Bowyer-Lowe Square Law Condensers, which give ease of calibration with increased selectivity and wave-length range; it accounts for the high efficiency of every instrument and part we make.

Buy Bowyer-Lowe Parts for all your sets and secure maximum signal quality through low losses.

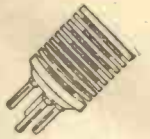

MATCHED H.F. TRANSFORMERS.

Every one guaranteed to match perfectly every other in its range. All ranges 150 to 3,000 metres and up, also special Neutrodyne Unit. Price each 7/-



ANTI-CAPACITY VALVE HOLDER.

Through low losses gives greatly increased efficiency especially on short wave-lengths. Fixed without metal nuts and screws. As used by Mr. P. W. Harris. Price 1/2



NEUTRODYNE CONDENSERS.

Minimum capacity practically zero. Low losses make high efficiency in tuning neutralising circuits. One screw fixing with 1/8" hole for spindle. Price 5/-



STUD SWITCH PARTS. Switch Arm, all studs, stops and screws, etc., for making any switch from 2 to 20 way. Drilling template supplied. Price 2/3



LOW LOSS COIL FORMERS.

For making short wave coils with minimum dielectric losses. Former is 3 1/2" in diameter, 6 inches long with terminals and soldering lugs each end and bracket for fixing. Constructed of Grade "A" Ebonite and Lacquered Br.cs. 5/-



VALVE WINDOWS. Heavily nickel plated, with rounded bezel, back plate, gauze and all nuts and bolts. A handsome finish to any set. Price each 9d.

ORDER DIRECT OR THROUGH YOUR DEALER.

Bowyer-Lowe Tested Components Built to secure Low Losses.

BOWYER-LOWE CO. LTD. RADIO WORKS LETCHWORTH HERTS.

C. M. FLETCHER AD.

Some No. 16 tinned copper wire for connections.
Suitable box or cabinet.
A packet of Radio Fress panel transfers for marking the panel.

Constructional Details

When purchasing the ebonite panel, be sure that it is guaranteed free from surface leakage, and also be sure to see that it is properly squared up. Nothing can be more annoying when the work is finished than to find that the panel is slightly over size and will not fit the cabinet. If you buy from a well-known firm you may be sure that both the above conditions will be fulfilled.

You will be able to mark out the panel quite easily from the drawing showing the lay-out, and you will not find any difficulty in drilling the necessary holes. If you look at the photographs of the back of the panel you will see that there are no nuts on the shanks of the terminals or valve sockets. After

the holes for these pieces have been drilled a No. 4 B.A. tap is run through the hole, and the terminal or valve socket then screwed in. This is quite a simple operation, and if you use a hand drill of the

manner, but in practice it is a very simple, quick, and effective method of tapping a thread into a hole.

Mounting the Transformer

Of course, if you have not the 4 B.A. tap, you can drill clearance holes for the terminals, and other screws, and secure them in position by means of the usual back-nut and washer.

The low-frequency transformer has one of its legs secured by one of the bolts holding the coil-holder in position. The leg diagonally opposite is secured by means of a short bolt tapped into a "blind" hole. This is very easily accomplished in the following manner. Mark on the panel the position of the necessary hole, using the transformer itself as the template. Now drill a hole not quite deep enough to pierce the panel. A short 4 B.A. bolt can then be carefully screwed into the hole, making its own thread as it goes along. This will probably be

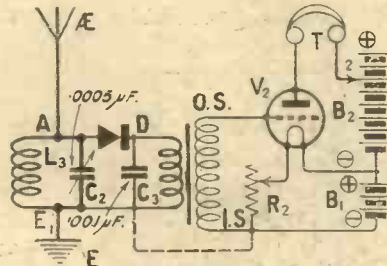

Fig. 3.—A direct coupled crystal and note magnifier may be used as above.

American type you will find it very easy to insert the tap in the chuck of the drill and run it through the hole in the ebonite panel. Some may criticise me for advising constructors to tap holes in this

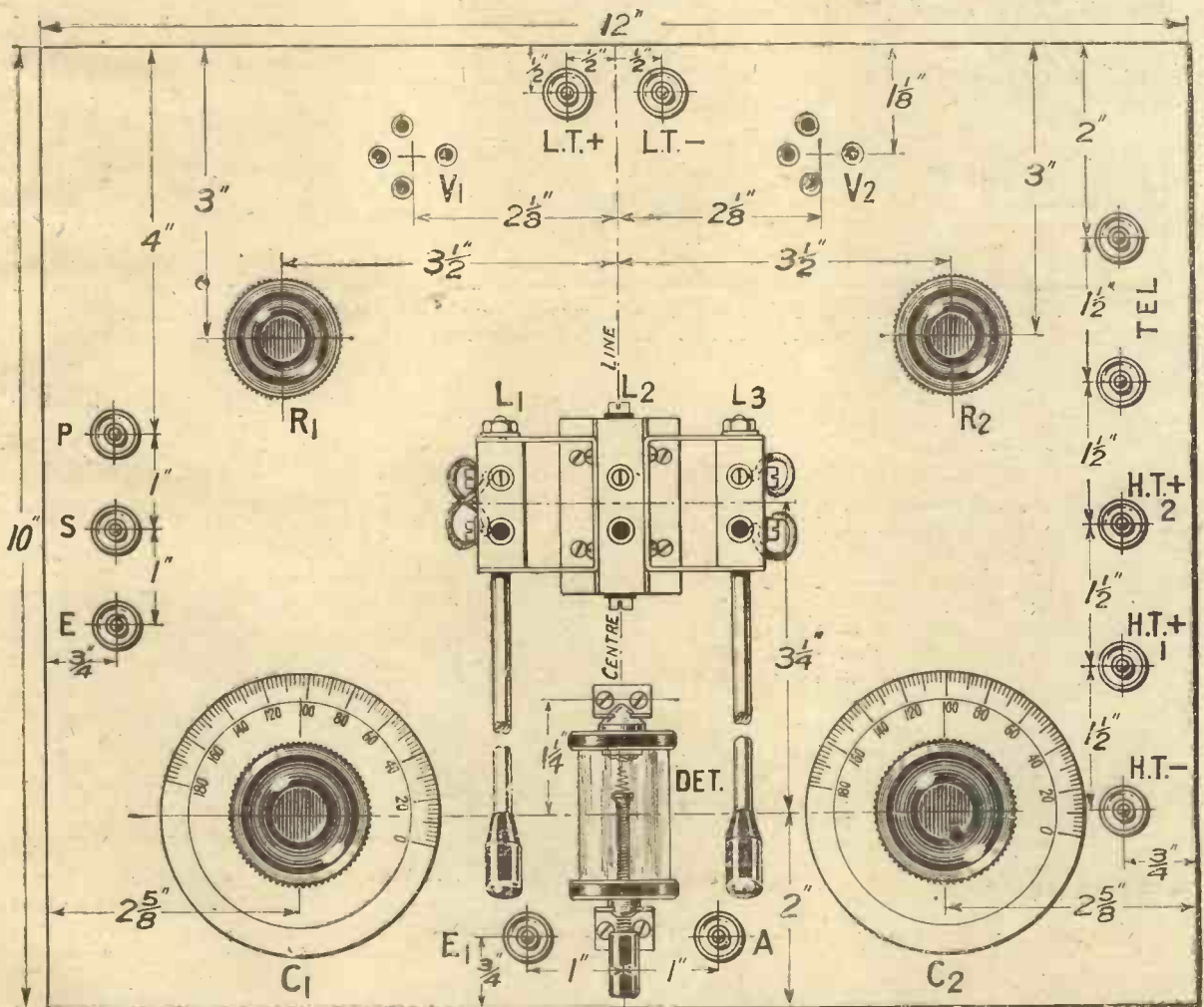

Fig. 4.—A dimensioned lay-out exactly to scale which can be used as a drilling diagram for marking out the panel. Full-size blueprint No. 101a may be obtained.

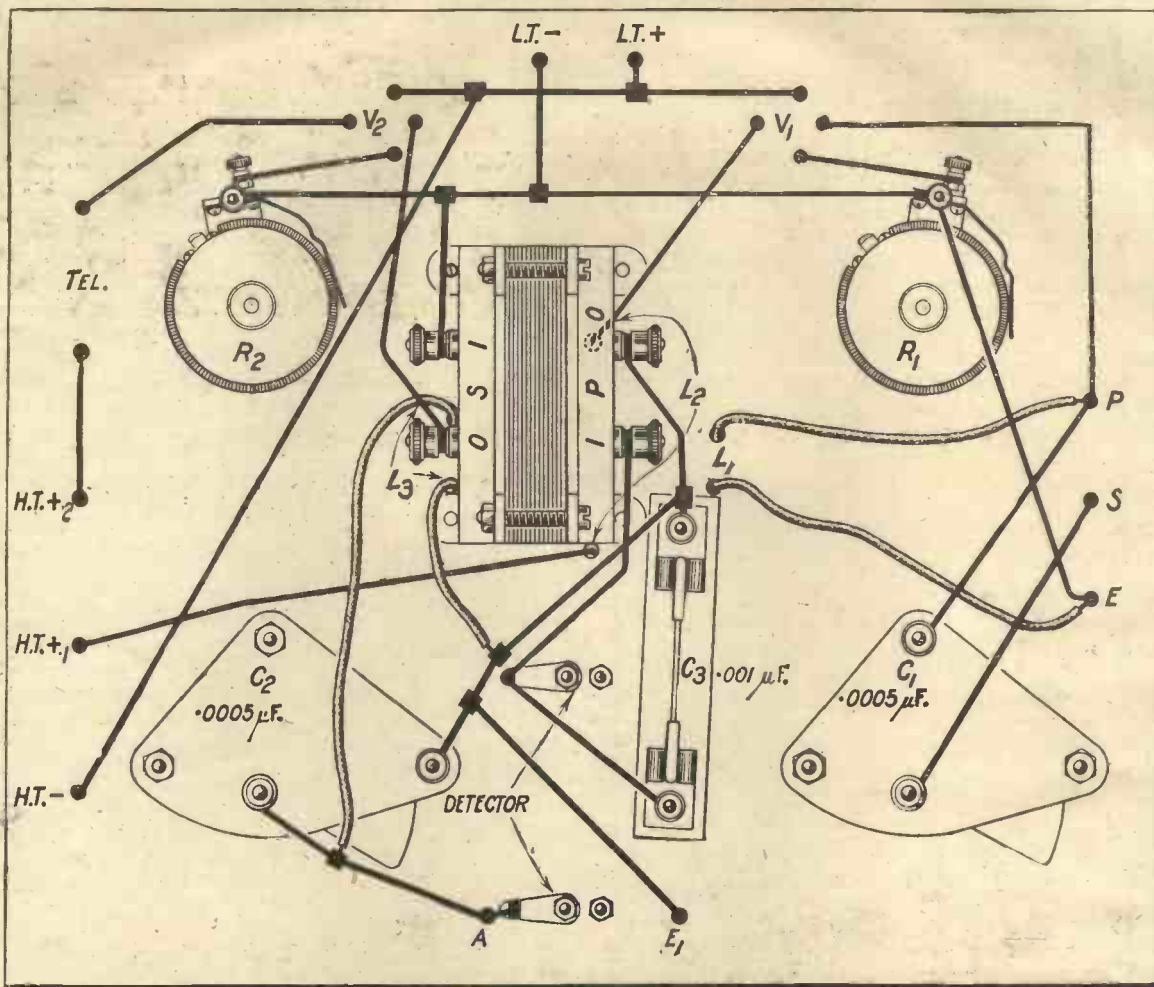

Fig. 5.—This back-of-panel wiring diagram shows the necessary connections. Blueprint No. 101b (full size) is available.

found easier than attempting to use straight or "plug" taps, and will be found to hold the transformer securely in position.

Wiring-up

Wiring is carried out with No. 16 S.W.G. tinned copper wire, and will be easily accomplished with the aid of the practical wiring diagram. The actual positions of the wires may be seen from the back-of-panel photographs. Flexible leads are used to join the moving sockets on the coil holder to the requisite points on the wiring system.

When wiring has been completed the panel may be mounted in any convenient form of box or cabinet, the coil-holder used giving suitable control whether mounted in a horizontal, vertical, or sloping position.

Coils

Using parallel tuning, that is, with the aerial lead joined to terminal P, earth on E, and S joined to E, we shall require, for the waveband up to 400 metres,

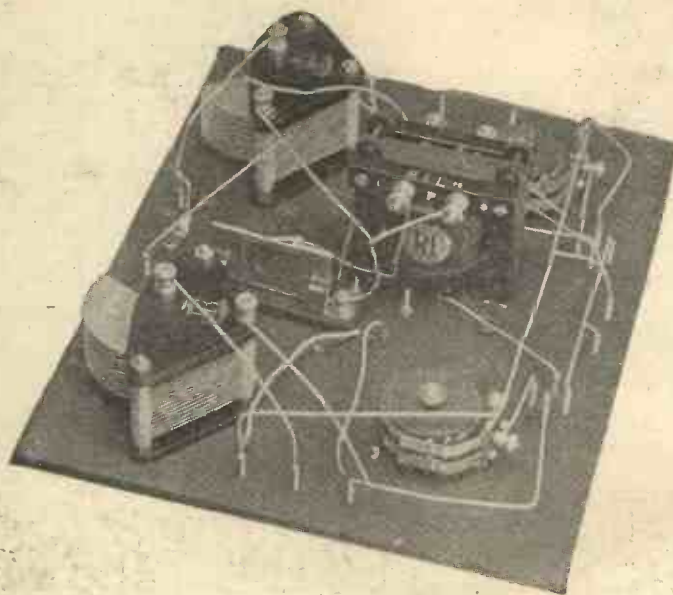

A view of the underside of the receiver which shows clearly the disposition of the components.

LISSENIUM

NO EXPERIMENTER'S OUTFIT IS COMPLETE WITHOUT ONE OR TWO OF THESE USEFUL SWITCHES

FOR ALL MAIN SWITCHING USES THERE IS NOW A LISSEN SWITCH WHICH YOU CAN JUST GENTLY PULL OR PUSH—each one as small as an efficient switch can possibly be—each one with negligible capacity—each one can be quickly fitted into an inch of space—and LISSEN ONE-HOLE FIXING, OF COURSE. LISSEN SWITCHES ARE SWITCHES WHICH HAVE BEEN DESIGNED PRIMARILY FOR RADIO WORK—but they are useful also for many other switching purposes.

THE LATEST ADDITION TO THE LISSEN FAMILY OF SWITCHES—the LISSEN Double Pole, Double Throw.

This is the very newest of the series, retaining all the neatness of the others, providing in a compact form the means for making all the connections required of a d.p., d.t. switch. As good as the rest. LISSEN ONE-HOLE FIXING, OF COURSE. Similar to LISSEN 5-point switch. Price 4/-



**LISSEN
2-Way
Switch**
2/9

**LISSEN
SERIES-
PARALLEL
Switch**
3/9





VARIABLE FINGER SWITCH
FIXING HOLE AND CONNECTION N°1
CONNECTION N°2

**PROTECTS
YOUR DULL
EMITTERS—**

This little device, called the LISSENSTAT RESISTOR, can be attached to any rheostat you may be using. Adds another 35-ohms resistance to it, which can be varied by means of the little finger switch shown, or entirely cut out of circuit by lifting the finger switch on to the centre contact. Is worth its price many times over. Only .. 1/3

You change over quickly from series to parallel tuning—by using the LISSEN Series-Parallel switch.

You cut out a stage of L.F.—by using a LISSEN Switch.

You disconnect both batteries and short the aerial to earth when the set is not in use—with a LISSEN Switch.

You may want to cut out a stage of H.F., when it is imperative to reverse your reaction coil—you do it conveniently with a LISSEN Switch.

You may want one of two alternative connections—it is quickly done with a LISSEN Switch.

- WHAT THE LISSEN 5-point switch does.**
- (a) Switches off one-stage of L.F. without touching the filament control—a separate switch for each stage.
 - (b) Connects the telephones to the plate of whichever valve it is desired to use, and at the same time switches off L.T. current from the unused valve.
 - (c) Cuts out a stage of H.F. in the same way as it does L.F.
 - (d) Will also disconnect both the H.T. and L.T. batteries, and short the aerial to earth so that the receiver can be left adjusted ready for switching instantly into use next time.
- Price 4/-

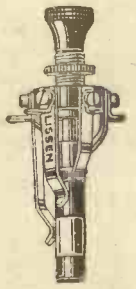

LISSEN REVERSING SWITCH.

Particularly useful when the LISSEN 5-point switch is used for cutting out one stage of H.F. When a H.F. stage is cut out, and reaction is being taken off the aerial circuit, it is necessary to reverse the reaction coil connections for each H.F. stage cut out, and this LISSEN switch conveniently does it. Can also be used anywhere when it is necessary to reverse the connections of a battery, a coil, or a condenser, for instance. VERY USEFUL FOR COMPARATIVE TESTS. With diagram 4/-

LISSEN MATCHED NEUTRALIZING TRANSFORMERS.

The LISSEN MATCHED NEUTRALIZING TRANSFORMERS described by Mr. W. H. R. TINGEY in "Wireless Weekly" are now ready for delivery. The first range ready is the "A" range, which covers the Broadcasting band. The transformers should be ordered in a set of three, the separate coils making up the set being known as A1, A2, and A3. The letter identifies the wavelength range ("A" for the Broadcasting band), and the number the position in which the transformer is used in the receiver. Price, per coil, 1/1; set of three, 1/3. Other ranges will soon be ready.

PARTS THAT PULL TOGETHER.—When you know that every vital part in your receiver is pulling strongly with each other, you know that you have a receiver which is the best you can ever get.

BUILD—WITH YOUR OWN HANDS—WITH ALL LISSEN PARTS

LISSEN LIMITED

20-24, Woodger Rd., Goldhawk Rd., London, W.12

Telephones : Riverside 3380, 3381, 3382, 1072.

Telegrams : LISSENIUM, LONDON.

Reduction in Prices

of all types of

B.T.H. RADIO VALVES

Effective February 2nd., 1925

TH**ERE** are no better valves in all the world than B.T.H. Valves—and few (if any) as good. The substantial reduction in prices noted below will make the advantage of using B.T.H. Valves even more evident than it was before. They are made in the Mazda Lamp Works, Rugby.

TYPE	CHARACTERISTICS	OLD PRICE		NEW PRICE	
GENERAL PURPOSE TYPES					
R	Filament Voltage.....	4 Volts	s. d. 12 6	s. d. 11 0	
	Filament Current.....	0.7 Amp			
	Max. Plate Voltage.....	100 Volts			
B 3	Filament Voltage.....	1.8 Volts	21 0	18 0	
	Filament Current.....	0.35 Amp			
	Max. Plate Voltage.....	80 Volts			
B 5	Filament Voltage.....	3 Volts	25 0	21 0	
	Filament Current.....	0.06 Amp			
	Max. Plate Voltage.....	80 Volts			
POWER AMPLIFYING TYPES					
B 4	Filament Voltage.....	6 Volts	35 0	30 0	
	Filament Current.....	0.25 Amp			
	Max. Plate Voltage.....	120 Volts			
B 6	Filament Voltage.....	3 Volts	35 0	30 0	
	Filament Current.....	0.12 Amp			
	Max. Plate Voltage.....	120 Volts			
B 7	Filament Voltage.....	6 Volts	37 6	32 0	
	Filament Current.....	0.06 Amp			
	Max. Plate Voltage.....	120 Volts			

Fit B.T.H. Radio Valves and make sure of good results

Advertisement of The British Thomson-Houston Co. Ltd.



2296

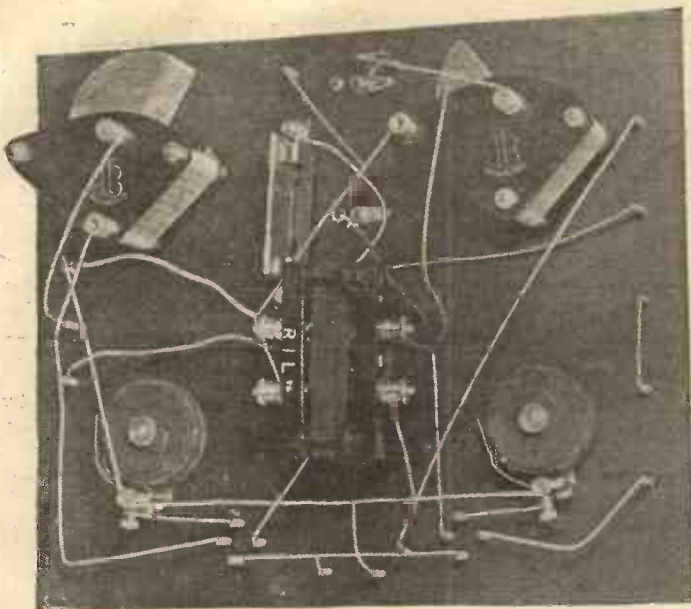

A further photograph which will help to simplify the task of wiring.

a No. 35 for L_1 , a No. 75 for L_2 , and a No. 50 for L_3 . Between 400 and 500 metres a larger coil will probably be required in the aerial socket L_1 , and a No. 40 or 50 may be used.

For Chelmsford and Radio-Paris, a No. 150 coil may be used in L_1 , a No. 250 or 300 in L_2 , while L_3 may be a No. 200.

In some cases better signals may be obtained on the lower wavelengths if a larger coil be used in the aerial socket, the aerial tuning condenser being used in series with the coil. In this case the aerial lead is joined to terminal S, terminal P being left free. The link between S and E is taken out, and the earth lead is left on terminal E. A No. 75 coil may now be used in the aerial socket, the other coils remaining as before if found suitable.

Direct or Loose Coupling

When changing from the two-valve and crystal circuit to the *loose-coupled* crystal and note magnifier circuit, no alteration in coil sizes will be necessary, the centre coil being merely pulled from its socket and laid on the table. When, however, we change from the "full" circuit to the *direct coupled* "crystal and one" circuit, we have to change the aerial lead to terminal A, and the earth lead to terminal E₁. The coil L_3 now becomes the aerial coil, the other two coils being inoperative, and its size should be

that used in the aerial socket L_1 when using parallel tuning with the complete circuit.

Valves

Any good make of general purpose receiving valve will be found satisfactory in this receiver, and the maker's instructions as regards anode voltage should be carefully followed. As regards dull emitters, you may certainly use them, provided you use suitable filament resistances. The Polar rheostats are provided with an interchangeable bobbin, so that you can purchase a standard holder and then get bobbins carrying suitable resistances for your particular valves.

H.T. Terminals

Separate terminals are provided for the supply of anode voltage to each valve; the terminal marked H.T. + 2 supplies the low-frequency amplifying valve, while the radio-frequency amplifier is supplied by means of the terminal H.T. + 1. Each terminal should be joined to a point on the high-tension battery corresponding to the voltage required by the respective valve, according to the manufacturer's instructions. In a first test, however, these two terminals may be joined together by means of a piece of wire, and a single lead taken to the high-tension battery.

Operation

Having completed the set and connected the aerial with batteries,

etc., to their respective terminals, light up the valves and slowly rotate both condenser dials until the local station is heard. During this process the coil L_3 may be kept close to L_2 , with L_1 swung well away. When signals are heard, reset the crystal detector to a sensitive spot, and slightly loosen the coupling between L_3 and L_2 , returning on C_2 . Now bring L_1 up closer to L_2 and note if any increase in strength results. If not, reverse the two leads to L_1 and try again. When L_1 and L_2 are close together the first valve will oscillate and will cause those squeaks and howls so familiar to all listeners-in. Therefore, if you are a considerate listener, and I am sure you are, do not bring L_1 close enough to L_2 to cause the set to oscillate, at any rate during broadcasting hours. If you wish to test whether oscillation is possible, wait until broadcasting hours are passed, and then try, but do not keep on doing it, or you may upset someone who is listening for a distant station.

If you are within about six miles of a main broadcasting station, and your aerial is reasonably efficient, you will probably find that the first valve does not make very much difference to the strength of signals from that station. In this case you may use one or other of the "crystal and one" circuits, as explained before.

Results

On a standard P.M.G. aerial in S.E. London excellent signals were obtained from 2LO, using each of the crystal circuits in turn. The addition of the high-frequency amplifying valve did not make any appreciable difference to the strength of local signals. After London has closed down, Madrid comes in at sufficient strength on the telephones for comfortable reception, and it is on distant transmissions such as this that the real benefit of the high-frequency amplifier is obtained.

Tested in the afternoon, during an interval in the programme from 2LO, the Birmingham station was heard at a strength which was a little too much for telephones, being audible about three feet from a standard C.A.V. loud speaker. The children's hour transmissions from Bournemouth and Newcastle were heard at good strength, while less strong signals were received at a condenser setting corresponding to Manchester's wavelength, no call sign being heard. Late at night three unidentified German stations were heard with some interference from local oscillators.

Low-Resistance Frame Aerials and Distant Reception

By A. D. COWPER, M.Sc., Staff Editor.

An article of absorbing interest describing the results of recent experimental work on frame aerial reception.

VERY little seems to be known on the subject of the relative efficiency of frame and out-door aerials, although the frame aerial would appear to offer one solution of the problems of broadcast reception in a crowded city. The inherent selectivity of the frame, due to its directional properties, as well as its immunity from local electrical disturbances, offers many advantages over the "P.M.G. aerial," apart from the physical impossibility of providing a good high outdoor aerial for every dweller in flats and rooms within the urban area. But one of the inheritances from the early days of exclusively long-wave Morse transmissions is the idea that frame aerial reception implies at least six valves in all, and a many stage high-frequency amplifier before the detector valve, in order to obtain signals of an intensity which will produce any effect at all on the detector. Generally two stages of H.F. amplification are incorporated in a frame aerial receiver, even when mainly intended for use at absurdly short distances from a medium-powered short-wave station, in accordance with this idea.

Inefficient Types

On examination of the types of frame aerials in common use in connection with such elaborate sets (super-regenerative receivers of the ultra-portable type will not be discussed here, as they belong to a different category altogether, although they have their legitimate uses), it is noticeable that usually very little effort has been made to produce a "low loss" inductance. The turns are often spaced to a reasonable extent; but very often the wire is of small gauge, heavily insulated, and even in extreme cases actually enclosed in a wooden casing. The superficial effect may be pleasing enough, but the high-frequency losses must be very appreciable in such a case, as a few

practical experiments on enclosed frame aerials will quickly show.

Design

It appeared to be of interest and importance, therefore, to investigate in a practical manner to what extent the elimination, as far as possible, of all losses through needless ohmic resistance and dielectric

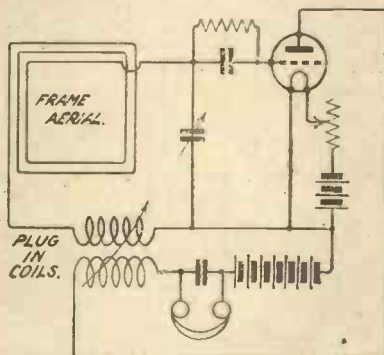

Fig. 1.—A method of obtaining reaction when using a frame aerial.

absorption, etc., would improve frame aerial reception and make possible the reception of distant stations with but moderate equipment. There are, of course, the orthodox formulæ for calculating the actual available signal voltage under definite circumstances, taking into account the "area turns" (the mean area of each turn or loop of the wire around the frame multiplied by the number of the turns),

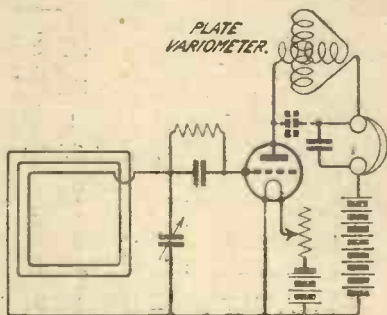

Fig. 2.—Obtaining reaction effects by means of a plate variometer.

the frequency of the radio transmission (the efficiency rapidly increasing with increase of frequency), and the distance. But recent work with short waves indicates that the last factor is the elusive one, since apparently New Zealand, for example is nearer to England for radio waves than Cairo in certain circumstances, and Glasgow or Belfast nearer to London than Birmingham is in others.

American Reception

The writer was recently able (*Wireless Weekly*, Vol. 5, No. 15) to hear distinctly, subject to the usual fading and some bad jamming, at least two American stations, KDKA and WBZ (as well as indications of a number of others) in the course of a couple of hours on one favourable night, all on a 2-ft. square indoor frame aerial of No. 20 S.W.G. d.c.c. wire, spaced at about $\frac{1}{4}$ in., and with detector valve followed by two note magnifiers alone. The first two valves were the D.E.5b, with a theoretical voltage amplifying factor of 20. No radio-frequency amplification was used, but finely regulated Reinartz type of reaction, together with a small tuning condenser. This result would appear to indicate that there is much more in frame aerial reception than is usually stated; that H.F. amplification is wholly unnecessary in such cases; and that the secret for successful reception was the elimination of all unnecessary H.F. resistance-damping, with the resulting light reaction demand and possibilities of delicate adjustments.

A Simple Circuit

In any case, in order to eliminate the tuning difficulties and the expected troubles with self-oscillation, implied by several stages of radio-frequency amplification, as well as the variable factor of the actual efficiency (amplifying factor) of the latter, it was decided not to attempt to add any high-frequency

amplification, but to investigate the possibilities of reception of medium distant Continental and British stations with the minimum equipment of a detector valve (a D.E.5b) followed by one note magnifier (also a D.E.5b of $M=20$, as before) with efficient coupling by a high ratio low-frequency transformer. With proper high-tension and carefully adjusted grid bias, the resulting audio-frequency amplification is of a high order; whilst with a carefully weeded

approximating closely to an ordinary reception circuit for use with an outdoor aerial. (Fig. 1.) This has the great disadvantage of involving a rapid change of wavelength with alteration of reaction coupling, as well as removing some of the inductance from the frame aerial, where it is useful to increase the "area-turns," to a small coil of minimum pick-up power. Direct application of a very large coil of a small number of turns (*i.e.*, another smaller

the common internally wound type with spherical rotor. (Fig. 2.) Practical trial in a frame aerial circuit gave fair results, but there was still a little difficulty in obtaining the exceedingly fine control that was needed, independent of frequency over a small range; so this was finally abandoned. When high-frequency amplification is attempted with a low resistance undamped frame aerial circuit, and sharply tuned intervalve oscillating circuits are used, this inherent capacitive feed-back becomes very prominent. The resulting instability has to be combated in various ways.

Neutrodyne Control

The present writer has suggested some devices from time to time where a compensating feed-back is used to produce stability, as in the tuned anode version of the Hazeltine Neutrodyne device worked out some time ago by the writer, this feed-back can be made variable at will so as to give a (negative) reaction control. (Fig. 3). Actually, a good deal of the increased efficiency of reception observed by some writers with high-frequency amplification in front of a detector valve may actually be due to this inherent reaction-effect assisting the direct reaction-coupling to an extent which makes the latter far more sensitive in adjustment. The writer has found it convenient in some cases to connect the grid leak to L.T. negative. Where several stages of high-frequency amplification are attempted, it becomes an easy matter to obtain electrostatic reaction between some one of the anodes and the grid of the first valve, via a small reaction condenser, on account of the reversal of phase at each stage. (Fig. 4.)

The direct reaction of the Hartley oscillator circuit, modified in some form to give reaction control,

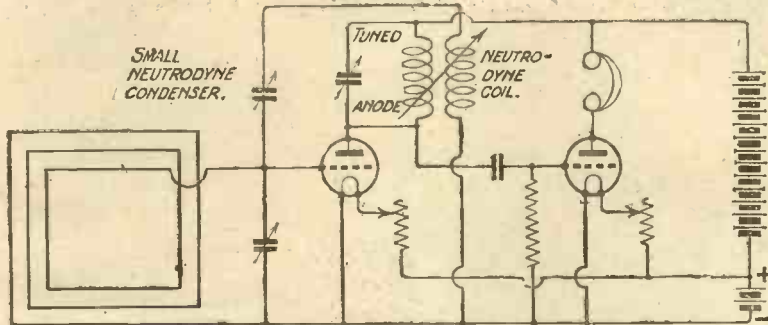

Fig. 3.—A simple neutrodyne circuit. Note that in this case the grid leak is shown connected to L.T. negative.

high-tension battery, and with only two valves in use, the quite necessary factor of a perfectly silent background was practically attainable.

Reaction

The matter of reaction control required very careful attention, as upon this depends the whole possibilities of success with such circuits. Oscillation hysteresis, or back-lash, must be wholly eliminated, so that the detector valve glides imperceptibly into and out of oscillation, so quietly that a plate milliammeter is almost a necessity to detect whether it is actually oscillating when not tuned to a signal. A large change of wavelength with every alteration of reaction coupling, as with the conventional two-coil tuner and fine wire coils, would be fatal to success; whilst exceedingly fine adjustment of coupling must be available, and, if possible, there should be some quantitative indication on a scale of degree of coupling for comparative observations.

Application

There are a number of different methods of obtaining reaction effects with frame aerial circuits. The simplest to improvise, and that perhaps used most often, involves the application of a small plug-in coil in series with the frame aerial (and preferably on the filament side of it) to which is coupled a reaction coil in the anode circuit,

frame aerial) in variable magnetic coupling with the main frame is clumsy from a mechanical point of view, and does not lend itself to accurate adjustment of coupling; besides suffering from, the same disadvantage as regards tuning.

Another Method

Another method, practical with easily oscillating valves, involves the inherent electrostatic coupling via the anode-grid valve capacity, a tuned anode (either of the coil-and-parallel-condenser type or the American device of a plate variometer). This gives in general a fine enough control over reaction, particularly when the anode circuit has rather flat tuning as the result of the use of fine wire or of a variometer of large distributed capacity, such as

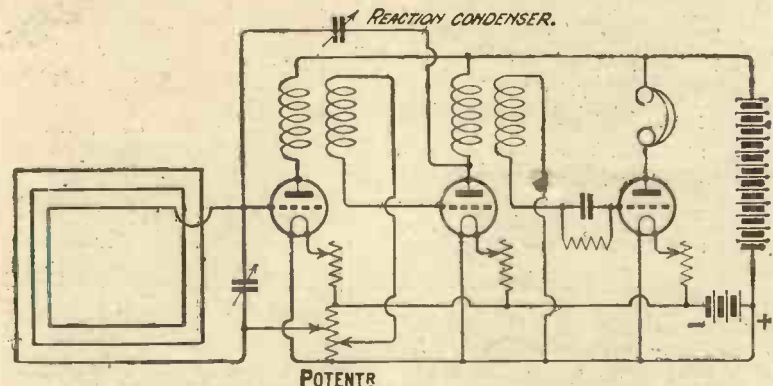
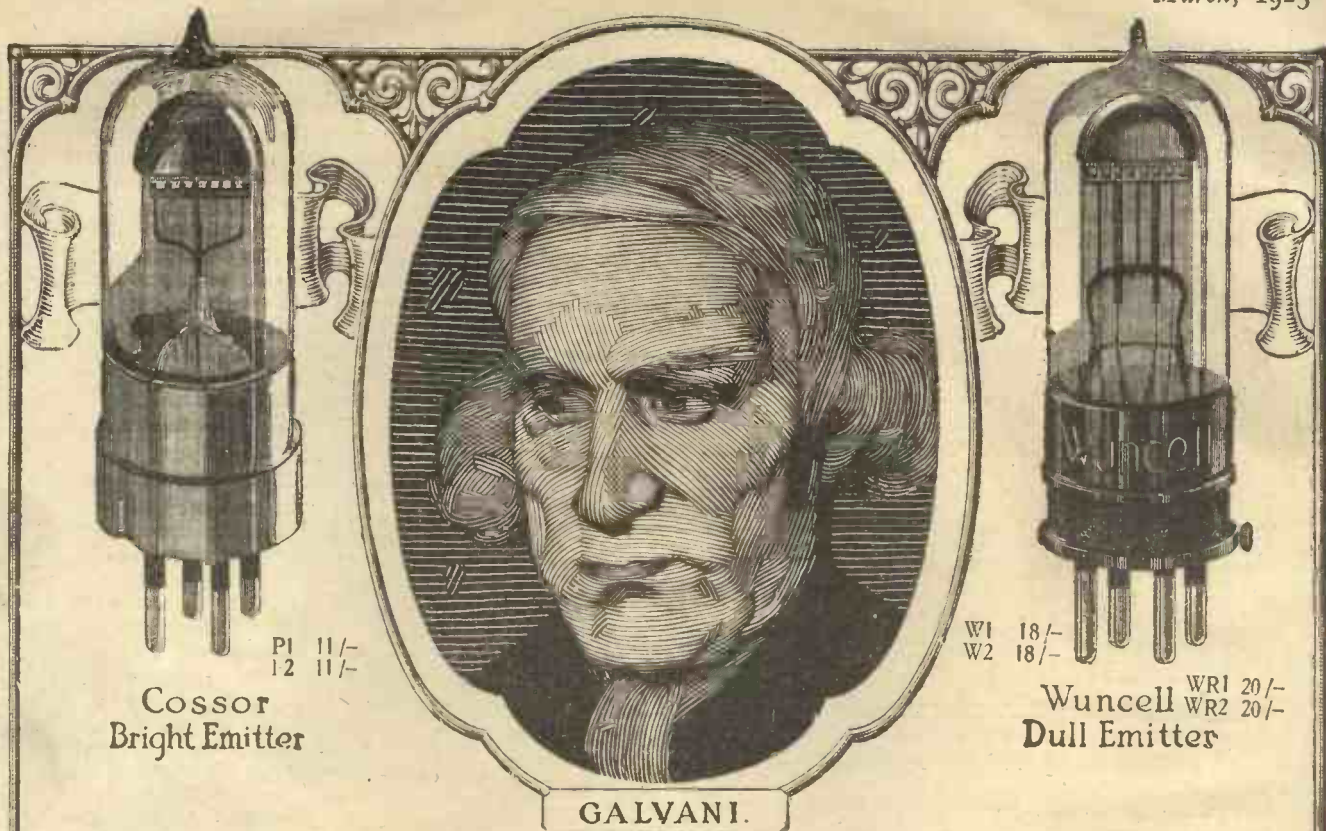

Fig. 4.—A three-valve circuit with two stages of H.F. amplification and electrostatic reaction.



The twitching of a frog's legs!

UNIMPORTANT and trivial details have often led to epoch-making discoveries.

Just as we are told that the evolution of the first steam engine came from James Watt and the kettle boiling on the hearth, so the twitching of a frog's legs played no small part in the discovery of the first electric battery.

Professor Galvani—a noted Italian Scientist—it is said, had passed a copper skewer through the limbs of a dead frog, and was about to hang them up on an iron nail in his laboratory. As soon as the copper touched the iron he noticed a convulsive twitching of the legs. That this was due to some electrical influence he proved by touching a nerve in the frog's limb with a piece of zinc, and a muscle with a piece of copper. As soon as these two metals were connected together a convulsive kick took place.

All Cossor Valves
reduced in price.

And so came into being the first recorded instance of the electric battery.

From the crude cell filled with acidulated water of 150 years ago we come to the modern dry battery and the accumulator—truly a great stride forward.

And in the design of Wireless Valves an evolution no less remarkable has taken place during the past two or three years.

Instead of Valves with a big current consumption glowing at a temperature of upwards of 2,000 degrees, there is now available the wonderful Wuncell Valve that operates with a glow that is well-nigh invisible. This long-life Valve is fully described in a Folder obtainable from any Dealer free of charge or direct from us.

No. 4 of Series

Cossor Valves

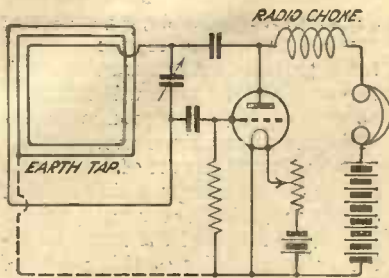

Fig. 5.—A very unstable circuit.

can also be utilised. In Fig. 5 there is indicated an inherently unstable circuit, which can, however, be modified as in Fig. 6 (which is one of the De Forest Ultraudion type), or as suggested by the writer, as in Fig. 7. In the last case, the tuning condenser can be placed right across the whole inductance, as shown, or across only the grid-filament portion. The former arrangement gives, according to some recently published work, an appreciably higher signal voltage on nearby powerful transmissions without the use of reaction, under similar circumstances, than that which involves the tuning of part only of the coil, on account of the redistribution of the casual frame-to-earth distributed capacities.

Reinartz Reaction

With the tuning condenser across part only of the inductance, we get (Fig. 8) the Reinartz type of reaction, which has proved to be so effective in ordinary selective reception with outside aerials. Here a fixed reaction coil is wound continuously with, and in the same direction as, the main tuning inductance, either on to the same former or closely adjacent so as to be close coupled magnetically with the first. This is fed *via* a small variable reaction condenser from the anode of the detector valve, the high-frequency impulses being prevented by an efficient radio choke from passing to "earth" *via* the distributed capacity of the phones or transformer windings and H.T. battery in modern versions of the circuit. The reaction control is then carried out entirely by this small condenser; and with proper design of the circuit and with low-loss inductances it is of an extremely fine and at the same time manageable type. The number of turns required in the reaction coil is surprisingly small with valves of high "M" value and liberal electronic emission. The reaction condenser can be of low maximum capacity: .0001 μ F; the usual troublesome change in wavelength

with alteration of reaction coupling is then almost entirely avoided over the small range necessary for fine adjustment; whilst the reaction demands vary but slightly with frequency over the whole tuning range. This facilitates "searching" enormously in practice.

Types of Frame Aerials

With the adoption of the Reinartz type of reaction it is possible to concentrate all the available inductance on the frame as effective

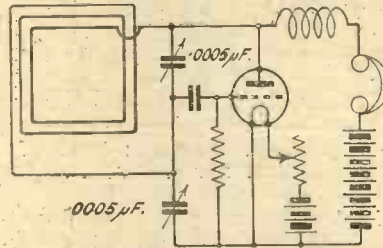

Fig. 6.—A circuit of the Ultraudion type.

"area-turns"; even the few reaction turns become now part of the frame, though not part of the directly tuned circuit.

In order to investigate practically the effect of an extremely low H.F. resistance in a frame aerial, and some other allied points, three moderately large frames were experimented with and compared as to results with a high outside aerial, a low "test aerial" in constant use, and smaller frame aerials. The tuning capacity across the inductances was kept as low as possible, consistent with a useful tuning range, in order to obtain maximum signals. Actually it was found that a low loss, low minimum tuning condenser of .0002 μ F actual maximum capacity served to tune the large frame aerial used over the range from about 1,100 to just under 600 Kc. frequency (280 to 520 metres wavelength).

Construction

The large frame aerials had a mean diameter of one metre, being actually of roughly hexagonal form, with the wires spaced at 8 millimetres ($\frac{1}{3}$ in.). The constructional details are suggested in the figures (Fig. 9). Three wooden bars a little over 1 in. square are notched in the centre so as to fit together in a cross, and combs are affixed to the ends of the arms to carry the windings, spaced at the required distance. Eleven turns of wire in the grid-inductance sufficed for the desired range; only two extra turns (at the inner end) gave an adequate Reinartz reaction coil.

No. 15 enamel insulated wire was principally employed, together with bronze strip (supplied for external aerials under the name of "Amplifytone"), 6 millimetres wide (about $\frac{1}{4}$ in.) and very thin and flexible. The latter should at least offer a minimum H.F. resistance; though the writer did not expect that in this position, wound with consecutive turns fairly close and parallel, there would be much noticeable difference between this and plain No. 15 wire, on account of the peculiar distribution of high frequency currents always at the outer edges and as far away from neighbouring currents (in the same sense) as possible. This was verified in practice, as but small differences either in tuning range or reaction requirements were noticed between the wire and the strip. The latter, however, can be recommended for practical use, as it winds on so much more neatly and gives a more finished appearance to the aerial. The wire (or strip) was kept well away from possible sources of dielectric losses, and each frame was supported on a stand near the centre of a room, away from walls and floor, when observations were being made.

Practical Details

The actual circuit, together with some of the values of components used, is given in Fig. 10. The grid leak had to be taken to the L.T. minus with the valve used, to eliminate back-lash, and the H.T. battery was tapped. The .0002 and .0001 μ F variable condensers (J.B. ebonite-end) were mounted on a convenient small vertical panel, each with 9-in. extension handles, with the radio former similar to an ordinary H.F. transformer, supplied by Messrs. Grafton Electric Co., mounted directly on the central terminal of the reaction condenser. The rest of the components were arranged on a large

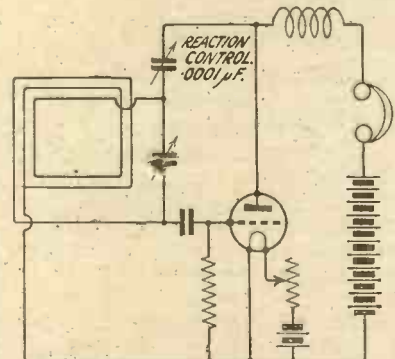

Fig. 7.—The author's modification of fig. 6.

baseboard, the board mounting components of Messrs. Peto-Scott being used largely. Fairly long but isolated leads of thick wire were taken to the frame aerial, at some distance away to reduce body capacity effects, which are very marked in such circuits. A Grafton grid condenser with 2 megohm grid leak of Dubilier make, Pye transformer, D.E.5b Marconi-Osram valves, H.T. battery made up of flashlamp units very carefully tested before use, Ediswan 'phones and subsequently an Ediswan small loud-speaker fitted by the writer with a larger trumpet, were used in the trials. The room in which these were carried out was on the first floor in a substantially built house, some 35 miles north of London, in a high part of rural Essex, and as remote from any outside aerials, etc., as practicable. Reception conditions were fairly normal, but improved, as usual, later in the evening. It is usually considered a fairly good location for distant reception on a high P.M.G. aerial.

Method of Logging

Stations heard were necessarily identified principally by their wavelength, as determined carefully with an accurately calibrated Townsend wavemeter, which had been repeatedly checked against various transmissions from a large number of stations; so that their apparent wavelength was in many cases known, as well as the advertised value. The German stations often give their actual wavelength during the announcements, and these generally check up very closely. The B.B.C. stations are fairly consistent, when not dodging heterodynes from other stations without notice, but are often apparently some distance off their nominal value. When a number of tests have to be made rapidly, it is impossible to wait for the station call to be given; in this case the nature and language of the transmission often gives confirmation.

Practical Operation

It cannot be too strongly emphasised that experiments of this nature, with a large frame aerial tuned with small tuning condenser, and not connected to earth at all, close to the operator, with a powerful audio-frequency amplifier pushed to the utmost limit of power, and with a circuit of minimal high-frequency damping worked with critical reaction adjustment. These can only be carried out with any prospect of success by the exercise of the ut-

most patience and care. The tuning is of a degree of sharpness which would be incredible to most beginners who have only learnt some of the art on a direct-coupled set with heavily damped outside aerial and large parallel tuning condenser. Even the noisy local station, which will come in at good

shake in the spindle, or irregular motion here, may render the fine tuning necessary impossible. The results obtained here will therefore be unlikely to be reproducible by other than the serious experimenter who has learnt the art of fine tuning and is aware of the meaning of hand capacities; which, of course, rather limits the scope of the really interesting possibilities of this mode of reception. For short-range reception of the local broadcast station these remarks do not apply with so much force.

Actually, the tuning-in is done by aid of a wavemeter in the usual way, at first; then a stations scale can be made. The table of results appended will give some indication of the settings to be expected, and the different frame aerials did not vary more than about 5 degrees in this matter.

Results

The table indicates what was obtained with the one pattern of frame aerial, 1 metre average diameter, with No. 15 wire, 11 turns in the grid circuit. This aerial had the turns arranged in the form of a flat spiral. Changing now to the second aerial, with the same number of turns arranged this time in the form of a very short solenoid of 11 turns of No. 15 wire, of the same average diameter, no sensible difference was noticeable either in ease of oscillation, tuning range (the setting was but 5 degrees different), or in efficiency of reception. Tested by repeated substitution, on Berlin, Rome, and subsequently (using here the loud-speaker) on 2LO at 35 miles, there was no difference that one could be sure of at all. A much smaller aerial might possibly have exhibited some difference. Directional effects were of the same order. If anything, the solenoid was a trifle sharper in this matter, but one could not be certain without elaborate quantitative measurements. On the distant stations, of course, directional effects were marked, but London, e.g., could not be tuned out in any direction, even though one general direction, roughly north and south, was better.

Improvement after Nightfall

With the aerial of bronze strip (which might be expected, superficially, to give an even lower H.F. resistance than No. 15 wire) but little difference was noticed, as already remarked. The later results with this aerial were subject to the usual progressive improvement of reception with time, after nightfall. The No. 15 round wire.

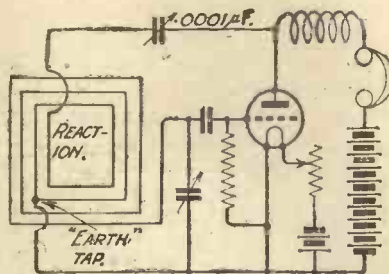

Fig. 8.—A Reinartz type of frame aerial circuit.

loud-speaking strength audible outside the room and almost unbearable on the headphones for any length of time, will be wholly missed by one who carelessly twirls the knobs. Without nearly critical reaction adjustment there is, naturally, precisely nothing to hear at all on the set; and a slight tap on the end of the 9-inch extension handles will tune a powerful station right out (or in). Moving away from the table on which the set was arranged, reduced London from a good round shout to a whisper by altering the tuning. The tuning condensers must be of a good substantial make, as otherwise any

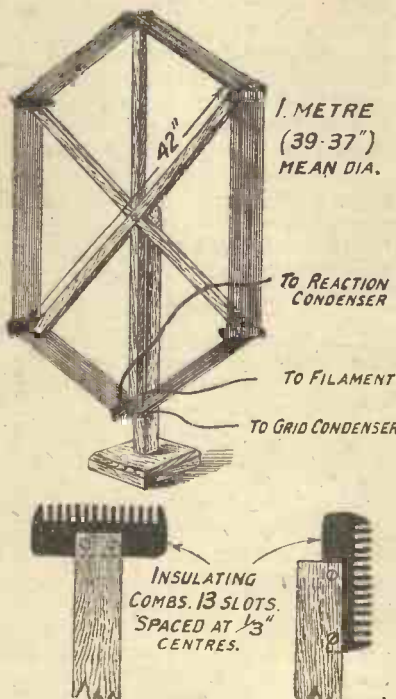

Fig. 9.—Details of an efficient frame aerial.

MUSIC ALL ROUND THE DIAL

FOUR AMERICAN STATIONS NIGHTLY!

"... With an indoor aerial on my Duodyne III. I receive all B.B.C., most Continental, and four American stations nightly, whether London is on or not. . . . Tuning is absurdly simple, as there is 'music all round the dial' . . ."

Golder's Green, N.W.

"The set goes very well indeed. . . . I may say we got Havana, Cuba, the other morning, which none of the other sets in this town have got yet." C. J. H., Thurso.

"I must say I am delighted with mine. Nightly I tout the Continent."

Bush, Bradford.

"You will be interested to know that I received WGY Schenectady on a loud-speaker almost as loud as 2LO on my Duodyne V. at Croydon . . ."

J. A. Fowler, M.I.Mech.E.,
Wellman Smith Owen Engineering Corporation, Ltd., Kingsway, W.C.2.

Duodyne

A Genuine Long Range

LOUD-SPEAKER RECEIVER

TWO STAGES OF HIGH-FREQUENCY AUTOMATIC TUNING.

Guaranteed Range under average conditions

- DUODYNE III. Headphones . . . 3/4,000 miles.
- DUODYNE V. Headphones . . . 4/5,000 miles.
- Loud-Speaker . . . 1/1,200 miles.

The extraordinary range and simplicity of operation, exclusive to the DUODYNE RECEIVERS, must make an irresistible appeal in Imperial and Continental markets.

THE DUODYNE Long-Range Receivers will discriminate between Radiola Paris and 5XX Chelmsford, or, used in conjunction with a CURTIS EJECTOR, will tune in any Broadcasting Station at will, while operating 1 1/2 miles from local Station or 200 yards from Relay Station.

A CHILD CAN TUNE IT.



The DUODYNE CABINET.—The Duodyne V. is also supplied in French Polished Oak Cabinet with folding doors, enclosed valves and tuning coils. Self-contained batteries. Instrument only . . .

The DUODYNE III. (Instrument only) Panel Type . . .

The DUODYNE V. (Instrument only) Panel Type . . .

The DUODYNE PORTABLE IV.—Loud-speaker from anywhere in the United Kingdom on Frame. Shortly available . . .

£27

£10 0 0

£18 18 0

£30 0 0

CURTIS

CONSTANT-TUNED H.F. AMPLIFIER

Automatic Tuning—No Condenser required.

The Heart of the Duodyne Receivers

The Curtis "Constant-Tuned" High-Frequency Amplifier is the only automatic high-frequency amplifier which, when connected in circuit, guarantees high efficiency for two stages or more of radio amplification on any wavelengths between 300 and 3,000 metres, and requires no additional controls, NOR MORE EFFORT, SKILL OR PATIENCE IN TUNING, THAN IS REQUIRED FOR THE OPERATION OF THE USUAL ORTHODOX SINGLE-STAGE TUNED-ANODE CIRCUIT.



Circuit diagrams supplied free with every amplifier.

- Type A, 300 to 800 Metres. Price 15/-
 - Type B, 800 to 3,000 Metres. Price 17/6
- Postage 6d.

BUILD YOUR OWN DUODYNE

—the genuine long-distance Receiver. Circuit diagrams, layout and SIMPLIFIED WIRING CHART and detailed instructions for operation in sealed envelope. **1'6**

GUARANTEED TO CUT OUT YOUR LOCAL STATION

Used in conjunction with an efficient High-Frequency Receiver, the

Curtis Ejector

enables any British Broadcasting Station to be tuned in at will while operating 1 1/2 miles from local principal station or even nearer from relay station.

Price 35/-

Practically eliminates Morse and Mush, and assures pleasing reproduction.



Sales Organisation :

PETER CURTIS, LTD.

IN CONJUNCTION WITH

THE PARAGON RUBBER MFG. CO., LTD. HULL
75, CAMDEN ROAD, N.W.1.

Telegrams : "PARACURTEX"—Phone : NORTH 3112.
BIRMINGHAM : 76, Newhall Street. Central 7236.
MANCHESTER : 312, Deansgate. Central 5095.



After 25 years'

close acquaintance with the needs of engineers we are naturally familiar with every phase of prevailing conditions.

In keeping pace with the latest advancements we have forged a link of confidence between the Home Constructor and ourselves.

To those who appreciate the dependable values offered by a house with a reputation to maintain we say "SPECIFY 'ORMOND' PRODUCTS —ALWAYS."

We specialise in turning Brass and Steel Screws and Machined Parts and Accessories of all descriptions.

All Cheques and Postal Orders should be crossed and made payable to the "ORMOND ENGINEERING CO."

Write for our New (1925) Catalogue.

TRADE TERMS ON REQUEST.

ORMOND
ENGINEERING CO.,
199-205, Pentonville Road,
King's Cross, London, N.1

Telegrams: "ORMONDENGI, KINCROSS."
Telephone: CLERKENWELL 9344 (3 lines).

FACTORY:
WHISKIN STREET, CLERKENWELL.

Look for the name "ORMOND" on our Products!

Neutrodyne Micro-Condenser



Registered Design
Applied for.

A useful adjustable condenser of small capacity and dimensions, soundly constructed, essentially designed for providing feed back and oscillation neutralising potentials.

One hole fixing.

Fitted with Terminals and Soldering Tags.

Price 2/- each.

Short Wave Air-Dielectric Fixed Condensers

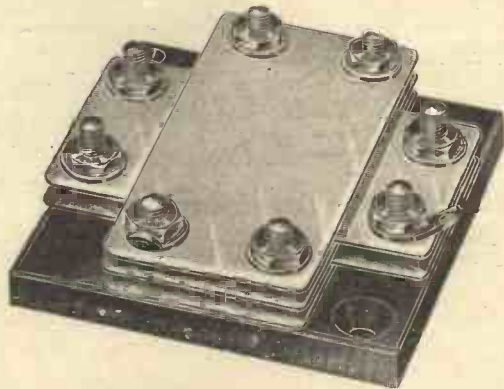

For sharp tuning and to shorten the wavelength, thus facilitating self-oscillation by the reduction of capacity in the aerial circuit, a small fixed capacity series condenser having an air dielectric must be used.

Nominal Capacities: .000025, .000035, .00005

Price 1/6 each.

ALSO MADE IN LARGER CAPACITIES
FOR CONSTANT AERIAL TUNING.

25 Years' British Manufacturing Experience.

which independent investigations appear to point to as the optimum gauge for these frequencies—even if not sharply distinguished—evidently suffices amply for the purpose.

oscillation in the tuning inductance, and so to build up an appreciable signal voltage on the grid. The more nearly "wattless" this current can be, *i.e.*, the less the damping, the higher the available signal

higher signal voltage on the grid of its detector valve with the comparatively small energy pick-up from the magnetic component of the received wave than the big outside aerial can from the far larger supply of signal energy available for it in the electrostatic component of the wave tapped by its greater span.

On account of the shocks and ill-tuned mush from innumerable sources to which the flat tuning and large dimensions of the P.M.G. aerial render it subject, a circuit coupled to it (unless extremely loosely coupled, as in a selective tuner or some H.F. couplings) cannot be brought to nearly the same delicately sensitive condition, so that the signal strength suffers on these very distant stations.

The writer strongly recommends experiments along these lines (of low-loss frame aerials with delicate reaction) for the serious experimenter and the D.X. telephony enthusiast alike.

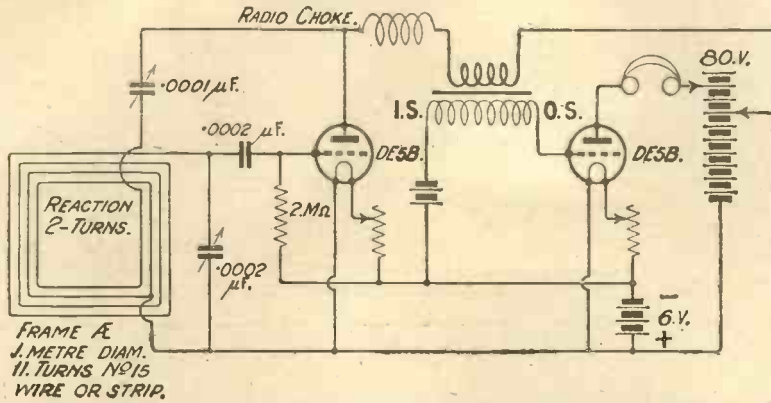

Fig. 10.—The practical circuit used by the author.

Conclusions

The rather remarkable results obtained with two valves, and with careful tuning, would seem to suggest that we are operating here under a set of conditions which have no close parallel in ordinary reception on an outside aerial. Actually the reception of the farthest stations, such as Rome, was markedly better than the writer has been able to achieve on a really good high outside P.M.G. aerial in the same location, with an unusually selective and efficient three valve receiver. It was louder, clearer, more free from incipient reaction distortion when properly adjusted, and wholly free from that distressing background of jamming, "atmospherics" and mush which makes distant reception in general an ordeal rather than a pleasure. A completely silent background is indeed rare in 1,000 mile telephony reception. Yet the Rome transmission came in for an hour or more as clearly and distinctly as many would be glad to receive the local station in the suburbs. The point of this technique appears to be that with the elimination of most of the interference and shock excitation on the one hand, and the elimination of the heavy damping of the outside aerial, fine wire inductances, and of the clumsy reaction which these involve in order to obtain reception of any efficiency at all, one is enabled to get so very much closer to the ideal condition in which all damping is removed by fine reaction (except that minimum required to maintain the speech forms, etc., intact), so that an almost indefinitely small amount of signal energy received from the far distant station suffices to maintain a (modulated) high-frequency

voltage. Hence our delicately poised low-loss frame aerial circuit is actually able to build up, according to these observations, a

Time, p.m.	Nature of signals.	Wave-length observed.	A.T.C. reading (.0002 μ F).	Probable origin.	Nominal wave-length.	
7.25	Woman singing	510	167	? Zurich ..	515	
	Music	500	160	Berlin ..	505	
	Music	475	140	? Munich ..	485	
	Music	468	135	Frankfurt ..	470	
	Faint wave	460	130	? Koenigsberg	463	
	German speech, man ..	445	118	Stuttgart ..	443	
	Faint wave	430	108	? Berlin	430	
				(altern.)		
	Woman's speech	425	105	Rome ..	425	
	Organ music	415	96	Breslau ..	418	
	German speech	405	93	Munster ..	410	
	Woman singer	360	55	Seville ..	350	
	Feeble speech	350	50	..	—	
	German speech	345	45	Nuremberg ..	340	
7.45	Music: heterodyne	330	35	Bremen ..	330	
				(? Radio		
	Music	320	30	Española ..	335'	
	Music, very distinct ..	300	18	Barcelona ..	325	
	German speech, loud ..	290	12	Hanover ..	296	
				2 new German stations just here ..	—	
	Loud wave	below 290	10	..	—	
	Loud wave	about 280	2	..	—	
	7.50	End of light overture.				
		Loud speech in Italian, woman	425	105	Rome ..	425
7.55	Changed to other aerial.					
	Speech as good; words in song distinct	425	110	Rome ..	425	
8.03	Excellent; just audible					
8.10	on L.S.	425	110	Rome ..	425	
8.10	280 to 520 m.: 31 waves counted. Changed to strip aerial			B.B.C. and Continental, and Relays.		
9.40	Rome on L.S., audible					
9.55	across quiet room.					

Regular Programmes from Continental Broadcasting Stations

Telephony except when otherwise stated. Corrected up to February 16th, 1925.

Edited by CAPTAIN L. F. PLUGGE, B.Sc., F.R.Ae.S., F.R.Met.S. Strictly Copyright.

Ref. No.	G. M. T.	Name of Station.	Call Sign and Wave-length.	Situation.	Nature of Transmission.	Closing Time or Approx. Duration.	Approx. Power used.
WEEK DAYS.							
	a.m.						
1	6.25	Hamburg	— 395 m.	Germany	Time Signal in C.E.T. and Exch.	5 mins.	1.5 Kw.
2	6.40	Eiffel Tower	FL 2600 m.	Paris	Weather Forecast	5 mins.	5 Kw.
4	7.05	Lausanne	HBz 850 m.	Switzerland	Weather Report	5 mins.	300 Watts.
5	7.55	Persbureau Vaz Dias	PCFF 2125 m.	Amsterdam	Stocks, Shares and News	10 mins.	2 Kw.
211	8.00	Radio-Wien	— 530 m.	Austria	Market prices	10 mins.	1 Kw.
8	9.23	Eiffel Tower	FL 2600 m.	Paris	Time Signal in G.M.T. (Spark)	3 mins.	60 Kw.
9	9.55	Persbureau Vaz Dias	PCFF 2125 m.	Amsterdam	Stocks, Shares and News	10 mins.	2 Kw.
10	10.00	Eiffel Tower	FL 2600 m.	Paris	Time Signal in Greenwich Sidereal Time (Spark)	5 mins.	60 Kw.
156	10.00	Radio Wien	— 530 m.	Austria	Concert	11.50 a.m.	1 Kw.
180	10.15	Breslau	— 418 m.	Silesia	Weather Report—Exchange	10 mins.	1.5 Kw.
11	10.30	Lyons	YN 50 m.	Lyons	Gramophone Concert	30 mins.	300 Watts.
12	10.30	Kbel	— 1160 m.	Prague	Exchange quotations	10 mins.	1 Kw.
13	10.44	Eiffel Tower	FL 2600 m.	Paris	Time Signal in G.M.T. (Spark)	3 mins.	60 Kw.
14	10.55	Eiffel Tower	FL 2600 m.	Paris	Fish Market Quotations—Cotton Exchange.	10 mins.	5 Kw.
15	10.55	Frankfurt	— 470 m.	Frankfurt	Time Signals in C.E.T. (spoken) followed by News	5 mins.	1 Kw.
182	11.00	Leipzig	— 454 m.	Germany	Concert	11.50 a.m.	700 Watts.
184	11.00	Zurich	— 515 m.	Switzerland	Weather Report	5 mins.	500 Watts.
17	11.10	Persbureau Vaz Dias	PCFF 2125 m.	Amsterdam	Stocks and Shares	20 mins.	2 Kw.
18	11.14	Eiffel Tower	FL 2600 m.	Paris	Time Signal in Greenwich Time (Spoken), followed by Weather Forecast.	5 mins.	5 Kw.
20	11.15	Voxhaus	— 430 m.	Berlin	Exchange Opening Prices	5 mins.	700 Watts.
30	11.30	Stockholm	— 430 m.	Sweden	Weather Forecast, followed by Exchange and Time Signal from Nauen.	None	750 Watts.
23	11.57	Nauen	POZ 3100 m.	Berlin	Time Signal in G.M.T. (Spark) This signal is relayed by Zurich and all German Stations except Frankfurt, Munich and Stuttgart.	8 mins.	—
157	noon	Zurich	— 515 m.	Switzerland	Weather Forecast, Shares, News	5 mins.	500 Watts.
24	12.00	Persbureau Vaz Dias	PCFF 2125 m.	Amsterdam	Stocks and Shares	8 mins.	2 Kw.
	p.m.						
26	12.15	Geneva	HBI 1100 m.	Switzerland	Lecture	12.45 p.m.	300 Watts.
25	12.30	Kbel	— 1160 m.	Prague	Exchange Quotations	10 mins.	1 Kw.
27	12.30	Lausanne	HBz 850 m.	Switzerland	Weather Reports, Time Signal in C.E.T. and News.	15 mins.	300 Watts.
32	12.30	Radio-Paris	SFR 1780 m.	Clichy	Concert followed by News	2 p.m.	8 Kw.
31	12.45	Persbureau Vaz Dias	PCFF 2125 m.	Amsterdam	Stocks and Shares	10 mins.	2 Kw.
33	1.00	Haeren	BAV 1100 m.	Brussels	Weather Forecast in French and English.	8 mins.	150 Watts.
34	1.00	Munich	— 485 m.	Bavaria	News and Weather Report	10 mins.	1 Kw.
37	1.15	Voxhaus	— 430 m.	Berlin	Stock Exchange News	5 mins.	700 Watts.
35	1.15	Komarow	— 1800 m.	Czecho-Slovakia.	Stock Exchange and Late News	10 mins.	1 Kw.
181	2.00	Breslau	— 418 m.	Silesia	News and Exchange Quotations	10 mins.	1.5 Kw.
40	2.30	Munster	— 410 m.	Westphalia	Stocks, Shares and News	10 mins.	1.5 Kw.
38	2.40	Persbureau Vaz Dias	PCFF 2125 m.	Amsterdam	Stocks, Shares and News	10 mins.	2 Kw.

MAXIMUM EFFICIENCY

must begin with design and be sustained through all the processes of manufacture if maximum efficiency has to be uniformly guaranteed.

The old-fashioned Fixed Condenser, with its plates and mica dielectric held together in a tin sheath and set in a mould of doubtful insulating properties filled with wax, was at best a temporary expedient which answered the abnormal demand inherent in a new and rapidly increasing industry.

The design and methods of manufacture of the **PARAGON-CURTIS ONE PIECE MICA CONDENSER** can alone guarantee uniform accuracy under all conditions and at all temperatures.

PARAGON-CURTIS ONE PIECE MICA CONDENSER.



ESSENTIAL FOR PERFECT RECEPTION
and
ABSOLUTELY INDISPENSABLE
for tropical and extreme climates.

Test Report by A. D. COWPER, M.Sc., Staff Editor "Modern Wireless."

ACCURACY.

"On test, the capacities came out quite close enough to the nominal for ordinary radio purposes, the .001 μ F nominal samples being about .00103 and .00091 respectively, and the .0003 μ F nominal being actually around .00033 and .00026 respectively. There was observed but a negligible greater high-frequency loss in this type than in a standard air-dielectric condenser.

PERMANENCY.

"As this one piece casting offers apparently considerable advantages as to permanency and independence of damp, high temperature, etc., an exceedingly strenuous test was applied to one of the samples, which was actually placed in water nearly at the boiling point for the better part of an hour. After this heroic treatment, the condenser showed a capacity which did not differ materially from that shown before, and it was still possible to get a valve to oscillate readily with this as the main tuning capacity across the grid-tuning-inductance. Evidently there need be no fears as to possible deterioration in stock of these 'Paragon-Curtis' fixed condensers."

- .0008 to .0006 2/6 each.
- Grid condenser with clips 2/9 each.
- Grid Leak 1/6 each.

Sales Organisation :

PETER CURTIS, LTD.
IN CONJUNCTION WITH
The Paragon Rubber Mfg. Co., Ltd., Hull
75, CAMDEN ROAD, N.W.1.
Telegrams: "PARACURTEX." Telephone: NORTH 3112.

CURTIS MICROHM VARIABLE MICA CONDENSER

ELIMINATES THE MANY DEFECTS IN THE EXISTING TYPE OF CONDENSER

The Curtis-Microhm Variable Mica Condenser—a precision instrument of very high efficiency—is scientifically designed to eliminate the disadvantages of the open vane type.

This Condenser, which, in every sense of the word, is in advance of accepted Condenser design, gives a Square Law Reading. In operation there is no backlash, since its precision gives "dead beat" action.

Many other obvious advantages may be enumerated. No moving connections; thus precluding any possibility of noise caused by faulty contact or mechanical weaknesses. Very low minimum; to be exact the capacity ratio in the Curtis-Microhm is 500-1—an advantage at once apparent. No interaction from adjacent components. Absolutely dust-proof, single hole fixing and most compact in design.

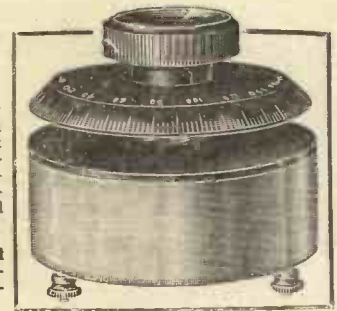

Essential for the perfect reception in all circuits; indispensable for Super Heterodynes.

For full particulars see Press Notices.

.001 Mfd.; .0005 Mfd.; .00025 Mfd.

Price 13/6

Distinctive

By no means the least important feature is the uniform ebony black, fine grain, dead matt surface so distinctive of and exclusive to

PARAGON Radio Quality Post Office Specification. "The Best Made." EBONITE PANELS

Sold everywhere in Sealed Cartons only stamped Paragon.

All "Modern Wireless" and Radio Press Panels supplied from Stock at 1d. per sq. in. Prices for drilling and engraving upon request.

STANDARD SIZES.			
8 x 6 x 3/16	2/6	24 x 10 x 1	14/6
8 x 6 x 1/2	3/3	24 x 12 x 1	17/6
10 1/2 x 8 1/2 x 1/2	5/3	8 x 5 1/2 x 1	2/9
12 x 10 x 1	7/3	10 1/2 x 7 x 1	4/7
12 x 12 x 1	8/6	22 x 6 x 1	4/6
14 x 12 x 1	10/-	22 x 11 x 1	15/3
16 x 12 x 1	11/6	16 x 9 x 1	9/-
18 x 12 x 1	13/-	12 x 11 x 1	8/3
18 x 6 x 1	6/9	12 x 8 x 1	6/-
10 x 8 x 1	6/9	7 x 5 x 1	2/3
10 x 9 x 1	5/8	10 x 5 1/2 x 1	3/5
10 x 5 x 1	3/3	10 x 5 x 1	3/3
12 1/2 x 9 1/2 x 1	7/6		

As used by British Government Departments, and specified by the leading Technical Journals.

PARAGON POLISHED MAHOGANY EBONITE THE NATURAL COLOUR OF NATURAL MAHOGANY

PANELS CUT TO SIZE, Squared, edges ground, 1d. per square inch. Valve and Coil Holders, Condenser Dials and Knobs in Polished Mahogany Finish to match.

This remarkable reception of the U.S. station at Springfield (Mass.) in Coventry is further proof of



super-efficiency.

Although "conditions were not good" He heard "perfectly at loud speaker strength"

on his A.J.S. 4-VALVE RECEIVER

Mr. S. Edward Bacon, Steward of the Coventry and County Club, received word by cable that his brother, a vocalist, would broadcast from the American station W.B.Z. (Springfield, Mass.), on Dec. 29th. Mr. Bacon, using a 4-valve A.J.S. Receiver, promptly got in touch from Coventry, and "heard both songs perfectly at loud-speaker strength."

The A.J.S. "UNITOP" CABINET RECEIVER

forms top section of "Unit System" Cabinet and contains A.J.S. 4-valve Receiver. Complete in itself, it may be converted into a beautiful pedestal cabinet by subsequent purchase of first a centre section to contain both batteries and then base section containing special A.J.S. Loud Speaker. Used alone, the "Unitop" is a compact and attractive piece of furniture and a highly efficient Receiver, easily portable for outdoor functions. In Mahogany, or Light, Dark, or Wax-polished Oak. Complete with all accessories, ready for use, 30 guineas (without accessories, £24/10/0).

A.J.S. LOUD SPEAKERS.

Accurately proportioned non-resonant horn, giving correct acoustic properties. True reproduction and extreme sensitivity without distortion. With metal horn and plated fittings, £4, 15, 0. With Oak or Mahogany horn and plated fittings, £5, 10, 0.

Ask the nearest Dealer to show you these and other A.J.S. Instruments, including the 2, 3, and 4-valve "Desk type" Receivers, the Unit System 4-valve Cabinet, and the A.J.S. 4-valve Pedestal Cabinet. Illustrated List Free on request.

RADIO SECRET REVEALED.
 Story of an Impromptu Concert From U.S. VOCALIST'S DESIRE. To Sing to Brother at Coventry.
 From a Gazette Correspondent.
 Coventry, Thursday.
 To hear his brother's voice coming to him in song across the wide space of the Atlantic has been the unique experience of Mr. S. Edward Bacon, steward of the Coventry and County Club, Coventry.
 His name—who were successful in getting into touch on Monday night with the American wireless station W.B.Z., at Springfield (Mass.), were interested to hear the announcement that a short concert would be given for the benefit of one of the artist's relatives who lives in Coventry, England.
THE EXPLANATION.
 The explanation is that one of the singers was Mr. Henry G. Bacon, a student of the Massachusetts Institute of Technology, and in his desire that his brother should hear him sing, he had cabled to him at Coventry the time the concert would begin.
 Mr. Henry Bacon sang two songs, "John Peel" and "Love, I am lonely," both of which Mr. Edward Bacon heard perfectly.

THURSDAY, JANU
VOICE ACROSS THE SEA.
Coventry Man in America SINGS TO RELATIVES.
 The statement by a correspondent in yesterday's issue of the "Midland Daily Telegraph" that he heard a concert broadcast from the American station W.B.Z. "for the benefit of one of their artist's relatives in Coventry, England," was read with interest, especially Mr. S. Edward Bacon, steward of the Coventry and County Club, who was also referred to. His article was written as follows:
 "I noticed in last evening's 'Telegraph,' in the Coventry column, a notice from a correspondent to a concert he had taken part in at Cambridge, Massachusetts, on Dec. 29, 'one of the artist's relatives in Coventry, England.' My brother, Mr. S. Edward Bacon, steward of the Coventry and County Club, Coventry, U.S.A., was the artist referred to. Both of which I heard perfectly through my four-valve 'A.J.S.' receiver. The correspondent says he was on the 'John Peel' and then 'Love, I am lonely.' I was present after the two songs I received three or four others 'Blue-eyed Susan' and 'The Combined Boston' and 'The U.S.A.' from the station let me hear 'John Peel' and 'Love, I am lonely.' He then went down for one more song."



Illustrated Catalogue sent free on request.

A. J. STEVENS & CO. (1914), Ltd., WIRELESS BRANCH, WOLVERHAMPTON. Telephone - 1550; Wireless Call Sign: 5 R.1. Telegrams - - - "Reception, Wolverhampton."

...down for a minute, and that they were afterwards switched through to a hockey match which was to be played at eight o'clock between the Hamilton players and a team selected from the Canadian National Hockey League.
 "I picked up the pen, too, and heard the... afterwards that Mr. ...

Ref. No.	G. M. T.	Name of Station.	Call Sign and Wave-length.	Situation.	Nature of Transmission.	Closing Time or Approx. Duration.	Approx. Power used.
WEEK DAYS (Contd.).							
39	p.m. 2.45	Eiffel Tower	FL 2600 m. . .	Paris . .	Exchange Opening Prices (Sat. excepted).	3 mins.	5 Kw.
158	3.00	Zurich . .	— 515 m. . .	Switzerland	Hotel Baur au Lac Concert, Re-layed.	5 p.m.	500 Watts.
202	3.00	Munster . .	— 410 m. . .	Westphalia	Concert	4 p.m.	1.5 Kw.
159	3.00	Radio-Wien . .	— 530 m. . .	Vienna . .	News followed by Concert . .	5 p.m.	1 Kw.
42	3.30	Frankfurt . .	— 470 m. . .	Germany . .	Light Orchestra	5 p.m.	1 Kw.
43	3.30	Königsberg . .	— 463 m. . .	East Prussia	Light Orchestra (Wed. and Sat. Children's Hour).	5-6 p.m.	1 Kw.
44	3.30	Voxhaus . .	505 & 430 m. . .	Berlin . .	Concert, followed by News . .	5 p.m.	700 Watts.
46	3.30	Leipzig . .	— 454 m. . .	Germany . .	Concert	5 p.m.	700 Watts.
47	3.35	Eiffel Tower	FL 2600 m. . .	Paris . .	Exchange Quotations (Sat. ex-cepted).	5 mins.	5 Kw.
48	3.55	Persbureau Vaz Dias.	PCFF 2125 m. . .	Amsterdam	Stock Exchange and News . .	10 mins.	2 Kw.
49	4.00	Kbel	— 1160 m. . .	Prague . .	Concert	5 p.m.	1 Kw.
160	4.00	Breslau . .	— 418 m. . .	Silesia . .	Light Orchestra	5 p.m.	1.5 Kw.
51	4.30	Radio-Paris . .	SFR 1780 m. . .	Clichy . .	Concert preceded and followed by News.	5.45 p.m.	8 Kw.
52	4.30	Eiffel Tower	FL 2600 m. . .	Paris . .	Exchange Closing Prices (ex-cept Saturday).	8 mins.	5 Kw.
54	5.00	Radio-Belg. . .	SBR 265 m. . .	Brussels . .	Concert followed by News . .	6 p.m.	2.5 Kw.
186	5.00	Frankfurt . .	— 470 m. . .	Germany . .	Lectures	6.30 p.m.	1 Kw.
187	5.00	Hamburg . .	— 395 m. . .	Germany . .	Music or Lecture	6.00 p.m.	1.5 Kw.
161	5.30	Munich . . .	— 485 m. . .	Bavaria . .	Light Orchestra or Lecture . .	6.30 p.m.	1 Kw.
162	6.00	Eiffel Tower	FL 2600 m. . .	Paris . .	Concert followed by News Bulletin	6.55 p.m.	5 Kw.
177	6.00	Radio-Barcelona	EAJI 325 m. . .	Barcelona	Concert	7.00 p.m.	650 Watts.
63	6.30	Stuttgart . .	— 443 m. . .	Wurtemberg	Concert and News	10 p.m.	1 Kw.
57	6.30	Kbel	— 1160 m. . .	Prague . .	Concert and News	8 p.m.	1 Kw.
58	7.00	Eiffel Tower	FL 2600 m. . .	Paris . .	General Weather Forecast . .	8 mins.	5 Kw.
60	7.00	Radio-Wien . .	— 530 m. . .	Vienna . .	Evening Programme	9 p.m.	1 Kw.
188	7.00	Frankfurt . .	— 470 m. . .	Germany . .	Lecture	7.30 p.m.	1 Kw.
61	7.00	Konigsberg . .	— 463 m. . .	East Prussia	Concert and News	9 p.m.	1.5 Kw.
62	7.00	Hamburg . .	— 395 m. . .	Germany . .	Concert and Late News	9 p.m.	1.5 Kw.
66	7.15	Lausanne . .	HB2 850 m. . .	Switzerland	Concert (Monday excepted) . .	9.30 p.m.	300 Watts.
64	7.15	Zurich . . .	— 515 m. . .	Switzerland	Concert followed by Late News	9 p.m.	500 Watts.
65	7.15	Leipzig . . .	— 454 m. . .	Germany . .	Concert and News (2 days a week till 10.30 p.m.)	9 p.m.	700 Watts.
67	7.30	Frankfurt . .	— 470 m. . .	Germany . .	Concert and News	10 p.m.	1 Kw.
59	7.30	Munster . .	— 410 m. . .	Westphalia	Concert followed by News . .	9.45 p.m.	1.5 Kw.
72	7.30	Voxhaus . . .	— 430 & 505 m. . .	Berlin . .	Concert followed by News and Weather Report.	9.30 p.m.	0.7 and 1.5 Kw.
73	7.30	Munich . . .	— 485 m. . .	Bavaria . .	Concert and News	10.0 p.m.	1 Kw.
69	7.30	Breslau . . .	— 418 m. . .	Silesia . .	Concert	9 p.m.	1.5 Kw.
164	7.30	Radiofonica Italiana.	— 425 m. . .	Rome . . .	Concert followed by News (Interval between 8.20 and 8.30).	9.30 p.m.	4 Kw.
74	8.15	Radio-Belg. . .	SBR 265 m. . .	Brussels . .	Concert preceded and followed by News.	10.10 p.m.	2.5 Kw.
75	8.30	Ecole. Sup. des P.& Tg.	FPTT 450 m. . .	Paris . . .	Concert, sometimes preceded by Lecture, usually outside broadcast.	9 p.m.	500 Watts.
76	8.30	Radio-Paris . .	SFR 1780 m. . .	Clichy . . .	Detailed News Bulletin	9 p.m.	8 Kw.
77	9.00	Radio-Paris . .	SFR 1780 m. . .	Clichy . . .	Time Signal followed by Concert	9.50 p.m.	8 Kw.
78	9.00	Radio-Iberica . .	RI 392 m. . .	Madrid . .	Concert, Advertisements . . .	Midnight	3 Kw.
189	9.00	Radio-Barcelona	EAJI 325 m. . .	Barcelona . .	Concert	11 p.m.	650 Watts.
190	9.00	Munster . . .	— 410 m. . .	Westphalia	Lecture on Languages	9.45 p.m.	1.5 Kw.
79	10.00	Eiffel Tower	FL 2600 m. . .	Paris . . .	Time Signal in Greenwich Sidereal Time (Spark).	5 mins.	60 Kw.
80	10.10	Eiffel Tower	FL 2600 m. . .	Paris . . .	General Weather Forecast . . .	5 mins.	5 Kw.
81	10.44	Eiffel Tower	FL 2600 m. . .	Paris . . .	Time Signal in G.M.T. (Spark)	3 mins.	60 Kw.
82	11.57	Nauen	POZ 3100 m. . .	Berlin . . .	Time Signal in G.M.T. (Spark)	8 mins.	—

See "Wireless Weekly" March 4th
For Detailed Programmes.

Ref. No.	G. M. T.	Name of Station.	Call Sign and Wave-length.	Situation.	Nature of Transmission.	Closing Time or Approx. Duration.	Approx. Power used.
SUNDAYS.							
	a.m.						
83	7.30	Frankfurt	— 470 m.	Germany	Morning Prayer	1 hour	1 Kw.
85	8.00	Leipzig	— 454 m.	Germany	Morning Prayer	1 hour	700 Watts.
165	8.00	Konigsberg	— 463 m.	E. Prussia	Morning Prayer	8.45 a.m.	1.5 Kw.
212	8.00	Voxhaus	— 430 m.	Berlin	Morning Prayer	9 a.m.	700 Watts.
86	9.00	Komarow	— 1800 m.	Czecho-Slovakia.	Sacred Concert	1 hour	1 Kw.
87	9.23	Eiffel Tower	FL 2600 m.	Paris	Time Signal in Greenwich Mean Time (Spark).	3 mins.	60 Kw.
213	9.40	Bloemendaal	— 200 m.	Holland	Divine Service	1 hour	—
89	10.00	Eiffel Tower	FL 2600 m.	Paris	Time Signal in Greenwich Sidereal Time (Spark).	5 mins.	60 Kw.
90	10.00	Kbel	— 1160 m.	Prague	Classical Music	1 hour	1 Kw.
92	10.00	Radio-Wien	— 530 m.	Vienna	Concert	11.50 a.m.	1 Kw.
191	10.15	Hamburg	— 395 m.	Germany	Concert	11.15 a.m.	1.5 Kw.
93	10.30	Lyons	YN 550 m.	Lyons	Gramophone Records	11 a.m.	300 Watts.
94	10.30	Stuttgart	— 443 m.	Wurtemberg	Classical Concert	1 hour	1 Kw.
192	10.30	Munich	— 485 m.	Bavaria	Sacred Concert	11.30 a.m.	1 Kw.
95	10.44	Eiffel Tower	FL 2600 m.	Paris	Time Signal in G.M.T. (Spark)	3 mins.	60 Kw.
96	10.30	Konigswusterhausen.	LP 2800 m.	Berlin	Concert	11.50 a.m.	6 Kw.
91	10.30	Breslar	— 418 m.	Silesia	Concert followed by Time Signal	11.50 a.m.	1.5 Kw.
97	10.55	Eiffel Tower	FL 2600 m.	Paris	Fish Market Quotations, followed by Weather Report.	12 mins.	5 Kw.
214	11.00	Munster	— 410 m.	Westphalia	Morning Prayer	1 hour	1.5 Kw.
98	11.00	Stockholm	— 440 m.	Sweden	Divine Service	12.15 p.m.	500 Watts.
101	11.57 p.m.	Nauen	POZ 3100 m.	Berlin	Time Signal in G.M.T. (Spark)	3 mins.	—
102	12.45	Radio-Paris	SFR 1780 m.	Clichy	Concert, followed by News	2.00 p.m.	8 Kw.
108	2.00	Munich	— 485 m.	Bavaria	Concert	4.00 p.m.	1 Kw.
215	3.00	Munster	— 410 m.	Westphalia	Concert	3.30 p.m.	1.5 Kw.
104	3.00	Breslau	— 418 m.	Silesia	Children's Stories	3.45 p.m.	1.5 Kw.
105	3.00	Stuttgart	— 443 m.	Wurtemberg	Light Orchestra	5.00 p.m.	1 Kw.
107	3.00	Frankfurt	— 470 m.	Germany	Children's Corner	4.00 p.m.	1 Kw.
167	3.00	Zurich	— 515 m.	Switzerland	Local Hotel Concert	5.00 p.m.	500 Watts.
216	3.00	Lyngby	— 2400 m.	Denmark	Light Music and Lecture	4.00 p.m.	500 Watts.
106	3.00	Radio-Wien	— 530 m.	Vienna	Afternoon Concert, preceded by News	5.00 p.m.	1 Kw.
168	3.30	Konigsberg	— 463 m.	E. Prussia	Light Orchestra	5.00 p.m.	1.5 Kw.
169	3.30	Voxhaus	430 & 505 m.	Berlin	Light Orchestra	5.00 p.m.	1 Kw.
170	3.30	Leipzig	— 454 m.	Germany	Light Orchestra	5.00 p.m.	700 Watts.
171	4.00	Frankfurt	— 470 m.	Germany	Light Orchestra	5.00 p.m.	1 Kw.
217	4.40	Bloemendaal	— 200 m.	Holland	Divine Service	5.40 p.m.	—
110	4.45	Radio-Paris	SFR 1780 m.	Clichy	Concert, followed by News	1 hour	8 Kw.
111	5.00	Radio-Belg.	SBR 265 m.	Brussels	Concert	1 hour	2.5 Kw.
204	5.00	Kbel	— 1160 m.	Prague	Concert by Radio Trio	7.00 p.m.	1 Kw.
173	5.00	Frankfurt	— 470 m.	Germany	Lecture, followed by Evening Programme	10.00 p.m.	1 Kw.
218	5.15	Zurich	— 515 m.	Switzerland	Club Concert	6.15 p.m.	500 Watts.
180	5.30	Barcelona	EAJ 1 325 m.	Spain	Concert	8.50 p.m.	650 Watts.
112	6.00	Eiffel Tower	FL 2600 m.	Paris	Concert, followed by News	1 hour	5 Kw.
219	6.00	Malmö	SASC 270 m.	Sweden	Concert	8 p.m.	500 Watts.
116	7.00	Munster	— 410 m.	Westphalia	Classical Concert	9.00 p.m.	1.5 Kw.
176	7.00	Copenhagen	— 750 m.	Denmark	Concert, followed by News	9.30 p.m.	2 Kw.
114	7.00	Radio-Wien	— 530 m.	Vienna	Concert	9.00 p.m.	1 Kw.
118	7.00	Konigsberg	— 463 m.	E. Prussia	Concert	9.00 p.m.	1.5 Kw.
119	7.00	Hamburg	— 395 m.	Germany	Concert, followed by News	9.00 p.m.	1.5 Kw.
120	7.00	Eiffel Tower	FL 2600 m.	Paris	General Weather Forecast	8 mins.	5 Kw.
125	7.00	Stuttgart	— 443 m.	Wurtemberg	Concert and Dance Music from 9 p.m.	11.00 p.m.	1 Kw.
124	7.00	Breslau	— 418 m.	Silesia	Light Orchestra	9.00 p.m.	1.5 Kw.
121	7.15	Lausanne	HJ2 850 m.	Switzerland	Concert	8.30 p.m.	300 Watts.
122	7.15	Zurich	— 515 m.	Switzerland	Concert	9.00 p.m.	500 Watts.
123	7.15	Leipzig	— 454 m.	Germany	Symphony Concert	8.40 p.m.	700 Watts.
220	7.30	Voxhaus	— 505 & 430 m.	Berlin	Evening Programme	11 p.m.	700 Watts. & 1.5 Kw.
174	7.30	Munich	— 485 m.	Bavaria	Concert	10.0 p.m.	1 Kw.
175	7.35	Radiofonica Italiana.	— 425 m.	Rome	Concert, followed by Late News	9.30 p.m.	4 Kw.
126	7.40	Ned. Seintoesl Fabriek.	NSF 1060 m.	Hilversum	Concert	10.10 p.m.	3 Kw.
127	8.15	Radio-Belg.	SBR 265 m.	Brussels	Concert, followed by News	10.10 p.m.	2.5 Kw.

The Power of Success



In the face of intense criticism, the performance of the Super Success L.F. Transformer is denominated super-excellent. Scientific data then count for little against the evidence of your own ears. The human voice with its countless inflexions, the whole gamut of music with an attendant wealth of harmonic and overtone, are reproduced rich in their faithfulness to the accomplished artiste's perfected art.

Nothing, if not the most precise and scientific manufacturing experience, explains the unusual performance of the Super Success. This same intense criticism and almost overweening desire to attain what has hitherto been considered beyond electrical manufacturing skill was unstintingly expended upon the Super Success before a single model reached our Sales Department. The production of a low frequency transformer which gives a remarkable build up of signal strength combined with a conspicuous richness and pleasing quality of tone deserves but one reward. This, a reward which comes to every Set Builder who builds with the Super Success—reception which is enviable indeed.

Ask also for the
**SUCCESS VERNIER
COIL-HOLDER.**

For panel mounting . . . 5/6
For behind panel mounting . . . 8/6
SUCCESS Neutrodyne Condenser 3/6

**THE SUPER SUCCESS (All
Black) L.F. Transformer**

21/-

**THE SILVER SUCCESS L.F.
Transformer. For second
stage.**

17/6

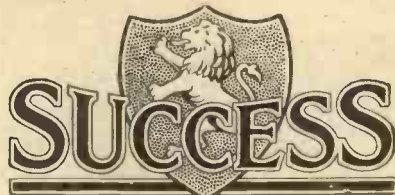

COMPONENTS

OBTAINABLE FROM ALL DEALERS.

BEARD & FITCH, Ltd.

34, Aylesbury Street, London, E.C.1.

Telephone: Clerkenwell 8911.

North of England Branch:

1, DEAN STREET, PICCADILLY, MANCHESTER.

Telephone: Central 8240.

Proven—Super-Excellent

In replying to advertisers, use Order Form enclosed.

Make your Set an Instrument!



No. 1 L.F. Transformer.

Wound with 42 gauge wire simultaneously with fine SILK. Even on 200 or 300 volts pressure gives no trace of distortion, and its amplification factor is decidedly above the average of other good - class transformers. Specially recommended for the "reflex" type. **23/6**



No. 1 Variometer.

The spindles of the Rotor are moulded in. In perfectly true alignment. They cannot come loose. The spindle has a metal bearing. All connections internal; two terminals; one-hole fixing. Wave length 250 to 750 metres on 100 ft. aerial **12/6**

Square Law Condenser.

Central Design. Takes up same room in set as plain type. Functions with accuracy to true Square Law curve when operated in either direction. Very low minimum capacity with low loss and low ohmic resistance to H.F. Currents. Single-hole mounting. 22 gauge vanes. .0003, 9/- .0005, 10/6. .001, 12/6. Tandem (double .0003), 16/8



Vernier Rheostat

(Pat. No. 213,030) Combined plunger and rotary movement. Push-pull movement for coarse setting; rotary for vernier. Wonderfully smooth movement; best ebonite former one-hole fixing. 6 ohms, 2/8; 10 or 12 ohms, 3/; 30 ohms 3/6



Valve Holder. (Panel-mounting type.)

Attached through the panel from the back. Constitutes its own template for drilling. Connections are made to four screws tapped into the sockets, soldering tags being provided. Price .. **1/6**

The Pre sland Safety Lead-in.

The Pressland Safety Lead-in has a self-contained discharge-gap, and provides for an external earth-wire, giving straight line from aerial to earth. It is scientifically shaped to form a petticoat insulator, free from surface leakage. Sizes: 6-in., 3/-; 9-in., 3/3; 12-in., 3/6.

Ask your Radio Dealer for Woodhall Guaranteed Components. Complete List on request to Sole Distributors:

Pressland Electric Supplies, Ltd.

Hampton-on-Thames. 'Phone: Molesey 22.

WOODHALL

Guaranteed Components

Panel-Mounting Coil Plug.

A very compact means of introducing a loading coil into existing sets; or for tuned anode, and other purposes. Mounted on panel from the back. Drilling template is provided with each plug. Price .. **1/6**



Mr. J. Scott-Taggart's 3-valve Dual Receiver, described in this issue, embodies the Woodhall No. 1 L.F. Transformer.



Ref. No.	G. M. T.	Name of Station.	Call Sign and Wave-length.	Situation	Nature of Transmission	Closing Time or Approx. Duration.	Approx. Power used
----------	----------	------------------	----------------------------	-----------	------------------------	-----------------------------------	--------------------

SUNDAYS (Contd.).

128	p.m. 8.30	Radio-Paris ..	SFR 1780 m.	Clichy ..	Detailed News Bulletin ..	9.00 p.m.	8 Kw.
129	8.30	Ecole Sup. des P.et Tgs.	FPTT 450 m.	Paris ..	Concert or Lecture. May begin 15 mins. earlier or later.	10.30 to 12 p.m.	500 Watts.
132	9.00	Radio-Iberica	RI 392 m.	Spain ..	Concert ..	midnight	3 Kw.
130	9.00	Radio-Paris ..	SFR 1780 m.	Clichy ..	Concert, followed by Dance Music.	11.00 p.m.	8 Kw.
131	9.30	Petit Parisien	— 345 m.	Paris ..	Concert (Items announced in English as well as French).	11.30 p.m.	300 Watts
133	10.00	Eiffel Tower	FL 2600 m. ..	Paris ..	Time Signal in Greenwich Sidereal Time (Spark).	3 mins.	60 Kw.
134	10.44	Eiffel Tower	FL 2600 m.	Paris ..	Time Signal in G.M.T. (Spark)	3 mins.	60 Kw.
135	11.57	Nauen ..	POZ 3100 m.	Berlin ..	Time Signal in G.M.T. (Spark)	8 mins.	—

SPECIAL DAYS.

194	p.m. 3.00	Stuttgart ..	— 443 m. ..	Wurtemberg	Sat., Children's Corner	5.00 p.m.	1 Kw.
137	4.00	Lausanne ..	HB2 850 m.	Switzerland	Mon., Children's Stories	1 hour	300 Watts.
224	4.00	Munich ..	— 485 m.	Bavaria ..	Children's Hour ..	5 p.m.	1 Kw.
180	5.30	Belgrade ..	HFF 1650 m.	Serbia ..	Tues., Concert ..	1 hour	500 Watts.
					Thurs.,		
					Sat.		
140	5.15	Zurich ..	— 515 m	Switzerland	Mon., Children's Corner	5 50 p.m.	500 Watts
					Wed.,		
					Fri.		
141	5.15	Zurich ..	— 515 m.	Switzerland	Sat., Club Band ..	30 mins.	500 Watts.
142	5.40	Ned. Seintoesl. Fabriek.	NSF 1000 m.	Hilversum	Mon. Children's Hour	6 40 p.m.	3 Kw.
203	6.00	Gotenborg ..	SMZX 460 m.	Sweden ..	Tues., Concert ..	8 p.m.	300 Watts
147	7.00	Stockholm ..	— 440 m.	Sweden ..	Wed., Thurs.,—Concert ..	8 p.m.	—
					Fri. & Sat.		
222	7.00	Ryvang ..	— 1025 m.	Denmark ..	Tues. & Fri.—Concert ..	8 p.m.	—
221	7.00	Copenhagen ..	— 750 m.	Denmark ..	Wed., Concert ..	8 p.m.	2 Kw.
					Thurs.	9.30 p.m.	2 Kw.
148	7.40	Smith and Hooghoudt	PA5 1050 m.	Amsterdam	Sat., Concert ..	10 p.m.	500 Watts.
150	8.40	Ned. Radio In.	PCGG 1070 m.	The Hague	Wed. Concert ..	9.40 p.m.	500 Watts.
					Mon. Concert ..	10.10 p.m.	1.3 Kw.
151	8.40	Amsterdam ..	PX9 1060 m.	Holland ..	Mon. Concert ..	10.40 p.m.	600 Watts.
152	8.40	Ned. Seintoesl. Fabriek	NSF 1060 m.	Hilversum	Fri. Concert ..	9.40 p.m.	3 Kw.
223	9.00	Malmö ..	SASC 270 m.	Sweden ..	Thurs., Sat.—Dance Music ..	11 p.m.	500 Watts
153	9.00	Le Matin ..	SFR 1780 m.	Paris ..	Sat. Special Gala Concert	10.50 p.m.	10 Kw.
197	9.00	Breslau ..	— 418 m.	Silesia ..	Sat. Dance Music ..	10 p.m.	1.5 Kw.
210	9.00	Radio Wien	— 530 m. ..	Vienna ..	Dance Music, Wed., Sat. ..	10 p.m.	1 Kw.
154	9.30	Petit Parisien	— 345 m.	Paris ..	Tues., Concert (Items announced in English as well as French).	11.30 p.m.	400 Watts
					Thur.		
155	10.00	Radio-Paris ..	SFR 1780 m.	Clichy ..	Two Evenings per Week—Dance Music.	10.45 p.m.	8 Kw.

The following are German Relay Stations :—
 Kassel, 288 m., 1 kw. relays Frankfurt.
 Bremen, 330 m., 1 kw. and Hanover, 296 m., 1 kw.; relay Hamburg.
 Nuremberg, 340 m., 1 kw.; relays Munich.

Detailed Programmes of many of the above Stations will be found in "WIRELESS WEEKLY" beginning 4th March. Order Your Copy Now.

DO NOT FORGET THAT SEVERAL CONTINENTAL STATIONS CAN BE HEARD EVEN ON A SINGLE VALVE SET.

Choke and Transformer Amplifiers

By H. J. ROUND, M.C., M.I.E.E.

In this article the well known chief of the research department of the Marconi Company deals with choke and transformer amplifier calculations.

IN a recent article in the *Wireless Weekly* (Vol. 5, Nos. 1 and 2), I indicated a simple graphical method of calculating the resistance amplifier.

In that article, to prevent complicating it, I slurred over the calculation of the choke amplifier. Here I propose to go more accurately into choke amplification and indicate how this bears on the transformer amplifier. If I slur over certain points it is due to limitation of space in this magazine, and my desire to get all the above points into one edition. In my previous articles I showed how by superimposing on a graph of the valve characteristic another graph of the circuit characteristic we could determine the general actions of the circuit as a whole.

Recapitulating a little, Fig. 1 is a graph of a valve.

The co-ordinates are I_A the plate current, and V_A the plate voltage, and each curve represents a different value of V_g , the grid voltage.

I showed that if we put the valve in the circuit of Fig. 2, then I_A the plate current obeys the law:

$$I_A = \frac{V_0 - V_A}{R}$$

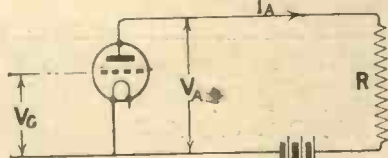

Fig. 2.—An elementary circuit.

and this equation drawn on the top of the valve characteristics (line $\frac{V_0}{R}$ to V_0 in Fig. 1) will enable us to read off the various

results we wish to know, such as magnification and possible sweep without blasting. I stated in that article that a choke differed from a resistance in that it enabled one to get double the voltage sweep without running into grid current or rectification when using the same high-tension voltage. But I drew a line for a choke and actually,

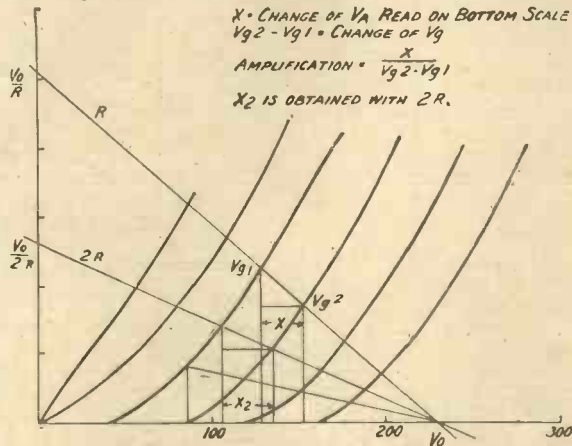

Fig. 1.—The graph of a valve. The ordinate represents I_A and the abscissa V_A the plate voltage.

in that case, it was roughly correct, but the full solution is so interesting that I am now going to give it.

In a resistance R , if we impress a voltage V across it, and V is a sine wave form, we can write:—

$$V = V_1 \sin 2\pi nt \quad (1)$$

and the current by Ohm's law is

$$I = \frac{V_1}{R} \sin 2\pi nt \quad (2)$$

the current is in phase with the voltage (n is the frequency).

In a choke coil L :—

$$\text{if } V = V_1 \sin 2\pi nt \quad (3)$$

the current is:—

$$I = \frac{V_1}{2\pi nL} \sin \left((2\pi nt - \frac{\pi}{2}) \right) \quad (4)$$

it is lagging 90° behind the voltage.

If we plot out 1 and 2 we shall obtain our straight line, but if we plot out 3 and 4 we shall get in nearly all cases an ellipse.

In this table I give the values of V and I at four points, easy to determine.

$$V = V_1 \sin 2\pi nt$$

When:—

$$t = 0 \quad V = 0$$

$$t = \frac{1}{4n} \quad V = V_1$$

$$t = \frac{2}{4n} \quad V = 0$$

$$t = \frac{3}{4n} \quad V = -V_1$$

$$I = \frac{V_1}{2\pi nL} \left(2\pi nt - \frac{\pi}{2} \right)$$

And when:—

$$t = 0 \quad I = -\frac{V_1}{2\pi nL}$$

$$t = \frac{1}{4n} \quad I = 0$$

$$t = \frac{2}{4n} \quad I = \frac{V_1}{2\pi nL}$$

$$t = \frac{3}{4n} \quad I = -0$$

This gives four points. If we plot by means of table a lot more points, we shall find that the curve follows an ellipse, the voltage axis of which is V_1 and the current axis is:—

$$\frac{V_1}{2\pi nL} \quad (\text{Fig. 3})$$

Now we can superimpose this on our valve characteristic, but the other way round, just as we put our line.

[You can write down the equations as we did with the resistance and see why the ellipse gets turned round horizontally.]

Of course, V and I refer to the plus and minus variation of the

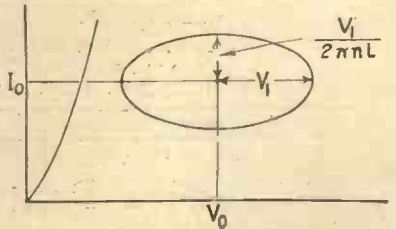

Fig. 3.—An ellipse obtained by plotting I against V .

alternating current, and when we superimpose on the valve curves we must put the centre of the ellipse at an arbitrary point fixed by the high tension voltage we are using

Quality Finish Reliability

THESE are the three features of the U.S. Super Transformer which have won for it an enviable reputation amongst experts and amateurs.

QUALITY—The U.S. Super is designed by experts, and made under ideal conditions. The core is packed with finest Stalloy iron, the winding is perfect, the terminals large and comfortable. Note especially the new earthing terminal.

FINISH—The U.S. Super is finished with the same attention to detail as is given in every stage of its manufacture. It is neat, of medium weight, and assembled with the greatest care by skilled instrument makers under expert supervision.

RELIABILITY—The U.S. Super has a *guaranteed ratio of 5.1*. It is subjected to rigorous tests before leaving the works; and the expert critics of the Wireless Press have tested it in all stages and under all conditions, and are unanimous in their praises.

A written guarantee for twelve months is given with every transformer,

Wholesale only

The U.S. Radio Co., Ltd.,
155, High Street, Lewisham, S.E.13.

Phone: Lee Green 2404. Telegrams: Supertran, Lewis, London.



Note the New Earthing Terminal.



Super Transformer

In replying to advertisers, use Order Form enclosed.

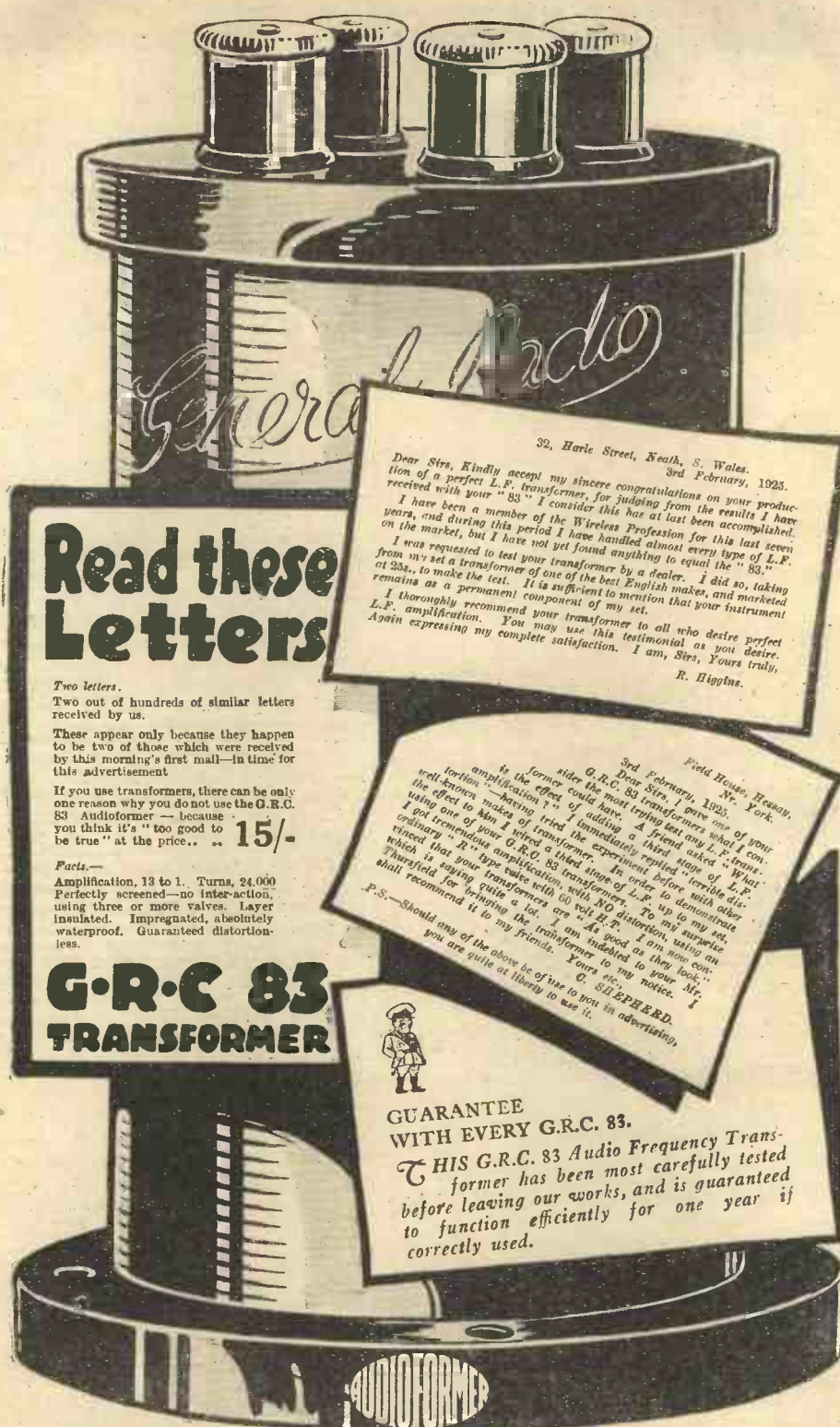

Read these Letters

Two letters.
Two out of hundreds of similar letters received by us.

These appear only because they happen to be two of those which were received by this morning's first mail—in time for this advertisement.

If you use transformers, there can be only one reason why you do not use the G.R.C. 83 Audioformer — because you think it's "too good to be true" at the price.. **15/-**

Facts—
Amplification, 13 to 1. Turns, 24,000
Perfectly screened—no inter-action,
using three or more valves. Layer
insulated. Impregnated, absolutely
waterproof. Guaranteed distortion-
less.

G·R·C 83 TRANSFORMER

32, Harle Street, Neath, S. Wales.
3rd February, 1925.
Dear Sirs, Kindly accept my sincere congratulations on your production of a perfect L.F. transformer, for judging from the results I have received with your "83" I consider this has at last been accomplished. I have been a member of the Wireless Profession for this last seven years, and during this period I have handled almost every type of L.F. on the market, but I have not yet found anything to equal the "83". I was requested to test your transformer by a dealer. I did so, taking from my set a transformer of one of the best English makes, and marketed at 25s., to make the test. It is sufficient to mention that your instrument remains as a permanent component of my set. I thoroughly recommend your transformer to all who desire perfect L.F. amplification. You may use this testimonial as you desire. Again expressing my complete satisfaction. I am, Sirs, Yours truly,
R. HIGGINS.

Field House, Ipswich, Nr. York.
3rd February, 1925.
Dear Sirs, I give you of your G.R.C. 83 transformers what I can. The most trying test any L.F. transformer could have. A friend asked "What is the effect of adding a third stage of L.F. amplification?" I immediately replied "terrible distortion."—Having tried the experiment before with other using one of your G.R.C. 83 transformers. To my surprise I got tremendous amplification. In order to demonstrate ordinary "R" type valves with 100% distortion, using an which that your transformers are "A good as they look." I was saying quite a lot. I am indebted to your Mr. Thursfield for bringing the transformer to my notice. I shall recommend it to my friends. Yours etc.,
G. SHEPHERD.
P.S.—Should any of the above be of use to you in advertising, you are quite at liberty to use it.



GUARANTEE WITH EVERY G.R.C. 83.
THIS G.R.C. 83 Audio Frequency Transformer has been most carefully tested before leaving our works, and is guaranteed to function efficiently for one year if correctly used.



Issued by the Publicity Department of the GENERAL RADIO COMPANY, LTD., RADIO HOUSE, 235, REGENT STREET, LONDON, W.1

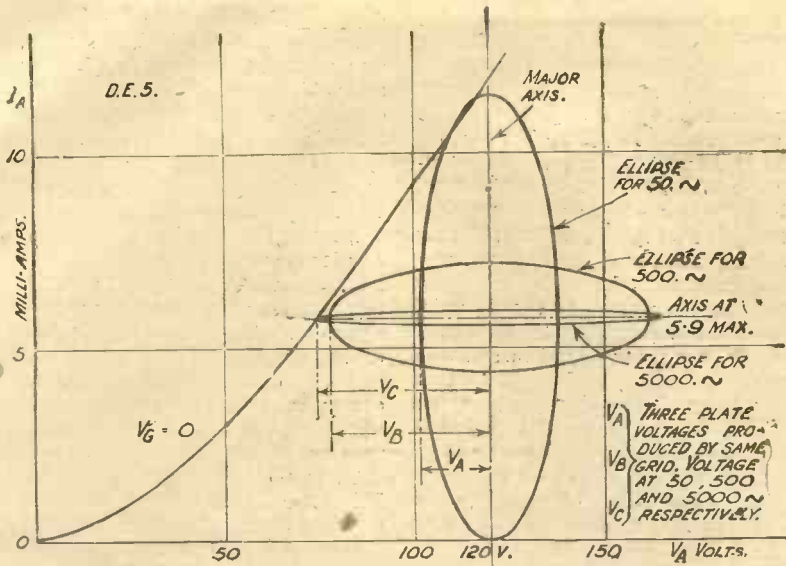

Fig. 4.—Curves for 50, 500 and 5000 cycles with L = 10 henries.

and at an arbitrary current value which we must decide upon.

Remember V_1 is arbitrary after we have settled the shape of our ellipse. V_1 settles the size of it. Increasing L or n makes the ellipse shallower until with L or n extremely large the choke acts like an infinite resistance as far as the alternating current is concerned. If n or L are small the ellipse extends vertically. If at any place the ellipse runs into the curve, $V_g = 0$; or into the axis, $I = 0$, then we get distortion.

Conditions for No Distortion

I need hardly give any examples of the use of this ellipse now, as you can easily draw one on the valve characteristic, which gives you just no distortion, and afterwards determine $2\pi nL$. If you are considering note magnifiers, you should take n as 50 — and 6,000 — as the two limiting values, and in neither case should there be rectification or grid current. It is quite as interesting as a crossword puzzle.

In Fig. 4, I have drawn ellipses for 50 —, 500 — and 5,000 — with L = 10 henries.

The first case is just inside limits everywhere. We can read off our magnification at all frequencies (it rises with the frequency) and also draw out our distortion due to curvature of the characteristic and the amount of safe grid volts we can apply. It also gives us our grid bias to work at. Choose another value of L and see what effect it has on magnification — magnification alteration with frequency and distortionless sweep.

If we shunt our inductance with a resistance R the ellipse has to be re-drawn by adding the ordinates of the line to those of the ellipse.

The Fig. 5 shows a case of this. Now a condenser has the two equations:—

$$V = V_1 \sin 2\pi nt$$

$$I = \frac{V_1}{2\pi nc} \sin \left(2\pi nt + \frac{\pi}{2} \right)$$

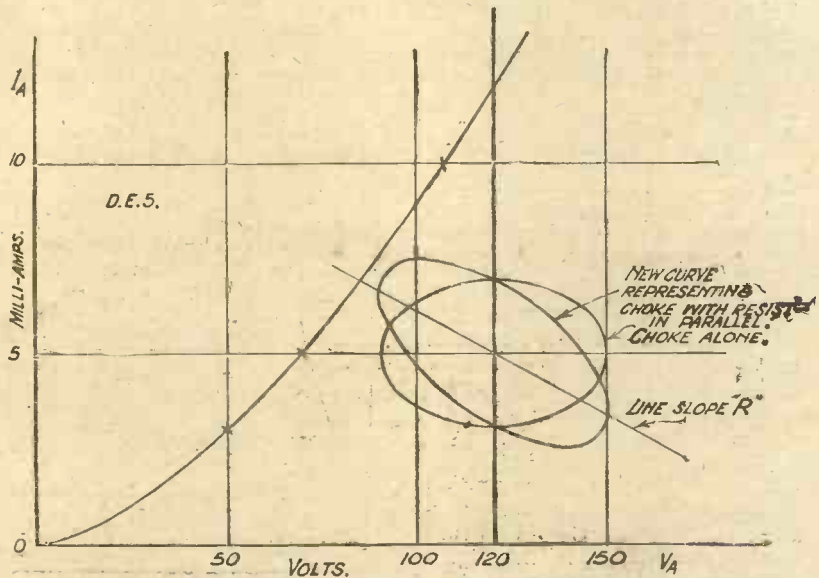

Fig. 5.—Curves showing effect of shunting the inductance with a resistance R.

180° difference of phase to the inductance case. Its primary ellipses are drawn exactly similarly, but, of course, as we cannot current bias it in the same way as the choke, for the moment we will only consider it in parallel with the choke. Owing to the current phase being 180° from the inductance case it is

easy to see that for some relation between pc and pL ($p = 2\pi n$) the ellipse becomes a horizontal line, or if a resistance is in shunt a sloping line, as though the resistance were there alone except for the current bias position. This condition of $\frac{I}{pc} = pL$ is resonance, and on either side we steadily run into a more and more elliptical condition with less and less magnification.

Magnification

It is interesting to note from our previous curves that the less L and the more C is the greater the rapidity with which the magnification falls off. But just imagine that by halving our L and doubling our C, at a certain frequency our magnification has fallen off. We can obviously recover our ground by altering our valve characteristic (steepening it up) so that the proportion remains as before. For instance, a DE5 will give the same magnification out of tune as an R valve with a quarter the inductance and four times the capacity. The "in tune" magnification with no resistance is independent of L and C.

Now here is where the transformer comes in. Suppose we wrap round our L twice the number of

turns and make a very tight coupled transformer of it, we get double our voltage on the secondary. Three times the number of turns three times the voltage, and there would be no limit to this but for the annoying fact that this secondary winding has a self-capacity, and as we

increase our secondary turns the primary condenser has to be reduced to keep the tune of the whole the same, and we come to our limit when the primary con-

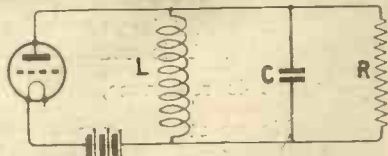

Fig. 6.—An arrangement of L, C and R in parallel.

denser has to be removed. Our maximum step up ratio has been obtained. The self-capacity has the relation to the original shunt condenser inversely as the square of the ratio of the number of turns, and we can see that the DE5 will enable us to get twice the magnification of the R with the same reduction of magnification at a position out of tune. If we are designing tuned transformers such as are required for supersonic receivers, our original $\frac{L}{C}$ can be much smaller and our in tune magnification much bigger. This has been a long way round. With our graphs we can obtain all the information we require. If we only need magnification there are easy little formulæ to get it with, but they only apply over very narrow limits. I will

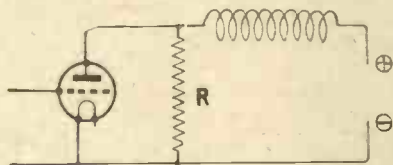

Fig. 7a. The voltages across the valve and impedance are opposite.

give one of these for those who would like to try it out. Suppose we only consider a valve through very narrow changes of V_p , V_A and I_a , then its equation becomes

$$I_a = \frac{V_p}{r_1} + \frac{V_A}{r_2}$$

You can determine this equation yourself from any valve characteristic. Now if L, C and R are arranged as shown in the Fig. 6 Magnification =

$$\frac{1}{r_1 \sqrt{\left[\frac{1}{R} + \frac{1}{r_2}\right]^2 + \left[\rho C - \frac{1}{\phi L}\right]^2}}$$

We have so far been considering circuits in which we have thought of the valve in series with the impedance. Very often for convenience a circuit arrangement called a constant current circuit is used. In essence this is not

different from the constant voltage current we have been considering, but we might think how to consider it on the diagram.

Whereas in Fig. 7a the voltages across the valve and impedance are opposite, in Fig. 7b they are the same way. There is no quantitative difference, but instead of drawing our line in the resistance diagram through V_0 and considering V_0 as always split up between the resistance and the valve, we draw our line through I_0 on the I_a axis, Fig. 8, (the current flowing where the grid is very negative through the resistance alone) and consider this current as always split up between the resistance and the valve—reading off our combined applied voltage from the end of the very large choke coil. Obviously, the choke coil has only constant current when $L = \infty$, but with practical values of the current change



Fig. 7b.—In this case the voltages are the same way.

in it can be small compared with the current change in either the valve or the resistance.

I have in the above article only hurriedly suggested to you methods which I constantly use and apply in practice, and which not only enable me to avoid waste of apparatus and time, but where great expense is involved in large gear make sure of all the dimensions before ordering material.

The methods may be clumsy, but as some of the work they do is almost beyond mathematics, they are very necessary.

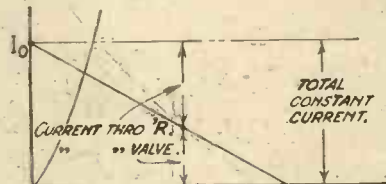

Fig. 8.—A constant current diagram.

"TRANSATLANTIC FIVE."

SIR,—Knowing that you at all times welcome Test reports and opinions of various circuits, I feel that it would be of interest to give my experiences with the "Transatlantic Five" (described by Mr. Percy Harris in the June MODERN

WIRELESS) which I have recently constructed.

I chose this particular circuit as one best suited to my requirements, and with one exception (which I will deal with later), I feel that for all-round performance and efficiency, thanks are due to Mr. Harris for evolving a circuit of this description.

Its outstanding feature is its exceptional purity, which, by the way, has been the first thing so favourably commented upon by various listeners. The set is very stable, and reaction—although applying itself somewhat critically—is very easily controlled, and in all my various tests I have not yet had recourse to use a reaction coil.

The valves in use are two Cossor H.F. Marconi D.E. 5b detecting, and two Marconi D.E. 5 low consumption power valves.

I am located at Hampstead, and, on test, 2 LO comes in on three valves with excellent loud-speaker strength, five, of course, being too loud for the reception of this station. Chelmsford is received just as loudly as London, but there is great difficulty in separating this station from Paris. Madrid comes in quite clearly after 2 LO has closed down.

The greatest trouble I have experienced up to the present is the inability to separate London from other stations in the British Isles, 2 LO being heard over a wide margin of the broadcast band.

At 1 a.m., G.M.T., January 12th, I endeavoured to find out how the set would stand up when put to the test of long distance reception. Using five valves and connecting my phones in series with the loud-speaker terminals, I switched on. Within a few minutes I was receiving a carrier wave; on making one or two adjustments I was receiving speech which resolved itself into an American Church transmission, a sermon being in progress, and apart from occasional fading, the strength and clearness of speech was excellent.

I listened right through the sermon, which ended in prayer, and at 1.30 the preacher asked the congregation to sing hymn 232, which I clearly heard.

Feeling tired, I disconnected the set at 1.40.

It will probably interest you to know that the whole transmission was received with the reaction shorted.

In conclusion, may I congratulate Mr. Harris in producing a straightforward circuit that does all he stated it should do.—Yours truly,

N. FEATHER.
Hampstead, N.W. 3.

Fit a 'Malone'
to your
'Phone
and get results rivalling a
50/- LOUD SPEAKER
for only **7/6** Postage 1/-
Fitted in a second, sound British made,
complete, strongly packed. Send P.O. 8/6
at once and listen in comfort. Send stamp
for free descriptive Leaflet W.
Write direct to Works:
MALONE & CO., LEIGY-ON-SEA, ESSEX

READ AMERICA'S FOREMOST RADIO JOURNAL
The "RADIO NEWS," published monthly
in America, contains amazingly interesting
articles on the latest discoveries in wireless
research, etc. It is edited by Mr. H. Gernsback,
so well known in the wireless world.
This journal comes to any address every month
for 12 months for only 13/6, post free. Send
to-day or call.

Sole British Subscription Agents:
**R. MCKELLEN & CO., 49, Shaftesbury Avenue,
LONDON, W. 1.**

AGENT WANTED for Australia by one of the
largest Wireless Component Manufacturers in
this country. Applicants must be firm of good
standing and have a live connection in Australia.
The Agency would include the whole of Australia
and would be a Buying Agency.—Box No. 17,
Ashburners' Advertising Agency, 10, Piccadilly,
Manchester.

IMP Battery Switch
Here is the switch you have been
waiting for. "On" and "Off" position
clearly indicated at all times.
Will carry 10 amps. Price 2/9
Ask your dealer to show you. Insist
on the original.
Gaston E. Marbaix,
27-28, Anning Street, E.C.2.
Phone: B'gate 1294.

ELECTRADIX RADIOS
ELECTRADIX RADIOS.—"C" Valves, Air
Force, low cap., 6/6 (post at buyer's risk).
Wavemeters, 50/-, 24, 25 and 26. Morse
Recorders, 26 10s. Wheat stone 28. Alternators,
23 10s. Valve Transmitters, 23.
Spark Sets, 15/6. R.A.F. Steel Masts, 2/6
per 5 ft. run. Receivers: 2-valve, 2B, 22;
3-valve, Mk. 4 23; 5-valve, 25 10s.; 7-valve
Marconi, 28. All prices less valves. Bridges,
23 and 25 10s. Res. Boxes, multi-range
standards, 1 to 2,000 ohms, 17/6 to 50/-.
Loud Speakers, 19/-. Ebonite Horns, 8/-.
Charging Dynamos Rotax, 23. Marconi
Rounds Valves, 3/6. Milliammeters, 30/-.
Amp and Voltmeters, all ranges. Ohm-
meters, 210. Testing Sets, 24 to 214.
Condensers, L.T. to 10,000-v., 1/6 to 22.
Call or write for new and enlarged catalogue.
Post Free 4d.
LESLIE DIXON & CO. LTD.,
9, Colonial Avenue, Minories, E.1.
'Buses pass the door. Telephone: Avenue 4166-
F.M.W.

>DULL EMITTERS REPAIRED<
Each concert tested, 10/6. 66 Valves, 12/6.
Bright Valves, 8/6. Sets and Phones re-
paired. LUID RADIO 06 Valves, Fil. 3 v.
Plate 30-100v. Excellent H.F. DET. L.F. 12/6
W.G. EAMES, 15, Red Lion St., London, W.C.1.

PREPARE
Your advertisements now for the
next issue of
"MODERN WIRELESS,"
closing for press on MARCH 14th.
All instructions should be for-
warded to
BARCLAYS ADVERTISING, LTD.
Bush House, Strand, London, W.C. 2.



**TRUEMUSIC
MINOR
Loud Speaker
21/-**

This Loud Speaker is now supplied with a
stand, as shown. There is, however, no
increase in the price. The resistance is
2,000 ohms.

Finished outside in nigger-brown, with
copper-plated terminals, the "TrueMusic
Minor" is one of the most pleasing and
attractive on the market. The inside of the
horn is of lacquered copper, giving a bright
and cheery effect—yet it does not need
polishing.

Ask to see the "TrueMusic Minor" Loud-
speaker at your favourite Wireless Shop.
Its performance will delight you.

The "Minor" reproduces all kinds of
Broadcasting perfectly. It will do full
justice to the most elaborate set, and will
get the best out of a small one.

All the family can enjoy Broadcasting
for the cost of one pair of 'phones.

For "DX" working or crystal sets,
T.M.C. Headphones are just what you
want; sensitive and clear-toned. They
are comfortable to wear, and absolutely
reliable.

Remember that all T.M.C. apparatus
carries a twelve months' guarantee.

Loud Speakers

TrueMusic Minor	£1 10
TrueMusic Junior	£2 10 0
TrueMusic Standard	£5 0 0
TrueMusic Concert Grand	£6 10 0

But it must be T. M. C.



T.M.C. No. 2a Headphones
4,000 ohms, 19/6.



T.M.C. No. 3 Lightweight
Headphones,
4,000 ohms, 22/6.



The Telephone Manufacturing Co., Ltd. (Makers of the famous laryngaphone),
Hollingsworth Works, West Dulwich, S.E.21.

E.P.S. 270;

In replying to advertisers, use Order Form enclosed.



The two flexible connections are for aerial and earth.

A NUMBER of crystal-set users near the coast and also near inland spark stations are considerably troubled by interference from Morse, and in the majority of cases it is found impossible to tune this out on the usual direct-

coupled type of crystal set. A coupled circuit can be used with advantage in these cases, but often it is felt that the additional expense and extra tuning control involved are features to be avoided if possible. The receiver about to be described is one of the simplest to make and handle, but has a greater degree of selectivity than is possible with any direct-coupled set. An additional advantage is the fact that the set is much more independent of the size of aerial

used, and since only a portion of the coil is included in the actual aerial circuit, the damping from this cause is lessened.

Semi-Aperiodic Aerial Coupling

Auto or semi-aperiodic aerial coupling is used, and this, with the special design of low-loss coil wound with heavy gauge wire, accounts for the good results which are obtainable.

A glance at the theoretical circuit of Fig. 2 will clearly show the general arrangement adopted. A tapped coil of 52 turns, in series with a coil block L.C. to take a loading coil, is tuned by a parallel condenser C of .0005 μ F. From the upper end of the coil block a crystal detector D is connected, and in series with this and the other end of the coils are the telephones. Aerial and earth leads are plugged into the sockets shown as explained later.

From the photographs the compactness of the set will be appreciated. Only two terminals appear on the panel, and these two at the right-hand top corner are for the telephones.

Clix Arrangements

A vertical row of six Clix sockets allows of varying numbers of turns of the coil being included in the aerial circuit. Aerial and earth leads are terminated by Clix plugs, which are plugged in these sockets, marked 1 to 6 in the front-of-panel diagram. Generally, the earth connection will be plugged into the socket marked 6 and the aerial into one of the remaining five, as determined by experiment.

Between each adjacent pair of sockets from 2 to 6 are thirteen turns of the coil, making fifty two turns in all. Between 1 and 2 a fixed-coil block is located.

Loading Coils

This allows of the inclusion of a loading coil so that the set may be arranged to tune to any required wavelength. For the 300-500 metre band this will be shorted by means of a shorting plug. With

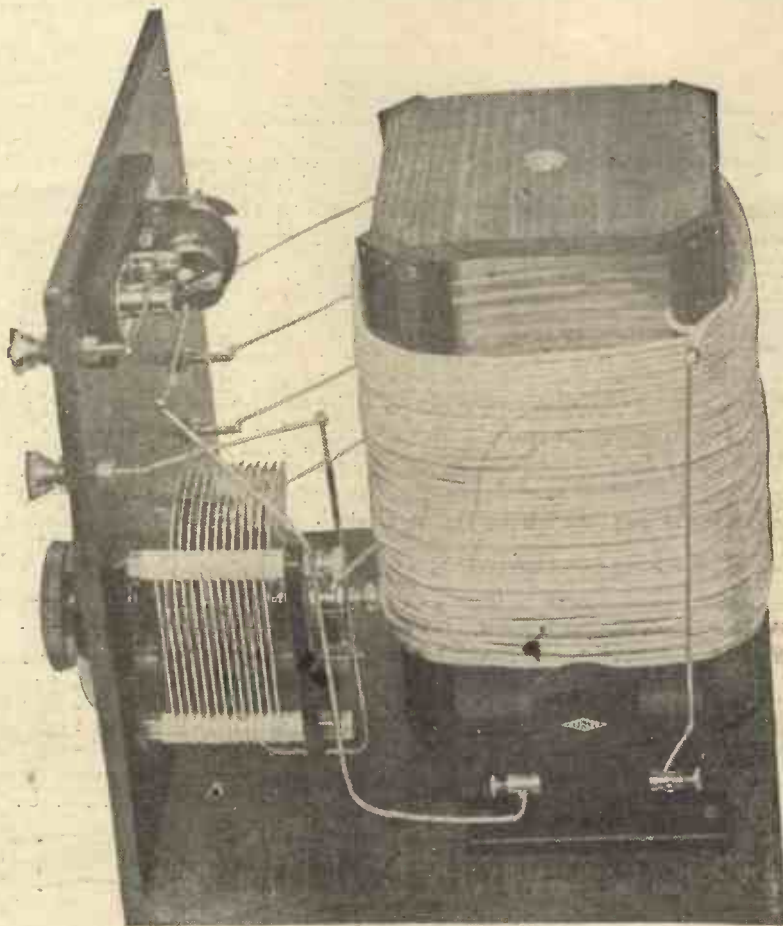

The set is now suitable for reception on the B.B.C. wave-band. When it is desired to receive on the longer wavelengths, the short-circuiting plug seen in the above photograph should be withdrawn and the requisite loading coil inserted.

“An Auto-Coupled” Crystal Set

By JOHN UNDERDOWN

In this compact receiver special arrangements are made for obtaining selectivity. The set is also arranged so that it may be used as a very effective wave-trap either for the 300-600 metre or for the higher wavelengths.



The crystal detector is placed out of harm's way and is easy to adjust.

the aerial plugged into socket 1 both the loading coil and that normally used are included in the aerial circuit so that the direct-coupled arrangement may be obtained. The dial seen to the right of the panel is that of the tuning condenser, and this, once the best tapping arrangement is found, constitutes the only control.

Back-of-Panel Lay-Out

From the photographs of the set withdrawn from its cabinet the back-of-panel arrangement will be clearly seen. The crystal detector is mounted behind the panel and to the top so that it may easily be adjusted by merely raising the hinged lid of the cabinet. This latter is of the same type as used for the All Concert de Luxe set, but takes a panel of 8 in. instead of 16 in. long. Below the crystal detector is the tuning condenser, which is of the square law type. A wooden base of half-inch-thick mahogany, attached to the panel by two wood screws, carries the low-loss coil and the block for the loading coil.

Materials Required

The components necessary to construct the set are as follows:—

- 1 Cabinet, All Concert type, but to take ebonite panel 8 in. square, complete with wood sub-base 8 in. by 7½ in. (W. H. Agar).
- 1 Ebonite panel 8 in. by 8 in. by ¼ in. thick. This should preferably be guaranteed leakage free, or, failing this, matted with emery paper to remove the surface skin (Peto-Scott).
- 1 .0005µF Square Law type variable condenser (Jackson Bros.).
- 1 "Gravity" crystal detector (Portable Utilities).
- 1 Coil block for mounting on wood.
- 1 Shorting plug for above (Peto-Scott).
- 1 lb. 18 gauge d.c.c. copper wire (Peto-Scott).
- 6 Clix with nuts only.
- 2 Clix with insulators and nuts (Autoveyors).

- 2 4 in. by 4 in. by ¼ in. pieces of mahogany.
- 4 strips ebonite, 6 to 7 in. by ¼ and ½ in. thick (Paragon).
- 2 W.O. type nickel terminals.
- Quantity of 16 gauge tinned copper wire.
- 1 packet Radio Press panel transfers.

The Coil

The coil consists of fifty-two turns of 18 gauge double cotton covered copper wire wound on a special former, and tapped at every thirteen turns.

The Former

To obtain a minimum amount of dielectric in the magnetic field of the coil two 4 in. square blocks of mahogany, teak or any hard wood

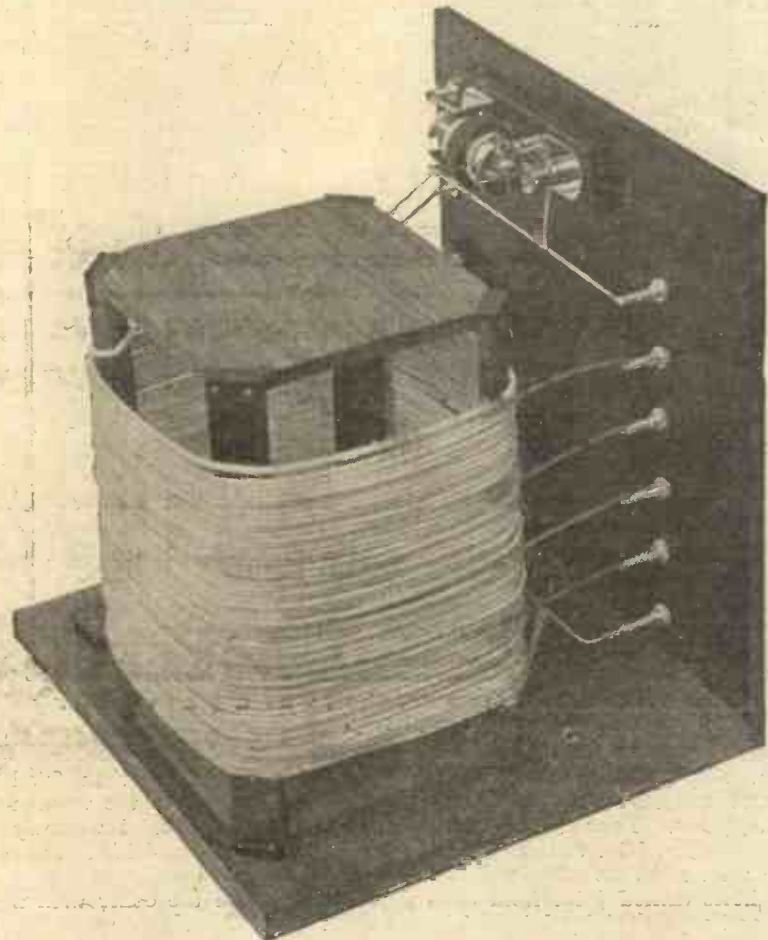

The connections from the low-loss coil to the "Clix" sockets may be seen in the above photograph, which will be helpful in wiring up.

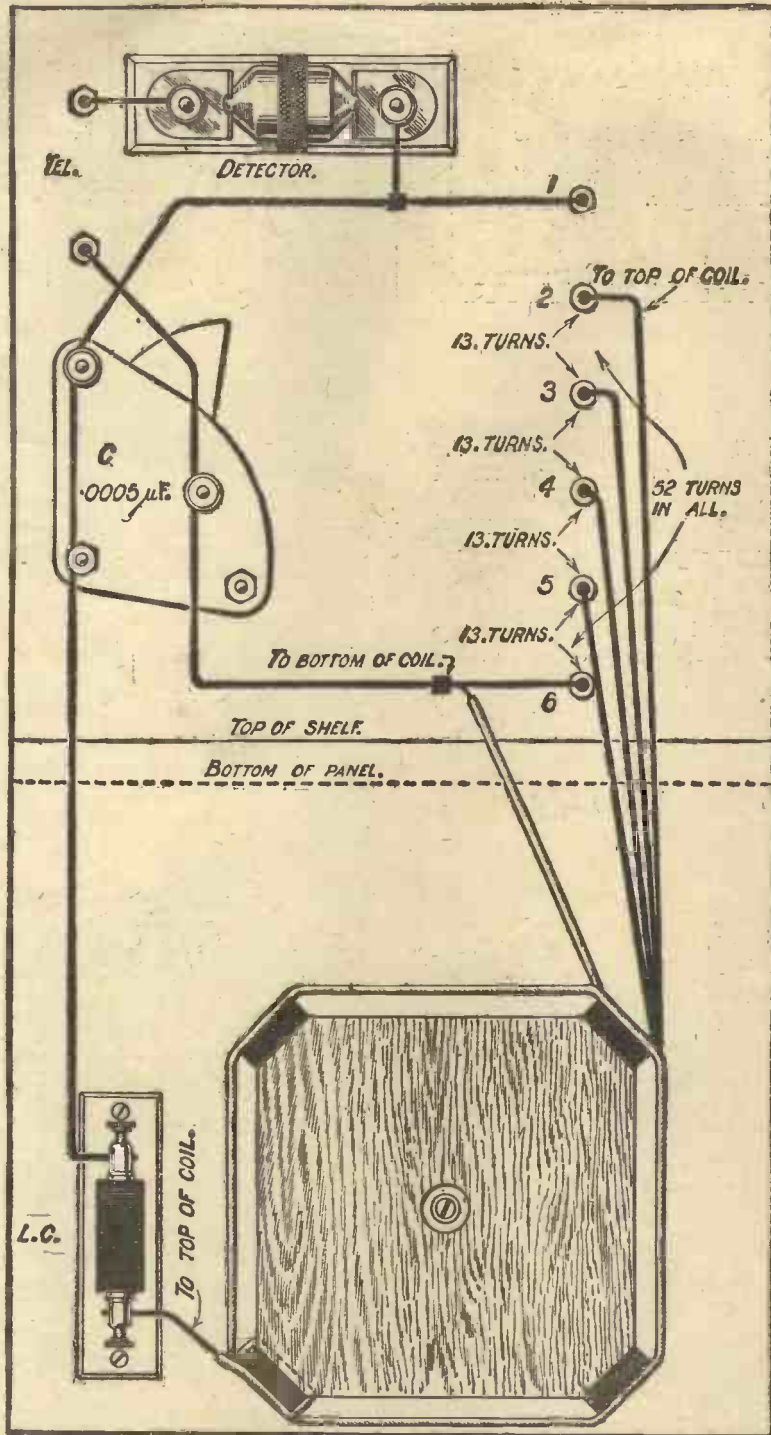

Fig. 1.—The wiring diagram, shown as a plan view for simplicity.

$\frac{1}{4}$ in. thick, are taken and the corners cut off as shown in the photographs. Four strips of $\frac{1}{4}$ in. thick ebonite, $\frac{3}{4}$ in. wide and from 6 to 7 in. long, are obtained and two holes drilled $\frac{1}{8}$ in. from each end and separated by $\frac{1}{2}$ in. The holes should be of suitable diameter to take thin brads, such as are used by shoemakers; an 8 B.A. tapping drill does admirably. These

$\frac{3}{4}$ in. wide strips are then fixed to the four corners of the wooden end pieces as shown. Previously the blocks should be drilled in the centre, one so as to take a suitable wood screw and the other with a hole of $\frac{3}{8}$ in. or so.

Winding the Coil

About 1 lb. of 18 gauge d.c.c. wire is required to wind the coil.

The wire is first twisted once round one of the ebonite strips and then wound on not too tightly. As long as the turns are wound on so as not to slip over each other a slight looseness will be found of advantage in making the soldered tappings rather than otherwise. Fifty-two turns should be wound on and the winding finished by twisting round the ebonite piece diagonally opposite to that used in starting.

The Tappings

Tappings are necessary at each 13 turns, and these are easily made if the wire is bared with a knife in the position shown in the photographs. If not too tightly wound a match stick on each side of the turn to which the tapping is to be made allows this to be isolated and a 3-in. length of tinned copper soldered in position without difficulty or injury to the insulation on adjacent turns.

Drilling the Panel

Having made the coil the panel may be drilled by consulting the drilling diagram. The Clix, terminals, condenser and crystal detector should then be mounted on the panel and the latter fixed to the wooden sub-base by means of two wood screws. After the terminals and Clix have been cleaned and tinned with a hot iron any nuts which may have loosened

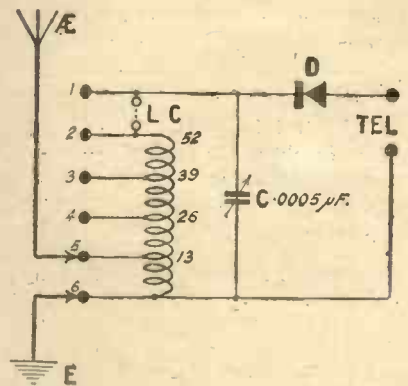
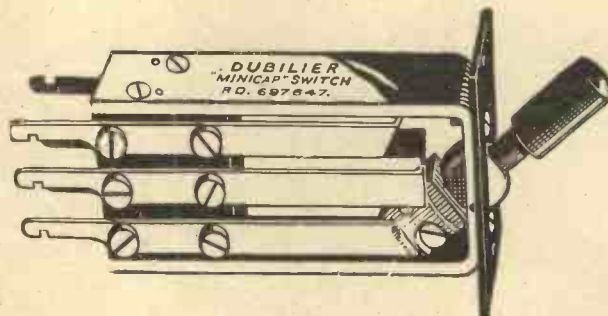

Fig. 2.—The circuit diagram.

should be given a half turn or so to take up any slackness. The coil block should next be mounted on the wooden base, and, consulting the photograph, a number of leads may be connected in position. The last stage is the mounting of the coil. This is placed in position after the centre for the fixing screw has been marked on the sub-base and a small hole drilled. A suitable wood screw is placed through the hole in the coil wooden end-piece and screwed into the hole in the sub-base by means of a long screw-



THE "MINICAP."

Every serious experimenter or constructor should number amongst his accessories at least one double-pole double throw switch.

The uses for such a switch are numerous and varied.

With its aid can be compared the reproduction from different telephones, loud speakers, detectors, transformers, circuits, or even complete sets, and, since the change-over is instantaneous, the comparison is far more effective than when numerous leads have to be changed.

Further uses are those of switching in and out steps of high or low frequency amplification, changing over from "series" to "parallel" adjustments, from "tune" to "stand-by," etc., etc.

In some of the instances mentioned, a small capacity between the various contacts of the switch is not harmful; in other cases, such as in H.F. circuits, it is imperative to eliminate self-capacity wherever possible.

The DUBILIER MINICAP (minimum capacity) switch has been designed with the object of ensuring that no undue capacity effects occur in the switch itself.

It can be mounted on the panel of a set if it is to be fixed permanently in one position, or, for experimental work, it may be mounted on a separate panel of its own and provided with terminals. In this way it becomes one of the most useful pieces of apparatus on the experimenter's bench.

Price **8/-**



DUCON WORKS,
VICTORIA ROAD,
NORTH ACTON.
LONDON, W.3.

DUBILIER
CONDENSER CO. LTD

Telephone :
Chiswick 22-1-2-3
Telegrams :
Hivoltcon, Phone,
London.

CAIN WAS A TILLER OF THE GROUND



Name ?

Something that was bestowed on you at your christening to identify you from your neighbour. Later, you possibly had another, but that was a nickname; and again on attaining an age of responsibility or the right of a pay envelope, you had a title of courtesy, but nothing to define your utility to man . . . as . . .

Cain was a tiller of the ground.

Mullard . . . a maker of valves:

Mullard . . . THE maker of valves.

Mullard . . . THE maker of MASTER valves.

A Master Valve for every wireless circuit.

Obtainable from all dealers.

Mullard
THE · MASTER · VALVE

Advt.—The Mullard Radio Valve Co., Ltd. (M.W.), Nightingale Works, Balham, S.W.12.

driver through the hole in the upper end of the coil former.

Completing the Wiring

The wiring is completed by soldering the tappings from the coil to the appropriate Clix sockets and to a lead from the coil block. This completed, the receiver is now ready for test.

Testing

For a test of the set, Clix or plugs should be affixed to aerial and earth leads respectively, and the earth lead plugged into socket 6 of the crystal set. The aerial plug should first be plugged into socket No. 5, thus including 13 turns of the low-loss coil in the actual aerial circuit. Having plugged aerial and earth leads in, the condenser should be rotated until signals are heard. This arrangement, of course, applies to the 300-500 metre band, and not to testing on 5XX. The socket coil is, of course, short-circuited at present by inserting the shorting plug. The crystal detector should then be finally adjusted by lifting the lid of the case and then gently rotating the clip-in portion of the Gravity type of detector mounted just inside the case. The ebonite insulated ring should only be touched when this adjustment is made. Little difficulty should be experienced in finding a sensitive spot by slowly rotating the unit carrying the enclosed detector.

Tuning

Having satisfactorily adjusted the crystal detector and found the set to be tuning correctly, experiments may now be tried as to the best amount of the coil to be connected in the aerial circuit for maximum signal strength. Generally speaking, this will be obtained with the aerial plugged into socket 4, whilst for maximum selectivity this will probably be found best plugged into socket 5. The less the amount of the coil contained in the actual aerial circuit, the greater is the selectivity.

Reception of 5XX

To test on 5XX, the shorting plug should be removed, and a No. 100 or 150 coil inserted. Generally, in this case, it will be best to connect the aerial to socket 1 when first testing. This arrangement gives a direct-coupled circuit of a non-selective nature which is most easy to tune. Later, the test of plugging the aerial in sockets 1 to 5 may be tried. This latter is only necessary when troubled by interference.

Using the Set as a Wave-trap

The set may be used as a very effective type of wave-trap, pre-

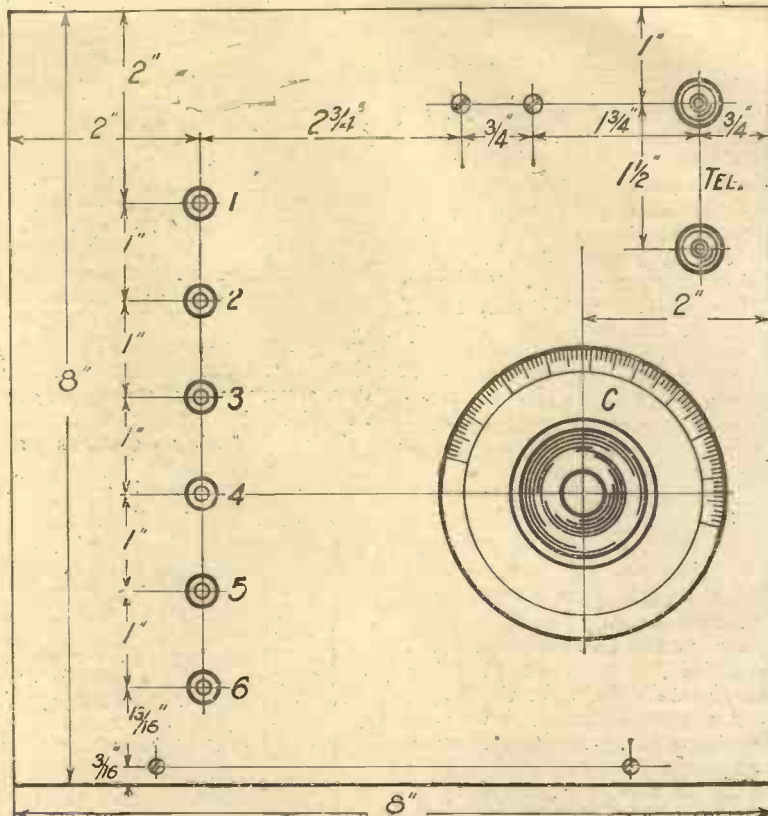

The panel lay-out. From the dimensions given it will be a very simple matter to drill the holes correctly.

viously described by Mr. G. P. Kendall in *Wireless Weekly*, and in this case the telephones are, of course, not connected in circuit. For use on the broadcast wave-

your set. This constitutes the type D wave-trap, which has been found to be a very effective arrangement. The trap should be set to the wavelength of the station which is causing interference, and once set should be left at this value. The desired station may then be tuned in on the other set.

For interference on the 5XX band of wavelengths, a 150 coil is plugged into circuit and the aerial may be plugged in any of the sockets from 2 to 5.

Test Report

Tested on an aerial of average dimensions, 35 ft. high and about 60 ft. long, excellent results were obtained with the earth plugged into socket 6 and the aerial into either of the sockets 4 and 5. The most selective arrangement was naturally when only 13 turns were included in the aerial circuit by placing the aerial plug in socket 5. Maximum signal strength on 2LO was obtained with the aerial plugged into socket 4. This arrangement probably gave an approximately tuned aerial circuit.

5XX was obtained at excellent strength using a 150 coil plugged into the loading coil socket, and with the aerial plugged into either socket 1 or 2.



The low-loss coil former.

length band the bottom 13 turns between sockets 5 and 6 are connected in the aerial circuit, the aerial being taken to 5 and socket 6 connected to the aerial terminal of

(Continued from page 171).

is obtained, whilst KDKA on 68 metres is received at loud-telephone strength with perfect clearness. On January 31, when the B.B.C. attempted to relay KDKA, signals were received with this little set direct from the Pittsburg studio with perfect clearness, without either distortion or atmospheric; the speech concerning St. Paul's Cathedral and the orchestral performance, "The Lost Chord," which followed, being perfectly clear.

The reception of KDKA may be attempted any normal evening at about 11 p.m. with this receiver with the full knowledge that at least some sort of signals will be received from that station, though different evenings will give different degrees of quality. As an example of this, the receiver was used for KDKA reception at about 11.15 p.m. on February 6, and though signals were at times all that could be desired, they were at other intervals so weak that the music could not be followed. On the following evening reception from the same station was again tried, with the result that the KDKA programme could be easily followed, the orchestral transmission of the "Bohemian Girl" being perfect.

Although the receiver has been used many times for reception from KDKA, never has it failed to bring in signals of some sort which rise to good signal strength later, with perhaps that well-known fading effect occurring at intervals.

*Trap-Circuit
Success.*

SIR,—My letter ought really to be a very long one, but I will endeavour to make it as short as possible.

I must preface my remarks on the trap-circuit by stating that I use a fairly efficient "Family Four-Valve" constructed on the lines of Mr. Harris' diagram, but with a slightly different lay-out and with different components. When I made it I fitted a dual coil-holder for aerial circuit so that I could use inductive coupling in order to make the set selective. As I live, so to speak, "on the doorstep" of 2LO, this station has always been a great trouble to me, and I did not find the inductive coupling had very much effect. Having a .001 condenser by me, I thought, after reading your article, that I would try the "trap," as shown in the

current number of MODERN WIRELESS. I therefore plugged in a 35 coil into the "spare" coil-holder and connected the .001 condenser across it. The result was truly wonderful, as without any difficulty or the slightest sign from 2LO, I was able to hear Bournemouth, Birmingham, Newcastle, etc., on the loud speaker. As a final test as to its efficiency, I tuned in Bournemouth as they were playing the last item before the time signal and news bulletin, left the set tuned and heard Big Ben from Bournemouth and London general news (copyright, etc.) All this without a trace of London.

The following stations are audible on the loud speaker: 5IT,

6BM, 5NO, Ecole des Postes, Madrid, Radio-Paris, the last very powerful. 2LO, SBR and several German stations will shout the place down. On two occasions I have had WGY, and so strongly that if anyone had told me that the latter station had been received in such conditions, I should not have believed it. I heard the whole of a Church service without interruption from WGY on January 12.

I must conclude by offering my sincere thanks to both yourself and to Mr. Harris for the fine circuit you have given us and wish success to MODERN WIRELESS.—Yours truly.

A. F. KENT.

Camden Town, N.W. 1.

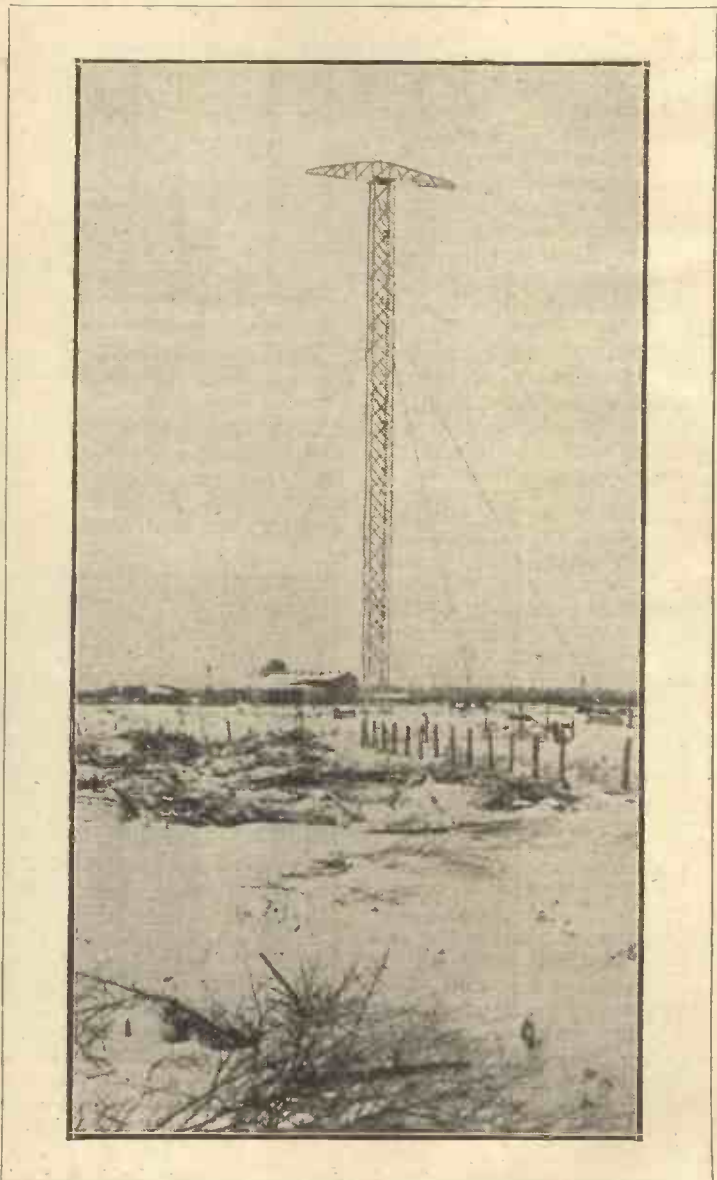

The above photograph shows one of the 300 ft. masts of the new short wave beam station, which is being erected near Montreal for communication with England.

for distance

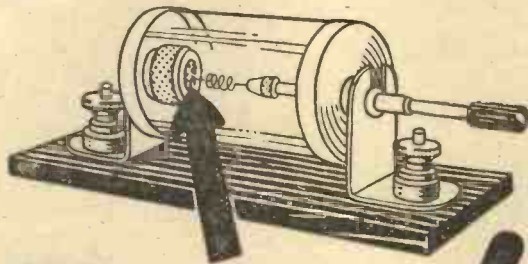

Neutron!

The consistent high sensitivity of Neutron Crystal is proved by the rapidly accumulating records of "long-distance" reception—and you can obtain the same results, with care in your choice and arrangement of apparatus; particularly in your choice of Crystal—at the same time the most important item and the least expensive. Be sure it is Neutron.

- | | |
|---|-----------------------|
| MANCHESTER from BAKEWELL
"A. C.," Bakewell, receives Manchester on a Neutron plain Crystal circuit. | 38
miles |
| BIRMINGHAM from LONDON
"L.V.C.," of Chiswick, receives Birmingham regularly on a Neutron without amplifiers. | 125
miles |
| CHELMSFORD from YORK
"E. C. D.," York, receives the high-power station on a single slider set, with Neutron. | 160
miles |
| BRUSSELS from CHISWICK
"L. V. C.," of Chiswick, receives Brussels on a Neutron, without amplifiers. | 200
miles |
| MADRID from CHIPPENHAM
"R. A. H.," Chippenham, regularly receives Madrid on a plain Crystal circuit, with Neutron. | 800
miles |
| WBZ from CHIPPENHAM
"R. A. H.," of Chippenham, also reports reception of WBZ (Springfield, Mass.) on a Crystal set, using Neutron, with 2 low-frequency valves acting as note magnifiers only. | 3,000
miles |



Concert Tested & Guaranteed Radio Crystal
Stocked by the Best Radio Dealers. Packed in tin with silver catswhisker. Insist on Neutron in the **1/6** Black and Yellow Tin—

Produced by **NEUTRON, LTD.**, Sicilian House, London, W.C.1. Phone: Museum 2677. Sole Distributors for United Kingdom:

V. ZEITLIN & SONS,
144, Theobald's Road, London, W.C.1.
Phones: Museum 3795 & 6841.



Portmanteau Words

I'm afraid I must confess a distinct weakness for Portmanteau Words; chiefly, I suppose, on account of their descriptive convenience. They always seem to mean exactly what they say; and, except perhaps in a rare case, such as that of the immortal "Brugglesmith," their meaning is evident at sight.

Take, for instance, the word **Volutone**. No doubt can rest in anyone's mind as to what *that* means.

Volume and Tone—the two essentials of a first-class Loud Speaker. Full Volume and Perfect Tone, a joy to listen to, and a treasure to possess.

But even this all-embracing word fails to convey its handsome appearance. The instrument's pleasing lines have a beauty rarely found in something that hitherto has usually been regarded purely as a piece of mechanism.

Go and have a look at a **Volutone**. Your local retailer is almost certain to have one in stock.

And when you have satisfied yourself as to its appearance, make a point of hearing it as well.

I think you'll agree then that I was quite right when I coined that essentially accurate word—**VOLUTONE**.

Muel's Fellows

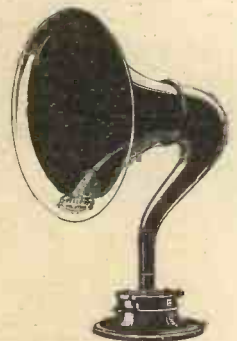

YEATES LTD.,
20, Store Street, Tottenham Court Road, LONDON, W.C.1.

Well-equipped Demonstration and Sales Office of Fellows Wireless Products. Wholesale and Retail.

FELLOWS WIRELESS

The Volutone Loud Speaker

gives really large volume of sound without sacrificing the quality of reproduction. The diaphragm is adjustable.

PRICE £4-10-0

DEPT. OF THE FELLOWS MAGNETO CO., LTD., PARK ROYAL, LONDON, N.W.1.

E.P.S. 970

In replying to advertisers, use Order Form enclosed.

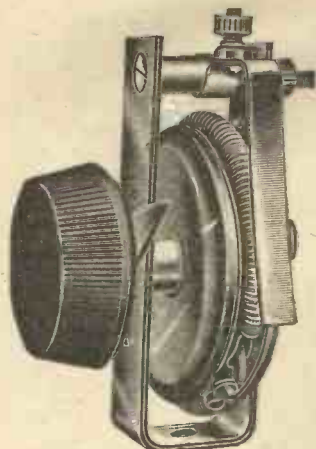

IGRANIC Filament Rheostat (Plain type).

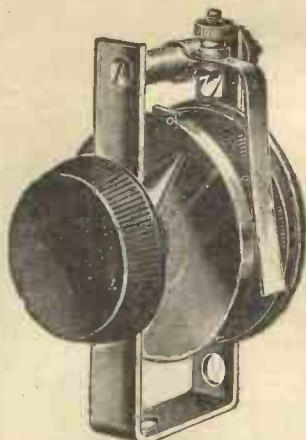

IGRANIC Filament Rheostat for D.E. Valves, 20-30 ohm.

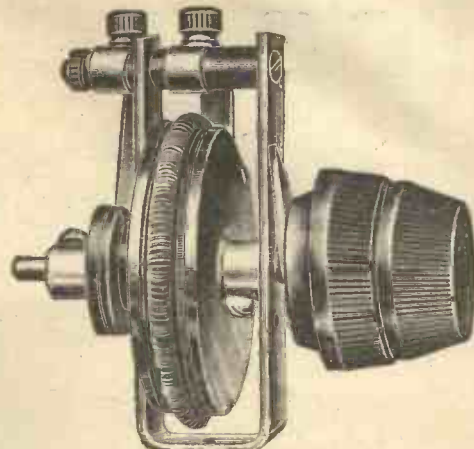

IGRANIC Filament Rheostat (Vernier type).



IGRANIC Auxiliary Rheostat.

A range of precise resistances

IGRANIC FILAMENT RHEOSTAT, VERNIER TYPE (Pat. No. 195903).

THIS instrument is admirable for the "control" of detector valves and critical control of regeneration. The brush and contact fingers are so mounted that the spring lies in the direction of the resistor, ensuring smooth, quiet and positive regulation. It is constructed for mounting on panels of from $\frac{1}{4}$ th to $\frac{1}{2}$ inch in thickness. Supplied with 4, 6, 8 or 10 ohms resistance. Packed in carton complete with fixing screws and drilling template for panel mounting. Price 7/- Ivorine scale for above 7/4d.

IGRANIC FILAMENT RHEOSTAT, (Plain Type).

This type Rheostat is suitable for high- and low-frequency amplifying valves and is recommended for controlling Dull Emitter Valves operated by 2-volt battery and also Bright Emitter Valves with 4 or 6-volt battery. Supplied with 4, 6, 8 or 10 ohms resistance. Price, packed in carton complete, with fixing screws and drilling template for panel mounting, 4/6.

IGRANIC FILAMENT RHEOSTAT For Dull Emitter Valves, 20 or 30 ohms resistance.

Designed for controlling all types of Dull Emitter Valves. It is smoothly and evenly variable over its whole resistance range and affords very fine selectivity. Suitable for controlling up to four valves, according to the type of valve used. Current carrying capacity 0.4 amp. Price, with screws and drilling template for panel mounting, either 20 or 30 ohms resistance, 7/-.

IGRANIC AUXILIARY RHEOSTAT, 25 ohms.

For joining in series with existing rheostats to obtain additional resistance for the control of Dull Emitter Valves. A hole is provided at one end to pass over the terminal of the Rheostat, and at the other end is fitted an adjustable clip with terminal. Any value of additional resistance up to 25 ohms may therefore be obtained. Easy to fit. No further control required. Price 1/3.

THE range of Igranic Rheostats gives you a choice for the control of every type of valve—from the extremely accurate Vernier Type for Bright Emitters to the auxiliary Rheostat which, when joined in series with your existing resistance, enables you to use a Dull Emitter Valve. They are built by Igranic craftsmen, who are famous the world over for the construction of electrical devices for the control of giant machinery. The wealth of experience gained thereby is reflected in the almost uncanny degree of filament control which you obtain from Igranic Rheostats.

ASK YOUR DEALER ABOUT THEM.

IGRANIC RADIO DEVICES include:—Honeycomb Duolateral Coils, Fixed Condensers, Filament Rheostats, Interval Transformers, Variometers, Vario-couplers, Bi-plug Coil Holders, Battery Potentiometers, Vernier Friction Pencils, etc., etc.

ALL CARRY A SIX MONTHS' GUARANTEE

Write for List Z 418.



149, Queen Victoria Street, London.

Works: BEDFORD.

Branches: BIRMINGHAM. CARDIFF. GLASGOW. LEEDS. MANCHESTER. NEWCASTLE.

These are the foundations of a BETTER set



IGRANIC "E" Type Transformer.



IGRANIC High Frequency Transformer.



IGRANIC-FRESHMAN Fixed Condenser.



IGRANIC Honeycomb Duolateral Coil.

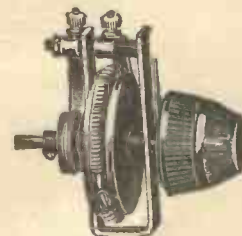

IGRANIC Rheostat (Vernier type).

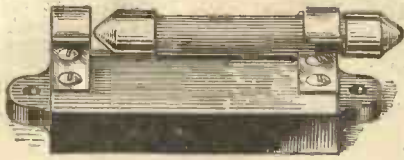

Fig. 1.—This caused a five-valve receiver to cease working:

Trouble Corner

By ADSUM

A Queer Problem

WHILST staying down in the country the other day I was consulted about a set by an agitated wireless enthusiast who explained that it was showing very strange symptoms. This set was used almost entirely for the reception of Bournemouth, that being the nearest broadcasting station. It was therefore left tuned to 385 metres, being switched on or off as required. What happened when it was brought into use was this. At the moment of switching on and for perhaps half a minute afterwards signal strength was quite up to the normal standard. Then a steady decline in the volume of sound set in, and eventually the loud-speaker was reduced to silence.

The Symptoms

I was told that the apparent remedy was to disconnect one of the high-tension leads for a moment, and that when contact was made once more signal strength would again be good, though the dying-away process would be repeated. The set I should say was a five-valver, the first two valves being high-frequency amplifiers, transformer coupled, and the last two note magnifiers, likewise transformer coupled. As soon as I heard of the symptoms I had an idea that the cause could be due to one thing only, though I decided not to say anything until I had been able to have a look at the wiring and the components. What cause would you have assigned for this rather

queer effect? Consider the facts that we have to go upon. There is a steady falling off in the output until the loud-speaker ceases to function. This may indicate a decline of some kind in the anode current. The decline might take place in the case of the last valve only, or one or all of the other valves might be affected. We can hardly imagine any high-tension

circuit of the rectifying valve; in fact, you can reproduce these symptoms exactly by using a hard valve as rectifier with grid condenser bit without a gridleak. Therefore from what I had been told I suspected that the gridleak might be at fault; this was the first thing that I looked at. Fig. 1 shows what was found on the underside of the panel. The leak had slipped, probably as the result of a jar, and was making no contact at all with the clips. During

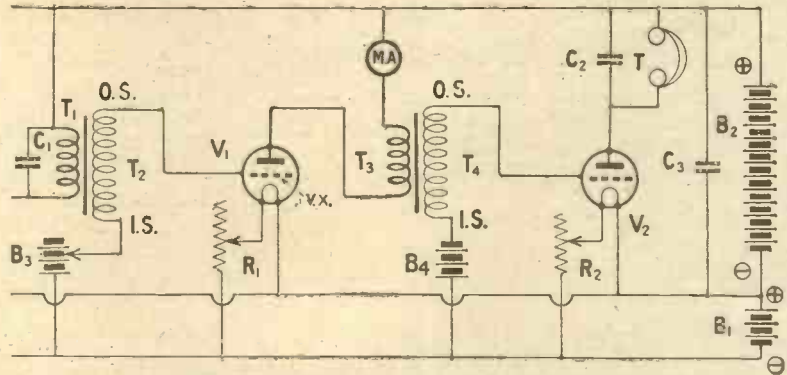

Fig. 3.—The milliammeter in the plate circuit of V₁ enables correct grid bias to be found.

battery becoming polarised so completely in a matter of thirty seconds that its output dropped to something negligible. And even if this had happened it would hardly be possible for the battery to become depolarised during the few moments rest given whilst it was disconnected.

Slack Filaments

The effect *might* be produced—I have actually known this occur once—by a very slack filament in one of the valves. If this were the case the static pull while the valve was working would possibly suffice to draw the filament out of position until it made contact with the grid. But if this were to happen there would not be a gradual decline to nothing in signal strength; the set would go out of action with a click as the filament made contact with the grid.

What the Trouble Was

The place where trouble is most likely to be found is in the grid

of the rectifying valve; in fact, you can reproduce these symptoms exactly by using a hard valve as rectifier with grid condenser bit without a gridleak. Therefore from what I had been told I suspected that the gridleak might be at fault; this was the first thing that I looked at.

No Gridleak

If there is no gridleak, the charge will continue to accumulate on the grid, making it steadily more negative. This means that the plate-filament resistance of the valve increases, with a consequent falling off in anode current, and if the process continues, practically nothing at all will be passed through the rectifier by the high-tension battery. An inspection of the characteristic curves of any valve will show the grid potential necessary with a given plate voltage to cut down the flow of current from filament to plate to a negligible value. Directly the high-tension battery is switched off, matters begin to right themselves.

Similar Cases

Though one does not often come

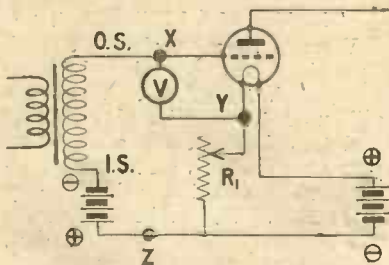
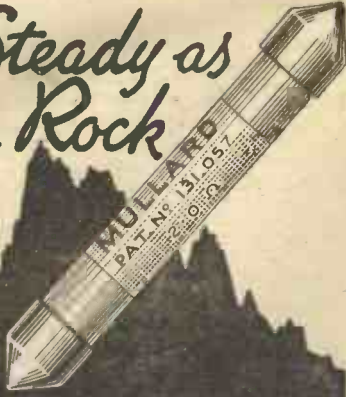

Fig. 2.—How grid potential may be measured. The voltmeter should have a high resistance.

Steady as
a Rock



**MULLARD
EVER-REST
GRID LEAKS**

are silent in use and constant in value. Absolutely unaffected by climatic conditions. Made in two types:

- (1) For grid leaks with suitable condensers; and
- (2) For Anode circuits of resistances amplifiers.

EVER REST Grid B .3 to 5 megohms, 2/6 each.

EVER REST Anode B .02 to 0.1 megohms, 2/6 each.

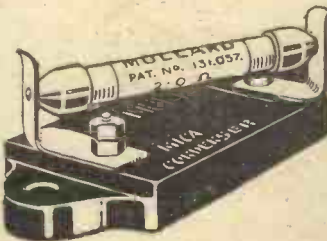

Complete with high standard and guaranteed exact capacity fixed condenser.

Grid B with .0003 mfd. Condenser Type M.A., 5/-

Mullard Condensers only

Type M.A.

.002—.004 mfd., 2/6 each

Type M.B.

.005—.01 mfd., 3/- each.



Adv. (Singapore), N.g.t.nga.e
Lane, Balham, S.W. 12.

across a case in which signals cease entirely owing either to the absence of a gridleak or to its having broken down, milder forms of the symptoms described are not at all uncommon. The effect of using a gridleak of much too high a value is to produce reception conditions which are very much like those of genuine fading. Owing to the large resistance of the gridleak which, though its stated value may be two megohms, may have a real value ten times as high if there is a total or partial dis-

working point is moved upwards towards the zero grid volts mark and—this is a very important point—needlessly overloading the high-tension battery. Too much results in distortion, if a strong signal takes the working point down on to the lower bend of the characteristic, and in weak signals, since it cuts down the flow of plate current to something smaller than is desirable. Most makers give the grid bias voltage necessary for their valves, and one can adjust it

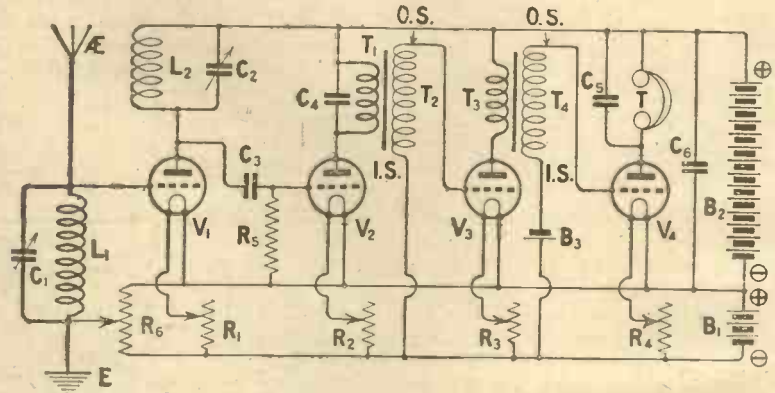

Fig. 4.—The circuit diagram of a receiver which was giving poor results.

connection inside it, the negative charge on the grid will build up more rapidly than it can leak away.

What Happens

We thus find that signal strength wavers, decreasing slowly as the grid charge accumulates and then going back to normal when it has leaked away. This state of affairs occurs not infrequently in resistance capacity coupled note magnifiers in which the values of the gridleak and condenser are unsuitable. Sometimes it may manifest itself in the form of a regular ticking, occurring several times a second or even at intervals of many seconds. Sometimes, again, there may be merely the unevenness in sound volume which has been mentioned. Personally I believe in using a gridleak of quite small value where resistance capacity coupling is employed for note magnifiers. This leak on my own set has a value of .5 megohm, and this, used in conjunction with a grid condenser of .005 μ F, gives very good results with all valves that I have tried.

Correcting Grid Bias

It is most important that the correct amount of negative bias should be applied to the grids of low-frequency valves. Too little means distortion, due to the flow of grid current which occurs when the

fairly accurately to the optimum point with the help of these, provided that both plate and filament voltages are known. I find that beginners are often rather troubled by this question of grid bias voltage, not knowing any means of finding definitely what is the best potential to apply. Here is a means of adjusting the grid voltage with great accuracy. It demands the use of that friend in need, the milliammeter, which, as I have said before, should form part of every wireless enthusiast's outfit, even if he possesses no other measuring instrument. If you wish to make sure that the grid voltage on your note magnifiers is right, and do not possess a milliammeter, you will be well advised to borrow one and use it in the way indicated. Fig. 3 shows how the instrument is used.

The Use of a Milliammeter

We will suppose that we wish to adjust the negative bias on the grid V.X. of V₁. Wire the milliammeter into its plate circuit and tune in as strong a signal as you can find. Start first of all by cutting out the grid battery altogether. You will find that the milliammeter registers a fairly high, steady current—it may be as much as 10 milliamperes in the case of a small power valve. You will notice, too, that its needle dips sharply

when certain sounds occur. The amount of the dip will depend upon the strength of the signal and the clearness of the speaker's enunciation. The same effect will be produced by loud musical passages and by strong high notes. The needle is moving mainly because partial rectification is taking place owing to the damping effect of the flow of current produced when the working point of the valve is carried up into the positive half of the curve. Now make the grid $1\frac{1}{2}$ volts negative by bringing a single dry cell into action. There will be a decrease in the steady plate current, and the dip of the milliammeter needle will be slightly less marked. Continue to increase the negative potential until the needle of the milliammeter remains almost stationary in spite of the modulation. In this simple way each of the note magnifying valves can be adjusted in turn to avoid distortion. For best grid bias, however, so as to reduce your plate current to the lowest efficient value, increase the grid bias until the plate current is reduced to practically zero. This, for example, may occur at 9 volts. Now halve this figure (i.e., $4\frac{1}{2}$ volts) and you have the best value for current consumption.

Large Cells

Theoretically, then, it should last indefinitely. In practice, however, it does not, especially if it consists of the smallest sized flash-lamp cells. Though they are called dry, these cells cannot work unless there is sufficient moisture in the jellified sal ammoniac solution which forms their electrolyte. In course of time evaporation takes place and the E.M.F. of the cells falls off, even though they are supplying no current, and are to all intents and purposes upon open circuit. I fitted a grid battery composed of two flash-lamp refills to a friend's set in March, 1924. I did not see it again until last January, when, as the set seemed to distort a good deal, I tested it out. The total voltage should have been 9, but actually it was rather under 3. On my own set I use two Ever-Ready No. 15 refills, which are made up of cells of large size. These are tapped, and leads are taken to the studs of a selector switch, so that the grid voltage may be adjusted readily. The present batteries were mounted in July, 1924, and their E.M.F. had fallen by the end of the year to 1 volt per cell or 6 volts maximum in place of 9. As the bias required with the valves in use is between 6 and 7 volts, this battery can still be used by placing

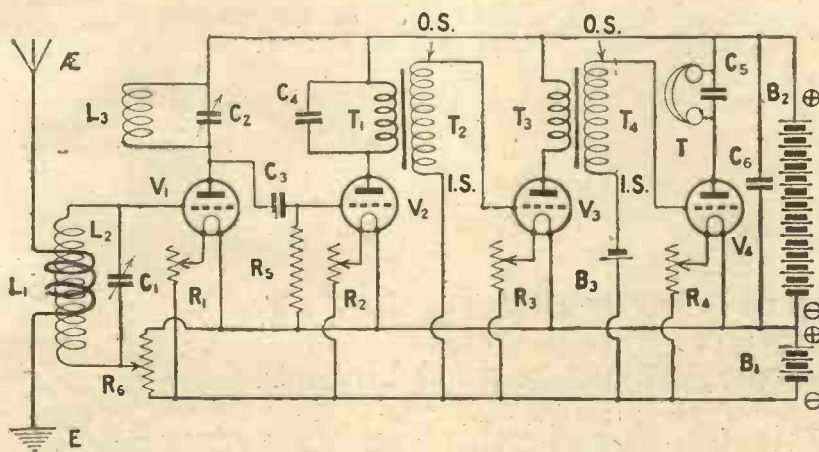

Fig. 5.—How the "deadness" in the Fig. 4 receiver was cured.

Grid Battery Trouble

It has often been said that the high-tension battery is the most neglected of all wireless components the average enthusiast giving it no attention at all and expecting it to last for ever. But I think that the grid battery is apt to be taken for granted even more than the high-tension unit. The load upon it is practically nothing at all, for if it is properly adjusted there should be no flow of grid current at any time.

the arm of the selector switch on the last stud. If, however, the battery had been a fixed one, the original 6 volts would have fallen off to 4 and there would be some distortion. In view of these facts, it is as well to use large cells for your grid battery and to put the voltmeter across them occasionally to see what their state is. If it is desired to ascertain the exact amount of grid bias that any valve is receiving, the voltmeter should be

Quality RADIO COMPONENTS.

Profusely illustrated twelve page CATALOGUE just out. If your dealer cannot give you one send us a card with his name and address to receive it direct FREE and POST FREE.

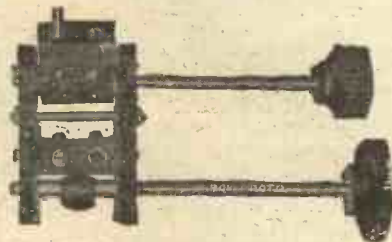

Prov. Protected.

CAM-VERNIER COIL HOLDER

Price 9/6, on base 1/- extra. With Reaction Reverse and Shorting Switch incorporated, 12/6. Postage 4d.

DUPLEX COILS

Postage 3d. each. Set post free.

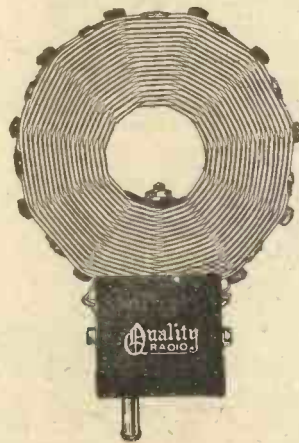

25	1/6
35	1/9
50	2/0
75	2/3
100	2/9
150	3/0
175	3/6
200	3/9

SWIVELLING COIL PLUG

for T.A.T. circuit. Type "J" 1/6 each. Postage 2d.



FIXED COIL PLUG

under panel connections. Type "D" 1/- each. Postage 2d.

GOSWELL ENGINEERING CO., LTD.,

123, PENTONVILLE RD., LONDON, N.1. Liberal Trade Terms. Phone: North 3051

placed across the points X and Y in Fig. 2, and not between X and Z, since there is a certain difference of potential between the filament leg of the valve and the L.T. — lead owing to the drop which takes place in the rheostat. This reading will be true only if the voltmeter is of very high resistance.

"Deadness"

I expect that you know what I mean when I speak of "deadness" in a receiving set. Signal strength is not very good, tuning is rather on the flat side, whilst the set can hardly be made to oscillate when you want it to do so. Stability is an excellent thing to aim at, but if you overdo it and produce deadness you have a receiver which is anything but a pleasure to handle. I came across one of these the other day. It was a four-valve affair, the circuit being as shown in Fig. 4. Both the A.T.I., L₁, and the anode inductance, L₂, were coils of an inefficient type, whilst the condensers in parallel with them were cheap affairs, badly designed and made of poor materials. So bad were the effects of damping and of losses that this receiver would not oscillate even with the slider of the potentiometer right over at the negative end. The owner wanted

to improve it, but desired to spend as little as possible in the process; hence it was of no use to suggest new condensers of better design and a fresh outfit of inductances. The only thing to do seemed to be to decrease so far as possible the damping introduced by the aerial-earth system into the grid circuit of the first valve. This was done very simply by winding sixteen turns of No. 22 S.W.G. D.C.C. wire round the outside of a plug-in coil and so producing an aperiodic aerial tuner (Fig. 5). Though it cannot be said that the set was anything like perfect, its performance was very greatly improved in this way:

Reducing Damping

Deadness in most sets can be cured by providing a double circuit tuner instead of a single circuit. If one works with a fairly loose coupling, aerial-earth damping in the grid circuit of the first valve can be reduced to something quite small, and the set will oscillate, provided that the inductances and variable condensers are not too utterly vile. If they are there is, of course, only one remedy, which is to scrap them and to substitute others. There are very few naturally stable sets which are

not considerably improved by the use of a double circuit tuner, which makes for great selectivity and enables very fine tuning to be done by means of small adjustments of the coupling between the A.T.I. and the C.C.I.

The "Double Circuit Neutrodyne Receiver"

SIR,—I write to let you know how pleased I am with the "Double Circuit Neutrodyne Receiver," by Mr. John Underdown, published in MODERN WIRELESS for November. Up to now I have received 14 stations, all at good 'phone strength, and Newcastle will work a loud speaker at decent strength. I live about 20 miles from Newcastle, and people who have heard my set say that it is the best 2-valve set they have heard. I decided to try another make of valve, but I have not improved it. The valves I have been using are general purpose dull emitters.—Yours truly,

H. BRANCHARD.

Bishop Auckland.

For Very Accurate H.F. Work.
PRICE 2/6



Where multi-valve receivers employ the same type and value of component for the interval coupling such as the Plug-In H.F. Transformer, condenser readings will be approximately the same. These will, however, vary to an extent governed principally by the fundamental capacities obtaining in the respective circuits. Unless each H.F. Stage is accurately tuned and balanced identically one with the other no signals may result; badly distorted reception, poor strength and the facility to fall into oscillation quickly will follow inaccurately tuned H.F. Stages.

COLVERN Tuning Condenser HELPS TO GET DISTANT STATIONS

Its low maximum capacity enables the accurate balancing of H.F. circuits. Each stage can be tuned up to perfect resonance and so remarkably controllable that during the operation of tuning the receiver may be kept from that point where it either heterodynes the incoming signal or falls over into violent self-oscillation.

The Colvern General Purpose Vernier enables you to separate signals working on approximate wave-lengths. Incorporate them into your existing set: And be certain to fit them to each new set you build.

Obtainable from your dealer. When ordering direct kindly give name and address of your dealer

COLLINSON'S PRECISION SCREW CO., LTD.
Maedonald Rd., Walthamstow, London, E.17 Tel.: Wal. 532

Barclays 728.

VELVET FILAMENT CONTROL

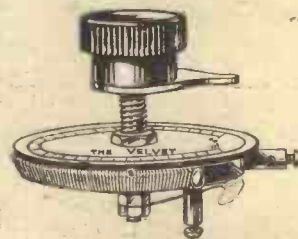

The Action of this Resistance is like Velvet. The usual harshness and grating have been entirely eliminated.

SPECIFICATION

The Resistance Bobbin is Eureka Wire wound, triangular shape for strength and durability, to the total resistance of 7 or 30 Ohms.

The Lamination is made from the finest Phosphor-Bronze, and is shaped to give a smooth and constant pressure on the resistance wire. This ensures perfect contact, perfectly smooth.

One-hole fixing for simplicity of mounting.

Insulated parts of finest Ebonite.

All fittings nickel-plated and polished.

The dial adds to the appearance of the finest set.

3/6

POST FREE

SECTIONS.

- 1—Shape of Lamination.
- 2—Section of Resistance showing formation.
- 3—Section of Ebonite Former shaped to take Triangular resistance wire.

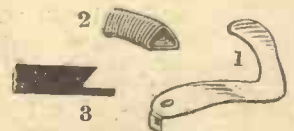

GUARANTEED 100 per Cent. Efficiency when fitted.

Manufactured by the firm who know technically what is required in the Radio World.

PUGH BROS., 95-101 HOLLOWAY RD., N.7.

**USED IN ALL THE
BEST CIRCUITS**

"GOLSTONE" (Regd.)

**LOW
FREQUENCY
TRANSFORMER**

**VALVE
RECEIVING
SETS**

**"GOLSTONE"
ONE VALVE
SET**

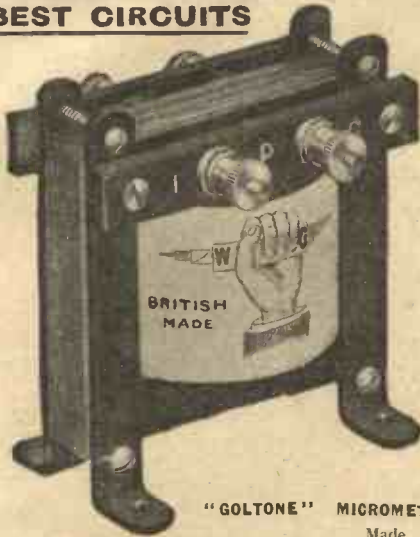

Size 3 1/2 in. by 2 1/2 in. by 3 3/4 in. deep.
Thoroughly recommended as a remarkably efficient Transformer for use in any circuit and with any type of Valve. Provides remarkable amplification with freedom from noise and distortion. No make of Transformer gives better results.
Ratio 5 to 1 and 2 to 1
Price 17/6.

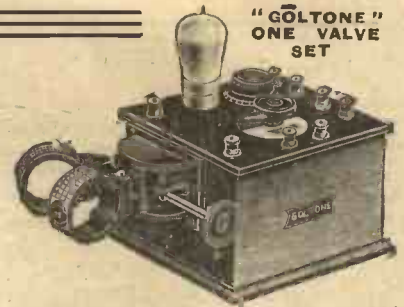

Elegant appearance. Highly selective. Simplicity in Tuning. Designed for receiving on any wave length. The "Golstone" One Valve Set gives excellent results and receives with remarkable volume and purity signals within a hundred miles radius. Price, including Coils suitable for B.B.C. Reception £2 18 0. Plus Marconi Patent Royalties 12/6. See Catalogue for particulars of Two, Three, Four and Five Valve Sets.

Large fully illustrated 32-page Radio Catalogue post free on request. Enclose Business Card or Memo heading for Trade Terms.

"GOLSTONE" MICROMETER REGULATING COIL HOLDERS.

Made from best quality Ebonite. Ensures the finest possible tuning, considerably increasing the Efficiency, Selectivity and Reliability of the Receiving Set.
Two-Coil Type 7/6. Three Coil Type 10/6. See Catalogue for other types.

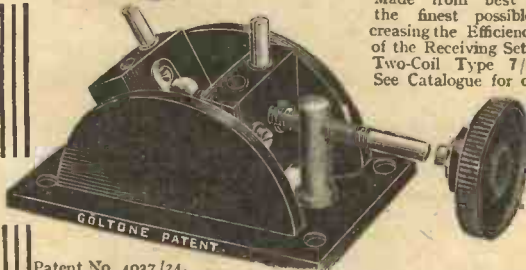

Patent No. 4037/24.

Ward & Goldstone
PENDLETON MANCHESTER LTD.

Address all communications to Head Office and Works:

PENDLETON, MANCHESTER.
STOCKS ALSO HELD AT GLASGOW DEPOT
95, PITT STREET.

"SAMPSON" ACCUMULATOR CARRIER.
Patent No. 214037/23.

Light, strong and exceedingly useful. Suitable for any size Accumulators. Folds flat to fit the pocket.
Price 2/6 each.
Warning. Rigorous action will be taken against infringements of this patent.

These lines are stocked by:
the leading Radio Stores.
Write direct if unobtainable.

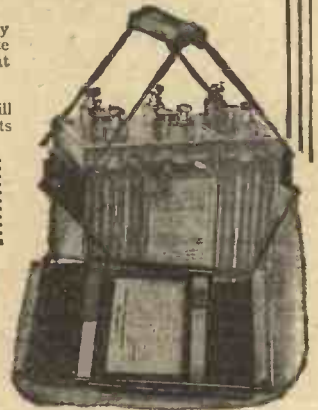

LOUD SPEAKERS

STANDARD	2000 ohms	£5 0 0
"	4000 "	£5 10 0
"	120 "	£4 15 0
JUNIOR	2000 "	£2 15 0
Black Crystalline or Black Satin Enamel.		
TOM-TIT	2000 ohms	30/-
Black Crystalline or Bright Stove Enamel.		

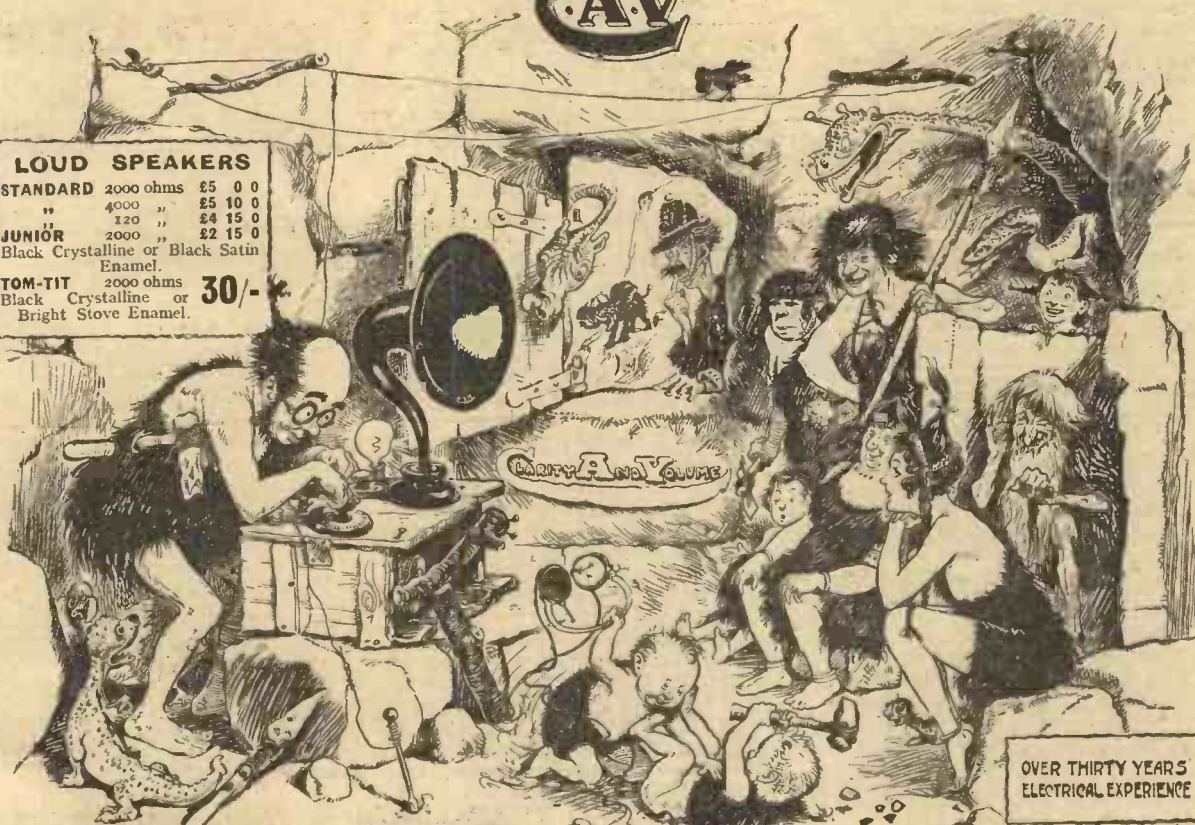

OVER THIRTY YEARS
ELECTRICAL EXPERIENCE

C.A. Vandervell & Co., Ltd.
ACTON VALE, LONDON, W. 3.
Members of the N.A.R.M.A.T.

IMMEDIATE DELIVERY 235

This refinement improves reception

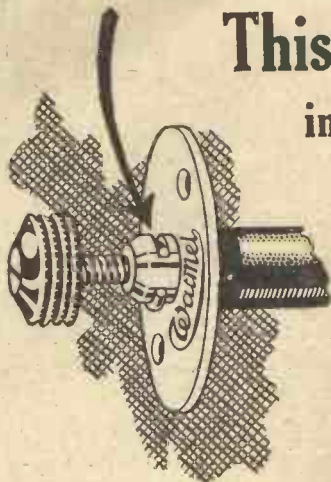

It is the little things that escape detection. A faulty connection here, and bad contact there—all play their damaging part in robbing your receiver of its fullest power and range.

Those experimenters who favour the use of the variable grid leak appreciate how it gives the final touch—clearing reception to make it rich, pure and round in tonal quality. The WATMEL is well known as the first variable grid leak which became available to the home constructor, and its consistent record for reliability to get the best out of the detector valve is without compeer.

Recessed into the collar a D shape spring presses firmly upon the controlling plunger. This device—truly a refinement which improves reception—ensures after constant use that the essential contact is always maintained electrically good.



All goods of our manufacture bear this mark. It is your only guarantee.

If you are troubled with poor results pay particular attention to the working of the Detector Valve. Reduce the H.T. voltage consistent with good volume, and incorporate THE WATMEL VARIABLE GRID LEAK.

WARNING!

The Watmel Wireless Co. wish to notify the trade and public that their Variable Grid Leak Application No. 206098 was contested in the Comptroller's Court, and on appeal; in both instances the Patent Grant was upheld and costs awarded.

It is the aim of this Company to protect traders', customers', and also its own interests by securing Patent protection for the novelties in its specialities, as it is these novelties, invented by experts and exhaustively tested, which are the Hall Mark of all Watmel Products.



Patent 206098

5 to .5 Megohms ... 2/6
50,000 to 100,000 Ohms 3/6

Other Resistances to suit any circuit.

Send P.C. for Descriptive Folder. SEE THE TRADE MARK



ON EVERY GRID LEAK. BEWARE OF IMITATIONS.

The WATMEL WIRELESS Co., Ltd.,
332a, Goswell Road, London, E.C.1.

Telephone

CLERKENWELL 7990.

Barclays 791

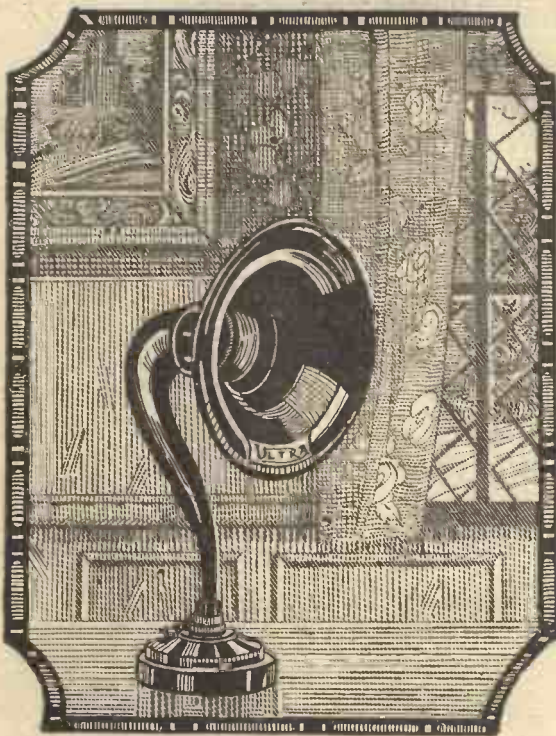

Perfect Music

YOUR set will give pure reproduction if it is fitted with an "Ultra," the loud speaker with a perfect tone and entire absence of shrill.

They take less current to operate efficiently than any other. Note, also, that they cost you less.

To ensure operating reliability they are fitted with an adjustment lever, conveniently placed in the front of the base.

Should you have any difficulty in obtaining same write direct to us with the name of your dealer.

27/6
ULTRA

Fitted with laminated pole shoes and magnetic shunt pass—which eliminates distortion.

Write for illustrated pamphlet post free on request.

E. E. ROSEN & Co, 158/160, City Rd, London, E.C.



Square-Law Condenser.

A NEW SQUARE-LAW CONDENSER

The Essential features of the Square-Law Type of Condenser are well known, but accuracy in manufacture is doubly essential to maintain their straight-line characteristics.

Capacities .001, .0005, .0003 and .0005 mfd.

With Vernier .001, .0005, .0003 and .00025 mfd.

Ask your wireless dealer to show you the whole series of

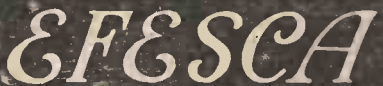

ONE-HOLE-FIXING COMPONENTS

Wholesale only:

FALK, STADELMANN & CO., LTD., Efesca Electrical Works, 83-85-87, Farringdon Road, LONDON, E.C.1



Efesca Tapped Aerial Tuner. Wave-length range 150-2,600 metres in conjunction with .001 condenser. Price 19/-. Incorporating studs and tapping Switch

The Radio Press Test Department

By R. TINGEY, M.I.R.E.

An interesting article by the chief of our Test Department in which a description is given of the tests which are applied to sets sent in by our readers.

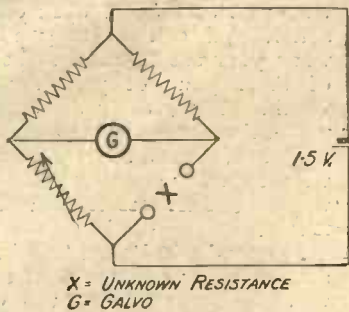

Fig. 1.—The method of determining the resistance of windings.

IT would be as well if both the public and the wireless manufacturers knew more details about our Test Department. I will therefore describe roughly the test that every set and component goes through.

The sets are delivered by hand at Bush House, or else arrive there by rail or post. They are then taken to our Test Department, which is situated about 6 miles from 2LO. Later we are moving this further out. At this end we have an experienced packer who unpacks the sets, books them in and fills up two test sheets with name and address, ties a label to the set and to every loose part that may come with the set, and marks the packing-case. The sets are then placed carefully on a rack in strict order so that they are tested in proper rotation.

Collection

The actual testing will be dealt with in detail after I have traced the set back to the owner, so for the moment I will say that it is tested, and the morning after the London ones are sent out again to the van, which takes them back to Bush House. Here they are again booked in; a card or letter is at once sent to the owner, informing him that his set is ready for collection. The sets that have to be sent by rail are packed at our works and a card or letter sent stating that they are ready for despatch. On receipt of a reply the sets are sent.

It has been found necessary to have a really experienced packer, as the transport is sometimes very severe on apparatus, and the number of instruments to be sent off has increased very much lately. Naturally, the supply of sets is not constant, and so there are periods when we are up to date with our work and others when we are behind. The time of three days, as published, is the minimum necess-

ary, that is, assuming we are up to date with the work and that the instrument has not a difficult fault. On an average the sets are two to three days at our Test Department, that is four to five days to the time they leave, providing a week-end does not intervene.

Now, having looked at the black side of things, we will follow the testing of the set and see if this detention is not worth while.

A Common Fault

The instrument that is next for test is taken in the morning and the wiring checked. Here it is of interest to note that we get very

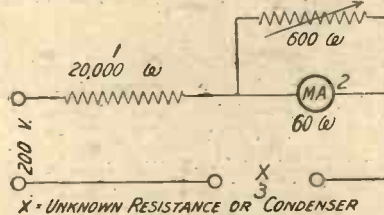

Fig. 2.—How high resistances are measured.

few sets indeed that are wrongly wired. The most common case of wrong wiring is on the "Puriflex." On this set there is a resistance shown from grid of first valve to L.T. and in the article it is stated that this resistance need not be used. The result of this has been that any number of readers have joined a wire across where this resistance was drawn. But what was intended was that the resistance should be taken out and nothing joined in its place. The effect of this mistake is to put the set entirely out of action.

Next, the resistances of the transformers are measured on a Wheatstone bridge, using 1.5 volts (Fig. 1). We get a large number of transformers having defective primary windings, and we should be glad if manufacturers would take

note of our method of testing those transformers and other parts. In most cases these transformers show no fault on the "megger," that is, the 500-volt test, so it is clear that a more delicate test is necessary.

"Leakage" Test

Next, the resistance of the potentiometer is measured, as is also any other low resistance there may be on the set. This finishes the Wheatstone test.

The set is then passed on for "leakage" test. This is not done on a "megger" for the reason given above. In addition there is difficulty in testing for a leak on a large condenser with a "megger," as it cannot be turned steadily enough to eliminate the continual charge and discharge as the speed is varied. Leaks are tested with a 200-volt H.T. battery (Fig. 2) connected in series with:—

1. A constant wire resistance of 20,000 ohms.
2. A 60-ohm microammeter shunted with a variable resistance of maximum value 600 ohms.
3. The leak under test.

Defective Grid Leaks

A simple calculation gives the amount of deflection with a given shunt for a given leak. By this

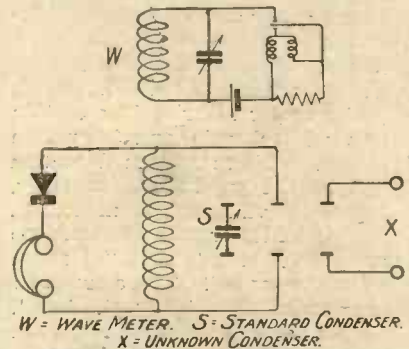

Fig. 3.—Method by which small condensers are tested by comparison with a standard.

method leaks up to 100 megohms can be traced, and also leaks can be measured across large condensers as the supply is absolutely constant. Anode resistances are also measured in the same manner. I have come across some anode resistances that show a break by this method which, however, does not show on the "megger." So I hope that firms who get a part back through our test will benefit by knowing our exact method of testing.

Several grid leaks that do not make contact or that do so intermittently have been injured by attempting to solder a lead on to them, and so breaking the maker's connection. Many a grid leak that we have had makes contact when the caps are turned or strained in a particular direction, through no fault of the makers, but through the constructor attempting to solder a lead on to it.

Bad Soldering

When we find leakage which appears to be in a component, we unsolder the leads from this component and test again to find out whether it is the component at fault or a leak somewhere else on the set. The chief trouble with leaks that are not desired has been traced to certain leaks on the panel and switchboard owing to a layer of flux caused by bad soldering. The average constructor would do well to read our articles on soldering with greater care, especially with regard to the amount of flux used. The ebonite itself is seldom bad, and in no cases has it been found to be where it has been bought from a reliable firm. All the panel leaks have been surface leaks due to the panel not being clean.

Capacity Measurements

The large condensers are next tested for capacity. By "large" I mean from .01 microfarad to 2 microfarads or more. These are tested on the instrument just described for measuring high resistances. The condenser is first discharged and then the high-tension suddenly switched on. The needle of the meter will rise to a certain value while charging and then return to zero. This maximum deflection varies with every different capacity, and so the value can be measured.

Then all the small condensers are measured. By "small" I mean .0005 to .01 μ F. These are done in a wireless circuit (Fig. 3). A coil, phones and crystal are placed across the condenser and the wavemeter tuned to the resulting frequency. Then a standard variable is inserted in place of the one

under test and varied until signals come in again. In this connection the fault most common is as follows. First the condensers have two screws each side, thus Fig. 4: The connection from the strip to the condenser is made by the maker by soldering the condenser end to the bottom of screw No. 1, and so if the constructor undoes screw No. 1, the connection to the condenser is broken and the component is then useless. Screw No. 2 is the correct one for making contact.

Faulty Condensers

But this is not the only fault of small condensers. In this connection it is most important to go only to the best makers. A batch of condensers we had lately were all about .0005, whereas some of them were labelled as high as .002. This is quite enough to put the set entirely out of action, and in the particular case referred to it did so.

We now examine the wiring for faulty connections and bad soldering, or, as it is called on the test sheet, continuity of circuit.

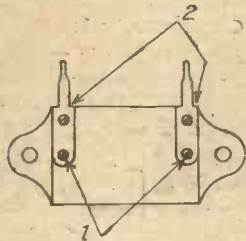

Fig. 4. — The two screws marked 1 should not be tampered with.

Badly soldered joints are common and not always easy to spot. Faulty connections to the variable plates of the condenser are also common. But what is still more usual and more subtle is a very common fault of some anti-capacity valve holders, again no fault of the makers but of the constructor. The spring connections are held on by screws from the underside. The constructor, when soldering, allows these securing bolts to warm up the surrounding ebonite through contact with the hot iron, which material in the case of these holders does not contract to its former size and so allows the screw to come loose, making only partial contact with the spring.

Aerial Tests

The set is now put on another rack for aerial tests in the afternoon when the broadcasting stations are on. Now you will no doubt think that a set, after being through these tests, is bound to be O.K. on the aerial. Far from it. If it were so our job would be easy and delay on your sets less frequent. We come

across many sets that pass all these tests and still won't work on the aerial. I can assure you that when your set happens to be one of these you get your money's worth. The greater the delay it means the more time we spend on it. Although, instead of greater praise, we get greater slanging and sometimes even solicitors' letters. Such is life!

Among the faults not found until aerial tests is self oscillation due to certain wires being too close to one another, or the two condensers, or the two halves of a double condenser, being too close together for the particular circuit: both subtle faults and hard to trace.

Lastly, we get the set which simply says "no signals," and it passes through its tests with flying colours. The signals from Birmingham or Aberdeen could knock one out of the room. What are we to do with it?

Conclusion

When you get such a report although perhaps it may seem unsatisfactory to you, your set has had the same amount of work put on it as others, and at least you know where *not* to look for your fault.

I hope this article will firstly give you still greater confidence in our Test Department. Secondly, save some of your expense and trouble by pointing out likely faults; thirdly, make you a little more patient; and please remember that we like to hear from you when we have been of assistance. It is easy to write when you have a complaint, but it gives encouragement to us to hear from those hundreds of cases where we have been of real assistance.

Later I hope to give you more details of the testing instruments themselves.

QUERIES.

Owing to the enormous increase in the queries received as a result of the publication of our new magazine, "The Wireless Constructor," the queries department is temporarily unable to deal with further queries, although every effort is being made to provide further facilities and new staff.

March, 1925

MODERN WIRELESS

Louden Valves



Filament Volts 4.8-5
Filament Amps. 0.4
Anode Volts 40-80



"A thousand melodies unheard before."—Roger.

If you would appreciate to the full the delicate texture and beauty of stringed music, fit your set with Louden Valves.

They have a long life. They are economical to use, and they cost only ten shillings; but their outstanding quality is the "Silver Clear" reproduction which they give.

No other valve made combines all these advantages in the same degree.

That is why the Louden Valve is coming so rapidly to the forefront of popular favour.

Fit them in your set, and you will be delighted with the results.

The Plain Louden for Detecting and Low Frequency Amplifying.

The Blue Louden for H.F. Amplification.

All Loudens are Silver Clear and free from "mush." Their current consumption is very low and their life long.

Price 8/6.

Louden Valves - Silver Clear

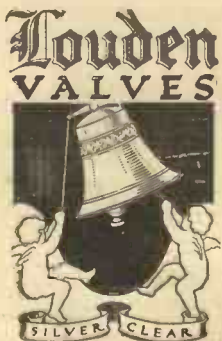

ADVT, OF THE FELLOWS MAGNETO CO., LTD., PARK ROYAL, LONDON, N.W. 10 E.P.S. 41.

In replying to advertisers, use Order Form enclosed.

Can you do this one?



One free "Powquip" Transformer (Shrouded Model) will be given for each of the first twelve correct solutions opened on the morning of the 12th March, 1925. Send your solutions with your name and address, written clearly at the foot of this page, to the address below.

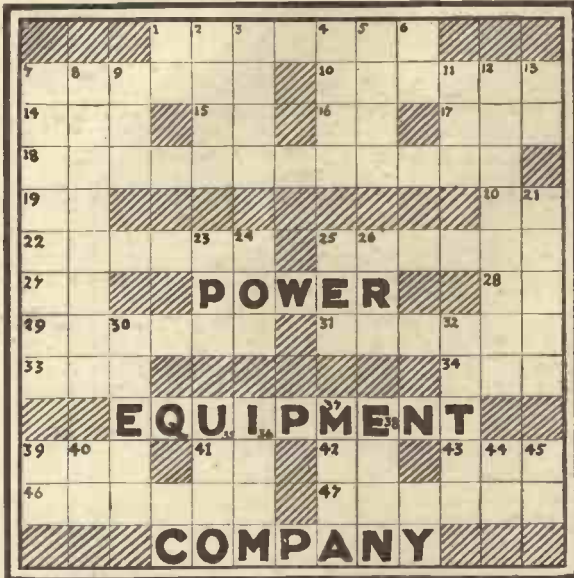

- Down.**
1. A "pub" without you.
 2. Food for horses.
 3. The weft.
 4. Employer.
 5. Entry.
 6. Father.
 7. Troubled.
 8. Annoy.
 9. Meadow.
 11. Spoil.
 12. Small firearm.
 13. Road abbreviated.
 21. Curiously.
 23. Found in the Zoo.
 24. Neither.
 25. Favourite.
 26. Period of time.
 30. The choicest.
 32. Locations.
 35. To.
 36. Separate detail.
 37. Easily split mineral.
 38. English town.
 39. 3rd.
 40. Consonant.
 44. Preposition.
 45. "Its" beheaded.

- Across.**
1. The best Transformer for the best set.
 7. Town in Spain.
 10. Impresses.
 14. Found in the earth.
 15. Preposition.
 16. Behold behold.
 17. Small island in a river.
 18. Our speciality.
 19. Signal of attraction.
 20. Towards.
 22. Pertaining to Mount Etna.
 25. Interval of time.
 27. Egyptian Sun God.
 28. Ancient beheaded.
 29. Engraver.
 31. Hanging ornament.
 33. Colour reversed.
 34. Sympathy beheaded.
 39. Vegetable.
 41. Two-thirds of a ton.
 42. Impersonal pronoun.
 43. Feed.
 46. Lodger.
 47. Sea borders.

THERE will be no more cross words if you fit "Powquip" Low-frequency Transformers in your set. Each transformer is fully tested before and after assembly, and on a standard aerial. Guaranteed for twelve months.

Open Type, 14/6. Shrouded Model, 18/-

The **POWER EQUIPMENT COMPANY LIMITED**

KINGSBURY WORKS, THE HYDE, HENDON, N.W.9

SHIPTON PRODUCTS

The SHIPTON NEW TYPE VARIABLE GRIDLEAK

Here is another SHIPTON efficient unit. Mechanically perfect and thoroughly tested by experts to secure maximum and uniform efficiency.

Silent in operation. Constant under different settings.

Can be calibrated accurately. Reliable under all conditions.

Price 3/-

You cannot afford—if it is good reception you want—to risk an unreliable grid leak. Be certain of what you are buying. Get a SHIPTON—you can't go wrong.

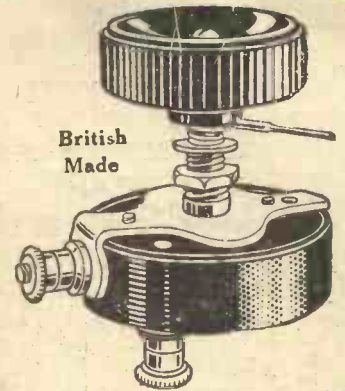

FARADAY HOUSE LABORATORY TEST REPORT. No. T/252/H.

The gridleak submitted was tested for resistance at various positions of its handle, and the resistances varied continuously from 0.5 megohms to 6.5 megohms.



- SHIPTON New Type STRIP RHEOSTAT 7 ohm (with fuse) 3/-
 - SHIPTON New Type STRIP RHEOSTAT 30 ohm. . . 3/-
 - SHIPTON New Type STRIP RHEOSTAT 60 ohm . . 3/-
 - SHIPTON POTENTIOMETER 600 ohm 4/6
- Packed in neat Huetette boxes.

The SHIPTON New Type Strip Rheostats

THE MOST PERFECT RHEOSTAT YET INTRODUCED is the SHIPTON. A specially designed spindle gives one-hole fixing and incorporates a tension spring which ensures perfect electrical contact at all times; terminal connections are provided. The 7 ohm Model is fitted with a fuse, which little device may save you the cost of an expensive valve. In operation they are noise free—quite an important consideration. As used in various Radio Press Receivers.

Do not forget the SHIPTON Potentiometer. Incorporate Shipton Rheostats, the Shipton Potentiometer and the Shipton Grid Leak—your valves will then be efficiently controlled.

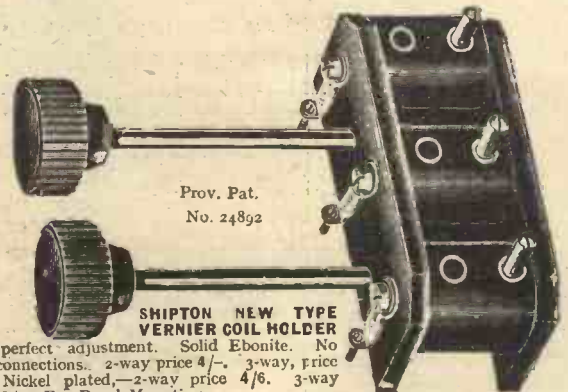

Prov. Pat. No. 24892

Gives perfect adjustment. Solid Ebonite. No loose connections. 2-way price 4/-, 3-way, price 7/6. Nickel plated,—2-way price 4/6, 3-way price 8/-. For Panel Mounting.

E. SHIPTON & CO. LTD.

37, TOTHILL STREET, WESTMINSTER, S.W. 1.
Telephone: Victoria 3171. Telegrams: "Rentfones, Parl."
Also at 14, KING STREET, COVENT GARDEN, W.C.2.
Trade Enquiries Invited.

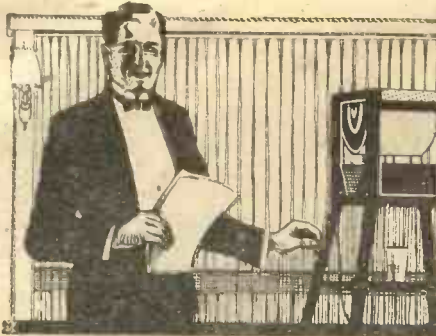

Radio Press News

A description of the latest Radio Press publications.

OF the various new publications of Radio Press, Limited, which have just appeared, of special interest to the readers of this magazine will be "Six Simple Sets" (R.P. Series No. 21), by Stanley G. Rattee, M.I.R.E., Staff Editor. This book, the latest addition to the Radio Press constructional series is certain to become extremely popular, selling, as it does, at the very modest price of 1s. 6d. (or 1s. 8d. post free). This little book contains a wide variety of extremely carefully selected designs, every one of which can be depended upon as a thoroughly practical and well-tested instrument. In Chapter 1, for example, will be found the fullest possible details for constructing a very simple, cheaply made crystal set of high efficiency, which is suitable both for the ordinary broadcast band of 300-500 metres and also for the reception of the high power station.

Valve Sets

In Chapter 2 there follows a similarly detailed description of a single valve set of very practical and efficient design using ready-made components throughout.

This little receiver was first described in *Wireless Weekly*, and many readers have reported obtaining excellent results with it, even at quite long distances, and it can be recommended to those who like to obtain the maximum results from the simplest of apparatus.

The contents of the book are progressively arranged, passing through a two and three valve design to a quite ambitious four-valve broadcast receiver which forms the last chapter. Simple every set certainly is, but no one should be deterred from obtaining the book by the feeling that probably they have been so simplified as to be lacking

in the efficiency which everyone demands in his receiver. On the contrary, the simplicity is that which results from skilful design, in the leaving out of non-essentials, the arrangement of the parts, and so forth of each instrument in such a way that it becomes as easy as

new and have never appeared elsewhere.

Valuable Features

A notable example of the new designs is that of the four-valve set already mentioned, in which a particularly simple but efficacious method of switching has been incorporated, which permits any combination of valves to be used, from one up to the full number, without the loss of efficiency which so commonly results from such an arrangement.

A particularly valuable feature of this book is that it may be regarded as a complete course of instruction in set building, in the sense that a complete novice might very profitably start by building himself the crystal receiver in the first chapter, and then gradually progress through the book as his experience widens, with the minimum of expense, since a design is included for a two-valve low-frequency amplifier which, although intended primarily as a power amplifier, can be regarded equally well as a perfectly standard low-frequency magnifier. Thus, the constructor can build either the single valve set already mentioned, or the Two Valve "Universal" receiver described in a later chapter, which consists of one high-frequency valve and detector, and add to either the low-frequency amplifier in question to permit of loud-speaker reception. This book is now on sale.



One of the receivers described in "Six Simple Sets," which has many stations to its credit.

possible to handle, thus permitting even the beginner to obtain the best possible results from the set. Certain of the designs have already appeared in *Wireless Weekly* and many favourable reports have been received from readers who have built them, while others are entirely

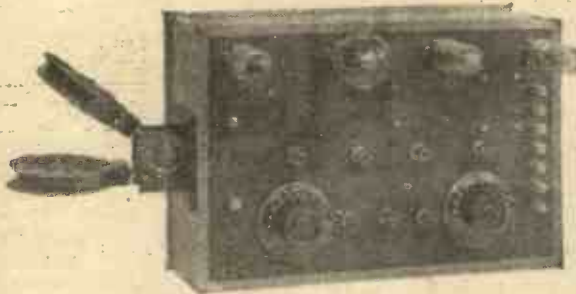

An efficient four-valve receiver suitable for family use, full constructional details being given in "Six Simple Sets."

The Omni Receiver

The four new publications described last month have now all been on sale for some time, and are meeting with an extremely rapid demand. Readers who have not already ordered their copy of the one that interests them should lose no time in doing so.

The readers of MODERN

WIRELESS have been quick to realise that the *Wireless Weekly* Omni receiver, described by John Scott-Taggart, F.Inst.P., A.M.I.E.E., in Radio Press Envelope No. 5 (price 2s. 6d., or 2s. 9d. post free) provides the ideal solution to the problem of an experimental set which shall yet be of pleasing appearance, and soon there will be f.w. experimenters who do not possess one of these marvellous receivers.

The Two-Valve Amplifier de Luxe

Those experimenters who favour the semi-unit system of construction in which one has perhaps a separate tuner, a high-frequency amplifier and a low-frequency amplifier, have been quick to avail themselves of the advantages conferred by Radio Press Envelope No. 7 (1/6, or 1/9 post free) in which Herbert K. Simpson describes the two valve low-frequency Amplifier de Luxe. They are finding this amplifier most valuable as a standard part of their equipment, since it can be added to any set which does not already possess low-frequency amplifying stages,

and can equally well be regarded as a power amplifier of extremely good capabilities. Those already possessing receivers capable of giving headphone results are also building this amplifier, since it enables them to convert their set into a loud-speaker outfit with the minimum of outlay and, furthermore, in a highly efficient manner.

The A.B.C. Wave-trap

The interference problem is still with us, but the A.B.C. Wavetrap described in Radio Press Envelope No. 6 (1s. 6d., or 1s. 9d. post free) by G. P. Kendall, B.Sc., Staff Editor, is likely to go far to solve it, so far as interference by a local B.B.C. station is concerned. Extremely favourable reports from constructors have already been received, and our readers appear to be realising that the cost of construction of such a simple instrument as is described in this Envelope is a very good investment indeed, providing, as it does, a solution in the great majority of cases of the problem of long distance reception during the operation of a local station.

The "Improved Two Valve Set"

SIR,—I have much pleasure in sending report of success obtained with the "Improved Two Valve Set" by Stanley G. Rattee, in MODERN WIRELESS January issue.

On an ordinary single wire outdoor aerial 70 ft. long, 30 ft. lead in, we received Manchester, Liverpool, Birmingham, Chelmsford on loud-speaker moderately loud. All the B.B.C. stations including relay stations good 'phone strength. We consider it exceptionally good to get four stations at loud-speaker strength on a two valve set. We are 21 miles from Manchester and 30 miles from Liverpool and greater distances from Birmingham and Chelmsford.

I thought you might be interested to know our results.

Thanking you for your valuable information given in MODERN WIRELESS and *Wireless Constructor* from month to month.—Yours truly, J. and J. E. KETTLE. Northwich, Cheshire.

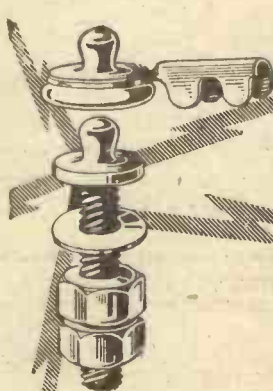

Take the WORRY out of Wireless

CONTENTS OF COMPLETE SET.

- 8 Terminal Studs
- 6 Multi-Connectors
- 4 Coloured Connectors
- 8 Discs (Black, Red and Blue)
- Phones + Phones —
- High Tension + High Tension —
- Low Tension + Low Tension —
- Earth Aerial

Complete with instructions.

When you build up your set—or re-wire it with Newey Snap Terminals—you straight away take all the small worries out of wireless. With a slight pressure of the finger perfect contact is made and any number of head-phones can be coupled together, one above the other, on the same connection.

Experimental sets can be easily built up and changed time after time with Newey Snap Terminals, obviating as they do the mess and uncertainty of wiring not perfectly soldered,



PETTIGEW & MERRIMAN, 124, Tooley Street, LONDON, S.E.1.

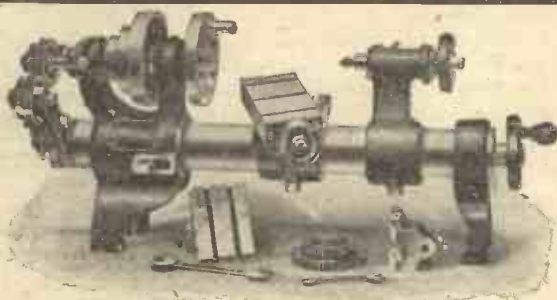

To all Experimenters

the ideal tool for all-round utility, wide scope and genuine worth is the

DRUMMOND 4-in. Universal Lathe

Besides all turning and screw-cutting, this Lathe with its circular bed, slicing saddle with slotted face, and the slotted and swivelling top slide, enables thousands of milling, drilling, boring and facing jobs to be performed speedily and accurately. Our lists give full details: Price only £9.

DRUMMOND BROS. LTD., REID HILL, GUILDFORD

—Post this Coupon—

Please send me list of Name
4-in. lathe, with details of deferred payment system. Address

(Send in unsealed envelope for 4d.)

Paraffin Wax—Its Proper and Improper Uses.

By J. NELSON.

PARAFFIN wax is a material which is largely used by wireless amateurs, so that a description of its properties may be of considerable use.

It is a residue or distillate from shale oil.

Normally it is sold as "Refined" or "Double Refined" as well as classified by its melting point, which varies from 110 degrees F. to 140 degrees F. It is usually graded under its various melting points, as follows:—118 degrees to 120 degrees, 125 degrees, 130 degrees, 132 degrees and 140 degrees.

How to Heat the Wax

Of these it is preferable to choose a wax between 120 degrees and 132 degrees. This is found best for insulating purposes, as it does not become brittle upon cooling at ordinary temperatures. Wax which has a high melting point, such as 140 degrees, is apt to be very brittle and develop cracks when cold.

In the past it was considered that paraffin wax was a permanently stable chemical body, but recent research has proved this to be erroneous. It will change its properties very easily with improper use, incorrect melting being an easy way of destroying its good qualities.

The only safe way to melt paraffin wax for amateur use is over a water bath, as by this means the temperature cannot exceed 212 degrees F. Overheating must be strenuously avoided.

For the best work the wax should be melted just before use, and must *not* be kept heated for a longer period than necessary. It is also necessary to keep it from the light as much as possible, as prolonged exposure to light tends to cause it to deteriorate.

When it is desired to impregnate such fine articles as telephone coils, etc., it is better to start with new wax, heated slowly under the above conditions, and after it has been used, say, for three meltings, to discard it. It need not be thrown away, as it can be used for other purposes. It is so cheap that it is not worth while running any risk when dealing with delicate windings

Not Waterproof

A very popular idea about paraffin wax is that it is waterproof, but this idea requires a good deal of qualifying. If a piece of wood or cardboard be impregnated in wax it certainly attains the property of throwing off water, and this largely by the greasy nature of its surface. This property has made it popular for use as an impregnating substance for articles which have to be exposed to the weather. From the electrical standpoint, paraffin wax can only be considered as a substance which is *not* non-hygroscopic, *i.e.*, it has a definite property of absorbing moisture into its mass.

If, however, a piece of cardboard or wood be dried, impregnated with wax and then exposed to the atmosphere, it will be found that its insulating properties fall rapidly, more especially in a humid atmosphere. This may be helped by capillary attraction or imperfect junction between the wax and the fibres of the material.

It is a common practice to immerse coils, etc., just as would direct in molten wax; this means that the article has to be kept

submerged until all the moisture is driven off. It will easily be understood that this is not a good practice, as it means keeping the bath hot for a longer period than necessary.

Before impregnating, all articles should be very thoroughly dried. This does not mean that they can just be warmed, but that they should be heated gently to the temperature just over 212 degrees F., if at ordinary atmospheric pressure. *In vacuo*, of course, a lower temperature may be sufficient.

Adding Ingredients

It is very unsafe to add other ingredients to paraffin wax, as its electrical properties may thus be considerably modified.

Ingredients may be added, such as colouring matter, when the wax is only to be used for finishing off the braiding on cables, partially waterproofing, etc., and for this purpose wax which has been discarded as unsuitable for fine coil use can safely be used.

A bad characteristic of wax is the facility with which it collects dust, and the difficulty or impossibility of removing this dirty layer from the waxed surface.

As a test of moisture in an article, dip it in wax heated to just over 212 degrees F. If the article is damp the wax will froth. If it is simply the air being driven out of the pores, say in cardboard which is dry, bubbles only will appear on the surface.

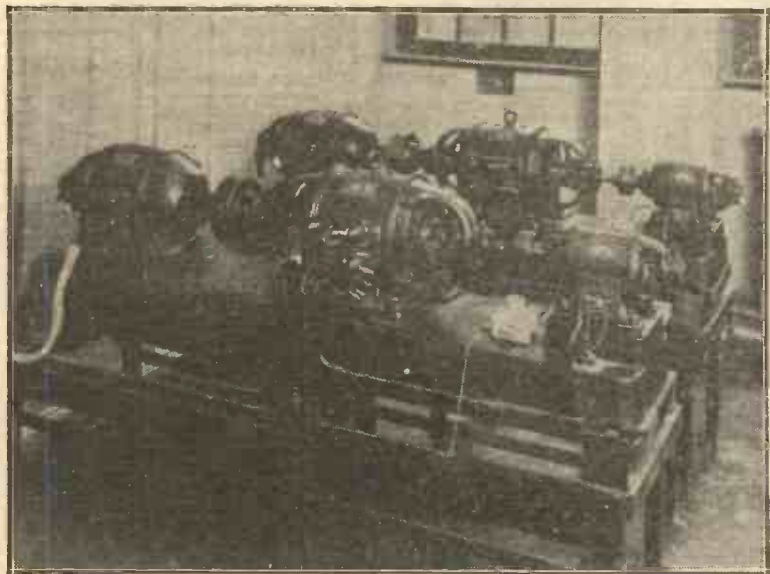

Our photograph shows part of the generator room at the Hamburg broadcasting station, which transmits on a power of 700 watts. This station is frequently heard by listeners in this country.

HULLO EVERYBODY!!

REVOLUTION

IN VARIABLE CONDENSERS
SQUARE LAW LOW-LOSS
 (SQUARE-LO-LOSS)
 WITH VERNIER.

NOTE
 LO-LOSS
 BUSHES

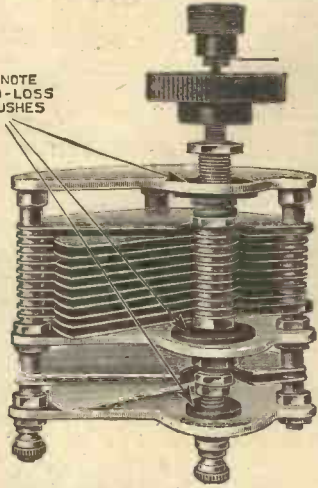

The only Condenser with the **Low-Loss Bushes**. Electrical losses reduced to a minimum.

Full capacity as rated.

Exceptional Low Capacity.

The Condenser for short wave-lengths.

Why buy a Condenser without Vernier when one **WITH** costs no more?

SQUARE LAW	.001	8/9
WITH VERNIER.	.0005	7/9
Including Knob and Dial (Ebony Ends 1/- extra).	.0003	7/-

TRADE SUPPLIED. Post 6d. Set.



"DE LUXE" MODEL

As shown, with Dial, Knob and Bush.

.001	6/11	.0003	5/-
.0005	5/6	.0002	4/9

Post 6d. Set.

Unsurpassed for fine tuning.

"NEW MODEL"

STARTLING REDUCTIONS.

ORDINARY	SQUARE LAW	Ebony Ends 1/- extra.
Aluminium Ends, Ebony Bushes.	Aluminium Ends, Ebony Bushes.	All complete with Knob and Dial. Post 6d.
.001 .. 6/8	.001 .. 7/6	set (3 sets 6d.)
.0005 .. 5/-	.0005 .. 5/9	
.0003 .. 4/6	.0003 .. 5/3	



TWIN CONDENSER SQUARE LAW

Ebony Ends.	.0025	12/6	.0003	12/6
	.0005	18/11		

Complete with Knob and Dial. Post 6d. set.

SQUARE LAW	STANDARD
.001 .. 9/6	.001 .. 8/6
.0005 .. 8/-	.0005 .. 7/-
.0003 .. 6/9	.0003 .. 5/9
.0002 .. 5/6	.0002 .. 5/-

Other sizes as advertised by "J.B." Post 4d.

CALLERS! THESE 4 COLUMNS FOR YOU NO POST ORDERS FROM SAME

Warning! Note name **RAYMOND** on windows. You will not be able to buy these goods otherwise. Nearest Tube Leicester Square. This address is at the back of Daly's Theatre. Open Weekdays 9 to 8, Saturdays 9 to 8.45, Sundays 10 to 1.

ACCUMULATORS
 2 v. 40 amps. .. 9/6
 4 v. 40 amps. .. 16/8
 4 v. 60 amps. .. 18/8
 4 v. 80 amps. .. 23/6
 6 v. 60 amps. .. 27/8
 6 v. 80 amps. .. 33/-
 6 v. 105 amps. .. 38/6
 Hart's Stocked. All High Quality.

EBONITE, 3/16 in.
 Stock Sizes.
 Cut to size 1d. 51. in.
 6 x 6 .. 1/4
 7 x 5 .. 1/4
 8 x 8 .. 1/10
 9 x 6 .. 2/-
 10 x 8 .. 3/-
 12 x 6 .. 3/-
 12 x 9 .. 4/3
 12 x 12 .. 5/8
 14 x 10 .. 5/8
 1/2 in. also Stocked.

Switch Arm, 12 Studs, 12 Nuts, 12 Washers.
 Lot 101d.

TAPPED INDUCTION COIL
 for Chelmsford.
 A Real Bargain 1/6

WEDGE COIL PLUGS
 Fitted Fibre 7d.
 Various 7d., 8d., 9d.
 Edison Bell .. 11d.
 Plaincoil Plugs .. 4d.
 Also 5d., 6d., 7d. each.
 Fibre Strip .. 2d.
 (38 in. by 1 in.).
 Empire Tape, doz. yds. 6d.

RAYMOND FIXED CONDENSERS
 .001, .0001 to .0005 10d.
 .002, .003, .004, 1/-
 .006, 1/3; .01, 1/9;
 .02, 1/9
 Ebony Base Terminals.

DETECTORS
 (Enclosed).
 Micrometer .. 1/6
 Half Opal .. 1/-
 Small Brass .. 8d.
 Large Brass 1/-, 1/3
 Nickel .. 10d. to 1/6
 Burndept .. 4/-
 Crystals Stocked.
 Neutron, Blue
 Tungstahite, Per-
 manite
 Shaw's Genuine
 Hertzite .. 10d.
 Uranium .. 1/-
 All known makes.
 4 Whiskers (1 gold) 2d.
 Gold and Silver do. 2d.
 7 Waxed Coils .. 1/8
 5 Waxless Coils .. 1/3
 For B.B.C.

SPECIAL!
 Vernier 2-way
 Coil Stands .. 3/6
 Geared d. ... 5/3

BOXES from 1/11
 7 x 5 9 x 6 12 x 9 14 x 10
 8 x 6 10 x 8 12 x 10, etc.

H.T. BATTERIES.
 60 v. 7/6
 30 v. 4/6
 30 B.B.C. 3/11
 30 B.B.C. 5/8
 3 v. B.B.C. 2/6
 1.5 (D.E.) 1/9
 Eveready 66 v., 36 v., 108 v. stocked.

D.C.C. WIRE
 per lb.
 18 or 20 g. 9d.
 22 g. 10d.
 24 g. 1/1
 26 g. 1/1
 28 g. 1/3
 30 g. 1/6

BASKET COILS.
 Chelmsford .. 11d.
 Also at 1/-, 1/3, 1/9
 B.B.C. Duplex
 Waxless set of 5 1/9
 Extra air space, 1 in.
 25, 35, 50, 75, 100.
 Wave-lengths given.

SWITCHES.
 D P D T, china base 1/4
 3 P D T .. 10d.
 Panel D P D T .. 1/-
 .. S P D T .. 10d.
 Ebony D P D T .. 2/3
 .. S P D T .. 1/3
 Tumbler .. 1/-
 On and off .. 10d.

VALVE HOLDERS.
 Legless .. 10d.
 Solid Rod .. 1/-
 Climax .. 1/6
 Murray .. 1/3
 Under Panel .. 1/3
 Templates .. 1d.

NEUTRODYNE CONDENSERS.
 Ormond .. 2/-
 Colvern .. 3/6
 Success .. 3/6
 Vernier (Colvern) .. 2/6

SPECIAL! VARIABLE CONDENSERS.
 SQUARE LAW WITH KNOB AND DIAL.
 0003 .. 4/11
 0005 .. 5/6
 Callers' Price.

SPECIAL!
 Leatherette Boxes with Lid .. 2/3 and 2/11
 Re-echo Crystal Sets .. 13/11

SPECIAL!
 Fine Crystal Set, sloping leatherette Cabinet. Fitted for Chelmsford and B.B.C. Wonderful value .. 9/11
 Variometer, Impregnated Board 1/6
 With Clips .. 2/3
 Formers .. from 4d. (Impregnated)
 Variometers, in-side winding, Ebonite former, similar to Fallon, etc. 6/11

VALVES
 Dutch Detectors .. 4/9
 "R" type .. 4/9
 .06 .. 11/-
 Phillips "R" .. 6/11
 French "R" .. 5/11

RADIO MICRO THE WONDER VALVE
 H.T., L.T., or D.
 3 volts .. 12/6
 Can be used on 2 or 4 volt. accumulator.

METAL .06
 Be sure "METAL" is Stamped on Valve and avoid imitations. One to each Customer at 10/11 Regular Price 12/6

ALL VALVES REDUCED
 (Marconi, Ediswan, Mullard, Cossor, Myers, etc.)

VARIOMETERS
 Very Special 200/650 metres. All ebonite. Double silk wound, callers only 4/-

TERMINALS
 (Complete)
 W.O., Pillar, Phone, brass, 1d. each; nickel, 2d. each; stop and valve Pins, 1d.; nuts, various, 6 a 1d.
 Valve Sockets 1d., 1d.
 Flush panel do. 1d.
 Spade Tags .. 6 a 1d.
 Do. Terminals 2 for 1d. do. Pins 2 for 1d.
 Screws and nuts 2 a 1d.
 Switch arms .. 7d.
 Nickel arms .. 10d.
 Studs, complete 2 a 1d.
 Phone connectors 1d.
 2 B.A. Rod ft. 2d.
 4 B.A. Rod ft. 2d.

Valve windows .. 4d.
 Washers .. 12 a 1d.
 Shorting plug and socket .. 3d.
 Shellac .. 5d.

H.F. TRANSFORMERS
 For Chelmsford .. 2/9
 For B.B.C. range 2/6
 Energo, McMichael, Bowyer - Lowe stocked.

MANSBRIDGE FIXED T.T.C. GREEN
 .25 .. 2/9
 1 mfd. 3/6
 2 mfd. 4/6

CONCERT COILS
 Set of 5 : 25, 35, 50, 75, 100, 10/- set.

Var. gd. Leaks .. 1/-
 Fixed 2 meg. 9d.
 Battery Links 3 for 2d.
 Ins. Hooks .. 2 for 1d.
 Egg Insulators .. 1d.
 Reel .. 2 for 1d.
 Ins. Staples .. 5 a 1d.
 6 ft. 'phone cords 1/- 1/6
 Sleeving 3 yards 9d.
 Tinned Copper 18 g. 5d.
 Bus bar, hank 6d.
 Knobs, 2 B.A. 2d.
 Wander Plugs .. 1d.
 Strip Aerial, 100 ft. 2/-
 7/22 Heavy, 100 ft. 1/11

COIL STANDS
 Ebonite, 2-way .. 1/9
 With ex. handles .. 2/3
 Nickel .. 2/8
 3-way .. from 3/11
 Basket Holders .. 8d.
 Best quality .. 1/-
 Basket spikes 7d., 9d.
 Anti cap. handles 9d.
 Lead-in Tubes .. 6d.
 Sorbo Ear Caps pr. 1/3

FLEX
 2-colour doz. yards 1/6
 Lighting doz. yards 1/8
 Twin silk doz. yds. 1/-
 Lead-in, thick, yd. 3d.
 Do., good, 10 yds. 1/-

Rheostats .. 1/-
 Ormond .. 1/6
 Ebonite Former .. 1/6
 With dial .. 1/11
 Shipton, Irganic, Burndept, McMichael, etc., etc., etc.

SPECIAL!
 Customers purchasing 20/- worth of our own goods (at full prices only) are allowed to buy a first-class pair of phones for 5/-, 4,000 ohms, as an advertisement. One pair to each customer. This offer must be taken advantage of at time of purchase.

CRYSTAL SETS
 For 5 X X and B.B.C. 7/11

RIGHT OPPOSITE
DALY'S
 GALLERY DOOR

K. RAYMOND
 27, LISLE STREET,
 LEICESTER SQUARE, W.C.2

HOURS
 OF BUSINESS:
 DAILY - 9 to 7.45
 SUNDAY - 10 to 1

No responsibility accepted on post orders unless cheques and postal orders are crossed and made payable to the firm. Moneys sent must be registered

Phone: GERRARD 4637

HULLO EVERYBODY!!

ALL THESE GOODS SENT POST FREE (U.K. ONLY) EXCEPT WHERE MARKED. FOREIGN POST EXTRA. ORDERS DESPATCHED IN STRICT ROTATION AT EARLIEST POSSIBLE MOMENT.

AERIAL 7/22 100 ft. 3/-	LIS-EN—Minor .. 3/6
Copper Strip .. 3/-	Stat 7/6
Allen Var. Grid Leak 1/9	Universal 10/6
BURN JET Detector 4/6	Switch 2-way .. 2/9
Basket Holders 1/3. 1/6	Series Parallel .. 3/9
Battery Links, doz. 1/2	Anode Res. .. 2/6
Bushes Ebonite .. 1/3	Var. Grid Leak .. 2/6
CRYSTALS each 1/6. Neutron, Gilray, Permalite, Blue Label, Tungstallite	Choke 10/6
COIL STANDS 2-Way—	L.F. T.1 30/-
Vernier 4/6, 5/-, 5/6	T.2 25/-
Geared 5/11 Polar 6/6	L.F. T.3 16/6
Shipton Vernier .. 4/6	Coils—
"Baby" ordinary 3/3	25 .. 4/10 35, 40, 4/10
With ex. handles 4/-	50 .. 5/- 60 .. 5/4
Nickel 4/3	75 .. 5/4 100 .. 6/9
Baby 3-way 5/6	150 .. 7/- 200 .. 8/5
Nickel 4/6	
Vernier 3-way .. 6/6	LOUD SPEAKERS
Shipton V. 8/-	C.A.V. Tom Tit .. 30/-
COILS D.C.C.	C.A.V. Junior .. 55/-
For Chelmsford .. 1/11	Sterling Baby .. 55/-
With Adapter .. 2/8	Sterling Dinky .. 30/-
200/2000 SET of 5 2/6	Amplion Junior .. 27/8
(Air Spaced Waxless)	Amplion Dragonfly 25/-
Extra Large Air-Spaced Set of 5 Duplex D.C.C. Coils, 25, 35, 50, 75, 100 2/9	All models stocked of leading makers.
Coil Plugs, Wedge, pr. 2/-	POLAR CONDENSERS
Edison Ball 2 for 2/6	.001, .0005 or .0003 10/6
Plugs with Fibre .. 1/-	· Micrometer .. 5/8
DETECTORS (Enclosed)	2-way Junior .. 6/-
Micrometer 2/6	RHEOSTATS
Nickel, Large .. 2/6	One hole fixing .. 1/6
Brass 2/-	C. & S. do. .. 1/5
Burndept 4/6	De Luxe and Dial .. 2/6
Mic. Met. 6/-	Burndept 4/8
FIXED CONDENSERS	McMichael Dual .. 7/6
EDISON BELL	Shipton Strip—
.001 to .0005 each 1/3	7 ohm (with fuse) 3/6
.002 to .006 each 2/-	30 or 60 ohm .. 3/6
Grid Leaks and clips 1/6	Potentiometer 600 .. 4/8
Dublioir .001 to .006 ea. 3/6	Crown for DE or R 2/6
.0091 to .0005 each 2/6	L.E.S. Micro Control 3/6
Grid Leak, 2 meg. 2/6	T.C.B. 6, 13, 30 ohms 4/-
.01 for L.S. 7/6	Potentiometer 600 .. 5/-
Anode Resistance on stand, 70,000, 80,000, or 100,000 each 5/6	SWITCHES
McMichael's 2-meg. Leak and Clips .. 2/6	Panel DPDT .. 1/6
100,000-ohm Res. .. 2/6	Panel SPDT .. 1/4
RAYMOND (Ebonite Base)	Ebonite DPDT .. 2/6
.001 to .0005 each 1/1	Ebonite SPDT .. 1/8
.002 to .006 each 1/3	Simplex Lead in .. 1/9
.01 or .02 each 1/9	Sq. Bus Bar .. 1/-
(Mansbridge Elsewhere.)	Switch Arms .. 1/8
Flex, 2 colour, 12 yd. 2/6	(Inc. studs and nuts.)
Lighting .. 12 yd. 2/6	TERMINALS
Small Non-Silk 12 yd. 1/6	Phone or W.O. doz. 1/9
GOSWELL QUALITY	Pillar large .. doz. 1/9
Valve Legs, Set 4 .. 1/3	Pillar medium .. doz. 1/3
Valve Holder .. 1/9	Nickel 6d. doz. extra. (All with nuts)
2-way Cam Vernier 9/-	TRANSFORMERS, L.F.
3-way Cam Vernier 12/6	Ferranti 17/8
3-way Ordinary .. 7/8	Igranio 21/-
2-way Panel .. 3/-	R.I. 25/-
3-way Panel .. 5/-	Ormond 14/-
Basket Holders .. 1/4	G.R.C. 83 15/-
H.F. TRANSFORMERS	Super Success .. 21/-
McMichael's 300/800 10/-	Standard Success .. 18/-
1100/3000 10/-	Brunet Shrouded .. 13/6
Energco, 250/700 .. 3/11	Formo Shrouded .. 18/-
450/1200 .. 4/3	Formo open .. 12/6
900/2000 .. 4/6	French 9/3
Raymond B.C. .. 2/9	VALVE HOLOERS
5 X X .. 2/9	Murray Anticap .. 1/3
ICRANIC—Rheostat .. 4/6	Lezless Anticap .. 1/3
30 ohms 7/-	Bretwood .. 1/9
Potentiometer .. 7/6	Climax UN panel .. 1/8
Variometer .. 10/-	(Similar to H.T.C.)
Coils (all numbers)	Solid Rod Standard 1/3
25 .. 5/- 35 .. 5/-	Goswell 1/8
50 .. 5/2 75 .. 5/6	VALVES
100 .. 7/- 150 .. 7/10	Myers Universal .. 12/8
200 .. 8/8 250 .. 9/3	French "R" .. 7/6
300 .. 9/5 400 .. 10/6	Dutch Detector .. 6/6
500 .. 10/6	Dutch "R" .. 5/11
	Metal "08" .. 13/11
	Radio Micro "08" 13/11

VALVES (continued)
Bright Emitter
B.T.H. "R" Ediswan A.R., Marconi Ostram "R" or "R5," Mullard O.R.A. Cossor L.F. P1. Cossor H.F. P2. Mullard H.F., Mullard L.F. .. 11/-
Dull Emitter
B.T.H. B3. Ediswan A.E.D.E., Marconi D.E.R., Myers, each 18/-
Dull Emitters
B.T.H. B5, Ediswan A.R., "06," Mullard D.F. O.R.A. 21/-
D.E. Power Valves
Marconi D.E. 6 22/6
Power Valves (for '06)
B.T.H. B0 .. 30/-
Marconi D.E. 4 26/-
Mullard D.F.A. 26/-
Power Valves, for B.E., B.T.H. B4, Marconi, Mullard 30/- (Valves posted buyer's risk.)
WATMEL
Var. gd. Leak .. 2/6
Anode Res. .. 3/6
WATES MICROSTAT
New Improved Model. Post Free. 2/9
BRETWOOD
New Model, variable grid leak .. 3/-
Anode Resistance .. 3/-
Anti-Cap Switch .. 5/-
TELEPHONE DISTRIBUTION BLOCKS. Table Pattern, takes 4 pairs of 'phones .. 3/6
ENERGO L.F. TRANSFORMER. For supreme Results, Efficiency, Finish, and Permanent Reliability. For 1st stage .. 15/-
THE MIC-MET SUPER CRYSTAL DETECTOR .. 6/-
ORMOND CONDENSERS with Vernier, one-hole fixing, .0005. Price 7/8. Post free.
PANEL SWITCHES. On and Off, Connecticut Nickel. Post Free .. 1/6
EASIFIX. Eliminates all ugly, loose wiring and minimises the risk of burning out valves. Each Conductor is distinctively coloured and enclosed within an outer-braiding. Complete with Wander Plugs .. 3/-
OLDHAM PORTABLE ACCUMULATOR
For '08 Valves, 2-in. series will run 6 weeks on one charge. Recharging costs a few pence only. 2 v. 10 amp. continuous 12/6. Will go in your waistcoat pocket.
BRETWOOD
Valve Holder .. 1/9
100 p.c. Efficiency. Eliminates poor reception. No soldering stop over or under panel.

HEADPHONES

ERICSSON CONTINENTAL.
your favourite 'phones. Entirely NEW MODEL. Most beautifully finished, exquisite tone. Ridiculous Price, per pair (4,000 ohms) 13/11

BRUNET
New Model "TYPE D." Hygienic Horn Headbands. Nickel-plated Stirrup. Black and White Cord. Each receiver stamped with trade mark. 4,000 ohms. Per pair, 16/6.

For the MAGIC HOUR!
When Fairyland becomes reality. Let the kiddies wear Featherweight 'phones. **BROWN'S "F" TYPE,** 4,000 ohms, 25/- pair.

N and K
LATEST MODEL. 4,000 ohms. Ideal for Crystal reception. Price in AMERICA, £2. All Stamped N and K. Price here, 17/6. Limited number of old models stamped N and K. 1,000 ohms. 12/11 pair. Post 6d. pair.

TELEFUNKEN (GENUINE). Adjustable. 4,000 ohms. Price 17/11.

SUPER L.F. (5-1) TRANSFORMER
Windings have insulated layers of 6 sections each, wonderful for amplification. Made in France, by the world's foremost firm. SPECIAL PRICE, 10/-.

PERFECT RHEOSTATS
Shipton New Type Strip Rheostat, 7 ohms (with fuse) .. 3/-
Shipton New Type Strip Rheostat, 30 ohms .. 3/-
Shipton New Type Strip Rheostat, 60 ohms .. 3/-
Shipton Potentiometer, 600 ohms .. 4/6
A specially designed spindle gives one-hole fixing and incorporates a tension spring which ensures perfect electrical contact at all times; terminal connections are provided. The 7 ohm Model is fitted with a fuse, which little device may save you the cost of an expensive valve. In operation they are noise free—quite an important consideration.

"UTILITY" SWITCHES.
2 Pole c/o Knob .. 4/-
2 Pole c/o Lever .. 5/-
4 Pole c/o Knob .. 6/-
4 Pole c/o Lever .. 7/6
Post 3d. each.

TELEFUNKEN TYPE

So Near to Originals you can scarcely tell the difference except not adjustable. 4,000 ohms. Pair 10/9.

£50 REWARD! given if the **DR. NESPER PHONES SOLD HERE ARE NOT GENUINE!** BEWARE OF FRAUDULENT IMITATIONS!! (Injunctions obtained)

Adjustable diaphragm, detachable receivers. double leather-covered head-springs, long flexible cords, nickel-plated parts. Very comfortable fitting to the head. Per Pair, 12/11. Post 3d. pair.

BRANDES
Matched Tone, 25/- pair. 4,000 ohms.

STERLING
Latest Model, 4,000 ohms. Wonderful Tone. 25/- pair.

G.R.C.
4,000 ohms. 20/- pair.

SIEMENS.
4,000 ohms. 25/- pair.

B.T.H.
Simply cannot be equalled. 4,000 ohms. 25/-.

Perfection and Quality. Weight negligible.

QUALITY (GOSWELL) RADIO COILS
Far more efficient than honeycomb or any other type of coil. Exceedingly strong and rigid, mounted on standard ebonite plugs. Brown finish, no wax or shellac used. MOUNTED.

25 .. 1/8
35 .. 1/9
50 .. 2/0
75 .. 2/3
100 .. 2/9
150 .. 3/0
175 .. 3/6
200 .. 3/9 Post 3d. Coil.

MANSBRIDGE CONDENSERS
Octopus, Tested at 350 D.C.
.01 .. 2/3 T.C.C.
.25 .. 3/- 2 mfd. 5/-
1 mfd. 3/8 1 mfd. 3/1
2 mfd. 4/6 .25 .. 3/6
Post 2d. each.

"WONDER" AERIAL WIRE
49 Strands Special Alloy Phosphor Bronze. For Frame, Indoor, or Outdoor Aerial.
Each strand is a separate conducting surface, is non-corroding, maintains its wonderful results all the time.
110 feet. 3/9 Post Free.

BEWARE of spurious imitations. This is the finest quality.

ACCUMULATORS FOR CALLERS ONLY

at present.

Bretwood Valve-holder extra value, 1/9

Manchester "Powquip," 15/6

Ormond 14/6

Standard "Powquip," 14/6

"R.I." NEW MODEL IN SEALED BOX

Don't Buy Otherwise. Post 25/- Free

FERRANTI L.F. BETTER THAN THE BEST 17/6

IMPORTANT NOTICE

TRADE COUNTER OPEN
will oblige you with any lines in stock, less 20% on Proprietary articles. NO POST ORDERS TRADE.

EBONITE PANELS 3-16th in.
8 x 8. 1/8 10 x 8. 3/6
7 x 5. 1/8 12 x 9. 5/-
8 x 6. 2/6 12 x 12. 5/9
9 x 6. 2/9 14 x 10. 5/9

CRITERION CONCERT COILS. Low Self Capacity. Every turn and layer airspaced. Perfect for Reaction. Mounted on Plug.
25 .. 2/- 50 .. 2/6
30 .. 2/3 75 .. 2/9
35 .. 2/8 100 .. 2/9
40 .. 2/6 100 .. 3/-
SET OF 5 (25, 35, 50, 75, 100) 10/- Post 3d.

RIGHT OPPOSITE
DALY'S
GALLERY DOOR
Phone: GERRARD 4637.

K. RAYMOND

27, LISLE STREET,
LEICESTER SQUARE, W.C.2

No responsibility accepted on post orders unless cheques and postal orders are crossed and made payable to the firm. Moneys sent must be registered

HOURS OF BUSINESS:
DAILY . 9 to 7.45
SUNDAY . 10 to 1

In replying to advertisers, use Order Form enclosed.



COMPONENTS WHICH MAKE the DELIGHTFUL RECEPTION HERE DEPICTED POSSIBLE



M.H. H.F. TRANSFORMERS
The last word in H.F. transformers. Made in 6 ranges (00 to 4) covering all wavelengths, 10/-. A set Nos. 00 to 4 in handsome case, 55/-



M.H. FIXED CONDENSER.
Standard M.H. interchangeable fixed condenser unit, 0.0001 μ F to 0.001 μ F, 1/9 each. 0.002 μ F to 0.01 μ F 2/3 each.

Perfection in reception came, When M.H. products grew to fame.

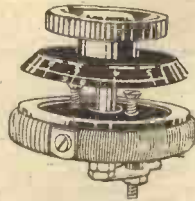

M.H. FILAMENT RESISTANCE.
Filament Resistances of reliability. Bright Emitter, 5/6. Dull Emitter, 6/6. Double Dull and Bright Emitter, 7/6.



M.H. REVERSING COIL HOLDER.

Perfect in action for standard Duolateral coils. The moving coil can be completely reversed in both its physical and electrical relationship with the fixed coil.
2-coil 21/-

Complete sets, similar to that illustrated below supplied in various sizes. Write for full particulars.

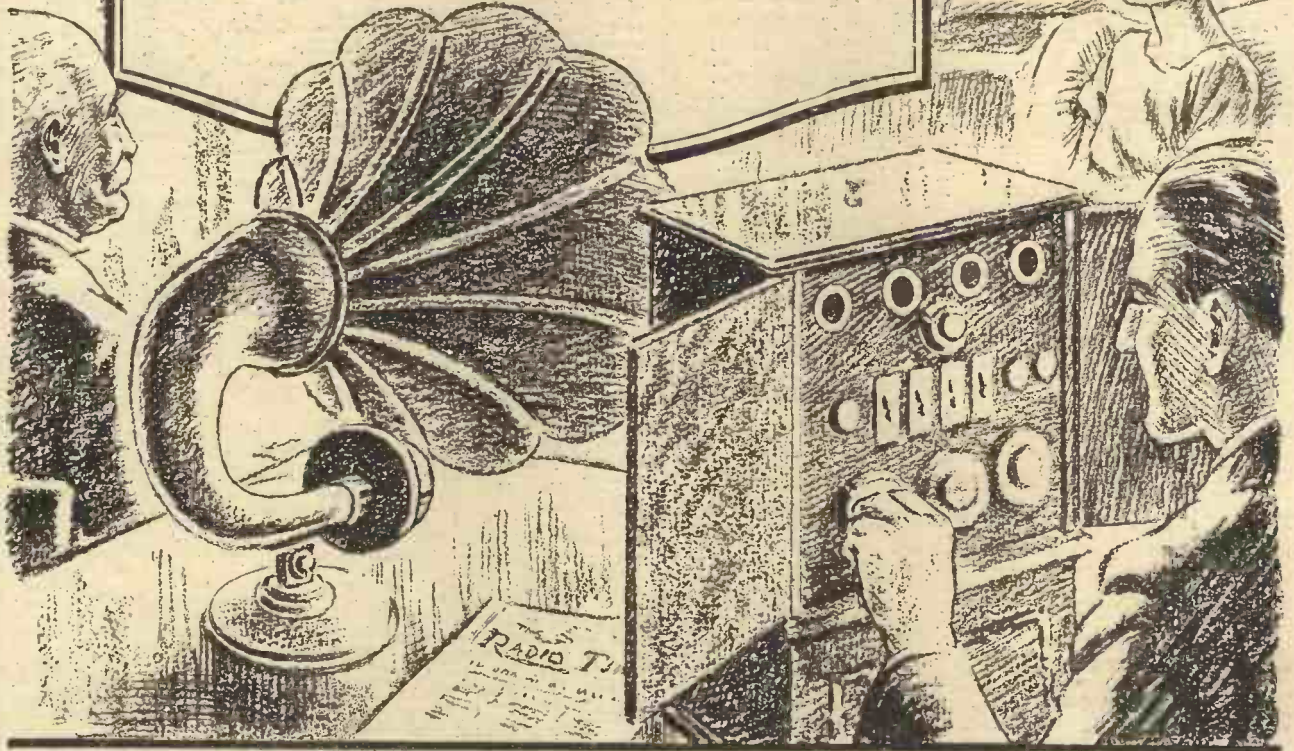

Showrooms:
RADIO CORNER,
179, Strand, London, W.C.2

L.M. MICHAEL LTD
Manufacturers of Wireless and Scientific Apparatus.

Head Office:
HASTINGS HOUSE,
Norfolk Street, Strand, W.C.2

Regular Programmes from American Broadcasting Stations

Hours of transmission given in Greenwich mean time and in local time prevailing.

Telephony only. Corrected up to February 16th, 1925.

Edited by Captain L. F. PLUGGE, B.Sc., F.R.Ae.S., F.R.Met.S.

Copyright.

WEEKDAYS.

Ref. No.	Greenwich Mean Time.	Local Time prevailing.	Name of Company owning Station.	Call Sign and Wave-length.	Situation.	Nature of Transmission.	Approx. duration of Transmission.
A. 1	11. 0 p.m.	6. 0 p.m.	Willard Storage Battery Co.	WTAM 390 m.	Cleveland, Ohio.	Dance Music, Concert, Orchestra.	1 hr.
A. 2	11. 0 p.m.	6. 0 p.m.	Westinghouse Electric & Mfg. Co.	WBZ 337 m.	Springfield, Mass.	Dinner Concert.	—
A. 65	11. 0 p.m.	6. 0 p.m.	American Tel. & Tel. Co.	WEAF 492 m.	New York	Musical Programme	5 hrs.
A. 61	11. 0 p.m.	6. 0 p.m.	The Detroit News.	WWJ 352.7.	Detroit Mich.	Dinner Concert.	—
A. 3	11.15 p.m.	6.15 p.m.	L. Bamberger & Co.	WOR 405 m.	Newark, New Jersey.	Orchestra.	—
A. 4	11.15 p.m.	6.15 p.m.	Westinghouse Electric & Mfg. Co.	KDKA 326 m. & 68 m.	Pittsburgh, Pa.	Dinner Concert or Organ Recital.	—
A. 5	11.50 p.m.	5.50 p.m.	"Kansas City Star"	WDAF 411 m.	Kansas City, Mo.	Market, Weather Report, Time Signal, Road Report.	4½ hrs.
A. 6	midnight	6. 0 p.m.	"Kansas City Star"	WDAF 411 m.	Kansas City, Mo.	Talks, Story, Music.	1 hr.
A. 7	midnight	7. 0 p.m.	Westinghouse Electric & Mfg. Co.	WBZ 337 m.	Springfield, Mass.	Market Report, Talks, Children's Stories.	15 min.
A. 8	12. 2 a.m.	6. 2 p.m.	Westinghouse Electric & Mfg. Co.	KYW 536 m.	Chicago, Ill.	News, Financial Markets.	16 min.
A. 9	12.15 a.m.	6.15 p.m.	L. Bamberger & Co.	WOR 405 m.	Newark, New Jersey.	Sports News.	—
A. 10	12.15 a.m.	7.15 p.m.	Westinghouse Electric & Mfg. Co.	KDKA 326 m.	Pittsburgh, Pa.	Children's Period. (not on 68 m.)	—
A. 11	12.15 a.m.	7.15 p.m.	Westinghouse Electric & Mfg. Co.	WBZ 337 m.	Springfield, Mass.	Talks followed by Concert or other Musical Programme.	—
A. 12	12.30 a.m.	6.30 p.m.	Woodman of the World.	WOAW 516 m.	Omaha, Nebraska.	Concert or Orchestra.	—
A. 13	12.30 a.m.	7.30 p.m.	Westinghouse Electric & Mfg. Co.	KDKA 326 m. & 68 m.	Pittsburgh, Pa.	News, Talks, Market Reports, Talks or Concert.	45 min.
A. 62	12.30 a.m.	7.30 p.m.	State College, Washington	KFAE	Pullman, Washington.	Concert.	—
A. 14	12.35 a.m.	6.35 p.m.	Westinghouse Electric & Mfg. Co.	KYW 536 m.	Chicago, Ill.	Children's Period.	25 min.
A. 15	12.45 a.m.	7.45 p.m.	General Electric Co.	WGY 380 m.	Schenectady, New York	Musical Programme and/or talks (except Wed. and Sat.).	—
A. 16	1. 0 a.m.	7. 0 p.m.	Westinghouse Electric & Mfg. Co.	KYW 536 m.	Chicago, Ill.	Talks, Dinner Concerts, Musical Programmes (Mondays excepted).	2½ hrs.
A. 17	1. 0 a.m.	7. 0 p.m.	Sears-Roebuck & Co.	WLS 345 m.	Chicago, Ill.	Children's Period.	45 min.
A. 63	1.15 a.m.	8.15 p.m.	The Radio Light-house	WEMC 286 m.	Berrion Springs, Michigan.	Concert.	1½ hr.
A. 18	1.30 a.m.	8.30 p.m.	Westinghouse Electric & Mfg. Co.	KDKA 326 m. & 68 m.	Pittsburgh, Pa.	Concert and Musical Programme.	—

WEEKDAYS—continued.

Ref. No.	Greenwich Mean Time.	Local Time prevailing.	Name of Company owning Station.	Call Sign and Wave-length.	Situation.	Nature of Transmission.	Approx. duration of Transmission.
A. 19	1.30 a.m.	7.30 p.m.	"Fort Worth Star Telegram."	WBAP 476 m.	Fort Worth, Texas.	Musical Programme (except Saturday).	1 hr.
A. 20	2.0 a.m.	8.0 p.m.	"Kansas City Star."	WDAF 411 m.	Kansas City, Mo.	Musical Programme.	1½ hrs.
A. 64	2.0 a.m.	9.0 p.m.	The Shepard Stores	WNAC 280.3 m.	Boston, Mass.	Concert.	2 hrs.
A. 21	2.55 a.m.	9.55 p.m.	John Wanamaker	WOO 509 m.	Philadelphia, Pa.	U.S. Naval Observatory Time Signal followed by U.S. Weather forecast.	—
A. 22	2.55 a.m.	9.55 p.m.	Westinghouse Electric & Mfg. Co.	KDKA 326 m. & 68 m.	Pittsburg, Pa.	Do. do.	—
A. 23	2.55 a.m.	9.55 p.m.	Westinghouse Electric & Mfg. Co.	WBZ 337 m.	Springfield, Mass.	Do. do.	—
A. 24	3.0 a.m.	9.0 p.m.	Woodmen of the World.	WOAW 526 m.	Omaha, Nebraska.	Concert (except Wednesdays).	—
A. 25	3.0 a.m.	10.0 p.m.	Westinghouse Electric & Mfg. Co.	WBZ 337 m.	Springfield, Mass.	Musical Programme (except Tuesdays)	1 hr. or 2 hrs.
A. 26	3.15 a.m.	7.15 p.m.	"Morning Oregonian."	KGW 492 m.	Portland, Oregon.	Markets, Weather Report, News, Police Reports (Saturdays excepted)	—
A. 27	3.30 a.m.	9.30 p.m.	"Fort Worth Star Telegram."	WBAP 476 m.	Fort Worth, Texas.	Musical Programme (except Saturday).	1½ hrs.
A. 28	4.0 a.m.	10.0 p.m.	Westinghouse Electric & Mfg. Co.	KYW 536 m.	Chicago, Ill.	Musical Entertainment (except Mondays). Sometimes begins 9.30 p.m.	1 hr. or 2 hrs.
A. 29	5.45 a.m.	11.45 p.m.	"Kansas City Star"	WDAF 411 m.	Kansas City, Mo.	Musical Entertainment	1½ hrs.

SUNDAYS.

Ref. No.	Greenwich Mean Time.	Local Time prevailing.	Name of Company owning Station.	Call Sign and Wave-length.	Situation.	Nature of Transmission.	Approx. Duration of Transmission.
A. 30	11.30 p.m.	6.15 p.m.	Westinghouse Electric & Mfg. Co.	KDKA 326 m. & 68 m.	Pittsburg, Pa.	Dinner Concert	—
A. 31	Midnight.	6.0 p.m.	Woodmen of the World.	WOAW 526 m.	Omaha, Nebraska.	Bible Study Hour	1 hr.
A. 66	12.20 a.m.	7.20 p.m.	American Tel. & Tel. Co.	WEAF 492 m.	New York.	Musical Programme	3 hrs.
A. 32	12.30 a.m.	7.30 p.m.	Strawbridge and Clothier	WF1 395 m.	Philadelphia	Church Service	—
A. 33	12.30 a.m.	7.30 p.m.	General Electric Co.	WGY 380 m.	Schenectady, New York.	Church Service	—
A. 34	12.30 a.m.	7.45 p.m.	Westinghouse Electric & Mfg. Co.	KDKA 326 m. & 68 m.	Pittsburgh, Pa.	Church Service	—
A. 37	12.30 a.m.	7.30 p.m.	Westinghouse Electric & Mfg. Co.	WBZ 337 m.	Springfield, Mass.	Concert or Music, etc.	—
A. 35	12.45 a.m.	7.45 p.m.	John Wanamaker	WOO 509 m.	Philadelphia, Pa.	Church Service (occasionally at 10.45 a.m. instead).	—
A. 36	1.0 a.m.	7.0 p.m.	Westinghouse Electric & Mfg. Co.	KYW 536 m.	Chicago, Ill.	Service & Musical programme.	—
A. 67	1.15 a.m.	8.15 p.m.	The Radio Lighthouse.	WEMC 286 m.	Berrion Springs, Michigan.	Church Service.	—
A. 38	2.0 a.m.	6.0 p.m.	"Morning Oregonian."	KGW 492 m.	Portland, Oregon	Church Service	—
A. 39	2.0 a.m.	9.0 p.m.	General Electric Co.	WGY 380 m.	Schenectady, New York.	Hotel Orchestra, relayed.	—
A. 40	2.30 a.m.	9.30 p.m.	Westinghouse Electric & Mfg. Co.	WBZ 337 m.	Springfield, Mass.	Concert or Music, etc.	—

Are you well equipped?

Senior Loud Speaking Equipment.
Price complete £32.



A QUESTION often asked by purchasers of the Western Electric Loud Speaking Equipments is: "Why is your equipment so distinctly superior in tonal quality without sacrifice of volume?"

The reason is a perfectly balanced equipment—an Amplifier that exactly suits the Loud Speaker, and a Loud Speaker that is unrivalled for tonal quality.

If you would be well equipped specify Western Electric Wireless Apparatus, then quality is assured.

Ask for illustrated booklets W. 528 and W. 529. They will be sent free upon request.

No. 44005 Loud Speaker with
No. 44013 Amplifier.
£23 : 10 : 6.
(Including Valves.)



Western Electric Company Limited.

CONNAUGHT HOUSE, ALDWYCH, LONDON, W.C.2.
CENTRAL 7345 (9 lines).

Branches: Birmingham, Leeds, Manchester, Newcastle, Glasgow, Cardiff, Southampton, Liverpool, Dublin.

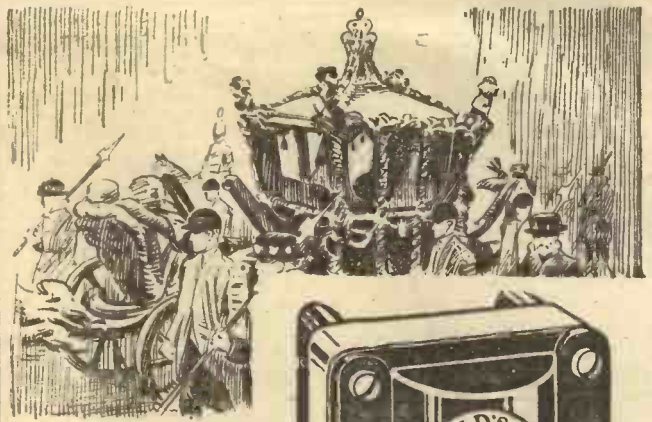

The
ROYAL ROUTE

Behind you lies the mediocre apparatus, consequent disappointment and failure. Before you, in company with these Royal products, you will enjoy the wonders of Radio with unqualified success.



This remarkable transformer has a secondary with so low a self-capacity as six micro-microfarads, a little scientific fact explaining the great purity which a correctly designed and faithfully manufactured transformer can reproduce. This fact is confirmed by practically all the technical authorities in Great Britain and endorsed by thousands of experimenters who show preference by incorporating the Royal into every successive receiver they build.

PRICE £1 0 0.

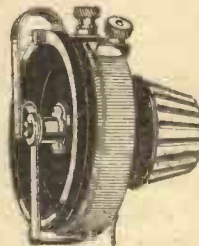

Beautifully made component which give perfect filament control. A pleasure to use and to own.

	Each
Royal Bakelite Rheostat,	
6 ohms	5/6
Royal " " 35 ohms	5/6
Royal " Vernier Rheostat,	
6 ohms	6/9
Royal " " 35 ohms	6/9
Royal Potentiometer, 400 ohms	6/9
Royal Metal Rheostat	
(Vernier) 6 ohms	4/3
Royal " " 35 ohms	4/3
Royal " " 6 ohms	3/3
Royal " " 35 ohms	3/3
Royal " Potentiometer	
400 ohms	3/3

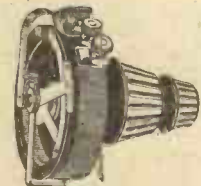

"ROYAL" VALVE CONTROL UNIT

being Vernier Rheostat and Potentiometer combined on one spindle. Rheostat 6 ohms or 35 ohms. Potentiometer 400 ohms. Bakelite throughout. A very valuable addition to any set.

PRICE 8/9 EACH.

ROYAL

The Mark of Sovereign Quality

R. A. ROTHERMEL, LTD.

Manufacturers and Suppliers of all kinds of Radio Apparatus,

24 & 26, MADDOX STREET, LONDON, W.1.

Telephones: Mayfair 578 and 579.

Barclays 789.

In replying to advertisers, use Order Form enclosed.

A STATEMENT

and Proof

ROSSLYN,
IRBY ROAD,
HESWALL,
CHESHIRE.
14.10.24.

Messrs. Chloride Electrical Storage Co., Ltd.,
Clifton Junction,
Nr. Manchester.

Dear Sirs,
I am writing to inform you that I have been successful in receiving several American Broadcasting Stations on one valve and using, both for L.T. and H.T., "Exide" Accumulators. This performance was carried out last year on two separate occasions, both after fitting "Exide" H.T. Accumulators.
I feel quite sure that as this is not an every day affair, you would like to be acquainted with the fact.

Yours faithfully,
(Signed) W. ARTHUR MADDOCKS.

WESTINGHOUSE ELECTRIC
AND MANUFACTURING CO.,
82, Worthington Street,
SPRINGFIELD, Mass.
Nov. 3, 1924.

Mr. W. Arthur Maddocks,
Rosslyn, Irby Road,
Heswall, Cheshire, England.

Dear Mr. Maddocks,
We wish to thank you for your letter of October 18th, reporting your reception of Westinghouse Radio Station WBZ. It is with pleasure that we enroll you as one of the distant listeners of our station. The program items you mentioned were broadcast by WBZ as mentioned by you.

Station WBZ is owned and operated by the Westinghouse Electric and Manufacturing Company, and is located at Springfield and Boston, Mass. We operate nightly between the hours of 6.0 and 11.0 p.m. Eastern Standard Time; which is five hours slower than Greenwich Mean Time, at a frequency of 850 kilocycles or on a wavelength of 337 metres. Power 1,000 watts.

We trust that your receiver will continue to function as well in the future, and shall be pleased to receive your comments and criticisms on our programs.

Yours very truly,
(Sd.) A. S. EISENMANN
Radio Station WBZ.

ASE. IET.

*America
on One Valve*

With **Exide**
BATTERIES for
WIRELESS

MADE AT THE LARGEST BATTERY
WORKS IN THE BRITISH EMPIRE.

Exide

THE LONG-LIFE BATTERY

LONDON :
219-229, Shaftesbury Avenue,
W.C.2.

BIRMINGHAM :
5 -58, Dale End.
Phone Central 7629-30.

MANUFACTURED BY

THE **Chloride** ELECTRICAL STORAGE
COMPANY LIMITED.

CLIFTON JUNCTION, NR. MANCHESTER.

MANCHESTER :
1, Bridge Street.
Phone City 9123.

BRISTOL :
22, Victoria Street.
Phone 6460.

SUNDAYS—(Continued.)

Ref. No.	Greenwich Mean Time.	Local Time prevailing.	Name of Company owning station.	Call Sign and Wave-length.	Situation.	Nature of Transmission.	Approx. duration of Transmission.
A. 41	3. 0 a.m.	7. 0 p.m.	"Morning Oregonian."	KGW 492 m.	Portland, Oregon.	Hotel Orchestra, relayed.	—
A. 42	3. 0 a.m.	9. 0 p.m.	Woodmen of the World.	WOAW 526 m.	Omaha, Nebraska.	Church Service	—
A. 43	7. 0 a.m.	11. 0 p.m.	"Fort Worth Star Telegram."	WBAP 476 m.	"Fort Worth, Texas."	Dance Orchestra	1 hr.

SPECIAL DAYS.

Ref. No.	Greenwich Mean Time.	Local Time prevailing.	Name of Company owning station.	Call Sign and Wave-length.	Situation.	Nature of Transmission and day of week on which occurring.	Approx. duration of Transmission.
A. 44	11.30 p.m.	6.30 p.m.	General Electric Co.	WGY 380 m.	Schenectady, New York.	Tues. & Thurs.—Hotel Music relayed. Wed.—Children's story.	—
A. 45	11.30 p.m.	6.30 p.m.	Strawbridge and Clothier.	WFI 395 m.	Philadelphia, Pa.	Mon. & Sat.—Hotel Concert Orchestra followed by Children's period at 7.0 p.m.	—
A. 46	midnight	6. 0 p.m.	Woodmen of the World.	WOAW 526 m.	Omaha, Nebraska.	Mon. & Tues.—Lecture. Thurs. & Fri.—Children's Hour. Sat.—Concert.	—
A. 47	12.30 a.m.	7.30 p.m.	John Wanamaker.	WOO 509 m.	Philadelphia, Pa.	Mon., Wed., Fri.—Organ or Orchestral Concerts, Talks.	3½ hrs.
A. 48	1. 0 a.m.	8. 0 p.m.	Strawbridge and Clothier.	WFI 395 m.	Philadelphia, Pa.	Thurs.—Boy Scout Programme, followed by Concert at 8.30 p.m. Tues. and Sat.—Concert.	2½ hrs.
A. 49	1. 0 a.m.	8. 0 p.m.	L. Bamberger & Co	WOR 405 m.	Newark, New Jersey.	Mon., Wed., Sat.—Musical Programme, Talks.	3 or 4 hrs.
A. 50	1. 0 a.m.	8. 0 p.m.	Willard Storage Battery Co.	WTAM 390 m.	Cleveland, Ohio.	Mon. & Wed.—Concert.	2 hrs.
A. 51	2. 0 a.m.	9. 0 p.m.	Willard Storage Battery Co.	WTAM 390 m.	Cleveland, Ohio.	Sat.—Dance Programme.	3 hrs
A. 52	2.30 a.m.	9.30 p.m.	General Electric Co	WGY 380 m.	Schenectady, New York.	Sat.—Dance Music.	—
A. 53	3. 0 a.m.	7. 0 p.m.	"Morning Oregonian."	KGW 492 m.	Portland, Oregon.	Mon. & Wed.—Concert. Tues. & Fri.—Talk.	—
A. 54	3.30 a.m.	10.30 p.m.	Willard Storage Battery Co.	WTAM 390 m.	Cleveland, Ohio.	Mon.—Dance Programme.	2½ hrs.
A. 55	3.30 a.m.	10.30 p.m.	General Electric Co.	WGY 380 m.	Schenectady, New York.	Fri.—Musical programme.	—
A. 56	4.30 a.m.	11.30 p.m.	General Electric Co.	WGY 380 m.	Schenectady, New York.	Tues. & Thurs.—Organ Recital.	—
A. 57	4.30 a.m.	10.30 p.m.	Woodmen of the World	WOAW 526 m.	Omaha, Nebraska.	Tues. or Thurs.—Entertainment. Fri.—Relayed Orchestra.	—
A. 58	4.30 a.m.	11.30 p.m.	Westinghouse Electric & Mfg. Co.	WBZ 337 m.	Springfield, Mass.	Tues.—Organ Recital.	—
A. 59	5.15 a.m.	11.15 p.m.	Woodmen of the World	WOAW 526 m.	Omaha, Nebraska.	Sat.—Entertainment.	—
A. 59a	6. 0 a.m.	10. 0 p.m.	"Morning Oregonian."	KGW 492 m.	Portland, Oregon.	Mon., Tues. and Sat.—Dance Music.	—
A. 60	6.0 a.m.	midnight.	Westinghouse Electric & Mfg. Co.	KYW 536 m.	Chicago, Ill.	Sat.—Hotel Band Relayed.	2 hrs.



"Lanite" Crystal

Samples of their crystal have been submitted by the "Lanite" Laboratories. This is placed on the market packed in a metal box in a carton together with a special alloy cat-whisker. The samples proved to be of fine grain, and uniformly brightly crystalline. On test the proportion of sensitive spots and the quantitative rectifying efficiency measured on the local station's transmission proved

to be of an order which would place this crystal amongst the highest class of artificial galenas. It was notably easy to cut, without crumbling, to fit in a small cup, and the pieces submitted were of generous size. The special cat-whisker gave, on separate test, a performance up to the usual standard of efficiency, though some experimenters would prefer a different shape given to the wire. We can certainly recommend this crystal.

"Alto" L.F. Transformers

From Messrs. W. F. Co., Ltd., we have received samples of their shrouded low-frequency inter-valve transformers, for first and second stage respectively. These are small instruments, measuring only 2 in. by 2½ in. and 1½ in. over the coil, with an iron core rather on the light side. They are enclosed in a metal casing, the small terminal screws being arranged close together on an insulating

Wonderful Wireless Invention makes "LESS" WIRELESS

Catwhiskerless, Batteryless, Worryless, Fuss-and-botherless Wireless.

The new invention, "Hovimo" Crystal Valve, is a revolution in wireless. It takes the place of fiddly-fumble cat-whiskers and old-fashioned detectors. Its use ensures a speedy end to all your detection troubles; no more fuss and bother; no more worry and disappointment; and no more "looking rather foolish" when a friend calls to hear the wireless and stays to stand by while you spend an evening tinkering about.

SIMPLE TURN OF MILLED SCREW FIXES THE "HOVIMO" CRYSTAL VALVE —and you get results that will make friends marvel at your uninterrupted pure, clear and bell-like tone.

THE "HOVIMO" CAN BE ATTACHED TO ANY SET.

It is equally excellent for crystal sets and for circuits employing crystal rectification. **Specially recommended for the S.T.100.** Ask your dealer for this wonder-working invention to-day; also obtainable, in case of difficulty, post free from address below.

HOVIMO CRYSTAL VALVE

The "Hovimo" is an entirely new invention and could not be confused with the ordinary "permanent" detector or compared with the silicon-beryllite and similar combinations.

3/6
BRITISH MADE

Every One Guaranteed
M. MOLBACK
Phone: Chancery 8391.

27, High Holborn, London, W.C.1

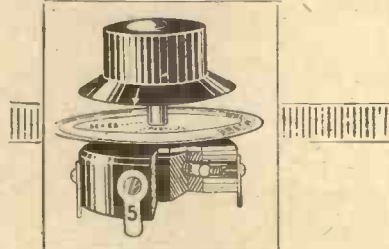

NEW ANTI-CAPACITY SWITCH

Bretwood specialities are known throughout the wireless world to be the last word in scientific achievement, and constructors will welcome news of a further Bretwood Product, an Anti-Capacity Switch, the principal features of which include—

Absolute freedom from capacity effects—Perfect Contact—Workmanlike Finish and Neatness of Appearance—Simple Single-hole Fixing, and Easy to make Wiring Connections.

Special spring loaded balls in the base make the Bretwood Switch wonderfully smooth in action, and ensure clean and perfect electrical contact at all times.

It is confidently offered to wireless constructors as the Anti-Capacity Switch par excellence, and of course it carries the famous 5/- Bretwood Guarantee. Post. 50 3d.

RADIO IMPROVEMENTS, LTD.,
12-18, London Mews, Maple Street,
LONDON, W.

All Bretwood specialities are obtainable from most Wireless Dealers.

BRETWOOD PATENT VALVE HOLDER

Your poor reception is probably caused by faulty valve holders. Fix Bretwoods' and get the maximum results obtainable. Easy to fix. Positively no leakage or capacity effects. Perfect contact. Can be mounted on front or back of panel.

Price 1/9, Postage 3d.



THE BRETWOOD GRID LEAK

This famous Bretwood Product is agreed by all authorities to be the best variable grid leak on the market. Tunes in distant stations as evenly as locals, and gives you the full strength of the incoming signals.

Price 3/-, Postage 3d.

Patent Pending. The "Leak" with the N.P.L. report. Send for a copy. It's free.

strip at the top. These small screws are rather crowded, so that some care has to be taken to avoid a disastrous short circuit between the H.T. primary connection and the secondary earth connection.

On practical trial under favourable conditions, with a small power valve, ample H.T. and proper grid bias, etc., in direct comparison with a number of other types of known performance, the No. 1 gave a really good performance for a small instrument. The build up, both by actual measurement and by aural observation, fell a little short of that given by large, expensive instruments of moderately high ratio (the ratio of these instruments is not given), and there was the expected loss in the lower frequencies which is generally observed in a miniature transformer. These, however, were not serious.

The 2nd Stage Transformer

With the No. 2 instrument in the second stage of a three-valve receiver, using again the most favourable combination of valves, etc., and in comparison with other standard instruments, the No. 2 gave results which were very fair for its size, but there was a marked fall off in the signal-strength com-

pared with a large, high ratio instrument. Presumably this second stage transformer was constructed with a small-step up turns ratio, a practice which does



The "Alto" shrouded L.F. transformer

not appear to have much to commend itself, as there was no difficulty with low-frequency oscillation when proper valves and grid bias values were used, and

the impedance of modern L.F. valves is generally lower than that of a detector valve. Beyond the same effect of raising the so-called "pitch" of the transmission slightly, by giving less amplification of the lowest frequencies, there was no noticeable distortion with this instrument when used with a bright emitter power valve capable of handling the energy.

The insulation resistance of these instruments was excellent on test and they appeared to be soundly constructed.

"Receptor" .06 D.E. Valves

Messrs. F. J. Browse have sent for test three samples of the .06 type of dull-emitter valve which they are putting on the market. These have rather a short, tubular shaped bulb, a quite small cylindrical anode and a spiral grid. The bulb is only partly obscured by the customary metallic mirror like deposit. They are rated at .06 amperes, about 3 volts for the filament, and an anode voltage of 20 to 100.

All three valves, on test, showed very closely the nominal consumption at 3 volts on the filament. The anode saturation current, with 100 volts H.T. and some

YOUR CABINETS.

The original House for hand-made and polished Mahogany Oak and Teak Cabinets to customer's own design. All Timber used in my cabinets is carefully selected and guaranteed THOROUGHLY seasoned.

YOUR PANELS.

Finest quality 1/4 in. thick Ebonite cut to size 1d. per square inch, 3/8 at 1d. per square inch. This Ebonite is guaranteed British Made to Post Office Grade "A" Specification, which is the best for wireless purposes. It is rich black in colour, takes a brilliant polish, can be threaded with ease, and possesses a high degree of mechanical strength.

SPECIAL OFFER. RELAY FOR REMOTE CONTROL.

Size 6 in. by 1 1/2 in. by 1 in. high. Suitable for fixing in corners and out-of-way places.

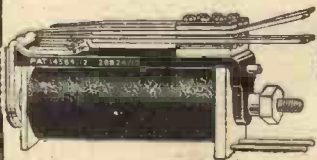

Mounted in mahogany case, 22/6 each.

A LIMITED QUANTITY ONLY.



TELEPHONE DISTRIBUTION BLOCKS.
Table Pattern, 3/9. Wall Pattern, 2/9 (illustrated). Postage d. extra. Made in Polished Mahogany, Oak or Teak. Terminals mounted on best quality Ebonite.

SOLDERING SIMPLIFIED.

Special flux cored solder in 2oz. boxes 1/3 post free. Used in the manufacture of telephone and telegraph apparatus.

W. H. AGAR,

Manufacturer of Telephone and Radio Apparatus,
19, Whitecross Place, Wilson Street, E.C. 2.
Telephone: LONDON WALL 3305.

Valves Repaired Promptly and Perfectly

Let us send you this useful Booklet. Gives curves of Radion Valves, prices for repair work, and shows what service your accumulator should give.

Bright Emitters 6/6
Dull Emitters:
2 volt type 9/-
.06 type 10/6

RADIONS LTD., Bollington, nr. Macclesfield

LANITE
The Ultra Sensitive
CRYSTAL

LANITE, the laboratory crystal, differs in its crystalline structure from all others. It has no dud spots. Its sensitiveness and volume are phenomenal. ORDER NOW. Diagrams and special whisker FREE with every crystal.

Lanite Laboratories, 6 Booth St. East, C.-on-M., Manchester.

PURER TONES

MORE VOLUME



From Dealers or direct from Laboratory.



20 volts positive grid bias, reached above 2 milliamperes in the case of two of the valves; with the third specimen only a very poor emission was recorded, and this was not capable of improvement by the usual "flashing" process of raising the filament to a white heat for a short time without any H.T. applied. Practical test showed that this last valve was not of much use in actual reception.

The characteristic curves were obtained for the two good specimens and showed satisfactory behaviour, though there was a noticeable difference between the two in the matter of A.C. impedance. That of the valve for which the curves are shown here was about half that of the other sample valve, for the 50-70 volt region, although the amplification factor was approxi-

mately the same for both, namely, $M = 8$. An ample straight portion for a grid potential swing of a magnitude sufficient for normal loud-speaking reception was shown

trial on broadcast reception. Excellent loud-speaking was obtained with 100 volts H.T. and grid bias of the order indicated. Whilst the first valve, of lower impedance,

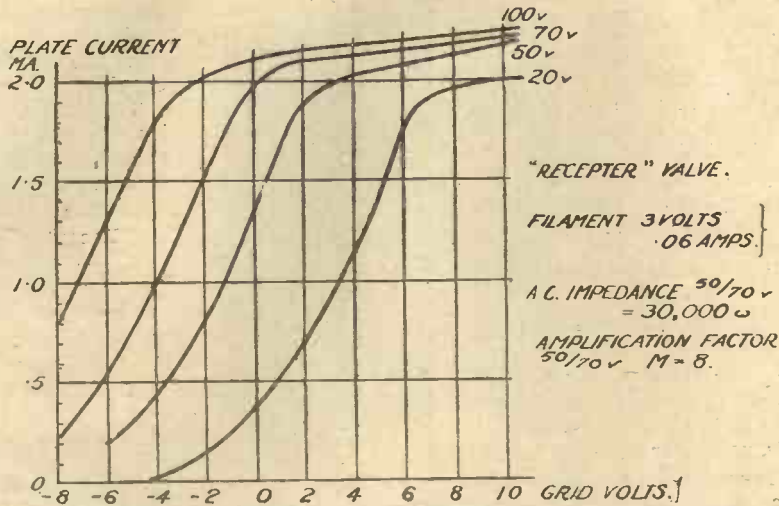

Characteristic curves for the "Receptor" .06 D.E. valves.

oscillated noticeably more easily than the second, both gave good results as detector with 50 volts H.T. They would oscillate with less than 3 volts on the filament; and could be used with down to 20 volts H.T. in this capacity. Results were satisfactory in H.F. amplification with about 50 volts H.T.

Tried together, in an H.F. det. and L.F. circuit with efficient tuning devices, on the low country test aerial, there was no diffi-

culty in going the rounds of all the main B.B.C. stations, some of the relay stations, and half a dozen Continental short wave stations, including the Nuremberg

stations, including the Nuremberg

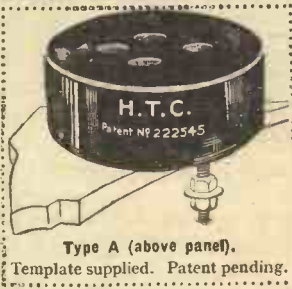

Type A (above panel). Template supplied. Patent pending.

WARNING.—Purchasers of Valve Holders are notified to beware of imitations. It is very necessary when buying to look for the name H.T.C. on the template, without which no Valve-Holder is the genuine and original H.T.C. It may be taken that colourable imitations—simply because they are imitations—will not nor cannot give the efficiency which is inherent to the H.T.C.

BRITISH AND FOREIGN PATENTS APPLIED FOR.

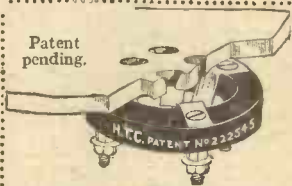

Type C (below panel). The special advantage of this type is the method of mounting—below panel. Template supplied.

YOUR VALVES YIELD THEIR UTMOST—

Little doubt can exist that the ordinary type of valve-holder with the sockets embedded in a compound of doubtful insulating properties may produce in your receiver varying conditions of inefficiency. These may be flat tuning, distortion, lack of power and inability to bring in those distant stations.

Every receiver to be thoroughly efficient should be designed to incorporate H.T.C. Valve Holders—a low-capacity unit which introduces the utmost efficiency into the heart of your set. If your set is a multi-stage H.F. you cannot expect the best results unless capacity effects at the valve are reduced to the minimum. It has been proved by such authorities as Mr. John Scott-Taggart and Mr. Percy W. Harris that for efficient H.F. work it is folly to employ the ordinary type of valve socket. These remarks apply equally emphatically to such apparatus as the more simple detector or one H.F. Receiver—for the utmost efficiency use only low-capacity valve holders—proved in practice the most satisfactory and effectual the H.T.C.

Type A (above panel) } Templates supplied } 1/9
Type C (below panel) } 1/6

The particular design of the H.T.C. Low-Capacity Valve Holders (covered by patents pending) is remarkably efficient. Experimenters using different types of valves know how the leg spacing differs with the type of valve. The H.T.C. Valve Holder is designed to take up these differences. Contact is made by means of a phosphor-bronze tongue springing against the valve legs. These springs are widely spaced—the construction which limits the capacity at the valve to that of the valve. This limitation frees the valve of the paralyzing capacity which deprives your set of the range and power of which it is capable. Get the best from your valves. You must fit low-capacity valve holders. Make no mistake—the H.T.C.

Your dealer may try to persuade you that something in stock is as good. H.T.C. Products are unrivalled for their electrical performance. If your dealer cannot supply, send direct to—

H.T.C. ELECTRICAL CO. LTD.

2 and 2a, BOUNDARIES ROAD, BALHAM, S.W. 12.
Trade Enquiries Invited TELEPHONE: Battersea 374. Barclays 750

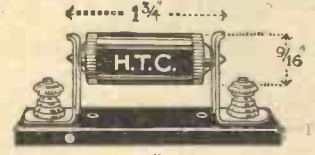

A FIXED DETECTOR. New and Reliable. Crystal reception has seen the introduction of various types of crystal-catswhisker and otherwise. After but a few evenings' exasperating pastime in searching for that sensitive spot—one you lost in the eternal search for one better—you'll find, as experimenters who have used crystal detectors for years, that a good crystal combination is alone satisfactory.

H.T.C. Detector Complete with Ebonite Base, Clips and Terminals 3/6 4/6

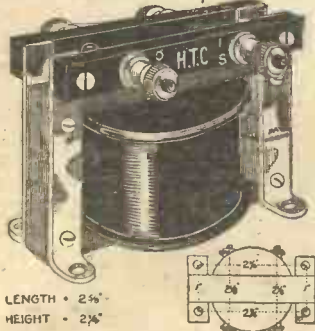

A DISTORTIONLESS L.F. TRANSFORMER Specially wound to prevent breaking down of primary winding—a common fault with many expensive transformers. Price 15/-

WATES WIRELESS WONDERS.

MONEY can be axiomatically described as the pulse of existence. This being so, value-for-money must be the paramount aim of any enterprise. Our policy is Value-for-Money. We invite you to drop a line for our latest catalogue, just published, and study the details of our components. There are terminals, condensers, transformers, coil-holders, microstats, and in fact everything necessary for constructing complete sets, as well as full details of our "Supratone" 2-valve Amplifier, "Bijouphone" Crystal Set, "Ideal" Accumulator, and "Pyramid" H.T. Battery. We suggest that by obtaining all your parts, etc., from the same source, greater satisfaction would be obtained than by dealing promiscuously with a number of different firms. Send for free copy of this Catalogue to-day.

The SUPRA Transformer

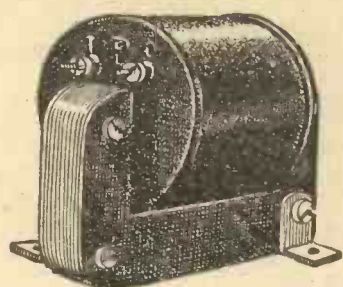

Time, research and careful study of transformer design have resulted in the twelve-and-sixpenny Supra Transformer being placed on the market. You need fear no distortion or weakness in the Supra—the original sectional wound transformer. Strangely enough, it is sometimes suggested that being low in price compared with competitive transformers, the quality is also low. The answer is obviously that the growing and enthusiastic popularity of the instrument is full justification for its being offered at such an exceptionally low figure. The Supra is fully guaranteed, and if absolute, satisfaction is not given customers' money is refunded.

Ratio 5 : 1 **12/6**

"K" Square Law condensers

A glance at the illustration will show the distinctive features of the 19-gauge plates, constituting a real "Square Law" variable condenser. There is no possibility of "shorting," owing to perfect spacing and rigid assembly. The wonderfully smooth movement ensures perfect ease of tuning. Prices include "Trolite" Knob and handsome 3-in. graduated dial.

0.001, 10/- 0.0005, 8/3 0.0003, 7/9 0.0002, 7/3
0.0001, 6/6 With Vernier, 0.001, 13/8
0.0005, 12/6 0.0003, 11/6

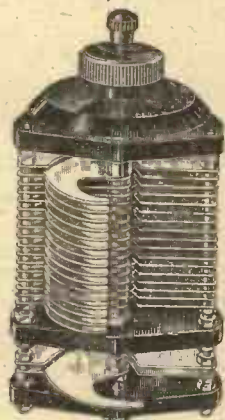

"K" tubular fixed condensers.

(Something quite new)

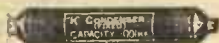

The success of this tubular fixed condenser is not surprising, for its unique advantages are now realised. Accuracy of stated capacity, extreme ease of fixing in any circuit and negligible space are outstanding features.

0.001 .. 2/- each.	0.0001 .. 1/9 each.
0.002 .. "	0.0002 .. "
0.003 .. "	0.0003 .. "
0.006 .. "	0.0005 .. "

WATES Bros., Ltd.,

12-14, Great Queen St., Kingsway, W.C.2
Phone : Gerrard 575 and 576. 'Grams : Zywateseng, Westcent.
Works : LONDON, BIRMINGHAM, and WESTCLIFF

SIEMENS SUPER-SENSITIVE HEADPHONES



These headphones are noted for clearness of tone, and are specially recommended for use with crystal sets, for tuning in distant stations, and in all cases where extreme sensitiveness is essential.

REDUCED PRICE 20/-

Resistance 120 ohms, 2,000 ohms, or 4,000 ohms, as required.

Obtainable from all leading dealers.

SIEMENS BROTHERS CO., LTD., WOOLWICH, S.E.18

THE NEW CONNECTING WIRE

GLAZITE

Don't risk burning out an expensive Valve!

"Glazite" makes that back-of-panel "short" an impossibility. Made of $\frac{1}{16}$ tinned copper wire, with a special glazed covering, "Glazite" possesses exceptional insulating qualities, which enables you to dispense entirely with insulating sleeving.

"Glazite" is damp-proof, flame-proof and cannot deteriorate in use. Your soldering iron cannot burn or melt "Glazite." "Glazite" has a high dielectric strength and is flexible.

"Glazite" is made up in neat coils 10 ft. in length and in four different colours—red, blue, yellow and black. Price 1/6 per coil.

Send a postcard for Glazite Leaflet, and name of nearest radio dealer carrying stock.

THE LONDON ELECTRIC WIRE CO. & SMITHS, LTD.



Makers of electric wire for over forty years. Our mark is a guarantee of quality.
Playhouse Yard, Golden Lane, London, E.C.1
'Grams : Electric, London.
'Phones : Clerkenwell 1388, 1389, 1390, 1391.



ELECTRON WIRE

THE PERFECT AERIAL



the aerial which encircles the earth

The World's Wonder Aerial—literally encircles the Earth. WHY? Because Wireless enthusiasts the World over know that they cannot afford to be without it. With "Electron" Aerial their chief difficulties are surmounted and perfect reception is assured.

ON SALE EVERYWHERE

There is a shop on the way home.

WARNING

Buy "Electron Wire" in our distinctive box as illustrated → plainly printed in blue on every side with



Refuse all others.



NOTE OUR NEW ADDRESS.

Loud Speaker and 'Phone Extensions: Electron Wire can be supplied in any length, laid double for extensions to any part of the house or garden, insulated with vulcanised rubber. No further insulation is necessary; it may be allowed to touch anything anywhere in perfect confidence.

100 ft. 300 ft. 500 ft. 1,000 ft. half mile
1/8 5/- 8/- 15/- 30/-

Postage 6d.

Laid double for loud speaker and 'phone extensions, carriage paid.

NEW LONDON ELECTRON WORKS, LTD.

Dept. No. 99, (Members of the B.B.C.)

EAST HAM, LONDON, E.6.

Telephone: 1408 East Ham.

Telegrams: "Stannum, London."

The WADE WIRELESS TOOL-SET

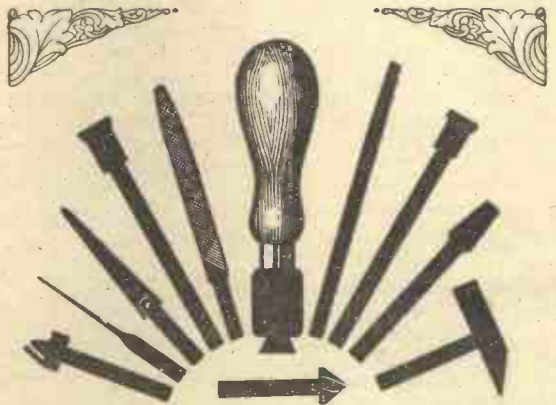

Here, at last, is the real Wireless Tool Set that every Wireless Constructor has been waiting for. No more spoiling a good panel by using the family screwdriver, hammer, and gimlet; no more trying to tighten nuts with an adjustable car spanner or a pair of pliers.

The Wade Wireless Tool Set includes:—

- 1 Extra Length Screwdriver, which enables you to get at screws inside your Set without fouling the wiring system.
- 1 Broad Screwdriver for turning all ordinary screws.
- 1 Wire Bender; invaluable for bending wire to any shape.
- 1 Hammer, for cabinet construction, straightening wire and for use generally where household hammer is far too clumsy.
- 2 Box Spanners, 4 B.A. and 6 B.A., absolutely essential for turning nuts in awkward places. They replace pliers which always burr up the nuts.
- 1 Counter Sink, to enable screw-heads to be sunk to the panel level.
- 1 Reamer, for enlarging holes to any diameter. Replaces numerous and costly drills.
- 1 Bradawl for starting screw-holes.
- 1 Double-sided File for smoothing-off soldered joints, etc.

All these tools fit into the Universal Holder provided.

If you cannot get the tool-set from your local dealer send direct to us, kindly mentioning the dealer's name.



C.A.V. SMALL TOOLS, LTD., 181, Queen Victoria Street, E.C.4.

E.P.S 26.

relay station, all at comfortable strength and in some cases on the loud speaker. The valves are somewhat microphonic, as is usually the case with this type.

Evidently, subject to a certain amount of variability in different specimens, these are excellent valves for general use. We have no doubt that, if occasional poor specimens can be excluded by proper tests before issuing them to the public, they will give every satisfaction at the moderate price at which, we understand, they are placed on the market.

New B.T.H. Valves

We have received from Messrs. British Thomson-Houston Co., Ltd., samples of their new types of D.E. valves, the "B. 3," "B. 6" and "B. 7." The first is a general purpose valve with a filament consumption adapted to the output of a single small accumulator cell, .35 amperes at 1.8 volts. The other two are small power amplifying valves for loud speaker work and therefore of lower impedance but of rather higher filament wattage than is usual with a general purpose valve. The B.6 takes .12 amperes at 3 volts in its rather unique type of filament, and the B.7 requires the usual current of .06 amperes, but now at 6 volts. Evidently the last two valves are still suitable for operating from dry cells of moderate size—a point which is of great domestic importance in practical broadcast reception.

Taking the B.3 at the convenient figure of 1.8 volts, which can be relied upon with a small accumulator towards the end of its charge, the characteristics were determined over the range indicated by the makers: i.e. 20 to 80 volts plate potential. The filament current was exactly .35 amperes. It will be seen that the characteristic curves were of excellent shape for a general purpose valve, the 50 volt curve giving promise of good detection and H.F. amplification, and the 80 volt curve indicating distortionless L.F. amplification with signals up to ordinary loud speaker strength with a grid bias of about 4 volts. This was confirmed in each case

in actual reception. Good detection was possible with less than 50 volts.

The valve is of normal shape, with a large cylindrical anode and a fairly open spiral grid. It will be seen that the voltage amplification factor was the satisfactory

grid. The filament current was almost exactly .12 amperes at 3 volts, at which figure the characteristics were determined, although the valve would operate at a somewhat lower voltage. Since in practice three dry cells are required for continuous satisfactory operation of the 3 volt dull-emitter type of valve, and dry cells which are not beyond their useful span of life will give a volt apiece, there is little point in using less than 3 volts on such a valve. It should be noted that in a three-valve receiver with this as the last note magnifying valve in company with two others of the .06 type, the total filament current amounts to .24 amperes, which is beyond the power of any but the largest types of dry cell for proper continuous operation in the daily reception of broadcasting. It would be preferable in such a case to provide three separate cells for the last valve.

The characteristics show, over the range of plate potential indicated by the maker, an available swing of grid voltage without leaving the straight portion of the characteristic or running into the positive region (with resulting distortion due to grid current) of nearly 10 volts in the 120 volt curve, and of some 4 to 5 volts in the lowest, 60 volt, curve. The A.C. impedance is low (about 12,500 ohms in the 70 to 120 volt region). The amplification factor is the excellent figure —of approximately 7.5 in the same region. Actual trial in reception, with 60 volts H.T. and 3 volts negative grid bias, showed excellent distortionless amplification for moderate loud-speaking and for amplifying fairly weak signals (such as, e.g., W.B.Z., who came in nicely after 11 p.m. on the loud speaker with this valve preceded by a detector valve of high M). For really powerful signals, such as those given by 5XX, 100 volts H.T. and 7 volts grid bias were called for.

The B.7 valve closely resembles the B.6 in outward appearance, but the filament took, on measurement, exactly .06 amperes at the full 6 volts of a three cell accumulator.

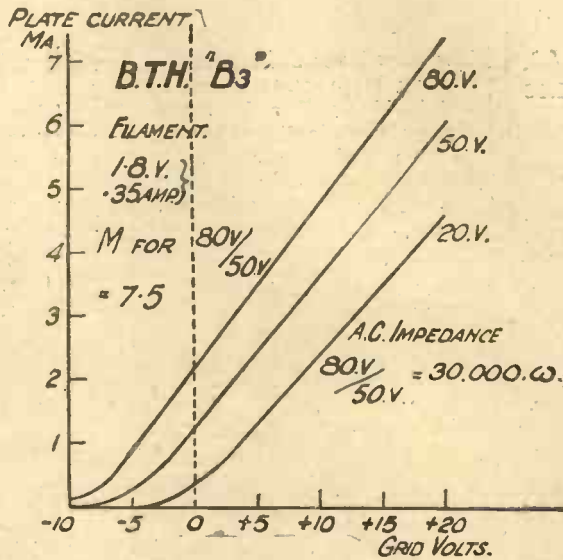

The B.T.H. "B.3" characteristic curve

figure of about 7.5 for the 80-50 volts region; and the A.C. impedance in this interval the fairly ordinary figure of 30,000 ohms. From our tests we can certainly recommend this valve for general use with a 2-volt accumulator.

The B.6 is a large valve with the flat box type of plate, a double, straight filament and a fine mesh

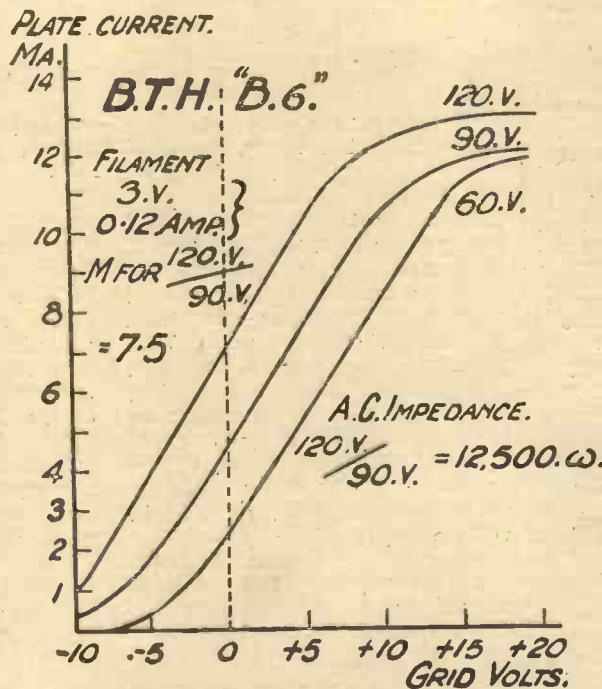

Characteristic curve for the B.6 valve, which is of the power amplifying type

REGISTERED
REPAIRS
TO HEADPHONES
TO LOUD SPEAKERS
TO COILS

Rewound to any Resistance and made equal to new. Price quoted on receipt of instruments. Prompt Delivery

THE VARLEY MAGNET CO.
(Dept. M), WOOLWICH, S.E.18
Established 26 years.
Phone: Woolwich 888.

2-Valve Receiving sets, ex-Army MK. III. These sets will receive several B.C. Stations. Range 260 to 1,880 metres. The very best of materials are used in these sets.

New	£4 15s.
Soiled	£4 0s.
Less Transformers ..	£3 0s.

A few with panels and various parts at 20s. Guaranteed. Trade supplied.

SWAN RADIO CO.,
18, Kingsland Road,
Nr. Shoreditch Church.

—PARIS AND OTHER STATIONS—
Clearly heard on Loud Speaker near London, using the "MIRACLE" MASTER 2-Valve Set, £3 12s. 6d., plus Royalties. 1, 2, 3, and 4 Valves. Trade supplied. Send stamp for particulars. **WORLD'S WIRELESS STORES, WALLINGTON.**

Cabinets You Want!
For Radio Perfection

PICKETTS are used for Finest Sets.
ESTIMATES PER RETURN.
Send for Cabinet List, Free.
PICKETTS CABINET (M.W.) WORKS,
BEXLEY HEATH, S.E.

Provincial representatives required to represent London Wholesale Wireless House on liberal commission basis. All or part time. Splendid opportunities for the right men.—Apply Box L931, Roy Hardy, Ltd., 292, High Holborn, W.C.1.

CABINETS.

The Popular "All Concert-de-Luxe," 14/6, post free.
A.B.C. Wave-Trap, 4/6, post free.

"Paragon" Panels Fitted at Lowest Prices. Send your requirements. We will quote you.

CATTERMOLE BROS., 17, Waller Street, HULL.

FOR SECURING YOUR AERIALS
and a Thousand Purposes where Great Strength and Strain is needed.
FLEXIBLE STEEL WIRE ROPE.



Aeroplane Cable made to Govt. specification to specified breaking strains. Orders of 10/- and over carriage paid, otherwise please add 1/- for postage

No.	Diam.	Br. Strain.	per 100 ft.
0	1/8"	5 cwt.	4/6
1	3/32"	10 cwt.	6/-
3	1/4"	20 cwt.	8/-
51	5/32"	25 cwt.	10/-
52	3/8"	35 cwt.	11/-

STRAINERS for use with above, right and left-hand threads, 9d. each, or 8/6 per doz.

SMITH & ELLIS (Dept. 85),
11, Little Britain, Aldersgate Street, E.C.1.

It is accordingly suitable for use in association with ordinary bright emitter valves operated from a 6 volt accumulator, without any special filament resistance; or together with the ordinary .06 type of dull emitter but with a suitable dry battery for the L.F. valve alone. The characteristics, over the maker's range, were those of a moderately low impedance small power valve, a very large plate current being obtainable, and a long available straight portion of the characteristic in the negative region. The amplification factor came out at around 8.5 in the 90 to 120 volt region, the A.C. impedance being about 17,000 ohms. In general, the valve closely resembled the B.6 in its behaviour, and excellent

(to avoid whistling as well as that unwanted partial rectification), the trouble can be dispelled without making undue demands on the L.T. battery when either of these dull emitter power valves is used. The H.T. battery must be large enough, though, to supply the extra 3 to 4 milliampere plate current required.

Micrometer Crystal Detector

We have received from Messrs. The General Electric Company a sample of their "Micrometer" crystal detector, fitted with a "Gecosite" crystal. This detector is of the horizontal glass enclosed type, fitting between spring supports on an ebonite base 2 3/8 in. by 1 1/2 in. The latter has screw-holes for fixing on the panel, etc. Sub-

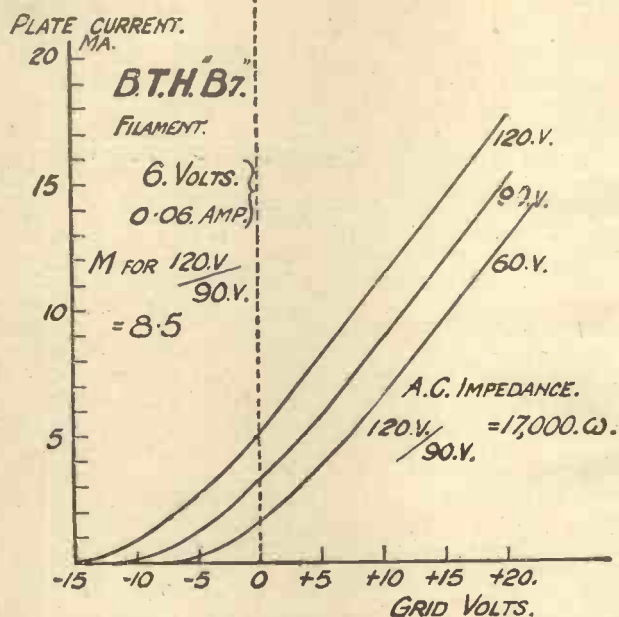

The characteristic curves for the B.T.H. B.7 valve, which is suitable for use with dry cells

distortionless loudspeaking resulted with proper H.T. and grid bias of the same order as with the latter.

It is a matter of fairly general observation (and complaint) that with the ordinary .06 type of D.E. valve in a two-stage L.F. amplifier, using efficient transformer coupling, horrid distortion often results on loud signals—which is due, of course, to the overloading of the last valve and the use of insufficient negative grid bias to keep the grid voltage swing wholly within the negative region. These two small power valves, the B.6 and B.7, can be well recommended for use in such cases in the last stage. With proper plate potential and grid bias on both L.F. valves

substantial plated terminals on the base provide for connections. The instrument was dismounted with much greater ease than usual, and was firm and secure when re-assembled. The crystal is secured by a flanged knurled ring screwing on a cup base fixed to one end of the case, and is immediately accessible for replacement or re-adjustment in its holder. A special point is the micrometer adjustment of the whisker, which was found, on trial, to work with the most delightful delicacy and certainty, and to give a light contact with the excellent springy whisker provided. The adjustment was not easily disturbed by vibration. The whisker-holder is mounted in the ordinary

type of ball universal joint, but rotation of an insulating knob at the end of the adjusting rod advances or withdraws the former by a fine micrometer screw action, a spiral spring taking up all backlash.

This detector has evidently been the subject of very careful design. The workmanship and finish are excellent, and the insulation resistance of the base passed severe test. We might suggest that the area of crystal surface exposed by the holder is rather unduly limited, so that the sensitive spots would be rapidly exhausted in daily use for broadcast reception, and that the holder might, with advantage, be made to take a rather larger fragment of crystal. The "Gecosite" crystal supplied with the instrument proved excellently sensitive on trial in reception of the local station.

"Trix" Valve Grips

We have received from Eric J. Lever a set of the "Trix" anti-capacity valve grips or valve-holder fittings. These consist of small copper spring contact pieces adapted for mounting by a small bolt apiece behind the panel, with the springy ends under $\frac{1}{4}$ in. holes drilled in the panel to accommodate the valve legs. When the valve legs are inserted in these large clearing-holes, they make contact with the springs; at the same time there is a minimum of solid dielectric between the legs. Electrical connections are made to the contact pieces by soldering tags on the outer side. A gummed paper template is provided for drilling the panel correctly, $\frac{1}{4}$ in. and $\frac{1}{8}$ in. drills, clearing size, being required.

It is evident that this device will give a valve holder of minimum casual capacity, and of insulation determined solely by the quality of ebonite used in the panel. For certain purposes, as for resistance-capacity H.F. coupling on the medium waves, and for really short wave work with small total tuning capacities, these holders may offer considerable advantages. The price is exceedingly moderate.

Cosmos D.E. 11 Valve

From Messrs. Metropolitan-Vickers Electrical Co., Ltd., have come samples of their new D.E.11 Dull Emitter Valve. This can best be described as being, in

build and filament requirements, etc., of the general type familiar to all as the "pea-nut." Thus the filament current was, in both samples submitted, around .25 amperes at 1.1 volts, and the



The "Micrometer" crystal detector of the General Electric Co.

filament operated at a very dull red heat, scarcely visible in bright daylight. The ordinary cap and four pin base is fitted, and a tubular globe of moderate dimensions. The plate and grid are of small dimensions, and vertical, while the glass is not obscured by the usual metallic mirror common in modern valves.

showed useful working properties, the 30 volt curve indicating good detection and H.F. amplification, and the 50 volt curve satisfactory L.F. amplification for moderate signals with a small negative grid bias, there being room for some 4 volts maximum grid potential swing without introducing distortion. At the maximum plate potential of 120 volts—which the valves stood without any indication of softening—a heavy grid bias is essential, the curves indicating 10 volts negative, and on actual trial at least 7 volts were required to avoid distortion; surprisingly large amounts of signal energy could then be handled. The voltage amplification factor came out at about 6 in the 30 to 50 volt region, the A.C. impedance showing the common figure of 30,000 ohms here.

In actual reception excellent results were obtained in H.F. amplification (with a coupling in which the grid to plate capacity had been effectively neutralised, which is particularly necessary with this type of valve), and also in detection, using 30 volts on the plate. Distant Continental stations were picked up with ease and comfort on an H.F. and detector receiver using the two sample valves. In a L.F. stage good amplification resulted with from 40 to 60 volts H.T. and 1.4 volts negative grid bias—one dry cell, connected to the L.T. minus. For use in a single valve receiver (where the smooth reaction obtainable with this type of valve gives a surprising effective range) in conjunction with a monster type of dry cell for L.T. supply, or for operation with proper filament resistances from a 2 volt accumulator of small size if several valves are used, the D.E. 11 valve can be well recommended.

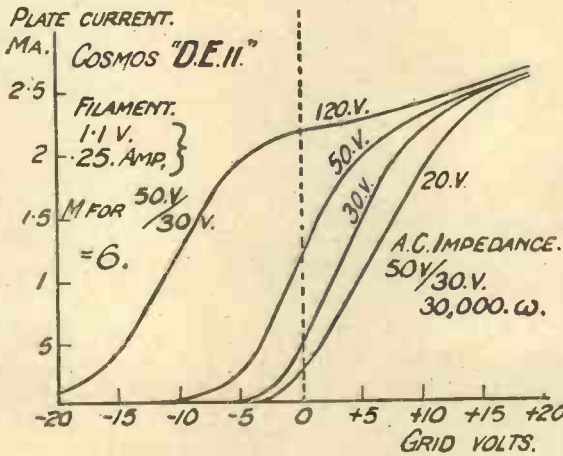

Characteristic curves for the Cosmos "D.E.11" valves, a test report of which appears on this page.

The two samples showed very similar characteristics, though the saturation plate current with high positive grid bias was appreciably higher in the one when both were operated at 1.1 volts on the filament. Raising the filament volts with the second to 1.2 gave the same saturation current, of the order of 4 milliamperes; but both valves operated quite satisfactorily on 1.1 volts or slightly less.

Over the range indicated by the makers from 20 volts (for detection) to 120 volts (for L.F. amplification), the characteristics

WHAT STATION IS IT?

Have you been puzzled by an unknown station playing a tune you recognise? Buy "WIRELESS WEEKLY" which will in future publish detailed programmes of Continental and American Stations.

FIRST PROGRAMMES IN THE ISSUE OF 4th MARCH.

Brown

Featherweight Headphones



DO not deny the kiddies the pleasures of Broadcasting. A pair of **Brown** Featherweight Headphones weighs but six ounces (including cords) and costs but 20/- per pair. They fit the head easily and comfortably. For children particularly they are ideal. Even the grown-ups appreciate their extreme lightness and sensitiveness.

4,000 ohms. **20/-** per pair.

Manufactured only by
S. G. BROWN, Ltd.
Victoria Rd., N. Acton, W.3.

REDUCED PRICE,

Showrooms :
19, Mortimer Street, W.1.
15, Moorfields, Liverpool.
67, High St., Southampton.

Gilbert Ad 2272

BARCLAYS SERVICE

The experience of the Principal and staff of this Agency is such that their advice and assistance, freely given to wireless manufacturers and retailers, is accepted as sound, accurate in every detail and of proven value.

The Manager has been intimately associated with wireless and advertising from the days when there was only one public wireless periodical in this country. He is well known to the trade generally and has chosen a staff of experienced men, each of whom, in his own sphere, is able to solidify the complete service rendered by the agency.

Representatives, copy writers, artists and lay-out men are all in close touch with every aspect of wireless sales promotion. The results of their co-operation are fully in keeping with the following extract from a letter just received :—

" We regret to have to inform you that this business has grown so rapidly during the last month (thanks to the wonderful result of your advertisements), that we have been quite unable to keep pace with our orders."

Why not take advantage of this accumulated experience and knowledge of present-day methods so essential to the expansion of your business.

Consultations Free by appointment.

BARCLAYS ADVERTISING Ltd
Advertising Consultants & Contractors.
Bush House, Strand, London, W.C.2.

Telephone: City 9911 (Eain. 9).

SAVE TROUBLE

Just send a subscription for your favourite wireless journals. Promptly delivered through the post.

MODERN WIRELESS

Twelve months - - - - 15/-
Six months - - - - 7/6

WIRELESS WEEKLY

Twelve months - - - - 32/6
Six months - - - - 16/3

The WIRELESS CONSTRUCTOR

Twelve months - - - - 8/6
Six months - - - - 4/3

RADIO PRESS Ltd.
BUSH HOUSE STRAND,
London, W.C.2.

MAGNUM

Owing to extreme delay in obtaining deliveries of certain makes of components used in Radio Press circuits we are offering the undernoted, composed entirely of Magnum or equivalent components.

COIL FORMER for A.B.C. Wave Trap cut from ebonite tube to author's design 5/6 (postage 3d.)

MAGNUM
All Concert de Luxe
Envelope No. 4
£7 5 0

MAGNUM
Transatlantic 4
£9 0 0

MAGNUM
Transatlantic 5
£9 10 0

Carriage and Packing FREE on Retail orders value £2 and over.

The cabinets, panels and general disposition of components of the above will remain in accordance with the author's specification.

We have large stocks of the following and can give good deliveries:—Bowyer-Lowe Condensers, and switch arms. Dubilier anode resistances and condensers. Transatlantic 4 panels drilled and engraved. Utility lever type anti-capacity switches. Connecticut switches. Burndept detectors potentiometers, and dual rheostats. Lissen 5-point and 2-point switches, Rheostats. Royal low-frequency transformers. Seven circuit crystal set cabinets. Igranite resistances.

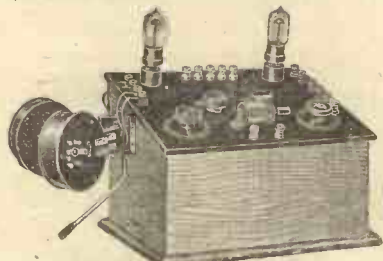

CONSTRUCT THE S.T. 100 for £7 0 0. (Envelope No. 1.)

CONSTRUCT THE A.B.C. WAVE TRAP for £2. (Envelope No. 6.)



CONSTRUCT THE 4-VALVE FAMILY for £9 0 0. (Envelope No. 2.)

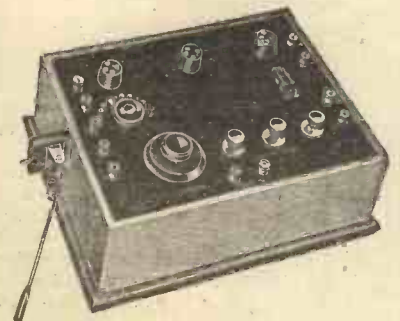

CONSTRUCT THE SIMPLICITY 3 for £4 13 2. (Envelope No. 3.)

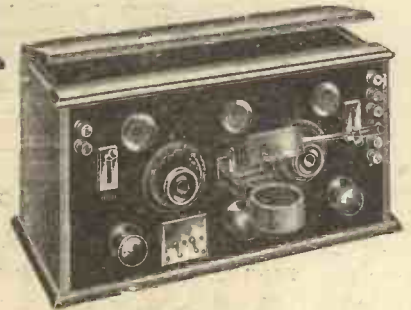

CONSTRUCT THE ALL-CONCERT-DE-LUXE for £9 9 0. (Envelope No. 4.)



MAGNUM H.F. TRANSFORMERS.
With Protected Windings.
The most efficient H.F. Transformer obtainable. (See report in "Wireless Weekly.")
7/- each. Postage 3d.
Guaranteed correctly matched 14/- per pair. (Postage 3d.)

No. 0	150-300
OA	250-525
1	300-600
2	550-1200
3	1100-3000

Special winding for Anglo-American Six referred to as Neutrodyne Units. Per set of 3 21/- (post free).



MAGNUM COIL HOLDERS.

2 WAY
9/6
Postage 6d. (Type I). Suitable for "Transatlantic V" "4-Valve Family" etc., etc.

2 WAY
12/6
Postage 6d. Suitable for "Omni" "Tri-Cell" "All-Britain" and all "Tri-Coil" Circuits.

2 WAY
9/6
Postage 6d. (Type R) Suitable for "S.T. 100" "Simplicity 3" "All Concert de Luxe" "3 Valve Dual" "Puriflex" etc.

1 lb. Hank No. 26 D.C.C. Wire for P.W. Harris Crystal Set, 3/- post free.

THE OMNI.

CONSTRUCT THE OMNI.

(Envelope No. 5). Including special machine-engraved panels £11 11 0.
As above but panels not engraved (Transfers included in No. 5 Envelope) £10 10 0.

TAPPED REACTANCE UNITS.

As illustrated in "Modern Wireless" (February issue) page 3 and described by Mr. G. P. Kendall. 1st stage for T.A.T. 15/-
Subsequent stages 21/-
Post free.

RADIO PRESS ENVELOPES.

No. 1.	S.T. 100	1/9
No. 2.	4 Valve Family	2/9
No. 3.	Simplicity 3	2/9
No. 4.	All Concert de-Luxe	2/9
No. 5.	Omni	2/9
No. 6.	A.B.C. Wave Trap	1/9
No. 7.	2-Valve Amplifier-de Luxe	1/9
No. 8.	1-Valve Reflex	1/9
No. 9.	Efficient Single Valve	1/9
	Radio Press Transfers	8d.

Note.—Leaflets dealing with Radio Press Envelopes Nos. 6, 7, 8, 9 now ready.

EBONITE COIL FORMER

(CROSS TYPE.)
as used by Mr. G. P. Kendall, 3/- post free.

MAGNUM 2 COIL HOLDER

Suitable for Transatlantic 4. Recommended for all sets employing 2-way coil holders with short handle. 9/6. Postage 6d.
Send stamp for illustrated list and set of leaflets dealing with Radio Press Circuits



MAGNUM ANTI-CAPACITY VALVE HOLDER.
An entirely new design made from best quality SOLID EBONITE specially channelled. As used on Radio Press sets. 2/6 each (post free)

Anode Coils tapped and complete, as used in the Simplicity 3 and T.A.T. 8/- post free.



MAGNUM NEUTRODYNE CONDENSER.
Specially designed and recommended for the Anglo-American Six and all Neutrodyne circuits described in Radio Press Publications 4/6 (postage 6d.).

BURNE-JONES & Co., Ltd.

296, BOROUGH HIGH STREET, LONDON S.E. 1.
Telephone Hop 6257. Telegrams BURJOMAG
Sedist London. Cables BURJOMAG, LONDON.
Mail order Dept.: 298, Borough High Street,
London, S.E. 1. All correspondence to 296,
Borough High Street, please.

WARNING

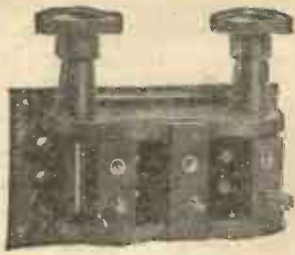

Three-way Coil Holder

**COIL
HOLDERS,
Two-way and
Three-way**

Letters Patent
Number
193150

It has come to our knowledge that certain coil holders are being offered for sale which are not of our manufacture and which are infringements of our Patent Number 193150.

It is our intention to uphold our rights and the rights of our licensees under this patent, and both trade and public are warned that the sale or use of these imitation coil holders renders them liable to action. Terms will be quoted to potential licensees on request.

January 31st, 1925



**BURNDEPT Ltd., Aldine House,
Bedford Street, Strand, London, W.C.2**

Modern Radio Sets should be made of **TROLITE**

for Elegance and Efficiency



Trolite PANELS are supplied with a beautiful polish which has no surface leakage—does not warp nor discolour. Ask your dealer to show you a full range of Trolite Mouldings.

**WHOLESALE ONLY FROM
F. A. HUGHES & CO., LIMITED,
204-206, GT. PORTLAND ST., LONDON, W.1.
Museum 8630. Distanc'g Wesdo, London**

T. O. BUSS

SCIENTIFIC INSTRUMENT MAKER

77, Clerkenwell Rd., London, E.C.1

Estb. 1850. Exhibition Awards: London, 1862; Sydney, 1879; Melbourne, 1880.

INTERVALVE TRANSFORMERS

Made like an Instrument by a Scientific Instrument Maker.



Correct priming impedance. Wound with correct gauge and quantity of wire. Heavy iron core to give good magnetic field—and will carry heavy currents.

PRICE
18/6

Ratio 5 to 1.

MADE LIKE AN INSTRUMENT.

This instrument is thoroughly tested and is
GUARANTEED FOR TWO YEARS.

Barclays 353

ACCUMULATORS RE-CHARGED FREE!

STANDARD MODEL. IN YOUR OWN HOME with the
"CHASEWAY" CHARGER



The "Chaseway" is a thoroughly practical electrical apparatus, designed specially to remove the re-charging bugbear. It can be connected by the merest amateur in any household having DIRECT (CONTINUOUS) CURRENT, and if used whilst current is in use for lights, irons, kettles, radiators, etc., costs nothing for the re-charging. Once fitted, it is there for life, requires no attention, and is a wonderful boon for all accumulator users.

No. 1 For any installation of 100 to 250 Volts. Size 9 in. x 3 1/2 in. 25/- complete.

No. 2 For installations of lower voltage. Size 9 in. x 3 1/2 in. 35/- complete, with 2 amp. resistance; or 40/- with 2-5 amp. adjustable resistance.

No. 3 For Shopkeepers, Garages and others who can re-charge batteries for revenue—will charge several accumulators at once, 24.

ASK YOUR DEALER FOR ONE or send remittance direct if any difficulty.

Ask for details of "CHASEWAY" Charger for Alternating Current—Better and Cheaper than all others.

Illustrated Catalogue of other "Chaseway" Specialities FREE on receipt of stamp. Contains many novel necessities.

ONLY
25/-
DON'T PAY MORE

"CHASEWAY"
VARIABLE GRIDLEAK

.001 to 20 megohms. A scientific instrument—the "nerves" of the receiving set. Remarkable sensitivity and range. One-hole fixing. No cardboard, no liquid, no pellets. Reliable for All Time.

CHASE ELECTRICAL MFG. CO., LTD.,
184m, Fleet Street, LONDON, E.C.4. 4/-

Central 1539. TRADE ENQUIRIES INVITED.

V. Pethick—Advertising—London.



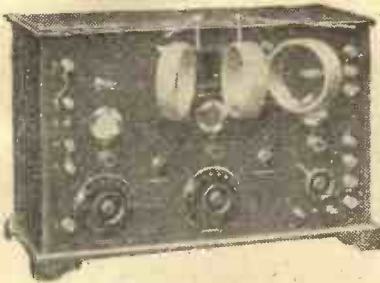

THE ALL-BRITAIN SET.
A wonderfully popular 3-valve Set, which, as its name implies, is capable of receiving all the main B.B.C. stations at good strength. A very simple Set to operate, and recognised as being very selective. Uses the new tri-coil circuit.



THE ANGLO-AMERICAN SIX.
Mr. Percy Harris' latest Set embodying three stages of neutrodyne high-frequency. Gives practically the power of a super-heterodyne with a great saving in valves. A few feet of wire around the picture moulding of a room is all that is necessary to operate this Set.

Amateur-built Receivers that any Expert would be proud to own.

If you can use a pair of pliers to cut a length of wire—if you can screw a transformer to a ready-drilled panel—if you can follow a simple wiring diagram, then you can build any of the splendid Sets illustrated on this page. From the 2-valve Resistoflex to the 6-valve Anglo-American designed by Mr. Percy Harris for "The Wireless Constructor," they represent all that is best and most original in British Radio design to-day.

Every one of these Pilot Receivers carries our full guarantee that if made according to our working instructions they will work perfectly. Indeed, we go further than that—

we have instituted a special Service Department to ferret out faults for you at a nominal cost should the Set not work when you have made it up.

Choose the best Set you can afford from the chart herewith—if you have some of the parts already, we shall be pleased to supply you with the balance. If you have all the parts already, we shall be equally pleased to supply you with only the panel or the cabinet. If you cannot make up your mind which Set you will build, write for a copy of our 32-page Pilot Chart (post free 3d.), containing upwards of 30 illustrations of Pilot Receivers with the fullest details.

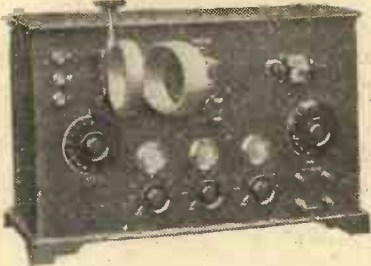

THE PURIFLEX SET.
Originally designed for "Modern Wireless" by Mr. Percy Harris. Uses a Crystal Reflex circuit with a two-stages of resistance coupled low-frequency amplification. Famed for its remarkable loud-speaker purity of reproduction. There is a complete absence of distortion with this Set.

This abridged Chart will aid you in your choice.

Name of Receiver.	No. of Valves.	Price of Panel drilled and engraved.	Kit of Components.	Oak Cabinet with baseboard.
All Concert-de-luxe	3	15 6	£4 15 6	17 0
S.T. 100 ..	2	7 0	£4 14 0	£1 10 0
Puriflex ..	3	15 6	£4 2 0	17 0
All-Britain ..	3	15 6	£4 16 1	17 0
4-Valve Family ..	4	17 0	£5 16 8	17 0
Transatlantic V ..	5	18 6	£5 8 5	17 0
Anglo-American 6 ..	6	£1 8 6	£9 9 9	£3 1 6
Transatlantic 4 ..	4	16 6	£5 13 6	£1 7 6
3-Valve Neutrodyne (Valve panel)	3	12 0	£4 8 8	£1 13 6
3-Valve Neutrodyne (Tuner panel)	—	11 6	£4 2 3	(to take both panels)
T.A.T. 4-Valve Set	4	£1 0 6	£5 15 6	£1 0 0
Harris Wavemeter	—	4 6	£1 6 0	12 6
3-Valve Dual	3	17 0	£5 5 0	15 6
Simplicity Receiver	3	12 0	£3 16 0	10 6
7-Valve T.A.T. Receiver	7	£1 17 6	£7 18 0	£1 12 6

*SPECIAL NOTE: Where all components and panel are purchased together a Marconi Royalty of 12s. 6d. per valve-holder must be paid.

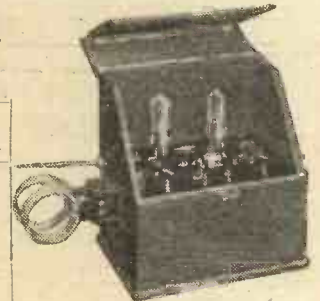

THE S.T. 100.
The world's Standard 2-valve Reflex, which gives probably the loudest signals it is possible to obtain with two valves. Tens of thousands of S.T. 100 Receivers have been built in America, although the circuit was first evolved by Mr. John Scott-Taggart (Editor of "Modern Wireless"). This Set is contained in a handsome oak double drop front, and possesses a most attractive appearance.

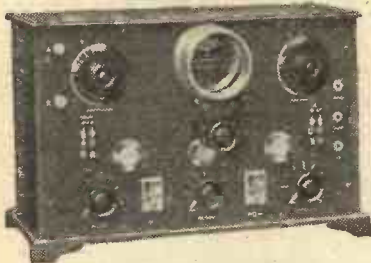

THE ALL CONCERT-DE-LUXE.
A most handsome Receiver with all fittings supplied nickel-plated. Simple switches enable note magnifier valve being cut out if not required. Has a telephone range of 800 to 1,000 miles under normal conditions. All battery connections at rear, and plugs and jacks for telephones and loud-speaker fitted to panel.

To get the full list of parts necessary for 30 different Receivers, send 3d. to-day for the Pilot's Chart—

If the 7 different Sets shown here are not suitable for you send 3d. at once for a copy of our 32-page Booklet giving illustrations of 30 different Receivers—ranging from simple Crystal to elaborate multi-valve Sets. A full detailed list of every component required for each Receiver. An invaluable little Booklet for the Home Constructor. In addition, we also issue a 48-page fully illustrated catalogue (the most complete in the trade) of Wireless Components, post free 3d.; and also Peto-Scott's Wireless Book, post free 1/5, containing more than 30 Circuit diagrams.

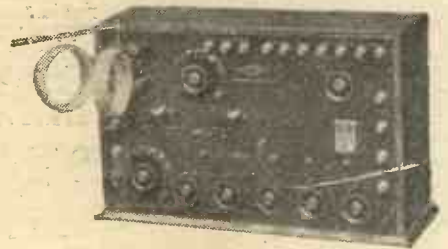

THE TRANSATLANTIC V. RECEIVER.

The first standard Set to use two stages of high-frequency amplification. A real long-distance Set. Will work particularly well on a simple little indoor aerial. Regular reception of American broadcasting and long-distance Continental stations at loud-speaker strength is an easy matter with this 5-valve Set.

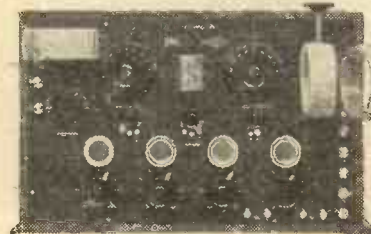

THE FAMILY 4-VALVE SET.
An ideal family Receiver originally designed by Mr. Percy Harris. Uses the familiar tuned anode and reaction circuit. Large numbers of users report regular reception of American broadcasting on this Set. Can be used as a two, three, or four-valve Set at will.

PETO-SCOTT Co., Ltd., 77, CITY ROAD, LONDON, E.C.1

Branches: LONDON—62, High Holborn, W.C.1. PLYMOUTH—4, Bank of England Place
LIVERPOOL—4, Manchester St. CARDIFF—94, Queen St. WALTHAMSTOW—230, Wood St.

P.S.2293

Build your own set
—and save pounds!

In replying to advertisers, use Order Form enclosed.

The Best By Test

EVERYTHING
A GOOD
CONDENSER
SHOULD BE.



"OCTOPUS"

	s.	d.
.01 ...	2	4
.05 ...	2	4
.25 ...	3	0
.5 ...	3	4
1 MF. ...	3	10
2 MF. ...	4	8

All capacities same size face, i.e., 2-in. by 1 1/4-in.

ACCURATE, NOISELESS, PERMANENT,
ABSOLUTELY RELIABLE, TESTED AT 350 VOLTS D.C.
BEWARE IMITATIONS, LOOK FOR THE TRADE MARK.
30 YEARS' EXPERIENCE OF CONDENSER BUILDING
are behind the
"OCTOPUS" GUARANTEED
Mansbridge Condensers

SETS OF PARTS FOR ANY AND EVERY CIRCUIT.

WE SPECIALISE IN GIVING THE BEST KNOWN VALUE AND SERVICE
WRITE YOUR ACTUAL NEEDS. GIVE US YOUR IDEAS AND LET US QUOTE.

EVERYTHING FOR WIRELESS AT ROCK-BOTTOM PRICES.

WRITE FOR LISTS.

Wholesale and Retail.

"RADIO STOCKS" (B. HAINE, Proprietor),
RADIO HOUSE, NEWMAN STREET, OXFORD ST., LONDON, W.1.

PHONE: MUSEUM 320.

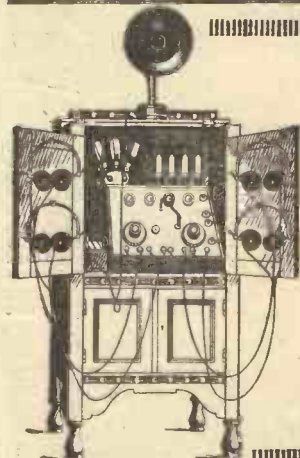

A HANDSOME PIECE OF FURNITURE

SOLID OAK STANDARD
CABINET WITH LOOKS

in which to lock up or build large panel receivers, such as:
4-valve Family. All Concert de Luxe. Transatlantic IV. and V. Wireless Magazine 4-valve Receiver. Anglo-American 6, 3-valve Dual, etc.

Ebonite panels can be supplied ready fixed: price on application
Willingly sent on approval against remittance. Guaranteed to specification.

Immediate delivery.

TRADE SUPPLIED

Price: 22 1/2 in. inside width .. £4 10 0
24 " " " " .. £4 15 0
36 (model de luxe) made to order.

Part carriage and packing 7/6 extra.

M. VERSTRAETEN

(Dept. 2) Melvill Chambers,
50a, Lord St., Liverpool



A LOUD-SPEAKER WITHOUT DISTORTION

One of the most natural tone Loud-Speakers on the market, and worked in conjunction with our "BIG BEN" 3-Valve Set the results are perfect. It has no Trumpet. It fits in any corner of the room without being noticed. The retail price in Mahogany or Oak is £6/10/0.

The "BIG BEN" 3-Valve Set complete with 1 B.T.H. "B6" Power Valve, 2 B.T.H. "B5" Valves, 1 roov. H.T. Battery, 1 4v. 80 amp. Accumulator, 1 pr. Siemens' Phones, Aerial, Insulators and "CELESTION" Loud-Speaker, retail price £28/1/0.

Arrange a demonstration at your local Dealer's. If he cannot supply, instruct him to write to us, or write direct to:-

STOCKALL, MARPLES & CO. (1912) Ltd.
6/10, CLERKENWELL ROAD, E.C.1.

Telephone: Clerkenwell 6345/6. Telegrams: Stockalls, Smiths, London.



THE STANDARD VALVE HOLDER

Hoult Patent 228014

MADE TO FIT ON PANELS
OR BASEBOARDS.

The Patent Reversible Feature
is the Secret.



1/3 each.

With Fixing
Screw.

When you think of Valve Holders, think of
The Athol Reversible Valve Holder!

If your local dealer has no stock send your order direct to—

LISTS ATHOL ENGINEERING CO. **FREE**
Cornet Street, Mr. Broughton, Manchester.

440,000

DON'T EXPERIMENT

with so-called infallible media for selling your Wireless Sets, Components or Accessories. Experimenting with wireless sets may be—and no doubt is—a lucrative and instructive hobby, but experimenting with your business and its capital is another thing altogether. It is invariably suicidal.

Start right at the commencement of your campaign by using only "MODERN WIRELESS," "WIRELESS WEEKLY," and "THE WIRELESS CONSTRUCTOR," the predominant three in Wireless, and, incidentally, the only Journals that matter in creating a public demand for your manufactures. When you have booked space in them your appropriation is complete and beyond equal.

**Modern Wireless
Wireless Weekly
Wireless Constructor**

In substantiation of this statement your advertisement will be read by no fewer than 440,000 Wireless enthusiasts—those that are really keen and are continually buying for new experiments and home-constructed sets. This figure represents the certified circulation of these papers, one of which alone has a circulation greater than that of all non-Radio Press papers added together. The elite and professional men, besides the amateur and experimenter, are readers and all may therefore be safely classed as potential customers. In fact, there is no waste circulation whatever.

Do not tolerate disappointing results any longer—they can be remedied, and speedily, too. (Phone: City 9911 (Extn. 9), or write for advertisement rates of "MODERN WIRELESS," "WIRELESS WEEKLY," and "THE WIRELESS CONSTRUCTOR," to:—

Advt. Managers:

**BARCLAYS
Advertising, Ltd.**

Advertising
Consultants & Contractors
Bush House, Strand, W.C.2



No. 4 of a Series.

The Living Artiste

JUST as the balance wheel is to the watch so is the L.F. Transformer to the Receiving Set.

Without the proper functioning of the one, even the finest gold watch is utterly useless. And without a Transformer capable of an equal amplification over all the usual frequencies, even a super-Receiver and the most expensive Loud Speaker are little more than ornaments.

There's about as much difference between the ordinary cheap type of Transformer and the superb Eureka Concert Grand as there is between

a cheap German watch and an English lever.

The Eureka Concert Grand is a laboratory production. Its 2½ miles of wire are wound with scientific precision and its turn ratio is calculated to a nicety. Its design is not based on academic theory but on the results of many hundreds of pounds' worth of actual research work.

A non-laminated core—a coppered steel case—an extremely generous primary winding—these are some of the factors that have caused the Eureka to be considered Britain's Transformer-de-Luxe.

The Transformer which enables the Loud Speaker to re-create the living Artiste.
Concert Grand **30/-** Portable Utilities Co., Ltd., Eureka **22/6**
Fisher Street, London, W.C.1. No. 2 (For Second Stage)

Supreme **EUREKA** for Tone

SOME NEW **RADIAX** SUPER-QUALITY COMPONENTS



The **Challenge Rheostat**

Beyond the ordinary in quality and finish, solid ebonite bobbin wound best Eureka wire, laminated spring arm which makes sure but easy contact, neat ebonite knob and pointer **3/6**

Send for Complete Catalogue of Radiax Sets, Components, and Accessories. Post free 3d.

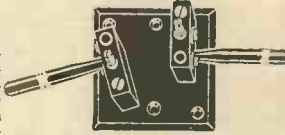

The "Swivel" COIL HOLDER

A New Pattern with both holders pivoted enabling every possible variation of coupling up to complete reversal; with anti-capacity handles long and highly polished Price **3/6** all over.

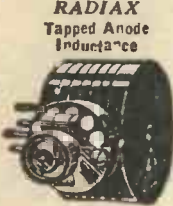

RADIAX Tapped Anode Inductance

Favourably reported on after test by "Wireless Weekly," see December 10th issue. Perfectly made and calibrated, while its neat dead end switch brings in the sections one at a time. Wavelength range 180-3,500, No. 574, 25/-.

Transformers H.F. (or tuned Anode Coils)

We specialise in H.F. Couplings and Reaction Units of all kinds. Complete Catalogue of Radiax Sets, Components and Accessories. Post free 3d.

Wavelength.	Price.
300-500	3/6
500-900	4/3
900-1600	4/9
1500-2600	5/6
2600-4000	6/8

RADIAX Accumulators.

Of guaranteed quality, high class make and finish.

2 Volt 40 amp.	11/6
4 " 40 "	18/6
4 " 60 "	23/9
6 " 40 "	27/9
6 " 60 "	35/-
6 " 80 "	42/-

H.T. Batteries
Of thoroughly reliable quality:
36 volts 8/6
60 " 10/8
100 " 18/8

RADIAX H.E. LOW LOSS COILS

The waxless inductances which increase volume, sharpen tuning and improve reaction. Guaranteed unsurpassed by any other make or type. Their unique construction makes them rigid and strong to handle.

Set of 6, including Chelmsford, with strong adjustable mount. Standard fitting, 25, 35, 50, 75, 100, 150 Postage 3d. **7/9**
Set of 9, up to No. 300 **16/9**

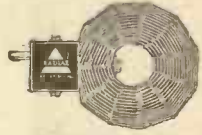

Any dealer can supply.



Mounted on Standard Plugs.—Set of 6, 12/6 (postage 4d.). Set of 9, 25/6 (postage 6d.).

RADIAX REACTANCE UNIT.

Instantly fixed to any panel—3 coils cover in range from 100 to 4,000 metres.

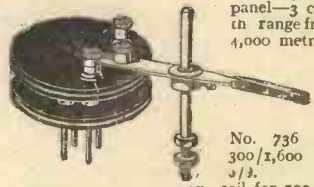

No. 736 with coil 300/1,600 metres, 3/3.
Ex. coil for 100/300, 3/3
Ex. coil for 1,600/4,000, 3/9

GET OUR FREE LIST OF SETS COMPLETED OR TO BUILD YOURSELF.



The "Mansbridge" Condenser

0.5 mfd. 4/- 1.0 mfd. 4/6
2.0 mfd. 5/6

RADIAX Ltd. 40, RADIO HOUSE, PERCY ST., Tottenham Ct. Rd., LONDON, W.1

3 minutes from Tottenham Court Rd. and Goodge St. Tube Stations, 'Phone: Museum 490.

Stop that leak!



HIGH-FREQUENCY currents have a habit of leaking away just where they are not wanted. A spot of moisture—a bit of surplus fluxite—a surface polished by metallic methods—these are some of the causes of leaky panels. Even an expert cannot tell by looking at an ebonite panel whether it is leaky or not—what chance, therefore, have you?

The only safe way of knowing that your next Set won't lose signal strength is to see that you are using a *guaranteed* leak-proof ebonite such as "Red Triangle" Brand.

Every sheet is tested by us for leaks with special electrical measuring instruments, and every one not coming up to our standard is rejected.

If your own Dealer cannot supply it send us your order direct and we will despatch by return of post. Don't prejudice the working of your new Set by using something that looks like ebonite when you can get really high-grade material from us at no greater cost. All panels sold only in sealed envelopes.

12 Stock Sizes:

6 x 8, 3/-	7 x 10, 4/3	8 x 12, 6/-	12 x 14, 10/6
6 x 18, 8/-	8 x 6, 3/-	10 x 12, 7/6	12 x 16, 12/-
7 x 5, 2/3	8 x 10, 5/-	10 x 24, 15/-	12 x 18, 13/6

All 1/4-in. thick. Sold in Sealed Envelopes.

Special Sizes:

All Concert-de-Luxe, 16 x 8 x 1/2	8/-	Resistoflex, 12 x 8 x 1/2	6/-
Transatlantic V., 22 x 11 x 1/2	15/-	Anglo-American, 36 x 9 x 1/2	20/-
All Britain, 16 x 9 x 1/2	9/-	Neurodyne Tuner, 12 x 10 x 1/2	7/6
S.T. 100, 12 1/2 x 9 1/2 x 1/2	7/-	Neurodyne Receiver, 12 x 10 x 1/2	7/6
Puriflex, 14 x 10 1/2 x 1/2	9/2	3-Valve Dual, 24 x 10 x 1/2	15/-
Transatlantic IV., 16 x 8 x 1/2	8/-	Harris Crystal Set, 9 x 5 1/2 x 1/2	4/4

Any Special Size Cut per return at 1d. per square inch.

Use



PE O-SCOTT Co., Ltd.

Registered Offices, Mail Order & Showroom, 77, CITY ROAD, LONDON, E.C.1.
BRANCHES: LONDON—62, High Holborn, W.C.1.
WALTHAMSTOW—230, Wood Street.
PLYMOUTH—4, Bank of England Place.
LIVERPOOL—4, Manchester St.
CARDIFF—94, Queen Street.

Red Triangle Ebonite

P S 2297

YOUR H.T. IS O.K.

when you instal "Hovimo" Screw Connectors

which are a revolution in H.T. efficiency. Avoid soldering; cheapen cost of complete battery by from 25% to 50%; ensure perfect "silent" working; are everlasting; allow easy replacement of units; will take ordinary wander plug; keep H.T. at equal voltage.



M. MOLBACK,
27, High Holborn,
London, W.C.1.
'Phone: Chancery 8391.

Ask your dealer for them

1/6

Per Doz. From dealers or direct.

PLUG HOLE



GRIP

Every part an
Exclusive Feature

Bell-mouthed Trumpet of polished oak or mahogany. Artistic in appearance and the best possible radiator of Sound, the "insulated" wood horn possesses especial merit.

Name - plate with Type and serial numbers thereon, by which the "HOUSE OF GRAHAM" unconditionally guarantees complete satisfaction to any possessor of an AMPLION.

Super Loud Speaker Unit incorporating the "floating" diaphragm. The unit is "insulated" and detachable from the sound conduit.



Sound Conduit provided with rubber bush to receive unit as well as connector at junction of conduit and horn, to ensure freedom from objectionable resonance.

The contour of the Sound Conduit affords a duct of considerable length, compared with the overall dimensions of the instrument, and the sweeping curve allows an unobstructed path for the sound waves.

The Conduit is hinged to the weighted electro-plated Base, ensuring stability and allowing the horn to be tilted to suit the acoustics of any apartment.

Making the AMPLION

The Loud Speaker Supreme

Obtainable from all Wireless Dealers of Repute.

Illustrated Folder post free from the Patentees and Manufacturers:

ALFRED GRAHAM & CO.

(E. A. GRAHAM)

ST. ANDREW'S WORKS, CROFTON PARK,
LONDON, S.E. 4.

"UTILITY" VARIABLE SQUARE LAW CONDENSERS

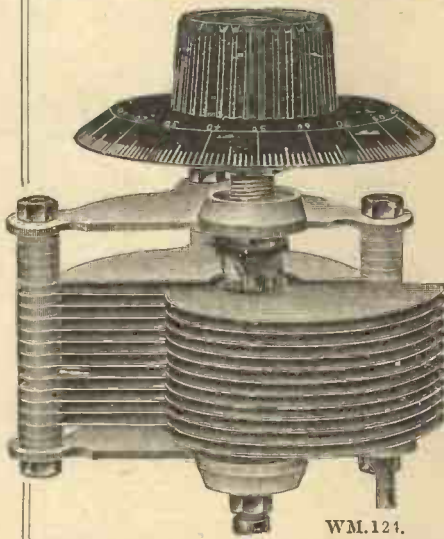

at
same price
as our
ORDINARY

PRICES.

Ref. No.	Cap.	Price.
WM.123	.001	12/6
WM.144	.00075	11/9
WM.124	.0005	10/6
WM.125	.0003	8/9
WM.145	.0002	7/9
WM.146	.0001	7/6

Vernier 2/6 extra.
Fitted with
Radion Dials.

WM.124.

NO-CAPACITY

The "UTILITY" NO-CAPACITY SWITCH, as used in the constructional articles appearing in this journal. Specially designed by electrical engineers to reduce the electrostatic capacity, this switch has proved to be exceptionally reliable in action and has self-cleaning contacts.

Size	Knob Type	Price
1 Pole Change over	WM.130/1	3/6
2 " " "	WM.130/2	4/-
3 " " "	WM.130/3	5/-
4 " " "	WM.130/4	6/-
5 " " "	WM.130/5	7/-
6 " " "	WM.130/6	8/-

Size	Lever Type	Price
1 Pole Change over	WM.147/1	4/6
2 " " "	WM.147/2	5/-
3 " " "	WM.147/3	6/-
4 " " "	WM.147/4	7/6
5 " " "	WM.147/5	10/-
6 " " "	WM.147/6	10/-

Black bronzed, lever pattern, nickel-plated, 6d. each extra.



WM.147/6.

SWITCHES

Manufactured by
WILKINS & WRIGHT LIMITED,
UTILITY Works, Kenyon Street, Birmingham.



Send for this
Useful Booklet

Here is a booklet that will prove useful. Send a postcard and we'll send you one—or ask your dealer for it. Gives tables showing how long your accumulator charge should last, shows characteristic curves of Radion Reliable Radio Valves, and gives information regarding valve repairs. Send for it to-day, it's free.

RADION VALVES REDUCED IN PRICE

RADION D.E. .34.—Filament 2 volts .34 amps. Anode 20-100. A first class general purpose 2-volt dull emitter. **17.-**

RADION D.E. .06.—Filament 3 volts .06 amps. Anode 20-100. One of the best valves of this type ever produced. **20.-**

The curves will convince you.

Radion G.P. 35 to 4 volts .48 amps filament. 10/- (price unaltered).



Advt. of RADIONS LIMITED, BOLLINGTON, Nr. Macclesfield

THE BOOKS

For Beginners
and Experts

The Radio Press Series.

No.		Price
1	Wireless for All	9d.
	By John Scott-Taggart, F.Inst.P., A.M.I.E.E.	
2	Simplified Wireless	1/-
	By John Scott-Taggart, F.Inst.P., A.M.I.E.E.	
3	How to Make Your Own Broadcast Receiver	1/6
	By John Scott-Taggart, F.Inst.P., A.M.I.E.E.	
4	How to Erect Your Wireless Aerial	1/-
	By B. Müell, A.M.I.E.E.	
5	The Construction of Wireless Receiving Apparatus	1/6
	By P. D. Tyers.	
6	The Construction of Crystal Receivers... ..	1/6
	By Alan L. M. Douglas.	
7	How to Make a "Unit" Wireless Receiver	2/6
	By E. Redpath.	
8	Pictorial Wireless Circuits	1/6
	By Oswald J. Rankin.	
9	Wireless Valves Simply Explained	2/6
	By John Scott-Taggart, F.Inst.P., A.M.I.E.E.	
10	Practical Wireless Valve Circuits	2/6
	By John Scott-Taggart, F.Inst.P., A.M.I.E.E.	
12	Radio Valves and How to Use Them	2/6
	By John Scott-Taggart, F.Inst.P., A.M.I.E.E.	
13	500 Wireless Questions Answered	2/6
	By G. P. Kendall and E. Redpath.	
14	12 Tested Wireless Sets	2/6
	By Percy W. Harris.	
15	More Practical Valve Circuits	3/6
	By John Scott-Taggart, F.Inst.P., A.M.I.E.E.	
16	Home-Built Wireless Components	2/6
17	Wireless Sets for Home Constructors	2/6
	By E. Redpath.	
18	Tuning Coils and How to Wind Them... ..	1/6
	By G. P. Kendall, B.Sc.	
*21	Six Simple Sets	1/6
	By Stanley G. Rattee.	
*22	Switches in Wireless Circuits	1/6
	By Oswald J. Rankin.	
RADIO PRESS PANEL CARDS.		
1	How to Make the W.I. Receiver	1/-
	By Herbert K. Simpson.	
SIMPLEX WIRING CHARTS.		
1	For 2-Valve Set	1/-
2	For 3-Valve Set	1/-
3	For 4-Valve Set	1/-
RADIO PRESS WIRELESS PANEL TRANSFORMERS 6d.		
"MODERN WIRELESS" COIL TABLE for Aerial, Anode and Re-Action Coils 6d.		
RADIO PRESS ENVELOPES.		
1	How to Build an S.T.100 Receiver	1/6
	By John Scott-Taggart, F.Inst.P., A.M.I.E.E.	
2	How to Build a 4-Valve Receiver	2/6
	By Percy W. Harris.	
3	How to Build the "Simplicity" 3-Valve Set	2/6
	By G. P. Kendall, B.Sc.	
4	How to Build the All-Concert-de-Luxe Receiver	2/6
	By Percy W. Harris.	
*5	How to build the Omni Receiver	2/6
	By John Scott-Taggart, F.Inst.P., A.M.I.E.E.	
*6	How to Build the A.B.C. Wave Trap	1/6
	By G. P. Kendall, B.Sc.	
*7	How to Build a 2-Valve Amplifier de Luxe	1/6
	By Herbert K. Simpson.	
8	How to Make a 1-Valve Reflex Receiver	1/6
	By Herbert K. Simpson.	
9	How to Build an Efficient Single-Valve Set	1/6
	By Herbert K. Simpson.	

The Radio Press Envelopes are the most complete guide to wireless construction ever devised. Every possible detail is explained and you cannot go wrong.

* Just Published

All the above can be obtained from wireless dealers, booksellers—or direct (plus 2d. postage on books and 3d. on Envelopes) from Dept. M.

RADIO PRESS LTD.
BUSH HOUSE, STRAND,
LONDON, W.C. 2.

Barclays Ad.

Ebonite has pores!



MAYBE you have always thought of ebonite as a smooth substance, but the microscope could tell a different story. If you were to place a piece of ordinary matt surfaced ebonite under a powerful lens you would be amazed to see how its surface is pitted with thousands of tiny holes and crevices. And it is quite possible that if the atmosphere is heavily charged with dampness—as for example, during a wet or foggy day, that these microscopic holes will be filled with a definite film of moisture which may be invisible to the eye.

Obviously this must mean a serious loss in signal strength, and is probably the reason why some Receivers mysteriously perform better on some days than on others. "But," you may say, "when I buy my ebonite panel I am told to sandpaper the surface to remove the

high polish." Why is this? The reason is because, to give ordinary ebonite its bright finish, tinfoil is used, and tiny particles are liable to become embedded in its surface to cause serious leakages and even short circuits.

Radion, on the other hand, is supplied with a highly polished non-metallic surface which should not be removed before use. Not only, therefore, are you saved the labour of sandpapering its surface, but you actually obtain a panel which repels moisture. Radion is the ideal panel material. It is infinitely superior to ordinary ebonite, because it has been developed specially for wireless use. It cuts and drills easily, and takes a good thread.

For your next Set use Radion and be free from worry. Supplied in black and mahoganite with dial and knobs to match. Fully guaranteed.

RADION

TRADE MARK

PANELS AND DIALS

Size	Black	Mahoganite	Size	Black	Mahoganite	Size	Black	Mahoganite
6" x 7"	3/6	4/3	7" x 14"	8/-	10/3	8" x 26"	17/6	21/3
6" x 10 1/2"	5/3	6/6	7" x 18"	10/6	12/9	9" x 14"	10/6	12/9
6" x 14"	7/-	8/6	7" x 21"	12/3	15/-	10" x 12"	10/-	12/-
6" x 21"	10/6	12/9	7" x 24"	14/-	17/3	12" x 14"	13/3	16/-
7" x 9"	5/3	6/6	7" x 26"	15/-	18/6	12" x 21"	19/9	24/3
7" x 10"	5/9	7/3	7" x 30"	17/9	21/6	14" x 18"	19/9	24/3
7" x 12"	7/-	8/6	7" x 48"	28/-	34/6	20" x 24"	39/6	48/-

SPECIAL NOTE: All Radion Panels are 7/16" thick. In addition to the sizes listed above, we can supply by return any special size cut to measure at the following prices: Black 1d. per sq. inch, Mahoganite 1 1/2d. per sq. inch.

AMERICAN HARD RUBBER COMPANY (BRITAIN) LTD.
Head Office: 13a Fore Street, London, E.C.2

Depots: 120 Wellington St., Glasgow. 116 Snow Hill, Birmingham. Irish Agents: 8 Corporation St., Belfast

Gilbert Ad. 2307.



Developed for the coal-mine—perfected for Radio.

SEVERAL years ago the Oldham special activation process passed its final tests and large quantities of the new Oldham Accumulators were supplied to coal mines throughout the country for use in the Oldham Miners' Electric Lamp. They were a tremendous success—as we knew they would be.

Extreme reliability—low upkeep costs—steadiness of output—the ability to hold a charge over extensive periods when not required for use—these and many other features have caused the sales of Oldham Accumulators to rise to a phenomenal height during the last year or two.

And now the same qualities that are in such demand below ground have combined to make the Oldham Accumulator-de-luxe for Radio use. It may cost you a shilling or so more than an ordinary accumulator—but remember that you can never really tell the cost of an accumulator until it is worn out. On that basis alone Oldham Accumulators are cheapest of all—for none can approach them for long life.

All good Radio Dealers stock them in the usual voltages and capacities.

OLDHAM & Son, Ltd., Denton, Manchester.
 London : Gt. Chapel St., Oxford St., W.1.
 Newcastle : 1, St. Mary's Place.

OLDHAM

ACCUMULATORS

Gilbert Ad. 2302.

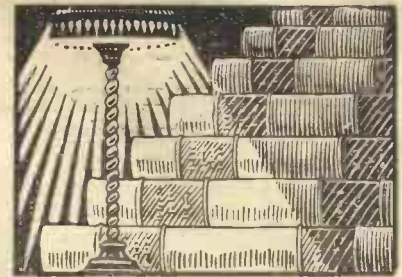

THE BOOKS

for Beginners and Experts

WITHOUT a doubt the very remarkable growth in the number of home-built Receiving Sets can be attributed to the exceptional Books and Magazines published by Radio Press, Ltd. This organisation—the largest of its kind in the world—has risen from quite modest beginnings because it was the first to realise that the crying need then, as now, was for dependable literature.

The moment a man gets really interested in Radio he is so fascinated that he immediately wants to learn more about it. Naturally he buys books and magazines—but let those books or magazines be too technical that he cannot understand and appreciate them, or let them contain inaccuracies or mis-statements and Radio loses another promising recruit.

Radio Press, Ltd., pursues a definite policy in its book publishing, which can be summed up as follows:—

(a) It publishes Books written only by authors of repute. Its Editorial Staff—both in number and in experience—the strongest in the country—is well able to check every manuscript submitted and to supervise generally the publication of every Book.

(b) Each Book selected for publication must fill a definite niche in the Radio Press Series. Just as there are many grades of wireless enthusiasts from novices to experienced experimenters, so there must be various types of Radio Press Books. At the same time, however, every phase of the Science is covered so thoroughly that anyone can build up a complete library as his knowledge increases.

(c) Every Radio Press Book is printed in good style, profusely illustrated and represents particularly good value for money. While several of the more elementary ones are published at a cheaper price, the bulk of the Radio Press Series cost 2/6 each. This price permits a very high quality being maintained and allows half-tone illustrations and, in the case of the constructional books, the fullest descriptions being given of every stage of Set building.

Make up your mind to look through the whole series at your Bookseller's or Wireless Dealer's—he has them in stock or will get them for you. It will be your first step to increased proficiency.

All Radio Press publications can be obtained from any Newsagent, Bookseller, or from local wireless dealer, or direct from the Publishers.

Complete List (M) Free on Application.

Radio Press Ltd.,

Bush House, Strand, London, W.C.2

GAMBRELL'S Neutrodyne Condenser

REDUCTION IN PRICE

The ORIGINAL stabilising condenser designed by Gambrells and recommended by Mr. Percy W. Harris and Mr. John Underdown.

NEW PRICE
5/6

The huge demand for this very popular model has enabled us to reduce the price considerably, and through increased production, to guarantee prompt delivery.

Wholesalers and Retailers, Amateurs and Experimenters are requested to write for particulars of our latest productions to

GAMBRELL BROS., LTD., 76, Victoria St., S.W.1



Barcays 756.

The A.T.E. Crystal Set
VARIOMETER TUNING
Two Aerial Terminals 200 to 600 and 600 to 1,200 metres. Four Phone Terminals.
Beautifully constructed Circular Panel in various shades and colours.
Effective range 20 to 25 miles.
Price 15/6 post free.
Trade inquiries invited.
Anderson's Wireless Sales Agency,
9-15, Oxford Street, LONDON, W.1.
Telephone: Gerrard 1749. Telegrams: ANWISALG, Westcent.

Wireless List "F"
Post Free
Price **10/6**
Postage 6d.
A most efficient device to which ordinary headphones are clipped by simple pressure on the spring clips.
The "Gramaphix" Loud-Speaker
The Gramaphix requires (according to distance from the Broadcasting Station) at least one stage of low-frequency amplification to give satisfactory volume.
HORNS TO MOUNT ON GRAMAPHIX:
Straight Horn (Bell 10 in.) 6/-. Swan-necked Horn (Bell 11 1/2 in.) 15/-. Small Curved Horn (Bell 8 1/2 in.) 7/6. Post 9d. extra.
RICHARD MELHUISE, Ltd., Electrical Engineers and Wireless Experts.
50, 51 & 84 Fetter Lane, London, E.C.4 Est. 1923

"BELLING - LEE"

INDICATING TERMINALS. Patent No. 560724
Heads cannot screw off
Tops engraved white on black. 16 engravings
Grips a snade tag or flex
Hole to grip phone tag or solid wire
Standard 4 B.A. Stem
Complete with nut & washer

MULTY-KONTACT PLUGS & SOCKETS Patent Nos. 205010 & 2674324
Recessed to take flex covering
Shock-proof insulating handle, red or black
Internal chuck head will grip any wire from 14 S.W.G. to 44 S.W.G.
Transverse tongues pressing outwards ensuring clean contact
Dome shaped indicating disc in red or black 16 indications.
Fixing nut and washer
Soldering lug

PRICE 3 1/2^d EACH BRASS
4 1/2^d EACH NICKEL
PRICE 7^d per set NICKEL PLATED
Your dealer can supply you. In case of difficulty, write direct to:—
BELLING & LEE, Ltd., Queensway Works, Ponders End

END YOUR DETECTION TROUBLES with the "HOVIMO" CRYSTAL VALVE

Replaces old-fashioned "permanent" detectors.
Every one guaranteed
From dealers or post free direct.
3/6
British Make.
The "Hovimo" Crystal Valve is an entirely new invention. It replaces catswhiskers and ordinary "permanent" detectors, which are often as difficult to fit into the individual set as they are to release once adjusted—in short 100 permanent detectors. The "Hovimo" Crystal Valve is easily fitted into any set, and is equally excellent for crystal sets and for circuits employing crystal rectification. When adjusted a simple turn of a milled screw gives instant reception—uninterruptedly clear and bell-like tone, even if you move the set! No batteries required.
M. MOLBACK, 27, High Holborn, London, W.C.1
Telephone: Chancery 8391.

Silvertown

WIRELESS ACCESSORIES.

Quality guaranteed by over 50 years' electrical manufacturing experience.



B 500

Interval Transformers.
Adopted by leading manufacturers of Wireless Receiving Sets and discriminating Amateurs in all parts of the World. Guaranteed for 12 months. Price 21/- each.



Filament Rheostats:
With finished and lacquered brass bush for panel mounting. Resistance wire wound on insulating rod, thereby giving perfectly smooth adjustment. Each supplied with diagram giving drilling dimensions. 3/6 each.

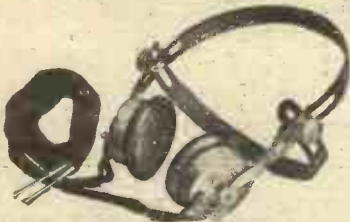

Telephone Headpieces.
The "Stalloy" diaphragms are matched so as to secure a balance of tone and quality. Resistance from 120 to 12,000 ohms. Price (4,000 ohms), 25/- each.

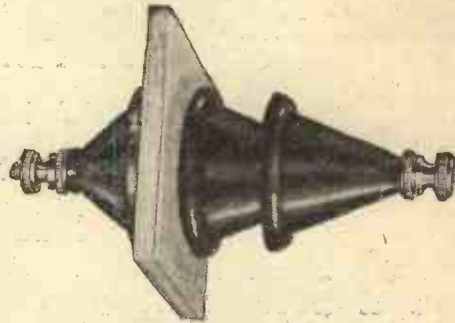

Silvertown Window-pane Insulators.

Made of best quality enamel-coated ebonite, these insulators give double protection against leakage by utilising the excellent insulating properties of glass. The rubber rings form a water-tight joint against the pane, thus keeping a portion of the insulator dry in wet weather. Price 4/- each.

Instructions and materials for making hole in window are provided with each insulator.



Silvertown Patent Cone Lead-in Insulators.

Another effective form of insulation, using the cone insulators in conjunction with an ebonite tube passing through a window frame or wall. Complete electrical efficiency is assured. Prices from 4/6 each.



Silvovox Loud Speaker.

This instrument will reproduce both speech and music without the loss of its original tone and quality. Coils wound to either 120 or 2,000 ohms.

The tone arm is a heavy aluminium casting.

Total height, 20 inches. Size of trumpet, 12 1/4 inches diameter.

Price £3 10s. each.

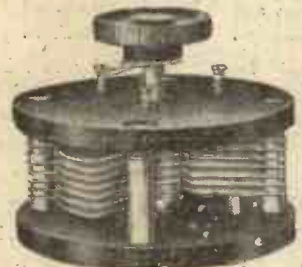

Variable Condensers.

(For panel mounting.)

Strongly constructed. Moving vanes are shaped to give low minimum capacity. Fitted with a stop to allow of a movement of 180° only.

From 5/6 each.

Makers : THE SILVERTOWN COMPANY,

106, CANNON ST., LONDON, E.C.4.

BELFAST: 75, Ann Street.

BIRMINGHAM: 15, Martineau Street.

BRISTOL: 4, Victoria Street.

CARDIFF: Pier Head Chambers, Bute Docks.

DUBLIN: 70, Middle Abbey Street.

GLASGOW: 15, Royal Exchange Square.

LEEDS: 1, New York Road.



Works: Silvertown, London, E.16.

LIVERPOOL: 54, Castle Street.

LONDON: 100 and 102, Cannon Street.

MANCHESTER: 16, John Dalton Street.

NEWCASTLE-ON-TYNE: 59, Westgate Road.

PORTSMOUTH: 49, High Street.

SHEFFIELD: 88-90, Queen Street.

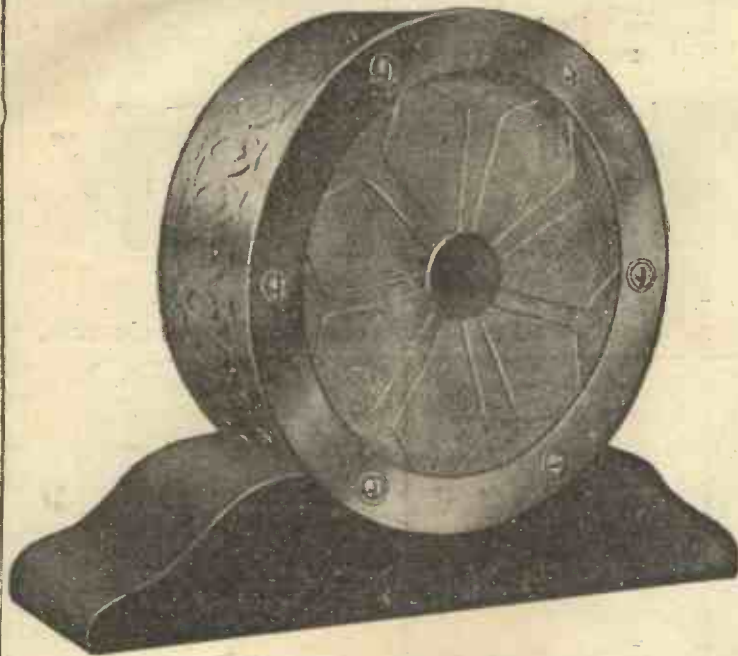

BECO

**Hornless
Loud Speaker**

NOT ONLY A BEAUTIFUL ORNAMENT FOR EVERY HOME, BUT A REALLY EFFICIENT SPEAKER, EQUAL IN VOLUME TO ANY STANDARD TYPE.

**YOU MUST HAVE ONE—
WHY NOT NOW?
BRITISH MADE.**

From all dealers or direct from—
NICKEL PLATED
52/6
POST FREE,

6 ins. high.
5 ins. dia.,
2 ins. thick.

The British Electrical Sales Organization,

Manufactured by the Patentees:
British Electrical Mfg. Co.
PUTNEY, LONDON, S.W.15.

623, AUSTRALIA HOUSE,
STRAND, LONDON, W.C.2.
PHONE CITY 7665.
TELEGRAMS PRIMOSTELE, LONDON

Trade **AERMONIC** Mark

Behind the Panel Valve Holder

Recommended by Mr. P. W. HARRIS.
As used in the Family Two-Valve Receiver described in the February issue of "Wireless Constructor."

Price 1/6 each. Post, etc., 2d.

NICKEL VALVE WINDOWS

Best finish. Mirror polish.

When used in conjunction with the Aermonic Valve Holder, give a neat finish to the Panel and enable you to see your Valve Filament. Easy to fit.



No. 1, 9d.



No. 2, 1/-.



No. 3, 1/-.

Post, etc., 2d.

If your local dealer cannot supply, obtainable from:—
V. R. PLEASANCE, 60, Fargate, SHEFFIELD.

'Grams: Aermonic, Sheffield.

Sole Distributors in the Midlands, North of England, Scotland and Ireland.

Perfectly simple and simply perfect

THE MIC-MET SUPER CRYSTAL DETECTOR

[REGD.] (PATENT NO. 221943.)

This instrument is micrometrical in principle and ensures a perfectly adjusted and rigid contact between crystal and contactor. By a combination of movements between the three knobs, any portion of the exposed part of the crystal may be contacted. For S.T. 100 and other circuits employing crystal rectification, the most efficient detector to use is the MIC-MET. Can be obtained from your local wireless dealer or direct from the manufacturers on receipt of 6s. P.O. Trade enquiries solicited.

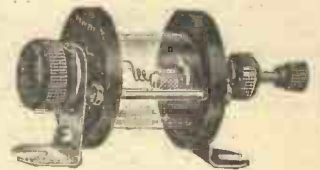

British Make.

Beware of imitations and infringements.

C. & J. ARRIGONI & CO., LTD., COMPTON PASSAGE, CLERKENWELL, LONDON, E.C.

Safe!

If you use the super-sensitive **Gil-Ray Crystal** you are SURE of the very best results. Price 1/6, of dealers everywhere. If unobtainable, send 1/6 and name and address of dealer to:—
The GIL-RAY Radio Co.,
Sicilian House, London, W.C.1.
Stocked by best factors and
V. ZEITLIN & SONS,
144, Theobald's Road, W.C.1.
Agents for Scotland & Ireland: Pettigrew & Merriman, 122, Tooley Street, S.E. 1.

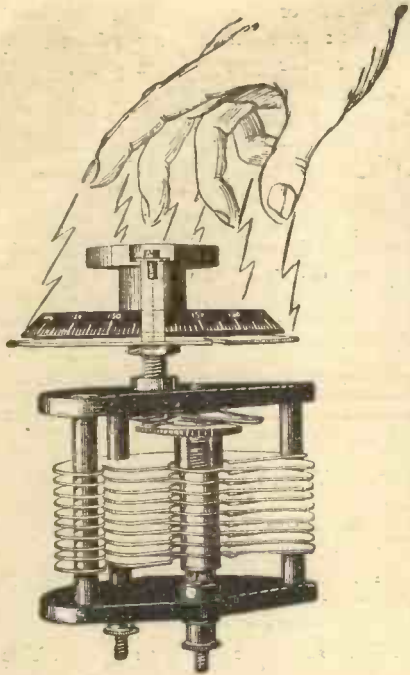

Makes tuning twice as Accurate

The "Fulstop" Variable Condenser possesses many valuable improvements in condenser construction. It enables tuning operations to be carried out with a hitherto unobtainable accuracy and completely abolishes all hand capacity effects. In addition to being a square law condenser which prevents the overcrowding of stations, the "Fulstop" condenser is so made that the whole of the circumference of the dial is graduated and being geared at two to one in relation to the moving plates, it allows twice the range of accuracy to be found in ordinary condenser design. This allows for very fine tuning and increased audibility. This condenser has been strongly recommended by the wireless press for use in situations where great accuracy is desired.

The only condenser which guarantees the elimination of hand capacity effects:

Prices:

·001.....13/6 ·000310/3
 ·0005.....11/3 ·0002..... 9/6

Stocked by most Wireless Dealers, but if you have any difficulty write to,

J. H. NAYLOR, LTD., WIGAN.



VARIABLE CONDENSER

HUNT'S NEW MODEL CRYSTAL DETECTOR

(Fig. No. 922)

CODEWORD — "VERNIER"

PRICE as illustrated **4/-** EACH but less crystal

MICROMETER ADJUSTMENT (without moving cat's-whisker or cup.)

DUSTPROOF GLASS CYLINDER

CATSWHISKER OR DOUBLE CRYSTAL (Spare cup, with fixing screws supplied free.)

A. H. HUNT, LTD.,
 (DEPT. 5), H.A.H. WORKS,
 TUNSTALL RD., CROYDON.
 "Keyage, Croydon" Addiscombe 1584-5



FIG. No. 922

YOUR OPPORTUNITY!

Thousands of men have lost their one great opportunity in life through leaving over until to-morrow that which should have been done immediately. You have to move in the world, you cannot stand still, so why not move in the right direction? Why not move now?



We have helped thousands of others to a successful career, we may or may not be able to help you, but in any case it costs nothing to enquire: our advice is free, and there is a possibility that it may be worth thousands of pounds to you, it may change your whole career, it may help you up in the world socially and financially, it certainly cannot harm you; therefore, you have all to gain and nothing to lose by seeking our advice.

We have booklets setting out the possibility in connection with each of the subjects shown in the lists, send for the one in which you are interested, or ask for our Private Advice.

Have You ANY Ambition?

W. Bennett

We specialise in all Exams. In most of the following subjects and we guarantee tuition until successful. No extra fees.

WE TEACH BY POST	Most Moderate Charges. Payable Monthly. All Text Books Free.	MY ADVICE IS FREE
COMMERCIAL	TECHNICAL	TECHNICAL—Cont.
Accountancy	Architectural Drawing	Mathematics
Advert. Writing	Building Construction	Matriculation
Salesmanship	Clerk of Works' Duties	Metallurgy
Auditing	Aviation	Mining
Banking	Boiler Engineering	Mine Surveying
Book-keeping	Boiler Making	Motor Engineering
Commercial Arithmetic	Chemistry	Naval Architecture
Commercial Law	Civil Engineering	Pattern Making
Company Law	Concrete and Steel	Sanitation
Costing	Draughtsmanship	Shipbuilding
Economics	Electricity	Structural Engineering
English and French	Engineering	Surveying and Levelling
Excise and Law	Foundry Work	Telegraphy and Telephony
Foreign Exchange	Internal Combustion Engines	Wireless Telegraphy
Modern Business Methods	Marine Engineering	Works Managers' Course
Secretariatship		
Workshop Organisation		

WRITE FOR FREE BOOKLET

to The Bennett College, Dept. 134, Sheffield, naming the subject you are interested in. Parents should seek our advice for their sons. Please state your age. Courses specially combined to meet all requirements. Why stay in the rut?



**The Aerial
You Have Been
Looking For!**

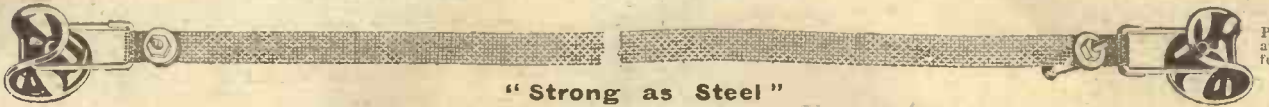

Patents applied for

"Strong as Steel"

MAGNIPLEX is made of specially woven Phosphor Bronze Wire Gauze of high tensile strength and conductivity, and can be used in any form of aerial.

Prices:— $\frac{3}{4}$ in. wide 3d. per foot; $\frac{1}{2}$ in. wide 2d. per foot. Supplied in lengths of 25, 50 and 75 feet including fittings, viz.:—End Terminal for Down Lead and Insulators ready for erecting. For lengths under 25 ft. fittings charged 1s. 3d. extra. Postage and Packing paid.

Our claim is backed by a guarantee that we will refund your cash without question if results are not better than your present aerial and more than justify the extra cost

HELIXO LTD.,
HENRY BUILDINGS, GRESSE STREET, RATHBONE PLACE, LONDON, W.1.
Phone: Muscum 6039.

BRITISH BATTERY CO., LTD.

CLARENDON RD., WATFORD, Herts.
(Telephone: Watford 617.)

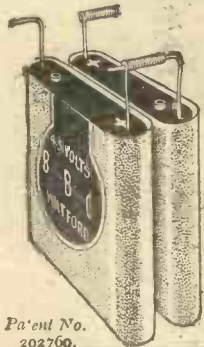

H.T. BATTERIES.

No. 1 W. Standard Pocket Lamp Size—4½-volt with patent spiral wire terminals and plug sockets to take Wander Plugs.
Note:—1 doz. 54 volts. Used units replaced easily.

PRICE CARRIAGE PAID 7/- PER DOZ., WITH PLUG

All standard voltages supplied with 3 volt tappings.

Guaranteed British Made at our own Watford Works

Patent No. 202760.

Barclays 755.

**A NEW FOUR VALVE SET.
A TWO VALVE TRI-COIL RECEIVER.
A CABINET THREE VALVE NEUTRODYNE RECEIVER.**

The Component Parts for these or any other sets we shall be pleased to quote for.

PANELS DRILLED FREE. ALL GOODS POST FREE.

We have satisfied customers all over the country, We can satisfy YOU.

Send your Enquiry to-day and ask for Price List.

WALTER E. REYNOLDS,
4, SOUTH STREET, FENTON, STAFFS.

Telephone; HANLEY 1405.

Member Firm of B.B.C.

Let the Public Hear—

your call. Do not rest content with just an appeal to the Trade to stock your manufactures. However excellent the goods may be, there will only be a regular and consistent demand provided the public know too!

If this avenue, viz., the Radio Press is thoroughly explored and the public are educated by your insistence to ask for your brand, sales must inevitably have a tendency to rise.

Ring City 9911 (Ext. 9) or write the Advt. Manager for particulars of MODERN WIRELESS, WIRELESS WEEKLY and THE WIRELESS CONSTRUCTOR, the only media in Wireless which thoroughly cover the whole subject and whose readers are *The Wireless Market.*

BARCLAYS ADVERTISING, Ltd.

Advt. Managers for Radio Press Publications,
Advertising Agents, Consultants and Contractors,
BUSH HOUSE, STRAND, LONDON, W.C.2

Don't tickle the Crystal—use

Harlie
FOOL-PROOF
DETECTOR

Provisional Patent 2679124
Continuous reception in any position at all times, owing to the special design of both crystal and catwhisker, always in contact.

GUARANTEED TONE-VOLUME-PURITY
SOME NOVEL FEATURES:—

1. Nickel-plated detachable dust-proof cover.
2. Special "Harlie" super-sensitive crystal.
3. Ebonite wheel for rotating crystal.
4. Catwhisker on slide for covering whole surface of crystal.
5. Nickel-plated sockets for panel mounting.

Obtainable from all dealers or direct from patentees and mfrs.
PRICE COMPLETE 5 6
Generous Trade Terms. Telephone Clissold 293.
HARLIE BROS., 183, Dalston Lane, HACKNEY, London, E.8.

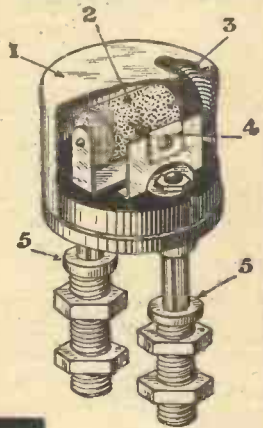

Barclays 754

100% EFFICIENCY H.T. BATTERY.

CONSTRUCTORS' IDEAL



See Apparatus Tested, April issue. Why buy inefficient tiny sealed-in batteries. I offer Terminalled Giant Unit Dry Cells, 1½ volts of 300 per cent. more capacity. See Photo. Cells, 4/- doz., plus carriage. 60 volt type in polished Oak Case as reported, 19/6, carriage 1/9. In card box 14 6. Every cell replaceable. Lists free. Sample Cell, 6d. Money back guarantee. Prompt delivery guaranteed. Direct only from Sole Maker: **FINCHETT (C.A.) Old Armoury, Oswestry.**

For advertisement rates for all Radio Press publications apply to

Barclays Advertising Ltd.,
Bush House, Strand, London, W.C.2

Telephone: City 9911.

HUNT'S NEW  ACCESSORIES
VARIABLE GRIDLEAKS

An absolute necessity for **D**istinct
Long-Distance Tuning.
The usual resistance employed by Wireless
is 1½ megohms, and with the "Hunt's"
instruments a variation of from ½ to 5
megohms can be immediately
made by turning the switch
during tuning operations.

EACH STOP A DEFINITE AND
REPEATABLE RESISTANCE.

"PANLEAK"

Fig. 1102: Underpanel Mounting Model is
perhaps the most popular of the
two models and is adaptable up to
a 3/8 in. panel:

PRICE 5/- EACH.

Complete as illustrated: Standard
calibration ½-5 megohms or to order.

Fig. 970: "HOLDER."
Valveholder complete as illustrated
1/3 each.

Fig. 1100: Same as Fig. 1102 but
top of panel mounting.

"VARLEAK"

PRICE 4/6 EACH.

Fig. 1110: Anti-capacity handle
9d. each extra.

Manufactured by

A. H. HUNT, LTD.

(Dept. 5), H.A.H. WORKS, TUNSTALL ROAD.

CROYDON.

"ELLA"
BATTERY CHARGERS
They work from a lampholder



A.C. Model.

Output 6 amps. 9 volts. Complete with
Pole Indicating Ammeter and all connecting
leads and adapter. To standard voltages and
frequencies up to 220 volts. £6 6 0

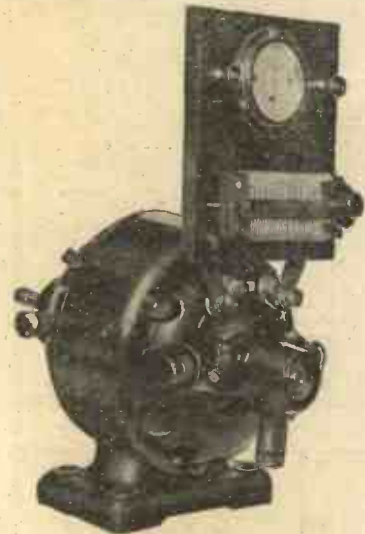

D.C. Model.

Output 5 amps. 9 volts. Machine only
£5 12s. 6d. With Switchboard and
Pole Indicating Ammeter and Regulat-
ing Resistance as illustrated - £6 15 0

Other voltages and frequencies £1 extra.

BATTERIES charged at home have much longer life and give better service than when charged outside.

"ELLA" Battery chargers save their cost many times over.

Write to Dept. "A" for descriptive leaflet. Trade supplied.

LIONEL ROBINSON & CO. 3a, Staple Inn,
London, W.C.2.

'Phone: Holborn 6323 (Two Lines).

"CABINETS OF MERIT"

(As supplied to the Radio Press)

BEARING THE HALL MARK OF DISTINCTIVE MATERIAL AND CRAFTSMANSHIP. SUPPLIED FOR ANY RADIO PRESS SET OR TO CUSTOMERS' OWN DESIGNS. ALSO DRILLED AND ENGRAVED PANELS.

Examples.	Cabinet.	Panel.
A Simplified 3-valve dual receiver	49/-	18/-
The Resistance Four	42/-	12 3
The Neutrodyne Junior	89/-	9/-
An Adaptable 2-valve Receiver	22/-	9/-
A Single Valve Receiver for K.D.K.A.	19/-	6 9
An Auto-Coupled Crystal Set	13 6	4 6

Carriage and packing extra.

Cabinets are best seasoned figured walnut, hand-made and polished. Panels are high grade ebonite, guaranteed electrically, drilled to Radio Press specification. Engraving 6d. per dozen symbols.

"S. A. CUTTERS,"

Head Office:—15, Red Lion Square, London, W.C.1

'Phone: Chancery 8042.

Cabinet Works:—Pimlico. Stores:—Blackheath.

"TURRET" MASTS



COLUBIAN PINE MASTS DESIGNED BY
NAVAL EXPERTS

27 Turret Two - £2 4 6	45 ft. Telescopic	£4 10 6
38 Complete - 3 19 6	55 ft. "	6 15 6
42 Telescopic - 4 4 0	58 ft. super -	6 19 6
IMP. ON & BLYTHE, 8-9, Sherwood St., Piccadilly, W		

BUYING A SHIP'S TRANSMITTER

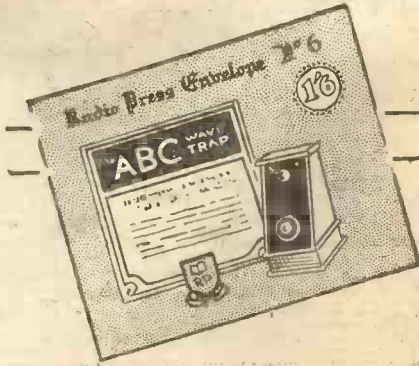

HOW TO MAKE THE
ABC WAVE TRAP
RADIO PRESS
ENVELOPE No. 6

1/6
POST FREE
1/9

RADIO PRESS

There is a story current from over the Atlantic of how New York listeners are suffering from severe interference from a ship station using an old-type spark transmitter. Rather than have their reception jammed continually, these enthusiasts propose to start a local fund with the object of purchasing for the offending ship a new and modern C.W. set.

* * * * *

Interference presents an apparently insurmountable obstacle to a great many wireless enthusiasts. How to tune-in a distant station while the local is working has caused many a listener a deal of unavailable trouble.

Radio Press Envelope No. 6 contains the answer to the problem, full details for the construction of the ABC Wave Trap. This instrument—the outcome of much experimental research work by G. P. Kendall, B.Sc., who is well known to readers of "Modern Wireless" and the other R.P. publications as a wireless authority—definitely succeeds as an eliminator of undesired signals. It incorporates three distinct types of wave traps, any one of which can be brought into operation at will.

R.P. Envelope No. 6 contains full and complete instructions for building the ABC Wave Trap, including blueprints and photographic illustrations.

With this aid you will find the Wave Trap as simple as the alphabet itself to make.

On test, the ABC Wave Trap tuned-in Bournemouth with 2LO working on full power only three miles distant, the London station being completely cut out.

Here, then, is what you have been waiting for. Buy Radio Press Envelope No. 6 to-day, and know the pleasure of receiving distant radio without interference.

Obtainable from all Newsagents, Booksellers, Wireless Dealers, or direct from the Publishers, Radio Press, Ltd. (Dept. M), Bush House, Strand, London, W.C. 2.

You can build this Wave Trap for about 30/- inclusive of handsome cabinet and coils which are built into the design. Normally constructed to operate on the 500-600 metre band.



Cut out your local station

Radio Press, Ltd.,
Bush House, Strand, London, W.C.2.

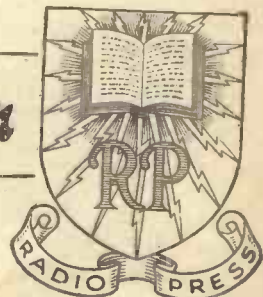

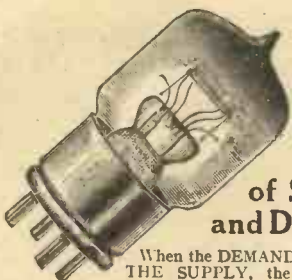

The Law of Supply and Demand

When the DEMAND EXCEEDS THE SUPPLY, the price of the article tends to increase; WHEN THE SUPPLY exceeds the DEMAND, the price tends to decrease.

If full value is offered, the demand will always be greater than the supply, and there will be no need to reduce the price of the article; moreover, the quality will remain the same. SUCH is the case with the

C. & S. DULL EMITTER
2V. 0.2A.
WHICH RECEIVED
NEW ZEALAND ON A SINGLE VALVE
PRICE 12/- EACH
Showcards now available.
CRAIK AND SMITH
ALLEN STREET, LONDON, E.C.1
Phone: Clerkenwell 7346

Barclays 7714

SOLDERED JOINTS SUPERSEDED!

You can easily connect up the most complicated set entirely without use of solder by using the new

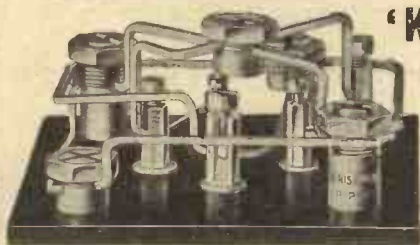

'KRISCROS' Connectors

Strong and perfect joints. Used by leading experts. A 'Krisros' for every standard thread.

PRICES - 1/6 to 3/- per doz. Send for list.

KRISCROS CO., 50, Gray's Inn Rd., W.C.1.

Radcom Vernier COIL HOLDERS.

The Perfect Panel Mounting Coil Holder.

Connections made under Panel.

Vernier Adjustment. 3-WAY 19/6
Radcom Finish. 2-WAY 14/6

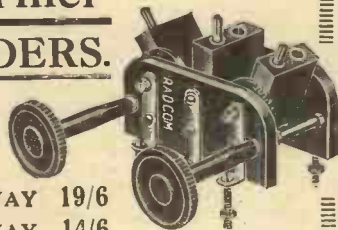

Radio COMPONENTS LTD

19, RATHBONE PLACE, LONDON, W.1
Telephone: - - - - MUSEUM 3495.
Telegrams: Radponents, Westcent, London.

ROSEBROS GUARANTEED RADIO COMPONENTS

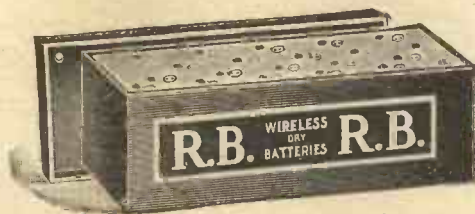

15 Volt 2/3 each. 60 Volt 9/- each.
36 Volt 5/3 each. 100 Volt 14/3 each.

These batteries are specially made for Radio work and are noiseless in use. Guaranteed to give satisfaction in service. The result of over 15 years' experience in Battery Manufacture.

R.B. High Frequency Transformers

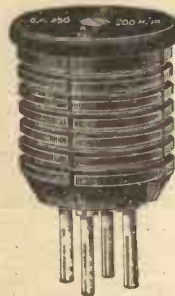

- No. 0 150 - 300 Meters 7/- each.
- No. 1 250 - 550 " 7/- each.
- No. 2 550 - 1200 " 7/- each.
- No. 3 1100-3000 " 7/- each.
- No. 4 2500-7000 " 7/- each.

Low Self-capacity and high efficiency transformers. Ebonite formers and Green Silk covered windings. Specially designed for neutrodyne circuits. Matched pairs can be supplied at NO extra cost for tuning with double condenser.

A NATURAL CRYSTAL Super Sensitive and Guaranteed.

6d.



6d.

SEALED BOXES.

SEALED BOXES.

Each crystal is tested and will give results equal to many high priced and fancy named crystals. A really good rectifying mineral at a reasonable price.

For use on ANY type of circuit.

The above TESTED Wireless Components can be obtained from all first-class Wireless Dealers and Stores, or Post Free from any of our addresses below.

Trade enquiries invited.

ROSE BROS. Electrical Co., Ltd.

London: 25, Milton St., E.C.1.
Glasgow: 194a, St. Vincent St
Manchester: 25-27, Miller St
Bristol: 83a, Redcliffe St.

S.S.A.

THE RADIO PRESS ENVELOPE SYSTEM

THE Radio Press Envelope System is generally acknowledged to be the greatest aid to the constructor yet evolved. Each envelope contains working diagrams, exact size blue prints of wiring and of the panel (suitable for drilling), a set of photographs printed on real art paper and in a manner impossible in a book or periodical and showing the set and wiring from every possible angle, a list of components and the full instructions for making each set and using it.



R.P. Envelope No. 1. Price 1s. 6d. (1s. 8d. post free). How to Make an Efficient 2-Valve Receiver using the ST. 100 Circuit. By John Scott-Taggart, F.Inst.P., A.M.I.E.E.

A huge number of this ST. 100 envelope has been sold, and practically all the tens of thousands of successful ST. 100 sets in the country have been made from this design, which works a loud-speaker with ease up to 30 to 35 miles.



R.P. Envelope No. 2. Price 2s. 6d. (2s. 8d. post free). How to Make a Family 4-Valve Receiver. By Percy W. Harris.

This is the ideal easily-handled set for long range loud-speaker work. For those some distance from a station this set is ideal.

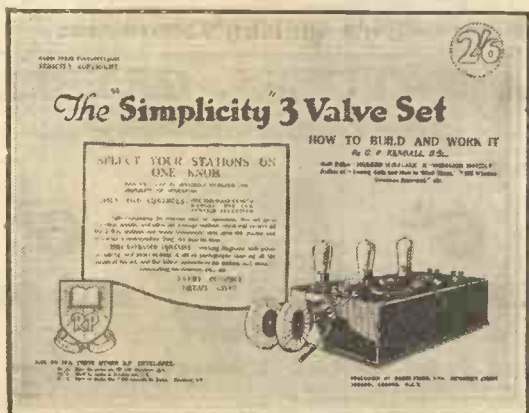

R.P. Envelope No. 3. Price 2s. 6d. (2s. 8d. post free). The "Simplicity" 3-Valve Set. By G. P. Kendall, B.Sc.

Notwithstanding extreme ease of operation this set gives excellent results and will receive all the B.B.C. stations and many Continental ones upon the 'phones and will work a loud-speaker from the nearest ones.

These envelopes are obtainable from all principal wireless dealers and booksellers or direct from the publishers:

RADIO PRESS, LTD., Bush House, Strand, London, W.C.2.



R.P. Envelope No. 4. Price 2s. 6d. (2s. 8d. post free). The "All-Concert de Luxe" Receiver. By Percy W. Harris.

A supremely efficient 3-Valve set with enclosed valves and all the latest technical improvements incorporated.



Two Popular Envelopes and A Book

BY

PERCY W. HARRIS

Editor of "The Wireless Constructor."

Mr. Harris' reputation as a constructional writer and designer is second to none.

With an almost uncanny knowledge of the needs of the "home constructor," he is not only able to design sets which rank as the best of their kind, but he is able to describe them with a skill which enables even the beginner to follow his designs and obtain equally good results. Tens of thousands of sets have been made according to his designs, and every one has enhanced the reputation of the author and also that of Radio Press Ltd., who have the exclusive services of Mr. Harris.

Mr. Harris has two envelopes to his credit, Nos. 2 and 4 of the Radio Press Envelope series, each containing pages of photographs on art paper, sheets of instructions, wiring and panel blue prints, lists of components, and, in fact, all the features which have made Radio Press Envelopes the last word in guides to the constructor. He has also written a standard constructional work, "Twelve Tested Wireless Sets," which has had an enormous sale and which will strongly appeal to readers of "Modern Wireless" as all kinds of sets, from a crystal to a "Transatlantic," are fully described.

Read this letter from the South-West of Africa.

SIR,—I suppose you will be surprised at hearing from someone in the outskirts of the Empire, but I am only writing you a few words of appreciation of the Family four-valve set described in Radio Press Envelope No. 2. This compact little set is by far the best operating set I have yet handled. Having had nearly 15 years' wireless experimenting, I have naturally handled many sets.

As to results obtained, these exceeded anything like expectations. Cape Town (750 miles) comes in at good strength on H.F. and detector. With note magnifier added, signals are too loud for 'phones. The power of Cape Town is the same as 2LO, so these results are far better than could be hoped for. JB (Johannesburg), with 4kw. in the aerial, comes in quite loud on two valves, his distance being 740 miles. Shipping comes in with a roar. 5XX comes in with fair 'phone strength on three valves. Three a.m. one morning I managed to pick up KDKA on three valves at good 'phone strength. All high-power Morse stations come in well, and I can get them any time of day or night on two valves.

Hoping you will find this interesting, and congratulating you most heartily on your design of a thoroughly reliable and efficient set.

Windhoek, S.W. Africa.

Yours truly, PERCY F. SYMONS.

And this one :

SIR,—About three weeks ago I purchased the envelope containing particulars regarding the "All Concert Receiver," and wish to give you my results.

Without any wavetrap I am able to tune in 2BD at excellent loud-speaker strength, and with very slight interference from 5NO.

OTHER RESULTS: Radio-Paris, loud-speaker. 5XX, good; 5NO, excellent; 2BD, excellent; 5SC, good: these are all the B.B.C. stations which I have bothered with so far. Le Petit Parisien, loud in 'phones. Vox Haus? (woman announcer), fair loud-speaker. Hamburg, good loud-speaker. Breslau, fair loud-speaker.

I have had many more foreign stations than these, but have not heard their call signs.

Durham.

HENRY R. MYERS.

- Twelve Tested Wireless Sets .. 2. 6d. 2/8d. post free.
By Percy W. Harris.
- Radio Press Envelope No. 2 .. 2. 6d. 2/9d. " "
By Percy W. Harris.
(4-Valve Family Receiver)
- Radio Press Envelope No. 4 .. 2. 6d. 2/9d. " "
By Percy W. Harris.
(3-Valve All Concert de Luxe)

All obtainable from wireless dealers and booksellers, or direct from the publishers, Radio Press Ltd., Bush House, Strand, London, W.C.2

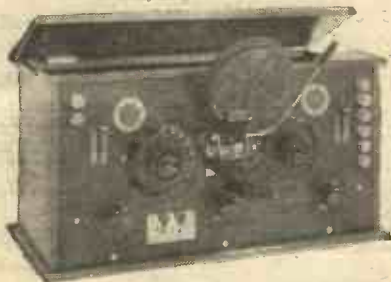

Envelope No. 4.

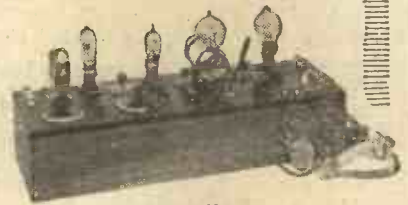

Envelope No. 2.

In replying to advertisers, use Order Form enclosed.

Barclays Ad.

Give your set "that professional look!"



TO BE KEPT PERFECTLY FLAT.

RADIO PRESS
Wireless Panel
Transfers

6^d

The most complete set of
Transfers on the Market.

"Give your own panels that professional appearance. The process is so simple in the use of a child's hands and the general effect is especially pleasing."

This transfer comes in 80 Press labels, including a way to other transfers to make up all the sets described in "WIRELESS" and "WIRELESS" and "WIRELESS". These transfers are of Radio Press quality and are enclosed in a stiff envelope in a packet.

INSTRUCTIONS

Before the label is used on the set, it must be fully soaked in water. Then the set must be dried, and the label must be placed on the set. The label must be placed on the set in the position of the label on the set. The label must be placed on the set in the position of the label on the set. The label must be placed on the set in the position of the label on the set.

Radio Press Ltd.
LONDON, W.C. 2.



IT'S the little things that count, and for sixpence you can give your set that professional look, by using "Radio Press Wireless Panel Transfers" (sold in large packets of 80 labels). They make all the difference and add finish to your Panel. The Radio Press use them on their own sets, which is in itself proof that they are the best—they are also the cheapest.

Buy a packet or two from your local wireless dealer, or bookseller, but be sure you get what you want.

"Radio Press" Wireless Panel Transfers 6d. per packet or 8d. post free direct from—

Radio Press, Ltd.

BUSH HOUSE, STRAND, LONDON, W.C. 2.



Books by JOHN SCOTT-TAGGART, F.Inst.P., A.M.I.E.E.

The total sales of books by this author have reached approximately half-a-million. This success has been attained by consistent accuracy, originality, and a very real sympathy for the experimenter and the man who "wants to know more." Under his direction, the three papers of the Radio Press have achieved outstanding success, and this is largely due to an instinct for realising what the wireless man wants to know, and then giving him the information in an accurate, lucid and thoroughly interesting manner.

The *Daily Express*, in its issue of November 5th, 1924, says:—

"British wireless engineers, however, are not in the least degree behind those of any other country in the world in developing radio receivers.

"Among the British experts who are keeping the British radio flag flying is Mr. J. Scott-Taggart, the energetic editor of several popular technical journals. It is doubtful if any other one person—unless perhaps Captain Round, of the Marconi Company—has been responsible for more original radio circuits and ideas than has Mr. Scott-Taggart."



Series		Series		Series	
No. 1. Wireless For All	... 9d.	No. 9. Wireless Valves Simply Explained	... 2/6	Elementary Textbook on Wireless	
No. 2. Simplified Wireless	... 1/-	No. 10. Practical Wireless Valve Circuits	... 2/6	Vacuum Tubes	... 10/-
No. 3. How to Make Your Own Broadcast Receiver	... 1/6	No. 12. Radio Valves and How to Use Them	... 2/6	Thermionic Tubes in Radio Tele-	
Radio Press Envelope No. 1 (ST.100 Receiver)	... 1/6	No. 15. More Practical Valve Circuits	... 3/5	graphy and Telephony (2nd Edition)	... 15/-

All these are obtainable from booksellers and wireless dealers or direct (plus 2d. postage on books and 3d. on the envelope) from Radio Press Ltd., the largest wireless publishers in the world, Bush House, Strand, London, W.C.2.

Barclays 1001.



The Set for the Man who likes to experiment

A LABORATORY in a single cabinet. These few words sum up the Omni Receiver, full constructional details of which appear in the Radio Press Envelope No. M5.

The Omni Receiver was designed by John Scott-Taggart, F.Inst.P., A.M.I.E.E., to enable the really keen experimenter to have a cabinet wireless receiver which could be wired up to, almost any circuit in a very short time—the set, however, always retaining its neat outward appearance.

The raising of the hinged lid of the cabinet discloses a panel on which have been mounted 50 well-spaced terminals, and that is the key to what has hitherto been considered an impracticable problem. The various components are mounted behind the front panel, and, generally speaking, the connections of each component are taken to the terminal panel. After the Omni Receiver has been completed, it is possible and an easy matter for any wireless enthusiast to try out and compare practically any new circuit, or variations in old circuits, by simply raising the lid of the cabinet and connecting up. It is advisable to use rubber covered flex for the purpose.

Every terminal on the panel under the lid of the cabinet is numbered, and a key is supplied. Using the numbered key it is an easy matter for the experimenter or even beginner to wire up and test the following 12 circuits, given in the envelope:—Crystal, Crystal and 1 L.F., Crystal and 2 L.F., 1 H.F. Crystal and 1 L.F., H.F. Crystal and 2 L.F., Detector and 1 L.F., Detector and 2 L.F., Single Valve Reflex, ST 34,

ST 45, ST 75, ST 100. It is simply a matter of connecting terminals 51-50, 51-28, 50-42, etc. From time to time new keyed circuits will appear in the Radio Press publications, principally *Wireless Weekly*. No wireless enthusiast should be without an Omni Receiver, the Receiver you can wire at will, always ready for future experiments.



This Radio Press Envelope No. M5 contains full constructional details, Blue-prints, Photographs, Diagrams, Key charts, a transfer of key numbers for the terminal panel, together with useful hints and tips for the constructor and many pages of interesting information, experiments, etc., showing the enormous advantages and possibilities opened out to owners of the Omni Receiver. Obtainable from all Newsagents, Bookstalls, local Wireless Dealers or direct from the Publishers. When ordering direct be sure and quote Envelope No. M5.

2/6
Post Free
2/9

Radio Press, Ltd.
BUSH HOUSE, STRAND, LONDON, W.C.2.

Barclays



ENVELOPE No. M9

Contains all the necessary instructions with working drawings, blue prints, &c., for making the above

SINGLE VALVE SET

THIS set is designed by HERBERT K. SIMPSON, and dozens of letters have testified to its range and power. Order "Radio Press" Envelope No. M9 to-day.

1/6 (Post free, 1/9.)

ENVELOPE No. M8

This envelope contains full and elaborate sheets of instructions, two full-size blue prints, three sheets of photographs on art paper and a sheet of working drawings, clearly showing how to make this—

ONE VALVE REFLEX RECEIVER

By Herbert K. Simpson.

An ideal one valve set for working a loud-speaker up to 10 miles from a broadcasting station. Strong phone signals are obtainable up to about 50 miles.

Order "Radio Press" Envelope No. M8 to-day.

1/6 (Post free, 1/9.)

Obtainable from booksellers and wireless dealers or direct from **RADIO PRESS, LTD.**, Bush House, Strand, London, W.C.2. The largest wireless publishers in the world.

**BUILD ONE OF
THESE FINE
"SIMPSON"
SINGLE VALVE
SETS**

**"RADIO PRESS"
ENVELOPES
Nos. 8 and 9
TELL YOU
HOW**

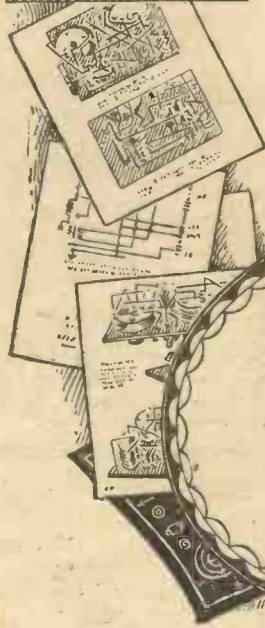

Index to Advertisers

	PAGE		PAGE		PAGE
Agar (W. H.)	253	Formo Co.	133	Portable Utilities Co., Ltd.	190, 265, 271
American Hard Rubber Co., Ltd.	269	Fuller's United Elec. Works, Ltd.	186	Power Equipment Co.	240
Anderson's Sales Agency	274	Gambrell Bros., Ltd.	274	Pressland Elec. Supplies	214
Arrigoni (C. & J.)	276	General Electric Co., Ltd.	177	Pugh Brothers	234
Ashburners	221	General Radio Co.	218	Radiax, Ltd.	266
Athol Engineering Co.	264	Gent & Co.	189	Radio Communication Co., Ltd.	134, 182
Auto Sundries, Ltd.	271	Gil. Ray Radio Co.	276	Radio Components	281
Autoveyors, Ltd.	272	Goswell Engineering Co.	233	Radio Improvements, Ltd.	252
Beard and Fitch	213	Graham (A.) & Co.	267	Radio Instruments, Ltd.	Cover iv
Belling & Lee	274	Hardy, Roy	253	Radio Stocks	26
Bennett College	277	Harlie Bros.	273	Radions, Ltd.	253, 269
Bowyer-Lowe Co.	194	Helixo, Ltd.	278	Raymond (K.)	244, 245
Brandes, Ltd.	178	H. T. C. Electrical Co.	254	Reynolds, (Walter E.)	278
British Battery Co., Ltd. (The)	278	Hughes (F. A.) & Co.	262	Ripaults	288
British Sales Organisation, Ltd.	276	Hunt (A. H.), Ltd.	277, 279	Robinson (Lionel) & Co.	279
British Thomson-Houston Co.	198	Igranie Electric Co., Ltd.	230	Rose Bros. Elec. Co.	281
Brown Brothers, Ltd.	189	Jackson Bros.	189	Rosen (Ed.) & Co.	236
Brown (S. G.), Ltd.	260	Kriseros Co.	281	Rothermel (R. A.), Ltd.	249
Burndept, Ltd.	Cover ii and 262	Lanite Laboratories	253	"S. A. Cutters"	279
Burne-Jones & Co., Ltd.	261	Lighting Supplies Co.	272	Shtiption (E.) & Co.	240
Buss (T. O.)	262	Lissen Co.	181, 197	Siemens Bros. & Co., Ltd.	255
Cattermole Bros.	258	London Electric Wire Co.	255	Silvertown Co.	275
C.A.V. Small Tools	256	Louden Valves	239	Simpson & Blythe	279
Chase Electrical Co.	262	McKellen (R.) & Co.	221	Smith & Ellis	258
Chloride Elect. Storage Co., Ltd.	250	McMichael (L.), Ltd.	246	Sterling Telephone Co., Ltd.	185
Collinson's Precision Screw Co., Ltd.	234	Malone & Co.	221	Stevens (A. J.) & Co. (1914), Ltd.	210
Cossor Valve Co.	202	Marbaix (Gaston E.)	221	Stockall, Marples & Co.	264
Craik & Smith	281	Melhuish (Rd.) & Co.	274	Swan Radio Co.	258
Curtis (Peter), Ltd.	205, 209	Molback (M.)	252, 266, 274	Telephone Mfg. Co.	221
Diamond Wireless, Ltd.	189	Mullard Radio Valve Co., Ltd.	226, 232	"U.S." Radio Co.	217
Dixon (L.) & Co.	221	Naylor (J. H.)	277	Vandervell (C. A.)	235
Drummond Bros.	242	Neutron, Ltd.	229	Varley Magnet Co.	258
Dubilier Condenser Co. (1921), Ltd.	225, 273	New London Electron Works	256	Verstraeten, (M.)	264
Eames, W. G.	221	Oldham Accumulators	270	Ward & Goldstone, Ltd.	235
Edison Swan Elec. Co.	193	Ormond Engineering Co.	206	Wates Bros.	255
Falk, Stadelmann & Co.	236	Pickett Bros.	258	Watmel Wireless Co.	236
Fallon Condenser Co.	186	Peto-Scott Co.	263, 266	Western Electric Co., Ltd.	249
Fellows Magnet Co., Ltd.	229	P. & M., Ltd.	242	Wilkins & Wright, Ltd.	268
Finchett (C. A.)	278	Pleasance, V. R.	276	World's Wireless Stores	258

100 YEARS' EXPERIENCE

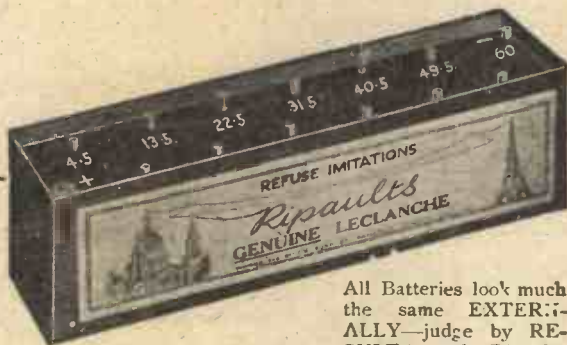

Be sure of your "H-T"

and eliminate one of the most prolific causes of wireless trouble. Buy a battery which you know will give you maximum service—which is backed by a great name and a vast experience. Your wireless dealer will supply—be sure you ask for RIPAULTS LECLANCHE BATTERIES—the proved best.

Write for lists illustrating and describing Ripaults Genuine Leclanche H-T and L-T Batteries and other components and accessories.

EXPERIENCE

OF BATTERY CONSTRUCTION AND SCIENTIFIC RESEARCH IS BEHIND THE FAMOUS



LECLANCHE WIRELESS BATTERIES

PRICES.

20 volts .. 4/9 60 volts .. 14/-
 36 volts .. 8/6 108 volts .. 25/6
 With two Wander Plugs. Tappings every 4½ volts.
RIPAULTS Ltd., King's Rd., London, N.W.1

Phones: North 4372 (4 lines),

COMPLETE RADIO CONSTRUCTORS COURSE WITHIN TWO COVERS

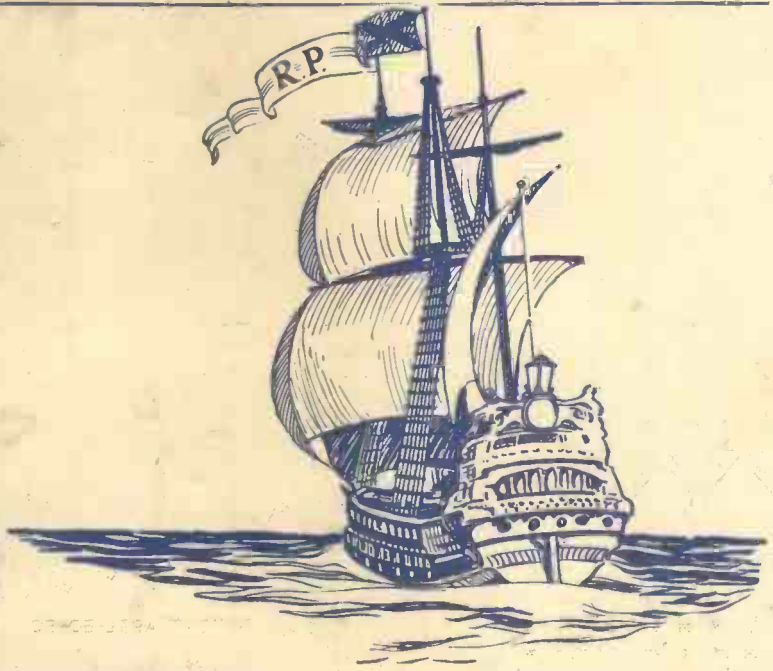

YOUR SHIP COMES HOME

WITH THE PUBLICATION OF THE LATEST RADIO PRESS BOOK.

To their already long list of wireless "Best sellers" the famous Radio Press have now added another book which it is anticipated will soon be found in the home of every wireless enthusiast.

"Six Simple Sets" by Stanley G. Rattee, M.I.R.E.,

like all the Radio Press books, fulfils a definite requirement of the radio public. This book constitutes what can be described as a carefully graded course of instruction in the making of wireless receivers from a crystal to a multi-valve set. It will especially appeal to that large and ever-growing body of wireless enthusiasts who desire to enter the field of experimental radio. Hitherto most of these enthusiasts have been puzzled as to the best way to commence, "Six Simple Sets" will solve their problem.

Every set is well and clearly illustrated by exterior and interior photographs and circuit diagrams, which enable one to readily construct any of the six sets described. Every set has been built by the Author, and is guaranteed to give your efficient results if you carefully follow the concise and clear constructional details supplied.

Stanley G. Rattee, Member I.R.E., is a well-known and appreciated contributor to *Modern Wireless*, *Wireless Weekly*, and *The Wireless Constructor*, and his constructional articles are very much valued by the thousands of readers of these Radio Press publications.

Those who purchase this book will soon have a practical knowledge of set construction and will be well equipped for taking up experimental work if so desired.

Ask for the Radio Press Series No. M.21, Price 1/6. Obtainable from all Newsagents, Booksellers, your local Wireless Dealer, or direct from the Publishers. Post Free, 1/8.

When ordering be sure and quote Series No. M.21.

CONTENTS.

CHAPTER I.	Page
An easily constructed Crystal Receiver	11
CHAPTER II.	
A Single-Valve "Component" Set	18
CHAPTER III.	
A Universal Two-Valve Receiver	27
CHAPTER IV.	
A Two-Valve Power Amplifier	35
CHAPTER V.	
A Simple Three-Valve Receiver	46
CHAPTER VI.	
A Four-Valve Broadcast Receiver	55
Coil Table	64

Get Your Copy To-day.

Radio Press, Ltd.

Bush House, Strand, London, W.C.2.



The Sensation of 1925



Users of the S.T.100 and other reflex circuits will find this detector specially suitable as it is unaffected by vibrations.

PATENT APPLIED FOR

A Crystal That Does Not Require Adjustment

The R.I. permanent mineral detector will revolutionise wireless reception for the crystal user. It is a scientific discovery and consists of the combination of a new costly mineral of high refractive index and another mineral.

No catwhisker inside

In the P.M. detector there is no catwhisker whatever, no hunting for the sensitive spot, an absolutely staple crystal. The rectifying spot is instantly found, and remains constant for an indefinite period: one of the elements is mounted so as to obtain a trigger action for changing the point of rectification if desired, as many amateurs prefer this. Every crystal user will have one of these detectors, requiring no skill to operate, and disposing of the necessity of continuous critical adjustment

Its inherent stability makes it particularly suitable to all valve and reflex circuit users.

Several supposed permanent detectors have been put on the market, but this detector, staple to a degree hitherto thought unattainable, perfect in action and backed by R.I., who have made exhaustive tests in all parts of the country over a considerable period of time, will secure the absolute confidence of every crystal user.

Write now for descriptive leaflets, free on application.

PRICE 6/-



Radio Instruments Ltd.
12 Hyde Street, Oxford Street

Telephone: REGENT 6214 (3 lines) W.C.1. Telegrams 'Instradio London'.