

MODERN WIRELESS



February

1/6

Vol. IV. No. 1.

Edited by JOHN SCOTT-TAGGART, F.Inst.P., A.M.I.E.E.

February, 1925.



In this issue

TRAP-CIRCUITS A NEW DEVELOPMENT
by
JOHN SCOTT-TAGGART
F. INST. P., A. M. I. E. E.

Vol. IV.

No. 1

A THREE-STAGE HIGH-FREQUENCY AMPLIFIER. By G. P. Kendall, B.Sc.

HOW TO MAKE AND USE A WAVEMETER. By Percy W. Harris, M.I.R.E.

THE LAW IN REGARD TO LOUD-SPEAKERS. By a Barrister.

A MUSIC-LOVER'S "PURIFLEX." By Donald Straker.

MAKING A CRYSTAL SET FOR CHELMSFORD. By A. D. Cowper, M.Sc.

TRANSMISSION TIMES OF CONTINENTAL AND AMERICAN STATIONS.

A Useful Single Valve Set.

A Beginner's Guide to Tuning-in.



You can build this Trap to cut out local interference.

Now for a Change—Switch over to Bournemouth.

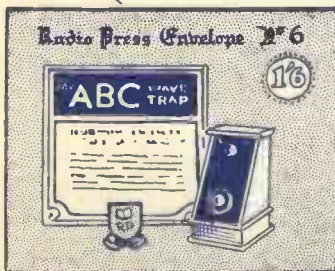

Anyone can build a wireless set from instructions contained in the Radio Press Envelopes. Build yourself the wavetrap described in Envelope No. 6. These Envelopes may be obtained from your regular wireless dealer, newsagent or direct from Radio Press Ltd., Bush House, Strand, London, W.C.2.

YES, but can you cut out your local Station? How often is that question asked by radio enthusiasts? The answer is to be found in the Radio Press Envelope No. 6, which contains full details for the construction of the A.B.C. Wave Trap—an instrument which is the result of much research by G. P. Kendall, B.Sc., into the question of the elimination of undesired signals. This instrument contains no less than 3 distinct types of wave trap arrangements, any one of which can be brought into operation at will. The contents of the Envelope include a

general treatise on the experiments, instruction sheets, blue prints, photographs and working drawings. When tested 3 miles from 2LO the A.B.C. Wave Trap completely eliminated the London Station and brought in Bournemouth. Although theoretically a loss in signal strength must be admitted, it is so small that it is seldom apparent to the human ear.

This highly efficient Wave Trap gives a choice of working with either A, B or C type of eliminator circuits, and its great efficiency is obtained by the elimination of losses in design.

We have every confidence in telling our readers that the A.B.C. WAVE TRAP will enable them to cut out their Local Station without sacrifice of signal strength, provided always that their aerial and earth systems are of average efficiency.

You can build this Wave Trap for about 30/- inclusive of handsome cabinet and coils which are built into the design. Normally Constructed to operate on the 300-600 metre band.



Cut out your local station

Radio Press, Ltd.,
Bush House, Strand, London, W.C.2.

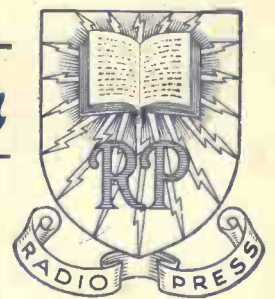

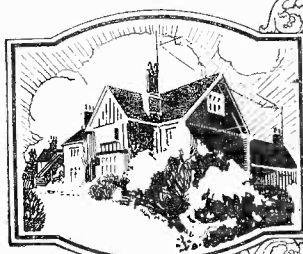

Editor:
JOHN SCOTT-TAGGART,
F.Inst.P., A.M.I.E.E.

Assistant Editor:
PERCY W. HARRIS, M.I.R.E.

Staff Editors:
E. H. CHAPMAN,
M.A., D.Sc.
A. D. COWPER, M.Sc.
G. P. KENDALL, B.Sc.
R. W. HALLOWS, M.A.
S. G. RATTEE, M.I.R.E.

Radio Press, Ltd.,
Publishers of "Wireless Weekly" and "The
Wireless Constructor,"
Bush House, Strand, W.C.2.
Telephone.—City 9911.

Contents

	PAGE.
An Experimenter's High-Frequency Amplifier	3
By G. P. KENDALL, B.Sc.	
In Passing	10
Trap Circuits: A New Development for Selective Reception	12
By JOHN SCOTT-TAGGART, F.Inst.P., A.M.I.E.E.	
A Music Lover's Puriflex	17
By DONALD STRAKER	
The Law in Regard to Loud Speakers	24
By F. E. SUGDEN, A.C.I.S., F.R. Econ. Soc., Barrister-at-Law.	
An Auxiliary "Super" Unit	28
By A. D. COWPER, M.Sc.	
Operating a Set for the First Time	36
Wavemeters: How to Make and Use Them	44
By PERCY W. HARRIS, M.I.R.E.	
A Chelmsford Crystal Receiver	52
By A. D. COWPER, M.Sc.	
Regular Programmes from Continental Broadcasting Stations	59
By CAPTAIN L. F. PLUGGE, B.Sc., F.R.Ac.S., F.I.T.Met.S.	
A Useful Single Valve Receiver	66
By JOHN UNDERDOWN.	
Trouble Corner	76
Regular Programmes from American Broadcasting Stations	83
By CAPTAIN L. F. PLUGGE, B.Sc. F.R.Ac.S., F.R.Met.S.	

Tested by Ourselves 96

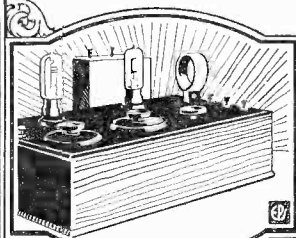

Scientific Adviser:
Prof. G. W. O. HOWE,
D.Sc., M.I.E.E.

Advisory Editors:
Prof. R. WHIDDINGTON,
M.A., D.Sc.
Prof. C. L. FORTESQUE,
M.A., M.I.E.E.

Advertisement Managers:
BARCLAYS
ADVERTISING LTD.,
Lush House, Strand, W.C.2
Tel.—City 9911.

All correspondence relating to contributions is to be addressed to the Editor of "Modern Wireless."

Nothing contained herein is to be regarded as permission or encouragement to infringe any patent rights.

Royal Palaces,
ST. JAMES'S.

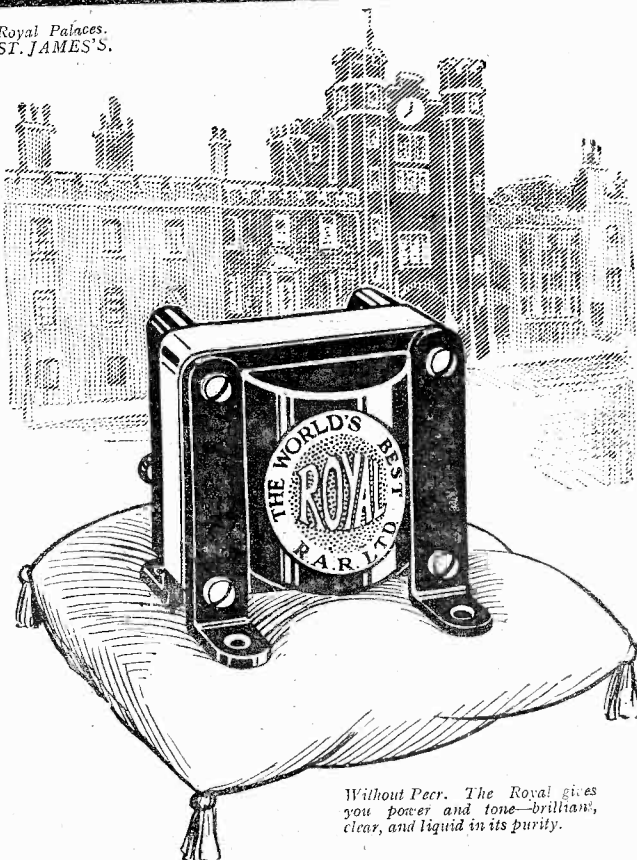

Without Peer. The Royal gives you power and tone—brilliant, clear, and liquid in its purity.

Peerless for quality of tone

If you have never experienced the pleasure of broadcast music as rich in tonal quality as though from a concert hall, do not be convinced that it is unattainable. Most, if not all, distorted music begins and ends in the unsatisfactory reproduction of inter-valve transformers.

You envy the mellow and full tones of the aristocratic set—you wonder how you can attain such *truthful* reception. Manufacturers of the Sets Aristocratic acknowledge the secret of the envied undistorted and liquid purity. Constructors! a word before you buy that new set of components—incorporate

The "Royal" Low Frequency SUPER TRANSFORMER

for sets aristocratic

AN OFFER

We are so confident of the supreme quality of the "Royal" Low Frequency Super Transformer that we are willing for you to test it against ANY other, on the strict understanding that we will refund the purchase price on return to us within 14 days, post paid.

FULLY GUARANTEED

Price £1-0-0

R. A. ROTHERMEL, LTD.

Manufacturers and Suppliers of all kinds of Radio and Wireless Apparatus,
24 & 26, Maddox Street, London, W.1

Phones: Mayfair 578 and 579.

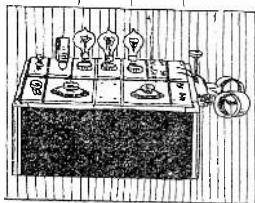
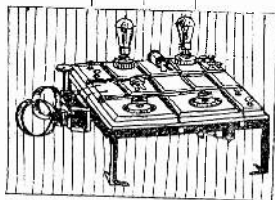
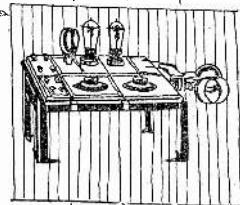
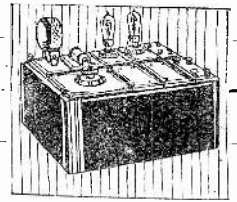
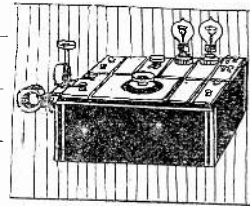
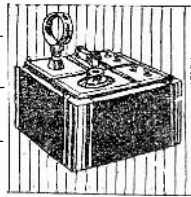
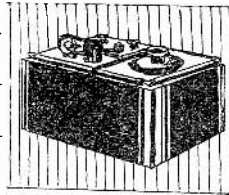
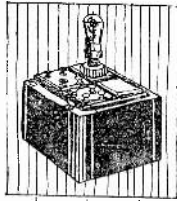

POLAR BLOK

System of Wireless Set Construction

Do you envy the man who has a lot of time and money to spend on wireless?

Some there are who would consider a man very fortunate who could spend pounds on ebonite, components, tags and terminals.

Do you want your wireless den strewn with wire, bits of solder, loose terminals, finished and partly finished sets—a pile of discarded ebonite in the corner, awaiting some future use. This is the state many got into before they found the only sensible method—the ideal method.

There are many who have not the time to spend on drilling holes in ebonite, mounting components and soldering wires.

In the past these people have been debarred from making all the experiments they wished. They have been unable to compare new circuits with standards, and developments have been missed.

An experimental set is built to determine results.

The "Donkey Work" involved in drilling holes and soldering make no useful contribution to the experiment.

It only retards progress.

Discerning experimenters are wiser.

Their components are mounted on small ebonite panels which can be quickly fixed on a frame.

The frame and case can be extended or reduced, according to the requirements of the experiment in hand.

Soldering is eliminated by the use of special slotted nuts. Good contact is obtainable by means other than solder.

The original stock of components is available for every experiment.

This is the Polar Blok way.

And the Cost? You will be delighted at the saving effected. As an indication, the cost of a four valve set is about £11 11s:

It is the only way for you, whether you make sets for use or experiment.

Write to us stating your requirements and we will advise your best course.



RADIO COMMUNICATION CO., LTD., 34-35, NORFOLK STREET, STRAND, W.C.2.

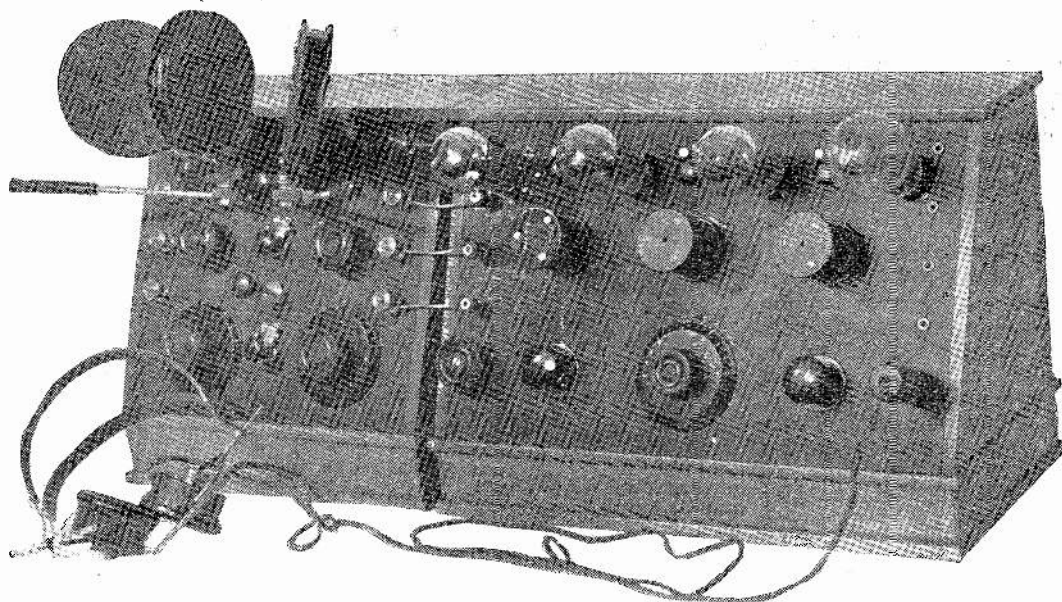

The tuner used with this instrument was described in the September 1924 issue. Certain slight modifications visible in the tuner were made to facilitate some special experiments.

An Experimenter's High-Frequency Amplifier

By

G. P. KENDALL, B.Sc., Staff Editor.

THE design of a high-frequency amplifier for experimental purposes is a somewhat different matter from the design of the corresponding portion of a self-contained receiver which is intended to serve purely as an instrument for the reception of broadcasting. In the broadcast receiver simplicity, combined with good results, is the essential, and one often finds that in such sets it is only possible to use one form of intervalve coupling, usually the tuned anode method. In an experimental amplifier, on the other hand, one must be able to use various numbers of valves, although, of course, switching schemes are as undesirable here as in the broadcast instrument, and it must be easy to try almost any type of intervalve coupling. Lastly, but by no means least, an experimental high-frequency amplifier must give results which are fully equivalent, valve for valve, to those of the instrument designed solely for reception, since few of us can afford to maintain an amplifier for purely experimental purposes which does

not give sufficiently good results to form also our main receiving equipment.

Good Results

The instrument which I propose to describe in this article will be found, I think, to meet these

results from the purely reception point of view, while it has proved invaluable for deciding, by experimental tests, upon the best system of intervalve coupling, and combinations of tuned and untuned stages, etc., for both short and long wave work.

An Important Point

The instrument illustrated in the photographs is the second which I have built, the first having been scrapped after a short time in use because I could see certain obvious improvements which have been incorporated in the present instrument. These were mainly a matter of rearrangement of wiring, but one important point deserves mention at this stage. Upon the first instrument I provided a separate filament rheostat for each valve, such an arrangement being, of course, a most desirable one in the majority of cases. Where a simultaneous system of tuning is used for several stages, as in this amplifier, however, I have found that to get the best results it is necessary to run each of the simultaneously

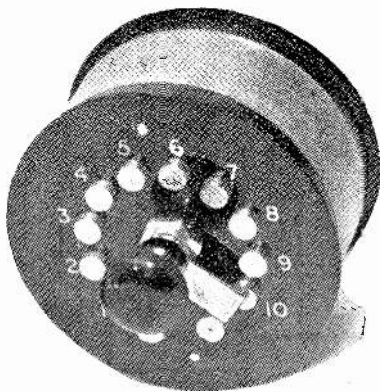

Fig. 1.—An experimental model of the tapped anode coil.

requirements fairly well, since I have had it in use for some months, and have obtained remarkable

tuned valves at approximately the same filament brilliancy, and also to use a similar type of valve throughout the instrument. In these circumstances a separate filament rheostat proved to be merely a nuisance, and upon the second instrument I therefore provided only one of large current carrying capacity for the first three valves.

General Arrangement of the Amplifier

The general appearance of the instrument is fairly clearly conveyed by the photographs, and it will be observed that it has been designed to operate in conjunction with the Experimenter's Tuner described in a recent issue of this journal, by myself, although, of course, it will function perfectly well in conjunction with any type of tuner which may be available. When used in this way, the result is a receiving equipment of remarkable capabilities and extreme flexibility, a great variety of possible tuning arrangements, intervalve couplings, etc., being available.

The amplifier provides for three stages of high-frequency amplification, the detector valve being incorporated upon the same panel. Upon the right-hand side of the panel a jack is provided for the telephones, and, of course, into this the input leads from a low-frequency amplifier can be plugged, and any desired number of L.F. stages can be added in this way. This jack is of the "single filament" type, and turns of the filament supply to all the valves when a plug is inserted in it, so that the filament rheostats can be set to

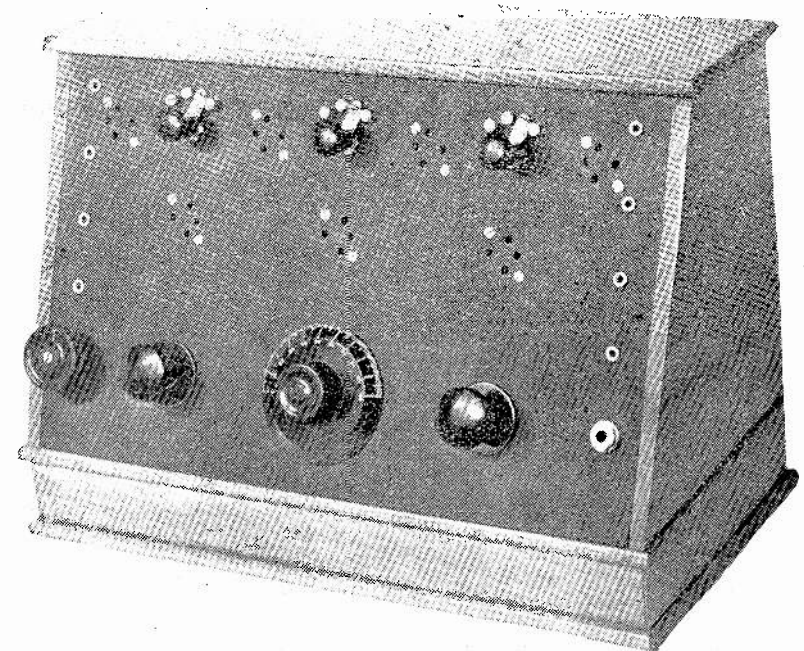

Fig. 2.—The panel lay-out is extremely simple.

the best position and need not be upset when switching off.

Coupling

Three standard valve sockets are provided for the insertion of intervalve coupling units, and into these a great variety of different couplings can be inserted by the simple provision of the usual four-pin base. Across the primary side of each of these four-pin sockets is wired one section of a triple variable condenser. Thus, all three stages can be tuned simultaneously by means of this condenser when three matched transformers are

employed, while, when it is desired to use an aperiodic or a semi-aperiodic intervalve coupling in one or more of the stages, that particular section, or sections, of the variable condenser can be switched off from the anode circuit in question by means of the small switches visible along the top of the panel between the valves.

Battery Connections

The two pairs of sockets on the right are for the low-tension and high-tension batteries, and it will be noticed that these are of the Clix variety, the battery leads terminating in Clix plugs. No separate high-tension terminal is provided for the rectifying valve, since this again is a complication which was included upon the first instrument which I built and which did not seem to justify itself.

Upon the left of the panel will be seen four more Clix sockets, and these correspond to the four terminals on the right-hand side of the previously mentioned tuner, the upper pair being for reaction. It may perhaps seem somewhat strange to the reader that reaction terminals should be provided upon an instrument having three high-frequency stages, since it will, of course, oscillate very freely without a reaction coil being used at all. It was done, however, in view of the fact that various numbers of valves might require to be used, and further because it was found that in many instances it was preferable

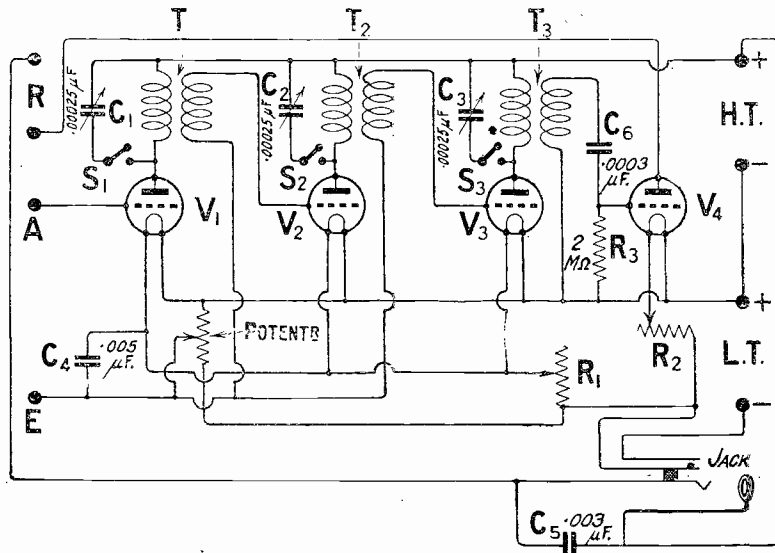

Fig. 3.—The simplified circuit.

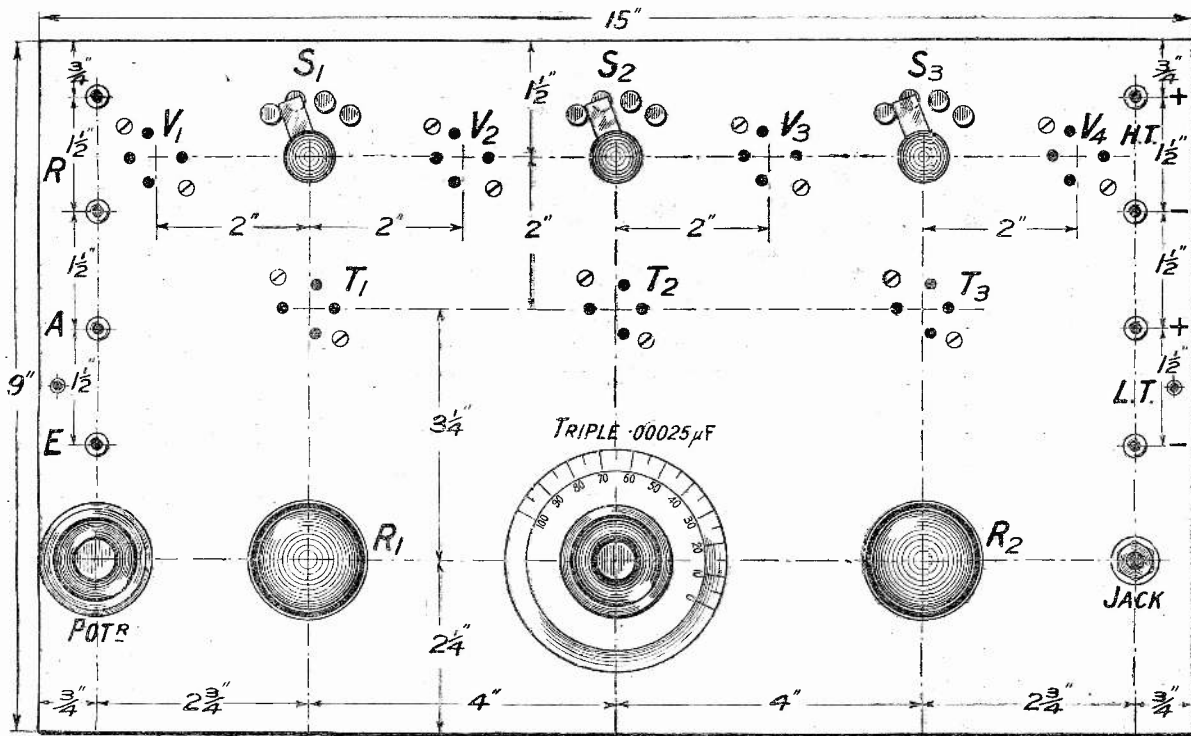

Fig. 4.—The panel lay-out should be followed carefully. (Blue Print No. 92a.)

to check self-oscillation by means of negative reaction rather than by means of the potentiometer.

The Circuit

The circuit of the complete amplifier is given in one of the accompanying diagrams, the tuned transformer method of coupling being illustrated. In this diagram the three sections of the triple condenser are shown as separate instruments, and the method of switching these across the anode circuits will be readily observed. It will be noticed in this diagram that a large condenser is connected directly between the earth terminal and the negative end of the filaments of the H.F. valves, and it should be noted that this is a most desirable refinement.

Another condenser which calls for a word of mention is that across the telephone contacts of the jack, the capacity of which is given as .003 μF, a somewhat undesirably large value. This was adopted because I commonly employ a resistance-capacity coupled low-frequency amplifier, and unless the condenser in question is fairly large there is a tendency for the high-frequency component of the anode current of the detector valve to be passed on to the resistance-capacity amplifier, and for howling to result in my case. No doubt if a transformer coupled low-frequency amplifier were used

the conventional value for a telephone condenser would be quite adequate, and would be preferable. So far as the actual working of the H.F. amplifier is concerned, I have found any size above .0005 μF to be quite adequate. Of course,

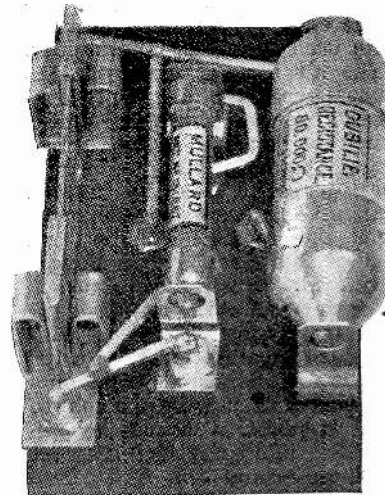

Fig. 5.—Resistance - capacity unit.

the smaller its value the better, so far as quality is concerned, when a resistance-capacity I.F. amplifier is used, but it must be large enough to ensure stability.

Filament Control

It has already been explained that only one filament rheostat

is provided for three high-frequency valves, and care should be taken to obtain a suitable instrument for this purpose. This rheostat must be capable of carrying the current of three bright emitter valves without undue heating, and yet its resistance should be high enough to enable it to control one valve only if desired. I have found that the Burndept rheostat, designed by the makers to serve only two valves, is quite suitable for this purpose, since it carries the 50 per cent. overload without overheating and is of adequate resistance to serve for the one valve only. Provision is made in the amplifier for the use of dull emitter valves in these first three sockets by the insertion of a Burndept socket for a fixed resistor in series with the filament lead, as may be seen upon the wiring diagram.

For the rectifying valve an ordinary Burndept Dual resistance is provided, and of course any rheostat can be used here which is suitable for the type of valve which you propose to employ. The filaments of all the valves are controlled by the "single filament" jack previously mentioned, which serves the purpose of an "on and off" switch. Reference to Fig. 11 will make its mode of operation clear, and it will be seen that when a plug is inserted in the jack the spring 1

is forced outwards, and by means of the little block of insulating material 2 forces the springs 3 and 4 together, thereby completing the low-tension circuit and lighting the valve.

Parts and Materials required for Construction

1 ebonite panel 1 1/2 in. by 9 in. by 1/4 in.

1 cabinet to carry the above panel (Scientific Appliances, Ltd.).

7 H.T.C. under panel type valve sockets.

1 triple condenser, .00025 μF each section (Bowyer-Lowe, Ltd.).

1 fixed condenser .0003 μF (Dubilier).

1 fixed condenser .005 μF (Dubilier).

1 fixed condenser .003 μF (Dubilier).

1 grid leak of 2 megohms (Dubilier).

1 "single filament" jack (Elwell).

1 Burndept Dual rheostat.

1 Burndept rheostat, two-valve size.

1 potentiometer (Read and Morris).

3 two-way switches (Bowyer-Lowe, Ltd.).

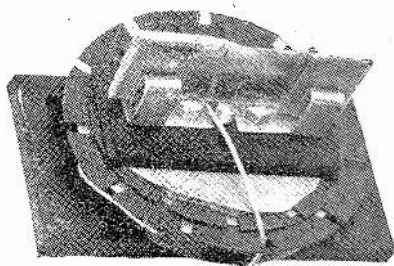

Fig. 7.—A semi-aperiodic transformer.

8 Clix sockets.

1 Burndept fixed resistor socket and short-circuiting plug.

Square tinned wire for connections.

In connection with the potentiometer it should be noted that the space available for this component is somewhat limited, and only certain makes will fit. Besides the Read and Morris type mentioned, the T.C.B. potentiometer will also serve, and certain others.

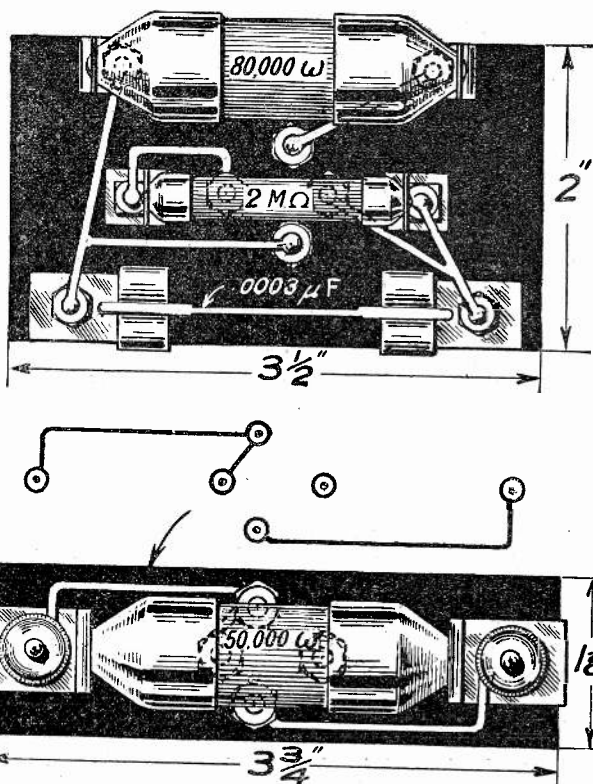

Fig. 6.—Wiring of the resistance-capacity units.

Wiring

I believe that little need be said regarding the construction and wiring up of the instrument, since it is most emphatically only suited to the experimenter of fair experience, and he will no doubt not be in need of minute instructions.

The first point concerns the connections from the triple condenser, since it might appear somewhat puzzling in the light of the photographs and the wiring diagram alone. It will be observed that two separate wires come away from the moving spindle and connect to different points along a third lead. This is done purely in order to equalise the length of the oscillatory paths associated with the three separate anode circuits, since it will be realised that if only one wire is taken from the spindle such equalisation would be impossible. Similarly, the three wires which come away from the separate sections are all equalised in length, the longest one having been cut first, and then the two others cut to the same length and fitted in by the insertion of a suitable bend.

The wiring of the telephone jack will depend upon the particular type of jack which the constructor is able to obtain; the supply of such jacks being apparently a somewhat irregular matter, one has to use more or less whatever type chances

to be available. The essential points about the connections for this jack are shown upon a separate diagram, and I think this will make the matter clear. If only a more complicated type of jack is available with a number of springs, the four connections required should be inserted amongst these springs in any convenient manner which will produce the desired connection of the 'phones into the anode circuit of the detector and the pressing together of the two springs which serve as a filament "on and off" switch, any other springs being left blank. Thus, the jack which I actually used had several springs which are not required, as will be seen upon the wiring diagram.

The grid leak is supported at one end by one of the clips of the

grid condenser, and to the other I soldered a thin wire, a procedure which is only to be recommended to those who are fairly expert with the soldering iron. If this operation is not carried out quickly with a really hot iron, the contents of the cartridge are liable to be cooked, with disastrous results upon the

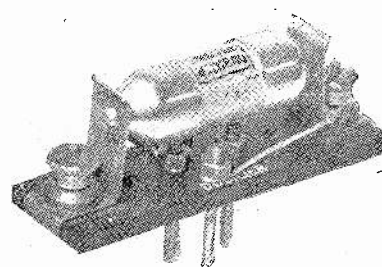

Fig. 8.—A simple resistance unit to precede the detector.

resistance of the leak. A much better method is, no doubt, to mount the leak separately in a pair of clips upon the panel.

Further Details

Regarding the general lay-out of the wiring, it need only be said that the arrangement visible in the photograph and depicted upon the wiring diagram should be followed as closely as possible, since this arrangement represents the result of many hours of patient

scheming and contriving, and embodies a number of particular features resulting from experience gained with the original amplifier, which was scrapped. It will be observed upon close examination that the critical wires, such as those from the grids of the valves, and those forming the tuned intervalve circuits, are reasonably short, while those which are long are all wires whose length is a matter of small importance. It is assumed, of course, that the reader is aware that some really low capacity valve socket *must* be used in constructing such an instrument as this.

Testing the Finished Amplifier

Upon the completion of the amplifier it is advisable to put it through some systematic test, to ensure that all joints are sound, and so forth, and in my own case it proved necessary to locate a fault resulting from the fact that one of the clips of the detector valve socket had loosened so that no proper contact was then made to the grid of the valve. The method which I adopted, and which I recommend every constructor to adopt, is to bring the instrument into use one valve at a time, satisfying oneself that that particular valve is functioning correctly before adding another. This can be done by the use of a flexible lead which is plugged into the

grid socket of each H.F transformer socket in turn; thus, the amplifier is placed beside the tuner, batteries connected and so on, and the reaction coil terminals are short-circuited. The E terminal is joined, of course, to the corresponding terminal upon the tuner, while from the G terminal of the tuner a flexible lead is brought, which terminates in a plug of some sort, such as a valve pin, which will fit into the transformer sockets. The

properly, one may then insert the wanderplug in the grid socket of the middle H.F. transformer, inserting a high-frequency transformer in the right-hand socket and a valve in the third socket from the left, and closing the right-hand single pole switch controlling the variable condenser, after which the right-hand H.F. valve should be lit to the correct brilliancy, which will usually be obtained with the filament rheostat just on, after which the variable condenser should be revolved until signals are once more heard.

The direction of reaction will now require to be reversed, and it should be found that the potentiometer affords a control of reaction.

Controlling Oscillation

In this way the circuits of each valve can be tested, and it will be found that after the second valve has been switched on, and most certainly when the third is in use, no reaction is needed to make the set oscillate. It should oscillate very freely with the potentiometer at any point more negative than the middle of its winding, and when all three fully tuned stages are in use with three matched transformers in the sockets it will further be found that it has to be turned rather far towards the positive end to stop self-oscillation. To obtain a convenient control of this tendency to self-oscillate the high-

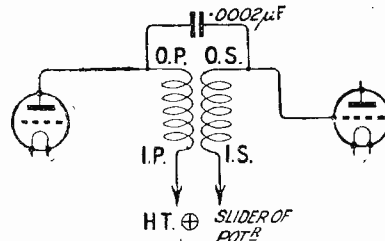

Fig. 9.—The connections of the aperiodic transformer.

detector valve is then inserted, and the plug is placed in the grid socket of the right-hand H.F. transformer (the transformer, of course, being removed). The detector valve is then lighted, and the local station is tuned in. The result should be the ordinary single valve strength of signals when no reaction is used.

The Next Proceeding

Being satisfied that the circuits of the detector are functioning

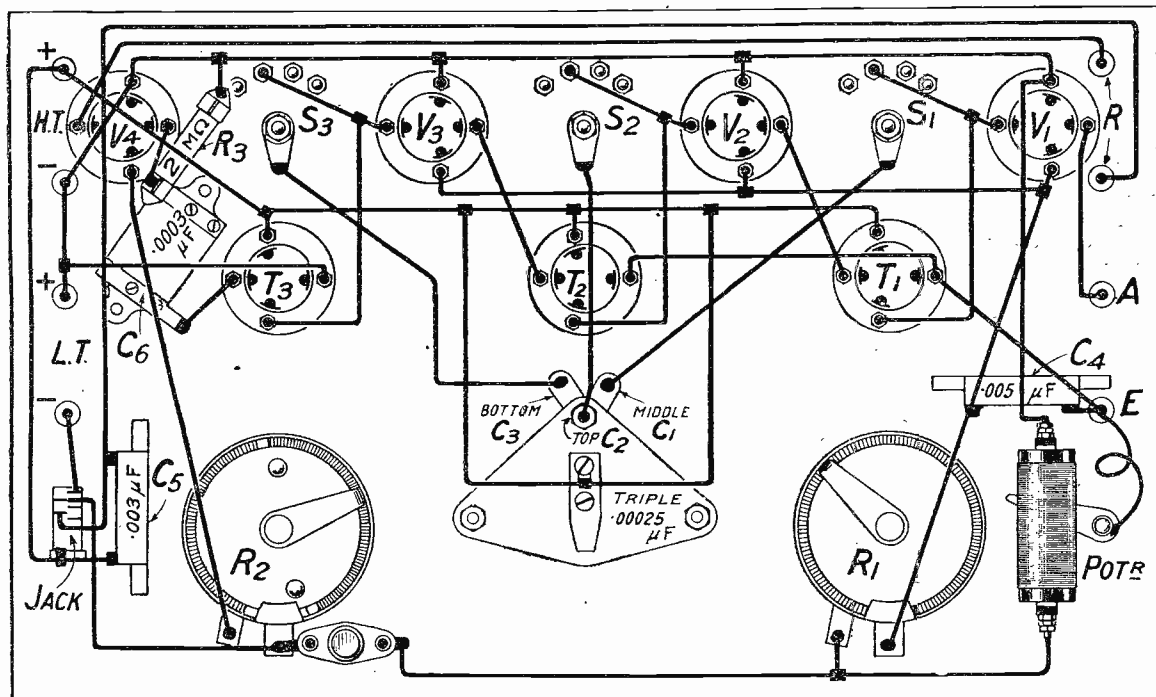

Fig. 10.—The socket for the fixed resistor is attached to R2, and a brass shorting plug is inserted when bright emitters are used. (Blue Print No. 92b.)

tension voltage should be adjusted with some care, a lower voltage being indicated if self-oscillation proves somewhat uncontrollable. The actual tendency depends, of course, very largely upon the type of valve in use, but with the great majority of types which I have tried, about 60 volts enabled a convenient control to be obtained.

Upon my own instrument, when the three tuned transformers are being employed, I find that the potentiometer has to be turned round about two-thirds of the way from the negative end towards the positive, which is, of course, too far for real efficiency, and therefore one must turn to some other means of checking the tendency to self-oscillation without using so much positive bias.

Negative Reaction

I have found that with the tuner referred to negative magnetic reaction provides this means, and enables one to obtain very much better results. A very small reaction coil must be used, such as the Gambrell a/2 or the Burndept Sr, or even one of the Burndept short-wave series. The size of this coil will, no doubt, depend upon individual conditions, but the reader should be warned that even when connected in the direction to produce negative reaction, bringing the coil up towards the aerial or secondary tuning coil will still cause the set to oscillate, as a result of the capacity between the coils, which produces ordinary capacity reaction. One must therefore try to find such a position for the reaction coil that it is near enough to produce a holding down effect from the magnetic negative reaction, and yet is not near enough to produce much capacity reaction.

Types of Interval Couplings and their Uses

The tendency to self-oscillation of the amplifier, of course, is primarily governed by the form of interval coupling which may be in use at the time, and it will be found extremely interesting to try different couplings, noting their suitabilities for different purposes.

For example, where the maximum of selectivity and signal strength is needed, no doubt three tuned stages of transformer coupling will be employed, but such a combination is somewhat tricky to handle, and the tendency to self-oscillation is, of course, very strong. A careful manipulation of negative reaction and high-tension voltage is needed to obtain good results in this way, and for my own purposes I have now decided upon a somewhat more controllable combination. One can, of course,

go to the other extreme and employ a semi-aperiodic coupling throughout, such as a tapped anode coil wound with resistance wire, or one may use some sort of combination of the two, such as the T.A.T. method, which possesses many of the advantages of both, or one may use some other mixture of tuned and untuned coupling which one may find to suit one's own requirements better.

A Useful Combination

A combination which I have found particularly advantageous is that of tuned transformer coupling for the first and last stages, and

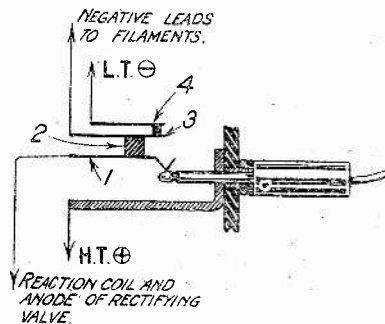

Fig. 11.—The connections of the filament jack.

some form of semi-aperiodic coupling in the intermediate stage. For this purpose the right and left hand sockets are fitted with an ordinary plug-in tuned transformer, the right and left hand single pole switches are turned to the right-hand position, which brings the condenser into operation, while the centre one is turned to the left to cut it off from that particular interval circuit. Into the middle socket is then plugged either a tapped anode coil wound with resistance wire and provided upon the same base with a grid condenser and leak, or else a semi-aperiodic transformer.

Good Stability

I find this combination to give very good amplification, and is just about as stable as the "Transatlantic" type of receiver, the potentiometer giving all the control which is required of reaction. No negative magnetic reaction is really called for in this case, although it can be used by the fairly expert operator with good effect.

If one requires the extreme of stability, one may try the T.A.T. combination, consisting of an aperiodic coupling in the first and last sockets and an ordinary transformer in the middle socket.

Those who wish to make the whole amplifier both stable and exceedingly straightforward to handle may use aperiodic couplings

throughout. This arrangement again, does not oscillate, in my case, without a reaction coil, unless an excessively high anode voltage is used, but, of course, selectivity is very low, and amplification is not particularly good.

I have devoted a good deal of attention to the use of the amplifier for long wavelengths, and have tried both tuned and untuned couplings in great variety, and find that, for convenience, stability, and a reasonable degree of selectivity, the T.A.T. combination leaves nothing to be desired. In the first and last sockets I insert a resistance-capacity coupling, and in the middle socket an ordinary transformer.

On Long Wavelengths

Upon the longer wavelengths three tuned stages are a trifle more stable than upon the shorter waves, but greater difficulty is experienced in finding a suitable size of reaction coil, and here I would suggest that two tuned transformers be used in the first and last stages, while in the intermediate stage a resistance-capacity unit is inserted.

Semi-Aperiodic Transformers

If it is intended to use semi-aperiodic transformers seriously, it is worth while to make up one or two for oneself, on the lines of the one illustrated in one of the photographs. The primary and secondary windings consist of basket coils wound upon fibre discs, cut to the usual spider shape, such as can be obtained from almost any of the smaller dealers in wireless accessories. These are supplied in sets of graduated size, and I used the second and third in the series, counting from the smallest end. The inner diameter of these coils is 1 1/4 in., and the number of spokes in the spider is not very important. They are wound with No. 40 single silk-covered resistance wire, there being 80 turns of wire upon the primary and 90 on the secondary.

The two coils, when finished, are given. A reasonably thin coating of shellac, well baked, and placed together so that the direction of both windings is the same, the mounting being left more or less to the reader's discretion.

The Transformer Connections

The connections from the inner and outer ends of the two windings should be made to four pins in such a way that the connections, when the transformer is inserted in one of the sockets, are as given in Fig. 9. It will be noticed in this figure that a condenser of .0002 μF capacity is shown

connected across the two outer ends of the windings, that is, from the plate to the grid of the successive valves, and this can be seen in the photograph of this component. The condenser in question is one of the clip-in type supplied by Messrs. McMichael, the two clips being mounted upon the clamping piece of ebonite which holds the transformer together. The best capacity should be determined by experiment, which is very easily done by means of the particular type of condenser indicated. This transformer will cover the band occupied

incorporated which upon the last stud brings in a resistance for the longer wavelengths. This unit is made in two types, one to precede the detector valve where no grid condenser and leak need to be incorporated in the unit, and the other for the earlier stages with such a condenser and leak.

Resistance-Capacity Units

Upon the longer wavelengths the resistance-capacity system is a very great convenience in one or more stages of the receiver, requiring no adjustment and producing great stability. I have not found

in the ordinary way, and upon this the necessary parts can be mounted and wired as shown in the diagram.

Results Obtainable

I speak of the results I have obtained with this amplifier with some diffidence, since, when it becomes a matter of three stages of high-frequency amplification, the things which one can do are both so extraordinarily good and so disappointing that they must often be experienced to be believed.

In the first place, I believe that the majority of people expect too much from three stages, so that one's disappointment on finding

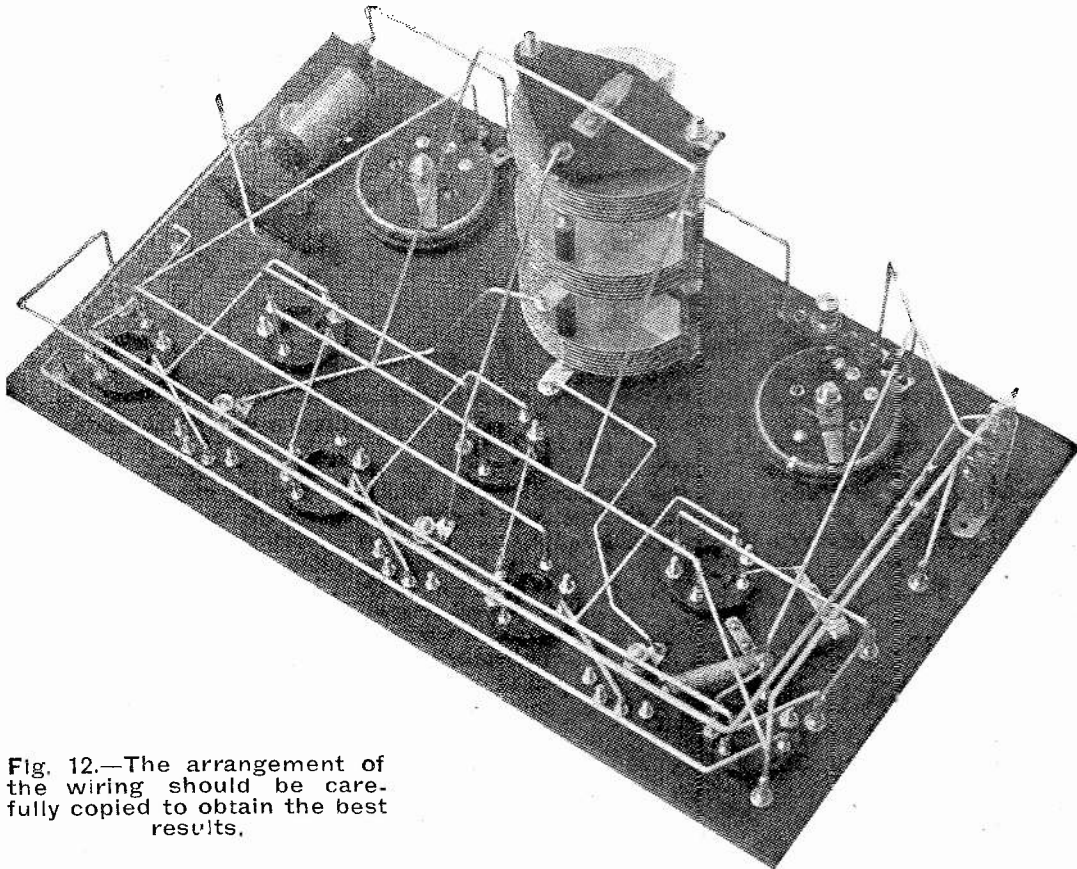

Fig. 12.—The arrangement of the wiring should be carefully copied to obtain the best results.

by the main broadcast stations quite comfortably, and if it is desired to make one for the relays, 60 and 70 turns should be tried.

Tapped Anode Coil Circuits

Effective tapped anode coils are somewhat troublesome things to make, and those which I employed can now be purchased ready for use, having been made to the design published in Radio Press Envelope No. 3, consisting of a winding of fine resistance wire with suitable tappings to cover the wavelength range of 200 to 600 metres. These coils can now be obtained from Messrs. Burne-Jones made up as a plug-in unit, with a tapping switch

it desirable to use three stages of resistance-capacity coupling, since amplification is only fair and the selectivity is very poor. It will therefore be sufficient to obtain, or make, two plug-in units so that, at the most, two resistance stages can be used, and one fully tuned stage.

For the simplest type of unit the ordinary Dubilier anode resistance upon its own base can be used, the necessary four valve pins being inserted in the base itself. The necessary connections are shown in one of the diagrams, while for the more elaborate unit a piece of ebonite $3\frac{1}{2}$ in. by 2 in. should be prepared with valve pins inserted

that, say, Birmingham is only fairly loud in the headphones is natural, but it is only from further experience that one realises that there appears to be a limit as to signal strength with this particular amplifier, up to which nearly all B.B.C. stations come upon all occasions. For example, one finds that Aberdeen is every bit as strong as Birmingham, as also is Belfast. Foreign stations, such as the more powerful German ones, easily come up to the same standard, and all give loud-speaker results with the addition of one stage of low-frequency amplification.



In passing

Strenuous Work

FOR some time now my stout friend Poddleby and I have been busily engaged on a very difficult piece of research work. Could you have seen us during the Christmas season whilst others were devoting themselves to mere frivolities, you could not, I think, have resisted uttering a little exclamation to indicate your mingled feelings of pity and admiration. Pity for the enthusiasts whose devotion to toil is such that they can have no part in the pulling of crackers, the donning of cardboard noses, the dancing of jazz, or the cracking of seasonable jests. Admiration for souls so wedded to their labour that they give not a passing thought to the gaieties in which others are lightly indulging. I would like you to picture the little scene in Poddleby's

now the piano's tinkling notes come trickling through the key-hole. But within all is hushed save for the scratching of pens, the rustling of papers, and our deep breathing as we grapple with the fierce problems that are before us.

The Fruits

What, you ask yourself, is to be the outcome of this mighty celebration? Why is Professor Goop not assisting in this intricate work? When shall we see the wonderful new circuit or circuits that will result from these Herculean labours? Reader, you are asking too much. Really, you must restrain your curiosity rather better than this. The task upon which we are engaged is so secret that I cannot give you the faintest indication of the goal that we have in view. Too often before now

I look up, fling down my pen, yawn, stretch my arms, light a cigarette, and tap Poddleby lightly on the head with a large volume in order to attract his attention.



Our brows furrowed with deep thought.

Poddleby gazes at me wearily. After his toil there is no real fight left in the man. For a few moments we sit in silence resting and blowing clouds of smoke. Then, at last, Poddleby clears his throat and breaks the silence. "I say," he says, "have you done No. 19? I'm blown if I can think of a word of six letters beginning with T that means a Patagonian chieftain."

A National Peril

Really, this cross-word business^s is becoming a very serious thing indeed. In Little Puddleton, for example, it is a positive menace

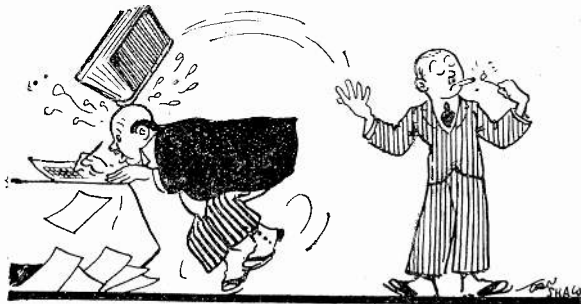

I tap Poddleby lightly with a large volume.

study. We sit on either side of the big table, our brows furrowed by the lines which deep thought produces, our right hands busily plying pen or pencil, whilst with the left we ruffle from time to time such locks as the years have left us. Before us are great books of reference, of which we make frequent use. We ply our writing instruments both upon ordinary paper, sheet after sheet of which filled with well-nigh indecipherable hieroglyphics falls to the floor, and also upon squared paper. From without faint sounds of revelry penetrate through the locked door. Now 2LO is calling, now the gramophone strikes up,

in wireless matters I have given a hint of some brilliant new discovery which some of the members of the Little Puddleton wireless club were about to give to the world, only to find that some villain seizes upon it, pursues our own lines, and then manages to get in first with the great idea and to claim all the glory for himself. Let it suffice that on the occasion which I am describing the two great minds are very hard at work, and when two such people as Poddleby and myself put our heads together in this way startling results are to be expected. Of course, we find it necessary to take a breather every now and then.

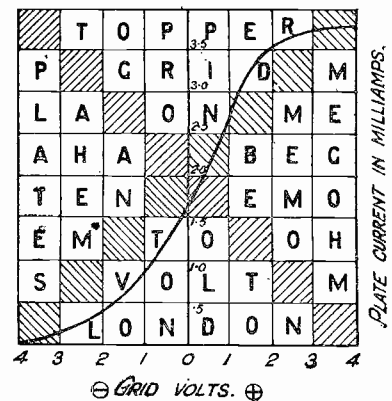

Fig. 1.—The sad effect of the prevailing craze.

to the progress of wireless. Gubbs-worthy, for instance, has not attended a meeting of the wireless club for three weeks, and there are cobwebs on Snaggsby's loudspeaker. Only the other night, when General Blood Thunderby was lecturing upon "Some Applications of the Thermionic Valve," he was unable to proceed with his paper owing to the fact that he had inadvertently left all his characteristic curves at home. In his haste as he left his abode he seized the wrong bundle of graph paper, so that when he essayed to refer to his carefully drawn characteristics, he found that in their stead he had come provided with a dozen cross-word puzzles in various stages of solution. This being so, it was resolved by Bumbleby Brown, and carried *nem. con.*, that the General should be asked to postpone the reading of the remainder of his paper until the members of the club had had time properly to consider the problems which he had laid before them:

Choosing a New Valve

Another very terrible example of the effects of the latest craze is shown in Fig. 1 of the drawings. As the club had decided to purchase a new valve, samples were sent to Professor Goop with the request that he would kindly test them out and report upon them. The curves which accompanied his report provided indisputable evidence that even the Professor had been combining business with pleasure. If this kind of thing

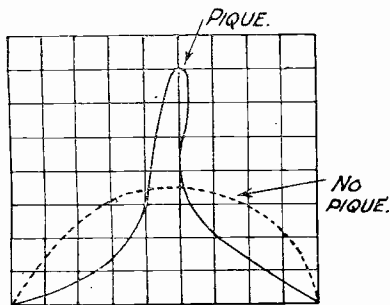

Fig. 2.—Illustrating the Pique effect.

goes on much longer I do not know what will happen to the club. I may say, however, that our members are having considerable success in competitions, particularly our worthy President, for, owing to the possession of a hobnailed liver produced by long residence in the East, the General is a past master at cross words.

The Serious Side

I am pleased to be able to report that I have been successful

in tearing the Professor at intervals from the grip of the prevailing passion and to induce him to help me in some serious wireless work. At the present moment we are engaged in investigating a phenomenon which we propose to call Pique Reaction. Curiously enough this morning's post brought a letter from a correspondent who has been working independently upon very much the same lines, and his experiences and conclusions tally very well with our own. Our first experience of the Pique effect came about in this way. We built some time ago in collaboration a set containing two stages of high-frequency amplification coupled by means of the well-known Biffkins-Blunderholme method, which gave very fair results, though it always seemed as if it should have been capable of doing rather better than it actually did. Eventually this set was discarded and we built in its place another with four stages of high-frequency amplification, the couplings in this case being of the super-putridyne type. With this results were perfectly amazing, every one of the 700 American broadcasting stations having been received upon the loud-speaker, sometimes four or five at a time. One night the Professor suggested that we should try the old set once more. We connected it up, and you may judge our surprise when we found that we were able to bring in Sloshtville (WHIZ) with considerably increased strength. So powerful, in fact, were the signals that the loud-speaker retired from the contest with a buckled diaphragm.

A Remarkable Effect

Fig. 2 illustrates the extraordinary Pique effect which occurred. The dotted line shows the normal signal strength of the Biffkins-Blunderholme receiver, whilst the solid line indicates the extraordinary results achieved by Pique reaction. For a time the Professor and I were at a loss to discover a reason for the occurrence of this strange phenomenon. We found, however, quite by chance that if the super-putridyne was removed from the house the Biffkins-Blunderholme set returned to its old bad ways. Then the explanation of the whole thing flashed upon us, and in our joy

at discovering the solution of the mystery we wept so copiously upon one another's necks that I had to borrow a fresh collar and an old coat from the Professor to enable me to continue the evening without catching my death of cold. The truth of the matter is that the Biffkins-Blunderholme was so hipped at having its nose put out of joint by the super-putridyne, that when given a chance once more to show what it could do, it excelled all previous performances.



The General is a past master of cross words.

Verification

By a series of experiments we have verified the occurrence of Pique reaction in case after case. Snaggsby, for example, is the possessor of a rather sulky crystal set which is in the habit of making a great deal of fuss even over the reception of 2LO. To find the sensitive spot on the crystal you must spend a long time with the buzzer, and when you have found it the fixed and moving plates of the condenser suddenly develop such affection for each other that they touch as they are rotated. Having rectified this little defect, you essay once more to tune in with the set only to find that whilst engaged with the condenser you have lost the sensitive spot. And if it is not the detector or the condenser, it is the telephones or the coil that give trouble. One night the Professor and I turned up with a valve set which we yoked to the aerial, leaving the crystal set upon the table so that it might be duly impressed. On changing over to the crystal receiver we found that 2LO, usually a still small voice, was coming in at such strength that his transmission could be heard with the 'phones on the table—provided that the listener's head was inside them. I regard Pique reaction as the most useful discovery in wireless made in recent times. If ever you build a surly set which refuses always to do itself justice, do not fail to see what Pique reaction will do.

THE LISTENER IN.

Trap Circuits: A New Development for Selective Reception

By JOHN SCOTT-TAGGART, F.Inst.P., A.M.I.E.E.

This article discloses a new and interesting method of selective reception and a new method of coupling valves for high-frequency amplification.

THE problem of selectivity is one which every experimenter, sooner or later, becomes interested in, and this is particularly so in the case of those unfortunate radioists who live near the coast or some high-power station which causes interference. The long distance enthusiast, or DX hound, as the Americans call him, is equally troubled, in many cases, by interference from a local broadcasting station.

There are, in general, two methods of obtaining selectivity in an ordinary circuit. High-frequency amplification alone, in nearly all cases, improves the selectivity of the wireless receiving apparatus, and it is commonly the custom to rely on improving the selectivity "as you go along." That is to say, that each stage of high-frequency amplification will help to eliminate stations.

Two Methods

Instead of relying on the progressive elimination of unwanted signals, another plan is to cut out the interference at the very beginning, and to use the high-frequency amplifying portion of the set for that purpose alone.

In some cases reliance is placed on both methods.

There is a good deal to be said for each plan. By cutting out unwanted signals at the very

beginning, it is quite possible also to cut down the desired signals to such an extent that it is hard to pick them up again by high-frequency amplification. This trouble is not experienced when high-frequency amplification is used first and reliance is placed on selective apparatus afterwards, or in the process of high-frequency amplification.

or they may be cut out after the first stage of high-frequency amplification, or any other stage for that matter. Cutting out, of course, it must be remembered, is a matter of degree, and absolute selectivity is an impossible achievement. It has also to be remembered that usually the employment of a selective device causes some weakening of signal strength, i.e.,

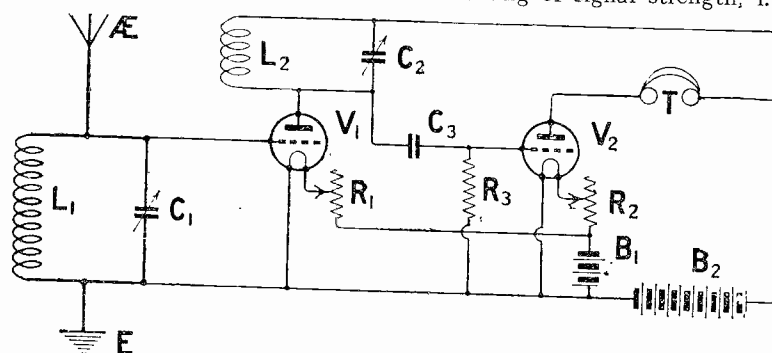

Fig. 1.—Illustrating the conventional tuned anode method of coupling.

In some cases, high-frequency amplification will improve very little the degree of selectivity obtained, and may only serve to make the interfering signal stronger.

The arrangement about to be described in this article may be applied to both systems. The unwanted signals may be cut out from the aerial circuit at the start,

the unwanted station may be cut out, but the desired station may be reduced in signal strength.

Trap Tuning

A common method of eliminating interference is to use a "wave-trap." Wave-traps may be of different kinds. They may be adjusted so that they cut out an interfering station and leave the desired signal, or they may be arranged so that the selectivity for the desired station is increased to such a point that the interfering station is cut out. A little thought will show that these two methods are quite separate. Reception of the B.B.C. station 2LO might, for example, be very flat on the set, and also interference might be coming in from a 450 metre ship station. It is quite possible to cut out the 450 metre ship station and yet leave the tuning on London as flat as before.

Another method, which seems

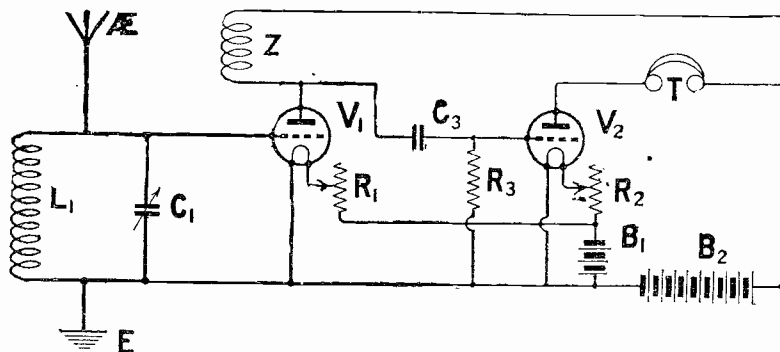

Fig. 2.—How a choke-coil may be used for coupling.

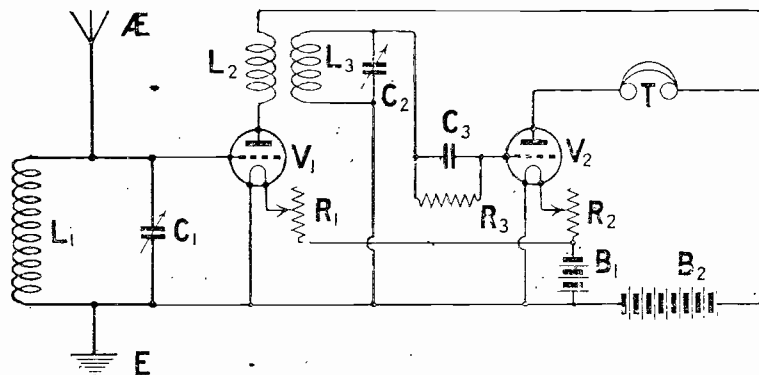

Fig. 3.—Using an H.F. transformer with the secondary tuned.

to be the more scientific one, is to improve the selectivity so that London tuning is very sharp, and in these conditions, interference will not be experienced from the 450 metre station.

The Origin

It is with this latter method of tuning that I am concerned at present, and the circuits have been given the name "trap circuits" because they involve an "aperiodic" (or untuned) coil coupled to a tuned circuit, this combination being frequently used in wave-traps. About the only detailed article on wave-traps is that which was written by Mr. Percy W. Harris in the issue of *Wireless Weekly* dated August 15th, 1923. It was, in fact, through using a wave-trap of this kind that the method of tuning the aerial circuit described below was incidentally discovered. The method of coupling one valve to another, however, was evolved, as a result of recent experiments I have carried out on variably coupled high-frequency transformers having tuned secondaries.

Preliminary Explanation

It will be best to outline briefly the different methods of coupling one valve to another.

Fig. 1 shows the tuned anode

method in which the inductance L_2 is shunted by a variable condenser C_2 , and tuned to the incoming wavelength. In these conditions the high-frequency currents in the anode circuit of the first

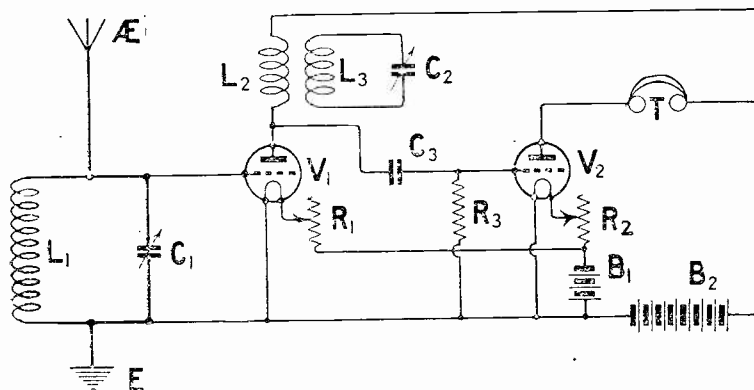

Fig. 4.—The author's anode trap method of coupling, showing the relation to Fig. 3.

valve set up potential differences across the circuit $L_2 C_2$, and these are communicated to the grid of the next valve. If the circuit $L_2 C_2$ is not tuned exactly to the incoming wavelength, the amplified signals will pass through the circuit and will not set up any potential differences across it, although if a circuit is tuned nearer to the

In the Fig. 1 arrangement it should be pointed out that the selectivity of the tuned anode circuit depends largely upon its resistance, and the larger the wire used and the fewer the losses in the tuned anode circuit, the more selective will the arrangement become. To improve the selectivity still further it is usual to introduce reaction into the tuned anode circuit from the anode circuit of the second valve, and this, of course, also improves the signal strength.

Tuned Transformers

Fig. 3 shows the tuned transformer $L_2 L_3$ in use, the secondary L_3 being tuned by the variable condenser C_2 .

It was while operating this receiver and circuits of the tri-coil pattern that I appreciated to the full extent that the tendency of the first valve to oscillate depended upon the coupling between L_2 and L_3 , and that when

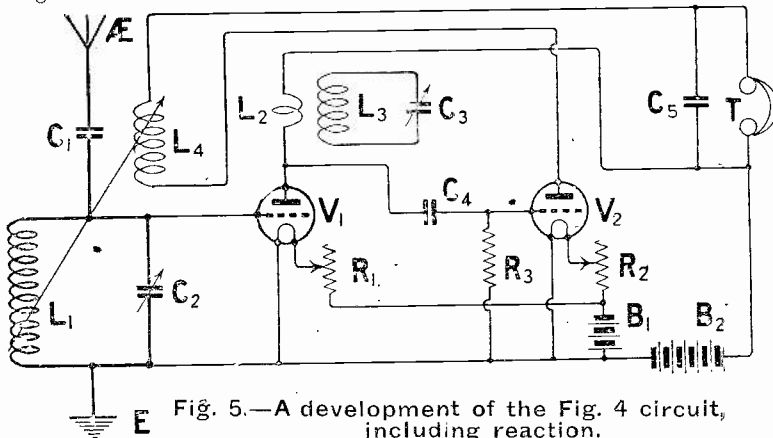

Fig. 5.—A development of the Fig. 4 circuit, including reaction.

sufficiently tightly coupled, the circuit $L_3 C_2$ acted in combination with L_2 so as to act in much the same way as the tuned anode circuit of Fig. 1. Coupling the circuit $L_3 C_2$ to the coil L_2 resulted in what was virtually equivalent to tuning the coil L_2 to the particular wavelength. This inductance L_2 was consequently not to be regarded as an ordinary inductance of an aperiodic or untuned nature, but as part and parcel of a single circuit which was tuned. If, however, the coupling between L_3 and L_2 was loosened, the coil L_2 got back much of its normal status as an isolated coil. If L_3 were kept well away from L_2 the latter simply reverted to its status as an untuned coil.

Self Oscillation

In actual fact the arrangement works in practice in this manner. As the coupling between L_2 and L_3 is tightened the first valve tends to oscillate much more readily on account of there being what is virtually equivalent to a tuned anode circuit and a tuned grid circuit. A circuit of the Fig. 3 type, if properly designed, will often oscillate even though there is no intentional reaction, and it may be necessary to connect the bottom of the grid circuit to the positive terminal of the filament accumulator, as shown in the figure.

These experiments, followed by a certain amount of reasoning, led to the development of the

first as if this anode circuit actually contained a tuned anode oscillatory circuit.

We now arrive at the Fig. 4 circuit, which is an example of my anode trap, coupling method. It will be seen that the secondary L_3 is now free, while the primary L_2 is, as before, in the anode circuit of the first valve. This anode is connected through the grid con-

as an ordinary untuned inductance and the signal strength will be very small indeed unless the coil is sufficiently large to act as a choke, in which case the arrangement will be equivalent to the Fig. 2 circuit. This choking effect, however, occurs only when the inductance coil is fairly substantial, and a good degree of amplification is obtained only when the choke

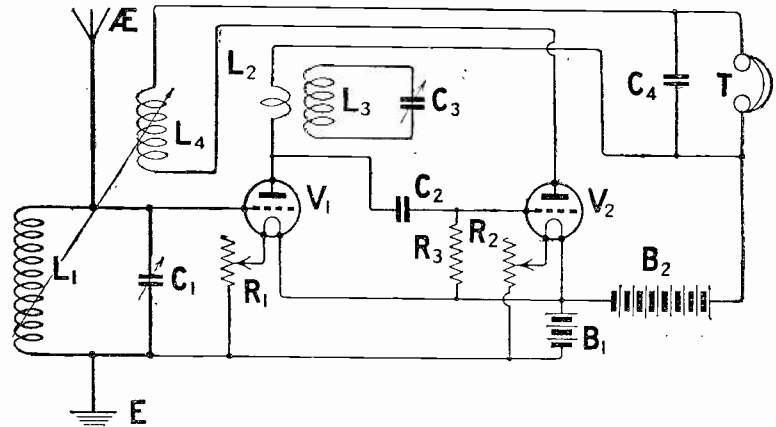

Fig. 6.—An alternative circuit in which the bottom end of the grid circuit is connected to L.T. negative.

denser C_3 to the grid of the second valve, the usual leak being provided in the position shown.

By tuning $L_3 C_3$ accurately to the grid circuit of the first valve, the anode circuit of the first valve is virtually turned into a tuned anode circuit, and in practice I have found that the same signal strength is obtained with the Fig. 4 arrangement as with the conventional Fig. 1 circuit.

coil is appreciably larger than the coil would be if it formed part of a tuned anode circuit.

Aperiodic Coil

In the anode trap circuits the coil L_2 is, in fact, a small one, and for reception of the British broadcasting stations will usually be in the neighbourhood of a 25 turn coil, although they have been worked down to 8 turns, and the arrangement would work on still fewer turns.

This, however, is conditional on the coil L_3 being sufficiently tightly coupled to L_2 so that the circuit $L_3 C_2$ now turns the inductance coil L_2 into what is virtually a tuned anode circuit.

Selectivity

Let us now see what happens if $L_3 C_2$ is not accurately tuned to the incoming wavelength. Under these conditions we tend to arrive at a state of affairs similar to that in Fig. 1, when the tuned anode circuit $L_2 C_2$ is out of tune with the incoming signals. The amplitude of the high-frequency E.M.F.s established across L_3 will be nil or negligible, and consequently signals will not be heard in the telephones. The coil L_2 now reverts to its original aimless and useless condition. It does, in fact, act much in the same way as an ordinary piece of wire would do, and the fewer the number of turns in L_2 the more like a wire will it be.

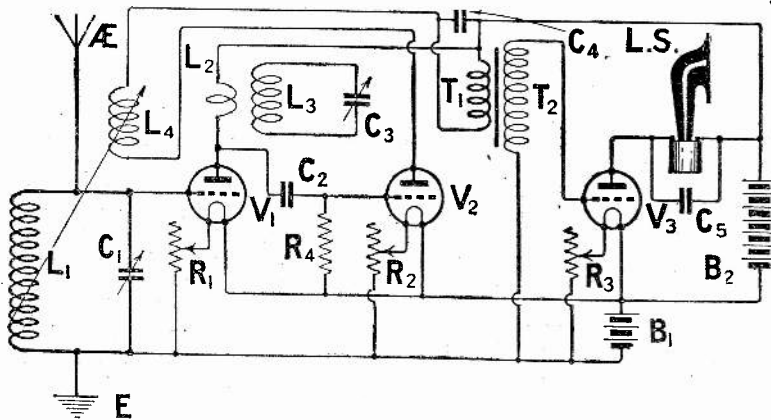

Fig. 7.—A three-valve trap circuit suitable for loud speaker work.

T.A.T. circuit and also the arrangement about to be described.

I argued in my own mind that if the coupling of the tuned grid circuit of Fig. 3 turned the anode coil L_2 into what was virtually a tuned anode circuit, then the grid of the second valve could be connected directly to the anode of the

On the other hand, the Fig. 4 arrangement is very much more selective than the Fig. 1 circuit.

In view of what I have said before, this is not very surprising. If we take the coil L_3 away from L_2 so that the circuit $L_3 C_2$ does not affect L_2 , then this latter inductance acts purely and simply

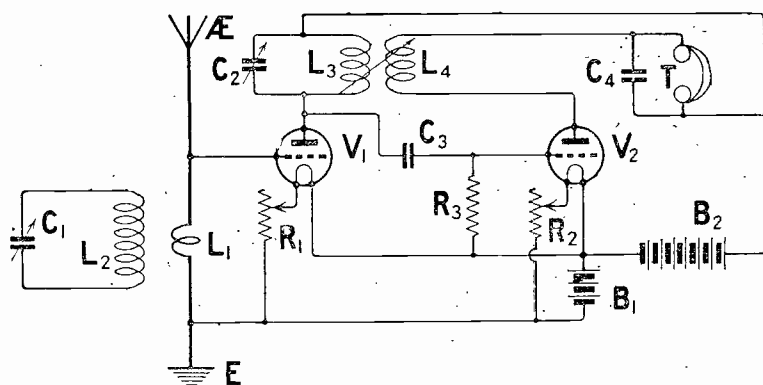

Fig. 8.—Illustrating the trap method of tuning the aerial circuit.

The coil L_2 will become a virtual short-circuit for any high-frequency currents in the anode circuit of the first valve, and no high-frequency E.M.F.s will thus be communicated to the grid of the second valve.

If, however, we tune L_3 C_2 absolutely accurately to the incoming wavelength, an astonishing change takes place, and signal strength increases to a maximum, but immediately drops to zero if the condenser C_2 is turned too far.

The adjustment of C_2 is therefore critical, and astonishing selectivity is obtainable with this arrangement even though no reaction is employed.

Coils

As for the type of coils used these may be wound in the shape of cylinders, the coil L_2 simply consisting of about 8 to 20 turns wound round the middle portion of the coil L_3 . Instead of doing this, however, ordinary plug-in coils may be used, the coil L_2 being, for example, a No. 25 coil, while L_3 is the usual size of coil used in a tuned anode circuit, say, No. 50 for most of the B.B.C. stations, or a No. 75 in the case of those using longer wavelengths.

The selectivity of the arrangement is so remarkable that to get the best results on weak signals it is desirable to provide a vernier with the condenser C_2 .

Introducing Reaction

Fig. 5 is a development of the Fig. 4 arrangement, reaction, however, being introduced by means of the coil L_4 coupled to L_1 . A constant aerial tuning condenser C_1 is shown in the circuit, but this is merely as a variation and is not an essential part of the circuit. The constant aerial tuning condenser, of course, improves the selectivity of the aerial circuit.

Fig. 6 is very similar to Fig. 5, but the constant aerial tuning

condenser is omitted. The bottom of the grid circuit is connected to the negative end of the filament accumulator instead of to the positive side. The experimenter

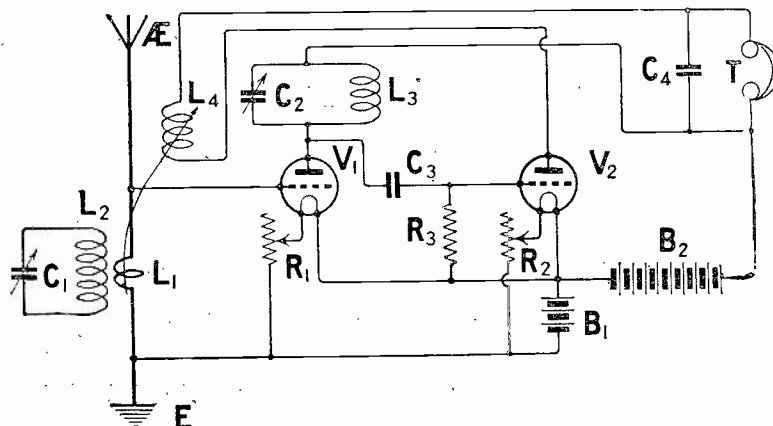

Fig. 9.—Similar to fig. 8, but with reaction on the aerial.

should always try which arrangement works best and where possible use the Fig. 6 connection.

Fig. 7 shows a very effective three-valve circuit using the anode trap method of coupling.

Trap Tuning on the Aerial Circuit

The use of the trap tuning method for obtaining selectivity

this method of tuning the aerial circuit. The signal strength is decreased very slightly, but the signals are capable of very critical tuning by means of the condenser C_1 . If the condenser C_1 is out of tune the coil L_1 acts as a virtual short-circuit across grid and filament and practically nothing will be received.

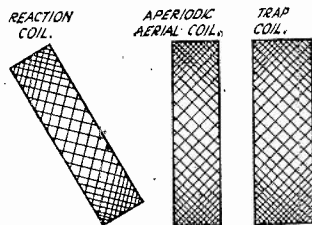

Fig. 10.—How a three coil holder may be used.

in the aerial circuit is due to Mr. W. H. Fuller, of the Radio Press staff, who has been working with me in connection with experiments on selective circuits. The arrange-

Constant Tuning

The arrangement of Fig. 8 is only an example of the use of the trap method of tuning the aerial circuit. It may be applied to any form of receiving circuit and possesses not only the advantage of selectivity, but also the advantage that the tuning of the arrangement is independent of the aerial, the setting of C_1 for a certain wavelength being constant whatever kind of aerial is employed. The arrangement is more constant than my constant aerial tuning method, although not quite so simple.

Moreover, two coils are required, as shown.

Effect of Reaction on Trap Circuits

The use of reaction in a trap circuit improves the selectivity as well as the signal strength. Fig. 9 shows an arrangement in which trap tuning is used on the aerial circuit, and reaction is obtained by coupling an inductance coil L_1 in the anode circuit of the second valve to the grid circuit of the first. It does not matter whether the inductance L_1 is coupled to L_1 or to L_2 .

The arrangement of Fig. 10 shows how plug-in coils may conveniently be arranged in the circuit of the Fig. 9 type.

Instead of using plug-in coils, a transformer may be used, or one of the new Igranic coils designed for so-called aperiodic aerial tuning in which the small turn coil is in the aerial circuit and the large turn coil forms the grid circuit.

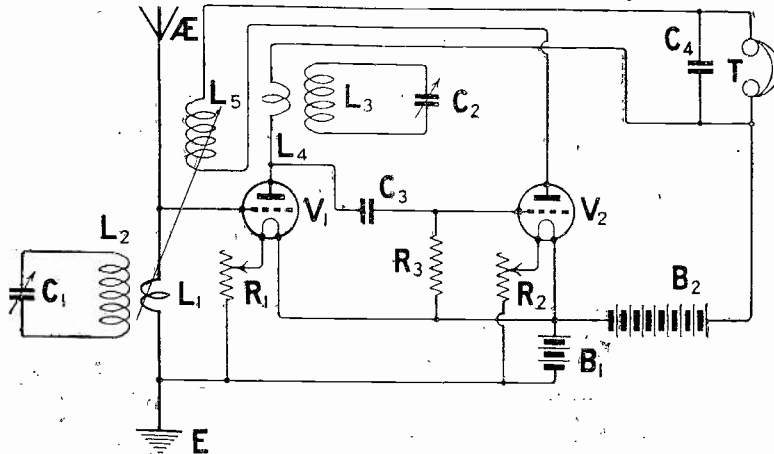

Fig. 11.—Using the trap method in both the aerial and anode circuits.

An ordinary high-frequency transformer may also be used for trap circuits, but it will be found that the primary has not sufficiently few turns to get the absolute maximum of selectivity out of the arrangement.

Using Trap Circuits in Aerial and Anode Circuits

Trap circuits may be employed in combination, one being used on the aerial circuit and the other in the anode circuit.

An example of this arrangement is shown in Fig. 11 and this will be found extremely selective, so selective, in fact, that the beginner may have some difficulty in tuning to a given station.

Conclusion

It must be remembered in looking at these circuits that in all cases the aerial circuit may have its lower end connected to the positive

or negative terminal of the filament accumulator. Whichever connection is made depends largely upon the type of valve used. Connecting to the positive terminal will always be the most stable arrangement, but may weaken signal strength. On the negative side, however, sometimes there may be too great a tendency for self-oscillation.

In all cases, of course, one or more stages of low-frequency amplification may be added in the usual way.

I would be very glad if readers would communicate to me results they obtain with these new methods.

I would like to take this opportunity of thanking the very large number of readers who are giving their results of the T.A.T. circuits. The communicating of results, whether good or bad, by different individuals is of very great help to readers generally, and enables

**A TRI-COIL
S.T. 100.**

SIR,—I have much pleasure in replying to your request for reports on tri-coil circuits, as I have made up the S.T. 100, using the tri-coil method. Up to the present I have not yet had an opportunity of thoroughly testing out the set, but perhaps the results I have obtained may be of interest to other readers. I am using Cossor P.1 Valves with 48 volts on the plate of the first, and 60 volts on the second. I have introduced two switches, one for series-parallel and the other to cut out the second valve. London is sufficiently strong on one valve to operate an Ultra loud-speaker loud enough to fill a large room. On two valves it is necessary to detune in order to make reception bearable. London comes in at crystal strength, using neither aerial nor earth. All B.B.C. stations come in—Birmingham and Bournemouth being too loud in the 'phones. This is with London cut right out. Paris (SFR), Madrid (Radio Iberica), Czecho-Slovakia (Kbel), and heaps of other Continental stations come in exceedingly well. I have had SFR on the loud-speaker, whilst Chelmsford was on. Tuning is exceedingly fine, vernier condensers being practically a necessity. This is the finest 2-valve I have yet tried, and considering the poorness of my aerial—30 ft. long, twin, 15 ft. high one end, and 30 ft. high the other—I think these results are really fine. Great selectivity, stability, long range and immense power are a few of the features of this circuit.

Trusting you will hear further reports of this excellent circuit, and wishing your journal every success.—Yours truly,

W. H. KNIGHT.
Kennington, S.E.11.

*Do not fail to order your copy
of next month's*

**DOUBLE
NUMBER**

OF
"Modern Wireless"

early.

Price 1/6

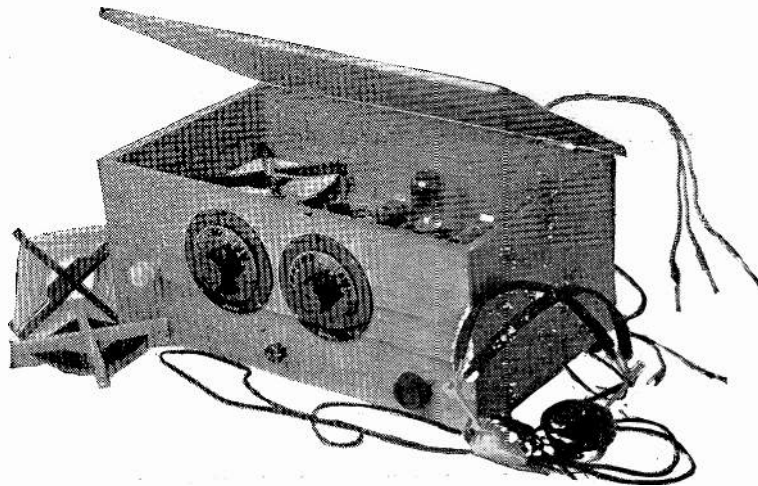

A photograph of the complete receiver, showing the permanent leads to L.T. and H.T. batteries.

A Music Lover's Puriflex

By
DONALD STRAKER

THE Puriflex circuit makes a strong appeal to the lover of music on account of its extraordinarily good reproduction. A very efficient arrangement of this circuit is employed in the receiver illustrated, and, although all components are enclosed in the case, its performance will be found to compare favourably with the more usual open-tray type. While primarily intended to give the purest possible reception at moderate ranges (50 miles from main B.B.C. stations or 200 from 5XX), it may be of interest to mention that from the writer's station, situated in an extremely favourable position in the Isle of Wight, practically all British and Continental telephony is easily tuned in on a large Amplion. Volume, of course, varies considerably, but Rome, Madrid, Newcastle and Aberdeen can usually be heard all over the house.

It will be seen that special Harris X coils are used in this receiver, and a note of warning should be sounded here to those constructors who are inclined to fight shy of all receivers demanding special coils. The appreciable increase in volume and selectivity which can be obtained with X coils is very well worth having when it can be pur-

chased so cheaply. After experience is gained on the initial attempt, subsequent coils can be made and wound in less than half an hour. Several makers are now willing to supply the necessary ebonite strips ready cut to size (6 in. by 1 in. by $\frac{1}{4}$ in.). Turns of wire can be added or removed in a few minutes, and consequently the most efficient inductance for a particular wavelength or aerial can be rapidly found by actual trial.

switch. This enables the unskilled to receive the local broadcast with the turn of a knob, provided the instrument is left tuned in. At the same time the design permits of interesting experiments with various types of semi-a-periodic aerial tuning.

The following components are used:—

- 1 Ebonite panel, 16 in. by 9 in. by $\frac{1}{8}$ in.
- 1 Ebonite panel, 4 in. by 4 in. by $\frac{3}{16}$ in.

- 2 Variable condensers, .0003 mfd. (Bowyer-Lowe square law, flange mounting type.)

- 1 Colvern micro-condenser.
- 3 Microstats. (Wates Bros.)
- 1 Master rheostat. (Igranic 6 ohm.)

- 4 Anti-capacity valve-holders. (Bretwood.)
- 1 Crystal detector. (Burn-dept.)

- 2 Fixed condensers, .0001 mfd. (Dubilier)
- 1 Fixed condenser, .0003 mfd. (Dubilier.)

- 2 Anode resistances, 80,000 ohm. (Dubilier.)
- 2 Grid leaks and clips, 2 meg. (Dubilier.)

- 2 Mansbridge condensers, .25 mfd. (T.C.C.)

- 1 Containing case with hinged lid and bottom screwed on, inside measurements 16 in. by 9 in. by 7 in. high.

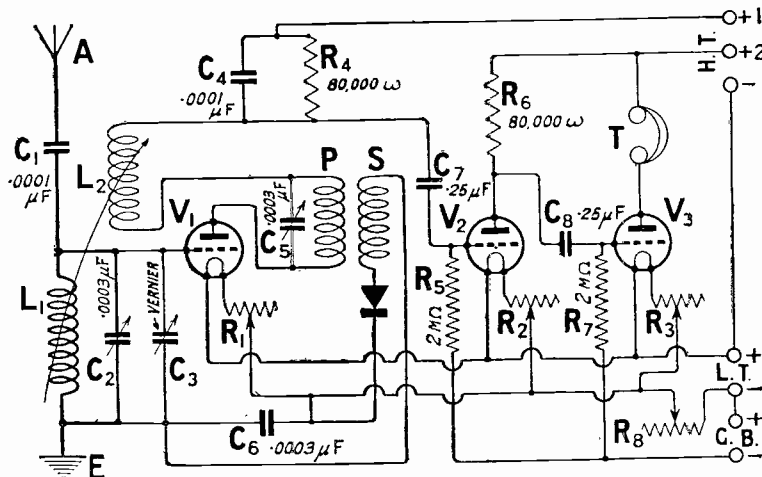
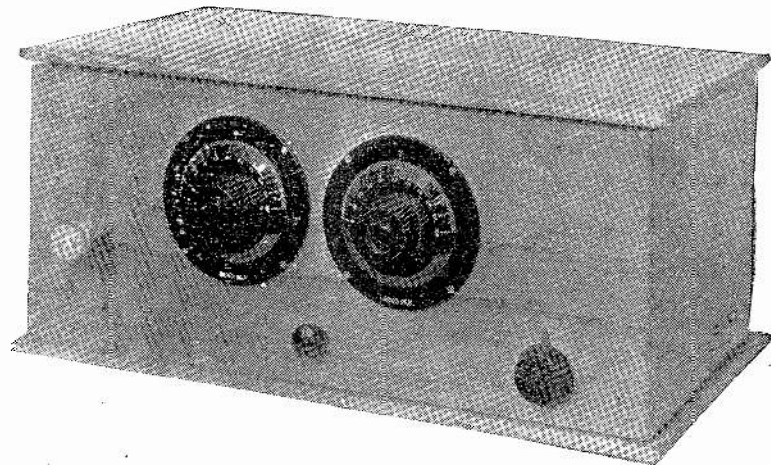

Fig. 1.—The theoretical diagram of the receiver, showing the inclusion of a master rheostat.

In the photographs the aerial tuning condenser dial is on the left, the small central knob below being a "Colvern" micro-condenser wired in parallel with the main condenser. The right-hand dial is that of the condenser tuning one of the windings of the H.F. transformer. The knob on the left is the reaction control, while that on the right is a 6 ohm Igranic rheostat which is used as a gradual "on and off"

This interesting receiver, made up by a reader from Mr. Harris's Puriflex circuit, has been tested by "Modern Wireless," and certainly gives excellent results.



The receiver itself strikes a distinctive note.

The Fittings on the Case

The positions of the condensers may be marked off from the measurements given in Fig. 3. The flanged mountings of the Bowyer-Lowe condensers require a hole $3\frac{1}{2}$ in. in diam. They should be marked out with the compasses and cut out with a pad-saw and finished off with a half-round file and glass-paper. If ordinary condensers are used in place of the flanged mount-

ing type they must be mounted on small ebonite panels (Paragon 4 in. by 4 in. by $\frac{1}{8}$ in. are suitable) and screwed to the front of the case after clearance holes have been cut to allow the condensers to project inside the case. After they are fitted the condensers should be removed for safety.

Mounting the Components

A drilling template is supplied with all Igranic rheostats, and the holes for the two fixing screws

should be countersunk so that the heads of the screws are flush with the front of case. The neck of the Colvern condenser will be too short if the wood is much thicker than $\frac{1}{4}$ in., but the wood can be recessed round the hole outside so as to allow the fixing nut to sink in and get an adequate grip of its thread. A nick should be filed in the knob of this condenser to indicate when the plates are in mid-position. The hole for the rod which controls reaction is better left until the

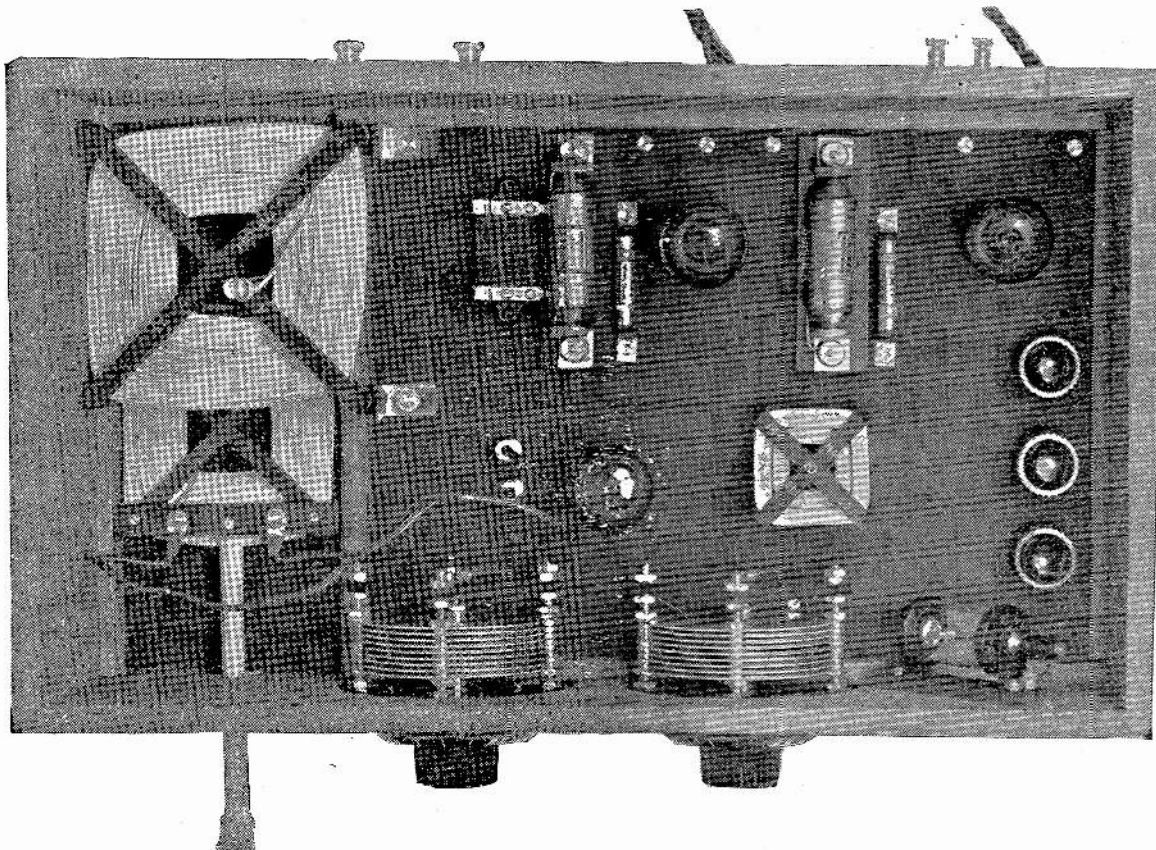

A plan view in which the disposition of the components may be clearly seen.

actual reaction coil is completed. A ledge of wood $\frac{1}{8}$ in. by $\frac{1}{2}$ in. is tacked all round the inside to support the panel. Its position should be arranged so that the surface of the panel is $4\frac{1}{4}$ in. down from the top of the case. (Fig. 2.)

Terminal Strips

Now take the small ebonite panel and cut it into four strips each 1 in. wide. One of these is for the terminals for aerial and earth. If desired, a third terminal can be put on this strip and connected to the grid side of the small C.A.T. condenser to give alternative parallel tuning. The writer, however, finds C.A.T. quite satisfactory on wavelengths up to 5XX, and so the alternative is not fitted to the receiver illustrated. The second strip is for the mounting of the Burndy crystal detector, which is screwed to the inside of the front of the case in the position shown dotted in Fig. 3. The third strip is sawn across to make two pieces 2 in. by 1 in. One carries the two terminals provided for grid bias,

while the other has two valve sockets mounted on it for the loud-speaker leads to plug in to. This last is screwed on inside the case, and the sockets project through two clearance holes drilled in the side of the case. Ordinary 'phone terminals may, of course, be used here, but they are not nearly so handy as the sockets. The experimenter will save himself much time by soldering valve pins to all his 'phone and loud-speaker leads and using valve sockets on his instruments in place of 'phone terminals. The grid bias terminals may be put on the back or right-hand side of the case, whichever best suits the constructor's wireless table.

Marking Out the Panel

The panel can be marked out for drilling from the measurements in Fig. 2. Many sets are marred by valve holders that only admit their valves after severe manipulation. This can be avoided by the use of a template, a $\frac{5}{32}$ in. drill being used. Although in most anti-capacity holders the

fixing screw is intended to be exactly midway between the grid and plate legs the writer finds that some of them vary somewhat, and it is better to push an old valve into the panel and press the holder over its projecting legs below the panel. The fixing screw should first be removed. With the holder pressed against the panel a needle point is passed through the screw hole and a tiny circle scratched on the ebonite. A mark can then be made at the centre of the little circle with the centre punch and a $\frac{1}{8}$ in. hole drilled through. The five holes should all be well counter-sunk on the face of the panel. If a little care is taken in the marking out and the drill is held vertical the constructor will find that his valves and transformers slide in or out without the usual argument.

Points to Note

The Microstats require a single hole $\frac{3}{8}$ in. diameter. The anode resistances form their own templates but must be kept $\frac{3}{8}$ in. away

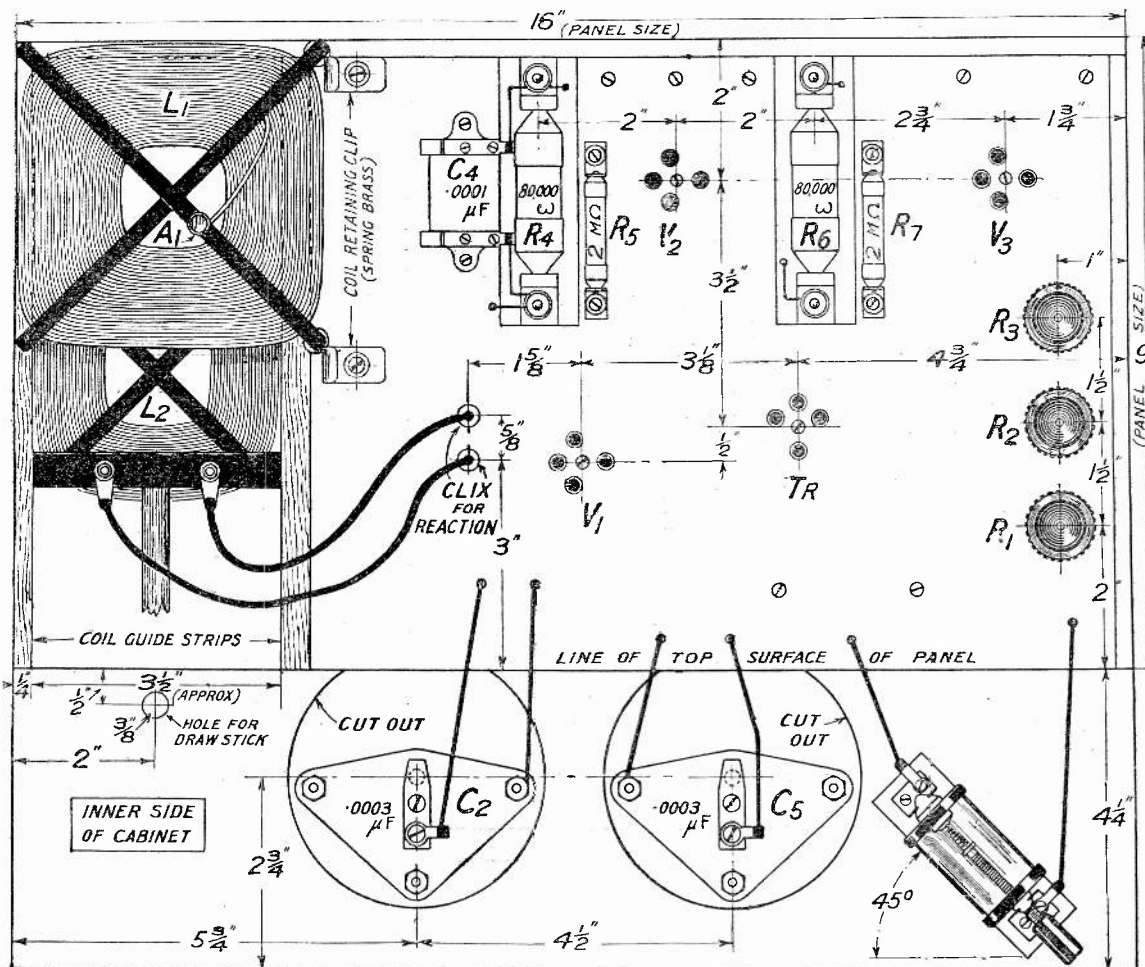

Fig. 2.—This dimensioned drawing may be used for marking out the panel. (Blue Print No. 91a.)

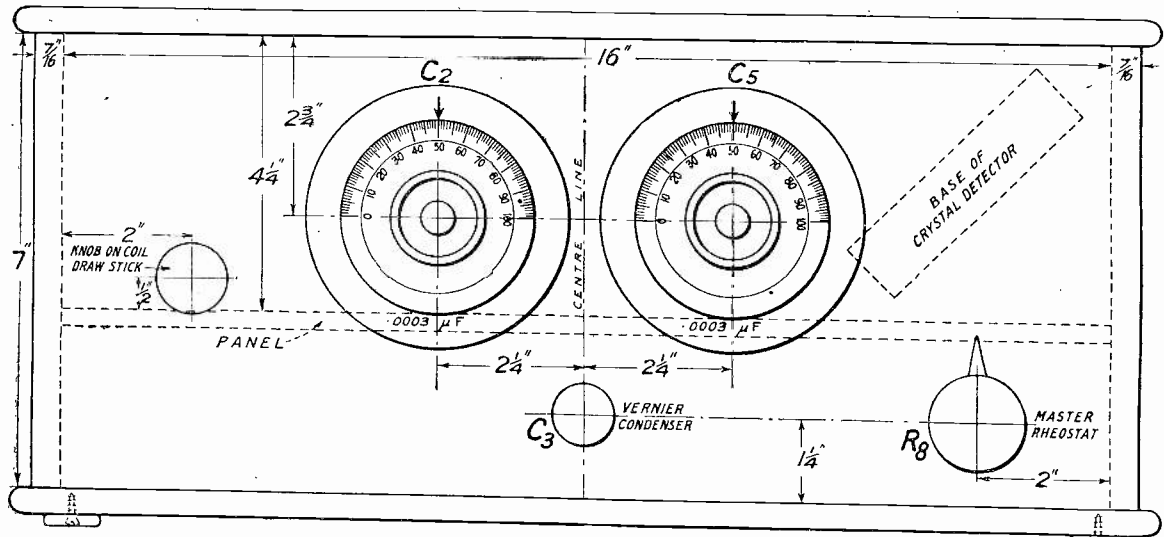

Fig. 3.—A front elevation of the receiver, giving the various measurements necessary.

from the back edge of the panel to allow room for the teak strip which holds the panel in place in the case. The clips for the two grid leaks are mounted directly on the panel, as shown in Fig. 2. A strip of teak $\frac{3}{8}$ in. wide, $\frac{1}{8}$ in. high and 9 in. long is fixed to the left of the panel by small screws from below. This forms a guide for

slips of teak at the back and at both sides. That on the left forms a ledge for the aerial coil, so it should be the same height as the strip already screwed to the panel ($\frac{1}{8}$ in.). The condensers should now be replaced.

Wiring the Instrument

A certain sequence should be followed in wiring. The low and high tension portion is first put in with No. 16 tinned copper protected by sleeving. Omit the wire joining the first valve to its Microstat for the present. It will be noted that the wire from the L.T. minus terminal runs straight through to one side of the .0003 μ F fixed condenser, and on its way it receives branches from the grid bias plus, the catwhisker, and the Igranic rheostat. Note the four $\frac{3}{32}$ in. holes through the panel for the wiring from the two anode resistances on the face of the panel, and also that the .0001 μ F fixed condenser is connected across the left-hand resistance. When this wiring is complete put in the H.F. portion with square wire, taking care that all the soldering is thoroughly sound. The two Mansbridge type condensers can now be fixed to the side of the case as shown in the photographs, and their attendant connections to the last two valves, the resistances and grid leaks, completed. Then put in the

wiring that passes through the four $\frac{3}{32}$ in. holes in the panel to the main condensers and also to the crystal. These wires should be protected by sleeving above the panel. Lastly, connect the first valve to its Microstat, keeping this wire well away from the H.F. wiring which it crosses and put in

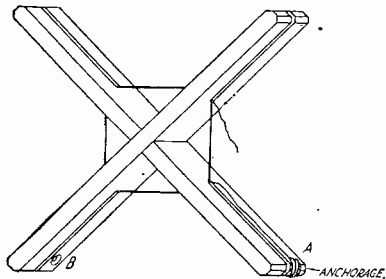

Fig. 4.—How to commence winding the coil.

the reaction coil and a support for the aerial coil. It appears in section in Fig. 9. The two contact springs for the aerial coil appear in Fig. 10. They are made from stout springy brass or phosphor bronze, and the angle is best formed by bending them over a rod held in the vice, as this material is apt to crack if bent over a sharp edge. They are fixed to the panel by 4 B.A. screws with nuts and washers, and they must be placed so that their contact faces are $4\frac{3}{8}$ in. away from the left-hand edge of the panel. When all the components are mounted the panel is ready to go into its place in the case. It is held in place by

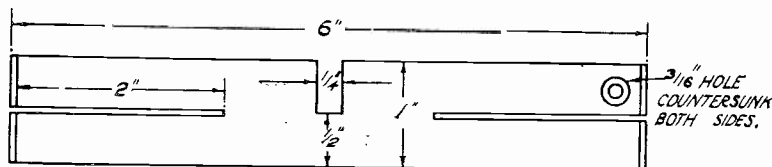

Fig. 5.—The dimensions for making the coil formers are given here.

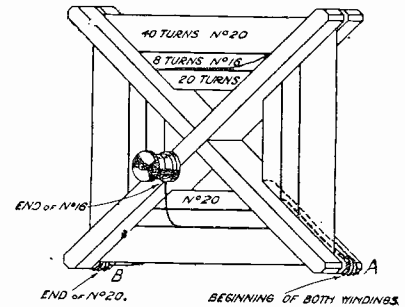
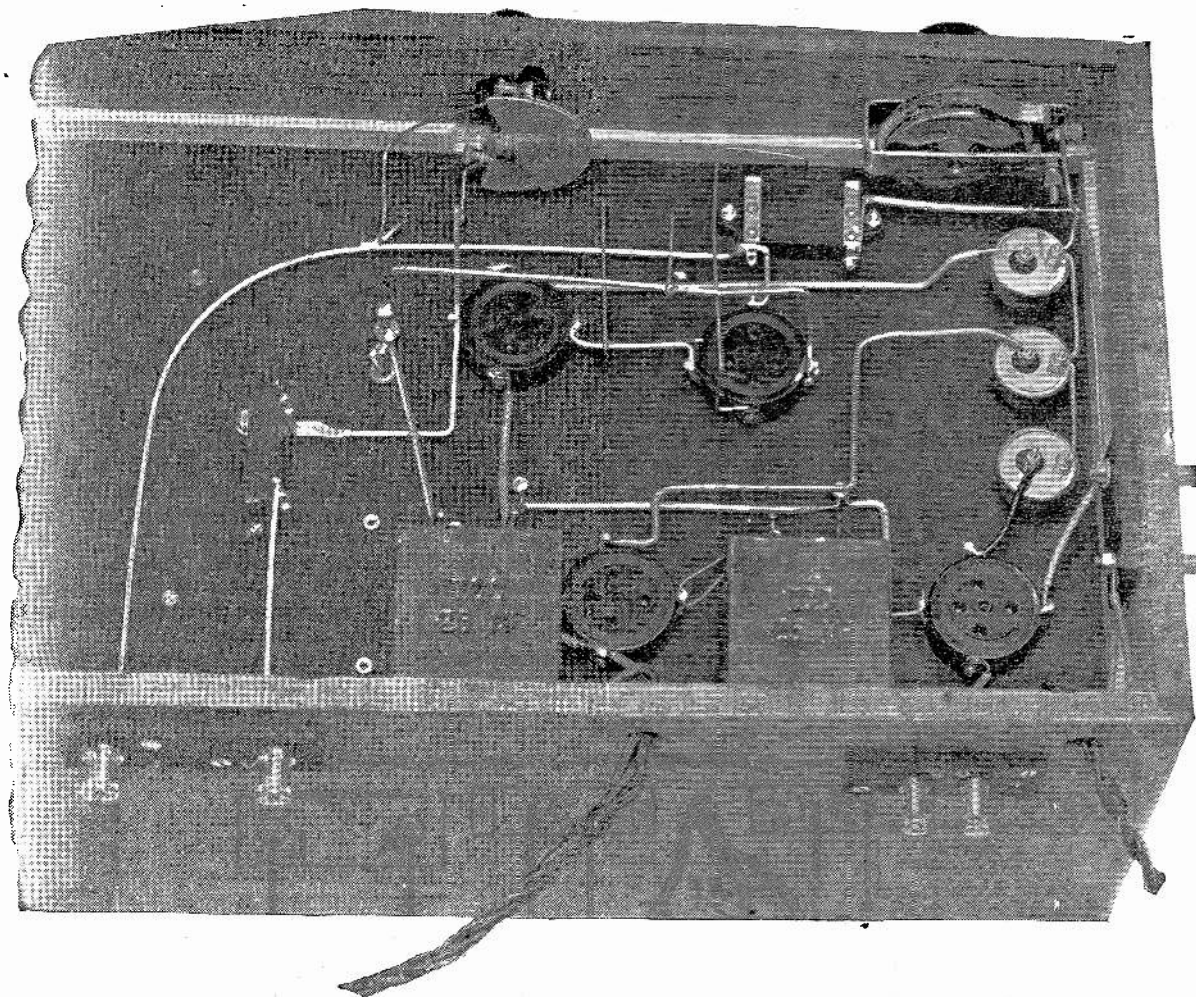

Fig. 6.—The "aerial tap" coil.

the square wire from the aerial-terminal to the C.A.T. condenser. The square wire will hold the latter in place without any other fixing.

Battery Connection

In place of the usual battery terminals this receiver is fitted with permanent battery cords. The low-tension cord is of very thick flex with spade tags at each end. These are clamped under the nuts on the 4 B.A. screws on the panel as shown, and pass out through a $\frac{1}{8}$ in. hole in the back of the case. They are clearly marked with bindings of red and blue silk for the plus and minus respec-



A view of the underside of the panel. Note the permanent battery leads.

tively. The H.T. cord is made by twisting three pieces of flex together, a spade tag being fitted to one end and a valve pin to the other end of each. The plus lead for the first valve is marked with one red binding, while that for the last two valves has two red bindings. These cords make wrong connections almost impossible, and are a great boon when one experiments with several different instruments.

Shunting Condenser

It will be noted that no shunting condenser is fitted across the H.T. battery leads in this receiver. The writer finds it advantageous to use separate H.T. batteries for all multi-valve sets with split H.T. supply. These are used for the medium and heavy duty on alternate days, and by this means their life is considerably prolonged. As they are used for a number of different receivers a large shunting condenser is permanently fitted to each battery instead of to each receiver. This subject has recently been fully explained by Mr. Percy W. Harris

in the issue of *Wireless Weekly* for December 31 last.

Coils

Details of the reaction coil appear in Fig 8. Two pieces of $\frac{1}{4}$ in. ebonite are cut to the dimensions given. Use two blades side by side in the hacksaw to cut the slots for the wire. Across the two lower corners a piece of fibre or ebonite is fixed by means of two C.B.A. countersunk screws. This piece of ebonite serves as a link for the push rod that controls the position of the reaction coil. The rod itself is a piece of $\frac{3}{8}$ in. "dowel rod," which can be bought at any ironmonger's. One end is slotted to admit the crosspiece B, and a wooden knob is fitted to the other outside the case. The hole in the case through which it passes should be an easy fit. The winding consists of 40 turns of No. 24 d.c.c. wire wound clockwise, as shown. The wander leads are of stout flex 9 in. long, with tags at one end and Clix plugs or valve pins at the other to plug into the

Clix sockets on the panel. A binding of sticky tape at each end helps the appearance. This coil is used for all telephony and gives good reaction over the whole band.

Figs. 4 and 5 show the construction of the aerial coil. Two strips of ebonite to the dimensions given are necessary for each coil. The slot should be wide enough to take No. 20 d.c.c. wire without any forcing. Note that the $\frac{3}{16}$ in. hole in the arm of the second strip should be on the opposite side of the slot to that of the first strip, so that when the two strips are fitted together both holes will be on the same side of the coil as at A and B. The holes are well countersunk on both sides, and the sharp corners at the end of each arm are filed off as shown.

Winding the Coils

To wind the coil, take a hank of No. 20 d.c.c. wire and bare the end for 9 in. by drawing it several times through a piece of folded glass-paper. Then, holding the ebonite X as in Fig. 4, pass

the end from right to left through the hole A, lead it round the end of the arm and pass it through the hole again. Draw the wire tight and repeat five times, keeping the turns neatly side by side. Now lead the wire from the hank up the arm A midway between the slot and the edge of the arm until it is bent round to enter the slot. Then wind on 45 turns clockwise as shown and finish at the arm B by anchoring it with five turns of bare wire through the hole B. These little turns should be scraped bright and tinned with a hot iron to give a wide clean contact with the contact springs when the coil is in place. This coil is for wavelengths up to 385 metres. For the stations above Bournemouth another coil should be wound with 55 turns of the No. 20 wire. Using C.A.T., the coil for 5XX should have 220 turns of No. 28 d.c.c. wire. The former for this coil can be made of dry wood, or even three-ply.

A Special Coil

An interesting "aerial tap" coil

can be made as follows (Fig. 6):— Cut the slots wide enough to take No. 16 d.c.c. wire. Begin the winding with No. 20 wire after anchoring as before at hole A. When twenty turns have been wound, anchor a length of No. 16 d.c.c. wire also in hole A and wind eight turns, also clockwise, on top of the wire already in the slot. Then cut the thick wire off with a few inches free and carry on with the No. 20 wire until a further 40 turns have been wound. Anchor at hole B as before. The free end of the thick wire is led to a terminal screwed into one of the arms near the centre of the coil. As all these coils are inserted in the receiver with the anchorages *downwards*, that at hole A will make contact with the spring at the back of the receiver which is taken to earth. The aerial, of course, should be connected to the terminal on the arm of the coil. With this coil a great deal of "mush" is eliminated and the tuning is exceedingly sharp. The first 30 deg. of the main condenser will cover the B.B.C. band,

and the small Colvern condenser will be appreciated. Reaction is used with this coil in the usual way, but greater care should be exercised, as the point of oscillation comes up rather suddenly.

Operation

Any good "general purpose" valve may be used, but it should be noted that the plate voltages specified by the makers regarding the use of grid bias are not usually intended to apply to resistance-coupled stages, and consequently the plate voltage specified for a particular valve should be increased by at least 30 per cent. to allow for the potential drop across the resistances. Using D.E.R. or B.T.H. B5 valves, the writer has not been able to detect appreciable improvement in quality or volume when using grid bias, though a meter would probably show a saving in plate current when the correct grid bias is employed.

When the instrument is completed a valve should be put into each holder in turn to make sure

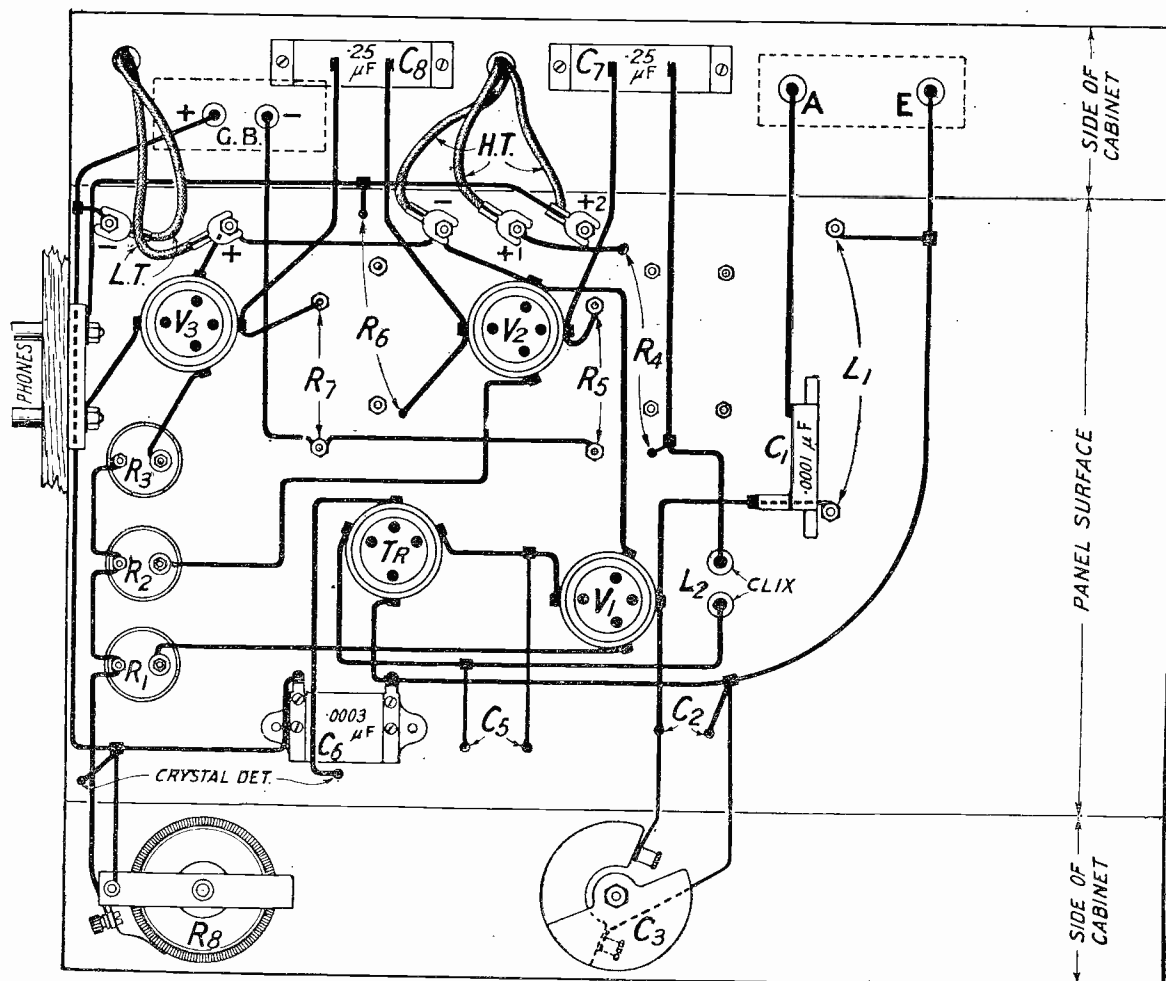

Fig. 7.—This diagram shows the wiring below the panel. (Blue Print No. 91b.)

that the low-tension side is working correctly. If .06 valves are used the Microstats should be turned very slowly, as their action is fairly rapid towards the "full on" position. For the first trial the grid bias terminals should be shorted with a piece of wire. The plate of the first valve may receive about 80 volts (the cord with one red binding), while 100 volts or even more may be used on the last two valves (cord with two red bindings). See that the contact springs press strongly against the coil anchorages and put a suitable H.F. transformer into the transformer holder. See that the catwhisker touches the crystal lightly.

Tuning In

Having drawn the reaction coil fully out, connect the aerial, earth and loud-speaker, and move the tuning condensers slowly until the local station is tuned in. These movements must be very slow, as there is a certain lag in the tuning of this circuit. The crystal can now be properly adjusted, and as it is possible to work with a good firm pressure, one setting will generally stay good for some weeks. If you have not worked with this circuit before, you will probably be amazed at the great volume of pure, undistorted sound coming from the loud-speaker.

Reaction

The reaction coil may now be pushed in gradually, care, of course, being taken to stop short of the point of oscillation, and the con-

denser dials turned back slightly to compensate for the coupling. It will be found that the oscillation point occurs much earlier when the aerial condenser is towards the zero end of its scale, but as the reading is increased for the longer waves the coil can be pushed in much more before the set oscillates. This is normal to most receivers, but when using the "aerial tap" coil the opposite effect may be observed and the coil may have to be pulled out as the condenser reading is increased. If no reaction effects are observed, the wander leads in the Clix sockets should be reversed. When using very small aeri- als it may be necessary to reverse the reaction leads to prevent the instrument oscillating even with the coil pulled out as far as possible.

Although a good aerial earth system is essential for long-range work, the local station or 5XX can be received really well on the loud-speaker with very little in the way of an aerial.

Excellent Reception

The writer receives Bournemouth at 38 miles very well indeed with a short length of flex hung up to a hook on the ceiling, and speech is audible anywhere in the room with no aerial at all. This, of course, requires critical reaction. The wiring as shown is suitable for Bowyer-Lowe, McMichael, Peto - Scott, and similar type H.F. transformers, but the writer has found that a considerable increase in volume and still greater in selectivity will be gained by using one of the home-made transformers described in *Wireless Weekly* for

December 10 and 17 last. The loud reception of Rome, etc., already mentioned, is obtained when using one of these transformers and the "aerial tap" coil.

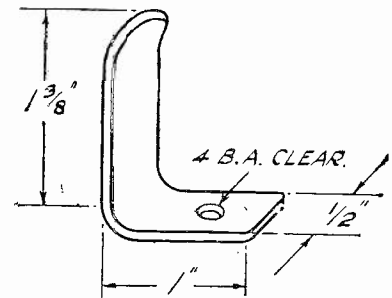

Fig. 10.—Dimensions of the contact strips for the aerial coil.

A Long-Distance Single-Valve Receiver.

SIR,—I recently made the single-valve set described by John W. Barber in your December issue of MODERN WIRELESS. Using series aerial tuning condenser, I picked up eight B.B.C. stations, my local station (5WA, 10 miles) audible all over the room in the 'phones. The receiver is wonderfully selective, being able to cut 5WA right out and getting 2LO and 2ZY at fairly good 'phone strength. The two Paris stations were also tuned in, Petit Parisien on 340 metres being very good indeed. The ease of tuning is a distinctive feature of the set. Accept my congratulations on the production of a 1-valve receiver, which I find is equal to many 2-valve circuits I have built before. Wishing you and your paper every success.—Yours truly, R. E. DAVIES. Treforest, near Pontypridd.

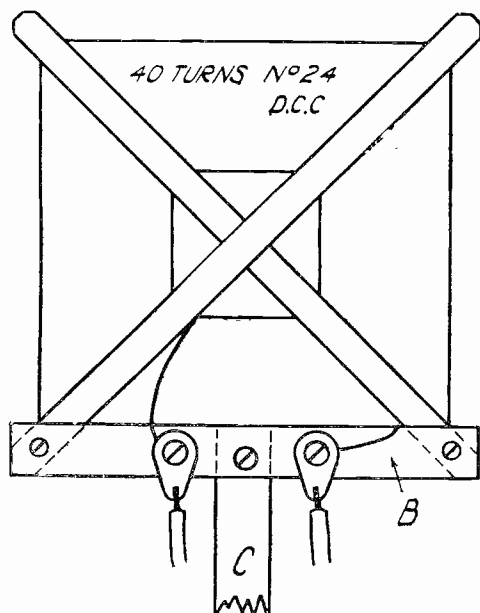

Fig. 8.—Constructional details of the reaction coil.

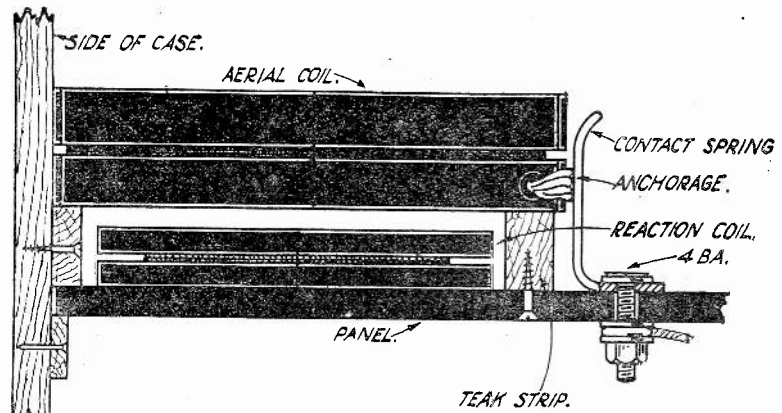
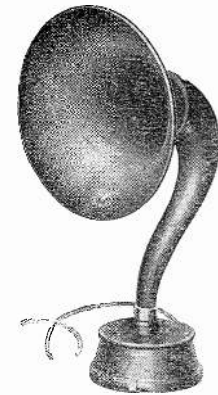

Fig. 9.—A sectional view showing the aerial coil in position above the reaction coil.

The Law in Regard to Loud-Speakers

By F. E. SUGDEN, A.C.I.S., F.R.Econ.Soc., Barrister-at-Law.

Written by an authority on the subject, this article can be taken as a guide on what definite action should be taken in cases where complaints of loud-speaker nuisance have been lodged.



RECENTLY listeners-in have been enjoying the British Broadcasting Company's successful efforts to broadcast the voices of the animals at the Zoo, which, though very interesting, were not very musical, and consequently some of our jealous neighbours who do not and will not participate in such pleasures take the first opportunity of making complaints in regard to the wireless enthusiasts, particularly those who are the happy possessors of loud-speakers and valve sets.

Nuisance

These troublesome neighbours make the complaint that a nuisance has been committed by such persons who possess loud-speakers. The law in regard to nuisance is very wide and care should therefore

be exercised to keep oneself strictly within certain limits.

Individual cases might with advantage be taken on their merits. If a loud-speaker is placed in such a position either inside or outside the premises, even with the best of intention of its owner, and as a consequence attracts a crowd of noisy and disorderly people close to one's dwelling-house because of its musical strains, such action would be legally deemed to be a nuisance, and the Court would prevent a continuance by granting an injunction restraining the owner of the loud-speaker from giving such innocent pleasure to pedestrians. This fact was laid down in the case of *Walker v. Brewster*, L.R 5 Eq. 25.

The question naturally flashes across one's mind what is a nuisance in this respect. The law defines it as an inconvenient or troublesome offence which annoys the community in general or a few individuals.

Attracting a Crowd

Vendors of wireless instruments and parts must exercise care when

a loud-speaker is fixed either just outside a shop or in such a position inside that, when in operation for advertisement purposes, large crowds are attracted, the crowd thus creating a nuisance. In the case of *Rex v. Lewis*, 72 L.T.N. 117, crowds gathered round a shop which exhibited attractive objects and the Court decided there was a nuisance because an obstruction was created on the highway.

Another Case

Regarding this alleged offence there is fortunately a limit to the right of the obnoxious complainant. If there are strains of music from a dwelling-house through the medium of a loud-speaker the theory of nuisance is fortunately more difficult to prove. In April last there was a case in the Courts (*Wyatt v. Marriatt*), where an action was brought against a professor of the violoncello because the professor was deemed to be an annoyance or a nuisance to such an extent as to interfere with the occupiers or tenants of other parts of the building, that is, he is alleged to have interfered with the quiet



The use of a loud-speaker of this size outside a dwelling-house might at times constitute an offence. It is, of course, designed for use at large gatherings where great volume is required.

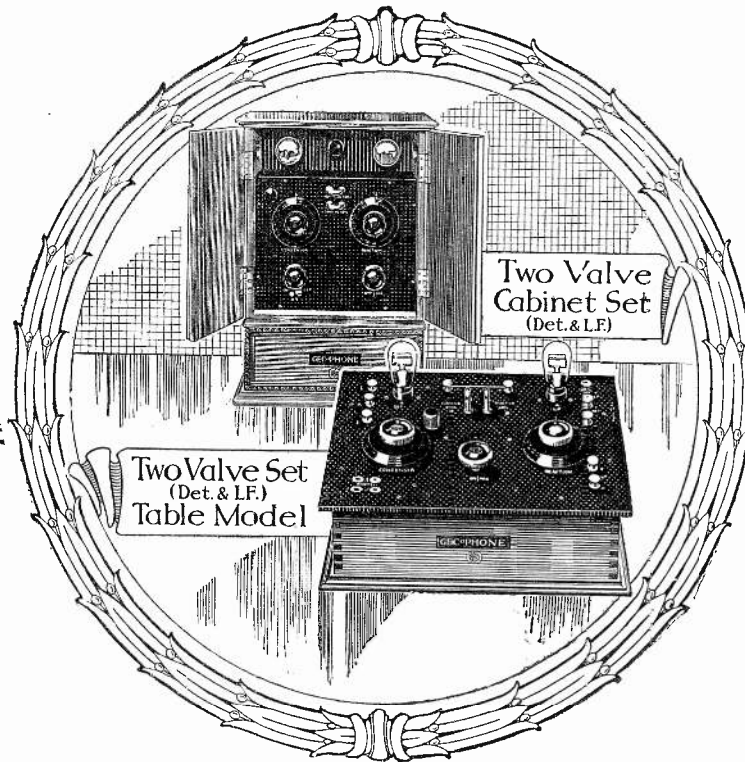

For Service & Satisfaction

GECOPHONE

(REGISTERED TRADE MARK)

NEW MODELS

The GECOPHONE Two-Valve Set (DET and L.F.) is supplied in cabinet or table models, and the purchaser has the choice of either D.E.R. or D.E. 3 Type Valves. The use of D.E. 3 Valves enables a dry battery to be employed instead of the usual accumulator—particularly useful for those living in districts where accumulator charging facilities do not exist. **THE SET WILL OPERATE A LOUD-SPEAKER DIRECT AT 12-15 MILES** from a main Broadcasting Station, whilst with Headphones telephony can be received at 100-150 miles. The wavelength of the set is 300-500 metres, whilst loading coils can be added for Chelmsford or higher wavelengths. Operation is simplicity itself. Connections are made simply by pushing plugs into sockets.

TABLE MODEL.		£	s.	d.
Cat. No. B.C. 3250, Set only with D.E.R. Valves	9	12	0
Cat. No. B.C. 3251, Set, but with all necessary batteries, headphones, etc.	..	13	0	0
Cat. No. B.C. 3255, Set only with D.E. 3 Valves	..	11	1	0
Cat. No. B.C. 3256, Set, but with all necessary batteries, headphones, etc.	..	13	10	0
CABINET MODEL.		£	s.	d.
Cat. No. B.C. 3200, Set with D.E.R. Valves and all necessary batteries, headphones, etc.	18	10	0
Cat. No. B.C. 3205, Set, but with D.E. 3 Valves	..	19	0	0

Ask your dealer to demonstrate these models to you.

GECOPHONE Sets are sold by GECOPHONE SERVICE DEPOTS, Electrical Dealers, Stores, etc.

Ask for price list (No. B.C. 3425).

Advertisement of The General Electric Co., Ltd. (Manufacturers and Wholesale only), Magnet House, Kingsway, W.C. 2.

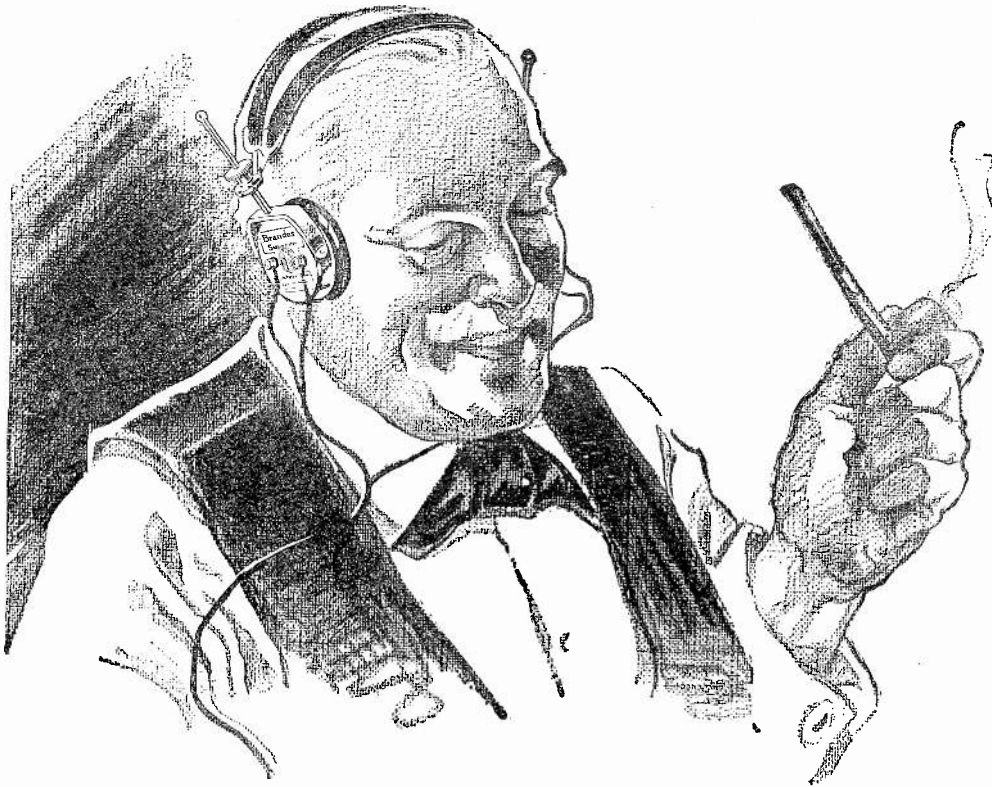

All Brandes products carry our official money-back guarantee, enabling you to return them within 10 days if dissatisfied. This really means a free trial.

Matched Tone means a technical improvement in telephone construction which should at once grip your attention. If you are intent on better broadcast reception, if you wish to gather the more distant signals with increased strength and clarity, then Brandes Superior *Matched Tone* Headphones are certainly what you want. Matched by ear, the two receivers of ordinary headphones cannot gain an exactly similar degree in tone and volume by a margin of eighty degrees. Brandes, matched by special apparatus, obtain corresponding sensitivity and volume in each receiver to within five degrees and a consequent increase of tone, purity, accuracy and strength. For just home stations or transatlantic and trans-continental telephony, get Brandes *Matched Tone* Headphones. Ask your Dealer for Brandes.

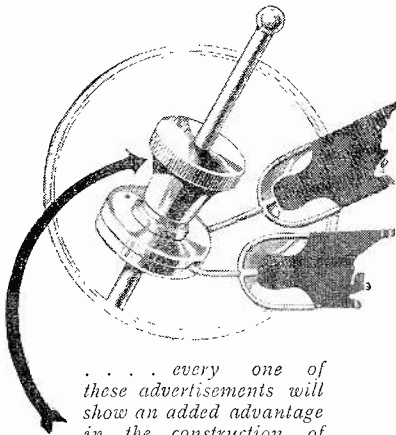

... every one of these advertisements will show an added advantage in the construction of Brandes Headphones.

The lock-nut on the receiver yoke is a clutch that tightens and holds the receivers firmly in place when satisfactory adjustment has been obtained. This point prevents the receivers from slipping, keeps the headphones in correct balance without possibility of working askew and makes the headband follow the natural line of the head. The whole family can wear the headphones with comfort

British Manufacture.
(B.B.C. Stamped).

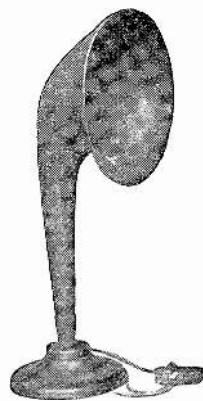

The *Table-Talker* is another Brandes quality product at moderate price. Its full round tones are wonderfully clear and pleasing. It is matched to the unit so that the air resistance produced will exactly balance the mechanical power of the diaphragm. This means beautiful sound-balance. Gracefully simple of line, it is finished a shade of neutral brown and is twenty-one inches high.

42/-

Brandes

The Name to know in Radio

Superior Matched Tone Headphones



THE . SAME . SOUND . IN . BOTH . EARS

and peaceful possession of the neighbours. The complaint was that the Professor practised the violoncello all day and also had pupils, and thus caused a nuisance. The complainant stated that he had requested the Professor to abate the alleged nuisance. The complainant also stated that as a result of the noise his health had been impaired; no mention was made of the condition of his temper. The learned Judge contended that there had been no breach for quiet enjoyment even though it was alleged that the Professor had played to excess, probably because he came to the conclusion that "music hath charms."

Street Organs

Apart from creating an obstruction, a wireless enthusiast would be wise to exercise discretion in operating a loud-speaker outside his premises. One can quite appreciate the alleged annoyance of the street organ, for, in the case of *Shields v. Howard*, 1897, 1 Q.B. 84, any householder within the Metropolitan Police District may personally, or by a servant or constable, require any street musician or singer to leave the neighbourhood of his house on account of illness of any inmate or of the interruption of the ordinary occupation of the inmate or any other reasonable cause. In fact, such an offender may be given into custody for three days or fined 40s. One can quite appreciate such an action being taken when the "organ grinder" plays "Home, Sweet Home," about seventeen times.

Bye-Laws

As the so-called evil of the loud-speaker is of modern origin, fortunately there are very few Urban District or Borough Councils that have yet made any bye-laws restricting its use.

In connection with the Leeds Corporation, under power granted to them by the Corporation Act, 1882, which figured so prominently a few weeks ago, also at Leeds, when an attempt was made to disqualify a City Alderman in reference to contracts with companies in which he was a director (*Lapush v. Braithwaite*). The bye-law made by the Leeds Corporation provided that no person should, to the annoyance or disturbance of residents or passengers, play organs unless it was at a lawful fair. This bye-law was tested by the case of *Teale v. Harris*, 60 J.P. 744.

An Injunction

The point arises, if an alleged nuisance has been going on continuously for some considerable time, would this fact make it perfectly legal for its continuance? Such is not the case, for it was decided in the case of *Rex v. Cross*, 3 Camp. 224, no length of time will legalise a public nuisance.

Suppose a nuisance has actually been committed by the use of a loud-speaker, the question is often asked what action can the offended party take and how may the owner of a loud-speaker protect himself. The complainant may apply to the Court for an injunction to prevent the wireless enthusiast using the loud-speaker any longer in the manner which is supposed to create a nuisance, and also the defendant will be compelled by the Court to pay the cost of the Court for the proceedings.

Preventing Proceedings

To prevent any proceedings being taken the loud-speaker owner should immediately cease to use the loud-speaker contrary to the wishes of the troublesome neighbour before the case comes before the Court, for in so doing the

complainant's act is thwarted on the eve of his sought-for victory. There is an example of such a procedure being undertaken in the case of *Barber v. Penley* (1893), 2 Ch. 447.

A Technical Offence

Finally, the greatest difficulty that will be experienced by the owner of the loud-speaker will be to prevent an obstruction. In fact, all street hawkers, the holders of outside political meetings, and theatre proprietors, are constantly on their guard in this respect, because however careful one might be, a technical offence in this way might easily be committed. There is an illustration of such an offence in the case of *Lyons v. Gulliver* (1914), 1 Ch. 631. On this occasion the manager and proprietors of a theatre were held liable for obstructing the plaintiffs' premises by reason of the assembling of a large crowd or queue in the street previously to opening the theatre.

Little fear need be entertained if a loud speaker is used indoors, not even when the B.B.C. broadcast the lion's roar, for even then one feels sure it will not be so loud as the roar of a quarrelsome neighbour.

The "Old Folks" Receiver

SIR,—Some results obtained on the above receiver may be of interest to you. The set, as I constructed it, as a Christmas present to the "Old Folks," is not quite the same in arrangement or components recommended—for instance, it had to fit a ready-made cabinet.

I installed the set at a point near Winchester, approximately 40 miles from Bournemouth, 60 from London and 90 from Chelmsford. Single aerial, 30 ft. high, shielded by trees on the north side. Chelmsford, direct coupled tuning, is too powerful for Junior loud-speaker and must be detuned.

Bournemouth and London do not interfere with each other in the very least, and both give very loud signals in speaker. Radio-Paris could be heard clearly 20 yards away. Madrid, 7 metres different from Bournemouth, could be tuned in at nice L.S. strength without interference from Bournemouth, although morse caused a curious distortion effect.

The following stations were also

tuned in, using the loud-speaker only without the aid of headphones:—Petit Parisien, Belfast, Cardiff, Ecole Supérieure, 3 German stations, Newcastle, Edinburgh, Birmingham and Aberdeen, all the above during one evening.

At 1 a.m. on January 1st, after trying for about 30 seconds, I tuned in an American station (with headphones, of course) and listened to an orchestra playing the Semiramide Overture until the announcer gave out that the Westinghouse station WBZ was closing, at about 1.20 a.m. The call sign I was not quite certain of, as it was not the one I was expecting. I also obtained for a few moments another station I could not identify.

Ease of operation—my mother, who had probably never seen a wireless set at close quarters, after an hour's instruction, had no difficulty in tuning in Belfast and Cardiff when the Bournemouth station was not giving an interesting item.—Yours truly,

C. B. E.

Wonston, Hants.

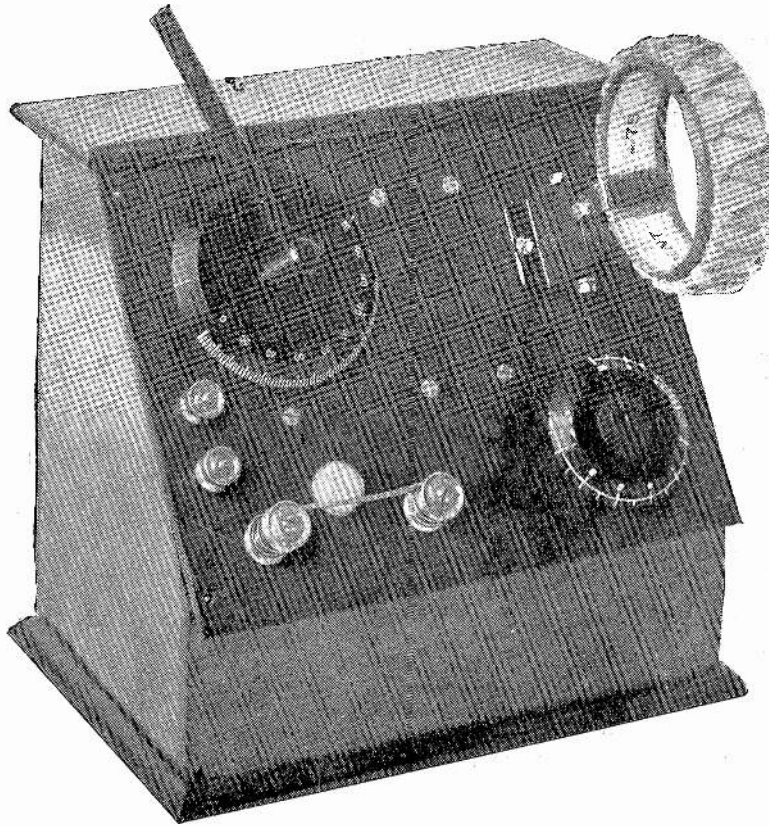

The "Super" Unit, with the short wave inductance in place and the telephone terminals short-circuited.

A METHOD of high-frequency amplification which appears to have decided possibilities is that of coupling a stable type of single-valve super-regenerative receiver extremely loosely to an oscillating circuit, itself coupled in turn in some way to an outside aerial of normal dimensions. The coupling has to be *extremely* loose; this is necessary not only because tight coupling here will effectively stop the super-regenerative action altogether, but because it is quite needless in order to hand over enough signal energy to give good reception on the "super." Excessively flat tuning also results with tighter coupling—and the tuning of a super circuit is flat enough already, from the nature of its mode of action.

"Super" Circuits

Something of this kind was apparently attempted in certain alleged versions of the Flewelling grid leak howl type of super circuit, where light coupling to an outside aerial was given by a small series condenser above the tapped A.T.I. Apart from any particular arrangements of blocking condensers and

variable grid leaks, etc., it is evident to any observant experimenter that with such an arrangement, and with an oversize reaction coil (particularly with a tuned reaction coil) very tightly coupled to the A.T.I., with ample H.T. and a valve of liberal emission it will sometimes be possible to get a typical grid leak howl, and the super-regenerative action which

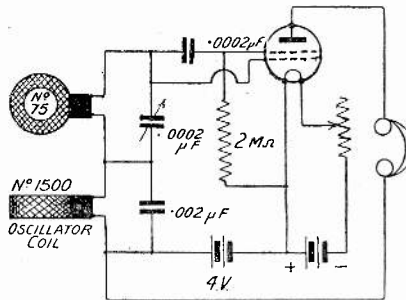

Fig. 1.—The circuit diagram.

accompanies this phenomenon. Of course, as usually described and figured, what is obtained is simply ordinary critical reaction or "homodyne" reception, the coupling to the aerial entirely excluding any genuine super-regenerative action.

The writer has shown recently

An Auxiliary "Super" Unit

By
A. D. COWPER, M.Sc.,
Staff Editor.

A remarkable little set, which, without direct connection will considerably increase the range of your crystal receiver.

(*Wireless Weekly*, Vol. 5, No. 10), how in a specialised and highly-complex receiver developed for a particular purpose, excellent results could be obtained in long-distance reception by proper application of this principle. There a very selective single-valve receiver, with critically controlled reaction, collected, as it were, the required signal on its high aerial, and brought it in to a local tuned circuit, to which was coupled very lightly the tuning inductance of a stable four-electrode valve version of the single-valve Armstrong super-regenerative circuit. The coupling had to be so slight that the tuning inductances were actually arranged at right angles and some inches apart. In this receiver the signals were still further amplified at audio-frequency by a two-stage amplifier connected via a filter circuit (to remove the quenching whistle of the super) to the super-regenerative receiver. This complex arrangement is hardly practicable, of course, for ordinary everyday use; and the critical adjustment, with the many possibilities of interaction between the various circuits, multiple heterodyne and re-heterodyne effects, etc., render it unsuitable for other than fairly experienced hands.

Inherent Stability

With a crystal receiver, however, it is quite a different matter. The heavy damping given by the crystal and the absence of any reaction effects imply such a degree of inherent stability that it becomes an easy matter to utilise this method of high-frequency amplification without introducing complex apparatus or many critical adjustments; provided that a really

LISSENIUM

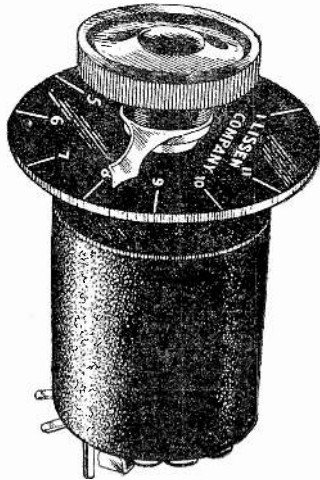

LISSEN REACTANCE
 150-10,000 metres **19/6**
Lissen One-Hole Fixing, of course.

The H.F. Unit to use in T.A.T. circuit

YOUR first stage of H.F. in the T.A.T. Circuit should be the LISSEN REACTANCE (patent). With its Reactance and Capacity values on each tapping point arranged to give just that degree of damping which keeps the set stable without any sacrifice of efficiency, with its windings and whole design balanced, the degree of amplification obtained is surprisingly

high for H.F. work. The purity of reception—the convenience in use, for it covers an extremely wide wavelength range despite its compact form—its small area to react to stray capacities—with its internally connected switch making it easy to cover each wavelength band quickly—it is highly recommended for this circuit.

The receiver fitted with LISSEN REACTANCE will pick up distant signals, and build them up, passing them powerfully on to the next valve. Simplicity itself to fit, connect and use. It will make your T.A.T. receiver powerful.

It is self-tuned, but a separate condenser may be fitted if desired (preferably use the LISSEN VERNIER, price 12/6, specially designed for fine tuning in H.F. circuits).

Use the right coils for the T.A.T.

For sharpness of tuning, for strength of signals, LISSENAGON (pronounced LISSEN-AGON) coils are unrivalled. Comparative tests by

thousands of users have proved their superiority. These are the coils to use for your tuned stage in the T.A.T.

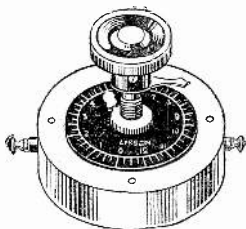

Your tuning condenser

The LISSEN Mark 2 Mica Variable Condenser gives you every change of capacity needed to work on short and long wavelengths. Makes tuning delightfully easy—with LISSENAGON Coils and this condenser you will have the best tuning combination it is possible to get.

LISSEN ONE-HOLE FIXING negligible minimum, .001 maximum—table or panel mounting without alteration. Price - **17/6**

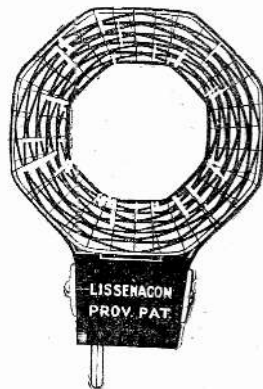

LISSENAGON TUNING CHART.

Note the Intermediate coils, 30, 40 and 60.

No. of Coil.	TABLE I. Wave-length range when used as Primary Coils with Standard P.M.G. Aerial and .001 mfd. condenser in parallel.		TABLE II. Wave-length range when used as Secondary Coils with .001 mfd. condenser in parallel.		PRICE.
	Minimum Wave-length.	Maximum Wave-length.	Minimum Wave-length.	Maximum Wave-length.	
25	185	350	100	325	4/10
30	235	440	130	425	4/10
35	285	530	160	490	4/13.
40	360	675	200	635	4/10
50	480	850	250	800	5/-
60	500	950	295	900	5/4
75	600	1,300	360	1,100	5/4
100	820	1,700	500	1,550	6/6
150	965	2,300	700	2,150	7/7
200	1,885	3,200	925	3,000	8/5
250	2,300	3,800	1,100	3,600	8/9
300	2,500	4,600	1,400	4,300	9/2

DONT MIX YOUR PARTS—there is a LISSEN Part for every vital place.

LISSEN LIMITED,

20-24, Woodger Rd., Goldhawk Rd., London, W.12.

Telephones : Riverside 3380, 3381, 3382, 1972.

BUILD WITH THE RIGHT PARTS.

Names famous in combination.
No. 1—Gilbert and Sullivan.

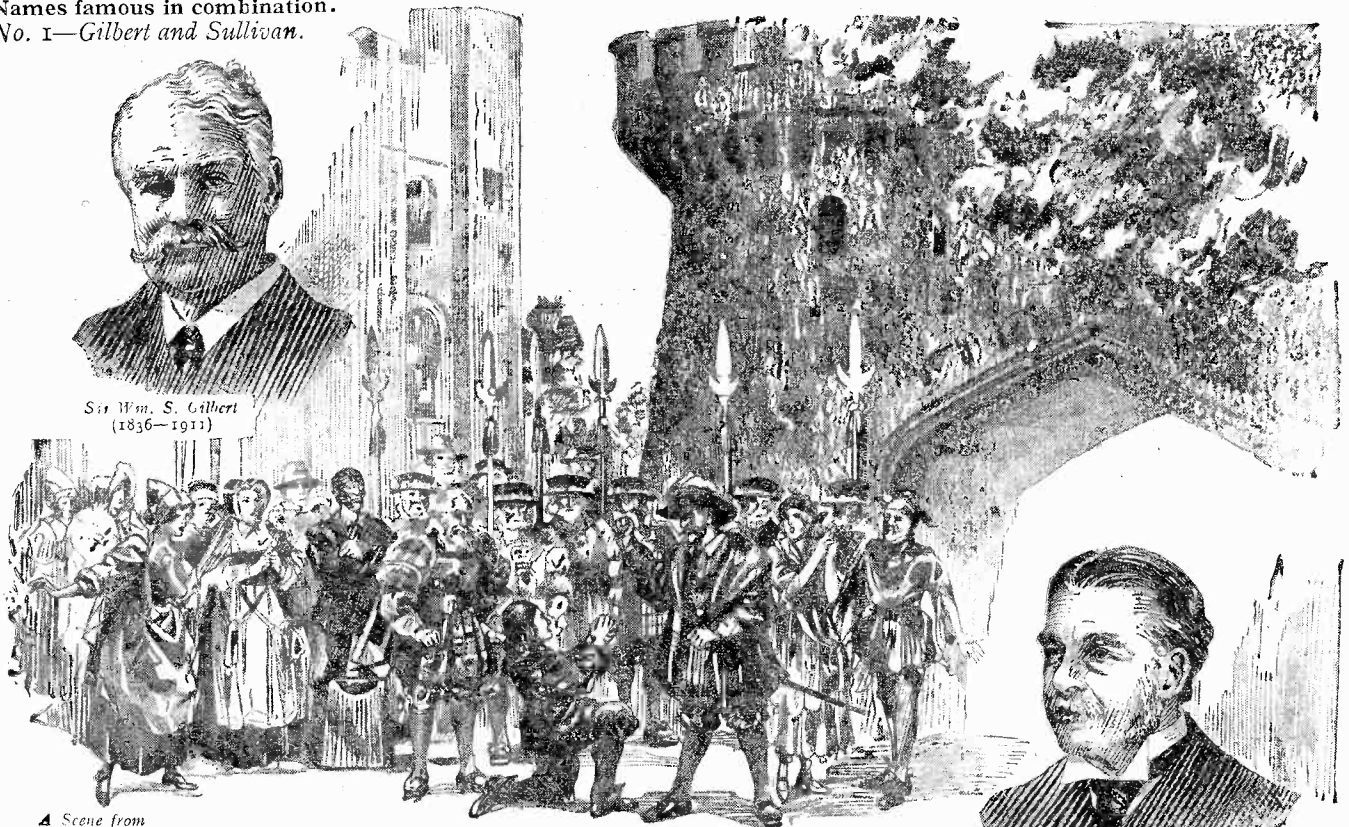

A Scene from
"The Yeoman of the Guard"

Sir Arthur S. Sullivan
(1842-1900)

COLLABORATION

THE joint work of Gilbert and Sullivan is one of the most notable instances of successful collaboration. Each won fame individually, but it is in combination that their names are most recalled.

Another outstanding example of successful collaboration is that of the two famous organisations, MARCONI and OSRAM.

These names on a wireless valve are your assurance of perfect design and efficiency in performance.

Read the 40-page wireless book *The Book of MOV*. Free from your dealer, or The M.O. Valve Co., Ltd., Hammersmith, London, W.6.

HOW TO ORDER YOUR VALVES.

For 2-volt Accumulators.		
Purpose.	Type.	Price.
†G.P.	D.E.R.	21/-
†L.S.	D.E.6.	25/-
For 4-volt Accumulators.		
G.P.	R.	12/6
G.P.	*D.E.3.	25/-
L.S.	D.E.4.	30/-
For 6-volt Accumulators.		
G.P.	R.5.V.	12/6
L.S.	D.E.5.	35/-
L.S.	.D.E.5b.	35/-
L.S.	L.S.5.	55/-

†G.P. = General Purpose.
†L.S. = Specially suitable for low frequency amplification for Loud Speakers.
*Can be used with Dry Batteries.
.For Resistance - capacity Amplification.

MARCONI VALVES

MADE AT THE OSRAM LAMP WORKS

Sold by Wireless & Electrical Dealers, Stores etc.

ANNOUNCEMENT OF THE M.O. VALVE CO. LTD.

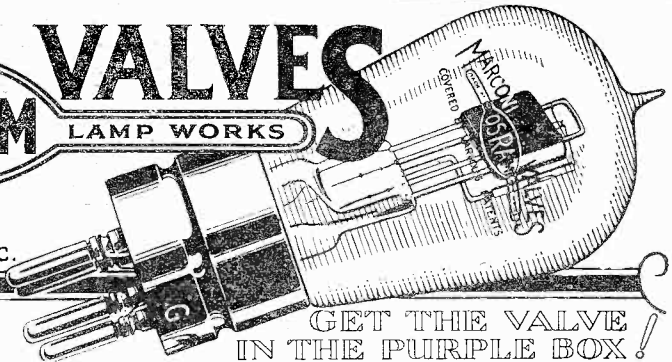

GET THE VALVE
IN THE PURPLE BOX!

simple and stable super-regenerative unit be available.

It is not necessary, in most cases, to provide further amplification beyond the H.F. amplification attained; and by listening on the crystal receiver itself, in place of on the super, the quenching whistle becomes scarcely noticeable even without the use of special filter circuits to eliminate it. The whole arrangement can then be

high-frequency oscillation in its own circuit before the quenching action operates in the usual way. This large oscillation will, via the loose magnetic coupling, again affect the crystal receiver, and give a greatly enhanced signal there. Unlike ordinary reaction taken to and beyond the point of self-oscillation, this checked action does not produce the familiar distortion of speech and music, and interference with neighbouring receivers is minimised.

A practical form of small cabinet-mounted H.F. amplifier of this kind, for use with ordinary existing crystal receivers and aerial arrangements, is described here. The circuit is the same as that indicated in the original article on the "Negadyne" receiver; the circuit diagram is reproduced here. It will be seen that a short-wave tuning inductance of the plug-in type is arranged in series

Dutch or Marconi-Osram D.E.7 four-electrode valve are connected to the top of the short-wave inductance, a grid condenser of usual size and a grid leak to the L.T. plus being provided on the outer grid. The outermost electrode, the "plate," is connected simply to the small H.T. battery plus; phones can be inserted in this circuit if desired, to observe directly if the action of this valve is correct. Only very small positive potentials are required on the inner grid and plate, four volts (one flash-lamp battery) generally sufficing.

The one critical adjustment is that of the filament temperature, which controls the relative power of the H.F. and quenching frequency oscillations. A really fine adjustment of the filament controlling resistance is imperative, particularly with the Marconi-Osram D.E.7 valve operating from a 2-volt accumulator. A good carbon compression type of resistance is indicated here. The .0002 μF tuning condenser should be fitted with an extension handle, though the tuning is not extremely critical.

General Arrangement

A practical arrangement is indicated in the figures, where all components are mounted on a small panel in a sloping front type of cabinet receiver; except the large No. 1,500 plug-in oscillator coil, which is mounted on an ordinary composition single coil-holder screwed to the floor at the back of the cabinet, and the battery. The single flash-lamp battery lies on the floor of the cabinet with flex connections, and terminals are

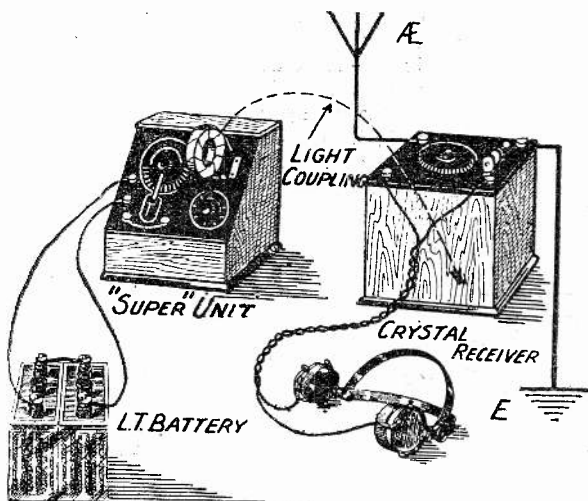

Fig. 2.—A pictorial diagram illustrating the method of coupling to a crystal receiver.

very greatly simplified, and it becomes a more practical proposition for general use. It is not suggested, however, that all critical adjustment is eliminated, or that the resulting circuit will give good results in the hands of those who habitually attempt to tune in, apparently, on the principle of the roulette wheel.

The "Negadyne"

In the "Negadyne" circuit, developed by the writer from the Dutch "negative resistance" four-electrode valve circuit, the "Numans Oscillator" (*Wireless Weekly*, Vol. 5, No. 12), we have the necessary simple and stable one-control type of circuit which will provide a practical super-regenerative unit for the purpose indicated, and which is also very easy to set up. Then with such a small self-contained super unit loosely coupled to the A.T.I. of an ordinary crystal receiver, the latter will become capable of receiving intelligible signals over an immensely increased range. For, relatively feeble signal impulses brought in by the aerial of the crystal receiver will suffice to energise the super-regenerative receiver, through the loose coupling between their tuning inductances; and the latter will build up a correspondingly large

with the usual large oscillator coil (a No. 1,500), the first being paralleled by its variable tuning condenser (which should not be larger than .0002 μF and should be of low minimum), and the latter having a fixed condenser of .002 μF across it, to give a very high audio-frequency quenching oscillation. Both grids of the ordinary

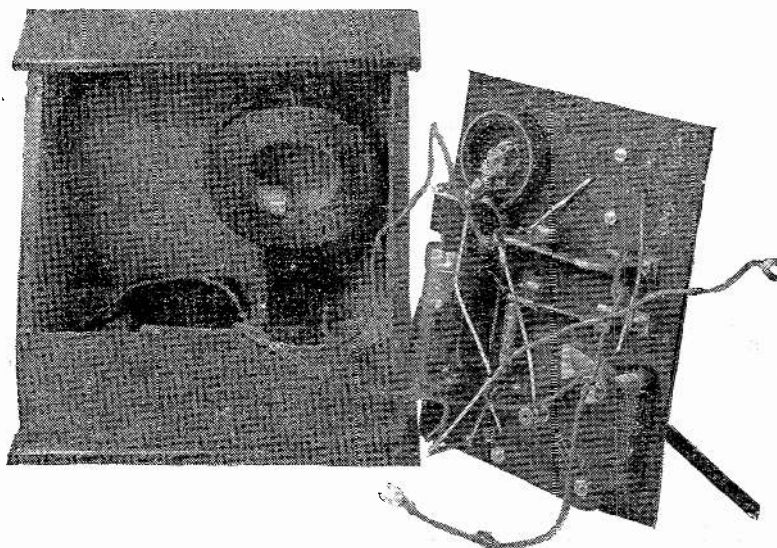

A view with the panel removed from the case. For the purpose of photographing it was necessary to remove some of the flexible connections.

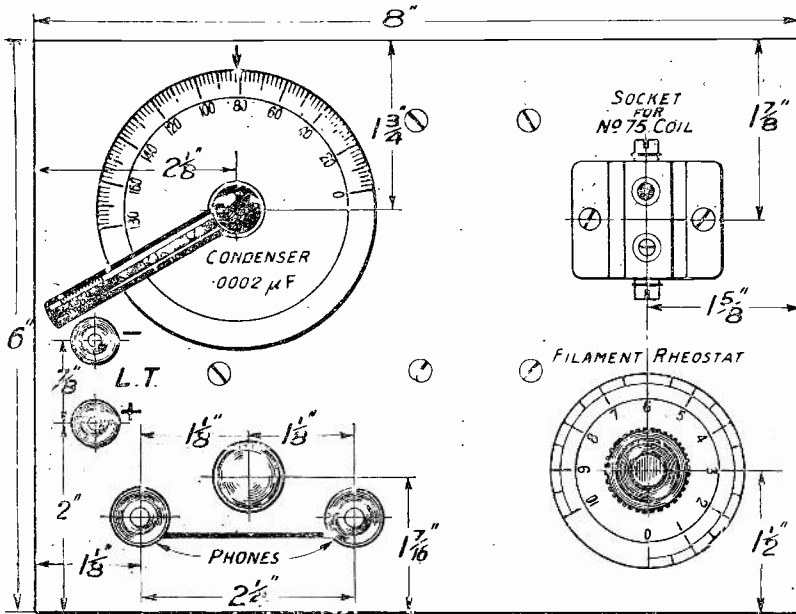

Fig. 3.—The dimensions given here will greatly simplify the marking out of the panel.

provided for connections to an external L.T. battery. With the D.E.7 valve, and a rather larger cabinet, the whole could be easily made completely self-contained and portable by including a small 2-volt accumulator for L.T. supply.

Components

For compactness and convenience the "Valvestat" single hole fixing combined filament resistance and valve-holder of Messrs. H. Clough and Co. was used in the instrument illustrated. The valve then lies horizontally, close behind the panel, wholly enclosed, but with a small opal window for observing the filament temperature. The tuning condenser was a .0002 μF ebonite end J.B., fitted with a small extension handle; grid leak Dubilier; fixed condensers Grafton Electric Co.; coil plugs Raymond; oscillator coil a No. 1,500 Igranic; short wave inductance a No. 75 Lissenagon; 4-electrode valve the ordinary Dutch type of bright emitter (filament 3.5 volts and about 1/2 ampere) or a Marconi-Osram D.E.7.

In these the inner grid is connected to a small screw on the metal cap, so that a short piece of flex and a spade-terminal are provided for this connection. Wiring was done as usual with bare tinned busbar. Care must be taken in so compact a set that the leads to the valve-holder do not accidentally touch the metal base of the valve when the panel is in place, as otherwise most mysterious phenomena will be observed. The cabinet shown (supplied by Messrs. Scien-

tific Electric Co.) represents about the minimum practical size, with a panel about 6 in. by 8 in.

Operation

The unit was tried, both with the Dutch type of bright emitter four-electrode valve, and with the M.O. D.E.7 four-electrode valve, using generally four volts H.T. The dull-emitter valve operated well with eight volts, but gave quite good results with four. The filament adjustment was extremely critical with this valve.

With the small screened 70 ft. single-wire test aerial in Essex, 20 ft. high, and using a large low-

resistance variometer for the A.T.I. of a crystal receiver enclosed in a wooden box; the "Super" being simply stood close to the box with its plug-in No. 75 coil parallel to and a few inches away from the variometer stator, the crystal circuit was tuned with the help of a wave-meter as usual to different broadcast station wave-lengths. Whilst listening on the phones attached to this plain crystal receiver the "Super" unit was set in operation and tuned in unison with the crystal receiver, the critical adjustment of the filament temperature for effective super-regenerative action being made whilst thus adjusted. (Preliminary experiments were of course made with a pair of phones in the plate circuit of the "Super" itself.)

Results Obtained

Birmingham, Glasgow, Aberdeen and Cardiff were thus tuned-in in turn during the late afternoon transmission, *i.e.*, in twilight, part of the time whilst London was transmitting 35 miles away and without serious interference from the latter. 2LO showed a marked improvement in signal strength (he is usually about 2 microamperes on the crystal on this aerial). In each case the distant stations were intelligible, the items being checked from the programme as well as wave-metered. "Talks" could be followed—even a woman's talk from Aberdeen in spite of the usual Morse jamming. Then, after some Morse interference, and the customary heterodyne by a German station became less prominent, the Belfast station was heard most clearly, so that it was actually

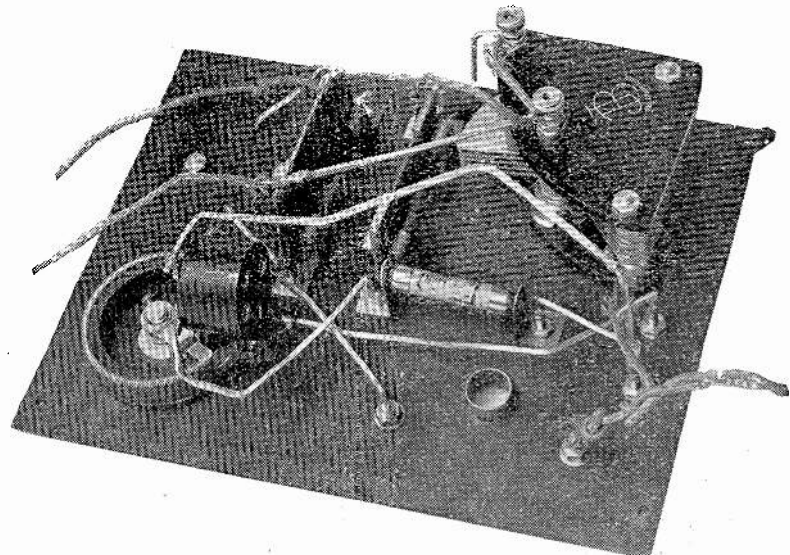

The disposition of the components may be clearly seen in this photograph.

STERLING

SQUARE LAW CONDENSERS

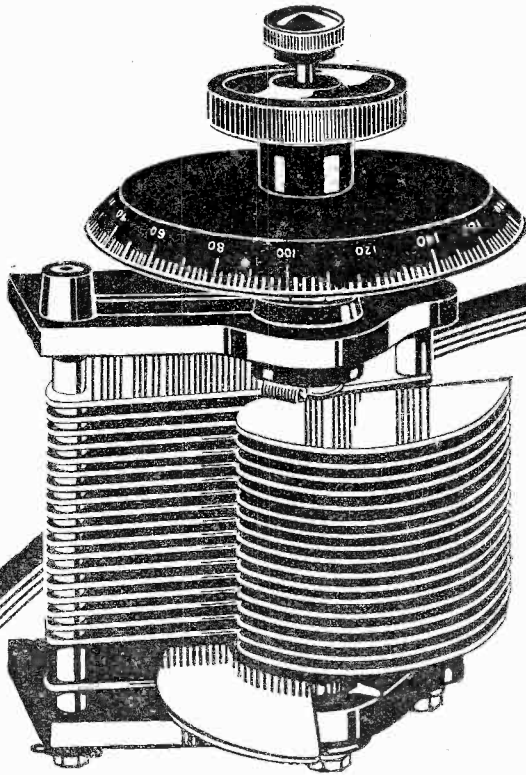

These Condensers banish all tuning troubles. The wave-length curve is a straight line, *i.e.*, the wave-length is directly proportional to the number of degrees through which the knob is turned. This gives much greater ease of tuning, a fact readily appreciated by any radioist.

The end plates are of reinforced insulating material, and the vanes are of brass. Made in three capacities, either with or without Vernier attachment, A small knob controls the latter independently of the other vanes.

Sterling Square Law Condensers are unrivalled for use in receiving sets and are specially recommended for use in the construction of wave-meters and other radio measuring instruments. Compare them at your dealer's and note their accuracy and finish.

Panel Type with Vernier Adjustment (as illustrated)

No.	Capacity	Price
R.272400025 mfd.	£1 3 0
R.27250005 mfd.	£1 5 6
R.2726001 mfd.	£1 10 6

Panel Type without Vernier Adjustment

No.	Capacity	Price
R.272900025 mfd.	£1 0 0
R.27300005 mfd.	£1 2 6
R.2731001 mfd.	£1 7 6

For Tuning H.F. Amplifying Circuits

No.	Capacity	Price
R.2740	.0002 mfd. (each unit) For two stages	£1 7 6
R.2743	.0002 mfd. (each unit) For three stages	£1 15 0

Enclosed Type

In metal case.

Specially recommended for experimenters or laboratory use. Rigidly mounted on a heavy cast aluminium plate, in which special provision has been made for the insulation of the fixed vanes. The moving vanes are electrically connected to the metal casing, which thus forms an adequate screen.

A fine index, secured to the spindle, works over an accurately engraved ivory dial, and thus enables exact readings to be taken. Two ebonite shrouded terminals are provided. N.P.L. Certificate will be supplied at extra cost if desired.

WITH UT Vernier Adjustment

No.	Capacity	Price
R.273700025 mfd.	£1 19 6
R.27380005 mfd.	£2 2 0
R.2739001 mfd.	£2 7 0

WITH Vernier Adjustment

No.	Capacity	Price
R.273300025 mfd.	£2 2 6
R.27340005 mfd.	£2 5 0
R.2735001 mfd.	£2 10 0

Your Radio Dealer can supply

Advt. of **STERLING TELEPHONE & ELECTRIC CO., Ltd.**

Manufacturers of Telephones and Radio Apparatus, etc.

210-212, TOTTENHAM COURT ROAD, LONDON, W.1 Works: Dagenham, Essex

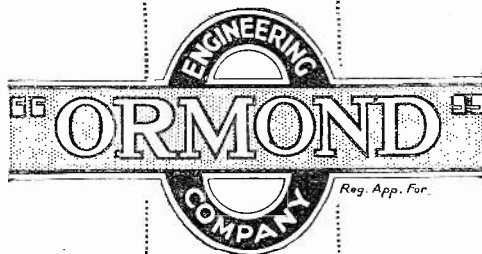

**Neutrodyne
Micro-Condenser.**

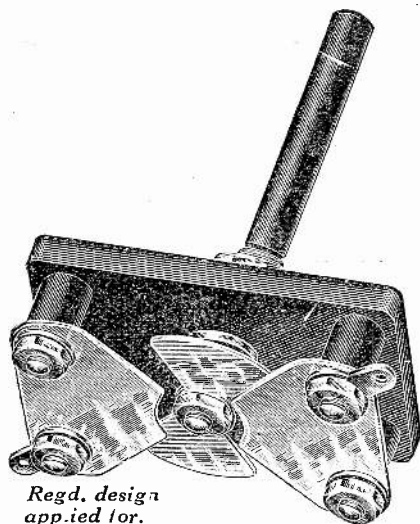

*Regd. design
applied for.*

A useful adjustable condenser of small capacity and dimensions, soundly constructed, essentially designed for providing feed back and oscillation neutralising potentials. One hole fixing.

Fitted with Terminals and Soldering Tags.

Price 2/- each.

**Short Wave
Air-dielectric
Fixed Condensers.**

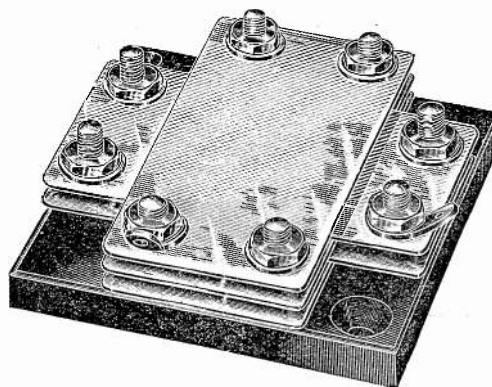

For sharp tuning and to shorten the wavelength, thus facilitating self oscillation by the reduction of capacity in the aerial circuit, a small fixed capacity series condenser having an air dielectric must be used.

Nominal Capacities, .00025, .000035, .00005.

Price 1/6 each.

Also made in larger capacities for constant aerial tuning.

YOUR GUARANTEE—The name "ORMOND" on every "ORMOND" product.

When you go buying for your set do you realise that its very life and vitality is in your care? Before you buy or build you should remember that "ORMOND" Products have a quarter of a century's reputation for dependability. Specify "ORMOND" Products and rest assured that neither your time nor expense has been wasted—you're right in always asking for the best, but say it the "ORMOND" way.

All Cheques and Postal Orders should be crossed and made payable to the "ORMOND ENGINEERING CO."

Write for our New (1925) Catalogue. Trade terms on request.

Ormond Engineering Co.,

199-205, Pentonville Road, King's Cross, LONDON, N.1

Telephone :
CLERKENWELL 9344 (3 lines).

Factory :
WHISKIN STREET, CLERKENWELL.

Telegrams :
"ORMONDENGI, KINCROSS."

25 Years' British Manufacturing Experience.

We specialise in turning Brass and Steel Screws and Machined Parts and Accessories of all descriptions.

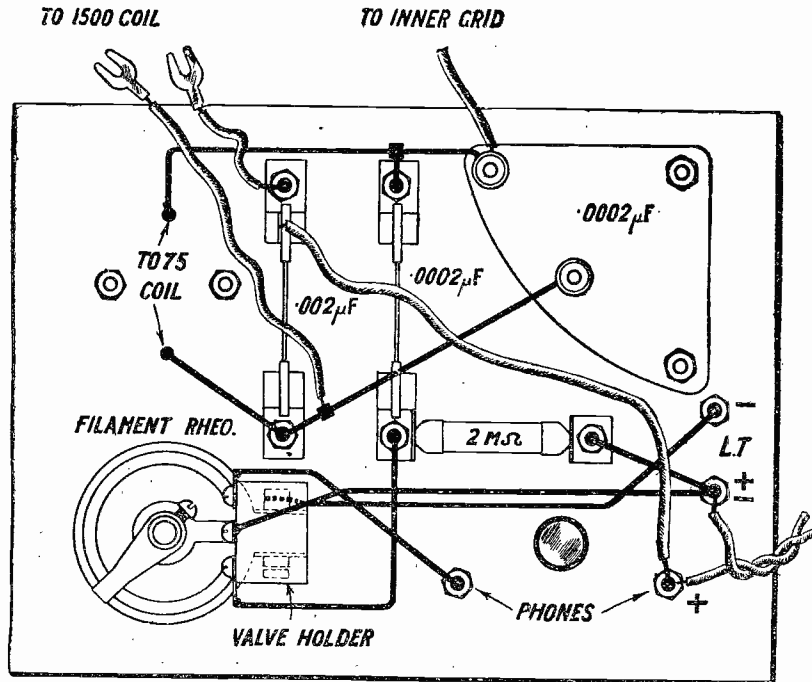

Fig. 4.—The wiring diagram. Note the flexible leads and the position of the valve holder.

audible at times on the loud-speaker at six feet in a quiet room, without any further amplification. The announcer's words and call sign, on closing down for a time,

were as clear as the local station is in daylight at 35 miles on the un-aided crystal, and on a really good aerial. Birmingham was also quite audible on the loud-speaker, and of

course 2LO. Naturally it is not suggested that this represents real loudspeaking. Innumerable Morse stations, spark and C.W. (the latter heterodyned as usual by the super) were also audible.

Reception on a Frame

It is evident that the same little instrument is available as a direct super-regenerative receiver with frame aerial or small indoor aerial. The frame aerial is plugged into the place normally occupied by the No. 75 coil, and should have rather more than the usual number of turns. From 10 to 20 turns should be tried, with ordinary sizes of frame aerials. On trial, London came in thus at good strength on a 2 ft. frame; a short earth lead; a short length of flex thrown on the table; or even on casual "capacity aerial" alone at 35 miles. With the frame, he was readily audible on the loud-speaker.

Other applications are for use as a heterodyne wave-meter, or separate heterodyne of simple design and minimum upkeep expenses for C.W. reception, by simply short-circuiting the large oscillator coil; or as a powerful single-valve reaction receiver controlled by the filament resistance adjustment as described in the article referred to.

SIR,—No doubt a word of appreciation of your work from an experimenter in this country will be appreciated by you. I have been experimenting in radio telephony and telegraphy now for a number of years, of course in rather a small way, as the excessive cost of apparatus makes it difficult for a working man to carry on; however, we do it. I have tried numerous circuits during the course of my experimenting, many American, English, local and several of my own design, but up to date have found nothing to equal those designed by yourself. The results have been extraordinary. My log-

An S.T. 34 Circuit in Australia.

book compares favourably with that of any experimenter in the country, thanks to John Scott-Taggart. At present I am using your circuit S.T.34, and, believe me, it functions admirably, although for long-distance work I found it essential to include a potentiometer to stabilise the first valve, i.e., the radio frequency amplifier. Using this circuit, my log shows such entries as KGO, broadcasting from San Francisco a distance of approximately 7,000 miles clear and loud on two valves; WGY (broadcasting), New York, approximately 10,000 miles, on two valves; and 5XX, known to you, I should say 12,000 miles, on three valves, voice and music quite clear. That, I think, sir, will convince any person of the efficiency of your design, as I use only three valves. Inter-state amateurs on telephony and CW, are extraordinarily loud, the distances

varying from 500 to 1,000 miles. My aerial is a four-wire cage 45 ft. long and 30 ft. high at each end; the earthing system is to the water service and also galvanised iron plates. For clarity of tone and perfection in reproduction this circuit, in my opinion, is unequalled. I cannot express myself to convey to you my appreciation of your work. I am a constant reader of MODERN WIRELESS, and it is all one could desire.—Yours truly,

ROBT. S. BURMAN.

Auburn, N.S.W.,
Australia.

HAVE YOU SEEN

The February issue of
"THE WIRELESS
CONSTRUCTOR?"

Free Blue Print of a Single Valve
Reflex Receiver

Wiring diagram of "The Anglo-
American Six,"

and many other features.

DOUBLE NUMBER.

You cannot afford to
miss next month's
"MODERN
WIRELESS"

which will be a Special
Double Number
Price 1/6

Operating a Set for the First Time.

Every month there must be a considerable number of our readers who sit down for the first time to operate a wireless set which they have either built, purchased or had given to them. It is hoped that the following very elementary notes may be found of real use to all those who find it a little difficult to decide which knob to twist first

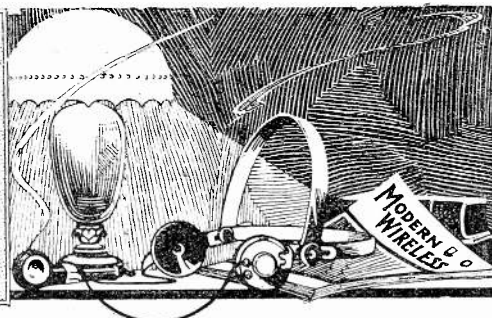

OPERATING a wireless set is by no means the simple and straightforward matter which it may appear if one talks to one of the old hands who can operate the most complicated set almost instinctively, and without a moment's consideration as to the correct control to manipulate to produce a given effect. On the contrary, to operate a set possessing several valves and anything except a specially simplified circuit requires a certain degree of skill if one is to obtain the full results of which the set is capable. No doubt, almost anyone possessing a very elementary knowledge can turn on the valves and obtain some sort of signals, provided they are not too far from a broadcasting station, but to bring out the full efficiency of the set is a very different matter.

A Crystal Set

The procedure will naturally be quite different in the case of varying types of sets, and we will consider first the simplest, namely, a crystal set in which the method of tuning is by means of a slider coil.

It is evident that two conditions must be satisfied before signals will be heard upon a set like this, and these two are, first, that the crystal detector must be adjusted to a condition of sensitiveness, and second, that the slider must be moved along the coil to a point which will give the desired resonance with the waves of the broadcasting station. One must adopt some logical method of arriving at this condition, and it is advised that the adjustment of the crystal be attempted first.

A simple method which is suitable for all cases where the crystal set is used within a reasonable distance of a main broadcasting station is as follows:—

Adjusting the Crystal

First set the slider at a position half an inch from the minimum end of the coil, that is to say, at the end from which a connection is made

from the end of the winding (it will be found upon investigation that the wire at the other end of the coil is simply fastened off and no connection is made to it). Now lower the point of the cat-whisker very gently upon the crystal, so that only the lightest of contacts is made, and see whether signals are heard. If no sound whatever is heard, raise the cat-whisker again, move it across the crystal and gently lower it upon another spot. If, after trying four or five different points upon the crystal in this way no sound is heard, move the slider of the coil along a further half inch and repeat the process with the crystal.

Getting the Best Results

In this way search the face of the crystal for a sensitive point, moving the slider along the coil $\frac{1}{2}$ in. at a time. Presently, signals will begin to be heard quite faintly, and one should then

stop moving the slider and devote one's whole attention to securing the loudest possible results by means of a search over the face of the crystal for a really sensitive point. Having secured a good adjustment here, which includes the provision of a suitable pressure of the point of the cat-whisker upon the crystal, move the slider steadily along the coil until the maximum point is found, beyond which signals begin to fall off again. Adjust the slider to the best position and then return to the crystal and make any necessary final adjustments.

Variometer Tuning

If no signals can be obtained by the method indicated, it may be that a defective crystal is in use, and a new one should be obtained, or it may be that the set is so far from a broadcasting centre that very accurate tuning is needed before signals will be

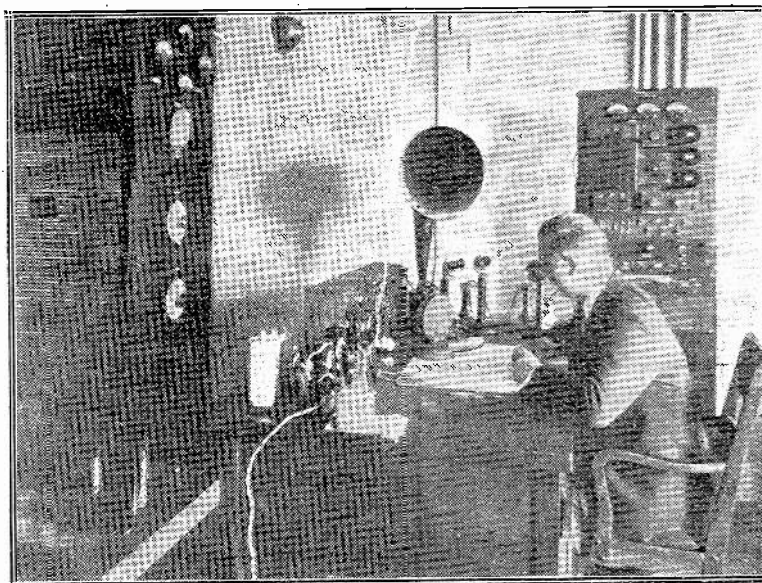

The operating room of the Canadian National Railways' radio station CKCH at Ottawa. This station, which broadcasts to the expresses, is the most powerful in the Dominion.

3,800 MILES ON A LOUD-SPEAKER. ALMOST AS LOUD AS 2LO.

"You will be interested to know that I received WGY Schenectady on a loud-speaker almost as loud as 2LO on my Duodyne V. at Crowton . . ."
 J. A. Fowler, M.I.A.E.E.,
 Wellman Smith Owen Engineering Corporation, Ltd.,
 Kingsway, W.C. 2.

Duodyne

"We all enjoyed WGY Schenectady on the Duodyne V. and loud-speaker, which came in as clear and as loud as our local station."
 Robinson, Hesse.

A Genuine Long Range **LOUD-SPEAKER RECEIVER** TWO Stages High-Frequency Amplification

AUTOMATIC TUNING

GUARANTEED RANGE
 under average conditions

- DUODYNE III. Headphones .. 3/4,000 miles.
- DUODYNE V. Headphones .. 4/5,000 miles.
- LOUD-SPEAKER .. 1/1,200 miles.

THE DUODYNE Long Range Receivers will discriminate between Radiola Paris and 5XX Chelmsford, or, used in conjunction with a CURTIS EJECTOR, will tune in any Broadcasting Station at will, while operating 1½ miles from local Station or 200 yards from Relay Station.

The extraordinary range, and simplicity of operation, exclusive to the DUODYNE RECEIVERS, must make an irresistible appeal in Imperial and Continental markets.

A CHILD CAN TUNE IT.

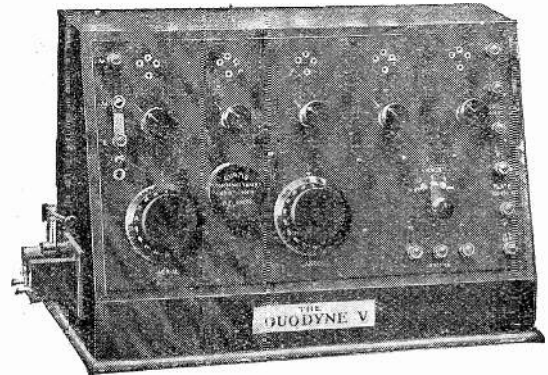

The DUODYNE III. (Instrument only) Panel Type £10 0 0
 The DUODYNE V. (Instrument only) Panel Type £18 18 0
 The DUODYNE CABINET.—The Duodyne V. is also supplied in French Polished Oak Cabinet with folding doors, enclosed valves and tuning coils. Self-contained batteries. Instrument only **£27**

CURTIS CONSTANT - TUNED H.F. AMPLIFIER

Automatic Tuning—No Condenser required.
 As used in DUODYNE and CURTIS Circuits

The Curtis "Constant-Tuned" High-Frequency Amplifier is the only automatic high-frequency amplifier which, when connected in circuit, guarantees high efficiency for two stages or more of radio amplification on any wavelengths between 300 and 3,000 metres, and requires no additional controls, NOR MORE EFFORT, SKILL OR PATIENCE IN TUNING, THAN IS REQUIRED FOR THE OPERATION OF THE USUAL ORTHODOX SINGLE STAGE TUNED ANODE CIRCUIT.

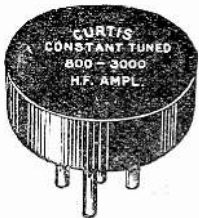

And with its automatic simplicity, combined with increased selectivity and power, is destined to make two stages or more of high-frequency amplification a *sine qua non* of every Wireless Receiver for the Experimenter and Home Constructor, or the purchaser who prefers to buy a professionally constructed instrument.

"Using a Curtis Amplifier and the Duodyne Circuit, I receive all British stations with an indoor aerial on a set made by myself." J. S., Tufnell Park.

Type A, 300 to 800 Metres. Price 15/-
 Type B, 800 to 3,000 Metres. Price 17/6
 Postage 6d.

BUILD YOUR OWN DUODYNE—the Genuine long-distance Receiver. Circuit diagrams and SIMPLIFIED WIRING CHART, together with complete schedule of all components required, supplied FREE with every Amplifier.

GUARANTEED TO CUT OUT YOUR LOCAL STATION

Used in conjunction with an efficient High-Frequency Receiver, the

CURTIS EJECTOR

enables any British Broadcasting Station to be tuned in at will while operating 1½ miles from local principal station or even nearer from Relay Station.

Price 35/-

THE CURTIS EJECTOR

Practically eliminates Morse and Mush, and assures pleasing reproduction.

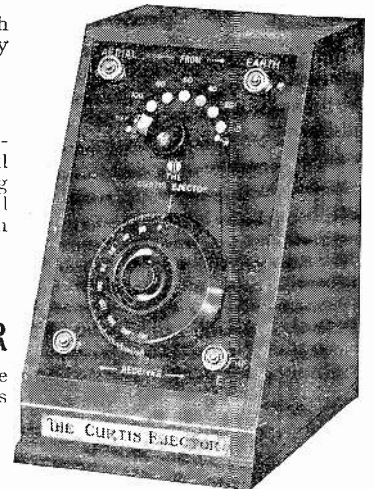

Sales Office :

PETER CURTIS, LTD.

IN CONJUNCTION WITH

THE PARAGON RUBBER MFG. CO., LTD., HULL.

75, CAMDEN ROAD N.W.1.

Telegrams : "PARACURTEX"—Phone : NORTH 3112.

BIRMINGHAM : 76, Newhall Street. Central 7238.

MANCHESTER : 312, Deansgate. Central 5995.

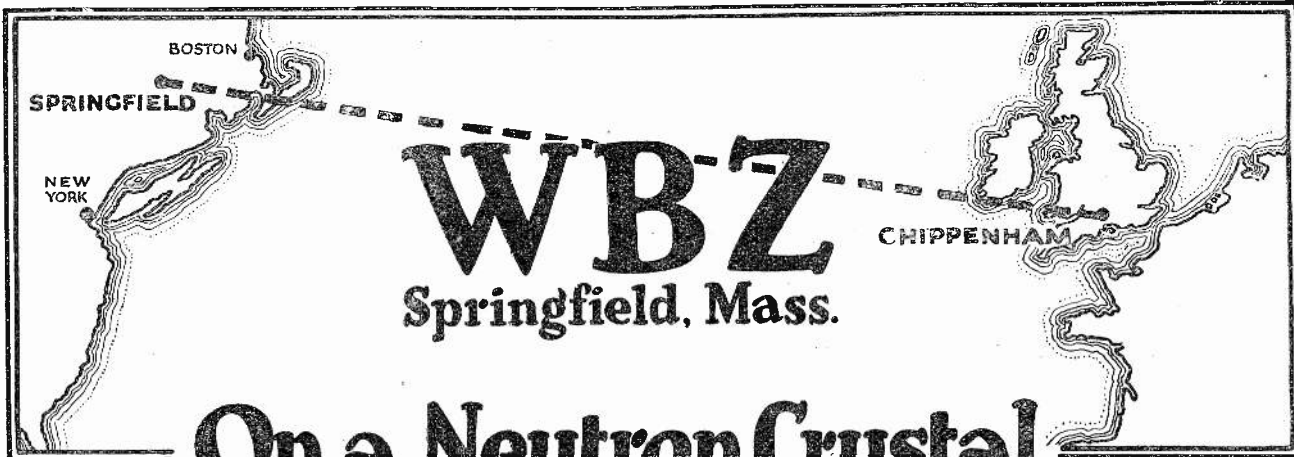

On a Neutron Crystal with 2 stages of Low Frequency

Chippenham, Wilts.,
December 14th, 1924.

Messrs. Neutron Ltd.,

DEAR SIRS,

NEUTRON CRYSTALS.

As an enthusiastic owner of a 5-valve set, I write to tell you of my surprising results with a small crystal set. Owning the above-mentioned set, and having been connected with Wireless Theory for the last 10 years and actual practice with a set for the past 5 years; I was, as I always have been, very sceptical about results when I bought one of your crystals a week ago. The results, however, have simply astounded me.

The first night, not having the ebonite ready, I just twisted some bare wire round the end of the detector and across the end of a plug-in (standard size) coil block; the other end I connected with a pair of 'phone tags and condenser. A .0003 mfd. variable condenser for tuning completed my very crude "outfit."

Coupling up aerial and earth, I was astounded by easily tuning **5WA** (40 miles), **6BM** (62 or 64 miles). I listened to the latter till close-down, and then picked up **Madrid** quite easily.

Of course, my mind was immediately filled with theories of re-radiation and such things as that. I will, however, admit that I made frantic haste to have everything properly mounted and soldered the next evening when I again repeated the same performance. Subsequent tests have proved that **5XX** (100 miles, approx.) is absolutely comfortable strength, and **2ZY** (Manchester) is also audible.

Coupling a 2-valve **LOW FREQUENCY** amplifier to the above-mentioned set at 1.50 a.m. this morning, I picked up music and solos (soprano and baritone) from **WBZ** (Springfield, Mass.), and was in good touch for about 10-12 minutes, when the signals faded away.

A continued watch was kept for 1½ hours, during which time I was in touch for about 60 per cent. of the time. Not so bad for the much-despised crystal. Needless to say, I am now very much converted.

It is my hope now to be able to receive America direct with crystal only, and with the strength that different stations have been coming in at this address I am feeling quite confident that it can be done. Needless to say, the crystal will be Neutron.

My aerial is 100 ft. long, 34 ft. high leading-in end, 28 ft. high far end. Please particularly note that all current was switched off from the valve set during these tests, and every precaution taken to give the crystal a "fair chance."

Very sincerely yours,
(Signed) R. A. H.

P.S.—During reception of Springfield, Mass., I distinctly heard the announcer give the call letters of the station *twice*, so that there is no doubt as to the accuracy of the reception.—R.A. H.

Stocked by the best Radio Dealers. Packed in tin with silver cat's-whisker. Insist on Neutron, in the Black and Yellow Tin—or send 1/6 and Dealer's name, and this wonderful Crystal will be mailed by return. **1/6**

THIS is, we believe, the record for long-distance broadcasting reception on land. Note that the only amplifier used was a **low**-frequency one; interpreted to the non-technical, this means that the signals were actually received and rectified by the **NEUTRON CRYSTAL**, the two valves serving merely as note-magnifiers, and not as "range-increasers."

The original letter, a copy of which is given here, may be inspected at the NEUTRON Offices.

Whilst the results claimed in this letter are exceptional, and probably due to very favourable conditions, which would need to be matched before equal results could be obtained by any experimenter, the letter yields sufficient proof of the super-sensitiveness of **NEUTRON CRYSTAL** to justify you in selecting this as **your** Crystal. Sooner or later you will come to it in any case, and in deciding **NOW** for NEUTRON you will easily **save the price of another pair of 'phones** by saving the expense of further tests.

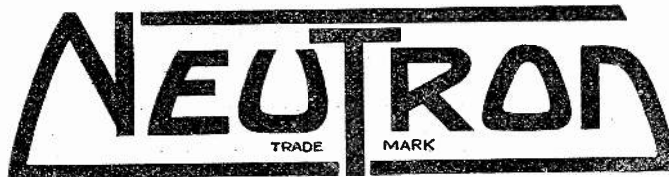

Concert Tested and Guaranteed.

Sole Distributors:—V. Zeitlin and Sons, 144, Theobald's Rd., London, W.C. 1. 'Phones: Museum 3795 and 6841. Produced by:—Neutron Ltd., Sicilian House, Southampton Row, London, W.C. 1. 'Phone: Museum 2677.



heard, and the only expedient is to try moving the slider along the coil in steps of $\frac{1}{4}$ in.

A very similar proceeding can be adopted in the case of a crystal set employing a variable condenser for tuning, or a variometer, the only modification required being to revolve the dial of the condenser or variometer, say, 10 degrees at a time in place of the $\frac{1}{4}$ in. advance of the slider on the coil.

A Single Valve Set

It may perhaps seem paradoxical, but it is undoubtedly a fact that when we come to valve sets,

parallel arrangement of the aerial condenser, connect the accumulator and insert a valve in the socket. Turn on the valve by means of the filament rheostat or filament switch, if one is provided, and note whether it lights correctly. If so, turn it off once more and connect up the high-tension battery, taking particular care to insert the plug in the correct sockets according to the positive and negative marks on the battery.

Filament Voltage

Before actually commencing to tune in we must now adjust the

battery, adjusting the filament rheostat so that the valve is fairly bright, but no more. This is a matter of considerable difficulty to a beginner who has no standard of comparison, and it is therefore advisable to make the adjustment roughly and correct it after obtaining signals.

Value of H.T.

High-tension voltage is a simpler matter, since the vast majority of valves upon the English market when used as detectors will give perfectly satisfactory results with a standard high-tension value of 60 or 72 volts.

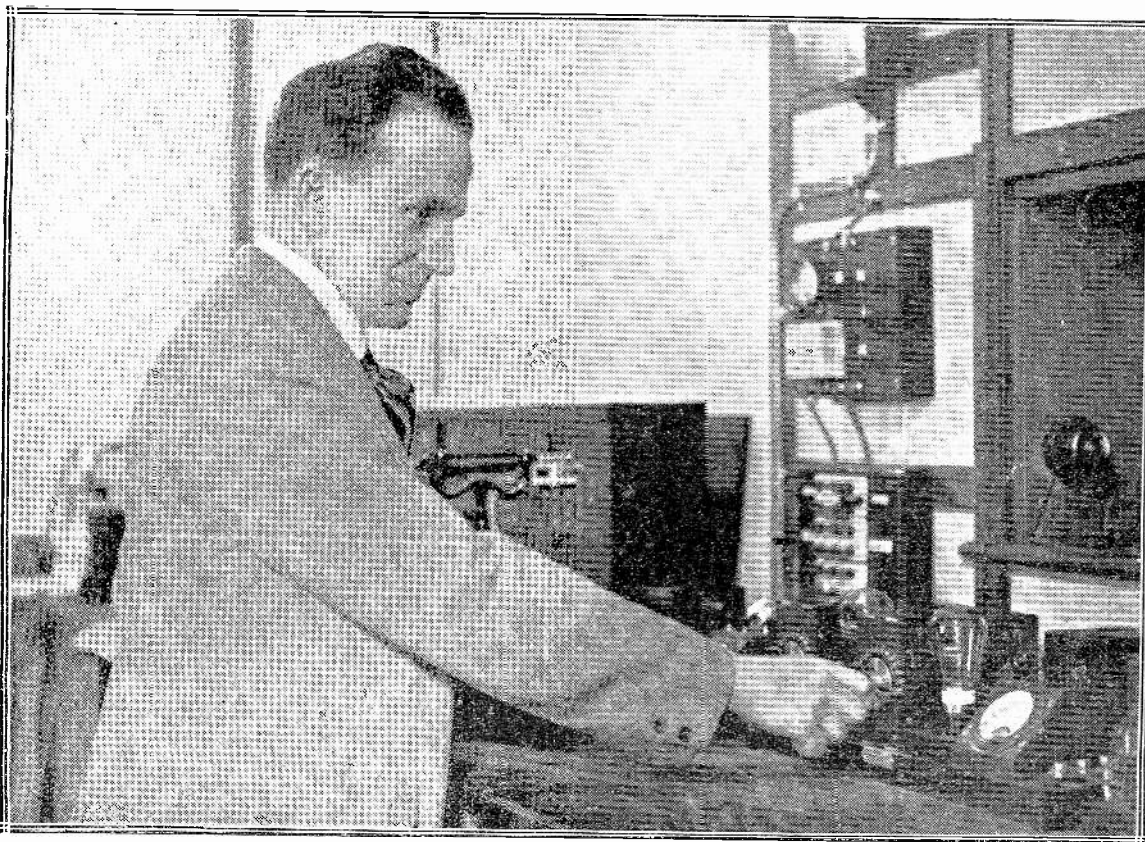

Our photograph shows Mr. Carver, the chief engineer of the Hull relay station, adjusting the apparatus in the control room.

provided that they are of a really simple nature, the operation of tuning-in may be actually simpler than in the case of a crystal set. In a single valve set, for example, there will probably be only one circuit to tune, just as in the case of a crystal set, and the operation of adjusting the crystal is eliminated. The following is the procedure in the case of almost any type of single valve set, and this should be read carefully since much of it applies to any valve set.

First connect aerial and earth to the correct terminals to produce the

valve to its correct condition, and two operations are involved here. First, we must see that the filament is lit to the correct degree of brilliance, and this depends upon the type of valve in use. With the ordinary bright emitter, the filament should be a fairly bright white, such as would be obtained, in the majority of cases, by turning the filament rheostat to the full on position with a four volt accumulator in use. Certain valves, however, require even a higher voltage than this, and it is therefore customary to use a 6-volt

The best thing to do, therefore, when a single valve set has been constructed, is to buy a 60 volt battery, or a 72 volt one if preferred, and insert the two plugs in the sockets which are farthest apart, as indicated by the numbers which are marked beside them.

The telephones are now attached and we are ready to commence tuning after the insertion of suitable coils in the appropriate sockets.

If the set includes reaction, as it almost certainly will, the correct coil to use in the moving holder will almost certainly be a No. 50

for the broadcast band, while in the aerial socket we may require a No. 25, 35 or 50, according to the wavelength which it is desired to receive, and whether constant aerial tuning is employed or not. If no constant aerial tuning is used, for the shorter wavelength band a No. 35 will almost certainly be required, or an equivalent size in any make which is not numbered in this way.

A Coil Table is Useful

At this point, it should be explained that everyone commencing the use of a wireless set should most certainly provide himself with the MODERN WIRELESS coil table, which solves all problems as to the correct size of coil to use for a given station. This coil table has now been reprinted upon stiff varnished cards and can be obtained from the majority of booksellers and wireless dealers for 6d., or direct from the publishers, 8d. post free.

Assuming that the correct size of coil has been inserted, we now have the choice of two methods of tuning in, and the one to adopt will depend upon our distance from the broadcasting station. At distances of less than, say, 20 or 30 miles, no reaction will be needed to obtain good signals, and the reaction coil should be swung right away from the other coil, and the operation of tuning is a merely mechanical one of revolving the variable condenser dial until signals are picked up. Having picked up the local station, tune it in to the maximum possible loudness upon the variable condenser dial and then consider whether it is necessary to use reaction. If signals are of fairly good strength, the reaction coil may be left where it is, but if they are at all weak, the coil may be gradually brought up towards the aerial coil, slight readjustments of the aerial condenser being made as this is done. Signals will gradually become louder provided that the direction of connections to the moving coil is correct, until the desired degree of loudness is obtained.

Reversing Leads

If the signals do not become louder, but on the contrary slightly weaker when the coil is brought up, even though the aerial tuning is readjusted, the direction of connections to the two leads of the moving holder should be reversed and the procedure repeated.

At this point we realise that we have reached the stage of wondering just how much reaction to use,

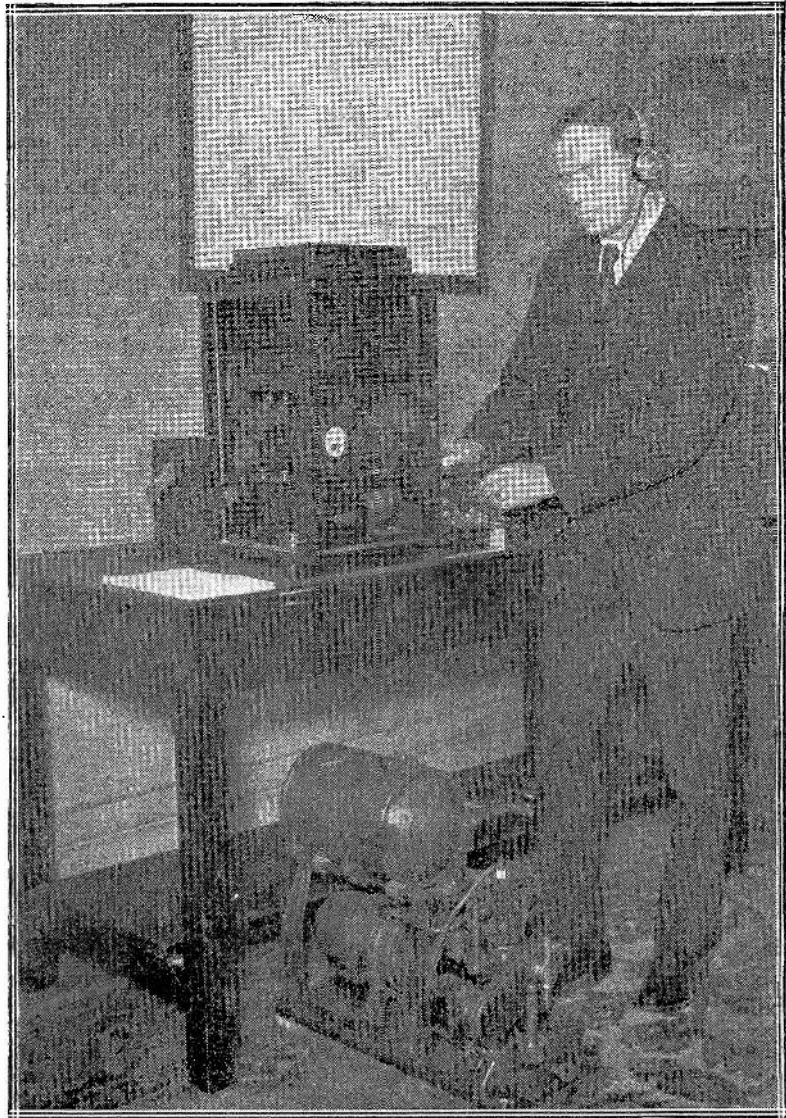

A self-contained wireless set for use on ships' lifeboats. An S.O.S. from this transmitter may be received up to a distance of 100 miles.

and some very definite words of advice indeed must be given here. However raw a beginner you may be you *must* find out for yourself and realise clearly just what reaction is and what it can do for you and your neighbours. Certainly, some simple book of theory should be obtained, and this point looked up, since one must have a clear understanding of the purpose of reaction, and know how it must be adjusted for the reception of telephony.

Correct Adjustment

It cannot be too often repeated that the correct adjustment for the loudest, and at the same time, the clearest telephony, is the point

just short of that at which the set passes into what is called "self-oscillation." If the set actually oscillates it may be possible to obtain still louder signals, but they are certain to be more or less distorted, and for this reason alone, a purely selfish one, one should keep off the oscillation point. Even when the set is brought just up to the verge of self-oscillation, there is some slight distortion taking place, and it is better, if one can do so without undue sacrifice of signal strength, to keep well clear of the oscillation point. Take an early opportunity of finding out for yourself what it sounds like when the set begins to oscillate, even though you may

The Gilt-edged Security

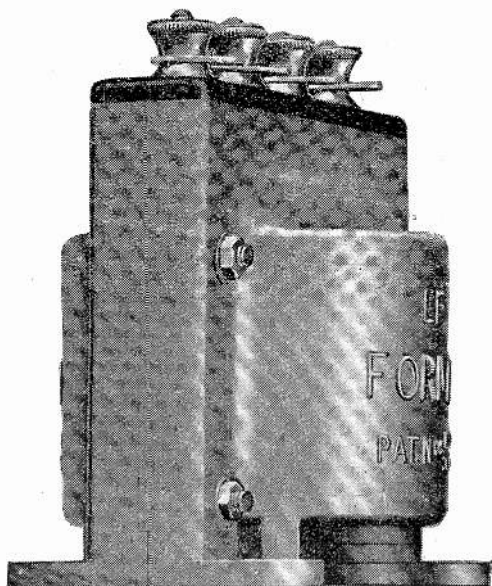

THE FAMOUS FORMO L. F. TRANSFORMER

INTENSE research and elaborate test methods—both scientific and practical—briefly explains the consistent high quality and performance of The Famous Formo. As the pioneer manufacturers of the unconditional guarantee we know that the incorporation of The Famous Formo L.F. Transformer into your sets is poles apart from a speculative adventure. You know—we know—that The Famous Formo is a gilt edged security.

Your dealer sells them. You cannot mistake The Famous Formo—look for the gilt finish.

Shrouded, PRICE 18/-
Open Type, PRICE 12/6

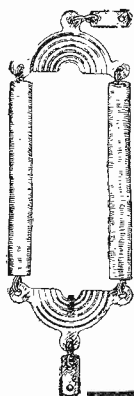

THE NOVELTY OF THE SEASON THE FORMO PORTABLE AERIAL

This aerial can be erected or taken down in a few moments, and may be erected in or out of doors, on a car, on a punt, or any other desired position. Guaranteed to receive up to 10 miles from Broadcasting Station on a Valve Set.

BUT many users are receiving on a Crystal Set up to this distance, and on Valve Sets, all B.B.C. Stations and most Continental Stations.

PRICE 7/6

THE FORMO COMPANY

(Arthur Preen & Co., Ltd.)

Contractors to the Admiralty, War Office, India Office, Air Ministry and Post Office.

Chief Office and Works:

CROWN WORKS, CRICKLEWOOD LANE, N.W. 2.

Scottish Branch: 22, York Place, Edinburgh. And at Birmingham, Manchester, Newcastle, Bournemouth.

Sole Agents for Bristol and Cardiff: The Sloan Electrical Co., Temple Street, Bristol.

Barclays 637.

DUCO VERNIER COIL HOLDER

(Prov. Patent.)

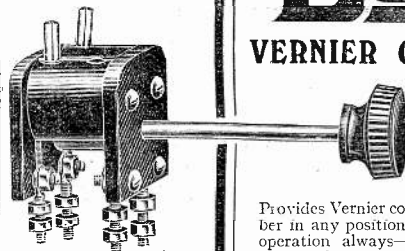

No. R.C. 50/4.
Two way, each 5/-

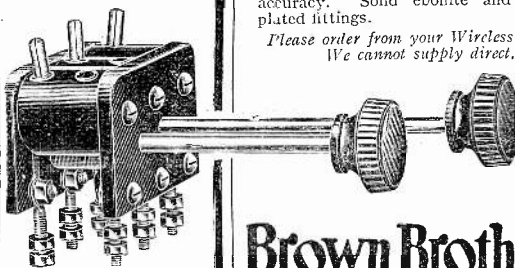

No. R.C. 50/5.
Three-way, each 7/6

Provides Vernier control of moving member in any position. Vernier control is in operation always—throughout the whole range of movement. NO BACKLASH. Connections are enclosed within the holder, and led down to the securing screws, thus obviating loose and broken wires. Guarantees tuning of extreme accuracy. Solid ebonite and heavily plated fittings.

Please order from your Wireless Dealer. We cannot supply direct.

Brown Brothers

Associated Companies: Thomson & Brown Brothers, Ltd., Brown Brothers (Ireland), Ltd.

Wholesale only.

Head Offices and Warehouses:

GREAT EASTERN ST., LONDON, E.C.2.
118, George St., Edinburgh, and Branches.

YOU CAN LOG STATIONS

Having once tuned in that distant station, you will want to get it again. In point of fact, you will calibrate your receiver and log up the condenser readings. With J.B. Instruments you can log up the readings, fully confident that at any time you may set your condensers to correspond with your record and the signals will come in accurately tuned.

This feature of J.B. Condensers is the outcome of a constant capacity at any given dial reading. Dielectric loss, caused, for example, by the bad insulating properties of end plates, may encourage the precipitation of water. This, being absorbed by the inefficient end plates, varies capacity readings in step with the vagaries of the weather!

The one precaution that you can take against this inefficiency is to build exclusively J.B. Condensers into your receivers. Constancy in capacity enables you to log those distant stations.

Incorporation of J.B. Condensers gives you the highest tuner efficiency. Fit them—preferably the J.B. Square Law.

.001	9/6	.00025	6/6
.00075	9/-	.0002	5/-
.0005	8/-	.0001	5/-
.0003	6/9	Vernier	4/6

As Condenser Manufacturers we have long realised the vital electrical duty of Variable Condensers. J.B. Condensers represent both high mechanical and electrical design.

J.B. Instruments are obtainable from all dealers or direct from the manufacturers: Post, one, 6d.; two, 9d.; three, 1s.

JACKSON BROS.

8, POLAND ST - OXFORD ST
LONDON - W.1.

(First Floor)

Telephone: GERRARD 7414

Barclays 509

In replying to advertisers, use Order Form enclosed



MADE IN ONE PIECE : NO WAX.

Patentees and Manufacturers, The Paragon Rubber Mfg. Co., Ltd.

ESSENTIAL for perfect reception and **ABSOLUTELY INDISPENSABLE** for Tropical and extreme climates.

Guaranteed uniform accuracy under all conditions and at all temperatures.

PROOF—

Test Report by A. D. COWPER, M.Sc., Staff Editor "Modern Wireless."
ACCURACY

"On test, the capacities came out quite close enough to the nominal for ordinary radio purposes, the .001 MF nominal samples being about .0003 and .0001 respectively, and the .0003 MF nominal being actually around .00033 and .00026 respectively. There was observed but a negligible greater high-frequency loss in this type than in a standard air-dielectric condenser.

PERMANENCY

"As this one piece casing offers apparently considerable advantage as to permanency and independence of damp, high temperature, etc., an exceedingly strenuous test was applied to one of the samples, which was actually placed in water nearly at the boiling point for the better part of an hour. After this heroic treatment, the condenser showed a capacity which did not differ materially from that shown before and it was still possible to get a valve to oscillate readily with this as the main tuning-capacity across the grid-tuning-inductance. Evidently there need be no fears as to possible deterioration in stock of these 'Paragon-Curtis' fixed condensers."

.0005 to .0006 2/6 each. Grid Condenser with clips 2/9 each.
Grid Leak 1/6 each.

Distinction

By no means the least important feature is the uniform ebony black, fine grain, dead matt surface so distinctive of and exclusive to

PARAGON Post Office Specification. Radio Quality EBONITE PANELS

"The Best Made."

Sold everywhere in Sealed Cartons only stamped Paragon.

All "Modern Wireless" and Radio Press Panels supplied from Stock at 1d. per sq. in. Prices for drilling and engraving upon request.

STANDARD SIZES.

8 x 6 x 3/16	2/6	24 x 10 x 1/4	14/6	18 x 6 x 1/4	6/9
8 x 6 x 1/2	3/3	24 x 12 x 1/4	17/6	12 x 8 x 1/4	6/9
10 1/2 x 8 1/2	5/3	8 x 5 1/2 x 1/4	2/9	10 x 8 x 1/4	6/9
12 x 10 x 1/4	7/3	10 1/2 x 7 x 1/4	4/7	7 x 5 x 1/4	2/3
12 x 12 x 1/4	8/6	12 x 6 x 1/4	4/6	10 x 9 x 1/4	5/6
14 x 12 x 1/4	10/-	22 x 11 x 1/4	15/3	9 x 5 1/2 x 1/4	3/5
16 x 12 x 1/4	11/6	16 x 9 x 1/4	9/-	10 x 5 x 1/4	3/3
18 x 12 x 1/4	13/-	12 x 11 x 1/4	8/3	12 1/2 x 9 1/2 x 1/4	7/6

PARAGON POLISHED MAHOGANY EBONITE

is NOT a composition, but GUARANTEED POST OFFICE QUALITY EBONITE, and is of similar specification to the now universally used PARAGON EBONITE.

PANELS CUT TO SIZE, Squared, edges ground, 1d. per square inch. Valve and Coil Holders, Condenser Dials and Knobs in Polished Mahogany Finish to match.

Sales Office:

PETER CURTIS, LTD.,

IN CONJUNCTION WITH

The Paragon Rubber Mfg. Co. Ltd., Hull

75, CAMDEN ROAD, N.W.1.

Telegrams: "PARACURTEX" — Phone: NORTH 3112.

BIRMINGHAM: 76, Newhall Street. Central 7236.
MANCHESTER: 312, Deansgate. Central 5095.

Barclays 657.

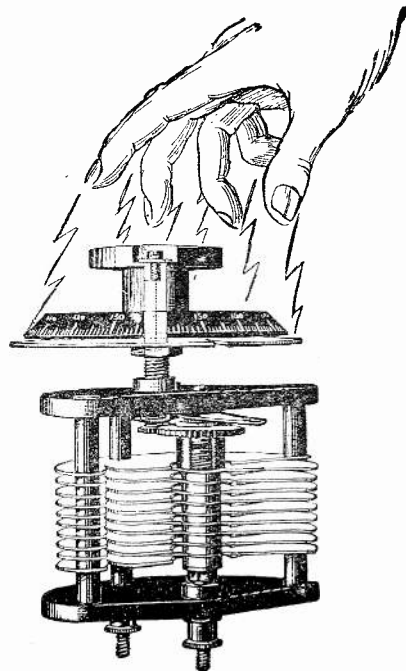

Perfect Tuning Greater Clarity

The new "Fulstop" Square Law Condenser is so designed that it will allow twice the degree of accuracy obtainable with the ordinary type of variable condenser. It is full of valuable detail improvements and shows a great advancement in modern design.

The dial of this instrument is graduated over the complete circumference and is geared at two to one in relation to the moving plates. This allows for perfect tuning and enables individual stations to be selected with exceptional ease. The "Fulstop" Condenser is also guaranteed to abolish all hand capacity effects, thereby greatly improving reception and giving better tone. It has been strongly recommended by the Wireless Press for use in situations where hand capacity effects are troublesome.

Prices:

.001.....13/6 .0003.....10/3
.0005.....11/3 .0002..... 9/6

Stocked by most Wireless Dealers, but if you have any difficulty write to

J. H. NAYLOR, LTD., WIGAN.



VARIABLE CONDENSER

for a few moments cause interference to your neighbours.

Testing for Oscillation

Take the reaction coil closer and closer to the aerial coil, constantly re-adjusting the aerial tuning condenser as you do so, until you find a point at which there is perhaps, a "plop," and upon varying the aerial condenser you will hear squeaks and howls mixed up with the transmission from the broadcasting station, and the transmission itself will become distorted. Further, if you tune the set away from the station you will probably hear a slight hissing and rustling noise showing that the set is oscillating, and touching the aerial terminal with a moist finger will produce a loud click in the 'phones, which click is repeated when the finger is taken off the terminal. The set is then oscillating and is capable of causing interference over an extraordinarily wide area. It should be made quite clear that the whistling and howling noises referred to are produced by the carrier wave of the broadcasting station and not by the mere fact that your set is oscillating. The set may be oscillating quite strongly, and yet if it is not tuned to a carrier wave, no whistles or howls will be heard.

Distant Reception

The proceeding to be adopted in picking up a really distant station with a single valve receiver employing reaction is somewhat different, since in this case it is almost always necessary actually to make the set oscillate in order to find a carrier wave, which then comes in as a musical whistle when first heard of extremely high pitch, and then as the variable condenser is rotated further the pitch sinks down through the whole audible scale to the lowest note and finally disappears, then a little further reappears again as a very low note and then rises to the highest audible as the condenser is revolved.

The method of operation adopted by the expert, then, is to tune the set very rapidly to the "silent point" in between the ascending whistles and quickly swing the reaction coil away from the aerial coil, retuning on the aerial condenser very slightly as he does so, whereupon the set just ceases to oscillate and the distant transmission will be heard with a further very slight re-adjustment of the aerial condenser. This, of course, involves a certain amount of inter-

ference as long as the set continues to oscillate, but a skilled user will reduce the whole operation to a matter of seconds only. The beginner, however, should most certainly not adopt this procedure, since he is bound to be somewhat slow and clumsy over it, but should rather try the following procedure.

Another Method

Make the set oscillate by bringing up the reaction coil until clicks are heard on touching the aerial terminal, and then proceed to search for a carrier wave by varying the condenser from zero towards its maximum, and upon hearing the first high whistle of one, take the reaction coil away from the aerial coil until self-oscillation just ceases and then revolve the aerial condenser further in the direction in which it was previously being turned until the distant speech or music is faintly heard; tune it in to the loudest degree possible, and then very gradually advance the reaction coil a trifle towards the aerial coil, again retuning. If this movement is carried too far the set will again burst into oscillation, and much care should be taken that this does not occur.

Multi-Valve Sets

The procedure in the case of a set employing two or more valves may be very closely similar to that which we have been considering, but the exact operation will depend upon the circuit incorporated in the set. If the set consists of, say, a rectifying valve followed by low-frequency stages, the method of tuning-in distant stations will be exactly the same as that which we have been considering, the preliminary operations being exactly the same, save that each of the valves must be illuminated to the correct degree, and a suitable high-tension voltage should be applied to the low-frequency valves if separate terminals are provided for the purpose. As a beginning, try 60 volts on the detector and, say, 90, or possibly quency amplifiers. If no separate a little more, upon the low-frequency terminals are provided for the purpose try a uniform voltage of 72 volts for the whole set.

Tuned High Frequency

In the case of sets employing high-frequency amplification there will almost certainly be another circuit to tune, and we are then confronted for the first time by the problem of a set upon which there are two or even more tuning dials. However, the mode of operation is

very closely similar to that which we have already been considering, since the reaction adjustment will be very much the same, depending upon the distance from the broadcasting station, but the mode of searching must be somewhat different. For one's first attempt one should rather adopt the logical method of setting both condensers to their zero readings, having inserted suitable coils, as per the previously mentioned table, then advancing the aerial condenser five degrees, revolving the anode condenser through its whole scale and back again to zero, advancing the aerial condenser another five degrees, and then revolving the anode condenser again round its whole scale and so on, until signals are picked up, whereupon one makes a careful final adjustment upon both the condensers, re-adjusting the reaction as before, adjusting filament current and so forth.

G. P. K.

The Home 3-Valve Receiver.

SIR,—Re your Home Three-Valve Receiver described in MODERN WIRELESS Christmas Number, you will be glad, I think, to hear some of the results obtained. I mounted the set with a power amplifier (transformer ratio 1:7), and am really astonished at the power and purity obtained. Brussels, Paris and Chelmsford are deafening; and London, Bournemouth, Newcastle, and many German stations come in at very good loud-speaker strength. The most astonishing thing is that not the least distortion is noticeable, thanks to the excellent L.F. mounting.

As a real wireless amateur, I think it is my duty to thank you for such a valuable mounting and for the priceless information already gathered in your publication.—
Yours truly,

R. OMMEGOWCK.

Antwerp.

FREE BLUE PRINT.

A Free Blue Print will be given away with next month's MODERN WIRELESS Special Spring Double Number.

PRICE 1/6

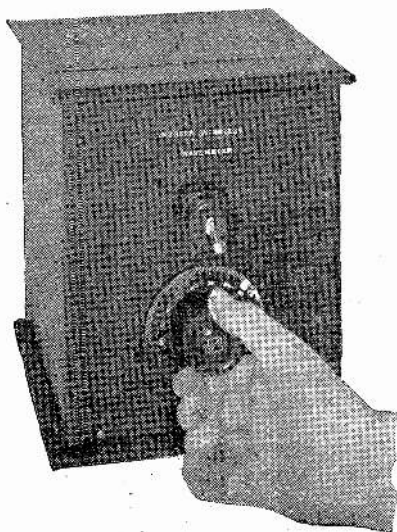

Setting the dial for a measurement.

ALMOST every listener could make good use of a wavemeter, and certainly every experimenter should possess one. Incidentally, if more wavemeters were used there would probably be less howling, which generally arises from hunting "all over the place" for a station which can be found only on one adjustment, to the intense annoyance of other listeners throughout a wide area.

What is a wavemeter? It consists in the main of a circuit in which oscillations may be set up. For use it will be calibrated—that is to say, its indicating dial will be used in conjunction with a table or chart which will show that, for example, 60 degrees is the setting

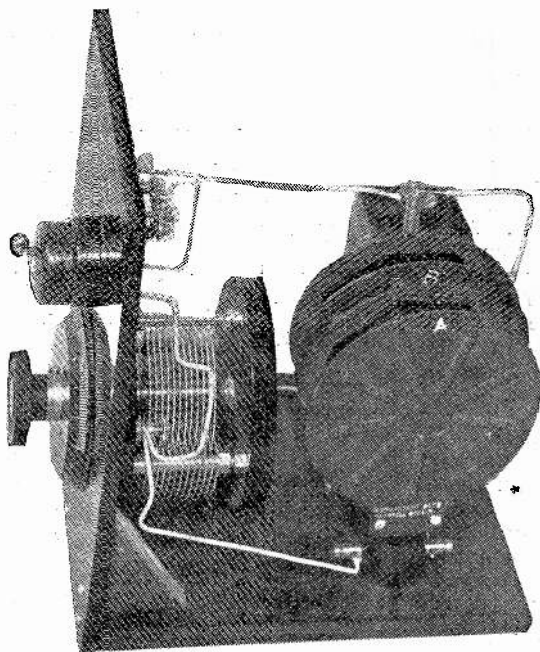

The wavemeter removed from its case.

Wavemeters

How to Make and Use Them.

By PERCY W. HARRIS, M.I.R.E.
Assistant Editor.

for 380 metres, while 75 degrees is, perhaps, the setting for 420 metres. It can function in several ways. Let us see what kinds of wavemeter are generally available.

(1) The Buzzer Wavemeter

The buzzer wavemeter consists of a circuit containing inductance and capacity (in plain words, a coil and a condenser), one or the other of these two units being continuously variable. Connected to this circuit is a little electric buzzer (operating on the same principle as the vibratory mechanism in an electric bell) and one or two dry cells to drive it. It consists simply of an electromagnet, an armature of soft iron (to which, in the case of an electric bell, the tapper would be attached), suitable contacts and the necessary framework. Current from the battery passes through the windings on the electromagnet to a spring contact on the back of the soft iron armature; from this contact to another on the framework and thus back to the battery.

Just as soon as current passes through the windings of the electro-magnet, the armature is drawn towards it, thereby opening the contacts. This causes the current to cease flowing, whereupon the armature is released, the contacts coming together once more, and the current flows again. In this way the armature is attracted and released and a buzzing is produced.

It is not the audible buzzing that is of use to us in wireless, but another phenomenon which accompanies it.

It really takes an appreciable fraction of a second for the

current to grow to its maximum in any circuit of an inductive nature. This fraction is very tiny in a circuit which can be made to oscillate at the frequencies used in wireless, but may be two or three seconds in a very heavy winding of wire on

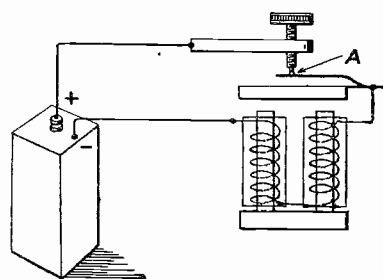

Fig. 1.—Illustrating the principle of the buzzer.

an iron core. If in the path of the current from the buzzer back to the battery we include the inductance, or coil of wire, in the oscillatory circuit to which we have referred in a previous paragraph, the current will take a tiny fraction of time to grow to its maximum here. There will be formed round the inductance a magnetic field which, if the circuit from the battery is suddenly broken, will set up a kind of "extra" current in the wire which will go to charge up the condenser. This condenser will discharge again through the inductance, the current will once more set up a magnetic field (although this time of lesser intensity), and so we shall have oscillations persisting until they die down due to losses by resistance and radiation.

Frequency

The frequency of the oscillations in this circuit will depend upon the inductance and capacity values. If we choose suitable values, it is a simple matter to produce oscillations of frequencies corresponding to all the different wavelengths on the broadcasting band. Commercial wavemeters consisting of a coil, variable condenser, a buzzer, "on-and-off" switch and terminals for the battery (if this is not built into the

Many beginners are under the impression that wavemeters are elaborate, scientific instruments functioning in a mysterious fashion and requiring much skill for their operation. That this is not so is shown in Mr. Harris' article, wherein he describes the construction of an efficient wavemeter and a number of interesting experiments which can be conducted with it.

instrument) are sold in very compact form. We can also make one quite simply, as I shall later show.

(2) Heterodyne Wavemeter

A more elaborate instrument is the heterodyne wavemeter. This can consist of an oscillatory circuit connected to a valve, a reaction coil being included in the plate of this valve so that continuous oscillations may be set up in the oscillatory circuit referred to. The heterodyne wavemeter is thus practically

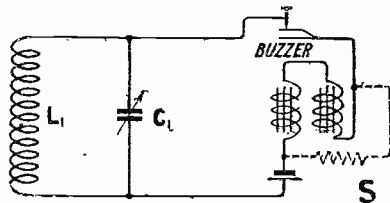

Fig. 2.—A simple wavemeter. The shunt S is sometimes included.

the equivalent of a single valve set with the reaction coil coupled tightly enough to produce oscillation, but with the aerial and earth disconnected. Heterodyne wavemeters enable very accurate measurements to be made, but are not instruments for the beginner.

(3) Transmitting Wavemeters

If we have our own transmitting apparatus and are radiating oscillations, we naturally desire to know the wavelength on which we are transmitting. Transmitting wavemeters consist of an oscillatory circuit, oscillations being set up in this by the transmitter near-by. We therefore require some form of detector to indicate to us when this closed circuit is in tune with our transmitter. There are several forms of detector which can be used here. If we are sending out damped waves, or telephony, we can shunt a crystal across our oscillatory circuit. If we are radiating continuous waves, we can have some form of sensitive

meter which will give an indication by the movement of the needle over a scale.

Home Construction of a Buzzer Wavemeter

The photographs and diagrams accompanying this article show a wavemeter which I have built in a cabinet which matches the All Concert-de-Luxe, the Transatlantic Four, and several other instruments of a similar size. Its construction is well within the abilities of any reader who has previously built his own apparatus, and the cost of building is quite low. We require—

- 1 Cabinet measuring 7 in. deep, 6 in. wide and 8 in. high (all internal measurements). That shown is a Camco cabinet.
- 1 Ebonite panel, 8 in. by 6 in. by 1/4 in.
- 1 Variable condenser (preferably square law), .0003 microfarad capacity. Any of the good makes will do; I have used the Peto Scott.
- 1 Small buzzer. (Silvertown & A.P.M. Co. buzzers are two of the kinds which will suit this instrument.)
- 2 Coil sockets for base board mounting.
- 1 Short-circuiting plug.
- 1 "On-and-off" switch. That shown is of the ebonite type generally

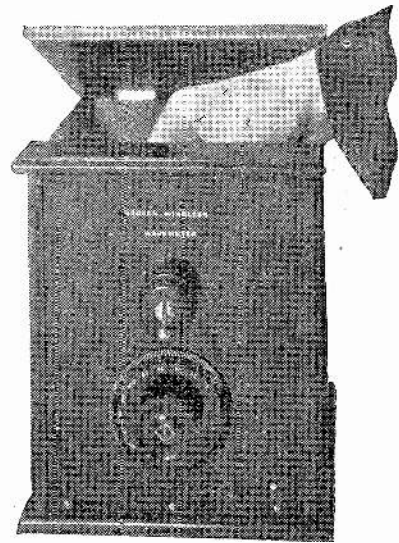

The buzzer is adjusted by lifting the lid.

fitted to motor-car dashboards. Any suitable "on-and-off" switch will do.
 1 Small dry cell.
 Suitable coils.
 The cabinet should have a lift-up lid for easy change of coils and for occasional adjustments of the buzzer.

Easy Constructional Work

The ebonite panel can be obtained cut to size and guaranteed free from surface leakage. If you cut the ebonite panel yourself, make sure that it is leakage free. If you have any doubt, remove the surface

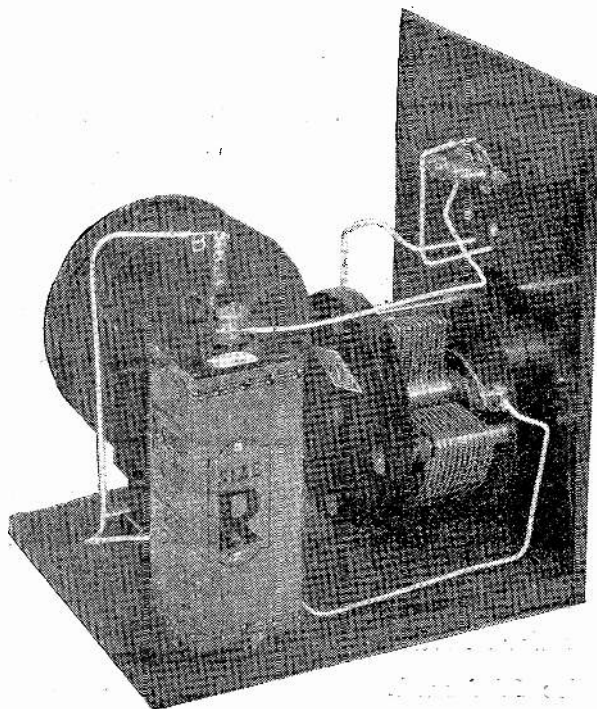

Another view of the interior mechanism.

Humiliation!

The one Word that describes your feelings when the Set your Guests have been specially invited to hear fails..... the Fault is in the Transformer!

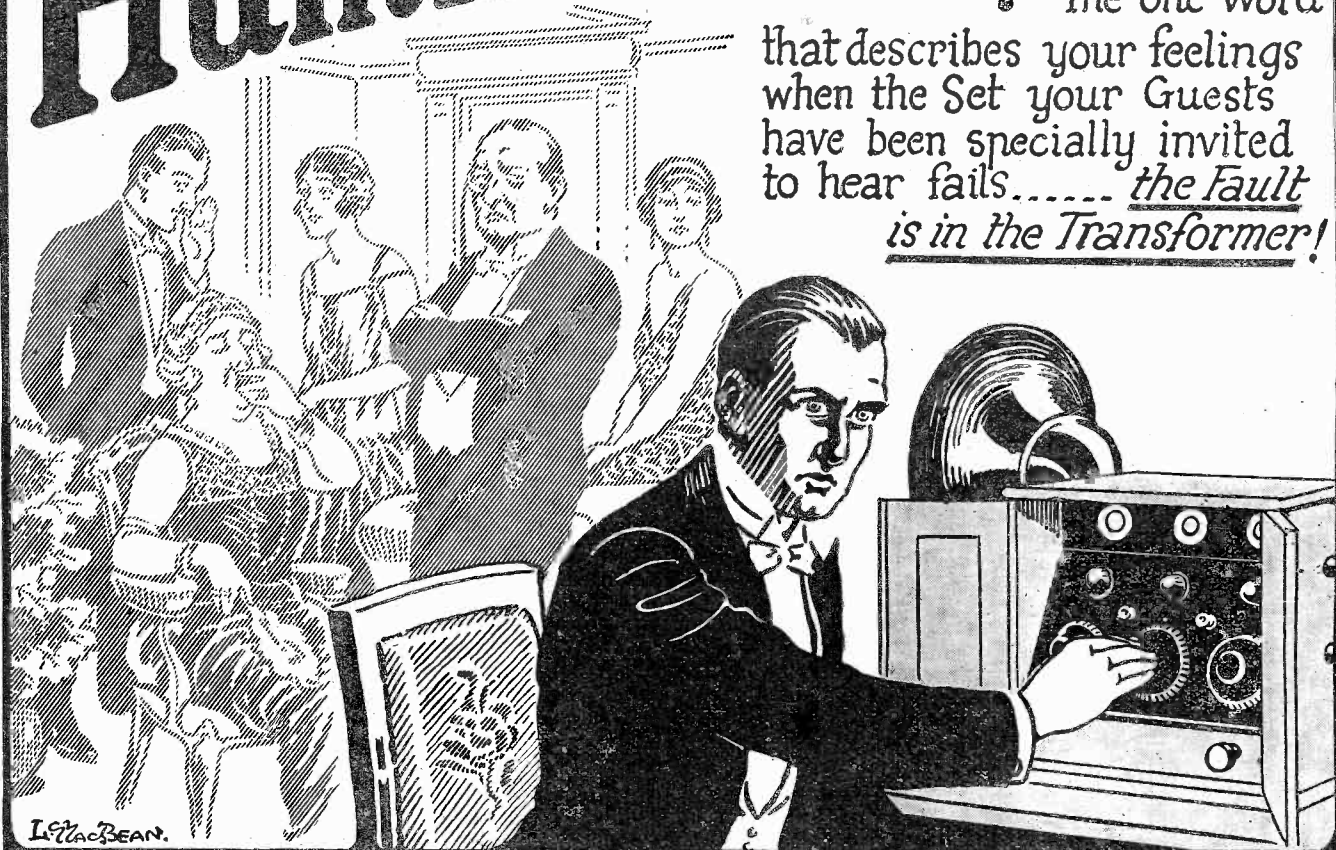

“POWQUIP” NEVER FAILS!

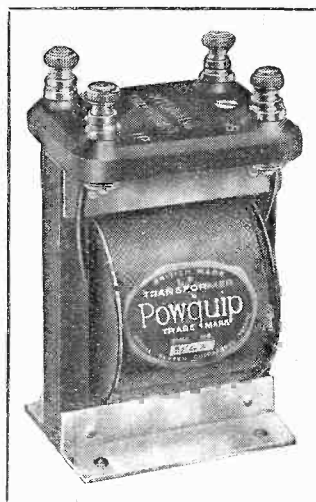

Standard Model.
Price 14/6 each.

**“POWQUIP” TRANSFORMERS
FOR RELIABILITY.**

Of all Dealers
or:—

The
**POWER EQUIPMENT
COMPANY LIMITED**

**KINGSBURY WORKS
THE HYDE, HENDON
LONDON - N.W.9**

Telephone : — Kingsbury 196-197.
Telegrams :—Powquip, Hyde, London.
Code :—Bentleys.

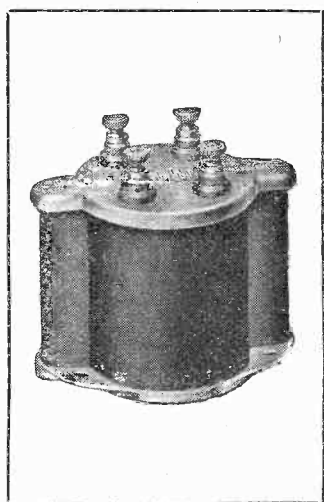

Shrouded Model.
Price 18/- each.

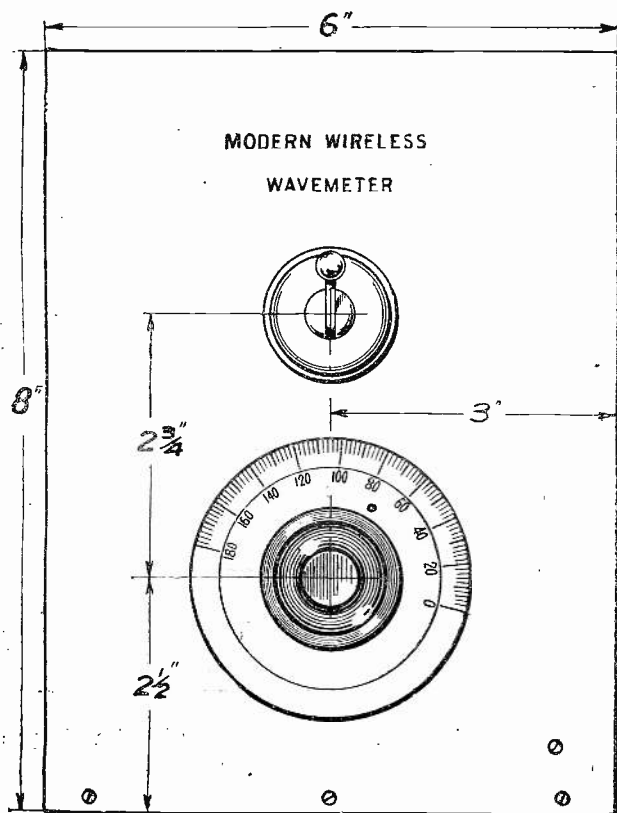

Fig. 3.—Detailed measurements of the front of panel.

skin of the ebonite on both sides of the panel with emery-paper.

The mounting of the variable condenser and the "on-and-off" switch will occasion no difficulty. The mounting of the buzzer will require a little care, for the securing screws are generally small. If you can obtain the buzzer ready mounted on a piece of ebonite it will be much easier to secure this to the back of the panel without injury to the delicate parts.

You will notice that the ebonite panel is secured in a vertical position to the wooden base board which slides in and out of the cabinet. To hold the panel upright you will need two or three screws along the bottom and some kind of bracket. As the panel is not large, a triangular piece of wood will be quite sufficient, or you may use a pair of brass brackets of a suitable size and easily obtainable from your ironmonger.

Coil Sockets

The coil sockets are placed side by side. The exact position of these two should be determined when you decide which make of coils you will use, as the coils should stand as close as convenient. Any of the well-known makes of plug-in coil will be suitable, and for reasons I shall later explain I use two coils simultaneously. It is not essential

to do this, and you can, if you like, use only one coil, in which case I advise you to mount both of the sockets as shown (in case you want to use the two coil method later) and to short-circuit the left-hand socket (looking from the front) until you need it.

For wiring up I have used the new product known as "Glazite." This consists of square section tinned copper wire enclosed in an insulating material, and is obtainable in a number of colours. It is stiff enough to stay in position when bent and gives quite an attractive appearance to the set, which, however, can be wired up in the usual way with tinned bus-bar wiring without any alteration in efficiency.

If you use a dry cell which has one terminal of the screw pattern and the other a flexible wire, it is just as well to provide yourself with a little brass connector consisting of a small tube with two securing screws, one at each end. This will enable you to connect the wire from the instrument to the negative lead of the battery without soldering, and will facilitate an interchange of battery when required. You can, of course, solder the connection if you like.

to do this, and you can, if you like, use only one coil, in which case I advise you to mount both of the sockets as shown (in case you want to use the two coil method later) and to short-circuit the left-hand socket (looking from the front) until you need it.

For wiring up I have used the new product known as "Glazite." This consists of square section tinned copper wire enclosed in an insulating material, and is obtainable in a number of colours. It is stiff enough to stay in position when bent and gives quite an attractive appearance to the set, which, however, can be wired up in the usual way with tinned bus-bar wiring without any alteration in efficiency.

The buzzer I have used is designed to work from a single dry cell, and it is convenient to use one of this type, but of course buzzers designed to work from two or three cells can be used if desired. There is, however, barely room enough for more than one cell in this particular box, and if you choose the size of cabinet I have adopted it will be best to use a one-cell type of buzzer.

Testing Out

Before the buzzer will operate it is necessary to place the coils in their sockets, or rather a coil must be placed in the right-hand socket, looking from the front. Unless this is done the battery circuit through the buzzer will not be completed. Place a pair of coils in the socket, connect up your battery, place the switch at the on position and see whether the buzzer is operating. If it does not buzz immediately, look for the adjusting screws, and carefully vary them until a satisfactory buzz is obtained. The chief adjustment is that of the contact screw, which is generally provided with a locking nut, and steadiness of note can be obtained by adjusting the tension of the spring by means of the tension screw, which will easily be found. Few buzzers can be relied upon to

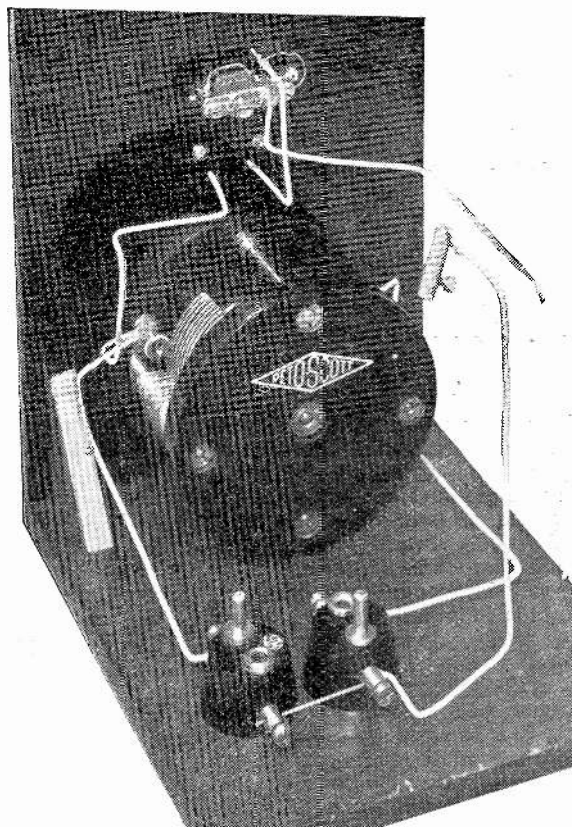

The coils and battery removed.

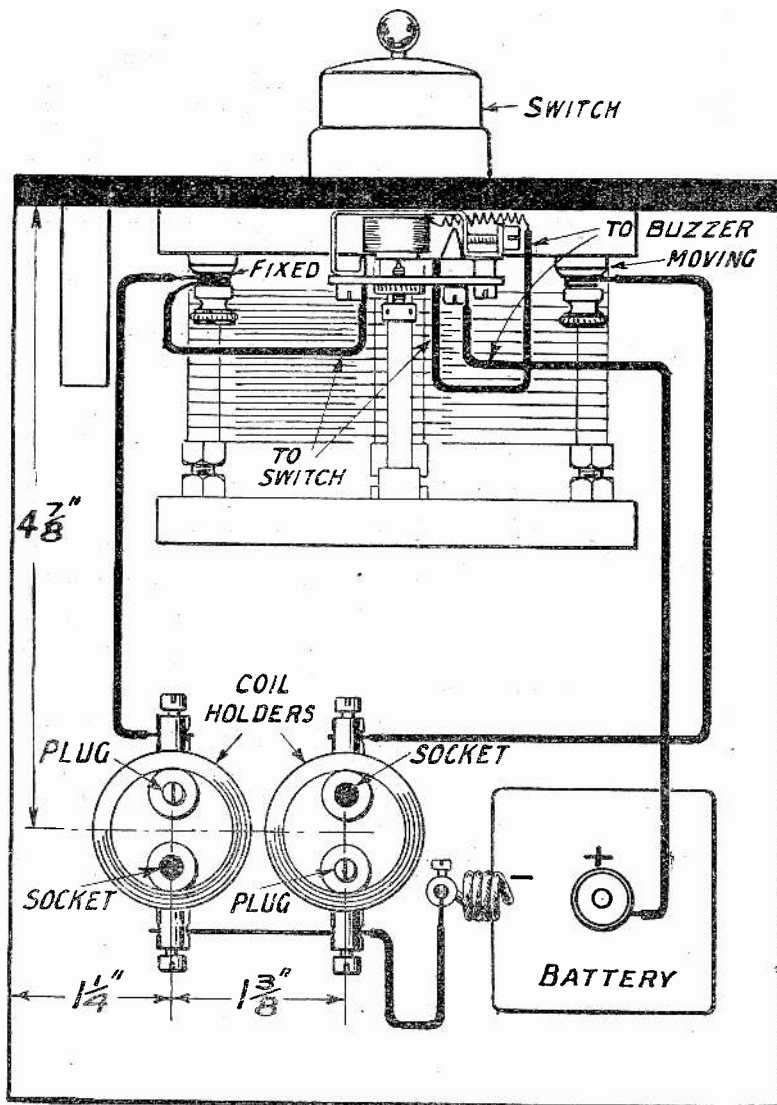

Fig. 4.—Practical wiring diagram.

operate successfully over long periods, and require adjustment now and again, even in the best commercial instruments.

Two Coils

You may wonder why I have used two coils in this instrument. If you examine the circuit diagram you will see that the two coils are in series and that the variable condenser is shunted across both. The battery circuit, however, is completed through only one coil, and this in practice gives sharper tuning. If you short-circuit the left-hand socket and place a coil in the right-hand socket equivalent in size to a No. 75 coil, you will find that this buzzer wavemeter will cover the whole broadcast range from well below 300 to over 600 metres quite successfully. If, however, you place a No. 35 coil in the

right-hand socket and a 50 coil in the left, you will cover about the same wavelength range, but tuning will be slightly sharper.

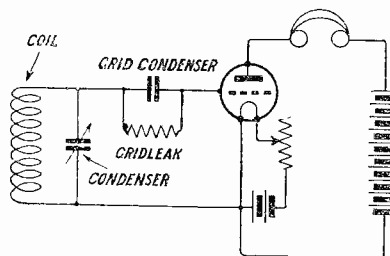

Fig. 5.—How to arrange a circuit for measuring capacity or inductance.

If you examine the diagram of connections and the photographs, you will see that the two coil sockets are arranged so that the

pin of one is alongside the socket of the other. It is necessary to arrange your plugs and sockets exactly in this fashion, or the windings will be reversed in relation to one another. For the broadcast band a 35 and a 50 together will suit, or a Gambrell A and B.

If the buzzer buzzes satisfactorily you will want to try out the instrument and calibrate it. First of all place it alongside your receiver (set for your local station adjustment), put the buzzer in operation, switch on your valve or valves and listen. Probably you will hear nothing, but as you vary the dial of the wavemeter variable condenser you will

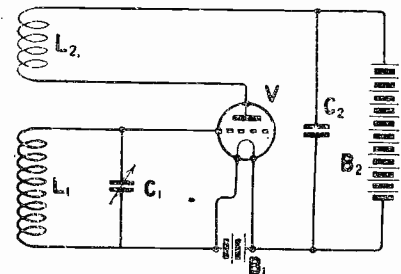

Fig. 6.—The circuit of a simple heterodyne wavemeter.

begin to hear a buzzing in the telephones, and on one setting this buzzing will be loudest. Turning beyond this point, the sound will die away again, and you will soon find it quite a simple matter to set the wavemeter on the exact position giving the loudest buzz in your receiver. You will, of course, know the setting of your receiver to get the best results from the local broadcasting station, so that if you adjust your dials for this you will be able to find the position on the wavemeter corresponding with the wavelength of your local station. Make a note of the reading, and if you know of any other positions on your receiver corresponding with other wavelengths, buzz for these and make a corresponding note. It is quite a good plan to keep a special notebook for the wavemeter readings.

If you have a friend who has a calibrated wavemeter, you may borrow this, or arrange for him to bring it to your house, and calibrate your own from it. To do this is quite a simple matter, and all you need is your own receiver and the two wavemeters. Take your friend's wavemeter and adjust it for a wavelength towards the bottom of the scale. Set it buzzing, and tune your receiver to this wavelength by adjusting it until you hear the loudest buzz from this meter. Turn off your friend's meter and leave your receiver set.

LISSENIUM

Bringing filament control to a fine art.

It is only when you have learnt from experience how LISSENIUM control aids your valve to detect that you appreciate how impossible it is to duplicate the performance of the LISSENIUM with any other rheostat.

The LISSENIUM gives you absolute control over the flow of a critical electron emission, putting such a fine edge on your detection that distant stations tune in better, stronger, more clearly than before.

With the knob of the LISSENIUM between your fingers you can feel for the point of sharpest tuning, and you will never fail to find it.

There are three models--

- LISSENIUM MINOR (patents pending), provides LISSENIUM control at a popular price **3/6**
- LISSENIUM MAJOR (patents pending) gives the most acute tuning possible **7/6**
- LISSENIUM UNIVERSAL (patents pending), with its protective device for dull emitters **10/6**

ALL HAVE LISSENIUM ONE-HOLE FIXINGS, OF COURSE.

Varying Grid Leak Value according to signal strength

There is considerable variation in grid voltage fluctuations according to the strength of signals coming through, and the grid leak value needs to be adjusted according as to whether you are receiving loud local signals or distant ones. For instance, on loud local stations the leak resistance required might be about $\frac{1}{2}$ meg. If a higher value is used the effect of the cumulative charges on the grid would be to introduce a certain amount of distortion. On the other hand, if the same low value is used in receiving distant stations, the signals will be very weak owing to insufficient resistance being interposed between the grid and earth to prevent the minute grid fluctuations from leaking away too easily. Increase the leak resistance in circuit, therefore, when weak signals are being received. By using the LISSENIUM Variable Grid Leak you are sure of having the means of obtaining correct grid potential under all conditions of reception. Has a low minimum and a high maximum. LISSENIUM ONE-HOLE FIXING, OF COURSE Price **2/6**

LISSENIUM Variable Anode Resistance, 20,000 to 250,000 ohms. **2/6**

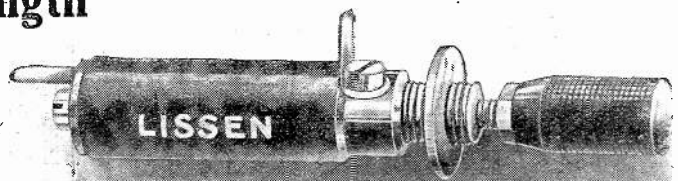
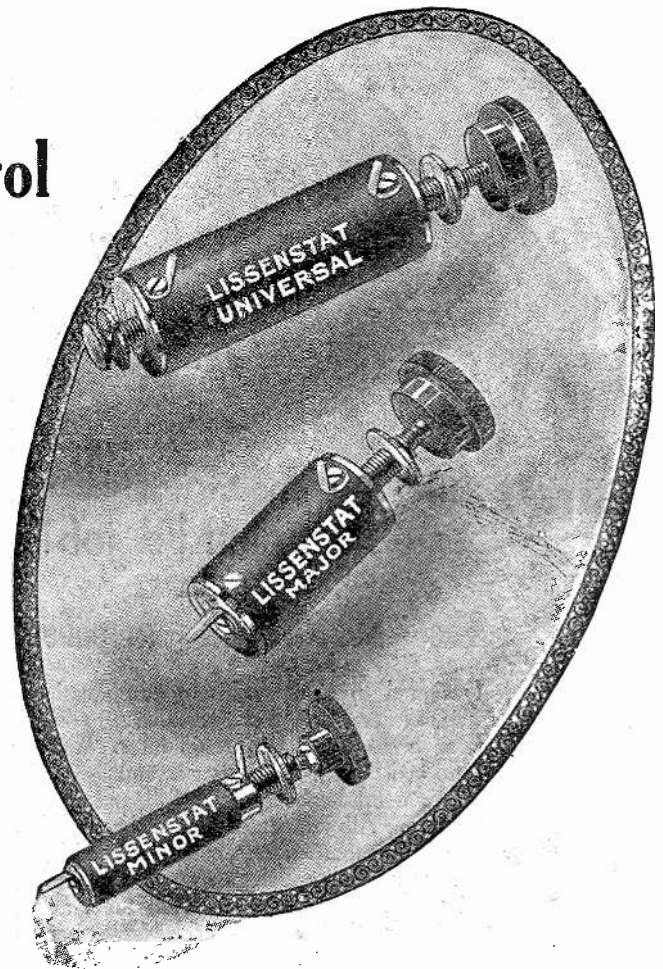

Smooth out loud speaker distortion by putting the LISSENIUM Variable Grid Leak across the secondary of the last transformer or across the loud speaker itself—first position is the better.

PARTS WHICH PULL TOGETHER
—there is a LISSENIUM Part for every vital place.

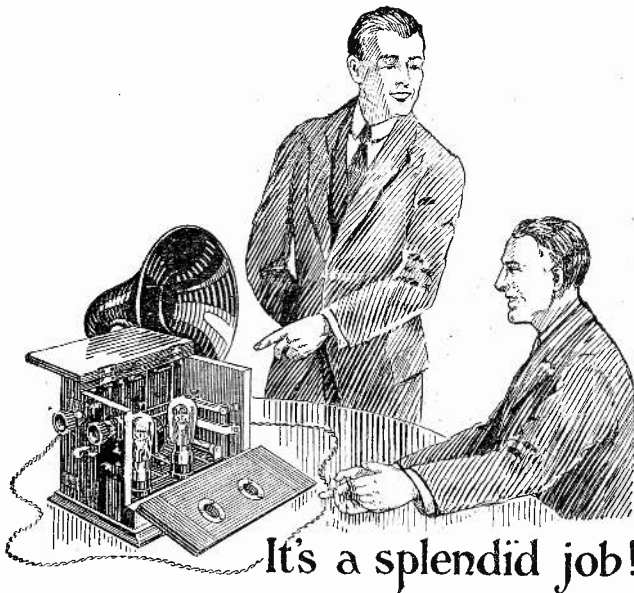

It's a splendid job!

The SUPRATONE Amplifier

Designed to give maximum amplification without distortion, this two valve Amplifier is a high-class job throughout. When used with any valve or crystal set, it works a loud-speaker with full and clear volume. All joints are soldered, and all terminals mounted on ebonite, the wiring being kept parallel. Two "Supra" transformers amplify with rich tone, and a "Microstat" adjusts each valve, controlled by master pull-push switch.

Negative grid bias is provided, and two "Mansbridge" condensers and a modulating resistance add to the purity of tone.

The Mahogany cabinet is beautifully finished and has hinged top and side, with two valve windows **£4**

The SUPRA Transformer

The wonderful success of our Amplifier is largely owing to this transformer. The windings are different from the ordinary, being in insulated layers each having six sections, giving wonderful amplification but no distortion. Ratio 5 : 1 **12/6**

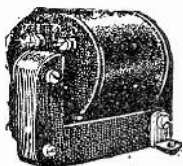

WYATES

12-13-14, Gt. Queen St., KINGSWAY, W.C.2

Phone: Gerrard 575/6.

'Grams: Zywateseng, Westcent.

WORKS: LONDON, BIRMINGHAM & WESTCLIFF.

ROSEBROS
GUARANTEED
RADIO
COMPONENTS

EBONITE PANELS

RADIO QUALITY

Size.	Price.	Size.	Price.
6½ × 5½ × ¼	1/9	10½ × 8½ × ¼	5/3
6½ × 5½ × ¼	2/-	12 × 10 × ¼	7/3
8 × 6 × ¼	2/3	14 × 12 × ¼	10/-
8 × 6 × ¼	2/10	16 × 12 × ¼	11/6

Other sizes to order.

THESE PANELS are of Finest Quality Ebonite. Matt finish and with square edges. Each panel is sent out in a priced envelope and ready for use.

Delivery from Stock Guaranteed

ROSEBROS COILS

No. of Coil.	Wavelengths in metres when shunted by '001 Var. Cond.	Retail Price.
25	160 to 350	3/9
35	250 to 500	3/9
50	350 to 750	3/9
60	400 to 850	3/10
75	500 to 1,150	4/-
100	600 to 1,650	5/6
125	700 to 2,000	5/9
150	850 to 2,500	6/-
200	970 to 3,400	7/-
250	1,300 to 4,500	7/6
300	1,900 to 6,000	8/-
400	2,600 to 8,000	9/6

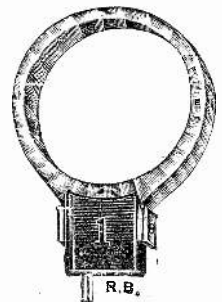

THE IDEAL CRYSTAL

For Distance, Volume or Reflex Circuits

A Spiral contact of a special alloy is included

A Super Crystal.

Triple Tested.

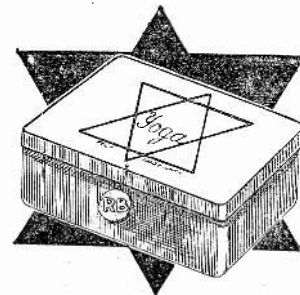

Loud, Clear.

Ever-lasting.

Sealed boxes

2/6 each

Trade enquiries invited.

ROSE BROS.
Electrical Co., Ltd.

London: 25, Milton St., E.C.1.
Glasgow: 194a, St. Vincent St.
Manchester: 25-27, Miller St.
Bristol: 83a, Redcliffe St.

S.S.A.

Now start your own wavemeter, and vary its dial until you get loudest buzzer signals in your 'phones. Make a note of this position, alter your friend's wavemeter to a slightly higher wave-length and take a new set of readings. Take as many readings as you can in this way, and when you have obtained all the figures plot out a calibration curve. A calibration curve is simply a diagram ruled into squares, wavelengths being marked off along one side and condenser degrees on the other. By making dots on the chart where the vertical and horizontal lines from the degrees and wavelengths intersect, you will see they form a line which will closely approach a straight line. Join all these points together and you will get the positions of intermediate readings.

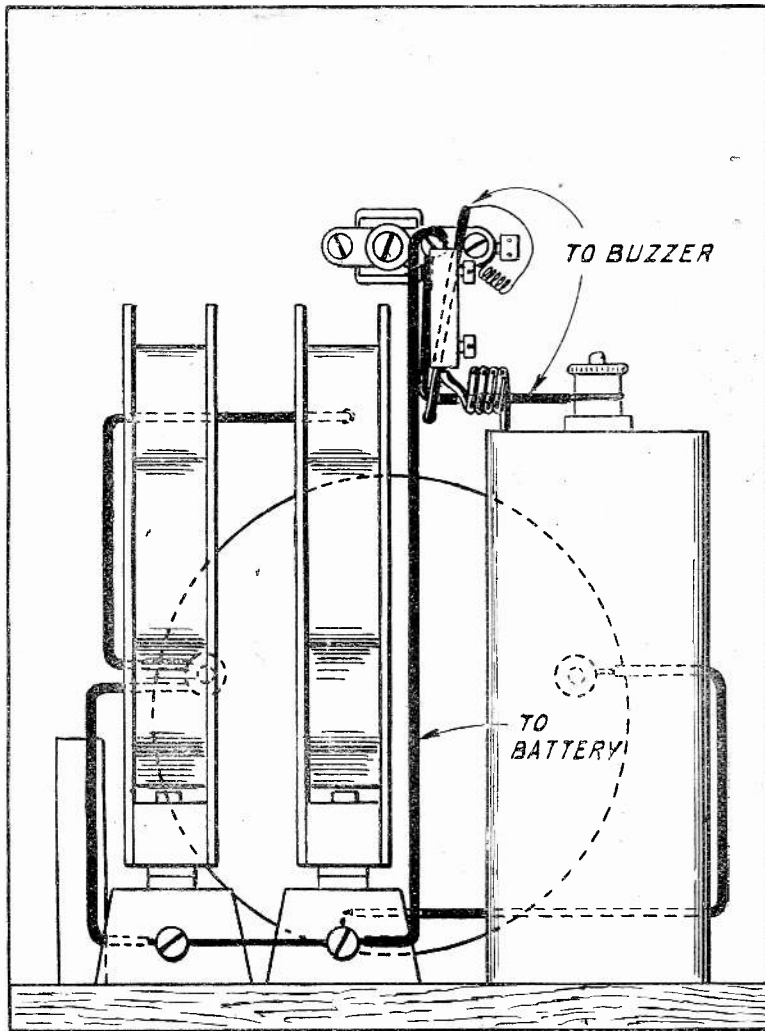

Fig. 7.—Another wiring diagram from a different angle.

When we say that a wavemeter tunes very sharply, we mean that you will get very little sound from it either side of the exact reading for the wave-length to which your receiver is set. By passing the buzzer current through only one portion of the total winding, sharper signals are obtained than when we pass the current through the whole of the winding. However, to obtain this sharpness of tuning we must sacrifice a little strength. There is not a great deal to choose between the two methods.

Uses of a Wavemeter

Now let us see how many uses there are for this instrument.

1. To adjust our receiver to the wavelength we wish to receive prior to the starting up of the broadcasting station.
2. To adjust a crystal detector to the most sensitive point prior to the opening of a broadcasting station.
3. To ascertain the wavelength range covered by a given coil and condenser.

4. To find the capacity of the condenser, the value of which we do not know.
5. To ascertain the inductance of a coil, the value of which we do not know.
6. To find the wavelength of a

the local station and to keep it thus set for general testing purposes. If you belong to the local wireless society you will have no difficulty in finding someone with a calibrated wavemeter who will help you to calibrate your own.

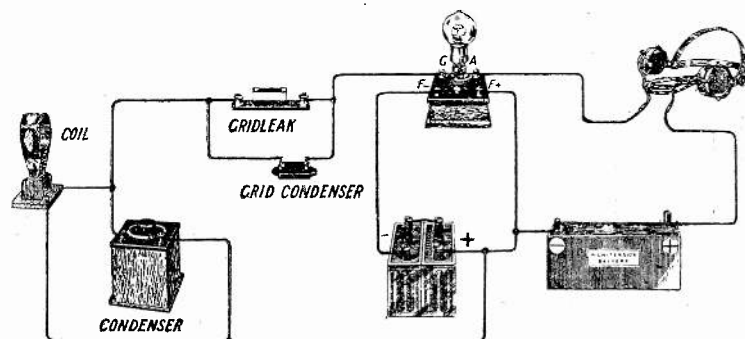

Fig. 8.—Pictorial arrangement of the Fig. 5 circuit.

7. To test whether our receiver is functioning properly.
8. To compare, roughly, the relative

If you have a sensitive set you will often pick up other stations. Every time you pick up a new station, find the setting on your wavemeter corresponding to it. In

(Continued on page 95.)

A Chelmsford Crystal Receiver . . .

By A. D. COWPER
M.Sc., Staff Editor.

Although primarily designed for the reception of Chelmsford, this receiver may also be used on the ordinary B.B.C. wavelengths.

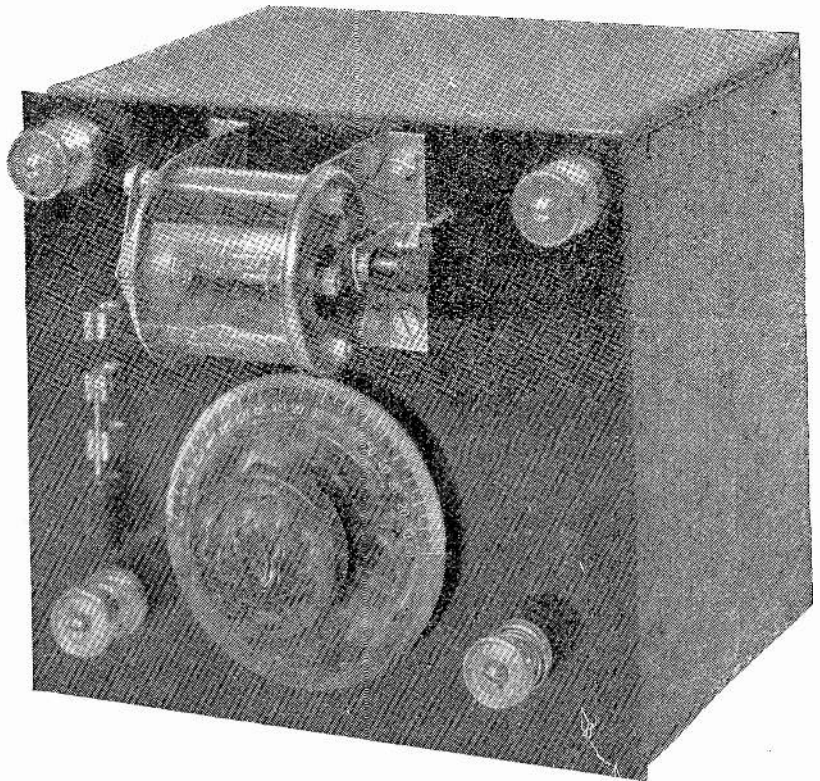

The switch on the left is used for changing over from short to long waves.

WITH the welcome news as to the permanency of a high-powered central station operating on a long wavelength, and of the more extended programme to be broadcast from 5XX and its successor in the Midlands, will certainly come a renewed demand for a crystal receiver for the longer waves: a "fool-proof" type of family set which anyone can operate; or alternatively a "stand-by" receiver to bring into use when the regular valve receiver for the local short-wave station is temporarily out of commission. Experi-

ence has shown that, except in the immediate neighbourhood in London—where reception of 5XX is occasionally extremely poor—and

perhaps in a few local "blind spots," the high-powered station is received well on the crystal over an immense area, and, of course, with certainty.

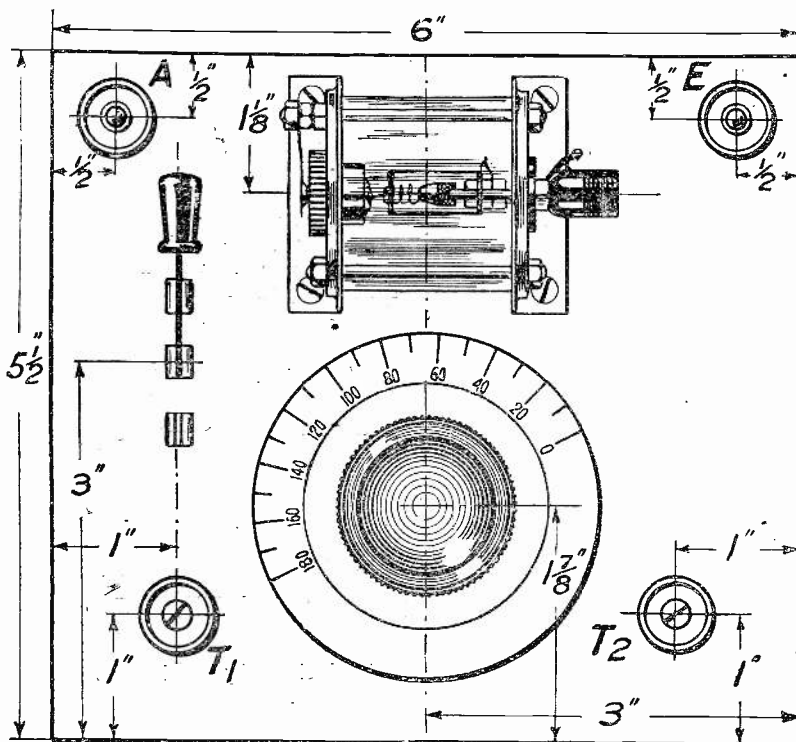
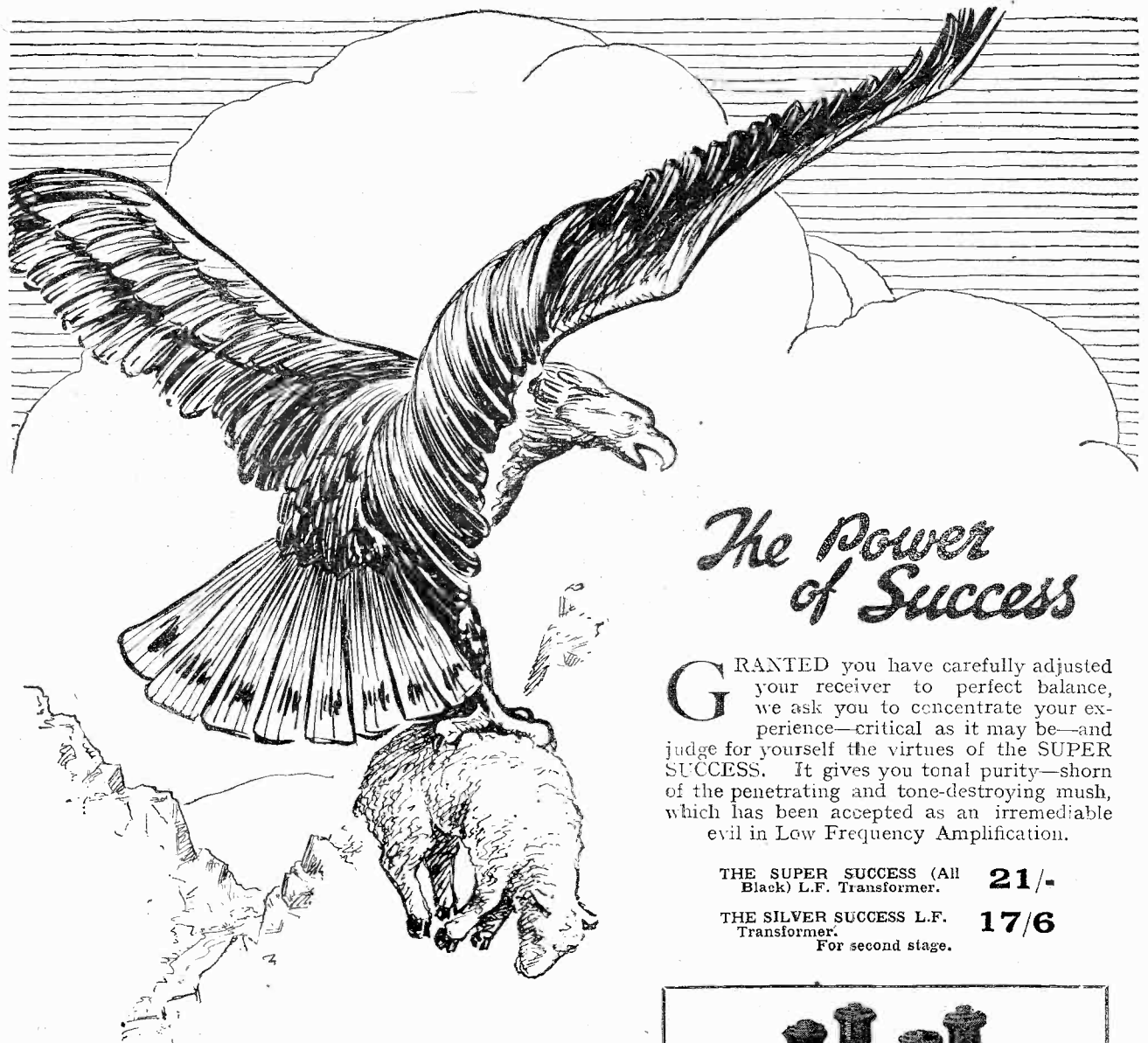

Fig. 1.—Dimensions for the panel layout are clearly shown on this diagram.

Excellent Signal Strength

With the simple little receiver described here, Chelmsford came in on a good high country aerial at 35 miles away with a signal strength which gave a comfortable reproduction of music on five pairs of phones in parallel. On a loud-speaker six people in a large room could distinctly follow the transmission, for the measured signal strength at night was no less than 36 microamperes for the whole rectified wave. This must not be mistaken for real "loud-speaking," but represents just four times the best obtainable result from the short-wave station (2LO) at the same distance and on the same aerial, even when equipped with a counterpoise earth. At night Radio-Paris came in quite distinctly in a quiet room on the headphones and on the same aerial, when Chelmsford was not working. Evidently, then, provided a good high aerial is available, together with a good earth, excellent reception may be expected on this receiver over a very large area from the new permanent station.



The Power of Success

GRANTED you have carefully adjusted your receiver to perfect balance, we ask you to concentrate your experience—critical as it may be—and judge for yourself the virtues of the SUPER SUCCESS. It gives you tonal purity—shorn of the penetrating and tone-destroying mush, which has been accepted as an irremediable evil in Low Frequency Amplification.

THE SUPER SUCCESS (All Black) L.F. Transformer. **21/-**

THE SILVER SUCCESS L.F. Transformer. **17/6**
For second stage.

Ask also for the
**SUCCESS VERNIER
COIL-HOLDER.**

For panel mounting 5/6
For behind panel mounting ... 8/6
SUCCESS Neutrodyne Condenser 3/6

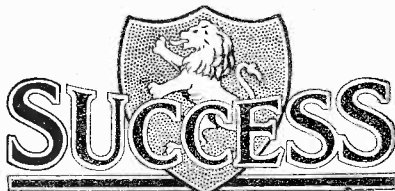

COMPONENTS
OBTAINABLE FROM ALL DEALERS.

BEARD & FITCH, Ltd.

34, Aylesbury Street, London, E.C.1.

Telephone: Clerkenwell 8641.

North of England Branch:
1, DEAN STREET, PICCADILLY, MANCHESTER.
Telephone: Central 8240.

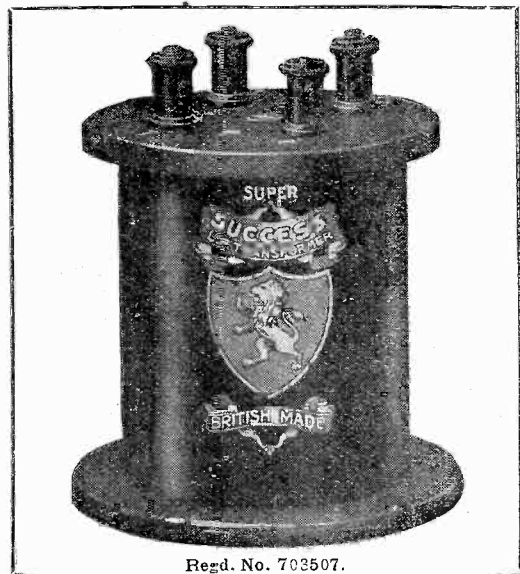

Regd. No. 703507.

Facts that count

Whether you are a serious experimenter or not you want a combination of

EFFICIENCY & SELECTIVITY with your Tuning Coils. These facts are dependent upon

LOW SELF CAPACITY

National Physical Laboratory Report on the

TANGENT TUNING COILS.

Coil No.	Self Capacity in Micro-Microfarads	Price	Complete Sets of Concert Coils
25	8 NOTE WELL	4/3	(W/L250
35	9 the extremely	4/3	to 1,180)
50	25 low self	4/3	16/- the set.
75	31 capacity.	4/6	
100	22 Compare them	5/-	11 Concert
150	16 with any other	6/-	Coils (W/L
200	22 make on the	7/-	250 to 9,500)
250	22 market.	7/6	67/- the set.

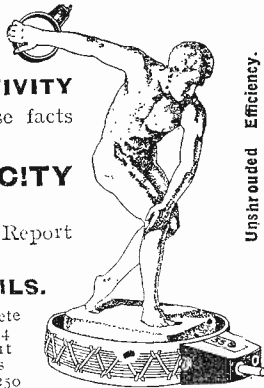

ASK YOUR DEALER TAKE NO SUBSTITUTE.

GENT & CO. LTD.

Established 1872.

Faraday Works, LEICESTER

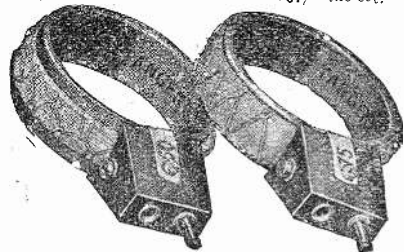

London—25, Victoria Street, S.W. 1.
Newcastle-on-Tyne:—"Tangent House," Blckett Street.

Lathes

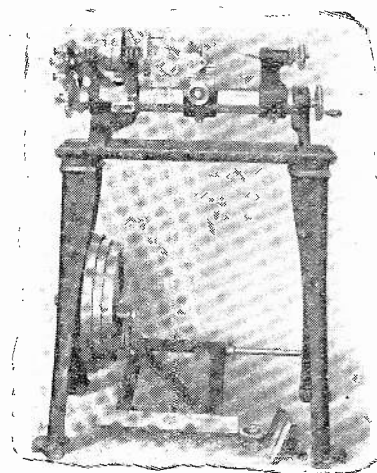

The Lathe has been called King of the Tools, and the description is apt. The amateur, the professional, the experimenter and the manufacturer all find the lathe the most essential aid if they construct their own plant. Not only for Wireless, however, is a handy lathe so valuable. In all branches of model and experimental work, and in car and motor-cycle overhauling, etc., it is always a prime essential.

For the home worker the best is the

DRUMMOND 4 in. Universal Lathe.

This tool will cover an almost infinite variety of work, including all plain turning in metal, wood, ebonite, etc., screw-cutting, drilling, boring, facing, milling, coil-winding, slotting, etc. The saddle and top slide are provided with bolt slots to enable work to be readily mounted. These work tables have a height adjustment relative to the lathe centres—a very valuable feature; this is effected by sliding saddle about the circular bed. We illustrate the lathe arranged on stand for treadle drive; note the heavy flywheel. Other forms of drive are supplied, and an extra long bed model is available at small extra cost. A Service Department is at your disposal—consult us.

Machines to suit all requirements supplied on deferred payment plan if required. Write for lists.

DRUMMOND Bros. Ltd.

Reid Hill, Guildford.



The C.A.V. SPEAKER

LOUD SPEAKER

is made in **THREE SIZES**
STANDARD - JUNIOR - TOM-TIT

Directly you hear the **C.A.V. LOUD SPEAKER** your search for an instrument capable of doing justice to the broadcasted programmes is at an end. Skilful design, sound workmanship and perfect finish are the secrets of its success, and our increased manufacturing facilities now enable us to guarantee

IMMEDIATE DELIVERY

A C.A.V. Loud Speaker makes just that difference—the difference between pleasure and disappointment, and we suggest you arrange for your dealer to give a demonstration without delay.

Meantime, write for illustrated folder.

C.A. Vandervell & Co., Ltd.
ACTON VALE LONDON, W. 3.
Members of the N.A.R.M.A.T.

STANDARD

120 ohms. **£4 15 0**

2,000 " **£5 0 0**

4,000 " **£5 10 0**

JUNIOR

2,000 ohms. **£2 15 0**

TOM-TIT

2,000 ohms. **£1 10 0**

The Coil

A low loss Harris frame-aerial type of coil is used, of a fairly substantial gauge of wire, simply tuned by a parallel condenser. In order to cover a fair range of wavelengths, and to allow the use of aerials of very different characteristics (even small indoor aerials in the immediate vicinity of the station), a large tuning condenser is used ($.001 \mu F$). Actually a $.0005 \mu F$ will generally suffice, with a generous outside aerial. The condenser used was a Raymond type with the usual one-hole fixing and metal end-plates.

The Former

The inductance is wound on the usual X frame of plywood, in slots cut in the wood. The two members of the frame are each 6 in. by $1\frac{1}{2}$ in., and have five slots each $\frac{3}{4}$ in. deep, cut with a hacksaw wide enough to take a single layer of the No. 22 S.W.G. d.c.c. wire used. They are half-notched in the middle to go together in X form. Twenty turns of the d.c.c. wire are wound on in the same direction in each slot, the wire being taken from the outer layer of the one filled slot to form the innermost layer of the next slot in succession when winding. If it is desired to receive the nearest short wave station as well in emergencies, a tapping is taken from the outermost turn of the first slot at the aerial end, so that the whole of the remaining four sets

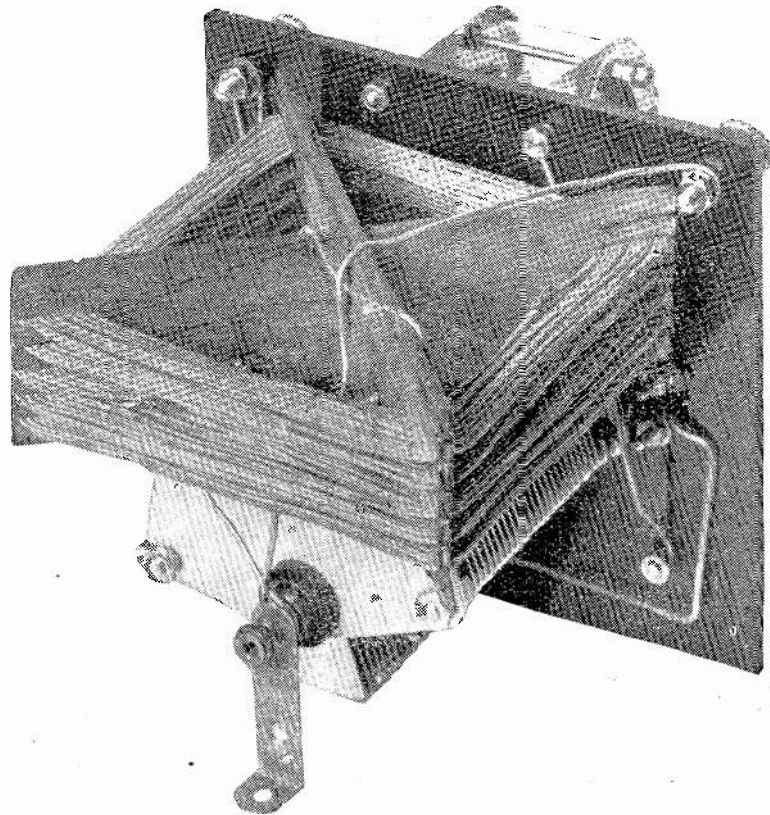

Showing how the set is supported by means of the bent brass strip when removed from the case.

of turns can be short-circuited by a switch as described below. The ends of the wire are taken to small terminals mounted in the wooden

frame, and the coil is ultimately secured in position by leads of stiff wire (No. 16 tinned copper) to these terminals, no other fixing being needed. The inner end of the first turn goes to the aerial, and the outer end of the fifth coil is connected to the terminal at the end of the tuning condenser spindle; and

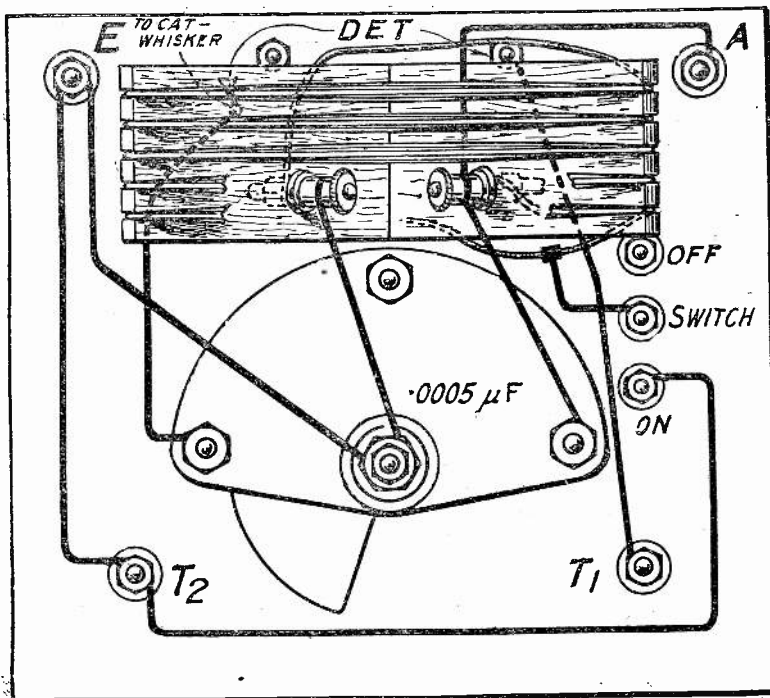

Fig. 2.—The complete wiring diagram for the receiver.

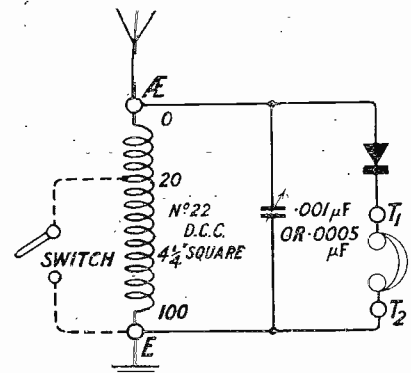

Fig. 3.—The theoretical circuit.

thence to earth. The fixed plates of the tuning condenser are also connected to the aerial end of the tuning inductance and to the crystal detector. All these connections are made with No. 16 tinned copper wire by securing

loops of wire under nuts or terminals; the only soldered joint is at the optional tapping at the 20th turn, and even this can be avoided by extending the tapping loop so as to nip this under a nut on the central part of the switch. The finished coil is *lightly* varnished with shellac (by pouring varnish well thinned by spirit over it and draining); and thoroughly baking before use.

The Panel

The actual panel was 6 in. by 5½ in. of polished "Radion" ebonite ⅜ in. thick, which does not require matting to remove the semi-conducting surface often present on nameless ebonite. This carries four terminals; aerial and earth at left-hand and right-hand

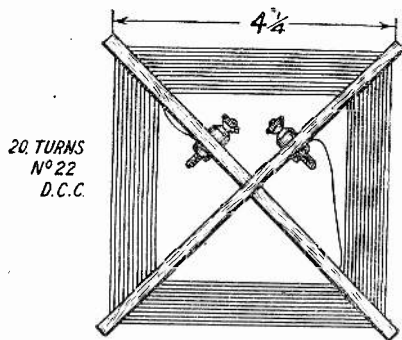
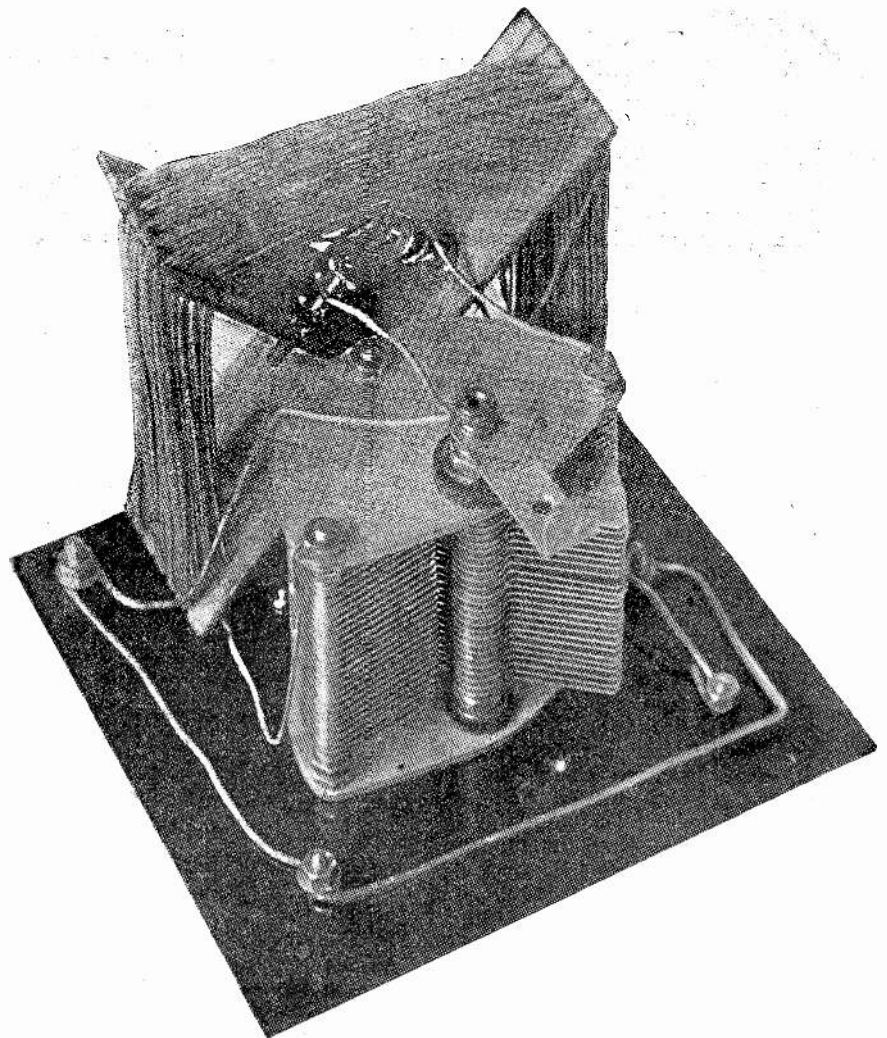

Fig. 4.—A drawing showing the X former.

top corners respectively, and two of the convenient multiple spring-grip telephone terminals obtained from Messrs. Gerard Radio at the bottom. The automatic crystal detector, of Marconi make, is secured by four small No. 4 B.A. screws and nuts to the upper centre of the panel. The tuning condenser spindle and scale are placed to the lower centre of the panel. The optional switch for giving the local short-wave station is located vertically on the left-hand side of the panel.

The Fittings

All the fittings used were nickel-plated, which, with the handsome mottled knob and bevel scale of "Trolite" composition, give a pleasing appearance to the little set. The nickelled terminals and two-way single-pole switch were supplied by the Grafton Electric Co. The detector (recently reviewed in the "Apparatus Tested" columns) automatically presents a fresh point on the crystal as well as applying the catswhisker on rotating a small knob at one end, so that this adjustment can fairly be said to be fool-proof within limits.



A view of the back of the panel which will be helpful when wiring.

The Cabinet

A plain box or small cabinet about 5½ in. by 6 in. and 5 in. deep, with one side of thicker wood to provide the base, supports the panel in a vertical position, the

removed from its case. If a larger box is utilised, naturally the panel can be enlarged to fit it.

Short-Wave Arrangements

When it is desired occasionally to receive the local short-wave station, the small double-throw single-pole switch shown is connected so as to short-circuit all but the first 20 turns of the tuning inductance. This does not give the full efficiency that a set specially designed for the 300 to 500 metres band can be made to give by using No. 15 or 18 wire and avoiding all dead-end losses (which will be appreciable here). With a small aerial and for Birmingham or Aberdeen a larger number of turns may be left in circuit. On a full-sized high outdoor aerial 35 miles from 2LO this arrangement gave with an ordinary earth about 4.5 microamperes for the whole wave, and therefore moderate reception on two pairs of 'phones only.

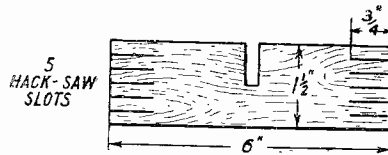

WOODEN FORMER
PLY-WOOD (2)
20 TURNS OF NO 22 D.C.C.
IN EACH OF FIVE SLOTS.
OPTIONAL TAPPING AT
NO 20 TURN

Fig. 5.—Constructional details of the coil and former.

whole simply sliding into place. A bent knee of ½ in. strip brass secured on the terminal at the end of the tuning condenser spindle supports the back of the instrument when

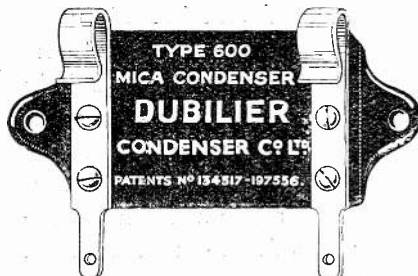
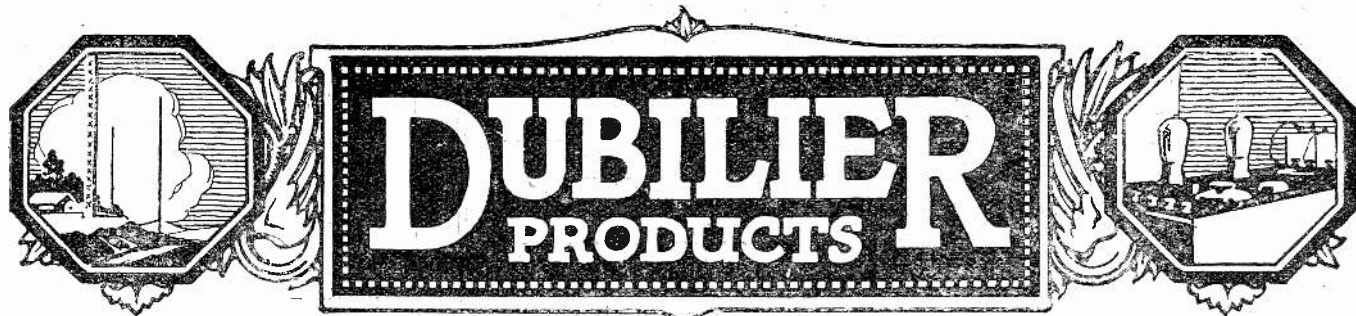

THE EFFICIENT WORKING OF YOUR SET

is dependent almost entirely on its components. The saving of a few pence on a small and apparently unimportant condenser may easily prevent an otherwise efficient set from giving its best results.

You yourself have no means of testing the capacity of condensers you buy, or of knowing whether their capacity remains constant when in use.

Your only safeguard lies in purchasing the products which carry the guarantee of a firm with a reputation to maintain.

All Dubilier fixed condensers are guaranteed to be within 15 per cent. of their stated capacity, and where desired they can be manufactured and guaranteed within still closer limits.

The types 600 and 600a are practically universal amongst manufacturers of complete sets, whilst experienced home constructors continually assure us that they can feel complete confidence in the working of their sets when—and only when—they have fitted Dubilier Condensers.

See that they are in your set as well

Type 600

For all purposes in connection with receiving apparatus. With or without clips for grid leak.

0'0001—0'0009 mfd. 2/6 each.

0'001 —0'006 „ 3/- each.

Type 600a

As Type 600 for vertical panel mounting.

0.0001—0.0009 mfd. 2/6 each.

0.001 — 0.006 „ 3/- each.



DUCON WORKS,
VICTORIA ROAD,
NORTH ACTON,
LONDON, W.3.

DUBILIER
CONDENSER CO LTD

Telephone :
Chiswick 2241.
Telegrams :
Hivolcon, Phone,
London.

Genuine "BRUNET"

STOCKED BY ALL LEADING WIRELESS DEALERS.

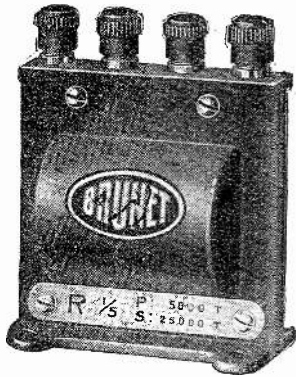

"BRUNET" L.F. TRANSFORMERS

enjoy as high a reputation as the famous "BRUNET" Headphones and many leading manufacturers of wireless sets in Great Britain and Europe have always used this L.F. Transformer owing to its magnificent amplification without distortion, freedom from breakdown, and high insulation resistance.

SHROUDED TYPE

Ratios 1/3 { 5,000 Primary turns.
15,000 Secondary turns.
Ratios 1/5 { 5,000 Primary turns.
25,000 Secondary turns.

Price 13/6 each

OVER 1,000,000 in use

"BRUNET" HEADPHONES



NEW MODEL, "TYPE D."

Hygienic Horn Headbands. Nickel-plated Stirrup. Black and White Cord. Each receiver stamped with trade mark, 4,000 or 8,000 ohms resistance.

"BRUNET" HEADPHONES

have been adopted by the majority of European Governments and Radio Companies as their standard type, and in Great Britain alone there are over 358,000 in use out of a total of 1,000,000 manufactured since 1914.

In the new model (illustrated) considerable improvements have been made in the head-band to ensure greater comfort; and the cord, of the same first-class quality, has been changed from green to black, striped with white.

Fully guaranteed, will be replaced without question if faulty.

PETTIGREW & MERRIMAN Ltd.,
122-124, Tooley St., London, S.E.1

Sole Distributors

Newey Snap

Terminals

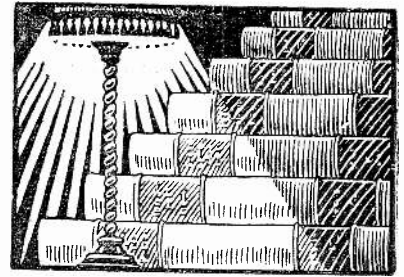

THE BOOKS

for Beginners and Experts

WITHOUT a doubt the very remarkable growth in the number of home-built Receiving Sets can be attributed to the exceptional Books and Magazines published by Radio Press, Ltd. This organisation—the largest of its kind in the world—has risen from quite modest beginnings because it was the first to realise that the crying need then, as now, was for dependable literature.

The moment a man gets really interested in Radio he is so fascinated that he immediately wants to learn more about it. Naturally he buys books and magazines—but let those books or magazines be too technical that he cannot understand and appreciate them, or let them contain inaccuracies or mis-statements and Radio loses another promising recruit.

Radio Press, Ltd., pursues a definite policy in its book publishing, which can be summed up as follows:—

(a) It publishes Books written only by authors of repute. Its Editorial Staff—both in number and in experience the strongest in the country—is well able to check every manuscript submitted and to supervise generally the publication of every Book.

(b) Each Book selected for publication must fill a definite niche in the Radio Press Series. Just as there are many grades of wireless enthusiasts from novices to experienced experimenters, so there must be various types of Radio Press Books. At the same time, however, every phase of the Science is covered so thoroughly that anyone can build up a complete library as his knowledge increases.

(c) Every Radio Press Book is printed in good style, profusely illustrated and represents particularly good value for money. While several of the more elementary ones are published at a cheaper price, the bulk of the Radio Press Series cost 2/6 each. This price permits a very high quality being maintained and allows half-tone illustrations and, in the case of the constructional books, the fullest descriptions being given of every stage of Set building.

Make up your mind to look through the whole series at your Bookseller's or Wireless Dealer's—he has them in stock or will get them for you. It will be your first step to increased proficiency.

All Radio Press publications can be obtained from any Newsagent, Bookseller, or from local wireless dealer, or direct from the Publishers.

Complete List (M) Free on Application.

Radio Press Ltd.,

Bush House, Strand, London, W.C.2

Regular Programmes from Continental Broadcasting Stations

Telephony except when otherwise stated. Corrected up to January 17th, 1925.

Edited by CAPTAIN L. F. PLUGGE, B.Sc., F.R.Ae.S., F.R.Met.S. Strictly Copyright.

WEEK DAYS.

Ref. No.	G. M. T.	Name of Station.	Call Sign and Wave-length.	Situation.	Nature of Transmission.	Closing Time or Approx. Duration.	Approx. Power used.
1	a.m.	Hamburg	— 395 m.	Germany	Time Signal in C.E.T. and Exch.	5 mins.	700 Watts
2	6.25	Eiffel Tower	FL 2600 m.	Paris	Weather Forecast	5 mins.	5 Kw.
4	6.40	Lausanne	HB2 850 m.	Switzerland	Weather Report	5 mins.	300 Watts.
5	7.05	Persbureau Vaz Dias	PCFF 2125 m.	Amsterdam	Stocks, Shares and News	10 mins.	2 Kw.
8	7.55	Eiffel Tower	FL 2600 m.	Paris	Time Signal in G.M.T. (Spark)	3 mins.	60 Kw.
9	9.23	Persbureau Vaz Dias	PCFF 2125 m.	Amsterdam	Stocks, Shares and News	10 mins.	2 Kw.
10	9.55	Eiffel Tower	FL 2600 m.	Paris	Time Signal in Greenwich Sidereal Time (Spark)	5 mins.	60 Kw.
156	10.00	Radio Wien	— 530 m.	Austria	Concert	Noon	1 Kw.
180	10.00	Breslau	— 418 m.	Silesia	Weather Report—Exchange	10 mins.	1.5 Kw.
11	10.15	Lyons	YN 470 m.	Lyons	Gramophone Concert	30 mins.	300 Watts.
12	10.30	Kbel	— 1160 m.	Prague	Exchange quotations	10 mins.	1 Kw.
13	10.30	Eiffel Tower	FL 2600 m.	Paris	Time Signal in G.M.T. (Spark)	3 mins.	60 Kw.
14	10.44	Eiffel Tower	FL 2600 m.	Paris	Fish Market Quotations—Cotton Exchange.	10 mins.	5 Kw.
182	10.55	Leipzig	— 454 m.	Germany	Stock Exchange News, followed by Concert	12 (noon)	700 Watts.
184	11.00	Zurich	— 515 m.	Switzerland	Weather Report	5 mins.	500 Watts.
15	11.00	Frankfurt	— 470 m.	Frankfurt	Time Signals in C.E.T. (spoken) followed by News	5 mins.	1 Kw.
17	11.10	Persbureau Vaz Dias.	PCFF 2125 m.	Amsterdam	Stocks and Shares.	20 mins.	2 Kw.
18	11.14	Eiffel Tower	FL 2600 m.	Paris	Time Signal in Greenwich Time (Spoken), followed by Weather Forecast.	5 mins.	5 Kw.
20	11.15	Voxhaus	— 430 m.	Berlin	First News Bulletin and Weather Reports.	5 mins.	700 Watts.
22	11.57	Leipzig	— 454 m.	Germany	Time Signal Relayed from Nauen	3 mins.	700 Watts.
185	11.57	Zurich	— 515 m.	Switzerland	Time Signal in C.E.T. do.	3 min.	500 Watts.
183	11.57	Munster	— 410 m.	Westphalia	Time Signal in C.E.T. do.	3 min.	1.5 Kw.
19	11.57	Konigsberg	— 463 m.	East Prussia	Time Signal in C.E.T. do.	3 mins.	1 Kw.
21	11.57	Voxhaus	— 430 m.	Berlin	Time Signal in C.E.T. do.	3 mins.	700 Watts.
23	11.57	Nauen	POZ 3100 m.	Berlin	Time Signal in G.M.T. (Spark)	8 mins.	—
157	noon	Zurich	— 515 m.	Switzerland	Weather Forecast, Shares News.	5 mins.	500 Watts.
24	12.00	Persbureau Vaz Dias.	PCFF 2125 m.	Amsterdam	Stocks and Shares	8 mins.	2 Kw.
26	p.m.	Geneva	HB1 1100 m.	Switzerland	Lecture	12.45 p.m.	300 Watts.
25	12.15	Kbel	— 1160 m.	Prague	Exchange Quotations	10 mins.	1 Kw.
27	12.30	Lausanne	HB2 850 m.	Switzerland	Weather Reports, Time Signal in C.E.T. and News.	15 mins.	300 Watts.
32	12.30	Radio-Paris	SFR 1780 m.	Clichy	Concert followed by News	2 p.m.	8 Kw.
30	12.45	Stockholm	— 440 m.	Sweden	Weather Forecast	5 mins.	500 Watts.
31	12.45	Persbureau Vaz Dias.	PCFF 2125 m.	Amsterdam	Stocks and Shares	10 mins.	2 Kw.
33	1.00	Haeren	BAV 1100 m.	Brussels	Weather Forecast in French and English.	8 mins.	150 Watts.
34	1.00	Munich	— 485 m.	Bavaria	News and Weather Report	10 mins.	1 Kw.
36	1.00	Stockholm	— 440 m.	Sweden	Time Signal	3 mins.	500 Watts.
37	1.15	Voxhaus	— 430 m.	Berlin	Stock Exchange News	5 mins.	700 Watts.
35	1.15	Komarow	— 1800 m.	Czecho-Slovakia.	Stock Exchange and Late News	10 mins.	1 Kw.
181	2.00	Breslau	— 418 m.	Silesia	Weather Report and Exchange Quotations	10 min.	1.5 Kw.
40	2.30	Munster	— 410 m.	Westphalia	Stocks, Shares and News	10 mins.	1.5 Kw.

Ref. No.	G. M. T.	Name of Station.	Call Sign and Wave-length.	Situation.	Nature of Transmission.	Closing Time or Approx. Duration.	Approx. Power used.
WEEK DAYS (Contd.)							
38	2.40 p.m.	Persbureau Vaz Dias.	PCFF 2125 m.	Amsterdam	Stocks, Shares and News	10 mins.	2 Kw.
39	2.45	Eiffel Tower	FL 2600 m.	Paris	Exchange Opening Prices. (Sat. excepted.)	8 mins.	5 Kw.
158	3.00	Zurich	— 515 m.	Switzerland	Hotel Baur au Lac Concert, Relayed. (Fri. excepted.)	5 p.m.	500 Watts.
202	3.00	Munster	— 410 m.	Westphalia	Concert	5 p.m.	1.5 Kw.
159	3.10	Radio-Wien	— 530 m.	Vienna	Concert	5 p.m.	1 Kw.
42	3.30	Frankfurt	— 470 m.	Germany	Light Orchestra	5 p.m.	1 Kw.
43	3.30	Konigsberg	— 463 m.	East Prussia	Light Orchestra (Wed. and Sat. Children's Hour)	1 hour	1 Kw.
44	3.30	Voxhaus	— 430 m.	Berlin	Concert, followed by News	5 p.m.	700 Watts.
46	3.30	Leipzig	— 454 m.	Germany	Concert	5 p.m.	700 Watts.
47	3.35	Eiffel Tower	FL 2600 m.	Paris	Exchange Quotations (Sat. excepted.)	5 mins.	5 Kw.
48	3.55	Persbureau Vaz Dias.	PCFF 2125 m.	Amsterdam	Stock Exchange and News	10 mins.	2 Kw.
49	4.00	Kbel	— 1160 m.	Prague	Concert	5 p.m.	1 Kw.
160	4.00	Breslau	— 418 m.	Silesia	Light Orchestra	5 p.m.	1.5 Kw.
51	4.30	Radio-Paris	SFR 1780 m.	Clichy	Concert preceded and followed by News.	5.45 p.m.	8 Kw.
52	4.30	Eiffel Tower	FL 2600 m.	Paris	Exchange Closing Prices (except Saturday).	8 mins.	5 Kw.
53	4.45	Stuttgart	— 443 m.	Wurtemberg	Concert followed by Weather Report (Saturdays excepted).	6 p.m.	1 Kw.
54	5.00	Radio-Belg.	SBR 265 m.	Brussels	Concert followed by News	6 p.m.	2.5 Kw.
186	5.00	Frankfurt	— 470 m.	Germany	Lecture	5.30 p.m.	1 Kw.
187	5.00	Hamburg	— 395 m.	Germany	Light Music	6.00 p.m.	700 Watts.
161	5.30	Munich	— 485 m.	Bavaria	Light Orchestra or Lecture	6.30 p.m.	1 Kw.
55	5.55	Lausanne	HB2 850 m.	Switzerland	Weather Report	5 mins.	300 Watts.
162	6.00	Eiffel Tower	FL 2600 m.	Paris	Concert followed by News Bulletin	6.55 p.m.	5 Kw.
177	6.00	Radio-Barcelona	EAJI. 325 m.	Barcelona	Concert	7.00 p.m.	650 Watts.
57	6.30	Kbel	— 1160 m.	Prague	Concert and News	8 p.m.	1 Kw.
58	7.00	Eiffel Tower	FL 2600 m.	Paris	General Weather Forecast	8 mins.	5 Kw.
60	7.00	Radio-Wien	— 530 m.	Vienna	Concert	9 p.m.	1 Kw.
188	7.00	Frankfurt	— 470 m.	Germany	Lecture	7.30 p.m.	1 Kw.
61	7.00	Konigsberg	— 463 m.	East Prussia	Concert and News	9 p.m.	1 Kw.
62	7.00	Hamburg	— 395 m.	Germany	Concert and Late News	9 p.m.	700 Watts.
63	7.00	Stuttgart	— 443 m.	Wurtemberg	Concert and News (Wed. and Sat. till 10 p.m.)	9.15 p.m.	1 Kw.
66	7.15	Lausanne	HB2 850 m.	Switzerland	Concert (Monday excepted)	9.30 p.m.	300 Watts.
64	7.15	Zurich	— 515 m.	Switzerland	Concert followed by Late News	9 p.m.	500 Watts.
65	7.15	Leipzig	— 454 m.	Leipzig	Concert and News (Wed. and Sat. till 10.30 p.m.)	8.40 p.m.	700 Watts.
67	7.30	Frankfurt	— 470 m.	Frankfurt	Concert and News	10 p.m.	1 Kw.
59	7.30	Munster	— 410 m.	Westphalia	Concert followed by News	9 p.m.	1.5 Kw.
72	7.30	Voxhaus	— 430 & 505	Berlin	Concert followed by News and Weather Report.	9.30 p.m.	0.7 and 1.5 Kw.
73	7.30	Munich	— 485 m.	Bavaria	Concert and News	8.40 p.m.	1 Kw.
69	7.30	Breslau	— 418 m.	Silesia	Concert	9 p.m.	1.5 Kw.
164	7.30	Radiofonica Italiana.	— 425 m.	Rome	Concert followed by News (Interval between 8.20 and 8.30)	9.30 p.m.	4 Kw.
74	8.15	Radio-Belg.	SBR 265 m.	Brussels	Concert preceded and followed by News.	10.10 p.m.	2.5 Kw.
75	8.30	Ecole. Sup. des P. & Tg.	FPTT 450 m.	Paris	Concert, sometimes preceded by Lecture, usually outside broadcast.	9 p.m.	500 Watts.
76	8.30	Radio-Paris	SFR 1780 m.	Clichy	Detailed News Bulletin	9 p.m.	8 Kw.
77	9.00	Radio-Paris	SFR 1780 m.	Chchy	Time Signal followed by Concert	9.50 p.m.	8 Kw.
78	9.00	Radio-Iberica	R.I. 392 m.	Madrid	Concert, Advertisements	Midnight	3 Kw.
189	9.00	Radio-Barcelona	EAJI. 325 m.	Barcelona	Concert	11 p.m.	650 Watts.
190	9.00	Munster	— 410 m.	Westphalia	Lessons in Languages (English, Spanish or Esperanto according to day)	9.45 p.m.	1.5 Kw.
79	10.00	Eiffel Tower	FL 2600 m.	Paris	Time Signal in Greenwich Sidereal Time (Spark).	5 mins.	60 Kw.
80	10.10	Eiffel Tower	FL 2600 m.	Paris	General Weather Forecast	5 mins.	5 Kw.
81	10.44	Eiffel Tower	FL 2600 m.	Paris	Time Signal in G.M.T. (Spark)	3 mins.	60 Kw.
82	11.57	Nauen	POZ 3100 m.	Berlin	Time Signal in G.M.T. (Spark)	3 mins.	—

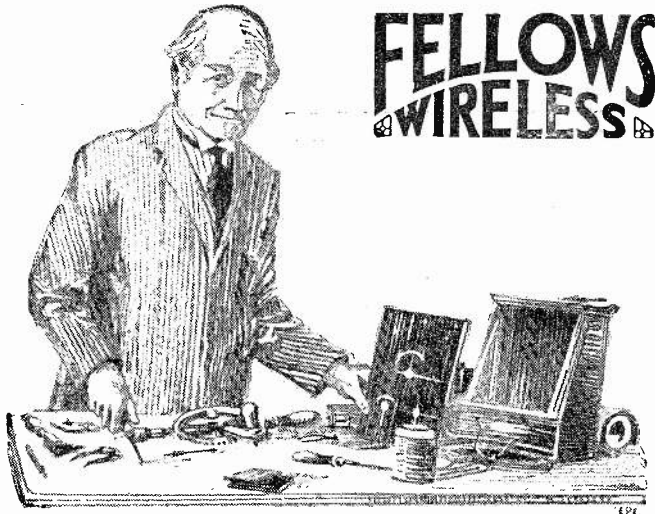

**FELLOWS
WIRELESS**

The WADE WIRELESS TOOL - SET



A busman's holiday

Eight hours to-day in the works, and when I do get home you still find me tinkering about with wireless apparatus. Well, there are worse ways of spending an evening, quite apart from the fact that it's both instructive and interesting. Besides, I might easily run across some wonderful circuit that even my very clever engineers down at the works haven't discovered. Who knows?

Anyway, it's a very pleasant pastime, and inexpensive so long as you don't have to keep on renewing your components, and my Fellows components seem to last me for ever.

My interval transformers and condensers must have been put into at least a dozen circuits, and my filament resistances and switch arms serve me time and again. Fellows coils are, of course, quite standard for all sets, and, even though I say it myself, they represent exceptionally good value for money; as you know, whatever the product, Fellows' policy always is

Quality Apparatus at Low Cost.

Much as I love

Low Frequency Interval Transformer.
Accurate and distortionless **20/-** each

Fellows Coils. For all purposes. Standard non-reversible pin contacts. **4/3 to 10/-**

Filament Resistances. 5 ohms, for panel or cabinet mounting. **3/-**

YEATES, LTD., 20, Store Street, Tottenham Court Road, London, W.C.1. Well equipped demonstration and sales offices of Fellows Wireless Products, Wholesale and Retail.

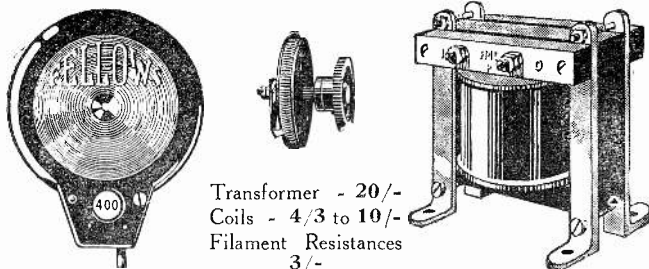

Transformer - 20/-
Coils - 4/3 to 10/-
Filament Resistances 3/-

Here, at last, is the real Wireless Tool Set that every Wireless Constructor has been waiting for. No more spoiling a good panel by using the family screwdriver, hammer, and gimlet; no more trying to tighten nuts with an adjustable car spanner or a pair of pliers.

The Wade Wireless Tool Set includes:—

- 1 Extra Length Screwdriver, which enables you to get at screws inside your Set without fouling the wiring system.
- 1 Broad Screwdriver for turning all ordinary screws.
- 1 Wire Bender; invaluable for bending wire to any shape.
- 1 Hammer, for cabinet construction, straightening wire and for use generally where household hammer is far too clumsy.
- 2 Box Spanners, 4 B.A. and 6 B.A., absolutely essential for turning nuts in awkward places. They replace pliers which always burr up the nuts.
- 1 Counter Sink, to enable screw-heads to be sunk to the panel level.
- 1 Reamer, for enlarging holes to any diameter. Replaces numerous and costly drills.
- 1 Bradawl for starting screw-holes.
- 1 Double-sided File for smoothing-off soldered joints, etc.

All these tools fit into the Universal Holder provided.

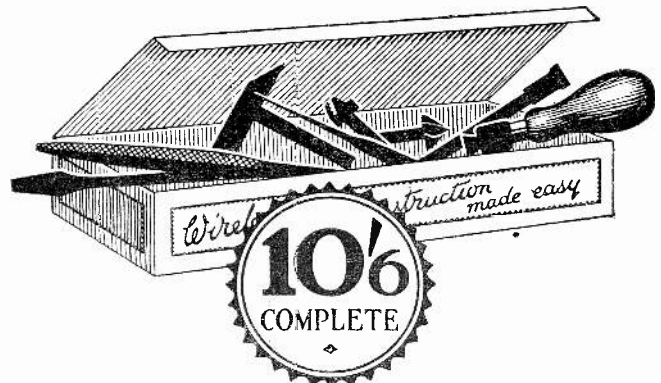

ADVL. OF THE FELLOWS MAGNETO CO., LTD., PARK ROYAL, LONDON, N.W. 10.

E.P.S. 118.

C.A.V. SMALL TOOLS, LTD., 181, Queen Victoria Street, E.C.4.

E.P.S. 26

In replying to advertisers, use Order Form enclosed

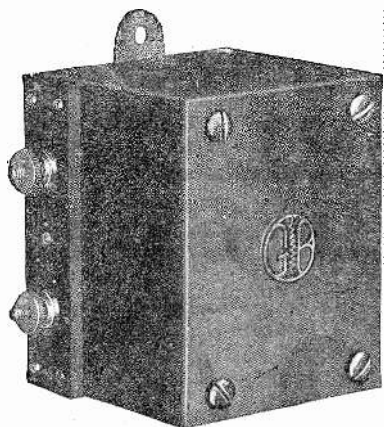

Gambrell L.F. Transformer.
Stage 1 and Stage 2, 27/6 each.

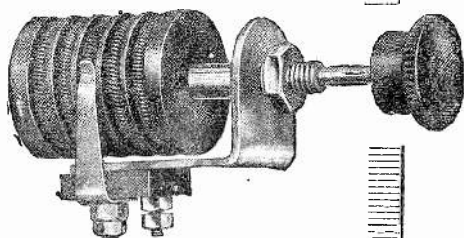

Gambrell Rheostat Dual Type.
5/6 each.

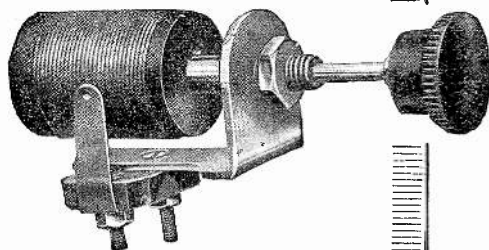

Gambrell Rheostat (5 ohms).
3/6 each.

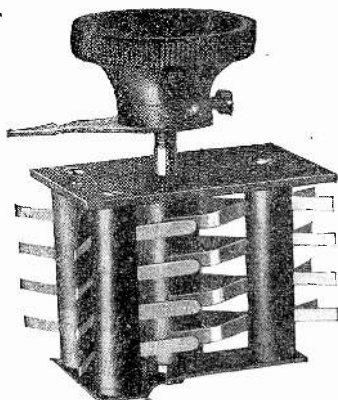

Gambrell Anti-Capacity Switches.
2-way, 7/0 each.
4-way, 9/6 each.

THE REPUTATION FOR
EFFICIENCY ESTABLISHED

during the last 30 years by

GAMBRELL'S

is fully maintained in each of their

Latest Productions

a few of which are illustrated.

Designed by men who are leaders and not merely copyists and embodying highest grade material and workmanship, these new components are

ESSENTIAL FOR EFFICIENCY

A postcard will bring you literature describing these and other new accessories each possessing features of outstanding merit worth your investigation.

GAMBRELL BROS., LTD.

76, Victoria Street, London, S.W.1

Works : *Merton Road, Southfields, S.W.18*

Phones : *VICTORIA 9938 — PUTNEY 3641-2*

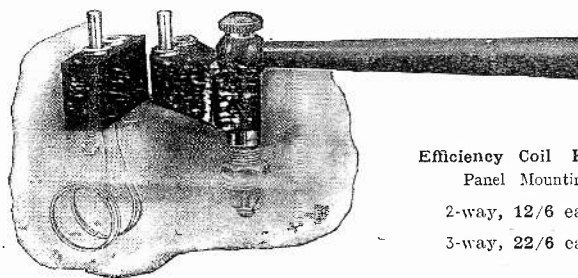

Efficiency Coil Holders
Panel Mounting
2-way, 12/6 each.
3-way, 22/6 each.

Ref. No.	G. M. T.	Name of Station.	Call Sign and Wave-length.	Situation.	Nature of Transmission.	Closing Time or Approx. Duration.	Approx. Power used.
SUNDAYS							
83	a.m.	Frankfurt	— 470 m.	Germany	Morning Prayer	1 hour	1 Kw.
85	7.30	Leipzig	— 454 m.	Germany	Morning Prayer	1 hour	700 Watts.
165	8.00	Konigsberg	— 463 m.	E. Prussia	Morning Prayer	8.45 a.m.	1 Kw.
86	9.00	Komarow	— 1800 m.	Czecho-Slovakia.	Sacred Concert	1 hour	1 Kw.
87	9.23	Eiffel Tower	FL 2600 m.	Paris	Time Signal in Greenwich Mean Time (Spark).	3 mins.	60 Kw.
166	9.30	Munich	— 485 m.	Bavaria	Sacred Concert	10.30 a.m.	1 Kw.
89	10.00	Eiffel Tower	FL 2600 m.	Paris	Time Signal in Greenwich Sidereal Time (Spark).	5 mins.	60 Kw.
90	10.00	Kbel	— 1160 m.	Prague	Classical Music	1 hour	1 Kw.
92	10.00	Radio-Wien	— 530 m.	Vienna	Concert	2 hours	1 Kw.
191	10.15	Hamburg	— 395 m.	Germany	Concert	11.15 a.m.	700 Watts.
93	10.30	Lyons	YN 470 m.	Lyons	Gramophone Records	11 a.m.	300 Watts.
94	10.30	Stuttgart	— 443 m.	Wurtemberg	Classical Concert	1 hour	1 Kw.
192	10.30	Munich	— 485 m.	Bavaria	Sacred Concert	11.30 a.m.	1 Kw.
95	10.44	Eiffel Tower	FL 2600 m.	Paris	Time Signal in G.M.T. (Spark)	3 mins.	60 Kw.
96	10.30	Konigswusterhausen.	LP 2200 m.	Berlin	Concert	11.50 a.m.	6 Kw.
97	10.55	Eiffel Tower	FL 2600 m.	Paris	Fish Market Quotations, followed by Weather Report.	12 mins.	5 Kw.
91	11.00	Breslau	— 418 m.	Silesia	Concert	1 hour	1.5 Kw.
98	11.00	Stockholm	— 440 m.	Sweden	Divine Service	12.15	500 Watts.
101	11.57 p.m.	Nauen	POZ 3100 m.	Berlin	Time Signal in G.M.T. (Spark)	3 mins.	—
102	12.45	Radio-Paris	SFR 1780 m.	Clichy	Concert, followed by News	2.00 p.m.	8 Kw.
108	2.00	Munich	— 485 m.	Bavaria	Concert	3.00 p.m.	1 Kw.
104	3.00	Breslau	— 418 m.	Silesia	Children's Stories	3.45 p.m.	1.5 Kw.
105	3.00	Stuttgart	— 443 m.	Wurtemberg	Light Orchestra	5.00 p.m.	1 Kw.
107	3.00	Frankfurt	— 470 m.	Germany	Children's Corner	4.00 p.m.	1 Kw.
107	3.00	Zurich	— 515 m.	Switzerland	Local Hotel Concert	5.00 p.m.	500 Watts.
106	3.10	Radio-Wien	— 530 m.	Vienna	Concert	5.00 p.m.	1 Kw.
108	3.30	Konigsberg	— 463 m.	E. Prussia	Light Orchestra	4.30 p.m.	1 Kw.
109	3.30	Voxhaus	430 & 505 m.	Berlin	Light Orchestra	5.00 p.m.	1 Kw.
170	3.30	Leipzig	— 454 m.	Germany	Light Orchestra	5.00 p.m.	700 Watts.
171	4.00	Frankfurt	— 470 m.	Germany	Light Orchestra	5.00 p.m.	1 Kw.
172	4.45	Stuttgart	— 443 m.	Wurtemberg	Concert	6.00 p.m.	1 Kw.
110	4.45	Radio-Paris	SFR 1780 m.	Clichy	Concert, followed by News	1 hour	8 Kw.
111	5.00	Radio-Belg.	SBR 265 m.	Brussels	Concert	1 hour	2.5 Kw.
193	4.00	Frankfurt	— 470 m.	Germany	Sacred Concert	1 hour	1 Kw.
196	4.45	Hamburg	— 395 m.	Germany	English Conversation	6.15 p.m.	700 Watts.
204	5.00	Kbel	— 1160 m.	Prague	Concert by Radio Trio	7.00 p.m.	1 Kw.
180	6.00	Barcelona	EAJR 325 m.	Spain	Concert	11 p.m.	650 Watts.
112	6.00	Eiffel Tower	FL 2600 m.	Paris	Concert, followed by News	1 hour	5 Kw.
114	7.00	Radio-Wien	— 530 m.	Vienna	Concert	8.30 p.m.	1 Kw.
118	7.00	Konigsberg	— 463 m.	E. Prussia	Concert	9.00 p.m.	1 Kw.
119	7.00	Hamburg	— 395 m.	Germany	Concert	9.00 p.m.	700 Watts.
120	7.00	Eiffel Tower	FL 2600 m.	Paris	General Weather Forecast	8 mins.	5 Kw.
125	7.00	Stuttgart	— 443 m.	Wurtemberg	Concert	9.15 p.m.	1 Kw.
173	7.00	Frankfurt	— 470 m.	Germany	Entertainment provided by Frankfurter Zeitung.	10.00 p.m.	1 Kw.
121	7.15	Lausanne	HR2 850 m.	Switzerland	Concert	8.30 p.m.	300 Watts.
122	7.15	Zurich	— 515 m.	Switzerland	Concert	9.00 p.m.	500 Watts.
123	7.15	Leipzig	— 454 m.	Germany	Symphony Concert	8.40 p.m.	700 Watts.
116	7.00	Munster	— 410 m.	Westphalia	Classical Concert	9.00 p.m.	1.5 Kw.
124	7.30	Breslau	— 418 m.	Silesia	Light Orchestra	9.00 p.m.	1.5 Kw.
174	7.30	Munich	— 485 m.	Bavaria	Concert	10.0 p.m.	1 Kw.
175	7.30	Radiofonica Italiana.	— 422 m.	Rome	Concert, followed by Late News	9.30 p.m.	4 Kw.
126	7.40	Ned. Seintoesl Fabriek.	NSF 1050 m.	Hilversum	Concert	10.10 p.m.	1 Kw.
176	8.00	Copenhagen	— 750 m.	Denmark	Concert, followed by News	9.30 p.m.	2 Kw.
127	8.30	Radio-Belg.	SBR 265 m.	Brussels	Concert, followed by News	10.10 p.m.	2.5 Kw.
128	8.30	Radio-Paris	SFR 1780 m.	Clichy	Detailed News Bulletin	9.00 p.m.	8 Kw.
129	8.30	Ecole Sup. des P.et Tgs.	FPTT 450 m.	Paris	Concert or Lecture. May begin 15 mins, earlier or later.	10.30 to 12 p.m.	500 Watts.
132	9.00	Radio-Iberica	RI 392 m.	Spain	Concert	midnight	3 Kw.
130	9.00	Radio-Paris	SFR 1780 m.	Clichy	Concert, followed by Dance Music.	11.00 p.m.	8 Kw.
195	9.00	Hamburg	— 395 m.	Germany	Dance Music	10 p.m.	700 Watts.
131	9.30	Petit Parisien	— 340 m.	Paris	Concert (Items announced in English as well as French.)	11.30 p.m.	400 Watts.
133	10.00	Eiffel Tower	FL 2600 m.	Paris	Time Signal in Greenwich Sidereal Time (Spark).	3 mins.	60 Kw.
134	10.44	Eiffel Tower	FL 2600 m.	Paris	Time Signal in G.M.T. (Spark)	3 mins.	60 Kw.
135	11.57	Nauen	POZ 3100 m.	Berlin	Time Signal in G.M.T. (Spark)	8 mins.	—

Ref. No.	G. M. T.	Name of Station.	Call Sign and Wave-length.	Situation.	Nature of Transmission.	Closing Time or Approx. Duration.	Approx. Power used.
SPECIAL DAYS.							
194	p.m. 3.00	Stuttgart	— 443 m. . .	Wurtemberg	Children's Corner	4.30 p.m.	1 Kw.
137	4.00	Lausanne	HB2 850 m. . .	Switzerland	Mon. Children's Stories	1 hour	300 Watts.
180	5.30	Belgrade	HFF 1650 m.	Serbia	Tues., Concert	1 hour	500 Watts.
					Thurs.,		
					Sat.		
140	5.15	Zurich	— 515 m.	Switzerland	Mon., Children's Corner	5.50 p.m.	500 Watts.
					Wed.,		
					Fri.		
141	5.15	Zurich	— 515 m.	Switzerland	Thurs. Lecture	30 mins.	500 Watts.
142	5.40	Ned. Seintoesl. Fabriek.	NSF 1050 m.	Hilversum	Mon. Children's Hour	6.40 p.m.	1 Kw.
203	6.00	Gotenborg	SMZX 460 m.	Sweden	Concert	8 p.m.	300 Watts.
146	7.00	Svenska	— 470 m. . .	Stockholm	Tues. and Thurs. Concert	9 p.m.	300 Watts.
147	7.00	Stockholm	— 440 m. . .	Sweden	Sat. Concert	10 p.m.	500 Watts.
148	7.40	Smith and Hooghoudt	PA5 1050 m.	Amsterdam	Wed. Concert	9.40 p.m.	500 Watts.
149	8.10	Middelraad	PCMM 1050 m.	Ymuiden	Sat. Concert	9.40 p.m.	300 Watts.
150	8.40	Ned. Radio In.	PCGG 1070 m.	The Hague	Mon. Concert	10.10 p.m.	1.3 Kw.
151	8.40	Amsterdam	PX9 1050 m.	Holland	Mon. Concert	10.40 p.m.	600 Watts.
152	8.40	Ned. Seintoesl. Fabriek	NSF 1050 m.	Hilversum	Fri. Concert	9.40 p.m.	1 Kw.
153	9.00	Le Matin	SFR 1780 m.	Paris	2nd & 4th Sat. Special Gala Concert of mth.	10.50 p.m.	10 Kw.
197	9.00	Breslau	— 418 m. . .	Silesia	Dance Music, Thursday	10 p.m.	1.5 Kw.
198	9.00	Hamburg	— 395 m. . .	Germany	Dance Music, Thursday	10 p.m.	700 Watts.
199	9.00	Frankfurt	— 470 m. . .	Germany	Special programme by local artists, Mon., Wed., Thu., Fri.	10 p.m.	1 Kw.
200	9.00	Munich	— 485 m. . .	Bavaria	Special Concert, Tues., Thu., Sat.	10 p.m.	1 Kw.
210	9.00	Radio Wien	— 530 m. . .	Vienna	Dance Music, Wed., Sat.	10 p.m.	1 Kw.
154	9.30	Petit Parisien	— 345 m.	Paris	Tues., Concert (Items announced in English as well as French). Thur. Dance Music	11.30 p.m.	400 Watts
155	10.00	Radio-Paris	SFR 1780 m.	Clichy	Wed., Fri. Dance Music	10.45 p.m.	8 Kw.

"MODERN WIRELESS" SPRING DOUBLE NUMBER.

A WONDERFUL PRODUCTION

The March issue of "Modern Wireless" (out 28th February), which will be sold at one shilling and sixpence, will be the finest number yet published. Among a large number of special features will be found a description of a **SPECIAL THREE-VALVE DUAL RECEIVER**, designed by Mr. John Scott-Taggart, F. Inst. P., A. M. I. E. E., and a **HANDSOME CABINET SET** by Mr. Percy W. Harris, M. I. R. E. Included in every copy will be a full-size

FREE BLUE-PRINT

from which the Cabinet Set can be wired with the greatest of ease. Many other valve and crystal set designs will also be published in this number.

SPECIAL ARTICLES FOR BEGINNERS

In view of the enormous demand, order your copy early.

ONE SHILLING AND SIXPENCE EVERYWHERE

Comprehensive Range

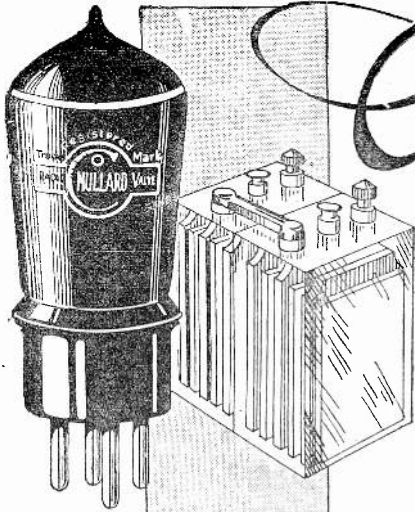

Single Ring
Bright Filament Type Valve

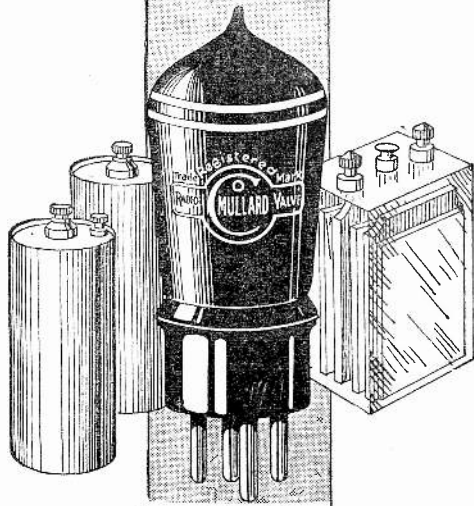

Double Ring
Dull Filament Type Valve

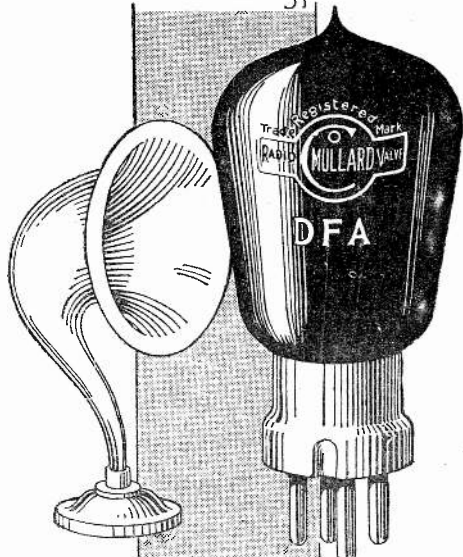

Loud Speaker Power Type Valve

Here are Master Valves for perfect long distance and pure tone reception.

You will find in these three groups a range of Master Valves that will produce the finest wireless reception from your set. Each type of Mullard Valve is the best that modern research can produce. Make your own choice.

BRIGHT FILAMENT VALVES

FOR 4-VOLT BATTERIES.

- Mullard H.F. Red Ring Valves for
H.F. AMPLIFICATION and DETECTION **12/6** each
Mullard L.F. Green Ring Valves for
L.F. AMPLIFICATION **12/6** each
Leaflet M. 8 gives full information.

DULL FILAMENT VALVES

Mullard H.F. Double Red Ring Valves for H.F.
AMPLIFICATION.

- Type D.3, for Accumulators **21/-** each
Type D. 06, for Dry Cells **25/-** each
Mullard L.F. Double Green Ring Valves for L.F.
AMPLIFICATION.

- Type D.3, for Accumulators **21/-** each
Type D.06, for Dry Cells **25/-** each
Leaflet V.R. 20 gives full information.

LOUD-SPEAKER VALVES.

- Mullard D.F.A. 0, for 4-volt Batteries **30/-** each
Mullard D.F.A. 1, for 6-volt Batteries **35/-** each
Leaflet V.A. 4 gives full information.

All these valves bear the Hall Mark of

Mullard

THE MASTER VALVE

Advt.—The Mullard Radio Valve Co., Ltd. (M.W.), Nightingale Works, Balham, S.W. 12.

In replying to advertisers, use Order Form enclosed

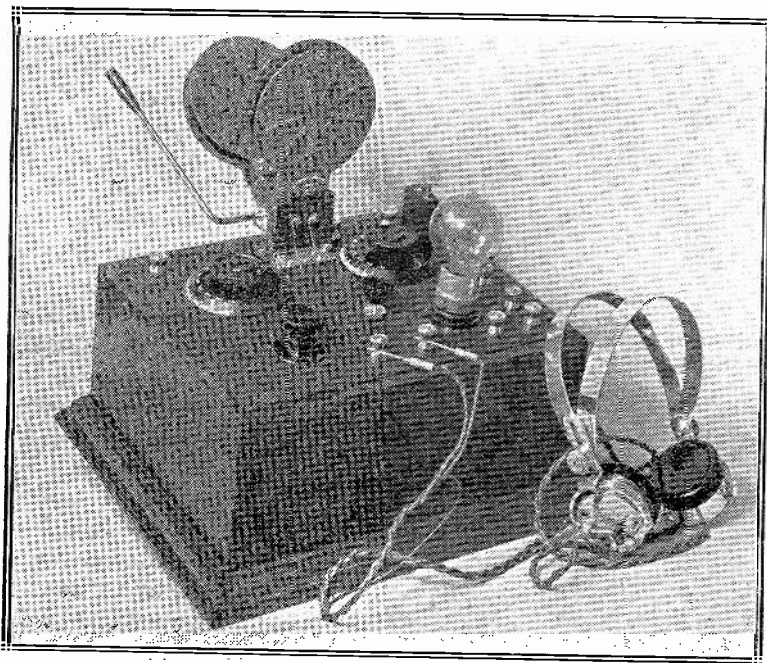

The appearance of the receiver when completed is very attractive.

A Useful Single Valve Receiver

By
**JOHN
UNDERDOWN.**

A double circuit tuner is the first obvious step in gaining selectivity not possible with the ordinary direct coupled type of circuit. This, however, necessitates the simultaneous adjustment of two condensers and of the coupling between three coils if reaction is used. In the hands of the novice this may present some difficulty and it was this aspect of the case which led to the simple but useful arrangement of combined series and parallel tuning used in the single valve set about to be described.

The Tuning System

This system of tuning may be regarded as an intermediate step between the direct and loose-coupled arrangements, and approaches the latter in selective qualities. The advantages of using a small series condenser in conjunction with the usual parallel condenser have been fully explained by Mr. John Scott-Taggart in his article on "Constant Aerial Tuning" in the issue of MODERN WIRELESS for February, 1924. This arrangement approximates more nearly to a secondary circuit, so that a given coil covers a greater wavelength range, and this can be predicted with fair accuracy with aerials of widely different characteristics. By making the series condenser variable the fullest use may be made of these advantages. On stiff aerials, *i.e.*, aerials which are not very efficient

and call for the use of excessive reaction, the damping effect may be minimised to a large extent by using the smallest value of series capacity consistent with stability.

A Concrete Example

For example, using direct coupling on my aerial system of which the earth is not too good, a coil of the order of a No. 75 was necessary to make the set oscillate, and control was not of an "easy" nature. Using the series parallel method with about 30 degrees of a .0003 series condenser (full scale 180 degrees) reaction was obtained over the whole range of the aerial coil with a coil of the order of a No. 35 and this with much easier control. Incidentally, the method can be incorporated in practically any set by placing

a series variable condenser between aerial and aerial terminal.

The Circuit

The circuit adopted in the set is shown in the theoretical diagram given. C_1 is the series condenser of ordinary type and .0003 μF in value, in parallel with this, shown dotted, is a coil L_3 . The use of this coil is optional and it is only inserted when it is desired to use

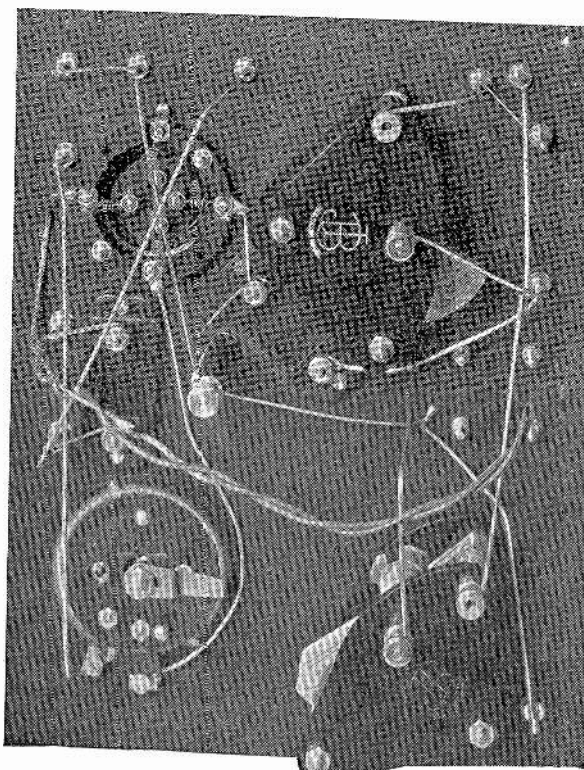

A general view of the wiring of this set.

THIS handsome little set uses a system of tuning combining the series and parallel methods. A wave-trap can be included without any alteration in the wiring.

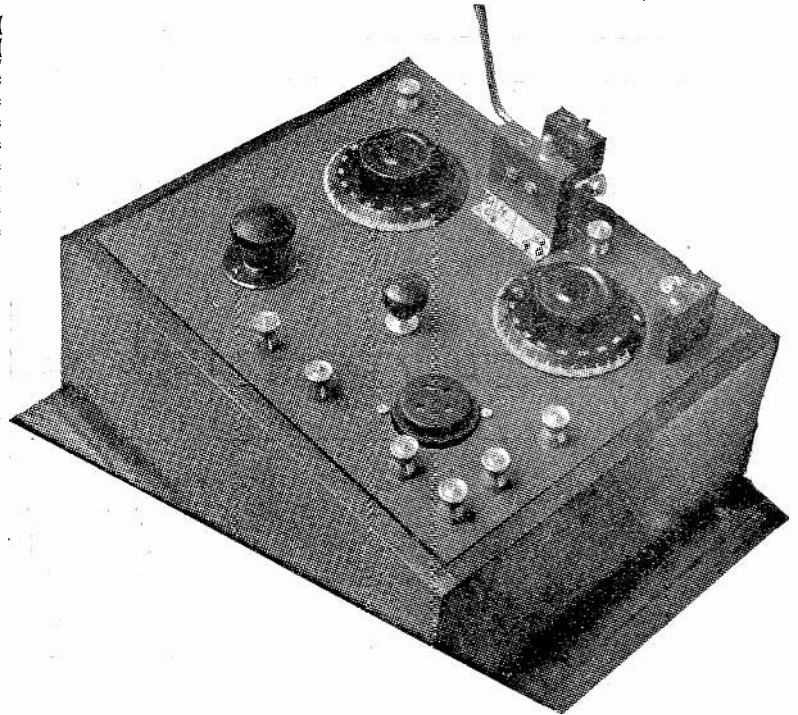

The coil block for the wave-trap coil is seen at the back right hand of this picture.

the type "A" wave-trap as described by Mr. Percy Harris in *Wireless Weekly*, August 15, 1923. For ordinary work this coil will not be used. The condenser C_2 of $.0005 \mu F$ is in parallel with the aerial tuning inductance L_1 . C_3 of $.0002 \mu F$ is the usual grid condenser, and used in conjunction with the variable grid leak R_2 allows of the usual leaky-grid method of rectification.

Reaction

Magnetic reaction is obtained by coupling the coil L_2 in the plate circuit of the valve with the aerial coil L_1 . The condenser C_4 of $.002 \mu F$ across the telephones is merely a bypass condenser for the high frequency component in the plate circuit which gives rise to reaction effects.

Panel Layout

From the illustration (Fig 2) the panel layout will be clearly seen and its neat, compact appearance appreciated. The series condenser is seen to the rear of the panel and that in parallel with the aerial coil to the front. The plug and socket coil block near the series condenser is that allowing the use of a wave-trap if desired. A 2-coil holder of well-known make is placed between the two condensers. The aerial coil L_1 is plugged into the fixed block, whilst the moving block takes the reaction coil L_2 . To the right of the series condenser is the valve socket. This is an "Anti-phonetic" type made by Burndepht, and although it takes up a fair amount of panel space is to be

recommended if some types of dull emitter valves are to be used, as jarring the panel, with this holder, does not give rise to microphonic effects. The knob seen in the centre of the panel is that of the variable grid leak R_2 . The knob of the filament resistance is to the right front of the panel. A dual type resistance is incorporated so that either bright or dull emitter valves may be used at will.

Terminal Arrangements

To the left of the panel the terminals are: A near the coil block; A_1 beside the 2-coil holder and Earth in the front left hand corner. The two H.T. terminals are at the rear of the panel, + being the one nearest the coil block. LT + is in the right hand corner and LT - directly in front of this. The remaining two right-hand side terminals are

for the telephone connections, that to the front being the positive terminal to which the + tag of the phones should be attached.

Possible Forms of Aerial Tuning

The aerial terminal arrangements allow of a number of different tuning arrangements being tried. With the aerial connected to A the combined series parallel method is brought into operation. With the same aerial connection and the condenser C_2 set at zero plain series tuning is obtained. Further with a suitable coil plugged into L_3 the type "A" wave-trap may be tried.

Simple parallel tuning is used by connecting the aerial to A_1 .

Components Required

The actual components used in the receiver are as follows. Makers' names are given so that readers who desire exactly to duplicate the set may do so. In any case only the best quality components should be used and the values given should be strictly adhered to. If desired rheostats of a value suitable to the type of valve used may be substituted:—

1 ebonite panel 10 in. by 8 in. by $\frac{1}{4}$ in. thick. That used has a matt finish. Readers are advised to use guaranteed ebonite, or failing this to remove the surface skin with emery cloth.

1 mahogany case to take above panel. The one used has a depth of $4\frac{1}{2}$ in. and was made by W. H. Agrur.

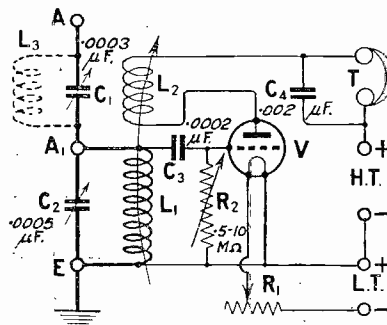
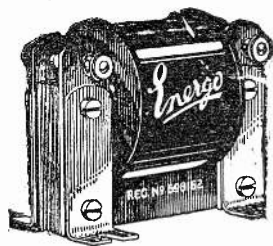

Fig. 1.—The theoretical circuit with the optional wave-trap coil shown dotted.



ENERGO L.F. TRANSFORMER.
For Supreme Results, Efficiency, Finish and Permanent Reliability. The Energo L.F. Transformer is highly suitable for all circuits, and especially recommended for first stage and reflex circuits. Price 15/- each. The Talk of the White City Exhibition.

Energo H.F. TRANSFORMERS MATCHED.

Most attractive and efficient. Wound with silk-covered wire. Made in all wavelengths.

No.	Wavelength in Meters.	Price
1	150—450	3/9
2	250—700	4/-
3	450—1200	4/3
4	900—2000	4/6
5	1600—3000	4/9
6	2000—5000	5/-

Wavelengths when used with .002 Condenser in parallel across primary

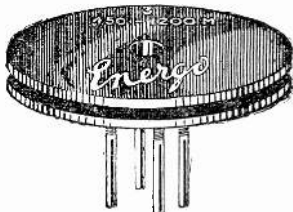

Energo

PRODUCTS

Make sure that your next set is fitted with Energo guaranteed components. For supreme results, permanent reliability and general efficiency they are unique and can be confidently recommended to every constructor.

Purchase from your local dealer.

If any difficulty in obtaining, please write direct to—

ENERGO PRODUCTS, LTD.,
2, OLIVER'S YARD, E.C.1.

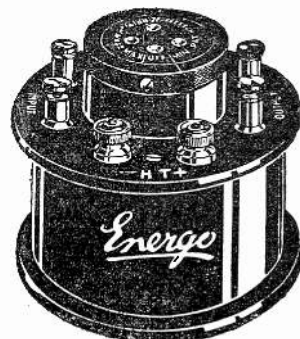

Energo ONE-VALVE AMPLIFIER. This unit embodies our Energo L.F. Transformer which ensures perfect amplification, a combined patent valve holder and rheostat, the whole fitted entirely in ebonite.

Provision is made for grid-bias. Very attractive and highly finished. Full instructions with each. Price 48/- each.

Energo LOW CAPACITY TUNING COILS.

Sharp Tuning. Low Self-capacity. Low Resistance. High Inductance.

These coils have been specially designed to give maximum results. Patent air-spaced winding and mounted in an anti-capacity and feather-weight method, they are particularly suitable where coil holders with loosely fitted spindles are used.

Approximate Wavelength Shunted with Condenser.

No.	Min. .0005	Max. .001	Price
25	85	280	3/6
35	125	450	3/9
50	140	650	4/-
75	225	975	4/6
100	300	1300	5/4
150	500	2000	6/-
200	600	2500	6/10
250	750	2750	7/1
300	1000	4000	7/5
400	1300	5250	8/3
500	1350	6500	9/-

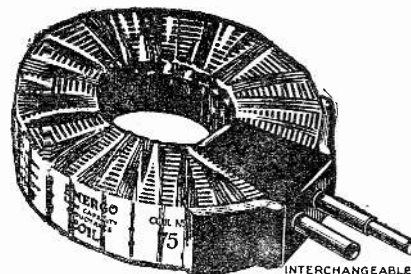

INTERCHANGEABLE CONTACT PINS

Barclays 600

THE SHIPTON NEW TYPE Strip Rheostat & Potentiometer

You buy good Valves—sensitive to perfect filament control—therefore build into your receivers rheostats which can control them.

THE MOST PERFECT RHEOSTAT YET INTRODUCED

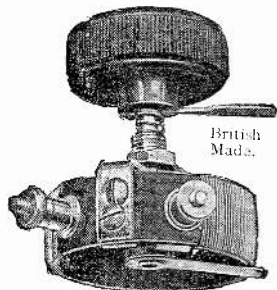

British Made.

is the SHIPTON. A specially designed spindle gives one-hole fixing and incorporates a tension spring which ensures perfect electrical contact at all times; terminal connections are provided. The 7-ohm Model is fitted with a fuse, which little device may save you the cost of an expensive valve. In operation they are noise free quite an important consideration.

As used in the 7-Valve T.A.T. Receiver described by Mr. John Scott-Taggart.

SHIPTON New Type STRIP RHEOSTAT 7 ohm (with fuse) 3/-
SHIPTON New Type STRIP RHEOSTAT 30 ohm 3/-
SHIPTON New Type STRIP RHEOSTAT 60 ohm 3/-
SHIPTON POTENTIOMETER 600 ohm 4/6
Packed in neat linonette boxes.

Ask your Dealer also for SHIPTON NEW TYPE VERNIER COIL HOLDER. Gives perfect adjustment. Solid Ebonite. No loose connections.
2-way ... Price 4/-
3-way ... Price 7/6
For Panel Mounting.

The SHIPTON New Type VARIABLE GRIDLEAK

Here is another SHIPTON efficient unit. Mechanically perfect and thoroughly tested by experts to secure maximum and uniform efficiency.

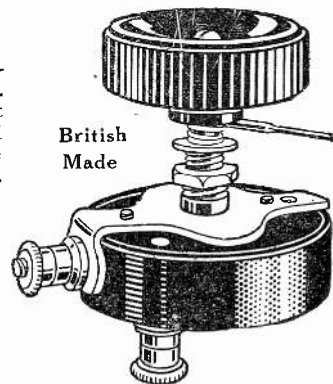

British Made

CHARACTERISTICS
Silent in operation.
Constant under different settings.
Can be calibrated accurately.
Reliable under all conditions
300,000 ohms to 6 Megohms.

Price 3/-

You cannot afford—if it is good reception you want—to risk an unreliable grid leak. Be certain of what you are buying. Get a SHIPTON—you can't go wrong.

SHIPTON Products are obtainable from all Dealers, or, if any difficulty, send direct, kindly giving your dealer's name and address.

E. SHIPTON & CO., LTD.

37, TOTHILL STREET, WESTMINSTER, S.W.1.
Telephone: Victoria 7. Telegrams: "Rentfoces, Parl."
Also at 14, KING STREET, COVENT GARDEN, W.C.2.
Trade Enquiries Invited.

MAGNUM

WE take this opportunity of tendering our apologies to those of our customers whose orders have been delayed owing to the extreme difficulty, and in some cases impossibility, of obtaining certain makes of components and materials necessary to complete their orders.

In order to overcome the difficulty we are offering various Radio Press circuits composed entirely of Magnum or equivalent components. These are guaranteed up to Magnum High Standard and to give equally good results as those used by the authors.

Not only will delays be avoided, but a substantial saving in cost will be effected, as shown below.

MAGNUM
All Concert de Luxe
Envelope No. 4
£7 5 0

MAGNUM
Transatlantic 4
£9 0 0

MAGNUM
Transatlantic 5
£9 10 0

The cabinets, panels and general disposition of components of the above will remain in accordance with the author's specification.

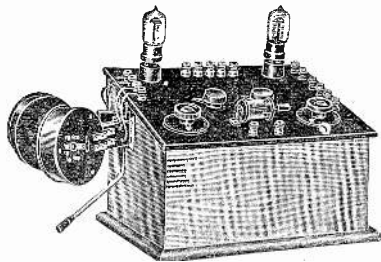

CONSTRUCT THE S.T. 100 for £7 0 0. (Envelope No. 1.)

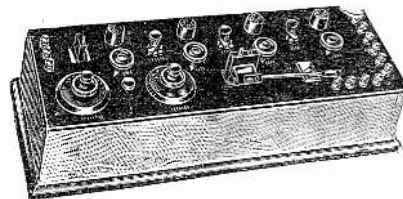

CONSTRUCT THE 4-VALVE FAMILY or £9 0 0. (Envelope No. 2.)

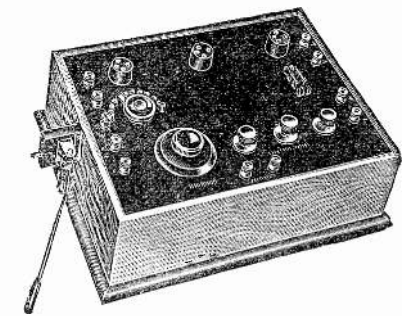

CONSTRUCT THE SIMPLICITY 3 for £4 13 2. (Envelope No. 3.)

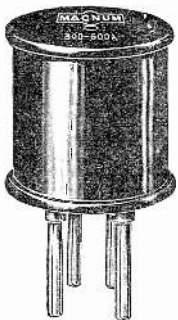

MAGNUM
H.F. TRANSFORMERS,
Recommended for all
Radio Press Circuits em-
ploying H.F.

- No. 0 150-300
- 0A 250-525
- 1 300-500
- 2 550-1200
- 3 1100-2000

7/- each. Guaranteed correctly matched
14/- per pair.

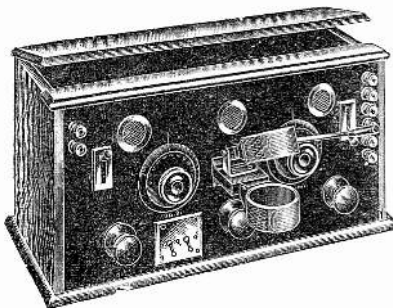

CONSTRUCT THE ALL-CONCERT-DE-
LUXE for £9 9 0. (Envelope No. 4.)

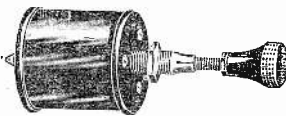

MAGNUM NEUTRODYNE
CONDENSER.

Recommended for all Neutrodyne
Circuits. 4/6 (Postage 6d.).

Anode Coils tapped and complete,
as used in the Simplicity 3 and
T.A.T. 8/- post free.

1 lb. Hank No. 16 D.C.C. Wire for
P.W. Harris Crystal Set, 3/- post free.

RADIO PRESS ENVELOPES.

Post free.

- No. 1. S.T. 100 ... 1/9
- No. 2. 4-Valve Family ... 2/9
- No. 3. Simplicity 3 ... 2/9
- No. 4. All Concert-de-Luxe... 2/9
- No. 8. 1-Valve Reflex Receiver 1/9
- No. 9. Efficient Single Valve Set 1/9
- R.P. Hot Pad Transfers ... 8d.

Send stamp for illustrated list and
set of leaflets dealing with Radio
Press Circuits.

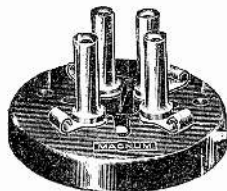

MAGNUM ANTI-CAPACITY VALVE
HOLDER.

An entirely new design made from best
quality **SOLID EBONITE** specially chan-
neled. As used in the set described by Mr.
Percy W. Harris 2/6 each

Carriage and Packing Free on RETAIL ORDERS
value £2 and over.

BURNE-JONES & Co., Ltd.

296, Borough High Street, LONDON, S.E.1.
Telephone: HOP 6257.
Mail Order Dept., 288, Borough High Street, S.E.1.

EBONITE COIL FORMER
as used by Mr. G. P. Kendall. 3/- post free.
MAGNUM COIL HOLDERS.



- Type L. for Transatlantic V, 4-Valve Family, etc. 9/6
 - 3-Way, for Omni., Tri-Cell, All-Britain, etc., etc. 12/6
 - Type R. for S.T. 100, Simplicity 3, All Concert-de-Luxe, 3-ValveDual, Puriflex, etc. 9/6
- Postage 6d. Postage 6d. Postage 6d.

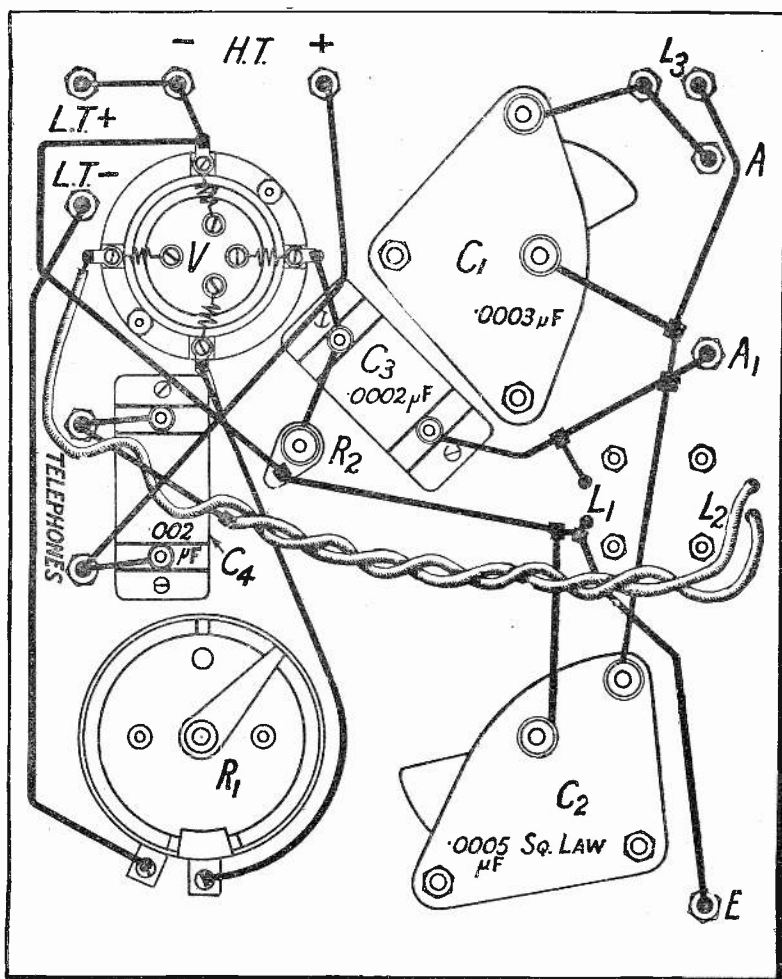

Fig. 3.—The panel wiring diagram. Blue Print No. 93b.

the valve socket may be mounted on the top of the panel.

Mounting the Components

This should present but little difficulty if the drawings and photographs are referred to. First mount the valve holder rheostat and terminals and then the condensers. These latter are of one hole fixing type and extremely simple to mount. Finally place the variable grid leak in position and then the fixed condensers can be conveniently placed, their position being determined with the other components in position. Although in the set these are fixed by screws tapped into the panel, it will probably be found easier to use 6 BA screws through the panel and nuts in the majority of cases.

Wiring

Wiring is carried out in 16-gauge tinned copper wire, previously straightened by stretching until felt to give. A careful study of the photographs and wiring diagrams will soon show how all the leads are taken.

Before commencing to solder the leads in position file the tops of all terminal shanks to expose

a bright surface, touch with soldering paste, and then tin with a really hot iron. Should any nuts have been found to loosen during tinning these may be given a half turn before proceeding further. With regard to wiring, leads near the panel should first be soldered in position and finally the remaining leads in any convenient order. From the photographs it will be seen that the leads to the reaction coil are of rubber-covered flex and twisted together. This method was merely adopted for convenience, although in some multi-valve receivers the method does tend to minimise interaction effects. The flex lead which goes to the plate of the valve is connected to the socket of the moving coil block. Sufficient flex has been used to keep these leads away from the other wires, and they are partially supported by a stiff connection from the telephone terminal nearest the valve socket. This may be seen in one of the photographs.

Operating the Receiver

The set is quite simple to operate and no difficulty should be experienced by the beginner. First the low-tension should be connected to the terminals marked LT+ and LT- in the front of panel diagram. The rheostat should be placed in the "off" position and the valve inserted. Now turn the knob and note that the filament lights correctly. Connect the H.T. battery to the terminals marked HT+ and -, using a value which will be indicated by the makers of the valve. Insert a coil of the order of a No. 35 in the fixed coil holder and one of the order of No. 50 in the moving or reaction socket. With the telephones connected to the appropriate terminals bring the reaction coil towards the aerial and a plonk should be heard in the 'phones denoting that the set is oscillating and the reaction coil correctly connected.

Tuning

Being satisfied that the set is working correctly, for a preliminary test, connect the aerial to A₁ and earth to E. With the two coils at right angles tune on

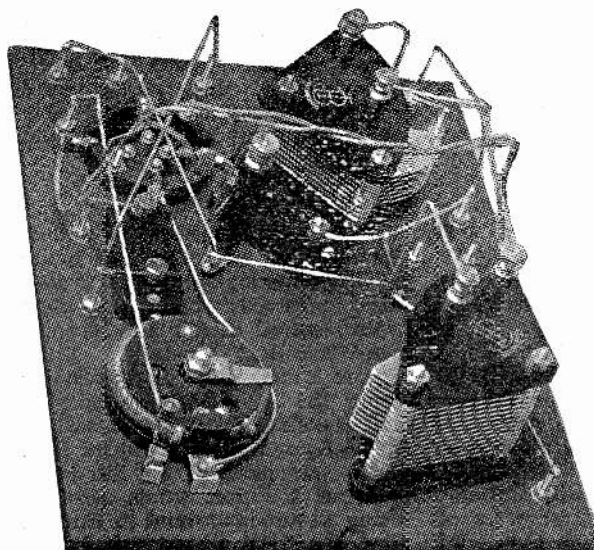

This view of the wiring will be helpful if used in conjunction with the Fig. 3 diagram.

the condenser C_2 until a signal is heard, then gradually bring the coils nearer together, tuning at the same time on C_2 . The signal should increase in strength. Take care not to bring the coils too near together or the set will oscillate and interfere with other listeners. The feel of the set being obtained, the series-parallel arrangement may be tried. Reverse the position of the coils, *i.e.*, make the aerial coil reaction and *vice versa*, and connect the aerial to A. Set C_1 to some intermediate position, say 50 degrees, and retune on C_2 . The signal should again be picked up and with this arrangement the tuning will be found to be sharper. A little experience in tuning on the two condensers and with reaction will soon show how to get the best out of the set. Reducing C_1 will tend to make the set oscillate more readily than with direct parallel tuning and selectivity will be increased. Series tuning may be tried using the same arrangement of coils but with C_2 set at zero. The effect of using the wavetrap may be tried by plugging in a coil of the order of a No. 50; the unwanted signal being tuned out on C_1 and the signal desired brought in on C_2 . Practice alone will decide the best method of carrying out these adjustments.

Valves

Any general purpose valves will usually serve well as detectors, and for most types a 60-volt H.T. battery will be found a useful size. I have used several types of bright emitter valves and a number of .06 types with success, there being little to choose between bright and dull emitter valves in this capacity. But when using the latter type of valve in the ordinary valve holder, the listener is often troubled with microphonic noises due to a slight vibration of the valve itself. No trouble of this kind will, however, be experienced with this type of valve in this receiver, as the valve holder chosen is of such construction as to absorb any slight shocks which may occur.

Test Report

The set was first tested on an aerial of 35 ft., average height, and about 60 ft. long, ten miles S.E. of 2LO. A .06 valve was used with 60 volts on the plate and run off a 4-volt accumulator. The coils used at first were of Gambrell make. With the aerial on A_1 2LO was received at good 'phone strength, but as before stated a rather large coil was found necessary for reaction. On

changing the aerial to A with a B coil in the aerial socket, an A served admirably for reaction and signal strength was improved. Best results were obtained with C_1 and C_2 reading 30 and 70 degrees respectively. On a loud-speaker the news bulletin could be followed in a small room, whilst the addition of 1 L.F. valve of the 2-valve amplifier described in the December issue gave full loud speaking. 5XX, using F in the aerial and D for reaction gave about the same

50 coil will be found suitable for the aerial circuit and a 35 or 50 for reaction. For 5XX and Radiola using the direct coupled arrangement with the aerial on A_1 a 150-coil will be suitable for the aerial circuit and a 200 for reaction. Eiffel Tower with the same aerial connection will require a 200 or 250 aerial coil with a similar size reaction coil.

Finally the author would be interested to hear from readers who make up this or any other of

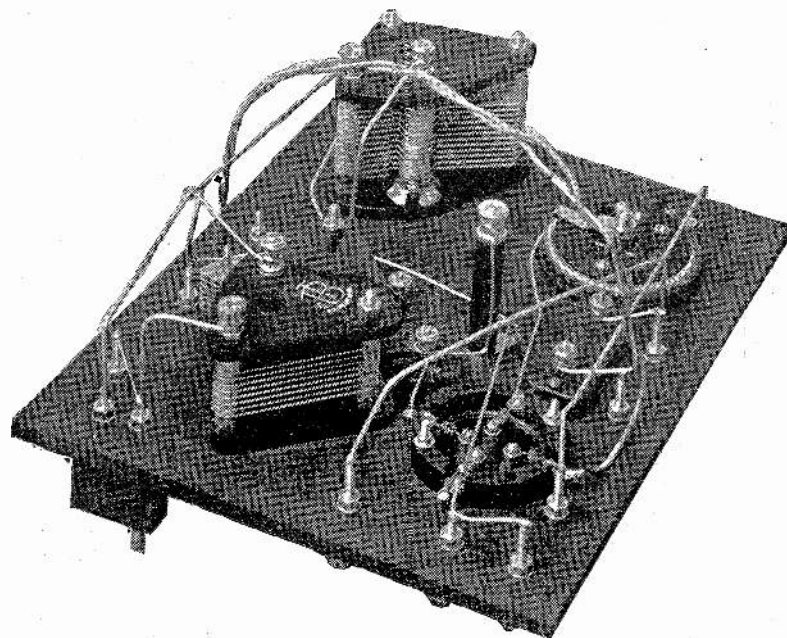

The twisted reaction leads stand well away from the other wiring.

strength as 2LO. Radiola was also received at excellent strength, but with 5XX in the background.

Subsequently during the evening Bournemouth, Madrid, Glasgow, Newcastle, Birmingham, Aberdeen and Cardiff were received and their call signs clearly heard, all at good 'phone strength.

Further Tests

Tested on a Sunday evening, before 2LO came on, as many as six German-speaking stations were received; three of them were received at fair and in some cases excellent strength. Eiffel Tower came through excellently using the A_1 connection with F and D coils. It could be heard on the L.S., and with an added L.F. valve was pleasant on the loud-speaker, the first words received being an announcement in English that the "All Blacks" had won their match against the French team in the afternoon.

Using numbered makes of coils and the series parallel connection, a

his sets, as such results are always helpful, both to other readers and in designing future sets.

CORRECTIONS

The Seven-Valve T.A.T. Receiver

We regret that in the January issue of MODERN WIRELESS, page 902, Fig. 7, a lead is shown from the spindle of the Condenser C_6 to the negative filament leg of the valve V_4 . This lead should be deleted. The only lead from the spindle of C_6 is that going to the H.T. lead above. The sole wire from the negative filament leg is that going to the filament resistance below.

Coil Sockets

In the list of components required, the four adjustable single coil sockets were attributed to the Penton Engineering Co., Ltd. Actually they were made by the Goswell Engineering Co., Ltd., who can supply from stock.

Charge your ACCUMULATOR

at Home with the TUNGAR BATTERY CHARGER.

Simple, Safe and Economical. No moving parts. Requires no attention. No Carriage, Owner-Driven, or Wireless Enthusiast should be without one. Will charge from 1 to 10, 6-12 volt batteries at a time. Delivers from stock. Descriptive booklet free on application. The Tungar Battery Charger is suitable for use on Alternating Current supply only.

Obtainable from your Garage or Electrician.

The BRITISH THOMSON-HOUSTON Co., Ltd., Mazda House, 77, Upper Thames Street, E.C.4



REPAIRS

TO HEADPHONES TO LOUD SPEAKERS TO COILS

Rewound to any Resistance and made equal to new. Price quoted on receipt of instruments. Prompt Delivery

THE VARLEY MAGNET CO. (Dept. M), WOOLWICH, S.E.18

Established 26 years.

Phone: Woolwich 888.

READ AMERICA'S FOREMOST RADIO JOURNAL

The "RADIO NEWS," published monthly in America, contains amazingly interesting articles on the latest discoveries in wireless research, etc. It is edited by Mr. H. Gernsback, so well known in the wireless world. This journal comes to any address every month for 12 months for only 13/6, post free. Send to-day or call.

Sole British Subscription Agents:

R. MCKELLEN & CO., 49, Shaftesbury Avenue, LONDON, W. 1.



FOR PROTECTING YOUR AERIALS

and a thousand purposes where great strength and strain is needed. FLEXIBLE

STEEL WIRE ROPE, Aeroplane Cable made to Government specification to specified breaking strains. PRICES BELOW COST. Orders of 10/- and over carriage paid, otherwise please send 1/- for postage.

No.	Dia.	Strain.	100 ft.
0	1/16	5 cwt.	4/6
51	5/32	25 cwt.	10/-
52	3/16	35 cwt.	11/-
53	7/32	45 cwt.	12/-
5	1/4	70 cwt.	14/-
7	11/32	100 cwt.	20/-

Strainers for use with above, right and left-hand threads, 9d. each or 8/6 per dozen. SMITH & ELLIS, Ltd. (Dept. 85), 11, Little Britain, E.C.1. Tel: City 8994.

ELECTRADIX RADIOS

ELECTRADIX RADIOS.—"C" Valves, Air Force, low cap., 6/6 (post at buyer's risk). Wavemeters, 59/-, 84, 85 and 85. Morse Recorders, 86 10s. Wheat stone 83. Alternators, 23 10s. Valve Transmitters, 83. Spark Sets, 15 6. R.A.F. Steel Masts, 2 6 per 5 ft. run. Receivers: 2-valve, 2B, 82; 3-valve, Mk. 4 83; 5-valve, 85 12s.; 7-valve Marconi, 83. All prices less valves. Bridges, 83 and 85 10s. Res. Boxes, multi-range standards, 1 to 2,000 ohms, 17 6 to 5/-; Loud Speakers, 19/-; Ebonite Horns, 8/-; Charging Dynamos Rotax, 83. Marconi Rounds Valves, 3 6. Milliameters, 33/-; Amp and Voltmeters, all ranges. Ohm meters, 810. Testing Sets, 4 to 8 14. Condensers, L.T. to 10,000-v., 1/6 to 82. Call or write for new and enlarged catalogue. Post Free 4d.

L. SLIE DIXON & CO., LTD., 9, Colonial Avenue, Mincing, E.1.

Buses pass the door. Telephone: Avenue 4766.

F.M.W.

T M C

CHI VALENTE VA SANO.

"Who goes slowly goes safely" say the Italians; and even Casanova saw something in that.

The idea suggests the keynote of T.M.C. production—that "infinite capacity for taking pains" that is exemplified in the three T.M.C. products here illustrated.

The non-resonating horn of the TrueMusic Concert Grand is of electrolytically deposited copper. This loud speaker gives the purest tone combined with large volume, and you cannot get a better for drawing-room and dancing purposes.

The T.M.C. Clear as Crystal Headphones *actually* give signal reception that is "Clear as Crystal." The T.M.C. No. 3 Lightweight Headphones weigh only 6½ ounces. The earpiece attachments do not catch in feminine hair, nor the V-connections on the masculine pipe.

T.M.C. No. 2A Headphones are just as good, but slightly heavier—and 3/- cheaper. As headphones for listening-in, they are just as good as they can be!

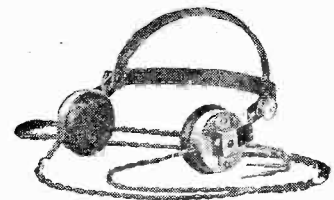

TrueMusic Concert Grand Nigger-brown finish, inside horn polished & lacquered, 4,000 ohms, 30 ins. high.

£6 - 10 - 0

T.M.C. No. 2A Headphones, 4,000 ohms.

19/6

T.M.C. No. 3 Lightweight Headphones, 4,000 ohms.

22/6

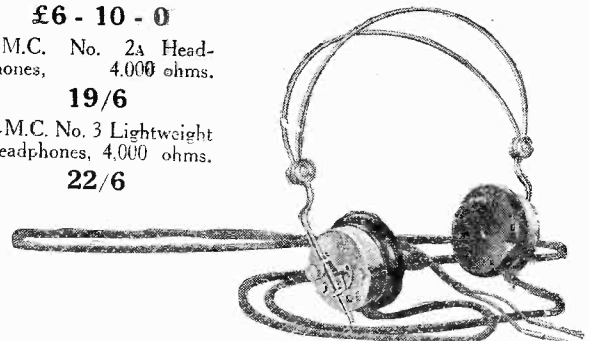

The Telephone Manufacturing Co., Ltd., Hollingsworth Works, West Dulwich, S.E. 21.

E.P.S. 208.

In replying to advertisers, use Order Form enclosed

"UTILITY" VARIABLE SQUARE LAW CONDENSERS

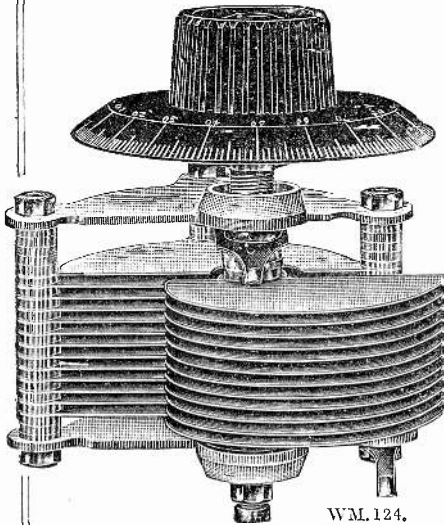

at
same price
as our
ORDINARY

PRICES.

Ref. No.	Cap.	Price.
WM.123	.001	12/6
WM.144	.00075	11/9
WM.124	.0005	10/6
WM.125	.0003	8/9
WM.145	.0002	7/9
WM.146	.0001	7/6

Vernier 2/6 extra.

WM.124.

NO-CAPACITY

The "UTILITY" NO-CAPACITY SWITCH, as used in the constructional articles appearing in this journal. Specially designed by electrical engineers to reduce the electrostatic capacity, this switch has proved to be exceptionally reliable in action and has self-cleaning contacts.

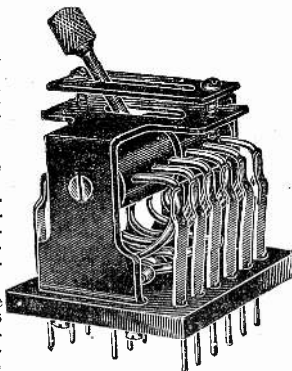

WM. 147/6.

Size	Knob Type	Price
1 Pole Change over	WM.130/1	3/6
2 " " "	WM.130/2	4/-
3 " " "	WM.130/3	5/-
4 " " "	WM.130/4	6/-
5 " " "	WM.130/5	7/-
6 " " "	WM.130/6	8/-

Size	Lever Type	Price
1 Pole Change over	WM.147/1	6/-
2 " " "	WM.147/2	5/-
3 " " "	WM.147/3	6/-
4 " " "	WM.147/4	7/6
5 " " "	WM.147/5	0/-
6 " " "	WM.147/6	10/-

Black bronzed lever pattern, nickel-plated, 6d. each extra.

SWITCHES

Manufactured by
WILKINS & WRIGHT LIMITED,
UTILITY Works, Kenyon Street, Birmingham.

Vital Factors —guaranteed for 12 months

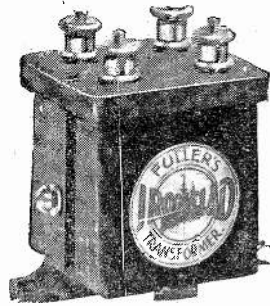

"Sparta" Ironclad Transformers.

Interval Type A. Ratio 1-5	20/-
Interval Type B. Ratio 1-4	24/-
Interval Type C. Ratio 1-4	24/-
Telephone Type T.A. Ratio 1-10	18/-
Telephone Type T.B. Ratio 1-10	23/-
Telephone Type T.C. Ratio 1-10	24/-

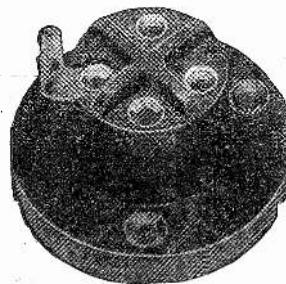

"Sparta" Valve Holders.

Contacts marked on both sides. Earthing clip to valve cap. Low self capacity. Made in two types. For front of panel, 2/- each. For underside of panel, 1/9 each.

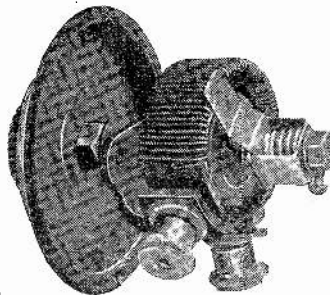

"Sparta" Filament Resistances.

Supplied for 1, 2, or 3 valves. Compact, and fitted with an "off" position obviating the need for a special switch.

1-Valve Resistance	4/3
2-Valve Resistance	4/6
3-Valve Resistance	4/9
Potentiometer	6/-

THE results obtained with a home-made receiver depend chiefly upon the components used. Many experimenters who achieve distinction by receiving over immense distances use simple circuits. These successes, nine times out of ten, may be attributed to the use of good components. "Sparta" components are good—in the finest sense of the word.

Good in design, good in workmanship and good in performance. Moreover, each one is guaranteed for 12 months. That is because we know they will perform their duties under all conditions.

"Ironclad" Transformers

Completely enclosed mechanically and screened magnetically. The heavy iron case maintains even coil temperature and prevents breakage of wire due to expansion and contraction. Especially layer-wound, moisture-proof coils parchment spaced. "B" and "C" type coils are spaced turn for turn with silk thread to reduce self-capacity and make turns rigid. Magnetic circuit has two air-gaps in series, thus preventing noise due to eddy currents.

Amplification is high, consistent with minimum of distortion.

Filament Resistances

The former is constructed from a fire-proof material. Each turn is rigidly supported.

Each resistance is sufficiently small to go into the same space as a valve-holder, thus allowing each valve to have its resistance mounted underneath it.

"Sparta" Potentiometers are of similar design to the filament resistances. Resistance value 400 ohms.

Space only permits us to show three components here. Just send a card for list 316B; it fully describes the complete "Sparta" range.

FULLER'S UNITED ELECTRIC WORKS, LTD.,

Woodland Works, Chadwell Heath, Essex.

Telephone - - - - - Ilford 1200 (6 lines)
Telegrams - "Fuller, Chadwell Heath."

London Depot

53, High Street, W.C.2.

Telephone - - - - - Gerrard 5070

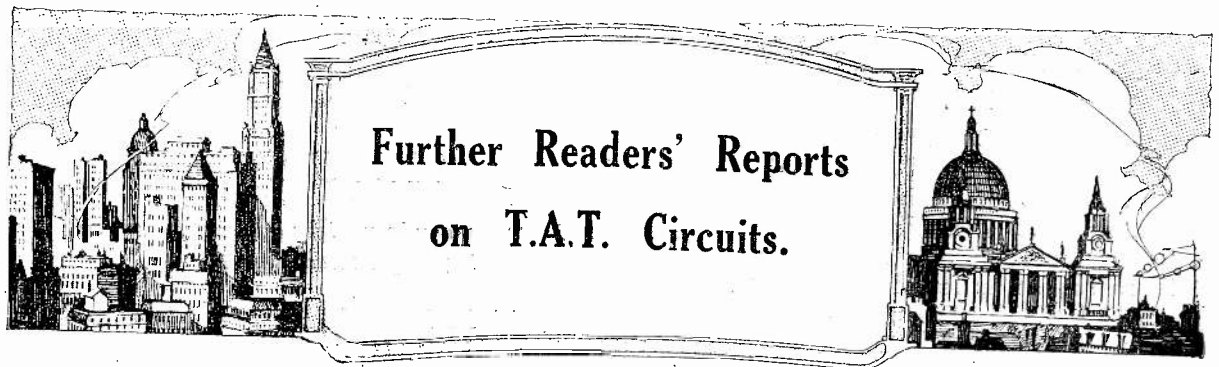

A T.A.T. 3-Valve Circuit.

SIR,—My results with a T.A.T. 3-valve circuit may be of interest. I have only put together a hook up of miscellaneous "table mounting" components on a wooden box. I hope to construct a proper set as soon as circumstances permit.

I get all B.B.C. main stations at excellent strength except Cardiff, which, by some freak, is never heard in this district. On the T.A.T. circuit I can just hear it. London and Manchester are very strong, using a 35 aerial coil, 100 choke coil (ordinary honeycomb type), 75 anode coil and 50 reaction. On these coils I also get Petit Parisien (strong), Radio-Iberica (rather weak), Hamburg (strong).

From Bournemouth and Newcastle I get strong signals on either 100 or 150 choke coil. They want something between these values to get full results. Glasgow, Belfast, and several unidentified Germans are very strong, with 150 choke coil, and Birmingham, Aberdeen, Berlin and other Germans are very strong with 200 choke.

I get Radio Belg. SBR at great strength with 25 aerial 75 choke, 35 anode, and 50 reaction. 5XX and Radio Paris roar in with 150 aerial, 100,000 ohms, 250 anode, 100 reaction. Eiffel Tower (telephony) is very strong on 250 aerial, 100,000 ohms, 300 anode, and 100 reaction. I use general purpose bright emitter valves with 54 volts H.T. and find no improvement by increasing it. I find adjustment of filament voltage important and when it is correct the set is most wonderfully stable. When receiving a distant station with reaction as close as possible morse signals will send the set into oscillation with each dot and dash, and it will come out by itself.

I have received several B.B.C. relays and have identified Plymouth and Edinburgh, and, of course, Liverpool.—Yours truly,

T. R. DRUITT.

Festiniog, North Wales.

A 4-Valve T.A.T. with Frame Aerial.

SIR,—I herewith enclose description of a T.A.T. 4-valve receiver, which may be of interest.—Yours truly,

H. B. BURDEKIN.
(2 J.N.)

Bilton, Nr. Rugby.

The following description of a T.A.T. 4-valve receiver, designed for frame aerial reception, may be of interest. I decided to build this receiver after reading your article in the November issue of MODERN

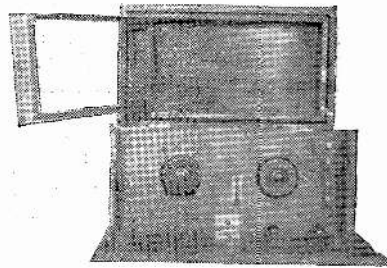

Mr. Burdekin's Receiver showing the hinged reaction coil.

WIRELESS, and must say how pleased I am with the results.

I have tried nearly every method of H.F. amplification, and find the T.A.T. system the best; the two great advantages, being stability and ease of control.

The set is designed with the frame aerial 8 in. by 15 in. in the lid; the reaction coil is hinged to this frame, and folded when the set is not required.

The front panel carries the two condensers, one the A.T.C., the other the T.A.C., a series parallel switch for use with outside aerial, an "on and off" switch for filaments, three filament resistances, and telephone terminals; all other terminals being brought to the rear.

With outside aerial, the frame (which is tapped) is used to act as the aerial tuning inductance.

Results with frame:—Birmingham

(30 miles): Very good telephone strength, works loud-speaker easily on adding L.F. amplifier. London and Manchester (80 and 100 miles): weak telephone strength. Working on outside aerial, results are splendid, all the B.B.C. stations can be heard, and a good number of Continental stations.

P.S.—All above tests have been carried out at Bilton, near Rugby.

A 7-Valve T.A.T. in Norway.

SIR,—I have read your very interesting articles about the T.A.T. system of high frequency amplification, and have built a 7-valve set—4 H.F., D. and 2 L.F.

On this receiver I heard five American broadcasting stations during the night between 7th-8th December.

The station WGY transmitting on approximately 380 metre wave I had on my Ethovox loud-speaker with good volume and excellent quality—Yours truly,

ALF. G. NIELSEN.

Kristiania, Norway.

A Report on the T.A.T. from Belgium.

SIR,—It may interest you to know I built up your T.A.T., Fig. 13 in the November number, but added a fourth valve to amplify, using a Thomson-Houston transformer. I was absolutely astounded at the result. I can now get practically every station in England, Germany, and France, also Madrid, and any amount of stations I cannot identify; "it's a walk-over." I am impatiently awaiting your five valves, and hope one will be able to cut out the two high-frequency valves and one amplifier for our Brussels station, as here one must not have reaction on the aerial.

Wishing your three papers every success and hoping to see the five valves in next month's issue.—Yours truly,

A. E. LICENCE.

Bruxelles.

Judge Settles Wireless Dispute.

In the Law Courts to-day Mr. John Citizen asked for an injunction to restrain Mr. Amateur from committing a nuisance by using his wireless. The nuisance was found to be caused by the Defendant's loud-speaker.

After the Defendant had been heard the Learned Judge suggested an ULTRA LOUD SPEAKER would restore harmony.

The Plaintiff and Defendant left the court completely reconciled.

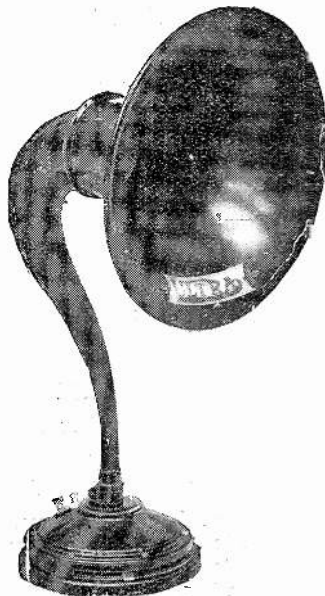

2,000 ohms,
27/6 each.

ASK YOUR DEALER FOR THEM

Should you have any difficulty in obtaining same, write direct to Messrs.

EDWARD E. ROSEN & CO.
158-160, City Road, London, E.C.
with the name of your Dealer.

Trouble Corner

by "ADSUM"

How a milliammeter may be used for detecting faults and for making simple measurements.

A Curious Short

A RATHER mystifying fault occurred to me the other day when using a two-valve set, the wiring diagram of which appears in Fig. 1. The history of the case and the symptoms are as follows:—On the previous evening the set had worked splendidly, and it was doing quite well on the night when the trouble manifested itself. After being put together in the first instance it had not been touched in any way as regards its interior economy. Whilst tuning in I happened to jar the table and was surprised to see the filament of the rectifier V_2 grow dim for an instant and then return to its normal brightness. I tapped the panel and noticed a distinct flicker in the glow of the valve. The slightest shake

trouble must be located in or near the rheostat of V_2 . The knob of this rheostat was touched. Instantly the dimming of the filament and the kick of the milliammeter were repeated. The set was disconnected and opened up for inspection. What had happened was this. The anode tuning condenser C_3 had been mounted rather close to the rheostat. So long as the arm of the latter was tight there was just sufficient clearance between the two.

The Cause

The brass contact arm of the rheostat had come loose on its spindle, so that when a jar occurred it lightly touched a nut of the condenser at the end of one of the pillars supporting the fixed plates, thus making a short-circuit across both

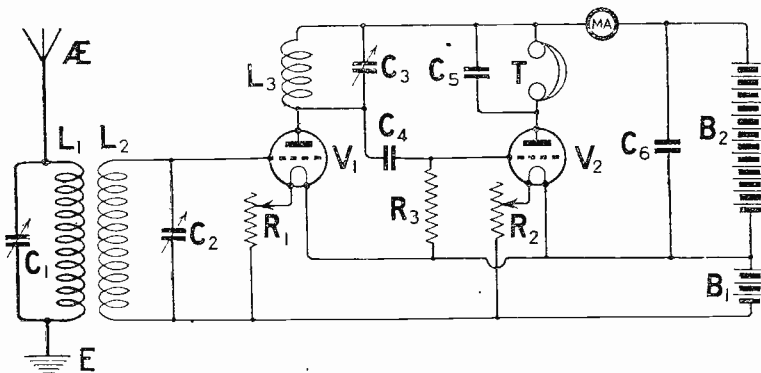

Fig. 1.—The two-valve circuit in which the curious short occurred.

either of the table or of the set itself produced the same effect on every occasion. Then I noticed the milliammeter which was in the circuit in the position shown in the drawing. Whenever the dimming of the filament occurred the needle kicked hard over against its stop. Obviously a high-tension short-circuit was taking place. One had then the following facts to go on. Jarring produced a high-tension short and a partial disconnection in the filament circuit of V_2 . V_1 was not affected. A moment's thought showed that the

high and low-tension batteries. The condenser, which was provided with a one-hole fixing, had also worked loose and had turned slightly so as to make contact between its nut and the arm of the rheostat possible. The trouble was rectified by tightening up the arm of the rheostat and by turning the condenser round a little. To make quite sure that the same thing did not occur again the arm was secured with a little solder and the one-hole fixing of the condenser was scrapped, two 4 B.A. screws driven through the panel

into its ebonite top plate being used instead.

Other Reasons

Even if the milliammeter had not been in the circuit the cause of the dimming of the filament trouble would have been tracked down quite quickly, for if the filament of one valve of the set grows dim under the effects of a slight jar the possible causes of this effect are not very many in number. The grid and filament may be very near each other so that they are brought into

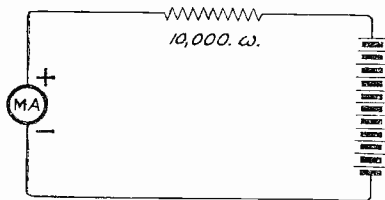

Fig. 2.—A circuit suitable for the measurement of H.T. voltage.

actual contact for an instant by the shake; or there may be a broken lead within the valve cap; or there may be a breakage in the filament leads, or the rheostat may be defective. It is just possible, though, that without the help of the milliammeter the short circuit might not have been detected. This would not have mattered very greatly, for it was automatically cured by setting the arm of the rheostat right. Still, I think that the milliammeter is by far the most useful measuring instrument that the amateur can have. If placed in circuit with the high-tension battery it enables him to see in an instant whether anything is wrong with the plate circuits of his valves, and in the case of the vast majority of breakdowns its indications lead one very quickly to the seat of the trouble. The experimenter who desires to take accurate measurements requires, of course, a carefully calibrated milliammeter, but the man who uses the instrument merely to help him to track down troubles when they occur will find that he has all he wants in the less accurately calibrated milliammeter, which can be bought for something under a pound.

Measuring H.T. Voltage

It should not be forgotten that if you possess a milliammeter you can use it not only for measuring the plate current but also for obtaining a fairly accurate indication of the voltage of both your batteries. Fig. 2 shows how the E.M.F. of the high-tension battery

may be ascertained by means of a milliammeter. A resistance of 10,000 ohms is placed in series between the battery and the instrument, and each milliampere registered represents 10 volts of E.M.F. By Ohm's Law voltage = current multiplied by resistance. One milliampere is .001 ampere. If therefore the instrument registers 4 milliamperes the voltage is .004 multiplied by 10,000, or 40. Resistances with reputed values of 10,000 ohms are never quite exact, so that the reading obtained will not be absolutely accurate. The exact value of the resistance may, however, be found if you have a friend who possesses a really good high resistance voltmeter. Get him to take the voltage of your battery.

Calibrating the Resistance

We can next wire up the circuit shown in Fig. 2 and take the reading of the milliammeter. Let us suppose that the actual voltage is 51 volts and that the milliammeter shows a current of 3 milliamperes. By Ohm's Law resistance = voltage divided by current or $\frac{51}{.003} = 17,000$ ohms.

We now know the value of the resistance and the voltage corresponding to any reading of the milliammeter can be found by remembering that each milliampere represents a voltage of 17. To measure the low-tension battery with the milliammeter we can conveniently use a resistance of approximately 1,000

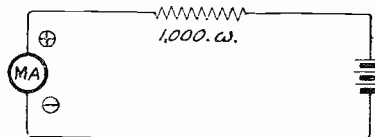

Fig. 3.—A suitable circuit for the determination of L.T. voltage.

ohms, in which case each milliampere will represent 1 volt. An old single telephone earpiece, calibrated as before with the aid of a good voltmeter, will answer very well indeed, or we may use the secondary of a low frequency transformer whose primary winding has been burnt out. If this is found to have a resistance of 400 ohms then we shall find that each milliampere will represent .4 volts.

Another Short

Another curious short circuit happened to a friend of mine a week or two ago. He had just finished constructing a three-valve set on the lines shown in the diagram in Fig. 4, V_1 being the rectifier and

Quality RADIO COMPONENTS.

Profuse y illustrated twelve page CATALOGUE just out. If your dealer cannot give you one send us a card with his name and address to receive it direct FREE and POST FREE.

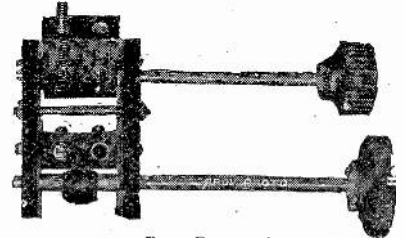

Prov. Protected.

CAM-VERNIER COIL HOLDER

Price 9/-, on base 1/- extra. With Reaction Reverse and Shorting Switch incorporated, 12/6. Postage 4d.

DUPLEX COILS

Postage 3d. each. Set post free.



25	1/6
35	1/9
50	2/0
75	2/3
100	2/9
150	3/0
175	3/6
200	3/9

PANEL COIL HOLDER

(no base)

Back connections eliminating flex.
2 way 3/-
3 way 5/-
N.P. 1/- extra.

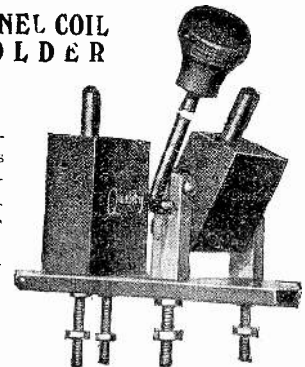

Post 3d.

Drilling template with all

GOSWELL ENGINEERING CO., LTD.,

12a, PENTONVILLE RD., LONDON, N.1.
Liberat Trade Terms. Phone: North 3051

V₂ and V₃ transformer-coupled note-magnifiers. On connecting up to try out the set he attached aerial and earth to their terminals, wired up the accumulator and placed the negative high-tension wander-plug in its socket. He then switched on the filaments, took the positive high-tension wander-plug and was placing it in its socket when a fat spark leapt across between its point and the metal contact of the battery.

A Mysterious Fault

Here there was a short circuit which required no milliammeter to show it up. He switched off the filaments and gently brought the plug up to its socket once more. Again the spark took place. The set was immediately disconnected and a careful examination of the wiring was conducted. Though every lead was carefully tested out, nothing whatever could be found to account for the short. Tests were then made with an ex-Army galvanometer, which was the only measuring instrument that my friend possessed. An old high-tension battery giving a voltage of about 30 was used for this purpose. With the galvanometer in series it was attached first to the high-tension terminals and then to the

low. In neither case was there the slightest response. This made it plain that neither the high-tension battery nor the low-tension battery was shorted individually, but that the short circuit must have occurred across the two. The low-tension

The only thing to do now was to consult the wiring diagram so as to see which leads were connected to high-tension positive and which to low-tension negative. The short must be occurring between one of each of these. It could not be due

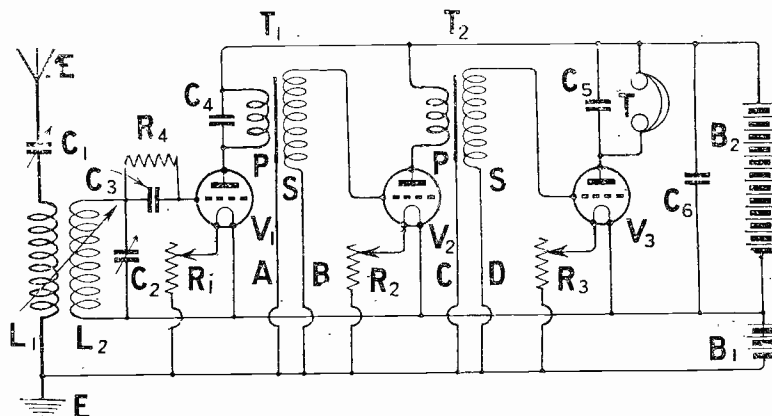
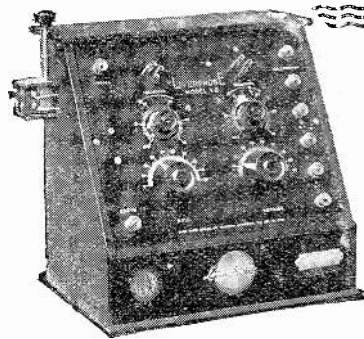

Fig. 4.—A circuit diagram of the receiver in which there was a leak between the primary and core.

terminals were therefore joined by a short length of wire, and the test was made again across those provided for the high-tension battery. An immediate and emphatic kick of the needle resulted. Again the wiring was traced out, and again no fault could be found by inspection.

to a broken-down high-tension battery condenser C₆, since nothing happened if the low-tension terminals were disconnected. An examination of Fig. 4 will show that as the short-circuit occurred whether the rheostats were switched off or not, the only connections



LIVERPHONE
"Model V.2"

Specification.

Magnificently finished mahogany cabinet. Panel of highly polished non-loss ebonite, beautifully engraved, with gold lacquered fittings. Consists of detector valve, full reaction, and one distortionless low frequency valve. Unlimited wavelength range. On a standard P.M.G. aerial is capable of operating a loud speaker satisfactorily within 25 to 30 miles of a main station or 5 miles of a relay station. Will receive all B.B.C. and many Continental stations in 'phones.

Instrument guaranteed unconditionally against manufacturing fault for 2 years.

PRICES:

Liverphone Model V.2, with every conceivable accessory, headphones, 2 Marconi valves, coils, H.T. and L.T. batteries, aerial equipment, etc. £14.0.0.
Instrument only £8.5.0.

Liverphone Model V.3, with all accessories £19.0.0.
Instrument only £12.5.0

All prices include Marconi Royalty.

We hold large stocks and can deliver anywhere carriage paid per return. We will instal set free of charge within 50 miles radius of Liverpool, if the aerial is already erected.

LIVER RADIO MANUFACTURING Co., Ltd.

30, Islington, LIVERPOOL

'Phone: North 1175.

Telegrams: "Lively, Liverpool."

Barclays 644

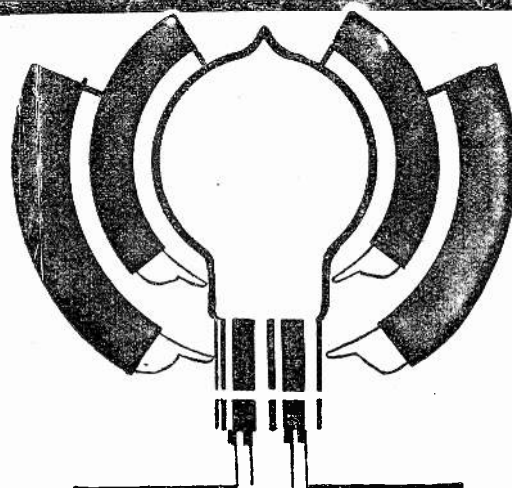

**FIT THE NEW
RADION
G.P. VALVE**

AND SIMPLIFY RECEPTION.

Here's an economical bright emitter general purpose valve with amplification factor of 9. Filament 3.5 to 4 volt .48 amp. Anode 30 to 90. Use it in any part of your set. Let us send you free and post free the curve for this valve. Just a P.C. will do.

RADIONS LTD., Bollington, Nr. Macclesfield.

From dealers **10/-** or direct

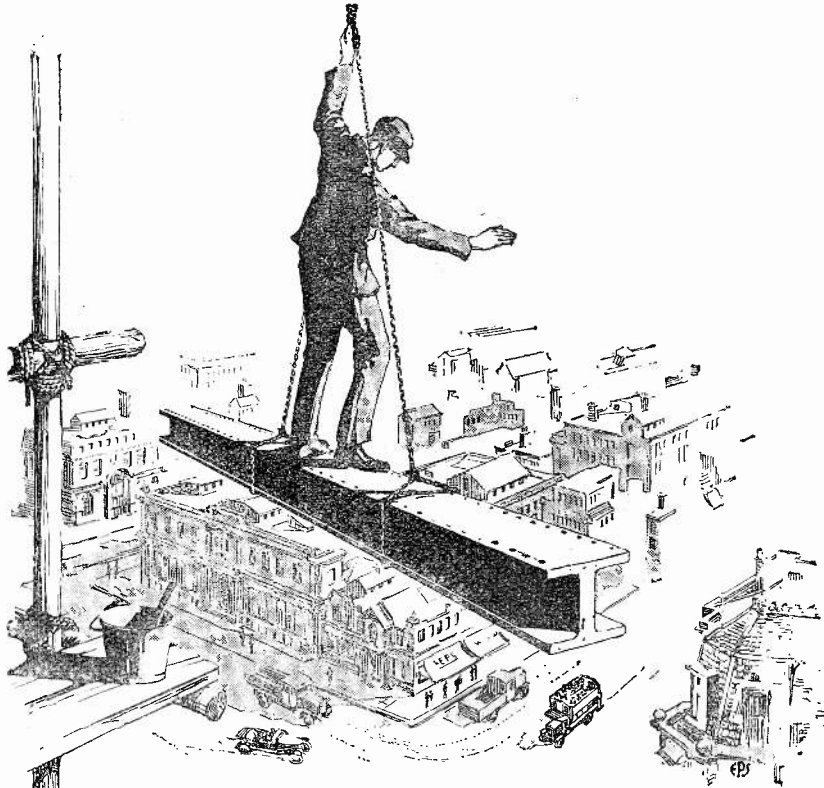

You are taking a risk

in fitting components of doubtful manufacture to your set.

As with most risks, you may be fortunate and "get away with it" until ninety and nine times. The hundredth time is your undoing.

Thousands of amateurs have testified that they can feel complete confidence in the working of their sets when—and only when—the condensers and resistances are of Dubilier manufacture. They know that behind each Dubilier product is an honest endeavour to put forth the best that science and craftsmanship can command. They know that they will have to pay more, but they also know that the outlay is an excellent insurance against breakdown or poor results.

Some of them know this because they took their friends' advice. Others took the risk.

All of them join in advising you **not** to take risks but to

Specify Dubilier.

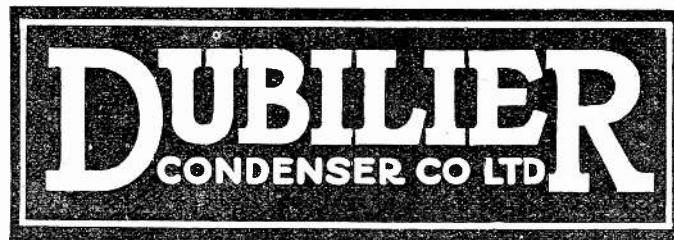

Ducon Works, Victoria Road, North Acton, London, W.3.

E.P.S. 123

In replying to advertisers, use Order Form enclosed

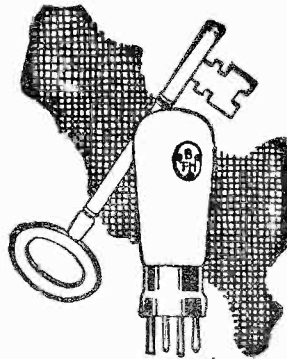

The Key to Good Reception

Good reception is dependent, to a great extent, on the *silent* functioning of the valves, which in turn is governed by the degree of "hardness." B.T.H. Radio Valves are perfectly silent in action, because they are completely exhausted. They are made by the most up-to-date machinery, and a special B.T.H. process is employed which produces an exceedingly high vacuum.

B.T.H. VALVES WILL DO ALL THAT VALVES CAN DO TO MAKE YOUR SET PERFECT

From all Electricians and Radio Dealers

B.T.H. RADIO VALVES

GENERAL PURPOSE VALVES:

Type R. ... 12/6 each

Filament Voltage.....4 volts
 Filament Current.....0.7 amp.
 Maximum plate voltage...100 volts
 Plate resistance.....27,000 ohms.

Type B 3 ... 21/- each

Filament voltage.....1.8 volts
 Filament current.....0.35 amp.
 Maximum plate voltage...80 volts
 Plate resistance.....27,000 ohms.

***Type B5. ... 25/- each**

Filament voltage.....2.8-3 volts
 Filament current...0.06 amp.(at 3 v.)
 Maximum plate voltage...80 volts
 Plate resistance.....17,000 ohms.

POWER AMPLIFYING VALVES:

Type B4. ... 35/- each

Filament voltage 5-6 volts
 Filament current...0.25 amp (at 6v.)
 Maximum plate voltage...120 volts
 Plate resistance 6,000 ohms.

***Type B6 ... 35/- each**

Filament voltage.....3 volts
 Filament current.....0.12 amp.
 Maximum plate voltage...120 volts
 Plate resistance 9,000 ohms.

***Type B 7 ... 37/6 each**

Filament voltage.....6 volts
 Filament current.....0.06 amp.
 Maximum plate voltage...120 volts
 Plate resistance 9,000 ohms.

*For use with Dry Cells



Advertisement of The British Thomson-Houston Co. Ltd.

responsible could be those marked A, B, C, D. If the short was occurring *via* B or D, then there must be a complete breakdown of the insulation between the primary and secondary windings of one of the transformers. Each was removed from the set and most carefully tested out in turn. The insulation between windings was found to be perfect in all respects. This left connections A and C by

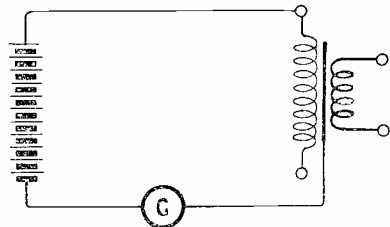

Fig. 5.—How a short between one of the windings and the core may be detected by connecting the battery positive lead to either Primary or Secondary.

means of which the cores of the transformers were earthed. Either lead A or lead C or both of them must be the culprits. If they were guilty, there must be a path for current from the primary windings to the core. A test showed instantly that there *was* in both cases. My friend had forgotten when he constructed the set that in the particular make of transformers used the centre point of the primary windings is connected directly to the core. Before you earth the core of any kind of low-frequency transformer it is always advisable to make sure that it is not constructed in this way, or alternatively that there is no fault in the insulation between the primary winding and the core. The test shown in Fig. 5, in which a milliammeter or a pair of telephones connected to a small battery may be substituted for a galvanometer, will show at once whether there is a leak between one of the windings and the core.

Valve Troubles

The other day a friend looking very woe-begone arrived holding in his hand one of the "06" type valves which he explained had gone on strike though it had been in use only for a very short time. The symptoms were that occasionally it would work, though as a rule it refused to do anything at all. So far as one could see through the almost opaque glass of the bulb there appeared to be nothing very much amiss with it inside. However, it was placed first of all in the low-frequency socket of an experimental set, which is provided

both with a milliammeter and with a means of varying the grid voltage by $1\frac{1}{2}$ volt steps. In this way a rough and ready characteristic curve of any valve can be obtained in a matter of moments. The filament lit up properly, and as the grid was made more and more positive there was a steady increase in the anode current until the saturation point was reached at a satisfactory emission. On the negative side the curve was quite good.

A Further Test

As a final test the valve was tried out on the 600 metre spark transmissions as a high-frequency amplifier, then as rectifier and finally as note magnifier. In all three positions it did extremely well. The friend went away duly comforted, but that evening he telephoned to say that the valve was once more refusing to do its duty. As I was quite certain that there was nothing wrong with the valve, I suggested that he should bring the set (a two-valver) round for examination. He appeared with it in a short time and we attached it to my aerial. I switched on and obtained excellent reception of 2LO at once. "Ah, but wait a moment," said he, and he gave the panel a knock. There was a nasty jarring noise and signals ceased. A further sharp tap brought them back again. Most wireless men, I think, would suspect from these symptoms that one of the soldered joints between the

low tension leads and the filament legs had come adrift and that the wire was making contact only by chance. On examination it was found that this was not the case, for the joints, though not very well made, were quite firm. What had happened was that the spiral of the rheostat was slightly crushed just below the point at which the contact arm rested. There was some play, too, in the spindle so that a slight shake was sufficient to make or break connection. To make the rheostat quite sound one would have needed to fit a new bush and a fresh resistance spiral. But I pointed out that by turning the knob so that the arm rested upon a place a little to one side or the other of the bad spot quite good contact was obtained.

Blameless Valves

I have known other cases in which valves have been suspected though equally blameless. It is quite common to find the insides of the legs of the holders very dirty, especially if the set has been left exposed to the effects of dust and damp. If the holder was not originally a very good fit, dirt particularly in the grid leg, is quite sufficient to account either for a complete absence of signals or for a very great deal of noisiness. Insides of valve legs can be kept quite clean by giving them an occasional rub with a piece of glass paper wrapped round a knitting needle.

A PRIZE COMPETITION. RESULTS.

We are advised that the prize-winners in the competition conducted by Messrs. British Radio Valve Service, Ltd., Hazlitt House, Southampton Buildings, Holborn, London, W.C.1 (the terms of which were advertised in these pages when the competition was announced), are as follows:—

1st Prize—£100.

W. H. GRAHAM, Esq.,
Red House,
Tywardreath,
Cornwall.

2nd Prize—£50.

J. H. CHILDS, Esq.,
5, Hill Road,
Barrow-in-Furness.

3rd Prize—£20.

J. DONALD, Esq.,
4, Oakend Way,
Gerrards Cross.

4th Prize—£10.

E. H. BYSSHE, Esq.,
P.O. Box 19,
Capetown,
South Africa.

5th Prize—£10.

REV. E. S. SPOONER,
The Manse,
Henley-on-Thames.

6th Prize—£10.

A. A. DAVIES, Esq.,
39, Upper Northgate Street,
Chester.

Free Entry Prize—£50.

F. A. H. MATTHEWS, Esq.,
Knap Villa,
Shaftesbury,
Dorset.

PHOTOGRAPHS.

The original photographic prints corresponding to illustrations of Radio Press Sets (including views of the wiring) may be obtained from Radio Press, Ltd., price 2s. 3d. each, post free. These reproductions are perfect reproductions and every detail is clearly visible. The name of the article and figure number should be quoted when ordering.

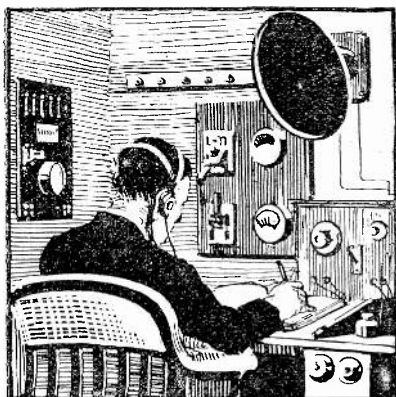

Test Report on "A Long Range 4-Valve Neutrodyne Receiver"

By JOHN UNDERDOWN.

Full constructional details of this efficient receiver appeared in last month's "Modern Wireless."

THE above set, particulars of which were given in the January issue, has been in use 12 miles S.E. of 2LO and has been giving excellent results, using both bright and dull emitter valves and on frame and outdoor aerials.

Preliminary tests were carried out on a useful portable frame aerial of Portable Utilities make, hexagonal in shape and about four feet across the diagonals. Full loud-speaker strength was obtained from 2LO. The quality was excellent, and there was a marked absence of mush, spark and local oscillation, which is so noticeable with the large outdoor aerial. On 'phones without the last valve Madrid and several other Continental stations were obtained at good telephone strength.

During the latter part of these tests three '06 type dull emitter valves were used for the two H.F. and detector stages, and a B.T.H. B₄ for the last stage. As low as 60 volts H.T. on all valves, with 1½ volts negative grid bias on the last, gave excellent results under these conditions.

Neutrodyne Components

Neutrodyne units of Magnum make were used throughout the tests and found comfortably to cover the broadcast band with the '0002 square law condensers. The ordinary 300 to 600 metre range of H.F. transformer used in the above case was not found to go low enough to give satisfactory tuning on London, but on the longer wave stations acted admirably. With regard to the question of neutrodyne condensers, I have used, besides the Gambrell type in the set, both Success and Colvern types with satisfactory results. In some cases the maximum capacity might be increased with advantage, as the condensers were nearly all-in when the set was stabilised. There are now a number of types on the market which may equally well be used, but the centres will, in most cases, have to be altered

somewhat from those shown in the drilling diagram previously given.

Results on Outdoor Aerial

Tested on a full-size outdoor aerial about 35 ft. high, and a buried earth which is not particularly good, 2LO and 5XX both gave sufficient volume on a large Allison loud-speaker to be audible all over the house and at some distance in the garden with doors and windows closed. On other B.B.C. stations also full loud-speaker strength was easily obtained. Cardiff was almost as loud as London, when the latter station was not transmitting. Manchester was also received at fair strength, but marred by Morse and mush from a nearby transmitter (CW). Later Madrid, giving an orchestral programme, was received at good loud-speaker strength, excepting when the aerial was swaying violently in a high wind. The effect was then somewhat similar to the fading effect observed on American transmissions. In the absence of 2LO's transmission, Bournemouth, during the children's hour, was received at sufficient volume for an ordinary room. When 2LO came on only the longer wave B.B.C. stations could be received successfully without swamping by this nearby station.

Continental Stations

Tested on Sunday, January 4, Glasgow and Newcastle were received while transmitting an evening service, a sermon from the latter being particularly clear and at times scarcely distinguishable in strength from that of 2LO.

Hamburg, giving a concert, was also received on the loud-speaker, but marred by spark and mush. Münster was particularly good and clear, as was another station announcing in German. Unfortunately, of a number of Continental stations of wavelengths between 390 and 550, few call signs or names were received.

Münster was clearly announced, but of several others received on the loud-speaker, the names were not distinguishable, due to interference. The words "Lorelei" and "Breslau" were heard preceding an orchestral item.

For these stations parallel tuning was used, a Gambrell "A" coil being used in the aerial socket and an "a/2" for reaction. The correct reaction connections were found to be sockets 1 to 6 and 2 to 7. Socket 5 was connected to 4 and A₁ joined to E.

Reception of 2LO

2LO also gave fair loud-speaker strength using the detector and L.F. valve only. In this case the first two valves were taken out and also the two neutrodyne units, whilst socket 3 was connected to the plate socket of V₂ by a flexible lead terminated by Clix plugs. No change of reaction connections was, of course, necessary, but the "a/2" coil was replaced by a "B."

5XX and Radiola were received at excellent loud-speaker strength with an "E" in the aerial socket, and an "A" for reaction. The former station was heard in the background whilst receiving the latter. Loud-speaking was also obtained from 5XX on the detector and L.F. combination.

Stabilising

With regard to stabilising the set, this is best done out of broadcasting hours, and some practice is needed before the combination giving stability over the whole range is obtained. In my case, when this was obtained, it was found unnecessary to alter these adjustments for 5XX, etc. The neutrodyne condensers were almost full-in for complete neutralisation.

Reviewing these results, the set can be recommended for loud-speaker work on a frame up to 10 miles or so from a main station, and for distant stations on an outside aerial.

Louden Valves

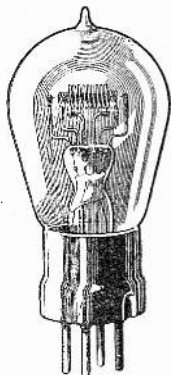

Filament Volts - 4.8—5
 Filament Amps. 0.4
 Anode Volts - 40—80

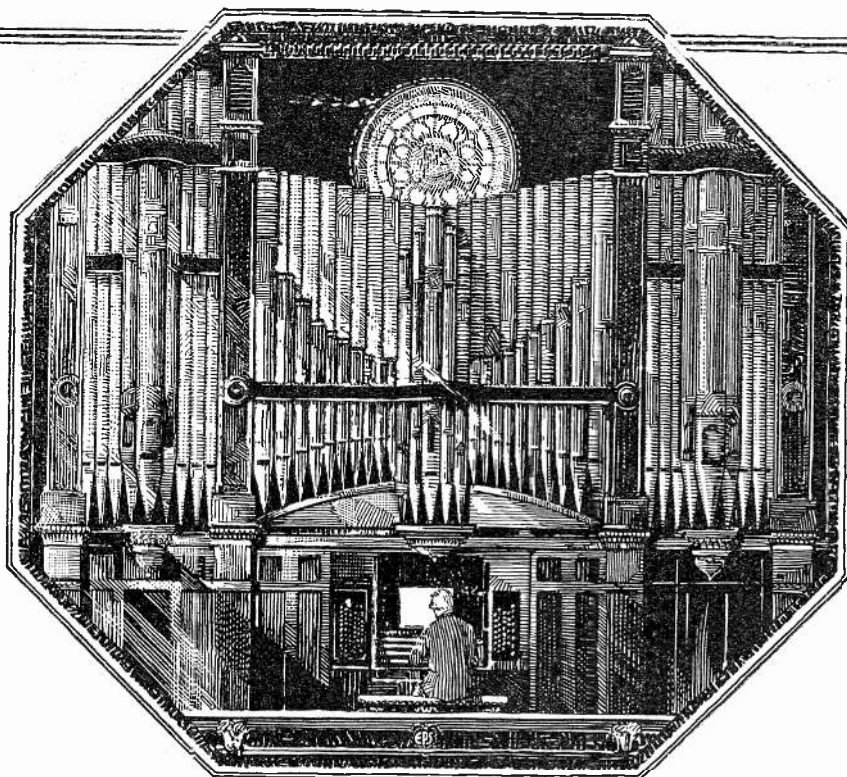

"There let the pealing organ blow."—Milton.

The organ is undoubtedly the most noble of all musical instruments, and at the same time the most versatile.

In the hands of a true artist the instrument lends itself to an almost infinite variety of expression and imitation.

The clear notes of the diapason, the shrill notes of the flute, the pure harmonies of stringed instruments, and even the liquid tones of the human voice can all be reproduced with a faithfulness that is almost startling in its reality.

It seems unfortunate, therefore, that the organ should be the most difficult of all musical instruments to transmit by wireless.

So if you hope to receive clearly the lovely music of the organ you must take all precautions at your end. And the first precaution of all is to use Louden Valves.

Louden Valves are absolutely free from distortion and all unwanted noises. It is this outstanding quality of Silver-Clearness which is mainly responsible for their amazingly rapid popularity.

For the listener-in, however interested he may occasionally be in distant stations, is chiefly concerned with clear reproduction. And this is precisely what the Silver-Clear Louden gives him, and will give you as well, without having to go to any large expense. For the Louden only costs 10/-. Try one to-day.

The Plain Louden for Detecting and Low Frequency Amplifying.

The Blue Louden for H.F. Amplification.

All Loudens are Silver Clear and free from "mush." Their current consumption is very low and their life long.

Price 10/-.

Louden Valves - Silver Clear

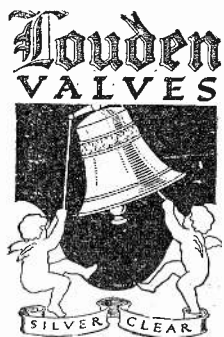

ADVT. OF THE FELLOWS MAGNETO CO., LTD., PARK ROYAL, LONDON, N.W.10 E.P.S.40

In replying to advertisers, use Order Form enclosed

The advertisement features a central illustration of a man in a suit and tie, holding a small box labeled 'Cossor valve'. Above him, the word 'Cossor' is written in a large, ornate, stylized font. Below the man, there is a circular seal with the text 'BE SURE THE SEAL IS NOT BROKEN' and the 'Cossor' logo in the center. The entire scene is framed by a decorative border with floral motifs at the bottom.

WHEN you choose a Cossor not only are you endorsing the judgment of the majority of wireless enthusiasts in this country, but you obtain a Valve guaranteed to be untouched from factory to user.

The ingenious and expensive method of swathing every Cossor Valve with cotton wool in a sealed carton permits the filament being tested by the Dealer *without breaking the seal.*

It is fully patented and affords concrete evidence of our keen endeavours to prevent Cossor users from being sold Valves which may have been used for demonstration or other purposes.

It is in your own interests to see that this seal is intact.

Advertisement of A. C. Cossor, Ltd., Highbury Grove, N.5.

Gilbert Ad. 2. 63.

Some New Radio Press Publications

WE have pleasure in announcing this month the appearance of four new publications which will prove of great interest to every reader of MODERN WIRELESS. The first editions of these publications are now on sale, and no time should be lost in ordering.

A New Book

First, we have a book of value to both the relative novice and the more advanced experimenter upon the use of switches of all types ("Switches in Wireless Circuits," by Oswald J. Rankin, Radio Press, Ltd., 1s. 6d., or 1s. 8d. post free). By the author of the popular "Pictorial Wireless Circuits," this book bids fair to achieve an equally great success, one of its greatest attractions being the provision of *both* the pictorial and the theoretical forms of the circuits, to suit readers of varying technical knowledge. A great variety of switching schemes are given (over fifty in all), and opposite each diagram is a description which gives the necessary explanations and practical details.

The other three publications are additions to the Radio Press Envelope series, describing three extremely interesting instruments with the usual wealth of elaborate detail, including the fullest instructions, blue prints, working diagrams, and generous photographic reproductions of the instrument and its construction.

The Experimenter's Problem

Radio Press Envelope No. 5 (The *Wireless Weekly* Omni Receiver, by John Scott-Taggart, F.Inst.P., A.M.I.E.E., 2s. 6d., or 2s. 9d. post free) will be welcomed by every constructor who has passed the novice stage, since one of the most difficult problems of the genuine experimenter is to reconcile the flexibility of a real experimental outfit with the requirements of appearance and convenience when required for general broadcast reception. The ordinary outfit consisting of components upon a bench, wired up to form any desired circuit, has many drawbacks, some of the chief of these being the unsightliness of the resulting installation, the number of stray wires, and the difficulty of tracing faults resulting from something coming adrift.

A modified unit system is no doubt a partial solution; but here again it is a matter of extreme difficulty to secure real flexibility.

A Successful Solution

A remarkably successful solution of the problem has been devised by John Scott-Taggart, F.Inst.P., A.M.I.E.E.; the Editor of *Wireless Weekly* and of MODERN WIRELESS,

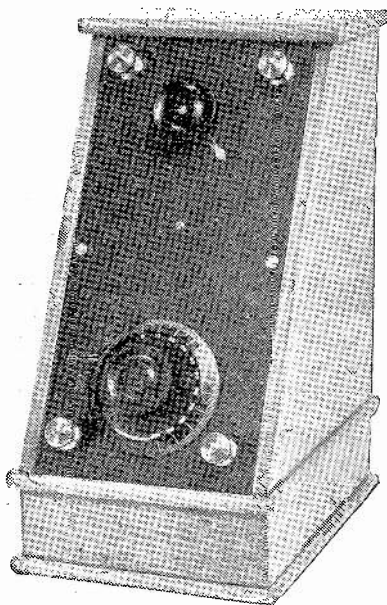

The A.B.C. Wave Trap

and by him christened the "*Wireless Weekly* Omni-Circuit Receiver." This instrument is extraordinarily flexible, since literally hundreds of different circuits can be tried, and yet it always retains the neat appearance of a finished set. Furthermore, it is an extremely easy matter to wire up any one of the possible circuits, and the operation need never take more than a few minutes. Enthusiastic builders of the instrument have christened it

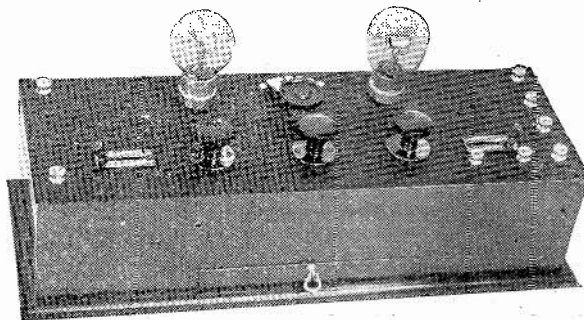

The Two-Valve Amplifier de Luxe

"an experimental laboratory in a single cabinet." It consists of a complete equipment of the necessary component parts, mounted upon ebonite panels, and the various connections are brought out to numbered terminals upon a top panel which is invisible when the lid is closed. To wire up a circuit, therefore, all that one needs to do is to open the lid and connect together with flexible links the terminals whose numbers are given in the "wiring key" of the desired circuit. It will hence be seen that only the slightest technical knowledge is needed if the keys are used, while the advanced experimenter will be able to wire up any circuit he pleases without such assistance.

Two Special Features

In addition to the usual details two specially attractive features are provided in the "Omni" Envelope, these being a complete transfer, operating on the same principle as the popular Radio Press Panel Transfers for "engraving" the terminal panel with the necessary numbers and symbols. As an alternative, a sheet of cartridge paper is also included upon which the same numbers and symbols have been clearly printed. This sheet can be fixed upon the terminal board if desired, and will, in any case, serve as a template when drilling the panel.

Cutting Out the Local Station

With the steady increase in the sensitivity of receiving apparatus and in the number of broadcasting stations, main and relay, the interference problem is becoming acute to more and more of our readers, and such a device as that described in Radio Press Envelope No. 6, under the title of "The A.B.C. Wave-Trap" (1s. 6d., or 1s. 9d., post free) by G. P. Kendall, B.Sc., Staff Editor, should prove a great boon, since in the great majority of cases it completely solves the

problem so far as the local broadcasting station is concerned. It will also be found of some assistance in extreme cases of spark interference. The author has devoted a great deal of experimental work to this particular problem, and has found that a low-loss inductance is most essential to success in wave-trap circuits, and he has incorporated a very simple, but effective, inductance in this particular instrument. A combination of switching and terminal

devices is provided which enables any one of the three most successful types of wave-traps to be tried. The instrument is exceedingly simple in use, can be added to any set, and is so arranged that it can be kept permanently wired to a set and

probably the ambition of almost every home constructor, and those who have hitherto felt that the conversion was a matter of too great an expense will find Radio Press Envelope No. 7 ("A. Two-Valve Amplifier-de-Luxe," by Herbert K. Simpson, 1s. 6d., or post

with a very convenient system of switching which enables one, both, or neither of the valves to be used at will.

Although the instrument can be used as a perfectly standard note magnifier in conjunction with any

The Omni-Circuit Receiver fully described in Radio Press Envelope No. 5.

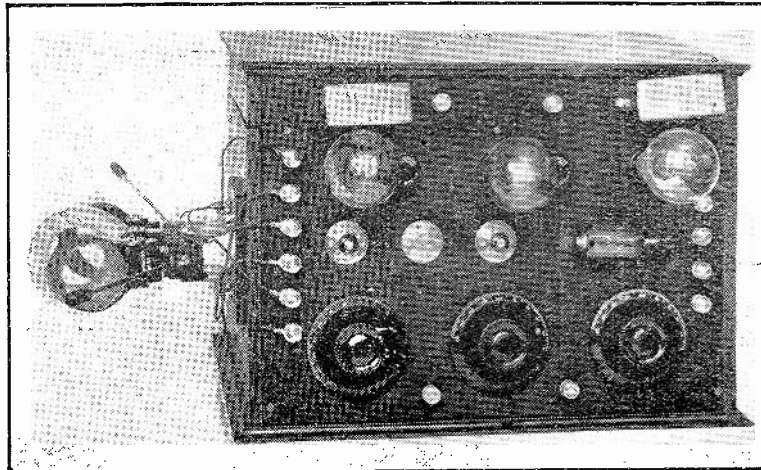

"An experimental laboratory in a Single Cabinet."

switched in or out of use as required. It can be put into any convenient type of cabinet, and the cost of the complete instrument should not exceed about 30s.

Dispensing with Headphones

To be able to dispense with the phones and use a loud-speaker is

free, 1s. 9d.) a real boon, since it enables them to make the change by adding to their present set, instead of building a new one.

The instrument is a two-valve low-frequency amplifier of good standard type, employing iron-core low-frequency transformers, and provided

receiving set which does not already possess low-frequency valves, it has been realised that provision must be made for the use of power valves and high anode voltages. A convenient device to enable grid bias to be used is incorporated, which permits a particularly exact and easy adjustment.

SMALL THINGS PLAY GREAT PARTS

Small things do play very great parts; and it is only after considerable experience you will discover that highly efficient Radio Apparatus is built of highly efficient components—small things playing great parts.

The Valve holder carries the heart of your receiver. Ordinary valve sockets carried in a moulding with poor insulating properties with nuts and washers only 1-16th inch apart are proved, by simple comparison, of very low efficiency. Such an arrangement produces distortion, short-distance paralysis and flat tuning in any receiver—adding considerably to the paralysing inter-electrode capacity of the four-pin valve.

Technical authorities—John Scott Taggart, F.Inst. P., A.M.I.E.E., and Percy W. Harris, are quite definite in their recommendation—

For successful H.F. reception use Low Capacity Valve Holders. For the highest efficiency of any stage, use Low Capacity Valve Holders.

Do not wait to find out these things for yourself — take their advice.

The H.T.C. are specifically designed to give efficiency to the heart of your receiver. Do not blind your set. Fit H.T.C. Low Capacity Valve Holders—they get the best from your valves.

Type A (above panel). Templates supplied 1/9
Type C (below Panel) 1/6

Your dealer may try to persuade you that something he has in stock is just as good. H.T.C. Products are unrivalled for their electrical performance. If your dealer cannot supply, send direct to:—

H.T.C. ELECTRICAL CO. LTD.
2 and 2a, BOUNDARIES ROAD, BALHAM, S.W. 12.

Trade Enquiries Invited. TELEPHONE: Battersea 374.

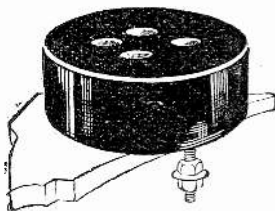

Type A (above panel)

Template supplied.

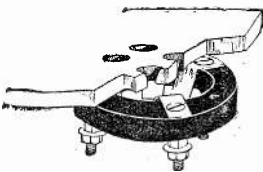

Type C (below panel)

The special advantage of this type is the method of mounting—below panel. Template supplied.

WARNING.—Purchasers of Low Capacity Valve Holders are notified to beware of imitations. It is very necessary when buying to look for the name H.T.C. on the template, without which no Valve-Holder is the genuine and original H.T.C. It may be taken that colourable imitations—simply because they are imitations—will not nor cannot give the efficiency which is inherent to the H.T.C.

BRITISH & FOREIGN PATENTS APPLIED FOR.

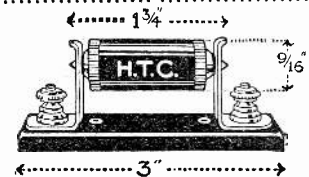

A FIXED DETECTOR. New and Reliable. Crystal reception has seen the introduction of various types of crystal—catwhisker and otherwise. After but a few evenings' exasperating pastime in searching for that sensitive spot—one you lost in the eternal search for one better—you'll find, as experimenters who have used crystal detectors for years, that a good crystal combination is alone satisfactory.

H.T.C. Detector Complete with Ebonite Base, Clips and Terminals .. 3/6

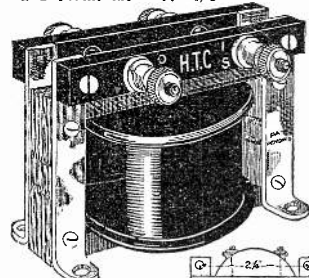

LENGTH • 2 3/4"
HEIGHT • 2 1/4"



A DISTORTIONLESS L.F. TRANSFORMER Specially wound to prevent breaking down of primary winding—a common fault with many expensive transformers. Price 15/-

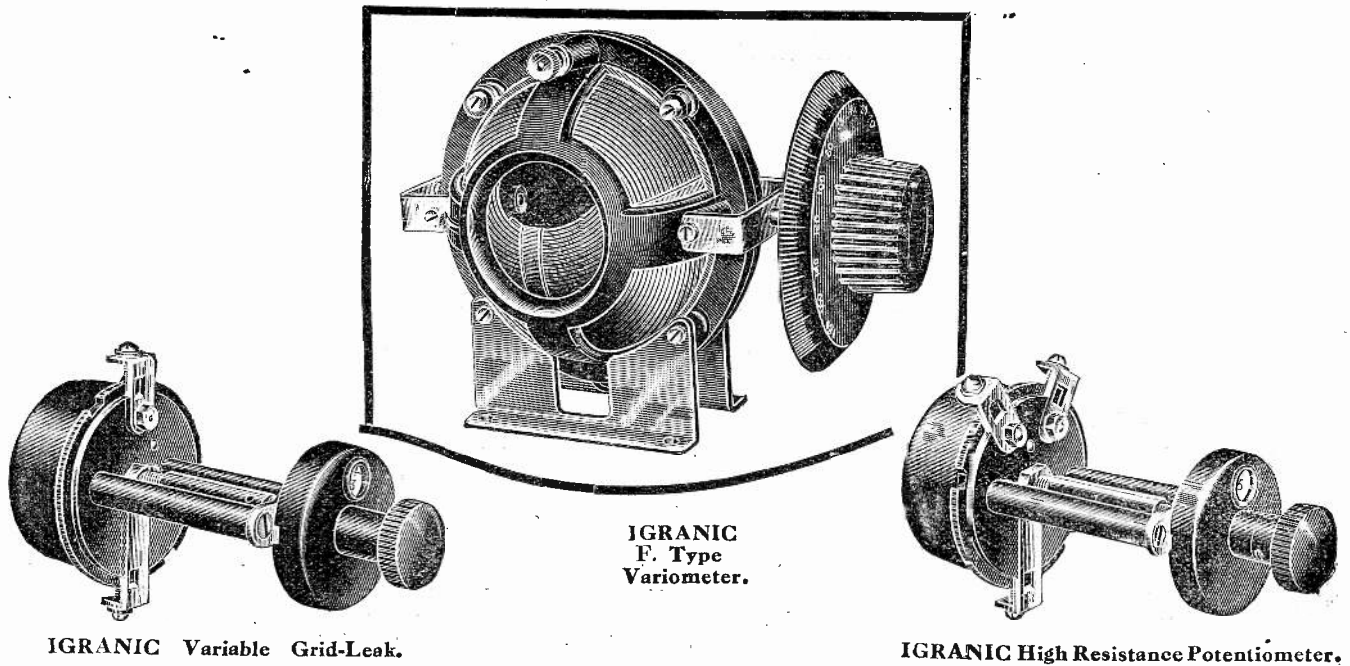

IGRANIC Variable Grid-Leak.

IGRANIC F. Type Variometer.

IGRANIC High Resistance Potentiometer.

Build these *new* components into your receiver and notice the improvement

IGRANIC F. Type Variometer

The great feature of this new Igranic Variometer lies in the fact that the stator moulding has been "skeletonised." Instead of the half stator moulding being a solid annular piece the outer and inner rings are joined by four webs. In addition the rotor winding is self supporting and thus the usual rotor moulding is dispensed with. The elimination of the moulded material which has been effected has resulted in a very big improvement in efficiency, due to the reduction of self-capacity and to the fact that the clearance between rotor and stator windings is very small. This type variometer is ideal for aerial tuning in either crystal or valve sets receiving B.B.C. stations. Supplied complete for fixing.

Price (250-600 metres), 12s. 6d.

IGRANIC Variable Grid-Leak

It gives a continuous variation of resistance from 0 to 5 megohms. Conducting parts are separated from the control knob and the metal spindle divided by insulating material in order to eliminate hand-capacity effects. Note the neat and original indicating dial. Single hole fixing.

Price, 8s. 6d.

IGRANIC High Resistance Potentiometer 30,000 Ohms.

Constructed on the same principle as the Igranic Variable Grid-Leak, as this form of construction overcomes the failings present in the wire-wound type of High Resistance Potentiometer.

Having a high resistance this new potentiometer is suitable for all the purposes to which an ordinary low resistance potentiometer is applicable, and is particularly recommended for use with grid cells for the control of potential applied to the grids of low-frequency amplifying valves. Owing to the high resistance value and consequent low current consumption of this potentiometer the useful life of the grid cells is considerably longer than when a low resistance potentiometer is employed. Smooth and even adjustment facilitates critical variations of grid potential and ensures silence in operation. Single hole fixing.

Price 8/6

That Grid-Leak you are so doubtful about for instance—let the Igranic Variable Grid-Leak show it how it ought to do its job! You cannot expect a fixed Grid-Leak to operate at maximum efficiency under all conditions. The Igranic Variable Grid-Leak allows of a smooth and continuous variation of resistance from 0 to 5 megohms, and thus ensures that the grid condenser discharges at precisely the correct rate. The better performance you obtain from this Igranic Grid-Leak you will obtain also from all Igranic Components—so that you will

build a better set with



They include Honeycomb Coils, Fixed Condensers, Filament Rheostats, Inter-valve Transformers, Variometers, Vario-couplers, Bi-plug Coil Holders, Tri-plug Coil Holders, Battery Potentiometers, Vernier Friction Pencils. All carry a six months' guarantee and are stocked by all reputable dealers.

Write for List Z 384

IGRANIC ELECTRIC CO., LTD.

149, Queen Victoria Street, London.

Works: BEDFORD.

BRANCHES:

BIRMINGHAM CARDIFF GLASGOW LEEDS MANCHESTER NEWCASTLE

Regular Programmes from American Broadcasting Stations

Telephony only. Corrected up to January 17th, 1925.

Edited by Captain L. F. PLUGGE, B.Sc., F.R.Ae.S., F.R.Met.S. Copyright.

WEEKDAYS.

Ref. No.	Greenwich Mean Time.	Local Time prevailing.	Name of Company owning Station.	Call Sign and Wave-length.	Situation.	Nature of Transmission.	Approx. duration of Transmission.
A. 1	11. 0 p.m.	6. 0 p.m.	Willard Storage Battery Co.	WTAM 390 m.	Cleveland, Ohio.	Dance Music, Concert, Orchestra.	1 hr.
A. 2	11. 0 p.m.	6. 0 p.m.	Westinghouse Electric & Mfg. Co.	WBZ 337 m.	Springfield, Mass.	Dinner Concert.	—
A. 61	11. 0 p.m.	6. 0 p.m.	The Shepard Stores	WNAC 280.3 m.	Boston, Mass.	Children's Period.	30 min.
A. 62	11. 0 p.m.	6. 0 p.m.	American Telephone and Telegraph Co.	WEAT 492 m.	New York City	Musical Programmes and Lectures	5 hrs.
A. 3	11.15 p.m.	6.15 p.m.	L. Bamberger & Co.	WOR 495 m.	Newark, New Jersey.	Orchestra.	—
A. 4	11.15 p.m.	6.15 p.m.	Westinghouse Electric & Mfg. Co.	KDKA 326 m.	Pittsburg, Pa.	Dinner Concert or Organ Recital.	—
A. 63	11.30 p.m.	6.30 p.m.	The Shepard Stores	WNAC 280.3 m.	Boston, Mass.	Dinner Dance Music	1 hr.
A. 5	11.50 p.m.	5.50 p.m.	"Kansas City Star"	WDAF 411 m.	Kansas City, Mo.	Market, Weather Report, Time Signal, Road Report.	10. 0 p.m.
A. 64	Midnight	7. 0 p.m.	"The Detroit News"	WWJ 518 m.	Detroit, Mich.	"Detroit News" Orchestra	1 hr.
A. 65	Midnight	6. 0 p.m.	Westinghouse Electric & Mfg. Co.	KYW 536 m.	Chicago, Ill.	Latest news of the world every half-hour (except Mon., 7-12 midnight)	—
A. 6	midnight	6. 0 p.m.	"Kansas City Star"	WDAF 411 m.	Kansas City, Mo.	Talks, Story, Music.	1 hr.
A. 7	midnight	7. 0 p.m.	Westinghouse Electric & Mfg. Co.	WBZ 337 m.	Springfield, Mass.	Market Report, Talks, Children's Stories.	15 min.
A. 8	12. 2 a.m.	6. 2 p.m.	Westinghouse Electric & Mfg. Co.	KYW 536 m.	Chicago, Ill.	News, Financial Markets.	16 min.
A. 9	12.15 a.m.	7.15 p.m.	L. Bamberger & Co.	WOR 495 m.	Newark, New Jersey.	Sports News.	—
A. 11	12.15 a.m.	7.15 p.m.	Westinghouse Electric & Mfg. Co.	WBZ 337 m.	Springfield, Mass.	Talks followed by Concert or other Musical Programme.	—
A. 13	12.30 a.m.	7.30 p.m.	Westinghouse Electric & Mfg. Co.	KDKA 326 m.	Pittsburgh, Pa.	Livestock and Produce Market Reports.	15 min.
A. 10	12.30 a.m.	7.30 p.m.	Westinghouse Electric & Mfg. Co.	KDKA 326 m.	Pittsburgh, Pa.	Children's Period.	—
A. 14	12.35 a.m.	6.35 p.m.	Westinghouse Electric & Mfg. Co.	KYW 536 m.	Chicago, Ill.	Children's Period.	25 min.
A. 15	12.45 a.m.	7.45 p.m.	General Electric Co.	WGY 380 m.	Schenectady, New York	Musical Programme and/or talks (except Wed. and Sat.).	—
A. 66	1.0 a.m.	8. 0 p.m.	The Shepard Stores	WNAC 280.3 m.	Boston, Mass.	Concert or Lecture	1 hr.

HULLO, EVERYBODY!!

POST FREE COLUMN.

- Sorbo earcaps, pair .. 1/8
- Ebonite coil stands, 2-way .. 3/6
- Ditto with extension handles (nickel) .. 3/11
- Ebonite 2-way cam vernier .. 5/-
- Ditto 2-way geared .. 5/11
- Shipton 2-way vernier .. 4/6
- Ebonite 3-way plain .. 4/6
- Ditto extension handles (nickel) .. 5/6
- Shipton 3-way vernier .. 7/6
- Aerial 100 ft. heavy 7/22 (with six insulators) .. 3/6
- Ebonite basket holders .. 1/6
- Murray valve holders .. 1/6
- Solid rod valve holders .. 1/3
- Bretwood anti-cap .. 1/9
- Legless anti-cap holders .. 1/3
- Ditto (Goswell) .. 1/6
- Flex twin min. silk 12 yds. .. 2/6
- Flex lighting, 12 yds. .. 1/6
- Flex red and black twin, 12 yds. C. and W. battery links, doz. .. 2/3
- DCC coil Chelmsford, use with .0005 .. 2/3
- DCC coil Chelmsford, use with variometer .. 1/9
- 72 in. phone cords (best) .. 1/11
- Valve legs, Goswell insulated, 4 1 lb. DCC 16 wire .. 1/3
- Simplex lead-in .. 3/6
- Neutrodyne vernier Colvern .. 3/6
- Independent vernier (both Colvern) .. 2/6
- Valve windows, 2 for H.F. McMichael's Barrel type .. 10/-
- BBC 300/600, 5XX 1100/3000, Energo 250/700, 3/11; 450/1200, 4/3; 900/2000, 4/6; 1600/3000 .. 4/11
- Raymond BBC 3/- 5XX .. 3/6
- 3/16 ebonite, 6 by 6 and 7 by 5, each .. 1/8
- 8 by 6 and 9 by 6, each 2/6 -; 10 by 8, 3/6; 12 by 9, 5/-; 12 by 12 .. 6/-
- Diamond weave coils (5) .. 3/6
- (Equal 25, 35, 50, 100 Honeycomb)
- "Kenite" Radio panels .. 3/8
- 8 by 6, 1/6; 9 by 6, 1/9; 10 by 8, 2/3; 12 by 9 .. 2/8
- Neutron crystal and whisker .. 1/6
- Radio Micro .06 valve .. 13/11
- French metal .06 valve .. 13/11
- Myers DE valve .. 21/-
- Myers Universal .. 12/6
- (Valves posted at buyer's risk)
- T.C.B., C, 13, 30 ohms, each .. 4/-
- T.C.B., 300 ohms potentiometer .. 5/-
- Copper tape aerial, 100 ft. .. 3/3
- Micmet detector .. 6/3
- Zurndepf detector .. 5/6
- Micrometer enclosed detector .. 2/9
- 1 1/6 square Bus bar hank .. 1/1
- 2 v. 40 amp. Hart accumulator .. 15/-
- Allen variable grid leak .. 1/9
- D.P.D.T. panel switches .. 1/9
- S.P.D.T. panel switches .. 1/5
- Bretwood variable grid leak .. 3/6
- Watmel variable grid leak .. 2/6
- Bretwood anode resistance .. 3/6
- McMichael's 2 Mst. grid leak .. 2/6
- McMichael's 100,000 ohm resistance .. 2/6
- Soldering iron and solder .. 2/9
- Mansbridge 2 Mfd. 1 mfd., 3/6; 25, 3/6; .. 01, 2/6
- L.F. TRANSFORMERS. Eureka Concert Grand .. 30/-
- Eureka 2nd stage .. 22/6
- Igranite new model .. 21/-
- General Radio 83 .. 15/-

RAYMOND VARIABLE CONDENSERS High Quality. New Prices.



NEW MODEL "DE LUXE" MODEL SQUARE LAW WITH VERNIER

With Knob and Dial.
 A.uminium Ends. Ebonite Ends.
 .0003 8/6 10/-
 .0005 8/11 10/6
 Post 6d. Set.



TWIN CONDENSER SQUARE LAW, Ebonite ends.

.00025 - 12/6
 .0003 - 12/6
 .0005 - 18/11
 TWIN (Ordinary) 9/-
 Equal units of .00025 or .0003, Complete with Knob and Dial, Post 6d. Set.

NEW MODEL "DE LUXE" MODEL

As shown, with dial, knob and bush.
 .001 6/11
 .0005 5/6
 .0003 5/-
 .0002 4/9
 Post 6d. Set.

UNSURPASSED FOR FINE TUNING.

NEW MODEL

With Knob and Dial. With vernier.
 .001 - 3/9
 .0005 - 6/11
 .0003 - 6/9
 With EBONITE DIAL and Two Knobs. Post 6d. Set.

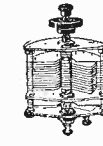

RAYMOND No. 3 CONDENSER WITH KNOB. POST 6d. SET.

.001 .. 6/11
 .0005 .. 4/11
 .0003 .. 4/6

JACKSON BROS.

SQUARE LAW.	STANDARD.
.001 .. 9/6	Variable Condensers, with Knob and Dial.
.00075 .. 9/-	
.0005 .. 8/-	.001 .. 3/6
.0003 .. 6/9	.0005 .. 7/-
.00025 .. 6/9	.0003 .. 5/9
.0002 .. 5/6	.0002 .. 5/-

Post 4d. Set.

RAYMOND SQUARE LAW Ebonite Ends.

.0003 .. 6/9
 .0005 .. 7/11

EDISON BELL.

.0001 to .0005 Fixed .. 1/3
 .002 to .006 .. 2/-
 .001 .. 1/3
 .003 with Grid Leak .. 2/6
 Variometer .. 10/6
 Twin Detector .. 5/6

LISSEN.

Variable Grid Leak .. 2/6
 Anode Resistance .. 2/6
 Lissen Minor .. 3/6
 Lissenstat .. 7/6
 Do. Universal .. 10/6
 2-way Switch .. 2/9
 Series Parallel .. 3/9
 T1 Transformers .. 30/-
 T2 .. 25/- T3 .. 16/6
 Coils: 25, 4/10; 30, 35, 40, 4/10; 50, 5/-; 60, 5/4; 75, 5/4; 100, 6/9.
 5 point Switch .. 4/-
 Lissen Choke .. 10/-
 Aux. Res. .. 1/3

ALL VALVES IN POST SENT AT PURCHASER'S RISK.

BRIGHT EMITTER 12/6

B.T.H., Ediswan, Marconi, Mullard, Cossor, Myers, Green and Red Ring, etc.
 .06, DER, ARDE, etc.
 Myers, Cossor, Mullard, Ediswan, Marconi, etc.
 Valves sent by post (purchaser's Risk)

LOUD SPEAKERS.

Sterling Dinkie .. 30/-
 Dragon Fly .. 25/-
 Junior Amplion .. 27/6
 Dr. Nesper .. 21/-
 Sterling "Baby" .. 55/-
 C.A.V. Tomtit .. 30/-

DUBILIER FIXED

.001, .002, .003, .004, .005, .006, Fixed .. 3/-
 .0001, .0002, .0003, .0004, .0005 .. 2/6
 Type 577, .01 .. 7/6
 Grid Leaks, each .. 2/6
 Anode Resistance 100,000, 70,000, 80,000, 100,000, on stand .. 5/6
 complete .. 5/6

GOSWELL ENGINEERING

2-way Cam Vernier .. 9/-
 3-way Cam Vernier .. 12/6
 3-way Ordinary .. 7/6
 2-way Panel .. 3/-
 3-way Panel .. 5/-

STERLING SQUARE LAW. (With Vernier.)

.001 .. 30/-
 .0005 .. 25/6
 .00025 .. 23/6

IGRANIC.

Coils: 25, 5/-; 35, 5/-; 50, 5/2; 75, 5/6; 100, 7/-; 150, 7/10; 200, 8/8; 250, 9/-; 300, 9/5; 400, 10/3; 500, 10/6.
 Fil. Rheostat .. 4/6
 Potentiometer .. 7/-
 30-ohm Rheostat .. 7/-

HEADPHONES

4,000 ohms Sterling .. 25/-
 B.T.H. .. 25/-
 Brandes Matched .. 25/-
 Brunet, New Model .. 20/-
 Telefunken .. 17/11

DR. NESPER HEADPHONES

Adjustable diaphragm, detachable receivers, double leather covered head-springs, long flexible cords, nickel-plated parts. Very comfortable fitting to the head.
 SEE TRADE MARK.
 4,000 ohms .. 15/6
 Post 6d. pair.

GENUINE N. & K.

No. 3, Latest Model 17/6
 NEW MODEL "D." Very Fine Value.
 4,000 ohms .. 15/11
 All stamped N. & K.

SPECIAL - To callers only.

To customers purchasing 20/- worth of our own goods we supply a first-class pair of 4,000 ohm 'phones for 5/- as an advertisement only.

REACTONE COILS.

For Chelmsford .. 2/6
 For Broadcasting .. 4/6

CALLERS COLUMN.

NOTE NAME, RAYMOND. No Post Orders from Same. D.C.C. WIRE.

per 1 lb.
 13 g. .. 9d. 20 g. .. 9d.
 22 g. .. 10d. 24 g. .. 1/3
 26 g. .. 1/1 28 g. .. 1/3
 30 g. .. 1/6 Etc., etc.
 Mansbridge 2 mfd. 3/9. 1 mfd. 3/3

EBONITE 3/16 in.
 6 x 6 .. 1/4 12 x 6 .. 3/-
 7 x 5 .. 1/4 12 x 9 .. 4/3
 8 x 6 .. 1/10 12 x 12 .. 5/6
 9 x 6 .. 2/- 14 x 10 .. 5/6
 10 x 8 .. 3/- Cut to size 1d. sq. in.

RAYMOND FIXED CONDENSERS.

.001, .0001 to .0005 .. 10d.
 .002, .003, .004 .. 1/-
 .006, 1/3; .01, 1/9; .02, 1/9

ACCUMULATORS.

2 v. 40 amps. .. 9/6
 4 v. 40 amps. .. 16/6
 4 v. 60 amps. .. 18/6
 4 v. 80 amps. .. 23/6
 6 v. 60 amps. .. 27/6
 6 v. 80 amps. .. 33/-
 6 v. 105 amps. .. 38/6

H.T. BATTERIES.

60 v. .. 7/6
 30 v. .. 4/6
 60 B.B.C. .. 8/11
 30 B.C.C. .. 5/6
 9 v. .. 2/6

Terminals, 1d. 1 1/2d. 2d. 'Phone, W.O., Pillar Nickel, ditto, 2d. Switch arms, 7 1/2d. with studs, 10 1/2d. Coil stands, 2-way, 1/9 2/3 3-way, 3/8, 4/6. Cam vernier, 5/3, 5/6. 3-way, 7/6, 12/6. Valve holders, 10d., 1/-, All makes stocked. Aerial 7/22, 100 ft., 1/11. Tape, do., 2/- Switches (panel), D.P.D.T., 1/- S.P.D.T., 10d. Crystal Sets, B.B.C. and 5XX, 7/11, 9/11 to 32/6. Fibre strip, 36 in. x 1 in., 2d. Wander plugs, pr., 2d. D.P.D.T., 1/4 S.P.D.T., 10d. on china base. Rheostats, C. & S., 1/3. Ormond, 1/8. Valves: Dutch, 4/9 "R.", 4/9 .06, 11/- "Metal" R., 6/2 Phillips, 6/11. "Metal" .06, 11/6 Radio Micro, 11/6. Ebonite coil plugs, 4d., 6d. shaped, 7d. up. Basket holders to 1/- B.B.C. or 5XX. Basket coils (5), 25, 35, 50, 75, 100, set 1/9. Flush panel sockets and nuts, 4 for 5d. Variometers, 1/3, 1/6, 2/3, 3/11, 4/6. Ditto, inside winding, worth 10/-, for 6/11. Micrometer detector, 1/7. Various, 9d. to 5/- Variable square law condenser, .0005, 5/11. Chelmsford coils, 1/- Holders, 9d. Shorting plug and socket, 3d. Grid leaks, 10d. Red and black twin flex, 6 yds., 10d. 12 yds. 1/6. Ebonite bushes, 1d. Battery links, 3 for 2d. H.F. transformers, B.B.C., 2/6 5XX, 2/9. Valve or stop pins and nuts, 2 a 1d. Valve sockets and nuts, 1d., 1 1/2d. 'Phone cords, 6 ft., 1/- and 1/6. Empire tape, 6d. 12 yds. Lead-in, 10 yds., 1/- Shellac, 5d. Rheostat, D.E. or R., 2/2. Boxes special line with lid, 8 x 6, 2/11. 1/16 square Bus. Bar hank, 6d. 18, 5d. Bell wire, 10 yds., 6d. 7 drills, 1/2. Wonder Aerial, 110 ft., 3/6. (Phosphor Bronze, 49 strands.) N. & K. pattern 'phones, 8/6.

RIGHT OPPOSITE DALY'S GALLERY DOOR

K. RAYMOND 27, LISLE STREET, LEICESTER SQUARE, W.C.2

No responsibility accepted on post orders unless cheques and postal orders are crossed and made payable to the firm. Moneys sent must be registered.

HOURS OF BUSINESS: DAILY - 9 to 7.45 SUNDAY, 10 to 1 'PHONE: GERRARD 4637.

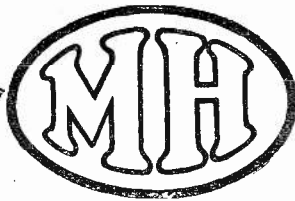

M.H. Products, so folks say, cost a trifle more—but pay.

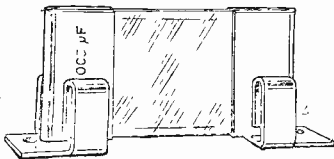

M.H. FIXED CONDENSERS

The M.H. standard interchangeable valve type condenser. Made of high grade ruby mica and tin foil. Connection is made by the two nickel plated metal ends to two nickel plated spring clips which go directly under terminal nuts. 0.0001 μ F. to 0.001 μ F., 1/9 each 0.002 μ F. to 0.01 μ F., 2/3 each. (Two clips are supplied with each condenser.)

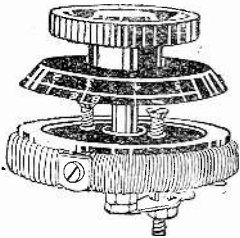

M.H. FILAMENT RHEOSTAT.

A distinctive type made for either Dull Emmitter or Bright Emmitter Valve purposes. The spool is a separate unit and solidly constructed, holding the resistance unit on its circumference. An off position is provided for.

BRIGHT EMITTERS ... 5/6
DULL EMITTERS ... 6/6

M.H. DOUBLE FILAMENT RHEOSTAT (as illustrated).

For use with both Dull Emmitter or Bright Emmitter Valves alternatively. Similar to the ordinary M.H. type Filament Rheostat, and also provided with an off position. The dial is engraved RED on the Bright Emmitter segment and WHITE on the Dull Emmitter segment. Price 7/6

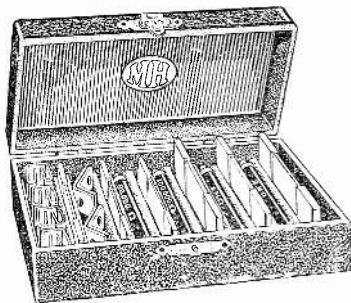

COMPLETE CASES OF

GRID LEAKS, CONDENSERS AND CLIPS.

Grid Leak, Anode Resistance, and Fixed Condenser Values are variable in their requirements for specific purposes. This case contains a selection of each, and is therefore all that is required for any purpose. Any value can be tried out to the exact requirements of each individual set or experiment if this case is kept by you.

PRICE 21/-

M.H. HIGH-GRADE COMPONENTS ARE WORLD-FAMOUS

Our standard receiving apparatus is used in every quarter of the globe, and our components are in demand everywhere. We have a set or component for every requirement.

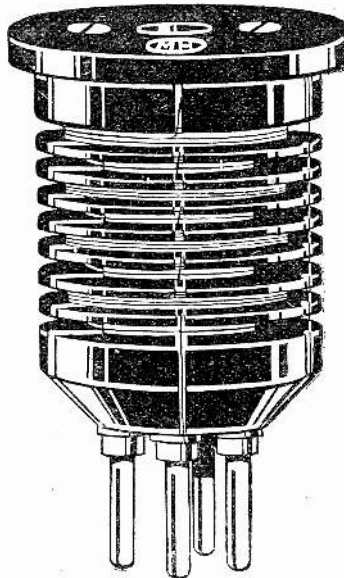

M.H. H.F. TRANSFORMERS

Plug-in, in six ranges of wavelength. 10/- each. A complete set in case, 55/- . Any number of each transformer supplied matched, at no extra cost, if specified when ordering.

M.H. NEUTRODYNE UNIT (A.6).

Similar to the H.F. Transformer, but wound to the special requirements of the neutrodyne circuit. 10/- each. Any number supplied matched, at no extra cost, if specified when ordering.

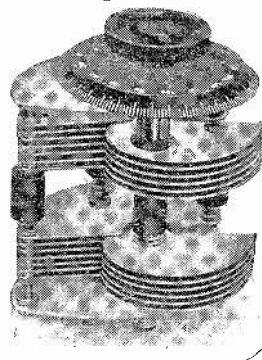

M.H. DUAL VARIABLE CONDENSER.

For tuning two stages of H.F. Amplification. Aluminium plate, square law, each half 0.0003 μ F. capacity. All variable condensers supplied in cartons containing the condenser, fixing screws, template for panel drilling and zero indicating tab.

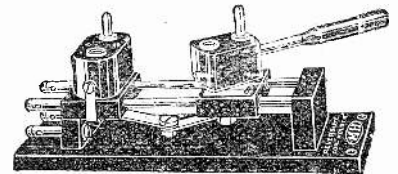

M.H. REVERSINE COIL HOLDER

Perfect in action taking the standard Duolateral coils. This coil holder enables the moving coil to be completely reversed in both its physical and electrical relationship with the fixed coil. It is a perfect variometer as well as a loose coupler and means of applying reaction. Two Coil ... Price 21/-

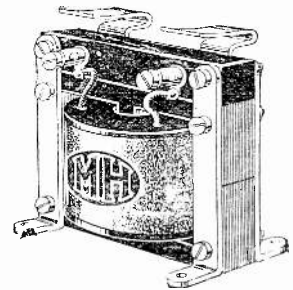

L.F. TRANSFORMER

A high-grade and efficient transformer of pleasing design for all inter-valve purposes, possessing the best possible electrical characteristics. A point to observe in the design is that the fixing-down lugs can easily be got at. The screw-driver when screwing in the holding-down screws is not fouled by any portion of the transformer. Tested to 1,000 volts.

PRICE 21/- EACH.



IN HANDSOME CASE

COMPLETE SET OF H.F. PLUG-IN TRANSFORMERS.

The H.F. Transformers are in six ranges of wavelength, necessitating six transformers. This case has been designed to take these six, the complete set and supplies, therefore, the entire requirements for all wavelengths.

PRICE 55/-

See Rooms:
RADIO CORNER, 179, Strand, London, W.C.2.

L.M. MICHAEL LTD

Manufacturers of Wireless & Scientific Apparatus.

Head Office:
HASTINGS HOUSE, Norfolk St., Strand, W.C.2.

WEEKDAYS—continued.

Ref. No.	Greenwich Mean Time.	Local Time prevailing.	Name of Company owning Station.	Call Sign and Wave-length.	Situation,	Nature of Transmission.	Approx. duration of Transmission.
A. 16	1. 0 a.m.	7. 0 p.m.	Westinghouse Electric & Mfg. Co.	KYW 536 m.	Chicago, Ill.	Talks, Dinners, Concerts, Musical Programmes (Mondays excepted). Children's Period.	2½ hrs.
A. 17	1. 0 a.m.	7. 0 p.m.	Sears-Roebuck & Co.	WLS 345 m.	Chicago, Ill.		45 min.
A. 67	1.30 a.m.	8.30 p.m.	Jack V. Elliot, Ltd.	CFCU 485 m.	Hamilton, Canada	Musical Programme	—
A. 68	1.30 a.m.	8.30 p.m.	"Pittsburgh Press," Kaufmann Baer Co.	WCAE 462 m.	Pittsburgh, Pa.	Musical Programme	1 hr.
A. 18	1.30 a.m.	8.30 p.m.	Westinghouse Electric & Mfg. Co.	KDKA 326 m.	Pittsburgh, Pa.	Concert and Musical Programme.	—
A. 19	1.30 a.m.	7.30 p.m.	"Fort Worth Star Telegram."	WBAP 476 m.	Fort Worth, Texas.	Musical Programme (except Saturday).	1 hr.
A. 20	2.0 a.m.	8.0 p.m.	"Kansas City Star."	WDAF 411 m.	Kansas City, Mo.	Popular Programme.	1½ hrs.
A. 21	2.55 a.m.	9.55 p.m.	John Wanamaker	WOO 509 m.	Philadelphia, Pa.	U.S. Naval Observatory Time-Signal followed by U.S. Weather forecast.	—
A. 22	2.55 a.m.	9.55 p.m.	Westinghouse Electric & Mfg. Co.	KDKA 326 m.	Pittsburg, Pa.	Do. do.	—
A. 23	2.55 a.m.	9.55 p.m.	Westinghouse Electric & Mfg. Co.	WBZ 337 m.	Springfield, Mass.	Do. do.	—
A. 24	3. 0 a.m.	9. 0 p.m.	Woodmen of the World.	WOAW 526 m.	Omaha, Nebraska.	Concert (except Wednesdays).	—
A. 26	3.15 a.m.	7.15 p.m.	"Morning Oregonian."	KGW 492 m.	Portland, Oregon.	Markets, Weather Report, News, Police Reports (Saturdays excepted)	—
A. 27	3.30 a.m.	9.30 p.m.	"Fort Worth Star Telegram."	WBAP 476 m.	Fort Worth, Texas.	Musical Programme (except Saturday).	1½ hrs.
A. 28	4. 0 a.m.	10. 0 p.m.	Westinghouse Electric & Mfg. Co.	KYW 536 m.	Chicago, Ill.	Musical Entertainment (except Mondays). Sometimes begins 9.30 p.m.	1 hr. or 2 hrs.
A. 25	4.30 a.m.	11.30 p.m.	Westinghouse Electric & Mfg. Co.	WBZ 337 m.	Springfield, Mass.	Musical Programme (Mon. & Thur.)	—
A. 29	5.45 a.m.	11.45 p.m.	"Kansas City Star"	WDAF 411 m.	Kansas City, Mo.	(Nighthawk Frolic) The "Merry Old Chief" and the Plantation Players, Hotel Muchlebach	1½ hrs.

SUNDAYS.

Ref. No.	Greenwich Mean Time.	Local Time prevailing.	Name of Company owning Station.	Call Sign and Wave-length.	Situation.	Nature of Transmission.	Approx. Duration of Transmission.
A. 30	11.15 p.m.	6.15 p.m.	Westinghouse Electric & Mfg. Co.	KDKA 326 m.	Pittsburg, Pa.	Dinner Concert	—
A. 31	midnight.	6. 0 p.m.	Woodmen of the World.	WOAW 526 m.	Omaha, Nebraska.	Bible Study Hour	1 hr.
A. 69	12.30 a.m.	7.30 p.m.	American Telephone and Telegraph Co.	WEAF 492 m.	New York City	Capitol Theatre, Grand Orchestra and Featured Soloists	20 min.
A. 32	12.30 a.m.	7.30 p.m.	Strawbridge and Clothier.	WFI 395 m.	Philadelphia, Pa.	Church Service	—

SUNDAYS—(Continued.)

Ref. No.	Greenwich Mean Time.	Local Time prevailing.	Name of Company owning station.	Call Sign and Wave-length.	Situation.	Nature of Transmission.	Approx. duration of Transmission.
A. 33	12.30 a.m.	7.30 p.m.	General Electric Co.	WGY 380 m.	Schenectady, New York.	Church Service	—
A. 35	12.30 a.m.	7.30 p.m.	John Wanamaker	WOO 509 m.	Philadelphia, Pa.	Church Service (occasionally at 10.45 p.m. instead).	—
A. 34	12.45 a.m.	7.45 p.m.	Westinghouse Electric & Mfg. Co.	KDKA 326 m.	Pittsburgh, Pa.	Church Service	—
A. 36	1. 0 a.m.	7. 0 p.m.	Westinghouse Electric & Mfg. Co.	KYW 536 m.	Chicago, Ill.	Service & Musical programme.	—
A. 37	1.30 a.m.	8.30 p.m.	Westinghouse Electric & Mfg. Co.	WBZ 337 m.	Springfield, Mass.	Concert or Music, etc.	—
A. 38	2. 0 a.m.	6. 0 p.m.	"Morning Oregonian."	KGW 492 m.	Portland, Oregon	Church Service	—
A. 39	2. 0 a.m.	9. 0 p.m.	General Electric Co.	WGY 380 m.	Schenectady, New York.	Hotel Orchestra, relayed.	—
A. 40	2.15 a.m.	9.15 p.m.	Westinghouse Electric & Mfg. Co.	WBZ 337 m.	Springfield, Mass.	Concert or Music, etc.	—
A. 41	3. 0 a.m.	7. 0 p.m.	"Morning Oregonian."	KGW 492 m.	Portland, Oregon.	Hotel Orchestra, relayed.	—
A. 42	3. 0 a.m.	9. 0 p.m.	Woodmen of the World.	WOAW 526 m.	Omaha, Nebraska.	Musical Chapel Service	—
A. 43	7. 0 a.m.	11. 0 p.m.	"Fort Worth Star Telegram."	WBAP 476 m.	"Fort Worth, Texas."	Dance Orchestra	1 hr.

SPECIAL DAYS.

Ref. No.	Greenwich Mean Time.	Local Time prevailing.	Name of Company owning station.	Call Sign and Wave-length.	Situation.	Nature of Transmission and day of week on which occurring.	Approx. duration of Transmission.
A. 44	11.30 p.m.	6.30 p.m.	General Electric Co.	WGY 380 m.	Schenectady, New York.	Tues. & Thurs.—Hotel Music relayed.	—
A. 45	11.30 p.m.	6.30 p.m.	Strawbridge and Clothier.	WFI 395 m.	Philadelphia, Pa.	Wed.—Children's story. Mon. & Sat.—Hotel Concert Orchestra followed by Children's period at 7.0 p.m.	—
A. 46	midnight	6. 0 p.m.	Woodmen of the World.	WOAW 526 m.	Omaha, Nebraska.	Mon. & Tues.—Lecture.	—
A. 47	12.30 a.m.	7.30 p.m.	John Wanamaker.	WOO 509 m.	Philadelphia, Pa.	Thurs. & Fri.—Children's Hour. Except Mon., Wed., Thurs.—Organ or Orchestral Concerts, Talks.	3½ hrs.
A. 48	1. 0 a.m.	8. 0 p.m.	Strawbridge and Clothier.	WFI 395 m.	Philadelphia, Pa.	Thurs.—Boy Scout Programme, followed by Concert at 8.30 p.m.	2½ hrs.
A. 49	1. 0 a.m.	8. 0 p.m.	L. Bamberger & Co.	WOR 405 m.	Newark, New Jersey.	Tues. and Sat.—Concert. Mon., Wed., Sat.—Musical Programme, Talks.	2½ hrs. 3 or 4 hrs.
A. 50	1. 0 a.m.	8. 0 p.m.	Willard Storage Battery Co.	WTAM 390 m.	Cleveland, Ohio.	Mon. & Wed.—Concert.	2 hrs.
A. 51	2. 0 a.m.	9. 0 p.m.	Willard Storage Battery Co.	WTAM 390 m.	Cleveland, Ohio.	Sat.—Dance Programme.	3 hrs.
A. 52	2.30 a.m.	9.30 p.m.	General Electric Co.	or WGY 380 m.	Schenectady, New York.	Sat.—Dance Music.	—

FALLON SQUARE LAW CONDENSERS

The New Fallon Square Law Condenser is absolutely the last word in perfect condenser construction. Extremely handsome appearance, all parts being heavily plated: .068 spacing (the closest possible). In the new model the overall length of the .001 condenser is only 4 1/2 in. as against 5 1/2 in. in the old model, and by a new idea in spacing washers, rigidity of construction, never before achieved in any make of condenser, has been obtained.

SQUARE LAW TYPE (As illustrated.)			
Price		Price	
.001 ...	9/6	.00025 ...	6/9
.0005 ...	8/6	.0002 ...	6/-
.0003 ...	7/-	Vernier 3 or 5 ...	4/6

STANDARD TYPE With Ordinary Vanes			
Price		Price	
.001 ...	8/9	.00025 ...	6/-
.0005 ...	7/-	.0001 ...	5/6
.0003 ...	6/6	Vernier, 3 or 5 ...	4/-

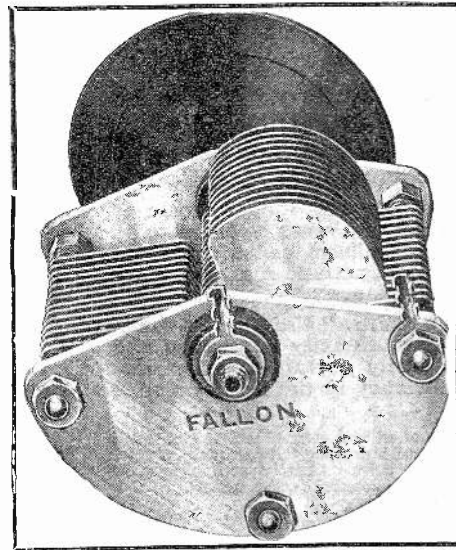

Features Include:
ONE HOLE FIXING, TAG CONNECTIONS, HEAVY ALUMINIUM TOP AND BOTTOM PLATES. Metal to metal adjustable bearings. Stout, well-cut aluminium vanes. Complete as-illustration.

FALLON FIXED CONDENSERS

—improve results in all Sets
Made of the highest quality mica and copper foil: each one tested and guaranteed. FALLON Fixed Condensers are right up to FALLON standard. Fitted with soldering tags and nuts for making clean connections.
British Reputation.—Your Condensers are not FALLON'S unless the name FALLON appears on same.
FALLON Fixed Condensers
Capacities up to .001, 1/3 each.
Capacities up to .004, 2/- each.
Fixed Condenser and Grid Leak Combined
(As illustrated.)
2 or 3 megohms, 2/6 each.

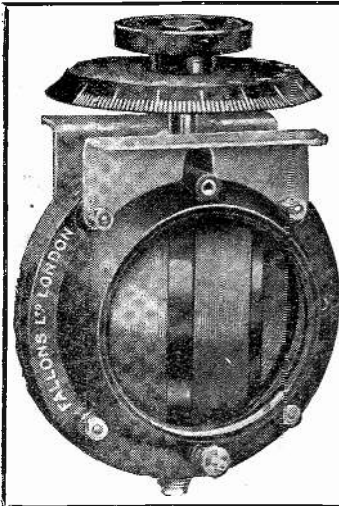

FALLON'S —The Premier— VARIOMETER—

Inside winding, suitable for broadcast reception on any P.M.G. Aerial, extraordinary close coupling ensuring large tuning range. Inductance, the highest possible—9.5 to 1. Metal feet can be adjusted to four different positions. As used in the Single Valve receiver for *all* wavelengths, described and illustrated in "Modern Wireless," July issue.

PRICE 10/- Postage 6d.

Fallon components are stock d by all dealers.

FALLON CONDENSER CO., LTD.

WHITE RIB ON WORKS, BROAD LANE, TOTTENHAM, N.15
BRANCHES: 3, King's St. West, Deansgate, Manchester; 120, Wellington St., Glasgow.

Barclays 618

WONDERFUL WIRELESS INVENTION MAKES "LESS" WIRELESS

Catswhiskerless, Batteryless, Worryless,
Fuss- and-Botherless Wireless



This entirely new invention—the "Hovimo" Crystal Valve—takes the place of old-fashioned detectors, catswhiskers, etc., and requires no batteries. It can be easily adjusted to suit the individual set and once right, remains right. Gives instant reception—uninterruptedly pure and bell-like tone. Is excellent for Crystal sets and for circuits employing crystal rectification, as well as for crystal loud speaker systems.

3/6

BRITISH MADE
Every One Guaranteed.

'HOVIMO'

CRYSTAL VALVE

Replaces the old-fashioned detector.

M. Molback, 27, High Holborn, London, W.C.1. Phone: Chan. 8391

Specially recommended for the S.T. 100. Must not be confused with Silicon-bornite or similar combinations. From dealers or post free direct.

"CABINETS AND PANELS"

FOR
RADIO PRESS RECEIVERS
AND TO CUSTOMERS' OWN DESIGNS.

EXAMPLES:—	Cabinet.	Panel.
AN EXPERIMENTER'S H.F. AMPLIFIER	34/-	8/6
A USEFUL SINGLE VALVE RECEIVER (J. Underdown)	18/-	5/-
AN AUXILIARY SUPER UNIT BOOSTER (A. D. Cowper)	22/-	3/-
A CHELMSFORD CRYSTAL RECEIVER	11/-	2/1
THE BUZZER WAVEMETER, as described by Mr. Harris in this Issue	20/6	3/-

Drilling and engraving for above panels 6d. per dozen holes or symbols respectively. Packing and carriage extra. All cabinets are best seasoned walnut, hand-made and polished. Panels are high-grade ebonite, guaranteed electrically, matt non-metallic finish. RADION Panels supplied if desired.

"S. A. CUTTERS,"

Head Office:—15, Red Lion Square, London, W.C.1

Phone: Chancery 8042.

Cabinet Works:—Pimlico. Stores:—Blackheath,

FACTS ABOUT THE MOST EFFICIENT COILS

that Wireless Research
has yet produced

If your receiver suffers from flat tuning, substitute Diamond Sunflower Coils and note how sharp the tuning becomes. Diamond Sunflower Coils gives razor-sharp tuning—their self-capacity is low and H.F. Resistance is low—electrical facts which make Diamond Sunflower Inductances preferable in any receiver.

A VERY IMPORTANT CONSIDERATION

The choice of an inductance for any given wave length is one of considerable importance. Many factors do intervene which make a coil between the usual sizes desirable for maximum signal strength.

Technical authorities—Mr. John Scott-Taggart principally—point out its advantages. It enables the highest inductance to be used with the lowest convenient variable condenser capacity. This does give better reception.

Diamond Sunflower are made in intermediate sizes—one of the many reasons why you should fit Diamond Sunflower Coils to your set. Besides, they will save you shillings on a complete set of coils.

Obtainable from your dealer or direct from the manufacturers.

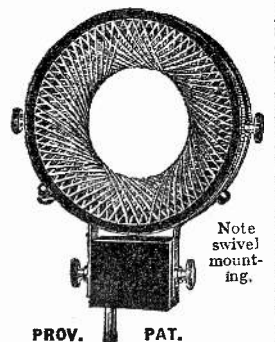

Note swivel mounting.



PLUG-IN

COILS

DIAMOND WIRELESS, LTD., 184a, OXFORD STREET, LONDON, W.1.
Telephone: MUSEUM 1380. Entrance: Gr. TITCHFIELD ST.

Barclays 645

In replying to advertisers, use Order Form enclosed

A.J.S. FOR RADIO PERFECTION

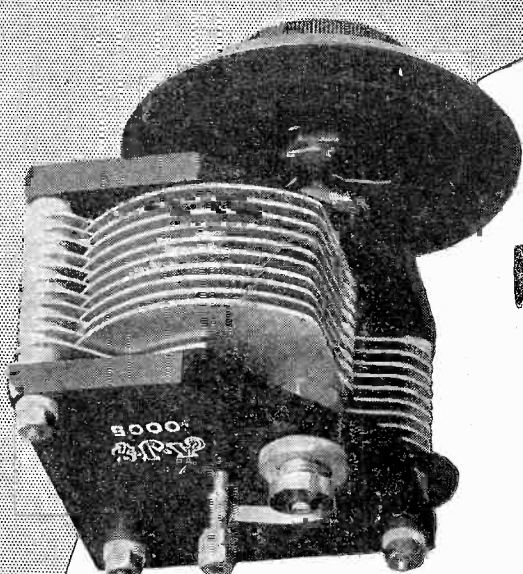

A.J.S. PATENT VARIABLE LOW LOSS CONDENSERS

Vanes shaped to give negligible minimum capacity and a greater maximum than with other types. No rubbing contact. Ebonite End Plates, adjustable brass burhes, knobbed dial, complete with 22-gauge aluminium vanes, .05 spacers.

	£	s.	d.
.0002 mfd. capacity	0	10	6
.0003 " " "	0	11	6
.0005 " " "	0	12	6
In polished walnut case with	1	5	0
electro-plated terminals	1	6	0
	1	7	6

EACH of the three A.J.S. instruments illustrated comes easily first in its own particular class. Behind them are the vast experience and unequalled resources of a famous Manufacturing House.

The A.J.S. Loud Speaker not only reproduces music or speech with a purity and volume that must be heard to be appreciated—appearance also has been considered. Its perfectly proportioned curves and artistic mat finish are a triumph of British workmanship.

Quite an exclusive idea is the A.J.S. "Unitop" 4-valve Cabinet Receiver. It is an exceptionally handsome and compact piece of furniture, easily portable, and representing supreme wireless efficiency in the least possible space.

A.J.S. Variable Low Loss Condensers, with or without polished walnut case, merit the closest investigation. Write for Illustrated List giving full particulars of these instruments as well as the A.J.S. 2, 3 and 4 Valve "Desk" type Receivers, the "Unit System" 4-valve Cabinet and the A.J.S. Pedestal 4-valve Cabinet.

A.J. STEVENS & CO. (1914) LIMITED

WIRELESS BRANCH, WOLVERHAMPTON

Phone: 1850. Wireless Call Sign: 8 E.L. Grams: "Reception, Wolverhampton."

THE UNITOP CABINET RECEIVER

forms top section of "Unit System" Cabinet, and contains A.J.S. 4-valve Receiver. Complete in itself, it may be converted into a beautiful pedestal cabinet by subsequent purchase of first a centre section to contain both batteries, and then base section containing special A.J.S. Loud Speaker. Used alone, the "Unitop" is a compact and attractive piece of furniture and a highly efficient Receiver, easily portable for outdoor functions. In Mahogany, or Light, Dark, or Wax-polished Oak. Complete with all accessories, ready for use, 39 guineas (Without accessories, £24 10s. 0d.)

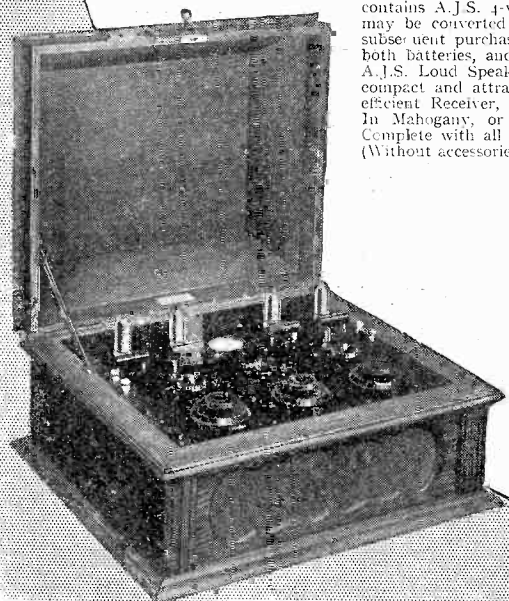

THE A.J.S. LOUD SPEAKER

The accurate proportions and smoothly blending curves of its non-resonant horn give to the A.J.S. Loud Speaker those correct acoustic properties which ensure true reproduction of the sound waves, while its extreme sensitiveness enables the utmost volume of sound to be produced with complete absence of distortion.

Price: With Metal Horn and Electro-plated Fittings, £4 15s. 0d.

With Oak or Mahogany Horn and Electro-plated Fittings, £5 10s. 0d.

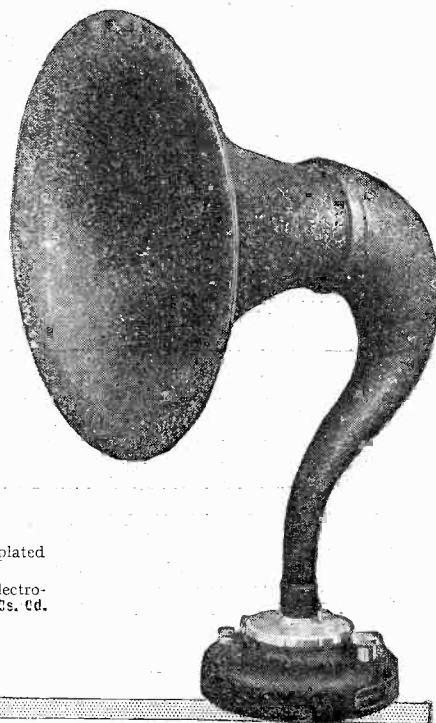

SPECIAL DAYS—(Continued.)

Ref. No.	Greenwich Mean Time.	Local Time prevailing.	Name of Company owning station.	Call Sign and Wavelength.	Situation.	Nature of Transmission and day of week on which occurring.	Approx. duration of Transmission.
A. 53	3. 0 a.m.	8. 0 p.m.	"Morning Oregonian."	KGW 492 m.	Portland, Oregon.	Mon. & Wed.—Concert. Tues. & Fri.—Talk.	—
A. 54	3.30 a.m.	10.30 p.m.	Willard Storage Battery Co.	WTAM 390 m.	Cleveland, Ohio.	Mon.—Dance Programme.	2½ hrs.
A. 55	3.30 a.m.	10.30 p.m.	General Electric Co.	WGY 380 m.	Schenectady, New York.	Fri.—Musical programme.	—
A. 56	4.30 a.m.	11.30 p.m.	General Electric Co.	WGY 380 m.	Schenectady, New York.	Tues. & Thurs. Organ Recital.	—
A. 59a	6.0 a.m.	10. 0 p.m.	"Morning Oregonian."	KGW 492 m.	Portland, Oregon.	Wed. & Sat.—Dance Music.	—
A. 60	6.0 a.m.	midnight.	Westinghouse Electric & Mfg. Co.	KYW 536 m.	Chicago, Ill.	Sat.—Hotel Band Relayed.	2 hrs.

(Continued from Page 51).

this way you will be able to reset your tuner to that position on another evening and quite likely pick it up again. The more stations you hear, the more easily can you calibrate your own instrument, provided you know the wavelengths on which they are transmitting.

I am giving herewith a blank chart which you may find convenient.

For Chelmsford a 200 and a 150 coil can be used, or singly a 400.

To measure the capacity of a condenser, the value of which we do not know, it is necessary to have

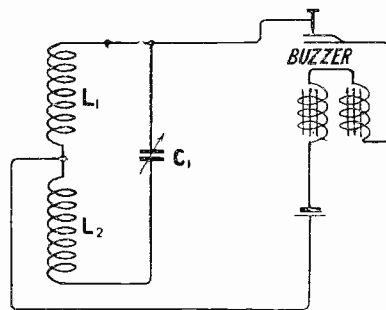
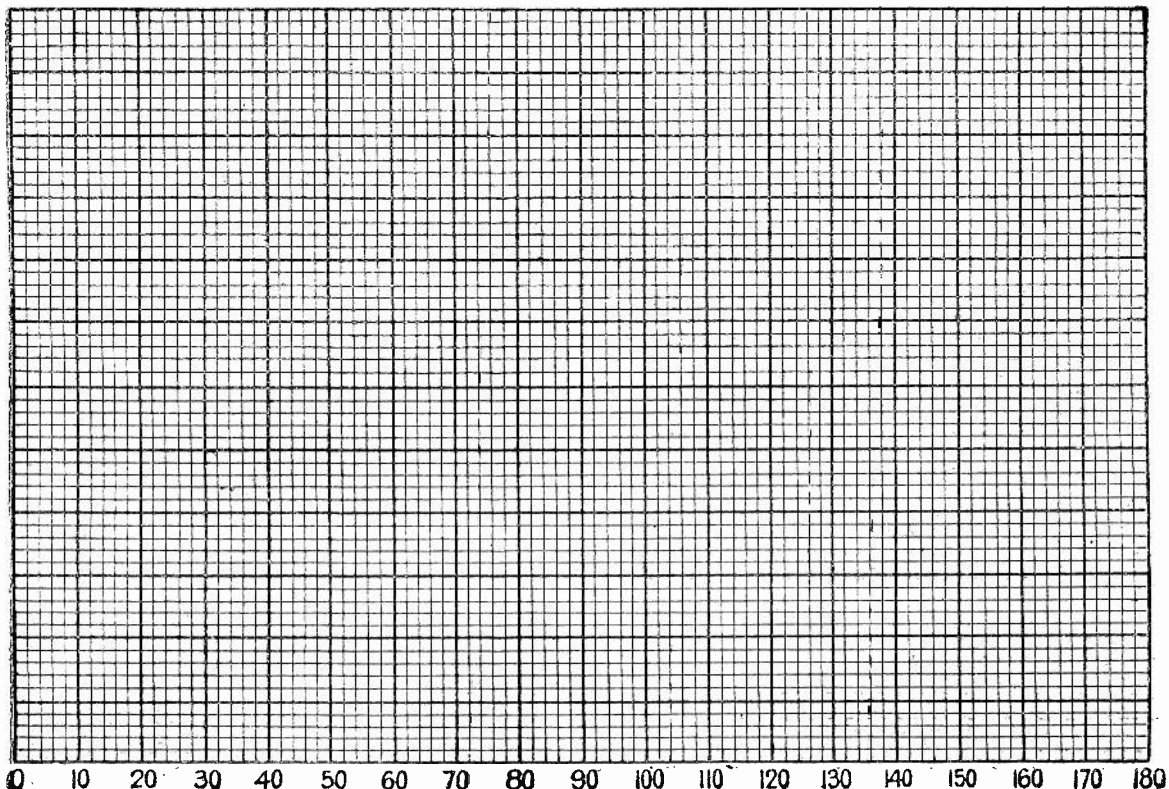

Fig 1.
The theoretical circuit of the author's wavemeter.

by us a condenser of known value. If, for example, we have a condenser we know to be .0005 capacity, maximum, we can place it across a coil connected to a detector valve and set our wavemeter so as to give a buzz when all the capacity is in. Now, if we substitute the known condenser for the unknown value its maximum should tune to the buzzer as before. If we have a calibrated condenser, then such comparisons are easy. Similar steps are taken in finding the value of an unknown inductance by comparing it with one the value of which is known.



A blank calibration chart.



Glazite Connecting Wire

Messrs. The London Electric Wire Company and Smiths, Ltd., have sent us for examination a sample of their "Glazite" connecting wire, for internal wiring of sets. This consists of a No. 18 S.W.G. tinned copper wire already covered with an insulating sleeving of coloured material. It is claimed to be damp-proof and flame-proof.

On practical trial it was found that the covering could be readily removed by a sharp knife, both at

the end of a connecting-piece and, where desired, in the middle of a length for side connections. The tinning was bright, and "took" the solder very much better than some types of so-called "tinned" bus-bar wire sold for such purposes. It was a matter of great ease, accordingly, to make the connections in an intricate and compact three-valve receiver which was wired up experimentally with this sleeving-covered wire. For L.T. battery connections and for H.T. circuits

which do not carry H.F. energy the insulated wire offers possibilities in compactness which the fashionable bare bus-bar with right-angle bends everywhere (to give sufficient clearance for safety) cannot attain. Of course, for high-frequency circuits, bare short connections, well isolated, are still indicated; otherwise, this tinned insulated wire offers decided advantages over bare tinned wire, and for such purposes it can be strongly recommended. With the extra stiffness imparted

SELL MORE
IN LANCASHIRE & CHESHIRE

Largest and most progressive firm of wholesalers and factors in the Provinces.

Old established—well known throughout the Trade—able to move quantities, desire:

EXCLUSIVE REPRESENTATION FOR LANCASHIRE & CHESHIRE.

Manufacturers of British wireless apparatus (components, complete sets, accessories) who wish to considerably increase their sales in these territories should in the first instance write to:

Factors for V.M.A. and for products of N.A.R.M.A.T. members. Highest references supplied.

Progress (Box No. 64),
BARCLAYS ADVERTISING, LTD.,
BUSH HOUSE, STRAND, LONDON, W.C.2.

T. O. BUSS

SCIENTIFIC INSTRUMENT MAKER

77, Clerkenwell Rd., London, E.C.1

Estb. 1850. Exhibition Awards: London, 1862; Sydney, 1879; Melbourne, 1880.

INTERVALVE TRANSFORMERS

Made like an Instrument by a Scientific Instrument Maker.



Correct priming impedance. Wound with correct gauge and quantity of wire. Heavy iron core to give good magnetic field—and will carry heavy currents.

PRICE
18/6

Ratio 5 to 1.

MADE LIKE AN INSTRUMENT.

This instrument is thoroughly tested and is GUARANTEED FOR TWO YEARS.

by the sleeving, it is strong enough for most wiring schemes. It was noticeable that the heat of the soldering-iron produced much less unpleasant effects when soldering close to this sleeving than is usually the case.

A Breech-Loading Crystal Detector

An ingenious and very practical type of enclosed crystal detector has been submitted to us by Messrs. The General Electric Company. This appears at first glance to be quite an ordinary type of horizontal glass encased detector, mounted between metal end brackets, on an ebonite base 3 in. by 1½ in., and the ends are actually fixed to this base. One end carries the usual universal ball-joint through which slides smoothly an ordinary whisker holder provided with a fine springy spiral whisker. In the other end, however, there is a cup into which a small plug or "breech-block" screws, securing the crystal in the cup, where it projects partly through a central hole and is exposed thus to the exploring whisker. By removing this plug the crystal can accordingly be instantly removed

or adjusted without dismantling any other part of the detector. A further refinement, for use when it is desired to get at the catswhisker, is provided by a small catch, which, when released allows the whole back end of the

to get a good setting of the whisker. The crystal-cup was observed to be on the small side; nevertheless we can heartily recommend this detector to those who are interested in retaining a high standard of daily reception by the frequent adjustment and renewal of their crystal. The finish and standard of workmanship are obviously of a high order. Good, accessible terminals, and screw-holes for fixing are provided in the base.

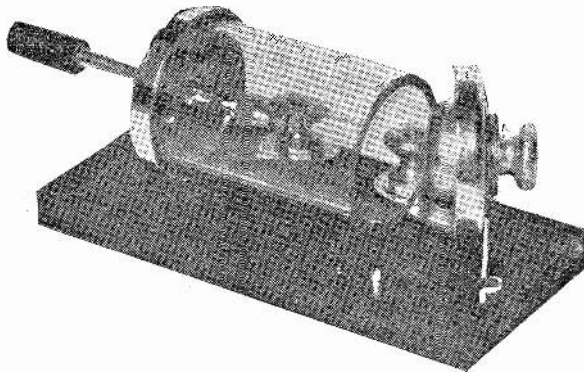

The Breech-Loading Crystal Detector.

T.M.C. Minor Loud-Speaker

A small and moderate priced loud speaker, named the "T.M.C. Minor," has been submitted by Messrs. The Telephone Manufacturing Co., Ltd. This is a handsome little instrument, finished in brown and dull copper, and is of the type which

rests in a sloping position on two short feet attached to the base and on the edge of the trumpet. The usual mechanism is provided for adjusting the magnets. The resistance of the windings is 4,000 ohms.

On trial the instrument proved sensitive and at the same time surprisingly powerful for its size.

5XX on an efficient crystal set

rests in a sloping position on two short feet attached to the base and on the edge of the trumpet. The usual mechanism is provided for adjusting the magnets. The resistance of the windings is 4,000 ohms.

7 ounces: 1 pound

"General Radiophones" weigh seven ounces.

Their price is one pound.

If you are buying weight they are the most expensive 'phones made.

If you are buying results they're far and away the cheapest.

And they are backed by the

General Radio

GUARANTEE.

* "General Radio" on a broadcast receiver or component means that it is definitely GUARANTEED to give absolute satisfaction.



Advertisement of the General Radio Company Ltd. Radio House, 235, Regent Street, London, W.1.

In replying to advertisers, use Order Form enclosed

and high aerial at a distance of 35 miles was plainly audible across a large room. With valve reception sufficient volume was obtained for any ordinary domestic use. The tone represented a marked improvement over the type of reproduction generally associated with the small blatant type of loud speaker, being very fairly free from distortion except in the matter of quantitative balance with the lower notes, e.g., in a band performance—this is perhaps almost inevitable with so small a trumpet. The sibilants came through better than usual. Altogether, in price, appearance, and actual performance, this little instrument represents a decided advance towards meeting the modern conditions of radio reception.

Accumulators

Samples of two sizes of small accumulators, celluloid-cased, suitable for operating radio receivers with a moderate number of bright-emitter valves, or for longer service in proportion, with the two-volt type of dull-emitter when used singly, have been submitted by Messrs. Oldham and Son, Ltd.

The 30-ampere hour (actual) capacity type measures 6 in. by 4 in. by 2½ in. deep, the 40-ampere hour type being of the same size,

but 3 in. deep, and having nine plates in the place of seven. Both patterns have very large coloured insulated terminals, easy to handle in an inaccessible corner of a cabinet, and on substantial screws. They are equipped with anti-splash vent-plugs of ample size, which screw out for refilling or replenishing the acid. The internal construction appeared to be sound; and on test the full capacity was indicated, the cells being supplied to us fully charged. A strong, neat carrying case of waxed hardwood was provided with the cells.

New Mullard Dull Emitter Valves

We have had an opportunity of carrying out extensive tests on specimens of the new dull emitter valves issued by Messrs. The Mullard Radio Valve Co., Ltd.: the D.3 H.F. and L.F., and the D.06 H.F. and L.F. As the index numbers imply, these are intended to operate at about .3 amperes and 1.5 to 2 volts; and at about .06 amperes and 3 volts respectively, the former being suitable for operating from a single small accumulator cell, and the latter from dry cells.

They are all fitted with the moulded insulating cap referred to in a recent report on new bright emitter Mullard valves in the

"Apparatus Tested" columns of *Wireless Weekly*, and have a bulb rather tubular in shape, partly obscured as usual with a metallic mirror. A small inclined tubular anode is fitted, with a close spiral grid of fine wire and in the H.F. valve (double red ring) the plate is rather larger than in the L.F. valve (double green ring), giving a larger impedance and higher amplification factor. The filaments in the L.F. and H.F. valves of the same rating respectively appear to have the same characteristics. The .3 ampere type took this current with 1.5 volts on the filament, and from .33 to .35 amperes at 1.8 volts. As this last voltage is a practical working figure for a small accumulator even towards the end of its charge, and as the saturation plate current was quite adequate for any ordinary purposes (some 4 milliamperes) with 1.8 volts on the filament, the characteristics were determined under these conditions. The 3-volt type took a fraction more than some of the existing types of ".06" valve, but the difference was negligible and the characteristic was determined at 3 volts and around .07 amperes.

As will be seen from the curves, the H.F. valves have almost identical characteristics, the amplifying

No more Pot Shots for the Best Spots on your Crystal

British Make

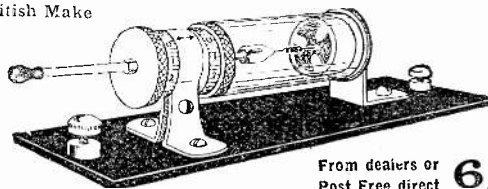

From dealers or Post Free direct **6/6**

HOVIMO AUTOMATIC CRYSTAL SPOTFINDER Spots the Right Spots Right-away

What is the usual method of finding the best sensitive spot on a Crystal? Generally a dig here, a poke there, and various random pot shots somewhere else. If you're lucky you hit a good spot. More frequently you get a bad one, often getting that same bad one again and again, whilst you sometimes lose your good spot in an attempt to get something better still.

This cannot happen with the new "Hovimo" Automatic Crystal Spotfinder. If you find an inferior or exhausted spot the "Hovimo" will not, unless you want it to, touch that spot again. When you get a result-producing spot the "Hovimo," by means of the special scale readings, will mark it off. In fact, it will thus mark off as many such spots as you desire, and it will enable you to go back, re-test each one, compare one with another, and select the best of the lot, thus obtaining with scientific accuracy and astonishing rapidity the finest reception a Crystal can give.

M. MOLBACK, 27, High Holborn, London, W.C.1.
Telephone: - - - - - Chancery 8391

The L.F. Transformer as used for the T.A.T. Receiver, described by Mr. Scott-Taggart.

The EFESCA L.F. Transformer (Type C) has been used by Mr. Scott-Taggart for the T.A.T. Long Distance Receiver.

A User says:—"It is the finest Transformer yet made for Loud-Speaker work, beating all the 30/- ones on the market. It gives results as good as any resistance capacity coupling without any loss of volume. It is absolutely free from any trace of distortion."

Ask your Wireless Dealer to show you



One-Hole Fixing Components

Send us a P.C. to-day for your copy of Catalogue 522/12. WHOLESALE ONLY:

FALK, STADELMANN & CO. LTD.

Esasca Electrical Works, 83, 85, 87, Farringdon Road, LONDON, E.C. 1

And at Manchester, Glasgow and Birmingham

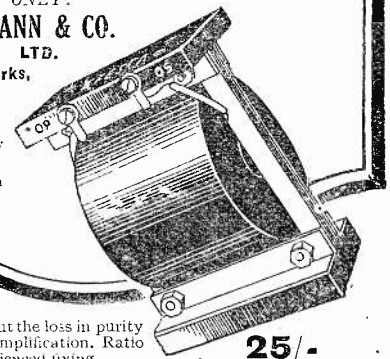

EFESCA L.F. TRANSFORMER TYPE "C."—Designed to give the amplification of a power transformer without the loss in purity of reproduction with power amplification. Ratio 2-1, one-hole generally experienced fixing.

25/-

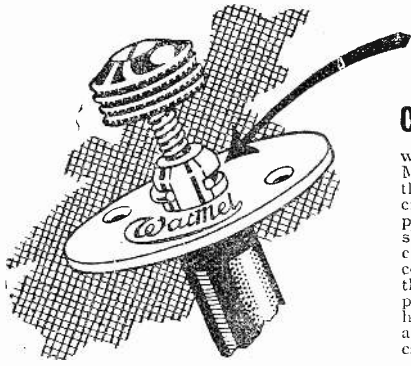

It's the refinement on the plunger!

which makes the difference. Many mysterious noises have their origin in the detector circuit. After considerable experiment we discovered that slackness of the plunger causing bad or intermittent contact was responsible for them. This same slackness permitted foreign matter to house itself between the collar and plunger — yet another cause of noisy operation.

The WATMEL therefore is now designed to obviate this trouble. A small but strong spring is recessed through the collar and compresses on to the plunger. This device ensures good contact. Slackness is automatically taken up, and the point of contact is always bright and clean.

The advantages of the Watmel Variable Grid Leak, incorporated in the Detector panel, are already well known. The addition of the compressing spring makes the WATMEL super-excellent for assisting detection.



All goods of our manufacture bear this mark. It is your only guarantee.

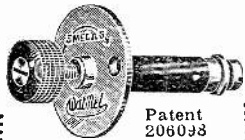

Patent 206098

5 to 5 Megohms .. 2/6
50,000 to 100,000 Ohms. 3/6

Other Resistances to suit any circuit.

Send P.C. for Descriptive Folder. SEE THE TRADE MARK.



ON EVERY GRID LEAK. BEWARE OF IMITATIONS.

WATMEL COIL FORMER

Suitable for winding any type of Inductance.

Price 4/6

WARNING!

The Watmel Wireless Co. wish to notify the trade and public that their Variable Grid Leak Patent Application No. 206098 was contested in the Comptroller's Court, and on Appeal; in both instances the Patent Grant was upheld and costs awarded.

It is the aim of this Company to protect traders, customers, and also its own interests by securing Patent protection for the novelties in its specialities, as it is these novelties, invented by experts and exhaustively tested, which are the Hall Mark of all Watmel Products.

THE WATMEL WIRELESS CO.
332a, Goswell Road, London, E.C.1.

Telephone

CLERKENWELL 7990.

Barclays 611

CARPAX

Tested Specialities for RADIO Enthusiasts.

Variable Grid Leak Detector, ideal for Reflex circuits. No Cat's-whisker worry .. 4/6

Carpax "Varimeg," the ideal Variable Grid Leak at last. Not compression type. Smooth variation, stable resistance .. 3/- Range, 1/2 to 5 megohms.

Carpax Valve Protector. Connect to one terminal of your H.T. battery and absolutely prevent valve blow-outs .. 2/6

Carpax "Varinode." A variable anode resistance on same principle as Varimeg. Range 20,000 to 250,000 ohms. 3/-

Electrad Certified Grid Leaks. Every one guaranteed, 2 megohms, 2/6

Grip Tite Connector Clips, 1/- each, small size, 4d. each. **Indor-zial,** 7/6. Send for list of complete receiving sets, 30/- to £11 10s.

Radio experimenters should send for our list of Tested Radio Specialities. This list is Free and Post Free. It will save you money and add to your enjoyment.

The above specialities are on sale at most dealers or direct from:

CARPAX COMPANY, Ltd.,
312, Deansgate, Manchester.

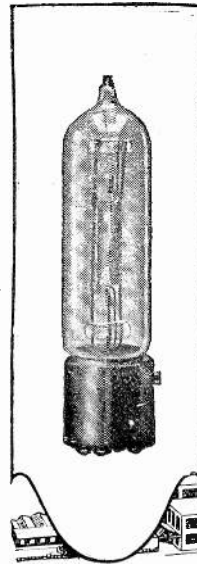

New Accomplishments

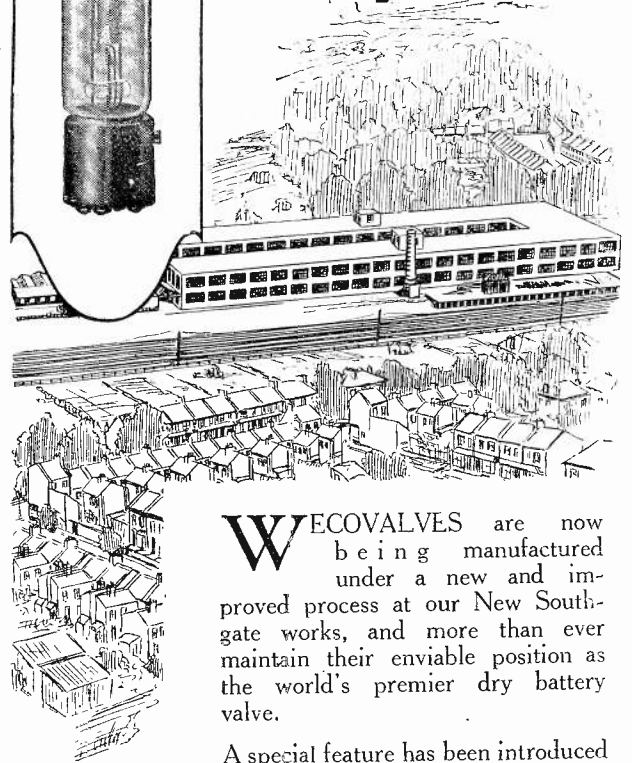

WECOVALES are now being manufactured under a new and improved process at our New Southgate works, and more than ever maintain their enviable position as the world's premier dry battery valve.

A special feature has been introduced whereby all valves are carefully tested for performance and distinctively marked as follows:

High Frequency Red Spot
Detector Green Spot
Low Frequency Orange Spot

The operating characteristics remain as before and the current consumed is 0.25 amps at 1.1 volts.

Recommend Wecovalves for:

Long Life, Sturdy Construction, Stability, Sensitiveness, Silence in operation and Low Self-capacity.

Buy British Goods.

Western Electric Company Limited.

CONNAUGHT HOUSE, ALDWYCH, LONDON, W.C.2.

CENTRAL 7345 (9 lines).

Branches: Birmingham, Leeds, Manchester, Newcastle, Glasgow, Cardiff, Southampton, Liverpool, Dublin.

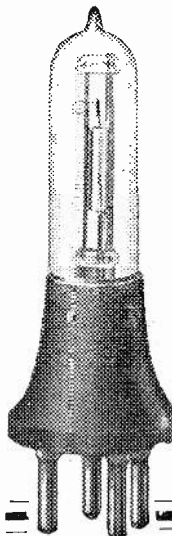

WECOVALES

In replying to advertisers, use Order Form enclosed

*“Cold is for the Mistress-Silver for the Maid
Copper for the Craftsman cunning at his trade
Good! said the Baron, sitting in his hall
But Iron-Cold Iron-is master of them all.”*
Rudyard Kipling.

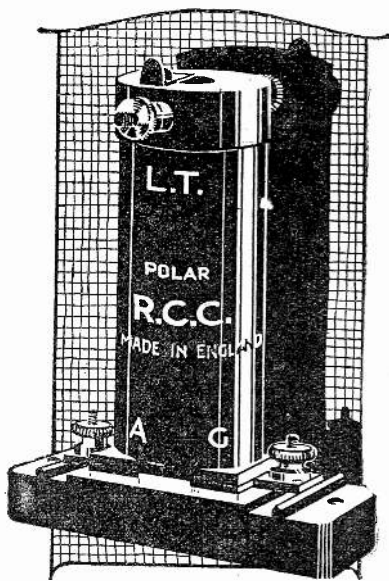

**POLAR
RESISTANCE CAPACITY
COUPLING UNIT
PRICE 15/-
ON SALE AT YOUR NEAREST
POLAR STOCKIST**

IS IRON YOUR MASTER?

Distortion of reproduction is invariably present in a wireless receiver incorporating Low Frequency iron-core Transformers. The iron core of the transformers is the chief cause of this, although of course there are contributory distorting factors due to the windings of the transformer. A rapidly increasing number of wireless experimenters and "listeners in" are now seeking purity of reproduction rather than volume of sound.

If you wish to eliminate distortion completely and to obtain pure reception, replace your intervalve transformers by the POLAR RESISTANCE CAPACITY COUPLING UNIT. This unit consists of an anode resistance, a Dubilier Condenser specially built for the purpose and a grid-leak. It is perfectly self-contained and has four clearly marked terminals corresponding to the four terminals of a transformer. The unit is built by British labour of best British materials throughout and backed by the usual Polar Guarantee. A wiring diagram is included in the 4 pp. explanatory leaflet which is supplied free on request.

In order to obtain the volume of sound equivalent to that given by two first-class transformers three Resistance Capacity Coupling units are required. The comparative cost of the two methods, at first glance, is rather in favour of intervalve transformer coupling, but considering that the difference is only a few shillings, it is well worth while to spend these few shillings and obtain perfectly distortionless reproduction.



YOU WILL ELIMINATE DISTORTION!

RADIO COMMUNICATION CO., Ltd., 34-35, NORFOLK STREET, STRAND, W.C.2.

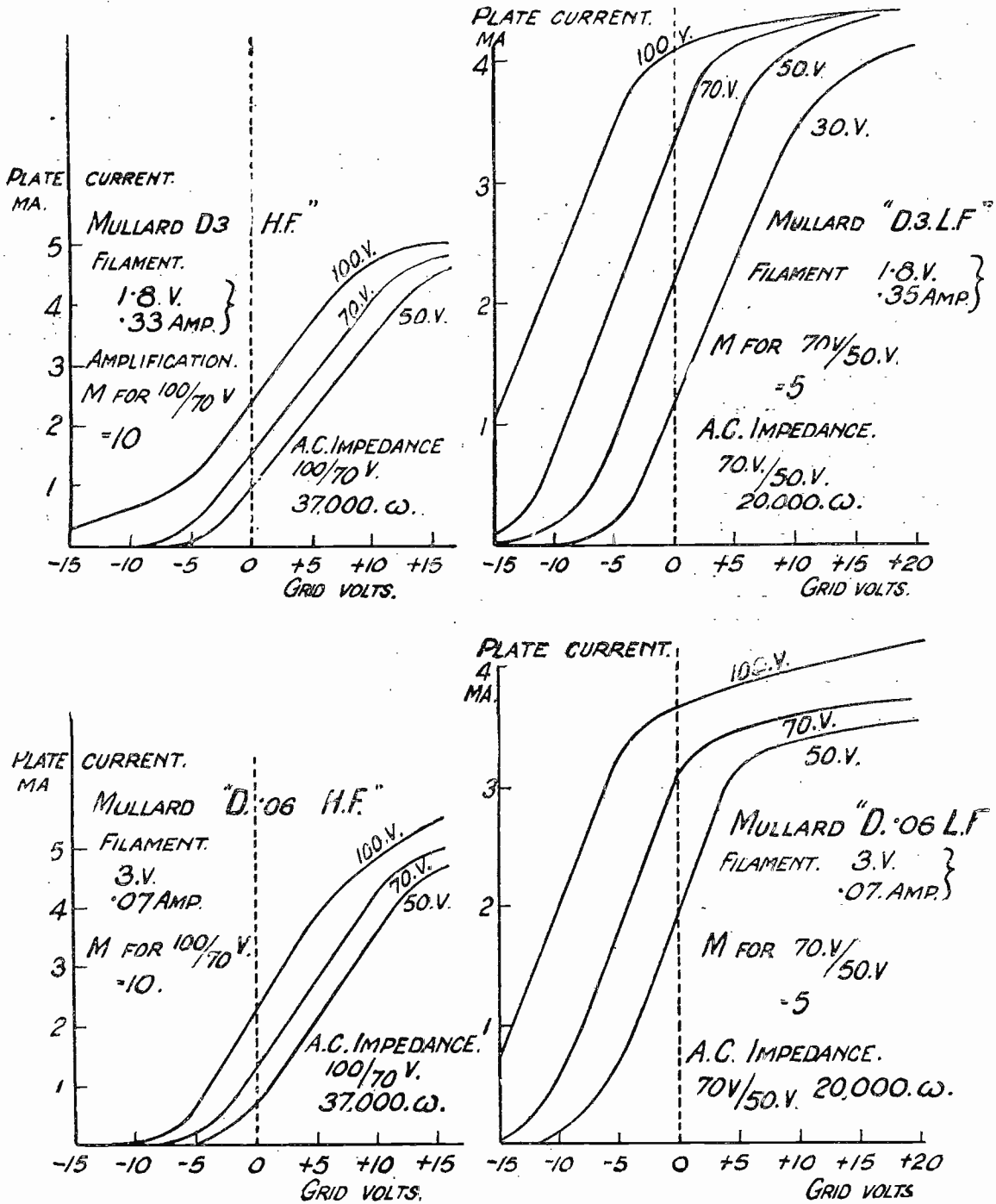

Characteristic Curves of the four new Mullard dull emitter valves of which a test report appears in these columns.

factor being about 10—which is a very satisfactory figure for ordinary applications—and an A.C. impedance of around 37,000 ohms (an ordinary value for a detector or H.F. amplifying valve) this in each case for the range of 70 to 100 volts plate potential. Both the H.F. valves, on actual trial in reception of distant telephony (German broadcast stations) gave good results with 50 volts H.T. as detectors and with 30 to 50 volts

as H.F. amplifiers, there being little to choose between them, or between these and reliable R valves of the bright emitter type. They oscillated with ease in each case.

The L.F. valves both show the desirable long straight characteristic in the negative grid potential region, the 100 volt curve in particular giving promise of an ability to handle considerable audio signal energy. It will be seen that with

a mean negative grid bias of 10 volts there is available a total swing of nearly five volts each way without leaving the straight part of the curve or, of course, getting the grid positive at the peak values. Accordingly it was to be expected that excellent loud speaking (without the distortion which comes from overloading the valve) would be obtained. Practical trial bore this out, 10 volts appearing to be the optimum value of grid bias

APOLOGY

Owing to the number of orders recently received our present staff has been quite unable to cope with them. All orders outstanding are being completed in rotation or the amount will be returned if the goods are not required owing to the delay in delivery. We hope, however, that by the time that this advertisement appears that all outstanding orders will have been cleared up.

Look up our other advertisements in this paper and the *Wireless Constructor* for goods which we supply.

Special terms to the Trade on foreign valves, phones, transformers, etc.,

H. LLOYD MARSHALL & CO.

8, WESTMORELAND BUILDINGS,
ALDRSGATE ST., E.C.1.

PARIS AND OTHER STATIONS
Clearly heard on Loud Speaker near London, using the "MIRACLE" MASTER 2-Valve Set, £3 12s. 6d., plus Royalties. 1, 2, 3, and 4 Valves. Trade supplied. Send stamp for particulars. **WORLD'S WIRELESS STORES, WALLINGTON.**

YOUR CABINETS

The original House for hand-made and polished Mahogany, Oak and Teak Cabinets to customer's own design. All Timber used in my cabinets is carefully selected and guaranteed THOROUGHLY seasoned.

YOUR PANELS

Finest quality $\frac{1}{4}$ in. thick Ebonite cut to size and fitted, d. per square inch. This Ebonite is guaranteed British Made to Post Office Grade "A" Specification, which is the best for wireless purposes. It is rich black in colour, takes a brilliant polish, can be threaded with ease, and possesses a high degree of mechanical strength.

TELEPHONE DISTRIBUTION BLOCKS.—Table Pattern, 3/9. Wall Pattern, 2/9 (illustrated). Postage 3d. extra. Made in Polished Mahogany, Oak or Teak. Terminals mounted on best quality Ebonite.

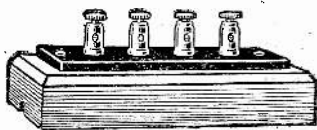

W. H. AGAR

Manufacturer of Telephone & Radio Apparatus. Tel: London Wall 3305
19, Whitecross Place, Wilson Street, E.C. 2.

with 100 volts on the plate, for really loud signals. With 50 or 60 volts H.T., a grid bias of 3 or 4 volts appeared best. On 30 volts H.T., it was possible to get moderate loud speaking with the grid merely connected to the L.T. minus; but this is inadvisable.

The A.C. impedance of the L.F. valves is moderately low, being about 20,000 ohms in the samples submitted, for the 70 to 50 volt range. The amplifying factor, which came out at around 5 in the same region, might with advantage be a little higher for ordinary use. On practical trial as the third valve in a detector and 2 L.F. straight reaction receiver, transformer coupled and of high efficiency, it gave excellent powerful loud speaking on Radio Paris mid-day transmission in Essex, using 50 volts H.T. and suitable grid bias.

"Kriscross" Connectors

In addition to the larger types which have already been reviewed, Messrs. "Kriscross" Co. have produced a smaller pattern of the connector known by this name, samples of which have reached us. These are made in Nos. 4, 5, and 6 B.A. sizes, turned from hexagonal stock, and have, in addition to the tapped hole of corresponding size at one end, the slot across the outer end which is typical of the larger patterns; but in this case only a single slot is provided. In place of the threaded lock-nut, also, for fixing the wires or bus-bar in the slot, these small types have a cheese-head screw in the end, working in such of the thread as is left in the sides of the slots, and adequate for securing one or two wires of a gauge proportional to the size of the fitting. The connectors are $\frac{1}{2}$ in. long in the body in each case. As with the larger patterns, they are intended to screw on the back studs of terminals behind the panel (these smaller patterns (type H) being suited to valve-legs and other fittings of small diameter) in order to facilitate the making of wiring connections without the use of solder; for which purpose they are evidently admirably adapted.

A "Station Indicator"

The present phase of radio development, where tuning-in to a desired station is a matter for nightly search (to the dismay of neighbours) or of laborious reference to a table of condenser-settings drawn up as the result of previous efforts, is but a passing one, as it is unthinkable that in a couple of years' time the proper "stations"

tables will not be universally in use on the tuning devices of domestic receivers, in place of meaningless degrees or mystic symbols which refer to wavelength or call sign. In anticipation of this development Messrs. Ensign Radio Co. have brought out a "Station Indicator," which enables the listener at least to save himself this irritating business of "searching" the ether or of looking up separate tables, by putting a permanent indicator in position right on the tuning dial for each of the usual stations heard.

This indicator consists of an engraved circle of a thin black material, carrying a 360 degree scale, and having two narrow slots in its periphery each nearly 180 degrees in length. In these semi-circular slots slide small white arrow-indicators carrying the name, call sign and wavelength of broadcast stations marked clearly on them. These can be slipped in at one point and slid round to the corresponding point on the scale at which the station in question has been previously found, and clamped there by their screw and nut. Extra arrows are supplied, we understand, at a few pence apiece. The lower semicircle serves for a long-wave range, when such is available on the receiver, a double-ended white pointer being provided for fixing under the usual ebonite knob on the spindle. When once applied and adjusted, to find a particular station on subsequent occasions it is only necessary to turn the pointer to the proper arrow.

The sample sent us, with a $3\frac{1}{2}$ in. diameter circle, was provided with four small holes for fixing, and had in addition a brass centre-bush of the one-hole fixing variety, but only long enough for a $\frac{1}{4}$ in. panel.

The printed instructions were rather confusing also, and few amateurs would care to drill and tap four No. 10 B.A. screw-holes in an ebonite panel to fix a scale, as suggested in these instructions. For British conditions, also, it would be preferable to give more room for an obvious abbreviation of the ordinary names of the stations, in place of their call-signs as in the samples submitted. We wonder what proportion of the million listeners here know at once where "OXE," "BAV," and "LP" are! The long-wave Paris station on 1,780 metres is now called "Radio-Paris," not "Radiola."

This indicator represents a decided step in the right direction, and as such we welcome it warmly; with a little attention to certain details it should be a real boon to many regular broadcast listeners.

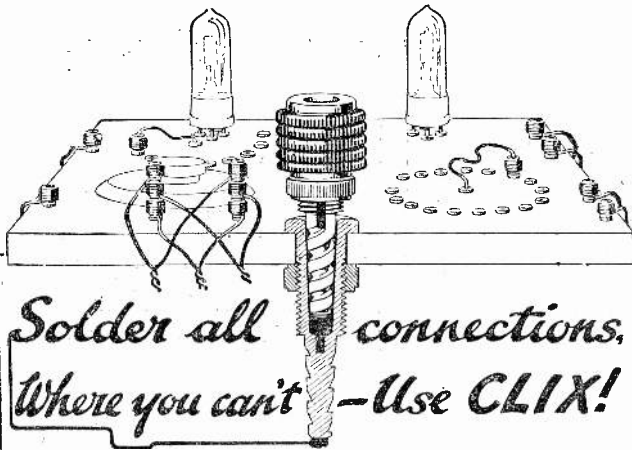

CLIX PROVIDES AN IDEAL POINT FOR SOLDERING

Perfect contact — instantaneously—everywhere.

The tapered design of CLIX plug-socket ensures full surface contact in every one of its countless applications.

That's why CLIX supercedes all forms of Plugs, Terminals, and Switches, and has standardised the wiring of all radio circuits.

Retail Prices

CLIX with Locknut, 3d.

CLIX Insulators (6 colours) 1d. each.

CLIX Bushes (6 colours) 1d. per pair.

CLIX

The *Electro-Link* with 159 Uses

Obtainable from all Wireless Dealers or direct from the Patentees and Manufacturers:



Radio Engineers and Contractors

84 VICTORIA STREET, LONDON, S.W.1.

SIEMENS LOUD SPEAKERS

Renowned for faithful reproduction, clearness, and purity of tone.

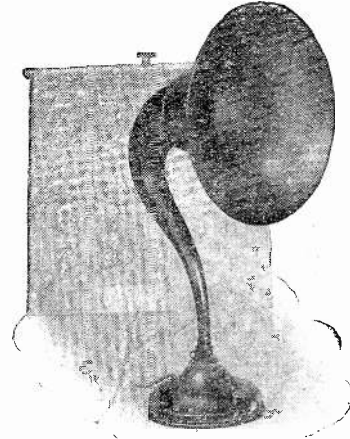

"THE BEST IN ITS CLASS."

NEW REDUCED PRICES:

120 ohms	£2 : 2 : 6
2,000 "	£2 : 4 : 0
4,000 "	£2 : 5 : 0

Also manufacturers of HEADPHONES.

Obtainable from all leading dealers

SIEMENS BROTHERS & CO., LTD., WOOLWICH, S.E.18

The Difference Fine Tuning makes to long distance reception

One of many users of the COLVERN writes:—

"Allow me to congratulate you on your Colvern Condenser. On Wednesday last I fitted one to the Anode Condenser of my S.T. 100 circuit and at 12 o'clock the same night started searching round with it: to my greatest surprise I heard a good hefty Yankee voice giving Market Quotations.

"To be able to pick up WBZ on the only three nights I have yet tried since fitting a Colvern certainly proves the great value of your component in giving the critical tuning necessary for a station as distant as WBZ."

C. W. BLAKE.

As used by Percy W. Harris in the "Anglo-American Receiver," described in the February issue of the "Wireless Constructor."

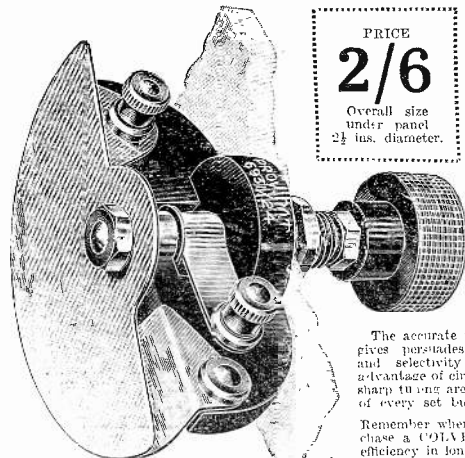

PRICE **2/6**

Overall size under panel 2 1/2 ins. diameter.

COLVERN General Purpose Vernier

—for the final balancing of TUNED CIRCUITS

The accurate tuning which the COLVERN gives persuades the utmost range, power and selectivity from your receiver. The advantage of circuits designed to give razor-sharp tuning are therefore within the reach of every set builder.

Remember when next at your dealers purchase a COLVERN—you cannot hope for efficiency in long distance work without it!

If your local dealer cannot supply, kindly send his name and address when ordering

COLLINS'S PRECISION SCREW CO. LTD
MACDONALD ROAD, WALTHAMSTOW, LONDON, E.17

Telephone—WALTHAMSTOW 532.

Barlays 6.9

Brown

Featherweight Headphones



FOR the magic hour when Fairyland becomes living reality let the children wear **Brown** Featherweight Headphones.

F-type Headphones, weighing 6 ounces only:—
 4,000 ohms per pair 25/-
 120 ohms " " 22/6

S. G. BROWN LIMITED
 Victoria Road, N. Acton, W.3.
 Showrooms:
 19, Mortimer Street, W.1.
 15, Moorfields, Liverpool.
 67, High Street, Southampton.

Gilbert Ad 2073.

THE ORIGINAL HOUSE SPECIALISING IN

Transformer Repairs

We repair any make of L.F. Transformer, making it Equal to New Satisfaction Guaranteed

5/-

CASH WITH ORDER
 POSTAGE PAID

When despatching enclose Name, Address and Date.

Transformer Repair Co.,
 HAY STREET, PORTSMOUTH

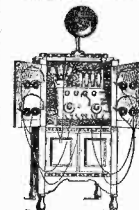

"MORRIS" SOLID OAK STANDARD CABINET with lock

for any kind of receiver. Bottom cupboard with lock for accumulators and stores. Height, 3 ft. 6 in.; width, 2 ft.; depth, 15 1/2 ins.

Back pane removable.
 Further particulars on application
 Price £4 10s.; part carriage and packing 7s. 6d. extra.

Same pattern. 24 in. wide inside. 5s. extra.

SOLID OAK WIRELESS TABLE with large drawer and bottom shelf for accumulator. Length, 23 in.; width, 16 in.; height 26 in. 27s. 6d., car. paid.



M. VERSTRAETEN,

(Dept. 2) Melville Chambers, 50a, Lord St., Liverpool

PICKETTS CABINETS DE LUXE MODEL. Polished

Takes Panel.	Mahogany	Oak
12 x 9	27/6	25/6
12 x 12	38/-	30/-
12 x 15	40/-	34/6
12 x 18	43/-	38/6

Carriage extra.
 Estimates per return post.
 Send for cabinet designs and lists free.

CABINET (M.W.) WORKS,
 BEKLEY HEATH, S.E.

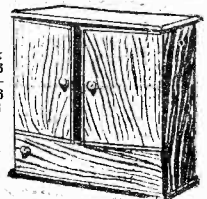

1,000 people for 8/-

This is the value the pages of "Modern Wireless" give all advertisers.

Could you conceive of a better bargain? Comparing the cost per page, £45, with the circulation of over 100,000 copies monthly, your advt. appears at the absurdly low rate of 8/- per page, 4/- per half page, or 2/- per quarter page p.r. 1,000 copies sold.

You cannot obtain such cheap, yet excellent, means of approaching the right public anywhere else. For instance, 1,000 letters mailed direct would cost £6 5s. in postage alone without taking into account the work and time involved. Take advantage of this sound method of creating sales. Write to the Advt. Managers for particulars of the rates for any space desired. There is, of course, a reduced rate for 6 or 12 consecutive insertions.

"MODERN WIRELESS,"

CITY 9911 (Extn. 9).

Advt. Managers:

BARCLAYS ADVERTISING, LTD.,
 Bush House, Strand, London, W.C.2.

HUNT'S NEW MODEL

CRYSTAL DETECTOR

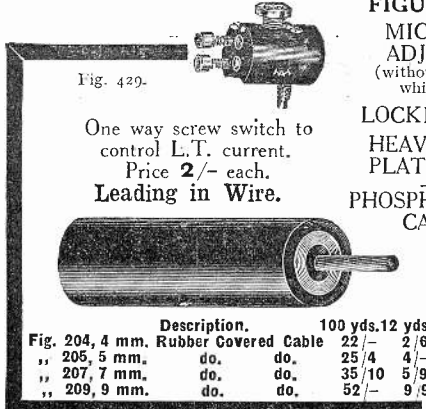

Fig. 429.

One way screw switch to control L.T. current.
Price 2/- each.
Leading in Wire.

Description.	100 yds. 12 yds.
Fig. 204, 4 mm. Rubber Covered Cable	22/- 2/6
" 205, 5 mm. do. do.	25/4 4/-
" 207, 7 mm. do. do.	35/10 5/9
" 209, 9 mm. do. do.	52/- 9/9



FIGURE No. 922
MICROMETER ADJUSTMENT
(without turning cats-whisker or cup).
LOCKING-SCREW.
HEAVILY NICKEL PLATED FINISH.
PHOSPHOR-BRONZE CATS-WHISKER FREE.



Code Word "VERNIER."
CATS-WHISKER OR DOUBLE CRYSTAL.
(Spare crystal cup with fixing screw supplied free.)
DUST PROOF GLASS CYLINDER.
Fig. No. 922.
"VERNIER"
CRYSTAL DETECTOR.
Price 4/- each.
Less Crystals.

REGISTERED  TRADE MARK.

A. H. HUNT, LTD.,
(Dept. 5) H.A.H. WORKS,
TUNSTALL ROAD,
CROYDON, SURREY

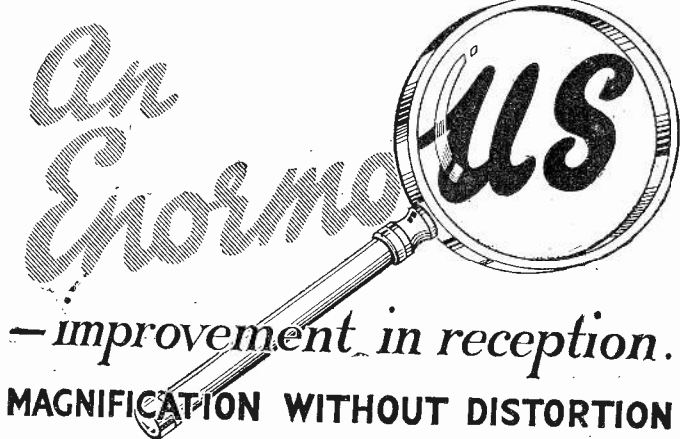

An improvement in reception.
MAGNIFICATION WITHOUT DISTORTION

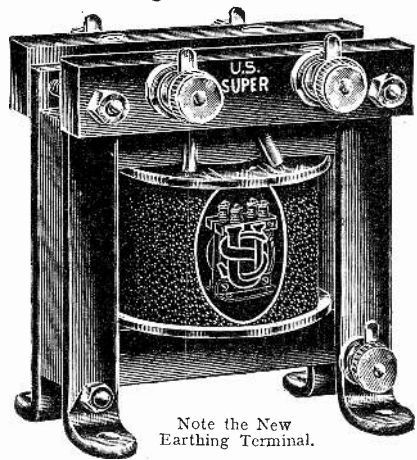

Note the New Earthing Terminal.

ADMITTED by leading experts to be unsurpassed in excellence of design, the U.S. Radio Transformer has been proved, under all conditions, the equal of any transformer on the market, irrespective of price. Guaranteed ratio of 5:1. Sold by all good dealers.
PRICE 18/6.
Wholesale only:—
U.S. RADIO CO., Ltd.,
155, High St., Lewisham, S.E.18.



The New Coloured Connecting Wire GLAZITE

Dispenses with the old insulating sleeving. GLAZITE Connecting Wire consists of tinned copper wire covered with cotton and finally covered with a film of high-class insulating material. GLAZITE is impervious to moisture and possesses the unique advantage of being flame-proof. GLAZITE has a high dielectric strength and considerable flexibility. Made in four colours.

"GLAZITE" is made in 10 ft. coils, packed 24 coils in a carton Assorted colours: Red, Blue, Yellow and Black. Retail price, 1/6 per coil. Ask your retailer about "GLAZITE" or write for leaflet.

This Mark  Guarantees Quality.

THE LONDON ELECTRIC WIRE CO. AND SMITHS LTD.
(Makers of Electric Wire for over forty years)
Playhouse Yard, Golden Lane, London, E.C.1

Telegrams: Electric, London. Telephone: Clerkenwell 1388, 1389, 1390, 1391.

BRETWOOD PATENT VALVE HOLDER.
Eliminate poor reception by adopting this scientifically designed Valve Holder, and obtain 100 per cent. efficiency. Easy to fix. No capacity. No leakage. Always perfect contact. No soldering. Can be mounted on front or back of Panel.
Price 1/9, Postage 3d.

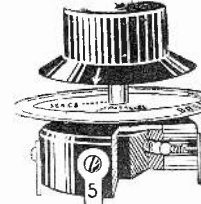

ANTI-CAPACITY SWITCH
We have pleasure in presenting another first-class speciality, which is the outcome of the famous BRETWOOD ANTI-CAPACITY VALVE HOLDER, which has gained such popularity among the wireless public on account of its scientific design and smart appearance. The Bretwood Switch is constructed on similar lines, and we claim that it is, like the Valve Holder, absolutely free from capacity effects, and we feel confident that this component will meet the most exacting requirements of the present day experimenter. One of the principal features of the Bretwood Switch is its beautifully smooth action, made possible by the spring loaded balls, and the wiping or rolling motion of the Phosphor-Bronze Balls always ensures clean and perfect electrical contact.
Features: 1. Absolute freedom from capacity. 2. Perfect contact. 3. Sweet and smooth action. 4. Practically no wear-and-tear. 5. First-class finish and neat in appearance. 6. Easy to fix (one hole fixing). 7. Very easy to make wire connections. 8. Like our other components, it is fully guaranteed. 9. For value offered, the price is moderate.
Price 5/- Postage 3d.

RADIO IMPROVEMENTS, LTD., 12-18, London Mews, Maple Street, LONDON, W.
All Bretwood specialities are obtainable from most Wireless Dealers.



It's THE LEAK that Counts.
The Bretwood Grid Leak (Guaranteed) tunes a carrier wave from the silent point up. The Bretwood is recognised by highest experts and experimenters as the only variable and reliable Grid Leak.
Price 3/- Postage 3d.
Patent Pending.



The Portable Accumulator for Dull Emitters

WHEN Dull Emitters first came on the market a new era was announced. The accumulator was to be relegated to the Dark Ages, and all valves would be run from Dry Batteries. This happy state of affairs, however, has not been realised. The Dry Battery has not proved itself to be the ideal method of lighting the filaments of Dull Emitters.

On the contrary—wireless enthusiasts now know that the Dry Battery fluctuates in output so much that good reception is impossible. Apart from this, of course, Dry Batteries are a perpetual expense.

The new portable Oldham Accumulator is so small that it can be placed in the pocket, and yet its output—for its size—is so high that it will run a 2-Valve Set using Wecos, Wuncells, or 1-volt Oras for 25 hours on a charge. For .06 Valves, two of them in series will run an S.T.100, for instance, six weeks on one charge. Whereas a Dry Battery when exhausted must be discarded, an Oldham Portable costs only a few coppers to be re-charged. Go to your Dealer to-day—if he is out of stock give us his name and we will see that he gets a stock at once.

Reverse it—shake it and still the acid won't fall out—

The Oldham "Non-Spill" constructed of best seamless celluloid, with large terminals and a screw vent. Absolutely non-spillable. Plates manufactured under the exclusive Oldham Special Activation Process. 2-volts 10 amp. hours continuous.

12/6

OLDHAM & SON, LTD.,
DENTON, MANCHESTER.
LONDON: Gt. Chapel St., Oxford St.
W.1.

NEWCASTLE: 1, St. Mary's Place.

Other Oldham Accumulators : Type C.L.

			£	s.	d.
2 volts	10 amps.	hrs. cont'us			
4 "	10 "	" "			8 9
6 "	10 "	" "	1	6	3
2 "	20 "	" "			11 1
4 "	20 "	" "	1	2	2
6 "	20 "	" "	1	13	3
2 "	40 "	" "			16 1
4 "	40 "	" "	1	12	2
6 "	40 "	" "	2	8	3

From all Dealers.



Gilbert Ad. 2095.

BARCLAYS SERVICE

The experience of the Principal and staff of this Agency is such that their advice and assistance, freely given to wireless manufacturers and retailers, is accepted as sound, accurate in every detail and of proven value.

The Manager has been intimately associated with wireless and advertising from the days when there was only one public wireless periodical in this country. He is well known to the trade generally and has chosen a staff of experienced men, each of whom, in his own sphere, is able to solidify the complete service rendered by the agency.

Representatives, copy writers, artists and lay-out men are all in close touch with every aspect of wireless sales promotion. The results of their co-operation are fully in keeping with the following extract from a letter just received :—

"We regret to have to inform you that this business has grown so rapidly during the last month (thanks to the wonderful result of your advertisements), that we have been quite unable to keep pace with our orders."

Why not take advantage of this accumulated experience and knowledge of present-day methods so essential to the expansion of your business.

Consultations Free by appointment.

BARCLAYS ADVERTISING Ltd
Advertising Consultants & Contractors.
Bush House, Strand, London, W.C.2.

Telephone: City 9911 (Extn. 9).

SAVE TROUBLE

Just send a subscription for your favourite wireless journals. Promptly delivered through the post.

MODERN WIRELESS

Twelve months - - - 15/-
Six months - - - 7/6

WIRELESS WEEKLY

Twelve months - - - 32/6
Six months - - - 16/3

The WIRELESS CONSTRUCTOR

Twelve months - - - 8/6
Six months - - - 4/3

RADIO PRESS Ltd.
BUSH HOUSE STRAND,
London, W.C.2.

An Aristocrat of LOUD SPEAKERS

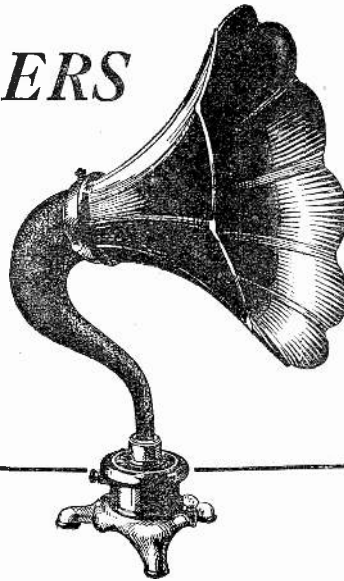

Illustration shows Swan Neck Model, fitted with highly-finished mahogany horn.

A.R. 15 £6 : 5 : 0

Also the same instrument, but with oak horn £6
Other models from 25/-

AESTHETIC in appearance and ranking highest in technical efficiency as a Loud Speaker—the AMPLION may be especially recommended to discriminating purchasers.

The beautifully polished mahogany trumpet, the rich black crystalline finish of the Sound conduit and case, and the highly nickel-plated base, all contribute to make this model eminently suitable for the most tastefully furnished room.

Possession of an AMPLION adds to your enjoyment of Radio, without being an "eyesore" in your home. If your furniture is oak, there is also a trumpet to match it.

Ask your local dealer to show you a sample.

The
World's
Standard

AMPLION

Wireless
Loud
Speaker

Obtainable from all Wireless Dealers of Repute.

Illustrated folder post free from the Patentees and Manufacturers :

ALFRED GRAHAM & CO.
(E. A. GRAHAM)

West End
Showrooms :

25-6, Savile
Row, W.1.

ST. ANDREW'S WORKS, CROFTON PARK,
LONDON, S.E.4.

Suburban
Showrooms :

82, High St.,
Clapham,
S.W.4.

Exide

THE LONG-LIFE BATTERY

Five H.T. Batteries in use

SIR ALFRED G. BOURNE,
F.R.S.,

Clifton Cottage,
Dartmouth, writes:—

For high tension I am using five of your 12BK's and they are giving the utmost satisfaction. I use lead bars for coupling up, and with the lead terminals I find no trace of noise due to the battery—they have revolutionised my reception. I charge these five together, using 100-watt metal filament lamp.

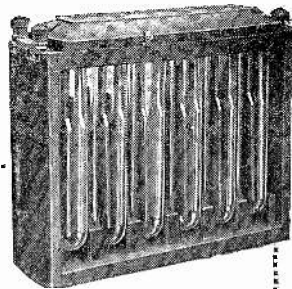

The Sign of SKILLED Service.

450

Exide Service Stations
in Great Britain and Ireland.

DEPOTS:

LONDON. BIRMINGHAM.
MANCHESTER. BRISTOL.

Manufactured by

THE **Chloride** ELECTRICAL STORAGE
COMPANY LIMITED.

CLIFTON JUNCTION, near MANCHESTER.

Two typical letters from the many satisfied users of Exide Batteries.

America on One Valve

Rosslyn,
Irby Road,
Heswall,
Cheshire.
14/10/24.

Messrs. Chloride Elec. Storage Co.,
Clifton Junction, Nr. Manchester.

Dear Sirs,—

I am writing to inform you that I have been successful in receiving several American Broadcasting Stations on one valve and using both for L.T. and H.T. Exide Accumulators. This performance was carried out last year on two separate occasions, both after fitting "Exide" H.T. Accumulators.

I feel quite sure that as this is not an everyday affair you would like to be acquainted with the fact.

Yours faithfully,
(Signed) W. Arthur Maddocks.

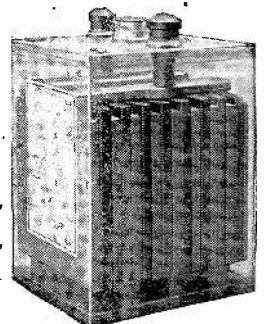

MADE AT THE LARGEST BATTERY WORKS IN THE BRITISH EMPIRE.

HUNT'S "H.A.H." FOR OPERATING



ACCUMULATORS, WIRELESS VALVES.

These accumulators are made of the very best material and are in every way absolutely reliable and satisfactory for wireless work.

BRITISH MAKE.

There is no better value on the market than the money spent on a good accumulator — and H.A.H. accumulators are good.

BRITISH MAKE.

Fig. No.	Voltage	Actual Capacity	Price	Fig. No.	Voltage	Actual Capacity	Price
1120	4	12	16/-	1132	6	12	24/-
1122	4	24	21/9	1134	6	24	33/-
1124	4	36	28/6	1136	6	36	42/9
1126	4	48	36/-	1138	6	48	54/-
1128	4	60	42/9	1140	6	60	64/-

WRITE FOR FREE CATALOGUE.

Fig. 261. Acid Hydrometer. Price 2/6 each. Ordinary type with glass jar.

A. H. HUNT, LTD. (DEPT. 5) H.A.H. WORKS : TUNSTALL RD., CROYDON.

Special Type, Fig. 264. Price 5/- each, with rubber bulb and glass chamber.

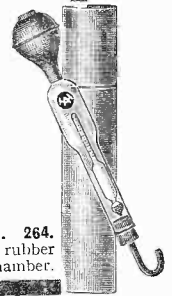
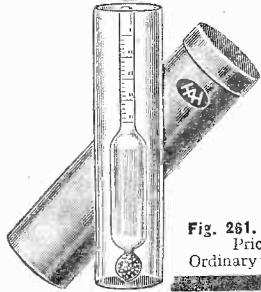

H.T. EFFICIENCY AS IT "WASN'T ON WEDNESDAY"

Asked the meaning of the word revolution, a small boy said that it was "something on Saturday as it wasn't on Wednesday." "Hovimo" Connectors are a revolution in H.T. Efficiency. Their use avoids soldering and cheapens cost of complete battery b from 25 per cent. to 50 per cent. The "Hovimo" also ensures perfect "silent" working, is everlasting, allows easy replacement of units will take ordinary wander-plug, and makes it possible to keep your H.T. at an equal voltage... British Make.

M. MOLBAC,
27, High Holborn,
London, W.C.1.
Phone: Chancery
8391.

Ask your dealer for them

1/6

Per Doz.
From dealers or direct.



KNIVETOWN RADIO PRODUCTS

THE CRYSTAL DETECTOR
FOOLPROOF
DUSTPROOF

Captain Eckersley

On November 24th. Broadcast that the ordinary cat's whisker detector, owing to its susceptibility to unavoidable vibrations, gives faulty reception and loses contact. The Knivetown Crystal Detector NEVER LOS CONTACT. Reception is as clear and tone and volume as good as a valve. Cut from black Ebonite, metal parts heavily nickelled. Complete with sockets, making it universal fitting. Supplied with superfine Crystal.

If you are out to improve your set, and get the best reception possible, GET ONE NOW.

Post your order now to
S. CORRE & CO.
(Dept. B), 86, ROSEBERRY AVENUE,
LONDON, E.C.1.
If unable to obtain locally.

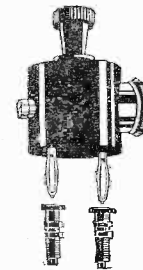

MANSBRIDGE CONDENSERS: BEST BY TEST.

Thirty years' experience of Condenser Building, together with finest materials obtainable, are behind the

GUARANTEE "OCTOPUS" MANSBRIDGE CONDENSERS

ACCURATE
NOISELESS
PERMANENT

Atmosphere Proof
Absolutely Reliable
Tested at 350 volts D.C.

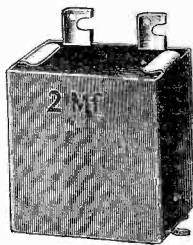

Cases Finished Dull Silver.

Capacity	Dimensions	Price (s. d.)
.01	2 in. x 1 1/2 in. x 1/8 in.	2 4
.05	2 in. x 1 1/2 in. x 1/8 in.	2 4
.25	2 in. x 1 1/2 in. x 1/8 in.	3 0
.5	2 in. x 1 1/2 in. x 1/8 in.	3 4
1 MF.	2 in. x 1 1/2 in. x 1/8 in.	3 10
2 MF.	2 in. x 1 1/2 in. x 1/8 in.	4 8

THERE IS NO BETTER CONDENSER.

INSIST UPON "OCTOPUS" MANSBRIDGE CONDENSERS. Deliveries by Return. Trade Enquiries Solicited up to 10 MF.

SETS OF PARTS for any and every circuit—"RADIO STOCKS" SPECIALISE IN GIVING THE BEST KNOWN VALUE AND SERVICE: WRITE YOUR ACTUAL NEEDS AND LET US QUOTE.

EVERYTHING FOR WIRELESS AT ROCK-BOTTOM PRICES.

"RADIO STOCKS" (B. HAINE, Proprietor),
RADIO HOUSE, NEWMAN STREET, OXFORD ST., LONDON, W.1.
PHONE: MUSEUM 3205.

VARIABLE CONDENSERS.

Best British Make.
Accurate Spacing. Perfect Finish.
Absolutely Best Value Obtainable.

Capacity	Ordinary s. d.	Square Law. s. d.	With 3 Plate Vernier. s. d.
.001	7 3	9 6	1/6 EXTRA.
.0005	5 4	8 9	
.0003	5 1	7 6	
.0002	4 5	6 6	
.00005	3 1	—	

RADSTOCK "WONDER" AERIAL.

49 Strands Special Alloy Phosphor Bronze Wire.

Each strand is a separate conducting surface, is non-corroding, maintains its wonderful results all the time.

100 feet, 3/9.
H.T. Batteries, 60 volt, finest Continental, 8/3.

Coil Holders, 2-way, from 2/6.
Valve Holders, Best Ebonite, 10d.,
Anti-Capacity, Legless 1/-, Murray's 1/3
Headphones, Continental 8/6, Nesper's 12/6, Telefunken 19/6.

WRITE FOR LISTS.
Wholesale and Retail.

BEST QUALITY BRASS PARTS AT MODEST PRICES.

Simple, Sound connections.

THE ORIGINAL SPADE TERMINAL WAS A WATES CREATION!

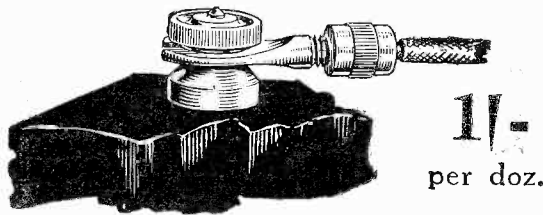

1/-
per doz.

ATTACHED TO ANY WIRE IN A MOMENT!

USEFUL TERMINALS, ETC.

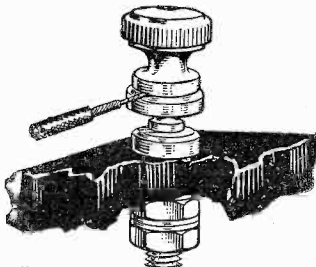

"Setaw" plug and socket terminal.

- | | |
|--------------------------------------|---------------|
| | per doz. |
| Valve Sockets | 8d. |
| Valve Fin with Collar | 8d. |
| Terminals, Heavy Pattern, 2 B.A. | 2/2 |
| Terminals, W.O., 4 B.A. | 1/- |
| Telephone Terminals, 4 B.A. | 1/- |
| Small Barrel Terminals, 4 B.A. | 1/- |
| Fancy Terminals, 4 B.A. | 10d. |
| 3-Part Terminals, 4 B.A. | 10d. |
| Wander Plugs, complete red and black | 4 1/2d. |
| Contact Studs, 5 B.A. | 4d. |
| "Setaw" Terminals (illustrated) | 4 1/2d. each. |
| Large Barrel Terminals, 4 B.A. | 1/- per doz. |
| Pin End Terminals | 1/- per doz. |

The DOMINOE CONNECTOR.

A useful and labour-saving device permitting up to four pairs of 'phones to be used in any combination of series or parallel. Of real ebonite, with special springs to grip kwikpins, which are attached to any wire in a moment.

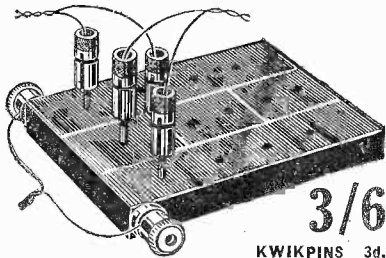

3/6

KWIKPINS 3d.

Send at once for our new interesting catalogue.

WATES
BROS., LTD.,

12, 13, 14, Great Queen St., Kingsway, W.C.2.

'Phone: Gerrard 575 and 576. 'Grams: Zywateseng, Westcent.

Works: LONDON, BIRMINGHAM and WESTCLIFF.

Excelling in "finish" and "design"

The popularity which Woodhall Components have achieved is due to their careful workmanship and scientific design; it is a popularity that arises from "satisfaction" rather than from "cheapness."

The **WOODHALL** No. 1 L.F. Transformer.

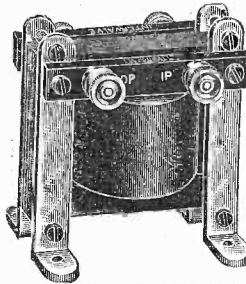

Of massive construction, produced for high efficiency—it is one of the highest priced, because its production cost is heavy. It is wound with 12 gauge wire wound simultaneously with fine SILK. It shows most marked superiority on 2nd or 3rd stage of amplification, even on 200 or 300 volts pressure giving no trace of distortion, and its amplification factor is decidedly above the average of other good-class transformers. Insulation is perfect between P. and S. and between windings and frame, and the transformer is one specially recommended for circuits of the "reflex" type .. **23/6**

The **WOODHALL** Vernier Rheostat

(Pat. No. 213,030.)



Combined plunger and rotary movement. The exceedingly fine adjustments it gives enable you to get the most out of your valves. Push-pull movement for coarse setting; rotary for vernier. Wonderfully smooth movement; best ebonite former; one-hole fixing.

6 ohms. 10 or 12 ohms 30 ohms
2/6 3/- 3/6

WOODHALL

Guaranteed Components

Sole Distributors:

Pressland Electric Supplies, Ltd., HAMPTON-ON-THAMES.

'Phone: Molesey 22.



TROLITE SHEETS & PANELS



No. 982



No. 963

The World's best Mouldings. Ex Stock

F. A. HUGHES & CO. LTD.,

204-206, Gt. Portland St., London, W.

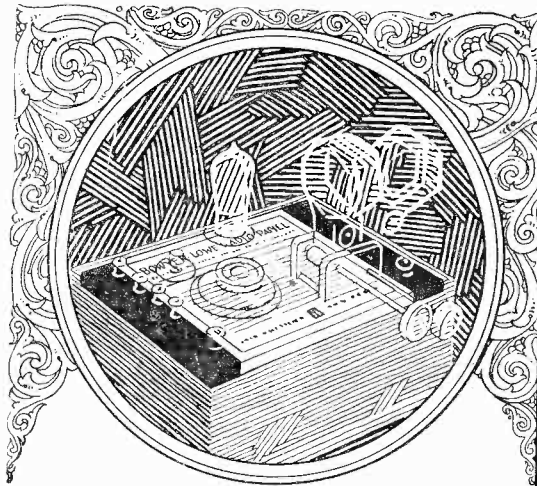

Buy Ebonite under Seal

If you could see your Radio Panel chosen, cut, marked, engraved and polished—if you could personally supervise every operation—still you would not be more thoroughly safeguarded than you are when you buy Bowyer-Lowe Panels in their sealed packages.

Before a single sheet of Ebonite is stamped with our trade mark and sealed under our label it is inspected, tested, checked and examined by experts whose one care it is to ensure that it is absolutely trustworthy in all respects.

A customer, writing of the appearance of Bowyer-Lowe Polished Panels, says they are "like pieces of fine porcelain." Every one is in quality worthy of its beautiful finish.

Bowyer-Lowe Panels of P.O. Grade "A" Ebonite are supplied in three forms: Semi-matt, cut to any size at 3d. per square inch. Polished one side and all edges, 1d. per square inch. Drilled and engraved for any Radio Press Set (except OMNI Top), 1½d. per square inch.

The panel is your set's foundation. Build well on Bowyer-Lowe Ebonite.

Bowyer-Lowe Tested Radio Panels Sold under Seal

Obtainable from all good dealers or direct from

BOWYER-LOWE Co.,
Ltd.
LETCHEWORTH

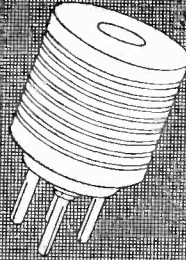

Every Bowyer-Lowe H.F. Transformer is guaranteed to match perfectly every other in its range. All ranges from 150 to 3,000 metres and up at a uniform price of 7/-.

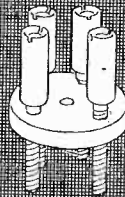

Bowyer-Lowe Anti-Capacity Valve Holders give greatly increased efficiency, especially on short wavelengths. No nuts required for fixing. Price complete 1.2.

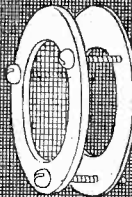

Bowyer-Lowe Plated Valve Windows, with rounded bezel, impart a fine appearance to your set. Sold complete with gauze, back plate, and all nuts and screws. Each 9d.

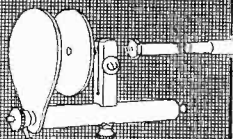

The Neutrodyne Condenser for efficient tuning of neutralising circuits. Minimum capacity practically zero. One screw fixing with additional 3/8 inch hole for operating spindle. Price 5/-.

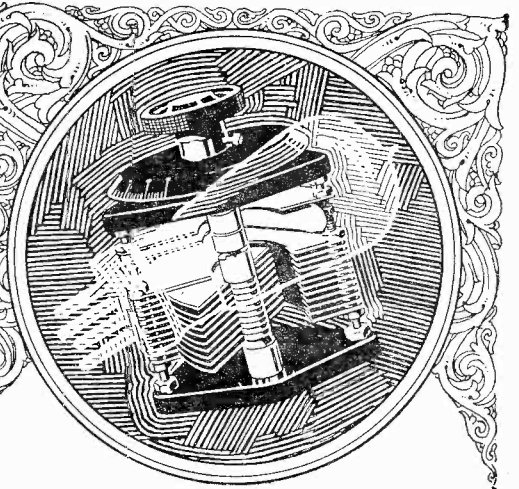

Equal to an extra Valve

If by simply changing your Condensers you could give your set additional power equal to that you would obtain by fitting an extra valve, you would be satisfied that the new condenser was something out of the ordinary.

This actually happened to one of our customers, who says: "The improvement your Square Law Condensers have effected in my Three-Valve All-Concert Receiver has practically given me another valve."

But sometimes these condensers show results even more remarkable. A customer in Grays, Essex, writes: "I have fitted the Condenser in my All-Concert Receiver to replace one of a cheaper make. I can get all B.B.C. Stations on Loud-Speaker, whereas I could only get London on phones before."

This result is unusual under any circumstances, but it definitely supports our claim that only Bowyer-Lowe Condensers obtain the Square Law effect with added selectivity, wavelength range and signal purity.

Always say Bowyer-Lowe Square Law Condensers. The name makes all the difference.

Bowyer-Lowe Tested Square Law Condensers

If your dealer does not stock, order direct. All ranges supplied in single, double and triple type. Prices from 11/6.

BOWYER-LOWE Co.,
Ltd.
LETCHEWORTH

BOWYER-LOWE TESTED COMPONENTS MAKE SUCCESSFUL SETS

Silvertown

WIRELESS ACCESSORIES.

Quality guaranteed by over 50 years' electrical manufacturing experience.

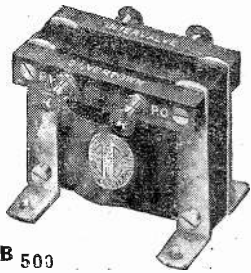

B 500

Interval Transformers.
Adopted by leading manufacturers of Wireless Receiving Sets and discriminating Amateurs in all parts of the World. Guaranteed for 12 months. Price 21/- each.



Filament Rheostats.
With finished and lacquered brass bush for panel mounting. Resistance wire wound on insulating rod, thereby giving perfectly smooth adjustment. Each supplied with diagram giving drilling dimensions.
3/6 each.



Ebonite Condenser Dials and Knobs.
In one piece, graduated in white, 0-180°, highly finished, complete with fixing screw, dial approximately 3 in. diameter. Complete, 1/3 each. Dials only, 10d. each.

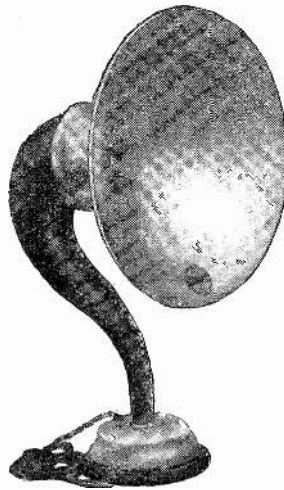

SILVERVOX LOUD SPEAKER

This instrument will reproduce both speech and music without the loss of its original tone and quality. Coils wound to either 120 or 2,000 ohms.

The tone arm is a heavy aluminium casting.

Excellent strengths can be obtained on an efficient 2-valve receiver within 10 miles of broadcasting station.

Total height, 20 inches. Size of trumpet, 12½ inches diameter.

PRICE £3. 10s. EACH.

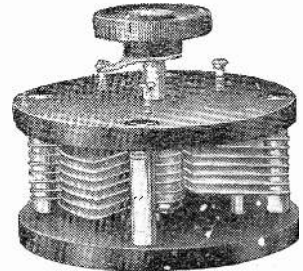

Variable Condensers.
(For panel mounting.)
Strongly constructed. Moving vanes are shaped to give low minimum capacity. Fitted with a stop to allow of a movement of 180° only.
From 5/6 each.

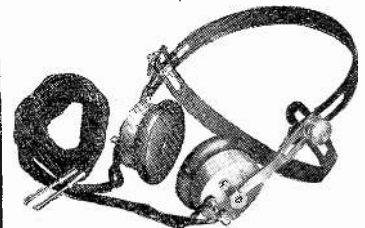

Telephone Headpieces.
The "Stalloy" diaphragms are matched so as to secure a balance of tone and quality. Resistance from 120 to 12,000 ohms. Price (4,000 ohms), 25/- each.

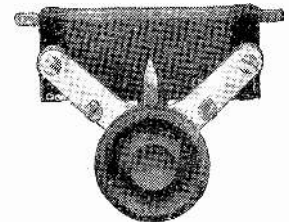

Potentiometers.
(For panel mounting.)
On rectangular ebonite former, complete with knob and pointer. Former mounted on cast brass frame. Resistance approximately 400 ohms. 7/6 each.

Makers : THE SILVERTOWN COMPANY,

106, CANNON ST., LONDON, E.C.4.

BELFAST : 75, Ann Street.
BIRMINGHAM : 15, Martinear Street.
BRISTOL : 4, Victoria Street.
CARDIFF : Pier Head Chambers, Bute Docks.
DUBLIN : 70, Middle Abbey Street.
GLASGOW : 15, Royal Exchange Square.
LEEDS : 1, New York Road.



Works: Silvertown, London, E.16.

LIVERPOOL : 54, Castle Street.
LONDON : 100 and 102, Cannon Street.
MANCHESTER : 16, John Dalton Street.
NEWCASTLE-ON-TYNE : 59, Westgate Road.
PORTSMOUTH : 49, High Street.
SHEFFIELD : 88-90, Queen Street.

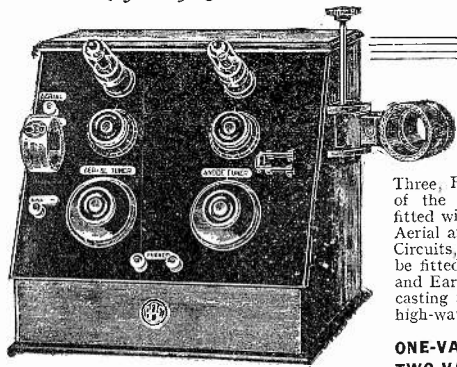

"GOL TONE" (Regd.) WIRELESS RECEIVING SETS

(British Made.)

Elegant appearance. Highly selective. Simplicity in Tuning. Designed for receiving on any Wavelength. The Two-Valve Set clearly receives British Broadcasting and Continental Stations, and for Loud Speaker reception the

Three, Four and Five-Valve Sets have proved entirely satisfactory in all parts of the Kingdom. Polished Cabinet, with removable back, Ebonite panel fitted with Valve Holders. Filament Resistances. Condensers for Tuning Aerial and Anode Circuits, Knife Switch for High- and Low-Tension Circuits, &c. Both the Low-Tension and High-Tension Batteries can be fitted inside the cabinet, and the only wires on view are the Aerial and Earth. Provided with Plug-in Coils to receive British Broadcasting Stations. Plug-in Coils to receive Paris, Berlin, and other high-wave Stations are interchangeable, and can be supplied.

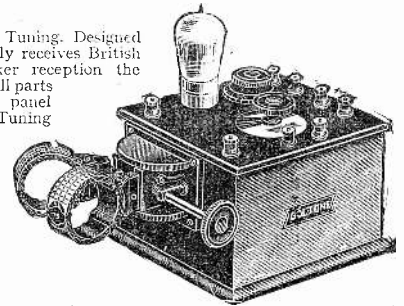

SINGLE VALVE SET, gives remarkable results and receives with Volume and Purity signals within a hundred miles radius.

- ONE-VALVE PANEL** £2 18 0 Marconi Pat. Royalties, 12/6 net.
- TWO-VALVE CABINET** £7 10 0 Marconi Pat. Royalties, 25/- net.
- THREE-VALVE CABINET** £10 10 0 Marconi Pat. Royalties, 37/6 net.
- FOUR-VALVE CABINET** £13 10 0 Marconi Pat. Royalties, 50/- net.
- FIVE-VALVE CABINET** £19 10 0 Marconi Pat. Royalties, 62/6 net.

"GOL TONE" WAVE TRAP



An extremely effective instrument, when used in conjunction with a variable condenser, .0005 mfd., for eliminating signal interference up to 600 metres, No. R5/750. Price 12/6. Fitted in polished hardwood box with ebonite panel and complete with suitable Condenser No. R5/1057. Price 32/6. Can be easily attached to any type of Receiving Set.

These Lines are stocked by the Leading Radio Stores. Write direct if unobtainable



Every Condenser Laboratory Tested. Stocked in all standard capacities. No. 6701. Price 1/3 each.

RADIO CATALOGUE No. R/111.

Large fully illustrated 32 pp. Radio Catalogue, post free on request. Enclose Business Card for Trade Terms.

"GOL TONE" MICROMETER REGULATING COIL HOLDERS. Patent No. 4037/24.

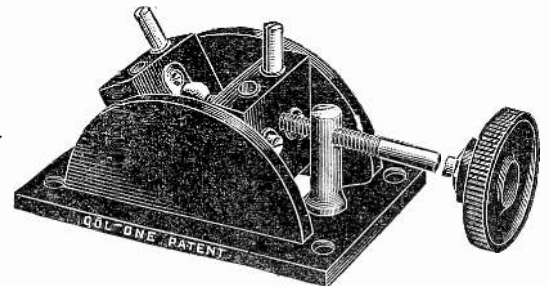

Highest grade finish enables the finest possible tuning considerably increasing the selectivity, efficiency and reliability of the Receiving set.

Two-Coil Type. Price 7/6
Three-Coil Type. Price 10/6



Super-Heterodyne Kits

Containing 3 R.110 and 1 each R.120 and R.130.

£6 : 12 : 6

This Kit embodies all the necessary matched transformers for constructing the most advanced set known in Radio. Operation is smooth and simple. Sets built of "Rauland" Super-Heterodyne parts are unsurpassed for selectivity, range, volume and tone quality. Immediate delivery.

World-Famous

RAULAND Transformers

Natural Amplification.

One of the outstanding features of a "Rauland" Transformer is the *naturalness* with which it amplifies both speech and music. Here's the reason why! The amplification characteristic curve of a

"Rauland" L.F. Transformer shows, in every case, a remarkable flatness throughout the whole range of audible harmonics. Hence the accurate reproduction of the *tone* created at the broadcasting station.

Pioneers in the Industry.

L.F. Transformers.

- Type R.21. Ratio 5-1. For 1st stage, 20/-
- Type R.12. Ratio 3-1. For 2nd stage, 18/9
- Type R.13. Ratio 10-1. For reflex circuits, 20/-

H.F. Transformers.

- R.140. **UNIVERSAL COUPLER**.—Brings about a high degree of selectivity in reflex circuits, 20/-
- SELF-TUNED H.F. TRANSFORMER**. Especially wound to suit the following valves:—
R.199 for D.06, D.E.3 and D.5, 25/-
R.201A for D.S.A.1, D.E.5 and D.4, 25/-
- R.110. **Long Wave Intermediate Frequency Transformer**, 4,000 to 20,000 metres. 75 to 15 kilo-cycles 30/-
- R.120. **10,000 Metres (30 Kilocycle) Tuned Transformer**, 30/-
- R.130. **H.F. OSCILLATOR COUPLER**, 150-650 metres, 25/-

Power Amplifying.

Push-pull—the most efficient method of obtaining undistorted Power Amplification.
R.30. Input, 25/-
R.31. Output, 25/-

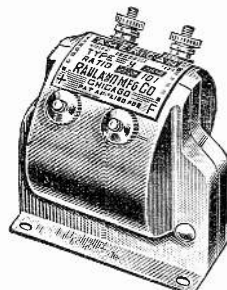

R.50. **"RAULAND LYRIC."** The L.F. Transformer par excellence—created for the *music* lover, 41/9

"All Amax Junior."

A home constructional One-Valve Reflex Receiver. Local stations easily received on Loud-Speaker. £6 6s.

"All Amax Senior."

A home constructional 3 H.F. Crystal Detector and 2 L.F. exceptionally selective and capable of Loud-Speaker reception over long distances. £12 12s.

THE NEW RADIO KEY BOOK
By E. N. RAULAND
Is now ready.

Full of up-to-date information and diagrams of the latest circuits, including Reflex and Super-Heterodyne. Two photographic blue prints sent with each book, upon receipt of 9d. in stamps.

Gaston E. Marbaix

27-28, Anning Street, E.C.2, and 169, High Street, Shoreditch, London,

Phone: Bishopsgate 1294.

THERE'S A RAULAND FOR EVERY CIRCUIT.

In replying to advertisers, use Order Form enclosed

HOLDRON'S

PECKHAM, LONDON.



ORMOND CONDENSERS WITH VER-NIER.—one hole fixing '0005. Price 7/8. Post free.

We undertake to refund money for any goods returned as unsuitable. Post orders sent by return.

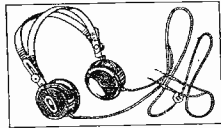

HOLDROPHONES.—4,000 or 8,000 ohms, very sensitive. Price 10/6. Post 6d.



ULTRA LOUD SPEAKERS.—New Pattern. Adjustable diaphragms, excellent reproduction. Price 27/6. Post free.

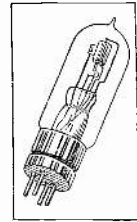

JUNOT DOUBLE FILAMENT VALVES Separate models for Detectors and Amplifiers. State which is required. Price 6/11. Post 4d.

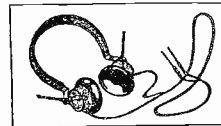

PHONES.—On test prove as sensitive as many sold at 25/- Neat in appearance, all black, comfortable in wear. 4,000 ohms. Price 9/6. Post 6d.



FRENCH POWER VALVES.—Dull Emitters, 12 amp. 3 volts to 400 volts H.T. Absolutely distortionless, with grid bias. Price 27/6. Post free.

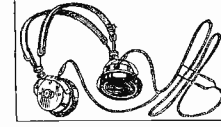

Genuine DR. NESPER PHONES.—4,000 ohms, adjustable diaphragms. Price 13/3. Post free.

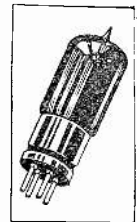

DUTCH VALVES.—For Detectors. 30-100 volts H.T. Price 4/6. Post 4d.



HIGH TENSION BATTERIES.—Noiseless in action. 60 volts with tappings. Price 6/11. Post 9d.



Genuine RADIO MICRO DULL Emitters.—06 amp. guaranteed 34 volts. 30-120 volts H.T. Excellent all-round valves. Price 12/6. Post 4d.

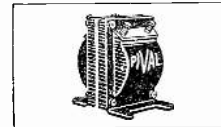

SHROUDED TRANSFORMERS. Will amplify without distortion. Well-known PIVAL make. Price 9/6. Post free.

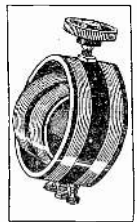

VARIOMETERS.—Ebonite Formers, one hole fixing. For Broadcast Band. Price 2/11. Post 3d.



HOLDRON'S REFLEXITE CRYSTAL.—Specially produced for Valve Reflex Circuits. Only obtainable from us. Price 1/- Post free.

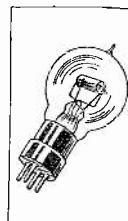

FRENCH VALVES.—Excellent all-round bright emitters. 30 to 100 volts H.T. Price 6/11. Post 4d.

All component parts mentioned in "Modern Wireless," etc., Constructional Articles in Stock at List Prices, Post free.

H. HOLDRON, LTD.

117, 119, 121, 123, 125, 135,
137, 139, 141, 143, 145, 147,

Rye Lane, PECKHAM, LONDON, S.E.15

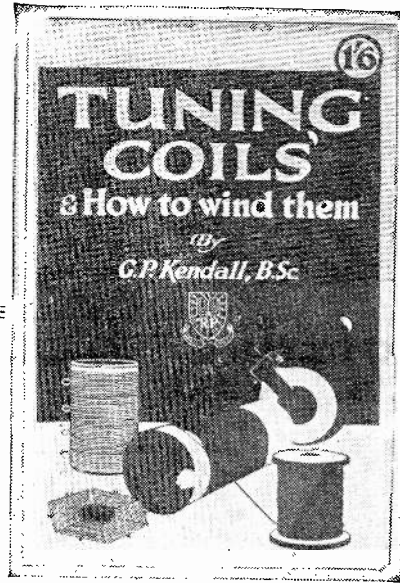

THERE is probably no single Component in any Receiving Set able to exert so much influence as an Inductance Coil. A highly efficient Coil (or Coils) will often make all the difference between mediocre results and really good loud reception.

Even if you feel that your present Set is giving tolerably good results, the chances are that it will be worth your while—presuming that you are using plug-in coils—for short-wave lengths to use a set of home-made basket coils. Such coils as these have particularly low self-capacity.

This book by G. P. Kendall, B.Sc. (staff editor) contains concise details for making every type of Coil used in Wireless to-day. Further, the advantages and disadvantages of each type are discussed in such a manner that the reader is able to make an immediate decision as to the actual coils suitable for his requirements.

All necessary data, such as diameter of tubes, gauge of wire, number of turns, etc., are given—the results of the author's own experiments.

No experimenter can afford to be without such a comprehensive guide as this.

TUNING COILS AND HOW TO WIND THEM.

SERIES No. M 18

1/6

Sold by all Booksellers, Newsagents, or through your local Wireless Dealer or 1/8 post free, direct from Department M.

Radio Press, Ltd.

BUSH HOUSE, STRAND, LONDON, W.C.2.

Easy - to - build Pilot Receivers based on Radio Press designs.

Send for the Pilot Chart without delay

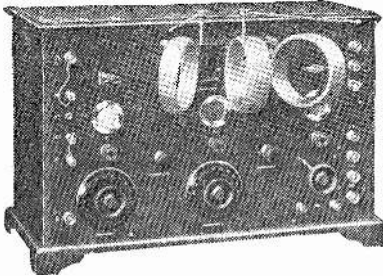

THE ALL-BRITAIN SET.
A wonderfully popular 3-valve Set, which, as its name implies, is capable of receiving all the main B.B.C. stations at good strength. A very simple Set to operate, and recognised as being very selective. Uses the new tri-coil circuit.

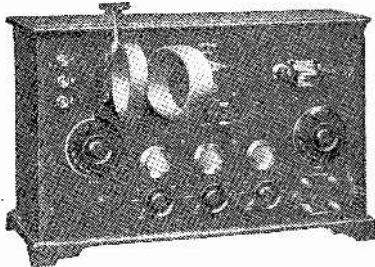

THE PURIFLEX SET.
Originally designed for "Modern Wireless" by Mr. Percy Harris. Uses a Crystal Reflex circuit with a two-stages of resistance coupled low-frequency amplification. Famed for its remarkable loud-speaker purity of reproduction. There is a complete absence of distortion with this Set.

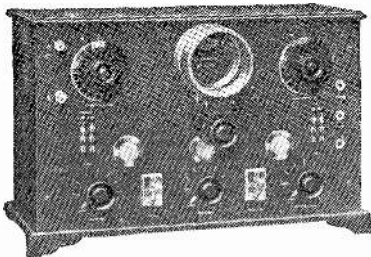

THE ALL CONCERT-DE-LUXE.
A most handsome Receiver with all fittings supplied nickel-plated. Simple switches enable note magnifier valve being cut out if not required. Has a telephone range of 800 to 1,000 miles under normal conditions. All battery connections at rear, and plugs and jacks for telephones and loud-speaker fitted to panel.

If you can use a pair of pliers to cut a length of wire—if you can screw a transformer to a ready-drilled panel—if you can follow a simple wiring diagram, then you can build any of the splendid Sets illustrated on this page. From the 2-valve Resistoflex to the 6-valve Anglo-American designed by Mr. Percy Harris for "The Wireless Constructor," they represent all that is best and most original in British Radio design to-day.

Everyone of these Pilot Receivers carries our full guarantee that if made according to our working instructions, they will work perfectly. Indeed, we go further than that—

we have instituted a special Service Department to ferret out faults for you at a nominal cost should the Set not work when you have made it up.

Choose the best Set you can afford from the chart herewith—if you have some of the parts already, we shall be pleased to supply you with the balance. If you have all the parts already, we shall be equally pleased to supply you with only the panel or the cabinet. If you cannot make up your mind which Set you will build, write for a copy of our 32-page Pilot Chart (post free 3d.), containing upwards of 30 illustrations of Pilot Receivers with the fullest details.

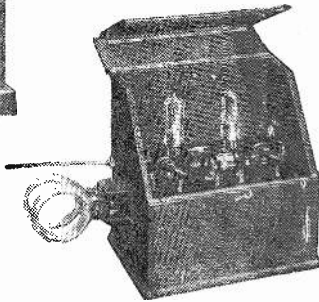

THE S.T. 100.
The world's Standard 2-valve Reflex, which gives probably the loudest signals it is possible to obtain with two valves. Tens of thousands of S.T. 100 Receivers have been built in America, although the circuit was first evolved by Mr. John Scott-Taggart (Editor of "Modern Wireless"). This Set is contained in a handsome oak double drop front, and possesses a most attractive appearance.

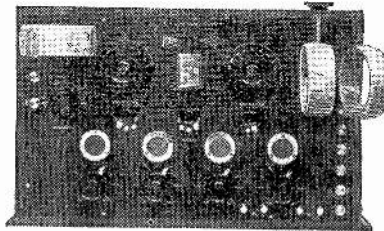

THE FAMILY 4-VALVE SET.
An ideal family Receiver originally designed by Mr. Percy Harris. Uses the familiar tuned anode and reaction circuit. Large numbers of users report regular reception of American broadcasting on this Set. Can be used as a two, three, or four-valve Set at will.

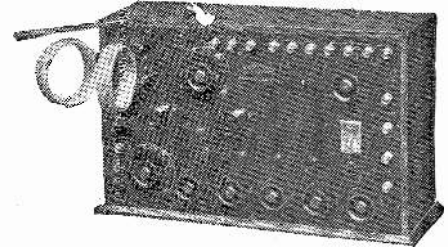

THE TRANSATLANTIC V RECEIVER.
The first standard Set to use two stages of high-frequency amplification. A real long-distance Set. Will work particularly well on a simple little indoor aerial. Regular reception of American broadcasting and long-distance Continental stations at loud-speaker strength is an easy matter with this 5-valve Set.

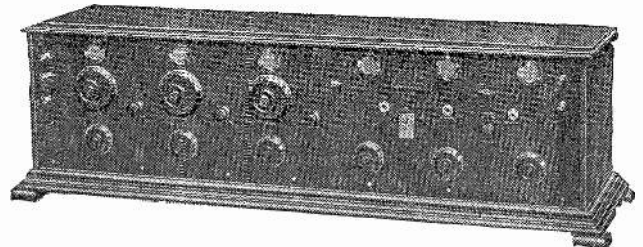

THE ANGLO-AMERICAN SIX.
Mr. Percy Harris' latest Set embodying three stages of neutrodyne high-frequency. Gives practically the power of a super-heterodyne with a great saving in valves. A few feet of wire around the picture moulding of a room is all that is necessary to operate this Set.

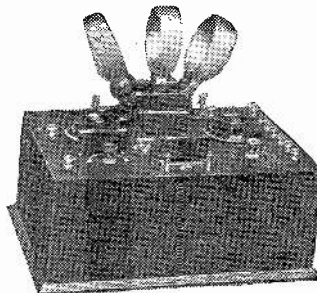

THE RESISTOFLEX.
Using the new 2-valve non-buzzing circuit evolved by Mr. Scott-Taggart and fully described in the October "Wireless Constructor." An excellent stable reflex which requires no crystal detector.

Name of Receiver.	No. of Valves.	Price of Panel drilled and engraved.	Kit of Components.	Oak Cabinet with baseboard.
All Concert-de-luxe	3	13 6	£4 17 6	17 0
S.T. 100 ..	2	7 0	£4 16 0	£1 10 0
Puriflex ..	3	12 6	£4 5 0	17 0
All-Britain ..	3	13 0	£4 9 0	17 0
4-Valve Family	4	19 6	£5 15 6	17 0
Transatlantic V.	5	13 6	£5 4 6	17 0
Anglo-American 6	6	£1 8 6	£9 5 0	£3 0 0
		£1 5 0		(Mahogany 3/- extra)
Transatlantic 4	4	16 6	£6 15 0	£1 7 6
3-Valve Neutrodyne (Valve panel)	3	10 6	£4 10 2	£1 13 6
3-Valve Neutrodyne (Tuner panel)	—	10 0	£4 2 3	take both panels.
T.A.T. 4-Valve Receiver	4	£1 5 0	£5 15 0	£1 0 0

†SPECIAL NOTE: Where all components and panel are purchased together a Marconi Royalty of 2s. 6d. per valve-holder must be paid.

SEND TO-DAY
for a copy of our 48 page Component Catalogue (post free 3d.) and for a copy of our Wireless Book (containing over 80 circuit diagrams and much useful wireless information) 1/3, post free 1/5.

PETO-SCOTT Co., Ltd., Registered Offices, Mail Order & Showroom
77, CITY ROAD, LONDON, E.C.1

Branches: LONDON—62, High Holborn, W.C.1. PLYMOUTH—4, Bank of England Place
LIVERPOOL—4, Manchester St. CARDIFF—94, Queen St. WALTHAMSTOW—230, Wood St.

In replying to advertisers, use Order Form enclosed

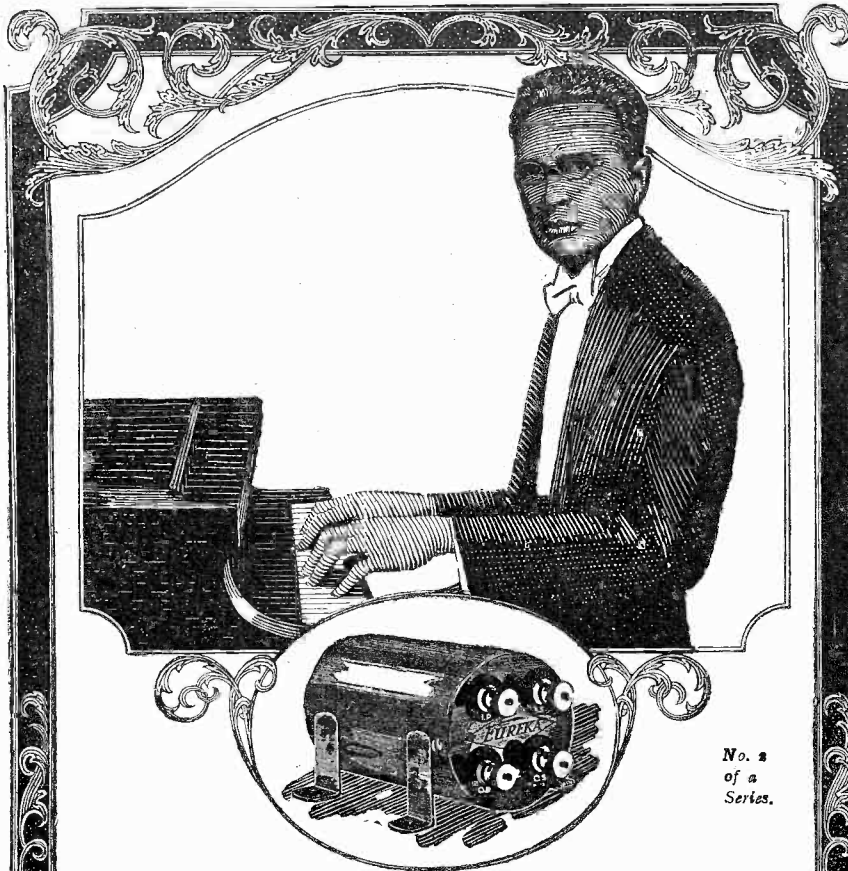

No. 2
of a
Series.

The Living Artist

THERE'S nothing more distressing than to hear a piano solo travestied by wireless. And nine times out of ten the fault lies not in the Loud Speaker at all but in the use of an unsuitable L.F. Transformer.

A good Transformer is something more than a bundle of laminations and a few thousand turns of fine wire. If it is to function correctly it must be designed according to definite scientific standards and not according to hit-and-miss methods.

Before a single Eureka Transformer was placed on the market many hundreds of pounds had been spent in research work. It was not a case of following current practice and adding one

more to the many already available. *The designers of the Eureka began where others left off.* They ploughed a lonely furrow—but they won through.

Eighteen months ago unknown, to-day the Eureka is recognised as being the country's finest L.F. Transformer. Its handsome appearance would certainly add an air of distinction to your Set, while its immense volume of superb tone would be a revelation to you.

Concert Grand 30/- **Portable Utilities Co., Ltd.,** Eureka No.2 22/6
Fisher Street, London, W.C.1. (For Second Stage.)

Supreme **EUREKA** for Tone

Gilbert Ad. 2082.

440,000

DON'T EXPERIMENT

with so-called infallible media for *selling* your Wireless Sets, Components or Accessories. Experimenting with wireless sets may be—and no doubt is—a lucrative and instructive hobby, but experimenting with your business and its capital is another thing altogether. It is invariably suicidal.

Start *right* at the commencement of your campaign by using only "MODERN WIRELESS," "WIRELESS WEEKLY," and "THE WIRELESS CONSTRUCTOR," the predominant three in Wireless, and, incidentally, the only Journals that matter in creating a public demand for your manufactures. When you have booked space in them your appropriation is complete and beyond equal.

Modern Wireless Wireless Weekly Wireless Constructor

In substantiation of this statement your advertisement will be read by no fewer than 440,000 wireless enthusiasts—those that are really keen and are continually buying for new experiments and home-constructed sets. This figure represents the certified circulation of these papers, one of which alone has a circulation greater than that of all non-Radio Press papers added together. The elite and professional men, besides the amateur and experimenter, are readers and all may therefore be safely classed as potential customers. In fact, there is no waste circulation whatever.

Do not tolerate disappointing results any longer—they can be remedied, and speedily, too. (Phone: City 9911 (Extn. 9), or write for advertisement rates of "MODERN WIRELESS," "WIRELESS WEEKLY" and "THE WIRELESS CONSTRUCTOR," to:—

Advt. Managers:

BARCLAYS

Advertising, Ltd.

Advertising
Consultants & Contractors

Bush House, Strand, W.C.2

A Standard Instrument

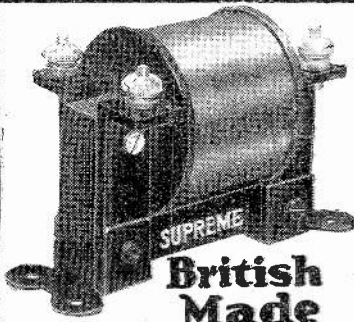

British Made

Price **12/6**

Nothing Better Made

The **SUMMIT MANUFACTURING CO.**
Gladiator Street, Brockley Rise,
London S.E.23.

It is no longer necessary to pay exorbitant prices for Low Frequency Transformers. The "Supreme" is equal in every respect to instruments sold at twice the price. It does not distort and gives the maximum amplification. We guarantee its reliability.

The increased range, purity of reception and amplification produced by "Supreme" Transformers will astonish you.

It's well worth while insisting on "Supremes" — obtainable at Dealers everywhere.

If not obtainable in your district, write sending name and address of your dealer

"SUPREME"



FINSTON FIXED CONDENSERS

are symbolic of Stonehenge because of the everlasting qualities which serve to make them immune from trouble in the most exacting and protracted use. They stand the test of time.

Guaranteed within 5% of stated capacity. This accuracy has never before been obtainable by the public. Buy one. Test one. It will prove our statements and thoroughly satisfy you.

FEATURES:

Reliability of Capacity. Finest grade Mica Dielectric. Highest possible quality Copper Foil. Adapted for Terminal or soldered connections.

CAPACITIES:

.001 to .0005, price **1/3** each.
.002 to .006, price **2/-** each.

If your dealer cannot supply Finston Components, send your order to us together with his name and address, please!

LIGHTING SUPPLIES CO.
2, FINSBURY AVENUE, LONDON E.C.2

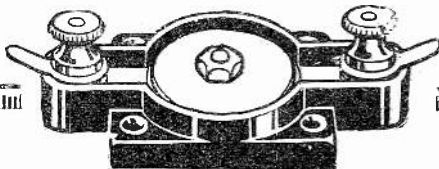

Barclays 619

'JIX' 2d. each.

or complete with terminal 3d. each.

The invaluable accessory to all wireless amateurs.

Jix makes the wiring of a set with bare wire (either square or round) exceptionally easy.

You just use a JIX instead of a nut and washer on the under side of the panel, push the wire into the tapered hole where it is firmly held until the set is tested and the circuit finally decided on.

YOU DON'T NEED THREE HANDS WITH JIX.

The smallest blow-pipe or soldering-iron will be sufficient to seal the joint with a minimum quantity of solder. Even after soldering, if it is necessary to alter the circuit, the wire can be unsoldered, and both JIX and the terminal can be used over and over again. JIX can be obtained from your usual wireless dealer, or in case of difficulty send remittance with his name to

W. H. BOWLING (M.W.) 44, Diamond Street, — **PEMBROKE DOCK**
Wholesale from A. J. Dew, Foughtons, etc.

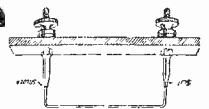

Also fitted with best quality insulated terminals, d. complete.

Safety First



BEFORE you build your Set make sure that your panel is free from leakage.

Safety First should be your watchword. A low-grade panel will nullify all your efforts and cause you endless trouble. Red Triangle Ebonite is fully guaranteed to be entirely free from leakage and to conform to the highest electrical standards. Its beautiful surface of velvet smoothness needs no tedious sand-papering before use.

Every Red Triangle Panel is supplied in a sealed wrapper bearing its distinctive label. Be sure you get Red Triangle Ebonite and accept no substitute. All ebonite appears alike, and the only way you can tell the good from the bad is to look for the Red Triangle on every package. If your Dealer cannot supply order direct from us.

12 Stock Sizes :

6 x 3, 3/-	8 x 6, 3/-	10 x 2 1/2, 15/-
6 x 1 1/2, 3/-	8 x 10, 5/-	12 x 1 1/2, 10/6
7 x 5, 2/3	8 x 12, 6/-	12 x 1 1/2, 12/-
7 x 10, 4/3	10 x 15, 7/6	12 x 1 1/2, 13/6

All 1/4-in. thick.

Special "Modern Wireless" Sizes :

All Concert-de-Luxe, 16 x 8 x 1/2	3/-	Resistoflex, 12 x 8 x 1/2	6/-
Transatlantic V., 22 x 11 x 1/2	15/-	Anglo-American, 36 x 9 x 1/2	20/-
All Britain, 16 x 9 x 1/2	9/-	Neutrodyne Tuner, 12 x 10 x 1/2	7/6
S.T.100, 12 1/2 x 9 1/2 x 1/2	7/-	Neutrodyne Receiver, 12 x 10 x 1/2	7/6
Paralex, 14 x 10 1/2 x 1/2	9/2	3-Valve Dual, 2 1/2 x 10 x 1/2	15/-
Transatlantic IV., 16 x 8 x 1/2	3/-	Harris Crystal Set, 9 x 5 1/2 x 1/2	4/4

Any Special Size Cut per return at 1d. per Square Inch.

TO THE TRADE: Red Triangle Ebonite is being extensively advertised, and, in spite of its superior quality, can be sold to you at prices no higher than that which you are paying for ordinary unbranded ebonite. Write to us to-day for details of our selling plan.

PETO-SCOTT Co., Ltd.

Registered Offices, Mail Order and Showroom,

77, CITY ROAD, LONDON, E.C.1

BRANCHES: LONDON—62, High Holborn, W.C.1.
PLYMOUTH—4, Bank of England Place. LIVERPOOL—4, Manchester Street. CARDIFF—94, Queen Street.
WALTHAMSTOW—230, Wood Street.



Red Triangle Ebonite

Gilbert Ad. 2115.

In replying to advertisers, use Order Form enclosed



3 SOUND MEDIA

When compiling your Advertising Campaign, do not overlook the claims of the three predominant media in radio; viz., MODERN WIRELESS, WIRELESS WEEKLY and The WIRELESS CONSTRUCTOR. You cannot afford to ignore the responsive public that eagerly and consistently studies the pages of these journals and which constitutes an excellent established market for your goods.

MODERN WIRELESS, WIRELESS WEEKLY and The WIRELESS CONSTRUCTOR readers embrace the huge section ranging from the youthful broadcast receiver experimenter and the amateur inventor to the highest expert in Wireless, and the greatest confidence is placed in the practical hints, diagrams and constructional notes repeatedly appearing in the columns of these journals, written by men whose names are "household words" in the world of radio. Such a specialised and interested community cannot fail to elicit the maximum response to your appeal.

Write now for advertisement rates and details of forthcoming issues to the Advertisement Managers—

BARCLAYS ADVERTISING, Ltd.
 Advertising Agents, Consultants & Contractors,
 BUSH HOUSE, STRAND, LONDON, W.C.2.
 Telephone. City 9911

*The Media in
 Wireless Journalism
 which constitute a
 complete and efficient
 Advertising Campaign
 for Selling Sets, Com-
 ponents or Accessories.*

MICROHM

VARIABLE CONDENSERS

OBVIATE THE DISADVANTAGES OF COMPLICATED CAPACITY VARIATION.

The Microhm Variable Condenser—a precision instrument of great efficiency—has been scientifically designed to overcome the disadvantages of the open-vane type. The question of the moving vanes varying in their distance from other parts of the set and thus setting up a complicated form of capacity variation is rendered negligible in our model by the fixed electrodes which entirely enclose the vanes. Other advantages include:—No interaction, No Hand-capacity effects, Extremely low minimum capacity. Ratio 500 1, Single hole $\frac{3}{8}$ " fixing. Compact and dustproof.

PRICES:—"C" Type. To give straight capacity curve.
 .0001—7/6. .00025—7/6. .0005—7/6.
 .00075—8/6. .001—8/6.

"W" Type—Square Law Principle—
 1,- extra on above prices.

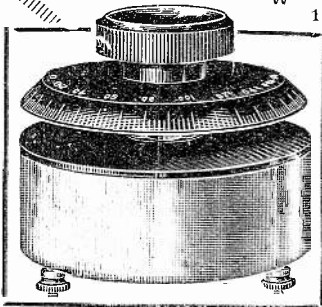

Fit a Microhm Variable Condenser to your set. You will speedily appreciate the difference.

Obtainable at most dealers or direct from the

Microhm Engineering Co.,
 Varsity Works,
 COLLEGE ST., LONDON, E.9.
 'Phone: Clissold 2857.

Barclays 125.

KING QUALITY

All the name implies

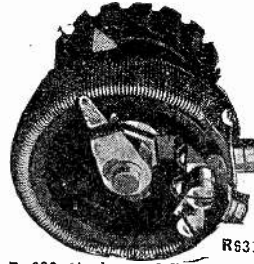

R. 630, 6½ ohms. 4/7. Current carrying capacity of 1.7 amps.
 R. 632, 25 ohms. 4/7. Current carrying capacity 7 amps.
 R. 634, 40 ohms. 5/3. For accurate control of .06 valves

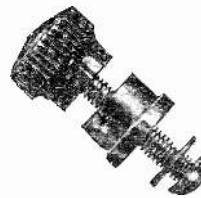

R. 75
 R.75. TERMINALS. Black Bakelite knob nickel base. 6d. each.

Throughout the conception and execution of King Quality Radio Parts there never has been and never will be any compromise on quality. The first glance will convince you that there couldn't have been a better name than "King Quality" for these products. Ask your Dealer to show you them.

KING QUALITY RHEOSTATS.

Single Hole Mounting.
 The base and knobs are of genuine Bakelite—the most satisfactory insulatory product—finished in black. All metal parts are heavily nickelled. Owing to the specially designed sliding contact adjustments can be made with a background of complete silence. Use a "King Quality" for critical control.

KING QUALITY POTENTIOMETERS.

Of similar design to the Rheostats. R.590. Resistance 400 ohms. 8/6.

KING QUALITY INDUCTANCE SWITCHES.

Providing a smooth, easy contact, they eliminate the necessity of soldering connections. Made throughout of Bakelite and supplied with distinctive knob and pointer. All metal parts are heavily nickelled. With knob and pointer. 8/4.

Plugs and Jacks, Dials, Switch Levers, Valve Sockets, and Valve Adaptors.

Sold by the best Dealers only.

A few district agencies open. Full catalogue upon request to sole European Representative:—

GASTON E. MARBAIX,

27-8, Anning St., E.C.2., and 169, High St, Shoreditch, London.

'Phone, B'gate 1294.

"ELLA"

BATTERY CHARGERS

They work from a lampholder

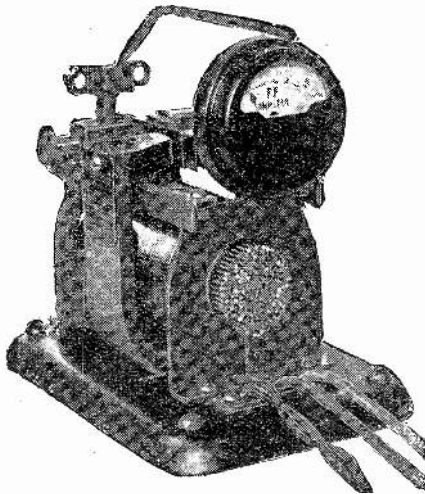

A.C. Model.

Output 6 amps. 9 volts. Complete with Pole Indicating Ammeter and all connecting leads and adapter. To standard voltages and frequencies up to 220 volts. £6 6 0

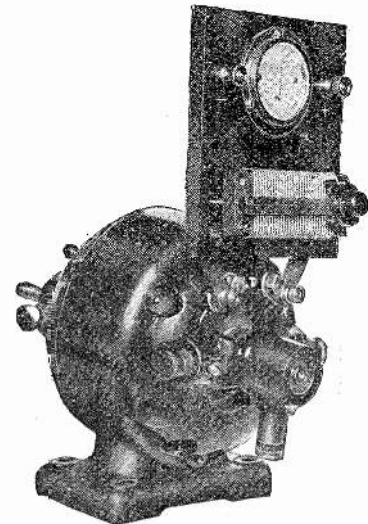

D.C. Model.

Output 5 amps. 9 volts. Machine only £5 12s. 6d. With Switchboard and Pole Indicating Ammeter and Regulating Resistance as illustrated - £6 15 0

Other voltages and frequencies £1 extra.

BATTERIES charged at home have much longer life and give better service than when charged outside.

"ELLA" Battery chargers save their cost many times over.

Write to Dept. "A" for descriptive leaflet. Trade supplied.

LIONEL ROBINSON & CO.

3a, Staple Inn, London, W.C.2.

'Phone: Holborn 6323 (Two Lines).

In replying to advertisers, use Order Form enclosed

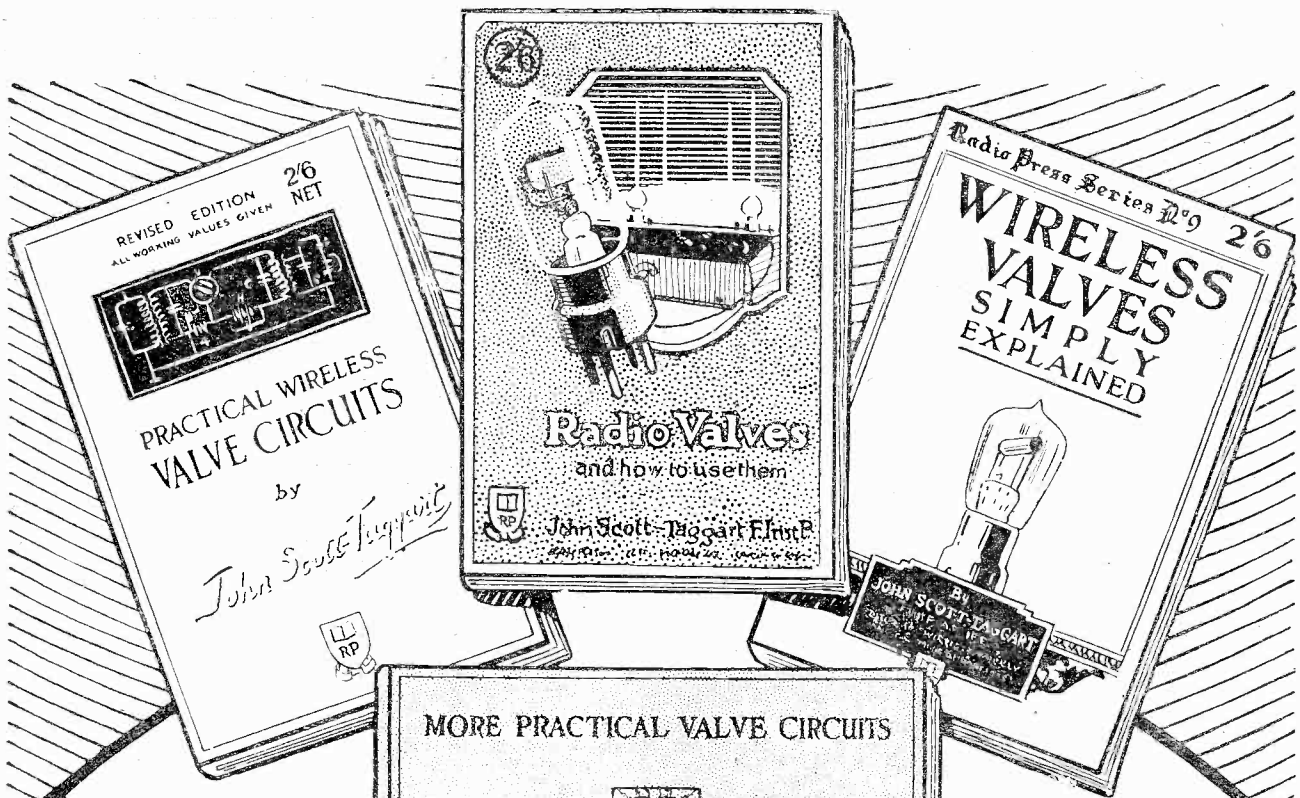

YOU NEED THESE BOOKS

Practical Wireless Valve Circuits

Series No. M 10.

This is the first book of ST circuits and is called **Practical Wireless Valve Circuits**, by John Scott-Taggart, F.Inst.P., A.M.I.E.E. Price 2/6 (post free 2/8). Circuits ST 1 to ST 67 are published in this book, which is selling as well to-day as when it was published. No experimenter worthy of the name can afford to be without the two ST Circuit Books. They are friends which will never lead you astray. Each circuit in both books is fully described and criticised.

All component values are given in the new editions of **Practical Wireless Valve Circuits** and **More Practical Valve Circuits**.

MORE PRACTICAL VALVE CIRCUITS



JOHN SCOTT-TAGGART, F.Inst.P.

"S.T." Circuits

These are too well known to need any introduction. This is the latest book of them:—

More Practical Valve Circuits

Series No. M 11.

By JOHN SCOTT-TAGGART, F.Inst.P., A.M.I.E.E.

Price 3/6 (post free, 3/8).

Full of dozens of original circuits which you will find nowhere else, as they are copyright. Circuits ST 68 to 141 and also ST 150 and 151 appear in this extremely useful volume, which has had an enormous sale amongst experimenters.

Radio Valves and How to Use Them

Series No. M 12.

Mr. Scott-Taggart has stated that he regards this as his best book on the Valve from the point of view of the beginner. **Radio Valves and How to Use Them**, by John Scott-Taggart, F.Inst.P., A.M.I.E.E. Price 2/6 (post free 2/8). This book is by far the largest published by Radio Press, Ltd., at 2/6, and is full of very valuable information. The reader is presumed to know only what is contained in our books, "Wireless For All" and "Simplified Wireless."

YOU NEED THESE BOOKS

Wireless Valves Simply Explained

Series. No. M 9.

By JOHN SCOTT-TAGGART, F.Inst.P., A.M.I.E.E.

The most popular moderately priced Book on the theory of Wireless yet written. It contains the results of many years' patient research and experiments—but told in a non-technical language which the amateur can easily understand.

How reaction is caused—how to stop self-oscillation—how to select suitable circuits for various purposes—how to receive C.W.—the answers to all these and many other questions are clearly given.

If you want to know how your set works this is the Book you need.

2/6 or 2/8 post free.

All Radio Press Books are obtainable from principal wireless dealers and through any bookseller, newsagent, or from Book Dept. M, Radio Press Ltd.

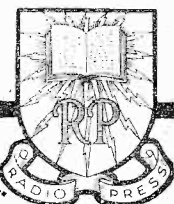

Radio Press, Ltd.

BUSH HOUSE, STRAND, LONDON, W.C.2

Barclays 1218.



ACCUMULATORS RECHARGED FREE!

IN YOUR OWN HOME WITH THE
"CHASEWAY" CHARGER

The "Chaseway" is a thoroughly practical electrical apparatus specially designed to remove the recharging bug bear. It can be connected by the merest amateur in any household having DIRECT CURRENT, and if used whilst current is being used for lights, kettles, irons, radiators, etc., recharges your battery free. Once fitted it is there for life, requires no attention, is perfectly safe and a wonderful boon, saving its cost in a short time.

The "CHASEWAY" ALTERNATING CURRENT will shortly be read. Send for details before purchasing other expensive apparatus.

- No. 1. Model for installations of 100 to 250 volts. size 9 ins. x 3 1/2 ins. ... complete **25/-**
- No. 2. Model for lower voltages and special circumstances, **35/-** complete with special resistance lamp (2 amps.), or **40/-** with special adjustable resistance (2 to 5 amps).
- No. 3. Model for Shopkeepers, Garages and Dealers recharging batteries for revenue details on application.

"CHASEWAY"

VARIABLE GRIDLEAK

infinitely variable .001 to 20 megohms.

A scientific instrument—the "nerves" of the receiving set. One hole fixing and reliable for all time. A distinct advance in grid leak manufacture. **4/-**

Ask your Dealer or send Remittance direct. Illustrated Catalogue of "Chaseway" specialties FREE on receipt of stamp. Contains details of many novel necessities.

CHASE ELECTRICAL MFG. CO., LTD.,
184m, Fleet Street London, E.C.4 (Central 1539).
TRADE MARKS INVIT. D. V.P.

PROV. PAT.

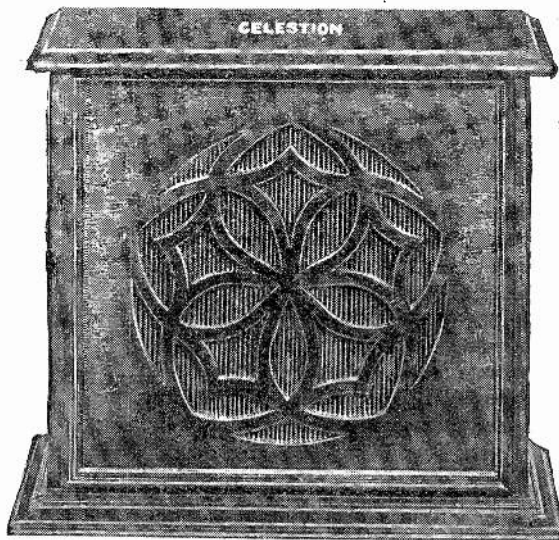

A LOUD-SPEAKER WITHOUT DISTORTION

One of the most natural tone Loud-Speakers on the market, and worked in conjunction with our "BIG BEN" 3-Valve Set the results are perfect. It has no trumpet. It fits in any corner of the room without being noticed. The retail price in Mahogany or Oak is **£6/10/0**.

The "BIG BEN" 3-Valve Set complete with 1 B.T.H. "B6" Power Valve, 2 B.T.H. "B5" Valves, 1 100v. H.T. Battery, 1 4v. 80 amp. Accumulator, 1 pr. Siemens' Phones, Aerial, Insulators and "CELESTION" Loud-Speaker, retail price **£28/7/0**.

Arrange a demonstration at your local Dealer's. If he cannot supply, instruct him to write to us, or write direct to:—

STOCKALL, MARPLES & CO. (1912) Ltd.

6:10, CLERKENWELL ROAD, E.C.1.

Telephone: Clerkenwell 6345/6. Telegrams: Stockalls, Smiths, London.

"THE ALTO" SHROUDED TRANSFORMER.

THIS TRANSFORMER represents the last word in efficiency for low-frequency amplification. It embodies a patent winding process and is tested to withstand 500 volts between windings. Being shrouded, it may be guaranteed absolutely free from distortion when used either singly or in cascade. The core is of finest Swedish transformer iron. Made in

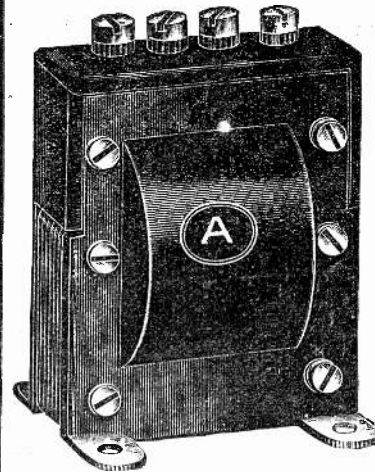

No. 9490.

two ratios, for first and second stages of amplification, the "Alto" Shrouded Transformer is designed to meet the requirements of the discriminating buyer.

PRICE **14/-** EACH.

Of all Wireless Dealers, Electricians and Stores.

Wholesale only from:—

THE WHOLESALE FITTINGS CO., LTD.

23, 25, 27, Commercial Street, E.1.

Phone: London Wall 1191.
Grams: "Calottes, Norton, London."

South London Depot: 65, Newington Butts, S.E. 11.
Phone: Hop. 773.

Also at
78-80, High Street, Manchester, and
14, North St. Stokes Croft, Bristol.

B.B.C. WIRELESS DRY BATTERIES For B.B.C. Sets

No. 1 W.

Standard Pocket Lamp Size—4 1/2 volt with patent spiral wire terminals and plug sockets to take Wander Plugs.

Note:—1 doz. = 54 volts.

Used units replaced easily.

Connect as illustrated.

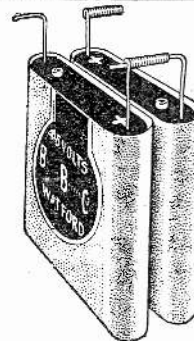

To connect in Series insert straight Terminal in Spiral of next battery. Bend spiral and thus ensure permanent electrical connection without soldering.

BRITISH MADE.

Patent No. 202760.

PRICE CARRIAGE PAID, **7/-** PER DOZEN, WITH PLUG.

Standard Sizes:

No. 2 W. Slab. 16 1/2 volts, 3-volt tappings.	Size approx. 9 x 1 x 3 ins.	Price 3/- each
No. 4 W. Slab. 36 volts, 3-volt tappings.	Size approx. 10 x 1 1/2 x 3 ins.	6/6 "
No. 5 W. Block. 60 volts, 3-volt tappings.	Size approx. 9 1/2 x 3 1/2 x 3 1/2 ins.	12/- "

Prices include Wander Plug. Carriage Paid.

Manufactured by—

Telephone: Watford 617.

The BRITISH BATTERY CO. LTD.
CLARENDON RD., WATFORD, HERTS

Barclays Ad.

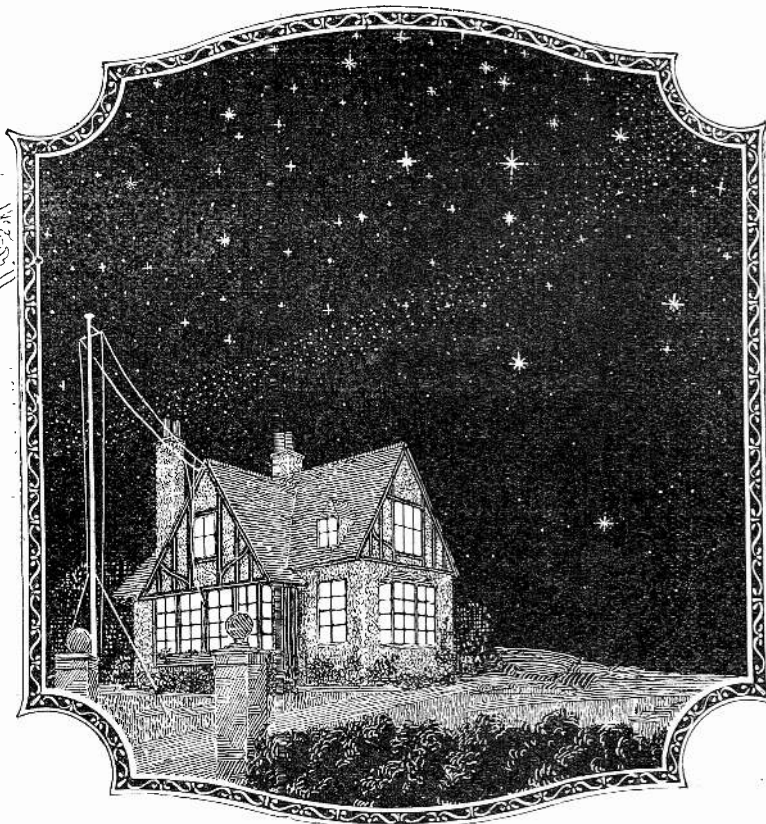

Complete the pleasures of Radio with *Wireless Weekly*

The man who owns a Receiving Set and treats it merely as a means of obtaining entertainment at little cost from the ether is missing one of the greatest joys of Broadcasting. For only those who really understand the principles—who can explain to their friends how Broadcasting is effected—and who, maybe, can build Instruments which will remain a visible sign of the interest they have taken in the newest and greatest of the Sciences—only these feel the real thrill of Radio.

It is to such a man that "Wireless Weekly" makes its greatest appeal. Educational without

being over-scientific—instructive without being boring, it undoubtedly wields the greatest influence among the young go-ahead experimenters of to-day.

Although in point of cost it is not the cheapest of weekly Radio Magazines, yet in comparison with the number of its pages, the lavishness of its illustrations and the dependability of its information, it certainly offers remarkable value for money. Why not purchase a copy of the current issue at your Newsagent's and form your own opinion—we will be well content to abide by your decision.

Wireless Weekly

As good as

Modern Wireless

6^d

Gilbert Ad. 1479



Don't worry
it out yourself
-let an expert
help you

PERHAPS you have built a Set and you cannot get it to work—don't worry, let a Radio Press expert help you. Probably you have made some little slip in the Circuit—maybe you have mis-read the wiring instructions. All you need is a copy of

Pictorial Wireless Circuits

By Oswald J. Rankin.

(Radio Press Series No. 8.)

This Book contains scores of different Circuits, each one of which is shown in pictorial form instead of the more technical diagrammatic manner.

Thousands of beginners have bought it and have been able to appreciate for the first time how easy it is to wire up a Set when the Circuit diagram is understood.

No matter which type of Set you are building, whether Crystal or multi-valve, and whichever type of tuning you will use, variometer or plug-in coils, you will find a wide variety of practical circuits shown in a manner even the veriest novice can readily understand.

From all Booksellers or sent post free 2d. extra direct from Publishers. **1/6**

When ordering quote Series No. M.S.

Radio Press Ltd.

Bush House, Strand, London, W.C.2.

Elusive signal strength!

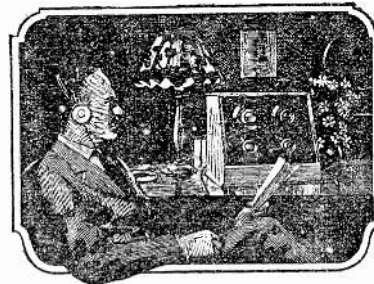

SMITH AND JONES both build the same Set. Both follow literally the instructions contained in the constructional article and both use the same components. Smith gets good results and Jones gets not a whisper. What is the reason? The panel. Or Robinson's Set used to give splendid results—all the B.B.C. Stations with 'phones on the table. Now he cannot pick up more than three or four. What is the reason? The low grade ebonite panel has probably absorbed some moisture from the atmosphere.

Perhaps you are a Jones or a Robinson and have been worried with poor results.

The remedy is to use a guaranteed panel material like Radion—the highest grade ebonite in the world. No matter where you buy it—whether in Glasgow or in Brighton—its quality is identical. Its wonderful lustre repels moisture

and need not be removed before use (this saves hours of tedious sandpapering). It is so tough and strong that a thickness of $\frac{3}{16}$ " is ample. Its insulation superiority has been endorsed by the leading experts in this country and in America, while its dielectric constant has been reduced to 3.9.

Your next Set is worthy of a good panel. Don't run the risk of poor results by using a piece of ordinary ebonite. Everyone knows that there is good ebonite and bad ebonite on the market, but few are in the position to be able to judge one from the other. The only safe way is to ask for Radion in one of its 21 different sizes. Remember that you can get it in black and mahoganite with dials and knobs to match. If your Dealer is out of stock he can get it for you by return, or, if you prefer it, we will supply it direct.

RADION

P A N E L S A N D D I A L S

Size	Black	Mahoganite	Size	Black	Mahoganite	Size	Black	Mahoganite
6" x 7"	3/6	4/3	7" x 14"	8/-	10/3	8" x 26"	17/6	21/3
6" x 10 1/2"	5/3	6/6	7" x 18"	10/6	12/9	9" x 14"	10/6	12/9
6" x 14"	7/-	8/6	7" x 21"	12/3	15/-	10" x 12"	10/-	12/-
6" x 21"	10/6	12/9	7" x 24"	14/-	17/3	12" x 14"	13/3	16/-
7" x 9"	5/3	6/6	7" x 26"	15/-	18/6	12" x 21"	19/9	24/3
7" x 10"	5/9	7/3	7" x 30"	17/9	21/6	14" x 18"	19/9	24/3
7" x 12"	7/-	8/6	7" x 45"	28/-	34/6	20" x 24"	39/6	48/-

SPECIAL NOTE: All Radion Panels are $\frac{3}{16}$ " thick. In addition to the sizes listed above we can supply by return any special size cut to measure at the following prices: Black 1d. per sq. inch; Mahoganite 1 1/2d. per sq. inch.

AMERICAN HARD RUBBER COMPANY (BRITAIN) LTD.
13a Fore Street, London, E.C.2

Gilbert Ad. 2099

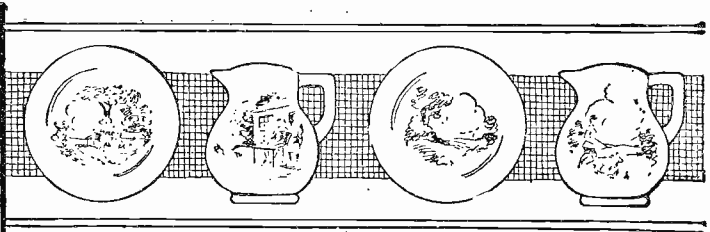

Give your Set that Professional Look!

About the year 1749 an engraver named John Sadler, of Liverpool, whilst taking proofs off a plate he had engraved, was suddenly startled by shouts of jubilation from his children in the room. On turning round to see the cause he found that one of them had picked up a still wet spoilt copy that he had thrown on the floor and applied it to a piece of crockery, and was triumphantly holding up the decorated piece of china. This accidental revelation was pursued by Sadler, and it is on record that together with a master printer named Green they, a short time afterwards, printed "1,200 earthenware tiles in about six hours, better and neater than one hundred skilful pot-painters could have painted in the common and usual way of painting with a pencil."

This is probably the earliest known transfer printing; after Liverpool many other factories, such as Battersea, Worcester, Bilston, Staffordshire, Swansea, Coalport and others, made transfer-printed ware.

Transferring is a common process in Lithography where it is used for "making up work," viz., transferring a lot of impressions either all of the same matter or different to a large stone so that they can all be printed at once.

Ladies use transfers for getting their designs on material for silk and other fancy work, in fact, its uses are innumerable.

The "Radio Press," were quick to realise the immense advantage the process offered to amateurs in lettering their panels as against the comparatively costly method of engraving, and thus have placed in the reach of everyone the Radio Press Panel Transfers.

PLENTIFUL SUPPLY NOW READY.
6d. per packet, or 3d. Post Free from

By using "RADIO PRESS WIRELESS PANEL TRANSFERS" (6d. per large packet of 80 labels), you can give to your set that finished appearance which makes all the difference. Not only are these transfers the cheapest and best but they are officially issued by the Radio Press for their sets. Buy a packet or two from your wireless dealer. They are also obtainable through every bookseller, but get the title right, if you want Radio Press quality.



Radio Press, Ltd.
BUSH HOUSE, STRAND, LONDON, W.C.2.

Perfectly simple and simply, per ect
THE MIC-MET SUPER CRYSTAL DETECTOR

[REGD.] (PATENT NO. 231943)

This instrument is micrometrical in principle and ensures a perfectly adjusted and rigid contact between crystal and contact. By a combination of movements between the three knobs, any portion of the exposed part of the crystal may be contacted. For **8.7.100** other circuits employing crystal rectification, the most efficient detector to use is the **MIC MET**. Can be obtained from your local wireless dealer or direct from the manufacturers on receipt of **6s.** P.O. Trade enquiries solicited.

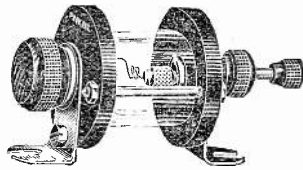

British Make.
 Beware of imitations and infringements.

C. & J. ARRIGONI & CO., LTD., COMPTON PASSAGE, CLERKENWELL, LONDON, E.C.



When fitting an Earthing Switch fit the **ARGUS** LIGHTNING PROTECTOR

ALL users of Wireless know well the importance of installing some substantial device to prevent natural electrical disturbances from destroying the wireless installations.

The "Argus" is the most efficient earthing switch, and enables listeners-in to use their sets in perfect safety, even during a thunderstorm.

Price Post 3d. **2/9** complete with instructions.

Obtainable from all Wireless Dealers, or direct from -
ANDERSON'S Wireless Sales Agency.
 9-15, Oxford Street, W.1.

Telephone: Gerrard 1749. Telegrams: Anwisalg; Westcent; London



Wireless List "F"
 Post Free

Price **10/6**
 Postage 6d.

A most efficient device to which ordinary headphones are clipped by simple pressure on the spring clips.

The "Gramaphix" Loud-Speaker

The Gramaphix requires (according to distance from the Broadcasting Station) at least one stage of low-frequency amplification to give satisfactory volume.

HORNS TO MOUNT ON GRAMAPHIX:
 Straight Horn (Bell 10 in.) **6/-**. Swan-necked Horn (Bell 11 1/2 in.) **15/-**. Small Curved Horn (Bell 8 1/2 in.) **7/6**. Post 9d. extra.

RICHARD MELHUISH, Ltd., Electrical Engineers and Wireless Experts,
 50, 51 & 84 Fetter Lane, London, E.C.4 Est. 1828

LANITE
 The Ultra Sensitive CRYSTAL

The Best Yet!

LANITE, the super-sensitive laboratory crystal, has made a sensational hit. Its sensitiveness is amazing; it is thoroughly sensitive all over too. Not a single "dud" spot. Immediately you will notice wonderfully increased volume.

Under test: It does not supply, undistorted, distortions and speed which are not with any crystal.

LANITE Laboratories
 6 Bo th St. East
C-on-M MANCHESTER

The 'HERALD' L.F. TRANSFORMER



This new Radiax Component is built to the proved most efficient design. It is manufactured with the utmost precision and care, and it is subjected to all reasonable and practical tests. It will give a high amplification without distortion, and if in these respects it does not equal any first-class transformer against which it is compared, we will refund cash if returned within 10 days.

Complete Illustrated Catalogue of all Components, Receiving Sets, Amplifiers, Constructors' Sets, etc., 3d. stamps. Receiving Sets only, gratis.

Price **15/-**.

to all reasonable and practical tests. It will give a high amplification without distortion, and if in these respects it does not equal any first-class transformer against which it is compared, we will refund cash if returned within 10 days.

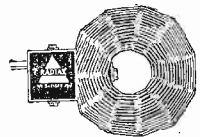

RADIAX DUPLEX BASKET COILS.

Far more efficient than honeycomb or any other type of coil. Exceeding strong and rigid, mounted on standard ebonite plugs. Brown finish, no wax or shellac used. MOUNTED.

FIT RADIAX SQUARE LAW CONDENSERS.

Of splendid quality and finish, very strong construction and highest possible electrical efficiency, this new Radiax production will Revolutionise Your Tuning.

The use of a good square law condenser facilitates the tuning on that portion of the scale hitherto difficult or impossible, and gives uniform results over the whole range. A Radiax Chart FREE with each enables you to identify by wavelength each station you tune in. It includes valuable hints on logging all stations heard.

Without Vernier. With Vernier.

.001	9/-	No. Price	No. Price
.0006	7/6	25 1/6	125 3/-
.0005	7/-	35 1/9	150 3/-
.0003	6/6	50 2/-	200 3/9
		75 2/3	250 4/6
		100 2/9	300 5/6

RADIAX LTD., 40, Radio House, Percy St., Tottenham Court Road, LONDON, W.1. Muscum 490.
 3 mtrs. Tottenham Court Rd. and Goudge St. Tube Stns.



Barclays 637.

ATHOL PORCELAIN COIL MOUNT
 With the perfect plug. Will fit any coil. 1/- each.

ATHOL COIL RECEPTACLES
 For anode coils, phone plugs, battery plugs, etc. Moulded 1/- Ebonite 1/3

ATHOL REVERSIBLE VALVE HOLDER
 The only single hole fixing holder that fits any set. 1/3 each.

ATHOL ENGINEERING CO.
 CORNET St., Hr. BROUGHTON, MANCHESTER. FREE

The Best Crystal Detector is the "LYDDON" POST FREE, 3/-

"Modern Wireless" Report (December issue) concludes as follows:-

"We can strongly recommend this ingenious and extremely practical detector, which should do a good deal towards raising the standard of crystal reception in many cases."

T.A.T. CIRCUIT, Improved tapped Resistance Choke, Tappings connected to Terminals. Easily fitted. 6/- post free.

JOHN T. NICHOLS,
 4-5, Glebe Road, Dalston, London, E.8.

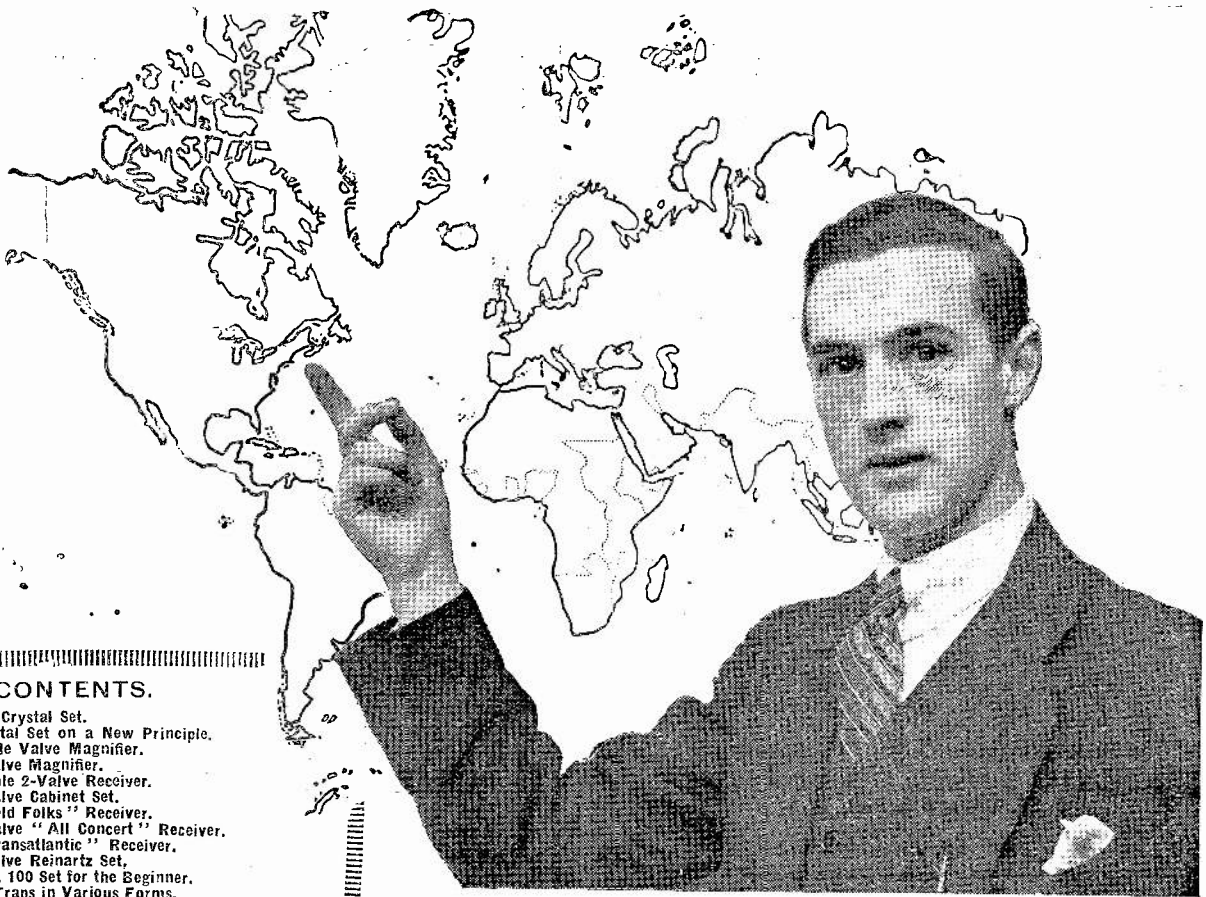

CONTENTS.

- 1 A 2/6 Crystal Set.
- 2 A Crystal Set on a New Principle.
- 3 A Single Valve Magnifier.
- 4 A 2-Valve Magnifier.
- 5 A Simple 2-Valve Receiver.
- 6 A 2-Valve Cabinet Set.
- 7 An "Old Folks" Receiver.
- 8 A 3-Valve "All Concert" Receiver.
- 9 A "Transatlantic" Receiver.
- 10 A 3-Valve Reinartz Set.
- 11 An S.T. 100 Set for the Beginner.
- 12 Wave Traps in Various Forms.

"I get these stations regularly"

So will you if you buy a copy of

TWELVE TESTED WIRELESS SETS

By **PERCY W. HARRIS**

2/6

Post Free
2/8



And make one of the fine multi-valve sets such as the "Transatlantic." This is the season for receiving broadcasting from American and Continental stations, and there is no more fascinating or instructive pastime than searching for those elusive stations.

They will, however, not be elusive if you build a set produced by such an experienced designer as Mr. Harris.

Look at the varied contents and you will realise what a bargain such a cheap but reliable book is. Every set is not merely tested by the author but by hundreds, and sometimes thousands, of readers who have bought this book.

Buy it to-day from your wireless dealer or bookseller (2s. 6d.) or quote series No. M. 14 and send 2s. 8d. to the publishers:

Radio Press, Ltd.,
Bush House, Strand, London, W.C.2.

Barclays Ad. 1173

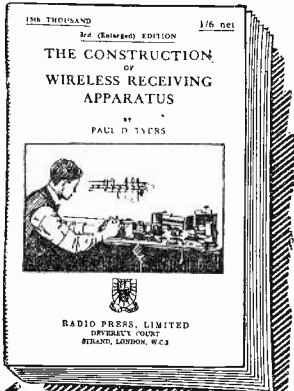

Owing to its great popularity we are now publishing the 6th Edition of this book, which has been written for the purpose of providing the wireless amateur and the general public with sufficient information concerning the actual construction of wireless receiving apparatus. Although the information contained within these pages is essentially of a practical nature, an indication has been given wherever possible of the function of each component. It is obvious, therefore, that if this is fully understood, the reader is in a position to produce a really efficient piece of apparatus. The mechanical construction has been reduced to a minimum, but this, of course, may be elaborated, if desired. Every component has been thoroughly tested, not only by the author, but by a number of experimenters with whom he is acquainted. Hence it is with every confidence that this book is placed in the hands of the wireless amateur.

CONTENTS.

ANODE AND GRID RESISTANCES
 General considerations—A graphite grid leak—An Indian ink resistance—A continuously variable resistance—An anode resistance for panel mounting—High resistance mixtures—Determination and regulation of resistance values.

FILAMENT RHEOSTATS AND POTENTIOMETERS
 General considerations—A single valve resistance—A stud type resistance—A rheostat for panel mounting—A graphite potentiometer—A liquid potentiometer.

INDUCTANCES
 General types—Basket coils—Slab and bank coils—Cylindrical inductances—A loose coupled tuning inductance—Bank and pile winding—Honeycomb coils—Isolateral coils—Other lattice coils—Variometers—Effect of dead end and self-capacity.

FILAMENT AND ANODE BATTERIES
 General considerations.

CONDENSERS, DETECTORS, AND TEMPORARY COMPONENTS
 A valve holder—Variable condensers—Vernier condensers—Grid condensers—By-path condensers—Crystal detectors.

AUDIO-FREQUENCY AMPLIFICATION
 General considerations—The bobbin—The core winding—Other types—Telephone transformer.

RADIO-FREQUENCY AMPLIFICATION
 General considerations—Resistance capacity unit—Reactance capacity units—Types of transformers.

THE CONSTRUCTION OF WIRELESS RECEIVING APPARATUS.
 By Paul D. Tyers.
 Series No. M.5, price 1/6, post free 1/8
 Obtainable from all newsagents, booksellers, or your local wireless dealer.
 If ordering direct be sure and quote Series No. M.5.
Radio Press Ltd.,
 Bush House, Strand, LONDON, W.C.2.

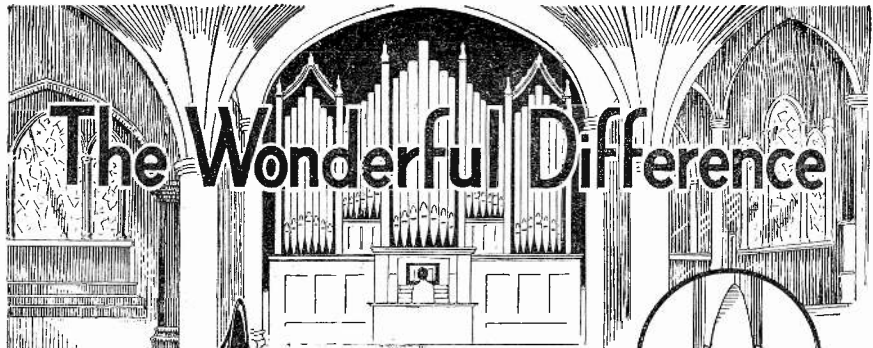

Voiced like
an Organ

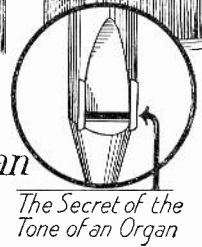

The Secret of the Tone of an Organ

THE whole basis of music is one of vibrations and harmonics, but the feature that makes or mars perfect music is the way in which the harmonics are produced from the vibrations.

Given a solid magnet structure and a correctly proportioned diaphragm you can take it that your vibrations will be really good, but the resulting harmonics depend entirely upon the way you use those vibrations. The great art of the organ craftsmen lay in their master-knowledge of harmonics, and the secret of their greatest achievement was the voicing of the pipes

THE RADIOSUN LOUDSPEAKER

is the only loudspeaker with the mouth of the sound chamber *voiced like an organ*. You can guess the immense difference this makes. Every intonation is reproduced from the vibrations of the diaphragm in perfect form, giving real music throughout the range of wireless broadcasting.

The RadioSun Loudspeaker was designed by an organist and engineer: that is why it can give you the purest music. Remember it is voiced like an organ, and it is the only loudspeaker with this supreme feature of design.

The entire magnet system is unique. Look out for further particulars of this wonderful loudspeaker in our advertising.

Write for Booklet explaining **THE WONDERFUL DIFFERENCE** free on application.

The Secret of the Tone of the RADIO SUN

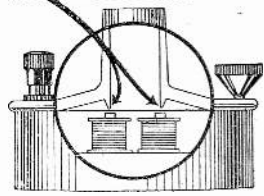

PRICE
£5

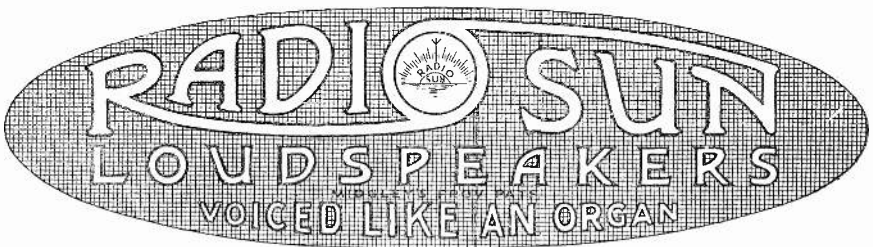

AUTO SUNDRIES LTD.,
 10, LOWER GROSVENOR PLACE,
 LONDON, S.W.1.

Barr's

In replying to advertisers, use Order Form enclosed

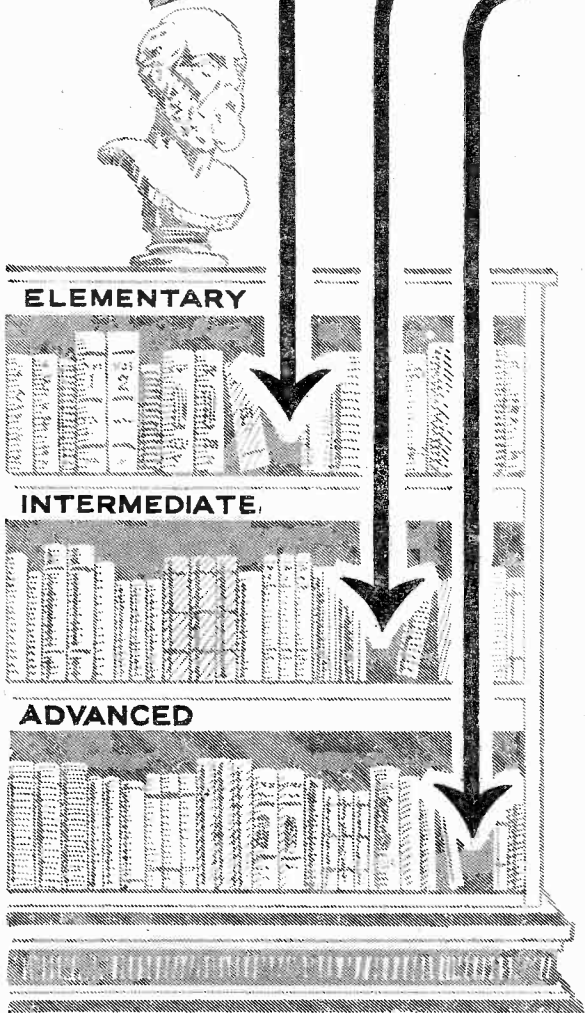

Put it there!

NO matter whether you are a beginner, amateur or expert in matters wireless, you will find one or more books that will be of very great assistance to you among the excellent series published by the Radio Press. It is quite likely that one of those illustrated above is just what you need now.

HOW TO MAKE YOUR OWN BROADCAST RECEIVER.

By John Scott Taggart, F.Inst. P., A.M.I.E.E.
An ideal book for the beginner, showing how he can build cheaply and well a Broadcast Receiver.

Series No. M.5.
1/6 or 1/3 post free.

HOME BUILT WIRELESS COMPONENTS.

Shows how the enthusiast can make for himself every component required for a Receiving Set. It pays for itself in the first few pages.

Series No. M.16.
2/6 or 2/8 post free.

WIRELESS SETS FOR HOME CONSTRUCTORS

By E. Redpath.

A book which instructs its readers how to make efficient Wireless Sets for all purposes, both simple and advanced.

Series No. M.17.
2/5 or 2/8 post free.

Complete List "M" of Radio Press Series of Books will be sent post free on application. Obtainable from all Newsagents, Bookstalls, local Wireless Dealers or direct from the Publishers. When ordering direct be sure and quote Series No. M.—.

Radio Press, Ltd.
BUSH HOUSE, STRAND, LONDON, W.C.2.

Barclays 1226

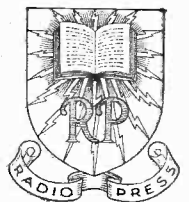

Whatever the Circuit—

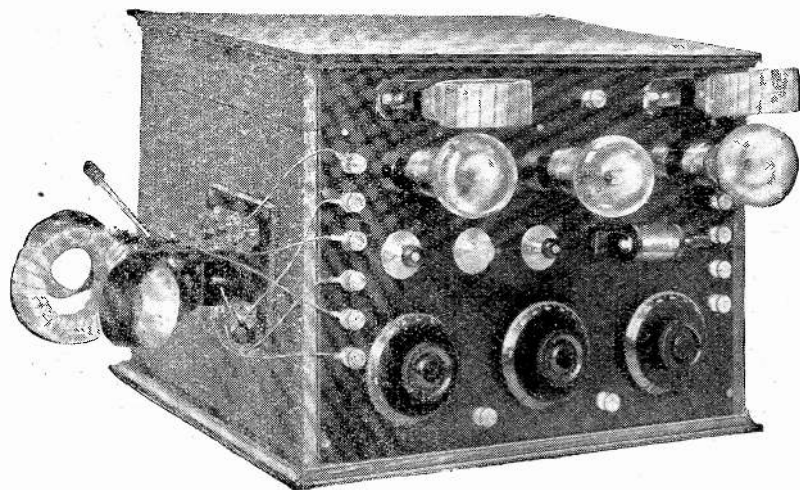

the Omni is the Set

A LABORATORY in a single cabinet. These few words sum up the Omni Receiver, full constructional details of which appear in the Radio Press Envelope No. 5.

The Omni Receiver was designed by John Scott-Taggart, F.Inst.P., A.M.I.E.E., to enable the really keen experimenter to have a cabinet wireless receiver which could be wired up to almost any circuit in a very short time, the set, however, always retaining its neat outward appearance.

The raising of the hinged lid of the cabinet discloses a panel on which have been mounted 50 well-spaced terminals, and that is the key to what has hitherto been considered an impracticable problem. The various components are mounted behind the front panel, and generally speaking, the connections of each component are taken to the terminal panel. After the Omni Receiver has been completed, it is possible, and an easy matter for any wireless enthusiast to try out and compare practically any new circuit, or variations in old circuits, by simply raising the lid of the cabinet and connecting up. It is advisable to use rubber covered flex for the purpose.

Every terminal on the panel under the lid of the cabinet is numbered, and a key is supplied. Using the numbered keys it is an easy matter for the beginner to wire up and test any one of the following twelve circuits, given in the envelope:— Crystal, Crystal and 1 L.F., Crystal and 2 L.F., 1 H.F. Crystal and 1 L.F., H.F. Crystal and 2 L.F., Detector and 1 L.F., Detector and 2 L.F.,

Single Valve Reflex, ST 34, ST 45, ST 75, ST 100. It is simply a matter of connecting terminals 51-50, 51-28; 50-42, etc. From time to time new keyed circuits will appear in the Radio Press publications, principally *Wireless Weekly*. No wireless enthusiast should be without an Omni Receiver, the Receiver you can wire at will, always ready for future experiments.

The Radio Press Envelope No. 5 contains full constructional details, Blue-prints, Photographs, Diagrams, Key charts, a transfer of key numbers for the terminal panel, together with useful hints and tips for the constructor and many pages of interesting information, experiments, etc., showing the enormous advantages and possibilities opened out to owners of the Omni Receiver.

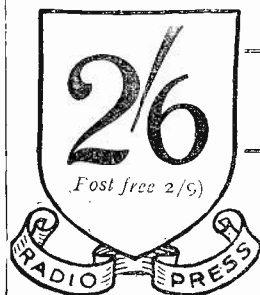

Always ready for the Future

Radio Press, Ltd.

Bush House, Strand, London, W.C.2.

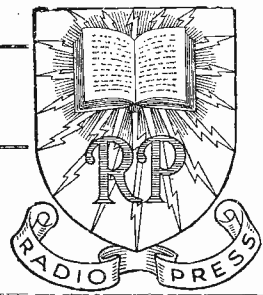

In replying to advertisers, use Order Form enclosed.

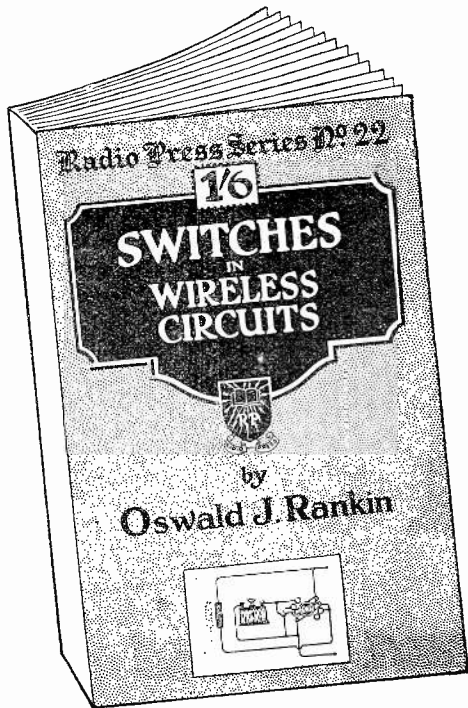

Switches in Wireless Circuits

By Oswald J. Rankin.

THIS is the latest addition to the series of authoritative books on wireless published by the Radio Press Ltd., books well known for their accuracy and great simplicity in giving the Public in a perfectly readable manner just the information they need.

This exceedingly useful Book contains over fifty different switching arrangements covering practically every possible requirement.

The diagrams are shown both theoretically and pictorially, so that even the absolute beginner cannot possibly go wrong through lack of knowledge in diagram reading.

Every enthusiast has used up valuable time worrying out the most efficient way to switch some particular circuit, component or accessory simply and economically. Switching often presents many difficulties, but with this new Book, all difficulties arising from a desire to switch your set efficiently, vanish together with possibilities of destroying valves and injuring batteries.

Ask for the book with the distinctive yellow cover.

The Radio Press Series No. M22, Price 1/6.

Obtainable from all Newsagents, Booksellers, your local Wireless Dealer, or direct from the Publishers. Post Free 1/8.

When ordering be sure and quote Series No. M22.



Switch and be Safe

Radio Press, Ltd.,

BUSH HOUSE, STRAND, LONDON, W.C. 2.

Darclay's 1231.

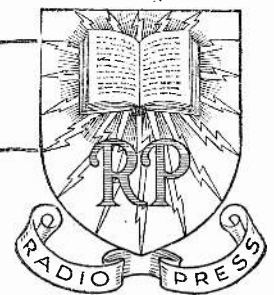



Tied to your Set?

Don't just listen with head phones

which cramp your movements and tie you to a chair with a yard or so of cord. Be free as the wind to move as you please, and allow others to converse freely; it is not good to suppress one's feelings too much.

Radio Press Envelope No. 7

shows you how to build a two-valve Power Amplifier which will enable you to "Dance to the Music your wireless set brings." It supplies that necessary power which swells the volume of music or speech without impairing the quality of reception in any way.

The apparatus described in this and other Radio Press Envelopes is of proven efficiency, and the success of the constructor is guaranteed by the Radio Press provided he follows exactly the clear and easy instructions given.

Obtainable from all Newsagents, Book-stalls, local Wireless Dealers or direct from the Publishers. When ordering direct be sure and quote Envelope No. M.7

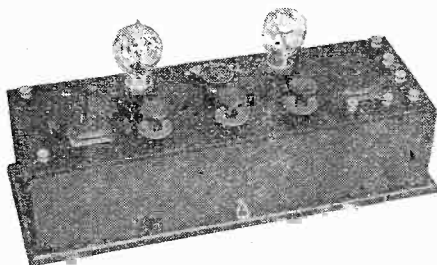

Radio Press Envelope No. 7.

A Two Valve Amplifier de-Luxe.

by Herbert K. Simpson.

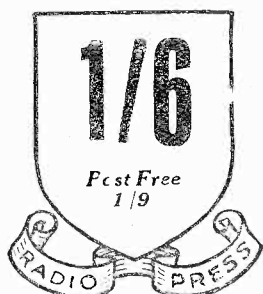

Dance to the Music Your Wireless Set Brings

Radio Press, Ltd.,
BUSH HOUSE, STRAND, LONDON, W.C.2.

Barclays 1230

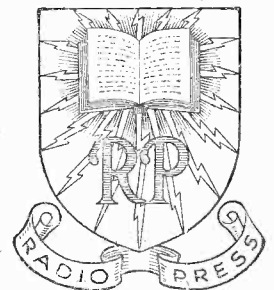

In replying to advertisers, use Order Form enclosed

Index to Advertisers

	PAGE.		PAGE.		PAGE.
Agar (W. H.)	102	General Electric Co., Ltd.	25	Power Equipment Co.	46
American Hard Rubber Co., Ltd.	123	General Radio Co.	97	Pressland Elec. Supplies	110
Anderson's Sales Agency	125	Gent & Co.	54	Radiax, Ltd.	125
Arrigoni (C. & J.)	125	Goswell Engineering Co.	77	Radio Communication Co., Ltd. .. .	2, 109
Athol Engineering Co.	125	Graham (A.) & Co.	107	Radio Improvements, Ltd.	105
Autoveyors, Ltd.	103	Harlie Bros.	132	Radio Instruments, Ltd.	Cover iv
Beard & Fitch	53	Holdrons	114	Radio Stocks	109
Bowling (W. H.)	117	H. T. C. Electrical Co.	86	Radio-Sun Elec. Co.	127
Bowyer-Lowe Co.	111	Hughes (F. A.) & Co.	110	Radiations, Ltd.	78
Brandes, Ltd.	26	Hunt (A. H.), Ltd.	105, 109	Raymond K.)	89
British Battery Co., Ltd (The)	121	Igranic Electric Co., Ltd.	87	Robinson (Lionel) & Co.	119
British Thomson-Houston Co.	73, 80	Jackson Bros.	41	Rose Bros. Elec. Co.	50
Brown Brothers, Ltd.	41	King Products	119	Rosen (Ed.) & Co.	76
Brown (S. G.), Ltd.	104	Lanite Laboratories	125	Rothermel (R. A.), Ltd	1
Burndep't, Ltd.	Cover ii	Lighting Supplies Co.	117	"S. A. Cutters"	93
Burne-Jones & Co., Ltd.	70	Lissen Co.	29, 49	Shipton (E.) & Co.	69
Buss (F. O.)	96	Liver Radio Mfg. Co.	78	Siemens Bros. & Co., Ltd.	103
Carpax Co.	99	London Elec. Wire Co.	105	Silvertown Co.	112
C.A.V. Small Tools	61	Louden Valves	83	Smith & Ellis	73
Chase Electrical Co.	121	McKellen (R.) & Co.	73	Sterling Telephone Co., Ltd.	33
Chloride Elect. Storage Co. Ltd.	108	McMichael (L.), Ltd.	90	Stevens (A. J.) & Co. (1914), Ltd.	94
Collinson's Precision Screw Co., Ltd.	103	Marbaix (Gaston, E.)	113	Stockall, Marples & Co.	121
Corre (S.) & Co.	109	Marconi-Osram Valve Co.	30	Summit Mfg. Co.	117
Cossor Valve Co.	84	Marshall (H. Lloyd)	102	Telephone Mfg. Co.	73
Curtis (Peter), Ltd.	37, 42	Melhuish (Rd.) & Co.	125	Transformer Repair Co.	104
Diamond Wireless, Ltd.	93	Microhm Engineering Co.	119	"U.S." Radio Co.	105
Dixon (I.) & Co.	73	Molback (M.)	93, 98, 109	Vandervell (C. A.)	54
Drummond Bros.	54	Mullard Radio Valve Co., Ltd. .. .	65	Varley Magnet Co.	73
Dubilier Condenser Co. (1921), Ltd.	57, 79	Naylor (J. H.)	42	Verströeten, M.	104
Energo Products	69	Neutron, Ltd.	38	Ward & Goldstone, Ltd.	113
Falk, Stadelmann & Co.	98	Nichols, John T.	125	Wates Bros.	59, 110
Fallon Condenser Co.	93	Oldham Accumulators	106	Watmel Wireless Co.	99
Fellows Magneto Co., Ltd.	61	Ormond Engineering Co.	34	Western Electric Co., Ltd.	99
Finchett (C. A.)	132	Peto-Scott Co.	115, 117	Wholesale Fittings Co.	121
Forno Co.	41	Pettigrew & Merriman	58	Wilkins & Wright, Ltd.	74
Fuller's United Elec. Works, Ltd.	74	Pickett Bros.	104	World's Wireless Stores	102
Gambrell Bros., Ltd.	62	Portable Utilities Co., Ltd.	116		

Harlie

FOOL-PROOF
DETECTOR

Provisional Patent 26791/24

Continuous reception in any position at all times, owing to the special design of both crystal and catswhisker, is the keynote of this excellent detector.

SOME NOVEL FEATURES:—

1. Nickel plated detachable dust proof cover.
2. Special "Harlie" super sensitive crystal.
3. Ebonite wheel for rotating crystal.
4. Catswhisker on slider for covering whole surface of crystal
5. Nickel plated sockets for panel mounting.

Obtainable from all dealers or direct from Patentees and Manufacturers.

Generous Trade Terms.

Telephone: Clissold 293.

**HARLIE BROS., 183, Dalston Lane,
HACKNEY, London, E.8.**

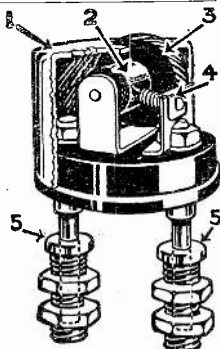

Price Complete **5/6**

Barclays 627

Let the Public Hear—

your call. Do not rest content with just an appeal to the Trade to stock your manufactures. However excellent the goods may be, there will only be a regular and consistent demand provided the public know too!

If this avenue, viz., the Radio Press is thoroughly explored and the public are educated by your insistence to ask for your brand, sales must inevitably have a tendency to rise.

Ring City 9911 (Extn. 9) or write the Advt. Manager for particulars of MODERN WIRELESS, WIRELESS WEEKLY and THE WIRELESS CONSTRUCTOR, the only media in Wireless which thoroughly cover the who's subject and whose readers are *The Wireless Market*.

100% EFFICIENT H.T. BATTERY.

CONSTRUCTORS' IDEAL.



See Apparatus Tested, April issue. Why buy inefficient tiny sealed in batteries. I offer Terminalled Giant Unit Dry Cells, 1½ volts of 300 per cent. more capacity. See Photo. Cells, 4/- doz. plus carriage. 60 volt type in polished Oak Case as reported, 19/6, carriage 1/9. In card box 14/6. Every cell replaceable. Lists free. Sample Cell, 6d. Money back guarantee. Delivery now ex stock. Direct only from Sole Maker: **FINCHETT (C.A.) Old Armoury, Oswestry.**

COUPON.

QUESTIONS AND ANSWERS.

In future this coupon must be accompanied with 2s. 6d. P.O.

"MODERN WIRELESS" February, 1925.

BARCLAYS ADVERTISING, Ltd.

Advt. Managers for Radio Press Publications,

Advertising Agents, Consultants and Contractors,
BUSH HOUSE, STRAND, LONDON, W.C.2

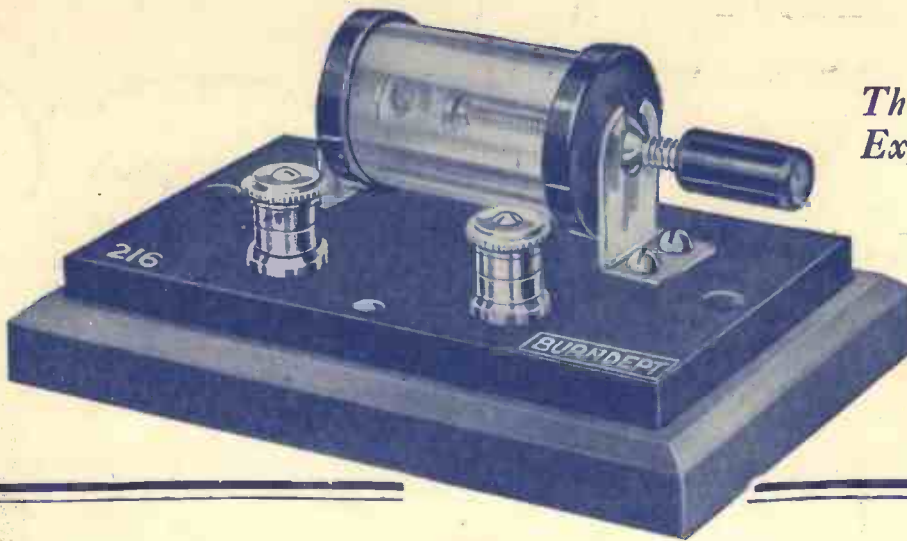

*The
Experimental Model*

This accessory is a very useful one to those who are frequently trying new circuits. The Crystal Detector is mounted on an engraved ebonite panel, fitted with gold-lacquered terminals, the whole being mounted on a polished walnut base.

The Popular Burndept Crystal Detector —now Reduced in Price

READERS of "Modern Wireless" should be pleased to learn that the Burndept Crystal Detector has been reduced in price. Both models will cost one shilling less from February 2nd next. The price reductions are made possible only by the enormous sales which enables us to effect savings on the manufacturing costs.

The Burndept Crystal Detector has unique features (it is manufactured under Patents 226135 and 226610), and because of its reliability and efficiency it has become very popular with constructors all over the country. Mr. John Scott-Taggart, F.Inst.P., A.M.I.E.E., recommends this Burndept component and other Radio Press writers strongly advocate its use.

Many wireless enthusiasts regard the Burndept Crystal Detector as the standard of efficient crystal rectification. It gives the best possible results, and is a component fit to use in the best set made. The gold cat-whisker of the Burndept Crystal Detector is controlled by a micrometer screw working through a ball-joint. The movement provides delicate adjustment, and the cat-whisker does not require frequent attention once set. All moving parts and the sensitive synthetic crystal are enclosed in a glass tube, protected from dust. The component is neat and well finished, and adds to the good appearance of any panel.

You can get this Crystal Detector from any Burndept Agent.
Purchase Burndept by its name—substitutes are not the same.

NEW PRICES

No. 215. Crystal Detector for panel mounting, in carton, with screws and drilling template,

Now 4s.

No. 216. Crystal Detector, for experimental use, as illustrated above,

Now 11s. 6d.

BURNDEPT

WIRELESS APPARATUS

BURNDEPT Ltd., Aldine House, Bedford St., Strand, London, W.C.2
Telephone : Gerrard 9072. Telegrams : Burndept, Westrand, London.

LEEDS : 12, Basinghall St. (near City Square). CARDIFF : 67, Queen St. NORTHAMPTON : 10, The Drapery.

No Interaction

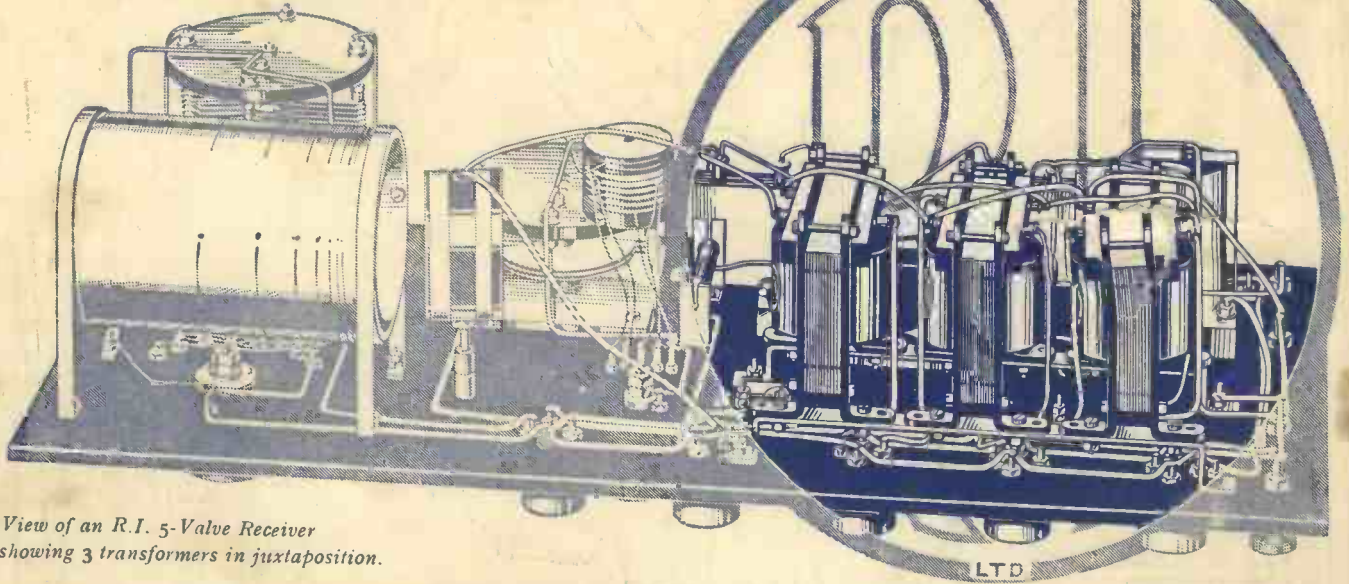

View of an R.I. 5-Valve Receiver showing 3 transformers in juxtaposition.

THREE TOGETHER—WITHOUT INTERACTION

THE R.I. TRANSFORMER has been universally admitted to be the world's general purpose transformer for perfect distortionless amplification. Its operation as a result of the special internal coil construction and heavy insulation has an efficiency higher than that of any other transformer on the market, and the general standard of transformation has been set as that of the

R.I. STANDARD

The R.I. has not only perfect operation in itself, but can be used in close construction with other R.I. transformers without the slightest interaction, as shown above in the R.I. five valve receivers.

NO DISTORTION—NO INTERACTION

That means that the R.I. is the only transformer for YOU.
See that you ask for an R.I.
No other transformer will ever satisfy you like an R.I.
Ask your dealer. Write for the R.I. catalogue, free on request.

PRICE **25/-**



Radio Instruments Ltd.

12 Hyde Street, Oxford Street

Telephone: REGENT 6214 (3 lines) W.C.1. Telegrams: Inradio London.