

MODERN WIRELESS



March.

1/6

Vol. II. No. 6.

Edited by JOHN SCOTT-TAGGART, F.Inst.P., A.M.I.E.E.

March, 1924.

SPRING
DOUBLE
NUMBER

16

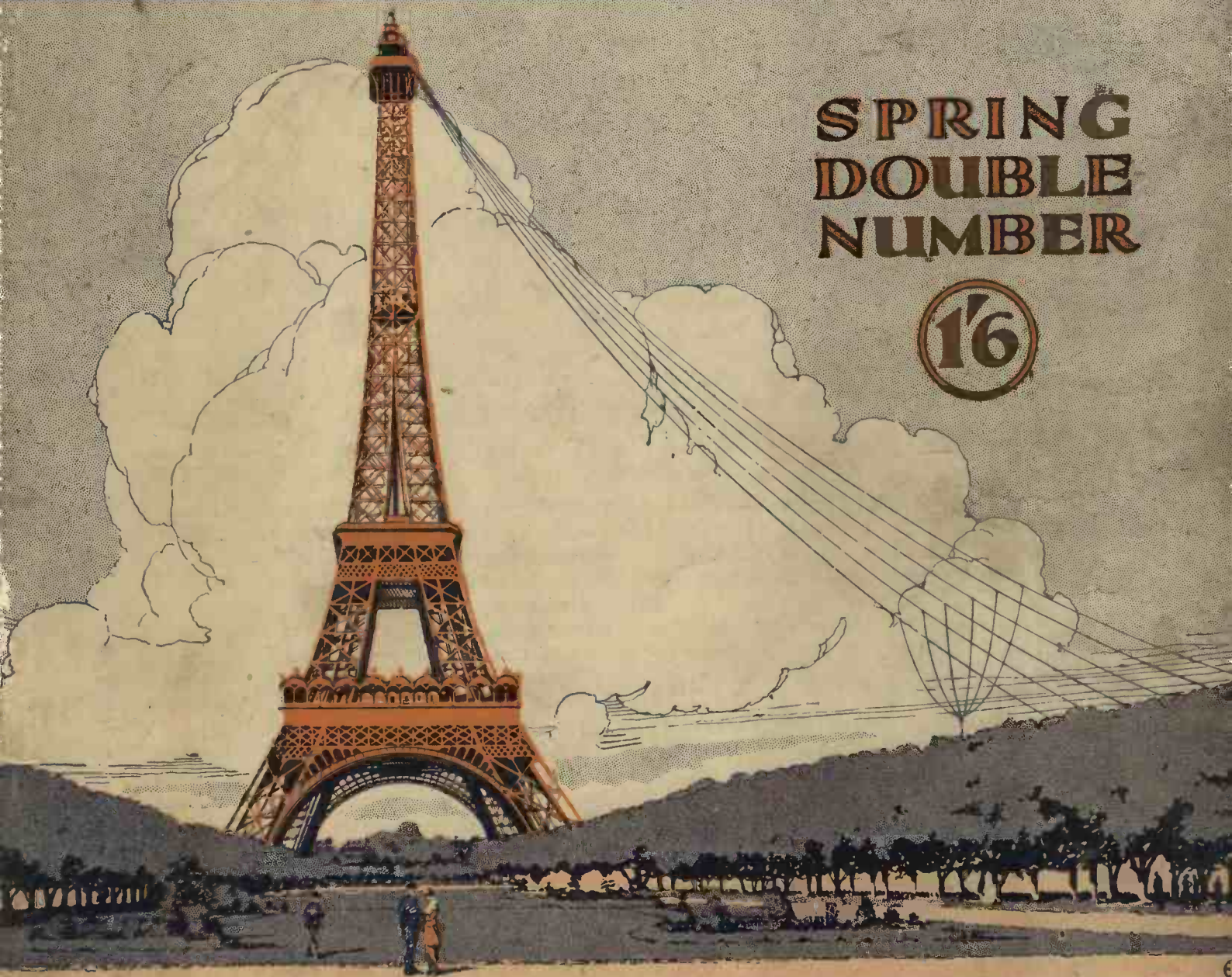

Vol. II.

No. 6

HOW TO BUILD A TEN-VALVE SUPER-HETERODYNE. *By Kenneth Alford.*
HOW TO MAKE THE "ST100 STAR" RECEIVER. *By John Scott-Taggart, F.Inst.P.*
BUILDING A THREE-VALVE REINARTZ SET. *By Percy W. Harris.*
WHAT VALVE SHALL I USE? *By R. W. Hallows, M.A.*
HOW TO MAKE TWO DIFFERENT CRYSTAL SETS.
A NOVEL DUAL AMPLIFICATION RECEIVER. *By A. D. Cowper, M.Sc.*
WHAT TO DO WHEN YOUR SET GOES WRONG.
BUILDING A THREE-VALVE DRAWING-ROOM RECEIVER.
DUAL CIRCUITS I CAN RECOMMEND. *By John Scott-Taggart, F.Inst.P.*
Practical Hints and Tips. Constructional Notes. Wireless Humour. How to Receive Time Signals from Paris. Etc., etc.

RADIO PRESS.
Series No. 8.

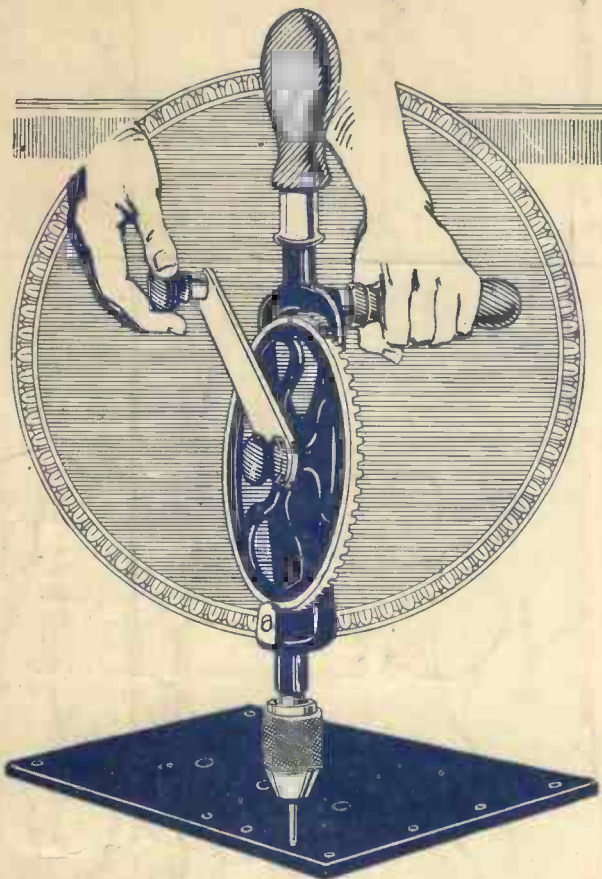

Stop!

Are you sure your
circuit is correct?

Eighteenpence invested
now may save you hours
of wasted labour.

IT'S easy to be wise after the event—and it is poor satisfaction for the man who has ruined a sheet of ebonite costing 5/- to find out that when the Set does not work, the fault lies in the circuit.

Many circuits are published to-day which can only give good service in the hands of the expert; therefore, the beginner often finds it difficult to make a choice.

Further, many beginners are quite unable to read a circuit diagram and are thus quite at sea when they commence building up a set.

To those—and also to many more experienced wireless enthusiasts—the new Book, "Pictorial Wireless Circuits," by Oswald J. Rankin, will

particularly appeal. Not only is each circuit shown clearly and free from unnecessary complication, and in actual picture form (with every component actually illustrated), but every one of the scores of circuits shown can honestly be recommended as the best possible arrangement.

Already this Book has run through one large edition and as soon as it gets a little more widely known there will hardly be a home constructor in the country who hasn't a copy handy on his bookshelf.

Remember, it contains complete details for all types of Circuits from simple Crystal Circuits to those suitable for multi-Valve Sets; and you'll save its cost the very first time you use it.

From all Booksellers, or
1.8 post free direct from
Publishers:

Radio Press Ltd., Devereux Court, Strand,

W.G.2.



Pictorial Wireless Circuits



Contents

	PAGE		PAGE
Frontispiece	412	A Double Dual Circuit ...	484
Editorial	413	By JOHN SCOTT TAGGART, F.Inst.P.	
A Self-Contained Three-Valve Set	414	A Two-Valve Drawing Room Receiver	488
By HERBERT K. SIMPSON.		By HERBERT K. SIMPSON.	
In Passing	420	How to Read a Wireless Period- ical	494
The Reinartz Circuit	423	Some Curious Reaction Cir- cuits	497
By PERCY W. HARRIS.		By A. D. COWPER, M.Sc.	
Radio Reminiscences	430	Which Valve Shall I Buy? ...	502
By LT COL. CH TWODE CRAWLEY, R.M.A.		By R. W. HALLOWS, M.A.	
Programmes of Broadcasting Stations	437	The Transatlantic Receiver ...	509
The S.T. 100 Star Circuit	438	Some S.T. 100 Appreciations ...	511
By JOHN SCOTT-TAGGART, F.Inst.P.		The Size of Coil to Use	512
More Birthday Messages	444	By G. P. KENDALL, B.Sc.	
Further Experiments in High- Frequency Amplification	445	Apparatus We Have Tested ...	515
By PERCY W. HARRIS.		Trouble Corner	520
Wireless From Odds and Ends ...	450	By "ADSUM."	
By A. H. BENSON		More Experiments with the All- Wave Receiver	523
A Ten-Valve Receiver	452	By JOHN SCOTT TAGGART, F.Inst.P.	
By W. K. ALFORD		Notes on the Transatlantic Receiver	530
The Limitations of Wireless ...	456	By PERCY W. HARRIS.	
The Care and Maintenance of Accumulators	460	How to Receive Time Signals... ..	532
By E. L. ROPPER		Aerial Circuit Tuning (contd.) ...	535
Dual Circuits I Can Recom- mend	463	By JOHN SCOTT TAGGART, F.Inst.P.	
By JOHN SCOTT-TAGGART.		A Simple Crystal Set for Broad- casting	540
F.Inst.P.		Adding Valves to a Crystal Set ...	545
When Your Set Fails	468	A Cam Type Variable Condenser ...	550
Reflex Receivers in Theory and Practice	470	The Interference Problem in Radio	552
By JOHN SCOTT-TAGGART, F.Inst.P.		A Direct Contact Sliding Plunger ...	555
A Tapped Inductance Crystal Set	475	A Useful Variable Condenser of Novel Design	556
By A. D. COWPER, M.Sc.		Sawing Ebonite	556
Hand Capacity Effects: Their Cause and Cure	477		
Above and Below the Broadcast Wavelengths... ..	481		

Editor:
JOHN SCOTT-TAGGART,
F.Inst.P.

Joint Assistant Editors:
PERCY W. HARRIS.
E. REDPATH.

Staff Editors:
E. H. CHAPMAN,
M.A., D.Sc.
A. D. COWPER, M.Sc.
G. P. KENDALL, B.Sc.
R. W. HALLOWS, M.A.
S. G. RATTEE.

Scientific Adviser:
Prof. G. W. O. HOWE,
D.Sc., M.I.E.E.

Advisory Editors:
Prof. R. WHIDDINGTON,
M.A., D.Sc.
Prof. C. L. FORTESCUE,
M.A., M.I.E.E.

Advertisement Managers:
SCHEFF PUBLICITY
ORGANISATION, LTD.,
1-5, Pall Mall, London,
S.W.1.

Tel.—Regent 2440.

MODERN WIRELESS

Radio Press Ltd

PUBLISHERS OF WIRELESS WEEKLY

DEVEREUX COURT.

• STRAND, W.C.2 •

1st.—Central 376

All correspondence relating to contributions is to be addressed to the Editor of "Modern Wireless."

Nothing contained herein is to be regarded as permission or encouragement to infringe any patent rights.

A Handsome Cabinet Set.

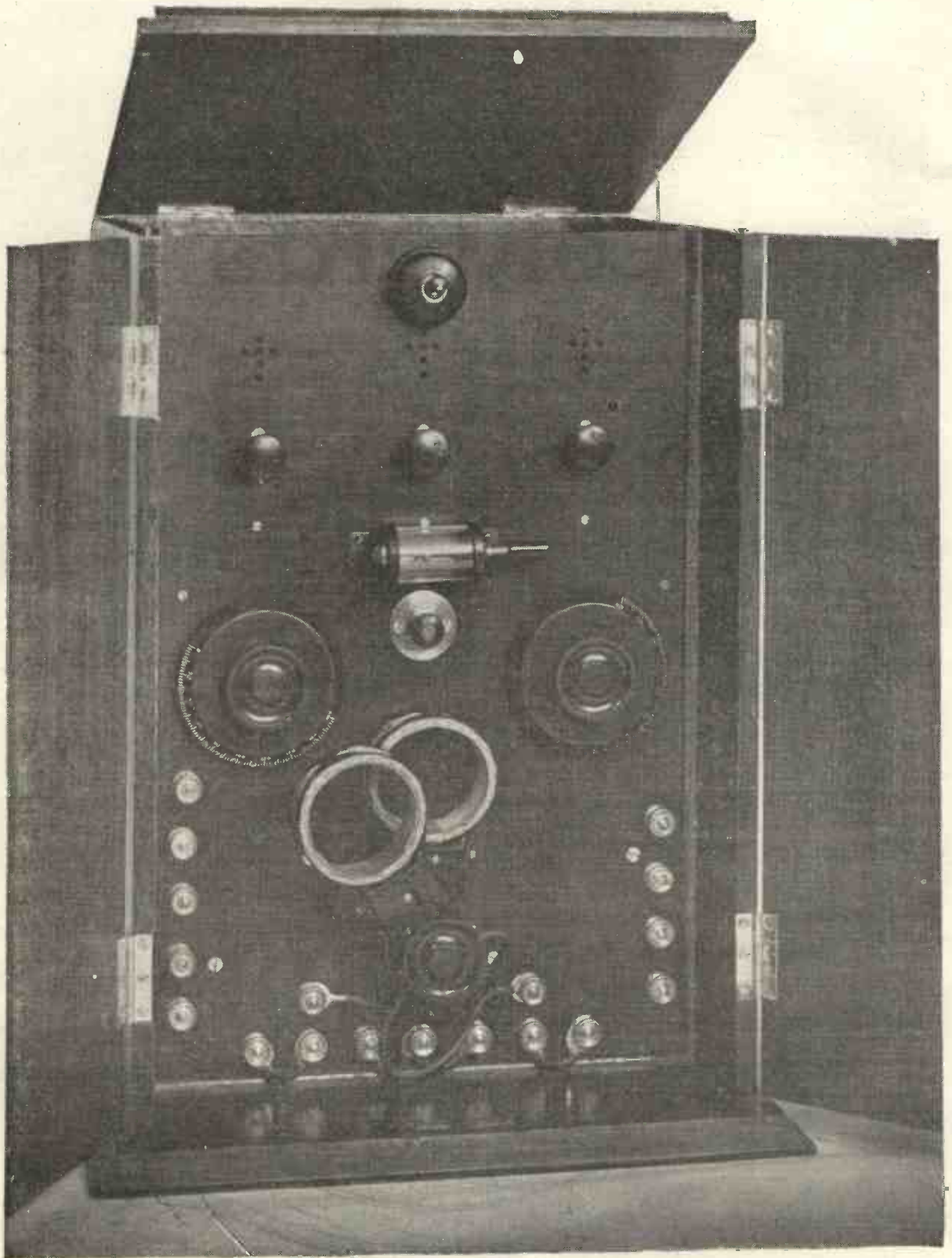

Full particulars of how to make this three-valve receiver are given on pages 415 et seq.



Editorial

THERE is no need to tell our readers that this is a special double number; the fact is apparent on the first glance at the magazine. We trust, however, that not only quantity but quality will be found in this issue, for no pains have been spared to make it by far the best we have produced.

In our endeavours to provide the finest possible radio magazine we shall be greatly helped in future by the magnificent response to our invitation to send in criticisms on the forms provided with last month's MODERN WIRELESS. So far we have only been able to analyse a portion of the huge response to this request, and it will be some time before we are able to complete our study of them. Meanwhile, we wish to tender our heartiest thanks for the kind expressions of confidence, and, not the least welcome, criticism.

This month we present for the first time a feature which is perhaps one of the most important innovations in the history of wireless journalism. We refer to the series of full-page photographs depicting the construction of a receiver. With these large and detailed photographs before him the home constructor is almost in the position of a man who is able to borrow the actual instrument, for every angle is shown and the minutest detail of construction becomes clearly visible. This feature, together with the improvement in the quality of the paper on which the magazine is printed, will still further facilitate the home building of good, sound and well-designed sets.

One-, two- and three-valve sets have frequently been described in our pages, so that the reader who keeps his copies has only to look back through issues of the last twelve months to find a wide variety of choice. In this issue we present by way of a change a constructional article dealing with the building of a ten-valve super heterodyne receiver. Whilst comparatively few home constructors will feel inclined to venture upon such an

undertaking, we feel sure that a very large number will be interested in the practical description of a receiver on which the author is able to receive American amateurs and broadcasting—even the 100-metre wave from KDKA (Pittsburg) using a comparatively small frame aerial. The Armstrong super heterodyne is perhaps the most efficient of all short wave receivers, and contrary to the common belief is relatively simple to handle. Mr. Kenneth Alford, the designer and builder of this set, is well known among the amateur transmitters, his station 2 DX being frequently heard after broadcasting hours.

Another feature which we think will have a wider field is the comprehensive article on the Reinartz circuit with full constructional details for a building of a three-valve Reinartz receiver. The reader who is interested in dual amplification circuits will find in this number welcome information including practical details for the building of two different sets, together with the beginning of a comprehensive survey of the whole field of dual amplification. At the other end of the scale the crystal user is well catered for with two sets of different design, each incorporating simple and well-tried methods of tuning.

We would like to draw the attention of new readers to the section "Tested by Ourselves," which, we are glad to see from the answers to our questions, is widely appreciated by our readers. This section is made up of reports on apparatus submitted to us by the manufacturers. Each piece of apparatus is carefully tested without any regard to the manufacturers' claims, so that whether the article examined is a simple crystal holder or an elaborate multi-valve set the reports can be relied upon as perfectly independent testimony. Apparatus can be submitted to this section of the magazine by any manufacturer whether he advertises in our columns or not and the reports are published without fear or favour.



A Totally Enclosed Cabinet Receiver

By HERBERT K. SIMPSON

This receiver is designed especially for those readers who desire to possess an instrument which is quite dustproof.

THE following description of a handsome three-valve set should be of interest to those who like to have a compact yet attractive-looking set, but who at the same time like to have some latitude for experiment.

In this set provision is made for two note magnifiers, which may be used after a rectifying valve or after a H.F. valve with crystal rectification. Thus the set will give good loud-speaker results from a local broadcasting station, while the more distant stations may be brought in by using a high-frequency amplifier, crystal, and the two low-frequency valves.

A view of the finished set with the doors and lid open is given in the frontispiece, and it is seen that the panel is mounted vertically in the cabinet. Looking at the top of the panel, a switch is seen which controls the filaments; immediately beneath this are seen three sets of holes, which permit the valves to be seen, and the degree of brilliance may be judged. Next we see the three filament resistance knobs, crystal detector, variable grid leak, aerial tuning and anode condensers, and the two-coil holder. The terminals on the left, from the top, are aerial, LT+, LT- and grid bias +, grid bias -, and earth. On the right we have HT+, HT-, and telephone terminals. The reaction leads may be reversed by means of the flexible leads, terminating in spade terminals, which are connected to the two terminals close to the coil-holder. The terminals in the bottom row, numbered 1 to 7, are for the purpose of changing the circuits, and are linked up by rubber-covered flex, the ends of which may be soldered to spade terminals.

Figs. 3 and 4 show the back of the panel, and it will be seen that the valves are mounted on a shelf above the condensers. This shelf may conveniently be of wood, with a hole cut in it to receive the ebonite strip upon which the valve holders

are mounted. This shelf is fastened to the ebonite panel by wood screws, and thus the necessity for drilling and tapping ebonite, which would be essential if the shelf were of ebonite, is obviated.



Fig. 1.—When the doors are closed everything is concealed.

Above the shelf are the three filament resistances, which are of a very efficient type made by T. C. Ball. These are obtainable in a suitable form for either bright or dull emitter valves, and care should

be taken to purchase the correct type for the valves to be used. The type designed for dull emitters may be used for ordinary valves, but as they would have to be set to the position of maximum current, no adjustment would be available.

Between the detector (whether valve or crystal) and the first note magnifier is a Pye No. 1 transformer, while the second transformer is a Silvertown. The circuit diagram is shown in Fig. 2, and it will be seen that by disconnecting all the terminals 1 to 7, and joining (4-7), we obtain a valve rectifier, with reaction, and two stages of note magnification, while the circuit using one high-frequency valve, crystal rectification, and two note magnifiers is obtained by joining terminals (1-2), (3, 4, 5) (6-7).

The ebonite panel measures 14 7/8 in. x 10 in. x 1/4 in., and should have the surface, or "skin," removed by rubbing with fine emery-cloth. The holes for terminals may be drilled, and the positions of the condensers, transformers, crystal detector, etc., marked. The positions of these components are seen in Fig. 5, which is to scale. The shelf should now be placed in position, and the supports fixed to the panel with wood screws, so as

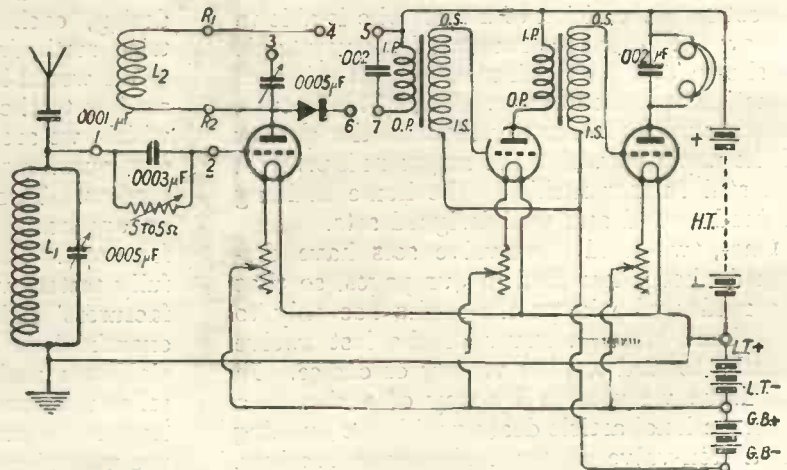

Fig. 2.—The theoretical diagram of the receiver.

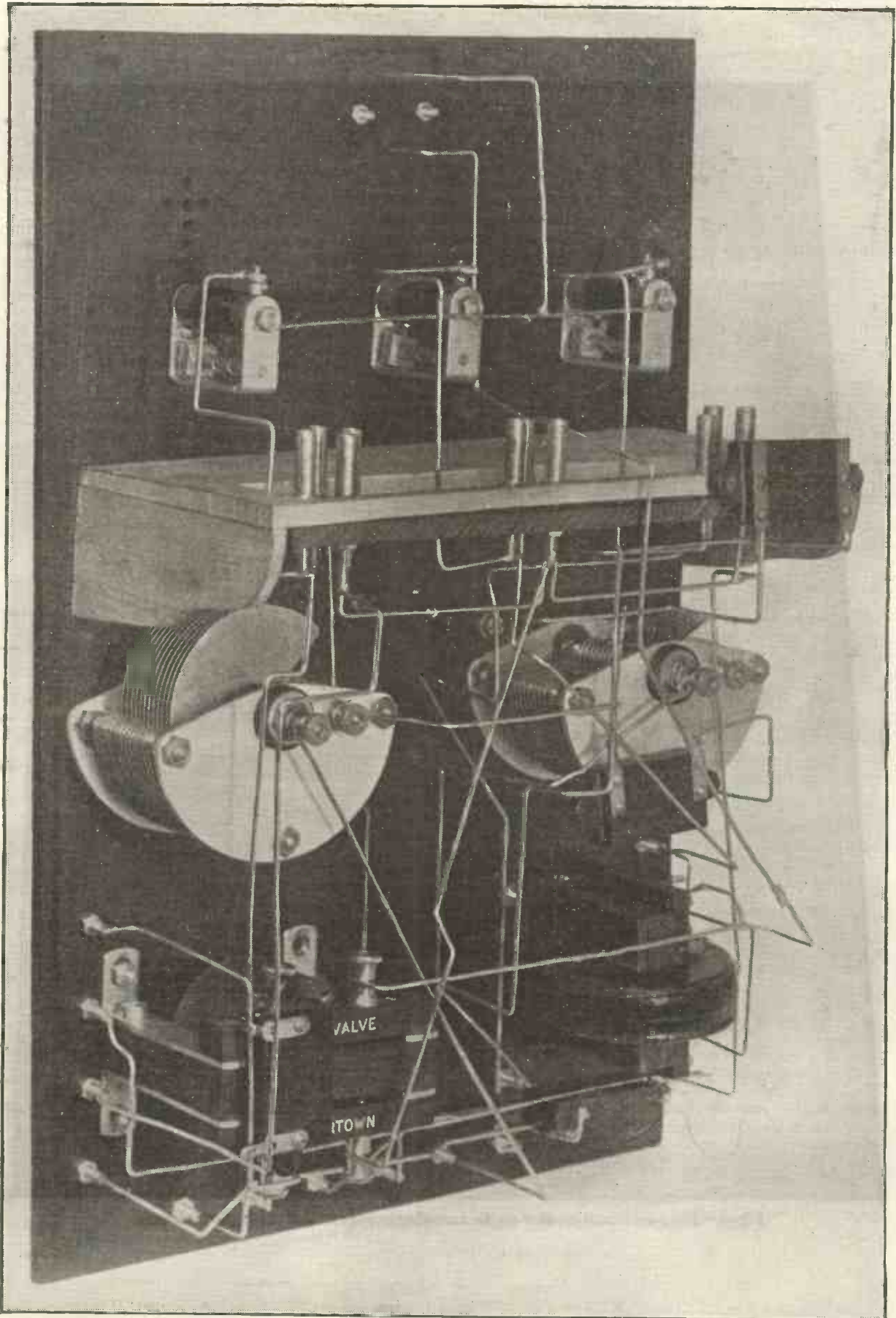

Fig. 3.—The disposition of the valve shelf, condensers, transformers, etc., will be gathered from this photograph.

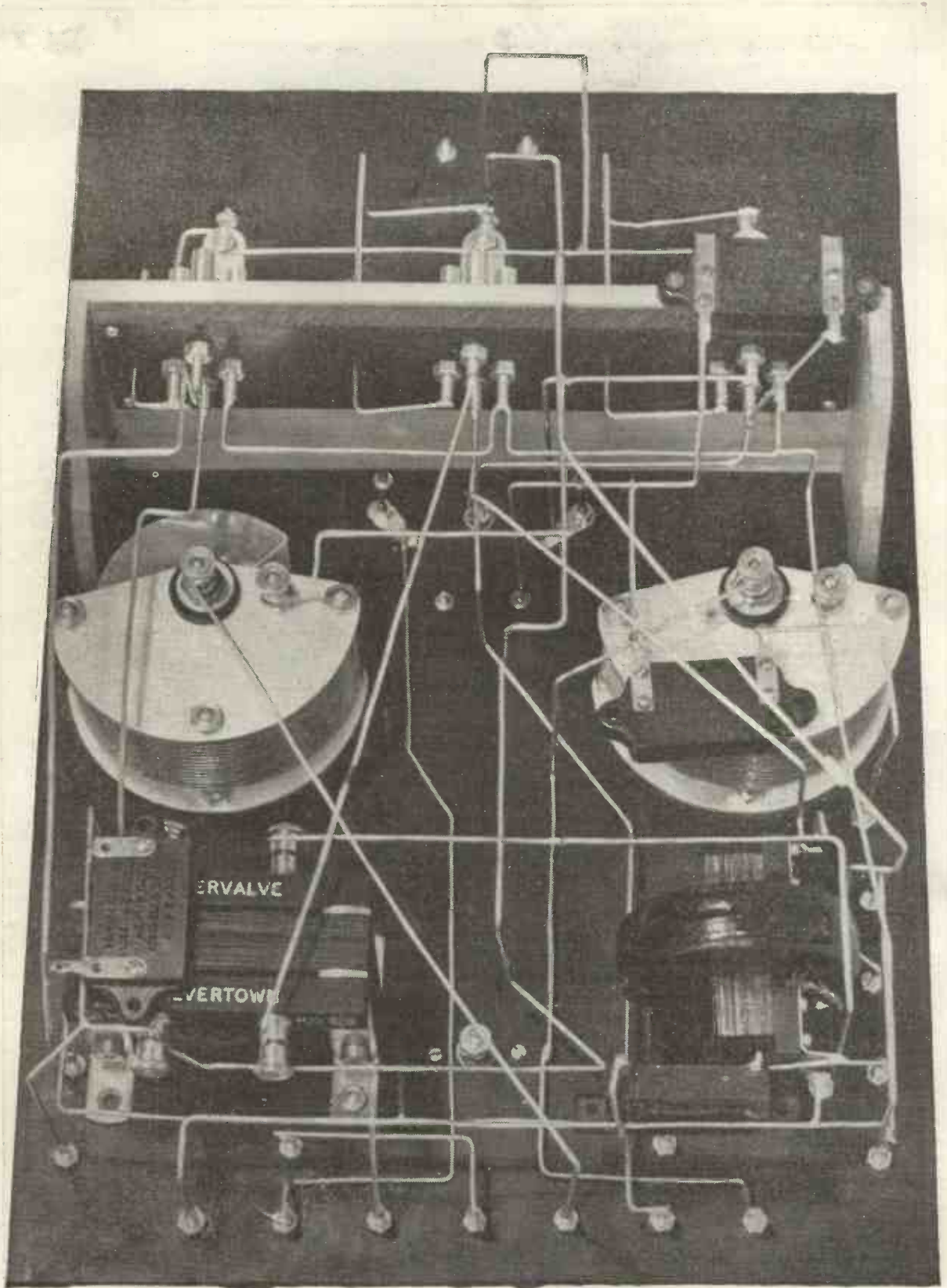

Fig. 4.—The panel from another angle, revealing connections of the lower terminals.

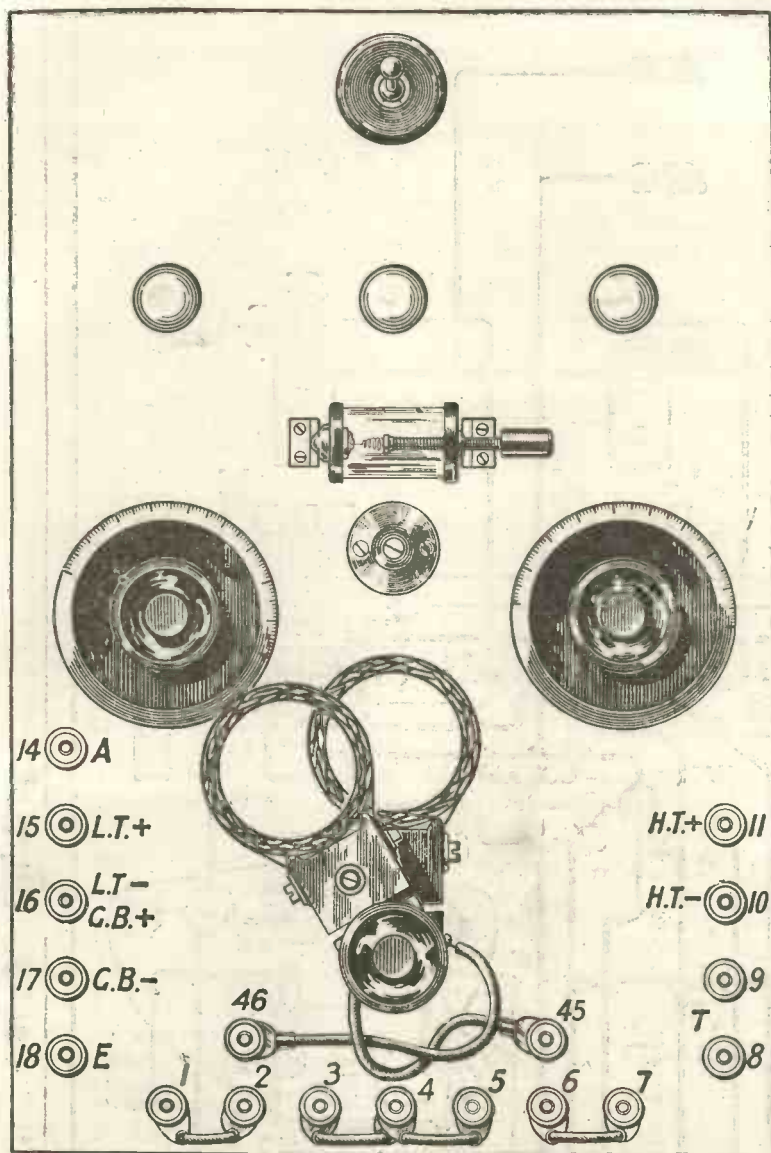

Fig. 5.—A scale drawing of the front of the panel

to clear the moving vanes of the condensers in all positions of the latter. The Watmel variable grid leak is mounted below the shelf, in between the condensers.

The shelf itself measures $8\frac{1}{2}$ in. \times $3\frac{3}{8}$ in. \times $\frac{1}{4}$ in., and has a hole $5\frac{1}{4}$ in. \times $1\frac{1}{2}$ in. cut in it for the ebonite strip which carries the valve legs. This ebonite strip measures $8\frac{1}{2}$ in. \times $1\frac{1}{2}$ in. \times $\frac{1}{4}$ in., and, after the holes for the valve legs are drilled, is fastened to the wooden shelf by means of wood-screws, the shelf being then secured in the same manner to the supports.

The coil-holder is made from a piece of 2 B.A. screwed rod, two flat coil plugs, and an ebonite knob. A piece of $\frac{1}{4}$ in. wood, the same size as the coil plug, is screwed to the ebonite panel, and a hole drilled through wood and panel for

the 2 B.A. rod. The two coil plugs now have the same size hole drilled through their centres. The piece of 2 B.A. rod is passed through the panel and secured on the under side by a spring washer and two lock-nuts. One of the coil plugs has two small holes drilled in it, by means of which it is secured with two wood-screws to the block of wood previously secured to the panel. Distance pieces are now put on the spindle, and these may conveniently consist of two or three brass condenser bushes, such as are sold by most dealers who supply parts for building variable condensers. The second coil plug is now put on the spindle, and finally a 2 B.A. screwed ebonite knob is fitted, so that by turning the knob the top coil plug is rotated. The length of rod projecting through

the top plug is adjusted so that the knob may be screwed hard on to the top plug. A small hole is drilled at each side of the fixed plug for the connecting wires, those from the moving coil being flexible and going to the two terminals provided. The construction of the coil holder is shown in the sectional view, Fig. 6. The plug nearest the panel is for the A.T.I., while the moving one holds the anode tuning coil L_2 . The filament switch may now be mounted at the top of the panel, and wiring commenced. No. 16 tinned-copper wire may be used, or if preferred square section tinned-copper may be employed. The latter gives a very neat appearance, but requires considerable care in bending to the exact size to fit between terminals.

A number is given to each terminal, also to every point to which connection has to be made, so that the wiring is much simplified. Fig. 7 shows the back of the panel, from which the wiring can be followed.

List of Parts, Numbered

- Circuit changing terminals (bottom row) 1 to 7 (right to left).
- Telephone terminals 8, 9.
- H.T.— 10.
- H.T.+ 11.
- Tel. condenser (.002) 12, 13.
- Aerial 14.
- L.T.+ 15.
- L.T.—, G.B.+ 16.
- G.B.— 17.
- Earth 18.
- Fixed aerial condenser (.0001) 19-20.
- A.T.C. 21-22.
- V_1 G. 23, P. 24, Filaments 25-26.
- V_2 G. 27, P. 28, Filaments 29, 30.
- V_3 G. 31, P. 32, Filaments 33-34.
- First transformer (Pye) I.P. 35, O.P. 36, I.S. 37, O.S. 38.
- Second transformer (Silvertown) I.P. 39, O.P. 40, I.S. 41, O.S. 42.
- A.T.I. 43-44.
- Anode tuning coil 45-46.

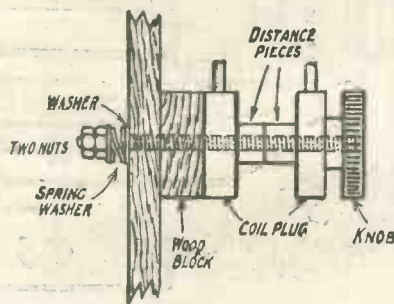

Fig. 6. Constructional details of the two-coil holder

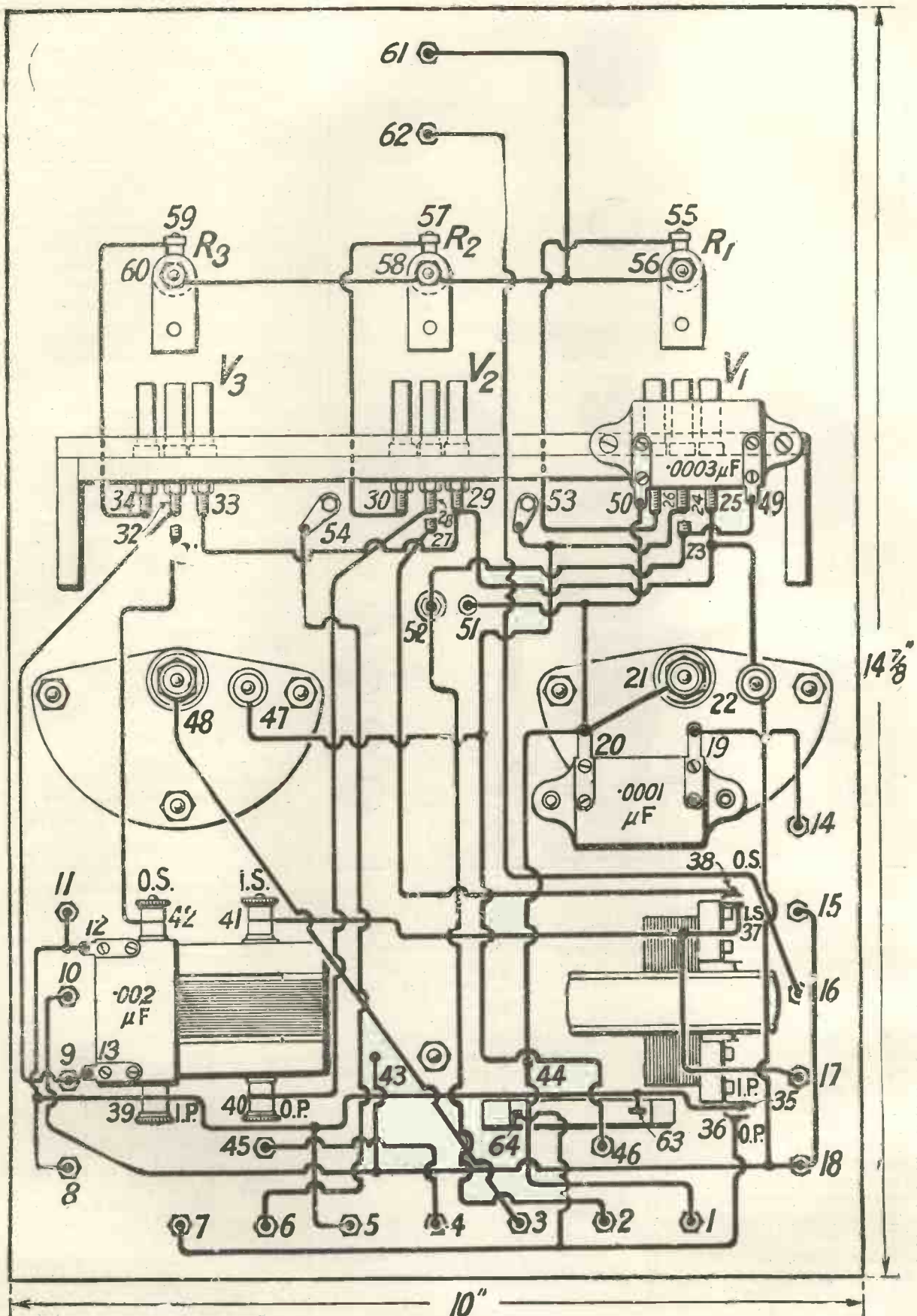

Fig. 7.—A diagram from which the actual wiring can be carried out

- Anode tuning condenser 47-48.
- Grid condenser (.0003) 49-50.
- Variable grid leak 51-52.
- Crystal detector 53-54.
- Filament resistances R_1 55-56.
 R_2 57-58.
 R_3 59-60.
- Filament switch 61-62.
- Transformer condenser 63-64.

The numbered points to be joined are enclosed in brackets:— (1-44-20-21-51-50), (2-52-23-49), (3-48), (4-45), (5-39-8-11-12-63-35), (6-54), (7-64-36), (9-13-32), (10-43-18-15-22-25-29-33), (14-19), (16-62), (17-37-41), (24-53-47-46), (26-55), (27-38), (28-40), (30-57), (31-42), (34-59), (56, 58, 60, 61).

The cabinet is seen in the photograph (Fig. 1), while full dimensions are given in Fig. 8.

The following pieces of wood will be required:—

- 1 Top .. $10\frac{1}{4}$ in. \times $10\frac{1}{8}$ in. \times $\frac{5}{8}$ in.
- 1 Base .. 12 in. \times $11\frac{1}{8}$ in. \times $\frac{3}{8}$ in.
- 2 Sides .. $14\frac{7}{8}$ in. \times $9\frac{5}{8}$ in. \times $\frac{3}{8}$ in.
- 1 Back .. $14\frac{7}{8}$ in. \times 10 in. \times $\frac{3}{8}$ in.
- 2 Doors .. $14\frac{7}{8}$ in. \times $5\frac{3}{8}$ in. \times $\frac{3}{8}$ in.

These should be planed up smooth, finishing with fine sandpaper, then stained and polished. The top and base may be shaped as shown before polishing.

Inside the cabinet, at a distance of $2\frac{1}{2}$ in. from the front, are fastened two strips of wood on each side, $\frac{1}{4}$ in. apart, between which the ebonite panel is held.

Each door is secured to the cabinet by means of two brass hinges, as is also the lid. For fastening the doors small bolts may be used, or "ball and socket" fasteners, in which the ball is fixed to the underside of the door, and is depressed as the latter is swung to, until it becomes lodged in the socket screwed to the base of the cabinet. A small lacquered brass handle is secured to one of the doors to facilitate opening the latter, and a strip of beading may be fastened to one to conceal the division between them. If desired, holes may be drilled in the sides of the cabinet for battery leads, etc., to pass through to the two vertical rows of terminals.

Care must be taken that the two coils are kept apart, or interference may be caused by oscillation to other listeners-in.

As will be seen from the circuit diagram, the constant aerial tuning system has been adopted, making the tuning of the set extremely simple.

It is necessary to see that the row of terminals along the bottom of the panel are correctly joined for the circuit in use, and also that the terminal (L.T.— G.B. +) is joined to the terminal G.B. — if no grid bias battery is employed.

If no reaction effect is noticed on bringing the two coils together the flexible leads should be reversed, as if the coil is connected the wrong way round it will tend to reduce the strength of signals.

Results.

The set will give excellent loud-speaker results from either circuit up to about 30 miles from a broadcasting station, while good phone signals are obtainable from the circuit using a high-frequency valve on distant stations.

The "All-Concert" Set

To the Editor of MODERN WIRELESS

SIR,—I feel I must tell you how pleased I am with your "All Concert" set. I made it with a few alterations of my own which were more convenient to me; for instance, I put the fourth valve all in the same cabinet, instead of in a panel by itself. I have a D.P.D.T. switch, to cut it (the last valve) in or out, reversed the positions of aerial and earth, L.T. and H.T. (in my case it suits me better this way) and I have brought the 'phone terminals all along the front of the cabinet $\frac{1}{2}$ doz. pairs all in parallel.

It is tip top, and with the four valves, works a loud speaker beautifully. The only fault is that I cannot hear London when Cardiff is going, the latter refuses to be cut out; however, a variometer in place of A.T.I. and condenser may cure it, I shall try it.

Yours truly,
V. TUGWELL.

Trelawney House,
Kilkhampton,
Cornwall.

EDITOR'S NOTE.—We do not agree that a variometer would increase the selectivity. A wave trap would be best.

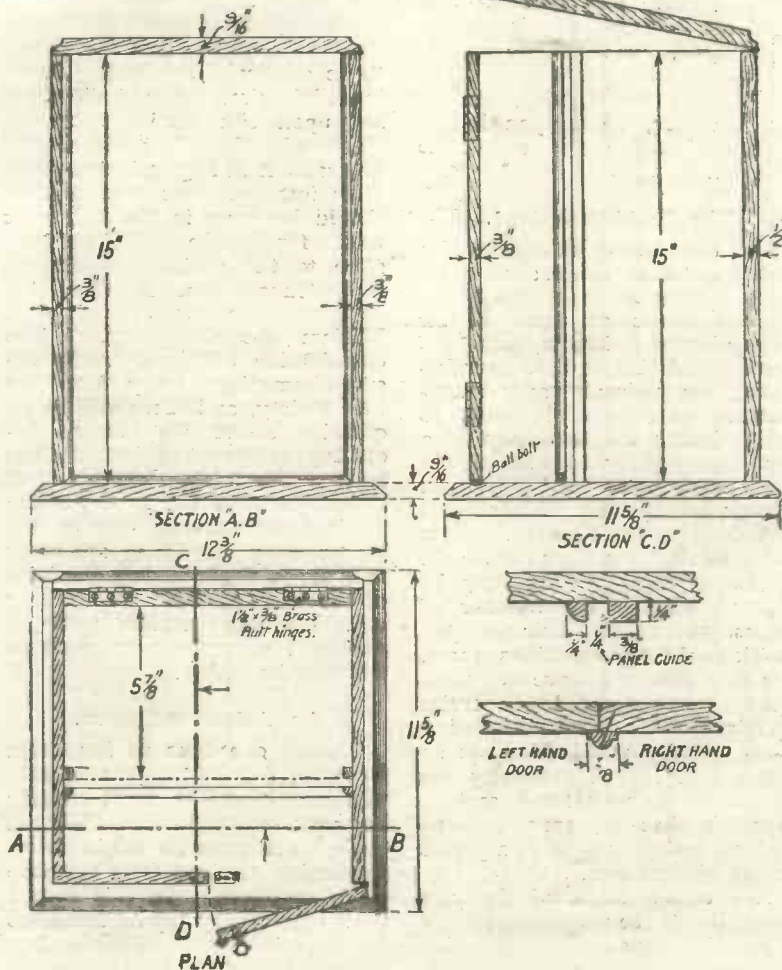
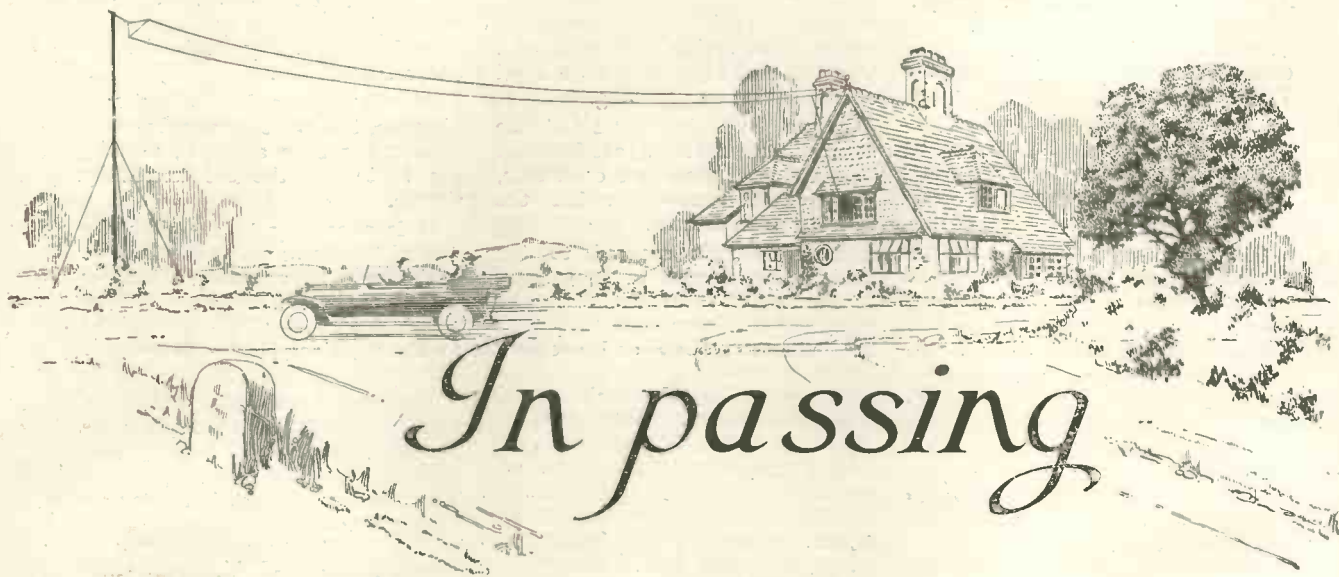

Fig. 8.—Practical details of the cabinet



For Millionaires.

SOMETHING, I have always felt, is lacking in the long list of wireless circuits and wireless sets that have so far made their appearance. We have designed sets for the young, sets for the old folk, sets for my lady's boudoir, sets for the flat, sets for the country house, sets for the beginner and sets that would finish anyone. Our manufacturers, keenly alive to the needs of the moment, have placed upon the market midget sets in match-boxes, giant sets in grand pianos, and medium sets in almost anything you like. But so far, even in our wireless dreams, we have considered the needs only of those of more or less moderate means. No attention has been paid to the requirements of the plutocracy, amongst whom we may number such worthy citizens as the profiteer, the idle rich and the Poplar dustmen. It is quite impossible for these people to do themselves justice in the matter of wireless, for though you have your set mounted in a Chinese lacquer cabinet and fitted with solid gold terminals you can hardly spend more than a paltry thousand upon it.

And even this will not give the plutocrat a set that is really worthy of his position. What he wants is valves, valves and yet more valves, for, no matter how imposing its outer shell may be, no set is really impressive if it contains but four or five glowing bulbs. Hitherto the difficulty of adding to their number has been well-nigh insuperable owing to the nasty little habits inherent in high-frequency

amplifiers, which seem to take as their motto "Two's company, three's a crowd." So much do they resent the presence of a third that a pair which has previously been perfectly well behaved will, upon the increase in their number being made, give the worst possible exhibition of tantrums. They will squeak, scream, howl, oscillate and back-fire, telling you in the plainest of language to remove the offender.

The Problem Solved.

For this reason it has so far been impossible to produce a set really worthy of such stately old English homes as those of Sir Blennerhasset Bluffingham (*né* Aaron Goldsücher) or Lord Bounderstreet, the eminent paper manufacturer who won his spurs so nobly during the cataclysm of a few years ago by introducing the Daily Quintuplicate Nil Return System for all units. Their needs cry aloud to the heavens. It is essential that some means should be found whereby they may be able to employ the number of valves to which their exalted position obviously entitles them. For this reason I have for some months past devoted my entire energies to the production of a really worthy multi-valve set so stable that it will positively eat out of its owner's hand and so imposing that it cannot fail to win him instant repute as a prince among wireless men.

The whole secret of the new circuit lies in the wonderful system of paradio-frequency valves which give such perfect control of the set, though there is no limit to

the number which may be used before the rectifier. In the diagram a mere quintet of paradio-frequency valves (V1 to V5) is shown. This is simply because the pages of MODERN WIRELESS are limited in size and the Editor flatly refused to allow the circuit to be continued overleaf. Drawings of the circuit in gold, silver and red upon silk scrolls measuring six feet by three feet will shortly be available at fifty guineas apiece. It is intended that one of these should be hung in the hall next to the family tree and, if possible, close to the portrait (obtainable in Tottenham Court Road) of that ancestor who came over with William the Conqueror. The combination will undoubtedly ensure immediate entry into the best society, and there will be no question about the owner's becoming permanent chairman of the local wireless club. The set itself should be mounted in a genuine Louis Seize cabinet, one of the marquetry panels being cut away in order to accommodate the horn of the loud-speaker. In this way even the most useless piece of antique furniture can be made to work for its living.

An Acknowledgment.

Though one likes to lay claim for originality for even the simplest wireless circuit, it must usually be admitted that the child of one's brain owes its origin to an inspiration received from someone else's products. In this case I must acknowledge my indebtedness to Captain B. B. Chuckersley, the gifted designer of the seventeen-valve set which was recently used

by him with such marked success for the reception of Transatlantic atmospherics. But for his fine example I might well have lost heart when, after countless experiments, light refused to dawn. But as it is, my unremitting labours have produced a set containing even more valves, and capable of receiving still more ear-splitting atmospherics, especially if the Silent Perfecto high-tension battery made by Messrs. Crackle and Fizz is fitted. The valves should preferably be of the most expensive type of dull emitter, and it is well to have the receipt for them framed and hung upon the wall in close proximity to the cabinet itself.

matter what may be their number or what voltage is delivered by the high-tension battery. Another feature is to be found in the free-action coil L 3, which, though of the largest size and tuned by the variable condenser C 3, is yet guaranteed to be incapable of causing the set to energise even the closest of neighbouring aerials. As will be seen the coupling used between the paradio-frequency valves is an ingenious modification of the well-known tuned anode method; the variable condensers C 5 to C 8 are placed in series with the inductances L 5 to L 8 instead of in parallel in the old-fashioned way. It is surprising that this simple transposition should not

its full impression upon the audience, especially if their eyes are as wide open as their ears. The owner should begin by cutting out one note magnifier and substituting a pair of telephones for the loud-speaker. Having tuned in 2 LO to perfection by means of the condensers C 1 and C 2 and the variable coupling between the inductances L 1 and L 2, he should then detune the circuit L 2, C 2, and decrease the coupling between L 1 and L 2 until signals are but faintly audible. This having been done the loud-speaker may be brought into action once more, and the second note magnifier re-connected. The right hand should now flutter lightly over the knob of

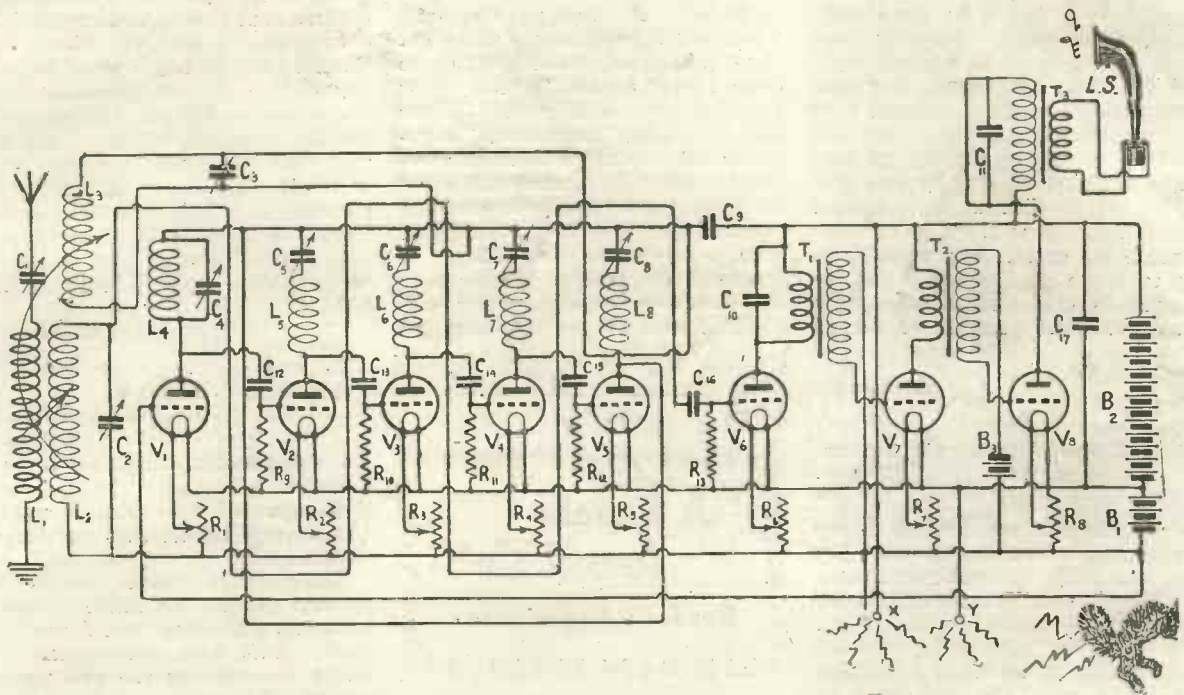

The Millionaire's Own. The Corona Curondel Paradio Frequency Circuit.

The Circuit.

A glance at the diagram will serve to show the beautiful simplicity of the circuit which I have named the Corona Curondel. It is claimed that no existing circuit diagram rises to such heights as R 13, L 8 and C 17, and it is doubtful if any set so far produced can show such an imposing array of knobs, handles and other accessories essential for the proper overawing of visitors. The secret of the ease with which it can be handled is to be found in the presence of the paralysing condenser C 9 which effectually stops any nonsense on the part of the paradio-frequency amplifiers, no

have occurred to the fertile brain of any other inventor, for it has the most extraordinary soothing effect upon even the wildest high-frequency valves.

Methods of Operation.

The set is not intended for long range work, quality of reception and stateliness of design having been aimed at rather than the power to bring in "mushy" noises from great distances. It is at its best when used in a London drawing-room for the reception of 2 LO. Its operation, though delightfully simple, requires to be carried out with a little care, as otherwise the set may fail to make

the condenser C 3 and those of the condensers C 5, C 6, C 7 and C 8. As these are adjusted individually the left hand should make slight variations in the setting of the condenser C 2 or the coupling between L 1 and L 2; but the greatest care should be taken not to bring signals up to their full strength until every knob has received at least one twiddle backwards and forwards.

On no account should one's friends ever be allowed to work the set. Such a calamity can always be avoided by the explanation that the circuit is of the most delicate nature and that if it were allowed even for one

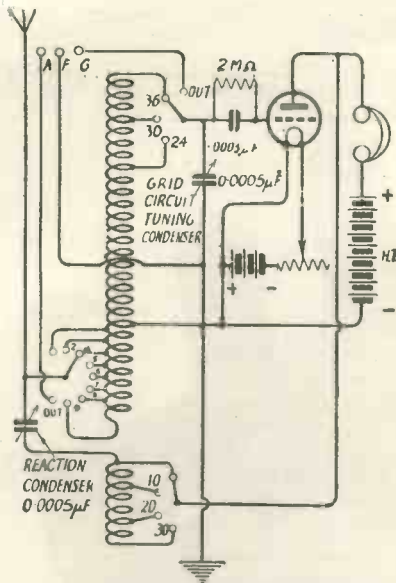

Fig. 1.—The author's first Reinartz Receiver.

IN June 1921, the American Magazine, "QST" published a short article from the pen of John L. Reinartz, of Connecticut, describing a new tuner he had invented. This proved very simple to handle when receiving continuous waves on the short wavelengths around 200 metres. In March 1922, a further article from the pen of the same author showed a number of improvements in the circuit, together with sufficient constructional details to enable the average experimenter to build a set. I was greatly taken by the idea and immediately built one, modifying the design somewhat, for whereas the Reinartz used a basket coil, in my model I worked out the number of turns and general disposition of parts so that the conventional cylindrical inductance could be used. A description of my receiver was published in this country in May of that year, and a number of experimenters built it up and reported favourably upon it. The Reinartz circuit used in my first article is given in Fig. 1. Several peculiarities in the circuit will be noticed. First of all it will be seen that the aerial coil is simply part of one coil which serves for both grid and aerial circuits. Actually the aerial coil has very few turns on it and is practically aperiodic. In this circuit there are tappings for each turn of an aerial coil up to 10. The grid circuit is tapped at 24, 30 and 36 turns (the former used was about $3\frac{1}{2}$ in. in diameter.)

A variable condenser of .0005 μ F was shunted across the grid coil. The usual gridleak and con-

The Reinartz Circuit and Some Modifications

By PERCY W. HARRIS, Assistant Editor.

The Reinartz Circuit, which is characterised by great simplicity of manipulation, has not yet received the attention it deserves in this country. Mr. Harris is a recognised authority on the Reinartz Circuit and was the first to introduce it into England. In this article he not only explains recent modifications of the original circuit, but also gives practical details of how a simple and efficient three-valve Reinartz receiver may be built up.

denser was used, and it will be noticed that the positive low-tension is earthed. The telephones are connected between the plate and the high-tension battery in the normal fashion, and on the same former as the grid and aerial coil, but separated from it electrically

is another coil of 30 turns, the turns being wound in the same direction as the grid and aerial coil. This coil was connected between the plate and a variable condenser of .0005 μ F, which in turn was connected to the aerial. Three additional terminals were provided marked respectively A, F and G. These were to enable an external loading coil to be added when it was desired to tune the set for longer wavelengths. By placing the aerial switch on "out" and the grid switch on "out" and by connecting an external coil to the terminals marked A, F and G, (the coil being so arranged that about a third of it was between A and F and two thirds between F and G,) the circuit became as Fig. 2. Without the loading coil the wavelength range of this set was up to about 400 metres, and of course the wavelength with external coils depended upon the size of these coils. I tried the set quite effectively up to 2,600 metres in this way.

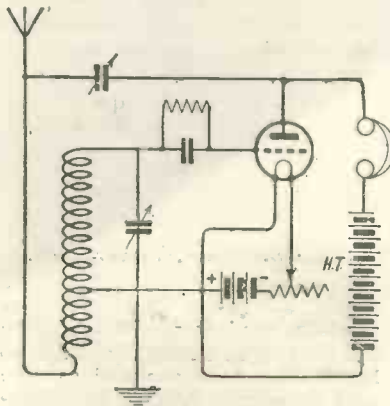
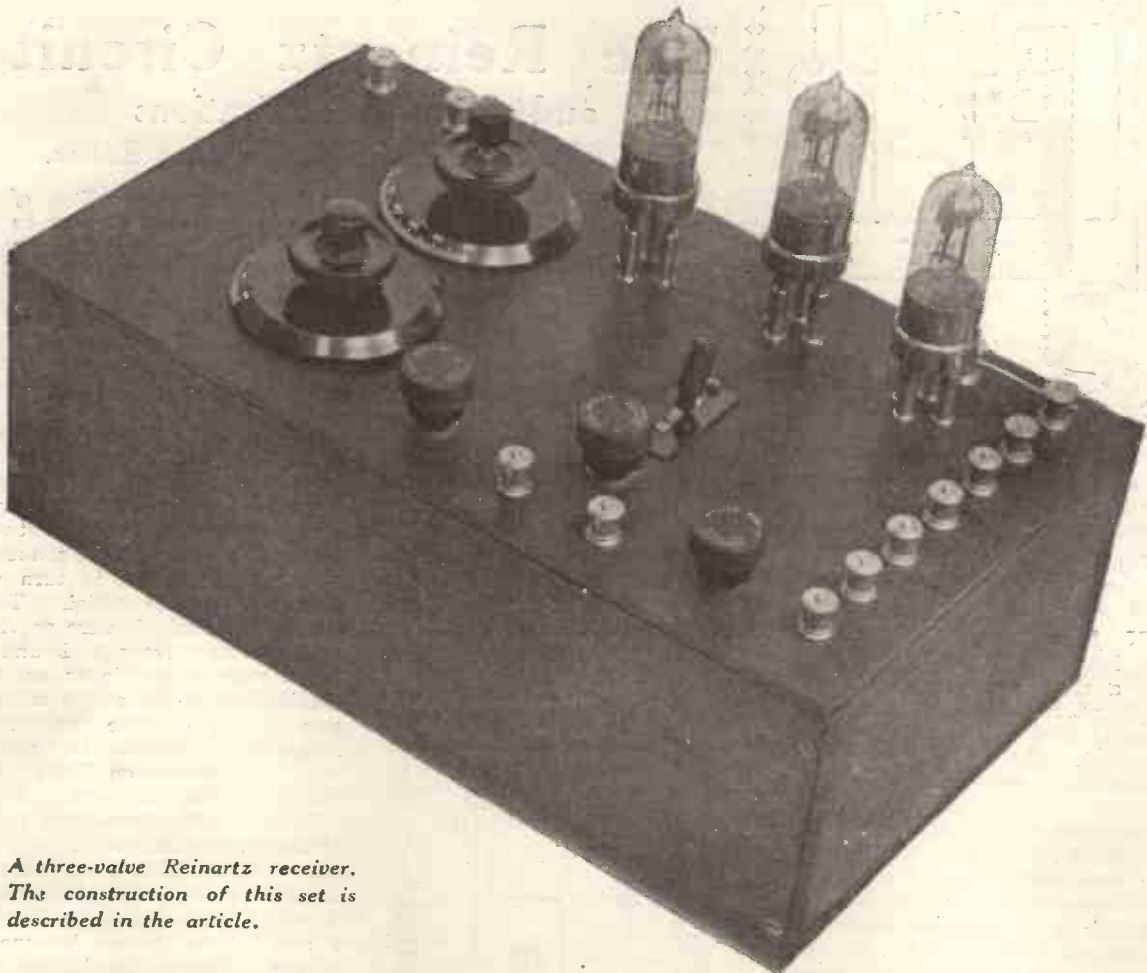

Fig. 2.—The Fig. 1 receiver when used with external coils.



John L. Reinartz himself with one of his tuners.



A three-valve Reinartz receiver. The construction of this set is described in the article.

A point of great interest in the Reinartz receiver is the method of obtaining reaction. The reaction effect is a combination of inductive and capacitive coupling and is controlled in the original design by setting the switch on the reaction coil and by varying the

reaction condenser. In operation the set proved extremely simple to handle, for once one had set the grid tapping switch at the wavelength range required, and the reaction switch at about the right position, the sole controls were the tuning by means of the grid con-

denser and the reaction by means of the reaction condenser. The aerial switch was generally set once and for all to suit the particular aerial. The reaction control had a special charm, for the building up of oscillations was so gradual that one could adjust the set to be on the brink of oscillation so delicately that a strong signal would send the set into oscillation which would immediately stop on cessation of the signal. Such an adjustment is very difficult with the ordinary form of reaction. Furthermore, when using the set for C. W. autodyne reception, the adjustment of the beat note was extremely simple. It was a comparatively simple matter to pick up a C. W. station on 200 metres or even lower, and stop on the particular heterodyne note one desired without any difficulty whatever.

In this form the Reinartz receiver was particularly efficient for C. W. reception, but unfortunately suffered in sensitivity on damped signals, such as spark and telephony. As a general rule it could be stated that a Reinartz so made was only about two-thirds as sensitive as a

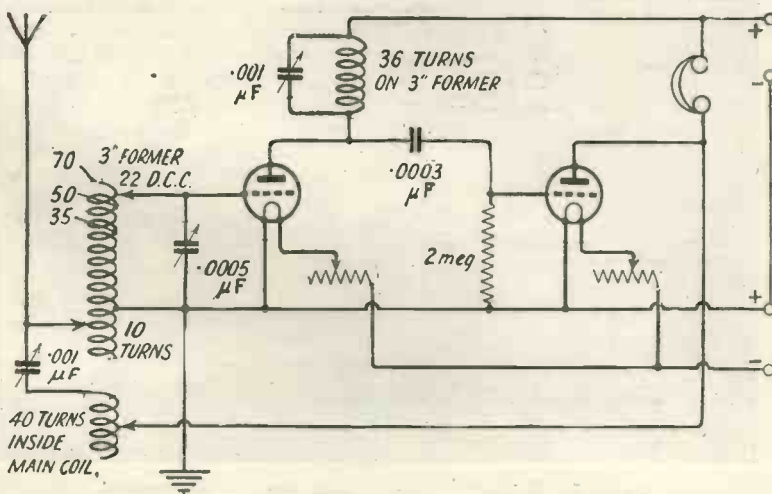

Fig. 3.—Mr. G. G. Blake's modification of the Reinartz circuit, using a high-frequency stage.

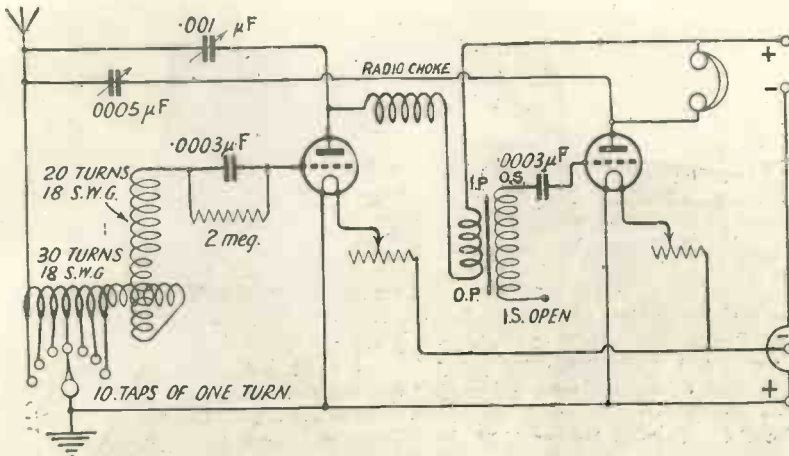

Fig. 4.—Reinartz's own modification, incorporating low-frequency reaction.

single valve used with the ordinary reaction circuit. Against this however, must be set the simplicity of handling and the very fine control of reaction. A month or two later Mr. G. G. Blake published a modification of the circuit incorporating one stage of high frequency in front of the valve.

Mr. Blake's circuit is given in Fig. 3. It will be seen that this is simply a tuned anode high-frequency coupling with the reaction taken from the second plate. Mr. Blake wound the plate inductance as a coil, which could slide in and out of the grid coil using 40 turns for it. I have tested out this circuit very thoroughly and could not obtain very satisfactory results with Mr. Blake's make-up, but on winding the 40 turns as two layers of 20 on the same former as the other coil, and increasing the aerial turns to 20 and not 10, and, furthermore, by making a different number of turns in the anode circuit with a smaller condenser, satisfactory high-frequency amplification was obtained. The receiver

embodying this circuit is published in my book "Twelve Tested Wireless Sets."

Before long a number of experimenters found that as the aerial coil adjustment was usually fixed after a very little experiment, and as, furthermore, one variable condenser on the inductance without tapings would cover the broadcast wavelengths quite comfortably, and as it was very seldom that one varied the plate inductance, it was possible to dispense with grid plate and aerial tapings. In passing, it should be mentioned that the usual shunting condenser across the telephones or primary of the transformer must not be included in a Reinartz receiver, as the telephones or transformer must act as a radio-frequency choke, or the high-frequency energy will take the wrong path.

The next step forward was the discovery that if fairly thick wire was used (No. 22 gauge or larger), the plate coil could be abandoned, provided the number of turns in

the other coils were suitably adjusted. On longer waves than broadcasting it had previously been found that the plate coil could be dispensed with, for if you examine the figure 2 you will see that exterior coil connections are so made that no plate coil is included. It was sometimes found an advantage to wind the grid inductance in bank formation, better signals being obtained in this way. Then Reinartz himself published the modification shown in Fig. 4, wherein the grid tuning was effected by a variometer which was tapped at one end in the manner shown. It will be noticed that No. 18 S.W.G. wire was used. Not content with using radio-frequency reaction, Reinartz also used audio-frequency reaction from the plate of the audio-frequency valve to the aerial. It will be noticed here that the lower end of the secondary of the intervalve transformer was left open and a blocking condenser inserted between the OS. terminal and the grid. I have tried this arrangement and obtained low-frequency reaction results, but the effect does not seem to be very reliable and, of course, differs with different transformers. It will be noticed that a radio-frequency choke is included in this case, and can always be included with advantage when the intervalve transformer used has a high self capacity in its windings. The choke can quite well consist of a 200 turns multi-layer coil of any of the good makes.

All of the Reinartz sets so far described (with the exception of that with a high-frequency stage in front of it) suffer somewhat in comparison with the ordinary straight circuits when sensitivity in the reception of damp signals is sought. Another big step forward was taken when Dr. E. H.

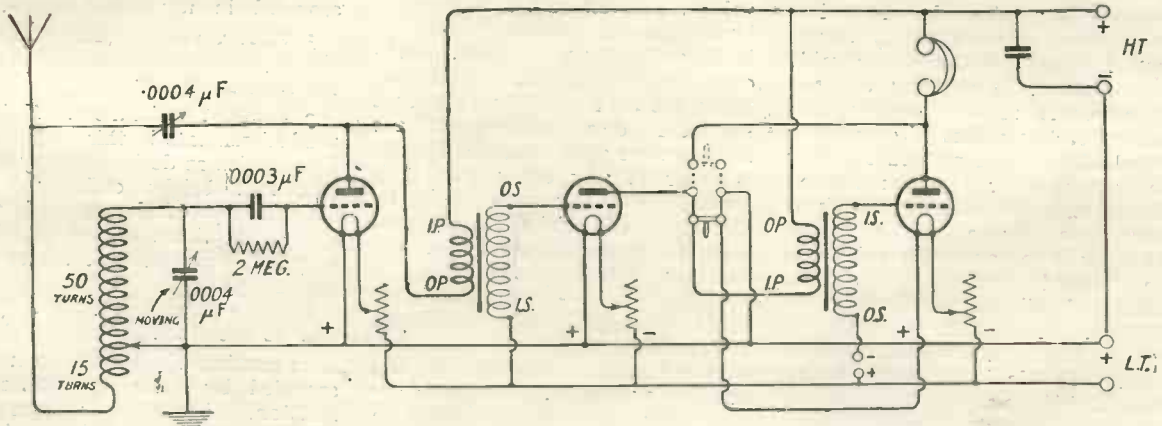
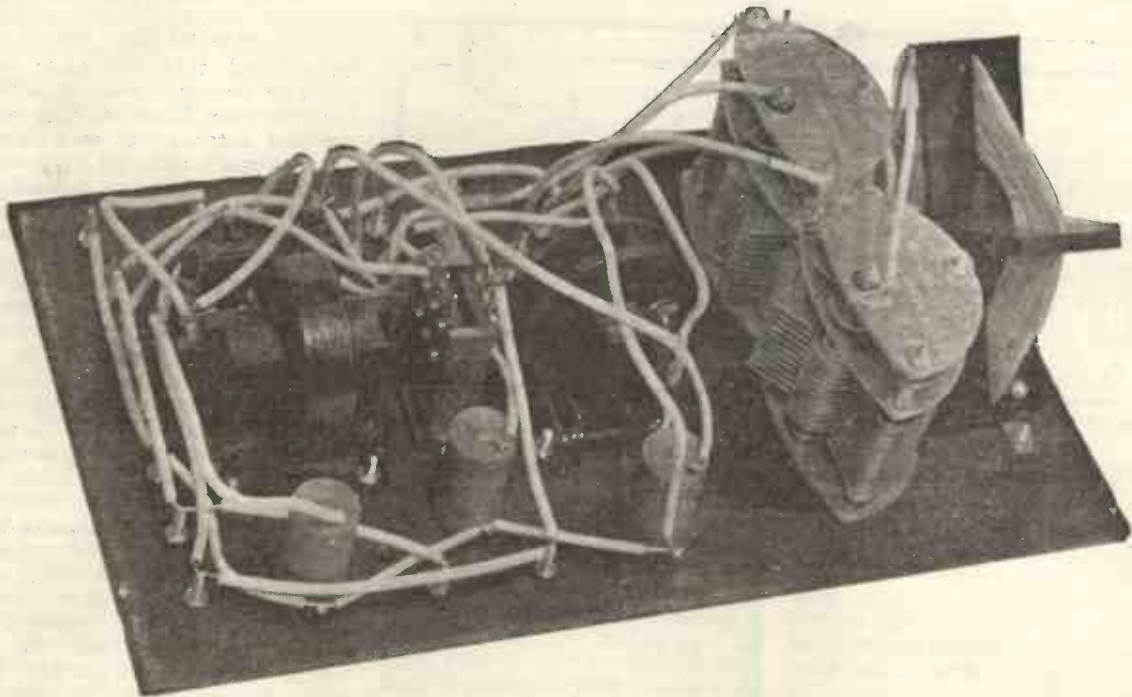

Fig. 5.—Theoretical diagram of the author's three-valve set.



Interior of set showing back of panel wiring.

Chapman introduced the Chapman-Reinartz method of winding coils. This consists in winding the aerial and grid turns simultaneously and then continuing the grid turns until a coil of the right size is made. The Chapman-Reinartz coil is a reversion to the original basket type and owing to the simultaneous windings has the advantage that signals obtainable with it are at least as strong as with any other single-valve reaction set that I have tried. Good results are obtainable in this way with quite fine wire, but it is always an advantage to use thick wire in a Reinartz receiver.

Basket coils are rather tedious to wind, and usually need some material, such as shellac or wax, to support them. The Reinartz receiver is particularly susceptible to resistance and capacity losses, and I have found a considerable improvement in winding the coil in a simple ebonite former consisting of two pieces of ebonite or wood, slotted and pressed together in the familiar egg box fashion. These strips of ebonite are given saw cuts for a depth of an inch or two, and the coils can be wound straight into the slots and will support themselves without any wax, shellac or other substance. A minimum of solid dielectric is included in the field, and if the coil is wound in the Chapman-Reinartz fashion a very efficient tuning arrangement is possible.

The receiver in the illustration is a 3-valve instrument consisting of a detector valve and two low-frequency valves. A switch is provided so that either two or three valves can be used. I have not included a switch so that one, two or three valves are put into circuit, for in the majority of cases it will be found that one listens on two valves, the third only being added when it is desired to work a loud-speaker. This particular Reinartz instrument is exceedingly easy to handle and gives quite remarkable results considering no high frequency is used. On anything like an average aerial it is possible to hear several of the broadcasting stations quite comfortably in the phones (using two valves) and on my own aerial I have had no difficulty whatever in listening to all of them. Anyone who builds this instrument will agree with me when I say that the old disadvantages of the Reinartz are abolished, and I doubt whether in any other way it is possible to obtain such results on distant signals without a stage of high frequency in front of the detector valve. The tuning is simplicity itself—one simply has to vary the grid-tuning condenser until one hears the signals and then intensify them by turning the reaction condenser. If signals are very weak and are not obtainable without reaction then it is only necessary to turn the reaction

condenser through a small angle and try again. Of course the set can be made to oscillate quite freely, but the control of oscillation is so gradual that there should be no excuse for the listener radiating during broadcast hours. The Reinartz is quite a powerful radiator when oscillating, just as is the usual single-circuit reaction receiver. This is mentioned because some readers might have the idea that the Reinartz is not a powerful radiator.

For the construction of the instrument you will want the following components:—

Ebonite panel of a minimum size of 12 in. by 8 in. (This can with advantage be somewhat larger, as the parts are rather crowded in my instrument.)

3 valve sockets. (These can be either the ebonite cased form or the separate legs.)

3 filament resistances. (I have used Lissenstats in this instrument because it was desired to try both dull and bright emitters. The ordinary type of filament resistance will work quite well here provided they suit the particular valves you are using.)

Ebonite former for coils. (This will be described later.)

12 terminals. (Those shown were supplied by John T. Nickles, of Dalston. They differ from the usual terminals, being nickel-plated, and look particularly smart

on a black ebonite panel. Ordinary terminals will of course do here.)

2 interval-transformers of good make. Those shown were made by Messrs. W. G. Pye & Co., of Cambridge. Any of the good makes seem to work quite well in the Reinartz receiver, and I have personally used Igranic, Radio Instruments and others quite successfully. The cheap shoddy transformers whose makers seem ashamed to place their names on them will not do in this circuit, and it is inviting trouble to instal them.

1 switch. (That shown is the Dubilier Minicap. A Dewar switch, Utility switch, Burndept anti-capacity switch or others of the same type can all be used here. Failing any of those mentioned a double-pole double-throw switch will be just as effective as any, but will not look quite so well.)

1 fixed condenser of .0003 μ F with gridleak of 2 megohms.

1 fixed condenser of 1 μ F (Mansbridge type.)

2 variable condensers of .0004 or .0005 μ F.

(These may have vernier plates in them if desired, and those shown are so fitted, but such additions are not absolutely necessary, although

they make the fine tuning a little easier.)

No. 22 gauge wire and insulating sleeving may be used for wiring up, or if the reader is sufficiently skilful he is recommended to use No. 16 square tinned copper for wiring up. Personally I prefer to wire my receivers in this way, but I am quite aware that a large number of readers are not sufficiently expert in wiring up to make a good job with this stiff wiring, so I have made the receiver with flexible wire and insulating tubing, as being most likely to meet the requirements of the average reader.

Constructional Work

Before ordering your ebonite panel it is well to assemble your other components and to lay them out in the relative positions shown in the illustration. If you use the ordinary form of filament resistance you may need to make your panel slightly bigger, as the Lissenstat takes very small panel space. The T. C. B. filament resistances take even less space for the panels, but forms such as the Igranic require larger area. In arranging your parts I strongly advise you to adhere to the relative positions shown. These have been worked out after a good deal of experiment.

Making the Coil

To make the coil you will first of all require the necessary former. This can be of either ebonite or wood. Cut two pieces $5\frac{1}{4}$ in. long by $1\frac{1}{2}$ in. wide out of $\frac{1}{4}$ in. ebonite and slot the middle for $\frac{3}{4}$ in. You should cut slots in the piece of ebonite as shown, with a hack-saw, or, if you have it, with a saw with a blade slightly thicker than that of the average hack-saw blade. When the slots have been cut, drill two holes as shown near the bottom of the slot, two about a third of the way up and two more at the top. Now take some No. 22 double cotton or double silk covered wire (it does not matter which), and undo from your reel enough to make about 15 or 16 turns round the former. You can roughly judge how much. It is not necessary to cut off the exact length at the moment. Now take one end of the wire still on the reel and one end of that portion which you have cut off, and thread them through the two lowest holes, so as to secure the ends in place. Leave a good 6 inches or more for subsequent connecting up, and as a precaution to enable you to identify the end of the wire, make a knot in the one you have already taken off the reel. Now carefully

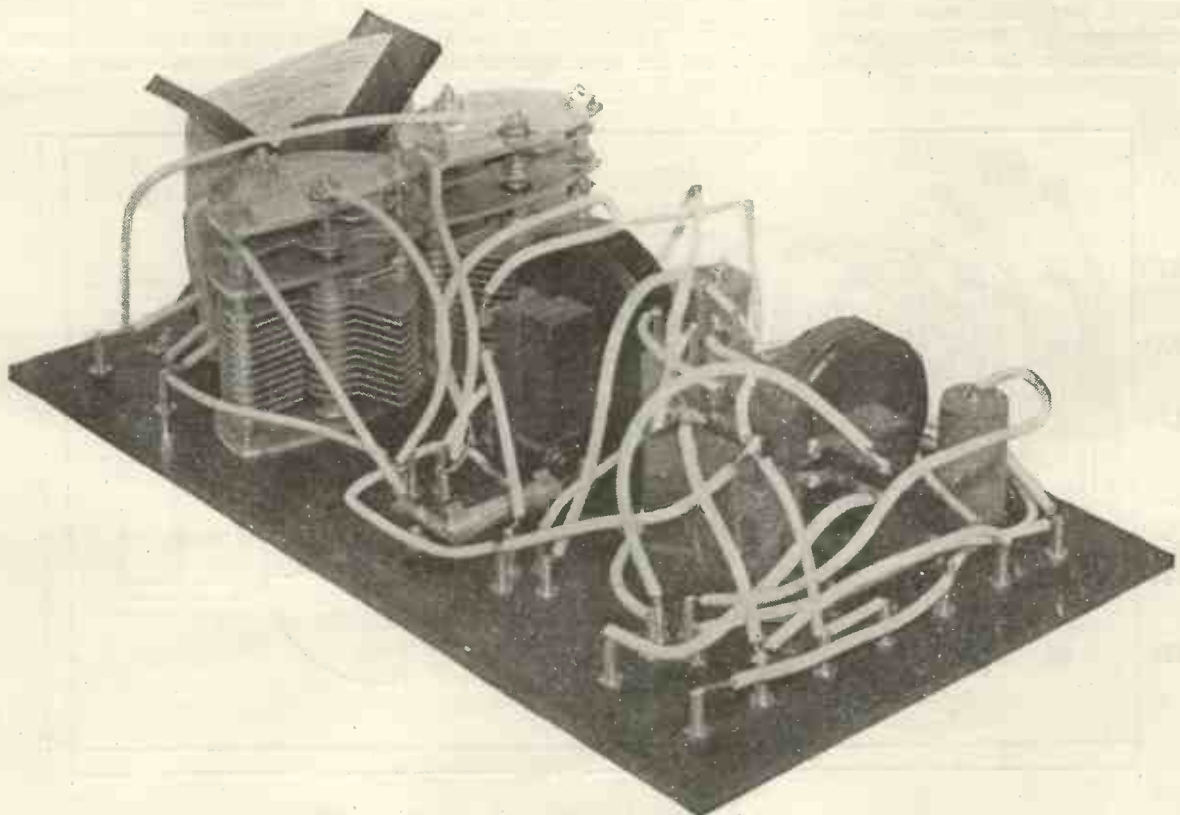

Another view of panel showing shape of special coil.

wind in both wires simultaneously in the slots until you have wound 15 turns of the two wires. Next take the end of the short wire and thread it through the second pair of holes and leave about 6 in. or more for subsequent connection. Wind on the remaining wire until you have a coil of 50 turns continuous (not counting the fifteen of the shorter). Secure the end of the coil by passing it through the two holes in the end of the former.

To fasten the coil to the underside of the panel you will require two small pieces of brass which you can cut with a pair of old scissors out of a piece of sheet brass. Drill two holes in these strips, and drill in the former two holes so that two 6 B.A. metal screws will hold the strips of brass to the former. The remaining holes of the brass strip can be used for securing the former to the panel by means of 6 B.A. screws and nuts. If you act in this way you will avoid the necessity of tapping any holes when making the securing brackets.

The other components can now be mounted on the panel, and the set will be ready for wiring up. The knotted end of the wire which, you will remember, was the beginning of the shorter coil, should now be soldered to the aerial terminal and the other end of this short coil as well as the beginning of the larger coil (the two wires were wound simultaneously) should be joined together and to the earth terminal.

The other end of the larger coil will go to the grid condenser and leak in the manner shown and to one side of the grid tuning condenser. The other side of the tuning condenser must be taken to the earth terminal, so that the variable condenser is across the two ends of the grid tuning coil. It is necessary to connect the moving plates of the condenser to the earth side, if hand capacity effects are to be avoided. The aerial terminal is connected not only to the knotted wire (of course the knots should not be left in this wire), but also to the reaction condenser (moving plates) the fixed plates of which are joined directly to the plate of the first valve. The plate of the first valve is also joined to the OP terminal of the first intervalve transformer the IP terminal of which goes to the positive high tension. Particularly notice that you must not place a fixed condenser across the primary of this transformer.

I strongly advise you to make soldered joints everywhere, and, of course, the surface skin of the ebonite should have been removed before starting work. This surface often contains traces of metal which is likely to prevent the proper functioning of the ebonite as an insulator. The surface can be removed with fine emery paper, rubbing steadily until all shine is removed. The dirty brown powder so formed can be washed off under

the tap, and a good black finish obtained by rubbing vigorously with a cloth on which is a trace of vaseline.

Soldering should of course be cleanly done. Before soldering, file the points to be soldered to remove any possible tarnish, and use only the barest trace of flux.

The rest of the wiring will be apparent from examination of the wiring diagram. Notice particularly in this case the connections IP, OP, IS, OS, on both transformers. The arrangement of the second transformer is I.S. to grid and IP to plate. This was done after experimenting with the connections to get best results, but the reader is recommended to try both transformers the same way first of all, and then to try the connection I have shown, to see which of the two is the better in his case. It is always advisable to place the transformers at right angles to one another as shown, and as far apart as is practicable. Do not, however, alter the relative positions of the coil and the two condensers for they have been placed in this way to make the wiring short. Sometimes slightly improved results are obtained by connecting a telephone condenser across the telephone terminals, but in the majority of cases I have found no advantage by so doing.

When you have finished the set, you will find the handling of it

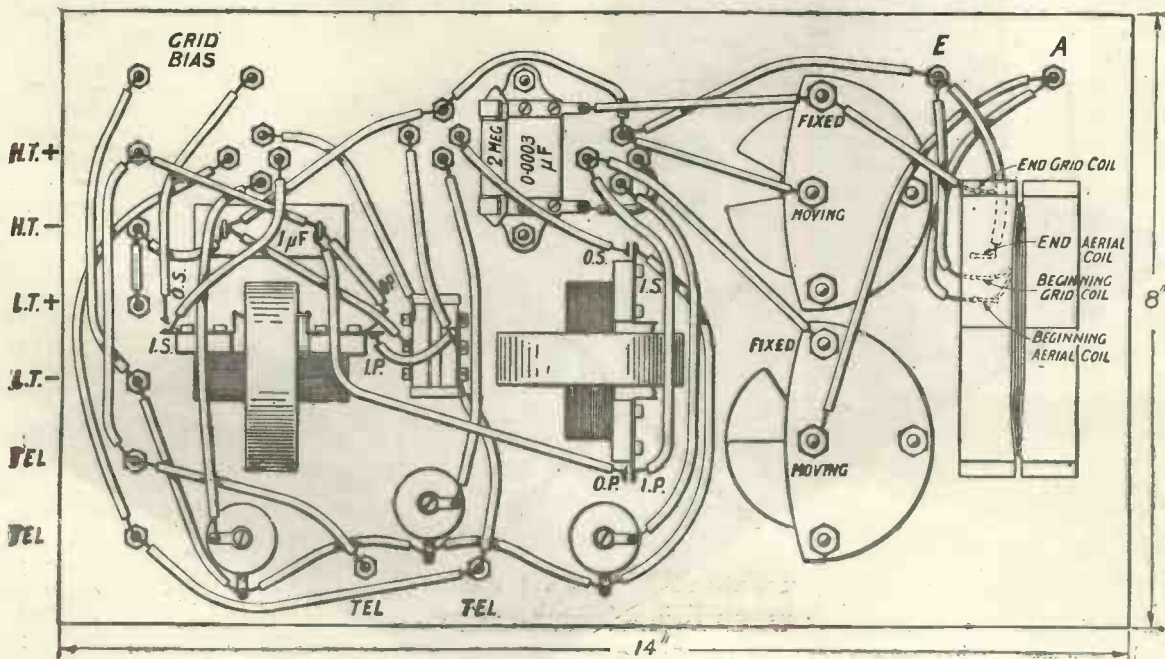

Fig. 6.—Wiring diagram of receiver.

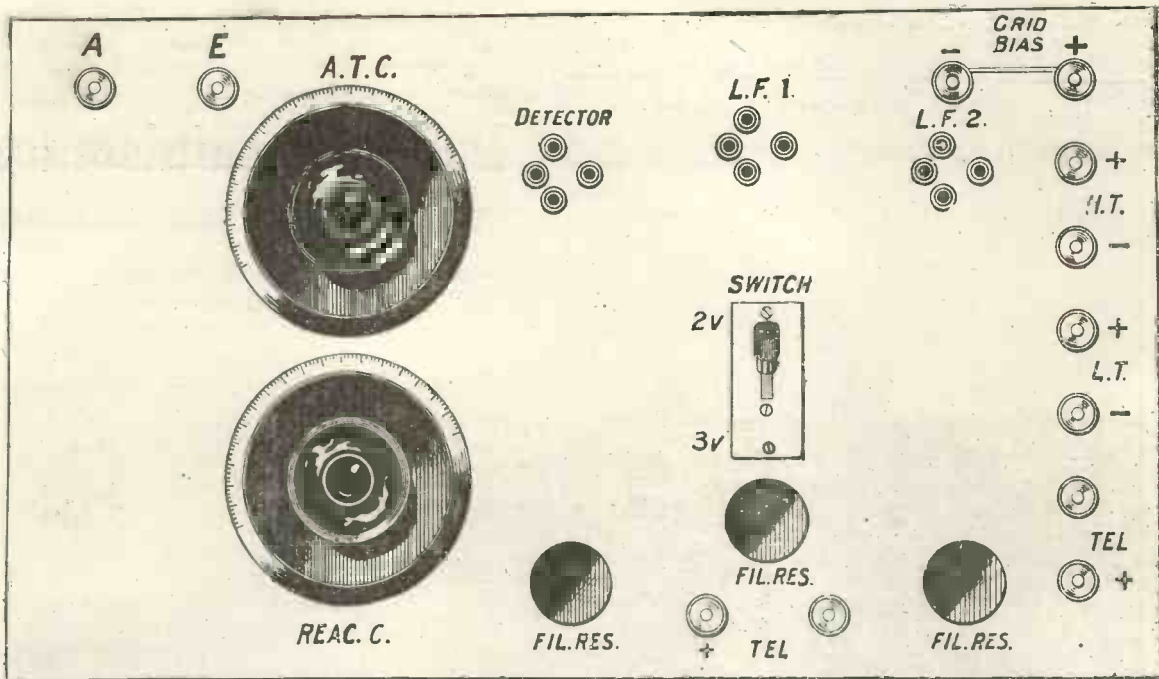

Fig. 7.—Panel Layout and connections of terminals.

slightly peculiar at first. The adjustment of the filament temperature of the first valve is rather critical, and is best found by trial. It is one of the advantages of the Reinartz that with a relatively small condenser one can cover a wide band of wave lengths. If the coil is wound exactly to the dimensions shown, you will find that it starts about 300 metres and runs up to about 700 metres or more. A.0003 variable condenser is sufficient to cover the broadcast band. However, I find the .0004 slightly preferable, as this enables ship signals to be included for testing.

Until you are used to handling this instrument (getting accustomed to it should not occupy more than half an hour) I do not recommend you to experiment with it during the broadcast hours. Best of all is to wait until after broadcasting is over and then to experiment on the 600 metre ship signals. These will be found in about 100 or 120 degrees on the condenser.

First of all tune with the upper condenser and then slowly turn the reaction (lower) condenser until you hear a "plop." Turn back slightly and move the upper tuning condenser until you obtain best signals and try varying the adjustment of the reaction condenser until you become accustomed to its handling. First of all you may find there is what is generally termed "backlash"—this means that after the point of oscillation

has been reached on the condenser, to stop an oscillation it is necessary to turn back quite a number of degrees. If this is the case try alternating the filament temperature slightly on the first valve until a point is found when there is no "backlash" whatever, but the slightest turn-back will stop oscillation. You will soon become used to handling this receiver, and then you can turn back to the broadcast band, always of course setting the reaction condenser at zero before trying to tune in. If you are not successful in picking up a station without reaction, advance the reaction slightly and then search once more. If again you do not find a station, still further increase

the reaction with each attempt for if you do not act in this way you may oscillate and cause interference. When you have acquired a little practice with this instrument you will find the reaction control extremely fine and easy to handle, giving a magnificent building up effect, and a strength of signals only excelled by a set containing a stage of high frequency in front of the detector valve (and very rarely equalled by an ordinary receiver using the more widely known inductive reaction).

The switch is so arranged, as you will find on examining the diagram, that on one side you are listening on two valves alone and on the other side on three. The switch is so wired that not only does it change over the telephones, to the right circuit, but it also extinguishes the filament of the third valve when this is not in use.

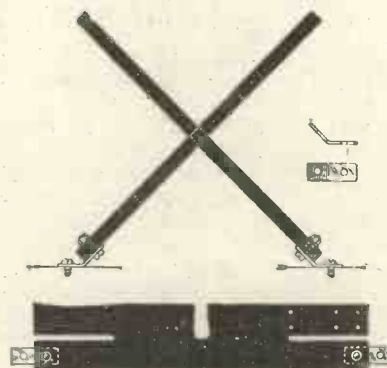

Fig. 8.—Details of coil former.

NOTICE

A FULL-SIZE BLUE PRINT OF THE WIRING DIAGRAM OF THIS RECEIVER IS OBTAINABLE FROM THE PUBLISHERS

PRICE 1/6^D.

Ask for Blueprint NR. 18



Gibraltar rock, used by the Admiralty as a wireless mast.

Radio Reminiscences

By Lt.-Col. CHETWODE CRAWLEY, R.M.A., M.I.E.E.

Deputy Inspector of Wireless Telegraphs, General Post Office.

Early Days

MY introduction to wireless telegraphy (no mention of "radio" then) was at a lecture by the late Monseigneur Molloy in Dublin, in the summer of 1898. Signor Marconi was present, and has told me since, that it was the best popular lecture he has ever heard; so it is no wonder that I caught the disease on the spot, and have suffered from it ever since. All I remember of the lecture is that a wireless message was transmitted in the lecture hall and received by a coherer on a tape. The Lord Mayor of Dublin, who presided, was given the tape, and turning to the audience said: "there is divil a message I can see but a lot of dots and dashes."

Admiralty Tests

A couple of years later the Admiralty sent some sets out to the Mediterranean fleet, and I was told off, with another officer, to rig up a set in our ship. The struggle lasted several days, and in the

end we were defeated, as the coherer resolutely refused to respond to the buzzer, though it worked gleefully with the wet fingers' test on the jigger's terminals. At last we had to send for help from a petty officer of Commander Jackson's ship, the fount of our wireless knowledge. To our disgust, he severed our carefully made connection between the aerial and earth terminals of the buzzer, and all was well!

Adventurous Days

But those were days of high romance and adventure when you connected up one part of a circuit to another on the off chance that something would happen, and it often did happen forcibly as those, too, were the days of "plain aerial" transmission. I well remember one of the first times I connected up the aerial to the spark gap, as my friend chose the same moment for adjusting the key. But we renewed our friendship next day. I remember, too, seeing a bluejacket play his

hose on the aerial when washing down ship. We were signalling on "plain aerial" and his language, as he dropped the hose pipe, was extremely entertaining.

In those days we disliked on principle all signal officers, as they were always fouling our beautiful aerials with their silly flags; but we knew when they were up to their tricks as our plain spark failed, and we sometimes got our own back in wet weather when a signalman touched the halliards. Later on, when tuned transmitters came into use, they had it all their own way, as we seldom knew when their flags were fouling; so to win them over to the importance of wireless we had to resort to flattery on the importance of "bunting tossing."

Wireless versus Bunting

As a matter of fact, in the early days the "bunting tossers" often established communication long before the "wireless experts" had got beyond the stage of exchanging V's.

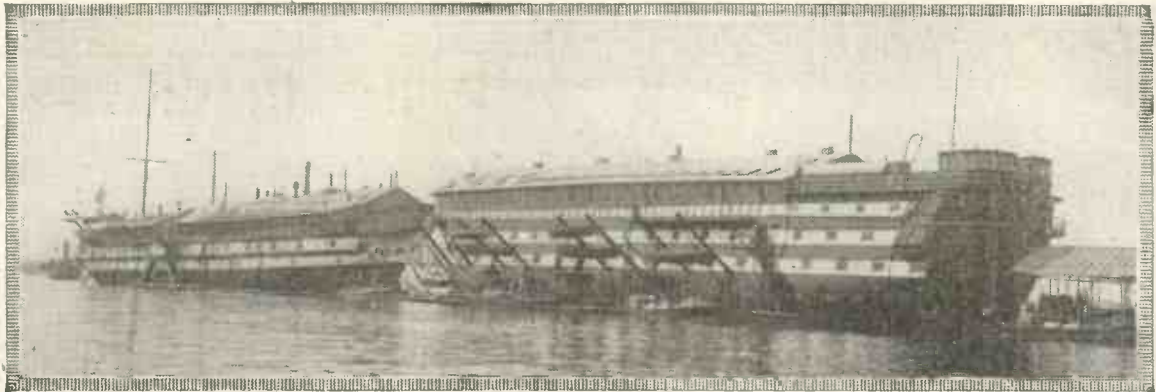

H.M.S. Vernon in 1903.

It was wonderful how a coherer receiving set, which refused to produce one word of a message, would cheerfully print strings of V's from the same source without a mistake when the receiving operator moistened his fingers and tickled it up at the right moment. Why it was I do not know; but those who have struggled with coherers will bear me out. During 1903-6 I was on the wireless staff of the *Vernon* at Portsmouth, where all experimental, instructional, and testing work was carried out.

H.M.S. "Vernon"

All coherers for the Navy were tested there and passed for acceptance if they could receive V's from a station at Portland. I have always thought that the firms

which supplied the coherers got off very easily, as our testing petty officer could cajole V's out of coherers which would never look at a real message. A few years later that same officer retired from the service and told me that he would henceforth lead a peaceful life far from the wireless crowd. But, poor fellow, his case was too far advanced, and he is still in full wireless harness, having altered only from a "wireless expert" to a "radio fan."

"Tuned Shunts" Receiving Circuit

It was at that time the *Vernon* produced the famous and now well-known, "Tuned Shunts" receiving circuit, combining an "acceptor" and a "rejector," a circuit which

was kept secret in the Navy, and for several years remained far ahead of commercial practice. In those days, too, in advance of commercial practice, we used variometers, but we called them "adj. L's." (adjustable inductances), as the stately word "variometer" had not then been coined for the purpose.

Most senior naval officers of the old sailing ship school, and there were plenty of them serving twenty years ago, were very suspicious of wireless and all its ways, and one often had to produce the message on the tape before they would believe it had been received.

The Magnetic Detector

This led to quite a struggle when the magnetic detector came along, and, as a result, the coherer with

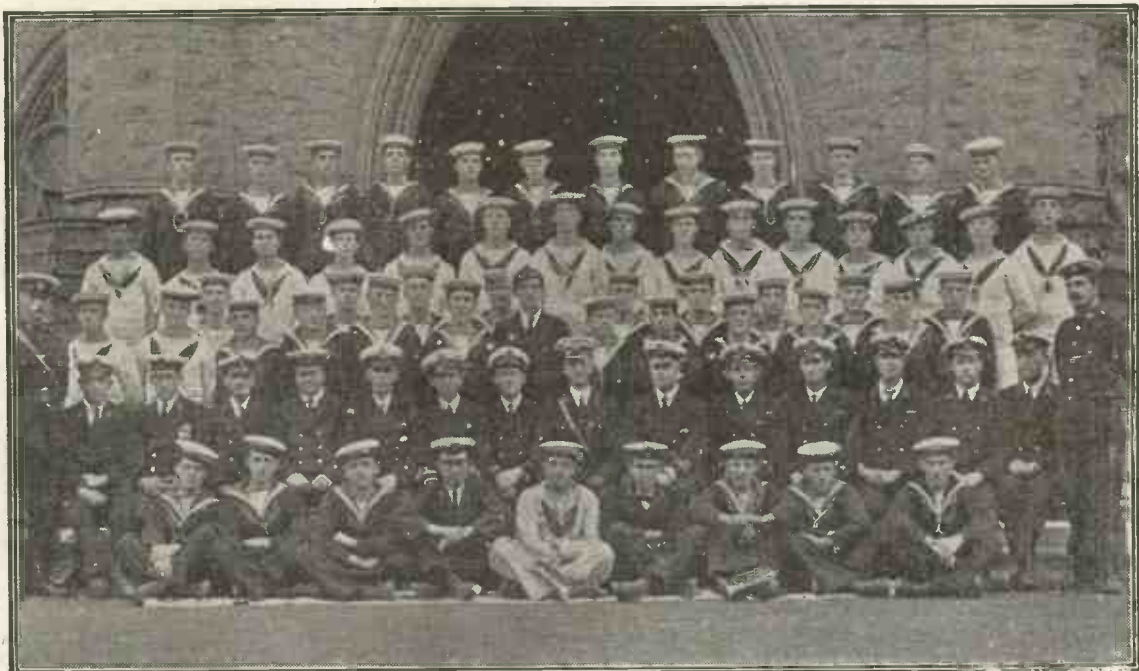

Photo]

Instructors, R.N.V.R. Wireless School, Crystal Palace.

[I. H. Everitt, Upper North...

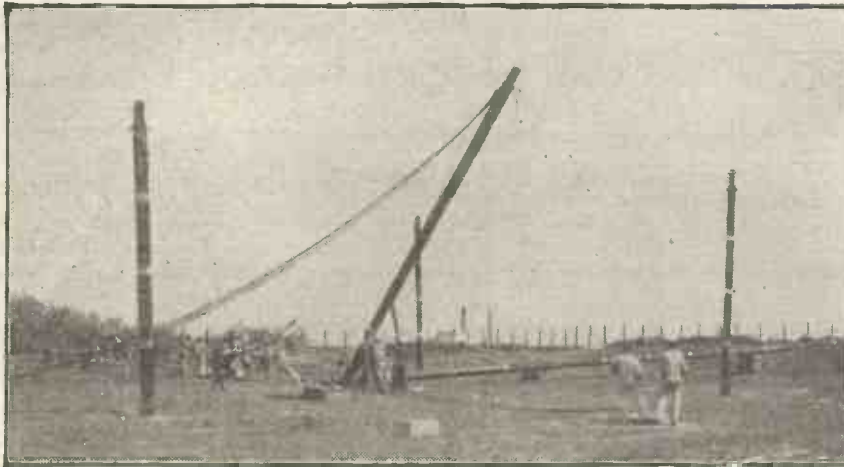

Erecting a direction-finding station in the Azores.

its inker was retained, in addition to the magnetic, for several years longer than was justified from the technical point of view.

In fact, we juniors were often "up against it" with the admirals and captains. Once when, as Wireless Officer of the Channel Fleet, I had tuned up a ship, the Captain reported me to the Commander-in-Chief for having "boarded his ship and upset his wireless installation," with the result that I had "to give my reasons in writing," and only just escaped being put under arrest.

"Guaranteed" Distance

On another occasion, when Wireless Officer of the Mediterranean Fleet, the Commander-in-Chief asked me whether I could guarantee communication with some cruisers which had sailed

under sealed orders, but he could not say where they were going. I tried to explain that I must know their destination before making a definite statement, but it was no good, so at last I said, I would guarantee communication to any large harbour in the Mediterranean with the exception of Marmarice, a harbour surrounded by high hills, and an old *bele noir* of mine. He smiled, and at once ordered out a ship to act as a wireless link, so I knew that I had hit the nail on the head that time. But we must get back to earlier days when things

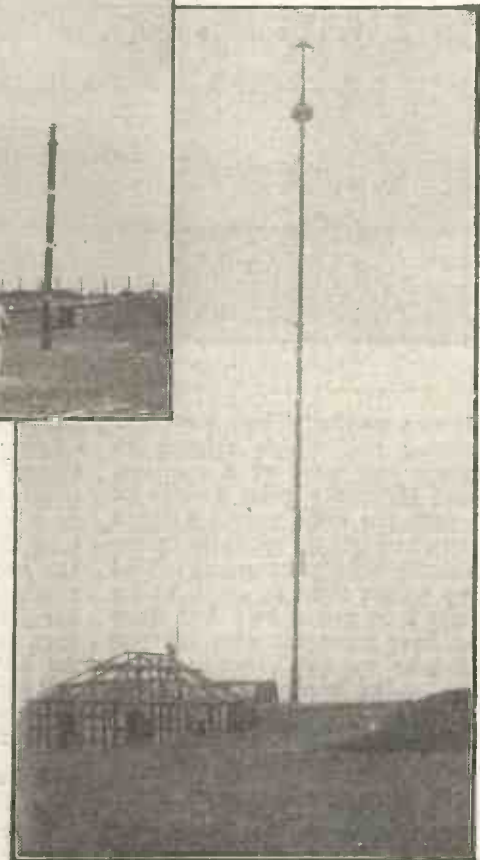

Another view of the station during erection.

were less cut and dried but more amusing.

Marconi and the Bacon

For several years I paid visits to the Marconi Company's stations at Poldhu in Cornwall and Clifden on the west coast of Ireland, on behalf of the Admiralty, alone, or as one of a party. On one of the latter occasions, when on the way to Clifden, I was sitting at breakfast time next Mr. Marconi in the Dublin-Galway restaurant-car. The attendant came round solemnly asking each member of the party what he would have for breakfast, and each one made the usual British reply: "eggs and bacon, please." Mr. Marconi, being more original, said: "Well, what have you got?" And the attendant replied: "I have eggs and bacon." "Have you anything else?" asked Mr. Marconi. "Indade, and I've not," came the reply, followed up by an indignant "and what more can ye be wanting, anyway." So Mr. Marconi joined in with the rest, and an excellent breakfast it was, very welcome to me as it



The author's tent at Kenya.

had been a bad passage, and I am no sailor in anything smaller than a battleship.

Directional Effects

It was on a visit to Poldhu that Mr. Marconi first demonstrated his discovery of the directional effects of low horizontal aerials. We all had dinner together at the hotel, which is a few hundred yards distant from the wireless station, and when the table was cleared Mr. Marconi placed a magnetic detector, with head phones for each of us, in the centre of the table. He connected one end of a piece of wire, a few feet long, to the aerial terminal of the instrument, and holding the other end just clear of our heads, walked round the table. When the wire was in the direction of the station, which was

fully locked up in a box, and which he could not then disclose to us.

"The Locked Box of Poldhu"

The reception was excellent and we very curious; but it was not till the Fleming valve patent was published some months later that we knew the contents of what we had christened "The locked box of Poldhu." In those days there was much secrecy about the apparatus used at large stations, and visits from Government officials were not always welcomed. In 1906 I was detailed by the Admiralty to accompany the late Sir John Gavey, of the Post Office, on a visit to a station erected by an American company, using Fessenden's patents for transatlantic communication, at Machrihanish in Scotland.

away, was a remarkable venture, as the steel mast, 415 ft. in height, was brought over in sections from the United States of America and erected on an insulated base in a few weeks. The installation, of about 25 k.w., was working in a few weeks more with a distinctive musical note, and its signals, which I often listened to at Gibraltar, were, I thought, superior in every way to those being sent from Poldhu. It must have been one of the first stations to use a high note. It was certainly the first I had heard, and I was then listening pretty constantly on various waves. Unfortunately, before many months had passed, the mast came down in a gale of wind, not, I believe, from faulty design, but on account of a flaw in the material, and the station was abandoned.



Photo]

R.N.V.R. Wireless School, Crystal Palace.

[T. H. Everitt, Upper Norwood.

transmitting, we heard loud signals, and when it was at right angles to that direction we heard nothing. Personally, I was amazed, and I consider this to have been the most impressive demonstration I have ever witnessed. Next day we had a full-dress demonstration with real aerials in the open country; but Mr. Marconi had shown us all there was to be shown in those two minutes at the dinner table. I remember we looked wise and asked him for explanations. He told us that he had not had time to consider explanations, but that Dr. Fleming, in London, was tackling that part of the business!

It was on the same visit that he showed us the reception of signals on apparatus which he had care-

The Machrihanish Station

The polite engineer-in-charge was so sorry that the station was out of action, and that in fact most of the apparatus was dismantled, facts very apparent from the hasty inspection which he permitted us to make on arrival. Next day we hoped to see more, but the dismantling process appeared to have progressed rapidly even during the night, so we decided to accept defeat and allow ourselves to be taken by the engineer to a picnic which he had thoughtfully arranged for us some miles away.

3,000 Miles Transmission

This Machrihanish station, which established communication nightly in 1905 with Brant Rock, 3,000 miles

Gibraltar

Except for the Eiffel Tower, I doubt if any European station in 1906 had so high an aerial as Machrihanish but in the following year the Navy had the highest aerial in the world at Gibraltar; in fact, I believe it is still the highest. I was Wireless Officer of the Atlantic Fleet at that time, and the idea should have been mine, but it wasn't! The suggestion was made by the Torpedo Officer of one of the ships, and would not have been carried through without his enthusiastic assistance. The idea was to use Gibraltar Rock itself, some 1,400 ft. high, as the mast. The top of the aerial was about 1,250 ft. above the installation which was fitted up in a motor

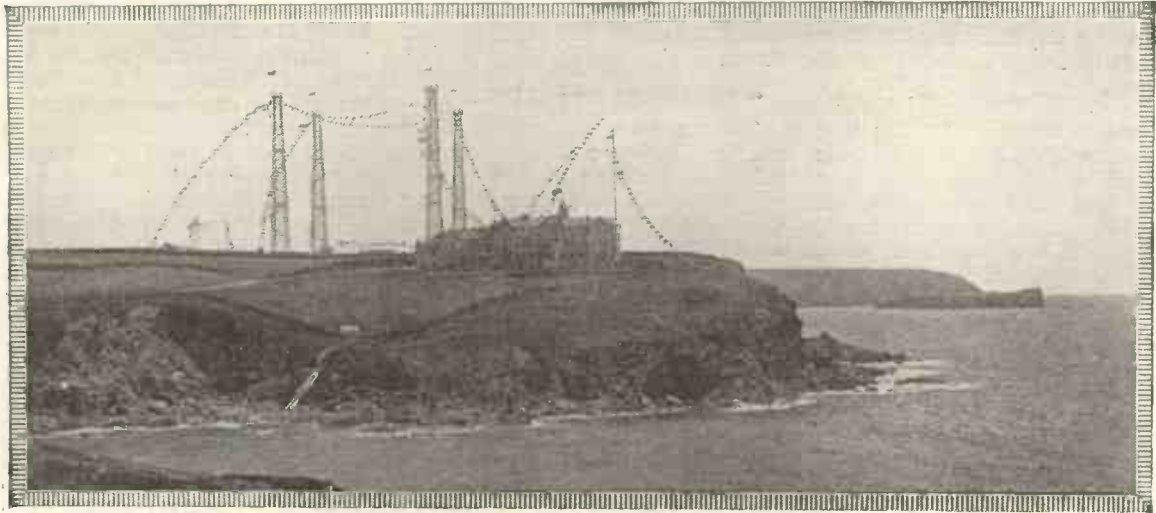

The Poldhu Station and hotel in 1905. Later these wooden masts were replaced by steel structures.

lorry lent by the Army and worked by the lorry's engine.

Wireless and the Laundry

During erection the rocks which we displaced from time to time made us most unpopular with a steam laundry situated at the bottom of the cliff; so much so that the naval Commander-in-Chief had to help us by a placatory visit to the Governor of Gibraltar on more than one occasion. Our naval experts at home were far from optimistic, as they had worked out on paper all sorts of troubles that might arise from absorption and reflection by the cliff, so that we were particularly anxious to carry out a good practical test.

I did not then know why Poldhu signalled the letter "S" (three dots) only in its famous first transatlantic tests; but when I found that our little station broke down whenever we tried a dash, I realised the inherent beauty of such a letter as S. So we, too, chose S for our test, and we hoped that if any ship could receive the S's up to a distance of about 500 miles by day the Admiralty might decide to erect a real high power station with the Rock as a mast.

The Mystery of the "S"

The long-looked-for opportunity arrived when the fleet sailed for home to give Christmas leave. If any of the ships could receive the S's on the third day out we had done our 500 miles. Most of us received well up to almost daylight on the third day, but on that crucial day, only one ship, that in which my friend the Torpedo Officer was serving, received the signals. He signalled to me that all his operators had heard distinct S's from Gibraltar. I was delighted and wrote a glowing report for the Admiral.

The Disastrous "Dash"

When we arrived at Portsmouth I found a telegram waiting for me from Gibraltar. It said that the station had broken down for good just before dawn on the third day. They had made a dash by mistake, and my friend's enthusiasm must have affected the ears of his operators. We sadly altered my report and dined together to celebrate the failure. But the Admiralty rose to the occasion, and in due course erected a high power station with

As this station was being erected a destroyer was completely wrecked on the rocks at Malta, and I tried hard to get it as an "earth," but the Admiral said that the rapaciousness of even a wireless officer must have limits, and we lost a beautiful, if expensive, "earth."

Foreign Navies and Wireless Telegraphy

In the Mediterranean we came into contact pretty frequently with foreign navies, and I remember a



The Wireless Station at Jamaica.

the Rock as a mast at Gibraltar, and there it has been ever since.

Destroyer as "Earth"

Several years later I made use of the same idea at Malta in suggesting the site for the station at St. Angelo, where the masts are on the top of a cliff and the station on the water's edge at the bottom.

night when one of their officers spent the whole of dinner in explaining to me what wonderful results they were getting with wireless telephony. I was greatly impressed, as we ourselves had nothing of the sort at that time. A year later we dined together again, and he reminded me of the pleasant time he had had in pulling my leg

on the previous occasion! But I got a bit of my own back the next day. He invited me and some others to come and see round his ship. He showed the party round, but I lost them and walked into the wireless cabin. The operator tried to persuade me to go out, but he spoke in a language which I did not understand. I had a pleasant quarter of an hour examining their arrangements in detail until my friend found me just where he feared I was, and told me quite clearly in a language which I did understand that no foreign officer was allowed inside their wireless cabin under any conditions whatever. I was duly contrite, but it was no use, as he knew me too well, so all he did was to ask me to lunch.

Early Telephony

The first time I tried wireless telephony was in the *Defiance* at Devonport in 1911 with an arc

no desire to visit it. I was asked to send home a photograph of this latter site but I had not got one, so sent an excellent substitute, a blank sheet of paper headed "View of site facing N.S.E. or W."

In Kenya Colony, the predominant features from a wireless point of view are atmospheric and mountains. Both are huge, and both are most disturbing to the site-hunter.

Lion Hunting

Talking of hunting reminds me of our grand lion hunt. We set off in the early morning on a lion's trail with a pack of dogs and a retinue of porters, gunbearers, and hangers-on of all kinds. Tartarin wasn't in it with us. We returned in the evening with the same retinue and the spoils of our hunt—a young partridge! But we had other thrills. One night, my friend and I turned in on opposite sides



Proposed source of water power for Kenya Station.

transmitter in the sending, and a Brown relay in the receiving, circuit, but I never got much more than a few muffled words and snorting sounds after weeks of trial!

The Imperial Chain

In 1912 I was lent to the Post Office to assist in selecting sites for stations for the Imperial Chain, in Egypt and Kenya. As regards wireless telegraphy, what impressed me most in Egypt were the remarks of the Military Commander-in-Chief, now Lord Byng, when he came to see our transmitting site, and found nothing but a desert and a three hours' wait for the next train to Cairo. Our receiving site was even more so, as it was in the same old desert but further from Cairo. Luckily the General expressed

of our capacious tent. We were replete with lion stories, so I had a loaded rifle beside me, and he had a loaded revolver. Now I heartily dislike anyone but myself with a revolver, as no weapon can go off so easily and unexpectedly, and my friend quite as heartily disliked the combination of a rifle and me. In the dead of night a large beast came into the tent, and stood exactly between us, I suppose for seconds, it seemed for hours, as my friend and I lay breathless, he thinking of my rifle, and I of his revolver. I guessed rightly that it was one of our dogs, and so did he; but neither knew what the other was guessing, and I shall never forget my relief when that old dog turned tail and stalked out again.

Special Atmospherics

As for atmospheric, I thought the highlands of Kenya must be the worst place in the world, until I went further west into Uganda where they had to earth the telephone system daily from 2 p.m. till the following morning. If there really is a worse country than Uganda for atmospheric I should like to hear of it, but I have no desire to see it. I have supervised the working of land stations in the West Indies, South America, West Africa and the Azores, but for atmospheric none of them is comparable with Uganda.

Sea-boots and Umbrellas

In Jamaica, in the West Indies, we had a cyclone just as the station had got into nice working order, the roof suffered badly, and for two days and nights we paddled about in sea-boots, with umbrellas up, stopping up holes in the roof and covering the plant with rugs, mats, blankets and such like; the two most uncomfortable nights I have ever experienced. It was worse than listening to jazz music from America at 3 a.m.

There is always difficulty in keeping one's stores intact abroad, and Jamaica was no exception. I had drawn most of those most useful to the natives, such as digging and tree-felling implements, from naval stores, and frequent losses got me into trouble with the stores officer, until I found out that "lost overboard" covered a multitude of sins. The station, I may mention, was in the centre of the island. That reminds me of the first position of an enemy submarine which we located by D.F. stations in the Azores. It was a good clear cut, and placed the submarine right in the centre of Spain.

Arrival of the Russians

At the beginning of the war I went to the Grand Fleet for wireless duties. I left London on the night when we first had news of the arrival in England of the phantom Russian troops, and told the story the following night to an army officer at the hotel in Kirkwall in the Orkneys. Next morning when the "boots" called me he told me that the military authorities had had official information of the arrival of a Russian army in England—not a bad expansion for one night!

Wireless and Submarines

We had plenty of excitement in those early days in the Fleet, as, judging from reports, as authentic as those of the Russian army,

**Regular Programmes from
British and Continental
Broadcasting Stations**

Times in Greenwich Mean Time.

GREAT BRITAIN.

Station.	Call Sign.	Wave-length.	Times.
Cardiff	... 5 WA	353	} 3.30 to 4.30 p.m.
London	... 2 LO	365	
Manchester	2 ZY	375	} 5.0 to 10.30 p.m.
Bournemouth	6 BM	385	
Newcastle	.. 5 NO	400	} SUNDAYS.
Glasgow	... 5 SC	420	
Birmingham	5 IT	475	and
Aberdeen	... 2 BD	495	8.30 to 10.30 p.m.

FRANCE.

EIFFEL TOWER. FL 2,600. metres
(Daily.)

- 6.40 a.m. Forecast.
- 10.50 a.m. Fish prices in the Paris markets.
- 11.14 a.m. Announcement of the time.
- 11.15 a.m. Regional forecast.
- 12.0 a.m. Livestock prices.
(Tuesdays and Thursdays.)
- 3.40 p.m. Financial news.
- 5.30 p.m. Closing prices.
(Saturdays excepted.)
- 6.10 p.m. Radio concerts.
- 7.0 p.m. General forecast.
- 10.10 p.m. General forecast. On Sundays
the radio concerts and fore-
casts are given at 7 o'clock.

ECOLE SUPERIEURE DES POSTES ET TELE-
GRAPHES (450 metres).

Concerts generally at 9 p.m. on Tuesday
and Thursday.

RADIOLA (1,780. metres).

- 12.30 p.m. } Concerts.
- 4.30 p.m. }
- 8.30 p.m. }

These concerts are preceded by news items.

BELGIUM.

BRUSSELS (405 metres).

- 5.30 p.m. } Concerts and News.
- 6.0 p.m. }
- 8.30 p.m. }

HOLLAND.

THE HAGUE, PCGG (1,050 metres).

Concerts. Sundays, 3.0 to 6.0 p.m.

THE HAGUE, HEUSSEN. PCUU. (1,050
metre:).

Thursdays, from 7.45 to 10.0 p.m., Irregular.
Sundays, from 9.40 to 10.40 a.m., Irregular.

THE HAGUE, VELTHYSEN, PCKK.

Fridays, from 8.40 to 9.40 p.m., Irregular.

THE HAGUE, IJMUIDEN, PCMM.

Saturdays, from 8.40 to 9.40 p.m., Irregular.

SPAIN.

MADRID (2,100 metres).

Trials from 10.0 to 12.0 a.m., Irregular.

SWITZERLAND.

LAUSANNE (1,100 metres).

8.5 a.m. Meteorological forecast for
Lausanne.

10.50 a.m. Meteorological forecast for
Geneva and Dubendal.

1.0 p.m. Meteorological report for
Switzerland.

6.55 p.m. Meteorological report for
Switzerland.

4.0 p.m. Tuesdays, Thursdays and
Saturdays, Concerts.

7.0 p.m. Mondays, Wednesdays, Fridays
and Saturdays, Concerts.

ITALY.

ROME (540 metres).

Weekdays from 5.0 p.m. to 6.0 p.m.

KBELY, near Prague (1,150 metres).

Concerts from 6.20 to 7.20 p.m.

**Further Additions to List
of Amateur Call Signs**

2 AS	W. H. MOON	2, Cornerswell Gardens, Penarth Glam.
2 DN	M. N. DURNFORD	Kingswear House, Kingswear, S. Devon.
5 FD	T. A. & J. H. HEWITSON	North Dene, 38, Grosvenor Road, Birkdale, Lancs.
5 GT	E. S. DOBSON	"Lorne House," Richmond Place, Ilkley.
5 LS	R. BLOXAM	99, Old Dover Road, Blackheath, S.E.3.
5 NL	H. C. TURNER	45, Manley Road, Whalley Range, Manchester.
5 SD	J. D. TURNER	Barwite, W. Dunstable, Beds.
5 UX	H. STEPHENSON	The Bottoms, Gildersome.
5 XN	H. W. EVERITT	30, Gourcock Road, Eltham, S.E.9.
6 AI	H. ANDREWS	Cynlais Garage, Ystradgynlais, Swansea.
6 DD	J. W. BARBER	205, Brockley Road, S.E.4.
6 IV	P. B. SNOADEN	34, Chandos Road, Harrow.
6 VK	J. H. BEAN	"Inglewood," Mt. Vernon Avenue, Blairhill, Coatbridge.
6 XY	F. CROPPER	42, Acres Lane, Stalybridge, Cheshire.
6 ZX	H. FIELD	Baggrave Hall, Leicestershire.
2 AAX	L. SMITH	"College House," London Road, Braintree, Essex.
2 AFB	W. M. MADDOCK	32, Richmond Crescent, London.
2 AFR	C. J. HEARSEY	"Holmdeane," 139, Fawnbrake Avenue, Herne Hill.
2 AGP	S. MEADOWCROFT	44, Carill Drive, Fallowfield, Manchester.
2 AHM	H. B. GARDNER	129, Salisbury Road, Barnet.
2 AIN	H. A. WHITE	1, Canterbury Road, Brixton.

CORRECTIONS.

2 HM	Does not belong to H. B. GARDNER, whose Station is 2 AHM.		
2 OG	A. COOPER	"Ivelet," Askham Road, Acomb, York.
2 SK	K. G. STYLES	43, New Oxford Street (2nd floor), W.C.1.
2 SL	K. G. STYLES	"Kitscot," Bower Mount Road, Maidstone.
5 UL	J. W. COVENEY	12, Wallwood Rd., London, E.17.
5 UZ	J. E. LLEWELLYN	"Elmfild," Baldock Road, Letchworth.

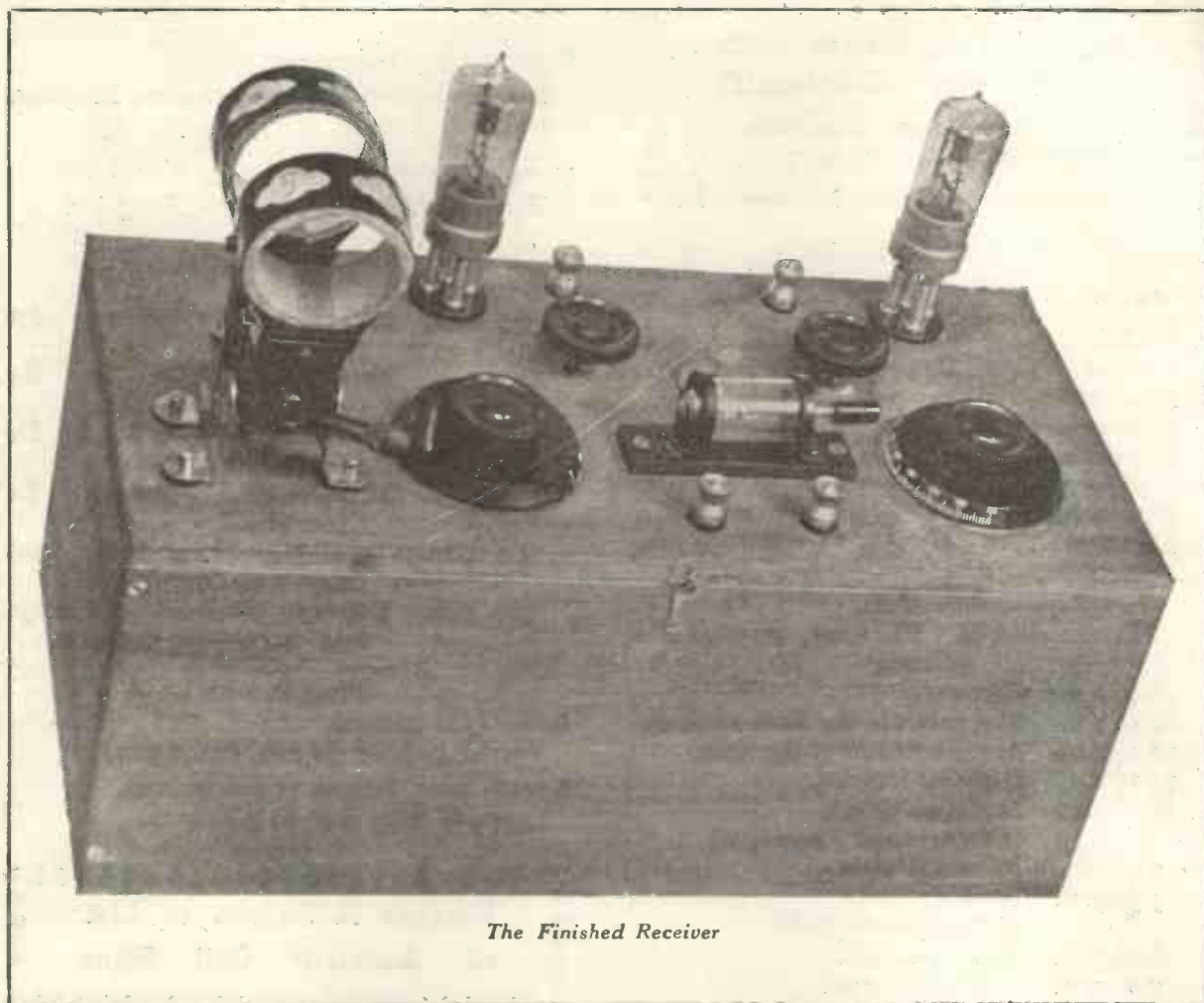

The Finished Receiver

The "S.T.100 Star" Circuit

By JOHN SCOTT-TAGGART, F.Inst.P., A.M.I.E.E.

Introductory

THE S.T.100 Star is an alternative to, rather than an improvement on, the S.T.100 circuit. The S.T.100 was first described in the June, 1923, issue of MODERN WIRELESS. Some experimenters found difficulty in obtaining all the results claimed for the circuit. This was because unsuitable transformers were used, or because the windings were connected the wrong way round. Soon afterwards a greatly improved form of the circuit was published in *Wireless Weekly*, the secondary of the transformer, which fed back the low-frequency currents into the grid circuit of the first valve, being connected in the aerial circuit. The circuit in its present form is capable of giving a great

output of strength, but there are still some who, through the use of inferior or unsuitable transformers, cannot obtain in full degree the amplification which should be obtained with the S.T.100 circuit. To these, the "S.T.100 Star" described below should prove of great interest.

The circuit is a modified form of the S.T.100, but instead of using a transformer to couple the first and second valves, an iron-core choke coil is employed. It is not possible, at this stage, to say which circuit gives the best results. If readers who experiment with this circuit will kindly inform us of the results, preferably the comparative results, they have obtained with this circuit, we shall be able to judge

how the circuits compare. At 12 miles from 2LO my own experience is that there is very little to choose between the S.T.100 and the S.T.100 Star. I get very loud and clear signals on the loud-speaker on a small aerial, about 75 ft. long and 15 ft. high. It is, however, extremely probable that when the reports come in, it will be found that some find the S.T.100 better, and some the S.T.100 Star.

The S.T.100 Star Circuit

The S.T.100 Star circuit is illustrated in Fig. 1. The aerial circuit consists of a variable condenser C_1 having a maximum capacity of $0.0005 \mu\text{F}$, the aerial inductance L_1 and the fixed condenser C_2 of $0.001 \mu\text{F}$ capacity. In the anode circuit of the first valve

This circuit will work a loud-speaker with perfect ease up to 25 miles from a broadcasting station. It is the outcome of an effort to simplify the S.T.100 circuit.

we have the inductance L_2 shunted by the variable condenser C_2 . This circuit is tuned to the incoming wavelength, the first valve acting as a high-frequency amplifier. Across the circuit L_2C_2 we have connected the crystal detector D and the primary T_1 of a step-up intervalve transformer T_1T_2 . The amplified high-frequency currents are rectified by the crystal detector D , and low-frequency currents are introduced into the grid circuit of the first valve by means of the transformer T_1T_2 . These low-frequency currents are amplified by the valve, the amplified low-frequency currents passing through L_2 and through the iron-core choke coil Z , which is included in the anode circuit of the first valve. In passing through Z the low-frequency current variations establish varying potential differences across this choke, and these are communicated to the grid of the second valve through the condenser C_5 , which is fixed, and has a capacity of $0.002 \mu\text{F}$. A gridleak R_4 , which may have any value from 100,000 ohms to 5 megohms without making much difference to signal strength, is connected across the grid and filament and serves to prevent an accumulation of electrons on the grid of the second valve.

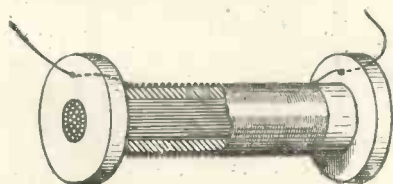

Fig. 2.—A simple choke coil.

In the anode circuit of the second valve is the loud-speaker L.S. or the telephone receivers, which are shunted by a condenser C_6 of $0.002 \mu\text{F}$ capacity. The value of the condenser C_6 may be made larger, and may even have a value of $0.05 \mu\text{F}$; the exact size of

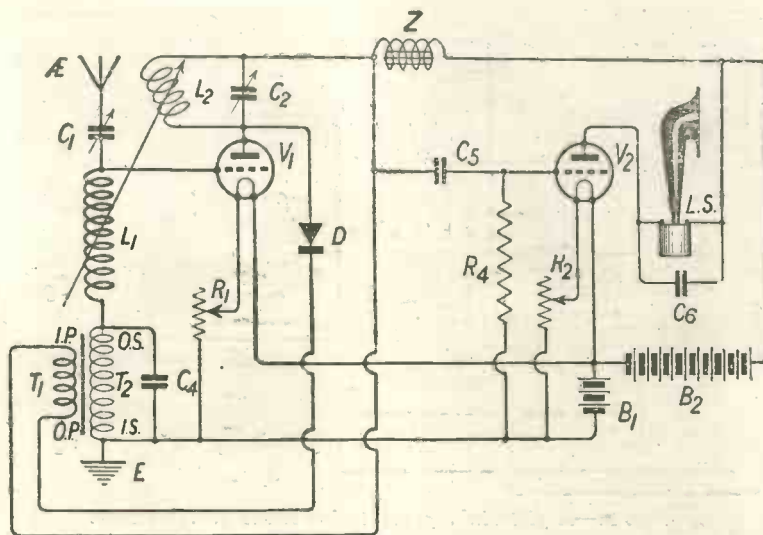

Fig. 1.—The new circuit.

the condenser depends very largely on the type of loud-speaker used.

The inductance L_2 is variably coupled to L_1 , so that reaction may be introduced into the aerial circuit. This reaction should, of course, be carefully applied so that the first valve does not oscillate and so cause interference with neighbours. It is important to see that the reaction coil L_2 is connected the right way round.

The high-tension battery B_2 has a value of from 60 to 100 volts; the latter value is preferable where good loud-speaker results are desired. When 0.06 dull-emitter valves are used the high-tension voltage need only be 70 or 75 volts.

The Choke

The iron-core choke coil Z is not specially designed. Practically any iron-core choke coil will do, and I have used the secondaries of microphone transformers, intervalve transformers and numerous other coils, wound on an iron core, without noticing any difference in the results obtained. Those who possess a spare intervalve transformer should try using the secondary as the choke coil. The ordinary S.T.100 set may easily be rewired to conform to this circuit, the only additional apparatus being the condenser C_6 . Suitable choke coils are manufactured by the Peto-Scott Company, Burne-Jones and Radio Instruments, Ltd. A suitable choke coil is that described in MODERN WIRELESS of January, 1924. A bobbin, measuring 4 in. long, is wound with 14,000 turns of No. 44 gauge double silk-covered wire. This bobbin is illustrated in Fig. 2,

and is slipped over a bundle of iron wires $\frac{1}{2}$ in. in diameter or thereabouts. There is no need to adhere strictly to these dimensions.

Advantages of the "Star" Circuit

The S.T.100 Star receiver should particularly appeal to the purchaser of cheap transformers. These are generally fatal to the S.T.100, but in the case of the S.T.100 Star quite good results are obtainable, although, of course, the same signal strength is not obtainable as when a better type of transformer is employed. The choke coil, of course, is much cheaper than an intervalve transformer, and whereas an intervalve transformer needs careful design and manufacture, the choke coil is, to all intents and purposes, fool-proof. Moreover, there is no chance of reversing the connections, as in the case of an intervalve transformer, and there are no peculiar capacity effects.

The circuit is very stable.

Pictorial Form of Circuit

The pictorial form of the circuit is illustrated in Fig. 3. The different components may be laid out on the table or mounted on a board.

When trying out a new circuit I invariably do this myself, and it is much better to try out the various components in this way before mounting them up into a set.

It will be noticed that there is no stabilising resistance in this circuit, as is necessary in the case of the S.T.100. This is rather a general statement to make, and therefore it should be added that if, with the transformer and choke

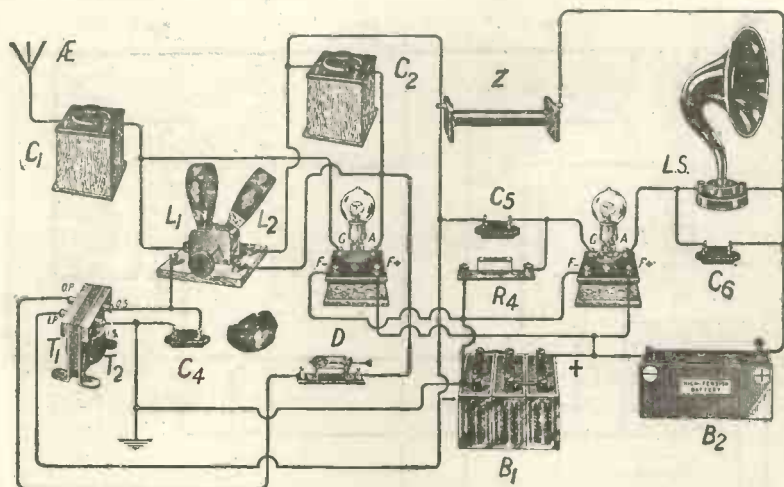

Fig. 3.—A pictorial representation of the S.T.100 Star.

used, there is a tendency to low-frequency oscillation or howling, a 100,000 ohm resistance may be connected across the grid of the first valve and the positive side of the filament accumulator.

As regards the coils used, this depends, of course, on the wavelength of the station to be received. In the case of 2LO the inductance L_1 may be a No. 75 coil and L_2 a No. 50 coil. When the constant aerial method of tuning is adopted, a fixed condenser of $0.0001 \mu F$ is connected in the aerial circuit, and the inductance L_1 is shunted by a variable condenser of $0.0005 \mu F$. In this case the inductance L_1 may be a No. 50 plug-in coil. When the series tuning arrangement of Fig. 1 is used, a No. 75 plug-in coil for L_1 will be suitable for all the broadcasting stations on most aeri-als, and if the condenser C_2 has a low minimum capacity, the coil L_2 may be a No. 75. This just brings in 2LO on the bottom of the condenser.

A Self-contained S.T.100 Star Receiver

A self-contained S.T.100 Star receiver is illustrated on the first page of this article. There are only four terminals on the panel; two for the aerial and earth, and two for the loud-speaker or telephone receivers. The actual instrument described consists of a wooden box with a removable lid. This lid is the panel on which the components and controls are fitted, and the lid, instead of being hinged, is so arranged that four pins projecting from a box pass through four holes in the lid or panel. A catch on each side of the box holds the lid down. This method was adopted by Mr. Harris in his All-Concert Receiver, and was copied in the case of the All-Wave

Receiver described in the last issue of MODERN WIRELESS.

The top panel in the set here described was made of wood, but ebonite is really preferable. The terminals are fitted to the lid with bushes of ebonite so as to minimise losses due to faulty insulation.

The Circuit Used

The actual circuit used in this set is given in Fig. 4, which is similar to Fig. 1 except that the constant aerial tuning system is employed, a fixed condenser C_3 of $0.0001 \mu F$ being included in the aerial circuit, and a variable $100,000$ ohm resistance R_3 is connected in the position shown. This resistance was fitted to stabilise the circuit if there was any tendency to low-frequency self-oscillation. In the set described no trouble was experienced, and the variable resistance was adjusted to infinity.

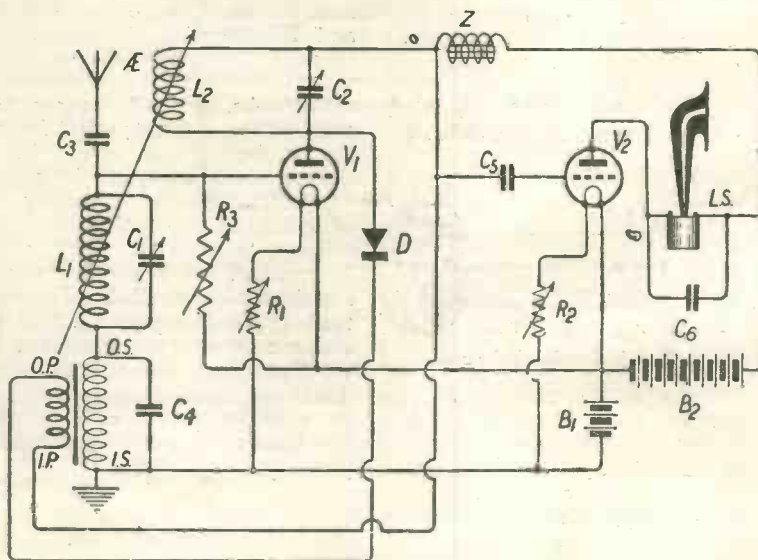

Fig. 4.—The actual circuit of the receiver illustrated.

Details of Construction

Fig. 5 shows a photograph of the top of the panel, and Fig. 6 is a drawing showing, in detail, the different components. The drawing is to scale, but the exact disposition is not essential.

The Wiring Diagram

Fig. 7 shows the wiring diagram of the receiver. This shows the underneath of the lid and also the box, which latter is cut away to show the two sets of batteries; the high-tension battery on the left and the three bell cells in the right-hand compartment, these latter serving to supply current for the filaments. The two resistances, R_1 and R_2 , regulate the current to the two valves, and, to enable bright-emitter or dull-emitter valves to be used at will, these rheostats are of the carbon compression type; either Microstats or Lissenstats will serve for this purpose.

The intervalve transformer shown in the diagram is of a cheap pattern which, nevertheless, gives quite good results. The marking of the terminals should be especially noted, and if the transformer to be used is not of the type indicated, care should be taken to see that the connections are made correctly. The wiring is carried out with bare tin copper wire, preferably of square cross section. It will be noted that there are three flexible rubber-covered leads going from different parts of the back of the panel to the batteries.

The Box Container

Fig. 8 shows the dimensions of the box container, which is of wood. There are two partitions,

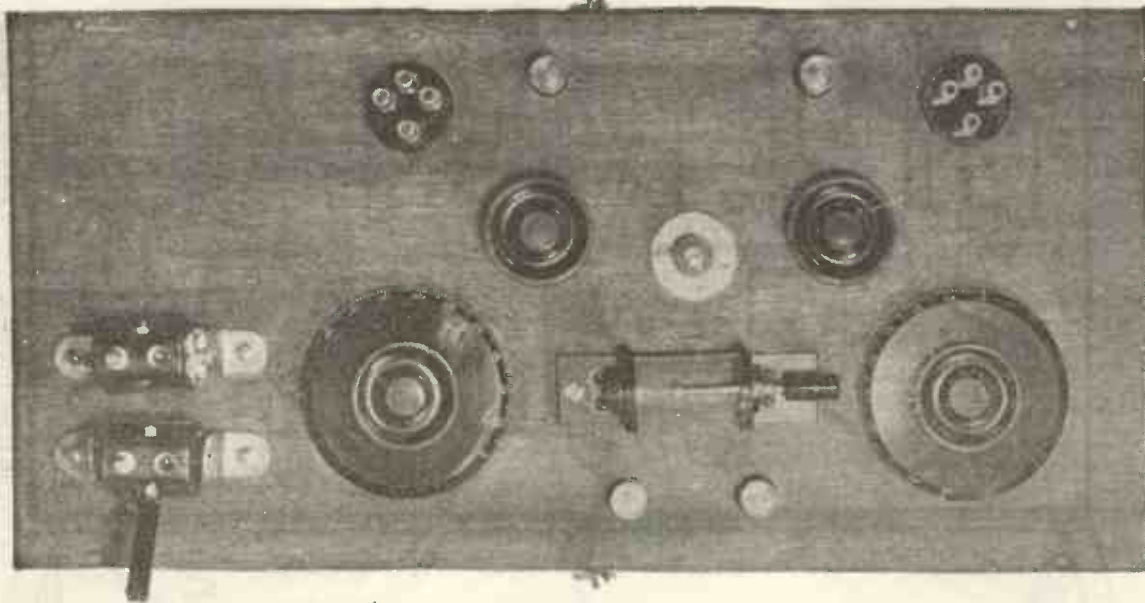

Fig. 5.—A bird's-eye view of the set.

which serve to make two receptacles for the two batteries. It is to be noted that 16 flash-lamp batteries connected in series are used for the high-tension battery.

General Notes

The set is primarily designed for use with dull-emitter valves, and although the three dry cells are shown connected in series for use with 0.06 valves, yet these could be connected in parallel

when using certain other types of dull-emitter valves.

There is a technical objection in having the batteries in the same box as the set, this being that the batteries form a large conductor at earth potential, which is brought near to the wiring, the condensers, etc. This objection could be got over by having a much deeper box, but this would make it less convenient. As the set works very well on local broadcasting,

any slight diminution of signal strength, due to the batteries being too close to the underneath of the panel, can be ignored.

Operating the Set

When operating the set the aerial is connected to the left-hand terminal, and the earth to the right-hand terminal. The telephones or loud-speaker are connected across the terminals marked "Telephones" in Fig. 6.

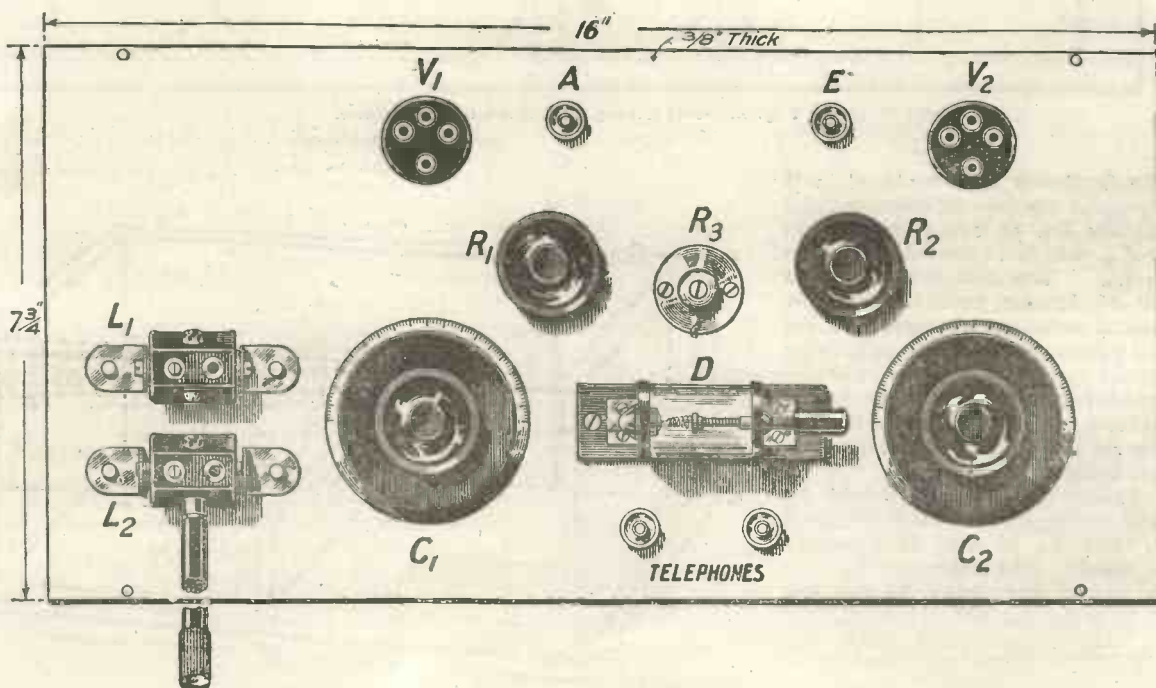

Fig. 6.—Plan of the panel.

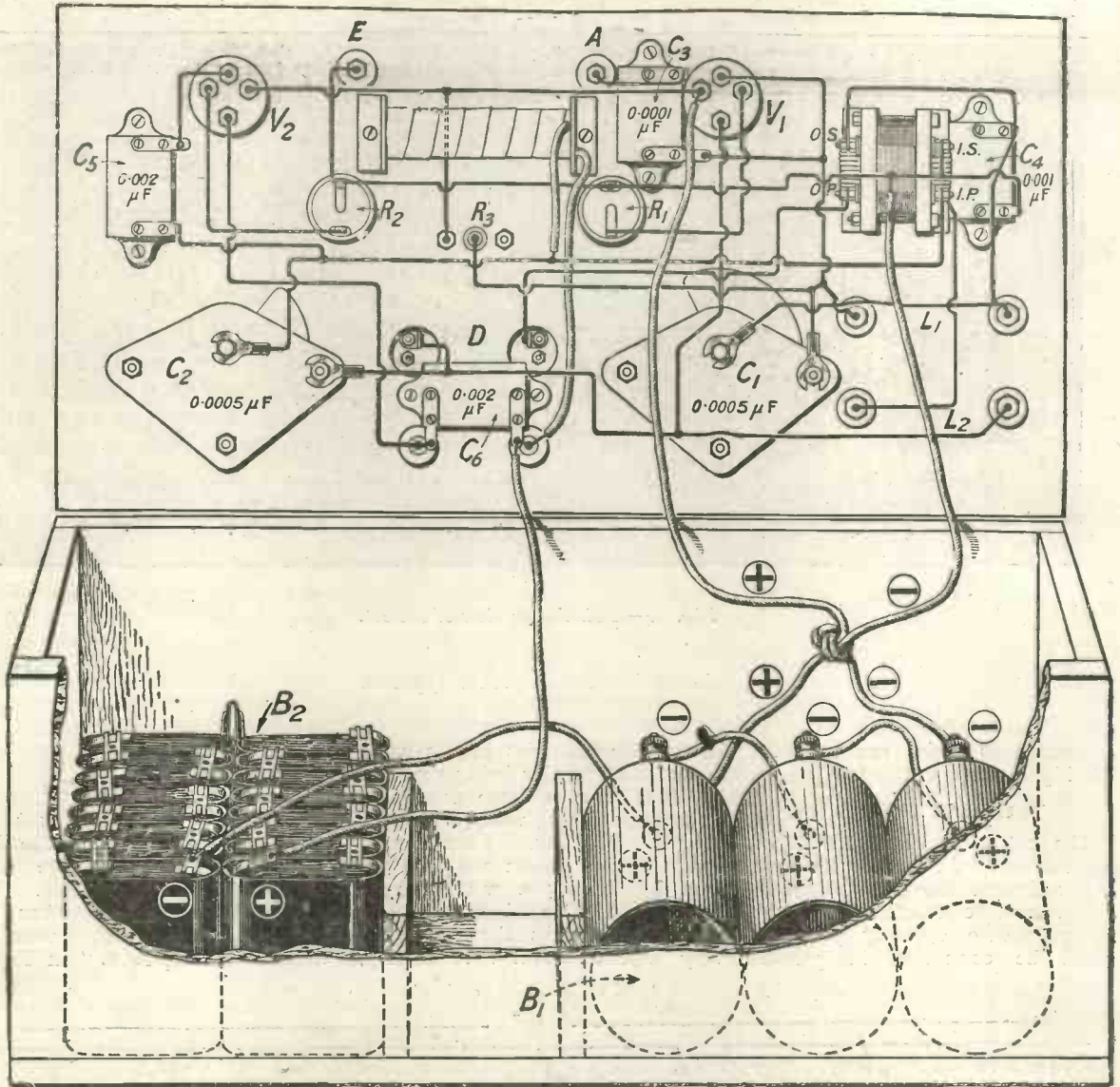

Fig. 7.—The wiring diagram and box details.

The fixed coil L_1 has placed in it a plug-in coil having 50 turns, and another No. 50 coil is plugged in to L_2 , which is movable relative to L_1 . The coil holders shown are of Igranic manufacture, but several manufacturers supply two-coil holders which will do admirably for the purpose. In the case of the broadcasting stations using longer wavelengths than 400 metres a No. 75 coil may be tried in each coil holder.

At first the two coils should be kept well apart, and the condensers C_1 and C_2 of Fig. 4 carefully adjusted. The resistance R_3 may be turned completely to the left so as to be cut out of circuit, and R_1 and R_2 adjusted until the valves are of the right brilliancy. The crystal detector should be adjusted so that the cat's-whisker

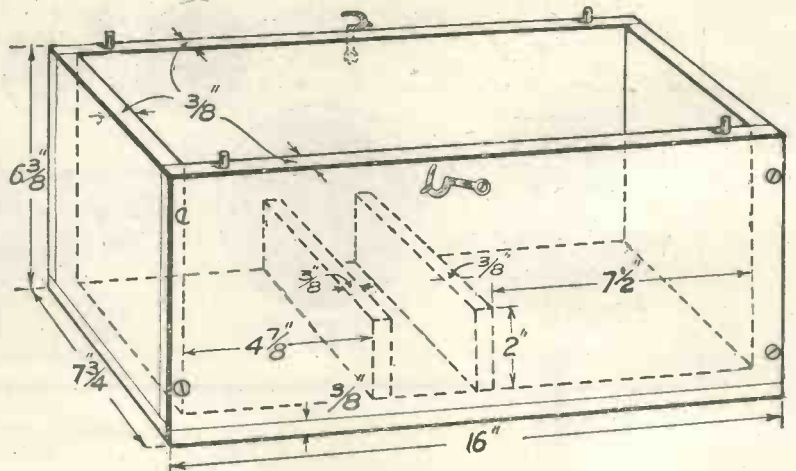

Fig. 8.—Dimensions of box.

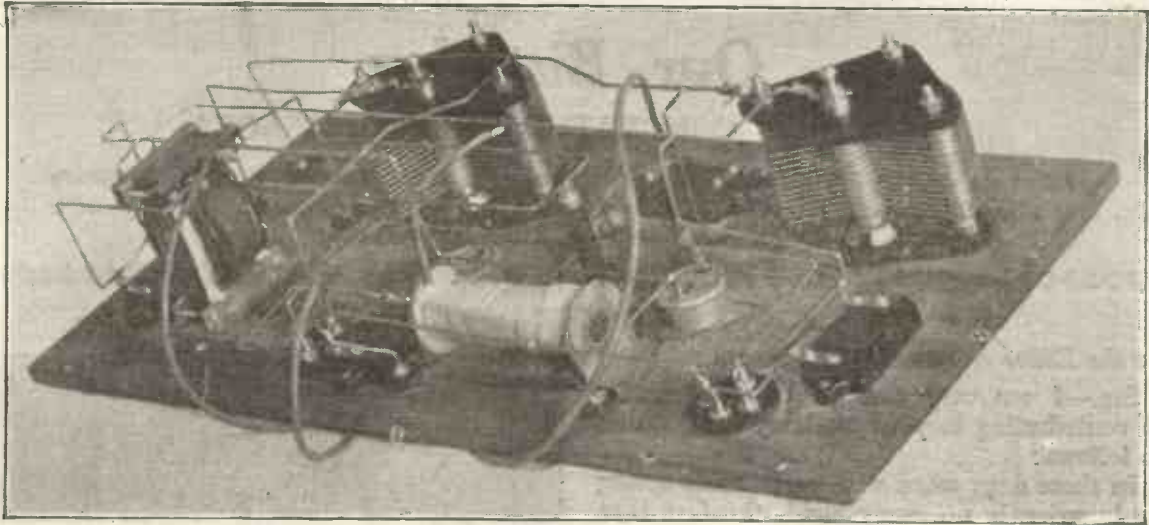

Fig. 9.—A view of the underside.

touches the crystal lightly. While the coils are still well apart and signals are being received, the crystal detector should be adjusted to its maximum sensitiveness and the coils then brought a little

closer together, retuning being accomplished on C_1 and C_2 . The coils are gradually brought closer and closer, at each stage the condensers C_1 and C_2 being retuned. If the coils are brought too

close together the set will oscillate and a howl will be obtained as the condensers are adjusted. If this is the case, immediately loosen the coupling between L_1 and L_2 and retune on C_1 and C_2 .

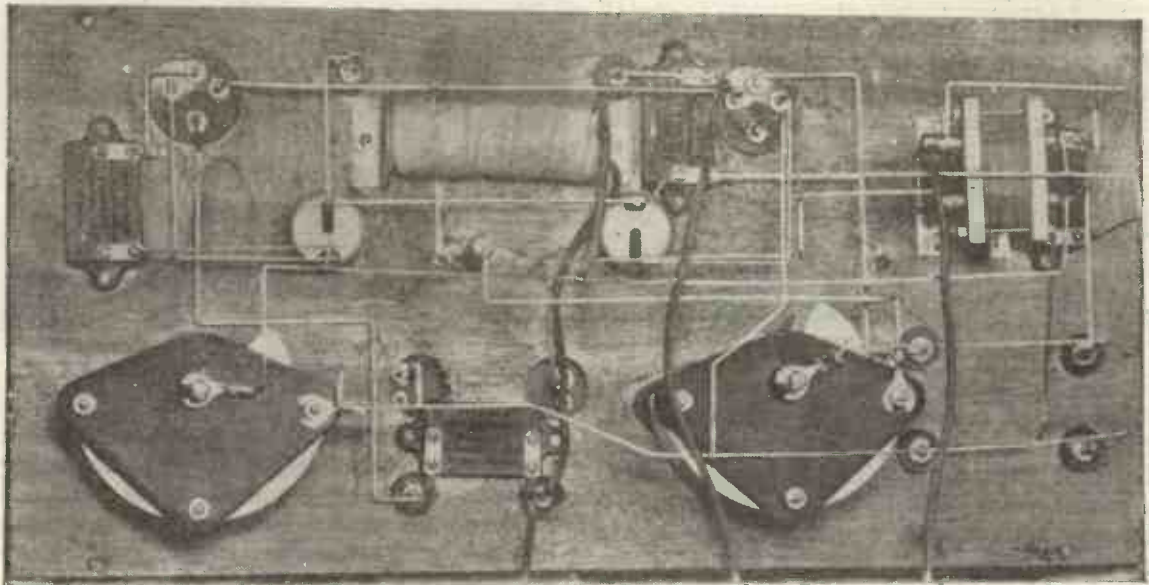

Fig. 10.—A direct view of the wiring.

Book Review

Tuning Coils and How to Wind Them. By G. P. KENDALL, B.Sc., Staff Editor, MODERN WIRELESS and WIRELESS WEEKLY. (Radio Press, Ltd., 1s. 6d.)

Probably no part of a receiving

set is so potent for good or ill as the tuning inductances, and, as the author of this book points out in his preface, probably no part is more neglected by most experimenters. Actually, good coils can make all the difference between fair and really good reception, and the author's object in presenting a clear and practical exposition of the whole subject of the design and construction of tuning coils is a most commendable one.

The book is very clearly and readably written, and covers the subject in a way that leaves the reader in no doubt upon any of the details of coil construction. It contains chapters upon turn numbers, choice of suitable wire, damp-proofing, all the various types of single and multi-layer coils, coil mounting, and some notes upon one of the latest developments—namely, aperiodic aerial coils.

Our Birthday

FURTHER CONGRATULATORY MESSAGES

Below we publish letters from Professor W. H. Eccles, D.Sc., President of the Radio Society of Great Britain, and from General Ferrie, the well-known French expert who is responsible for the world-famous Eiffel Tower installation.

To the Editor of MODERN WIRELESS.

SIR,—I am very glad of an opportunity of contributing to your birthday symposium, as follows :

In these days when wireless journals spring up luxuriantly on every hand, the fact that MODERN WIRELESS enters its second year with a firmly established clientele and goes forward with the certainty of wielding great influence on many aspects of our subject, is proof enough that the management have hit off the needs of a large fraction of the old and the new wireless public. Probably the triumph of MODERN WIRELESS amidst the general melee of the wireless periodicals may be ascribed to the fact that it happily combines simplicity of expression with technical accuracy. But whatever the explanation, I have great pleasure in wishing it augmented prosperity and influence.

Yours faithfully,

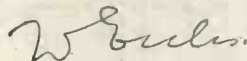

To the Editor of MODERN WIRELESS.

DEAR SIR,—Among the numerous problems which engage the attention of radio engineers, that of the short wavelengths certainly occupies the most important place. All the attempts in recent years, and in particular the recent two-way transoceanic communication on the 100-metre wave, have brought into evidence the surprising ease with which these waves are propagated. The feebleness of the energy sufficient to cover nearly half the globe with a blanket of waves which are easily perceptible staggers the imagination.

Efforts of technical men certainly tend to concentrate more and more upon the practical use of short waves.

If, on the other hand, one reflects upon the direct relations which exist between the phenomena of propagation and the whole of physical phenomena, one cannot fail to predict that, sooner or later, the laws of these relations



A recent photograph of Dr. Eccles.

will be discovered ; they would then render the most invaluable service to meteorology, because the electro-magnetic waves allow us to explore the entire atmosphere, in regions absolutely inaccessible to all our known methods of investigation.

The astonishing penetration of short waves will enable us soon to establish, with little difficulty, a considerable number of observation stations, which will prove the most valuable instruments in the study of the atmosphere we have ever had.

Yours faithfully,

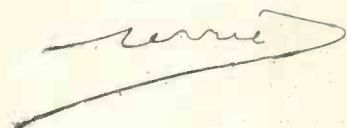

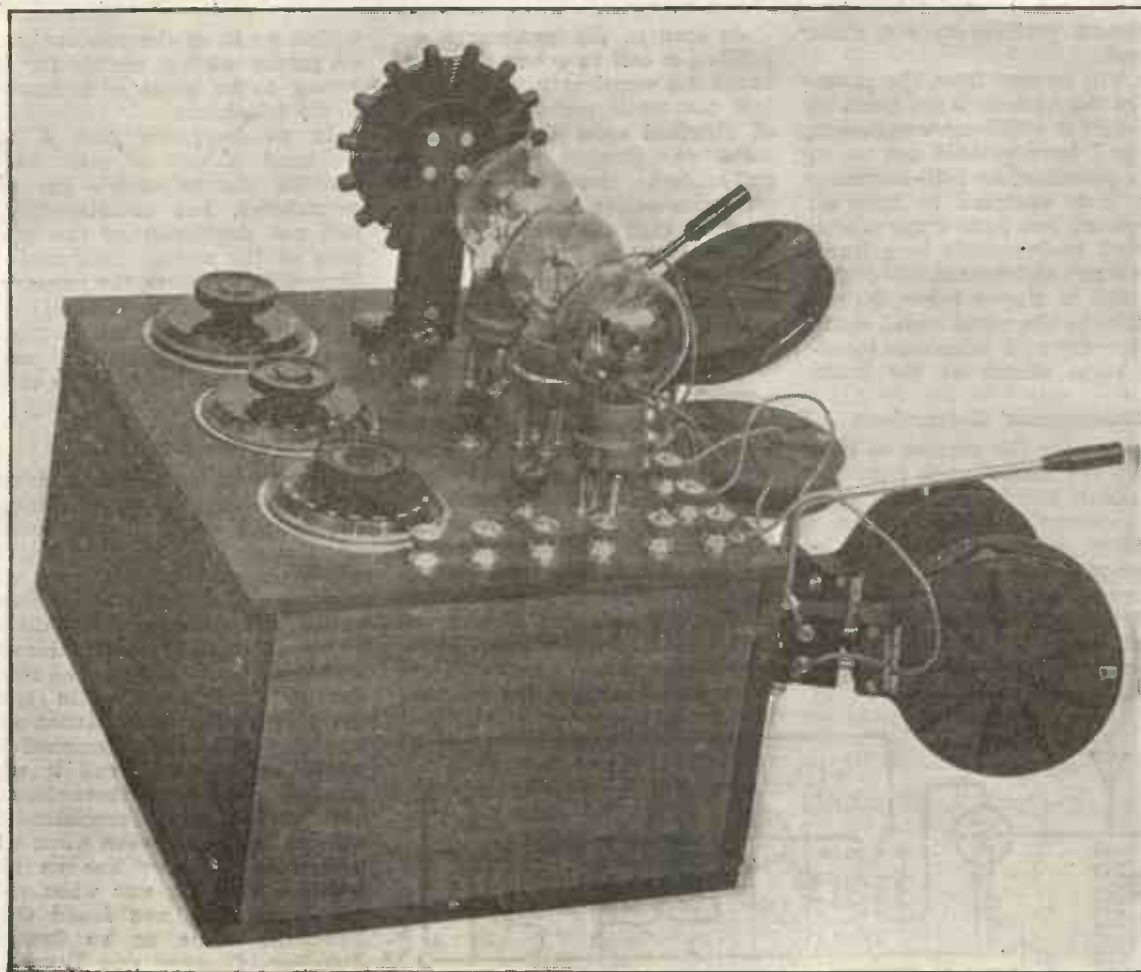

The experimental receiver used for the tests described.

Further Experiments in High-Frequency Amplification

By PERCY W. HARRIS, Assistant Editor

In this article the experiments described in last month's issue are continued with two stages of high frequency, using loose coupled transformers.

IN last month's MODERN WIRELESS I described some experiments I had conducted with a modification of the American Grebe C.R.13 receiver and by reviving the old method of using loosely-coupled transformers for high-frequency amplification. The article in question has brought me many letters from readers who have tried the method described with highly satisfactory results, and several have confirmed the view that amplification so obtained is greater than with the usual tuned anode method. The importance of low resistance in receiving circuit windings is being more and more realised, particularly as on the

very short wavelengths used in recent Transatlantic amateur communications it is essential to use thick wire for successful receiving coils. Since writing last month's article I have conducted a number of further experiments and have now built up an experimental 2H.F. receiver specially for use with loosely coupled transformers. This receiver is illustrated and described in detail in the following article, so that any readers who would like to follow out the same line of experiments may do so without much of the tedious preliminary work. At the same time I would like to state at the beginning that the receiver about to be

described is simply an experimental instrument. It does not represent a design suitable for ordinary handling by the less-skilled amateur and is not in any sense a broadcast receiver for general use. At the same time in the hands of the experimenter who does not mind fine adjustment and careful handling it is capable of giving quite remarkably good results. It is well to make this quite clear at the beginning of the article, as I do not wish the reader to be misled into thinking that he has simply to follow the design in this article and build up a receiver which will give at once a greater high-frequency amplification than he

has found possible by any other method.

As will be seen from the photographs the receiver is not made up on a board or with loose components, for, as I have pointed out on so many occasions, in high-frequency work it is essential to keep an instrument free from stray capacities and unnecessarily long leads. The present instrument, the circuit of which is shown below, has in addition to the usual aerial, earth and battery and telephone terminals, eight others at the back.

Transformer Connections

These are for the purpose of connecting the flexible leads from the coil-holders, one coil of each acting as a primary and the other as a secondary winding of the high-frequency transformers. By varying the separation of the coils in each holder various degrees of tightness of coupling may be obtained and naturally one can try various kinds and makes of coil as well as

As soon as the instrument was finished a coil to cover the usual broadcast wavelength was plugged into the aerial socket and a pair of identical coils (Gambrell "B" coils) was plugged into the two coil-holders. It will be noted from an examination of the circuit diagram that the grid circuits of the second and third valves are tuned, and not the anode circuits of the first and second valves.

Sharpness of Tuning

The primaries of the first and second transformers were provided by plug-in coils of various sizes while the coupling of the primary and secondary of both coils was adjusted to varying degrees as the experiment proceeded. First of all nothing was heard owing to the extreme sharpness of tuning, but after a few minutes' adjustment the London station six miles distant was picked up clearly and the general tuning of the set tried

within 20 ft. of the receiver gave, on proper tuning, signals far too strong to be borne with comfort in the telephones.

It so happened that I had on hand a pair of coils which enabled me to match the two secondaries, but unfortunately I had not duplicates of the other coils of the series. This made it impossible to match the primaries. The primaries being untuned could be of different sizes, and excellent results were obtainable by using one or two sizes larger in the anode coil with fairly loose coupling.

Critical Coupling

It was soon found that there was a critical coupling on each transformer and owing to the inevitable stray couplings interaction and consequent self-oscillation was easily set up. A particular point about the instrument which differentiated it from many others I have used was that once the three circuits were properly in tune the tendency to self-oscillation was largely reduced (not increased as might be expected) and it was possible to adjust all three circuits and obtain great amplification without oscillation even when the potentiometer slider was on the negative side. It was when this fine adjustment was found that Newcastle came in so loudly. Aberdeen, Glasgow and Birmingham were all heard shortly afterwards with very great clarity and purity, and with none of the slightly distorted quality so often found when signals from distant stations are greatly magnified. When the coupling was correctly adjusted the selectivity was tremendously high—far greater than I have ever obtained before.

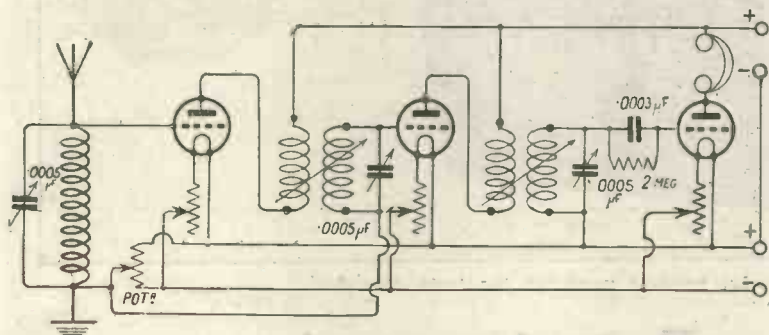

The circuit diagram, showing tuning of transformers' secondaries.

different sizes. Tuning the aerial circuit is carried out by means of a plug-in coil and a variable condenser, whilst other variable condensers are built into the instrument in such a way that they are connected across the secondary windings of the transformers. So as to reduce stray capacities and other losses to the lowest possible figure stiff No. 16 square tinned copper wire is used for connecting up, the leads-in carefully spaced in the manner shown. Potentiometer control of the grid voltage on the first and second grids is provided, the third grid being connected via the usual grid leak and condenser to the positive of the low tension battery. The reader will thus see that although the transformers can easily be changed the main parts of the receiver are kept in fixed positions. In this way we can avoid misleading indications which might come from alterations and disposition of the parts during the changes of other components.

It was found that at a short distance, as is usually the case, the high-frequency stages were adding practically nothing to the amplification, and on turning off the first two valve filaments the plate and grid coupling was sufficient to pass the energy through from the aerial to the last valve circuit. After trying various couplings and various sizes of coils in the primary position a further adjustment was made and a musical programme, thought to be 2LO again, was picked up. On listening, however, this proved to be Newcastle. This is the first occasion with any receiver on which I have mistaken a provincial broadcasting station for London and gives some indication of the strength of signals possible in this receiver when the adjustments happen to be correct. Tuning, however, was found to be exceedingly tricky and is practically impossible with any comfort without the use of a wavemeter. A wavemeter placed anywhere

Four-pin Valves

It will be noted that the ordinary 4-pin sockets were used and not the low capacity valves I have described in my Transatlantic receiver. Marked advantages would probably have been obtained with V.24 or QX valves, but until the makers are in a position to supply these valves in a much more uniform quality than is now the case, I am inclined to put up with the disadvantages of the 4-pin type.

As previously mentioned, certain leads have been brought out to the terminals and these terminals have to be connected with the coil-holders with flexible leads. This of course adds to the length of the wiring, and when further experimenting has been done it should be possible to devise a much

simpler instrument with much shorter wiring and consequently no interaction between the stages, but the reader who is really fond of experimenting can spend a very interesting time with this instrument. In next month's issue I hope to be able to give a description of a number of modifications which can be attached to these eight terminals so as to try different forms of intervalve coupling and doubtless a number of modifications will suggest themselves to more advanced readers.

Low capacity windings are highly desirable in the coils used in this particular instrument and excellent results should be obtainable with thick wire basket coils carefully wound without any shellac, wax or other impregnated substance. Aperiodic primary coils wound directly over secondary windings can be used in this instrument, and those readers who have experimented with wavetrap coils wound in this way may care to try them here. Meanwhile the following detailed description of the constructional side of the work may prove of value.

Components required

1 ebonite panel measuring 12 in. by 9 in. by $\frac{1}{4}$ in.

16 terminals.

3 filament resistances. (I have used Lissenstats here to enable bright and dull emitters to be tested.)

3 sets of valve sockets. (I do not recommend the ebonite-cased form here, as it has too large a capacity. Use the separate sockets.)

3 variable condensers. (The exact value of these condensers is not important. In the instrument described I have used 3 Fallon condensers each of .0005 μ F (nominal), but .0003 μ F could be used for the two high-frequency tuning condensers.)

1 socket for plug-in coil. (You can use the ordinary commercial socket, or, as I have done, separate brass sockets let into the panel. These are obtainable from the Bowyer-Lowe Co., Ltd.)

1 Dubilier condenser, .0003 μ F, with clips and 2 megohm grid leak.

2 two-coil-holders. (One of these should be sufficiently stiff in its movement that when placed in the position shown the upper coil will not fall down by its own weight. A Magnum coil-holder was used on the right-hand side, and an old two-coil-holder of unknown make on the left. The Magnum holder is quite stiff enough for the purpose, as is the average panel mounting holder.)

Suitable wooden box,

Quantity of No. 16 square section tinned copper busbar wire. (This wire is now obtainable from several makers, and is highly recommended for use in such receivers as this.)

1 potentiometer for panel mounting. (A "T.C.B." potentiometer was used in this instrument owing to the small space it takes.)

It should not be necessary, but I am afraid I must once more emphasise the tremendous importance of removing the surface skin of the ebonite before mounting up the various component parts. I mention this in every article I write, but I still have receivers brought to me with the original skin left on the ebonite and giving the usual leakage troubles, distortion and frying noises. One or two makes of ebonite can be relied upon to be free from any conductive surface, but unless you are per-

obtainable at the usual price of 1s. 6d. from this office. If you require it, ask particularly for Blue Print No. 19.

If you should be using the separate pins for the plug-in coil socket, be very careful how you mark out the panel for them. The spacing between centres of the two holes is exactly $\frac{1}{8}$ of an inch. Of course, if you use the ordinary panel mounting socket you will have no trouble in ascertaining the size of holes necessary. There is no particular advantage in using the separate pins, except that the appearance is neater.

The terminals are all spaced exactly 1 inch from one another, and the condensers are placed as close to one another as is convenient. Some variable condensers are provided with paper or cardboard drilling templates, which greatly

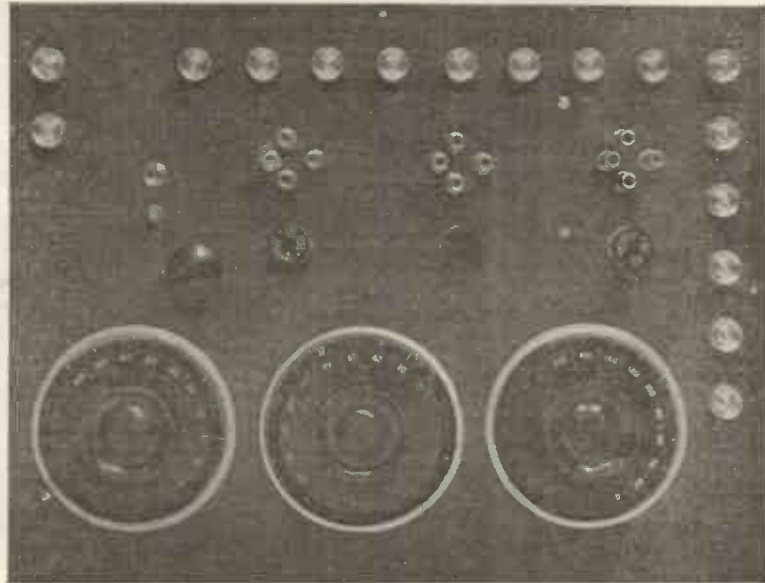

Plan view of panel. The terminal connections will be gathered from the wiring diagram on the next page but one.

fectly sure in this matter do not take any risks. With two stages of high-frequency surface leakage is to be avoided at all costs.

The detailed drawings accompanying this article will show you how to lay out the various component parts on the panel. If you have not yet invested in a steel rule and a scribe, I strongly advise you to obtain both as soon as possible. The scribe is a very sharply pointed steel instrument, obtainable for 8d. or 1s. at any good tool shop. With it you can scratch lines on the back of the panel and mark out the positions of the various parts. A full-size blue print of the panel is, of course,

facilitate the drilling of the panel to take the securing screws. The Fallon condensers have an aluminium disc which goes behind the dial. This disc itself will serve as a drilling template. Any good variable condensers will do here, and provided they are of good quality, there will be little to choose between various makes. In passing I should say that with the particular circuit here described it is not practicable to use the double condenser which was incorporated in my Transatlantic set. The Transatlantic set is a finished design, and the two primaries which are tuned are identical, the coupling being always the same in each case so as

not to upset the tuning. In this instrument, however, the grid circuits are tuned, and any alterations in the coupling will upset the tuning more than sufficient to make double condenser tuning impracticable. It should also be noted that the interposition of the grid condenser and leak in the grid circuit of the last valve is another factor which would upset the balance. Furthermore, by having separate condensers different coils can be used—a great advantage and convenience in experimental work.

The critical reader will immediately notice that no condenser is placed across the high-tension ter-

any good make of potentiometer will do here. For marking out the position of the valve legs I have found the Morris steel template highly satisfactory. This consists of a disc of steel on one side of which project four sharp points at exactly the correct spacing for the valve pins. There is also a central hole which enables one to locate the position satisfactorily. All that is necessary to do is to place the steel disc on the panel and give it a sharp tap with a hammer. The four steel points will then enter the ebonite and give very accurate drilling positions. By carefully drilling precisely on these points the

very hot soldering-iron of such a temperature that on being placed on the point of the screw or terminal to be soldered a small bead of solder is left. If the iron is not hot enough it will need to be held on the terminal for some little time, and this will heat up the shank and in turn soften the ebonite surrounding the shank. The result will be a loose terminal, which may wrench off the soldered connections at a later date.

There is rather a knack in making these connections with a stiff busbar wiring, and once you have acquired this knack you will probably want to wire every set in

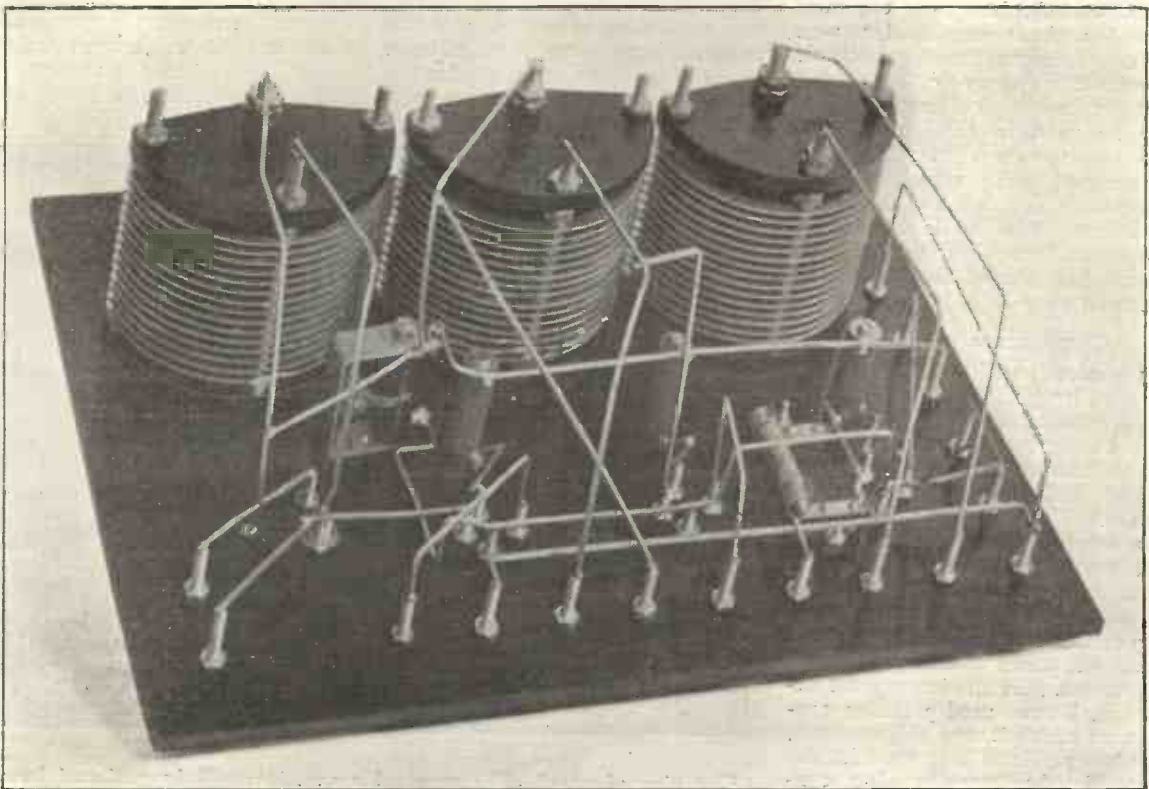

The actual wiring is carried out with stiff wire as shown.

minals, nor is a telephone condenser included. Both of these condensers are necessary for successful work, and it might be wondered why they are not shown. The reason is that it was desired to try all kinds of values here. A $1 \mu\text{F}$ condenser is advisable across the high-tension terminals, and a $.001$ or $.002 \mu\text{F}$ across the telephone leads. It should not be imagined that the set will not work without these condensers; actually it will do so quite well, but the results will not be generally satisfactory without one or both of them.

The potentiometer control is useful in experimental work, and

reader will be able to space his valve pins very exactly; indeed the fit of the valves in the sockets so mounted is generally much superior to that in the average cheap valve sockets obtainable ready finished.

Wiring Up

Before commencing to wire up, a smooth file should be rubbed over all contacts which have subsequently to be soldered. Before proceeding further, remove the brass filings with a soft brush, and at all costs avoid the use of an excess of soldering flux. Use a

this way. The secret, if it can be called one, is to use a well-tinned and thoroughly hot soldering-iron and to cut each connecting wire and bend it to shape *before* soldering is commenced. Do not attempt to solder a straight wire to a terminal and then subsequently bend it to shape. I generally try and attach a small coating of solder to the end of each wire before placing it in position, so that a quick touch of the hot soldering-iron will cause the two beads of solder to run together into a good smooth join. Should you not tin the end of each wire separately, in this way you may

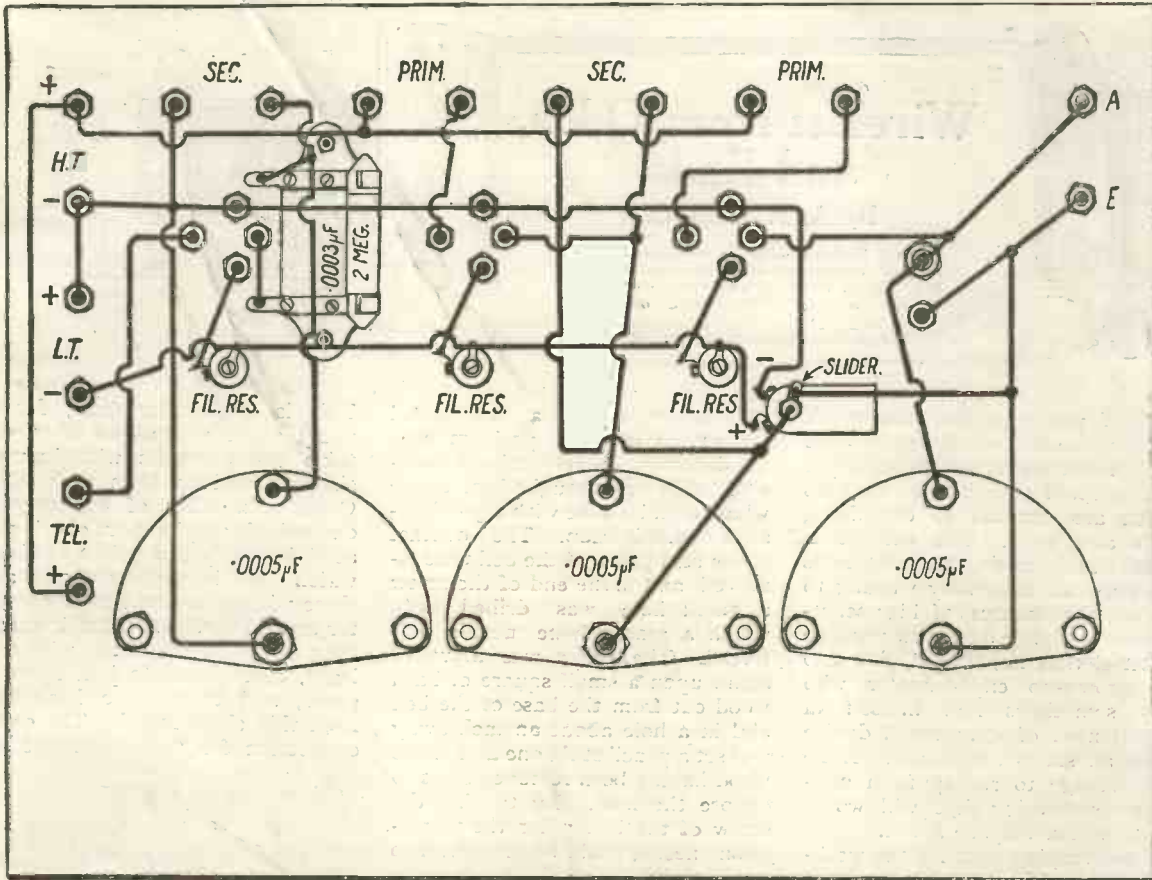

Practical wiring diagram and terminal connections.

have trouble in making a neat connection.

Notice that the wiring has been worked out to be as short as possible. This general arrangement should not be departed from.

Operating the Set

When everything is finished, test out the connections of the filament circuit first of all so that there may be no risk of burning out your valves by applying the high-tension to the wrong connections, and then choose some time after broadcasting hours to try out the set. This is important, as until you get used to the manipulation there is a great tendency to radiate with this receiver. You can, of course, try it out with a loop, in which case the connections of the loop or frame should be taken to the aerial and earth terminals and no plug-in coil used in the aerial socket. A frame con-

sisting of 10 turns of wire round a frame with 2-foot sides will suit here. The space between the turns should be about 1/4 in., but smaller spacing will give quite good results. If possible obtain a good buzzer wavemeter of some reliable type and practise your tuning with this. The grid coils in the two coil-holders should have the same value, and it is preferable to use plate coils each of the same value in the two sockets. At the present juncture I do not feel inclined to say too definitely which is the best size of coil to use, because this depends to some extent on the make of coil and its external dimensions; but so far as the grid coils are concerned, these, of course, must be of such a size as will cover the particular band of wavelengths chosen. The plug-in coil in the aerial socket can be a Gambrell "A," an S.2 of Burndept, a 35 Igranic (50 for longer wavelengths), or a 35 or 50 Atlas, to name a few

of the best-known coils. A 28 or 35 Pye coil also serves excellently here. The grid coils can be Gambrell "B," Igranic, Burndept, or Atlas 50 or 75; or Burndept S.4. One of the new Igranic concert coils can be used here and in the other sockets if desired. If home-made basket coils are used, thick wire should be chosen, and about 60 or 70 turns used. The plate coils in the two moving coil-holders can be one size above the grid coil with advantage, although two sizes may prove satisfactory if the coupling is not too close.

Finally, and once more, I would like to emphasise that this is an experimental receiver which is not easy to tune. Do not attempt its construction and manipulation unless you have had experience in tuning ordinary receivers. The sole object in building this instrument is to acquire data on the use of loosely-coupled and other high-frequency transformers.

THE LATEST CONSTRUCTIONAL BOOK.

"Wireless Sets for Home Constructors"

By E. REDPATH (Radio Press Ltd.), 2s. 6d. (post 2d.).

Full instructions for making a great variety of highly successful receivers are in this book by one of the most popular writers of constructional articles.

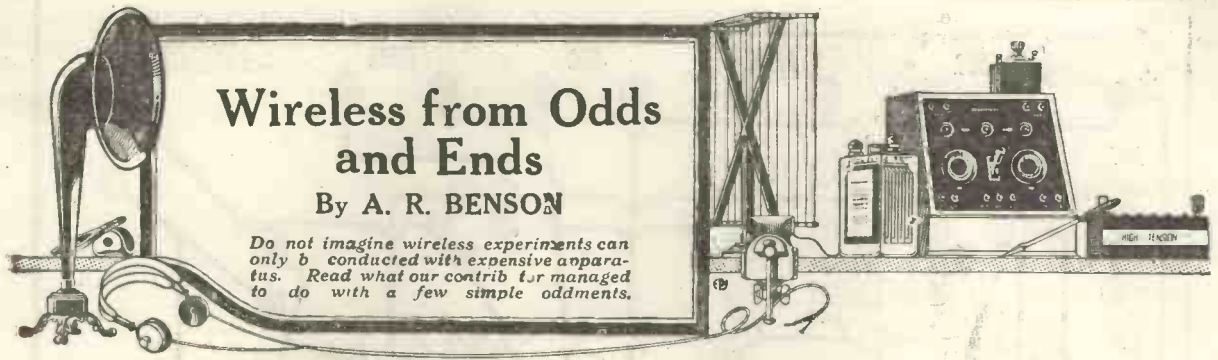

FEW people realise how much potential wireless gear there is in the average house in the lumber room and in those drawers which are devoted to containing odds and ends. The subject is worth while pursuing, for it interests not only the schoolboy wishing to eke out the resources of his pocket-money by using as far as possible material that is at hand, but also the grown-up experimenter who may sometimes find himself in urgent need of some small device when all shops are closed. If he can manage to rig up from oddments something that will work, the situation may be saved.

I was staying once for the week-end with a friend who had not at that time tackled wireless, though to-day he is as keen an amateur as you will find. On the Sunday we were talking of wireless and so much did my enthusiasm fire him that he expressed the strongest possible desire to see and hear something of its workings. Before the afternoon was over I had managed to rig up purely from the contents of his oddments drawers a set that actually brought in GNF. I cannot claim that we heard telephony, for this took place before the broadcasting era began.

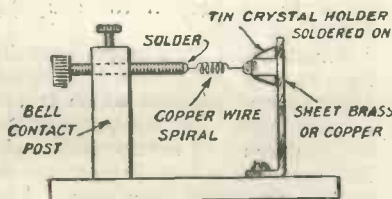

Fig. 1.—The converted electric bell fitting.

A search amongst his "scrap" disclosed an ancient electric bell which had long been discarded as too full of years to be of further service. This provided a great deal of the necessary material. The bobbins were carefully unwound and the wire from them was utilised for making up a basket

inductance upon a cardboard former. The next problem was the detector. No crystal was available, so it was thought best to see what could be done with a graphite-steel combination. The contact screw and pillar of the bell were removed, and in the end of the screw a small hole was drilled into which a gramophone needle was forced. The pillar was mounted again upon a small square of hard wood cut from the base of the bell and in a hole about an inch away was set a pencil stub, one half of the wood having been removed so as to expose the lead. By turning the screw of the bell pillar the gramophone needle could be brought into contact with the graphite. Had the smallest scrap of crystal been available a really good detector could have been made, as shown in Fig. 1. The crystal holder here is made from a piece of tin which is cut to the shape of a cross, the arms being about $\frac{1}{4}$ in. wide and $\frac{1}{2}$ in. in length. The junction of the arms is soldered to the top of an upright made from sheet brass, and the arms are then bent round the crystal so as to grasp it firmly.

As the inductance was not variable, except in so far as one could strip off wire until the approximately correct size was reached it was necessary to have some kind of variable condenser for tuning purposes. This was improvised from a couple of round tins one of which fitted fairly closely inside the other. The smaller was covered with a layer of writing paper, held in place by gum. Though the capacity was very small this improvised variable condenser worked amazingly well. We had no telephone receiver of any kind but my friend was able to borrow one from an enthusiast who lived close by. In this connection I would like to mention that there is an idea prevalent that a crystal will work only with telephones in which the resistance of each earpiece is at least 500 or 1,000 ohms.

This is quite a mistake, for at fairly short range one often obtains better results with low resistance receivers than with high. Quite a number of ex-Army 60 ohms single earpieces are obtainable at ridiculously low prices at shops which deal in surplus goods, and these will make first-rate head-sets for crystal use. All that is necessary is to provide them with flex leads, taking care to join them in series, and to make a headband from thin sheet metal. The earth connection for this makeshift set

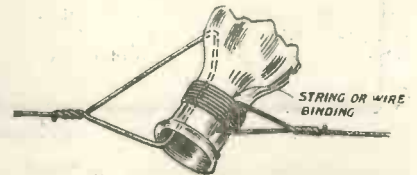
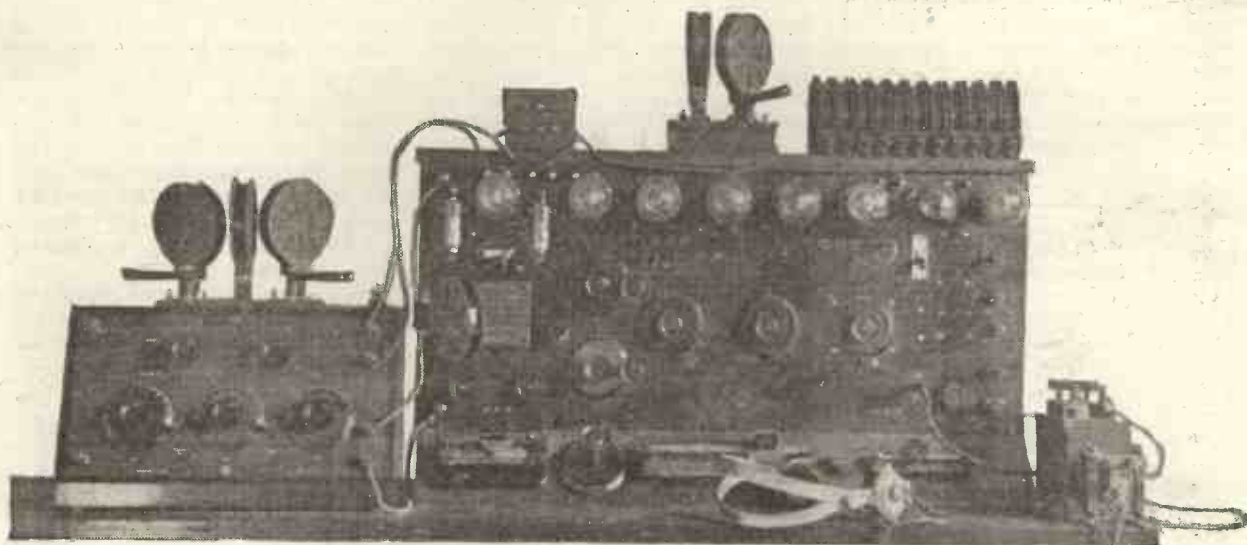

Fig. 2.—A broken bottle as aerial insulator.

was made to a handy water pipe, but the aerial presented at first rather a difficulty. However, a number of odd lengths of bell wire were found in various drawers, and these when soldered together gave a total length of about thirty yards. Insulators were made from the necks of old bottles in the way shown in Fig. 2. Two of these were used at each end of the wire. The far end of the aerial was suspended with the aid of a length of clothes-line from a convenient tree in the garden, the other being attached in the same way to one of the pipes running downwards from the gutter on the roof.

All was now ready for the attempt. Searching and adjusting might have been lengthy processes, but, more by good luck than good judgment, the coil had been wound with very nearly the right number of turns, and fortunately a sensitive spot on the graphite was found very quickly. This was done by running a lead from the front door electric bell to the earth side of the tuning coil and keeping the bell with its



A Ten Valve Receiver

How to Build the Armstrong Supersonic Heterodyne

Foreword.

IT is well known that the limitations of receivers employing high-frequency amplification are very serious when dealing with frequencies higher than 1,000 kilocycles ($\lambda = 300$ metres). These limitations are chiefly due to inter-electrode capacity of the valves used, and in a lesser degree to capacity between valve sockets, and badly arranged wiring.

The arrangement due to that very eminent radio engineer, Edwin H. Armstrong—who incidentally gave to the world one of the greatest assets to wireless, viz., reaction, or regeneration—was an extremely ingenious scheme overcoming almost completely the limitations of the ordinary receiver on short wavelengths. Stated simply his scheme was as follows:

A signal is received and rectified by a valve in the ordinary way at its fundamental frequency, let us say 3,000 kilocycles (100 metres). An outside heterodyne frequency is superimposed on this (supplied by an oscillating valve system) to give a resultant beat frequency corresponding to a wavelength of, say, 3,000 metres (1,000 kilocycles).

Now high-frequency amplification can be very efficiently carried out on this wavelength by means

of a cascade of valves coupled in various ways, viz. :—

- (1) Resistance / capacity.
- (2) Transformer.
- (3) Reactance or impedance capacity.

The resultant beat frequency mentioned above is therefore passed

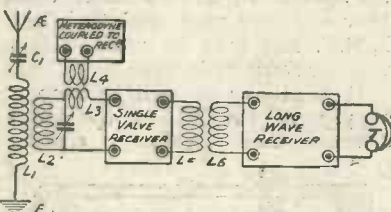

Fig. 1.—Theoretical diagram illustrating the superasonic arrangement.

on to a complete long-wave receiver and is again rectified and may undergo note magnification as desired.

At first the apparatus may appear a very complicated arrangement and apparently difficult to operate owing to the multiplicity of controls, but it may be stated most emphatically that this is not the case, and the ease of picking up signals and the subsequent finer tuning of them is a sheer delight after the heartbreaking adjustments required by an ordinary receiver, to say nothing of the capacity effect of the hands so noticeable when deal-

ing with these extremely high frequencies.

A simply understood diagram is appended showing the idea of the super-heterodyne (Fig. 1).

The aerial circuit is tuned in the ordinary way and is coupled to a closed tuned circuit—a few turns of inductance of this circuit are coupled to the heterodyne and the output of the single-valve receiver—i.e., the beat frequency—passed through the primary winding of a transformer, the secondary of which is connected to the input terminals of the long-wave receiver.

Preliminary Description.

In the instrument illustrated and described in this article several departures are made from the original Armstrong specification outlined above, the most important of which are :—

(i) A valve acting as a high-frequency amplifier at the fundamental frequency is added before the detector valve.

(ii) The heterodyne valve is coupled to a "tuned anode" circuit of this high-frequency amplifier instead of to the closed grid circuit.

(iii) Semi-aperiodic intervalve coupling of the long wave H.F. valves is employed instead of the aperiodic or resistance / capacity coupling.

By W. K. ALFORD
(2 DX)

The Armstrong Super-Heterodyne is undoubtedly the most efficient receiver of very short wavelengths. The instrument described in this article is marvellously sensitive and will receive American broadcasting on a small frame aerial.

A full diagram of the instrument is shown in Fig. 2. The coupling of the H.F. valves on the long wave side is shown as "transformer," with the exception of the first valve, although originally resistance/capacity coupling was employed, the essentials (condensers and resistances) being left in the instrument.

The change was made after the general behaviour had been studied, owing to the higher amplification gained by the use of semi-aperiodic transformers, and also that the casual picking up of long wave c.w. signals by the instrument itself could be minimised.

The choice of coupling is left to the interested reader, but it should be added that the simplicity of the resistance/capacity method is worthy of consideration.

Gambrell "efficiency" coils are used throughout the instrument, both for the aerial and closed circuits, and the fundamental tuned anode circuit. Coils H and J have been found very satisfactory in the "transfer" transformer between the short and long wave sides of the instrument. These coils possess negligibly small self-capacity, and great virtue lies in the fact that, owing to their spaced layers, the shielding of the inner layers by the outer layers is minimised—an important factor in coupled circuits dealing with very high frequencies.

Details of Components.

(1) Heterodyne coils—the usual inductively coupled grid and anode circuit is used in the heterodyne as this is found to give a cleaner and purer frequency than the simpler auto-coupled arrangements.

Two sets of coils cover the whole range of wavelengths from 70 to 800 metres with a .001 μ F condenser in parallel with the grid coils.

No. 1.—Approximate range 190-830 m.

Grid coil.—24 turns 28 d.s.c. wound hankwise on former 1 1/2 in. diam., then removed and bound.

Anode coil.—30 turns 28 d.s.c. as above.

No. 2.—Approximate range 70-250 m.

Grid coil.—8 turns 28 d.s.c. wound on 9-slot card former 1 1/2 in. diam. at bottom of slots.

Anode coil.—10 turns 28 d.s.c. wound as above.

In the instrument described two ebonite boxes as used in ex-government heterodyne wavemeters were available, and the coils were mounted in these boxes—the pins on to which they fit being on the face of the instrument (see Fig. 1) in such a position that the swinging tuned anode coil may be coupled to any desired degree with the heterodyne coils.

A micro-condenser of .0005 μ F is shunted with the main heterodyne condenser and is essential for very short wave reception.

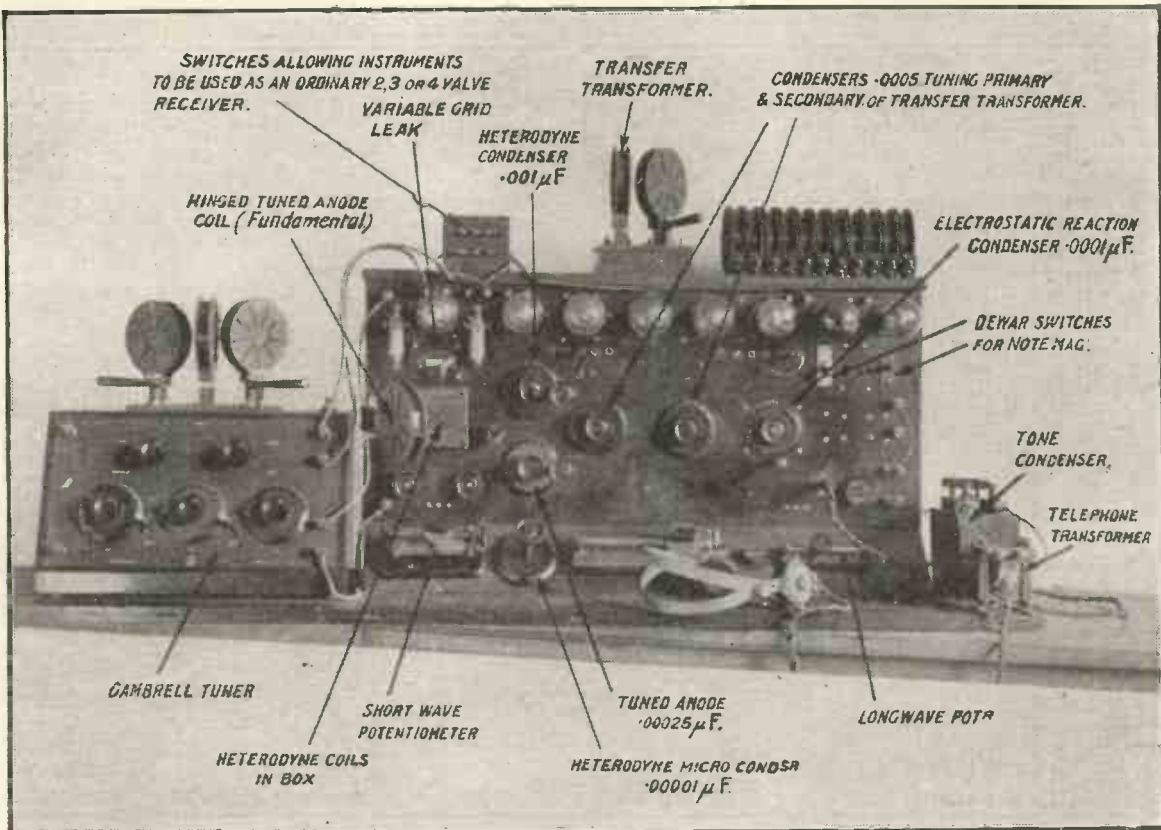

This photograph illustrates clearly the purpose of the various components and their general disposition

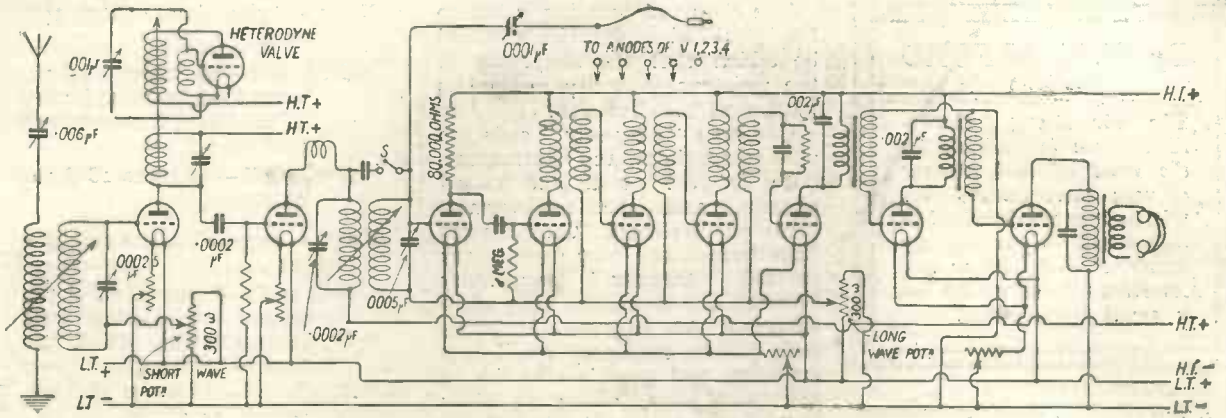

Fig 2.—The circuit diagram of the complete receiver.

The Long-Wave Coupling Transformers,

These are of the semi-aperiodic type with an optimum on approximately 2,800 m. as in Fig. 4.

The eight slots are filled with 40 S.W.G. s.s.c. copper wire, and alternate ones are connected together, taking care that the winding remains in the same direction of rotation. Four slots compose the primary and four slots the secondary winding, the ends being

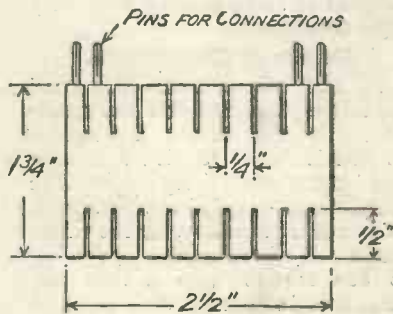

Fig. 3.—How the transformers are made.

brought out to pins screwed into the former for connection purposes.

The "Breaking-In" Plugs

In order that the number of valves may be varied in the long-wave side of the instrument, a plug and series of sockets are used (beneath valve No. 4). A sketch of the arrangement is shown in Fig. 4.

When the plug from the input is inserted the ebonite inset pushes the bronze strip out of contact with

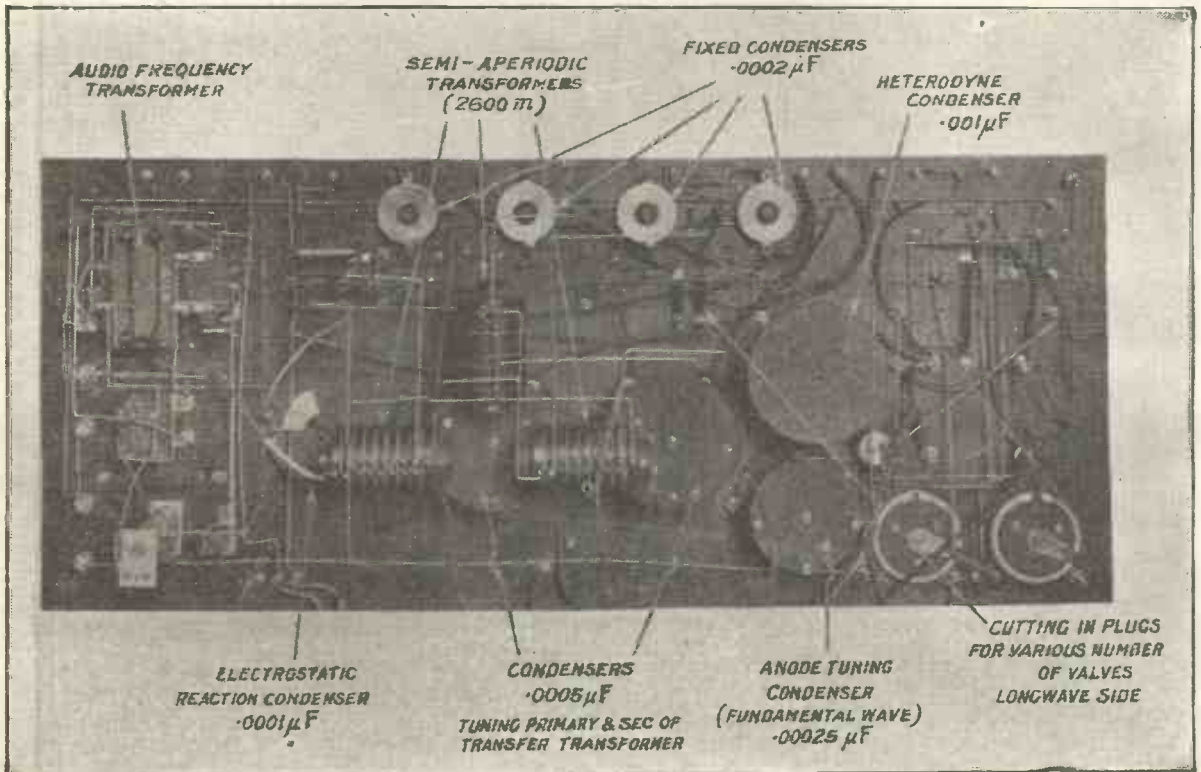

The back of panel connections depicted in detail.

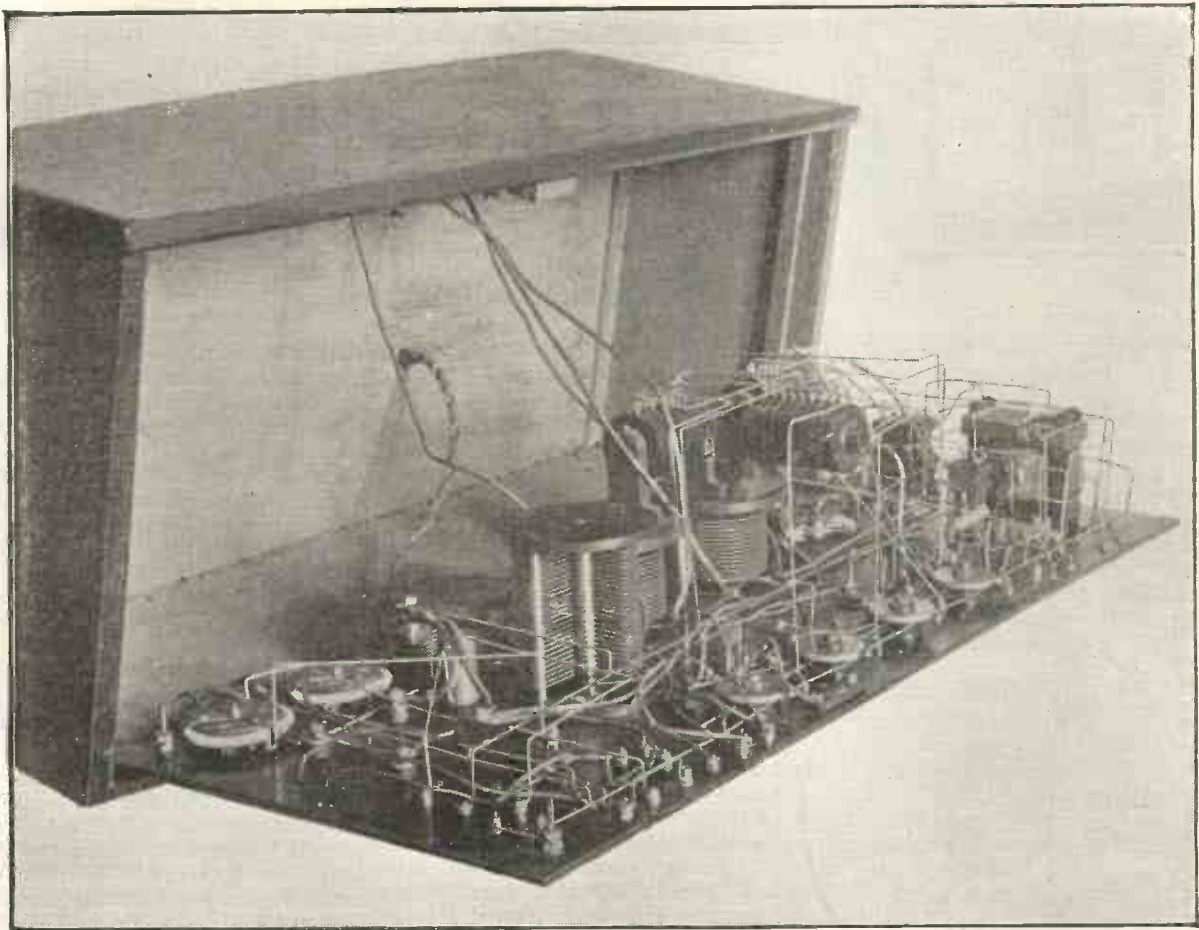

This picture will give a good idea of the height of various components and mountings.

the bush, thus breaking the transformer secondary circuit and connecting the grid directly to the plug.

The other series of sockets (beneath valve 4) connects the input of the long-wave side to the anodes of valves 1, 2, 3, 4 through a small variable condenser of .0001 μ F capacity. This enables any desired amount of electrostatic reaction to be introduced as an additional control to the potentiometer.

The fifth socket is blank to allow of this form of reaction to be cut out.

General Lay-Out of the Instrument.

An actual dimensioned general arrangement of the instrument is not appended, as there is no special merit in this particular design, and much interest is gained in individual arrangements.

As previously explained in the first part of this article, the Superheterodyne is simply an arrangement coupling together a receiver of short waves with a receiver of long waves—so that the two

individual receivers may each be used separately as desired.

The actual size of the panel is 29 in. by 12 in. by $\frac{1}{4}$ in. ebonite, and the disposition of the various parts can be easily scaled from the plan photograph and the front view. It is important that the high-frequency transformers should be arranged with their axes at right angles, and that grid and anode wires should not run parallel and in close proximity to each other, otherwise trouble will be experienced in self-oscillation.

The potentiometer control on the grids of the short and long wave

H.F. valves is also important, and is a most useful control.

Much useless fiddling about and waste of time is avoided if, when the instrument is about to be tested, each side (short and long wave) is tested on signals *individually*, when adjustments can be made and an idea of general efficiency can be got.

If possible the heterodyne should be calibrated for wavelength against a heterodyne wavemeter of known accuracy, and, of course, the position of the heterodyne condenser on the set is a useful indication when searching for a signal of known wavelength.

It should be noted that there will be *two* positions of the heterodyne condenser which give the requisite beat frequency to pass on to the long-wave amplifier, and to avoid misleading ambiguity the *upper* of these two positions should always be used.

There should be no difficulty in picking up, say, broadcasting on the instrument. When first tested the one thing to look out for is that, if the long wave side refuses to

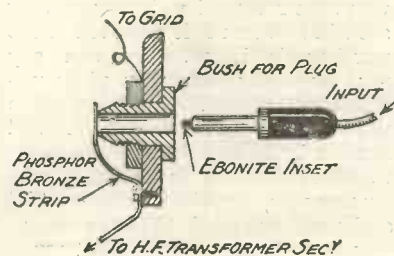
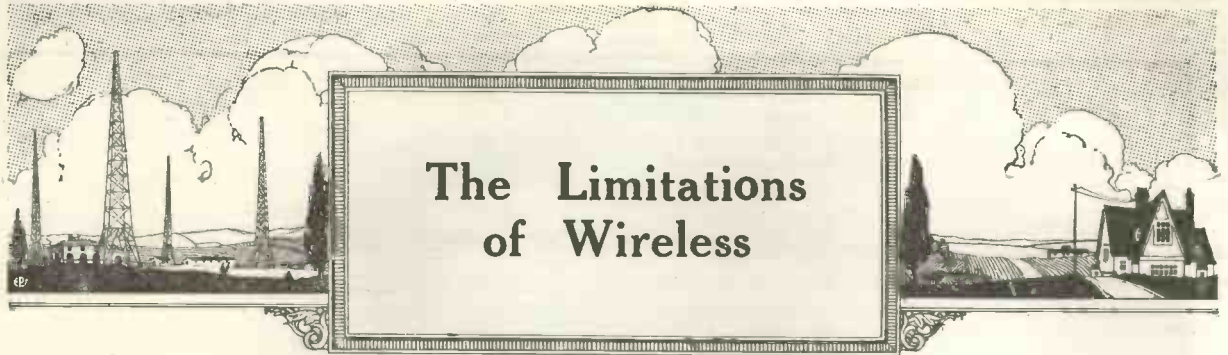

Fig. 4—Details of plug connections.

(Continued on page 459.)



The Limitations of Wireless

THERE can be no doubt that wireless is the finest hobby of modern times, from whichever aspect it is regarded. The experimenter, who is perhaps quite as interested in discovering how and why he receives signals as in the nature of the communications themselves, has before him a field that is unlimited, for the variations and

these things are done—has also a hobby of fascinating interest, for he has at his disposal an unfailing source of good music and something that will keep him in touch with the world's literature, art and science.

Some Limitations

But we must not lose sight of the fact that wireless, like all the greatest products of science, has its limitations. To take examples from other departments, we find that the microscope can go so far and no further. It will never enable us to see such tiny things as the atom or the still smaller electron, for the simple reason that an object whose length is less than half that of the wavelength of light cannot be dealt with by its lenses. The astronomer cannot continue indefinitely to bring distant worlds nearer by enlarging the size of his telescope. Besides the enormous mechanical difficulties that arise when huge parabolic reflectors come to be cast and ground, there is the fact that the earth has an atmosphere whose presence distorts to some extent the feeble rays of light that come in from great distances. Nor can he say with certainty, "I will photograph this eclipse or that transit"; he never knows whether the presence of clouds or of fog will interfere with his operations.

An Unfair Question

One of the most unfair questions that can be put to a salesman in a shop which deals with wireless goods is, "Will you tell me what the range of this set is?" The plain truth is that no one can predict with any kind of certainty what the range of a given receiving set will be when it is installed in the purchaser's home. We can say that normally the range of an unaided crystal is about twenty-five miles. This means that it will receive broadcast transmissions up to this distance in ordinary circumstances, provided that aerial and earth are good, that the insulation of the set is all that it should be, that there are no serious losses in inductances or condensers and

that the telephones are of good average sensitiveness. But notice in the last sentence the inclusion of the words "in ordinary circumstances." You may have aerial and earth, insulation, inductances, condensers and telephones that are beyond reproach, and yet fail to receive properly at less than the prescribed twenty-five miles. Or even if these things are not so perfect as might be desired, strong signals may come in from distances that are almost incredible.

Blind Spots

Those places in which signal strength with given apparatus and at given range is weak are known as blind spots. These are far more common than most people realise at present. Places in which reception is abnormally excellent have not so far received a general name, but we may refer to them as good spots. How is it that some places are normal whilst others are blind and others, again, good? This is another of the wireless questions to which there is as yet no definite

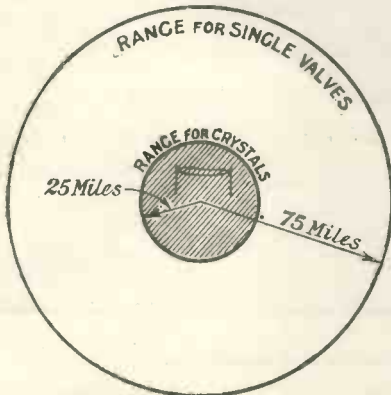

Fig. 1.—The ideal. If it were not for limitations we could map out wireless in this way

combinations that may be tried out with even quite a small set run to enormous numbers. Wireless, too, is full of problems that are awaiting solution. We have rough ideas of hundreds of questions with which it is concerned without being able to find definite solutions that are universally accepted. No one, for example, can state without fear of contradiction that he knows precisely how the crystal rectifies.

Doubtful Points

We know that it does so, and that rectification may be performed in any one of several possible ways; but which is the real way, and just how the process takes place, is still a mystery which is open for some investigator to solve. The broadcast man too—that is to say, the man who places the wireless set in the same category as the gramophone, regarding it merely as a machine which, when turned on at the right time, will provide entertainment, and not bothering his head about the means whereby



Fig. 2.—This shows very much more what is to be expected

answer, though several have been given, any of which may prove to be correct.

We know that the waves radiated from an aerial are made up of two components—the electric, which are waves moving vertically, and the magnetic, whose field is horizontal and at right-angles to that

of the electric component. It is a combination of the two into an electro-magnetic impulse which conveys the sounds as speech or the signals of Morse from one aerial to another. But how these impulses travel, and which component is the more important, is still a matter of argument. The electrical school contends that the carrying medium is the intangible omnipresent ether, and that the vertical components are the more important.

The Magnetic School

The magnetic school, on the other hand, regards the earth itself as the main carrying medium and attaches little importance to the ether. Until recently the second theory mentioned was not very widely accepted, but it is gaining adherents to-day, largely owing to the experimental work done by Dr. Rogers, who has succeeded in both transmission and reception in an iron-lined room, using what has been rather quaintly described as a "buried aerial." In any case we must admit that the nature of the earth's surface does exercise an enormous influence over the quality of wireless reception. Take for example the four stations shown in Fig. 3, of which A is the transmitter. Using a given power, he can expect to reach the receiving aerial, B, over the thousand miles of water that lie between the two stations; but the same power will barely suffice to reach C, between which and A lie sixty miles of parched desert. The country between A and D is what we may describe as ordinary, being neither very wet nor very dry. Here the probable range will be 250 miles. D, then, is a normal spot, whilst B is good and C blind.

Strange Places

Good, normal and blind spots may occur within very short distances of one another. The little town in which I live is twenty-five miles from London and seventy from Birmingham. It lies in a hollow, and upon the rather steep-sides of a deep valley running approximately north-west and south-east. Up the hill towards the southern part of the town conditions are extraordinarily good, 5IT having been received frequently upon a crystal. Lower down upon this side reception may be described as of good average quality, neither very much better nor very much worse; a crystal will bring in 2LO, but will not respond to Birmingham. At the bottom of the valley and on the heights of the northern part of the town conditions are distinctly below the average. Here, excepting one or two small areas,

even 2LO cannot be heard without the use of a valve. In one small place, then, certainly within a square mile, all three classes of wireless spots are to be found, and there are further peculiarities. In my own house, for example, I cannot make any use of a frame aerial even with two stages of high-frequency amplification. These examples will serve to show how impossible it is to guarantee particular results with any set.

Differences

Three people might purchase identical receivers; one would write a glowing testimonial of the wonderful efficiency of his set, the second would be satisfied, whilst the third would probably feel that he had been badly let in. Further, at one house at any rate, a set guaranteed to bring in stations up to a hundred miles away on a frame aerial would give very poor performances.

But this is not to say that those who live in blind or semi-blind

and if that fails to give you what you want, see what a frame aerial will do. Curious though it may seem, there are places where the frame does better than the outside aerial. One such that I have visited is in Wiltshire. Here I was asked by a friend one day to see if I could discover what was wrong with his set, which proved upon examination to be giving very poor performances. It consisted of two high-frequency valves, transformer coupled, a rectifier and a note magnifier, and was of a well-known make which usually does very well. Even when a Brown's microphone amplifier was added, strength was no better than one would have expected of a two-valve set with rectifier and note magnifier.

A Strange Cure

Tests showed there was nothing wrong with the set itself nor with aerial or earth. Having tried every thing with no success at all; I was on the point of despairing when a sudden inspiration came. There

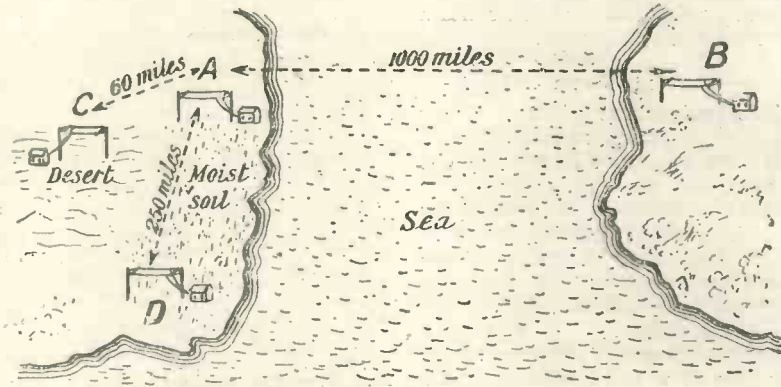

Fig. 3.—Land and water ranges.

spots must make up their minds that wireless is not for them. There is probably no place in this country where quite good reception cannot be obtained with due care and the exercise of a little thought. In a good spot almost any kind of aerial will do. You may erect a mast that is not very high and suspend from it a poorly-insulated wire which will give quite passable reception. In bad spots you must make up for the poor wireless quality of the locality by paying particular attention to the height and insulation of the aerial, to the earth, and to other small points of detail which matter much less in more favoured places.

Experiments with Aerials

One can always experiment, usually with profit, in the matter of aerials. If the usual aerial and earth do not work satisfactorily, try the counter-poise;

was no reason in it; it was simply a last hope. A wire was twisted round the lead covering of a nearby electric light wire and taken to the aerial terminal, the outside aerial being disconnected. Immediately signals came in with excellent strength. The set is now worked upon a 4-ft. frame, and does very well indeed.

Good Spots

It seems probable that good spots are due to some particular formation of the ground, very probably to a sub-soil kept constantly damp either by springs or by the presence of a lower layer of impermeable clay. If blind spots are upon level ground, the reason for their poor wireless qualities may be that there are large veins of metallic ore in the neighbourhood. In really quite a different class are places which are screened by ranges of hills, which may or may not con-

tain metallic deposits. In Fig. 4 we have a long winding valley between two ranges of hills. Here an aerial situated at A might be expected to receive very well indeed from a broadcasting station placed as shown. At B, reception should be good, though not so good as at A. At C, it will probably be poor, and at D, which is "blanketed" by both ranges of hills, it is likely to be very poor indeed. But even if we have a map of the country and know something of its geology, we cannot predict with anything like certainty that any place will be good, bad or indifferent from a wireless point of view; for example, a station such as C in Fig. 4 might be particularly good, owing possibly to some focusing effect of the hills. In some Welsh valleys, for instance, reception is particularly good, whilst in others "blanketing" is very bad indeed. I have always wondered whether the badness of Sheffield as a wireless spot is not due to the presence all round the town of enormous slag heaps which contain vast quantities of metal.

Getting Them All

The beginner at wireless, or the man who has advanced from a small set to one of larger size, has usually one outstanding desire: he wants to be able to get every British broadcasting station. One quite frequently hears salesmen asked the question: "If I buy this set shall I be able to hear all the B.B.C. stations?" The proper answer, of course, should be: "If you live in a good wireless spot, and if you erect this set so as to give it every chance, you should be able to do so; but I cannot guarantee that you will be able to hear them all." It may be the fault of the transmitting plants of the stations themselves, or of their aerials, or it may be due to some quality of the soil in the district in which they are situated, but the fact remains that some of them appear to have a much more limited range than others.

Trouble with Manchester

In the south of England, Manchester is by far the hardest to pick up. Still, most good sets will do it under normal conditions. But there is a far greater difficulty than that of mere range which bars our way when we want to hear all broadcasting stations. This lies in the fact that telephony cannot be sharply tuned, and that the closer you are to a broadcasting station the greater will be the wave band covered by its transmissions. The effect of a nearby broadcasting

station upon an aerial is not unlike that caused by atmospherics. A very strong impulse reaching an aerial causes it by sheer shock to vibrate at its fundamental wavelength. Hence it produces a sound which is audible on all wavelengths and cannot be tuned out. The strength of broadcast transmissions does not approach that of atmospherics, and therefore the shock effect is much less marked. Still, if they are powerful it may be found that they blot out everything else for 100 metres or more on either side of their own wavelength. If I use a single-circuit tuner, 2LO is audible from about 250 to nearly 500 metres.

Selective Tuning

With a selective tuner this is, of course, very much reduced, in fact with its help it is possible to bring in either Cardiff or Bournemouth, only 15 metres on either side of 2LO, without interference. This, however, is a diffi-

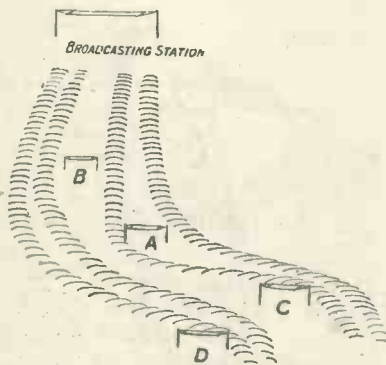

Fig. 4.--How stations in long valleys may be screened

cult feat, and it cannot be done without a certain amount of labour. Wave traps help to a very great extent, and those who are troubled by interference, whether it be from spark transmissions or from other broadcasting stations, will do well to try out one of the three types described recently by Mr. Percy Harris. Here, then, is one of the great limitations of wireless telephony; if you wish to increase the range of your station, so that quite small sets will bring in its transmissions in distant places, you must increase your power; by doing so you very much widen the wave band covered; hence it is not at present possible for a large number of high-powered stations to work on anything like the same wavelength without causing very great mutual interference.

What Is the Gain?

After all, is there anything to be gained so far as broadcasting is con-

cerned in being able to bring in all stations? The true experimenter will reply at once that there is, for long range is almost everything to him. But those who use wireless sets chiefly for the purpose of listening to music will look at the matter from rather a different standpoint. It may be said at once that no matter what type of set you use, you will obtain the most pleasant reception from the stations whose signals are the strongest, for with them you can work your valves so that they are not going "all out"; there is no need to use reaction, except perhaps as an aid to sharp tuning, and a second note magnifier will usually suffice. As soon as we attempt to bring in very distant stations we must add high-frequency amplification to the rectifier. Now, though high-frequency amplification certainly gives greater range, it also increases the amount of "mush" which is brought in; hence signals are not so pure and we become conscious of a kind of background of woolliness.

Reaction and Clarity

When we make full use of the reaction coil we again detract from the clarity of our reception and bring up every parasitic noise that is inherent in the set. It must not be forgotten that through the reaction coil is flowing current from the high-tension battery which is the source of nine-tenths of such parasitic noises that do occur. When we couple this coil to an inductance in the grid circuit, the tiny variations in the output of the high-tension battery, which must occur through partial polarisation, are communicated to the grid and passed on in amplified form. It follows then that the more we "press" the set, the less good will our reception be. A further point is in the note magnifiers. Every valve amplifying at low frequency must distort to some extent for a variety of reasons. With one low-frequency stage distortion may be so small as not to be noticeable, but when we add a second we make whatever faults there are very much worse. For this reason a weak signal, brought in only by the use of, say, two high-frequency stages and reaction, can seldom be raised to loud-speaker strength with that background of silence which is so desirable or with complete absence of distortion. When we try to do it we nearly always find that we have to complain bitterly of atmospherics, which are really, not atmospherics at all in most cases but amplified noises due to the set itself.

Noises

True atmospheric are in this country not of very common occurrence upon the shorter wavelengths in the darker months; or one should say that they are seldom so bad as to interfere very seriously with reception. Still, their occurrence does place yet another limitation upon wireless, a limitation which concerns in this case not so much the range of wireless as the certainty of communication at any given time between two stations which are normally capable of reaching one another. The operator at a station which we will call A cannot say: "I communicated easily with B last night and tonight; therefore I shall be able to do it next Tuesday week." If atmospherics are very bad the two stations may not be able to work together at all on that day.

Causes of Atmospheric

Atmospherics appear to be due to electrical disturbances in the atmosphere. They are usually at their worst when a thunderstorm is raging in the neighbourhood, but they may occur and be very bad indeed at times when there is no

thunder about. Some are produced by the rapid deionisation of the air which occurs shortly after sunset; and they may be heard again when the process of ionisation begins at sunrise. Again, barometric disturbances may be responsible for them, for the varying pressure causes charged strata of the atmosphere to rise or fall, bringing them into contact with other layers carrying a different charge. Very many devices have been tried and much work has been done with a view to the elimination of atmospheric interference with wireless work. So far the matter seems to be beyond our control, especially on the higher waves where the wavelengths used in wireless approach those of atmospherics themselves. In years to come the solution may be found in the use of very short waves, to which inventors and experimenters are now giving a great deal of attention.

In Conclusion

The conclusion, then, to which we come is this. We can now send messages, whether in the form of signals or by the spoken voice, from place to place with very fair certainty that they will be received

by stations within the normal working range of our transmitter. If we purchase a receiving set, we can feel fairly sure that it will do what is expected of it. If it is erected in a normal locality it will work well in connection with an aerial of the standard kind, whilst if the place in which it is used is a bad one from the wireless standpoint the set can be made to give results by paying due attention to the design of the aerial and to the quality of the earth connection. We must expect a certain amount of interference if we live within a short distance of a broadcasting station, but we can do much to eliminate this by the use of selective tuning circuits and of some kind of wave trap. Atmospherics will occur, but they will not happen so frequently as to be a marked nuisance; in fact there will be very few days in the year when good reception is not possible. The main thing to bear in mind is that wireless has certain limitations, and that, such as they are, we must be content to put up with them. Do not expect too much from your set, and at the same time do not expect too little.

R. W. H.

How to Build the Armstrong Supersonic Heterodyne—(continued from page 455).

stop oscillating and on turning the heterodyne condenser, more harmonics are heard than Leafield ever produces (!), it is usually due to self-oscillation of the short wave side, and its potentiometer should be adjusted to give sufficiently positive bias to the grid of the first valve to stop this.

In the front view photograph a Gambrell tuner is shown which has given every satisfaction with the set, and the use of a good instrument for this purpose cannot be over-emphasised. Critical adjustment of the coils is important, and as the efficiency of the set is much assisted by the use of a secondary closed circuit, condensers capable of delicate variation should be used.

Reaction on the short wave side is rarely required, adjustment of the

potentiometer being usually sufficient; in fact, it is useful sometimes to introduce a small amount of negative reaction for stabilising purposes, especially on very short wavelengths.

Performance

The Superheterodyne, in the author's experience, is the most remarkable receiver known to the wireless science. Its capabilities seem unlimited and are demonstrated by the fact that at one moment one is receiving signals of medium telephone strength; by adjustment of the various parts of the receiver these signals are brought to loud-speaker strength without difficulty. As an indication—a carrier wave which will give only just audible and intelligible speech on an ordinary H.F. Rectr., L.F. receiver gives

loud and clear speech on the heterodyne with only two more effective valves operating.

As regards reception on a 2 ft. frame aerial, this instrument gives all the broadcasting stations at good strength without note magnification, and with one note magnifier 5SC (Glasgow broadcasting station) is unbearable in the phones.

Its record on this frame was signals of good strength from 4FT, an American amateur in one of the central American states.

KDKA (Pittsburg) roars in on 103 metres with one stage of magnification, using the aerial, and is just intelligible on the frame.

In conclusion, I shall be happy to assist all who undertake the construction of this type of instrument, through the medium of MODERN WIRELESS.

Read "WIRELESS WEEKLY" for sound advice and constructional articles.

The Care and Maintenance of Accumulators

By R. L. ROPER

To obtain satisfactory results from a valve receiver it is essential that the filament supply should be steady and dependable. This contribution, by pointing out the importance of proper care of the accumulator, should give valuable assistance in keeping the battery in good condition.

ALTHOUGH the accumulator is not an accessory peculiar to wireless, it is universal where bright emitter valves are used, and it can be a big factor for good or evil in the operation of the set. Owing to the conditions to which accumulators of the type used in wireless have been required to stand up in automobile work, they have reached a high state of efficiency and ability to withstand rough usage. Consequently, under the less strenuous conditions of wireless work they are apt to be looked upon as "fool-proof," and their service taken as a matter of course. In addition, they are very often out of sight and consequently out of mind.

Simple Rules

If accumulators are to render efficient and reliable service, there are a few simple rules



A typical hydrometer for testing accumulators

which must be obeyed, the more so as non-observance will result in the total or partial destruction of the accumulator, or, at the very least, a discharged cell at a most inconvenient time.

In order to understand clearly the necessity for this care of the accumulator and the dire consequences of non-observance, it is perhaps as well to see how it is constructed and the action which takes place in the cell which supplies the electricity we use.

The Lead Cell

By far the most common type is the lead and sulphuric acid cell. The cell is, of course, familiar to us all, but its composition may be of interest to many. The outer casing must be of some substance impervious to the action of sulphuric acid, and if it is transparent we can see inside, which is

all to the good. For this reason celluloid is popular. Glass serves the purpose well where risk of breakage is small, and it is more durable and cheaper than celluloid.

Enclosed in this case are two sets of plates, alternately connected and evenly spaced from each other.

The negative plates consist of lead (Pb) and are all joined to a common bar at the top culminating in the negative terminal. Between the negative plates are spaced the positive plates of lead peroxide (PbO₂), which are similarly joined to a common bar which carries the positive terminal.

Construction of Plates

The plates are of peculiar construction and each set is "burned" to its own lead connecting bar. The construction of the plates does not

concern us beyond the fact that it is such as will give them porosity and permits of expansion and contraction under variation of temperature without undue change of shape. It will be noted that as the positive plates are between the negative there will always be one more negative plate than there are positive. It is not necessary to have more than three plates, but in order to obtain a workable capacity these plates would need to be of large area and would result in a cell of awkward dimensions; therefore, for commercial purposes, the total required area is obtained from a number of suitably shaped plates joined together.

The Electrolyte

Surrounding all the plates and rising to a point high enough completely to cover them is the electrolyte, consisting of pure dilute brimstone sulphuric acid. The top of the case is

covered in to obviate loss by spilling, and the vents left for filling purposes are usually fitted with a rubber cork which has a small glass tube through its centre to permit the escape of gas.

All the constituents must be pure: The water used to dilute the acid must have been distilled so that it is chemically pure; water which might be excellent for drinking purposes may be injurious.

The sulphuric acid must be "brimstone" sulphuric acid, since some acid is made from iron pyrites, and iron damages the negative plates. This is important, and the same damage would occur if iron were introduced by the water added to replace evaporation.

Chemical Action

We will now consider the chemical action which takes place, giving rise to potential differences in the cell. It is such that this chemical action is completely reversed when current from another source of higher potential is passed through the cell in the opposite direction to its own potential. The chemical action which takes place in the cell when current is being drawn from it, *i.e.* it is being discharged, is as follows:

The lead peroxide (PbO_2) on the positive plates combines with the acid to form lead sulphate ($PbSO_4$), meanwhile the acid becomes more dilute. When current from the charging source is put through the cell in the opposite direction, the chemical action is reversed: the lead peroxide is restored on the positive plate, the acid regains its former strength and the lead sulphate on the negative plate is removed. This may be better seen in a tabulated form.

	Positive plate.	Electrolyte.	Negative plate.
Cell being discharged	PbO_2 ↓ $PbSO_4$	H_2SO_4 ↓ $2H_2O$	Pb ↓ $PbSO_4$
Cell being charged	$PbSO_4$ ↓ PbO_2	$2H_2O$ ↓ H_2SO_4	$PbSO_4$ ↓ Pb
Condition when fully charged	Rich chocolate in colour.	Specific gravity 1.22	Bluey grey in colour.
Condition when discharged	Rusty brown in colour.	Specific gravity 1.18	Light grey in colour.

A fully charged cell has a potential of 2.2 volts, and the specific gravity of the electrolyte should be about 1.22. During discharge the voltage falls rapidly to 2.1 v., and then very

gradually and slowly to about 1.9 v., when it again falls rapidly to complete discharge. The rate at which a fully charged cell may be used to send current depends upon the total area of its plates. The maximum rate as a rule is that at which the cell becomes discharged to 1.9 v. in 8 hours. Practically all accumulators have printed on them the maximum rate both for discharge and for charge, together with the sp. gr. of the electrolyte to be used.

When current is being drawn from a cell the voltage gradually falls and the specific gravity

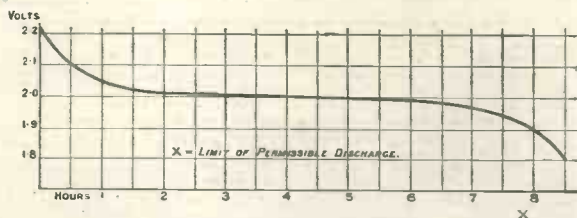

The discharge curve of an accumulator.

of the electrolyte is reduced. When the voltage has fallen to 1.9 v. and the sp. gr. of the acid reduced to 1.18-1.85, the cell is said to be discharged and should be immediately placed on charge. This does not agree with the table set out above, where the acid is reduced to water and the lead peroxide turned to sulphate. In practice it is not permissible to approach these conditions, otherwise the lead sulphate deposited on the plates would become permanent, and it would be impossible to break it up by passing a charge in the opposite direction to the potential of the cell. When this occurs the cell is said to be "sulphated," and there is no remedy except to buy new plates; virtually a new cell. In a less extreme case, which may occur from a discharged cell being allowed to stand some time without a charge, the plates are still said to be "sulphated," but it may be possible to overcome this by a long overcharge at a moderate current.

Capacity Explained

The capacity of a cell is referred to in ampere hours, which is the product of the current in amperes multiplied by the duration in hours which will bring the cell to its discharged state.

Voltages higher than two are obtained by batteries of cells connected in series, *i.e.* the positive of one cell connected to the negative of the next, and so on, which will give the added voltages of all at the extreme terminals. This arrangement of cells is variously described as a battery, secondary battery, storage battery or accumulator.

Whilst the chemical action described above is taking place heat is generated and the plates

will expand. If the electrolyte does not cover the plates, the uncovered portions will be unaffected by the action and will not expand in company with the action and will not expand in company with the covered portions; this will tend to buckle the plates concerned and may cause a short circuit by the actual touching of adjacent ones, or by the expulsion of a portion of the compound formed in the plates lodging between them.

A certain amount of water from the electrolyte will evaporate, especially when the cells heat up; this must be replaced periodically,

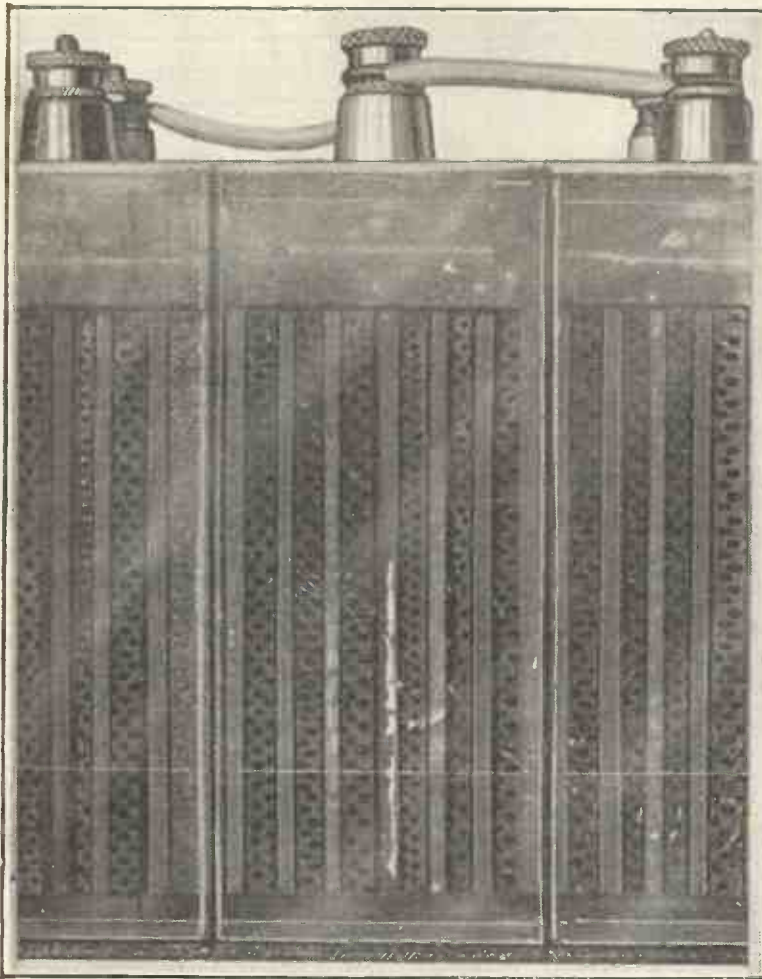

The white deposit on the edge of a plate is the deadly "sulphate" which soon ruins a cell.

to keep the plates covered, by distilled water, which should if possible be introduced into the bottom of the cell to ensure mixing, by some such means as rubber tubing used in cycle valves and a fountain-pen filler.

Corrosive Sprays

The gas from the cells is corrosive, so that the terminals and wire lead ends should be kept covered with a film of vaseline.

It is well to bear in mind that, with a 6 v. accumulator and a valve, or valves, which work on 4 v. or less, it is possible to reduce the resistance of the filament control so that the valve functions when the accumulator has reached and passed its "discharged" state without one having noticed the fact, but it will be almost a certainty that its potential will have still further dropped when next required and obstinate sulphate may have been formed. The condition of a cell should be determined both by a voltmeter, the reading being taken when the cell is connected in circuit, and by taking the specific gravity of the electrolyte by means of a hydrometer at a normal temperature of 50°-60° F.

From the above we can evolve a few simple rules for the maintenance of an accumulator. The conditions most tending to long life and efficient service are: regular work, regular charging, and periodic attention. The maker's instructions should be implicitly carried out, especially as regards the initial charge, maximum rate of discharge, rate of charge, and the specific gravity of the electrolyte. The condition of the cells should be periodically checked, both during discharge and at the termination of charge, when both the maximum voltage and specific gravity should have been obtained.

How to Choose a Cell

If you are purchasing a new set of accumulators, one or two points need to be considered. The case should be transparent so that the condition of the plates, etc., can be examined and any buckling, disintegration or loss of electrolyte may be readily observed. The accumulator should be of sufficient capacity to ensure a reasonably

long discharge at the load you intend to put upon it. For instance, if you have a three-valve set with each valve taking 0.75 amps., giving a total of 2.25 amps. If you expect to use your set nightly during the week for three hours, which equals 21 hours for the week, giving a total of 47.25 ampere-hours, a 50-ampere-hour accumulator will be the smallest capacity from which you can expect the required service.

Dual Amplification Circuits I Can Recommend

By THE EDITOR

The ever-growing popularity of reflex circuits with their economy in valves will make this article of great interest.

DUAL amplification, or reflex circuits, are certainly becoming very popular, and the beginner is anxious to know what particular circuits he should try out in the first place.

In the first place, I would never advise an absolute beginner to work with a dual circuit. The chief trouble with dual amplification circuits is that they tend to oscillate at low frequencies, i.e. a continual buzzing noise is often obtained when the circuit is first connected up. This may be due to the individual characteristics of the components used, or to the design of the circuit.

We have recently learnt a great deal more about the effective design of dual amplification receivers, and whereas formerly only a few experimenters tried out these arrangements, there are now tens of thousands who are not only interested in dual circuits, but are actually using them with great

valve and a crystal detector over short ranges. With two valves it is possible to obtain very excellent results indeed, provided a good circuit is employed.

This circuit $L_2 C_2$ consists of an inductance, preferably a plug-in coil, and a variable condenser C_2 of say, $0.0005 \mu F$ capacity. This circuit is tuned to the same wave-

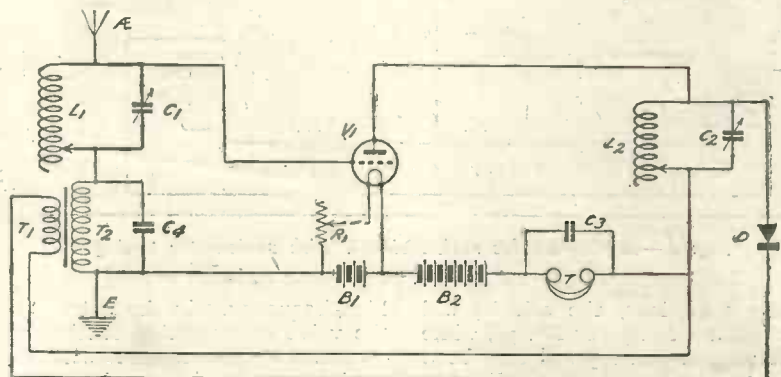

Fig. 1.—A simple and efficient single-valve dual set.

One-Valve Circuit

The constructor or experimenter who desires to use a single valve

length as the aerial circuit, which includes the inductance L_1 , which is also preferably a plug-in coil, the variable condenser C_1 of $0.0005 \mu F$ capacity, and the fixed condenser C_4 , which has a value of $0.001 \mu F$ capacity.

The high-frequency currents in the aerial circuit are communicated to the grid of the valve and are amplified by it, the high-frequency oscillations in $L_2 C_2$ being rectified by the detector D , the resulting low-frequency currents being fed into the grid circuit of the valve once more. The valve now amplifies these low-frequency currents, which pass through the inductance L_2 and through the telephones T . These latter are shunted by a condenser C_3 of $0.002 \mu F$ capacity; this condenser acting as a by-path for the high-frequency currents in the anode circuit. The O.S. (outside secondary) terminal of the interval transformer $T_1 T_2$ is connected to the grid, through the inductance L_1 , while the I.S. is connected to earth. The O.P. (outside primary) of the primary T_1 is connected to the crystal detector D .

In this circuit there is no reaction

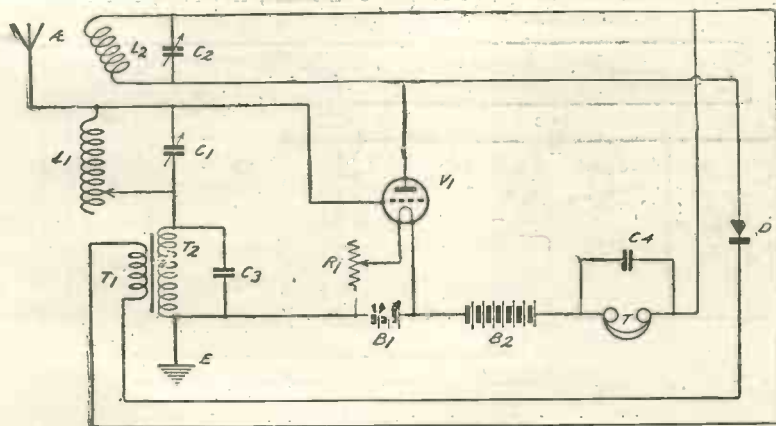

Fig. 2.—A similar circuit, but with reaction introduced.

success, and with the consequent saving of at least one valve.

The one-valve experimenter is the one who is most likely to benefit from the principle of dual amplification. It is, in fact, possible to work a loud-speaker using simply a

and crystal cannot do better than join up the circuit illustrated in Fig. 1. We have here a single valve high-frequency amplifier, in which the amplified oscillations appear in a circuit $L_2 C_2$ in the anode circuit of the valve V_1 .

between the grid and anode circuits, and no trouble should be experienced by the experimenter in working a simple circuit of this kind. The variable condenser C_1 may be tried in series with the aerial lead, in which case, of course, a greater value of inductance L_1 will be required. When constant aerial tuning is used, the fixed condenser of $0.0001 \mu\text{F}$. is connected in series with the aerial lead, and a parallel tuning condenser C_1 is used. Under

whistle is heard, the reaction coil should immediately be withdrawn from the other.

When dual amplification circuits, employing reaction, are being used, a second phenomenon very often presents itself. As the reaction is increased, the valve will suddenly begin to buzz, this buzz being due to low-frequency self-oscillation. The buzzing noise is of lower note than the whistle, which is produced when the valve is oscillating at

to oscillate either at high or low frequency, but rarely at both. It is, as it were, as if the valve was uncertain whether to oscillate at high or low frequency, and very frequently it changes its mind. For example, in the case of a dual circuit, the valve will first oscillate at high frequency, and then suddenly change over and start oscillating at a low frequency. In the case of a dual amplification circuit, the valve will try and oscillate at either high frequency or low frequency if it possibly can, and when reaction is being employed, the tendency is to oscillate at high frequency. The moment high-frequency oscillations are generated by the valve, the operating conditions change, and this change will make the valve prefer to oscillate at low frequency, which it immediately proceeds to do. This low-frequency oscillation is productive of a loud, buzzing noise in the telephone receivers or loud-speaker, and the only way to prevent it is to loosen the reaction and sometimes it is also necessary to dim the filament of the valve.

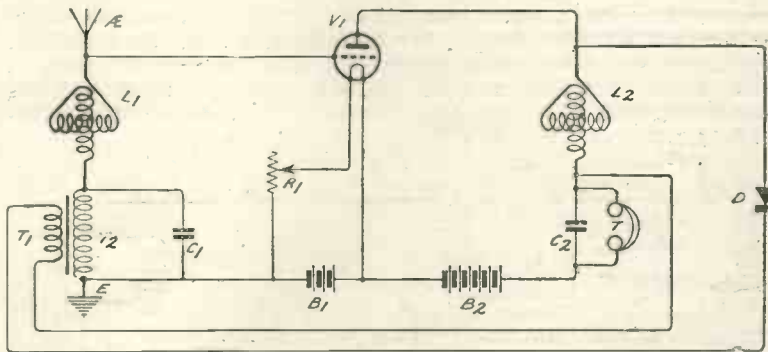

Fig. 3.—A single-valve reflex circuit with variometer tuning.

these conditions, the coil L_1 will be either a No. 50 or No. 75, while the plug-in coil L_2 will also be a No. 50 or No. 75, according to whether the broadcast wavelength is below or above 400 metres. As a matter of fact, a No. 50 coil will generally do for the whole waveband, even up to 600 metres, but a larger value of variable condenser is then required, which is not conducive to obtaining the maximum results.

Another Single-Valve Dual Circuit

Another single-valve dual circuit is that illustrated in Fig. 2. The circuit is similar to the preceding one, but reaction has been introduced into the aerial circuit, by coupling the inductance L_2 to L_1 . This reaction must be gently applied and great care taken to avoid self-oscillation. The reaction coil L_2 should at first be kept away from L_1 , and the two condensers C_1 and C_2 carefully tuned. The reaction coil is then brought a little closer to the aerial coil, and retuning carried out on the condensers C_1 and C_2 . The reaction coil is then brought again a little closer, and this process is continued until the loudest signals are obtained without self-oscillation. If the reaction is made too great, the valve will oscillate at once, and a musical whistle will be heard which varies if one or other of the condensers C_1 or C_2 is adjusted. The moment this

high-frequency. In the latter case the valve is generating continuous oscillations which interact with the carrier wave of the broadcast station, and produce musical notes; the pitch of these varies if the high-frequency tuning is altered, but the low-frequency buzzing, which is so often heard on a dual amplification circuit, is independent of the high-frequency circuit, and the pitch of

A Stabilising Hint

A very good method of stabilising a dual amplification circuit is to connect a variable 100,000 ohm resistance across the grid and filament of the valve. This will usually make practically no difference to the signal strength, but will control the dual amplification circuit which tends to get out of hand.

You must, however, not become

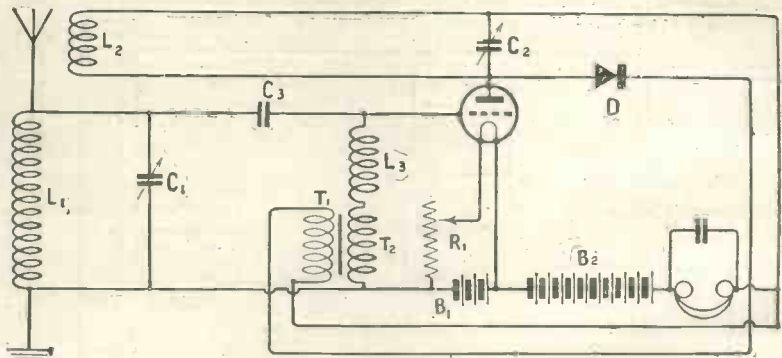

Fig. 4.—A dual circuit employing a choke.

the note is not varied by altering either of the tuning condensers C_1 or C_2 .

Even in the best dual circuits, low-frequency buzzing is often set up when reaction is being used. A peculiarity of the valve is that when both high and low-frequency circuits appear in the grid and anode circuits, the valve will tend

annoyed if a dual amplification circuit buzzes at you when you tighten the reaction too much. Do not be too ready to blame the circuit because your mishandling produces a roar in the telephone receivers. It would be a great advantage if all "straight" valve circuits produced a very large buzzing noise when the reaction is

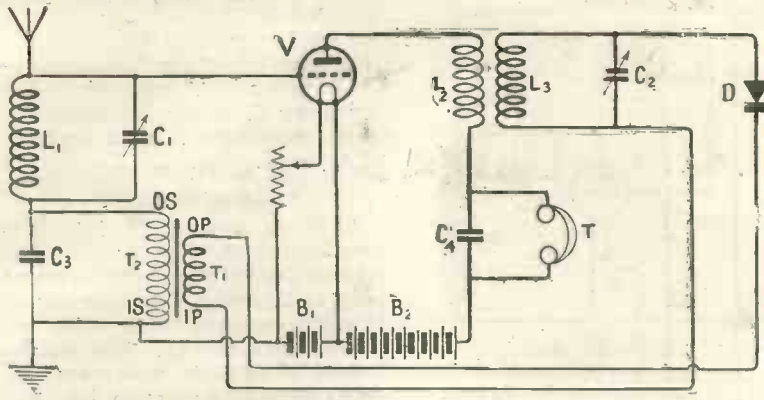

Fig. 5.—A circuit in which a coupled plate tuning arrangement is used.

increased too far. It is, of course, well known that the present canary noises heard by the careless beginner when tuning in his valve receiver are not sufficient to make him realise the nuisance he is to his neighbours. The user of a dual amplification circuit, however, contrary to general opinion, is probably far less guilty of making trouble in the ether than his friend who uses a straight circuit. The user of a dual amplification circuit generally knows about it if he tightens the reaction too much, and he has to loosen the reaction immediately for his own comfort.

A Variometer Dual Circuit

Fig. 3 shows a modified arrangement of Fig. 1, in which variometers are employed for tuning the grid and anode circuits. This arrangement will give good results, but it is important to note that the variometer L_2 in the anode circuit of the valve must be of a sufficiently large size; the usual type of variometer sold for connecting in the aerial circuit is not sufficiently large. If this latter type of variometer is to be employed, then it

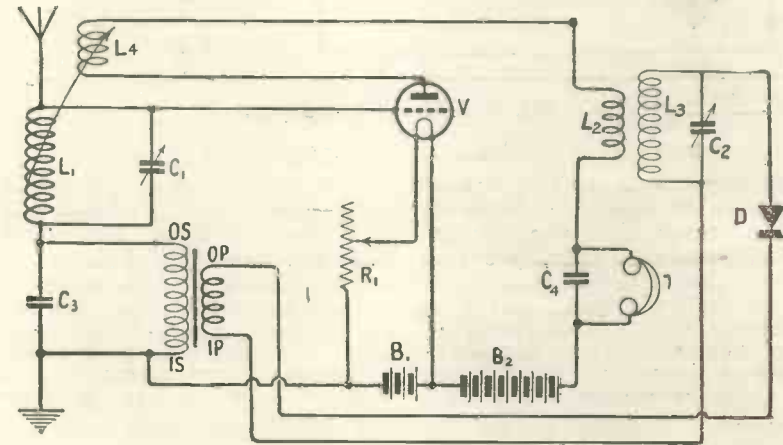

Fig. 6.—A reflex circuit employing reaction.

should be shunted by a fixed condenser of $0.0003 \mu\text{F}$.

The circuit is very simple to tune, the only adjustments being the two variometers, but on the other hand, the signal strength obtainable is not usually as great as when reaction is obtained, and, of course, it is not possible to obtain an adjustable reaction effect with the Fig. 3 circuit, although a

certain amount of reaction will, in many cases, be obtained through the natural coupling in the valve.

A Dual Circuit Using a Choke Coil

Fig. 4 illustrates a single-valve dual amplification circuit in which instead of connecting the secondary of the transformer in the aerial circuit (a principle advocated by the writer, particularly in connection with the S.T. 100 circuit, but applicable to all dual amplification circuits), a high-frequency choke may be employed, and the transformer secondary T_2 is connected in series with the air-core choke L_3 of 200 to 250 turns (plug-in coil),

is connected across the grid and filament of the valve, a condenser C_3 of $0.0003 \mu\text{F}$ being connected as shown, the object of this condenser being to prevent the secondary T_2 being short circuited through the inductance L_1 . The object of the choke coil L_3 is to prevent the secondary T_2 short circuiting the high-frequency oscillations applied to the grid of the valve by the circuit $L_1 C_1$. In this case the high and low-frequency input circuits are in parallel, whereas in the preceding figures they have been connected in series. The object of using the air-core choke is really the same as that which suggested the use of the secondary of the transformer in the aerial circuit. The reason is that we desire to keep the filament battery and high-tension battery and telephone receivers at earth potential, and that if the transformer secondary were to be connected between the earth and the filament battery, as frequently appears in many circuit diagrams published, all the above-mentioned components would have their potential varied at low frequency with respect to earth, and consequently touching any of

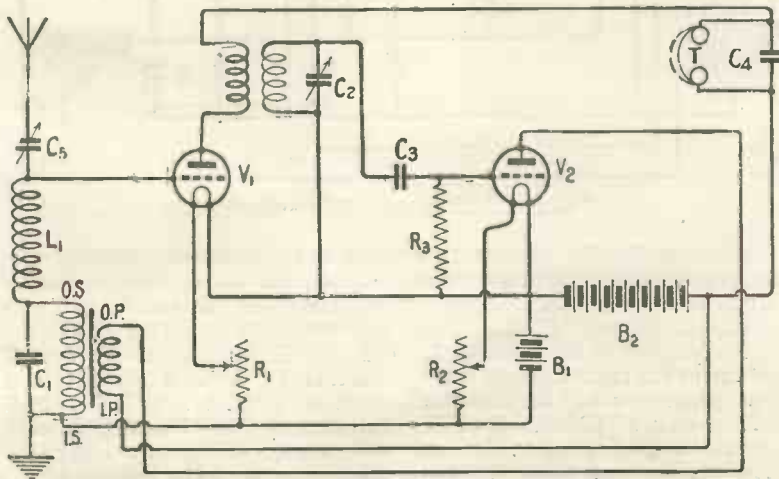

Fig. 7.—A reflex circuit with valve rectification.

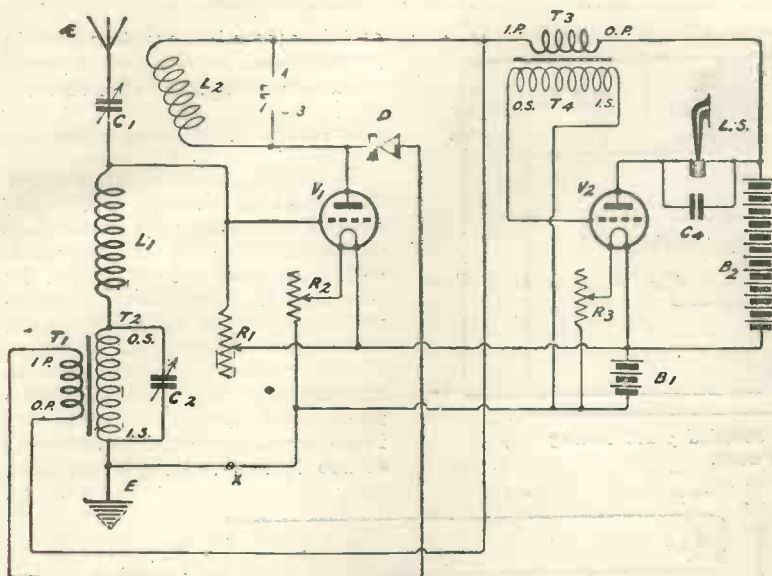

Fig. 8.—The S.T.100 circuit.

the parts, such as the filament battery or telephone terminals, would result in a weakening of the signals, and probably set up low-frequency oscillation.

The use of a choke in Fig. 4, therefore, is for stabilising purposes, and in practice this method is adopted by the Marconi Company in one of their broadcast sets. Personally, I prefer to use the arrangement with the transformer secondary connected in the aerial circuit, as the use of the choke seems to involve a certain loss in signal strength. On the other hand the latter arrangement is preferable where there is interference from A.C. mains, etc. When such interference is experienced, the connections of the transformer secondary in the aerial circuit often accentuates it.

The anode circuit of the valve is as before, and consists of an inductance L_2 shunted by a variable condenser C_2 , the crystal detector and the primary T_1 being connected across the oscillatory circuit.

How to Achieve Great Stability

Stability is not the chief aim of the experimenter who wishes to use dual amplification circuits; results are what he strives for, and maximum output is very often obtained at the expense of stability.

There are, however, some who, while content to receive signals falling a little short of the maximum, are not content unless the signals are obtained without undue forcing.

The simplest method of obtaining stability in a dual amplification circuit is to separate the detector

circuit from the anode circuit of the valve. Fig. 5 shows how this may be done. Instead of having a tuned anode circuit we have an inductance L_2 which is coupled to another inductance L_3 , the coupling preferably being variable. The circuit L_3, C_2 is tuned to the incoming wavelength, and the high-frequency oscillations in the anode circuit of the valve are

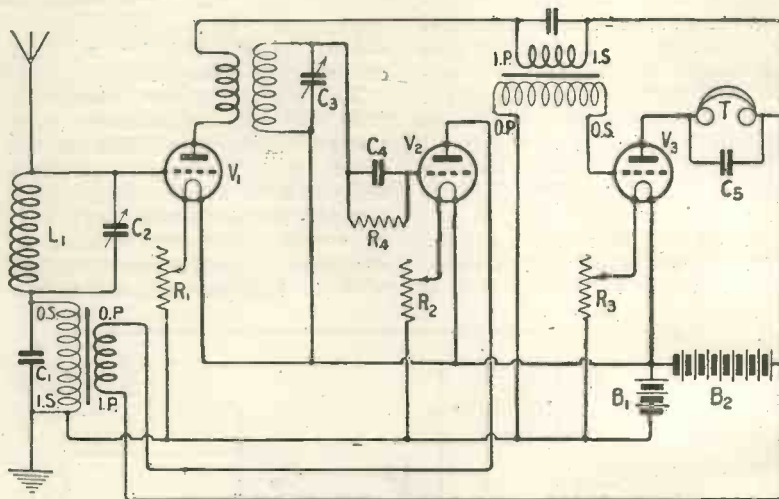

Fig. 9.—A three-valve reflex circuit.

induced into L_2, C_2 . Across this secondary circuit we have a crystal detector D and a primary T_1 of the step-up transformer T_1, T_2 . The entire separation of the primary T_1 from the anode circuit of the valve ensures the absence of the chain of low-frequency amplification which is so detrimental and which sets up low-frequency oscillations. The

telephone receivers T , are, of course, included in the usual position in the anode circuit of the valve, and they are shunted by the condenser C_4 of $0.002 \mu\text{F}$. capacity. The condenser C_3 across the secondary of the transformer has a capacity of $0.001 \mu\text{F}$.

Adding Reaction

If it is desired to introduce reaction into the Fig. 5 circuit, the arrangement of Fig. 6 will be found very satisfactory. In this circuit two anode inductance coils are provided, L_1 and L_2 . The coil L_1 is coupled to L_1 in such a manner as to introduce reaction into the aerial circuit, while the coil L_2 is coupled to the inductance L_3 of the circuit L_3, C_2 ; this circuit, incidentally, will be found considerably selective.

A Useful Two-Valve Circuit

A useful two-valve dual amplification circuit which can be thoroughly recommended is that illustrated in Fig. 7. In this circuit a series aerial condenser is employed and the coupling between the anode circuit of the first valve and the grid circuit of the second is by means of a transformer, the two windings L_2 and L_3 preferably being variably coupled. The second valve acts as a detector, and the rectified low-frequency currents are communicated to the

grid of the first valve through the transformer T_1, T_2 , the secondary of which is in the grid circuit. In the anode circuit of the first valve we also have the telephones T shunted by a fixed condenser of $0.002 \mu\text{F}$. capacity. If it is desired to introduce reaction, a portion of the anode inductance may be coupled to the aerial inductance.

The S.T. 100

The S.T. 100 is illustrated in Fig. 8, and it will not be necessary to enter into details because these have so often previously been given, and will also be found in my new book, "More Practical Valve Circuits," which also includes many developments of the S.T. 100 and alternative arrangements.

The circuit involves one stage of high-frequency amplification, followed by crystal rectification and two stages of low-frequency amplification, the first stage being accomplished by the first valve, which also acts as a high-frequency amplifier. The secondary of the transformer is included in the aerial circuit and stability is obtained by means of a variable 100,000 ohms resistance connected across the grid of the first valve and the positive terminal of the filament accumulator.

Another Circuit

Another circuit is that illustrated in Fig. 9, which is similar to Fig. 7, but is provided with an additional stage of low-frequency amplification, a second intervalve transformer being used to couple the anode circuit of the first valve to the grid circuit of the third. When speaking of coupling in this connection, it is meant, of course, that the low-frequency currents are transferred from the anode circuit of the first valve. The high-frequency currents, of course, are transferred from the anode circuit of the first valve to the grid circuit of the second valve.

Importance of Crystal Detectors

In all circuits in which a crystal detector is employed in combination with a valve, it is extremely important to ensure that a good crystal detector is employed. Many of those who do not obtain good results with dual circuits have to blame their crystal detectors, and it is advisable to test these detectors if at all possible, on an aerial; that is to say, using the crystal detector in conjunction with the tuned aerial circuit. This, of course, cannot be done when far from a broadcasting station, but those who live near broadcasting stations should certainly select a good crystal for use with their valves.

Those who desire to know more about dual circuits will find a large number in the book above mentioned, which gives an ample selection with comments on, and full values of, every circuit.

Extracts from our Post Bag

To the Editor of MODERN WIRELESS.

SIR,—I am sending you a photo of my wireless outfit, as it may perhaps interest you. It is very small and compact. It is a 5-valve set, 2 H.F. Det. and 2 L.F. The measurements of the panel are 12 in. by 12 in.; cabinet, 12½ in. wide and 15 in. high, with drawer for sundries underneath the panel. It is very similar to the Transatlantic set which you gave in November, I think. I get all B.B.C. stations on 3 valves phones, and 4 valves loud-speaker; in fact, I have only used all 5 valves once. I generally use 2 H.F. D. and 1 L.F. The tuning is variometer. By two switches of my own make I can get any combination of valves and ways of switching. If your Transatlantic set and note magnifier for same, as given in MODERN WIRELESS, is as efficient, I can recommend it to anyone. The tone in loud-speaker is as pure as a crystal.

Yours sincerely,
H. H. W.

Oldham, Lancs.

To the Editor of MODERN WIRELESS.

SIR,—I have received WIRELESS WEEKLY and MODERN WIRELESS from their first issue and consider them the best books on sale.

I have tried nearly all the circuits you have published from time to time and found them to give easily the results you claimed for them.

I was especially pleased with the modified ST 100 which gave loud-speaker results from both Glasgow and Bournemouth. But I have no terrible liking for the crystal.

Seeing in one of your late numbers of WIRELESS WEEKLY that a Mr. —, of Bombay, received some of the BBC stations using double reactance, I decided to experiment, and with the enclosed circuit obtain every night the following results:

Glasgow, Bournemouth, Cardiff, Newcastle, Aberdeen, London, Birmingham and Manchester come in well on Amplion loud-speaker (£6 model), Glasgow being the strongest, Bournemouth next, and so on in the order given above.

L'Ecole Supérieure is splendid on the 'phones and quite readable on the loud-speaker.

As you will see by the diagram, I use rather large condensers across both the loud-speaker and the H.T. battery, these making the tone beautifully rich while still keeping the articulation perfectly clear.

As I consider these rather fine results, I thought perhaps some of your readers might like to try this type of receiver. My aerial is the ordinary P.M.G. 100 ft., about 35 ft. high, while the earth is the water main.

I might add in conclusion that in the last five weeks I have received WGY six times, it being once readable for about ten minutes in the loud-speaker.

This receiver is fairly easy to handle, but the coils must be very loosely coupled (almost at right angles) to avoid reradiation. All parts, with exception of valves, loud-speaker and 'phones are made entirely by myself and I will gladly furnish details of same.

I am, yours truly,
R. HALDANE CARSON.
Belfast, Ireland.

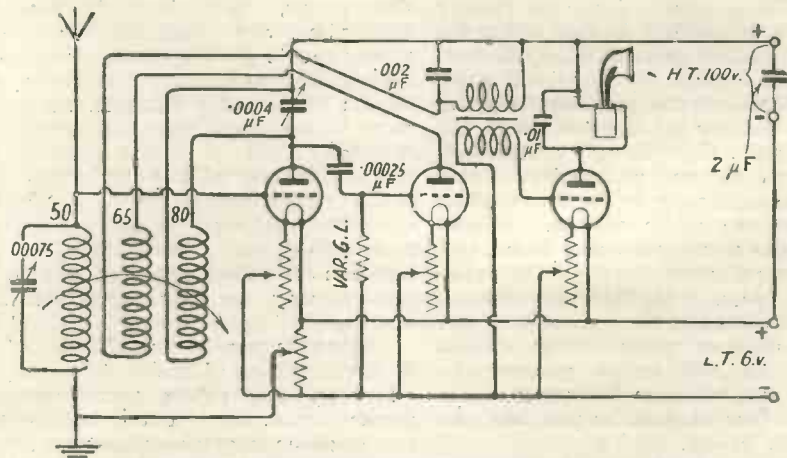

A double reaction circuit on which our correspondent gets very good results.

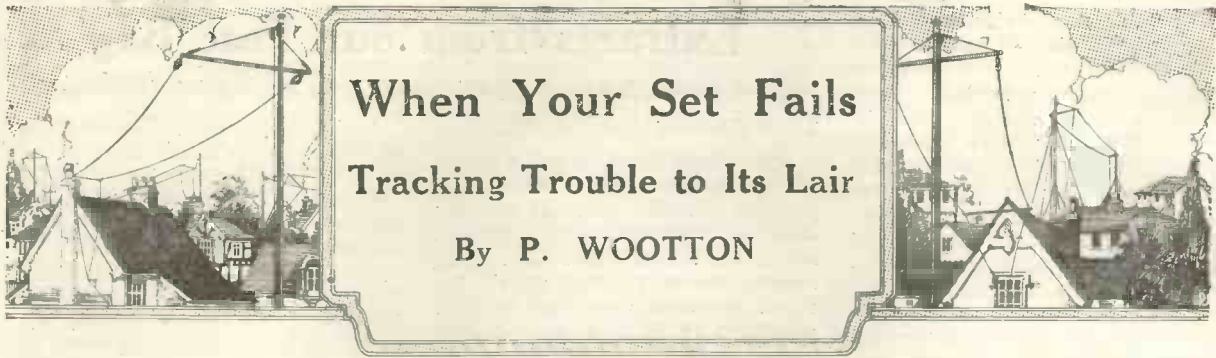

When Your Set Fails Tracking Trouble to Its Lair

By P. WOOTTON

YOU needn't tell me—I know just what happened. Outside the pouring rain of a wretched evening—inside the comfort of a cheerful fire, the children in bed, yourself home from business and your friends from up the road gathered round. A good set and a good loud-speaker and, above all, a good programme announced, and then—?

Silence—dead silence! Not a sound out of the thing! You only really appreciate what a good programme the Broadcasting Company gives you when your set won't work; and as a very large number of readers of MODERN WIRELESS have taken up the new hobby within the last few months, a few hints born of painful, and sometimes expensive, experience may perhaps be of value to them. The eerie fascination of wireless—a fascination psychologists have not yet explained—is tempered by an occasional diabolic obtuseness of the apparatus (by no means confined to the cheap and nasty set). It means that a hundred-guinea cabinet receiver is far more difficult to put right than the humble crystal set.

Crystal Set Troubles

The simplest fault to remedy in a crystal set is that when the cat-whisker gets out of adjustment. Good signals are obtained when only a light contact is made by the cat-whisker on the surface of the crystal. Crystals vary a great deal in quality and uniformity. Some specimens seem uniformly sensitive over the whole surface. Others of the same make and brand will frequently reveal only a few sensitive spots. A careful and systematic exploration of the surface with the cat-whisker point, being careful not to use undue pressure or friction, will soon find you another spot just as good as you had the night before.

The real trouble begins when for some reason or other a wire gets

loose inside and no signals come through. My experience is that the breakage of a wire internally is almost always due to a terminal working loose, so that when the top wire is screwed underneath it, the whole terminal turns and wrenches off the wire below. When all signals have suddenly disappeared and you know your crystal is right, carefully try the terminals and find whether any of them are loose. If you find such a terminal, ten chances to one the trouble is beneath it.

Unless you are experienced in handling wireless apparatus, I do not advise you to open up the average commercial set. They are often so constructed that wires are connected from the panel (which is removable) to some fixed part of the box. For this reason, when the panel is lifted up, there is great danger of breaking off a wire before you discover what you have done. It will generally pay you to take the set to your dealer and let him have a look at it. The charge for repairing a crystal set is very reasonable.

Faults in Outside Leads

Frequently, however, the trouble arises from the earth or aerial connections, particularly in the springtime, when the tendrils and young shoots grow up with almost unbelievable rapidity. The leaves of the creeper, for example, may come into contact with the aerial wire and lead its feeble current to earth instead of to your instrument. Everything may be quite clear now, but wait till the spring and notice the difference. In addition, a sudden gust of wind may swing your aerial against a conductor.

Quite a frequent source of trouble is the breakage of the earth wire owing to some object, such as a perambulator, lawn mower or garden implement, catching against it. Corrosion may set in and interpose an insulating film between the

wire and its terminal. Of course your halyard may break on a dark night and let down the whole aerial without your noticing it.

Valve Set Troubles

Valves, like electric lighting bulbs, have a habit of burning out at unexpected moments. Most good modern valves have a reasonable life, but occasionally a faulty product will burn out in a short time. Of course, if your valves are fitted on the outside of the set, see that they show this fault by "going out." Lack of lighting is not always due to the burning out of the filament, but may have been occasioned by faulty contact with the socket. To make sure, and particularly if it is a multi-valve set, pull out the doubtful valve and plug it into another socket, putting the valve which it replaces into the first socket. If your valve will still not light in the second socket, whereas the second valve will burn in place of the first, you can be fairly sure that your filament has gone, although it is not possible in most valves to see this by inspection. If, however, no valve will burn in that particular socket, the cause will very likely be due to the fact that the rubbing contact of the filament resistance is not touching the wire spiral on which it runs.

If when you switch on the set none of the valves will light, it is most improbable that all of them have burnt out together. In this case look for a faulty connection with your accumulator. Accumulator terminals sometimes get very corroded, and if they are loose there may not be proper contact between the wire and the cell itself. Sometimes, too, I have found trouble due to looseness of the terminals on the strips which connect the various cells together. Try every nut to see that it is tight and clean. Sometimes you will find that the valves will light

and you are hearing local broadcasting, but for some reason or other the signals are much fainter than usual. Look first of all to see that your tuning adjustments are correct. If they are and the signals are still weak, try turning the aerial tuning adjustments to see whether the strength increases with change. If a considerable readjustment of the aerial tuning is necessary to bring signals back to their original strength, *i.e.*, if the tuning positions are quite different from usual, the chances are that something is wrong with your aerial or earth connection. A disconnected earth lead will sometimes be the cause, for, particularly when you are fairly near to a broadcasting station, it is quite possible to get good signals without any earth connection at all. In these circumstances to get best strength resetting of the tuning adjustments will be necessary. Similarly you can frequently hear quite good results with no aerial on your set, particularly with a multi-valve type of instrument. Here again the tuning adjustments will be quite different from normal to get anything like good results.

Noises

If in addition to usual music and singing you hear all kinds of scratching noises, these may come either from extremely bad atmospheric conditions or from the high-tension battery. To test whether noises are due to atmospheric conditions disconnect the aerial without altering the tuning adjustments. If the noises still continue with the aerial leads disconnected, it is probable that the high-tension battery is becoming exhausted. This exhaustion is usually first shown by considerable diminution in the signal strength, although when you are near a broadcasting station and have ample strength to spare you may not notice this diminution. Noises can also be caused by an accumulator being faulty. Incidentally, I strongly advise you to buy your high-tension batteries from a dealer who does a good trade. These batteries deteriorate considerably in stock, whether they are used or not, so that it is far better to get one quite new. The high-tension battery on a two- or three-valve set should last you from six to nine months without trouble. Frequently you will get even longer life.

Telephone Troubles

A complete absence of signals

may often result from faulty telephone headpieces. Sometimes the signal may be quite clear and then suddenly disappear, coming back again after a moment or two. If such is your experience, bend your head about to see whether a movement of the cord is the cause of this. Sometimes through constant twisting and un-knotting there may be an intermittent disconnection within the cord. Pass the cord through your fingers, bending it as you go, and perhaps you will come to a point where a movement either way will bring signals in and out again. New telephone cords are quite cheap, and are obtainable at any dealer's. You can fix them yourself in those cases where the connections are made externally. Where the cords pass through the casing of a telephone it is just as well to leave the fitting of a new cord to your dealer.

Plug-in Coil Troubles

Sometimes, particularly in sets where tuning is done by means of a variable condenser and separate coils which plug into sockets, the coil may not be making good contact in the socket through dirt or undue bending the pins. Try moving the coil in the socket and see whether signals go on and off as you move it. If this is the case, withdraw the coil from the socket, open out the pin of the coil and that of the socket slightly with a penknife, and after making quite sure that both are quite clean and bright, push them into position again. This should bring the signals up to normal.

There is a right and a wrong way of taking a coil from its socket. The worst way is to pull it out by the top of the ring. This places undue strain upon all connections and will inevitably ruin the coil after a time. The right way is to take hold of the coil by its base or plug so that no strain whatever is applied to the windings or the strip round the coil. A straight, even pull should be used—do not wrench the coil to get it out.

Valve Pins

It does not follow that because a filament is alight the valve is necessarily making good contact with all its pins. As you know, there are four pins, only two of which are connected to the filament. The other two are connected to the grid and plate respectively, and must make good, sound contact

if proper signals are to be received. Unfortunately valves are often made with badly-spaced pins, and often, too, holders have their sockets badly spaced. If you have doubts whether all pins are making good contact, open them up slightly with a penknife so that they make good contact everywhere.

Some sets are fitted with tubular valves. The filament connections to these are at the top and bottom end, the plate and grid contacts being at the side. There is a right and a wrong way of putting these valves into their sockets. Usually one of the clips on the side of the valve is marked green or red. Be sure that this is making contact with the green or red clip at the side. The clip may need a little cleaning occasionally to make good contact.

Dull-emitter valves eventually become useless, not through their filaments burning out, but by sudden loss of their emitting properties. This cannot be found by inspection. If a dull emitter has been burnt too brightly it will lose its sensitiveness and may need to be replaced. It is always well to keep one or two spare valves carefully packed away so that if one should fail at a critical time you will not lose the rest of the concert by having no spare on hand.

A Final Tip

You will be surprised how easy it is to miss the obvious. I have known experts hunt for a quarter of an hour to find some mysterious fault in the set which in the end turned out to be nothing more than the aerial wire not being connected or the battery joined the wrong way round. Don't look for mysterious faults until you have hunted for the obvious ones. Last of all, remember that even the broadcasting apparatus breaks down sometimes. You may be hunting all over your set because signals have disappeared, when really something has broken at the local station! After some experience you will get to know instinctively whether the fault is at your end or theirs. If when signals suddenly cease you can still hear howling from oscillating amateurs who, like you, think their apparatus is wrong, you may be sure that nothing is wrong with your set. The sounds from oscillation, although irritating, are generally of feebler intensity than the signals from the broadcasting station, so that if you hear the former you may be sure the latter are "*non est.*"

Reflex Wireless Receivers in Theory and Practice

By JOHN SCOTT-TAGGART, F.Inst.P., A.M.I.E.E.

This article is the first of an important series dealing exhaustively with dual amplification in all its forms. A further instalment will appear next month.

Chapter 1.—The Principle of Dual Amplification.

REFLEX wireless receivers are those in which one or more of the valves act as both high and low-frequency amplifiers. It is assumed, of course, that the reader is well acquainted with the ordinary principles of high-frequency amplification and the magnification of the low-frequency currents obtained after the process of rectification which will usually be carried out by means of a crystal detector or three-electrode valve acting in such a capacity.

It was found as long ago as 1912 that the three-electrode valve was not only capable of amplifying high-frequency oscillations and low-frequency currents, but that by using proper circuits the valve could amplify both types of currents at the same time without there being any undesirable mutual interference. Circuits in which a valve acts both as a high-frequency amplifier and as a low-frequency amplifier are known as dual amplification circuits or reflex circuits. This latter term implies that after rectification the low-frequency currents are led back and amplified by one of the valves which has acted as an amplifier of the original high-frequency currents.

High Sensitivity

Reflex receivers are naturally highly sensitive because one valve is giving two stages of amplification. This type of circuit naturally results in a very appreciable economy in thermionic valves, and in many cases only half the number of valves are necessary to carry out any desired reception.

Very little has been accomplished in the way of developing dual amplification circuits except during the past year. This fact is significant because there are numerous special problems which have to be faced and solved when a wireless receiver is being designed to operate on the dual amplification principle. The greatest problem is to prevent low-frequency reaction which causes

buzzing or squealing noises to be heard in the receiver. The way in which the various difficulties may be met are described in the following pages, and it will be seen that dual amplification is a subject in itself.

Elements of Dual Amplification

In a wireless receiver of the reflex type, the low-frequency currents have a frequency between about 200 and 3,000. These currents are those obtained after the rectification of the incoming signals which may be due to broadcast transmissions, continuous waves or spark signals. This book is primarily

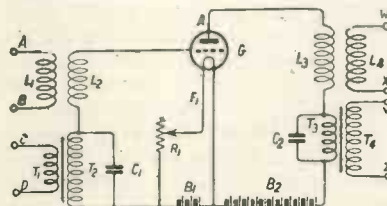

Fig. 1.—The general arrangement of a three electrode valve as a dual amplifier.

concerned with the design and operation of receivers for the reception of spark signals and modulated signals, such as those sent out from a broadcasting station. Nevertheless, the same circuits, by the use of external heterodyne, may be used for the reception of continuous waves. When continuous wave or spark signals are to be received it is not so important to design the circuits with a view to avoiding distortion effects.

It is proposed to deal in this chapter with the general principles of dual amplification. A three-electrode valve may be used as a dual amplifier, not only in receiving circuits, but in transmitting arrangements.

General Arrangements

Fig. 1 shows the general arrangement of a three-electrode valve as a dual amplifier. The input circuit

is the grid circuit and it will be seen that two transformers are used to feed the input circuit. The transformer, L_1, L_2 , is an air-core transformer which supplies to the grid circuit high-frequency currents which we may assume are being supplied by a source connected across the terminals, A, B. The transformer, T_1, T_2 , is connected in series in the grid circuit and supplies low-frequency currents from a source which may be connected to the terminals, C and D. The condenser C_1 is a fixed condenser having a capacity of, say, $0.002 \mu F$, and its object is to allow the high-frequency current induced into L_2 to communicate its effect to the filament F_1 of the valve V_1 . If the condenser C_1 is omitted, the secondary, T_2 , will act as a choke to the high-frequency currents in the grid circuit, and this will prevent the full E.M.F.'s supplied by L_2 to be communicated to the grid of the valve. In most transformers, however, there is a fairly substantial self-capacity in the secondary windings and this will, in many cases, be sufficient to allow the passage of high-frequency currents.

Two Output Circuits

There are two output circuits, one a high-frequency output and the other a low-frequency output circuit. In Fig. 1 it will be seen that the high and low-frequency output circuits are in series. The transformer, L_3, L_4 , allows the amplified high-frequency energy to be led away from the terminals, W, X. The iron-core transformer, T_3, T_4 , allows the amplified low-frequency currents to be led away from the terminals, Y, Z. A fixed condenser, C_2 , of, say, $0.002 \mu F$ capacity, is connected across the primary, T_3 , in order that the high-frequency currents in the anode circuit of the valve may flow readily. If the condenser, C_2 , were omitted the primary, T_3 , would act as a choke coil and would tend

to choke out the high-frequency currents in the anode circuit of the valve. Nevertheless, even though the condenser, C_2 , were omitted, in many cases there would still be a certain high-frequency output owing to the self-capacity of the winding, T_3 . This self-capacity has a very important bearing on the operation of dual amplification circuits, and it is almost impossible to lay down any definite rule about the necessity for by-path condensers such as C_1 and C_2 . In some circuits, or when using certain component parts, these by-path condensers are essential; in other cases they may be omitted; in some cases the value of these condensers is a matter for experiment with the particular components used. Different transformers, for example, have different self-capacities and different impedances; this also applies to telephone receivers and loud-speakers. These facts, however, are merely being stated for introductory purposes.

Looking at the Fig. 1 circuit we see that the grid, G_1 , of the valve, V_1 , has its potential changed both at high and low-frequencies. The grid, G_1 , has a normal operating potential which, if no battery or potentiometer is included in the grid circuit, will be somewhere in the neighbourhood of -1 volt. This potential is due to the drop in voltage across the rheostat, R_1 , and is relative to the negative side of the filament.

Low-frequency Currents

Let us first consider that low-frequency currents of an alternating nature are applied to the terminals C, D, no high-frequency currents being applied to the terminals A and B. Under these conditions the grid has its potential varied first in a positive and then in a negative direction at a low-frequency. When the grid is positive there will be an increase in the anode current and this will flow through the primary, L_3 , of the high-frequency transformer, L_3, L_4 , and through the primary, T_3 , of the iron-core step-up intervalve transformer, T_3, T_4 , and then through the high tension battery to the filament. The currents flowing through the primary, T_3 , will be amplified currents and the condenser, C_2 , will have practically no effect on their amplitude as this condenser is of small value in relation to the frequency of the currents. The low-frequency currents flowing through T_3 will be passed on to T_4 , the transformer being of the iron-core type. The magnified low-

frequency currents may be led away from the terminals, Y, Z; they might, for example, be used to operate telephone receivers or might be led to the grid circuit of a second valve to be amplified once more. If we desired to cause the amplified low-frequency currents to operate high resistance telephone receivers, the transformer might be eliminated and the telephone receivers connected in place of the primary, T_3 .

The low-frequency currents passing through L_3 will not affect the secondary, L_4 , and therefore no low-frequency currents could be drawn from the terminals, W, X. This is, of course, due to the very loose coupling effect between the coils, L_3 and L_4 .

Now let us consider that high-frequency currents are applied to the terminals A and D and that low-frequency currents are applied to

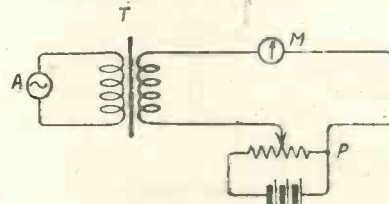

Fig. 2.—A useful analogy.

the terminals C and D. The high-frequency currents will be passed on by means of a transformer, L_3, L_4 , to the grid circuit of the valve and the condenser, C_1 , will obviate any choking effect which the secondary, T_3 , might have on the high-frequency currents. These latter, therefore, might be said to ignore the transformer in the grid circuit. The grid, G_1 , will now have its potential varied above and below its normal operating potential which will be -1 volt. Magnified high-frequency oscillations will flow in the anode circuit of the valve and these will pass through L_3 , the condenser, C_2 , and the high-tension battery. Here again the high-frequency currents ignore the transformer, T_3, T_4 , and pass through the condenser, C_2 . If this condenser were missing they would flow through the natural condenser which constitutes the self-capacity of the primary, T_3 . The high-frequency currents flowing through L_3 are passed on to the secondary, L_4 , and may be drawn away from the terminals, W, X. They might be detected, for example, by connecting a crystal detector and telephone receivers across the terminals, W, X. For the sake of simplicity, the high-frequency transformers are shown aperiodic, but there is

no reason why they should not be tuned to the frequency of the high-frequency currents being amplified by the valve.

We see then that the valve will act as a high and low-frequency amplifier because the frequencies are so different that the transformers by their very nature act as "sifters-out" of the currents they wish to select. Let us now consider that the high and low-frequency currents are both being applied to the input circuit of the valve. The grid potentials are now somewhat complex. We can consider the low-frequency currents as taking control and slowly moving the operating point on the grid potential anode current characteristic curve of the valve; in other words, the normal operating potential of the grid, instead of remaining at -1 volt, is being varied slowly on either side of this by the low-frequency currents.

Operating Potentials

At one instant the operating potential of the grid may be -1 volt, the next $-\frac{1}{2}$ volt, then back to -1 volt, and then $-1\frac{1}{2}$ volts, and so on. These changes are taking place at, say, 1,000 times per second, which is a very slow frequency when compared to the high-frequency currents which we will assume are due to signals having a wavelength of 300 metres, the currents, therefore, having a frequency of 1 million. We can relatively say that the grid potential is being only slowly varied by the low-frequency currents. We have assumed that the change of voltage from -1 volt to $-\frac{1}{2}$ volt takes one 4,000th part of a second. During this period the grid is having impressed on it a fluctuating voltage which is first positive and then negative, and the frequency of which is 1 million per second. During the time taken for the grid potential to become $\frac{1}{2}$ a volt less negative due to the low-frequency currents, there will be 250 complete cycles of oscillating current applied to the grid. From the point of view of the high-frequency currents applied to the grid, the potential of the latter remains practically steady, and, in fact, this slow low-frequency change of the normal grid potential does not interfere with the high-frequency amplifying action of the valve.

Two Currents

In the anode circuit of the valve we have the two sets of currents flowing. We have the low-frequency changes of the steady anode current and super-imposed on these we

have the high-frequency current changes which are 1,000 times as rapid.

It is most important that a proper conception should be had of the fluctuating grid potential and fluctuating anode current, and one or two analogies may help to make it clear, firstly, how the valve will act as an amplifier of two different sets of currents and, secondly, how these currents can be amplified without mutually interfering with each other.

A Useful Analogy

A very useful analogy is that shown in Fig. 2. In this figure we have a potentiometer, P, passing a steady current through the direct current ammeter, M; at the same time an alternating current is being fed into the ammeter circuit by means of the transformer, T, the letter A representing the alternator. The needle of the ammeter will normally, we will suppose, be in the position shown. If the flood on the potentiometer is left stationary, it will be noticed that although the ammeter needle remains, on an average, in the position shown, the low-frequency currents superimposed on the direct currents in the ammeter circuit will cause the needle to vibrate on either side of its normal value. By moving the potentiometer slider more to the left, a larger direct current will be made to pass through the ammeter M; but although the needle of the ammeter will move to one side, yet it will still continue to vibrate in sympathy with the alternating current which first adds and then subtracts itself from the steady current flowing through the ammeter. Thus, although the steady current flowing through the ammeter may be varied by moving the slider up and down along the potentiometer resistance, yet the low-frequency vibrations due to the alternating current will still remain. The ammeter, M, may therefore be said to be responsive, not only to the slow changes in the current flowing through it, but also simultaneously be responsive to the more rapid alternating current. It must not, therefore, be thought something very unusual for a valve to be carrying out two duties at once.

A Further Analogy

Another analogy which may help is that of a person swinging backwards and forwards in an ordinary child's swing. If a person could watch this simple act from a stationary spot in the universe, the motion of the person on the

swing would be very complex. Not only would he be moving backwards and forwards in the swing, but he would be travelling through space at a terrific rate. To those of us on earth the person in the swing is simply carrying out a very elementary motion and only a single motion; we are not concerned with the other attendant motion of the earth.

Consider again a person walking up and down the corridor of a train in motion. If the train is going smoothly and the blinds are all drawn, those in the train would only be concerned with the up and down motion of the man in the corridor; he would not be concerned with the forward motion of the train, and this would in no wise affect his walking up and down. Conversely, the train, if it had a mind, would not be at all concerned as to what

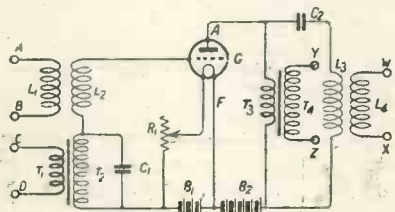

Fig. 3.—Connections for parallel output.

was going on inside the corridor; its sole object is to travel from one spot to another, and the mere walking up and down of a person along the corridor would not in any way affect this motion.

Similarly, the high-frequency currents and low-frequency currents both use the valve as an amplifier; but ignore each other in the process of amplification. Only when one set of currents seriously alter the operating conditions does the other set of currents affect it. As long as the man in the corridor only walks up and down, the train does not mind, but if he at one end puts on the brake, then the train immediately feels the effect and its motion is affected. Innumerable examples could be given of two separate motions taking place independently of each other, but the examples given should be sufficient to indicate that widely different frequencies may be amplified by a valve without any trouble whatever. There are, however, conditions in which one set of currents will interfere with the other, and examples of this will be given as we proceed.

Parallel Output Connections

Although in Fig. 1 we have indicated how the high and low-frequency output currents may be

drawn off separately by the use of different types of transformers, yet there is another general method of arranging these transformers. In Fig. 1 they are shown connected in series, while in Fig. 3 a change has been made by connecting them in parallel. It will be seen in Fig. 3 that while the input circuits remain the same as in Fig. 1, the high-frequency transformer, L₃ L₄, is no longer in series with the primary, T₃, of the iron-core transformer, T₃ T₄, used for drawing off the low-frequency currents. The primary, T₃, of the iron-core transformer is now in the anode circuit of the valve and the normal steady anode current flows through this transformer. The high-frequency currents will not pass through the primary, T₃, on account of the impedance of the winding, T₃, and the currents therefore prefer to pass round the path comprising the condenser, C₂, and the inductance, L₃. The condenser, C₂, may have a capacity of 0.002 μF. The primary, T₃, will not act as a short circuit to the high-frequency currents because it would choke them back. Also the condenser, C₂, in series with L₃, would not short circuit the low-frequency currents passing through T₃, because the condenser, C₂, has a relatively small capacity, and the low-frequency currents which might pass through C₂ would be exceedingly feeble. In any case, these low-frequency currents would not be passed on to the secondary, L₄, of the transformer, L₃ L₄.

We thus see that it is possible by using parallel connections of this kind to still separate out the high and the low-frequency currents in the anode circuit of the valve. Instead of a transformer, T₃ T₄, telephone receivers might, of course, be connected in the place of T₃, if the low-frequency currents are to be indicated without any further amplification.

(To be continued.)

A CORRECTION

It is regretted that by a printer's error the price of Messrs. J. H. Taylor's 60 volt H.T. battery was given in the last issue of "Modern Wireless" as 6/-. This should have been 8/-. post free.

The most important
Component of
Your Set—



The Valve.

You cannot obtain maximum results from a valve set unless these most important accessories are of the best manufacture and highest efficiency. There are many cheap and inferior foreign valves on the market which are offered as being "just as good."

Do not be misled, but insist on

MARCONI VALVES
MADE AT THE **OSRAM** LAMP WORKS

which were giving accurate distortionless results long before the Broadcasting era. The experience thus gained is now available for all wireless uses.

SOLD BY ALL LEADING WIRELESS DEALERS, ELECTRICAL CONTRACTORS, ETC.
BUY BRITISH GOODS ONLY.

Sound Wave of the Saxophone

The
SAXOPHONE
— star performer of
the Jazz Band

PRICES :

Model H.1, 21 in. high	
120 ohms ..	£5 5 0
2,000 ohms	£5 8 0
4,000 ohms	£5 10 0
Model H.2, 12 in. high	
120 ohms ..	£2 5 0
2,000 ohms	£2 8 0
4,000 ohms	£2 10 0

Due to its conical Aluminium diaphragm—spun to the fineness of paper—and its vibratory reed, the **Brown** actually gives, for the same number of Valves, a 30% increase in volume over other Loud Speakers.

Remember that the **Brown** is invariably installed in the homes of those who are music lovers. Why not benefit by their experience and select one at your dealer's to-day?

S. G. BROWN Ltd., N. Acton, W.3.
Retail: 19, Mortimer Street, W.1,
and 15, Moorfields, Liverpool.

Brown

Elementary Textbook on Wireless Vacuum Tubes
by **John Scott-Taggart**
F.Inst.P., A.M.I.E.E.

Wireless Vacuum Tubes
— an elementary Text-book written by John Scott-Taggart

FOR less than the cost of a Valve the keen experimenter can obtain a Text-book—the only one of its kind—on the complete working of the Thermionic Valve. Carefully printed and well bound in full cloth, this book should be on the bookshelf of everyone who is out of the novice stage and who aspires to some sound theoretical knowledge of Radio.

Its wide scope, coupled with the fact that its contents are arranged in a progressive and logical order, render it ideal as a work of reference rather than a book that one would attempt to assimilate at a sitting.

With its 250 pages and more than 130 diagrams and illustrations, it represents remarkable value for money and is a book that would be gladly appreciated as a birthday or other gift by any wireless enthusiast.

10/- from all Booksellers, or sent post free direct by the Publishers.

Radio Press Ltd.
PUBLISHERS OF AUTHORITY WIRELESS LITERATURE
DEVEREUX COURT, STRAND W.C.2.

A Tapped Inductance Crystal Set

By A. D. COWPER, M.Sc., Staff Editor

A simple set which gives stronger signals than the ordinary single-circuit type of receiver.

PERHAPS the simplest way to obtain the large range of inductance required in a receiver, in order to cope with the increased range of broadcast wavelengths, is to use a tapped inductance.

A serious defect of the tapped inductance is, however, the dead-end effect of the unused turns. This loss can be very serious when by chance any portion of the dead-end turns happens to provide a resonating circuit in tune with the received signals. One rather heroic method of reducing this loss sometimes practised is deliberately to short-circuit part or whole of these dead-end coils. It is claimed that this either produces a shielding effect, or else effectively detunes the surplus inductance.

However, it is possible to turn this idle (and mischievous) portion of a tapped inductance to useful purposes by adopting the principle of the "auto-transformer"—by analogy with L.F. alternating-current practice—as suggested in the circuit diagram of the crystal receiver illustrated here. Except for a limited number of single turns at the earth end of the tuning inductance, which are used for fine tuning (and whose effect in this connection will be negligible), the whole of the tapped inductance is included across the crystal detector and 'phones; hence any E.M.F.s induced in the otherwise idle turns will now be utilised.

A great temptation offers here to tune this whole inductance with a small parallel condenser, and expect to get the voltage "step-up" so glibly claimed by many writers (on analogy with close-coupled aperiodic L.F. transformers used in ordinary A.C. electrical engineering practice) as we have a larger number of turns in this "secondary" than are included in the aerial circuit with which it is coupled. Careful quantitative experiments carried out with the explicit purpose of testing this alleged "step-up," and made with a microammeter measuring the whole carrier-wave of local broadcasting, rectified with the aid of a good standard crystal, showed

that, in place of a step-up, there was a very distinct loss of effective signal voltage and resulting signal-strength when this "secondary" circuit of the auto-transformer was tuned with even the minimum possible parallel capacity. On the other hand, with the receiver about

standard. This appears to have reached a limit when (with the whole H.F. ohmic resistance reduced to an insignificant minimum) the energy loss due to the heavy dumping introduced by the crystal is just made up by the limited energy picked up by the

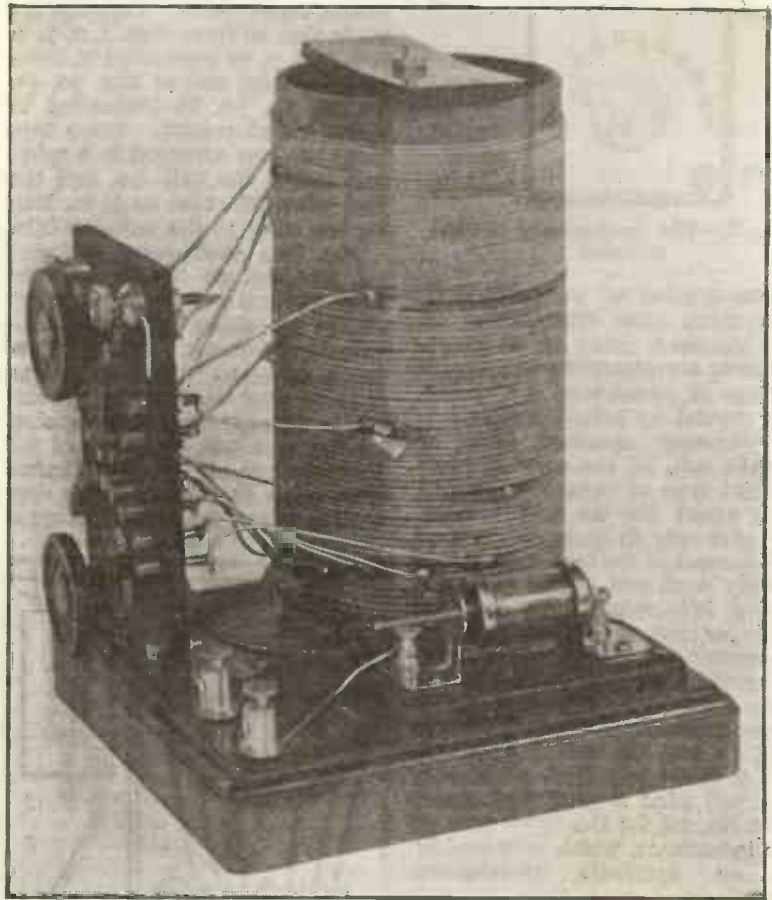

Fig. 1.—A side view of the set.

to be described, precisely the same optimum signal-strength was obtained as with the standard air-core variometer of No. 15 S.W.G. enamel wire, which gives the maximum signal-strength obtainable with a given aerial and transmission, by the writer, and which is accordingly, adopted as the

aerial; so that further signal-energy is not available, however applied. The secondary tuned circuit, therefore, only introduces needless losses and complication.

Careful quantitative experiment, as well as more casual aural observations made with the aid of quick-switching devices (to cheat

that automatic and unconscious adaptation of the ear to varying levels of audio-intensities, lead to the conclusion that the use of wire below about No. 18 S.W.G. in the aerial circuit on the short broadcast wavelengths causes needless losses of signal-strength through ohmic-resistance damping. Thus, while 2LO, at 13 miles from a fairly good and low-resistance P.M.G. aerial, will give with a good

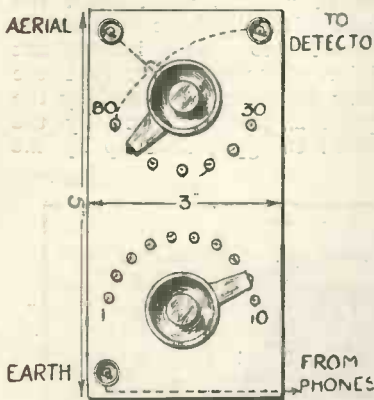

Fig. 2.—The arrangement of the switches

galena crystal an available D.C. component after rectification on the standard tuner of 18 micro-amperes, corresponding to a signal-voltage of about 0.45 volt across the crystal by actual calibration, an ordinary standard type of plug-in coil, or the average commercial type of variometer wound with about No. 26 S.W.G. wire, will give only 80 to 85 per cent. of this current at the best, or approximately 0.28 volt, while thin-wire sliding inductances give only 40 to 60 per cent. of the standard.

Accordingly, No. 16 S.W.G. wire is specified for that portion of the inductance which is most in use in the aerial circuit for the lower wavelengths, and No. 20 S.W.G. (which has a fairly low H.F. resistance, and will wind a good deal closer than No. 16) for the upper part of the inductance, which acts mainly as an aperiodic transformer secondary.

Constructional

Materials : Waxed-cardboard inductance former, 6½ in. by 3½ in. diameter ; ½ lb. No. 16 S.W.G., d.c.c. wire ; 2 oz. No. 20 S.W.G., d.c.c. wire ; base-board, 6 in. square ; ebonite panel, 5 in. by 3 in. by ¼ in. ; 2 switch arms and knobs and 3 terminals ; 2 telephone (wood-screw) terminals ; 17 contact studs and nuts ; crystal detector on base, complete ; 2 B.A. rod and nuts ; No. 18 tinned copper

wire ; shellac varnish ; mica ; brass angle pieces, screws, etc.

One end of the No. 16 wire is made fast in a small hole near one end of the former, and the ½ lb. of wire wound on as closely as possible. This will give nearly 50 turns. Then the end of the No. 20 wire is connected securely by twisting and soldering to the end of the No. 16, and another thirty turns or so wound on to a total of 80 turns. The tappings are then made by the well-known expedient of lifting the wire at the points required by the aid of a screwdriver or a large nail, slipping a piece of stout mica about ¼ in. by ½ in. under the raised wire, and scraping off the insulation from this portion and soldering on a short piece of No. 18 tinned copper wire. Tappings are made thus at turns Nos. 1, 2, 3, 4, 5, 6, 7, 8, 9, 10 (connected to lower switch-points) and at Nos. 30, 40, 50, 60, 65, 70, 80 (connected to upper switch-points). These tappings are best arranged in a spiral half round the cylinder, and the lead wires left 2 in. to 3½ in. long for soldering to the switch-points.

The two multi-point switches are arranged as shown on the small vertical ebonite panel, which stands at about 2 in. from the inductance former, to allow of access for making the connections. A great deal of time and trouble will be saved if both tapping-points on the wire coil, and ends of the contact-studs, are well tinned before attempting to solder on the connecting wires, and if tinned copper

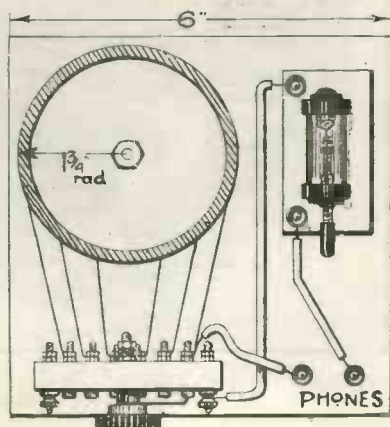

Fig. 3.—Showing the disposition of the parts.

wire be used for connections as suggested. The inductance should be given a good coat of shellac varnish when completed, and well dried in a warm place. For convenience here an open mounting is adopted on a small base-board—of a type supplied in many

electrical shops for mounting domestic electrical appliances—the inductance being secured by a long belt of No. 2 B.A. screwed brass rod co-axial with it and screwed into the base, with a cross-piece of ebonite and a nut at the top. The switchboard panel is fixed by two small bent brass brackets (actually those supplied by Peto-Scott with their board-mounting components) and a screw and small bolt to the

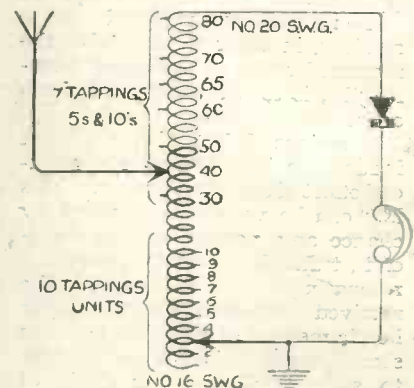

Fig. 4.—The circuit.

base-board, being further held fairly rigid by the connecting wires. An ordinary type of mounted crystal detector, such as has been frequently described and is obtainable for a moderate sum from any radio dealer, is screwed to the base-board ; and the telephone terminals are also carried on the base.

Exception may be taken to the mounting of the telephone terminals directly on the wooden base ; as the insulation resistance between these, on dry varnished wood, on actual test with the "Meg" tested showed around 100 megohms at 500 volts, as compared with the average audio-frequency impedance of the telephones of some 15,000 ohms, the question of poor insulation scarcely arises.

As most careful measurements failed to show the slightest gain of signal-strength by the introduction of the conventional 'phone blocking condenser, the latter is omitted.

The short wiring (upper end of inductance to detector, detector to 'phone terminal, second 'phone terminal to earth terminal) is carried out with exposed No. 18 wire above the board. Some experimenters obviously may prefer to mount the whole instrument in a cabinet behind a larger panel of ebonite, in which case the wiring can be all concerted.

The wavelength range as shown is from below 350 to about 550 metres on a P.M.G. aerial.

Hand-Capacity Effects, Their Cause and Cure

By GEOFFREY ELTRINGHAM

The annoyance caused by hand-capacity effects is particularly noticeable when fine tuning and critical reaction are necessary. The causes and cures are clearly explained in this article.

EVERYONE who has used apparatus possessing sharp tuning and critical adjustments must have noticed that there are certain parts of the instrument which seem very sensitive to the presence in their vicinity of the operator's hand. Especially in the case of receivers employing reaction, a number of disturbing effects are found to occur when the hand is placed anywhere near various components of the set. For example, when tuning-in signals from a continuous wave station with an oscillating receiver it will often be noticed that, after setting the tuning condenser to a value which gives a good readable note in the phones, when the hand is removed from the dial the note varies in pitch considerably; upon the shorter waves the signals may even vanish entirely. Again, when tuning-in very weak telephony with the aid of reaction it may be found that upon removing the hand either the speech disappears altogether or else the circuit breaks into oscillation. The set may also oscillate unexpectedly when the hand strays near various other parts of the receiver, such as the valves, H.F. transformers, and so on.

These and a number of other phenomena are grouped together under the name of "hand-capacity effects," and it is well worth while to devote a little time and consideration in so designing the set as to minimise them as much as possible. The experienced experimenter is, as a rule, quite familiar with these effects, and also with the best methods of eliminating them, but the matter is far otherwise with the beginner, to whom they are often very puzzling.

The phenomena, of course, are simply due to the fact that placing a conductor, such as the hand of the operator, near to certain parts of the set which carry high-frequency currents alters the capacity of those parts and so alters their tuning and upsets their equilibrium in various ways. If

this explanation is kept clearly in mind during the more detailed consideration of the various problems which arise in attempting to remove hand-capacity effects, little difficulty will be experienced in applying the principles to be laid down at a later point in this article.

To reduce, if not eliminate, hand-capacity effects one can proceed upon any one of three lines, or rather, if the writer's advice is taken, upon a judicious combination of the three. These three methods are, firstly, careful design of the set; secondly, screening of certain parts; and, thirdly, the employment of long handles to certain of the controls.

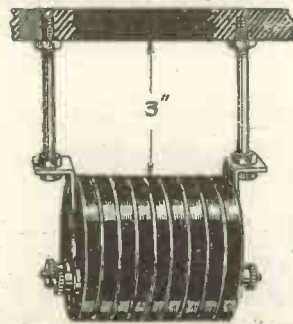

Fig. 1.—Anti-capacity mounting of H.F. transformer.

Good Design

Undoubtedly the best of the three, this method of reducing the trouble should be given much more attention than it usually receives, since it is a definite preventive, where the others are merely palliatives.

Considerable care should be devoted to arranging the high frequency circuits, towards the back of the panel and keeping all the components of each tuned circuit as close together as possible, in order that the wires connecting them may be short. Some thought should further be given to arranging the various controls in such a way that in operating any of them it is not necessary to stretch the hand across parts of the tuned circuits. For example, it is gener-

ally best to place the filament resistance along the front edge of the panel, and then immediately behind them the various condensers of the tuned circuits.

It is usually well to endeavour to separate the wiring of the H.F. circuits from that of the L.F. and D.C. circuits and run the former wires at a distance of perhaps two inches beneath the panel. Such an arrangement is beneficial not only in reducing hand-capacity effects, but also the various objectionable inductive phenomena which may occur in valve circuits.

A somewhat similar expedient which the writer has found of considerable benefit is to mount certain of the H.F. components at a distance behind the panel. This can usually be done quite readily by the use of either long B.A. screws, or pieces of screwed brass rod tapped into the panel, as illustrated in Fig. 1, which shows one of the slot type H. F. transformers mounted in this way upon a small piece of ebonite representing the panel.

This method can be easily applied to variable condensers by the simple process of fitting them with long spindles like that illustrated in Fig. 2. The knob and dial can then occupy their usual positions upon the panel, while the condenser itself is some three inches behind it, and practically free from capacity effects in consequence.

Screening

A method which is used to a considerable extent in the United States is to place some sort of earthed metallic shield between the components and the back of the panel. Sheet copper is usually employed for the purpose, screwed to the panel behind the various condensers, variometers, etc. A better but much more expensive method is to use ebonite, or rather "Bakelite," into the centre of which fine copper gauze has been moulded. This material is used for the panel itself, and provides very effective screening. A possible drawback is to be found in the fact that special precautions have to

be taken to insulate terminals by bushing each separately. Some attempts have also been made to use metal panels, but the practical difficulties seem too great for the average constructor to tackle.

The Use of Long Handles

When most amateurs find themselves troubled with capacity effects in operating their sets their first thought seems to be some sort of long handle to hitch on to each control knob so that they can manipulate it from a distance. The result, when the receiver is completely equipped, is such a sprouting of handles in all directions that it becomes confusing to pick out the one that one wants. Moreover, they are very apt to foul one another and the various other projections upon the panel, and to



Fig. 2.—Condenser extension handle.

Become a source of profanity rather than convenience.

From these preliminaries it will be inferred that the writer is no great believer in anti-capacity handles, holding them to be really a confession of failure in the more scientific methods. No doubt they have their legitimate uses, such, for example, as enabling one to obtain a very fine adjustment of tuning upon a variable condenser, though even this should not be really necessary if the capacity of the condenser is suited to the work which it has to do. The only case, perhaps, in which they are really justifiable is that of the usual pattern of coil-holder, in which the operator's hand otherwise approaches rather close to the coils, in a position where screening is neither desirable from a theoretical point of view nor convenient from a practical one.

A Series Parallel Switch

A useful gadget for the experimenter

A VERY convenient and simply constructed series and parallel switch can at a small cost and trouble be made at home by those possessing ordinary mechanical knowledge.

The diagrams show clearly its construction, and the wiring diagrams the manner in which it is connected to the aerial and condenser.

The base, A, is a piece of ebonite, 2 in. by 2½ in. thick having ½ in. hole drilled through the centre to take the spindle, B. Screwed into the base are five studs, C, three of which carry the spring contacts D. On each stud is filed a flat to take the spring contacts, the flats are drilled to take small screws to secure the spring

pillar and the spindle through a spring washer as shown.

The rotor is a piece of ½ in. ebonite turned to 1 in. diameter, a ½ in. hole is drilled through the centre in which fits the spindle, B. Two grub or contact screws are fitted to the rotor: one screws right through and grips the spindle, the other is only screwed half-way through. When the spindle is rotated through 90 degrees, connections are altered as shown in the diagrams.

The drawing is full-size scale. It might be mentioned that the spring contacts off used electric torch batteries can be used for the springs and bent as shown in the drawing. The wire connections can be soldered to these while the other two studs without springs can have the wires connected under the

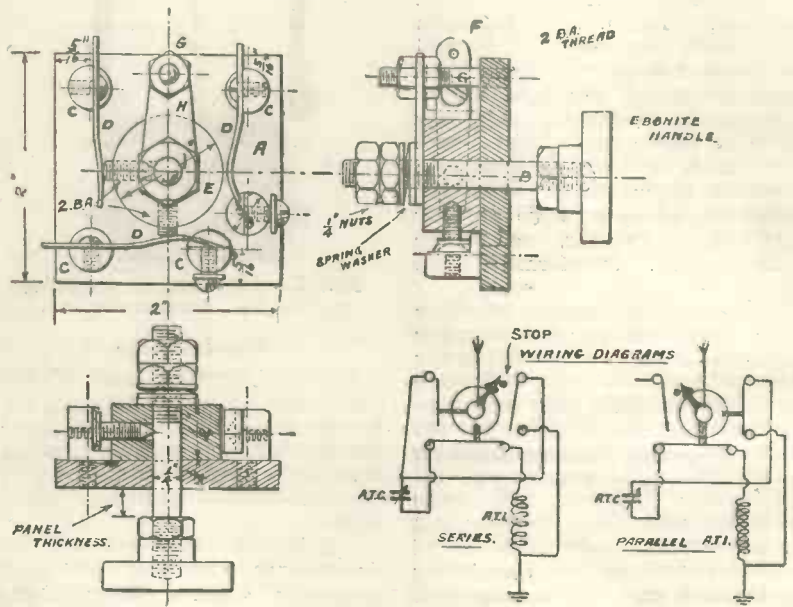

Diagrams giving full constructional details of this novel and useful switch.

contacts which are extended as shown at F, to receive the wire connections. A pillar, G, fitted with two nuts is also screwed into the base, this is for the purpose of taking the aerial wire. Over this pillar and the spindle, B, is fitted a brass plate, H, which bears on the ebonite rotor, F, and makes electrical connection between the

screw heads. This switch takes up very little room and is a very convenient size and works exceedingly well. A pointer could be placed between the ebonite handle and shoulder nut and two stops screwed into the panel to give the two positions of the switch as shown in the wiring diagrams.

GEORGE H. BOREHAM,

THINGS YOU SHOULD KNOW ABOUT FILAMENT CONTROL—

Your dull emitter valves must have fine control—and this fine control must LAST. When you buy your rheostat, do not merely ask whether it gives fine control, do not rely upon the evidence of initial demonstration, but ASK HOW LONG THE FINE CONTROL WILL LAST FOR. If you are offered a powder rheostat—ASK, WILL THE POWDER "PACK" together in use? ASK WHETHER ANY POWDER RHEOSTAT YET MADE HAS EVER FAILED TO "PACK" AFTER USE. "PACKING" means the tendency to close together, which is an inherent trouble in all powder rheostats which rely upon the application of pressure for the variation of resistance. "PACKING" is a likely source of great trouble in a powder rheostat. With a cheap rheostat your dull emitter valves are always in danger. You can get the valve to glow, BUT THIS IN ITSELF IS NO TEST OF FINE CONTROL. ASK HOW MANY TURNS the knob will make from the point where the filament begins to glow until the position of minimum resistance of the rheostat is reached. Oftentimes, with a cheap rheostat, the whole range of resistance variation is accomplished with HALF A TURN OF THE KNOB. This means that a shade of a turn represents many ohms variation. A little turn too much, and the result is a burnt-out valve. Every time this sort of control is moved your expensive dull emitter valve is in danger. HOW DIFFERENT IS LISSENSTAT CONTROL—every part of a turn represents a fractional change of resistance. General turns are necessary to vary the resistance over the whole of its range. Positive variation throughout. If you buy dull emitter valves, it is worth while using LISSENSTAT control. AND LISSENSTAT CONTROL A LONG TIME HENCE WILL BE THE SAME FINE, PERFECT CONTROL IT EVER WAS. Why risk a substitute when you can now get your choice of three types of LISSENSTAT CONTROL?

The latest type of Lissenstat Control—the LISSENSTAT MINOR (prov. pat.)—

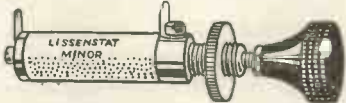

This is intended to provide something of the beautiful LISSENSTAT control at a popular price. Infinitely superior to wire or powder rheostats. Well made throughout. Indestructible. The LISSENSTAT MINOR is the next best thing to LISSENSTAT control itself. It is a perfect little device. For efficiency, use a Lissenstat Minor for each valve. **3/6**

The LISSENSTAT (prov. pat.)—

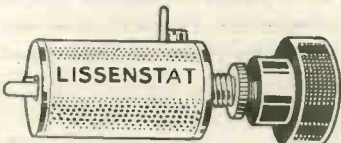

There is a perfectly free movement of the whole resistor column—fine variation of resistance because of the elastically deformable spring discs which form part of its unique construction—it is an ideal control for dull emitter valves. All those who desire exact control of critical electronic emission should use the LISSENSTAT. It adds range to a receiver in a way you never thought filament control could. Brings detection to the finest point. Use a separate Lissenstat for each H.F. and the detector valve. **7/6**

The Protection of the LISSENSTAT UNIVERSAL—



This is specially designed to provide a safeguard against burning out expensive dull emitter valves. A minimum resistance can be left in circuit to protect the valve, and yet the resistance can be reduced to zero when full battery pressure is needed. It gives all the beautiful LISSENSTAT control with the additional protection named. Full resistance is 50 ohms. Use one for each H.F. and Detector for efficiency. **10/6**

To those who make the mistake of thinking that LISSENSTAT (prov. pat.) control is the same thing as an ordinary rheostat—LET THEM TRY THE DIFFERENCE. After you have tried all the other controls on your receiver in vain to bring in a distant station you know is there, just a tiny turn of the LISSENSTAT knob will bring it in clearly and through a dead background of silence.

USING COILS IN THE ANODE CIRCUIT

—with crystal rectification.

When crystal rectification is used in the anode circuit, there is a highly damped effect in the circuit, and consequent loss of selectivity. It is therefore all the more important that there should be no additional damping losses in the coils and condensers used. Due partly to the negligible losses in the coils themselves, and also because the magnetic linkage between the coils is so strong, LISSENAGON coils can be kept at comparatively a great distance apart and still they will oscillate easily. And such a strong mutual coupling can be obtained (as is desirable when crystal rectification is used in the anode circuit), that the additional efficiency of LISSENAGON coils will be plainly noticed.

LISSENAGON TUNING CHART

Note the New Coils: 30, 40 & 60

TABLE 1.			TABLE 2.		
Wavelength range when used as Primary coils with Standard P.M.G. Aerial and .001 mfd. condenser in parallel.			Wavelength range when used as Secondary Coils with .001 condenser in parallel.		
No. of Coil.	Minimum Wavelength.	Maximum Wavelength.	Minimum Wavelength.	Maximum Wavelength.	PRICE.
25	185	350	100	325	4/10
30	235	440	130	425	4/10
35	285	530	160	490	4/10
40	360	675	230	635	4/10
50	480	850	250	800	5/4
60	500	950	295	900	5/4
75	600	1,300	360	1,100	5/4
100	820	1,700	500	1,550	6/9
150	965	2,300	700	2,150	7/7
200	1,885	3,200	925	3,000	8/5
250	2,300	3,800	1,100	3,600	8/9
300	2,700	4,500	1,300	4,300	9/2

LISSENAGON COILS TUNE SHARPLY AND STRONGLY BECAUSE THEY TUNE WITHOUT ENERGY LOSS

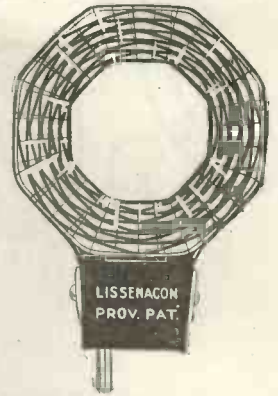

Regeneration is No Alternative to Radio Frequency Amplification—

It is a mistake to assume that because aerial reaction is used there is no need for radio frequency amplification in the same receiver. One stage of LISSEN REACTANCE (prov. pat.) should be used in every receiver. It makes reproduction purer, brings in distant stations with far greater ease and certainty, and makes a receiver far more sensitive. LISSEN REACTANCE makes rapid tuning possible and H.F. amplification exceedingly efficient and easy. It is simple to connect—see blue print with each. It has a switch already mounted and complete. No complications.

150 to 10,000 metres **19/6** 150 to 600 metres **17/6**

Radio Frequency Plus Regeneration—

That is why LISSEN REGENERATIVE-REACTANCE (prov. pat.) has been so successfully used in the reception of American telephony. It replaces aerial reaction and makes a receiver exceptionally sensitive. It is NON-RADIATING, replaces plug-in coils, is lower in cost than a set of coils to cover the same wide range—it is easier to handle, one knob controls tuning and reaction. Introduced into the anode circuit it forms an unequalled first stage of radio frequency. Reception is often possible with both aerial and earth connections dispensed with. Blue print with each shows the easy connections. Unbroken regeneration possible over the whole range, complete with internally connected switch. No soldering. LISSEN ONE-HOLE FIXING, OF COURSE—**£2 12 6**

Tune always with a vernier (preferably use the LISSEN Vernier, specially designed for fine tuning in H.F. circuits), price **12/6**

Sensitivity aided by the LISSEN VARIABLE GRID LEAK—

There is a unique resistant element used in the LISSEN Variable Grid Leak which cannot be duplicated because it is covered by definite patent claims. Valves vary in characteristics, and it is an excellent thing to be able to alter the leak value. With the LISSEN Variable Grid Leak the exact value of leak resistance can be selected to suit every working phase of the valve and circuit, thereby obtaining correct grid potential UNDER ALL CONDITIONS. LISSEN ONE-HOLE FIXING, OF COURSE—POSITIVE **2/6** STOPS BOTH WAYS



Build up Beautiful Tone Quality—Put the LISSEN T₁ Transformer immediately after the detector valve—a wonderful power amplifier, too—this incomparable transformer can also be used throughout. IT HAS A COIL WHICH WOULD AMPLIFY BY ITSELF WITHOUT ANY IRON CORE AT ALL ... **30/-**

Audio Frequency in Relex Circuits—It has been found that the LISSEN T₂ transformer is an ideal transformer in these circuits, where it yields very powerful amplification with great purity of tone **25/-**

An Excellent Light Transformer—One of the best light transformers made is the LISSEN T₃ **16/6**

BUILD WITH ALL LISSEN PARTS—we guarantee every LISSEN part to satisfy you perfectly—we EXPECT to hear from you if you are not satisfied.

Text Book of LISSEN Parts post free 8d.—free if applied for on trade heading.

LISSEN LIMITED,

20-24, Woodger Road, Goldhawk Road, Shepherd's Bush, London, W.12.

'Phone: 2339 Hammersmith. Telegrams: "Lissenium, Shepherds, London." (Foreign) "Lisscnium, London."

BUILD WITH THE BEST PARTS

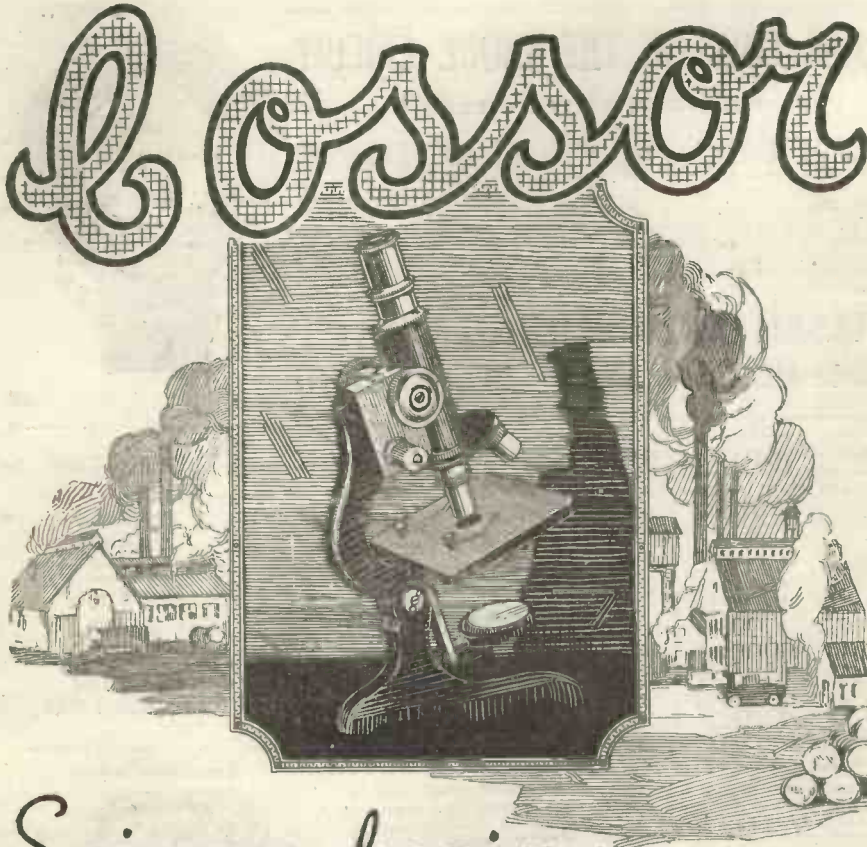

Science begins — but Industry completes

A GREAT English scientist worked out the theory of electron emission and, by building a two-electrode Valve, was the first to apply his discoveries to Wireless, whilst a famous American scientist went a step further and added the grid—thus greatly increasing its scope and utility.

But it remained for the inventor of the Cossor Valve to discover the most practicable method of utilising the greatest possible proportion of the electron stream.

It is safe to say that the invention of the hood-shaped Grid and Anode is the greatest contribution yet made by Industry to the science of Radio.

TYPES :

- P-1 (For Detector or L.F. use) ... 12/6
- P-2 (With red top for H.F. use) ... 12/6

Advertisement of A. C. Cossor, Ltd.,
Aberdeen Works, Highbury Grove, N.5.

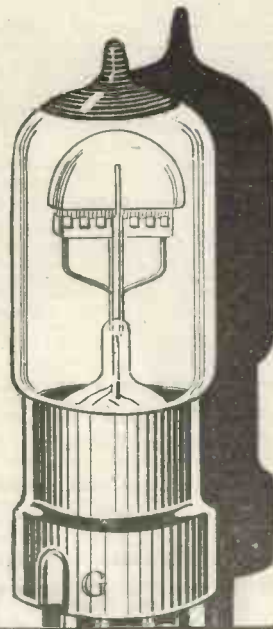

Its curved filament ensures long life

Gilbert Ad. 557



Save Money this way—

It is not difficult to make the majority of the components for your Wireless Set if you can only get the right information.

The book "The Construction of Wireless Receiving Apparatus," should be particularly useful to any enthusiast who possesses a few simple tools and who can follow out elementary instructions. With a little care, your home-made apparatus should work almost as well as bought components, and will leave you money to spend in other directions.

You can make all these Components at home—

- Anode and Grid Resistances.
- Filament Rheostats.
- Potentiometers.
- Crystal Detectors.
- L.F. Transformers.
- H.F. Transformers.
- Basket Coils.
- Slab Coils.
- Solenoid Coils.
- Duolateral Coils.
- H.T. Batteries.
- Condensers.

1/6

From all Booksellers, or 1/8 post free direct

RADIO PRESS, LTD.,
DEVEREUX COURT, STRAND, W.C.2

Radio Press Wireless Library No. 8.



Above & below the Broadcast Wavelengths

Short Waves

TIME was when the shorter wavelengths, by which I mean those of 300 metres and under, were looked down upon by experts as being of little or no use for anything like long distance work. This idea, however, has proved to be utterly false, for transmissions remarkable both for the distance covered and for the smallness of the power used have been accomplished upon wavelengths so short that it would have been deemed impossible but a little while ago to cover more than the smallest distance with them. The reception of American broadcasting, whose transmissions are made upon a band ranging from a little over 300 to just beyond 500 metres, must have become so common that now the man with a set of respectable size who cannot get them is considered more remarkable than he who can.

Duplex Working

Duplex working has been successfully carried out both by the English amateur, Mr. J. A. Partridge, and by the well-known Frenchman 8AB with amateurs in the United States upon about 150 metres, and anyone who cares to rig up a set that is capable of tuning down to 100 metres can be pretty sure of picking up a great number of American amateurs on any night when conditions are favourable. We are told that the next step for long distance communication will be the use of directional or semi-directional wireless, with which the wavelength must necessarily be something very short indeed.

Beam Wireless

As is well known, it is now possible to focus the radiations from a transmitting aerial into a beam in very much the same way that the rays of a searchlight are collected into a pencil with almost

parallel sides. The means used is the same in principle in both cases: Focussing is effected by the aid of parabolic reflectors. With light there is no particular difficulty in doing this since as the wavelength is very short indeed the reflectors can be of quite small size: but with wireless waves things are not quite so simple, for the height of the reflector must be at least equal to the wavelength of the transmission. It follows, then that only waves that are comparatively short can be used.

The great point about directional wireless is that it very much decreases the input power needed

will be reached by more than a tiny fraction of the whole. The dissipation is very much more marked in the case of wireless waves, whose movement is not confined like those of water to one plane. It has been calculated that a receiving aerial favourably situated at a distance of ten miles from a transmitting station can never expect to receive more than one trillionth of the power radiated. This being so it is obviously necessary with non-directional wireless to waste an enormous proportion of the energy put into the transmitting set when a long distance has to be covered.

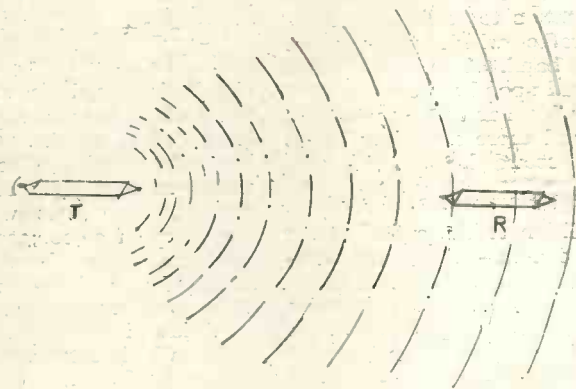

Fig. 1. Showing the waste of energy with ordinary transmitter.

to cover a given distance. This will be readily understood when it is remembered that non-directional or "broadcast" wireless radiations are sent out equally in all directions. The old and well-worn analogy of the ripples set up by a stone falling into water shows plainly how energy is dissipated when waves move outwards in concentric circles. A dozen corks floating upon the surface of the water at like distances from the stone's point of impact will each receive an equal amount of energy from the ripples, but none of them

By focussing the waves into a beam at the source from which they are radiated much of this waste can be done away with. A certain amount of diffusion will naturally take place, just as it does with the rays of a searchlight, but the waste from this cause will be comparatively small.

Beam wireless, to give it its latest name, seems likely to bring the once despised very short wave into its own. One imagines that the great transmitting stations of the future will be designed some-

thing after the manner of light-houses, save that the beam will not revolve automatically. It will be under the control of the operator,

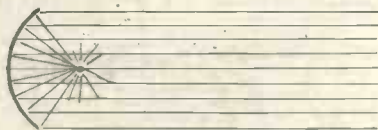

Fig. 2.—A reflector used for beam wireless.

who will be able to direct it towards the station with which he wishes to work. He will be able to communicate with any station within the range of his apparatus, but when he does so he will not broadcast his transmissions. They will be sent to the desired station, and only stations situated almost on a straight line joining the two will be able to tap the messages. Obviously a very much smaller input will suffice for this, since such a much greater proportion of the energy radiated will be doing useful work. Adoption of the short wave directional system will also go far towards solving one of the most pressing problems of the present day which is concerned with the very crowded condition of the ether upon certain wavelengths. One has only to tune in to the regions round about 12,000 metres to realise the enormous traffic which takes place upon this band. The babel always to be heard upon both 600 and 300 metres is familiar to every wireless man; and there are other bands almost as crowded.

Harmonics.

In addition to the actual transmissions of non-directional wireless an enormous amount of interference is caused by harmonics which are especially prevalent with transmissions made with either the arc or tonic train methods. Harmonics will exist as before when wireless becomes more directional, but their effects will be confined to the comparatively narrow belts affected by the transmissions responsible for them.

I was rather amused to notice not long ago a statement by one writer that he had tuned down to 50 metres and had discovered large numbers of our own amateurs working. He mentioned the call signs of several, one of whom had not transmitted within some months of the date mentioned, whilst two or three others whom I questioned on the point told me that they never had worked on 50 metres and that they could not do so if they wanted

to! There are, as a matter of fact, very few amateurs indeed licensed to transmit upon such short wavelengths, and it is only occasionally that they indulge in working between themselves. I venture to doubt whether the receiving set of the man who wrote that paragraph could be tuned down to 50 metres. My own is fairly efficient, and it has been especially designed to avoid all stray capacities on the high-frequency side; but I am pretty certain, though I cannot claim to have tried it, that it would not work efficiently on anything like 50 metres. As a matter of fact I do not think that there are many "straight" sets in the country that would. To get down to anything as low as this it is almost essential to use the Supersonic circuit, a description of which I gave some time ago in "Above and Below the Broadcast Wavelengths." In case readers have forgotten the principle I will briefly mention the way in which it operates. Very roughly it may be described as follows: The aerial



Fig. 3.—How wires will act as a mirror.

circuit is tuned to an incoming wave which we will suppose has a length of 15 metres. Coupled to the aerial circuit is a local oscillator tuned to a slightly different frequency, 15 metres will mean a frequency of 20,000,000 cycles per second. The local oscillator is set for a frequency of, say, 20,010,000 or 19,990,000, either of which gives a beat of 100,000 cycles, which corresponds to 3,000 metres. The rest of the set is simply such as would be used for the reception of 3,000 metre transmissions.

This arrangement may be applied to transmissions on much higher wavelengths than that mentioned; in fact, a friend of mine who is a very keen "collector" of American amateur stations uses it always for picking up C.W. transmissions higher than this. He finds that by arranging his oscillator so that the beat frequency is 100,000, he obtains excellent results with much greater signal strength than is possible on a "straight" set. When I mention that he has on more than one occasion logged over a score of

Trans-Atlantic amateurs at a sitting, it will be seen that there is really something in this method.

The B.B.C.'s attempts at re-transmitting American broadcasting as picked up by a very large receiving set have not so far (Dec. 28th) been very successful. Complaints were made on almost every occasion that atmospherics were phenomenally bad. And certainly the rattles and crackles which all but drowned either speech or music seemed at first sight to bear out this contention. On several occasions, however, when I tuned in after they had closed down I was able to pick up WGY



Fig. 4.—Showing the concentration on the receiving aerial.

direct with quite respectable signal strength and with no particularly bad accompaniment of atmospherics. Mr. Percy Harris tells me that he had the same experience. This seems to point to the probability that the giant receiving set about which we had heard so much was to some extent, at any rate, responsible for the parasitic noises that came through. The impression obtained was that the receiver was generally upon the very verge of oscillation. Anyone who cares to try the experiment for himself will find that when his set is in such a condition it becomes exceedingly noisy, especially if the high-tension batteries are not quite up to the mark. The noises are, I believe, due partly to distant atmospherics, for all crackles picked up are intensified by the set owing to its very sensitive condition at this point, and partly to the enormous amplification of noises due to defects in the set itself which takes place. As an experiment I picked up WHAZ on 380 metres and found that though signals were not very strong atmospheric disturbances were not so great as to drown speech and music.

It is quite possible that those who undertook the task of reception for relaying purposes were too ambitious in the number of high-frequency stages which they used. It is a truism that after the second every additional high-frequency valve fitted to the set increases enormously the difficulty of operating it. No matter what circuit may be used two factors present themselves to add complications. The first is, of course, oscillation,

with which we are all only too familiar, and the second is high-frequency distortion which can produce the most unpleasant effects upon reception. There is another point which is not generally realised. Add one high-frequency valve to your rectifier and you greatly increase the range of your set. A second brings a further increase, signals which were faintly audible with one stage now becoming quite strong. But when you go beyond this the increases in range and strength become very much smaller as further valves are added, and if you continue to wire more and more valves in circuit a point is reached after which further stages have very little effect indeed except to make reception exceedingly noisy.

Atmospherics

As a matter of fact, atmospheric, should not be particularly bad at this time of year upon the short waves. When they are very violent, as is frequently the case in summer time, the shock effect produced by them is sufficient to set an aerial vibrating at its own natural frequency; but when their oscillations are of small amplitude their effects are very much less noticeable on the short wavelengths. As one goes up the scale one finds that they increase in intensity, especially after the 2,000 metre mark is passed.

This is one reason why waves below 500 metres are especially suitable for the transmission of telephony. If atmospheric were entirely absent better results and greater range would doubtless be obtained upon the longer waves, but if one tunes in fairly regularly the telephonic transmissions of Radiola on 1,780 and the Eiffel Tower on 2,600 metres one realises that atmospheric interference is far more common on these longer wavelengths than it is upon the short ones.

Sharp Tuning

The question of sharpness of tuning, and therefore of non-interference with other stations also comes in. It must be remembered that unlike a C.W. signal a telephonic transmission is not confined to one sharply tuned wavelength. As modulations must be impressed upon the carrier wave a telephonic transmission really takes the form of a band rather than of a single wave. This is especially noticeable at short range, as any who live in the neighbourhood of a broadcasting station will have discovered. Using a double circuit tuner of the

most selective type I find that 2LO, 30 miles away, is distinctly audible 10 metres on either side of his own wave. It is not always realised that though we speak of wavelengths it is the frequency which is the determining factor in tuning. A transmission upon 265 metres has a frequency of 821,912 cycles per second, but if we reduce the wavelength by 5 metres we obtain a frequency of 833,333, a difference of 11,421 cycles which is fairly considerable. Now let us see what the effect would be of reducing F.L.'s wavelength by 5 metres. With a wavelength of 2,600 metres we have a frequency of 115,385 cycles. If we reduce by 5 metres to 2,595 the frequency becomes 115,607, a difference of only 222 cycles. It is obvious, then, that below 500 metres two stations can work without mutual interference with much less interval between their wavelengths than would be possible if both were transmitting upon something in the neighbourhood of 3,000 metres. Hence telephony with its rather broad tuning is best confined to the lower wavelengths where any increase or decrease

A much more important problem is that concerned with the number of wires. The solution depends really upon what you wish to do with your aerial. If you are a long-wave man then the aerial with two or more well-spaced parallel wires is indicated; but should you confine yourself chiefly to short wave reception, the single wire will give the best results, since, provided that the set is efficient, it enables one to tune down without great difficulty to the higher frequencies. Personally, after a good deal of experimenting with various types I found that the single wire inverted "L" aerial is perhaps the best for all-round use, for one can reach even the greatest wavelengths by loading it up without any marked loss in efficiency. A further point which commends this type of aerial is to be found in its cheapness. The weight of one wire is very much less than that of two or more with the accompanying spreaders, and it offers a far smaller resistance to the gales of winter. Hence lighter poles may be used, and it is not so necessary to lay out money upon wire

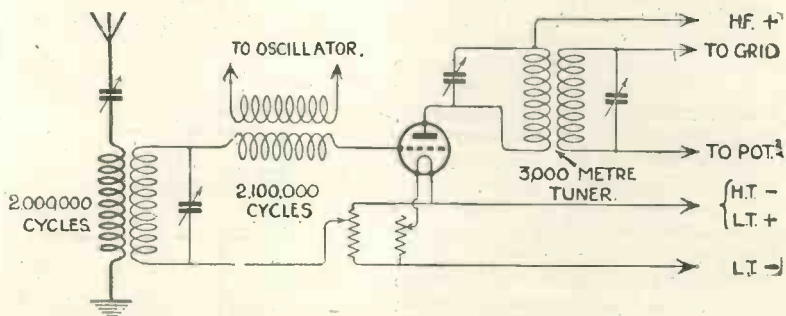

Fig. 5.—A super-heterodyne circuit.

of very small amount makes an enormous difference to the frequency. C.W., on the other hand, which can be very sharply tuned, can make use of the higher wavelengths without causing serious mutual interference between stations using neighbouring waves.

The great aerial question, whether to use a "T" or inverted "L" aerial, whether it shall be of the single, double or multiple wire type, still continues to rage furiously. There is not really very much to choose between the "T" and the inverted "L," provided that a good length can be obtained in either case; but if the aerial must necessarily be short then the inverted "L" type will usually be found the better since the natural wavelength of a short armed "T" aerial is very low.

ropes and the like. Also the number of insulators required is of course very much less. The single wire aerial has a very low capacity and a comparatively high inductance value, which is as it should be, at any rate for reception upon waves of moderate and short length.

On the night after these notes were written quite a successful reception of KDKA was accomplished by the B.B.C and relayed from all stations. Though the receiver again appeared to almost at the oscillating point most of the speech was distinctly audible and the musical items were very good. The symptoms resembling fading which were noticeable seem to have been due to the receiver going in and out of oscillation at intervals.

LAMBDA.

A Double-Dual Receiving Circuit

By JOHN SCOTT-TAGGART, F.Inst.P., A.M.I.E.E.

A description of a receiver using two stages of high-frequency amplification and two stages of low-frequency amplification with which the Editor has recently carried out successful tests.

A TYPE of circuit which enables a high degree of amplification to be obtained is that illustrated in Fig. 1 and Fig. 2.

It is a double dual circuit in which two valves are used to carry out both high- and low-frequency amplification of the signals. The first valve first acts as a high-frequency amplifier; the second valve then gives a second stage of high-frequency amplification; a crystal detector then rectifies the high-frequency currents and the resultant low-frequency currents are fed back into the grid circuit of the first valve, which now acts as a low-frequency amplifier. The amplified low-frequency currents in the anode circuit of the first valve are now fed into the grid circuit of the second valve which acts as a low-frequency amplifier. To enable the two stages of low-frequency amplification to be accomplished, the loud-speaker or telephone receivers are included in the anode circuit of the second valve.

A reference to Fig. 1 will help to explain how the circuit operates. The valve, V_1 , acts as a high-frequency amplifier, a tuned anode circuit, L_2, C_2 , being included in the anode circuit. This circuit, L_2, C_2 , is tuned to the same wavelength as the incoming signals, and the high-frequency potentials are communicated to the grid of the second valve through the grid condenser, C_5 , which is of $0.002 \mu\text{F}$ capacity, this capacity being much larger than ordinarily used in high-frequency amplifier circuits, for the simple reason that it has to carry the low-frequency currents as well, as will be explained later. The gridleak, R_4 , is connected across the grid and negative terminal of the filament accumulator to enable any excess of electrons on the grid to leak away.

The second valve now acts as a high-frequency amplifier, a tuned anode circuit, L_3, C_7 , being included in the anode circuit of this valve. It is to be specially noted that the second valve is not intended to act in any way as a rectifier,

but merely as a high-frequency amplifier and also, as will be shown later, as a low-frequency amplifier.

Having obtained the magnified high-frequency oscillations in L_3, C_7 , we rectify them by means of the crystal detector, D , the rectified currents passing through T_1 and inducing alternating currents in T_2 , these latter being communicated to the grid of the first valve. A condenser, C_3 , of $0.001 \mu\text{F}$ capacity is connected across T_2 to by-path the high-frequency current in the aerial circuit.

The first valve now acts as a low-frequency amplifier, and in the anode circuit will be seen the

The object of this condenser is to by-path the high-frequency currents; the low-frequency currents, however, passing through the choke, Z , will cause low-frequency potential differences to arise across the ends of Z , with the result that the low-frequency pulses are communicated to the grid of the second valve, through the condenser, C_5 , which has a capacity of $0.002 \mu\text{F}$.

These low-frequency potentials on the grid of the second valve will cause low-frequency changes of current in the anode circuit of V_2 ; these currents pass through the loud-speaker, $L.S.$, and operate it. The loud-speaker is shunted by a condenser, C_6 , of $0.002 \mu\text{F}$ capacity.

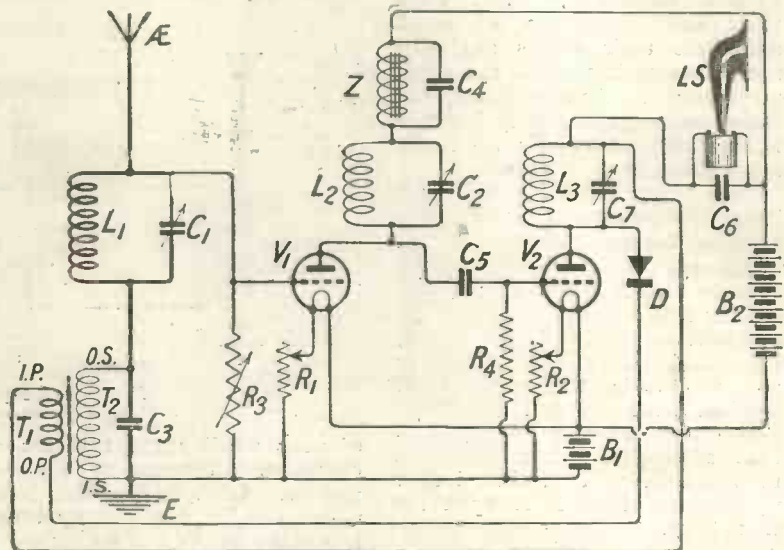

Fig. 1.—The new arrangement giving two stages of high-frequency with dual amplification.

choke coil, Z , which possesses an iron core. This choke coil may consist of 14,000 turns of No. 38 silk-covered copper wire wound on a bundle or iron wires 5 in. long and $\frac{1}{2}$ in. diameter. The secondary of an intervalve transformer may be used, and in fact, almost any kind of iron core choke will do. Even a pair of telephone receivers may be tried. The choke, Z , preferably has connected across it a condenser, C_4 , which may have a capacity of $0.0005 \mu\text{F}$ or $0.001 \mu\text{F}$.

The circuit, L_3, C_7 , is of course tuned to the incoming wave-length, and the inductance, L_3 , may be coupled to L_2 , or to L_1 to obtain a reaction effect, all the circuits being then readjusted. Similarly, the inductance, L_2 , might be coupled to L_1 , the coil, L_3 , being left by itself. Various changes may be tried in order to obtain suitable reaction coupling.

A 100,000 ohm variable resistance, R_3 , may be connected across (Continued on page 487)

HOME CONSTRUCTORS !!

THE SIMPLEX RADIO CHART IS ALL YOU REQUIRE.

THE CIRCUIT. High Frequency tuned anode coupling with intervalve reaction, as USED by 95 per cent. of the PROFESSIONAL MANUFACTURERS throughout the world and guaranteed to receive from anywhere all British, Continental and American Broadcasting.

WHAT YOU GET :-

1. A schedule of all material required.
2. A plan for laying out all components.
3. A wiring Key which eliminates all possibility of error.
4. And a book of instruction which includes the fullest information for the operation of the Set.

For 2, 3 or 4 valves 1/- each, postage 1 1/2d extra, or supplied

FREE WITH THE RADIO-STRUCTA

Combines
ELEGANCE
with
EFFICIENCY

with all components mounted in position and ready for wiring. The whole fitted in handsome French Polished Sloping Mahogany Cabinet with removable bottom to facilitate wiring.

THE RADIO STRUCTA in specification, quality, finish and resultant efficiency is the GUARANTEED EQUAL of the best known professional models.

Mounted but not wired.

2 valves	£5 5 0
3 valves	£8 0 0
4 valves	£10 10 0

Wired ready for use.

2 valves	£8 15 0
3 valves	£10 0 0
4 valves	£13 0 0

THE CURTIS REFLEX FOR FAULTLESS REPRODUCTION IS INCOMPARABLE



Range: All British Broadcasting Stations on Headphones and 40 miles on A LOUD SPEAKER

Price £12:0:0
(Royalties £2 2s. 6d.)

THE PROVED
BEST BY TEST

PETER CURTIS, LIMITED,
34, WHITFIELD STREET, LONDON, W.1.
(Off Tottenham Court Road). Telephone Museum 8439.

The

WOODHALL

No. 1 Variometer

is the only spherical variometer with one-hole fixing, metal bearing, & rigid spindles.



Patents pending.

Distinctive in being built on sound mechanical lines, in addition to being in every sense a scientific instrument.

The Stator windings are internally mounted and the clearance between Rotor and Stator is less than 1/16th inch. The result is extremely sharp and selective tuning, and a wide range of wavelengths—250 to 750 metres on 100 ft. aerial. Highly efficient for Anode Tuning.

The spindles are of square section, actually moulded into the Rotor; they cannot work loose.

A long metal-to-metal bearing is provided, and the "feel" of the rotation is extremely smooth and permanently a pleasure.

The connections, putting the Rotor in series with the Stator, are by means of spring plungers, fitted internally.

Size, 3 1/2 in. by 3 in. by 2 1/2 in.

Two terminals are provided.

To mount on panel, you need to drill *one hole only*, and lock the nut on the surface of the panel. For board mounting, four brackets are supplied, which allow the Variometer to be mounted either horizontally or vertically (as illustrated). Price, including Knob and Dial

17/6

For two stages of high-frequency put in the Tandem Condenser.

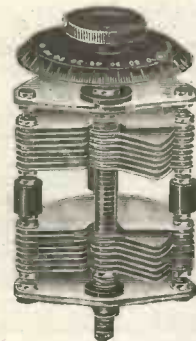

Consists of two matched condensers, each .0003, with a common central electrode. The end plates are of aluminium, with best ebonite bushes, accurate bearings giving smooth movement, and adjustable tension. The vanes are 22 gauge aluminium, 3/32nd spacers. The adjustment of vanes is a point to which very careful attention is paid. Terminals are provided—no soldering required. Mounted on panel by drilling *one hole only*. Price .. **16/9**

Woodhall Standard Variable Condensers are made in the following capacities.

.0005	.. 5/3	.0005	.. 8/-
.0001	.. 5/6	.00075	.. 8/6
.0002	.. 6/-	.001	.. 10/6
.0003	.. 6/6	.0012	.. 12/-

Knob and Dial, 1/9 extra.

Also made with Vernier attachment, at the following prices, complete with knob and dial.

.0005	.. 16/6	.001	.. 18/6.
-------	---------	------	----------

WOODHALL Fixed Condensers

Guaranteed built with finest Ruby Mica and Copper foil. Beware of cheap unbranded condensers, made with waxed paper.

These condensers are within 10% plus or minus of capacities stated, and each one is tested carefully before packing. Prices: .0001 to .001 mfd., 1/3; .002 and .003, 2/-; .005, 2/6.

WOODHALL Grid-Leak Condensers

The neatest and most compact method of mounting grid leak; resistance: 2 megohms. Capacities: .0002, .0003, and .0005 mfd. Price ... 2/6



Write for Leaflet giving full descriptions of Woodhall-Wireless Components, Variable Condensers, Fixed Condensers, Rheostats, Detectors, Coil-holders, etc.

WOODHALL-WIRELESS Components are obtainable from any leading Wireless Dealers. Dealers should specify WOODHALL-WIRELESS Components in ordering from their usual Factors or Wholesale Distributors.

In any case of difficulty in obtaining, Experimenters or Dealers should communicate with

The Woodhall-Wireless Mfg. Co.,
55, Cardington Street, Euston, N.W.1

Telephone: Museum 8566.

Wholesale only.

— GRIFFIN'S —

Hop 1806. 80, NEWINGTON CAUSEWAY
(Corner of Lancaster St.),
Elephant & Castle, London, S.E.1.



**THE 'GRIFFIN' UGLY
HEDGEHOG L.F.
TRANSFORMER** **PRICE
22/6**

Actual Ratio 4.7 to 1. each.
Wound with 21,000 turns
Best Silk-covered wire. Postage free.

**THIS WILL SOLVE HALF YOUR TROUBLES.
GUARANTEED** MINIMUM DISTORTION
MAXIMUM AMPLIFICATION

Money refunded if not satisfied.
STOCKED by all leading WIRELESS TRADERS
Don't accept an imitation—See our name on Ebonite.
SPECIALISTS IN PARTS FOR ALL CIRCUITS
Advice free. New Catalogue free on application. Also trade list.

Perfectly simple and simply perfect

**THE MIC-MET
SUPER
CRYSTAL DETECTOR**
(PROV. PATENT 22153)

This instrument is micrometric in principle and ensure a perfectly adjusted and rigid contact between crystal and contactor. By a combination of movements between the three knobs any portion of the exposed part of the crystal may be contacted. To use one of these detectors to realise the value of a crystal set. To be obtained at most wireless repositories, or direct of the manufacturers on receipt of 6/- postal order.

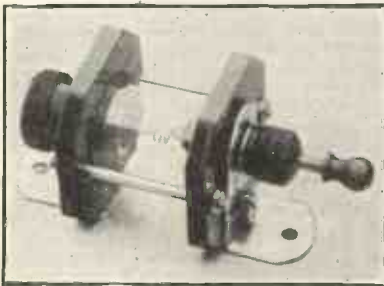

Trade Terms Solicited. British Make
C. & J. ARRIGONI, COMPTON PASSAGE, CLERKENWELL, LONDON, E.C. 1.

WHOLESALE ONLY.

WIRELESS DEALERS. Our 44-page Trade List of Radio parts now ready showing Trade and Retail prices. It is yours for the asking.

COMPLETE SETS, ACCESSORIES & COMPONENT PARTS

We were one of the very first Wholesale Factors of "Wireless," and our Catalogue is the very latest thing in Wireless. Send Trade Card.

**STAGGERING PRICES. HUGE STOCKS.
BUY FROM AN ESTABLISHED HOUSE.
IMPORTANT—Trade Only Supplied.**

HOBDAY BROS., LTD. (Dept. B.), 21, 23, 25, & 27,
GT EASTERN ST., LONDON E.C.2.
*Phone:—CLERKENWELL 2800 (6 lines)

All Previous Lists Cancelled.

THE WILKINSON MOTOR & ENGINEERING CO.,
10, 12, 14, 29, 31, 33, Lonsdale Rd., Kilburn, N.W.6.
H. E. WILKINSON, M.J.I.E., M.I. Radio E., Proprietor. Same address since 1900
"EIFFEL TOWER" (TRADE MARK) MASTS

The Masts are built of selected wood soaked in creosote, all main parts are screwed together and banded with galvanised iron. All upright timbers are Oregon Pine.

The Mast is sent out in 10 ft. sections, complete with screws, Steel Jointing Plates, and instructions for assembling and erecting. These Masts are triangular in shape and made of triangular material, giving great strength combined with lightness. No foundations required.

PRICES:—CASH WITH ORDER— CARR. FORWARD.
20 ft.—£2 0 0. Weight 30 lbs. Base Size 16 ins. Triangular.
30 ft.— 3 0 0. " 50 " " 22 "
49 ft.— 3 17 6. " 70 " " 26 "
50 ft.— 4 15 0. " 90 " " 29 "

Reg. de len 694837 **MAST SUNDRIES—**
Seven Strand Rigging Wire in 50 and 100 ft. coils 1/9 and 3/8 each. Rigging Strainer Screws (Galvanised) 1/- each. Wall Hooks 1/6 doz. Galvanised Pulleys 1/6 each. Insulator: 6/- doz.
WE SUPPLY ALL THE LEADING WIRELESS COMPANIES.

FOR THE EXPERIMENTER

These EXCELLENT UNITS have been DESIGNED to give the MAXIMUM EFFICIENCY combined with SIMPLICITY in MOUNTING which is UNIQUE and to be sold at the very MODEST SUM asked for them.



**FOR PANEL MOUNTING AS ILLUSTRATED.
FOR ALL BROADCAST WAVELENGTHS.**

	s.	d.
Ideal Vario Broadcast Tuner..	3	6
Anode Reactance	4	3
Vario Tuner with Reactance..	5	9
A.T.I. with Reactance	4	3
A.T.I., Reactance and Anode	6	3
Loose Coupler and Reactance	6	3
Loose Coupler without Reactance	4	0
Post and packing extra 6d.		

The Coils are specially wound and contain no WAX.
Use them in your next set and their merits will appeal to you.

Microphones for transmitting. P.O. standard pattern, solid back .. 15 0
Relays for remote control. These will operate with one dry cell and have double line contacts for L.T. & H.T. circuit. Unmounted .. 10 0
Mounted in teak case, with 3 pairs of connecting terminals .. 17 6

YOUR CABINETS.

The original House for hand-polished Mahogany, Oak and Teak Cabinets made to customer's own design. Ebonite Panels cut to size, drilled and engraved.
Country Customers please note.—All goods sent on approval against cash.
W. H. AGAR, Manufacturer of Telephone and Radio Apparatus,
TEL.: L. WALL 3305. 19, WHITECROSS PLACE, WILSON STREET, E.C.2.



FOR SECURING YOUR AERIALS

And a thousand purposes where great strength and strain is needed. FLEXIBLE STEEL WIRE ROPE. Aeroplane Cable made to Govt. specification to specified breaking strains. PRICES BELOW COST. Orders of 10/- and over carriage paid, otherwise, please add 1/- for postage.

No.	Dia.	Strain.	100ft.	No.	Dia.	Strain.	100ft.	No.	Dia.	Strain.	100ft.
0	1/16	5 cwt.	4/-	53	7/32	45 cwt.	12/-	7	11/32	100 cwt.	20/-
3	1/8	20 cwt.	8/-	5	1/4	70 cwt.	14/-	8	3/8	120 cwt.	21/-
51	5/32	25 cwt.	10/-	6	9/32	80 cwt.	15/-	9	13/32	140 cwt.	22/6

Strainer for use with above, right and left hand threads. 9d. each or 8/6 per doz.
SMITH & ELLIS Ltd., (Dept. 85), 11, Little Britain E.C.1 Tel. City Road.



**'TURRET'
Columbian Pine Masts
700 IN USE.**
Designed by Naval Experts.
REDUCED PRICES

27 ft. Turret Two Complete	37/6
28 ft. Turret Super Mast	53/6
36 ft. in 3 sections	71/6
42 ft. Telescopic Mast	78/6
45 ft. Super Telescopic	84/6
55 ft. Doubly Telescopic	£5/19/6
58 ft. Super Mast	£6/9/6
Turret Poles, 13ft.	5/9
16 ft. 2 1/2 in. base	7/9
28 ft. 2 pairs clamps	17/9
42 ft. 4 pairs clamps	29/9

Send for List.

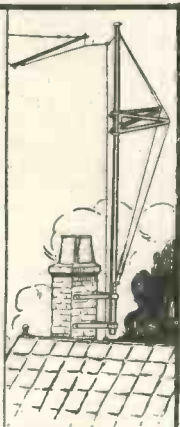

SIMPSON & BLYTHE, 8-9, Sherwood St., Piccadilly, W. 1

ATHOL PORCELAIN COIL MOUNTS

List No. 26/1P. **1/- EACH.**
WITH CLIPS AND SCREWS FOR PANEL MOUNTING, 1/3.
WITH CLIPS AND TERMINALS FOR BASEBOARD MOUNTING, 1/6.

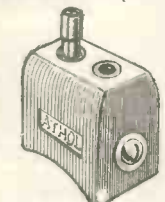

SEE THAT YOUR COILS ARE FITTED WITH THESE.
Best Results are only obtainable with High Insulation Resistance and Low Distributed Capacity such as these mounts provide.

FROM YOUR LOCAL DEALER, or, if difficult:—
ATHOL ENGINEERING COMPANY,
CORNET STREET, H. BROUGHTON, MANCHESTER.

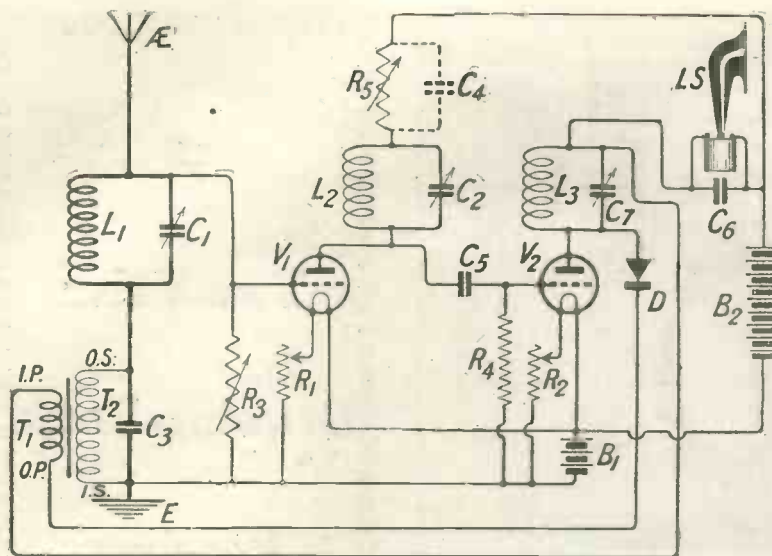

Fig. 2.—A simplified form of Figure 1.

the grid and filament of the first valve for the purpose of stabilising the circuit, if this is found necessary.

A Successful Modified Circuit

A simpler arrangement, which many will prefer, is that illustrated in Fig. 2. This time the low-frequency interval coupling is a resistance, R_5 , which is a variable 100,000 ohm resistance. This resistance may be shunted by a

condenser, C_4 , having a capacity of $0.0005 \mu F$ or $0.001 \mu F$.

The other values in the circuit are the same as those in Fig. 1. The Fig. 2 circuit is considerably more stable than that illustrated in Fig. 1, the tendency to low-frequency self-oscillation being much less, owing to the non-inductive character of the resistance, R_5 .

Values of Inductances

Plug-in coils are preferably used on these circuits. For the reception of broadcasting, the inductance, L_1 , will be a No. 25, 35 or 50 coil, according to the size of aerial employed; a No. 35 will be the usual size. If, however, constant aerial tuning is employed, a fixed condenser of $0.0001 \mu F$ capacity is included in the aerial leads, and in this case a No. 50 coil may be used for L_1 . The coil, L_2 , in the anode circuit, and also the corresponding coil, L_3 , will be a No. 50 for the B.B.C. stations on the lower wave-lengths and a No. 75 for those using longer wave-lengths.

The variable condensers, C_1 , and C_2 , in both circuits have a value of $0.0005 \mu F$.

We invite readers who try either of these circuits to let us know the results obtained. Up to 15 miles from a broadcasting station there should be no advantage over the ST. 100 circuit, for the simple reason that the valves are already fully loaded at this distance. The crystal detector, moreover, is also working at full pressure at this short distance. Reports are particularly desired from receiving stations above 30 miles from a broadcasting station.

Important Notice

READERS will be interested to hear that in WIRELESS WEEKLY has just begun a series of "official" and special set construction articles, each of which gives the very fullest details, enabling anyone to construct at home sets which are both first-class in appearance and performance.

Each of these sets is being *personally* tested by John Scott-Taggart, F.Inst.P., A.M.I.E., Editor of WIRELESS WEEKLY, and a report by him of the performance of each set accompanies every article. This double check by the author and the editor will ensure that each set described really performs its work satisfactorily, and is part of our policy of having every set described thoroughly tested by a responsible member of the staff.

WIRELESS WEEKLY is, of course, the 6d. weekly companion to MODERN WIRELESS, and though by no means the cheapest weekly paper, every effort is constantly made to increase still further its prestige amongst the better class of experimenter and constructor. If you have not yet tried it, give an order to your newsagent to send you the next two or three issues. The constructional features alone are worth the money, and, of course, you read the technical and constructional articles with that feeling of quiet confidence in their soundness and "workability," which is so important when reading a wireless paper.



Fig. 1.—The finished set with the lid closed down.

A
Two-Valve
Drawing-Room
Receiver

THE need is often felt for a really compact receiver, which can take its place in a room without making its presence obtrusive, and which does not need constant attention while listening in.

The set to be described will appeal to those who need a set fulfilling the above conditions, as it is made to produce the best results with a minimum of adjustments for tuning.

A photograph of the finished set with the lid closed is shown in Fig. 1, and the inside of the set in Figs. 2 and 3. All the components, with the exception of the inductance and its switches, are mounted on the baseboard, as can be seen from the photographs. Fig. 9 shows the underside of the completed instrument.

As can be seen from Fig. 6, the set is of the two-valve type, the first valve acting as a detector, while the second is a low frequency or note magnifier. A circuit diagram is shown, from which the method of wiring can be followed, and it can also be seen that the selector switches on the aerial tuning inductance permit any number of turns, from nine up to the maximum on the coil, to be used. The selector switches provide both coarse and fine tuning, and are mounted on ebonite, a strip of the same material being used to carry the valve-holders and filament resistance. As the base is of wood, all terminals should be mounted on ebonite bushes, which

may either be purchased, or made from instructions given in the January 1924 number of MODERN WIRELESS.

The inductance is wound on a 3-in. diameter cardboard tube, 4½ in. long, and consists of 72 turns of No. 20 S.W.G. double cotton covered wire, tapped at each turn for the first eight turns, and afterwards at every eighth turn. About ½ in. is left between the edge of the tube and the first turn. The tappings may either be made by scraping the insulation off the wire at the point where the tapping is to be made, and solder-

ing a lead on at that point, or by making a hole in the former and looping the wire through, leaving sufficient wire to reach the stud. In either case, the lead should be looped through a hole near the edge of the former, to keep it in place, and if the tappings are made in the second manner, this also helps to prevent the turns from becoming loose.

The ebonite panel, upon which the switches are mounted, measures 6½ in. × 3½ in. × ¼ in., and the switch arms have a radius of 1½ in. The panel should be obtained slightly oversize, and filed up

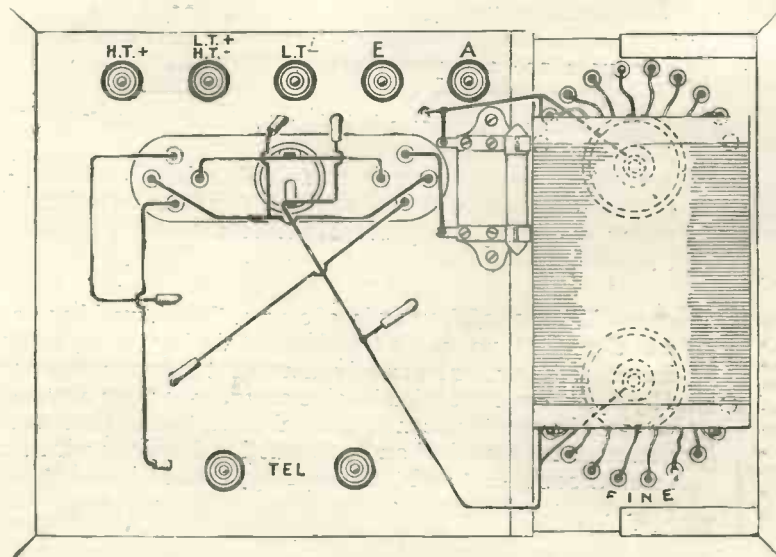

Fig. 3.—A plan of the bottom of the set.

By

HERBERT K. SIMPSON

A simple receiver with a minimum of adjustments, which any member of the family can work by pressing a button.



Fig. 2.—A photograph of the set with the lid open.

square and to the exact dimensions. This is important if a good fit in the cabinet is to be obtained.

The centres of the switches should then be marked, 2 in. in from each end of the panel, and 1 1/4 in. from the sides, and a semi-circle marked out, 1 1/2 in. radius, with a pair of dividers, lightly scratching on the ebonite. Do not use compasses, as a pencil line will form a leak from one stud to another.

The centre of each stud is then marked on the semi-circle, also

the positions of the stops. The distance between studs should be such that the switch-arm will pass easily from one stud to the next, and not become wedged in between. A good average distance between the centres is 7/16 in., when using studs the heads of which are 1/4 in. in diameter.

These holes are then drilled, also one hole in each end of the panel and three along one side, as seen in Fig. 7.

The studs and switch arms may now be fitted, after which the

inductance may be joined up to the studs. Take the beginning of the winding—the end from which single turn tappings are taken—and connect it to stud No. 7 on the fine tuning switch. Connect the first tapping to stud No. 6 and so on, until all of the first eight studs are joined up. The next tapping goes to stud No. 1 on the coarse-tuning switch, and the end of the coil terminates at No. 8. Thus the beginning of the coil goes to stud No. 7 on the fine-tuning switch, and the end to No. 8 on the coarse switch.

A piece of wood 5/16 in. thick is now to be prepared, to serve as the partition marked A in Fig. 7. This is made by taking a piece 8 1/8 in. x 4 1/2 in. and marking the centre of one of the 8 1/8 in. sides. On each side of this mark, measure off a distance 3 3/8 in., and join up the two points thus obtained to the corresponding ends of the other 8 1/8 in. side. The wood is then cut along these lines, and the correct taper will be obtained.

The ebonite panel is now fastened, with three wood-screws, to the 6 3/4 in. side of the partition, and the inductance former may be secured to this by a small screw in each end.

The base B (Fig. 7) may now be prepared, from 5/8 in. wood, measuring 8 1/8 in. x 6 1/8 in., and holes for terminals and leads should be drilled. Looking at Figs. 4 and 5, it will be seen that a hole is cut in the baseboard to take the ebonite strip upon which the valves and filament resistance are mounted. The size of the ebonite strip will

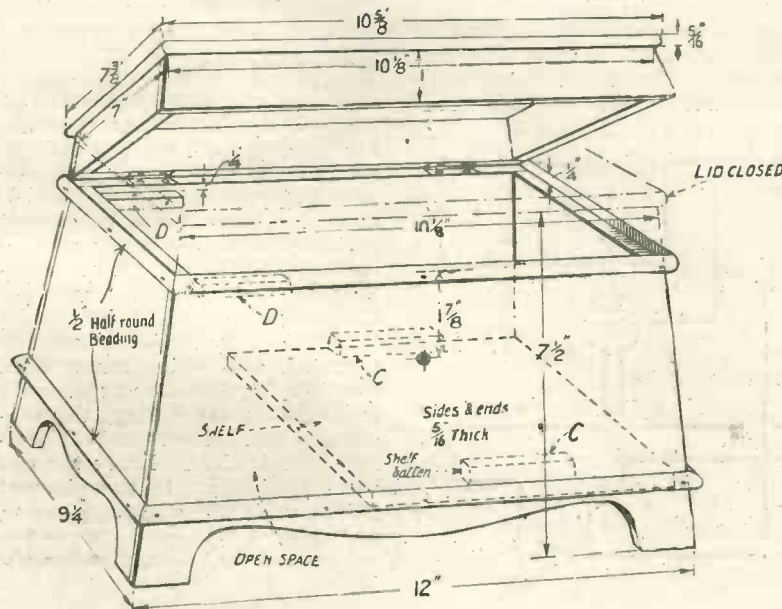

Fig. 4.—Diagram giving the measurements of the containing box.

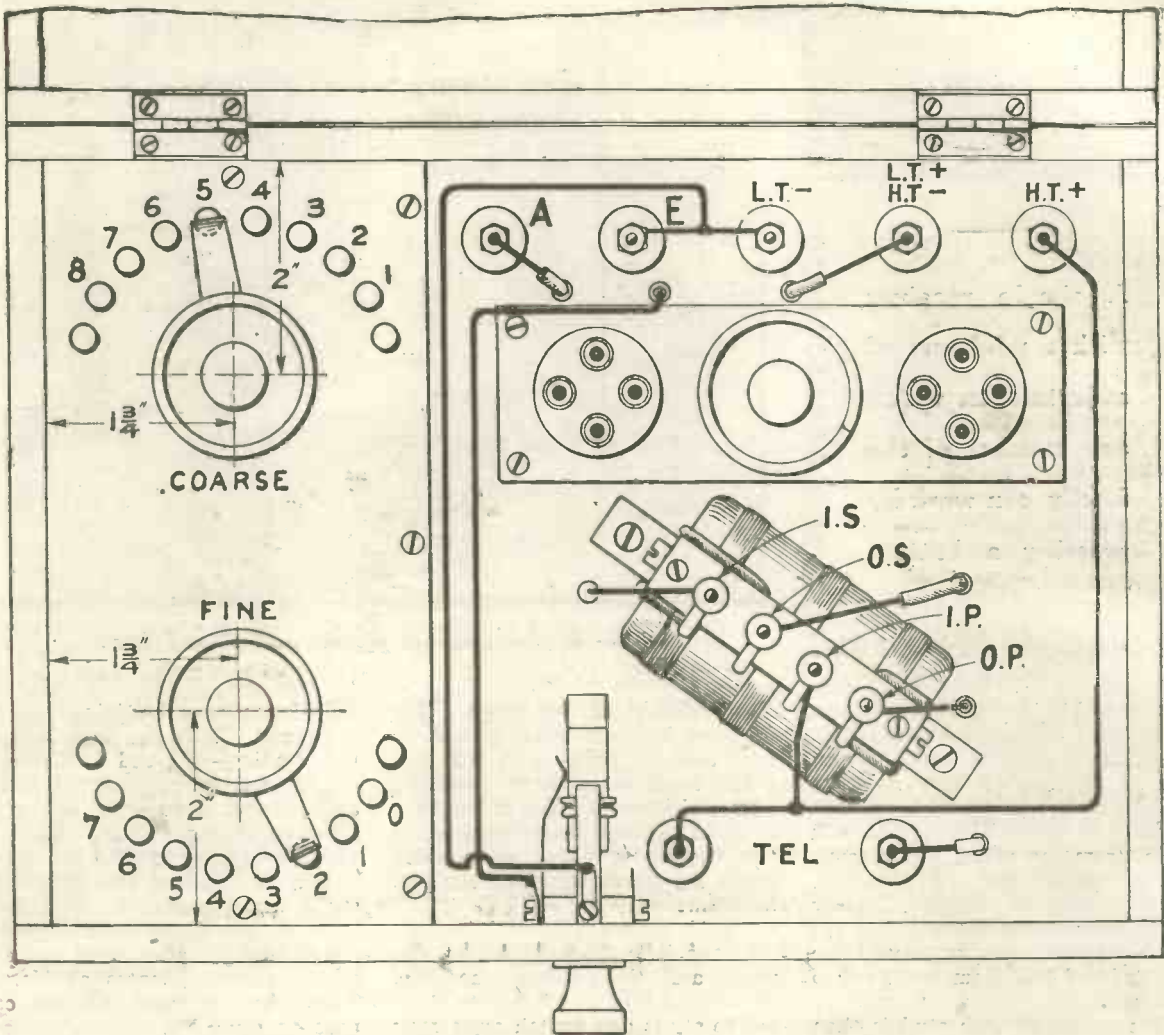

Fig. 5.—A view from above which shows the layout of the components.

depend upon the type of resistance employed, but in the set described, where a "Microstat" was used, the ebonite measures $5\frac{1}{8}$ in. \times $1\frac{3}{8}$ in. \times $\frac{3}{16}$ in., and the hole in the wood is

cut so that the ebonite overlaps it at the sides, while the ends of the hole are made semi-circular, in order to permit the ebonite to be secured to the base with wood-

screws. In this case the hole measures $4\frac{1}{2}$ in. \times $1\frac{3}{8}$ in.

The grid condenser and leak, of .0003 μ F and 2 megohms respectively, are mounted at one end of the hole in the base, as shown in Fig. 9, and the terminals may be secured in the holes previously drilled for them. When this is done, the base should be secured to the partition A in the manner indicated in Fig. 7. The transformer (the one shown being of the hedgehog type, made by Griffin Wireless Ltd.), may now be mounted, and wiring commenced. No difficulty should be experienced in following the wiring, the diagrams and theoretical circuit making this clear. Leave the two wires joining up to the filament switch until the cabinet is made, and proceed with the latter.

Views of the side and end of the box are given in Fig. 7, and two pieces of wood to each size will
(Continued on page 493)

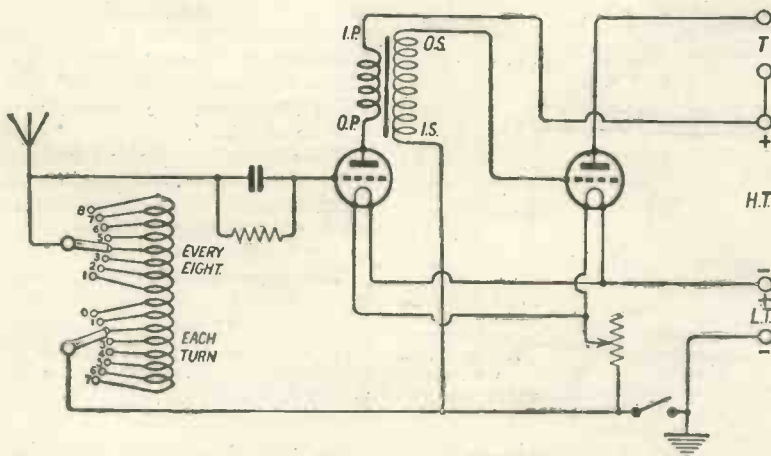
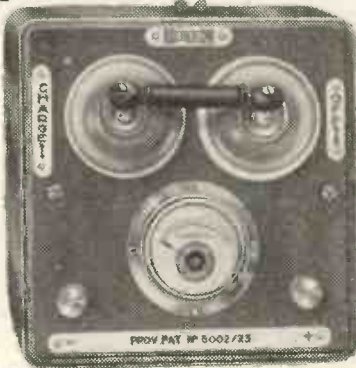

Fig. 6.—The circuit diagram, showing how the aerial coil is tapped.

ULINKIN

(Prov. Pat. No. 5002/23)

THE D.G. HOME BATTERY CHARGER
Charges Accumulators at Home
Free of all Cost!



If you have a Direct Current lighting or power circuit of any voltage, the ULINKIN is all you need to charge your own accumulators at home.

The ULINKIN is easily and simply fixed, within a few minutes, to your existing circuit, and is then ready for immediate use at all times.

To charge, you simply connect the accumulator to the two terminals on the ULINKIN and switch on. Then, whenever you are using electricity for lighting or heating purposes, the ULINKIN charges your accumulators without consuming any extra current, and is therefore free of all cost.

AUTOMATIC IN ACTION.
NO LAMPS — NO NOISE.

Requires no attention and cannot go wrong.

Price **£2 : 2 : 0** Carriage Free.

Complete with simple instructions for fixing.

Cut out your present cost and inconvenience by installing a ULINKIN To-day.

Illustrated Pamphlet and full particulars post free on request.

Sole Distributing Agents: *Trade Enquiries Invited.*

The GRAN GOLDMAN SERVICE,
 (Dept. M2), 71, Fleet Street, London, E.C.4.

The



ANODE CONVERTER

THIS unit has been specially designed to meet the demand for a reliable substitute for the high-tension battery. It is especially useful in connection with power amplifier work where a considerable plate current is taken at a high voltage. Worked from the ordinary 6-volt accumulator of your set, the consumption is only 1.15 amperes. Reception is perfectly smooth without any of those parasitic noises so often due to faulty high-tension batteries.

Supplied in the following standard voltage ranges:—

Type A.—6-70 volts, for general reception.

Type B.—6-120 volts, & Type C.—12-300 volts, for two-stage power amplification.



“HAVE A GOOD ONE.”

Write for full particulars.

THE M-L MAGNETO SYND., LTD.
 Wireless Department
 Coventry.

FORMO SERVICE

The Ideal Transformer Graded.

- A—Ratio 1.2
- B—Ratio 1.3
- C—Ratio 1.4
- D—Ratio 1.5

&
 Telephone one price 13/-

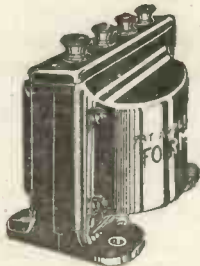

The FAMOUS FORMO Radio Components

Render **AMERICAN BROADCAST**

Possible using L.F. Stages, and are unequalled for use in DUAL CIRCUITS, or where extra sensitivity is required.

THEY ARE NOT APPROACHED FOR QUALITY, PRICE, OR PERFORMANCE and are UNCONDITIONALLY GUARANTEED.

THE FORMO COMPANY

(Arthur Preen & Co., Ltd.)

Offices & Works: CROWN WORKS, CRICKLEWOOD LANE, N.W.2
 List B.22. on request.

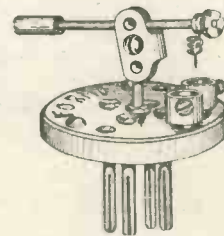

The FORMO Plug-in Detector for replacing Detector Valve & for DUAL Circuits 4/-

DIAMOND SPECIALITIES

DIAMOND "SUNFLOWER" COILS.
 No finer plug-in Coil, minimum self-capacity, 50-30,000 metres, from 4/6

DIAMOND VARIOMETERS.
 Wound d.s.c. on ebonite, one hole fix, knob and dial, 200 to 600 metres approx. 5/9

DIAMOND FIXED CONDENSERS.
 Well made in ebonite, all values, guaranteed capacities, with terminals... .. 1/-

BATTERIES.
 Long-life pocket batteries for building up H.T. each 4/6

RESISTANCES.
 12 ohm for Dull Emitter Valves each 2/6

SPEARPOINT CAT'S-WHISKER?.
 Extremely fine and rigid point, made from "Phosverum," the super alloy 3d.

BRETWOOD GRIDLEAKS.
 Variable, 0 to 6 megohms, one hole fix, guaranteed 2 years 3/-

HOUGHTON RHEOSTATS.
 Silent, strong, perfect control, 1 year's guarantee, 7.5 ohms, one hole fix 5/-

DR. NESPER "PHONE".
 Highly sensitive. Adjustable magnets, 1,000 ohms resistance... .. 14/9

VERNIER COIL HOLDERS.
 Smooth, fine adjustment, solidly made in ebonite 6/6 & 7/6 Etc., etc.

Cash with Order. Write for complete catalogue. Trade supplied.

THE DIAMOND WIRELESS EQUIPMENT COMPANY,

184a, OXFORD STREET, LONDON, W.1.

Entrance. Gt. Titchfield Street.

'Phone: Museum 1480.

E.C.H. & Co,

In replying to advertisers, use COUPON on last page

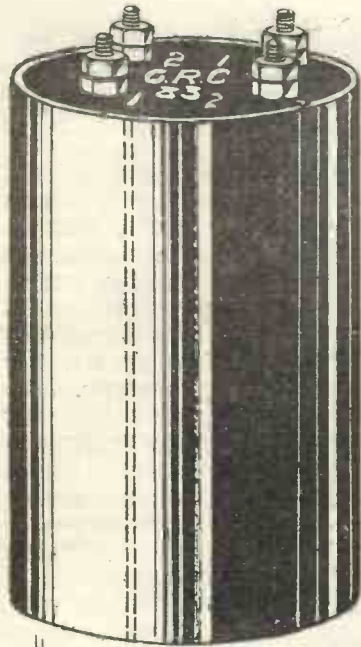

ANOTHER BLOW TO Foreign Competition

G.R.C. 83 AUDIO FREQUENCY Amplifying Transformer IS NOW HALF ITS FORMER PRICE

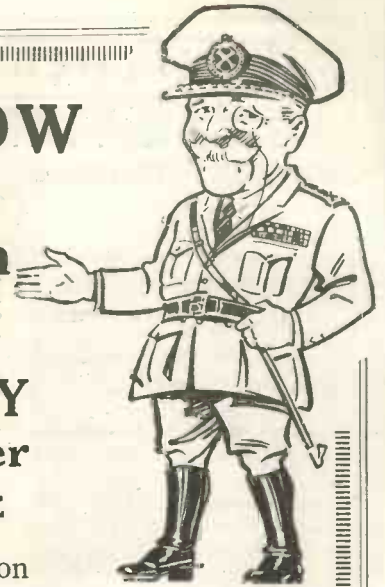

Triple Tested
24,000 Turns
Perfectly shielded.
*(The original shielded
Transformer).*

To absolutely destroy foreign competition on radio instruments, the inefficiency of which is doing much harm to the home market, we give you the opportunity to buy the best amplifying Transformer made, at less than the cheapest foreign article.

General Radio

What 5 T.R. says—

Messrs. The General Radio Company,
8, Cowley Road, Cranbrook Park,
Twyford Abbey Works, Harlesden,
Essex, 8th December, 1923.
Dear Sirs,
I have pleasure in informing you that I recently purchased one of your 15s. Audioformer Transformers, and having subjected same to a rigorous test, I thought you would be glad to hear the result. Used as an intervalve transformer (1st Stage, J.F.) it was unexcelled for silent working and amplification. The reception was particularly clear. I can honestly say it is equal in efficiency to any of the most expensive Transformers which I have used. I have also used it in conjunction with a microphone amplifier on the Transmission side (30 volts between the windings), and could wish for nothing better for this work.
The neatness and compactness of the piece of apparatus led me to purchase it, and I do not hesitate to advise my many radio friends to purchase Audioformers.
Yours faithfully,
ASHTON J. COOPER (5 T.R.),
Member R.T.S.,
Member R.S.G.B.

Only the most up-to-date labour-saving equipment and tremendous production make it possible to buy this efficient instrument at the startling price of

Complete with full instructions, mounting **15'** screws, template and latest circuit diagrams

TURN RATIO 2:1:1.
(The correct ratio for amplifying voice and speech frequencies.)
AMPLIFYING RATIO 5:5:1.

AT ALL
GOOD DEALERS.

GENERAL RADIO COMPANY LIMITED

**RADIO HOUSE,
235, REGENT STREET,
LONDON**

WORKS :
HARLESDEN,
N.W.10.

BRANCHES :
ALL
CITIES.

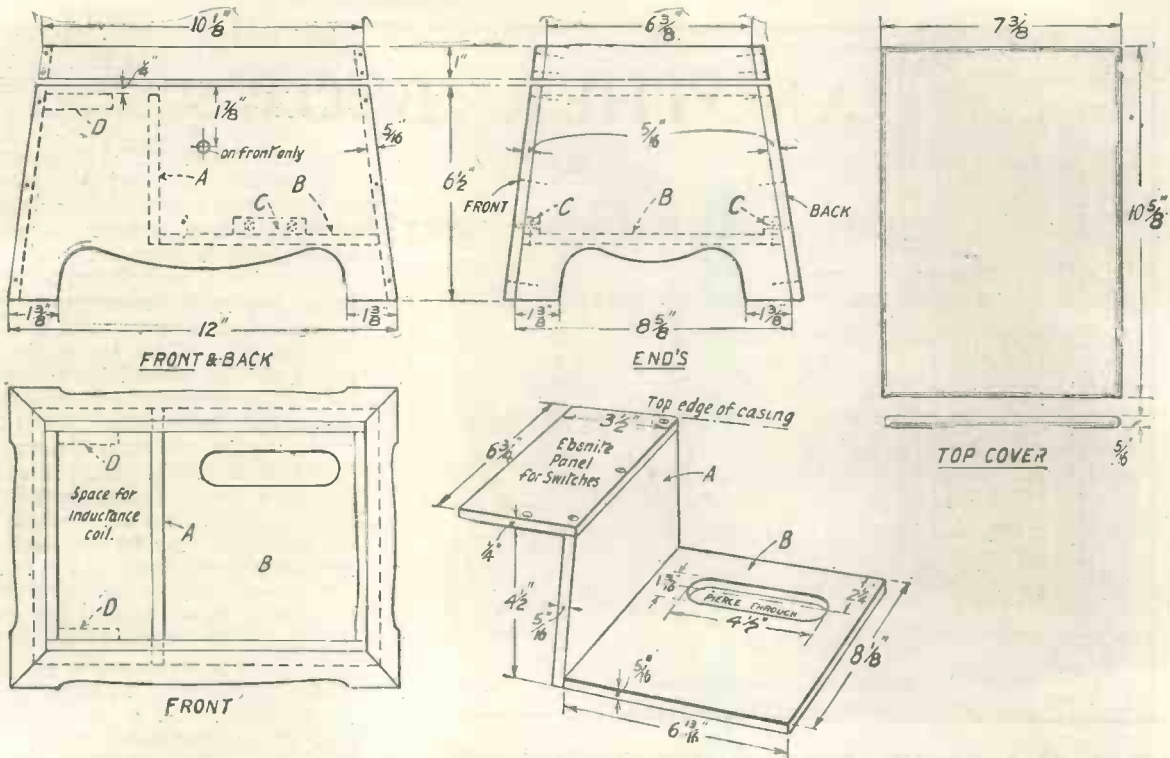

Fig. 7.—Details of the parts of which the cabinet is made.

be required. The strips at the top are for the lid, and may be made by cutting the wood to the overall size, and afterwards cutting off the 1-in. strip.

In the front piece only a hole is cut as shown, for the filament switch, which is of a very useful type supplied by Lissen, Ltd.

The sides and ends are shaped as shown, and this is best done by means of a fretsaw. The box is now formed by glueing the pieces together as shown in the figure, and securing by means of small brads. Note that the front and back portions overlap the ends, and not vice versa.

The four small strips are then joined up to form the lid, and are glued and fastened with brads to the top cover, which measures 10 5/8 in. x 7 3/8 in. x 1/8 in., the edges being rounded off and sandpapered smooth.

The instrument board may be placed in position in the cabinet, and the exact positions of the four small wooden ledges marked. These ledges, seen as C and D in Fig. 7 are then secured to the cabinet with wood screws, and the instrument-board screwed to the supports. The filament switch is then fastened in position in the front of the box, and the two wires soldered to the contacts.

The lid is hinged to the back of the cabinet by means of two small

brass hinges, and some pieces of 1/2 in. half-round beading may be secured to the cabinet in the positions shown in Fig. 1.

When the set is complete, the cabinet may be stained and polished, but it is not recommended

that this be done before completion, owing to the possibility of damaging the finish when mounting up the instrument board.

The set may now be connected up to an aerial and tested. The batteries and telephones must be

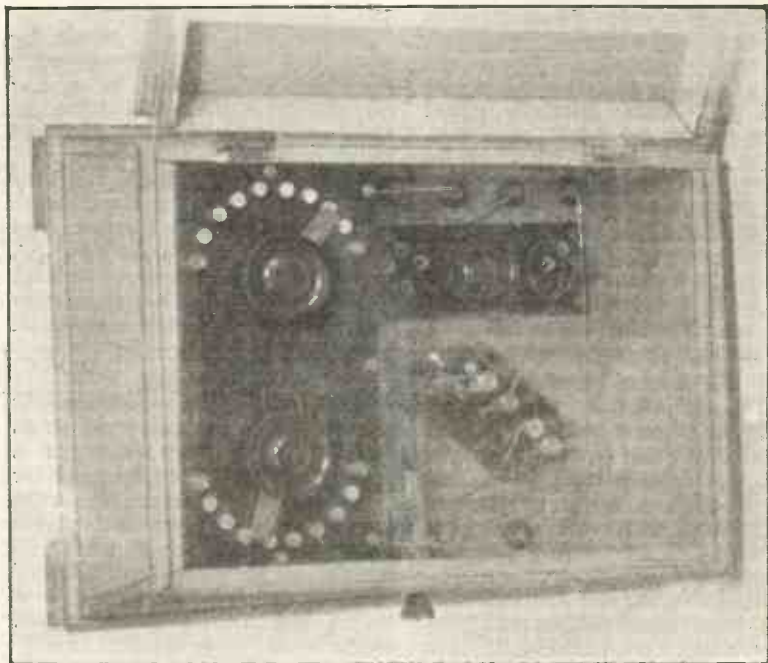

Fig. 8.—An interior view of the completed instrument.

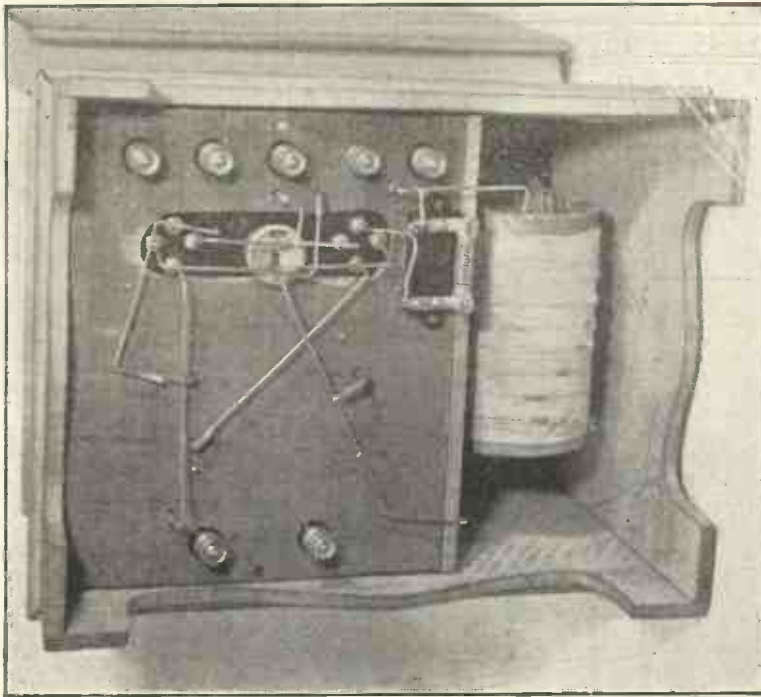

Fig. 9.—The bottom of the set showing the terminals and tuning coil.

joined up to the terminals, under the set, indicated in Fig. 5. The fact of having all terminals under the set preserves the outline of the cabinet, while leads to the terminals are concealed from view.

To tune in, turn on the filaments and put the coarse-tuning switch on stud No. 1. Move the fine-tuning switch over its studs to find a signal, and if nothing is heard, try with the coarse switch on stud 2, and so on until results are obtained. When the station is heard, tuning should be adjusted so that a movement of the fine tuning switch, on either side of the "best" point, effects a diminution in signal strength. Once the set has been tuned to any particular station, it need not be touched, as the filaments may be switched on and off without opening the lid.

The set will easily cover the broadcast wave band, and will operate a loud-speaker up to 8 miles from a broadcasting station, while 'phones may be used up to 25-30 miles. On a good aerial, and under favourable conditions, these distances could be exceeded.

How to Read a Wireless Periodical

IT has frequently been brought to my notice that there are a great number of enthusiastic wireless amateurs and experimenters who have no conception of how to read a wireless periodical. Apparently the majority are content to buy a paper every week and just read it. Some carefully guard these papers for future reference, whilst others simply let them lie about or be thrown away.

Now these papers must be kept—that is the first piece of advice; and the second is that they must be kept in a place easily accessible and in their correct order of dates of issue. This facilitates reference and saves time and temper.

Need of a Notebook

Now, the primary essential in reading a wireless periodical, which contains about seventy-five per cent. technical matter, is to provide oneself with a fairly substantial notebook of convenient size and a fountain pen or pencil; the use of these is obvious.

When reading an instructional or constructional article and you come across a good hint or tip in it of something that interests you, make a note of it and carefully copy the sketch or diagram if one is given. This particular item

may not be of immediate use, but almost without doubt you will find it will be on some future occasion, and it is to be found where it is wanted when required.

Follow this method week by week and you will be agreeably surprised to discover in a few months' time that you have an invaluable collection of accurate knowledge which will save you pounds, and in addition, the very fact of writing them down helps to memorise them. Further, you will assist the Editor of your pet paper, because instead of writing him and using up his time, you will possibly find the answer in your own notebook.

A Warning

Now as regards the actual reading of an article. Do not treat it as you would a short story in a popular magazine, to be read for a few minutes' pleasure, and then cast aside and forgotten. This is all right if you do not wish to acquire an intimate knowledge of wireless, but are just satisfied to be an ignorant knob-twirler and easily upset by a simple inquiry from a friend who wants to know how and why the set works.

Take the article, paragraph by paragraph, and read it carefully

and slowly. Should it contain a reference to a diagram or a sketch, refer immediately to that diagram and study it. When you have done this, go back to the paragraph and read it again, and what probably seemed to you to be incomprehensible in the first instance is now easily understood. Proceed in this manner to the end of the article and you will find that the technical subject matter has been studied and understood instead of being scanned in the ordinary manner and forgotten, because it was thought to be too far advanced to be readily comprehended.

Third Readings

Many articles too are well worth reading a second or even a third time, and many a difficult problem will gradually unfold itself, because you have done justice to yourself and the writer of the article.

Another tip worth having is, when reading through the advertisements, if you come across one that might interest you at some future date, just make a note of it in your book.

N.B.—Make a note of this article and the first time you go out, buy a notebook with a good strong cover.

ALEC. COHEN.

Silvertown

WIRELESS ACCESSORIES.

Quality guaranteed by over 50 years' electrical manufacturing experience



EBONITE TRANSFORMER FORMERS
No. 2. Complete with metal legs, 1/3 each. Made in other sizes.

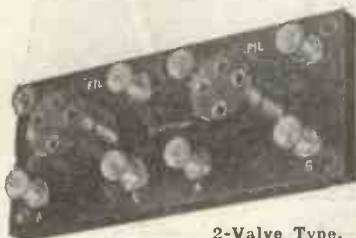

2-Valve Type.
MOUNTED VALVE SOCKETS
Single, double and triple. Suitably engraved for use with valves or for plug-in type high-frequency transformers. 5/6, 9/- and 13/6 each.

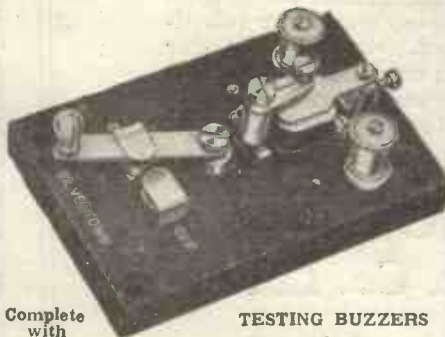

Complete with Switch.
TESTING BUZZERS
Mounted on ebonite base with terminals and shunt or mounted with terminals, shunt and switch. Supplied unmounted, 3/6, 7/- and 8/- each.



Silvertown "Featherweight" Insulators.

Weight 1 oz.
Length 5 ins.
Price 2/- each.
Small in diameter. Small area or surface leakage.

Cup in centre keeps a portion of the insulator dry in wet weather.

Ends are made of Duralumin, to reduce weight. Electrical efficiency is superior to that of a number of porcelain insulators in series. The capacity effect of Silvertown Insulators is very small.

These are the best and most effective insulators ever devised.

Silvertown "Everdry" Insulators.

Weight 2 1/2 ozs.
Length 7 ins.
Price 3/- each.

SILVERTOWN EBONITE SHEET, ROD and TUBE.

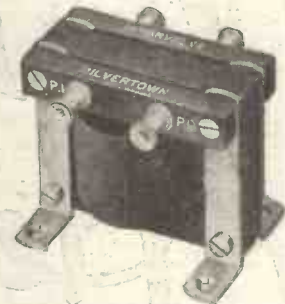

SILVERTOWN INTERVALVE TRANSFORMERS

Tested 1,000 volts between windings and 2,000 volts between winding and frame. 2 1/2 in. high by 3 1/2 in. wide by 2 1/2 in. deep overall. Weighs 1 lb. 3 1/2 ozs. Price 21/- each.



FILAMENT RHEOSTATS

With finished and lacquered brass bush for panel mounting. Resistance wire wound on insulating rod, thereby giving perfectly smooth adjustment. Each supplied with diagram giving drilling dimensions. 3/6 each.



FIXED MICA CONDENSERS

Built up with copper foil and best ruby mica dielectric. High insulation and capacity adjusted to within 5 per cent. Stocked in capacities from 0.0001 to 0.01 mfd. 2/- to 3/6 each.

Makers : The Silvertown Company, 106, Cannon Street, London, E.C. 4. Works : Silvertown, London, E. 16, and Burton-on-Trent.

BRANCHES:

BELFAST : 75, Ann Street.
BIRMINGHAM : 15, Martineau Street.
BRISTOL : 4, Victoria Street.
CARDIFF : Pier Head Chambers, Bute Docks.

DUBLIN : 15, St. Andrew Street.
GLASGOW : 2, Royal Exchange Square.
LEEDS : 1, New York Road.
LIVERPOOL : 54, Castle Street.
LONDON : 100 & 102, Cannon Street.

MANCHESTER : 16, John Dalton Street.
NEWCASTLE-ON-TYNE : 59, Westgate Road.
PORTSMOUTH : 49, High Street.
SHEFFIELD : 88/90, Queen Street.

← Note the leather covering



B.T.H. Headphones

**Best
and
most
comfortable**

B.T.H. Headphones have achieved a remarkable reputation for their wonderful sensitiveness and tonal quality. They perfectly reproduce speech and music and give maximum amplitude of sound. In many cases the substitution of B.T.H. Headphones for other makes has enabled listeners to hear distinctly broadcast programmes which had previously been inaudible.

Buy B.T.H. Headphones for better hearing

The latest type of B.T.H. Headphones, as illustrated, is much lighter and more comfortable than the original pattern. The headband is of plated wire covered with leather, and is constructed so as not to disarrange the hair, while the earpieces can be instantly adjusted to the head without any manipulation of nuts or screws.

B.T.H. Headphones (4,000 ohms.)—Reduced Price 25/- per set

The British Thomson-Houston Co. Ltd

Wholesale only

Works: Coventry London Office: Crown House, Aldwych, W.C.2

Branches at: Belfast, Birmingham, Cardiff, Dublin, Glasgow, Leeds, Liverpool, Middlesborough, Manchester, Newcastle, Swansea, Sheffield.

Sole Agents for the Music and Gramophone Trade:

THE MURDOCH TRADING CO., 59 & 61 CLIFTON ROAD, LONDON, E.C.1.

1965



Some Curious Reaction-Circuits

By A. D. COWPER, M. Sc., Staff Editor

A critical examination of several "stunt" circuits much in vogue.

CONSIDERABLE controversy has arisen amongst experimenters regarding the results claimed by advocates of certain types of reaction-circuits, which are alleged to give effects of the nature of super-regeneration when used with an outside or P.M.G. aerial. In particular there is a circuit credited to Flewelling, as it has, in common with the well-known Flewelling "Super" circuit, a .006 μ F fixed condenser introduced between grid-circuit and filament, with a feedback from above the 'phones to the grid, as shown in the first figure. Great claims are freely made as to loud-speaking at, say, 30 miles with this set together with absence of objectionable whistle.

Now "loud-speaking," like "Signals R 9," is an extremely elastic term. Actually, there is nothing exceptional at 30 miles in getting quite a reasonable degree of mild "loud-speaking," at least sufficient for one or two quiet listeners in a small, still room, away from traffic noises, using a single valve (with a good high P.M.G. aerial), a really efficient tuner with low-resistance inductances properly designed, and skilful use of reaction. Thus at a point about 35 miles N. of London, on an aerial situated in a slight valley, but with a 35-foot pole to support it, with an old Siemens-Halske valve with 50 volts on the plate, and reaction insufficient in any circumstances to make the set oscillate, the writer has heard London quite clearly in daytime on an ultra-loud speaker. At London, in daytime, Birmingham has come in quite audible in the loud-speaker (in a small quiet room) and a specially efficient tuner and with a good suburban aerial; whilst both Glasgow and Newcastle are clearly audible late at night on favourable occasions.

Since there are many claims for successful reception of American broadcasting on a single valve with reaction, and the writer has shown that, without any suspicion of "super" effects, all B.B.C. stations can be heard on a 15-foot vertical earth-lead alone (if one has the patience to tune them

in), it is scarcely necessary to postulate super-regeneration to explain successful reception of these stations on any kind of outside or comparatively large indoor aerial, nor a certain measure of loud-speaking on a good outside aerial at a score of miles or so, with a single valve.

In order to examine more closely this claim for exceptionally good reception with an alleged Flewelling circuit, that shown in the diagram was fitted up with standard types of components, but with switching-gear arranged so as to be able to switch over in a moment from an ordinary reaction-circuit to one after the original Flewelling

stations at 70 and 100 miles, making any slight readjustments of reaction and tuning required to give best results in either position, *not the slightest difference* was observed in signal-strength, either measured by direct aural observation (in rapid and repeated comparison), or more scientifically by observation on a shunted microammeter included in the plate-circuit, measuring the total rectified carrier-wave. Either with full P.M.G. aerial, earth-lead alone, or "capacity aerial" (tuning-coil plus stray pick-up on leads, etc.), except for a slight difference in freedom of oscillation, there was absolutely nothing to choose

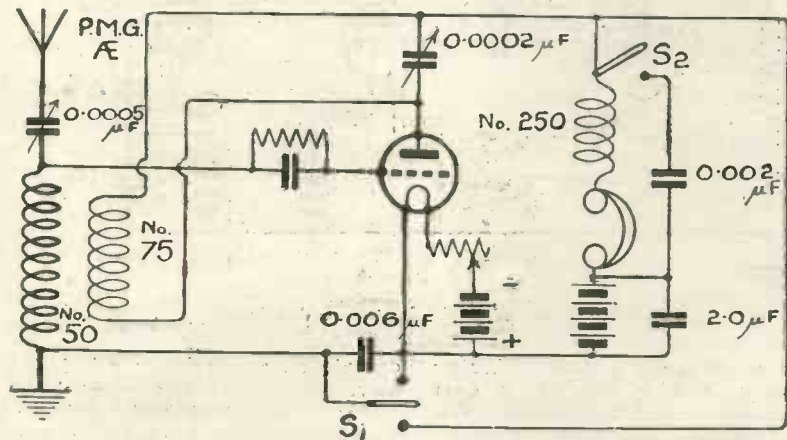

Fig. 1. "Flewelling" type of circuit.

(simplified) super-circuit, but using an outside aerial, with which, of course, the super-effect is inoperative (the slightest capacitive or resistance load here effectively stopping the grid-leak howl which supplies the quenching oscillation in the Flewelling genuinely super-regenerative circuit). Thus the switch S_1 introduces the .006 μ F fixed condenser, and brings in the feedback from above the 'phones, as shown originally by Flewelling; the switch S_2 cuts out the usual bridging or blocking condenser across the 'phones, also putting into effect the radio-choke coil of about 250 turns, which should assist the feedback effect.

On tuning-in critically both loud local transmissions, and distant

between the normal circuit and that which imitates the Flewelling arrangement. This confirms innumerable observations of the writer and his colleagues of a less formal character. Actually the writer has shown that for genuine super-regenerative effects, with a suitable small frame-aerial or merely "capacity aerial," this .006 μ F condenser and special feedback can be dispensed with (*Wireless Weekly*, Vol. 2, No. II, p. 414). It is difficult to see how this curiously-arranged blocking condenser of .006 μ F can produce any useful effect in such a circuit: its only real effect is that of a 'phone and H.T. blocking condenser, together with a transfer of the grid-leak to the H.T. plus in place of the more

usual arrangement. On close examination it will be seen that there is in addition a *small* negative low-frequency reaction-effect introduced: the high audio-frequency impedance of the 'phones, together with the fairly high "reactance" to audio-frequencies of the .006 μ F blocking-condenser, will cause a certain hand-back of audio impulses into the grid-circuit, where they will travel up through the comparatively small impedance aerial-tuning coil and affect the grid, but in a manner that will give negative audio-reaction. This affects slightly the whistle-note when acting as a real super-circuit; the effect with an outside aerial is negligible, as it can be balanced out by slightly closer H.F. reaction. Accordingly, the good results claimed for this type of circuit must be traced to other features than the particular arrangement of the blocking-condensers.

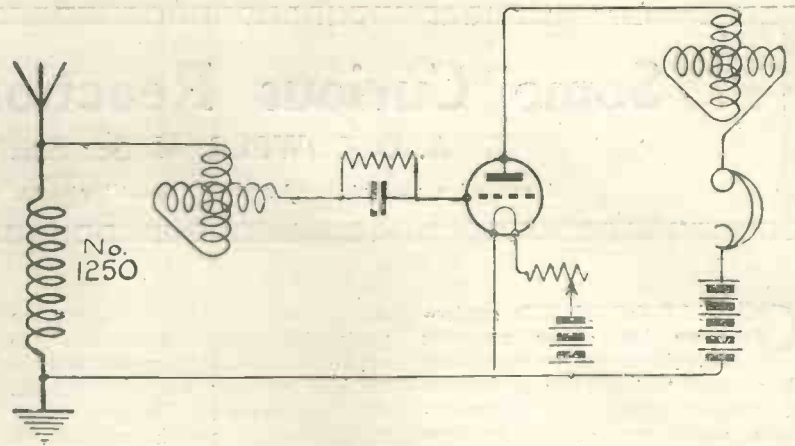

Fig. 2. "Autoplex" circuit.

frequency quenching oscillation and whistle, and therefore no Armstrong super-effect; but with a small aerial; such as a small frame aerial, or indoor aerial, it will

emission, etc. With an outside aerial, on account of the elimination of so much tuning capacity by the series arrangement of the A.T.I. (as in the short-wave receiver), quite good results are obtained as an ordinary reaction-circuit when using a low-resistance variometer of the correct inductance value—which will be considerably higher, of course, than would suffice in the ordinary parallel position. A large Igranic variometer, or other large internally-wound variometer of the type recommended for intervalve use, say 4 in. in diameter and with 100 or more total turns of as thick wire as can be got in, is suitable here.

A circuit which bears some superficial resemblance to the Autoplex is that described in *Wireless Weekly*, Vol. 2, No. 20, by a correspondent, Mr. C. Lyons, where, however, a *small* inductance is used in place of the large No. 1250. This gives an entirely different effect, though just as remote from any super-regenerative action. It is the "auto-transformer" effect so often used in C.W. and telephony trans-

(Continued on page 501.)

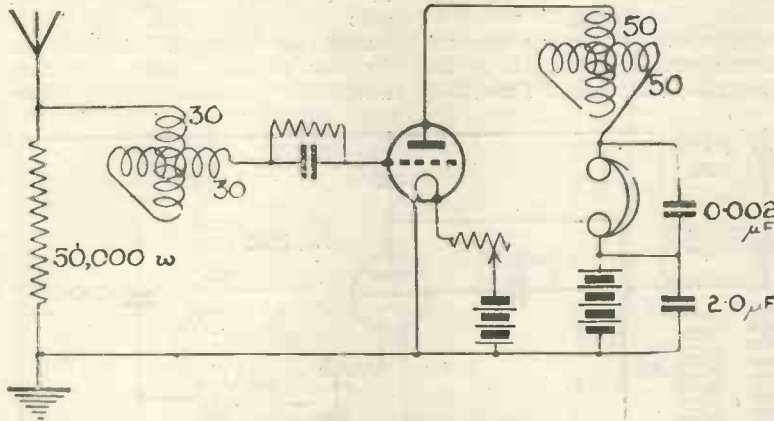

Fig. 3. R.A.F. short-wave receiver.

The *Autoplex* circuit (*Wireless Weekly*, Vol. 2, No. 18, p. 621) is another which has caused much controversy. This is shown in the second diagram. It should be examined in comparison with the old R.A.F. short-wave circuit, recently referred to by the writer (*Wireless Weekly*, Vol. 3, No. 3, p. 81). It will be seen that these are identical, except that in the *Autoplex* circuit the low-value grid-leak resistance (50,000 ohms), which is used in the other circuit to discharge "statics" and provide a continuous leak-path for the ordinary grid-leak, has been replaced by a large radio-choke (No. 1250 coil), which has exactly the same effect, with the added disadvantage of clumsiness, greater cost, and the bringing in of unwanted long-wave stations to which it approximately tunes the aerial. Since there is no long-wave reaction, there can be no tuned high-audio-

operate as an ordinary grid-leak-howl super, with a quenching frequency adjustable in the ordinary way by variable grid-leak, or variable grid-condenser, giving suitable values of H.T., filament

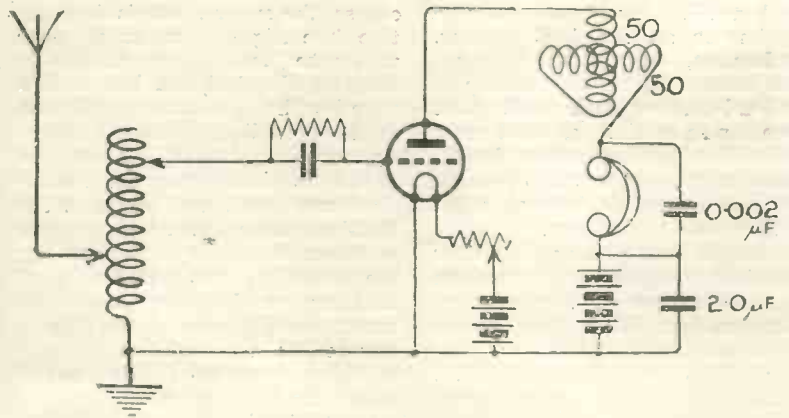

Fig. 4. Auto-transformer circuit.

CUT PRICES BUT NOT "JUNK!"

and sold on satisfaction or money back guarantee.

Aluminium Vanes, 5d. doz. Aerial Pulleys, 6d. Anti-Capacity Handles, 6d. Aerial Wire—Finest 7/22, 2/3 100ft. Postage 1/-. Cat's Whiskers—Gold, 2d.; Silver, 1d.; Spearpoint, 2d. Set of 4, 6d. Coils, Basket. Set of 6, 1/11. Waxless, duo-air spaced, "Radstock," 4 1/2-vt. Batteries (British), 4/9 doz. Variable Grid-leaks, 1/11. "Bretwood," 3/-. "Radstock," Tapped Studs, 5/9. Coil Holders, solid ebonite, 2-way, 4/-. 3-way, 5/-. Sockets, 7d. each. Condenser and Grid-leaks, 2/-. Grid-leaks, all megs., 1/- and 1/9. Detector Glasses, 3d. each. Buzzers, 2/6. Condensers, Fixed—To .001, 9d.; To .005, 1/-. To .01, 1/9; To .1, 2/9. Variable—.001, 8/-. .0005, 6/-. .0003, 5/6; .0002, 4/6; Vermier, 4/-. With aluminium end plates. Knob and dial. Condense^r Dials, 0-180, 11d.; with knob, 1/4 and 1/9. Bushes—Top, 1d.; Pottom, 1d. All S. and D.C.C. wires stocked. Voltmeters, 5/6, 8/6. Condenser End Plates, drilled and tapped, 9d. each. Solid ebonite. Contact Studs, 4d. doz. Stops, 2 a 1d. Connecting Wire, tinned copper, 3 yds. 2d. Jack Switches, 2-way, 5/6; 4-way, 7/6. Wander Plugs, 3d. each. Crystals. Every make stocked. Zincite, 9d.; Bornite, 6d.; Talite, Hertzite, 9d.; Galena, Silicon, Carborundum, 3d.; Copper, Pyrites, 6d.; Marvellite, 1/3; Melitza, 1/-. Midite, 1/-. Gold Seal Plastic Metal for fixing Crystals, 6d. packet. Crystal Cups, 4-screw, 1 1/2d. Crystal Detectors, Plain brass, 1/3; Nickel, 1/6; Dustproof, 1/6, 2/6; Plug-in Type, 3/6; Perikon, 2/3 and 2/9 (Zincite and Bornite). Crystal Detector Parts, in envelope, 9d. and 1/3. Nickel, 1/- and 1/6. "A.A." Earth Clips, adjustable, 6d. Ebonite, 3/6 lb., any size cut. Filament Resistances, "Perfecta," 1/9; "Super" 2/6. Ebonite Dial, 7d. "Radstock," for dull emitters, 30 ohms; velvet actions, 2/9. Foil. Copper, 3d. foot. Tin, 4d. Formers, 12 by 2, 2d.; 12 by 4, 3d.; 12 by 5, 4d. H.T. Batteries, 36 vt. 8/-. 63-vt., 12/-. Finest British. Mead-phones, Continental, 10/6; Adjustable, 14/9; Browns, 25/-. Pival, 16/6; British Fellows, 18/6; T.M.C., 19/6; Brandes, 25/-. Almpion³ Loud Speaker, 42/-. "Ultra," 4,000 ohms, 37/6. Postage, 2/-. Insulated Hooks, 1 1/2d. Tape, 6d. roll. Insulators—Egg, 1 1/2d.; "Lion," 1/3; Reel, 1d.; Shell, 2d. Empire Tape, 1/9 doz. yards. Jack and Plug, 3/9. Spade Terminals, 4 a 1d. Screwed, 2d. each. Pin, 2d.

Be Wise! Buy Quality! and avoid "Junk" Trouble.

Knobs, finest, 4d., 3d., and 2d. Lead-in Tubes, 12 in., 11d.; 9 in., 10d. 6 in., 9d. Flat Simplex, L pattern, 1/6. Glass Tubes, 9d., 7d., 6d. Mica, .002, 2d. sheet. Nuts, 2 B.A., 2 1/2d.; 4 1/2 6/8 2d. doz.; O.B.A., 4d. Potentiometers, 250 ohms, 4/6; 400, 5/-. guaranteed bronze wound. Scales, Ivory, 0-180, 3d. Set Name Tabs, 6d. Bell Wire, 3 yds., 2d. Slider Rods, 3 1/2d. Plunger, 3d. Best, 6d. Wound Vario-couplers, 5/6; on ebonite, 8/6. Tapped Coils, 20 and 10 turns, 2/11 and 3/6. Spacers, large, 2 1/2d. doz.; small, 1 1/2d. doz. Spring Washers 3d. doz. Slewing, all colours, 4 1/2d. a yd., 3 yds., 1/- Shellac, 6d. ble. Wood's Metal, 2d. Switches, 1st quality change over, S.P.S.T., 1/-. S.P.D.T., 1/6. D.P.D.T., 2/-. Panel-Mounting, nickel, S.P.D.T., 1/-. D.P.D.T., 1/6. Switch Arms, 8d., "Super" 1/-. Screws, to 1/2 in., 5d., 1 in. 9d. doz. Screwed Rod, 12 in., 2 B.A., 2 1/2d.; 4 B.A., 2d. Valve Legs, 10d. doz. Transformers, H.F. Plug, 1, 150/450, 3/9; 2, 250/700, 4/-. 3, 450/1,200, 4/3; 4, 900/2,000, 4/6; 5, 1,600/3,200, 4/9; 6, 2,200/5,600, 5/-. Transformers, 5 to 1, L.F., 11/9 and 15/-. all guaranteed. "Popwip," 13/6; best nickel, 14/6. Bobbins, 1/6. H.F. Formers, 2/-. Valve Pins, 9d. doz. Terminals. W.O., 2d., telephone, 1 1/2d.; pillar, 2d.; wood screw, 1 1/2d. Telephone Cords, 10 1/2d., "Super" 1/9. Tablets, Earth, Aerial, etc., 1d. Valves, all makes, sent at own risk. Valves, repaired, 7/6. Variometers, double wound, 2/9. Formers, 6d. pair. Valve Holders, finest ebonite, 1/3; moulded, 9d. (nut and washer). Washers, 1d. doz.

EVERY ACCESSORY ON THE MARKET STOCKED.
STOCKISTS FOR "POLAR" "LISSEN" "IGRANIC" "DUBILIER," ETC.
LARGEST STOCKS IN BRITISH ISLES.
 Imperative.—Kindly send ample postage; balance always refunded.
SEND FOR FREE LIST. Trade supplied at separate trade counter.
"RADIO STOCKS, Ltd."
 Open Sat. Museum 4213 ("RADIO HOUSE") OPEN SAT.
 87-89, NEWMAN T., OX R ST., LON., ON, W.
 Between Oxford Circus and Tottenham Court Road. Also
 7, Bear St., and 43a, Croun Street, Leicester Square, W.

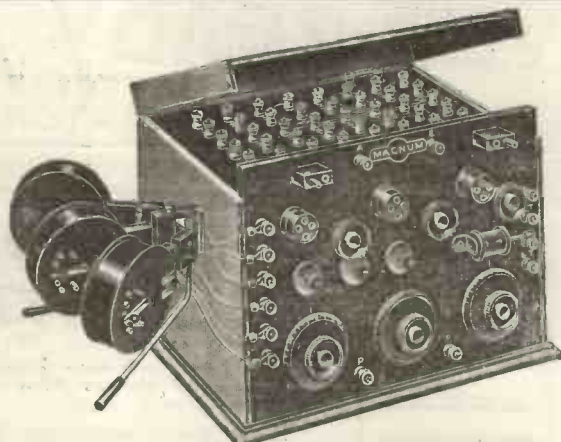

RECEIVES EVERYTHING FROM EVERYWHERE.
 The Wonderful "OMNI" as described by Mr. J. Scott-Taggart.
 As illustrated **18 Guineas.**

TO CONSTRUCTORS.—All components stocked for the OMNI, S.T. 100 Star, Family 4-Valve Receiver, 3-Valve Reinartz, and all circuits described in "Modern Wireless," "Wireless Weekly," and Radio Press Envelopes.

Components recommended for the S.T. 100 Star.

2-Way Coil Holder. Improved type	Each
Magnum Choke	9/6
Crystal Detector with Crystal	3/-
Var. Condenser .0005, complete	8/-
Fixed " .0001	1/3
" " .001	1/3
" " .002	2/-
Var. Resistance, 50,000-100,000 ohms	3/6
Valve Holders	1/3
Terminals with Bushes	3d.
Magnum Intervalve Transformer	15/-
Cabinet 16 by 7 1/2 by 6 1/2	15/-
Ebonised Panel 16 by 7 1/2 by 1 1/2	4/-
Microstat Fil. Resistance	2/9

We are shortly offering Magnum Concert Coils ranging from 150-600 metres.
 Price per set of 4 ... 25/-
 " separately, each ... 7/-

Send Stamp for Illustrated List and set of Leaflets dealing with "Twelve Tested Sets," including the above.

ALWAYS SPECIFY "MAGNUM."
 Experimental Stations:—
 2FP New Cross.
 2PB Kennington.
 2CT Lambeth.
 6CW Streatham.
BURNE-JONES & Co., Ltd.,
 Manufacturing Radio Engineers,
MONTFORD PLACE, KENNINGTON,
LONDON, S.E. 11.
 'Phone: Hop 6257.

Radio Press Handbook and Diary for 1924.

Size 5 1/2 in. by 3 1/2 in., solidly bound in grained leather cloth, fitted with pencil. Diary portion shows a whole week at an opening. Large number of pages of technical data, including several pages of electrical formulae which will prove invaluable to the serious worker **2/6**

Radio Press Popular Wireless Diary for 1924.

Size 2 1/2 in. by 4 1/2 in. Strongly bound in leather cloth with rounded corners. One complete week shown at each opening. Wireless pages include information on call signs, circuit diagrams, Morse Code, electrical data, full instructions for building a complete Receiving Set, etc., etc. **1/-**

In Leather, with pencil **1/6**

Published in conjunction with Charles Letts & Co.

Radio Press Diaries for 1924

FOR your appointments—to chronicle your doings—for the thousand and one things connected with your life, you need a Diary.

This year purchase a Wireless Diary and get some useful information without extra cost.

These two Radio Press Diaries are both extremely neat and well-produced little Books. They do everything that a Diary should do—they are convenient in size and shape—do not bulge the pocket—strongly bound to give a whole year's service, and more besides, if needed. Just the Diary, in fact, to suit the most critical. From all Booksellers or direct (postage 2d. extra) from Radio Press, Ltd.

EVER-READY BRITISH MADE
DRY BATTERIES & ACCUMULATORS

FOR EACH AND EVERY WIRELESS PURPOSE

INSIST ON
"EVER-READY"
 WIRELESS
 BATTERIES AND
 OBTAIN SATISFAC-
 TION AND 100 PER
 CENT. EFFICIENCY

OVER 20 years' experience and research, the finest materials, expert supervision, and careful testing at all stages of manufacture are the reasons for the superiority of "Ever-Ready" Wireless Batteries.

The "Ever-Ready" series embrace all types of Batteries for every Wireless purpose.

Special types of large capacity Dry Batteries are provided for the filament heating of each of the newest types of low-temperature valves.

Write for particulars of these and the standard sizes and voltages of high-tension Battery units.



Service D.X. Department,
The EVER-READY
 Coy. (Great Britain) Ltd.
 Hereu'es Pl., Holloway,
LONDON, N.7.

"ELLA" BATTERY CHARGERS

They work from a Lampholder.

SAVE THEIR COST IN A FEW WEEKS.

A.C. Model
 (as illustrated)

Output 5/10 amps. 6 volts. Complete with Pole Indicating Ammeter and all connecting leads and adapter. From stock, £6 6 0, for frequencies 40 to 60, and voltages 100 to 220. Other frequencies and voltages £1 extra and to special order.

Also D.C. Model.

Output 5 amps 9 volts. Machine only, £5 12 6. With Switchboard and Pole Indicating Ammeter and Regulating Resistance, £6 15 0. With Resistance, Ammeter and Voltmeter £7 2 6.



Both A.C. and D.C. Suitable for Motor Car Batteries.

TRADE SUPPLIED.

LIONEL ROBINSON & CO.,

3, STAPLE INN, LONDON, W.C.1

Phone, Holborn 6323.

Announcing

THE

J.B.

Trade Mark

SUPER ALL-METAL CONDENSER

The universal success of J.B. Condensers is well known. After repeated requests we can supply a SUPER ALL-METAL CONDENSER. We have retained the constructional features in this new model—triangular end-plates, one-hole fixing, small spacing (Dielectric .026) and our exclusive metal-to-metal bearings and Spring adjustment.

END PLATES OF BRASS

Fixed Vanes are triangular for board mounting

Six months written guarantee against faulty materials or workmanship.

Complete with Knob and Dial.	
.001 ...	10 6
.00075 ...	9 6
.0005 ...	8 -
.0003 ...	6 9
.00025 ...	6 9
.0002 ...	5 6
.0001 ...	5 3
Vernier ...	4 6

Large Ebonite Top and Bottom Bush of Grade A Post Office ebonite, ensuring absolute insulation.

THE **J.B.**

MICRODENSER

A NEW VERNIER CONTROL (Prov. Pat. 28028-23.)

Trade Mark

THE IDEAL VERNIER CONTROL

Results after rigorous tests prove that our condensers incorporating our Vernier control surpass every other method of fine tuning.

After coarse tuning, finer tuning is secured by the vernier, for which a separate knob is provided.

Hand capacity effects are reduced to the absolute minimum.

Readings are taken from the one dial making it suitable for use in wave-meters and calibrated circuits.

Complete with Knob and Dial.	
.001 ...	11 6
.00075 ...	11 -
.0005 ...	10 -
.0003 ...	8 9
.00025 ...	8 9
.0002 ...	8 -
.0001 ...	7 9



THE **J.B.**

Trade Mark

STANDARD MODEL

VARIABLE CONDENSER
 ONE-HOLE FIXING.

End plates made by special process ensuring low dielectric losses.

Large metal-to-metal bearings and accurate close spacing.

After severe tests leading manufacturers producing first-class wireless sets use our Condensers, Complete with Knob and Dial.

.001 ...	8 6
.00075 ...	8 -
.0005 ...	7 -
.0003 ...	5 9
.00025 ...	5 9
.0002 ...	5 -
.0001 ...	4 9
VERNIER ...	4 -

The "J.B." TWIN Condenser. Capacity each half .00025 mfd; 19/6 each. Ideal for use in circuits employing 2 H.F. stages. With Vernier £1 2s. 6d.

Makes other than the "J.B." are being forced upon the Wireless Public as the guaranteed "J.B." Make sure it is the genuine "J.B." Your dealer will supply you. If not, write to the manufacturers:

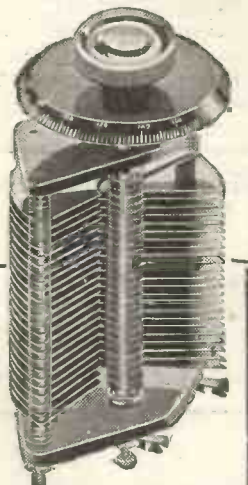

"J. B." Condensers are BRITISH MADE. Trade inquiries invited.

JACKSON BROS.,

The Condenser Specialists,

8, POLAND STREET, (First Floor) OXFORD STREET, LONDON, W.1.

Postage and Packing Extra on all Models. One, 6d. Two, 9d. Three, 1/-.

Phone: Gerrard 6187.

Some Curious Reaction Circuits—
(Continued from page 498).

mitters, with their large exposed tuning inductances and "anode" and "aerial-taps." As shown in the diagram of a schematic receiver arranged on this principle, the aerial, with its large capacity to earth, is tapped-in on a lower turn of the tuning-inductance, since it requires lower inductance to tune it. The grid-connection is taken much higher up, so as to provide a tuned circuit, tuned in unison with the aerial circuit (with which it has part of the tuning inductance in common, and hence is closely coupled with it), but with the very much smaller grid-to-filament capacity of the valve, in series with the grid-condenser. The last circuit can be made of low resistance and freely resonating, so that a high P.D. is built up across the grid-filament part of this oscillating circuit. This so-called "step-up" effect (on analogy with low-frequency close-coupled transformers) gives excellent signal-strength. Accordingly, such a circuit, if made up with inductances of the right value and of low resistance, will give good reception, and might easily be accused of being a "super" circuit. Actually, the inductance required in the grid variometer is much higher than usual in A.T. variometers; so that close-wound spherical variometers are specified with small, clearance, possessing, therefore, considerable distributed capacity to help out the inductance in tuning to the required wave-length in this position. With a series condenser in the aerial circuit, the circuit oscillates more freely, and greater signal-strength is obtained: this, however, is best placed on the aerial side, resulting in the circuit

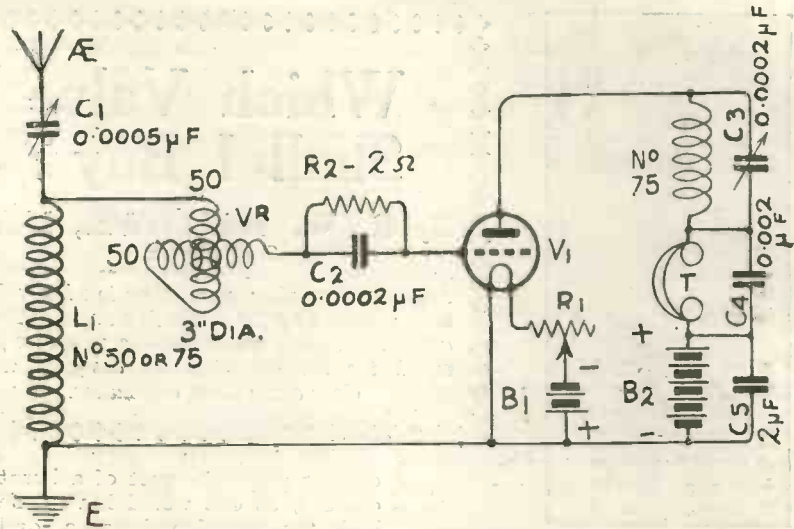

Fig. 5. A powerful broadcast receiver (auto-transformer type).

shown in the figure. This gives as good signals as any the writer has tried on a P.M.G. aerial for one valve direct-coupled. Either a fixed (.0001 or .0002 μF) series condenser can be used, with a variometer wound of No. 20 or 18 S.W.G., d.c.c., total about 60 turns on 3 in. diameter stator and corresponding rotor; or else a .0005 series variable condenser and a basket or other coil of 50-75 turns of No. 18 S.W.G., d.c.c.—or even an ordinary plug-in coil of that value—and for grid variometer one approximately of the same dimensions wound with at least No. 26 S.W.G. (better larger gauge), some 100 turns in all. The tuned anode can be a similar variometer bridged by a .0001 μF fixed condenser, or a No. 75 coil and .0002 μF low-minimum variable condenser, as shown. The circuit is first tuned with the grid variometer short-circuited, with critical reaction; then the variometer is

cut in, and the whole retuned, following up with reaction as needed. It will be found to oscillate more easily in the latter condition.

This is not suggested as an easy circuit for fool-proof daily reception of broadcasting; but is worth while for the ambitious experimenter who wants to get the most from a single valve.

A modification of the last, actually distinctly different in action and tuning conditions, and resembling to some extent an extremely selective short-wave receiver recently described by the writer for use with easily-oscillating valves such as the pea-nut, is that shown in the final diagram. In this, it will be noticed, direct electrostatic reaction is used from the plate to the aerial-end of the grid-variometer. This has the effect of isolating this portion of the circuit, so that it forms a small closed oscillating circuit of its own, apart from the A.T.I., though of course involving the aerial-to-earth capacity (in series with the A.T.C.). The reaction-effect is something after the style of the De Forest Ultraudion circuit in one of its modifications. Accordingly, this grid circuit has to have enough inductance to tune to the required wave-length with these extremely small capacities, helped out to some extent (though wastefully) by distributed capacity in the variometer itself. A large variometer with ample windings is, therefore, quite necessary: the large Igranic does here, or in general one of about 4 in. diameter and with 160 or more total turns of wire. A radio-choke of some 250 turns is required; the reaction condenser can be an ordinary three-plate "vernier," or other small size of low minimum capacity,

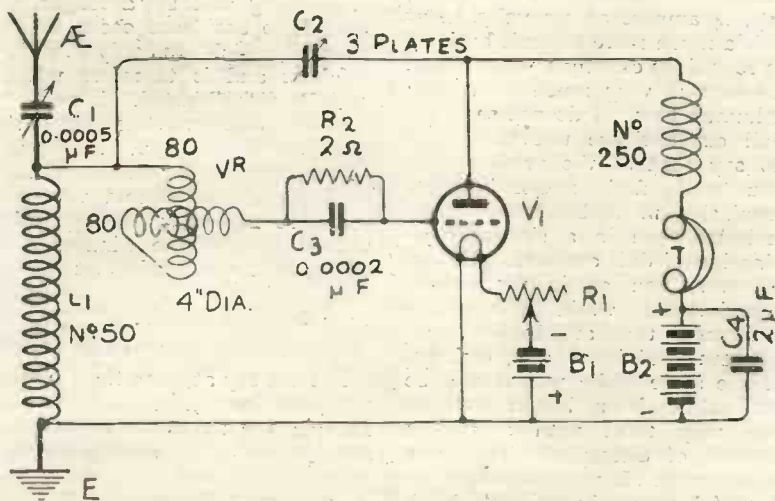

Fig. 6. A selective circuit with capacity reaction.



The Marconi R4C valve for power amplification.

LITTLE more than a year ago there were only two or three types of receiving valve available for amateur use, and the characteristics of these were so well known that one had small difficulty in coming to a decision when a choice had to be made. To-day the position is entirely different, for there is a positive wealth of valves; we are suffering, in fact, almost from an *embarras de richesse*. I have not totalled up the number now at the disposal of the amateur, but at a rough estimate there must be the best part of a hundred of various types and different makes, every one of which has its own special points.

Bright Emitters.

The first thing for the amateur to decide is whether he shall use ordinary valves or dull emitters upon his apparatus. If he lives in the country, so that he cannot readily get his accumulators charged, his choice is to a great extent decided for him by circumstances; he will go for one of the dull emitter types, whose low consumption makes it quite possible to work them from dry cells. But how is the enthusiast affected who has every facility for accumulator charging? In his case has either type any particular advantage over the other? Here are the points in favour of the high temperature valve. To begin with, its initial cost is comparatively low. This means that should one of those little accidents that will happen even in the best regulated wireless sets occur, one does not suffer the same pangs if a bright

Which Valve Shall I Buy?

By R. W. HALLOWS., M.A.,
Staff Editor.

Beginners are often puzzled as to what valve they should buy for a particular set. This article, by clearly indicating the purposes for which the various types are designed, will clear away these difficulties.

emitter plays the part of a burnt offering, as one would have done had the sacrifice been a dull emitter. Further, thirty shillings worth is just as easily dropped as twelve shillings and sixpence worth. So far, then, the older type of valve has it. We must also consider the fact that as its filament is designed to carry a comparatively large current ranging from .4 ampere in some types to as much as 1 ampere in others, it is not nearly so much affected by slight overloads as the dull emitter, which may be rendered useless by being run under too heavy a current for quite a short time.

Rheostats.

For valves of this kind moderately priced rheostats of standard make are quite suitable; but when we come to the dull emitter, we cannot obtain good results unless we provide something more elaborate, and therefore more expensive. The bright emitter valve is a delicate piece of apparatus in every sense, but the dull emitter is still more so. It is comparatively easy to duplicate valves with filaments designed to work upon, say, .4 ampere at 3.5 volts. But it is a much more difficult business to reproduce exactly a valve whose filament is very much finer than a human hair. I do not say that dull emitters are uneven, but I do say that at the present time you will find rather greater regularity in a batch of bright emitters than in a similar combination of dull emitters. Unless, however, you go in for careful experimental work, the slight differences that are to be found between individual dull emitters of the same make will hardly be noticeable. Your bright emitters you may treat with a certain amount of disrespect. They will stand what I may describe as "careful rough handling." With

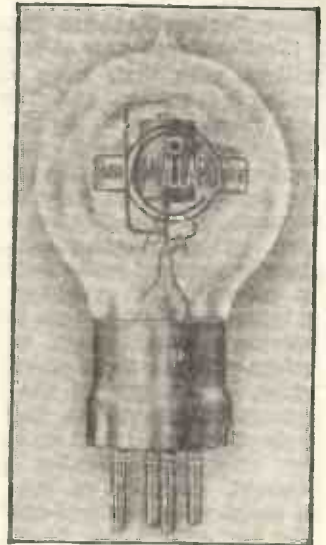

The Mullard P.A. power valve

them you will break all the recognised rules by committing, without doing them much harm, such misdeeds as switching on or off without the use of the rheostat, and using a vastly excessive plate voltage; you may leave them lying about on your bench, you may even drop them (though this is not advised) short distances on to hard surfaces. Yet in spite of this they will give you good service for a very long time. The older type of valve, then, has a very great deal to recommend it; and it is unlikely that for some time to come the experimenter will discard it altogether in favour of its low consumption counterpart.

Dull Emitters.

And what is there to say on behalf of the dull emitter? A very great deal, as we shall see. In the first place the high initial cost is offset by increased economy in working and by a longer life should no accidents occur to the filament, which runs only at a dull red heat and is therefore not so rapidly disintegrated. I want to consider dull emitters from the point of view, not of the dweller whose home is far removed from a charging station and who will therefore naturally use dry cells, but of that of the wireless man who has no difficulty at all in having his accumulators attended to when they require it.

Accumulators versus Dry Cells.

Let me say at once that anyone who can use an accumulator for heating the filaments of his dull emitters should do so in preference to employing any kind of dry cell. A moment's thought will show

the reasons why this will give steadier and better working. The dry cell, no matter what its size, is not naturally suitable for delivering a continuous current, even if the amount be small. Directly the cell is placed under load its voltage begins to fall. If the current taken is small, the decrease of E.M.F. will be slow, but there will nevertheless be a certain decrease. This means that to obtain absolute evenness in working, one would require to fit to the rheostat a clockwork device on the lines of that which moves the astronomer's telescope. The resistance would thus be decreased progressively to compensate exactly for the fall in voltage.

Advantages of the Accumulator.

With the accumulator we work, so to speak, along a straight line. Once the cell has settled down after being charged, it retains its E.M.F. with no falling off for a long period. We can thus find the best adjustments of our valves, and leave them set with the assurance that we are obtaining the best that they can give. When signal strength begins to decline we know that it is time for the accumulator to visit the charging station.

Disadvantages of Dry Cells.

But with the dry cell we are working in a series of ups and downs, which, tiny though they may be, make a good deal of difference. What I mean is this. We adjust our rheostats and get the set working well. At the end of an hour or two reception is not quite so good as it was; therefore we reduce the resistance in the filament circuits a trifle and bring it up again. Actually strength has been falling off almost imperceptibly the whole time, though we did not notice it until the weakening became marked. So much for the filaments; but it must not be forgotten that the same up and down process is occurring in the grid circuits as well. On the high frequency side let us suppose that we are working a 1-volt valve from a single dry cell. Across the rheostat in the negative leg of the filament there is a drop of .5 volt; hence, when the battery is up to its full voltage, the greatest positive potential that we can apply to the grid is 1 volt. With the decline in voltage the grid potential falls off; hence the valve tends to become less and less balanced whilst it is worked continuously. With the accumulator none of these things occur and much steadier working is obtained.

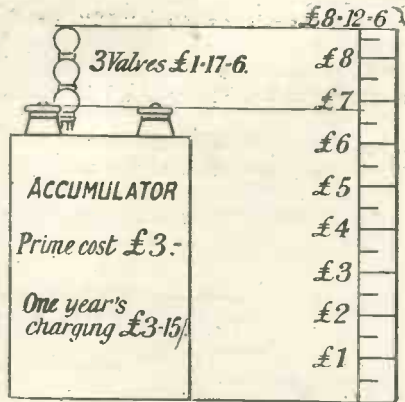

Fig. 1. Diagram showing price and working cost of three bright emitter valves.

Questions of Cost.

Now let us consider the annual budgets of two wireless men using similar three-valve sets. The first purchases a trio of ordinary valves with a voltage consumption of .5 ampere, the second a set of dull

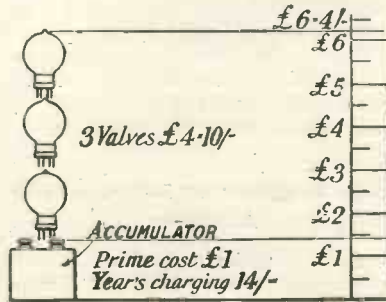

Fig. 2. Diagram to the same scale as Fig. 1, showing the cost when using 3 ".06" valves.

emitters using .06 ampere. Each works his set on an average of two hours a day, or, say, 700 hours during the year. Here are the first man's accounts:—

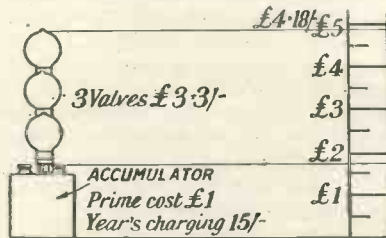

Fig. 3. Illustrating the costs with 3 A.R.D.E. valves. With D.E.R. valves charging would approximate 18/-.

	£	s.	d.
3 valves	1	17	6
6 volt 50 ampere-hour (actual) accumulator	3	0	0
Accumulator charged, say, 25 times at 3s.	3	15	0
	£8	12	6

The second man's accounts are as follows:—

	£	s.	d.
3 valves	4	10	0
4 volt, 20 ampere-hour (actual) accumulator	1	0	0
Accumulator charged, say, 7 times at 2s.	0	14	0
	£6	4	0

Dull Emitter Economy.

The dull emitter, therefore, represents a considerable saving at the end of twelve months' working. In addition, it must be remembered that after 700 hours work "bright emitter" valves will be approaching the end of their career, even if some of them have not already succumbed, though the dull emitters would, as a rule, be good for at least as long again. Even if we allow each of our users to break or burn out two valves of this particular type during the period the balance will still be slightly in favour of the dull emitter—£9 4s., as against £9 17s. 6d.

The A.R.D.E.

If a rather more robust dull emitter such as the Ediswan ARDE were chosen for the test, the figures would be as under. Here the valve consumes .3 ampere with a potential of 1.5 volts.

	£	s.	d.
3 valves at 21/-	3	3	0
2 volt, 50 ampere-hour (actual) accumulator	1	0	0
Accumulator charged 15 times at 1s.	0	15	0
	£4	18	0

Here the user may break and replace all three valves during the year and still be on the right side as compared with the bright emitter man. Dull emitters, then, certainly make for economy, and if they can be worked off accumulators they will give results that will bear comparison with those produced by bright emitters of the same class.

The D.E.V. and D.E.Q.

When I say of the same class I mean that with two exceptions all dull emitters are general purpose valves. It is therefore not fair to compare their performances with those of bright emitters especially designed for particular purposes. The two exceptions are the D.E.V., which is the low temperature counterpart of the V24, and the D.E.Q., which represents the Q valve in dull emitter form. These are both very expensive

valves, their price being in the neighbourhood of 35s. apiece, and I am not sure that they are easy to obtain at the present time.

Three Purposes of the Valve.

The general purpose valve is, of course, a compromise. It is not always realised that on the multi-valve set the valves are called upon to perform three entirely different duties.

High-frequency.

The valves on the high frequency side receive from the aerial or from the valves preceding them oscillations at radio frequency which, when we get down to such a short wavelength as 100 metres, occur 3,000,000 times a second. Their business (Fig. 4) is to amplify these oscillations and pass them on so that the form of the waves is absolutely unaltered, save that their amplitude is increased. The greater the frequency the more will the effects of any small capacities be felt. Hence it is desirable that these valves should be so designed that capacity between electrodes and between the points of the seating should be reduced to the lowest possible degree. Further, in order to prevent distortion from occurring, we require a valve in which the flow of grid current will

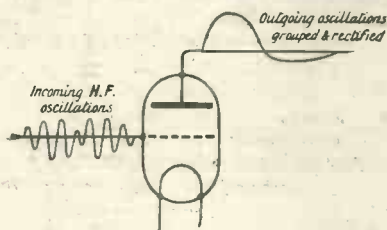

Fig. 5. The rectifier's task.

be very small when the grid is in the neighbourhood of zero potential. On the high frequency side a high impedance in the valve is an advantage.

The Rectifier or Detector.

The rectifying valve presents a different problem. Its function is to receive oscillations, either direct from the aerial or in an amplified form from the high frequency circuits, to reduce them to audio frequency and to pass on waves in which one half of each cycle has been as nearly as possible eliminated; the nearer the approach to the complete elimination of half cycles the more efficient will rectification be. Rectification may be done in two quite different ways; we may make use of the lower bend in the grid-volts plate-current curve or we may use the bend in the grid-volts grid-current

characteristic. Certain special rectifiers such as the "Q" are intended for plate rectification and are therefore designed to have a very marked lower bend in the grid-volts plate-current curve. It may safely be said, however, that ninety-nine per cent. of the receiving sets now in use employ grid rectification which is accomplished

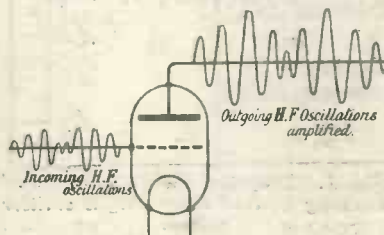

Fig. 4. The high-frequency amplifier's duty.

by means of gridleak and condenser. It is desirable that the rectifying valve, whichever form of rectification is used, should have a low capacity since it has to deal with oscillations at high frequency. It should also have a fairly low impedance to match that of the telephones or of the primary of the transformer which follows it,

Note Magnifier or Low-frequency Amplifier.

Note magnifying valves have a very much simpler task than either of the others (Fig. 6). In the first place they have to deal with oscillations at audio-frequency whilst capacity effects are not nearly so marked, and, secondly, oscillations which come to them have already been rectified. Low capacity, then, has not nearly the same importance as with valves of the other two classes. The most important requirement in a low-frequency amplifying valve is that it shall possess a characteristic curve with a long straight portion. If the straight part is short the operating point may pass round the bend at top or bottom, and distortion will result when strong signals are being received.

Grid Potential.

It is desirable that the potential of the grid be kept considerably negative; hence the flow of grid current is automatically kept down. What is essential is that the straight portion of the curve should be very long, for if it is not the peaks of the waves will be cut off by their raising the grid potential to the point at which the upper bend in the curve

occurs, as has just been explained. In the note magnifying valve a fairly low impedance is desirable for the same reasons as those which affect the rectifier.

General Purpose Valves.

A general purpose valve, such as the Mullard Ora, the M.O. "R" and "R5," the Ediswan "A.R." and the "Xtraudion," is designed to function in any part of the set. Hence its curves, its impedance, and its capacity must all be averaged. That is to say, it will give good performances anywhere, but it is hardly fair to compare it with special purpose valves. To take an analogy of life a well-bred horse of sturdy build might be used for hacking, for hunting, between the shafts of a trap, or in the plough; it might even win a point-to-point race. It would do all these things quite well, but they would be done rather better by a hackney, the cob, the hunter, the Clydesdale and the thoroughbred, each of which is a horse bred for a special purpose.

With the two exceptions mentioned, then, all dull emitters are general purpose valves. Valve manufacture and design have been brought to such perfection now-

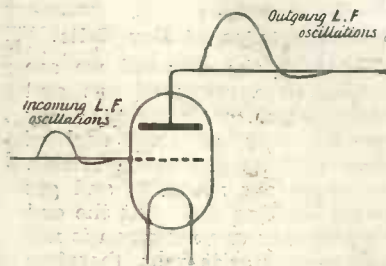

Fig. 6. What the note magnifier does.

days that the general purpose valve gives amazingly good performances in any part of the set. On the next page is a list of the dull emitters now available, with their particulars and some notes on their qualities.

British-manufactured Valves the Best.

The quality of the British general purpose valves is extremely good; in fact in no country in the world are amateurs so well provided for by valve-makers as in this. One can, therefore, purchase any type of valve of this class with entire confidence that it will be all that is expected of it. The purchaser should be guided to some extent by the size of his accumulator and the facilities for charging which are at his command. If, for

(Continued on page 507.)

EDISWAN VALVES

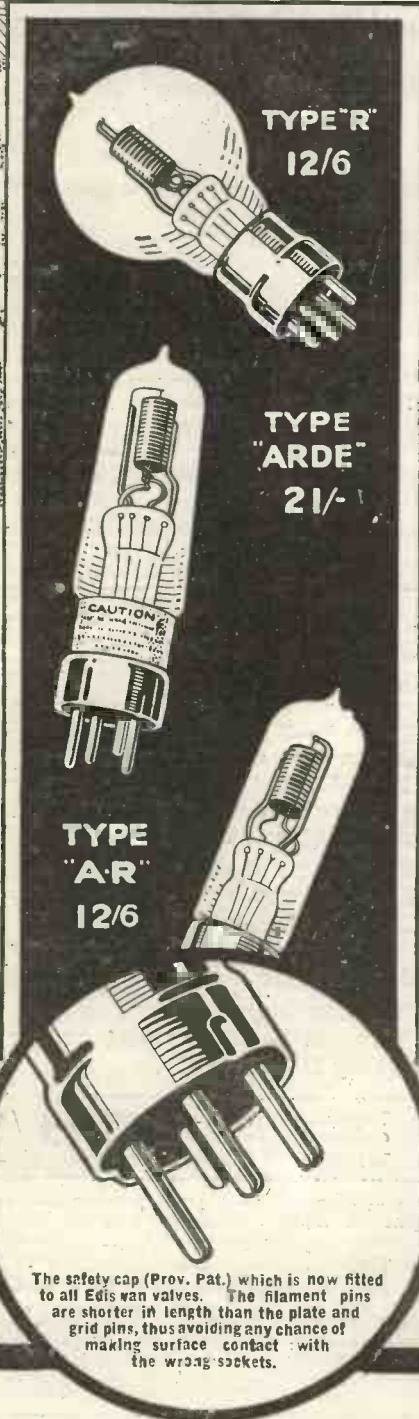

TYPE "R"
12/6

TYPE "ARDE"
21/-

TYPE "A-R"
12/6

The safety cap (Prov. Pat.) which is now fitted to all Ediswan valves. The filament pins are shorter in length than the plate and grid pins, thus avoiding any chance of making surface contact with the wiring sockets.

Read what Users say about Ediswan Valves

Actual performance has proved beyond doubt the outstanding superiority of Ediswan Valves. Manufactured in the same factory as the famous Ediswan Electric Lamps, full advantage is taken of the 40 years' manufacturing service and research which has made the name "Ediswan" famous as a guarantee of perfect satisfaction.

Darlington, January 14th, 1924.
Regarding my reception of Calgary Canada, C.F.C.N., with 3-Valve Broadest Receiver using Ediswan A R Valves, I have also had the following stations:—
PWX. Cuban Telephone Company, Havana, Cuba.
WMAL. Trenton Hardware Co., Trenton, New Jersey.
WGY. General Electric Co., Schenectady, New York.
WMAF.
JJW.

In all 18 American transmissions, all taking place on an inside aerial. WMAL could be plainly heard 2 ft. from the 'phones, the last being an amateur station calling ARRL. As I do a lot of experimental work, especially long distance receiving, I have tried many makes of valves, and I have always had best results with your A R type. The advantage I have found is that they are superior to the others that I have experimented with in the following ways: their action being very stable (a great advantage in long-distance receiving), they are good H.F. and L.F. Amplifiers as well as good Detectors, and clear speech is a special feature.
I do not hesitate in saying that the A R Valve is the best high temperature valve that I have had experience with and I can recommend same for all types of receiving, either broadcast or experimental. H. W. T.

TYPE "AR" and "R"	12/6
TYPE "ARDE"	21/-
(Dull Emitter)	
TYPE AR.06	30/-
(Can be run off Dry Cells)	

Have you had your FREE copy of illustrated booklet "The Thermionic Valve."? If not, send a postcard to-day. Your dealer holds stocks to supply you. If not, write us direct, giving his name and address:

The Edison Swan Electric Co., Ltd.,
Contractors to H.M. Admiralty, War Office, Royal Air Force.
123/125, Queen Victoria Street, E.C. 4, and 71, Victoria Street, S.W. 1.
Works: Ponders End, Middlesex.

Branches in all Principal Towns.

"Buy British Goods On v."

Your results largely depend on the quality of Component Parts.

Build your own set from sound parts and materials—you will then thoroughly understand your set and know that the quality of every detail is right. We test every part before we decide to stock it, and offer our customers unbiased advice and assistance.

A Few Suggestions :

- Parts for Crystal Set - - - - - 7/6
- Parts for 1 Valve Set, without box panel or plug-in coils - - - - - £1 12 6
- Parts for 3 Valve Set, including variometer, condensers, oak box, drilled ebonite panel, screws and terminals - - - - - £6 15 0

3 VALVE 'ALL CONCERT' RECEIVERS

All parts and 3 coils for 3 valve "All Concert" receiver, excluding valves, batteries phones, panel and box - - - - - £5 15 0

Transformers.

Ferranti, Igranic, R.I., Burndept.

"W & M" Variable Condensers.

High quality, accurate, very low minimum capacity:

- 001 16/- ·0003 10/6
 - 0005 12/- ·0002 7/6
- Vernier 4/6.

Filament Resistances.

Ashley, T.C.B., Igranic, McMichael, Peerless, W & M, G.E.C., Western.

Hart and Exide Accumulators.

All sizes supplied ready for use.

ALL DULL EMITTERS AND PEANUT VALVES IN STOCK.

Only tested high-quality parts are sold. No ex-Government stock.

Trade Supplied. Enquiries Invited.

GENERAL WIRELESS LTD
21, GARRICK STREET
LONDON W.C.2.

Nr. Leicester Sq
Tube.

Telephone:
Gerrard 8460.

"In actual reception of broadcast speech and music, good amplification was observed together with an absence of parasitic noises."

said of H.T.C.—the good TRANSFORMER

The H.T.C. Transformer is designed to give maximum amplification without distortion.

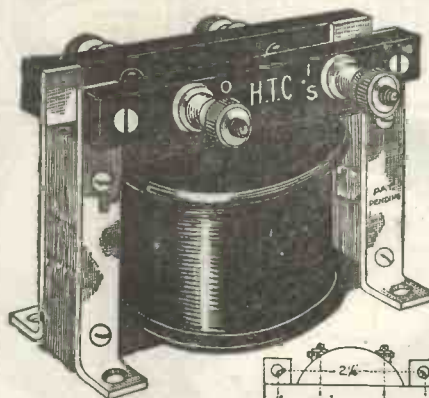

The success it has achieved, succeeds good craftsmanship and good materials, observing good design. The H.T.C. is made with a larger iron core to function at low magnetisation. Therefore, absence of unwanted noises and distortion due to ill design.

Proved exceptionally efficient on S.T.100—one of the most rigorous tests to which a transformer may be subjected.

Try H.T.C. Transformers in the 2 H.F. and 2 L.F. circuit you propose building.

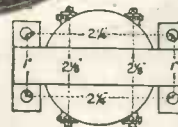

LENGTH - 2 1/2"
HEIGHT - 2"

PRI E
15/-

The H.T.C. Transformers are eminently suitable for all dual amplification circuits described in "Modern Wireless." May be used in Cascade.

H.T.C. ELECTRICAL CO., LTD.,

2 & 2a, BOUNDARIES ROAD, BALHAM, S.W.12.

Trade Enquiries Invited.

TELEPHONE: Battersea 374

No Receiver is better than its Components

Unless you can absolutely rely upon the efficiency of your components no experiment you make can give satisfying results.

Most of the foremost experimenters in this country use Bowyer Lowe Tested Components because they know them to be mechanically and electrically accurate.

It is worth much to you to know that the parts you are using are as good as they can be made.

TINNED COPPER WIRE	1/16th Square 2 ft. lengths Postage 4d. extra	1/9 Doz.
--------------------------	---	--------------------

Let us send you our full list of tested Components. It is quite free. A postcard brings it. Drop us a line to-night.

SALES DEPT. :-

The Bowyer-Lowe Co., Ltd., Radio Works, LETCHWORTH.

WHOLESALE DISTRIBUTORS: SCOTLAND: Messrs. Robb Bros., Ltd., 69, West Nile Street, Glasgow, and North Street, Dundee. NORTH OF ENGLAND: Messrs. Wadsworth, Sellers & Co., Standard Buildings, Leeds. MIDLANDS: Messrs. Robb Bros., Ltd., 9, Barnstone Road, Nottingham.

Which Valve Shall I Buy?—*continued from page 504.*

example, he possesses a large low-tension battery and is the fortunate owner of the Tungar or some other equally good home-charging apparatus the amount of current consumed does not matter to him. On the other hand, the man whose accumulator is of small ampere-hour capacity will be well advised to go for valves whose filaments have a comparatively low rating; for if batteries are never put under too heavy a load their life is very greatly prolonged.

Special Purpose Valves.

Of the special purpose valves there are many interesting and extremely useful kinds. The first



The Marconi QX valve.

are those which are so designed as to eliminate as far as possible the capacity between electrodes and between the points of attachment to the mounting. The points at which capacity occurs are seen in the figure: Perhaps the best known of these is the famous V24, a valve of the test-tube type, in which the filament is suspended between supports sealed into the glass at either end, whilst the grid and plate contacts are at either side of the tube.

V24 and Q Valve.

V24 was designed particularly as a high-frequency amplifier, in which position there are few valves to equal it for short wave work. The rectifier of the same class is the Q valve, and its improved form QX. It is of the same shape and size, the main con-

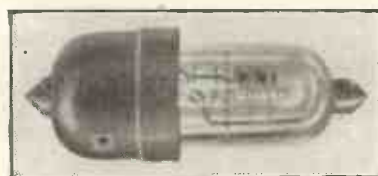

The Mullard ORA B valve.

structional differences being in its grid and plate, which are especially designed for the work which it has to do. This valve is intended to function as a plate rectifier, working upon the lower bend of the characteristic; it therefore needs

neither grid-leak nor condenser. It also makes a very efficient high-frequency amplifier, though owing to its amazingly high impedance, which is of the order of 250,000 ohms, it will not work well as a note magnifier except on sets with specially designed intervalve transformers. Both V24 and Q require .75 ampere at 5 volts. They are rather expensive valves, but if carefully handled their life is a long one. These valves are especially handy in making up sets where space is limited, since owing to their small size they occupy but little room.

Special Dull Emitters.

D.E.V. and D.E.Q. are the dull emitter equivalents of the preceding

Using these valves myself, though no direct reaction is used,

D.E.V.s as rectifier and note magnifier. The plate voltage used for the H.F. valves is 40, and for the others between 60 and 70. The high-tension current consumption is 6 milliamperes, which is

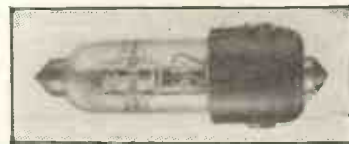

The Mullard S3 valve.

well within the powers of an ordinary high-tension battery.

Mullard Valves.

Another good series of anti-capacity valves is that made by the Mullard Company. The first of these is the Ora B, which is

Valve.	Fil. volts.	Fil. amps.	Notes.
D.E.V. ..	3.	.2	Good note magnifier and rectifier.
D.E.Q. ..	3	.2	H.F. amplifier and rectifier.
A.R.D.E. ..	1.5	.3	Excellent valve, very robust.
D.E.R. ..	1.8	.4	Good performer, rather microphonic
L.F. Ora (A) ..	1.8	.2	} Very satisfactory, especially L.F. Ora (C).
L.F. Ora (B) ..	1.8	.3	
L.F. Ora (C) ..	1.8	.4	
"Wecovalve" ..	1.0	.25	Good little valve, very robust.
Cossor "Wuncell" ..	1.0	.25	Very efficient. Has long life.
D.E.3 ..	3	.06	} Rather fragile, but quite efficient and very economical. Good on H.F. side.
A.R.06 ..	2.5	.06	
B.T.H. B5 ..	3	.06	
D.F. Ora ..	2.5	.06	

The list of general purpose bright emitters is as follows:—

Valve.	Fil. volts.	Fil. amps.	Notes.
Mullard Ora ..	3.5	.6	An excellent valve.
M.O. R... ..	4	.75	A fair performer, but rather heavy in its current demands.
M.O. R5 ..	5	.5	A first-rate general purpose valve, particularly good as rectifier or note magnifier.
Ediswan A.R. ..	4	.75	Works well anywhere.
Xtraudion ..	4	.4	Good note magnifier and does well as H.F.
B.T.H. ..	4	.75	A good sound valve throughout.

all British broadcasting stations, as well as those on the western side of the Continent, come in at good loud-speaker strength, and American broadcasting is often received on the loud-speaker. These valves are rated at .2 ampere at 3 volts. My experience is that the current required is usually rather less than the amount stated. The present quartet show an ammeter reading of .7. They are worked off a 4-volt 50-ampere hour (actual) accumulator, which, in spite of the fact that the set is in pretty constant use, makes very rare visits to the charging station. The valves in this case are two D.E.Q.s on the high-frequency side and two

simply the well-known Ora valve made up with a special mounting. As will be seen, the filament contacts are at the point of the cap and at the end of the tube, whilst



The Marconi Q valve.

grid and plate connections are placed at either side of the cap. Others of the series which are similar in design, though smaller

in size, are the S₃ and the S₇. The former is specially designed for low anode voltages, working quite well with as little as 15 volts on the plate. I have actually obtained quite good signals whilst using a single flash-lamp battery for the anode supply. S₇ is a first-rate rectifier.

Cossor Valves.

Two other good special purpose valves are the Cossor P1 and P2, the former being a very good rectifier and note magnifier, whilst the latter is a high-frequency amplifier of particular merit. In this connection I should say that the Cossor Company are now making a special form of their "Wuncell" valve, the P4, for high-frequency work. I have not had the opportunity of testing this valve, but I hear good reports of it. This is, of course, a true dull emitter working at 1 volt and consuming about .2 ampere.

Power Valves.

The valves known as power amplifiers form a class by themselves. They are intended for loud-speaker use with very high anode voltages where a large volume of sound is required. For this reason they have been designed to give a very long straight portion of the grid-volts plate-current characteristics. A very efficient member of this class is the Mullard P.A. which consumes .85 ampere on the filament with a working E.M.F. of from 3.6 to 4 volts. The anode voltage is usually from 150 to 200; with the latter amount the emission at zero grid volts is 22.5 milliamperes. The M.O. Valve Company turns out two very good types, the bright emitter L.S.2 requiring 6 volts and consuming rather more than an ampere of current, and the dull emitter L.S.5 which consumes only .4 ampere. The B.T.H. R valve B4, whose filament current is .25 ampere at 6 volts, works well with from 40 to 100 volts on the anode. It is a very satisfactory power amplifier, which will meet all the requirements of those who require a large output from the loud-speaker.

Special Rectifiers.

Very few special rectifiers are available for the amateur, and as a matter of fact there is little to be gained from using one in sets which have one or more stages of high-frequency amplification. One type, however, may be mentioned as being particularly good, and this is the M.O. R4C, whose fila-

ment current consumption is .65 ampere at 3.8 volts. This valve was, I believe, designed for use in the Navy. It is a splendid performer, and will stand any amount of work.

Dutch Valves.

For the single valve man there is nothing to beat one of the soft Dutch valves which are now obtainable at low prices from advertisers. The type recommended has a vertical grid and plate with a U-shaped filament. It is a rather squat cylindrical valve with a standard 4-pin mounting. If one can get hold of one of these valves with exactly the right degree of softness wonderful results can be obtained with a single valve set. Those who contemplate purchasing one should endeavour to see it tested in the

brought in quite as strongly as is comfortable with the telephones. I have actually worked a loud-speaker from a single valve set, bringing in 2LO, whose distance from my station is that mentioned, with sufficient volume to make the music audible to everyone in a room 15 ft. square.

Soft Valves.

It would, I think, be a good thing if British makers were to turn their attention to the soft rectifying valve, for I am sure that it would have a very large sale amongst amateurs. Our American friends have plenty. At the present time it is the single valve sets which cause most of the trouble by oscillating during the reception of broadcasting. The hard valve oscillates as a rule quite readily, and when it is worked at its most sensitive point the slightest adjustment of the controls may produce re-radiation from the aerial. The soft valve, on the other hand, is much more stable when worked at its sensitive point, and as its tendency to oscillate is very small it is not nearly so likely to be guilty of causing interference. If, therefore, a soft valve of well-known make were available for general use I believe that interference, which is at present a serious problem, would be very greatly reduced.

Conclusion.

In this article an attempt has been made to give a brief survey of the various kinds of valves which are at the disposal of the wireless man. I have used every one of those mentioned, with the exception of the Cossor Wuncell, and my experience has been that taking our valves as a whole British amateurs have nothing to complain of the way in which makers cater for their needs. There is one small improvement in the boxing of valves which might very well be introduced. In buying a valve of well-known make at the present time one knows that the valve itself is a good one, but there is no guarantee that it has not been used for demonstration purposes, and perhaps seriously overloaded. There is no reason why the valves should not be put in sealed boxes with the tips of their pins only protruding and with a small hole cut in the side of the box. The purchaser could then see the valve's filament tested, and he would buy it with the knowledge that he was obtaining a brand new article which had not already seen a good deal of work.

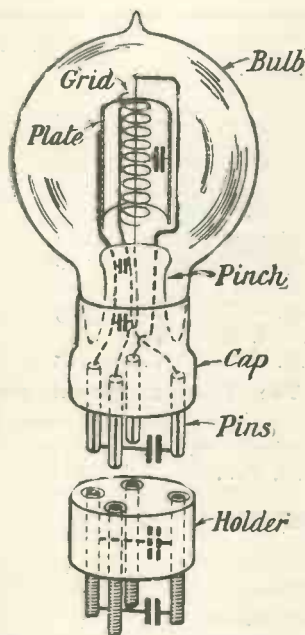

Details of the three electrode valve and its holder.

shop and to select one which blue-glow with between about 35 and 50 volts on the anode. It should be worked with a plate voltage in the neighbourhood of 25 with the filament fairly bright, though not bright enough to crackle. These valves are very stable; in fact, it is difficult to make them oscillate if one tries to do so. They are therefore ideal for use in single valve sets employed for broadcast reception. Owing to their rather soft nature the emission from the filament is high, since ionisation by collision occurs. Rectification is extraordinarily good, and with even a single valve a broadcast station 30 miles away can be

connection of the grid leak is altered as I suggest. I can see no way of avoiding them being different unless it were permissible to put a condenser and grid leak permanently between the first two valves even when transformer coupling were used. I have done this as an experiment in a receiver used for Morse reception, as opposed to telephony, and its effect was nil; but it would possibly induce rectification to some extent in the second valve and cause consequent distortion in reception of telephony.

If you can find time to reply I should be grateful, as I am entirely out in the cold here with no one to discuss matters with and never having heard a signal on any valve set other than of my own construction! If you cannot find time, Mr. W.P.B. is under your table.

Yours truly,
MEADE J. C. DENNIS (Col.)

To the Editor of MODERN WIRELESS.
SIR,—As I have not seen any results of tests of the "Transatlantic Receiver" published in MODERN WIRELESS from readers who have made this set from Mr. Harris's instructions, perhaps you may be interested to hear my experiences.

Aided by one of my students at this college, I constructed the set shortly before Christmas, inserting one or two slight modifications. I have used Lissenstat filament resistances on all three valves, and find them invaluable for fine adjustment on the two H.F. valves, the filament control of these two being, as Mr. Harris stated, extremely critical. The space saved by the one hole fixing has enabled me to align the two condenser dials, which, in my opinion, improves, the general appearance considerably. When first using the set, we found oscillation to be very considerable, and even the potentiometer (an Igranic) was hardly sufficient to control this. A faulty V24 valve, with plate and grid unevenly fixed, was found to be the cause; and now that this has been replaced by a sound valve of the same make, the potentiometer appears to be unnecessary and is, in fact, never used.

A slight modification has been made in the manner of fitting the reaction coil to the plate telephone circuit, so as to enable the panel still to be withdrawn intact from the cabinet when required, which is not possible in Mr. Harris's design, owing to stiff permanent leads from the last plate and the

telephone being taken to the wooden top of the cabinet. I take these leads to two terminals in the ebonite panel immediately above the detector valve, flexible leads then going to the reaction coil on the top of cabinet. A variable grid leak is found to be unnecessary.

I get Bournemouth, naturally very loud, also Newcastle, Glasgow and Aberdeen practically whenever I want. Manchester is rather elusive, but good at times, as is London, which fades. Cardiff, the nearest station, is curiously very uncertain, and Birmingham can only seldom be found. Eiffel Tower, Radiola and Ecole are generally excellent. On December 30 at 6 p.m. I received Rome loudly, more faintly on the next night. The German and Dutch concerts are faint. America I have not seriously tried for.

If any of your other readers have constructed this set, I should be very glad to know their experiences.

I should like to congratulate Mr. Harris on the exceptional clarity of his articles, and you on the excellence of MODERN WIRELESS generally.

Yours faithfully,
D. R. EDWARDES-KER.
Newton Abbot, Devon,
Feb. 4, 1924.

Thoroughly BRITISH Our Type All Condenser

—for Panel Mounting—still retains all the special features which have made it famous, and measure of its popularity can be further judged in the fact that again we are able to reduce our prices owing to increased demand. All Colonial and Foreign orders receive prompt and efficient attention. We have large experience in handling Overseas trade.

BRITISH REPUTATION.—Your Condenser is not a "FALLON" unless the name "FALLON" appears on same.

ALL-BRITISH MANUFACTURE.—Delivery ex Stock. Our Motto is **QUALITY FIRST**, and every Condenser carries our money back guarantee.

**WE HAVE THE COURAGE OF OUR CONVICTIONS,
WE PUT OUR NAME "FALLON" ON EVERY
CONDENSER WE MANUFACTURE.**

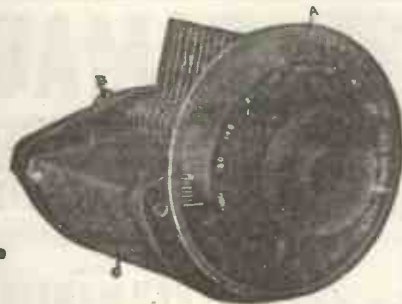

SPECIAL FEATURES—

- A.—Aluminium Screening Disc, which, besides enhancing the appearance of the dial as it lies flush with the panel, prevents the hand of the operator producing capacity.
- B.—Metal to metal adjustable bearings.
- C.—Stout well-cut Aluminium Vanes.

Complete in EVERY respect and exactly as illustrated.
Reduced Retail Prices are now as under:—

Plates.	Retail Selling Price.
57001	8/-
290005	6/-
190003	5/6
1500025	5/-
130002	4/6
5 Vernier	4/-
3 Vernier	3/6

NOTE CHANGE OF ADDRESS TO NEW AND LARGER WORKS.

FALLON CONDENSER CO., LTD.,

THE CONDENSER PEOPLE,

WHITE RIBBON WORKS, BROAD LANE, N.15. Telephone : Tottenham 1932.



Some S.T.100 Appreciations

Gas-pipe Aerials.

SIR,—There are many people, it seems—I meet quite a lot—who cannot install wireless owing to being unable for some reason or other to erect an outdoor aerial. This particularly applies to flat-dwellers.

In your valuable paper I see regular articles on outdoor aerials, frame aerials, and makeshift indoor aerials, but never any suggestion of having no aerial but using two earths.

I have been using the S.T.100 circuit for about six months now, and find my outdoor aerial quite unnecessary. I connect my aerial terminal to the gas point in the room and my earth to the rising main (water, of course), and get perfect results on the loud-speaker; in fact, it seems (this may be imaginary) that the results are clearer and of a better tone. I find the 100,000 resistance unnecessary, and I get no A.C. hum, which I often get when using the outdoor aerial. I use for 2LO, with the two earths, a 35 and 50 coil, or 50 and 75, Igranic. The tuning is remarkably sharp; in fact, you can easily pass it over. I use a .001 A.T.C. in the aerial, and a degree right or left cuts the station out.

It appears to me that with an extra H.F. stage I ought to be able in this way to tune-in other stations whilst 2LO is working, although only about three miles from 2LO.

However, my chief point is the suggestion for flat-dwellers.

As you may pointedly suggest that my gas-pipe, through insulation at joints, is really acting as an ordinary aerial, I would state that with an outside aerial I invariably use the gas as my earth (terrible thought to some people). I took a lead to the water-pipe to see if the results were any better, but I found no difference whatever.

Yours truly,

G. R. S.

London, S.W.5.

[EDITOR'S NOTE.—The use of the gas-pipe as an earth with outside aerial is dangerous, and should never be permitted.]

An American Appreciation.

SIR,—I have been experimenting with circuits for about three years. Your S.T.100 circuit gives me the best results as regards loudness of signals that I have been able to get.

Two tubes equal three tubes.

I have received stations as far as 900 miles. I intend to keep on experimenting with this circuit.

Yours faithfully,

RAY OEFINGER.

Bridgeport, Conn.

The Envelope Set.

SIR,—A few weeks ago I wrote you with reference to my intention of making an S.T.100 wireless set from the instructions and diagrams contained in Radio Press Envelope No. 1.

I have used ordinary variable condensers instead of those of "Polar" type, and considering this is my first attempt at fitting up a set, I am perfectly satisfied.

On Christmas Eve I heard the carols broadcast from London very clearly on the loud-speaker; while on Christmas Day I took my set to Haslemere, Surrey, and threw a line over a bough of a tree, attaching the end of the aerial to this, and doing the same with the other end of the aerial, attaching it to another tree, the height above the ground being about 22 ft. The same evening we got Bournemouth, hearing a lecture on moths very clearly on the loud-speaker. Here at Windsor I am getting better results on an aerial 22 ft. long with buildings higher than the aerial all round. Aberdeen has been received clearly, and also Birmingham and Newcastle.

I am afraid you will be weary reading all this, but I feel sure you will be glad to know how successful I have been by following the instructions as supplied by you.

I am using dall-emitter valves.

Yours faithfully,

G. CHILCOTT.

Windsor.

SIR,—Having seen on many occasions letters published regarding the S.T.100 circuit in your valuable paper, it occurred to me that another would not be out of place.

I built up a set using the S.T.100 circuit some months ago, and the results are more than I expected. I have a single aerial 40 ft. long and about 29 ft. high, and not what one might term situated in an ideal place; however, I receive all the B.B.C. stations very well; in fact, they come in on the loud side. I also get, I take it to be, "Paris School of Posts" with equal strength. Aberdeen, Birmingham and others come in just the same as Cardiff, our nearest station. I also pick up in the forenoon Croydon Air Station very clearly.

All components were purchased from Peto-Scott, Ltd. I use Mullard O.R.A. valves with a plate potential between 45 and 50 volts and three pairs of Western Electric 'phones in series. I think this performance does credit to the inventor of the S.T.100, and also to the manufacturers of the various components.

I have several friends who have heard this set and can bear out my statement, and am always prepared to demonstrate to anyone else. After tuning in the various stations I made out a list stating the coils used and their position, also the positions of the condensers, and in the L.T. circuit I have a tumbler switch, so that when a certain station is required I simply plug in the necessary coils, place the condensers, switch in, and there you are. This does away with the usual musical (or otherwise) sounds when tuning in, which not only upset yourself but all other comrades. In my opinion there is quite enough of this at present without my howling added.

I am, Sir,

Yours faithfully,

W. H. HALL.

Porth, Glamorganshire.

The Size of Coil to Use

By G. P. KENDALL, B.Sc., Staff Editor

So many readers find difficulty in the choice of coils for desired wavelengths that the following article is of especial interest and assistance

PROBABLY the most efficient method of tuning yet devised is that which makes use of interchangeable inductance units mounted upon plugs. The correct size of coil for any given wavelength can be plugged into circuit with the minimum of trouble, dead-end effects are absent, and the whole of the wire in circuit is usefully employed. The commercial coils are made with such numbers of turns that each covers, with a variable condenser of suitable size, a range of wavelengths which overlaps those of the coils above and below in the series. This is a desirable arrangement, since it is a fact that better signals are usually obtained with a large coil and only a small parallel capacity than with a smaller coil and a large reading on the condenser scale, for any given wavelength.

The choice of the correct coil for any particular station is therefore a matter of some importance, and also of appreciable difficulty to the

wavelength range of a series of coils of the standard turn numbers to cover the short and medium waves. It is assumed that the coils are wound upon a "former" of a diameter of two inches (the standard commercial size) and that they are shunted by a variable condenser having a maximum capacity of 0.0005 μ F and a really low minimum, no other apparatus which would affect the tuning being connected to them. In particular, no aerial or earth is allowed for, and therefore the wavelength ranges covered are those which the coils would give in a tuned anode or a secondary circuit.

The wavelength ranges given must, of course, be regarded as approximate, since no mention is made of the method of winding of the coils. The figures given have been averaged from a number of tables of different types, but will be found to hold fairly closely for all the more common multi-layer types, such as the lattice and honey-

Basket coils will differ more seriously than the other types, since they give slightly less inductance per turn and their self-capacity is considerably lower. Their minimum wavelength with a given condenser will hence be much lower, and the maximum will also be reduced, although to a lesser extent.

To choose a coil from the table is simple: The wavelength which it is desired to receive must fall near the bottom of the range of the coil, and the correct coil to meet this requirement is easily ascertained by inspection of the table. For the sake of example let us suppose that we desire to pick a coil for the reception of signals upon a wavelength of 300 meters. Upon referring to the table, we find that this wavelength is included in the ranges covered by coils Nos. 2, 3 and 4. Coil No. 2; however, is ruled out as being too small, because the required wave is quite near the top of its range, while coil No. 4 is also unsuitable, since 300 metres is its actual minimum, and therefore if the variable condenser chances to have a rather large minimum value it may not be possible to tune down to the required wave. It is then seen that No. 3 is the correct coil, and a similar process of reasoning would indicate that No. 4 is the right coil for 400 metre reception.

In actual practice the figures given may be considerably modified by several factors, the chief of which is the minimum capacity of the variable condenser. Remember that when a condenser is set to the zero mark on its scale there still remains a certain amount of capacity in circuit, the magnitude of which depends upon the design of the condenser. A good condenser is one which has, among other desirable features, a very low minimum value, and this usually is to be found in those possessing ebonite top and bottom plates, and air dielectric. If the condenser's minimum is rather high it will be necessary to use a coil a size smaller, with a resulting loss of signal strength. For example, with an efficient variable condenser the coil to use in the tuned anode for broadcasting is one of 75 turns, but with a condenser of poor

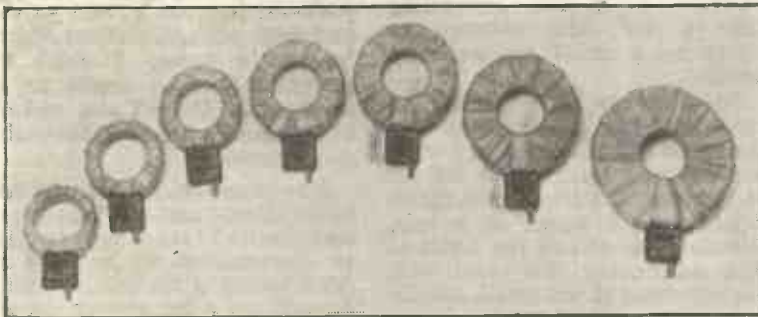

Part of a set of interchangeable coils to cover all wavelengths

novice. The whole question of turn numbers is one which at first sight appears most complex, but which is capable of being made very simple by the use of certain tabulated information and an understanding of the elementary fact just mentioned—namely, that where there is a condenser in parallel with a coil, that coil should be as large as possible.

The most useful type of table for choosing the proper size of coil for any particular purpose is that which gives the wavelength range of each coil when used with a variable condenser of a stated capacity. Such a table follows, and indicates the

comb. Differences in the method of winding will produce small variations, chiefly in the minimum wavelengths.

Coil number	Number of turns	Wavelength range (metres)
1	25	100—250
2	35	150—350
3	50	200—500
4	75	300—700
5	100	400—1,000
6	150	500—1,500
7	200	800—2,000
8	250	900—2,500
9	300	1,200—3,000
10	400	1,500—4,000

performance a 50-turn coil will be the largest that can be used.

The arrangement of the wiring in the set will also affect the wavelength range of the coils to some extent. If the wires are all short and well-spaced from each other little difference will be found between the wavelengths given by the coils when in use in the set and when measured in a test circuit, but if on the other hand long leads are taken off to switches, coil holders, etc., and the wiring generally is straggling and tangled up, the effect will be to add all the stray capacity of these wires on to the minimum capacity of the condenser, and again it may be necessary to use a coil one size smaller than could be employed in an efficient set.

The matter is rather less simple when we come to consider the size of coil for the aerial circuit, because here we have not merely the inductance of the coil and the capacity of the variable condenser to consider, but also the unknown quantity of

Wave length	Stations to be received	Aerial circuit	Anode circuit	Reaction
300-500	British Broadcasting and Shipping	35, 50	50, 75	75
600	Shipping	50, 75	100, 150	100
800-1,000	Aircraft	75, 100	150, 200	150
1,050	Hague	75, 100	150, 200	150
1,785	Radiola (Paris)	100, 150	250, 300	200
2,600	Eiffel Tower	200, 250	300, 400	200

the capacity of the aerial, which, of course, varies with different specimens. It is therefore impossible to give definite figures which will fit the case of any aerial, but the general rule is to allow one size smaller for the aerial coil, having decided upon the correct size for the tuned anode coil. It will often be found, however, that a still smaller coil is needed, as is shown in the table above.

This table assumes an aerial tuning condenser of 0.0005 μ F and an anode condenser of 0.0003 μ F. The alternative sizes given for the anode

coil are intended to show which coil to use in the two types of sets: (a) the efficient set with short wiring and low minimum condensers (large coil) and (b) the other kind of set wherein a smaller coil must be used.

Most of the manufacturers of coils now supply a special set of "short-wave" or "concert" coils for broadcast reception having distinguishing letters or numbers which do not indicate the number of turns. With these coils it is usually correct to use a No. 2 or 3 in the aerial, and No. 4 in the tuned anode for broadcast reception.

ECONOMIC ELECTRIC LTD.

"XTRAUDION"

The great silent Amplifier. Whether for H.F. or L.F. the "Xtraudion" Valve gives the most perfect undistorted Amplification and it uses little more current than a Dull Emitter. It only wants .4 amps at 4 volts.

PRICE

12/6

1/6

"RECTARITE"

The Great Detector. The Crystal that makes Loud Speakers talk. Send for our Radio List and read about these two inventions and all other requisites. Send 4d. in stamps. "Rectarite" is sold in Glass Tubes, price 1/6. Send for Trade Terms.

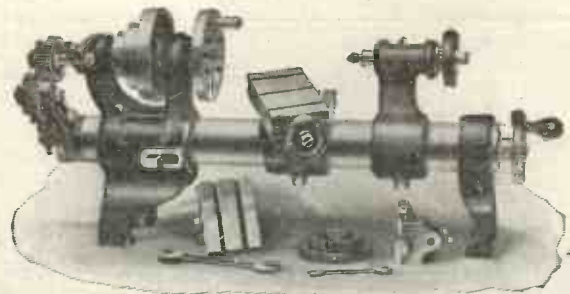

The DRUMMOND 4-in. Multi-purpose Lathe.

Make it yourself!

—half the fun in Wireless is gone if you buy everything complete

Winding coils, turning up formers, plus, knobs—a hundred and one jobs, drilling, slotting, boring, screwcutting—all may be done well and cheaply on the Drummond. A contact stud—or a bush for your car—make it yourself, and pay for the lathe with the money you save.

DRUMMOND Bros. Ltd., REID HILL, GUILDFORD.

—Post this Coupon—

Please send me, post free, lists of your small lathes, with details of deferred payment system. Name Address

(Send in unsealed envelope for 1/4d.)

Head Office: 10, FITZROY SQUARE, LONDON, W.1. Showrooms: 303, EUSTON RD., N.W.1. Branch and Works: TWICKENHAM.

A PRIZE-WINNING SET

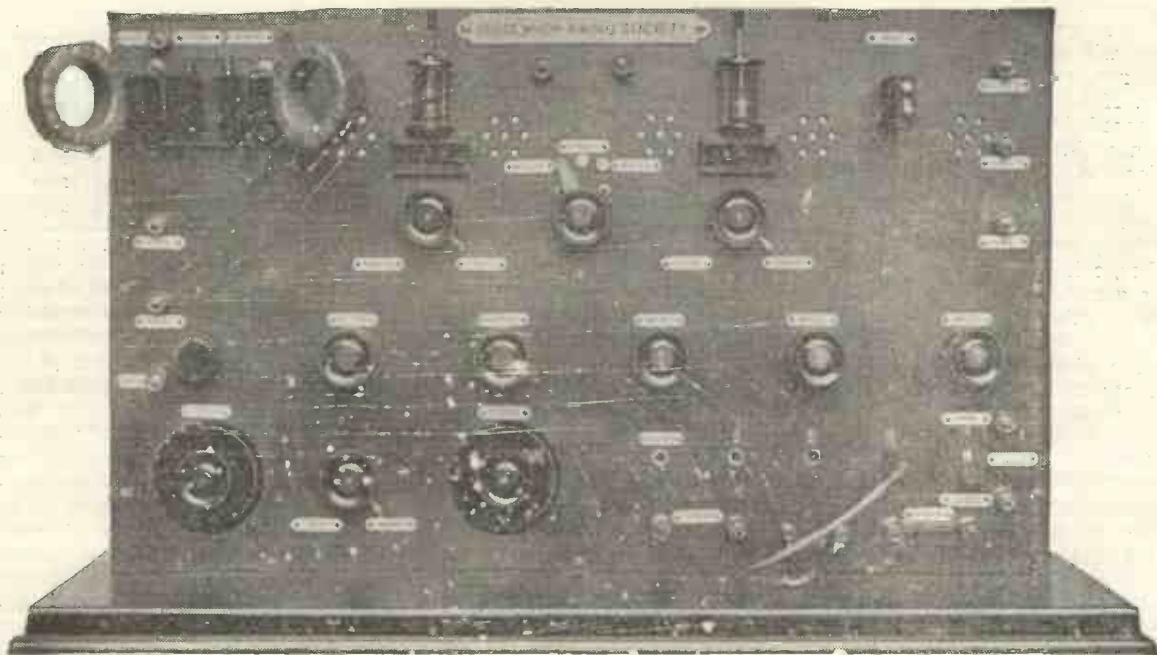

An ambitious receiver which has given remarkably good results.
An exterior view of the Woolwich Radio Society's set.

☐ The "Sparta" represents a definite advance in Loud Speaker construction. Singularly free from distortion, it permits a degree of clear and sweet-toned reproduction hitherto unattainable. The distinctive appearance of the "Sparta" makes it a worthy addition to any scheme of furnishing.

☐ To see and hear a "Sparta" is to realise why it has been called "The Ultimate choice of the connoisseur." It will be well worth your while to learn more about this remarkable instrument.

Type "A" 120 ohms.	} 24 : 15 : 0	Type "B" 120 ohms. The first Loud Speaker to provide for additional control through a 6-position tone selector.
Type "H.A." 2,000 ohms		E5 : 15 : 0
Type "H.N.A." 4,000 ohms		

Write to-day for Lists No. 315 and 316.

Demonstrations of the "Sparta" Loud Speaker are given during broadcasting hours at Gamage's, Harrods, Selfridges, the Service Trading Co., 280-92, High Holborn, City Accumulator Co., Ltd., 79, Mark Lane, E.C.3, etc., and at our own depots.

FULLER'S UNITED ELECTRIC WORKS, Ltd.,

Telephone: Woodland Works, Chadwell Heath, Essex. Telegrams: Fuller, Chadwell Heath.
London Depot, 58, High Street, W.C.2.

Sparta LOUD SPEAKER



The "Royal" L.F. Transformer

From Messrs. R. A. Rothenel, Ltd., comes an attractive type of L.F. interval transformer, of particularly fine workmanship and finish. It is of a compact type, measuring only 2½ in. by 2½ in. Small terminals are provided on the front, making rapid changes of connections in experimental work an easy task. On trial in actual reception, excellent amplification was obtained without noticeable distortion. Tested with the "Meg" by 500 volts D.C. between windings, and from each winding to the metallic casing, the insulation proved exceptional.

A Small Drawing-room Loud-Speaker

A great step of advance in the direction of adapting the radio-phonograph for permanent introduction into refined homes is implied in the design of the Ultra Hornless loud-speaker.

The sample submitted for practical test took the form of a "bon-bon box" of chaste appearance, in black and nickel-plate, some 5 in. diameter and a little over 2 in. deep, standing on three low feet. The small terminals were underneath, as also the adjusting knob (of comfortable size and smooth adjustment) so that the connecting wires were readily overlooked, and no suggestion of a mechanical or electrical instrument remained. It could be described as elegant, but inconspicuous, and eminently suitable for use in a drawing-room, where it would take its place amongst other ornaments, or on account of its small size might easily

be concealed amongst table decorations, etc.

The instrument owes its technical effectiveness to the use of a very large and exceedingly thin dished diaphragm, the electrical mechanism concealed in the base being of more or less conventional design. The diaphragm is protected by a metal grid and gauze on the top.

On actual trial, with a receiver which was known to give loud and undistorted reproduction, the tone was noticed to be soft, but loud enough to fill a small room. There was no noticeable distortion; the tone was as pure as that with a crystal and good head-phones, the



The Ultra hornless loud-speaker.

gramophone suggestion being absent.

We anticipate a considerable increase in the popularity of loud-speaker reception when the non-technical public begin to realise that a loud-speaker need not be the blatant, raucous thing that they have been accustomed to find it, but can be made as pleasant and refined as this example.

A Crystal Detector

A covered crystal-detector, of the cat's whisker-galena order, which is made as a scientific instrument, with micrometer adjustments is the "Mic-Met" Crystal Rectifier, a sample of which has been submitted for test by J. Arrigoni.

This is of the horizontal type, with glass barrel and ebonite ends; it is adapted for mounting on two terminals or small bolts spaced at 2½ in., slotted metal feet being provided for this purpose.

Both crystal and cat's whisker-holder rotate and advance by means of fine-thread screws working against springs; but these are eccentric to one another, so that a slightly-cranked cat's-whisker has a radial motion over the crystal which, combined with the rotation that can be given to the crystal-holder, effectively searches the entire exposed face of the crystal. The latter is held in a capsule (which screws right out in a few turns) by a spring plunger, no set-screws or Wood's metal being necessary. Accordingly, it is an easy matter to turn over the crystal to expose a fresh surface, or to replace it wholly. The advancement of the whisker is effected by an independent-micrometer screw, which was found to work smoothly and without shake.

The whole mechanism was found to operate with conspicuous ease and certainty, with a refreshing absence of shake and back-lash. Few detectors are as immune from the effects of accidental shocks or vibration, and the finding of sensitive points on the crystal became a positive and systematic

process, in place of the usual blind scratching. By actual measurement of signal-strength produced on the crystal with the local broadcast station's wave, it was possible to check up the effectiveness of the setting; with this instrument it was possible to find quickly an optimum setting without the use of the phones at all.

An example of the careful thought that has evidently been put into the design of this instrument is the provision of a tiny chuck to hold the whisker. The detector can be heartily recommended for use with any crystal set, and should do much to facilitate the most irksome part of crystal reception: the repeated search for these elusive sensitive spots.

Plug-in Coils

We have had an opportunity of submitting to a thorough trial and measurement of efficiency in reception, five coils, Nos. a, A, B, C, D, of the type put on the market by Messrs. Gambrell Bros., Ltd.

These coils correspond roughly in inductance value to the standard type of plug-in coils of about 25, 40, 60, 85, and 120 turns respectively. The makers claim an unusually low distributed capacity and large tuning-range in consequence.

The design is peculiar, in that the windings are actually in the form of a regular nine-sided figure, being wound on and supported by nine sets of small spacer-bars that pass through slots in the circular side-checks of the coil. The finished coils have a uniform diameter of approximately 4 in.

On trial, the resistance of the coils was found to be about normal; but both tuning-range with a given variable condenser and measured signal-strength in broadcast reception were sensibly higher than are usually observed with purchased coils. The efficiency of the A coil in the reception of 2LO was numerically considerably above that of any other coil compared with it under identical circumstances. The five coils covered conveniently from some 200 to around 1,500 metres wave-length on a P.M.G. aerial and with a tuning-condenser of reasonable size, and proper choice of reaction-coil could be made throughout the range.

Two-Coil Holder

Messrs. Gambrell Bros., Ltd., have sent in for trial a two-coil holder for use with their unique type of plug-in coil, which permits

of exceedingly close coupling when desired, and enables the coupling to be reduced actually to zero by withdrawing the moving coil and rotating it into a position where it is at right angles to and in a line with the axis of the fixed coil. This is achieved by a swinging arm, on which the moving coil is mounted at an angle of 45 degrees, actuated by a handle sufficiently long to minimise hand-capacity effects.

The holder is mounted on a small ebonite panel 5 in. by 4½ in., adapted for screwing on to the top of a cabinet, etc., with the coils in a



The Gambrell coil holder.

vertical position. A certain clearance is required for the connections and fittings at the back of the small panel. A spring-washer is fitted on the moving spindle, a set-screw locking the nut behind it; and ample bearing surface is provided, so that the spindle and arm move steadily; it would be inadvisable, however, with this pattern, to mount it on the side of a cabinet. The plug fittings are of the standard size; but the holder proved unsuitable for other makes of plug-in coils. The large Gambrell coils swing up readily, barely scraping one another, until the two coils are practically flat one against the other.

Connection is made to the moving coil by flexible wires. We noted with approval the reasonably large and convenient terminals fitted on the base.

On trial, the insulator proved excellent. In actual reception, using Gambrell coils, a smooth control over reaction-coupling was observed, making fine tuning possible, and greatly facilitating the process of searching for distant stations.

Non-Inductive Resistance Strip

We have received a sample of the "Nonindohm" resistance rib-

bon, put on the market by Messrs. British Radiophone, Ltd. This consists of a double tape of fabric, about ½ in. wide, with a 3-16 in. centre gap occupied by a ladder of the fine (continuous) resistance wire, which is bare of insulation, but spaced in this manner by being woven right into the fabric at the edges, so as to avoid short-circuiting contacts and at the same time provide easy contact for external tappings.

On test, a foot length offered about 400 ohms resistance. The wire is rated to carry 0.15 amperes without undue heating.

For potentiometers, both of the fixed type for controlling H.F. valves, and for sliding contact types, and for auxiliary resistances for the .06 D.E. valves, this convenient and compact form of resistance has obvious applications. Other possibilities will occur to the electrical experimenter.

A Unit Moving Coil Holder

A coil holder of similar good finish and insulation resistance is that made by the Grafton Electric Co., for screwing on to a base or panel. A spindle with knob rotating in metal bearings carries the coil-holder; and electrical connections are taken through these bearings, instead of by flexible wires. On trial, the action was smooth and positive, the electrical connection being reliable and silent. We would like to see, though, more effective counter-sinking of the bolt-heads behind the base; and rather larger terminals would be of advantage.

Insulated Connectors

A sample of their "Jiffy-Link" insulated connector for use in wiring radio apparatus, switchboards, etc., has been sent to us for examination by Messrs. Loveland Bros. and Sons. This sample consisted of a length of No. 20 bare copper wire, enclosed in insulating sleeving, with a terminal-eye formed securely in the wire at each end, for application on an ordinary type of terminal.

The makers list lengths from ½ in. to 24 in., with eyes of Nos. 3 or 4 B.A., and with a variety of different coloured sleeveings; they mention further types of the same linking device.

For those who are particular as to the appearance and arrangement of their wiring, and who dislike soldering, these links present some obvious advantages.

(Continued on page 519.)

Secure Perfect Radio Reception

BY USING

“IGRANIC RADIO DEVICES”

IGRANIC HONEYCOMB CONCERT COILS.

(De Forest Pat. No. 141344).

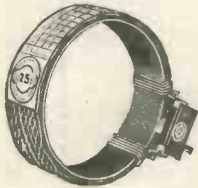

In addition to the existing range of gimbal and plug mounted honeycomb coils, we have now developed a set of concert coils which are suitable for the range of wavelengths covering the British Broadcasting Company's stations. Supplied in sets of four only.

PRICE £1 PER SET.

IGRANIC 30-ohm RHEOSTAT for DULL EMITTER VALVES.

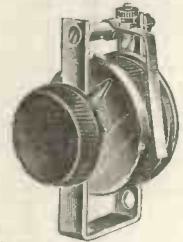

With the introduction of the new Dull Emitter Type Valves, Igranic radio engineers have developed this 30-ohm rheostat. The method of construction ensures smooth and silent operation.

PRICE 7/-

IGRANIC HONEYCOMB COILS.

(De Forest Pat. No. 141344).



These coils are scientifically designed and carefully made, and are renowned for their high efficiency, low self capacity, small absorption factor and minimum high-frequency resistance. Made in two types—Gimbal and Plug Mounted. Wavelength range approximately 100 to 25,000 metres.

FILAMENT RHEOSTATS

(Pat. No. 195903).

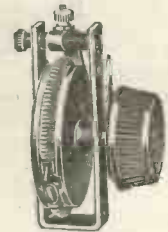

“Igranic” Filament Rheostats ensure smooth and silent operation under all conditions of filament control. Adjustable contact fingers. Nickel finish. Resistance range from zero to four ohms by fine variation. Supplied in two types—Plain and Vernier.

PRICE: PLAIN, 4/6. VERNIER, 7/-

TRIPLUG COIL HOLDERS.

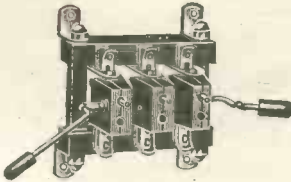

Panel Mounting Type,

Widely known for the accommodation of the Honeycomb Standard Plug-in Coil. Movable sockets are provided with ebonite handles to permit of adjustment without capacity effect caused by close proximity of operator's hand. Finest nickelled fittings; instrument finish.

PRICE 16/-

INTERVALVE TRANSFORMERS.

(Pat. No. 205013).



By recent improvements in design these transformers have brought low frequency amplification of speech and music up to the highest stage of satisfactory reproduction. Scientifically constructed of the finest materials.

PRICE : SHROUDED, 21/- OPEN, 20/-

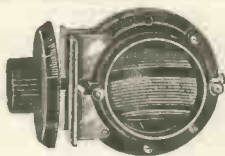

Type H.

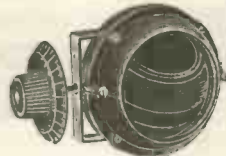

Type S.R.

VARIOMETERS.

Made in the two types as illustrated. Type “H” for tuning the aerial circuit and type “S.R.” for the anode circuit of a high frequency valve. Both covering an approximate wavelength range of from 150 to 800 metres in their respective circuits, they accomplish all that could be desired in variometer tuning. Rotor and stator of hard moulded ebonite. Rotor externally and stator internally wound.

PRICES : type H 15/-, type S.R. 18/-

Complete in both cases with knob and dial.

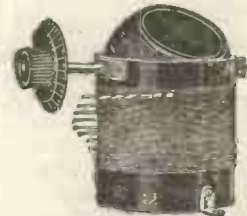

TYPE H.R. VARIOCOUPLER.

This variocoupler covers the entire range of B.B.C. wavelengths. Stator and rotor of hard moulded insulation. Windings self-supporting and impregnated solid. Tapping points shown on stator are staggered to facilitate soldering of connections. Highest possible grade of workmanship and finish.

PRICE 19/-

Obtainable from all high-class dealers.

Manchester : 30, Cross Street.
 Birmingham : 73-4, Exchange Buildings, New Street.
 Glasgow : 50, Wellington Street.
 Cardiff : Western Mail Chambers.
 Bradford : 18, Woodview Terrace, Manningham.
**149, Queen Victoria Street,
 LONDON.**



Write for List Z160.

Newcastle : 90, Pilgrim Street.

Concessionaire for France and Belgium :
L. MESSINESI,
 125, Avenue des Champs Elysees, PARIS,
 94, Chaussée d'Ixelles, BRUSSELS.

Works :
 Elstow Road, BEDFORD.

How to determine suitable Values for Rheostats.

TABLE 3.
Values of Resistance and current carrying capacity of Rheostats in Filament Circuits.

Type of Valve.	Ohmic Resistance and Continuous Current carrying capacity of rheostats required when rheostat controls given number of valves. NOTE.—In almost all cases, each rheostat controls one valve only.				
	1 valve.	2 valves.	3 valves.	4 valves.	5 valves.
Ordinary Bright Emitters (No. of Cells = 3)	22 ohms. 7 amp.	15 ohms. 14 amps.	1 ohm. 21 amps.	8 ohms. 28 amps.	.6 ohm. 25 amps.
Type R, Dull Emitter (No. of Cells = 1)	.5 ohm. 4 amp.	.3 ohm. 8 amp.	.2 ohm. 12 amps.	.13 ohm. 16 amps.	.1 ohm. 20 amps.
"Pea-Nut" Dull Emitter (No. of Cells = 1)	4.6 ohms. 25 amp.	2.4 ohms. 5 amp.	1.6 ohms. 15 amp.	1.2 ohms. 10 amp.	1.0 ohms. 125 amp.
.06 Ampere, Dull Emitter (No. of Cells = 2)	* 27 ohms. .06 amp.	* 14 ohms. 18 amp.	* 9 ohms. 18 amp.	* 7 ohms. 24 amp.	* 5.5 ohms. 3 amp.

* NOTE.—It is advisable that the resistances for the .06 ampere valve be in two sections, half being permanent and the other half variable. For example—in a one valve set, 14 ohms should be wired across. Ready to connect with the rheostat and valve, the variable rheostat having a resistance of 13 ohms.

It is essential that suitable filament rheostats be used in conjunction with the above valves and batteries, in order that the best results may be obtained. It should be specially noted that most of the rheostats now offered for sale were designed for use with bright emitter valves, and are unsuitable for use with the new dull emitter valves.

It is important to have the resistance of a valve sufficient to reduce the voltage to the minimum voltage required, as otherwise the filament will be over-heated and this will, in some types of dull emitter valves, reduce their efficiency to that of the bright emitters. On the other hand, if the resistance be too high a value, the greater part of it is useless, and the regulation on the useful part is comparatively coarse.

To obtain the correct value of resistance required, the following formula may be used:

$$\text{Value of resistance required} = \frac{\text{Number of cells in series} \times 2}{(\text{Lowest voltage required to operate valves} \div \text{Current required per valve}) \times (\text{Number of valves controlled by rheostat})}$$

The values given in Table 3 have been obtained by the use of this formula.

Characteristics of Exide Batteries.

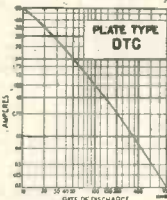
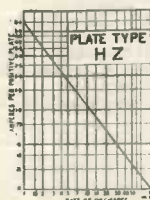
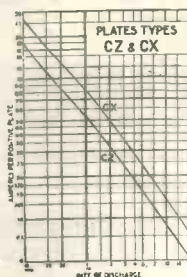

The above curves give the actual capacity obtainable at various rates of discharge.

Note that the values on the vertical scale are given per positive plate. (The figure following the alphabetical symbol by which the various cells are catalogued denotes the number of positive plates).

Example: A CX 5 cell discharged at 5 Amperes (= 1 ampere per positive plate) would give that current continuously for approximately 14 hours.

The above illustration gives an idea of the amount of valuable information contained in the new 12-page EXIDE Booklet.

The book has been entirely re-written, and contains much technical information of value to every wireless user.

A Post Card will bring a copy by return.

Ask for BOOK 4027d.

CLIFTON JUNCTION,
Nr. Manchester.

THE Chloride ELECTRICAL STORAGE
COMPANY LIMITED.

LONDON:
219/229, Shaftesbury
Avenue, W.C.2.

BIRMINGHAM: 57/58, Dale End.

MANCHESTER: 1, Bridge Street.

MANUFACTURERS OF

Exide

The long life battery.

AND CHLORIDE BATTERIES FOR HOUSE LIGHTING.

Tested by Ourselves (Continued from page 516.)

A Valve-Panel Window

A neat window-fitting for use with the modern type of valve-mounting behind the panel, for viewing the state of the filament, is produced by the Grafton Electric Company. This takes the form of a plated ring $1\frac{1}{2}$ in. diameter, with a false ring for the reverse side of the panel, fixing by three small bolts. The 1 in. diameter window thus formed is filled up by fine metal gauze. The fitting is well finished and would grace any set.

A Plug-in H.F. Transformer

A high-frequency transformer suitable for the broadcast wavelengths, and of the small plug-in variety, wound on an ebonite bobbin, has been submitted for test by Messrs. Edison Swan Electric Co., Ltd.

On test with a standard type of two-valve set, it was found to tune well over the range from 390 to 600 metres and to give satisfactory amplification in this region. It is neatly finished and strongly constructed; it proved convenient in use, and with reasonably large series aerial condenser there was no trouble with instability when using one H.F. stage.

Filament Resistance

A type of filament resistance which will appeal to the amateur constructor is that marketed by Messrs. Edison Swan Electric Co., Ltd., samples of which have come to us for practical trial.

The resistance is of the usual circular type for mounting behind a panel; it is provided with screws and already tapped bosses for this purpose. The contact is made very positively and smoothly by a special spring device mounted on the end of a moving arm, and the latter is fastened securely to its spindle (while allowing for longitudinal adjustment to accommodate different thicknesses of panel) by a substantial set-screw, which represents a commendable improvement over the customary rather insecure type of fastening. Substantial terminals on extension arms, well away from the moving parts, will delight the home constructor. A sturdy and positive stop at "full-on" and "off" positions is provided, and an indicator on the neat knob which operates the device. The resistance is around 4 ohms; in actual operation it carried the current for an R valve without unduly heating and gave smooth and silent control. It is well finished, the workmanship being considerably above the average.

Ella Converter

FROM Messrs. Lionel Robinson and Co. we have received for test two "Ella" battery chargers (A.C. model). Both of these instruments have been carefully tested in actual work by different members of our staff in different districts. The charger, as will be seen from the illustration, is of the vibratory type and is fitted with a pole indicating ammeter and suitable leads for quick attachment. To charge a battery it is merely necessary to connect the cell to a pair of leads and plug-in a connector into the nearest lamp socket. The charger starts to function immediately and gives a "taper" charge, that is to say, the charging rate for a discharged accumulator starts fairly high and



Ella Converter.

tapers off as the battery reaches the fully charged point. This, of course, is a desirable characteristic.

A number of wireless accumulators were charged with the instrument, which was kept running without interruption for a considerable time. The charging rate averaged about 3 to 4 amps, and although the instrument became quite warm after about an hour's working, the temperature did not increase above a safe point, there being ample heat radiating surface. Even after a prolonged run it was commendably free from sparking, and in fact only a very occasional scintillation was perceptible even with the heaviest load. Adjustment of the vibrator is made possible by two millet screws, and once the best adjustment has been found it can be left for very long periods without alteration. In action the vibrator gives out a

steady hum which might be annoying in a living room, but would cause no inconvenience in a cellar or outhouse where such devices are usually used. Altogether it appears to be a thoroughly reliable type of vibrating rectifier.

Headphone Pads.

We have received from N. Heywood a sample of rubber pads for fixing on the earpieces of headsets, in order to exclude outside sounds and give greater comfort in a long session of listening.

These take the form of circular discs of sponge rubber, $2\frac{1}{4}$ in. diameter, with a centre aperture, and are intended to be fixed to the ebonite caps by means of a solution, a small tube of which was enclosed in the box with the pads.

On extended practical trial, the greater comfort and isolation from casual interference by external noises was noticeable, particularly in exacting and lengthy experimental work. The band of the 'phones had, of course, to be sprung out somewhat to accommodate the extra thickness; it was observed that the fixing solution supplied did not hold for long, and was best substituted by shellac. The device will no doubt appeal to those who have to use crystal sets under adverse circumstances and to the serious experimenter who is condemned to wear the head 'phones for hours at a time.

Microstat Filament Resistance

Messrs. Wineberg & Co. have submitted for trial a sample of their Microstat filament resistance, which by the use of resistance discs compressed by a screw is claimed to give particularly smooth and uniform control of the filament current.

This instrument takes the form of a small brass cylinder, adapted for one-hole fixing through the panel in an extremely simple manner; connections are made to soldering tags at the rear end. Thus it occupies very little space in the receiver.

On trial in actual reception, the device proved capable of handling the current for two R valves without distress; while at the same time excellent control was obtained with a pea-nut type of dull-emitter valve, with which narrow adjustment of filament current is called for. The resistance proved silent and constant in continuous use. At the very reasonable price asked for this instrument, it can be well recommended for amateur construction and experimental work alike.

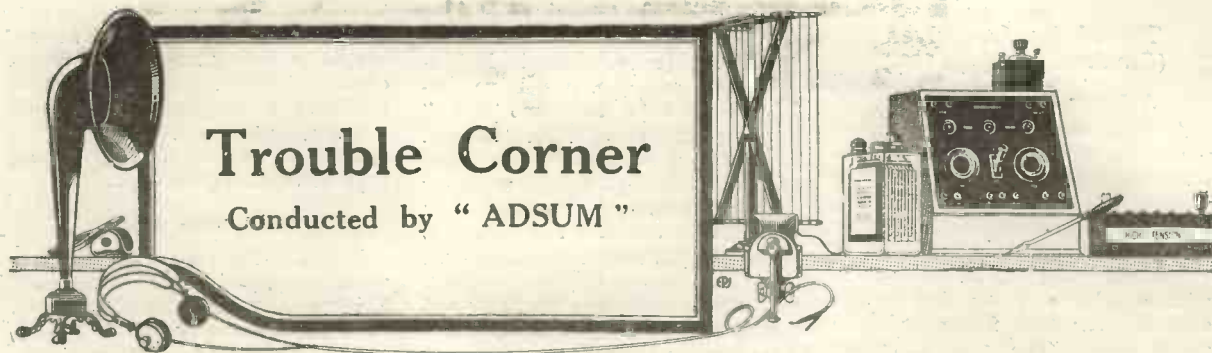

IT is intended under this heading to deal month by month with various rather out of the way faults which occur in receiving sets. The writer has kept for some time a record of those which have happened to himself and has also noted down such as have been experienced by his friends at various times. Some are fairly straightforward and might have been discovered almost at once if luck had been upon the searcher's side. Others however are of quite a different nature and unless one had some idea of what to suspect it might have been—indeed it usually was—a long and difficult business to track them down to their sources. It is hoped that readers who are interested will give others the benefit of their experiences by sending in brief accounts of such breakdowns, giving all the necessary details of the way in which the trouble first manifested itself and of the means whereby it had been eventually traced and cured.

A Wise Precaution

When asked by a beginner at wireless what is the most useful instrument to buy, the writer always recommends the purchase of a milliammeter and strongly advises that it should be kept wired in series with the high tension battery when the set is working, in the way shown in Fig. 1. If this is done one has one's finger so to speak always on the pulse of the set and one's search for faults when they occur is considerably narrowed down. Take for example the case of a set such as that shown in Fig. 1. The milliammeter reading when the set is working perfectly is taken and noted down for future reference. Let us suppose that it is two milliamperes. If at any time signals become weak the first thing to do is to glance at the pointer of the instrument. Should it still register two milliamperes we know (a) that there is nothing wrong with the plate circuits; (b) that the valves are above sus-

picion as regards at any rate three out of their four connections (filament and plate); (c) that we need not look to batteries or battery connections for the source of the trouble; (d) that there is no short circuit or broken circuit on the high tension side of the set. This narrows down the field of your search to quite small dimensions. The fault, if it is not in the phones, must lie either in the grid circuits, which include grid condenser, grid-leak and transformers or in what we may call the tuning part of the set. So far as transformers are concerned we are limited to the secondaries, for their primaries are in the high tension circuit. By the tuning part of the set is meant (1) the aerial; (2) the earth; (3) the aerial tuning inductance, and aerial tuning condenser; (4) the closed circuit inductance and closed circuit condenser. The grid circuits can be tested out very easily. Begin with that of the

fault the milliammeter will register an increase as it moves upwards towards the positive end. Having thus tested all the rest of the set nothing remains but the aerial and earth, and the fault will be found in one or other of these.

Uses of the Milliammeter

Besides enabling you to trace faults the milliammeter will tell you a whole host of things about your set. You wonder perhaps whether oscillation is taking place; watch the pointer of the milliammeter as you tighten couplings or adjust the variable condenser. As the oscillation point is approached the needle will begin to fall back a little, and when the set actually oscillates it will drop quite suddenly to something very much below the normal reading. Are you running your filaments too bright? The milliammeter will tell you. If without any increase of plate voltage you find a slightly

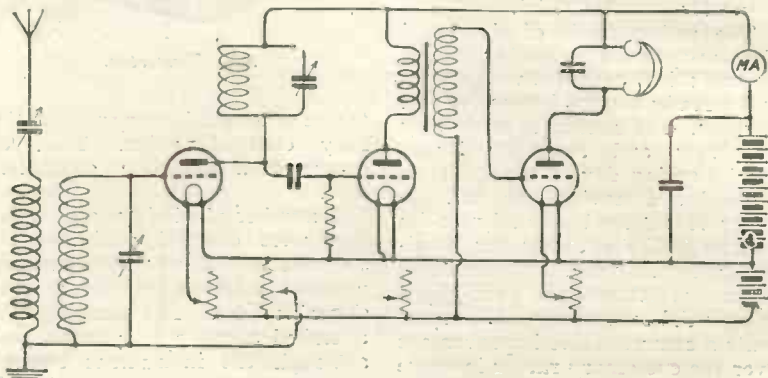

Fig. 1.—How to connect a milliammeter.

low frequency valve. Increase the negative potential of the grid biasing battery and watch the milliammeter. If current passed decreases, this grid circuit is as it should be. If not there is a fault. Test the rectifier in the same way by removing the gridleak and connecting the grid battery in its place. The high frequency valve may be tried simply by moving the slider of the potentiometer from end to end. If there is no

higher reading than normal shown then you are obtaining a greater emission by overheating the filaments. In the same way if the filament voltage remains unchanged the milliammeter will enable you to see whether you are using too high a voltage from the high tension battery. It will tell you better than any voltmeter the condition of either battery. For testing the low tension battery you require a 1.000 ohm resistance.

This may very well take the form of a single wound telephone bobbin such as may be purchased from advertisers from a shilling. Wire this in series with the accumulator as shown in Fig. 2, and take the reading when it is fully charged. If the resistance has its stated value the reading will be 6 milliamps; in fact with a resistance of 1,000 ohms the milliammeter becomes a volt-meter, each milliampere representing one volt. If the value is

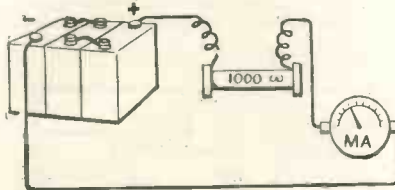

Fig. 2.—Testing the accumulator.

slightly different you can calculate it at once by Ohm's Law $R = \frac{E}{C}$. Once the resistance is known exactly the voltage can be measured at once by the formula $1,000 \times E = C \text{ (milliamps)} \times R \text{ (ohms)}$. For example if the reading is 9 milliamperes and the resistance 500 ohms then

$$1,000 \times E = 9 \times 500$$

$$1,000 \times E = 4,500$$

Therefore $E = 4.5$

To test the high tension battery it is best to use a resistance such as that employed in anode circuits with a value of about 50,000 ohms. Its true value may be found in the same way as before by actual test with the milliammeter and a new high tension battery. Future readings can be worked out in a moment by the formula. This method has the great advantage that it throws only a very small strain upon the high tension battery when the test is made, for the current passed even with a 100 volt battery will not exceed two milliampere. Milliammeters are not expensive to buy; in fact they can often be picked up from dealers in disposals goods for quite small sums and anyone who requires one will soon find that it is an extremely good bargain. The best type to purchase is one with a scale reading from 0 to 20 or 25 milliamps. As the divisions are fairly large there will be no difficulty in obtaining quite an accurate reading.

A Curious Case

Here is a strange case, liable to happen to anyone, which occurred to the writer some time ago before a milliammeter was fitted to the set.

On the previous evening reception had been very good indeed, but this time when the set was switched on signals had fallen off to but a fraction of their proper strength. The set was a four-valver with two high frequency stages, tuned-anode coupled, a rectifier and a note magnifier. Aerial and earth came through all tests with flying colours, there was nothing wrong with any of the coils or the condensers which tuned them, no loose connection or short circuit could be found in connection with any of the plates or grids. The telephones and transformers were tried and found perfectly in order. The batteries were up to their full voltage. All terminals were tested and found properly tightened up. The valves fitted tightly into their sockets and no grid had sagged on to a plate.

When all these tests had been made it seemed as if nothing else was left to be done and the matter might have remained a mystery had it not occurred to the victim to take a new valve (dull emitters were being used) and to try the result of using it to replace each of the four in turn. Nothing happened when it was placed in the sockets of the high frequency valves or the rectifier, but when it was employed as a note magnifier signals suddenly resumed their wonted strength and clearness.

employing the very useful milliammeter. This particular defaulting valve was cured eventually by being run for a considerable time with the plate current switched off.

A Curious Occurrence

One night the set, when adjusted to the known setting of 2LO, responded so weakly that signals were barely audible in the loud speaker though normally they could be heard all over the house. Though usually the particular set in use (one high frequency, aperiodic transformer coupled, a rectifier and two note magnifiers) was so stable that it could not be made to oscillate upon broadcast wavelengths, it was now found to emit squeaks when either the tuning condensers or the coupling between primary and secondary circuits were altered. A trial showed that 2LO could be brought in by leaving the secondary at its normal setting and increasing the capacity added to the primary to something considerably beyond the ordinary amount required. But when this was done the set was very unstable, oscillating on the slightest provocation.

The cause was not discovered for some minutes but a little thought showed that something must have happened to either aerial or earth. A walk outside showed that the

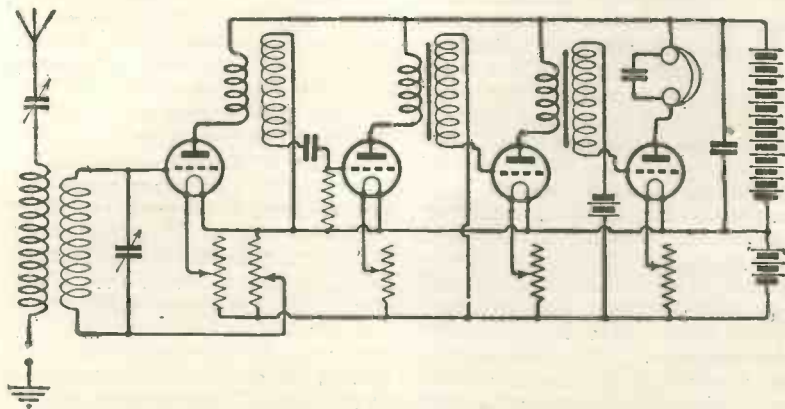

Fig. 3.—A disconnected earth lead makes the set unstable, though signals can be brought in by increasing the capacity of the A. T. C.

The mystery was solved instantly. The low frequency valve had suddenly fallen off in its emission either through ageing or because the filament had at some time during the previous reception been worked at rather too high a temperature. This is a fairly common fault with dull emitters if one does not exercise extreme care when using them. It can be detected either in the way indicated or by em-

earth lead was no longer attached to the terminal of its insulated tube. A recently acquired puppy had found it a splendid thing to play with and his teeth marks on the insulation of the wire showed that he had pulled and pulled until it came adrift. A note was made for future reference: if the set is unstable and if more capacity is required in the aerial tuning condenser examine the earth lead.

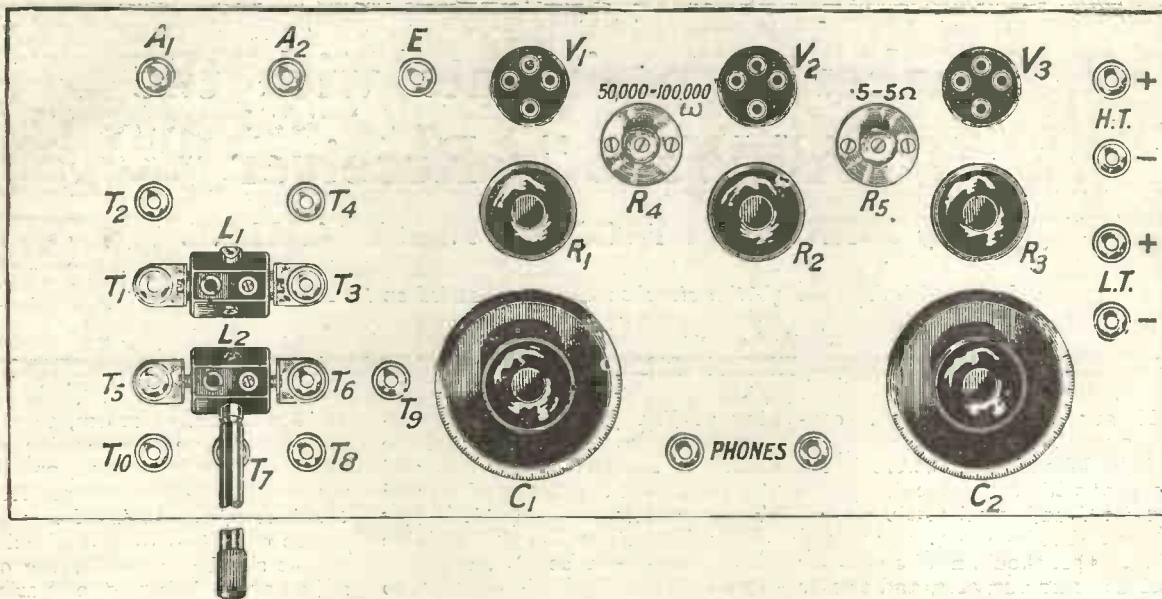

Fig. 3.—The panel of the "All-Wave" receiver.

coils should, first of all, be well apart, and under these conditions the aerial condenser C_1 of Fig. 3 should be adjusted until the loudest signals are obtained. The reaction coil L_2 is then brought closer to L_1 and the condenser C_1 is returned. Bringing the coil L_2 closer to L_1 should result in an increase in signal strength, after a re-tuning in each case, of the condenser C_1 . If the signal strength does not increase, it is a clear indication that the reaction coil is the wrong way round, and the next step is for the experimenter to reverse the leads to the coil L_1 . We have stated that the terminals T_1 and T_2 are connected, and that T_3 and T_4 are also joined. The experimenter should now disconnect these leads and connect T_2 to T_3 and T_1 to T_4 . The process of gradually bringing up the reaction coil to the coil L_1 and re-tuning on C_1 should be gone through, and it will be found that the strength of signals will increase. The coupling should not be made

too tight; otherwise the second valve will oscillate and a chirp or howl heard when the condenser C_1 is adjusted. If this howl is heard; immediately loosen the coupling, or distance, between L_1 and L_2 .

same as that given in Fig. 4, but now has the variable condenser C_2 connected in the anode circuit. This is brought into circuit by adding to the connections given when describing Fig. 4, by joining T_5 to T_9 .

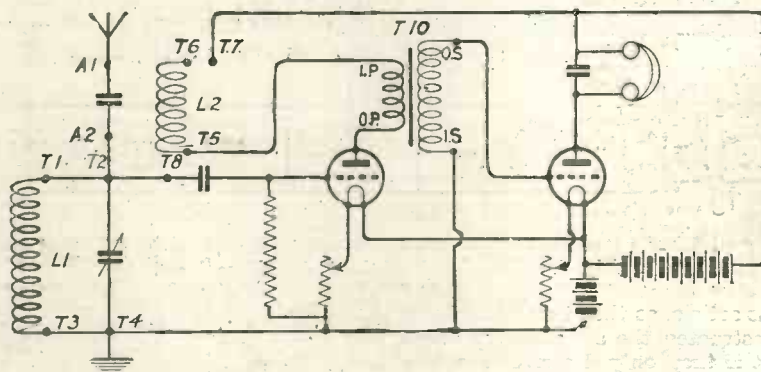

Fig. 4.—A circuit employing reaction.

Another Two-Valve Circuit

Fig. 5 illustrates another two-valve circuit which is really the

This circuit is very liable to oscillate, and is not recommended. In any case, the reaction coil should be kept well away from the other coil at all times.

A Single-Valve Circuit

A single-valve circuit, using the All-Wave receiver, is illustrated in Fig. 6. Assuming that the aerial, telephone and battery connections have been made and that all other leads have been disconnected, the following connections are necessary:

The first and third valves are switched off. T_1 is connected to T_2 , and T_3 to T_4 . T_2 is connected to T_8 , the anode resistance R_1 being switched off. The terminal T_{10} is connected to T_5 , while T_6 is connected to the right-hand telephone terminal of Fig. 3.

(Continued on page 529)

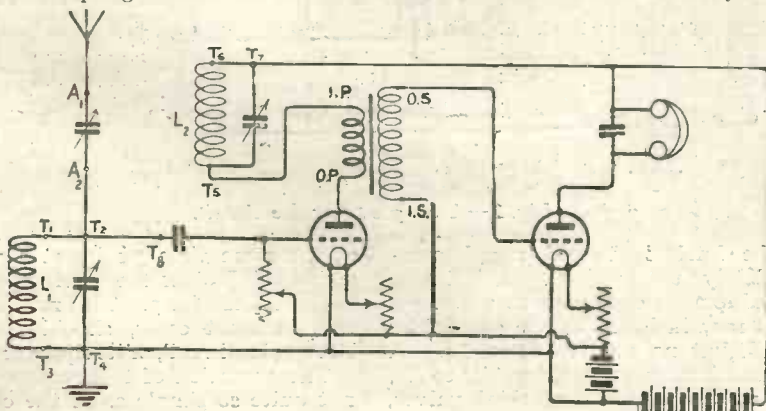
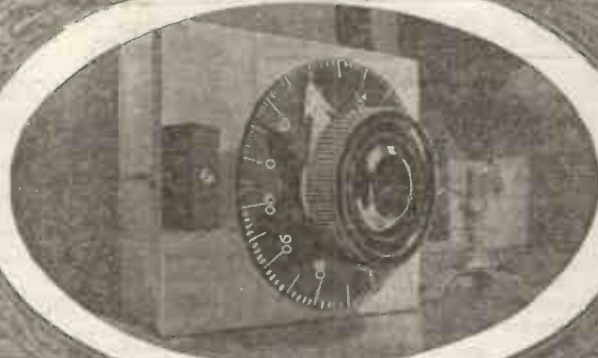

Fig. 5.—A circuit in which the reaction coil can be tuned.



**THE
FAMOUS POLAR .001 MICROFARAD
VARIABLE CONDENSER**

THE BEST ALL-ROUND CONDENSER ON THE MARKET

Is admirably adapted for the efficient tuning of aeri-als. This applies especially to the case of a loosely-coupled aerial, where the .001 value should be used for the PRIMARY of the aerial system.

The capacity curve of a POLAR CONDENSER is a STRAIGHT LINE. This means that its tuning is ACCURATE and CONTINUOUS.

The .001 POLAR CONDENSER is equally useful for REJECTER CIRCUITS and WAVE TRAPS.

The following circuits give their best results when fitted with POLAR .001 CONDENSERS: ST100 Flewelling, ST75, ST76, ST34, PW.

Proof of our confidence is the fact that ALL RADIO COMMUNICATION COMPANY Sets—both Marine and Broadcasting—are fitted with POLAR CONDENSERS.

Every POLAR VARIABLE CONDENSER carries a definite guarantee for twelve months. If during this time it develops any mechanical defect it will be replaced free of charge.

BEST VALUE. HANDIEST SIZE.

It is of general utility, indispensable alike to amateur, experimenter and expert.

Prices :—Unmounted, 14/-. Mounted, 20/-.

RCC
RADIO COMMUNICATION
COMPANY, LTD.
34-35 NORFOLK ST. LONDON, W.C.2

NEWCASTLE 11, Eldon Street	GLASGOW 123, Rennie Street	BRANCHES: CARDIFF Abercrombie, Rector, 5, Percy St.	LIVERPOOL 117, Dale St.	SOUTHAMPTON 15, Queen's Terrace
-------------------------------	-------------------------------	--	----------------------------	------------------------------------

POLAR

EVERYBODY

ALL POST FREE IN THIS COLUMN.

Switch Arm, one-hole fixing (best)	1/3
Above, with 12 best 1/4 by 1/2 studs and nuts.	2/2
Voltmeter, in Case, 0-15	5/2
Valve Windows	1/2
Ebonite Dial and Knob, hand-polished	1/6
Ebonite Dial (scale 0-180), hand-polished	1/6
Dial and Knob, scale 0-180, two designs	1/9
1/2 in. Ebonite Condenser Ends and Bushes	1/9
Spade Terminals, screw pattern	1/6
Pin Terminals, screw pattern	1/6
D.P.D.T. Nickel Switch on Ebonite	3/6
S.P.D.T.	2/4
D.P.D.T. Switch for Panel Mounting	2/4
S.P.D.T.	1/9
Phone Cords, double, 54 in. long	1/6
Phone Cords, double 72 in. long	2/-
100 Feet Aerial Wire and 4 Egg Insulators	3/9
Hand-polished Ebonite Valve Holders, 8 nuts.	1/6
Ebonite (Moulded) ditto	1/2
Twin Flex for long leads	doz. yds.
High-class Rubber Lead-in	10 yds.
Bell Wire, D.C.C. I.R.C. (not rubbish)	20 yds.
Coil Plugs, Ebonite, not substitutes	pair
Ditto on Stand, with Terminals	2/-
Single Holder and Plug for Basket Coils	1/3
Basket Coils, set of 6 (up to 3,500 metres)	2/6

Raymond Fixed Condensers, guaranteed:—	
.0001 to .0005	1/3
.001 to .005	1/4
.006	2/-
Filament Resistance (Edison Bell)	3/-
Filament Resistance, with Dial	2/6
Crystal Detectors, very fine value, nickel-plated, extra quality	3/11
Telephone Terminals and Nut	doz.
Large W.O. Pillar and Army Type	doz.
Small Pillar	1/4
Extra Large for Aerial and Earth	2 for 9d.
Strip Copper Aerial Wire (Tape), 100 ft.	3/6
Tinned Copper—	
14-gauge, 1/-; 16-gauge, rod, for 36 feet.	
18-gauge, 9d.; 20-gauge, 8d.	
Steering for 14- and 16-gauge	3 yds. 1/9
Steering for 18- and 20-gauge	3 yds. 1/6
Engraved Scales, 0-180	9d.
Filament Dials, 0-10	1/3
Ditto with Knob	1/3
Circle Scales, 0-300, Black or White	9d.
0-100	1/2
Set of 12 Names, Black or White	9d.
Gold Seal Plastic Metal	9d.
Grid Leak, 2 meg. 1/5; with .0003 Condenser	2/6
Valve Sockets with Shoulder	doz. 1/6
Ditto plain, all with 4 nuts	doz. 1/3
Special Screw Crystal Cup, quick fix	6d.
Telephone Wood Screw Terminals	6 for 1/-
100,000 ohms resistance	2/6

Ebonite Panels, 1 1/2, best quality:—	
6 x 6, 2/6.	8 x 6, 3/3.
9 x 6, 3/6.	12 x 9, 5/3.
12 x 12, 6/-.	
Lissenstat Minor	3/6
Lissenstat	7/6
Wamel Grid Leak	2/9

Igranic Concent Coils, set of 4:		
Wavelength range with .001 mfd. condenser in shunt:		
C 1	110-285 metres	£1
C 2	205-500 "	the set
C 3	348-706 "	of
C 4	495-1050 "	4 Coils.

For Lissen, Radio Instrument, Igranic and proprietary articles see separate announcements.

VARIABLE CONDENSERS. NEW MODEL

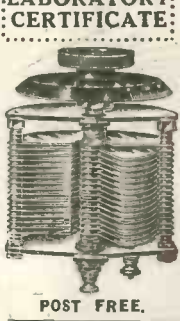

NATIONAL LABORATORY CERTIFICATE

One hole fixing

Cap. guaranteed. Minimum space required. Finely adjusted .073 in. spacers. Aluminium ends. Fully assembled for panel mounting as sketch. Including Knob and dial.

.001	-	-	8/3
.00075	-	-	7/3
.0005	-	-	6/3
.0003	-	-	5/9
.0002	-	-	5/-
.0001	-	-	4/4

POST FREE.

OUR USUAL CONDENSER

ONE HOLE FIXING

.088 spacing. Fully assembled for panel mounting. Complete with Knob and Dial. If no dial required deduct 6d.

.001	-	6/6	.0003	-	4/6
.00075	-	5/9	.0002	-	3/6
.0005	-	5/-	.0001	-	3/2
Vernier	-	3/-			Post Free.

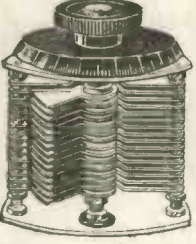

DUPLEX CONDENSERS

This Condenser is composed of two equal units, of .00025 mfd., operated by one Knob and Dial, thereby enabling you to tune two circuits by one turn of the dial. Can be used in series or parallel. Complete, as shown with aluminium ends, Knob and dial.

Post free **13/6**

CONDENSER and VERNIER COMBINED	Require no Flowery Language to Sell Them.
	Complete with Knob and Dial.
.001	.0005 .0003
12/6	10/6 8/6

TRADE COUNTER OPEN.

Lissen, Radio Instruments, Igranic, Edison Bell and proprietary articles stocked. Ericsson, N. and K. and Fellow Phones, Rotax Accumulators, Fixed and Variable Condensers, Terminals, etc. Best possible quality. No goods supplied without trademark. Members of Radio Clubs please show your membership card for discount (not given otherwise).

CALLERS ONLY ALL POST ORDERS FROM OTHER COLUMNS. TERMINALS, WITH NUTS.

Telephone, large	each	11d.
Telephone, Pillar W.O.	each	1d.
Large size Pillar 2 B.A.	each	3d.
Various	each	1d & 1 1/2
Valve sockets	doz. 10 1/2 d.	1/-
Contact Studs	doz.	4d.
2, 4, 5, 6 B.A. Nuts	3 doz.	6d.
2 B.A. Rod 2d. foot	2 ft.	5d.
4 B.A. Rod 2 1/2 foot	2 ft.	4d.
Valve Pins	doz.	6d.
Brass Bushes		1d.
Spade Tags, best quality	doz.	4d.
Screw Spade Terminals	2 for	2 1/2
Pin Screw do.	each	1d.
Stop Pins	2 a	1d.
Plug and Socket	pair	1 1/2
Easyfix Cup		1 1/2
Switch Arms	8d., 9d. &	10d.
Ditto, with 12 Studs and nuts		1/-
English Flash Lamp Batt.	doz.	4/3
H.T. Batteries, 36 v.	4/9 &	5/6
H.T. Batteries, 60 v.	8/9 &	10/6
Filament Res., with Dial		2/-
Set of Names (12)		5d.
0-300 Dial		5d.
Scales (Engraved) 0-180		4d.
Multiphone Terminals	9d. &	1/-
Insulators, Egg, 4 for		6d.
Large Shell		7d.
Small Shell	4 for	6d.
Aerial Wire	100 ft.	1/10
Extra Hard Drawn	100 ft.	2/4
Valve Windows		3d.
Engraved Dials 0-300		4d.
Ebonite Dial and Knob 0-180	1/1 &	1/3
Filament do. ; 0-10		9d.
Filament Dial 0-10		6d.
Fixed Condensers to .001 10d.; .002 to .005		1/-
.006		1/6
Ins. Screw Eyes		1d.
4 Cats' Whiskers (one gold)		3d.
Gold Whisker		1d.
Shaw's Hertzite		1/-
Geosite (G.E.C.)		1/6
Zincite, 6d.; Boronite		6d.
Coil Holders & Plugs	1/11 &	1/3
Coil Plugs, Ebonite	7d. &	9d.
Do., on Base	1/- &	1/3
Best Valve Holders		1/3
3 made, above	10d., 1/- &	1/3
Tinned Copper, 16, 18, 20-g. Stocked		
Copper Foil	ft.	3d.
Filament Res., good		1/6
Formo, ditto		2/6
Rubber Lead-in	10 yds. 1/- &	1/3
Bell Wire, D.C.C. I.R.C.	10 yds.	5d.
Twin Flex	12 yds.	1/6
Heavy Rubber Lead-in	yd. 2d. &	3d.
Basket Coils (6) up to 3,500		1/9
Waxless (5)		1/11
D.P.D.T. Switches for Panel		1/6
S.P.D.T.		1/3
Telephone Cord Pair 9d. 72" long		1/4
Ebonite Ends (1) and bushes	pair	1/3
Alum. Ends & Bushes	pair	1/3
Grid-Leak (2 meg.) 1/- with Condenser .003		1/9
Empire Tape	yard	1d.
Adhesive do.	roll	4d.
A.A. Earth Clips		7d.
Washers, 2 and 4 B.A.	3 doz.	2d.
100,000 ohms Res.		1/6
Tel. Term. Wood Screw		1d.
Shellac (good)		5d.

NO POST ORDERS IN THE ABOVE COLUMN.

RIGHT OPPOSITE
DALY'S
GALLERY DOOR

K. RAYMOND
27, LISLE STREET, W.C.2

HOURS
OF BUSINESS:
DAILY - 9 to 7.45
SUND. 10.30 to 1

PHONE: GERRARD 4637.

In replying to advertisers, use COUPON on last page

*The Valve that
made the Sensation!*

**Here is the
SECRET.**

Consumption, 0.42 amp.
average.

Filament Voltage, 5.0volts.

Anode Volts, 50—100.

British make throughout.

Every Valve stamped
"B.B.C."



**The Thorpe
K.1 Valve**

is adaptable to every type of receiving circuit, but more especially to those employing dual amplification and super-regeneration. The high efficiency of this Valve is due to the employment of a special anode which forms a perfect electron trap owing to the great surface area presented.

A new and original method of exhaustion has been adopted which guarantees a very accurate degree of vacuum.

The Valve has been subjected to exhaustive tests, and has been received with approbation everywhere.



OBTAINABLE of all DEALERS

or direct from the Sole Distributors for Great Britain & Ireland.

BOWER ELECTRIC, Ltd.,

15, Grape Street, Shaftesbury Avenue, LONDON, W.C.2.

Further Experiments with the "All-Wave" Receiver
(Continued from page 524)

The only disadvantage of this arrangement is that the primary of the intervalve transformer is permanently included in the anode circuit, but this does not make any difference to the operation of the circuit.

The same remarks regarding reaction apply to this circuit as to the previous ones. The reaction coil should be brought up gradually to the other inductance, and if the reaction is the wrong way round then the connections between T_1 and T_2 and between T_3 and T_4 should be altered as previously described.

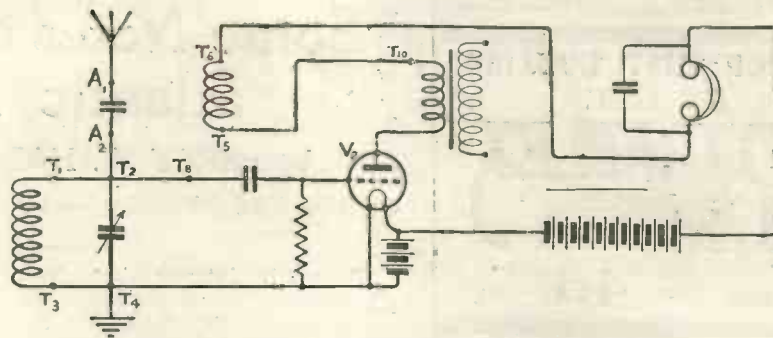

Fig. 6.—A simple single valve circuit with reaction.

Foolproof Attachment to Valve Sets

Constructional details of a little attachment which will prevent valve accidents

THE prevalent tendency in wireless, as in everything else, is towards the dawn of the foolproof era, but there still are one or two directions in which improvements remain to be effected.

One of these—which not a few careless experimenters have already realised to their sorrow—is in regard to coupling the high- and low-tension batteries to their respective terminals on the panel. Many

ebonite, about 2 in. long and $\frac{3}{4}$ in. wide, and each of these is fashioned to form a frame, into which one of the respective pairs of spade terminals is fixed. This prevents accidental contact, and consequent short-circuiting, between any of the spade terminals, it ensures that the two H.T. leads and the two L.T. leads are maintained in their proper pairs, and it eliminates the possibility of the one H.T. and one L.T. lead being accidentally paired together.

Diagram 1 shows the construction of the frame, which merely consists of the plain piece of ebonite drilled with two $\frac{5}{16}$ in. holes to accommodate the milled edges of the spade terminals. The distance between the holes (a) should correspond to the distance between the positive and negative screw terminals on the panel, so that the positive and negative spade terminals can engage with them.

It will be observed that the holes are not equidistant from the two edges of the frame, but, as shown by measurements "a" and "b," that they are appreciably nearer to one edge than to the other. Distance "b" should be about $\frac{1}{4}$ in. or such as will not hinder the spade terminals from making contact with the screw terminals on the panel (see diagram 2), whilst distance "c" should be

greater, say $\frac{1}{2}$ in., so that the frame, if inadvertently inverted, will not allow connection to the wrong terminals to take place.

The only danger that then remains is that the L.T. frame, *in toto*, might be connected to the H.T. terminals on the panel, or vice versa. This can be overcome if the two frames are marked "H.T." and "L.T." respectively; or if the screw terminals on the

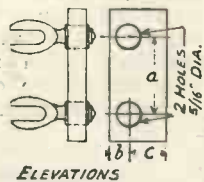

1.—Showing details of the attachment.

little things can here go wrong. The attachment of the H.T. leads to the L.T. screw terminals may ruin the valves. An accidental contact between two of the spade terminals may short-circuit the battery in a moment. Then again there is the hindrance which follows the mingling of the positive and negative leads.

To overcome these sources of worry is quite a simple matter. No materials are needed beyond a couple of small pieces of $\frac{1}{4}$ in.



Fig. 2.—This diagram makes clear that the leads cannot be connected if reversed.

panel are also arranged that the distance "a" on the L.T. frame is different from distance "a" on the H.T. frame; or again, if the position of the screw terminals on the panel will permit, by combining the two short frames into one longer one.

I have made this simple improvement on my own valve set, and have been more than repaid for the trouble incurred, by the worry and anxiety which I now find myself spared.

J. L. COUPS.

STOCKED by all *reputable* DEALERS

STOP THAT HOWLING!

USE

PARAFLEX
ANTI-CAPACITY
EBONITE
SLEEVING.

Better than Bare Wire. **4d.** per vard.

REVOLUTION IN PANEL MARKING

THE "NU-GRAVING" PROCESS

Neater, Cleaner and Cheaper than any other known method.

Series 1. 63 words & letters **7½d.**
Series 2. Scales and Dials

Postage 1½' extra each series.

The **CURTIS**
EBONITE VARIOMETER.

Close Coupling



Of robust construction and guaranteed efficiency.

Wound with 22 D.C.C. Wire. Wavelength Range: 250-550 metres.

PRICE **7/6** With Paralite Turret dial **9/-**

CRYSTOR COWL



INSULATORS AERIAL

Guaranteed Maximum Efficiency.

1/6 per pair

LEAD-IN, 4/- each.

PETER CURTIS, LIMITED.

34, Whitfield St., London, W.1.

(Off Tottenham Court Road.)

Telephone: ... Museum 8489.

Some Notes on the Transatlantic Receiver

by PERCY W. HARRIS, Assistant Editor

SO much interest has been shown in the transatlantic receiver described in the November issue of MODERN WIRELESS that a few further notes on the subject may perhaps be useful. At the same time I will take this opportunity of answering a few queries about the set.

First of all, with regard to the valves; these in many cases seem to have given trouble as for some reason or other (best explainable by the makers) there is a lack of uniformity in producing this type.

Excellent results with this set have been obtained in using the dull emitter equivalent of the V.24 and QX valves, i.e., the D.E.V. and D.E.Q. respectively. Occasionally trouble has been given by the lack of matching of the two transformers,

should pick those which are designed for high-frequency amplification. It is quite a good plan to cut the valve sockets to half their usual length and, instead of securing them on the panel with nuts at the back, to cut a screw-thread in the panel so that nuts are obviated.

The original transatlantic set is still in practically daily use on my experimental table and continues to give extraordinarily good results. Using a 2-ft. frame aerial with 10 turns, I have been able to hear Aberdeen, Newcastle, Glasgow and other of the broadcasting stations quite clearly in the telephones, without using any subsequent amplification, and by using the note magnifying addition described in the December issue it has been possible to work a loud-speaker quite well in this way. With the resistance coupling about to be described I have read most of the East coast United States high-power stations on the very long waves, while at the other extreme on the smallest transformer I have had no difficulty in working the loud-speaker (using the amplifying panel) on the "Old Vic" short wave-length transmissions.

The actual wave-length used is below 150 metres, and I have been asked not to reveal it in print to save the transmissions from the inevitable howling which might occur through the misuse of reaction receivers in searching for the carrier-wave.

Even down on 100 metres it is possible to use this set although naturally the size of tuning con-



Top view of the first resistance capacity coupling unit.

but in the majority of cases these have been satisfactory.

A large number of readers have written to ask whether it is possible to use the ordinary four-pin valves in this set. Generally I have not recommended their use seeing that a large part of the virtue of this set is due to the absence of stray capacities which are often so detrimental in high-frequency amplification. Several readers, however—by careful arrangement and by using the separate pins rather than the ebonite sockets—have obtained excellent results, and I would like to draw the attention of readers to a letter in this issue giving details of how one set has been made in this way.

If four-pin valves are used, the first two valves should be chosen with a view to their high-frequency amplifying properties. The popular "general purpose" valves are not the best to use and the reader



Rear view showing wiring.

denser is such that tuning is exceedingly difficult. The control of oscillation by means of the potentiometer remains uniform and

Time Signals, and How to Listen for Them with a Crystal Set

An Interesting summary of the various time signals which can be heard in this country with the simplest of apparatus

LONG before broadcasting came into being the wireless time signals sent out by a number of stations throughout the world were used by amateurs and experimenters as a means of checking the accuracy of their watches and clocks. Most popular of all the time signal stations was the Eiffel Tower of Paris, and it is not generally known that even a simple crystal set is quite sensitive enough to hear these time signals, whilst a knowledge of Morse is not required to understand them.

The most interesting of all the time signals is perhaps the series sent out every night from the Eiffel Tower at 10.44, 10.46, and 10.48 p.m., Greenwich Mean Time. These time signals are preceded by certain Morse signals which the beginner can ignore. Exactly at 10.44 p.m. the station begins a long series of dashes, spaced at regular intervals and precisely on 10.45 a dot is sent. At 10.46 a second series of dashes begins, and this time each dash is followed by two dots and precisely at 10.47 a dot is once more given. At 10.48 a series of dashes and 4 dots commences, terminating at 10.49 with a final dot. Thus one is able to check to a fraction of a second, the time at 10.45, 10.47, and 10.49 p.m. An identical series is sent out at 10.44, 10.46 and 10.48 a.m.

If your set is so arranged that you can tune up to 2,600 metres, you will have no difficulty whatever in picking up these Morse and time signs. If your crystal set is fitted with a plug and socket for increasing the wavelength range, you will need to withdraw the plug from its socket and insert it in a No. 300 plug-in coil, whereupon you will hear signals quite distinctly. A valve set, of course, will give very loud signals and with three valves its strength will be much more than you can comfortably bear in the telephones. For the benefit of those who are accustomed to listen to Eiffel Tower telephony we may say that the time signals take place on exactly the same adjustment. The tuning is much less sharp than is the case with telephony.

These are not the only time signals sent out by the Eiffel Tower: there is another series known as the "scientific time signals" which, however, cannot easily be interpreted by the beginner. These are sent out about 10 o'clock a.m. and p.m. and consist of a series of dots regularly spaced. They are useful for tuning up your set preparatory to receiving the 10.44 signals, but can only be fully utilised with the aid of scientific apparatus. They are really sent out in order that astronomers and others may check their astronomical clocks with a degree of accuracy not possible on the 10.44 time signals.

If you study a complete radio time-table you will find that time signals are sent out from Paris at other times of the day, *i.e.*, at 10.44 a.m. (these signals as stated are the same as those at 10.44 p.m.) and at 9.26 until 9.30 p.m. These last are known as the international system of time signals and are somewhat different in their formation. Five seconds after 9.26 there occurs a series of three dashes, each dash a second long and the dashes separated by an interval of exactly one second. At 15 seconds after 9.26 another series of three is sent, and between 25 and 30 seconds is a continuous dash. Again at 35 seconds we have three dashes a second long with one second intervals and at 45 seconds after the minute a further series. Precisely at 9.27 we have the Morse letter X (dash, dot, dash) repeated a number of times until at 55 seconds after 9.27 occurs a series of three dashes each a second long with a spacing of one second, the last dash terminating exactly at 9.28. Shortly after 9.28 the Morse letter N (dash dot) is sent at regular intervals and a series of three dashes terminates at 9.29. Shortly after 9.29 we have the Morse letter G (dash, dash, dot), and three dashes with the last terminating at 9.30 finish up the series.

Another series of time signals which can be read with a well-adjusted crystal receiver is that sent out from the Nauen station near Berlin. These are also in the

International code of time signalling just described, and are sent out at 11.57 a.m. and 11.57 p.m. The wavelength is 3,100 metres and identical signals are also sent out at the same time by continuous waves on 13,000 metres. Of course these latter cannot be heard on a crystal receiver, but the strength of the 3,100 metres (a 400 coil will do for this) is quite sufficient for anyone to read when listening carefully.

If you are fortunate enough to possess a receiver which is capable of receiving continuous wave signals on long wavelengths, and if you are sufficiently experienced in tuning, you will find it interesting to try to pick up the time signals from Annapolis in the United States. The Annapolis station is very powerful, and although its signals are rather mixed up with those of many other high power stations, it is a comparatively simple matter to pick them up when you have acquired skill in tuning. The midday American time signals sent out from Annapolis are heard in this country at 5 p.m. in our time owing to the five hours difference. Annapolis signals are sent out as a series of dots, one dot a second, the dots for last 5 seconds of each minute being omitted. Exactly on the hour a dash is made. The midday signals start 5 minutes before the hour and there is another series of signals sent out between 5 minutes to 10 and 10 p.m. (being heard here between 2.55 and 3 a.m.). The call sign is NSS (—) and the wavelength 17,145 metres. The signals are sent out with an arc transmitter of very high power.

Time signals bring home to us very forcibly the wonderful distances which wireless signals will travel and still be heard. They also emphasise the differences in time between two countries: thus an experimenter in Boston with a really good set can listen about seven p.m. to the midday signals from Pearl Harbour, Hawaii, and the midnight signals from Nauen in Germany, the interval being only a few minutes.

P. W. H.

Have you a Wireless Set ?

Then you need

CLIX

(TRADE MARK)

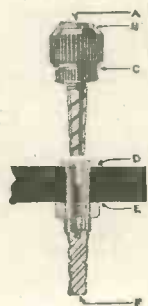

CLIX is the most ingenious and efficient contact or terminal on the market to-day, and most inexpensive. It consists of a combined plug and socket which readily solves every wiring problem, and supersedes every kind of Terminal. This is how it is used :

CLIX may be wired at any of the points A, B, C, D or E, by passing the end of the wire

- A** Down the socket, through the slot—clamping the end at C.
- B** Through the slot, down the socket—clamping the end at C.
- C** Round the shank under the rim—clamping the end at B or D.
- E** Through the slot or round the thread—clamping the end at C or E.
- F** Affords an ideal point for soldering when permanent connections are required.

Prov. Patent,
No. 13950/23.

RETAIL PRICES.

CLIX	3d. each
CLIX LOCKNUTS	½d. each
INSULATORS (six colours)	1d. each
with Locknut and Insulator	4d. each
Bushes (six colours)	1½d. pair
with Lock nut and one pair Bushes...	4½d. each

Postage extra—2d. per doz. : 4d. per gross.

CLIX is obtainable from all high-class wireless dealers or direct from the Patentees and Manufacturers :—

AUTOVEYORS Ltd

Radio Engineers and Contractors,

84, VICTORIA STREET, LONDON, S.W.1

'Phone: Victoria 309.

'Grams: "Auto.eyor, Sousest, London."

Ask your dealer for a demonstration of the

3-E.V.C.

Because it is the **PROVED** rejector of all interference in listening-in. The 3-E.V.C. is the most important of all Wireless accessories.

WIRELESS VALVES



2Kf-Mr. Partridge Mitham. — The Mullard receiving valves are on the left and the Mullard transmitting valves on the right.

First Across

YOU know the keenness and the rivalry which goes to win the coveted phrase "First across." Every wire is subjected to most careful scrutiny, but the choice of valve is almost a religious ceremony, so essential is the right selection of the valve:

The First amateur "Just across" the Atlantic, working both ways, was

Mr. PARTRIDGE, MERTON LANE, MITCHAM

and the first schoolboy

Mr. C. W. GOYDER, MILL HILL SCHOOL

They both used

MULLARD VALVES

Why not get the best out of your set ? The Mullard range is comprehensive and any dealer can supply you with the right Mullard Valve for your circuit or set.

Ask him to-day.

Mullard



A Valve for Every Wireless Circuit

Advt. The Mullard Radio Valve Co., Ltd., Nightingale Works, Nightingale Lane, Balham, S.W.12.

(E.P.S. 108)

In replying to advertisers, use **COUPON** on last page

"ATLAS" SPECIALITIES.



"ATLAS" PATENT PLUG-IN COILS

Customer. "I see you stock 'ATLAS' PATENT PLUG-IN COILS. Could you tell me how it is they are so efficient, please?"

Dealer. "Well, one of the principal reasons is that since High-Frequency Currents tend to keep to the surface of a conductor, it follows that the greater the circumferential area the less the effective resistance; and as the Patent Winding of these Coils is comprised of **TWIN WIRES**, with a consequent larger surface area (or skin effect) than is possible with single-wire wound coils, the 'ATLAS' PATENT PLUG-IN COILS offer the least possible resistance to such High-Frequency Currents."

Customer. "Now what about cutting out unwanted stations for which the manufacturers are making such a big claim?"

Dealer. "The 'ATLAS' COILS being wound in true concentric circles, there is an entire absence of sharp bends which are so detrimental to any coil. Furthermore, the special arrangement of 'Separators,' separating the layers of the windings from one another, provide the **MAXIMUM** amount of **AIR-SPACING**, which renders **FINE TUNING** not only a possibility, but an actuality and which, of course, is the **GREAT ESSENTIAL** in the **CUTTING OUT** of **UNWANTED STATIONS**. A marked increase in signal strength is also effected."

Manufactured Solely by

H. CLARKE & CO. (MANCHESTER), LTD.,

**RADIO ENGINEERS,
"ATLAS" WORKS,
OLD TRAFFORD,
MANCHESTER.**

*Phones :
683 & 793 Trafford Park.

*Grams :
"Pirtoid" Manchester.

Aerial Circuit Tuning

By John Scott-Taggart, F.Inst.P., A.M.I.E.E., Editor.

(Continued from page 326 of previous issue. This part was unavoidably left over.)

The greatest advantage of the series condenser arrangement is that the set will work on widely different aerials without the necessity of constantly changing the plug-in coil. From the point of view of semi-constant aerial tuning the Fig. 7 circuit is much to be preferred to the Fig. 5 arrangement.

Neither the series nor the parallel arrangement, however, is good enough. It is not possible to specify, for example, in an article

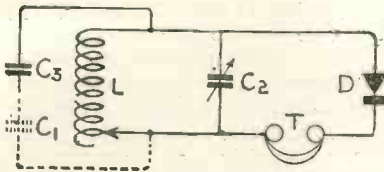

Fig. 10.—The simplified circuit of Fig. 9.

that the correct coil for broadcast wavelengths is a No. 50 plug-in coil. Authors have to specify alternative numbers; for example, No. 25, No. 35, No. 50, or No. 75 coil. These alternatives need not be given in the case of the constant aerial tuning system.

The Constant Aerial Tuning System

This system involves the use of a small series condenser which is connected in series with the aerial, the aerial inductance being shunted by a variable condenser of the usual size, say, 0.0005 μ F. The series condenser in the aerial circuit is fixed, and has a capacity of 0.0001 μ F.

The idea, broadly, is that by using a very small series condenser in this way, this condenser acts in series with the condenser formed by the aerial and earth, with the result that the inductance L of Fig. 9, which shows the system, is shunted by an almost negligibly small capacity due to the aerial. On the other hand, this capacity would have quite an appreciable effect if the inductance L₂ were not itself shunted by the variable condenser C₂, with which the tuning is accomplished.

In Fig. 9 the capacity of the

aerial is shown by C₁, and this condenser, in series with C₃, gives a resultant capacity which is always negligible with regard to the capacity of C₂. Consequently all sizes and shapes of aerials may be connected on to the circuit without in any way affecting the tuning of the circuit L C₂. I can, for example tell you that you will get 2LO by using a No. 50 honeycomb condenser C₂ of 0.0005 μ F maximum capacity adjusted to a fixed degree. Whatever kind of aerial you use, and wherever you may be, you will always be able to tune on to 365 metres with a No. 50 coil and a 0.0005 μ F variable condenser. There is absolutely no necessity for me to say: "Try a No. 25. If you do not get 2LO, try a No. 35 or a No. 50, or a No. 75 coil." I simply say: "Use a No. 50 coil, and whether it is an indoor aerial or a large outdoor aerial, you will not need to modify your coil."

The use of this constant aerial tuning system will be a great factor in ensuring uniform results in home-made sets or commercial sets. The system makes tuning simplicity itself, and it makes the set foolproof. Even the experimenter with long experience in tuning will find the arrangement exceedingly useful, although if an extra terminal is provided on the set it is always possible to connect the aerial directly on to the top of L in Fig. 9, thereby cutting out C₃.

On the broadcast waveband the use of the small fixed condenser in the aerial circuit does not noticeably affect signal strength, but on the longer wavelengths it is better to connect the aerial directly to the top of L.

Apart from the fact that tuning is substantially independent of the aerial used, a much wider range of wavelengths is obtained with a given coil and variable condenser. Since the shunt capacity due to the aerial is rendered almost negligible, the same range of wavelengths may almost be obtained, as in the case of a secondary circuit or tuned anode

circuit. Similar sizes of coils will also usually be used for aerial and anode tuning.

Fig. 10 shows the simple circuit corresponding to Fig. 9. The capacity across L, due to the condensers C₃ and C₁ in series, may almost be neglected, because C₃ is very small, and the total capacity to the left of L is still smaller. An interesting comparative figure is given later.

The Ballast Method

Another attempt to solve the same problem resulted in the Ballast circuit illustrated in Fig. 11. In this case a fixed condenser C₃ of 0.0003 μ F capacity is connected across the aerial and earth terminals of the receiver, while tuning is accomplished by means of the condenser C₂, which has a maximum capacity of 0.0005 μ F. The inductance L is not shunted by any condenser.

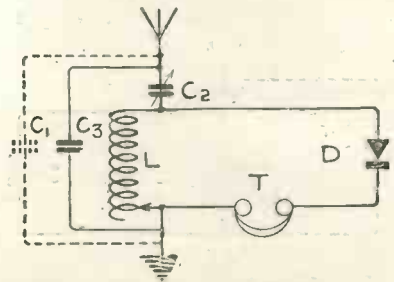

Fig. 11.—The Ballast method.

In Fig. 11 the aerial capacity is represented by the phantom condenser C₁. A simplified form of the circuit is shown in Fig. 12, from which it will be seen that the inductance L is shunted by two capacities in series, one of the capacities being the variable condenser C₂ and the other being a composite capacity, consisting of the Ballast condenser C₃, which has in parallel with it the aerial capacity C₁.

From the point of view of making the receiver insensitive to changes in aerial capacity, the circuit is an undoubted success, and is very much better than the series arrange-

ment of Fig. 7 and the parallel arrangement of Fig. 5. The circuit, however, is only half as good as the Fig. 9 constant aerial tuning system, and changing the circuit of different aerials necessitated a greater readjustment of the variable condenser C_2 .

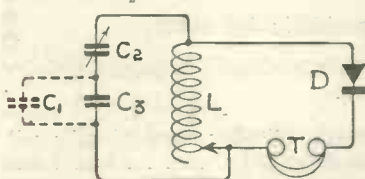

Fig. 12.—The Ballast circuit simplified.

The circuit can be made more and more insensitive to changes of aerial capacity by increasing the Ballast capacity C_3 , but even when C_3 had a value of $0.0003 \mu F$, signal strength was greatly reduced, and this is much worse when C_3 is increased. The circuit of Fig. 11 cannot, therefore, be recommended as an efficient constant aerial tuning system.

A Very Constant Circuit

The most constant of all the circuits described in this article is illustrated in Fig. 14. This circuit is a combination of Fig. 11 and Fig. 9. Three condensers are employed. The condenser C_3 has a value of $0.0001 \mu F$, while C_2 has a maximum value of $0.0005 \mu F$, and C_1 is a fixed condenser having a

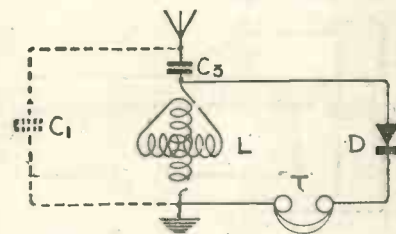

Fig. 13.—A simple variometer circuit.

value of $0.0003 \mu F$. The aerial capacity is shown by the phantom condenser C_1 , and the arrangement of the different capacities is illustrated in Fig. 15.

The circuit may be said to be entirely independent of changes in aerial capacities for all practical purposes, but while the ideal is achieved in this respect, the signal strength is very considerably impaired, and the Fig. 14 circuit shows the disadvantages of the Fig. 11 Ballast circuit. I cannot, therefore, recommend the Fig. 14 arrangement, and my final conclusion is that the arrangement in Fig. 9, which uses a series condenser C_3 of $0.0001 \mu F$ capacity

and a further condenser C_2 of $0.0005 \mu F$ capacity, is the best all-round arrangement for constant aerial tuning.

Variometer Circuits

Fig. 13 is a simple variometer circuit, but a fixed condenser C_3 which may have a value of $0.0003 \mu F$ is connected in series with the variometer. The aerial capacity is shown by the phantom condenser C_1 . This circuit is extensively used in crystal receivers using variometers, and the arrangement has the advantage of being far less susceptible to changes in aerial capacities than the arrangement of Fig. 3. The circuit, of course, cannot compare with the Fig. 9 circuit or some of the other constant aerial tuning methods, but nevertheless where it is desired to design a crystal receiver using a variometer so that it will cover a given range of wavelengths on widely varying aerials, the circuit of Fig. 13 is to be recommended.

Aperiodic Aerial Circuits

Before passing on to some detailed figures, it would be just as well to draw attention to Fig. 16 circuit which Mr. Harris has frequently described in these columns. The aerial circuit is not tuned at all, but about 8 turns of inductance are wound closely over the secondary L_2 , which is tuned by means of the variable condenser C_2 . The coil L_1 will usually be placed in the middle of L_2 , and this circuit is also independent of changes in aerials, but the arrangement does not lend itself to the use of plug-in coils or for use when a wide band of wavelengths is desired. On the other hand, with a given inductance and condenser, the waveband obtained is equal to that of a tuned anode circuit or a secondary circuit.

Some Actual Figures

I have worked out a few figures to corroborate the experimental results I have obtained with the circuits given in this article.

I have assumed that the variable condenser C_2 , shown in the various circuits, is adjusted to a capacity of $0.0003 \mu F$. Two aerials are considered, one having a capacity of $0.0002 \mu F$ and the other twice the capacity—viz., $0.0004 \mu F$. It is supposed that both aerials are tried on each of the different circuits, and the effect on the tuning is noted. In the case of Fig. 3, changing from the small aerial to the large aerial results in an increase in capacity across L_2 of $0.0002 \mu F$ —i.e., changing the aerial

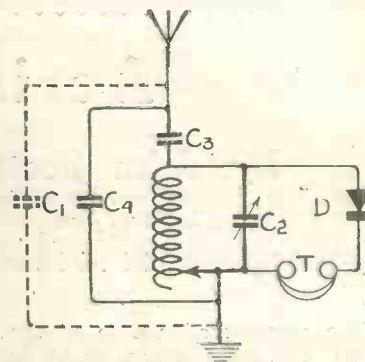

Fig. 14.—The most constant circuit of all.

results in 100 per cent. increase in the capacity across the inductance. This means a very large change in the tuning of the aerial circuit.

1. In the case of Fig. 3, the only capacity across the inductance is the capacity of the aerial. Hence such a circuit is very susceptible to aerial changes. In the case of two aerials, of $0.0002 \mu F$ and $0.0004 \mu F$, the use of the larger condenser means a 100 per cent. increase in the capacity across the inductance.

2. The Fig. 5 arrangement, using a parallel tuning condenser, is considerably better. With the small aerial in use, the total capacity across the inductance L is $0.0005 \mu F$, of which $0.0003 \mu F$ is the condenser C_2 , and $0.0002 \mu F$ is the capacity C_1 of the small aerial. With the large aerial, the total capacity across L is $0.0007 \mu F$. Using the large aerial, we have an increase of the total capacity of $0.0002 \mu F$, an increase of 40 per cent., which is far less than the 100 per cent. in the preceding case, but even now the change in tuning is very considerable.

3. The Fig. 7 arrangement, using a series tuning condenser, is not nearly so bad. In the case of a small aerial, the total capacity is $0.00012 \mu F$, while with the large aerial the total capacity across the inductance L is $0.00015 \mu F$. The use of the large aerial is equivalent to adding $0.0003 \mu F$ to the total capacity, which represents an increase of 25 per cent. This compares very favourably with the 40 per cent. in the case of parallel tuning. Different aerials, however, still produce widely different tuning of the aerial circuit.

4. The Fig. 9 constant aerial tuning system is the recommended circuit. The total capacity across L , in the case of the small aerial, is 0.000367 , while with the

(Continued on page 539.)

B.B.C. WIRELESS DRY BATTERIES For **B.B.C. Sets**

No. 1 W.

Standard Pocket Lamp Size—4½ volt with patent spiral wire terminals and plug sockets to take Wander Plugs.

Note — 1 doz. = 51 volts.

Used units replaced easily.

Connect as illustrated.



To connect in Series insert straight Terminal in Spiral of next battery. Bend spiral and thus ensure permanent electrical connection without soldering.

BRITISH MADE.

Patent applied for.

PRICE CARRIAGE PAID, 7/- PER DOZEN, WITH PLUG.

Standard Sizes :

No. 2 W. Slab, 16½ volts, 3-volt tappings. Size approx. 9 x 1 x 3 ins.	Price 3/- each
No. 4 W. Slab, 36 volts, 3-volt tappings. Size approx. 10 x 1½ x 3 ins.	" 6/8 "
No. 5 W. Block, 60 volts, 3-volt tappings. Size approx. 9½ x 3½ x 3½ ins.	" 12/- "

Prices include Wander Plug. Carriage Paid.

Manufactured by *Telephone: Watford 617.*

The BRITISH BATTERY CO. LTD.

CLARENDON RD., WATFORD, HERTS.



20 YEARS' EXPERIENCE

WE TEACH BY POST.

Most Moderate Charges Payable Monthly.

SPECIAL OFFER 35/- Dictionary for 6/-

To extend the name of the BENNETT COLLEGE we are publishing an illustrated encyclopaedia Dictionary of Engineering, Civil, Motor, Elect., Mech. The proper price is 35/- It is in 24 monthly parts of 16 pages each part. You may have part 1 free, and if you are satisfied send only 6/- and you will receive all the other 23 parts. The offer only applies to the first 1,000 applicants. Send for part 1 to-day; you are under no obligation.

Have You Any Ambition ?

To Learn a Trade or Profession—or go higher in your present vocation. Have you a son ? Does he, or do you wish to pass any qualifying Exams ? Remember every man is the Architect of his own fortune, and I can show you how to study in your spare time (by post) and thus reach the highest positions. As my advice is free, write to me and let me help you as I have helped thousands of others.

J.A. Bennett

We specialise in all Exams.

COMMERCIAL

- Commercial Arithmetic
- English and French
- Book-keeping
- Modern Business Methods
- Commercial Law
- Company Law
- Secretaryship
- Accountancy
- Auditing
- Banking
- Costing
- Advertising and Salesmanship

TECHNICAL

- Architectural Drawing
- Building Construction
- Clerk of Works' Duties
- Aviation
- Boiler Engineering
- Boiler Making
- Chemistry
- Civil Engineering
- Concrete and Steel
- Draughtsmanship
- Electricity
- Engineering

Foundry Work

- Internal Comb. Engines
- Marine Engineering
- Mathematics
- Matriculation
- Metallurgy
- Mining
- Mine Surveying
- Motor Engineering
- Naval Architecture
- Pattern Making
- Sanitation
- Shipbuilding
- Structural Engineering
- Surveying and Levelling
- Telephony
- Wireless Telegraphy

WRITE FOR FREE BOOKLET

to The BENNETT COLLEGE, Dept. 134, SHEFFIELD, naming the subject you are interested in. Please state your age. Courses specially combined to meet all requirements. Why Stay in the Rut ?



ESTABLISHED 1900

TECHNICAL SHEFFIELD COMMERCIAL

(Dept. 134)

“WIRELESS VALVES”

ORDINARY ‘ R ’ VALVES

6/6 each.

The satisfactory repair of Wireless Valves is now an accomplished fact

We guarantee all Valves repaired by us to give entire satisfaction coupled with prompt delivery.

Write:

Radions Limited,

Bollington, near Macclesfield.

Trade or private customers receive every attention.

Deliberately designed

COSMOS RADIO COMPONENTS

"COSMOS" FILAMENT RHEOSTAT

made in two standard patterns constructed with phosphor-bronze contact arm ensuring reliable contact. Resistance is carried on a porcelain former absolutely unaffected by heat.

Supplied complete with terminals, screws, dials and knobs, suitable for back of panel or face of board.

Face of Board 6d. extra.

For one valve
(6 ohms)

4/-

For 2 or 3 valves
(2.75 ohms)

4/-

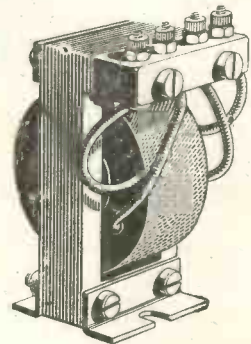
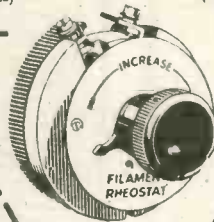

"COSMOS" L. F. TRANSFORMER

is specially designed for utmost clarity of reproduction. Of solid construction and high efficiency, it is free from noise and will safely stand the high voltage and heavy loading used for power amplifiers.

Ratio to 4.	Ratio to 9.	Telephone In Box.	Transformer Unmounted.
15/-	15/-	22/6	12/6

"COSMOS" PLUG-IN TYPE STRIP INDUCTANCE COILS.

(Patent applied for.)

Constructed on an entirely new principle, these coils are wound with strip of special design, composed of a number of copper wires embedded side by side in prepared paper. The coils have extremely low self-capacity and small high-frequency resistance. They are provided with plug and socket to fit standard coil holders.

MADE IN SEVEN INDUCTANCE VALUES.

4/6, 4/9, 5/-, 6/-, 6/6, 7/- 8/9.

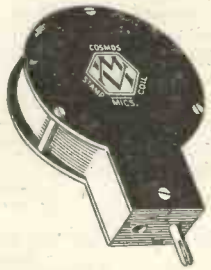

"COSMOS" High Frequency Inter-Valve Vario-Transformer.

(Patent applied for.)

Tuned on the Variometer principle. Has primary and secondary windings ON BOTH the fixed and moving bobbins. Uniformly high efficiency and amplification are obtained over the whole broadcasting waveband.

18/6

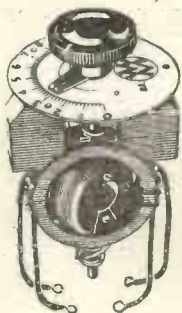

"COSMOS" VARIOMETER AND VARIO-COUPLER.

Wound on best quality micarta tubing having high insulation and low dielectric loss. Supplied with terminals, dial knob, pointer and fixing screws. VARIOMETER for tuning aerial circuits over wave-lengths of 300 to 600 metres. With .0002 mfd. in parallel it is suitable for tuning anode circuits over similar wave-lengths. VARIO-COUPLER is suitable for wave-lengths up to 1,000 me. res.

8/-

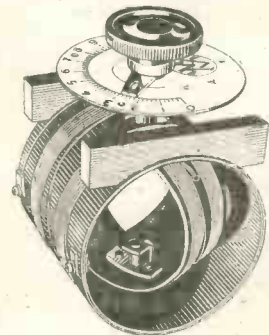
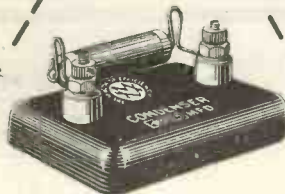

"COSMOS" FIXED CONDENSER and GRID LEAK.

The condenser, as shown, is enclosed in a moulded ebonite case with external terminals. It is built up of plates of copper foil separated by selected mica dielectric rigidly fixed in position.

Condensers only with "Leak" clips, .0003 mfd; 2/6
Condensers only, without "Leak" clips, various capacities ... 1/9 to 2/6 each
Grid Leak, 1, 2 or 3 Megohms, 1/-

"COSMOS" RADIO COMPONENTS are obtainable from all wireless retailers. Demand "Cosmos" Components by name. If you have any difficulty, write to our works giving name and address of your usual dealer.

METROPOLITAN Vickers

ELECTRICAL CO. LTD

Head Office and Works : - Trafford Park, MANCHESTER.
London Showrooms : - - 232-233, High Holborn, W.C.1.

A copy of the "Cosmos" Catalogue and Handbook (D.S. 7117/1) post free for 2d. stamps.

R.
P.O.I.

Aerial Circuit Tuning.
(Continued from page 536.)

large aerial it is $0.00038 \mu\text{F}$; the difference is $0.000013 \mu\text{F}$, or 5 per cent. variation in the total capacity as a result of using an aerial of 100 per cent. greater capacity than the smaller aerial. This figure is eloquent of the usefulness of the constant aerial tuning system.

5. In the Fig. 14 circuit, the use of a Ballast condenser, which is not recommended on account of the resultant decrease of signal strength, a large measure of constancy is obtained. The small aerial in use gives a total capacity of $0.00019 \mu\text{F}$ across the inductance L. In the case of the large aerial the capacity is increased to $0.00021 \mu\text{F}$, a difference of $0.00002 \mu\text{F}$, which represents a 10 per cent. increase by the use of the larger aerial. This, of course, would not make very much difference in the aerial tuning, but the result is not nearly as good as the Fig. 9 circuit.

6. In the Fig. 14 arrangement we have by far the best circuit from the point of view of constancy of aerial tuning. The capacity with the small aerial is 0.000383 , while with the large aerial it is only very slightly different, and is 0.000388 . By the use of an aerial of twice the capacity, we only add

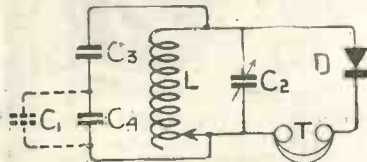

Fig. 15.—Fig. 14 simplified.

$0.000005 \mu\text{F}$ to the total capacity across the inductance L, which does not alter the tuning. The change in aerials only results in a 1 per cent. increase in the total capacity across the inductance, but on the other hand, signals are considerably weakened, and the circuit is therefore not to be recommended.

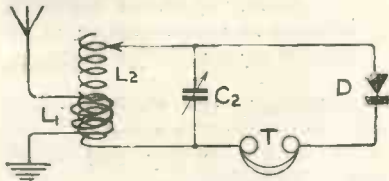

Fig. 16.—An untuned aerial circuit.

Conclusion

The conclusion to be drawn is that the Fig. 9 circuit is easily the best. Greater and greater constancy of aerial tuning could be obtained by making C_3 of smaller capacity than $0.0001 \mu\text{F}$, but if a smaller value than this is used, the signal strength falls off, and the value given is the one recommended.

**LONG DISTANCE
CRYSTAL RECEPTION.**

To the Editor of MODERN WIRELESS.

SIR,—This place is equidistant from Lowestoft, Ipswich and Norwich and fully 100 miles from London. Using a good aerial single wire, full length, 40 ft. high, which is practically unscreened, being well above my house, which is the only one near it, and a good earth.

I have heard the following stations on the plain crystal circuit and Brown's phones. Basket coils for A.T.I., up to 500 metres and staggered lattice coils above that; a .001 polar condenser, galena type crystal and gold cat's-whisker; detector circuit straight off the A.T.I.; phones, 4,000 ohms.

2LO, 375—Average strength 21 by shunted phones, i.e., just audible with 200 ohms across phones. A perfectly reliable reception here on the crystal.

Bournemouth, 285—Speech intelligible nearly all the time, but some fading.

Newcastle 5NO, 400—Heard him say "5NO calling"; speech intelligible occasionally; much fading and noise.

Glasgow 420—Speech clearly readable at intervals and always audible.

Birmingham, 475—Not quite so clear as Glasgow.

Aberdeen, 495—Never intelligible but faintly audible.

Eiffel Tower, 2,600—French clearly intelligible most of the time. Weather report. Very little fading. Noise the main trouble.

A very good imitation of silence can be maintained in the wireless den.

This is not in the nature of freak reception apparently, as it can be repeated nearly any day in the winter. Cardiff (now a nuisance to 2LO) can be heard through 2LO on the crystal as it can with valves unless a closed circuit is used.

These results seem to be rather at variance with the average experience, but my own conclusion is that given sensitive phones, silence, and well-adjusted crystal, telephony is not worth amplifying unless it can be heard faintly but clearly on a plain crystal circuit, as the extraneous noises, all amplification seems to delight to honour, will spoil it.

Yours faithfully,
F. C. JAMES.

Diss, Norfolk.

T. O. BUSS,
77, Clerkenwell Road, E.C.1

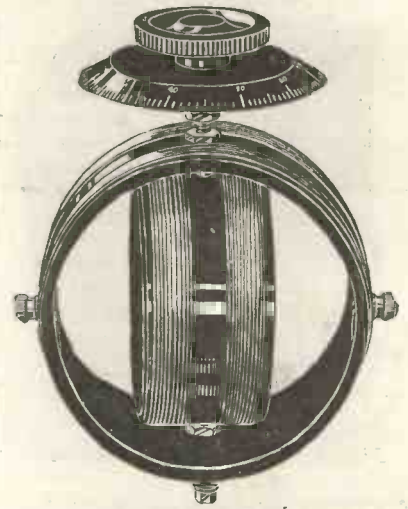

VARIOMETERS.

Bushed Bearings, Ebonite Dial 0-100, and Knobs. Metal Parts Plated. Wavelength 340 to 560 metres.

Adequate provision is made for mounting on a panel, and the dial is neatly and clearly engraved.

Marvellous Price 4s. 6d.
TRADE SUPPLIED. POST 6d. Extra.

HEADPHONES 12/9
Genuine French Telephones, most sensitive obtainable, 4,000 ohms with cords

"Ebonite"

POSTAGE FREE. ANY SIZE CUT.

	s. d.	£ s. d.
8 x 1 x 1/4 ...	7	12 x 10 x 1/4 - 7 6
4 x 4 x 1/4 ...	1 3	17 x 8 x 1/4 - 8 9
7 x 6 x 1/4 ...	2 8	
10 x 6 x 1/4 ...	3 9	18 x 18 x 1/4 - 15 9
17 x 5 x 1/4 ...	5 3	36 x 18 x 1/4 - 17 6

TRADE SUPPLIED.

Invaluable to Crystal Users.
EARWIG-SKER
An entirely NEW type of Cat's Whisker, Patent applied for.
A GENUINE INVENTION
which will appeal to those who wish to get even better results than hitherto.
NOT AFFECTED BY VIBRATION
Post Free 7s. d. (Please send P.O.)
MARSHALL & CO., Belfast Rd., N.16.

WIRELESS WEEKLY

is the most

Popular Wireless Weekly Journal

IT IS A SPLENDID ADVERTISING MEDIUM

Advertisement Managers:
Scheff Publicity Organisation, Ltd.
125, PALL MALL, LONDON, S.W.1
Phone: REGENT 2440 (2 lines).



Fig. 1.—The complete receiver.

THE crystal receiver about to be described has given very good results on the B.B.C. stations up to 10 miles, and can be made very easily by even a beginner. Fig. 1 gives a good idea of the finished receiver, and, as can be seen, provision is made for coarse and fine tuning, with terminals for aerial, earth and telephones.

Materials Required

For the Set :—

- 4 terminals.
- 16 contact studs.
- 4 stops.
- 2 switch arms, radius 1½ in.
- 1 cardboard tube, 3 in. diameter, 4½ in. long.
- 1 crystal detector.
- 1 piece ebonite, 7½ in. x 6½ in. x ¼ in.
- Some 20 S.W.G. D.C.C. wire.

A Simple and Efficient Crystal Receiver for Broadcasting.

By HERBERT K. SIMPSON.

A description of a thoroughly efficient receiver which we have tested ourselves.

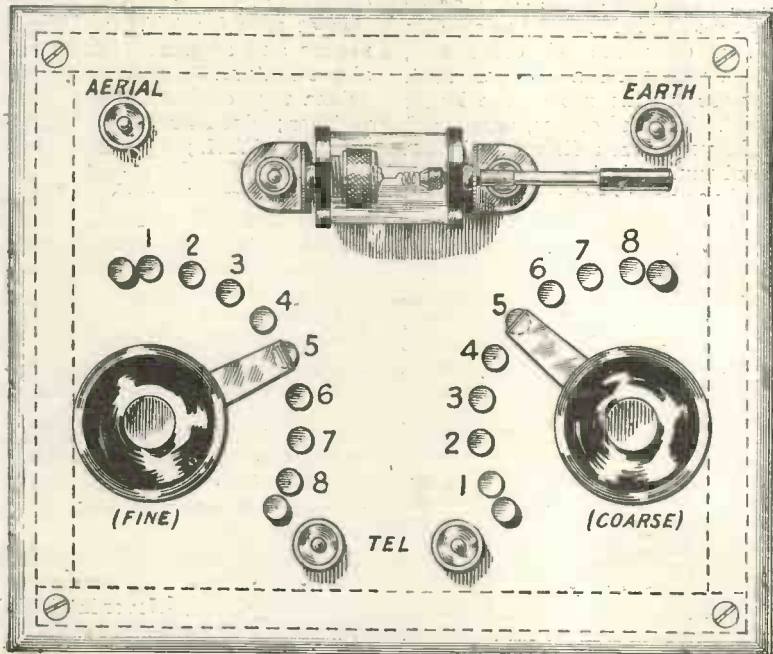

Fig. 2.—The lay-out of the panel.

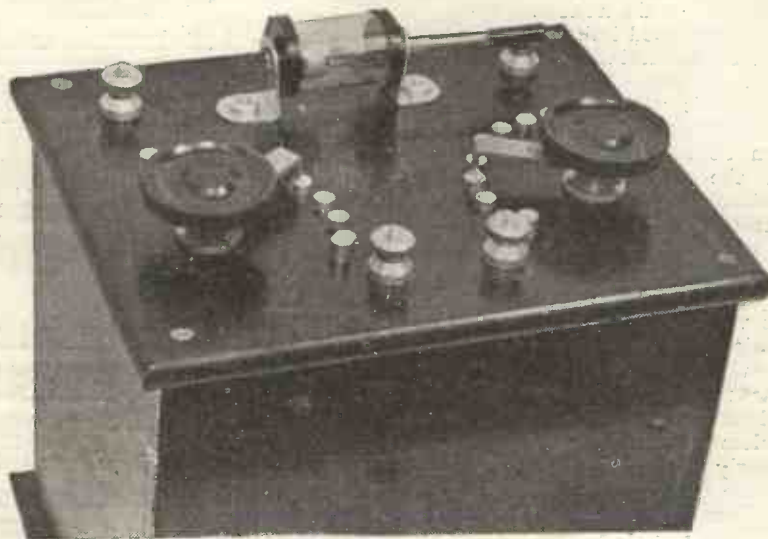

Fig. 3.—A nearer view of the receiver, showing details of the panel.

For the Box :—

- 2 pieces of hard wood, 7 in. x 5¼ in. x ¾ in. for the sides.
- 2 pieces of hard wood, 5 in. x 5¼ in. x ¾ in. for the ends.
- 1 piece of hard wood, 7½ in. x 6½ in. x ¾ in. for the base.

If desired, the ebonite panel may be replaced by wood, but the latter should be dry and about ¼ in. to ⅜ in. thick.

The Inductance

The inductance can be made first, and should be commenced by making a hole about ⅓ in. from one end of the former and threading the wire through this. Make another hole near the edge, and thread the wire through this also, leaving

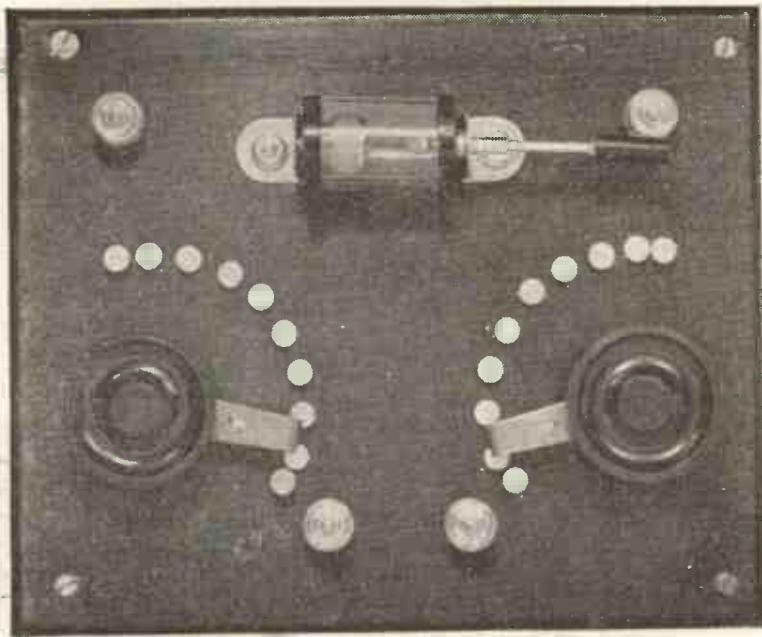

Fig. 4.—A plan of the panel showing disposition of switches, etc.

about $2\frac{1}{2}$ in. of free wire. Now wind one turn of wire round the former and make a tapping here. This is best done by making a hole in the former close to the turn and a little beyond the first hole, and threading the wire through. Make a hole near the edge of the former and thread through, leaving about the same length of free wire as before. Make eight tappings in this manner, and then wind eight turns straight off, make a tapping, eight more turns, a tapping, and so on, until the total of 71 turns has been completed. Bring the last eight tappings out of the opposite side of the former to the first eight.

The Panel

Turn now to the panel, and fix the positions of the centre spindle of the switch arms. Now take a compass, and with a radius of $1\frac{1}{2}$ in., the same radius as the switch arms, make a circle on the reverse side of the panel. The holes for the contact studs may now be drilled, and care must be taken that the holes are just far enough apart to allow the arm to rest on two studs without falling down between them. With studs of $\frac{1}{4}$ in. diameter head the holes should not be more than $\frac{7}{16}$ in. apart if the width of the switch arm is $\frac{5}{16}$ in. A good average distance between the centres of the studs is $\frac{3}{8}$ in. Next, a stop should be placed at each end of each set of eight studs, to prevent the arm going too far.

Ordinary brass screws may be used for the stops, and also, if desired, they may be used to replace the studs, the arm moving over their flat heads.

The terminal holes may now be drilled and the terminals fitted. The crystal detector may be made if desired, but as this component

can be purchased very cheaply, the saving hardly warrants the extra work involved. The detector should be mounted, and when all the studs are slipped into position, the inductance may be wired up.

Looking at the panel from the underside (Fig. 6), connect the beginning of the winding to the stud marked No. 8, the first tapping to No. 7, and so on, until all the first eight tappings are used up. Then start at No. 1 on the coarse tuning switch, making sure the tappings are being connected in their right sequence. If screws are used for the studs, the wires will have to be soldered on to the "studs," but if the ordinary contact studs are used the wires can be held under the nut on each stud.

Wiring Up

Next wire up the terminals as shown in Fig. 6, taking a wire from the aerial terminal to the "fine tuning" switch arm and also to the crystal. Connect the other side of the crystal detector to the telephones, and the other side of the telephones to earth and the "coarse tuning" switch arm. Use 20 S.W.G. wire for connections.

The panel is now complete, and we may turn our attention to the box, which is seen in Fig. 7. The pieces of wood should be planed

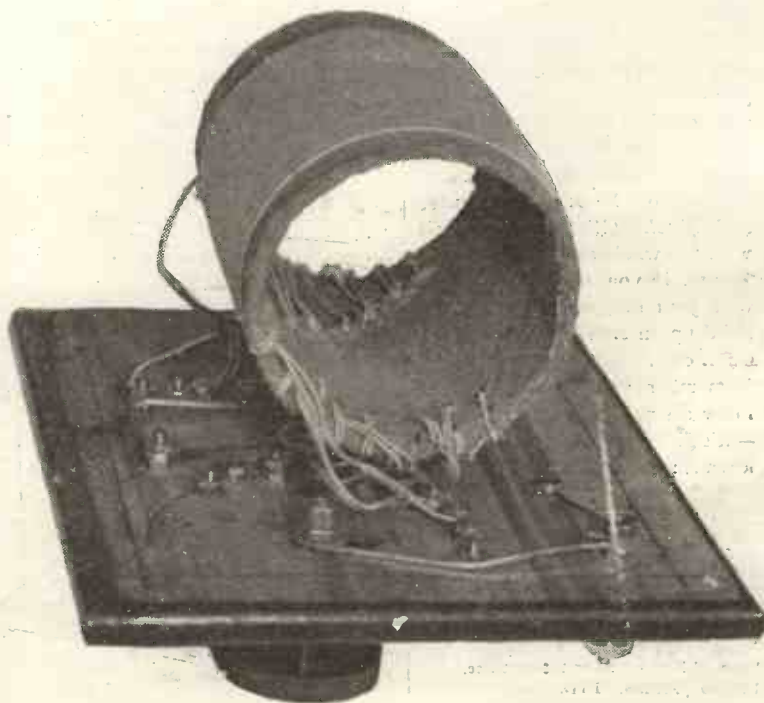

Fig. 5.—An underneath view of the panel, showing the coil and connections.



Splendid Broadcast Sets made without special skill.

It is not often easy to condense into a single constructional Article all the details necessary for a complete beginner to build up a Broadcast Receiver.

Naturally the space in a Magazine like MODERN WIRELESS is rather limited. Therefore, if you are looking for a first-class book on how to build good Crystal Sets, you cannot do better than get this one. "How to make your own Broadcast Receiver" is written by John Scott-Taggart, F.Inst.P. (Editor of MODERN WIRELESS and Wireless Weekly). It deals with the whole subject from A to Z, and if you are at all handy with your fingers, you can easily build up an excellent Receiver at small cost.

Remember you do not need to know a single thing about Radio—it's all in the book, and you can learn it in a few hours.

1/6 Get a copy TO-DAY.

From all Booksellers, or 1/8 post free.
RADIO PRESS, LTD.
DEVEREUX COURT, STRAND, W.C. 2.

Radio Press Wireless Library, No. 3.

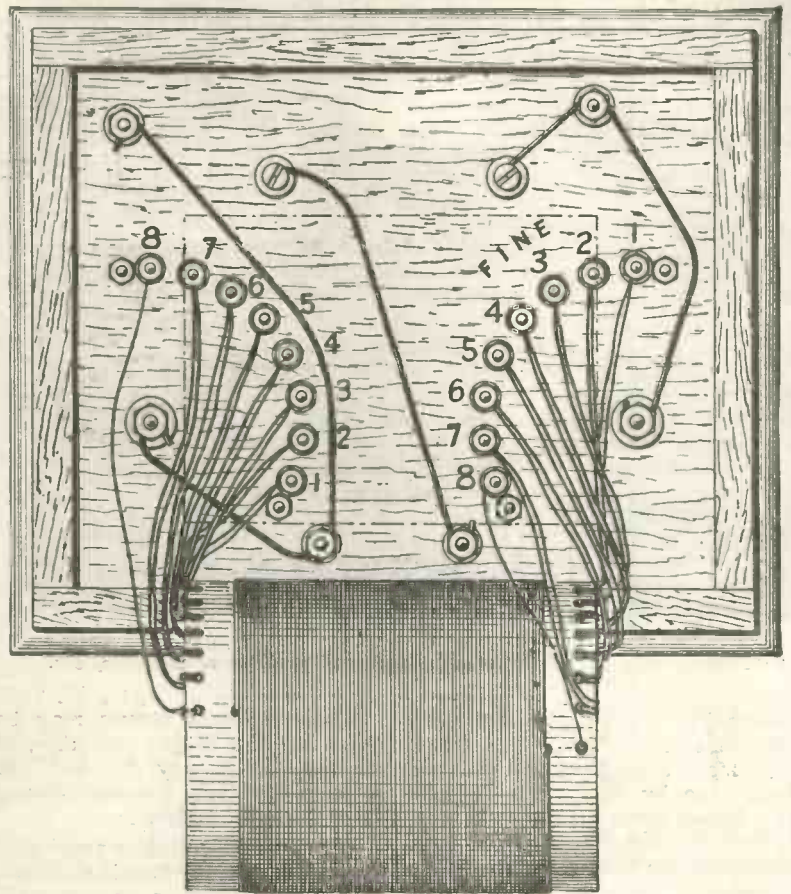

Fig. 6.—Wiring plan.

up smooth, and then glued together. It is advisable to secure them by brads, and the whole can be greatly improved in appearance if stained and polished. The panel is secured to the box by a screw at each corner.

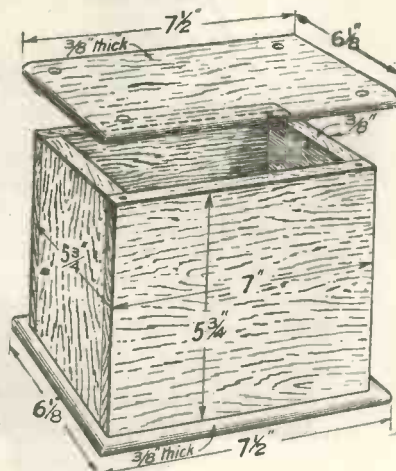

Fig. 7.—Details of the containing box.

Operating

To tune in, connect up aerial, earth and 'phones, see that the cat-whisker is touching the crystal, and put the coarse switch on Stud 1. Now move the fine tuning switch over its studs to find a signal. If there is no result, move the coarse switch to No. 2 stud and again move the fine switch over its studs. Repeat this on all studs of the coarse switch until the signal is heard at its best, after adjusting the detector to give the best result. When the signal is heard, adjust the fine tuning switch so that a movement either side of the best point decreases the signal strength.

When broadcasting is not on local amateurs may be tuned in, and if the set is fairly near the coast ship signals may be heard. The set will easily cover the whole broadcast wave-band on any aerial. In conclusion, the set has given loud signals on local broadcasting, and was found to be in every way satisfactory, and well repaid any pains taken in the construction.



The Magician of the Steel Case

ALTHOUGH the *Eureka* L.F. Transformer has only been on the market a month, keen experimenters are already wondering what black magic is responsible for the immense amplifying properties sealed up in its steel case.

Science and skilled engineering practice are happily combined in the *Eureka*—its handsome coppered case not only gives life-long protection to its contents but actually prevents interaction through radiation. Even when two *Eureka* Transformers are adjacent no distortion or howling can result.

And its amplification factor compels critics to revise their opinions as to what an L.F. Transformer really can do. To the non-technical it is sufficient for us to say that with a strong plate voltage and sufficient negative grid bias, the Concert Grand will give louder and purer signals

than *two* ordinary L.F. Transformers.

Remember that in a 3-Valve Set, for example, the cost of the intervalve Transformer is less than 10 per cent. of the whole cost—yet no other component carries such a responsibility for ultimate success or failure.

- Made in two types :
- Eureka Concert Grand, 3½ inches long, 2¼ inches high ... **30/-**
 - Eureka No. 2 (for 2nd stage) 3¼ inches long, 2 inches high ... **22/6**

While you are building your Set make the first cost last cost by using a *Eureka* Concert Grand, guaranteed to give you faithful and enduring service. If your Dealer has not received his supplies, write us direct giving his name.

Q Dealers: *Eureka* Transformers will be widely advertised and a heavy demand is anticipated—apply to your factor now.

THE ELECTRIC APPLIANCES CO. LTD.

7 and 8, FISHER STREET, LONDON, W.C.1.

Branch Offices: LEET'S—1, Oxford Place. MANCHESTER—9, St. James' Square.
Scottish Agent's: Blackie, Miller and Russell, Ltd., 30, Gordon Street, Glasgow.

EXTRAORDINARY DISCOVERY !!!

Aerial which needs no insulators, will increase efficiency by 50% and is cheaper than bare wire.

CLEVER ADAPTATION OF SCIENTIFIC FACT.

Wireless experts agree that the ether waves flow only on the surface or skin of the conductor which carries them. Therefore, aerials which consist of several small wires stranded together are more efficient than a single wire of thicker gauge.

The Best Conductors.

It is also an established fact that SILVER is the finest conductor, closely followed by TIN. Silver is not only too expensive to use generally as an aerial, but for many technical reasons it is impracticable.

On the other hand, Tin, an expensive conductor, four times the value of copper, lends itself admirably, inasmuch as it can so easily be coated on other wires of the necessary strength and durability, so that it fulfils the purpose of a perfect conducting "Skin."

The Secret of Electron Wire.

ELECTRON wire is that it consists of eight wires—each separate strand is scientifically coated with a skin of pure tin.

Enthusiasts who are using Electron wire in all parts of England and America report wonderfully clear results with either crystal or valve sets. The high-frequency currents penetrate the protective coverings, all incoming signals being held. Suspend Electron wire where you will, lead direct to the set (no separate lead-in required), use Electron wire for the earth, and a greatly improved reception will be the result.

Extend your 'Phones or loud-speaker to any part of the house or garden with Electron wire, which being insulated with vulcanised rubber, no further insulation is necessary. You may allow it to touch anything, anywhere, indoors or out-of-doors in perfect confidence. Electron wire has no equal at 10 times the price.

THE CHEAPEST AERIAL and the Best in the World.

100 ft. **1/8** carriage paid.

If you cannot get it from your local dealer, send 18 direct to us, together WITH HIS NAME and ADDRESS, and we will send 100 ft. sufficient for a complete aerial, lead-in and earth.

300 ft. 500 ft. 1,000 ft. 1 mile.
4/3 6/3 10/3 17/6
CARRIAGE PAID.

Money Refunded if not entirely satisfactory.
Prices for larger quantities upon application.

NEW LONDON ELECTRON WORKS, LTD.,
99, Regent's Dock, London, E.14.
TELEPHONE: EAST 1821. TELEGRAMS: "STANNUM, LONDON."



TO REMIND YOU

that the "Efficiency Inductance" is still the best on the market. Compare the list below with those published for other coils.

Coil.	Wavelength range shunted with .001 capacity condenser.	Self-capacity in Microfarads.	Price.
a	75 to 330	.000004	5/9
A	120 " 525	.000004	5/9
B	200 " 855	.000005	6/-
C	285 " 1200	.000006	6/9
D	400 " 1700	.000006	8/-
E	600 " 2875	.000008	9/6
F	1040 " 4350	.000009	10/3
G	1575 " 6800	.000011	12/-
H	2250 " 9500	.000014	14/-
I	3425 " 14500	.000017	16/-
J	5000 " 25000	.000021	19/-

Gambrell Bros., Ltd. 76, Victoria St., S.W.1.
(entrance in Palace St., Victoria 9938)

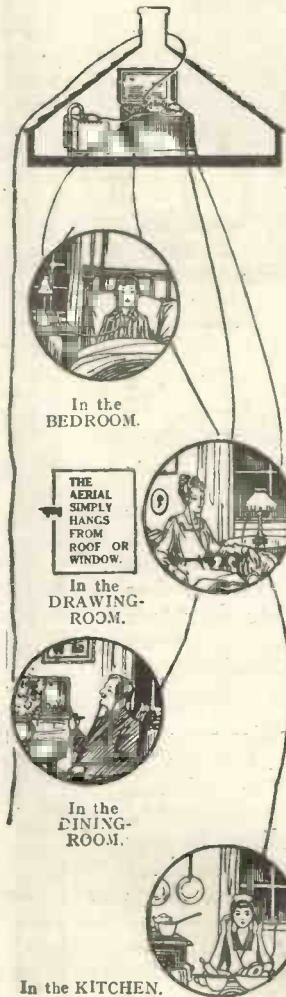

THE

"Tangent" Head Phone

25/-

A Head Phone with tradition behind it.

Established in 1872, Gents' have manufactured every kind of Phone for every kind of purpose for the last 30 years.

This fact has, undoubtedly, a bearing on the great and ever-increasing popularity of the "TANGENT" Head Phone.

Supreme Efficiency, combined with Comfort to the Wearer, are the out standing Features of this Phone.

4000 ohm resistance. Suitable for Crystal or Valve Sets.

Ask your dealer; if in difficulty, write us to name nearest Stockist.

GENT & Co., Ltd., FARADAY WORKS, LEICESTER.

The name TANGENT or this mark guarantees British make.

Adding One or Two Valves to a Crystal Set

By HERBERT K. SIMPSON

This article, by an experienced constructor of wireless apparatus, will be of considerable interest to those who wish to get beyond the crystal stage.

THERE must be a number of users of crystal sets who have thought about adding a valve to their set to obtain louder signals, and then wondered how to do it. The simplest way is to add the valve as a note magnifier, and the set to be described will be quite suitable for addition to any crystal set, while two of the amplifiers will give excellent loud-speaker results up to 10-15 miles from a broadcasting station.

The finished amplifier is seen in the photograph, Fig. 1, and it will be seen that the set is of very simple design, so that no difficulty

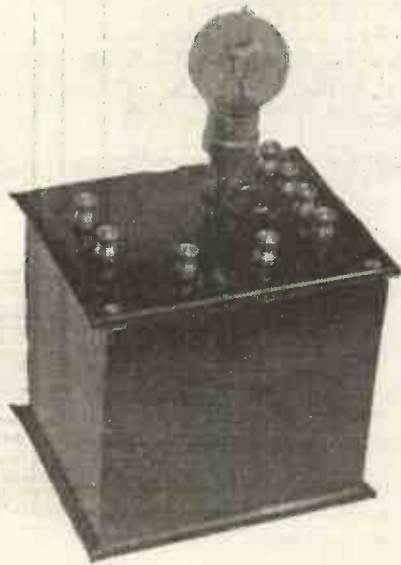

Fig. 1.—The L.F. unit.

should be experienced in the construction, even by a novice.

Materials required :—

- 1 L.F. transformer of any good make.
- 1 filament resistance.
- 1 valve holder.
- 8 terminals.
- 1 valve.
- 1 piece of ebonite $7\frac{1}{2}$ in. \times $6\frac{1}{2}$ in. \times $\frac{3}{16}$ in.

The components actually used included an Igranite L.F. transformer and a "Microstat" filament

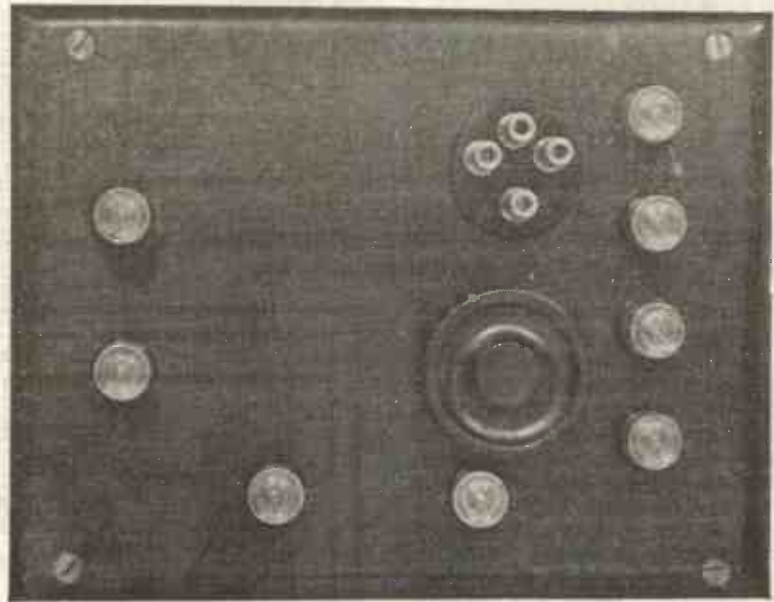

Fig. 2.—Plan view of the unit.

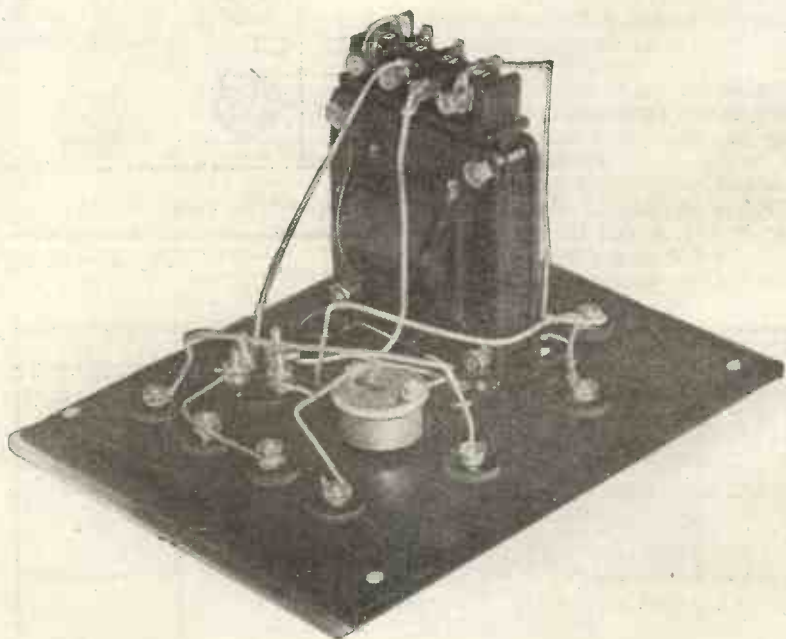

Fig. 3.—The internal arrangement of the single valve note magnifier.

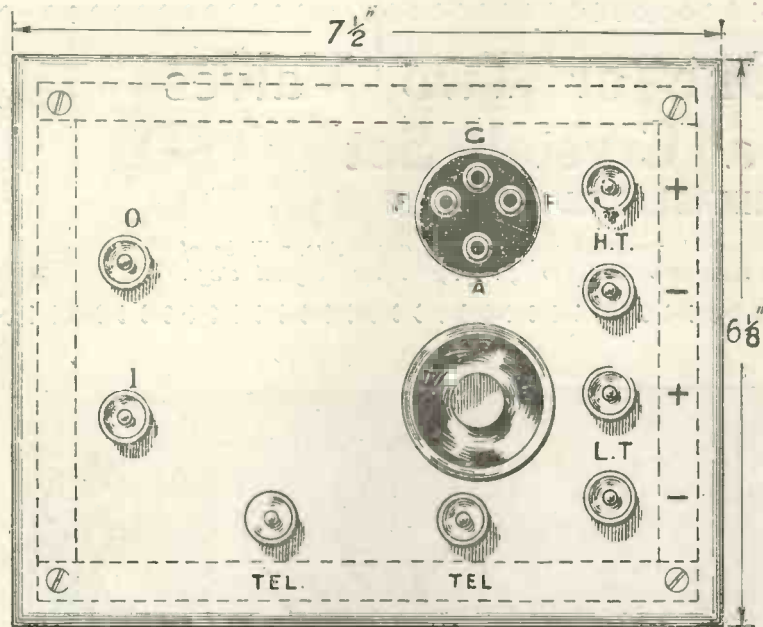

Fig. 4.—The panel lay-out.

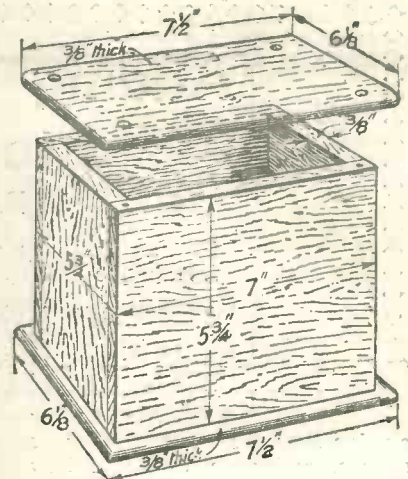

Fig. 7.—Details of the box.

each piece to shape, and then fitting it into place. The transformer is secured to the panel, if of wood, by ordinary screws, but if the panel be of ebonite, lols must be drilled and bolts

resistance. Any good make of transformer and resistance may be used, but it is as well to remember that a resistance of the compressed carbon type, such as the one mentioned, is equally suitable for either dull emitter or high temperature valves; thus if such a resistance be fitted, either type of valve may be used at will, without any alteration to the set.

The panel should be of ebonite, but wood may be used if desired, provided it is thoroughly dried before use. Again, all terminals should be mounted on ebonite strips, or bushed with ebonite tube where they pass through the wood, with ebonite washers under the terminal head and nut. The positions of the terminals are given in Fig. 4. The valve holder should be mounted on ebonite, and a hole cut in the panel to receive it.

The underside of the panel is seen in Fig. 6, and the wiring can be easily followed. Use 16 S.W.G. wire for the connections, bending

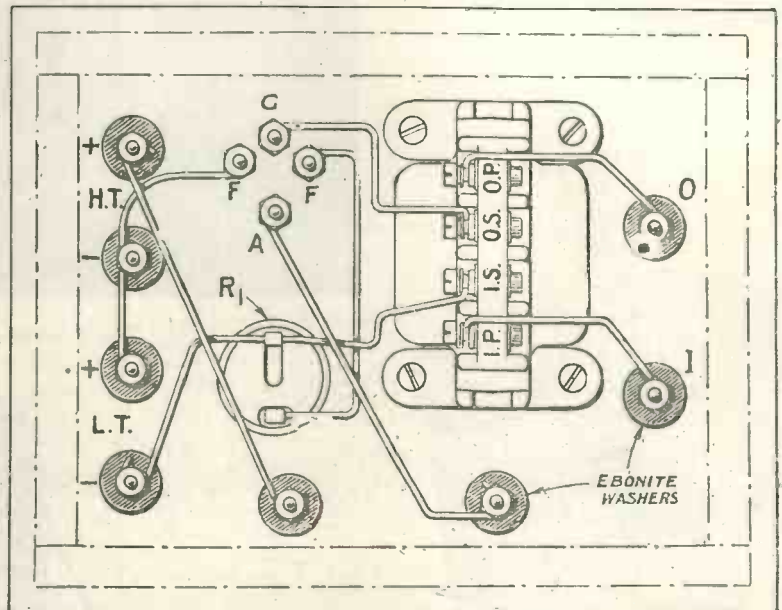

Fig. 6.—Wiring of the L.F. unit.

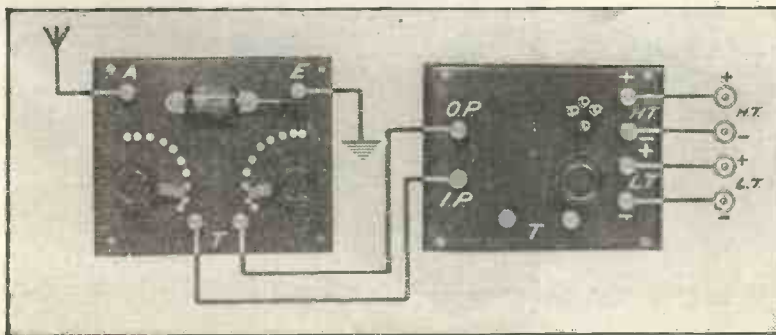

Fig. 5.—The crystal set and one L.F. stage.

with nuts used to secure the transformer to the panel.

Wire up as follows:—

- Terminal H.T. + to telephone terminal, other telephone terminal to plate of valve.
- Terminal H.T. - to terminal L.T. + to one filament leg of valve.
- Terminal L.T. - to filament resistance and also to I.S. of transformer.
- Terminal O.S. of transformer to grid of valve.
- Filament resistance to second filament leg of valve.

(Continued on page 549.)



is essentially light and careless. The spirit of it is lost if one has to go abroad to find it. But in these winter evenings a little music and the humorous tale go well at home. Let words and music ring out clearly through a Fellows Loud Speaker.

The Fellows Junior Loud Speaker is remarkable for its good tone and its extraordinarily reasonable price.

Fellows Magneto Co., Ltd.
Park Royal, N.W. 10. Phone: Willesden 1560-1



PRICE:
£1 : 17 : 6
Stock Models wound to 2,000 ohms; other resistances to order.

FELLOWS
Loud Speakers

E.P.S.43



Brandes

Mother, with much of her time occupied in a domestic sphere, finds Wireless a welcome diversion. Brandes bring a wealth of information on current topics, fashion notes, music and plays, with the wonderful tone qualities always found in the "Matched Tone" feature.

PRICE 25/-

British Manufacture (B.B.C. stamped) and conform to all new licensing regulations.

BRANDES, LIMITED

Walmar House, 296, Regent Street W.1

Phone: Langham 1525. Trade Enquiries Invited.

GLASGOW 47, Waterloo Street
NEWCASTLE 5 & 6, Post Office Chambers

*Manufactured by Brandes, Limited,
at Brandes Works, Slough, Bucks.*

Matched Tone
TRADE MARK
Radio Headphones



What do you want to know? —there's a Radio Press Book to help you.

**Choose your Books
from this List:**

	Price
1. Wireless for All	6d.
By JOHN SCOTT-TAGGART, F.Inst.P.	
2. Simplified Wireless	1/-
By JOHN SCOTT-TAGGART, F.Inst.P.	
3. How to Make Your Broadcast Receiver	1/6
By JOHN SCOTT-TAGGART, F.Inst.P.	
4. How to Erect Your Wireless Aerial	1/-
By B. MITTELL, A.M.I.E.E.	
5. The Construction of Wireless Receiving Apparatus	1/6
By P. D. TYERS.	
6. The Construction of Crystal Receivers	1/6
By ALAN L. M. DOUGLAS.	
7. How to Make a "Unit" Wireless Receiver	2/6
By E. REDPATH.	
8. Pictorial Wireless Circuits	1/6
By OSWALD J. RANKIN.	
9. Wireless Valves Simply Explained	2/6
By JOHN SCOTT-TAGGART, F.Inst.P.	
10. Practical Wireless Valve Circuits	2/6
By JOHN SCOTT-TAGGART, F.Inst.P.	
12. Radio Valves and How to Use Them	2/6
By JOHN SCOTT-TAGGART, F.Inst.P.	
13. 500 Wireless Questions Answered	2/6
By G. P. KENDALL & E. REDPATH	
14. 12 Tested Wireless Sets	2/6
By F. W. HARRIS.	
15. More Practical Valve Circuits (Cloth Bound)	3/6
By JOHN SCOTT-TAGGART, F.Inst.P.	
16. Home-Built Wireless Component	2/6
Elementary Text-book on Wireless Vacuum Tubes 10/-	
By JOHN SCOTT-TAGGART, F.Inst.P.	

(post free)

WHETHER you are erecting an Aerial, building a Set, or endeavouring to find out how one works, there is a wide choice of **Radio Press** Books ready to help you.

Don't attempt to struggle along in the dark by yourself, but make use of the assistance freely offered you by the authors of these Books. Remember each is written by an expert in his own particular branch of Radio and every author is a man of note.

All Books obtainable from any Book-seller, or in case of difficulty any Book will be supplied (postage 2d. extra) by Publishers direct.

Radio Press Ltd.,
Devereux Court, STRAND, W.C. 2.

Gilbert Ad.

Adding One or Two Valves to a Crystal Set.

(Continued from page 546.)

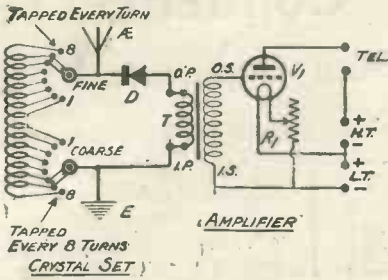

Fig. 8.—Circuit diagram of the crystal and one valve set.

Terminal O.P. to input terminal O.

Terminal I.P. to input terminal I. We may now turn to the containing box, seen in Fig. 7, for which we shall require the following pieces of wood, $\frac{3}{8}$ in. thick:

- 2—7 in. \times 5 $\frac{1}{4}$ in. \times $\frac{3}{8}$ in. for the sides.
- 2—5 in. \times 5 $\frac{1}{4}$ in. \times $\frac{3}{8}$ in. for the ends.
- 1—7 $\frac{1}{2}$ in. \times 6 $\frac{1}{2}$ in. \times $\frac{3}{8}$ in. for the base.

These should be planed off smooth, and finished with sandpaper, after which they should be carefully glued together and secured by means of small brads. The whole may then be stained and polished, and then set aside for a while to dry thoroughly, after which the panel may be secured to the box by four screws, one at each corner.

To connect the amplifier up to an existing crystal set the phone terminals of the crystal are connected to the input (O. and I.) terminals of the amplifier. High-tension battery and accumulator

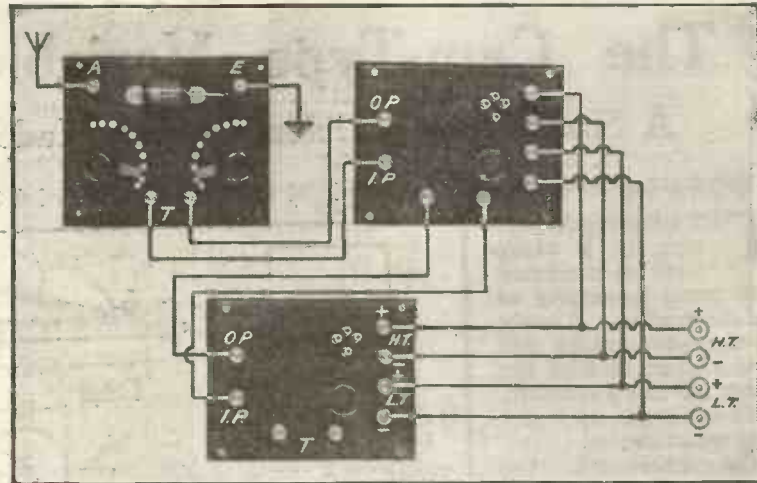

Fig. 10.—Schematic diagram when two L.F. stages are used.

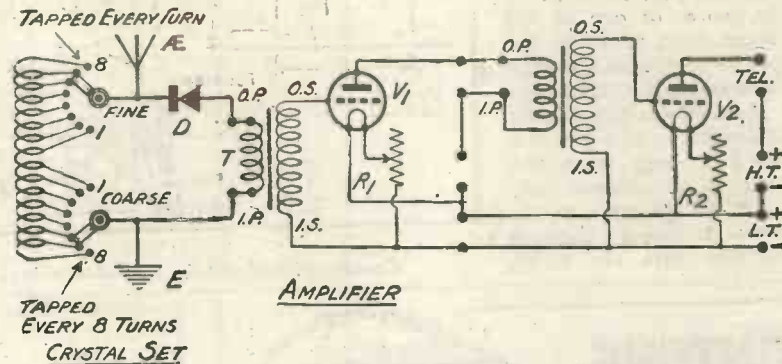

Fig. 11.—Circuit diagram of the crystal and two valve set.

are joined up to the terminals indicated in Fig. 4, while the phones are connected to the two terminals in the front of the amplifier panel. Fig. 5 shows how this amplifier unit is connected to the crystal set

in the previous article, and Fig. 8 gives the circuit diagram. Sixty volts is a good value for the H.T. battery, while a 6v. accumulator will serve to heat the filament of an ordinary valve; if a dull emitter be employed, however, a dry cell may be substituted for the accumulator. Having connected up as above, switch the filament on and tune the set in the usual way, adjusting the filament resistance until best results are obtained.

Fig. 10 shows how two of these amplifier units may be connected to the previously described crystal set. The telephone terminals of the first amplifier are connected to the input terminals of the second amplifier, the top phone terminal going to the input terminal marked O. Corresponding battery terminals on each set are then connected together, e.g., H.T. + to H.T. +, L.T. - to L.T. -, etc. The loud-speaker then goes to the telephone terminals on the last amplifier.

Fig. 11 gives the theoretical circuit diagram of this.

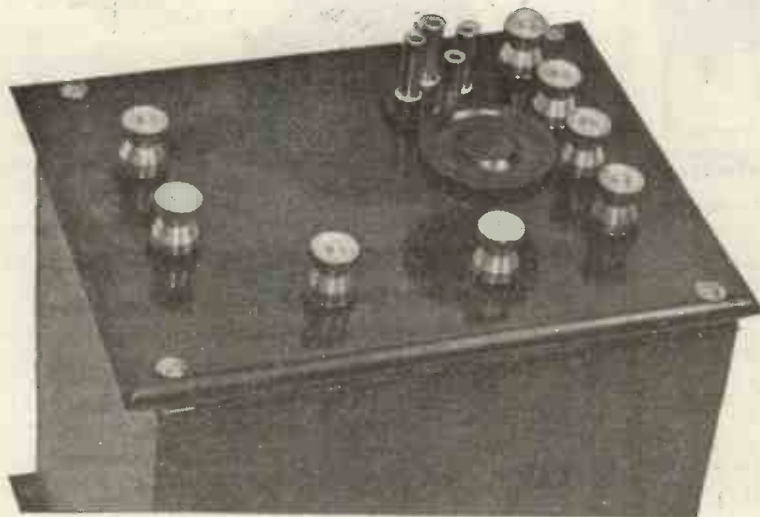

Fig. 9.—A perspective view of the note magnifier.

The Cam-Type Variable Condenser

A Simple and Efficient Device Made from Oddments.

THE following description of a cheap variable condenser may prove interesting to the constructor. A study of the photographs will give a clear idea of the design of the condenser, and when made up it is a very useful device.

The baseboard, the dimensions of which are 5 in. by 2 in. by $\frac{3}{8}$ in., has a piece of wood 2 in. by 3 in. by $\frac{3}{8}$ in. fastened in the centre of one of the longer sides to carry the spindle and scale. Fasten down on to the baseboard a piece of springy copper foil, $2\frac{1}{2}$ in. by $1\frac{1}{2}$ in., with a lug $\frac{3}{4}$ in. long from the centre of the shorter side, Fig. 1, F1. Screw a wood-screw terminal through this lug into the wood,

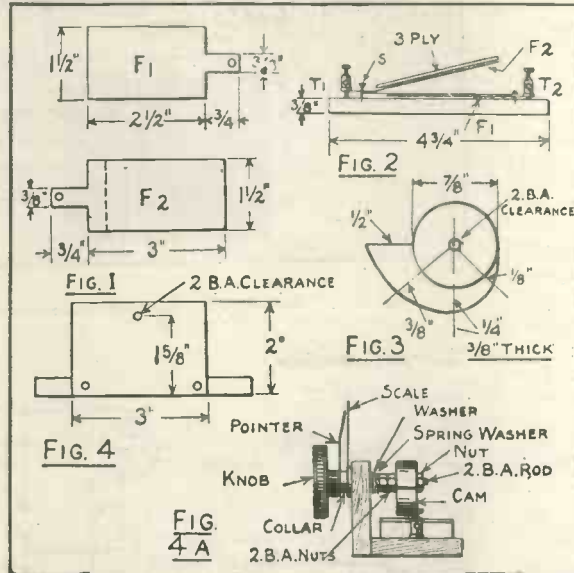

Constructional details and dimensions.

making sure of a good contact between the foil and the terminal. Now cut another piece of copper foil, F2, 3 in. by $1\frac{1}{2}$ in., with a $\frac{3}{4}$ in. lug as before, and fasten it securely to a piece of thin wood, $2\frac{1}{2}$ in. by $1\frac{1}{2}$ in., the wood being flush with the end of the foil farthest from the lug. Screw another terminal through this lug into the baseboard at the end opposite the first terminal, and hold this foil down by two small screws in the corners nearest its terminal. There should be half an inch between these screws and the end of the first piece of foil. A piece of mica, $3\frac{1}{2}$ in. by 2 in. by .002 in., is placed between the foils and fastened to the wood at the corners

BONTONE PHONES

POINTS TO CONSIDER.

Every Phone is sold under **GUARANTEE.**

Every Phone is tested before leaving Factory.

We are old-established British Manufacturers, whose object is to give complete satisfaction.

Why saddle yourself with Continental Phones distributed by unscrupulous Importers with small offices and elaborate notepaper and **NO GUARANTEE** or hope of redress if found faulty?

Originals of upwards of 100 unsolicited Testimonials and letters of appreciation can be seen at our Offices.

GUARANTEE. We agree to replace or return cash if Phones do not give complete satisfaction, subject to Phones being returned to us within 7 days of purchase, undamaged.

BONTONE PHONES (4,000 ohms.)

BRITAIN'S BEST.

SENSITIVE, DURABLE, COMFORTABLE, AND BEAUTIFULLY FINISHED.

Manufactured entirely by British Labour.

Apply to your local dealer or apply direct giving your dealer's name to:—

B. D. & Co. (Edward A. Boynton),

Works: GOSWELL ROAD and CITY ROAD, LONDON, E.C.1.
Offices: 167-173, GOSWELL ROAD, LONDON, E.C.1.

Admiralty, War Office and India Office Contractors.



14/6

per pair. Carriage paid United Kingdom.

The Best The "ECCENTRO" CRYSTAL DETECTOR

(Patented).

This Detector reduces Crystal adjustment to the foolproof operation of turning a knob. It is undoubtedly THE BEST on the market. It is a real piece of mechanism, Fool-proof, dustproof and shockproof. A real temper saver.

Complete with crystal.



SEND FOR ILLUSTRATED LIST POST 8/- FREE

If your local dealer cannot supply you send direct to us

TO THE TRADE. Our revised TRADE List will interest you. We can guarantee delivery from London Stock.

W. JOANES, Sole Agent,

42, JENNER ROAD, STOKE NEWINGTON, N.16,

Phone: DALSTON 4741. Telegrams: "CRENEVA-STOKE LONDON."

The Interference Problem in Radio

By E. F. McDONALD, Jr., President of the National Association of Broadcasters (U.S.A.).

This article, from an American contributor, indicating the position of affairs in the United States, has a distinct bearing on the problems on this side of the water.

IN analysing the radio interference situation at the present time, it should always be remembered that while broadcasting is of paramount importance to millions of people throughout the country, there are other phases of the radio industry which must be considered and upon which depends much of the commerce of the world. Transatlantic and ship-to-shore radio traffic are of vital importance. The work of the serious radio experimenter is also of the highest value in furthering the advancement of the radio art. In order that the broadcast listener may get the most out of his radio receiver, a thorough knowledge of the causes of the interference which he occasionally experiences, together with the various means available for their reduction or elimination, is essential.

Types of Interference

There are, of course, various types of interference occasioned by different causes. The two most annoying at the present time are telegraph code interferences from ship and shore stations working on low wavelengths of around 450 metres, and the re-radiation of radio receivers of improper design or improperly operated by unskilled users. It is to the interest of all participating in the radio industry to assist in correcting these conditions as well as the other causes of interference.

The National Association of Broadcasters have been in conference with the Hon. Herbert Hoover, Secretary of Commerce, on the subject of ship interference, and through his efforts and co-operation are arranging for international regulations providing for the carrying on of ship-to-shore traffic on wavelengths outside the broadcasting band. This article, therefore, treats only with the interference created by re-radiation from radio receivers.

A Common Fallacy

It is a popular fallacy that all that is necessary to put a stop to any undesirable condition is the passing of legislation. Unfortu-

nately this idea has occasionally taken root and grown into something that constitutes a real menace at the heart of our American civilisation. There is nothing more detrimental to the moral of a nation than the adoption of legislation which is obviously impossible of enforcement, and which, through the ease with which it may be ignored, teaches wholesale disrespect not only for the law but for the authorities that make it.

Ironclad Laws

We have, at the present time, a startling example of an "ironclad" law which, so far at least, it has been impossible to enforce, and which has probably worked a greater evil than that which it was designed to eliminate—the Prohibition Amendment. During the war the Navy Department undertook, through its Intelligence Service, to prohibit the use of transmitting and receiving apparatus throughout the country. The prohibition on transmitting was comparatively easy to enforce, but although every effort was made to eliminate reception, in the final analysis it came down simply and squarely to reliance on the loyalty and patriotism of the individuals which go to make up our great nation. Obviously the individuals who really desired to use radio for ulterior purposes had no such sense of loyalty, and, as a consequence, to a great extent all that was accomplished was the prohibition of the use of radio receivers in the hands of those who would not use them in any case to the disadvantage of the country, whereas it was practically impossible to stop the use of such apparatus in the hands of those intent on serving their own ends.

Reaction Sets

For these reasons the adoption of legislation prohibiting the use of receivers which feed back energy into the antenna is obviously absurd. The adoption of an Act of this kind would be comparatively easy, but the enforcement would require a greater force of officers and special agents than

we have at the present time attempting to enforce prohibition. Certainly our Government cannot afford such an expenditure, even if it were possible completely to eliminate radio feed-backs by such means. It should be remembered that in the first place the locating of the offending receivers which feed back into antennæ would be comparatively difficult, and even when they were located it would be a simple matter for the user of a set of this kind to disconnect the tickler coil, or whatever means was used to feed back the energy, while the inspector was present, and attach it the moment he left. The enforcement of any such Act would also be rendered extremely difficult because of the statutes prohibiting the entrance of private dwellings without proper search warrants.

What can be done?

Granting that the feed-back from radio receiving sets is harmful, and that preventive legislation, if not impossible, at least is impracticable, what is to be done?

Obviously the solution to the problem is constructive action on the part of the radio manufacturer. At the present time the laboratories of eight of the largest manufacturers of receiving apparatus are at work day and night on the production of a simple device to be connected ahead of receivers feeding back which will not allow the passing of this energy out to the antenna. Such a device, when developed and perfected, will be put on the market by the manufacturers according to an agreement among them at practically actual cost, so that the users of all types of sets will have the benefit of this device without undue expense. It is not fair or reasonable to expect the users of feed-back receivers to scrap and throw away apparatus representing the investment of many hundreds of thousands of dollars when, by the addition of some simple device, the harmful re-radiation can be entirely removed and reception improved.

(Continued on page 555.)

DUBILIER GRID LEAKS



Constructional Chats

BY PHILIP R. COURSEY, B.Sc.

No. 5

On the Use of Grid Leaks.

GRID LEAK resistances form an essential part of many radio receiving circuits using thermionic valves. In particular a grid leak is very commonly employed when the valve is used as detector, the leak resistance being connected either across the condenser which is inserted in the wire connecting to the grid of the valve, or connected directly between the grid and the filament of the valve.

The function of this grid leak resistance is to provide a path through which the electrons which collect upon the grid of the valve can leak away back again to the filament. Hence it follows that the value of this leak resistance is not particularly important within comparatively wide limits. If the leak has too low a resistance it will impair the proper functioning of the valve, while if it is too high the use of reaction becomes difficult. In many receivers the use of resistances of higher value than the conventional 2 megohms often leads to slightly improved results, and leaks of 3 or 4 megohms resistance may be tried with advantage.

The experimenter using very short wavelengths is also specially recommended to try values other than the normal one, in particular in these cases a lower resistance value (of about 1 megohm or slightly less) often leads to improved results and easier control of the receiver.

THE DUBILIER CONDENSER CO. (1921), Ltd.

Dept. D

Ducon Works, Goldhawk Road, London, W.12.

Telephone:

Telegrams:

Hammersmith 1084

Hivolcon, Phone, London.

(E.P.S. 50)

Ask to hear the STERLING "AUDIVOX"

The SUPREME Loud Speaker



Resistance
120 or
2,000 ohms

Buy British
Goods
only

In black
or brown
enamel

In black and
gold floral
design

£5 15 0

£6 0 0

Faithful to an Echo in Reproduction

Clear, mellow and resonant in tone and capable of greater volume than any other instrument of similar type. Even the most exacting musician listens with true pleasure to an "Audivox." Its reproduction is free from distortion.

Instal an "Audivox" with a "Sterling" receiving set and you are assured of all the pleasure that broadcasting can give—not occasionally but constantly; not in part but in full all the time.

HEAR IT AT YOUR DEALER'S

Advt. of **STERLING TELEPHONE and
ELECTRIC CO. LTD.**

210 Tottenham Court Road, London, W.1

Works - - - - - **DAGENHAM, ESSEX**



A new system simplifies the home construction of this fine Reflex Set.

WHILE to many enthusiasts who already have some knowledge of Radio the constructional articles in *MODERN WIRELESS* and *Wireless Weekly* are quite sufficient, yet to some beginners and others the elementary details of construction may have been omitted. Obviously exigencies of space in a magazine often render it necessary for an article to be kept brief.

In order to assist the novice and the man who has never built a Set before, however, we have produced a special Series of Envelopes, each dealing with one particular type of Set in a most comprehensive manner.

The first one of the series is devoted to building up the S.T.100 shown above and contains blue prints, wiring diagrams, illustrations of finished instruments taken in various positions, complete working instructions, etc., etc. Absolutely every possible assistance is given so that the novice can follow the instructions and build a first-class Set without possibility of error.

S.T.100

Although it is less than six months since the S.T.100 was introduced to the public through the pages of *MODERN WIRELESS*, yet scores of thousands of Receiving Sets incorporating it are giving complete satisfaction in all parts of the country. For a general purposes, economical Set the S.T.100 would be hard to beat. On an average Aerial all B.B.C. stations can be heard at good strength, while it has a Loud-Speaker range of 30 to 40 miles.

It is particularly economical because it only uses two Valves (a Crystal acting as Rectifier), yet immense amplification is obtained because the first valve acts as a high-frequency and low-frequency amplifier simultaneously.

To build such a Set is within the reach of anyone, the following being practically the only components required: Two variable condensers, two valve-holders, two rheostats, one fixed resistance, one coil-holder, one crystal detector, the necessary terminals, panel and cabinet.

¶ Why not rebuild your present Set into an S.T.100?

16

RADIO PRESS, LTD., DEVEREUX COURT, STRAND, W.C.2.

Radio Press Envelope N°1

The Interference Problem in Radio
(Continued from page 552.)
A New Device

The public will not be hard to persuade to use a device which will cost little and which will not only through reciprocity eventually eliminate all feed-back howls, but will also improve reception and increase the selectivity of a receiver with which it is used.

It is often said that one of the most interesting phases of radio to the novice is its possibility of original experiment. Many of the more important developments in the radio field have been made by novices. From this standpoint, then, the development of a one-way valve to prevent radiation from receivers certainly offers wonderful possibilities. With the general public interested in the development of a universal attachment of this kind, as well as with the well-equipped laboratories of the larger manufacturers of radio apparatus earnestly working on the problem, not much time will elapse before there is available a universal radiation preventer which will be adaptable to all types of receivers, and will not only end the present annoyance, but, through uniform retail price and its advantages from the selectivity standpoint, will be desirable for general public use.

□□□□□□□□□□□□□□□□□□□□
A Direct Contact
Sliding Plunger
□□□□□□□□□□□□□□□□□□□□

THERE is undoubtedly considerable room for improvement in the existing types of plungers which are at present on the market. They possess several weak points, mainly the variable form of contact which they make upon the coil. The type of plunger here described diagrammatically is well worth trying and will be found much more efficient than the old forms.

This plunger is quite simple for the handy man to make. We first require a block of ebonite for the slider. A piece of springy brass is then screwed on to the underside and shaped, as shown. The top of the slider is drilled and tapped, and the screw with the ebonite cap fixed on is inserted from the inside. Having screwed this in, drill the ebonite knob to suit the screw, and when fixed pin through. By screwing in one direction, the slider is forced upwards until it is released from the coil, and can be moved backwards or forwards quickly to the

desired point. By screwing in the other direction the slider is forced downwards until any degree of contact is obtained, it being possible to vary the pressure by the aid of the springy brass.

H. B.

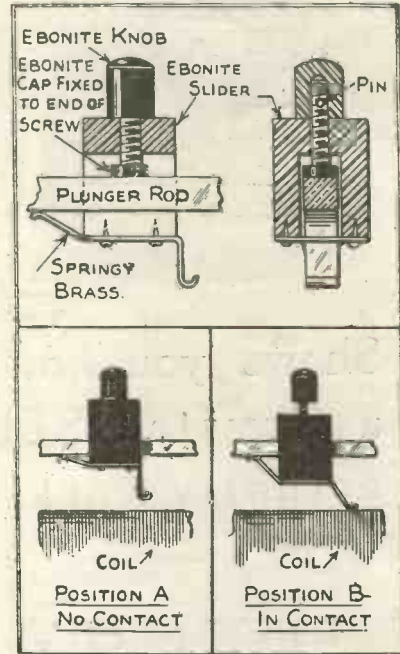

A useful type of slider making direct contact

COMPONENTS OF PROVED MERIT FOR THE HOME CONSTRUCTOR

THE MARK OF MERIT on any Wireless Set or Component is a guarantee of efficiency, reasonable price, and sound British Manufacture.

We are exhibiting in the Electrical & Allied Engineering Section of the BRITISH EMPIRE EXHIBITION 1924.

Complete catalogue over 100 profusely illustrated pages post free 1/8.



Filament Resistance for Flat Mounting. Standard M.H. high-grade finish. 4/6.

Send sixpence in stamps for full list of Components.



Knobs with EXTENSION HANDLES; Standard Condenser or Filament Resistance knob with ebonite handle and pointer. 1/6



Fixed Condenser and clips, Standard M.H. flat type, any value 0.001 μ F. to 0.00015 μ F. 1/4.

Send for list of Shop-soiled goods at reduced prices. Genuine Bargains of high-class apparatus.



GRID LEAK OR ANODE RESISTANCE and clips. Standard M.H. Tubular type, all values. Grid Leak, 1/-; Anode Resistance, 1/3.

L.M. MICHAEL LTD
IN CONJUNCTION WITH B. HESKETH LTD

SHOWROOMS: { RADIO CORNER, 179, STRAND, LONDON, W.C. 2,
5, YELVERTON ROAD, BOURNEMOUTH.
All correspondence to Head Office:
HASTINGS HOUSE, NORFOLK STREET, STRAND, LONDON, W.C. 2.



Shows you how a Crystal Set actually works

ONE of the most fascinating features of Wireless lies in its utter simplicity. In "Simplified Wireless," for instance, the whole principles are laid bare in such simple language that boys of all ages can readily understand them.

A very interesting course of elementary electricity is given, and full details are given for commencing at the very beginning, and building up a workable Receiver more or less out of material found about the home. "Simplified Wireless" is a thoroughly readable book, and one you'll enjoy reading immensely.

Read this interesting List of Contents

Some General Remarks regarding Wireless—The Telephone Receiver Transformers—Air-core and Iron-core Transformers—Step-up and Step-down Transformers—Inductances—Condensers—Frequency and Wavelength—The Aerial Circuit of a Wireless Receiver—The Use of a Variable Condenser when Tuning—The Crystal Detector—A Receiver Using a Variable Condenser—Loose-coupled Circuits—Notes on the Erection of Aerials—Frame Aerials—Loud Speakers—How to Make a Simple Broadcast Receiver—Operation of the Receiver—The Variable Inductances—Some simple forms of Crystal Detector—The Telephone Condenser—The Complete Arrangement of the Apparatus—Operation of the Circuit.

1-

From all Booksellers, or 1/2 post free
RADIO PRESS, LTD.,
DEVEREUX COURT, STRAND, W.C. 2.

Radio Press Wireless Library, No. 2.

A Useful Variable Condenser of Novel Design

THE capacity of a variable condenser can be multiplied by adding in parallel fixed condensers of suitable capacities, and a combination of a fixed and a variable condenser of equal capacities can be successfully used to get any capacity, provided its value does not exceed the total capacity of both condensers.

The above principle gives rise to this variable condenser, which consists of a moving blade condenser of about .0001 μ F. capacity, and five fixed condensers of nearly the same capacity. The variable part has four moving blades of standard size, separated by $\frac{3}{8}$ in. washers, thus giving a capacity of about .0001 μ F., the fixed condensers being simply rectangular pieces of brass foil, of suitable size, and separated by ebonite sheets, $\frac{1}{8}$ in. thick. A cylindrical brass piece of a suitable shape, mounted on an ebonite cylinder, clearly shown in the photograph, automatically makes contact with the springs soldered to the fixed condensers; a pointer attached to the cylinder moves on a circular scale, marked 1, 2, 3, 4, 5, 0, and denotes



Fixed and variable condensers are here combined.

the number of condensers in parallel with the variable part.

For capacities up to .0001 μ F., the variable condenser is only used, while for greater capacities the required number of fixed condensers can be put in parallel with it and the finer adjustment is made by turning the moving blades. The whole arrangement forms a compact variable condenser that can easily be fitted in a cabinet 2 1/2 in. deep, 3 1/2 in. wide and 4 in. long, and the fact that the real variable part has a low capacity of .0001 μ F. makes the whole apparatus capable of fine adjustments.

M. J. C.

Sawing Ebonite

NO doubt there are quite a number of amateurs who have found considerable difficulty in sawing ebonite perfectly straight. It is really a very simple matter when the proper tools and the proper methods are used. An amateur has been known to clamp a 6-in. steel rule in a

ordinary hack-saw with the blade fairly tight. Make a start for the saw with a file, and do not forget



The right way

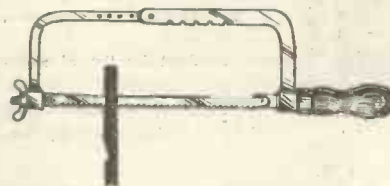

The wrong way

vice together with the ebonite and to cut along the straight edge. The result was badly cut ebonite and a spoiled steel rule.

The correct method is to use an

to allow for the thickness of the cut. When sawing, do not saw so that the saw is cutting through the thickness of the ebonite, but make it cut the length of the panel, as shown in the sketch. In this manner the saw will guide itself, and the result will be a straight and even cut. It will be necessary to trim up the edge very slightly with a file, and the edge will be found quite level, thus saving a lot of time trueing-up.

J. G. B.

BEWARE OF WORTHLESS IMITATIONS, SEE THE TRADE MARK *WatMel* ON EVERY GRID LEAK.

WATMEL VARIABLE GRID LEAK
(Patent No. 206098),

Constantly Variable;
Silent in operation.
Constant in any
temperature.
Dust and Damp
proof.
Each tested and
guaranteed.
Neat and well
made.



GRID LEAK
5 to 5 megohms 2/6.
ANODE RESISTANCE
50,000 to 100,000
ohms 3/6.
Suitable for S.T.
100 Circuit.

SEND P.C. FOR DESCRIPTIVE FOLDER.

WATMEL WIRELESS CO., Connaught House, 1a Edgware Road,
Marble Arch, W.2. Tel. 4575 Paddington.

ARE YOU BUILDING UP?

GET the best out of your Wireless by building up the "Service" way. The "Service" Radio Unit System has been evolved to enable you to improve your receiving apparatus with a minimum of additional expense and trouble.

BUY "SERVICE" UNITS AND GET BEST RESULTS AT LEAST COST.

The "Service" High Frequency Units, using the famous Lissen Super Regenerative Reactance, prove positively that the best possible results can be obtained in this way. No loss of energy. Full amplification of distant signals. These Units do give the extra efficiency so vital on long distance work. Only the very best components all through.



Our 26 page book tells all about it and gives all prices. Sent for 2d. stamp for postage.

THE SERVICE CO., Ltd.
292, HIGH HOLBORN, LONDON, W.C.1

Tel.: Holborn 666 (3 lines).
Telegrams "Admittedly," London.

'Phones REGENT 609. EAST HAM 172. WIMBLEDON 2398.

I.R.M. 3-VALVE SET

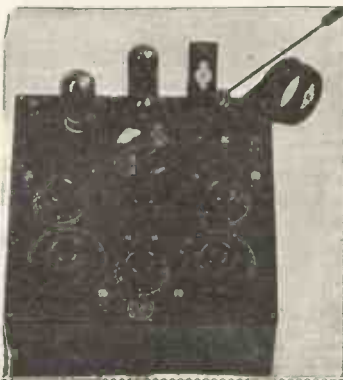

A customer using this receiver writes:

Kirkcubright, 12 Feb. 1924.
"I can receive on a Sterling Loud Speaker with fair strength from ALL the B.B.C. Stations. It pleases me to be the owner of such a fine set."

Panel 10 inches square only
PRICE completely assembled with all licences paid £9 9 0

THE I.R.M. 4-VALVE SET.
Same in size and appearance as the 3 valve set.
Of this set a customer writes—

Leven, 19-12-23
"I have a 2-valve amplifier with 2-valve amplifier the whole costing about £50 with headphones. Your 4-valve set is worth ten times the 'set'."

Price with all royalties paid £13 13 0

Crystal Sets from 12/6.

I. R. M. WAVE TRAP
This instrument will eliminate interference from a station half a mile away and can be attached to any set.
Price complete 25/-.

The "N.S." Accumulator. This wonderful accumulator may be fully charged in one hour. It will not sulphate under any circumstances whatever. Write for particulars.

PRICES: { 4 volt, 30 A.H. actual, £1 2s. Carriage forward.
6 volt, 30 A.H. actual, £1 10s. Carriage forward.

WE SUPPLY EVERYTHING WIRELESS. SEND US YOUR INQUIRIES. SEND FOR ILLUSTRATED LISTS.

INTERNATIONAL RADIO MANUFACTURERS, Ltd.,
16, Palace House,
128, Shaftesbury Avenue, W.1
and at 39 Station Rd. Manor Park, E. 12



A. MUNDAY, LTD.

ELECTRICAL ENGINEERS,

59, WATLING STREET,
London, E.C.4.

'Phone: 2972 CITY. (One door, Queen Victoria St.)
AND

45, EASTCHEAP, London, E.C.3.

STERLING, BROWN'S, SIEMENS HEADPHONE

4,000 and 8,000 ohms headphones in stock.

ALL LOUD SPEAKERS

AMPLIFIERS, etc.

R.I., IGRANIC, BURNDIPT, LISSEN and POLAR PARTS IN STOCK

.001 CONDENSERS BEST QUALITY WITH DIAL and KNOB - 8/-

EVERYTHING ELSE FOR WIRELESS AND ELECTRICAL WORK.

"ELKAY" WIRELESS CO.

159-225-227, BISHOPSGATE, LONDON, E.C.2.

BRITAIN'S LARGEST WIRELESS STORES

Everything from a Nut to a 10-Valve Set.

Send Stamp for Latest List. Telegrams {ELKAYWIRY, AVE, LONDON. Telephone {CENTRAL 8544, RETAIL. BISHOPSGATE 2313, Wholesale.



—no one taking a real interest in Radio can afford to be without *Wireless Weekly*.

THE man who probes beneath the surface wanting to know how his Set works—the man who feels that the more he learns about Radio the greater the enjoyment he'll get from Broadcasting—the man of moderate means who wants to build the best possible Set that his slender purse will permit—these are the regular readers of WIRELESS WEEKLY.

SPECIAL ARTICLES :

A special feature of great interest is a regular talk every week on the Valve by John Scott-Taggart, F.Inst.P., the Editor and an authority on the Valve. These articles are essentially practical, and because they are invariably illustrated with diagrams are of great value to the beginner.

CURRENT NEWS :

Because WIRELESS WEEKLY is produced under most efficient publishing conditions, it is usually in the position to present to its readers the first details of all new inventions and discoveries in the Radio field. An independent news service gives the Broadcast listener a weekly causerie of the doings of the eight B.B.C. stations.

CONSTRUCTIONAL ARTICLES :

Probably the feature which has done more than anything else to create the great circle of WIRELESS WEEKLY readers is its exceptional constructional articles. These range from the simplest crystal set to the most complex super-heterodyne Receiver. Among the last few issues will be found full details how to build the following tested instruments :

- A Practical Neutrodyne Receiver.
- An Experimenter's Unit Receiver.
- A Short-Wave Receiver.
- A Separate Heterodyne.
- A Loosely Coupled Crystal Set.
- The Cowper Short-Wave Receiver.
- A Telephony Transmitter.
- A Power Amplifier.

Surely the Magazine capable of dealing authoritatively with such a wide range of subjects is particularly cheap at sixpence !

6^d.

every Wednesday.

Radio Press, Ltd, Devereux Court, Strand, W.C.2.

Wireless Weekly

Just Published.

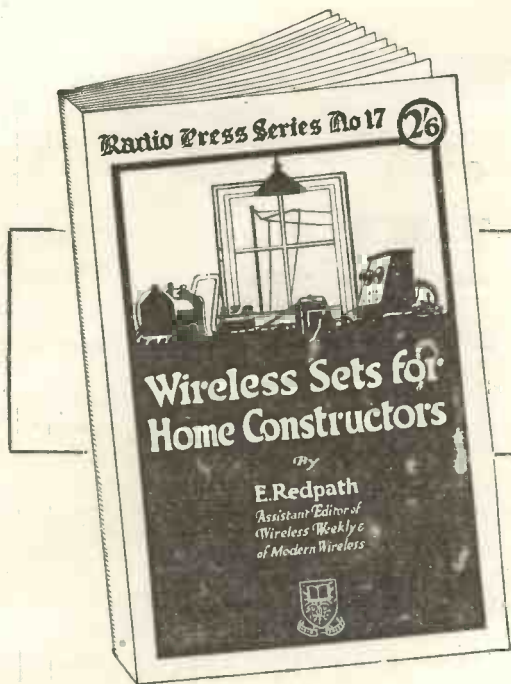

A New Radio Press Constructional Book.

NOW ON SALE.

RADIO PRESS
SERIES, NO. 17.

Wireless Sets for Home Constructors

By **E. REDPATH,**

*Assistant Editor of
"Modern Wireless" & "Wireless Weekly."*

CONTENTS:

- Simple Crystal Receivers.
- An Inductively - Coupled
Crystal Receiving Set.
- Testing and Operating Cryst-
tal Receiving Sets.
- A Two-valve Low-frequency
Amplifier.
- Adding Amplifiers to Crystal
Sets.
- A Two-valve Broadcast
Receiver.
- A Three-valve Regenerative
Receiver.
- A Single-valve Reflex
Receiver.
- A Three-valve Broadcast
Receiver.
- A Four-valve Universal
Receiver.

2/6

Post Free, 2/8

RADIO PRESS, LTD.,
DEVEREUX COURT,
STRAND, W.C. 2

THE latest addition to the Radio Press Series of Constructional Books. Contains designs for a number of Receiving Sets of proved efficiency. The author has had considerable experience in designing Sets suitable for the average enthusiast to make up, and this Book is the direct outcome of experiments carried out during the past few months.

Every instrument is well within the ability of the man who can handle the ordinary household tools, and full particulars are given for making even the components required. The scope of this Book includes Crystal and Valve Receivers with a range from 25 miles up to 3,000 miles on telephony.

Follow the Instructions and Success is Certain

In replying to advertisers, use COUPON on last page

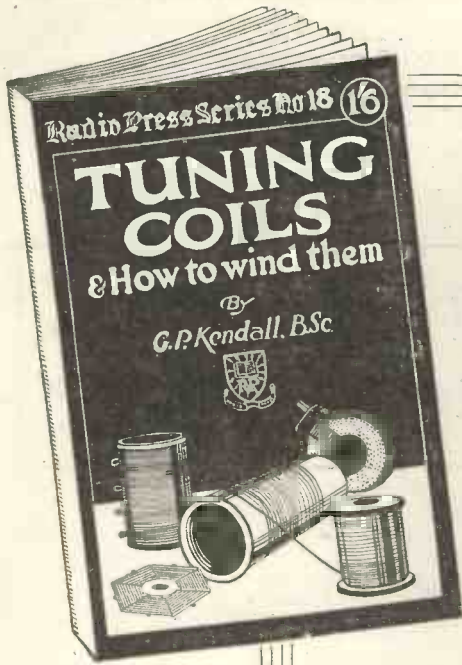

Tuning Coils

and how to wind them.

By G. P. Kendall, B.Sc.

Just
Published.

THERE is probably no single Component in any Receiving Set able to exert so much influence as an Inductance Coil. A highly efficient Coil (or Coils) will often make all the difference between mediocre results and really good loud reception.

Even if you feel that your present Set is giving tolerably good results, the chances are that it will be worth your while—presuming that you are using plug-in coils—for short-wave lengths to use a set of home-made basket coils. Such coils as these have particularly low self-capacity.

This new Book by G. P. Kendall, B.Sc. (staff editor) contains concise details for making every type of Coil used in Wireless to-day. Further, the advantages and disadvantages of each type

are discussed in such a manner that the reader is able to make an immediate decision as to the actual coils suitable for his requirements.

All necessary data, such as diameter of tubes, gauge of wire, number of turns, etc., are given—the results of the author's own experiments.

No experimenter can afford to be without such a comprehensive guide as this.

Published by
Radio Press, Ltd.,
Devereux Court, Strand, W.C.2.

1/6

Sold by all Booksellers,
or sent Post Free direct, 1/8.

RADIO PRESS
SERIES, No. 18.

In replying to advertisers, use COUPON on last page

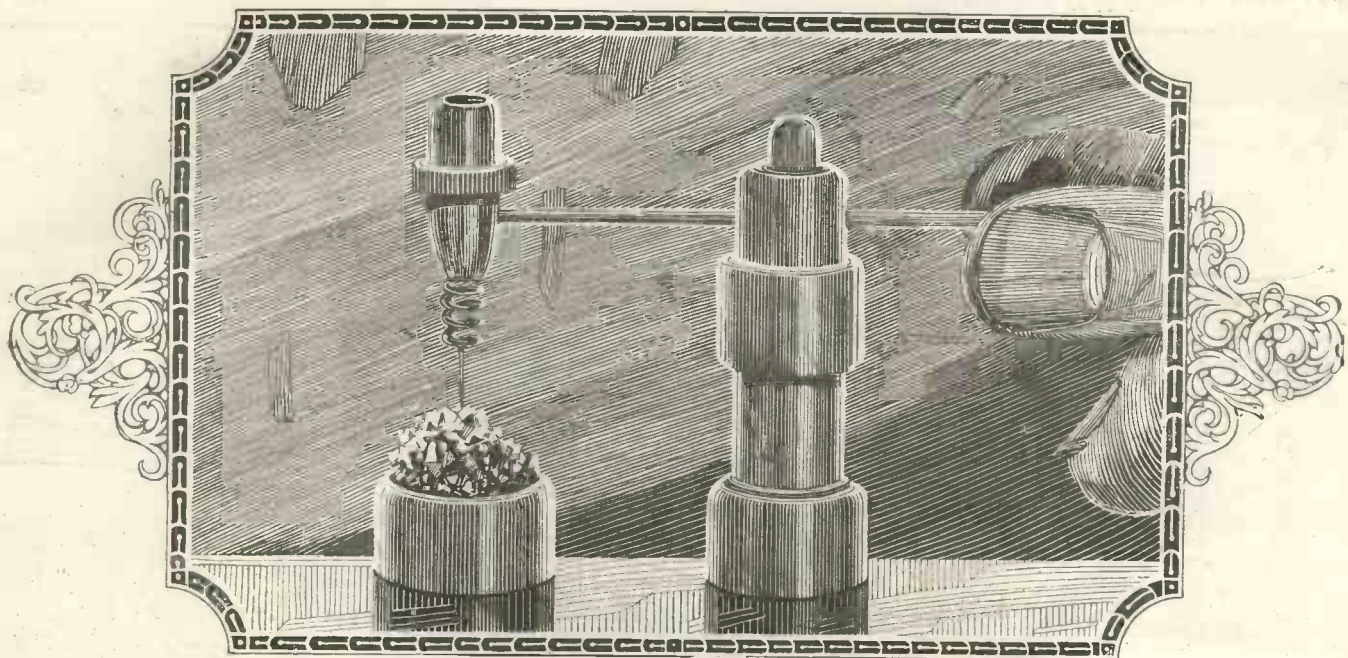

The construction of Crystal Receivers

By Alan L.M. Douglas.

ONCE again the Crystal Receiver is having the attention of experimenters. The last twelve months have proved to a very large number of Crystal enthusiasts that correct design makes a tremendous difference in results. Given favourable conditions a really good Crystal Set in the hands of a man who understands it, reception over a range of 100 miles is not at all uncommon. Assuredly even more remarkable progress is certain during the next few months. If you have a Crystal Set already you will find that *The Construction of*

Crystal Receivers will show you many ways in which you can improve it at small cost. On the other hand, if you are going to build one, you will find a choice of several different designs to select from. The experimenter will appreciate the section devoted to a description of the famous Mark III Tuner, and its capabilities. Even the man with a Valve Set would find it very useful—provided he lives within reasonable distance from a B.B.C. station—to have a good Crystal Set for emergency use against his batteries running down.

Published by
Radio Press, Ltd.,
Devereux Court, Strand, W.C. 2.

1/6

Sold by all
Booksellers or
sent 1/8, post free.

There's an exceptional field for experiment in the Crystal Receiver.

In replying to advertisers, use COUPON on last page

Gilbert Ad. 553.
561

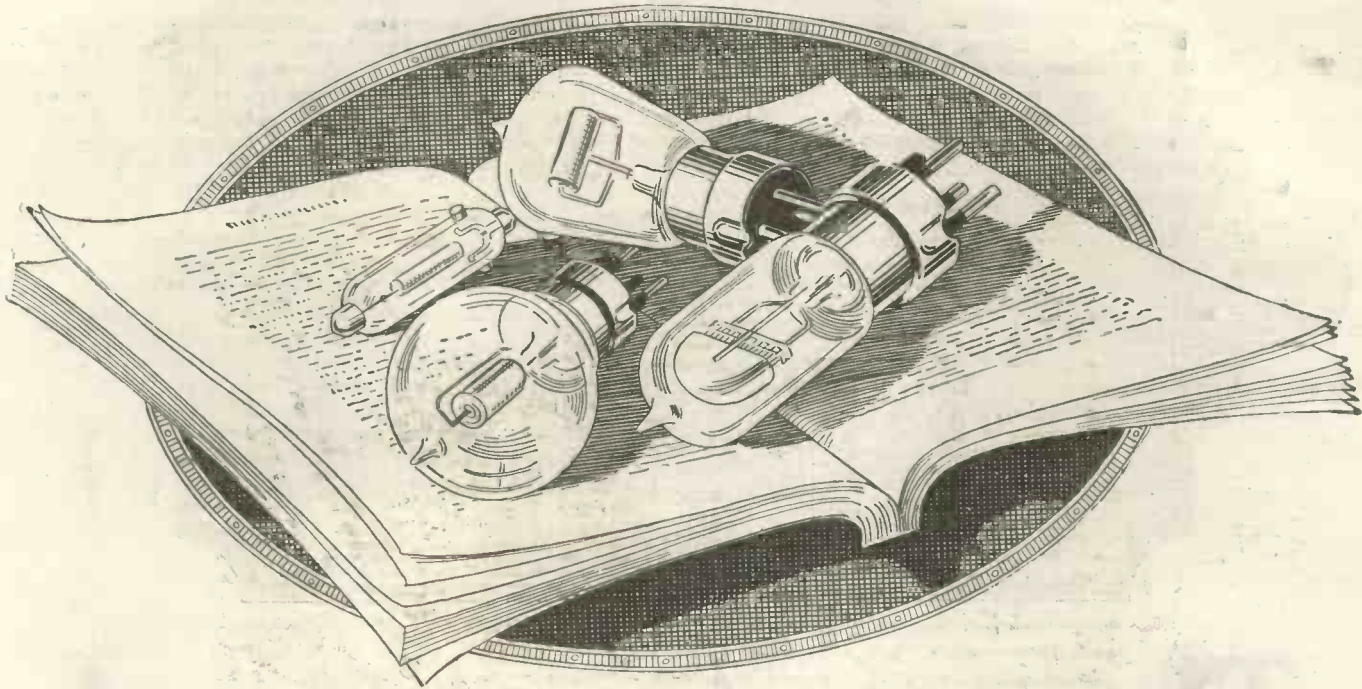

Radio Valves and how to use them

By John Scott-Taggart F.Inst.P.

TO a very large number of Wireless enthusiasts the Valve is still enveloped in mystery.

This lack of knowledge may be due in part to the fact that many books on the Valve are apt to presume that the reader has a good groundwork in electricity and wireless in the first place.

It is to remedy this that Mr. Scott-Taggart has prepared his new Book "Radio Valves and How to Use Them." As Editor of "Modern Wireless," he has come into close contact with a very large number of wireless

enthusiasts who are particularly good on the construction of Sets, but who are not too well versed on the theoretical side.

Every question that you could ask about the Valve is answered in this Book—and answered in a most helpful and convincing manner with many diagrams.

To understand the working of your Valves is to be in a position to get the best possible results from them, and ultimately greater pleasure from Broadcasting. Surely half-a-crown is little enough to pay for such invaluable assistance?

Radio Press Series Number 12.

Sold by all Booksellers
or sent, post free, 2/8.

2/6

Published by Radio Press
Ltd., Devereux Court,
Strand, W.C.2.

If it's a Radio Press Book—you can depend upon it



The new Book of S.T. Circuits

By JOHN SCOTT-TAGGART, F.Inst.P.

EVERYONE needs this handsome volume of new S.T. Circuits. The fame of S.T. 100, the dual amplification Circuit using but two Valves yet giving the signal strength of at least four, has spread throughout the country. Many thousands of Wireless enthusiasts are using this Circuit with every success.

Other S.T. Circuits equally as useful and likely to become quite as well known are given for the first time in "More Practical Valve Circuits," by the Editor of MODERN WIRELESS.

"More Practical Valve Circuits" contains the fullest data for over 80 different types of Circuits, including all recent discoveries, such as the Armstrong and the Flewelling. Not merely are Circuit diagrams given with the greatest exactitude, but sufficient details as to condenser and resistance values, etc., as will enable the experimenter to build up any Receiving Set without further help.

3/6

Bound in full cloth.

No matter how much or how little experience you may have had in Wireless, the moment you decide to build your own Set you should buy a copy of this book and make quite sure that you are starting with a good practicable and efficient Circuit. Its cost will be saved many times over in time and materials.

RADIO PRESS, Ltd., Devereux Court, STRAND, W.C. 2.

Gilbert Ad. 570.

In replying to advertisers, use COUPON on last page



—the most popular little Radio Book ever written!

New Revised Edition now on sale.

Contents

The Morse Code.
 How to tell what station is working.
 How wireless signals are actually sent.
 Nature of waves.
 Light and wireless waves compared.
 How wireless waves are set up and detected.
 How wireless stations work at the same time without interfering with each other.
 Does weather affect wireless?
 How does a wireless station know when another wireless station is wanting to send a message to it?
 The different kinds of wireless messages which may be picked up.
 Waves from a wireless telephone station.
 General notes on different kinds of waves received.
 Some elementary instruction in electricity.
 How a wireless receiver detects wireless waves.
 The Aerial or Antenna.
 The Earth connection.
 How a wireless set is tuned to a certain wavelength.
 The Variable Condenser.
 The Detector.
 The Crystal Detector.
 The complete wireless receiving circuit.
 Special tuning arrangements:
 How a valve works.
 How to start a wireless station.

9d.

from all book-sellers, or direct 11d. post free.

Have you a friend who is anxious to take up Wireless—if so, here is a Book you can recommend

AS a wireless enthusiast yourself, no doubt a number of your friends seek information from you when they take up wireless.

Why not recommend them to buy "*Wireless for All*," an excellent book written by John Scott-Taggart, F.Inst.P. (Editor of MODERN WIRELESS), so that they will be able to obtain a thorough insight into wireless quickly?

"*Wireless for All*" is written for the absolute beginner—for the man, in fact, who does not know the difference between an aerial or an earth, a valve or a crystal. It is therefore strictly non-technical in its scope. The immense popularity enjoyed by this book may be gauged by the fact that more than 100,000 copies have been sold to date, and booksellers report that it is still in very great demand.

Radio Press Limited,
 Devereux Court, Strand, W.C.2.

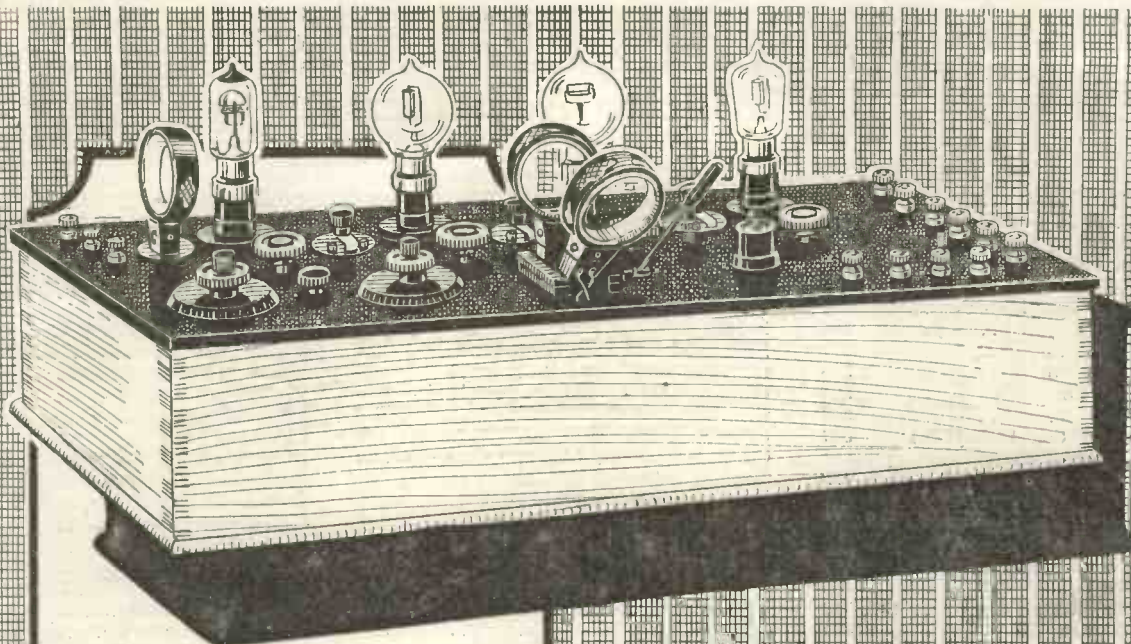

THE splendid 4-Valve Set, designed by Percy W. Harris and shown above, can be made by anyone familiar with the ordinary household tools and able to follow simple and concise instructions.

It contains one H.F. Valve and one Detector followed by two Note Magnifiers. By an ingenious and simple method of switching any combination of Valves from one to four can be used at will. Reaction is used on the tuned anode coil while a potentiometer makes the Set very stable and really easy to tune.

Its capabilities will, of course, vary under local conditions, but it will undoubtedly pick up all B.B.C. stations and most of the Continental ones; while, if conditions are favourable, several of the American stations can be heard at good strength.

Full instructions showing how to build this "family" Receiver, together with blue prints, wiring diagrams and instructions for working it will be found in *Radio Press Envelope No. 2* (No. 1 deals with the ST100 Set) obtainable at any Bookseller at 2s. 6d., or from Radio Press Ltd., the Publishers of the Magazine, for 2s. 8d. post free.



Build your own 4 Valve Receiver

Radio Press Envelope No.2

2/6

Index to Advertisers

	PAGE		PAGE		PAGE
Agar, W. H.	486	Edison Swan Electric Co., Ltd.	505	McMichael (L.), Ltd.	555
Arrigoni, C. & J.	486	Electric Appliances Co.	543	Metropolitan-Vickers Elec. Co., Ltd.	538
Athol Engineering Co.	486	Elkay Wireless Co.	557	M.L. Magneto Syndicate	491
Autoveyors, Ltd.	533	Ever-Ready Co. (Gt. Brit.), Ltd.	500	Mullard Radio Valve Co., Ltd.	533
B. D. & Co.	550	Fallon Condenser Co.	510	Munday (A.) & Co.	557
Barnard (J. W.) & Haynes	531	Fellows Magneto Co., Ltd.	547	New London Electron Works.	544
Bennett College	537	Forno Co.	491	Radio Communication Co., Ltd.	525
Bland, S. E.	531	Fuller's United Elec. Works, Ltd.	514	Radio Instruments, Ltd.	Cover iv
Bower Electric Co.	528	Gamage, A. W.	509	Radio Stocks, Ltd.	499
Bowyer-Lowe Co.	506	Gambrell Bros., Ltd.	544	Radions, Ltd.	537
Brandes, Ltd.	547	General Electric Co., Ltd.	473	Raymond (K.)	526-7
British Battery Co., Ltd. (The)	537	General Radio Co.	492	Roberts (A.) & Co.	531
British Thomson-Houston Co., Ltd.	496	General Wireless, Ltd.	506	Robinson, Lionel. & Co.	500
Brown (S. G.), Ltd.	474	Gent & Co.	544	Service Co., Ltd.	557
Burne-Jones, Ltd.	499	Gran-Goldman Service	491	Silvertown Co.	495
Chloride Elec. Storage Co.	518	Griffin, E.	486	Simpson & Blythe	486
Clarke (H.) & Co. (Manchester), Ltd.	534	Hobday Bros.	486	Smith & Ellis	486
Cossor Valve Co.	480	H.T.C. Elec. Co.	506	Sterling Telephone Co., Ltd.	553
Curtis (Peter), Ltd.	491, 530	Igranic Co., Ltd.	517	Ward & Goldstone, Ltd.	551
Diamond Wireless Co.	491	International Radio Mfrs., Ltd.	557	Watnal Wireless Co.	557
Drummond Bros.	513	Jackson Bros.	500	Wilkinson Motor Co.	489
Dubilier Condenser Co. (1921), Ltd.	553	Joanes, W.	550	Woodhall-Wireless Mfg. Co.	485
Economic Electric, Ltd.	513	Laker Co.	531		
		Lisser Co.	479		

"EBONITE."—Cut any size. Post and Packing 1d. 1 in. x 1/2 in. x 1/4 sq. in. Panels Drilled, ask for quotation. Wornald & Son, Mangnall St., Braford Rd., Manchester. *Phons: Central 2368. Trade Invited.

J. DYSON,
5 & 7, Godwin Street, Bradford. Complete Sets. All Accessories. Tele. 6037 & 6038. Telegrams: "Equipment."

POST PAID WIRELESS MATERIALS.
Brown's Type A New Ex-Govt. 2J ohm. Headphones, 25s. 6) volt H.T. Battery 8s. Complete Price List Free.—J. H. TAYLOR & Co., Macaulay Street, Huddersfield.

Ultra-Adjustable Headphones, 4,000 ohms, highly sensitive, easily adjusted diaphragms, satisfaction guaranteed. 25/- post free.
BAKER BROTHERS, Corporation Rd., Middlesbrough.

A. Franks, Ltd., 95-97, Deansgate, 44, Market Street, 73, Oxford Street, 12, Victoria Street, Manchester, and 90, Bradshawgate, Bolton.

WIRELESS INVENTORS.
Advice Handbook on Patents and Trade Marks. Consultations free.—B.T. King, Regd. Patent Agent, 148a, Queen Victoria St., E.C.4. *Phone: Central 682.36yrs.ref.s.

French Manufacturer headphones and loud speakers for wireless requires London representative having clients amongst wholesalers.—Falco, 7, Rue de Moscou, Paris 80.

EDINBURGH.
Spensers (Scotland), Ltd., 119, George St., Edinburgh. Agents for Burndept. Ltd.

WILKINSON'S WIRELESS SERVICE. All Wireless Supplies, Complete Sets Installed, Phones and Valves Reaired, and Accumulators Recharged.—152, Church Street (Opposite the Miller Arcade), Preston.

COUPON

Questions and Answers

In future this coupon must be accompanied with 2s. 6d. P.O.

"MODERN WIRELESS" March, 1924

USE THIS COUPON

in writing to advertisers in "Modern Wireless."

CUT HERE

In connection with your announcement in MODERN WIRELESS, please supply me with:

Enclosed please find remittance of.....
(Leave blank if not an order)

If an open envelope is used in applying for catalogues a half-penny stamp will cover postage.

Name.....

Address.....

.....

Date.....

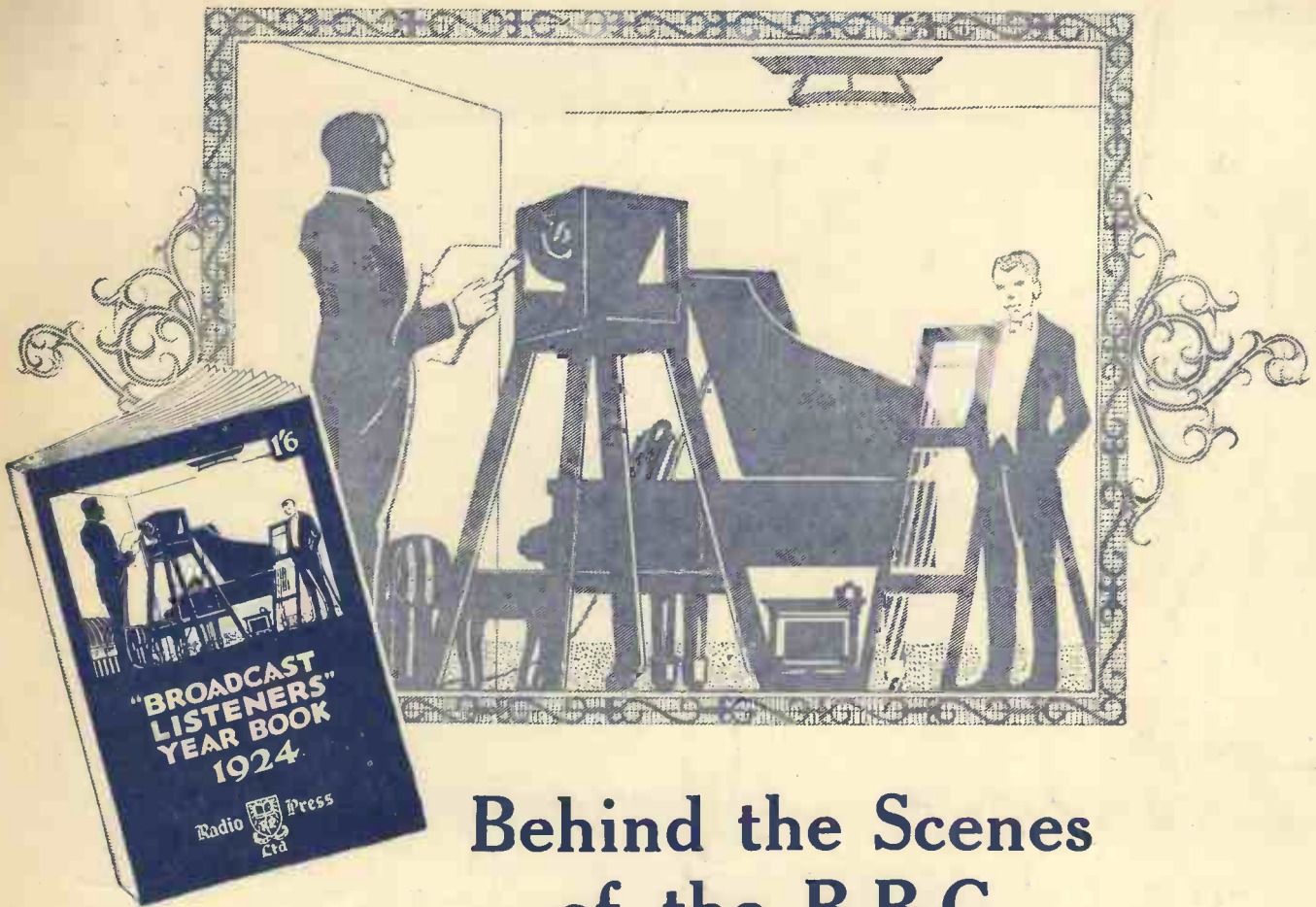

Behind the Scenes of the B.B.C.

Contents.

Notes on the eight B.B.C. Stations.
Continental Broadcasting—what to listen for.
How to look after your Set.—By *Perce W. Harris.*
Buying a Broadcast Receiver.—By *G. P. Kendall, B.Sc.*
The Wireless Musical Cinema—a peep into the Future.—By *R. W. Hallows, M.A.*
In and out of the Studio.—By *John Henry.*
The Children's Corner.—By *Uncle Caractacus.*
The Importance of the Musical Programme.—By *Dan Godfrey, Jun., A.R.A.M.*
The Work of an Announcer.—By *Rex Palmer.*
How It is Done.—By *P. P. Eckersley, Chief Engineer to B.B.C.*
A Visit to 2LO.—By *E. Alexander.*
What has been done—a review of the first year's Broadcast.—By *A. R. Burrows.*
The Future of Wireless.—By *John Scott-Taggart, F.Inst.P., A.M.I.E.E.*
The British Broadcasting Co., Ltd., and its aims and objects.—By *J. C. W. Reith.*
How to listen to and appreciate Musical Broadcast.—By *Douglas Hopkins, A.R.C.O.*
A special feature consists of new portraits of the authors of the articles and of all the principal B.C. personnel.

MANY times, as you sat and listened to Broadcasting, you must have wondered what goes on in front of the microphone. How concerts are broadcast, what the Studio looks like, how the transmitting gear is actually operated, and so on—the whole business of Broadcasting has intrigued your curiosity.

To give you a better insight into this absorbing subject, therefore, we have prepared a special "Broadcast Listeners" Year Book. This Book is quite different from the usual Radio Annuals because it is strictly non-technical.

The full list of contents is shown here, but it can only give you but a slight idea of its scope. If you really appreciate Broadcasting, then you'll say that this is the most interesting book on the subject you have ever read.

As only a comparatively small edition has been printed you are advised to make early application to your Bookseller or send 1/8 direct to us.

1/6

"BROADCAST LISTENERS" YEAR BOOK

The World's Transformer

R.I.



Our new 50-page
Catalogue
free on request.

25/-

ONE PRICE.
ONE QUALITY.

IT is recognised that an L. F. Transformer gives higher amplification than any other form of L. F. Intervalve coupling; it is therefore essential that the best transformer only should be used. This is less important where a single stage is employed but absolutely vital if more than one stage is used. Perfect results with an R. I. Transformer are certain. Wireless dealers realise this and therefore recommend the R. I. Transformer, when they want their customers to be satisfied.

R. I. TRANSFORMER ADVANTAGES:—

- | | |
|--|--|
| <i>Its unique system of winding.</i> | <i>Its freedom from distortion.</i> |
| <i>Its extremely large copper and iron area.</i> | <i>Its capability of taking high voltages.</i> |
| <i>Its enormous amplification.</i> | <i>Its robustness and</i> |
| | <i>Its absence of internal noises.</i> |

Get an R.I. for your set to-day and you will find that it will increase the efficiency of your circuit.

RADIO INSTRUMENTS LTD.

Managing Director: J. JOSEPH, M.I.E.E.

Chief Designer: W. A. APPLETON, M.B.E., M.I.R.E., late Admiralty Technical Research Officer

Works, Offices and Showrooms:

12, HYDE STREET, NEW OXFORD STREET, W.C.1.

Telephone: Regent 6214-6215-6216.

Telegrams: "Instradio, London."

