

Radio  
**CONTACT**

ENTERTAINMENT & TIPS FOR THE FAMILY  
TECHNICALITIES FOR THE ENTHUSIAST & CONSTRUCTOR

Volume 1

No. 1

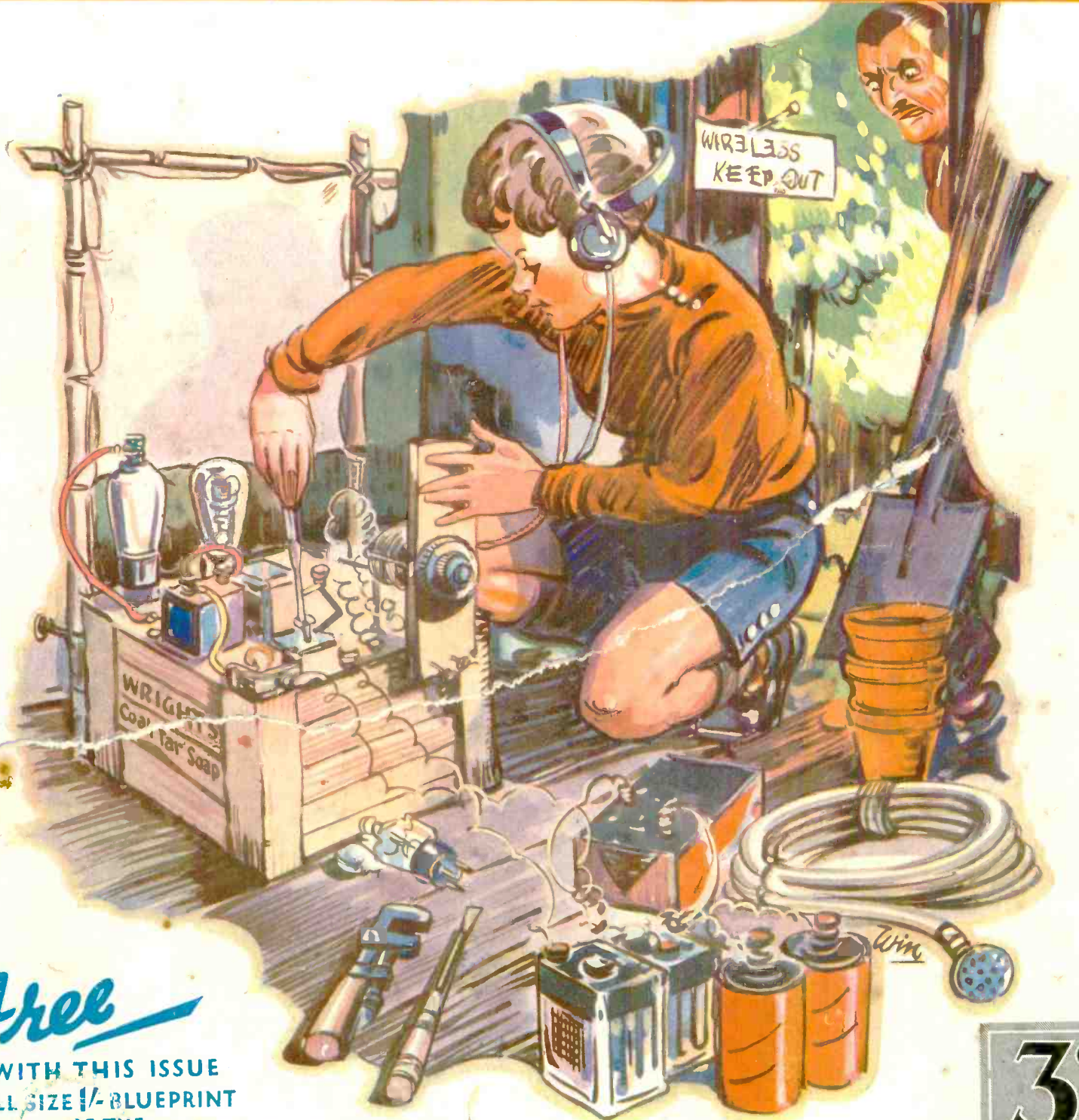

*Free*  
WITH THIS ISSUE  
FULL SIZE 1/- BLUEPRINT  
OF THE  
"SKY RAIDER"

3<sup>d</sup>



# A NEW VIVIDNESS *WITH* EXTRA POWER



"Stentorian" type PMS2. Standard size diaphragm. New "Whiteley" speech coil and "Nital" magnet. Price 32/6

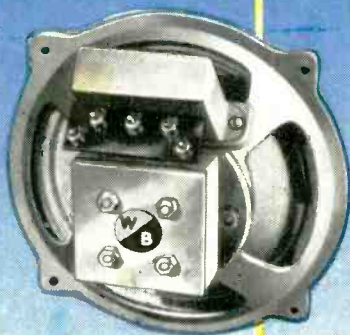

"Stentorian" Baby type PMS6. Price 22/6



"Stentorian" type PMS1. Never before has such a speaker been available at a popular price. Oversize diaphragm. Enormously powerful "Nital" magnet, and "Whiteley" speech coil. Price 42/-

- NEW MAGNET BRINGS DOUBLE SENSITIVITY!
- NEW SPEECH COIL BRINGS AMAZING REALISM!
- INNUMERABLE ADDED REFINEMENTS COMPLETE A BRILLIANT DESIGN.

The exclusive control of a new magnetic material giving enormously increased power at the same cost—and a consequent complete revision of design to include an unique speech coil not before usable in a "domestic" speaker—those briefly are the reasons for the extraordinary performance of W.B. "Stentorian" speakers.

New detail improvements are of course incorporated. The air-gap is completely protected from dust at front, back, **and sides**. Multiple ratios provide accurate matching for **any** output, or to **any** receiver for extension purposes; and you will find other small but useful refinements.

But it is the patented "Nital" magnet which brings the enormous volume, and the exclusive "Whiteley" speech coil which gives the brilliance, crisp "attack", and uncanny realism.

**You must hear the amazing difference this new speaker will make to your set. Ask your dealer today.**

Write for the new W.B. Stentorian folder



The "STENTORIAN" Baby Loudspeaker type PMS6 is exclusively specified in all "CONTACT" Receivers.

# STENTORIAN

Whiteley Electrical Radio Co., Ltd. (Dept. 4), Radio Works, Mansfield, Notts.  
Sole Agents in Scotland: Radiovision, Ltd., 233, St Vincent Street, Glasgow C.2. Sole Agents in I.F.S.: Kelly and Shiel, Ltd., 47, Fleet Street, Dublin

# As Specified

## By Graham Farish

# SKY RAIDER

## STENTORIAN • MYSTIC Q

### EXQUISITE WALNUT CABINET

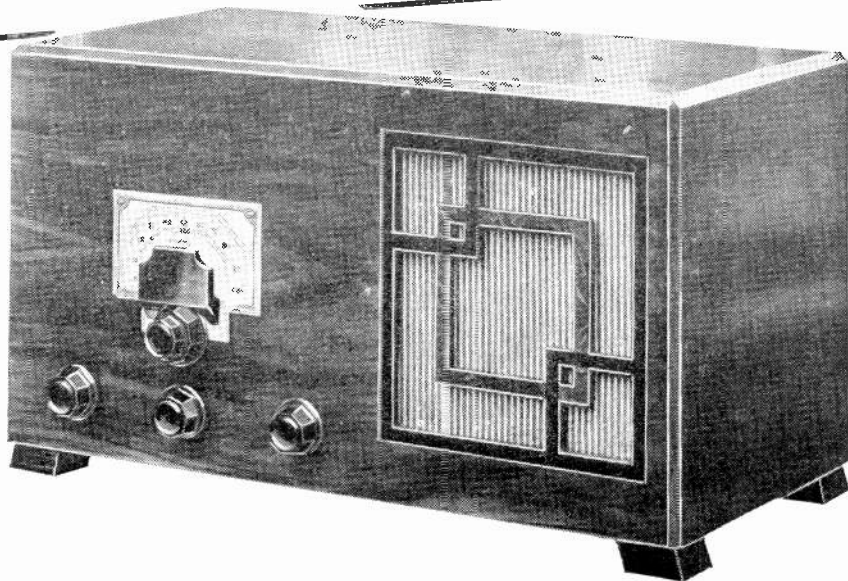

Ⓢ OBTAINABLE FROM ALL  
GOOD RADIO DEALERS

Dimensions : 19½" wide × 9½" × 9½"

# 15/-

A B.R.G. Cabinet was chosen by Messrs. Graham Farish for the splendour of its design and master craftsmanship... lovely wood with ebony black contrasting fret and surround, and beautiful finish—only a B.R.G. Cabinet does full justice to the wonderful Sky Raider, Stentorian and Mystic Q Receivers. Supplied with front ready-drilled for escutcheon and control knobs of any of these sets.

BRITISH  
**RADIOGRAM**

*If any difficulty, send direct to Sole Wholesale Distributors:*

BRITISH RADIOGRAMOPHONE CO., LTD., Pilot House, Church Street, Stoke Newington, London, N.16

Telephone: CLISSOLD 6287 - 6288

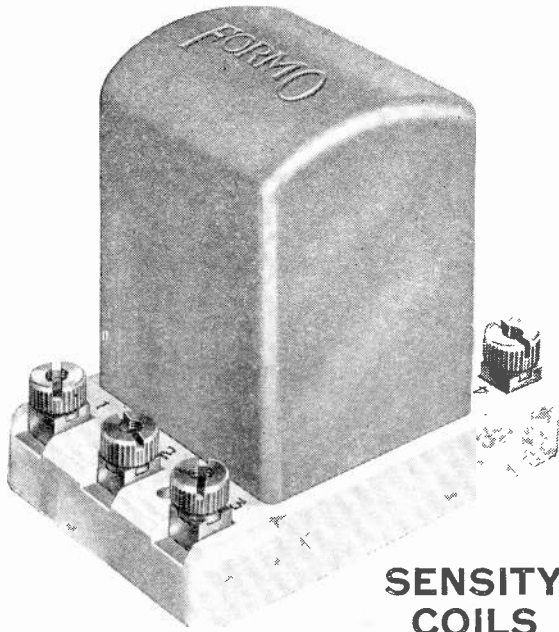

**SENSITY COILS**

A distinct advance in design has been evidenced in this new iron-cored coil which is wound with Litzendraht air-spaced wire and mounted on a Steatite base with a former of Trolitul, a compound specially designed for the reduction of high-frequency losses.

Quite apart from its very economical price and its particularly attractive design, this coil is one which has an extraordinarily high efficiency.

There is not at present on the market any coil of any kind which combines all the features which have been incorporated in the Sensity coil, yet the price has been fixed to place this very high-grade component within the reach of all.

The finish is in dreadnought grey, with nickel terminals and, of course, a white Steatite base.

- Aerial Coil Type T1 (without reaction) . . . . . 5/-
- Aerial Coil Type A1 (with reaction) . . . . . 5/-
- H.F. Coil Type P.P.1 . . . . . 5/-

# Even better in quality — YET TODAY'S FORMO SENSATIONALLY

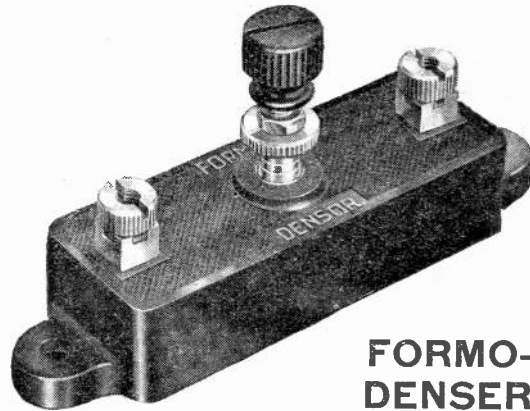

**FORMO-DENSER**

A component which still retains its popularity among home constructors and set designers. Is eminently suitable for use as a Neutralising condenser, Aerial condenser, Grid condenser, Reaction condenser, Tone Control condenser.

Available in the following capacities :

Ref.	Max.	to	Min.	Price
F	-.0001	..	-.000005	1/6
J	-.0003	..	-.000025	1/6
G	-.001	..	-.0002	1/6
H	-.002	..	-.001	2/3

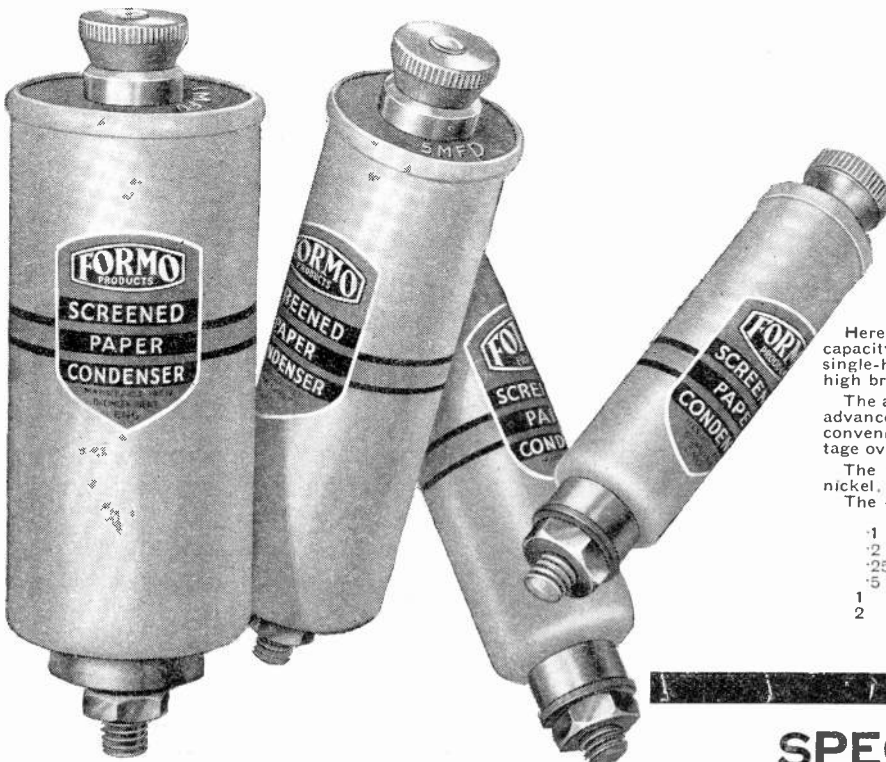

**SCREENED PAPER CONDENSERS**

Here we offer a novelty in condenser design. Large-capacity condensers in a compact form arranged for single-hole fixing, fully screened, and of exceptionally high break-down voltage.

The appearance of the Formo Condenser is a distinct advance on anything hitherto attempted, whilst its convenience in use will be found an inestimable advantage over the type which has been in use heretofore.

The finish is in dreadnought grey, with all fittings nickel.

The capacity is engraved direct on the cap.

.1 mfd.	..	..	..	..	1/6
.2	"	"	"	"	1/6
.25	"	"	"	"	1/6
.5	"	"	"	"	1/9
1	"	"	"	"	2/-
2	"	"	"	"	3/-

**SPECIFIED FOR ALL**



*even more advanced in design*

**PRICES DROP TO  
LOW LEVELS!**

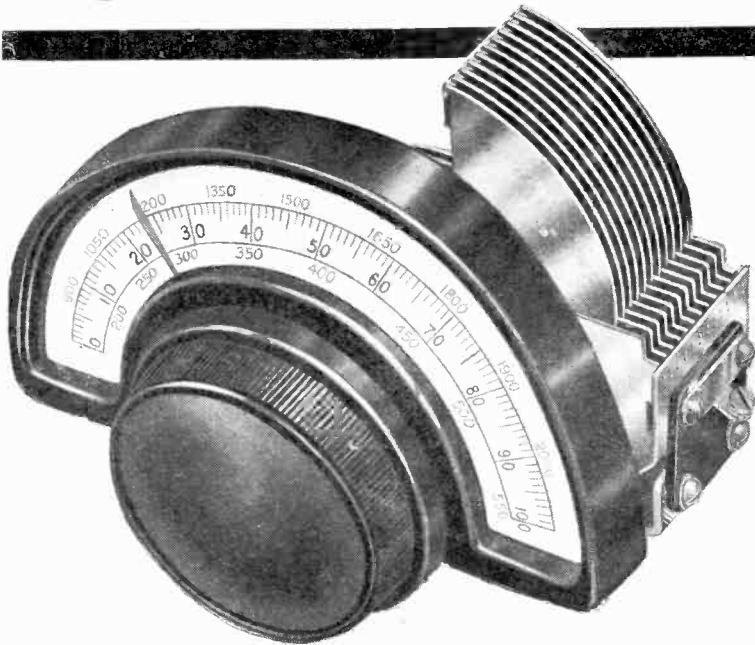

HERE'S TIMELY NEWS for every radio constructor and owner! Formo products—always the leading name in quality components—have been, *not merely reduced*, but entirely re-based on a new, sensationally low level!

Since radio was in its infancy you bought Formo Components, regardless of the slight extra cost, for their reliability, advanced design and greater efficiency. Good reasons. To-day, *while these same virtues are even more pronounced*, you may buy Formo components for their additional economy!

Ask for Formo Components when constructing or modernising your existing receiver. Buy better—buy cheaper. A new folder describing the latest Formo Components has just been issued—write for a copy to:—



Masons Hill, Bromley, Kent

**SINGLE-UNIT  
TUNING CONDENSER.**

**Type S.U.5**

A really substantial and first-class slow-motion condenser with "Mystic" Drive which does not require a specially shaped hole cut in the panel. Simplicity of mounting is its keynote. The condenser has an all-steel frame of most rigid design, whilst the slow-motion device is of hardened and ground steel friction surfaces.

The losses on this condenser are extraordinarily low, and in consequence a sharpness of tuning is obtainable which noticeably improves the results from any set. Finished in dreadnought grey with black bakelite knob and escutcheon. Floodlit scale in dual colour engraving. .0005-mfd. capacity **6 6**

**TWO-GANG CONDENSER.**

**Type D.U.5**

Constructed on most sound and robust lines with a minimum of insulating material and has losses of particularly low order.

For convenience in matching, a trimmer is provided on the second gang, adjustable by a screw, whilst the dual knob enables the main condenser drive to be operated with a final adjustment on the remaining half of the gang for vernier trimming adjustments.

The escutcheon combines metal and bakelite in a most artistic manner and no special panel cut-out is required. The front bakelite cover is instantly removable to enable replacements of the illuminating bulb to be effected.

The usual Formo dreadnought grey finish has been applied to the heavy steel frame and dust cover, while the floodlit tuning scale is engraved in two colours.

2-gang Condenser complete with Chrome and Bakelite floodlit drive **11/-**  
Cover to match **1/6**

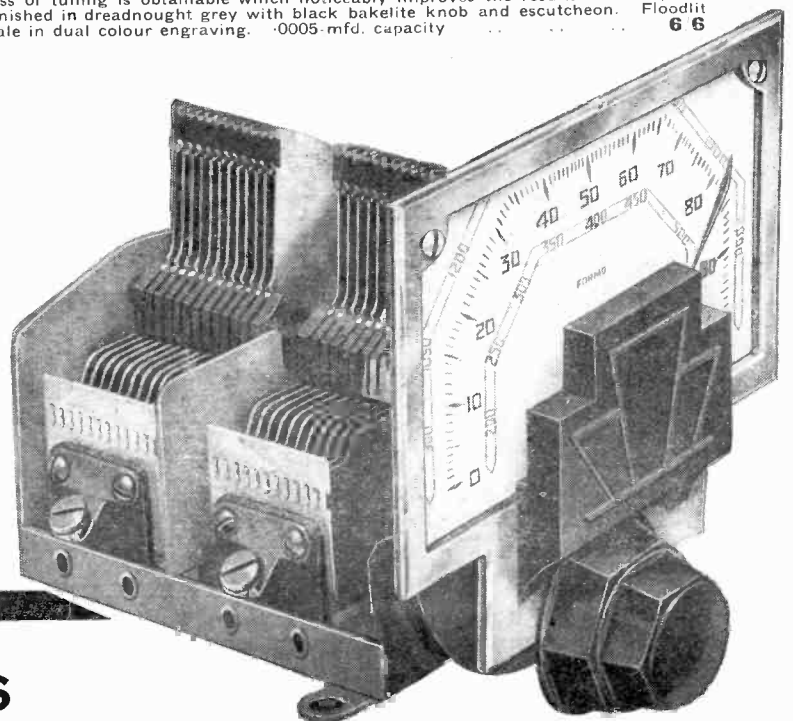

**CONTACT RECEIVERS**

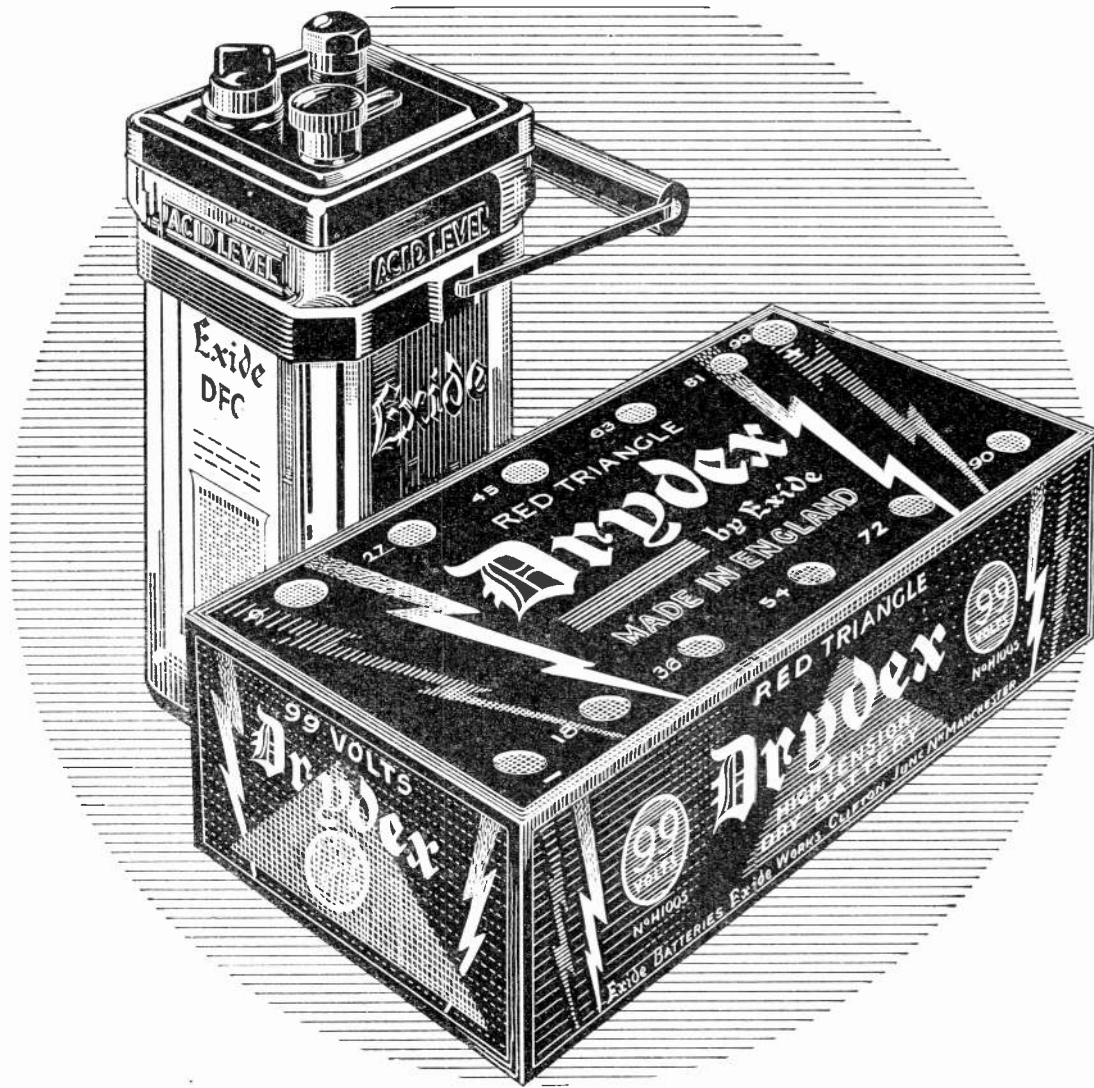

A complete range of batteries to meet  
every requirement of modern radio  
*or, in three words*

# Exide and Drydex

EXIDE BATTERIES, EXIDE WORKS, CLIFTON JUNCTION NR. MANCHESTER  
Branches: London, Manchester, Birmingham, Bristol, Glasgow, Dublin and Belfast

R24



ENTERTAINMENT & TIPS FOR THE FAMILY  
 TECHNICALITIES FOR THE ENTHUSIAST & CONSTRUCTOR

VOLUME 1

No. 1

## CONTENTS

	PAGES
RADIO GOSSIP .. .. . By the Editor	6-7
FIVE-MINUTE EXPERIMENTS .. .. . The technical staff shows you how to get still better results.	8-9
YOUR AERIAL AND EARTH .. .. .	12
"CONTACT" ABROAD .. .. . A cruise round some of your favourite overseas stations.	13-16
THE "SKY RAIDER" .. .. . The most sensational set of the 1935 season.	17-24
THE "SKY RAIDER" Test Report .. ..	25
"CONTACT" WORLD-WIDE STATION FINDER	26
HOW YOUR COMPONENTS ARE MADE .. .. A glimpse into a modern radio component factory.	27
THE "STENTORIAN" .. .. . A straight three-valver with immense possibilities.	32-33
ECONOMY VALVES FOR BATTERY SETS .. .. The latest battery valve practice carefully explained.	34-35
THE "MYSTIC Q" .. .. . Full details of an astonishing two-valver.	36-37
1935 LOUDSPEAKER DESIGN .. .. .	38



# Radio

IN making our bow to the radio public on this, the first appearance of "Contact," we feel that while a few editorial words may be desirable by way of introduction, neither excuse nor apology is necessary to the public or to our journalistic rivals. There are other wireless journals, each one excellent and invaluable in its own particular way, and each with its own circle of followers. We have not the slightest intention of challenging any one of them; but we do feel that there is room for us.

"Contact" is an independent magazine sponsored by manufacturers who have the real interests of the home constructor at heart, and it will always be our policy to cater for the home constructor first and foremost.

For instance, in this first issue, apart from many matters of general interest, three specially designed sets of outstanding appeal are presented. Two of them, the "Contact Mystic Q" and the "Contact Stentorian," are modernised versions of old and tried favourites, possessing all the advantages which originally made them popular, with the addition of a performance suitable to deal with the added difficulties that broadcasting progress has brought in its train; while the third, the "Sky Raider," is what one might term a "hot number," and is literally streets ahead of anything yet designed for the home constructor in the price classification to which it belongs.

Fullest details of all three sets are given in the pages allotted to them, and it remains for us merely to recommend the various circuits to your attention.

## A HOME CONSTRUCTION "BOOM."

Home radio construction, like almost everything else concerning modern life, is subject to waves of fashion. Radio itself started with home construction, and for some years it was next to impossible to obtain the necessary components, except, in some cases, at exorbitant cost. Eventually the factory-built receiver at reasonable price was possible, and it became the fashion to use ready-made apparatus, especially as in improving the quality of components the manufacturers forgot to improve the cost.

The result was that in many cases it cost the home constructor more to make his own set than to buy a ready-made receiver of similar performance. That was an absurd position, of course; and at the present moment it will already have been noted that component and valve prices generally show a marked downward tendency.

There is every logical reason, therefore, to

anticipate a boom in home construction, quite apart from the fact that there is ample concrete evidence that such a boom is actually on its way. How many of the old-time constructors who had forsaken it will return to their hobby it is impossible to say, but all the time fresh material is coming to swell the ranks, and the designer has now, as ever, to remember that a large proportion of those who will desire to build his sets start from scratch in the matter of skill, knowledge and experience. And that is why we are sure of the reception of the three sets sponsored in this first issue of "Contact."

Two of them can easily be built without previous experience; while the third, the super sports model of the trio, so to speak, is a matter for automatic graduation as experience is gained.



The origin of Copenhagen's interval signal.

## THE GLAD HAND.

Still speaking of ourselves—for the last time in this issue—"Contact" has already received many messages of goodwill from all over the world from kindly disposed people who believe with us that we have a distinct mission. If one-half of those good wishes materialise, then "Contact" will be the 1935 Season's most outstanding success.

## DROITWICH PERCENTAGES.

Mr. Noel Ashbridge, the B.B.C. Chief Engineer, estimates that as soon as the new Droitwich high-power station, which will

shortly displace the enormously popular 5 X X, is completed, 98 per cent of the population of England and Wales will receive a good service of one programme, and 85 per cent of two programmes.

At first glance one wonders what there is to get excited about, since a very large proportion of the population is already receiving two—or more—programmes. Their main difficulty seems to be that they receive them all together, and would be more than content to receive only one at a time.

## A 600-YEAR-OLD INTERVAL SIGNAL.

It is not claimed that the four bars of music illustrated were written specially for radio purposes, although that is their present use. According to an interesting letter from the Danish State Broadcasting Company, the original music was taken from an old Danish law book, known as the "Codex Runicus," dating from somewhere about the year 1300. It is part of a contemporary Danish ballad, and is now broadcast as the Copenhagen interval signal.

We are in a position to deny the rumour that Henry Hall is negotiating for the copyright!

## RADIOLYMPIA, 1934.

There is the less need to deal with the Olympia Radio Show from either technical or entertainment standpoint in that the first appearance of "Contact" has been deliberately timed to coincide with the date of opening of the exhibition.

As a matter of fact, it is just as true this year as in any previous season to describe the show as the "finest ever," for if revolutionary developments in design are lacking to give Olympia sensational appeal, there has never been a more representative display of British radio products of all kinds, nor more solid evidence of the detail improvement, making for reliability and standardisation of performance, in which the British manufacturer excels.

It is perhaps as well that designers should be given breathing space occasionally, for progress has been rapid and, in some respects, almost startling in the immediate past, and it is an unfortunate fact that at previous shows certain items of development have been exhibited which were not properly out of the experimental stage—with natural and inevitable disappointment to the public.



# Gossip

by *The Editor*

## CAR RADIO HAS COME.

Varied though the opinions held in regard to the safety or otherwise, and entertainment—or otherwise!—of car radio, there can be no two opinions as to the fact that it has arrived. The number of different makes and types increases almost weekly, and one is glad to note British enterprise in this respect.

Although the power problem may seem a little complicated, a motor-car radio set is not at all difficult for the amateur to construct. Neat suppressor kits, for the purpose of eliminating interference from the electrical gear of the engine, are now being marketed at moderate prices.

It is to be anticipated that when Olympia changes over from radio (and other things) to automobiles in the autumn, car manufacturers will be found to have given much more serious attention to the equipment of their products with integral wireless: and it is not too much to expect that in some cases the radio will be fitted as standard equipment, instead of as an "extra."

## TELEVISION DEVELOPMENT.

Television on practical and commercial lines seems to be a long time on the way in comparison with car radio, for the obvious reason that the former is an intricate separate science, whereas the latter is a mere aspect of ordinary wireless.

Now that television apparatus—crude and elementary, but relatively practical at least as an experimental toy—is obtainable by the public at low cost in kit form, there is more hope of rapid development.

Public interest "made" radio in the early days, and there is no reason why, if it can be stimulated, it should not equally "make" television. It supplies the necessary incentive to the manufacturer to expend not-immediately-productive capital on experiment; and, with the knowledge that a large public is awaiting his perfected product, it is likely that development will be hastened more or less regardless of cost. There is undoubtedly a great deal of business ready for the first manufacturer to put a practical and reasonably priced television set on the market; but there are wheels within wheels, not fully appreciated by the public, in regard to television development, which is not held up alone by technical difficulties.

In the meantime, it is possible that the same incentive that moves the manufacturer might serve to make the B.B.C. do something really useful in providing transmissions of the desired quantity and quality. Until such service is assured, television apparatus can scarcely hope to touch sales figures that mean anything.

## KÖNIGSBERG'S BROAD HINT.

One must give credit to the Königsberg studio designers for the delicacy of the hint conveyed in the maxims embodied in the

structure of the Main Studio balcony. "*Alles lönt selbst das Schweigen*," the audience is told. "Everything can be heard except Silence." It certainly would be a crime to drop even the proverbial pin in face of a gentle but all-embracing intimation like that!

## PEEPS INTO THE FUTURE.

By a slight indulgence in pure imagination, and by ignoring all the preliminary difficulties, one can visualise the television set of the future. It will, of course, be a "televisoradiogram," a kind of home cine apparatus, capable of both gramophone and radio sound production, and additionally of projecting on to a screen pictures obtained by both radio transmission and from existing films.

in some respects the most natural development, so far as de-luxe equipment goes, from present types of apparatus, and one would not be inclined to put it into the very far distant future.

## THE SATURDAY "MUSIC-HALL."

It is announced that the regular Saturday evening music-hall "shows" will be resumed by the B.B.C. at a later season. There has been a great deal of heated argument by the highbrows and lowbrows as to suitable ingredients for the *olla podrida* which constitutes any night's broadcast programme, and it is admittedly the hardest thing in the world to please everyone in such a colossal entertainment scheme as national broadcasting.



Königsberg's Main Studio

Presumably the sound film will have been so developed by this time that the gramophone part of the apparatus will be brought into line and the disc record finally scrapped; while the ability to produce both "movies" and "talkies," properly synchronised, in the home will in itself be a great advance on anything yet possible.

We can have movies and talkies separately now, with two distinct sets of apparatus, but that is a very different thing from the televisoradiogram of the future. All this is not such a violent stretch of the imagination. In fact, such an instrument as that suggested above is

Curiously enough, however, one seldom hears criticism of the music-hall shows, no matter how venerable the listener. The music-hall is apparently accepted as the one admissible sop to the lowbrow listeners; and the reason for the entire absence of protest from the other camp is that, having tacitly agreed to leave us—the great majority—our music-hall, they just settle down to enjoy it themselves!

Anyway, we are to have our music-hall back again, and we are going to enjoy it ourselves—even though an extension speaker to the bath room (it being Saturday night) is necessary.

# Five Minute



Fig. 1—How often do you have to jump up from a comfortable armchair to vary the volume of reception? The accompanying illustration shows a very simple method of obtaining remote control. The wiring is simple, and the only components required are a Graham Farish  $\frac{1}{4}$  megohm Volume Control at 3/-. This control is only applicable when no D.C. current flows through the Speaker windings.

Fig. 1

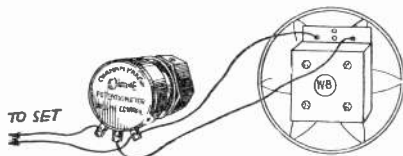

Fig. 2—The remote Tone control can be dealt with in a very simple manner. In this case, a Graham Farish 25,000 ohms Volume Control at 2/9 should be used with a Graham Farish .01 mfd. Fixed Mica Condenser.

Fig. 2

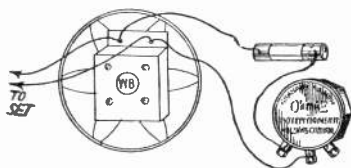

Fig. 3—So many listeners miss the enjoyment of radio through having to confine themselves whilst listening to the room in which the set is situated. An extension speaker, or speakers, can be very easily fitted by using one wire only. This is very clearly shown in the diagram, and the only component required is a Graham Farish 2-mfd. Mansbridge-type Condenser at 3/-, which can be actually fixed to the back of the set or at a convenient position on the wall, or skirting, in close proximity to the set. Make sure the condenser is connected to the plate side of valve. This method cures instability due to long speaker leads.

Fig. 3

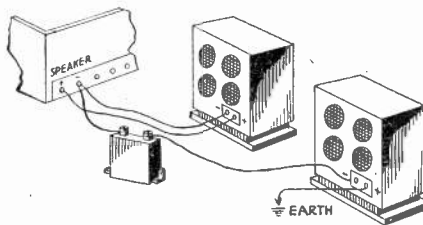

Fig. 4—Here is a very simple unit which requires four very moderately priced components, and which any constructor can build into a combined tone and volume control unit, either for attachment to the set or for remote control to an armchair. Ask your dealer for a Graham Farish .01 Fixed Mica Condenser at 1/6 and a .1-mfd. G.F. Tubular type Condenser at 1/6, and two G.F. Volume Controls, one 25,000 ohms and one 250,000 ohms, at 2/9 each.

Fig. 4

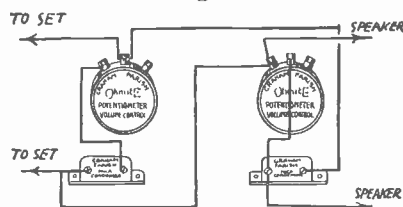

Fig. 5—As a general rule, a pentode will not handle a very large input, and is merely designed to give a large output. It is often desirable, therefore, to incorporate a volume control to restrict the input. The component required here is a Graham Farish  $\frac{1}{4}$ -meg. Potentiometer at 2/6, which should be wired in the manner shown. This system cannot be used with Q.P.P. such as is used with the SKY RAIDER and MYSTIC "Q" Contact Sets, but is applicable to the STENTORIAN.

Fig. 5

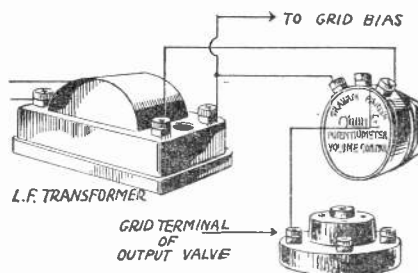

Fig. 6—Differential Volume Control. It sounds intriguing, but this little experiment merely calls for the use of a differential reaction condenser in the aerial circuit to control volume by increasing or decreasing the input to the aerial. Apart from its duties as a volume control it will function very efficiently as a "station separator" if overlap of transmissions is encountered. Your local dealer can supply you with a Graham Farish Litlos Differential Condenser of .0003 capacity for 2/-, and this is in every way suitable.

Fig. 6

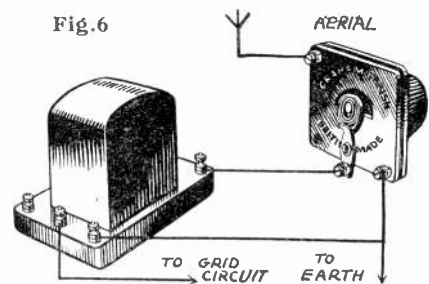

Fig. 7—Whistle Filter. A simple and easily made Heterodyne whistle filter can be made with an H.F. Choke, and two fixed Condensers. A fairly high inductance choke is required, such as the Graham Farish H.M.S. at 2/6 with two .005-mfd. fixed mica condensers at 1/6 each, or two G.F. Tubular type condensers .005 mfd. at 1/- each.

Fig. 7

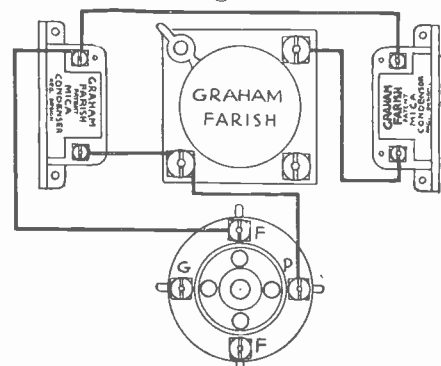
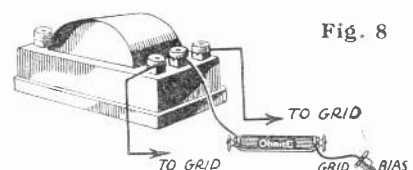

Fig. 8—Parasitic oscillation sometimes occurs in Q.P.P. systems, and can be traced by distorted output, or a "plop" when one of the anode terminals of the output valve is touched. This can nearly always be cured by inserting a  $\frac{1}{4}$  megohm resistance in the grid bias lead to the Q.P.P. transformer. The resistance required is one Graham Farish Ohmite  $\frac{1}{4}$  megohm at 1/6.

Fig. 8



# Experiments

Fig. 9—Some Q.P.P. valves are liable to over-accentuate the high notes, and where a speaker is used that has rather a high tone, then some kind of filter is required. All that is necessary is a Graham Farish 0005-mfd. Tubular Condenser at 1/- across the anodes of the valve.

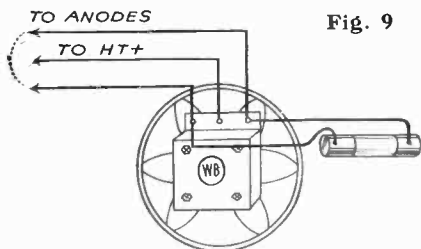

Fig. 9

Fig. 10—Man-made Static. If your reception suffers from interference caused by adjacent electrical machinery, a cure can often be effected by inserting a fixed condenser, Graham Farish Tubular type of 0002-mfd. capacity in series in your earth lead. If this does not reduce or entirely eliminate the interference, it denotes an inefficient earth. Substitute immediately with a Filt ever-damp percolative earth.

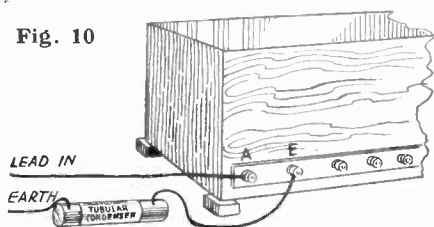

Fig. 10

Fig. 11—H.F. leakage into the L.F. circuit of the receiver often produces distortion. Try inserting a small H.F. choke in the grid lead of the amplifying valve. Component required: Graham Farish Disc H.F. Choke 2/-.

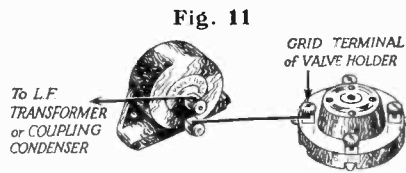

Fig. 11

Fig. 12—Rough reaction control is sometimes due to resonant peaks in the H.F. Choke used in the detector anode circuit. A resistance connected across the choke will often effect a considerable improvement. Resistance required would be one Graham Farish 30,000 Ohmite, at 1/6.

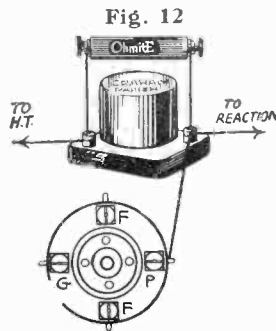

Fig. 12



Fig. 13—When the reaction condenser is obviously too large a capacity for the set, and only half its control is used, a reduction of its value can be made by connecting another condenser of similar size in series with it, thus spreading the control over its entire range. Condenser required one 0003-mfd. Graham Farish Fixed Mica type at 1/-.

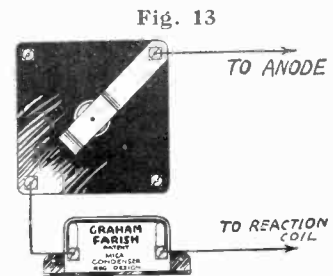
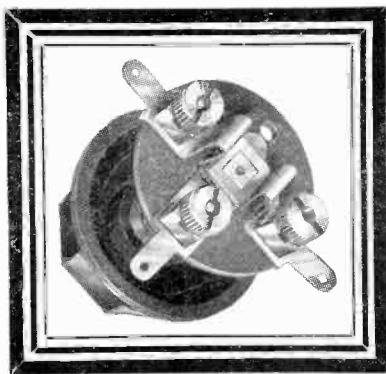

Fig. 13

## SPECIFIED in all "CONTACT" Circuits

Snap Switches—an entirely new range of Radio Switches for the home constructor



PRICES:

2-point Snap Switch 10d.  
3-point Snap Switch 1/-

Supplied complete with black bakelite knob

Snap Switches employ a new type of self-wiping contact, which gives a firm and positive snap action with electrically dead silent contact. They will not deteriorate over years of service.

The tests applied to the new Snap Switch before production included one of 50,000 rotations in order to prove that all Snap Switches can be relied upon to give at least 10 years' satisfactory use.

# SNAP SWITCHES

10  
TEN YEARS TEST  
10

SNAP SWITCHES LIMITED · MASONS HILL · BROMLEY · KENT



**A NEW**  
**Graham Farish**  
**VOLUME**  
**CONTROL**  
 for **only 2/9!**

**1935**  
**RADIO**



**GRAHAM FARISH**

**OHMITE VOLUME CONTROL**

Yet another striking example of Graham Farish value. An entirely new element of extra high current carrying capacity has been incorporated. The spring wiper operating through a cylindrical sleeve, ensures a firm but positive point contact. Finished in black bakelite with dreadnought grey metal cover, complete with control knob. All standard values.

**PRICE**  
**2/9**

**7-PIN VALVEHOLDER**

These Valveholders have exceptionally low-loss moulded bases, the insulating material between the sockets being reduced to a minimum. Contacts are of phosphor bronze, sturdy in design, with special terminals. Price

**1/3**

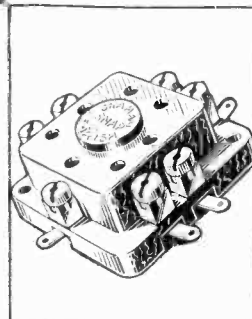

**4, 5 and 9-PIN VALVEHOLDERS**

Substantial phosphor bronze contacts provide a sure connection, freedom from noise and fluctuation in the filament current.

4-pin .....  
 5-pin .....8d.  
 9-pin .....2/- **6d.**

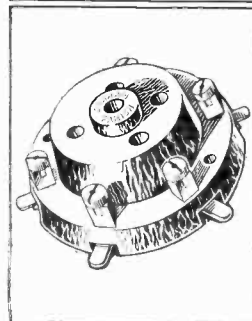

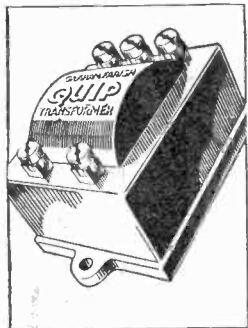

### QUIP TRANSFORMER

Suitable for the new Q.P.P. double Pentode valves or any push-pull circuit requiring a high step-up ratio, parallel fed. It has a high primary inductance of 60,70 henries, straight line amplification over 50 to 9,000 cycles and a full step-up ratio of 1/8. Extremely low capacity windings and minimum flux leakage. Price

**10/6**

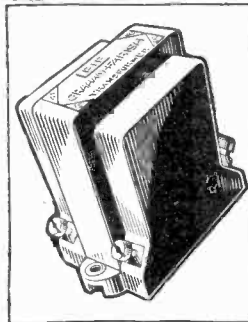

### PIP GENERAL PURPOSE TRANSFORMER

The Pip transformer is thoroughly sound in construction and design and gives results equalling and even better than others at a higher price. Made in ratios of 1-3 and 1-5. Price

**6/6**

## MAX PARALLEL FEED TRANSFORMER

One of the most astounding contributions to better and lower-priced 1935 radio. Designed for two main ratios of 1-3 and 1-5 with primary inductance of 80 and 35 henries respectively. Alternative ratios of 1-1, 1-2, 1-4, and 1-6 are also obtainable with the same transformer. The design is carried out in glossy black bakelite and fitted with the new type of terminal developed by Graham Farish for the home constructor.

PRICE

**4/6**

# THE PEAK OF PERFECTION



**GRAHAM FARISH LIMITED BROMLEY KENT**

**TRANSFORMING TRANSFORMER VALUES**

# Your Aerial & Earth

**I**NCREASE of power in broadcast transmission and efficiency in wireless receivers tends to disguise the fact that the best aerial-earth system that it is possible to instal is only just good enough, no matter what your set. Also, the fact is usually overlooked that from the moment the aerial-earth system, of any type, is installed, it begins to deteriorate. Bare wire and insulators of an outdoor aerial collect a coating of grime which is more or less conductive, in the case of the insulators, and thus defeats their object. In regard to the earth, the metal of the plate or tube and the connecting wires corrode; while in hot, summer weather the surrounding earth loses its moisture and, consequently, its conductivity. The result is inevitably deterioration of performance of the set; and it is a question to what extent the general deterioration of reception in summer time is due to the natural falling off due to atmospheric conditions or to the gradually failing efficiency of the aerial-earth system.

Neither the aerial nor the earth is a detail that can be installed—and forgotten. Each needs correct design and construction in the first place, naturally; but subsequent maintenance is almost equally important. An annual clean, whether a spring clean or otherwise, is essential; but it is desirable also that a type of insulator should be used with which it is impossible for either dirt or moisture to make a leakage path from the actual aerial wire to earth. A substantial improvement, therefore, can often be obtained by substituting insulators of a more efficient type than by merely cleaning the dirty ones.

## A "MADE TO MEASURE" AERIAL.

Undue prominence is usually given to the actual length of the aerial wire, within the limit of 100 ft. permitted by the Postmaster-General. It is not necessary to take full advantage of this maximum length; but, on the other hand, it is not harmful—providing always that points of proximity to earthed objects (such as trees and walls) are reduced to the lowest possible number and area, and that the lead-in is insulated from direct contact. The

only disadvantage attaching to the use of aerials of widely differing length is that in a set in which several tuning circuits are engaged for one-knob control the aerial circuit may be thrown out of line with the remainder unless measures are taken to adjust matters.

The "SLOT" Aerial Filter "fits" your aerial to your set.

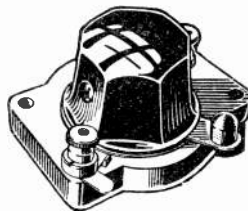

This is very easily done with such a simple device as the Graham Farish "Slot," with which any aerial can be made to fit any set merely by turning the control knob until best results are obtained. In addition such a device helps to neutralise the faults of an inefficient aerial by reducing the self-capacity, and thereby increasing the selectivity of the set. It can be fitted in a minute or so either inside or outside the set, and serves as an entirely satisfactory adjustable selectivity device by means of which this particular quality may be varied at will to suit prevailing conditions.

Faults with the earth generally concern either corrosion of the earth plate or the lead to the set at its point of connection to the plate, or lack of moisture in the ground in which the plate is buried. The latter is especially the case in such times of drought as that through

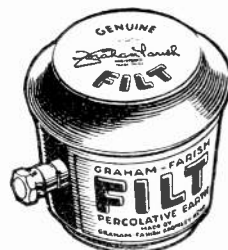

"FILT," a percolative chemical earth device now used by more than a million British listeners.

which we are passing, and the obvious remedy of "watering" the neighbourhood of the earth should be followed. Better still, perhaps, would be the substitution for the existing earth plate of the "Filt" device, which by its design overcomes finally and completely any trouble from this cause. The device

contains chemicals which have the property of attracting moisture, with the result that the contact surface is not merely that of the little copper container but of many cubic feet of surrounding earth which become permeated with the moisture attracted by "Filt." Naturally, the connecting lead must be inspected from time to time for continuity, but, beyond this, once the device has been fitted the user is sure at all times that the essential earth contact of his set is as perfect as it is possible to secure.

## 'WARE LIGHTNING.

There is much misconception as to possible danger from lightning and the means to be taken to eliminate it. An external switch by means of which aerial and earth can be connected positively together is perfectly efficient in eliminating the danger, providing that the need to close the switch is not forgotten. There is, however, the disadvantage that so long as the switch is closed the set cannot be used, and probably two journeys out of doors in the rain are needed first to close and then to open the switch when the danger is past.

The "GARD" Lightning Arrester does not interfere with reception—even during the most violent storms.

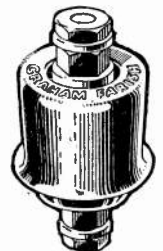

Danger and difficulty are both overcome by using the "Gard," another Graham Farish device of degree of usefulness far out of proportion to its small dimensions. This affords permanent protection from lightning dangers, and as its operation is automatic it allows the set to be continuously used if required. So assured are the makers of the efficiency of the "Gard" automatic lightning arrester that a guarantee is given under a penalty up to £200 to cover damage caused by the failure of the "Gard" device to operate.

With the three devices mentioned in operation the wireless user can rest content that he has taken every precaution in existing circumstances to secure the best possible wireless reception.



# 'CONTACT' ABROAD

## A Cruise round a few of your favourite Overseas Stations

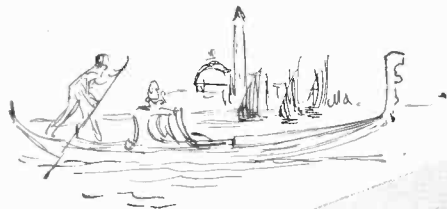

(Right) Modern yet entirely "homely"—the "Studio Villa Louvigny," and (below) interior of one of the studios.



(Left) An imposing view of Luxembourg's aerial.

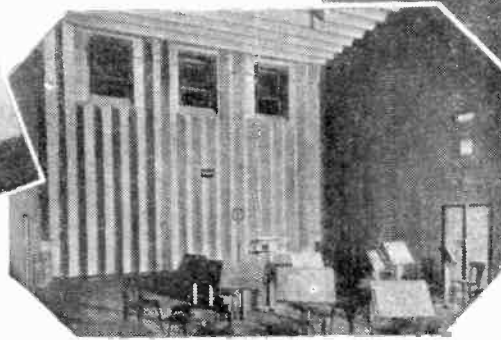
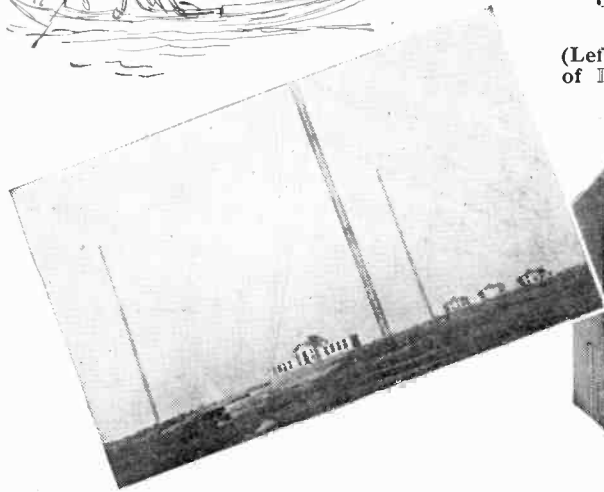

(Below) Station Director, M. Jean Martin—and how he directs that station! Listeners in all parts of the world tune in regularly to Luxembourg and report excellent quality of the transmissions.

Evelyne Wybrands, the charming French announcer.



(Below) Vivacious Eva Sievert, the English announcer, possessor of a voice heard by many thousands of English listeners.

M. Henry Pensis, Luxembourg's Orchestra leader.



**LUXEMBOURG.** Our first contact is with Luxembourg, transmitting on a wavelength of 1,304 metres and using 150 kw. power. The programme arrangement is such as will appeal to the average English listener, and the quality of the transmissions is exceptionally good.

Luxembourg has the added advantage of being particularly free of interference from "overlapping" transmissions, and on a receiver such as the "Sky Raider" it can be relied on to give many hours of splendid entertainment.



# 'CONTACT' ABROAD

(continued)

Most listeners have at some time or another experienced the thrill of tuning-in "a foreigner" for the first time, but present-day receiver designers, taking the fullest advantage of the enormous strides made recently in component and valve design, are able to reproduce foreign broadcasts in such a manner that the thrill has gone and left us only with the desire merely to criticise either selectivity or quality or both. This is as it should be, although listeners do not yet realise that "listening in" intelligently is as much an art as reading intelligently. Choose your programmes well in advance—make a note of the station you want to hear at any given time, and **STICK TO THAT PROGRAMME**. Deny yourself the urge to "run round the dials"—just to see what's on."



(Above) Emil Holm, Programme Director of Danish State Broadcasting, and (left) one of the studios.

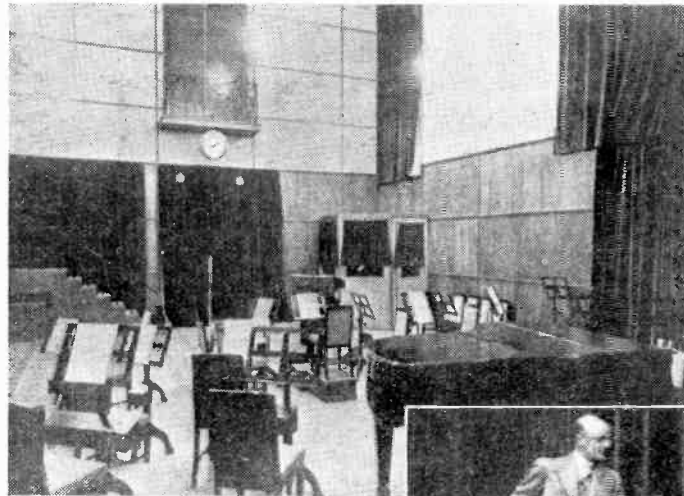

Mme. Grete Otto apparently engaged in a wordy argument with Daniel Prior, refereed by Carl Schionning—three of the Kalundborg announcers.

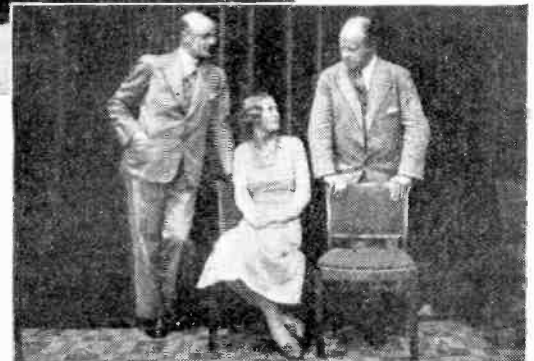

(Below) A magnificent view of Switzerland's giant aerials at Beromunster.



**KALUNDBORG**—a 75-kw. station working on 1,261 metres and **COPENHAGEN** on 255.1 metres at 10 kw. are both worthy of keenest attention. The standard of entertainment set by "Danish State Broadcasting" has reached a very high level, and Kalundborg (which relays Copenhagen) certainly deserves a reservation on your tuning chart.

Another station putting out really excellent programmes and received easily in this country is **BEROMUNSTER**, operating with 60-kw. power on a wavelength of 539.6 metres. Many of their broadcasts are of an entirely "national" character and are particularly interesting.



# 'CONTACT' ABROAD (continued).

Another of the high-power Continental stations regularly heard in this country is **BUDAPEST** on 549.5 metres, operating with a power of 120 kw.

The aerial shown on the left has been erected for the new Budapest 314-metres transmissions. (Below) the Budapest technical buildings.

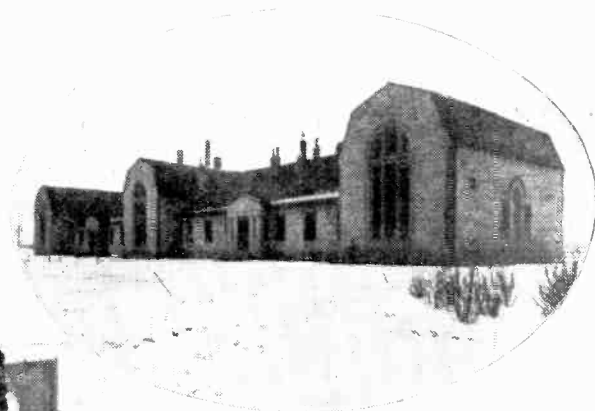
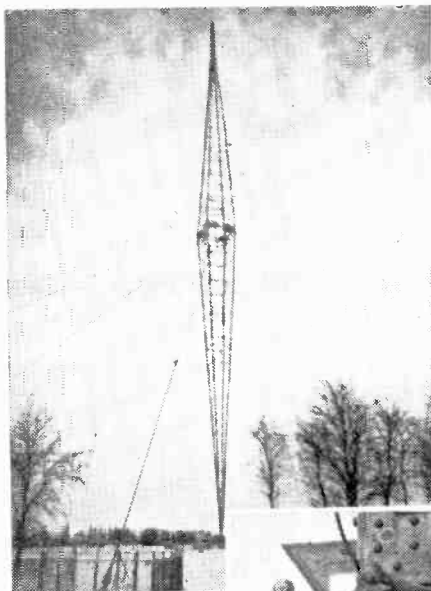

The actual size of the pylon insulators can be judged by comparison with the guard. (Below) Three of the Budapest announcers: Mme. Lilly Tamas and MM. Rosner and Radó.

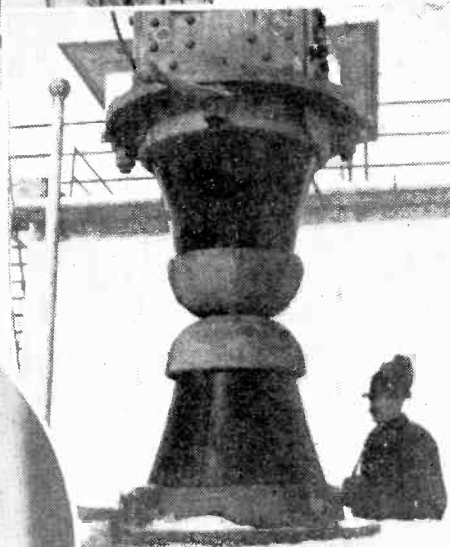

Mme. Bozsi Gecso, Budapest announcer, "at the mike."



FECAMP (206 metres, 10 k.w.) provides some very popular numbers for listeners in the Midlands and the South of England, and can be tuned in long after all other stations have closed down.

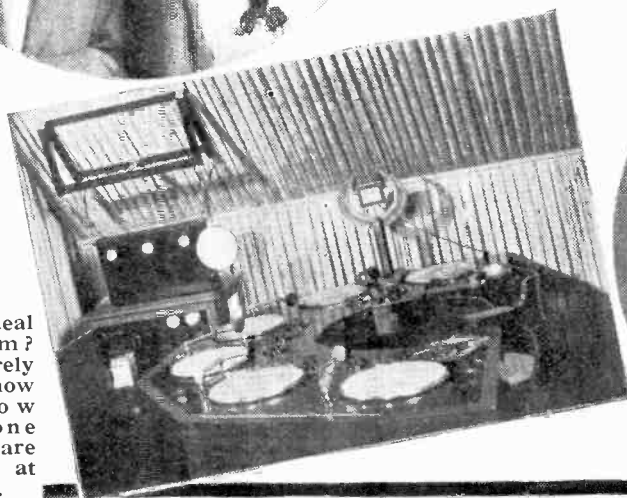

Is this the ideal radiogram? No--we merely want to show you how gramophone broadcasts are dealt with at Fécamp.



Bernard McNabb (Uncle Benjy), a very popular favourite among listeners to the Normandy broadcasts.





# CONTACT ABROAD

(Continued)



The essentially modern outlook of the new Germany is vividly reflected in the accompanying photographs of the **KONIGSBERG** Station (291 metres) and studios.

Studio No. 1 Konigsberg (right) clearly shows the organ swells behind the orchestra, and (below) another of the magnificent studios.

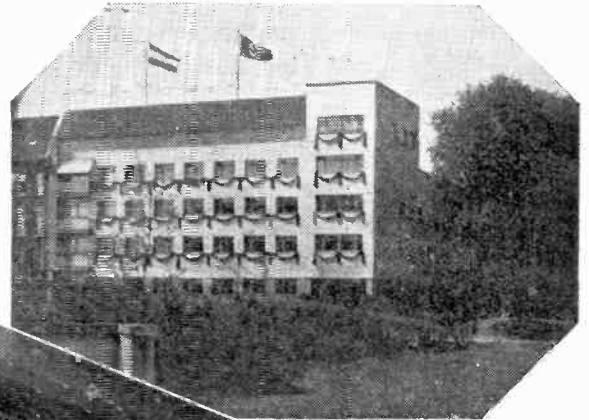

(Above) The Konigsberg Station buildings.

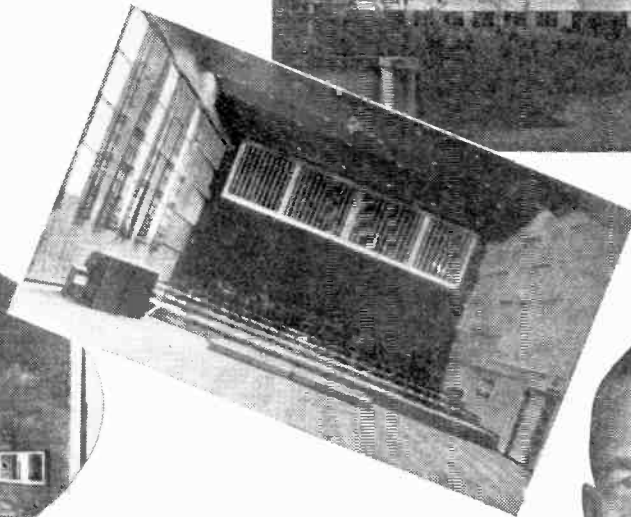
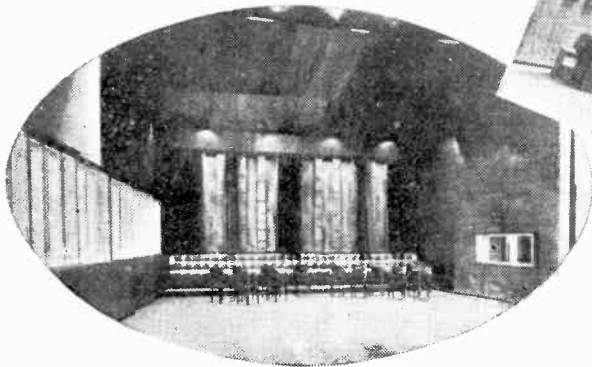

General Major a. D. Haenicke, "O.C." Konigsberg.

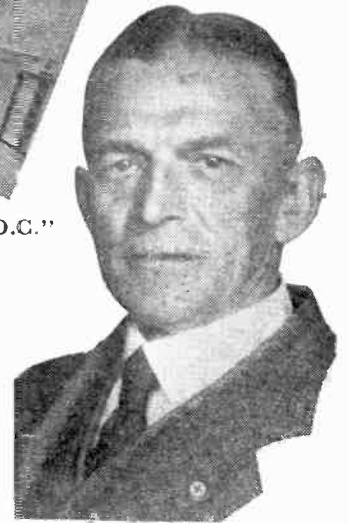

Broadcasting in **POLAND** has also reached a magnificent pitch of efficiency. It is estimated that the number and situations of the Stations now erected give every corner of this vast country "crystal set" efficiency, or, in other words, anybody in Poland with a crystal set can now listen-in.

One of the Warsaw studios (right) in sharp contrast to the ultra modern Konigsberg studios.

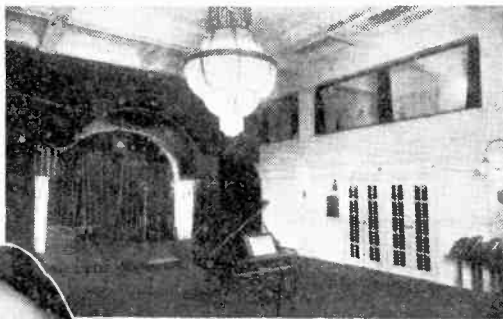

(Below) A magnificent setting for the Warsaw aerials.

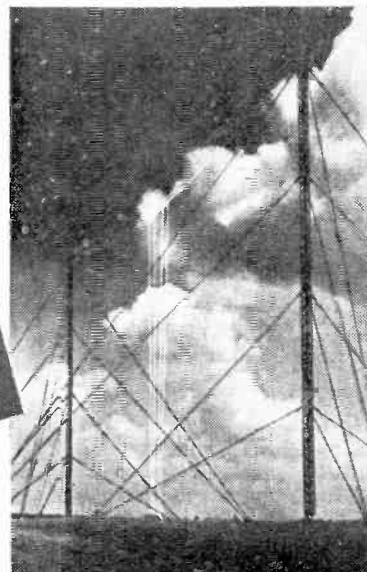

M. Thadée Bochenski, announcer from Warsaw and (left) Director Stéphan Tymieniecki, of the Katowice Station, popularly known as "Papa Stéphan" to thousands of Polish listeners.

HOLD EVERYTHING!

# "THE SKY RAIDER" ARRIVES



**NEW!**

'SENSITY' COILS

DUST-CORED, AIR-LITZ WOUND, STEATITE MOUNT

**NEW!**

2 IN 1 VALVES

COLOSSAL RANGE & VOLUME

**NEW!**

FLOODLIGHT SCALE READING

ONE HOLE FITTING, NO PANEL CUTTING



READ THE ASTOUNDING TEST REPORT ON PAGE 25

STEEL CHASSIS CONSTRUCTION



# THE ASTOUNDING

## COSTS LESS THAN

**A**T last the ideal battery radio—a design positively scintillating with new ideas. New components, new valves, new coils, new transformers, new speaker—all based on designs which are literally miles ahead of the times. And the result? The entire European Continent, and beyond, at your finger-tips—reproduction of home and foreign transmissions uncannily life-like—range and selectivity beyond your wildest dreams.

From the moment you mount the first component in position on the chassis you begin to feel the joy of recreating a masterpiece. The simple blue-print of the "SKY RAIDER," pictorial diagrams and general instructions, are sheer genius reduced to paper and print. Every constructional detail is carefully catered for—all the little worries of assembly and wiring, down to the minutest detail, completely eliminated.

Three valves only!—and yet these three have the thrilling performance of a perfectly balanced "eight stage." Your first trip round the tuning dial is literally a trip around the length and breadth of Europe.

The "SKY RAIDER" designer is justly proud of a truly magnificent achievement. He was asked to produce a super-efficient circuit, modern to the very last detail and free of all expensive complications, which should yet be wholly satisfying to the "DX" fan and the music lover alike—the whole to be simple to construct and even more simple to operate. There can be no doubt that the instructions have been more than adequately fulfilled. Test results, taken at what is admitted to be the least advantageous time of the year, show an astounding performance—not only in the number of transmissions received at truly colossal power, but in the extreme ease with which the traffic congestion of the ether was straightened out, and full, natural reproduction obtained. Independent critics are amazed at the performance of the

"SKY RAIDER," for when all is said and done the circuit is by no means complicated and the number of components used in its construction is reduced to the absolute minimum.

In writing of the "SKY RAIDER" it is impossible to do justice to the subject by referring to the circuit as a three-valver. Such a description is misleading when judged by the past standards of three-valve performance. The "SKY RAIDER" sets a completely new standard in battery valve sets—places home-constructed sets on an entirely new plane—a new level far ahead of the "factory built" receiver, and an utterly new conception of the term "three-valver."

To obtain a truer impression of the "SKY RAIDER" performance, comparison with

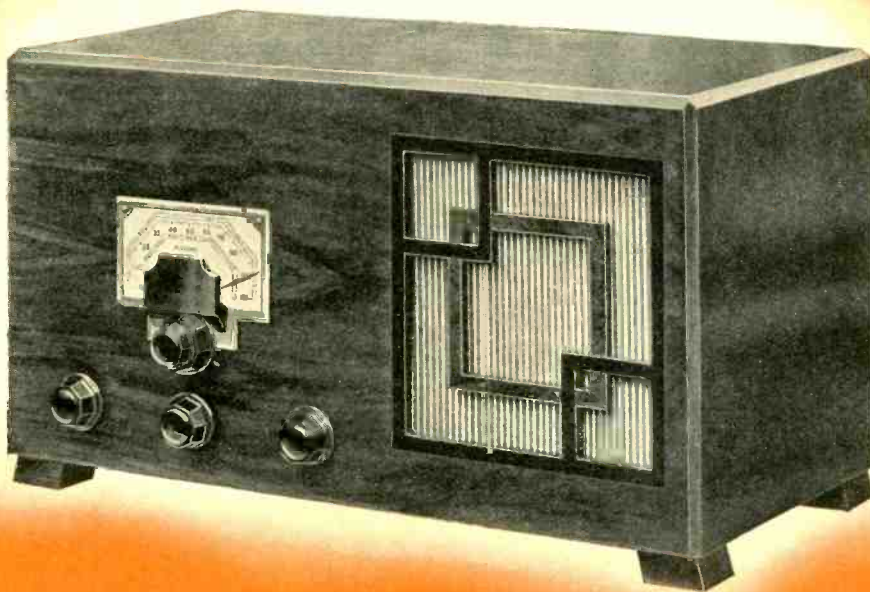

# CONQUEROR



# "SKY RAIDER"

## "FACTORY-BUILT"

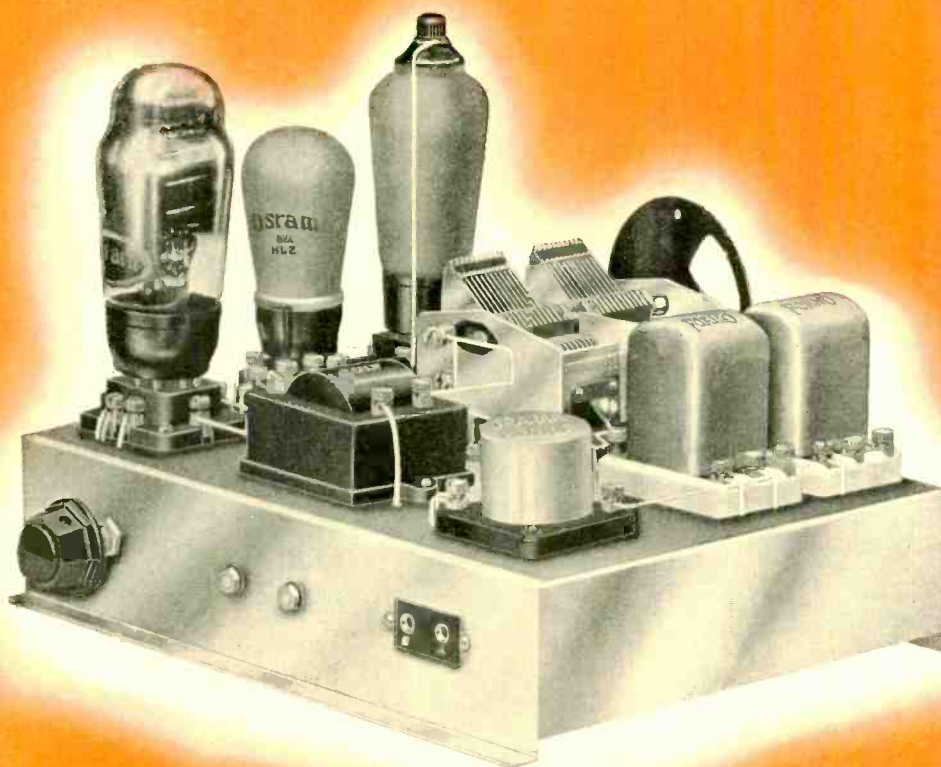

the best efforts of a really well-designed 1934 five-valver will give it you up to a point. The "SKY RAIDER" is easily its equal in volume, selectivity and sensitivity, but has it absolutely beaten on the score of complete controllability of the H.F. stage.

Much the same applies to the low-frequency section of the set. The modern method of amplification employed in the "SKY RAIDER" derives from one single valve far greater volume and infinitely better quality at an enormously lower expenditure of high-tension current than was possible only a short while ago with two ordinary L.F. stages.

Valve improvement has been mainly responsible for the excellence of the "SKY RAIDER," so far as we have proceeded with its description, and indeed the battery set user has much to be thankful for in regard to the recent developments which have made this magnificent circuit possible. For several years he has, quite rightly, complained that radio development has left him out in the cold—that progress has been almost entirely limited to mains apparatus. Valve makers, however, are awake at last to the fact that there are, and always will be, very many radio enthusiasts who are without the facilities of a domestic electricity supply, and a large number more who have very sound

# OF THE ETHER

**NEW!****"SENSITIVITY"****COILS****AIR-LITZ****WOUND**

reasons for preferring battery operation to the mains drive. The latest valve developments are, in fact, a very definite attack on existing battery valve standards.

The result is the production of the variable-mu pentode type of high-frequency amplifying valve, giving a tremendous stage gain with complete controllability, in which several important disadvantages of the older screen-grid valve have been eliminated; and of the double-pentode output valve, which can be used in the extraordinarily efficient and economical system of low-

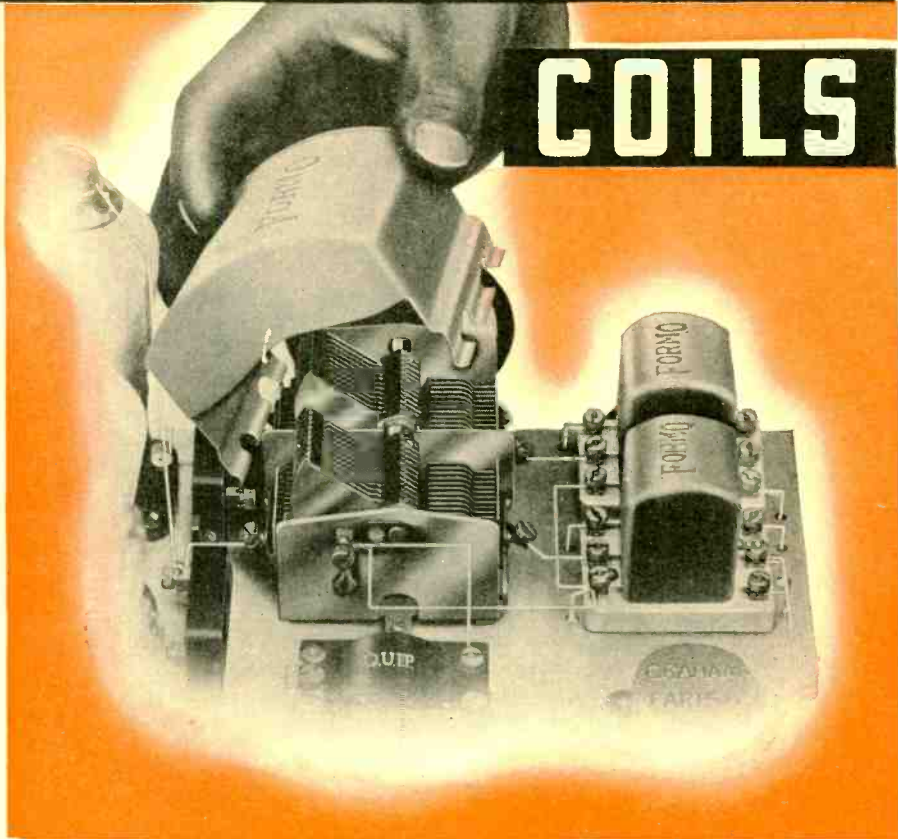
**IRON-DUST CORE**

frequency amplification known as "quiescent push-pull." With these two valves in a suitable circuit, and with appropriate operating potentials, the battery user is no whit behind the mains user in regard to the capabilities in every respect of his set. And that is one of the reasons for the almost incredibly fine performance of the "SKY RAIDER."

The finest possible quality and a degree of sensitivity capable of pulling in every transmission in Europe of a worth-while nature, as well as a goodly selection from farther afield, would be of little use, however, without the power to discriminate between the closely-packed programmes from which the listener has to choose. In fact, unless ample selectivity is available, the more sensitive the set the worse its performance will be.

**NO-LOSS STEATITE BASE**

So, in spite of the great importance of a pleasing, natural tone and of the ability to receive relatively weak transmissions at great distances, selectivity is the greatest need of all. It is the quality that has to be provided for first of all in designing a receiver; and it is perhaps the most difficult of all to provide for in a measure suitable for a highly efficient modern receiver under modern conditions of broadcasting. The Lucerne Plan, which is the scheme at present being followed by the great majority of European broadcast stations, permits a separation of 9 kilocycles between the frequencies of the carrier waves of adjacent transmissions, and no receiving set possessing a lesser degree of selectivity is of any real use under present conditions.

By using a multiplicity of sharply-tuned circuits, it is not difficult to obtain the required degree of selectivity, but it is done at the expense of simplicity, and a set designed on these lines is not the most



**NEW!****2 IN 1 VALVES****RADIO'S LATEST WONDER**

suitable for home construction in the matter of ease of building or economy of cost. For the "SKY RAIDER" something very different was essential. Super efficiency had to be secured, but not at the expense of simplicity; and cost had to be kept down. In view of the enormous range possible and, therefore, the great number of different stations that could be brought in with the latest H.F. Pentode valve, the designers' task was not a light one. As a matter of fact, only the eventual perfection of the Formo "Sensity" coil made success possible.

The same general type of coil is used in all the "CONTACT" sets, but a special model, capable of dealing with the greater range of the "hot number" of the trio—the "SKY RAIDER"—had to be designed, and in the final result a degree of selectivity fully adequate to requirements was obtained, while the general design of the set as a whole was not hampered with unnecessary complications.

In those three details—the two special valves and the small-dimensioned but tremendously efficient tuning coils—lies the greater part of the secret of the "SKY RAIDER'S" almost unbelievable performance. The remaining part of the secret is the extreme ingenuity of the circuit itself, which provides all the refinements necessary to bring the set right ahead of present-day practice, together with an economy of parts and space which makes the "SKY RAIDER" outstanding among the sets of the season.

For those who are able to read a technical diagram, full details are provided elsewhere; but there are many constructors who are not altogether at home with this form of diagram, and for them it may be useful to run briefly over the circuit. The aerial, then, feeds into the aperiodic primary of a transformer coupling, which system is applied to the long as well as the medium wavelengths, and the whole transformer constitutes the iron-cored aerial coil. The secondary is tuned by one 0.0005-mfd. section of a two-ganged variable condenser. In order that the frame and moving vanes of this condenser may be kept at earth potential, to avoid trouble from hand-capacity effects in tuning, the bottom ends of both primary and secondary coils of the aerial transformer are earthed and the unusual method of coupling the high-potential end of the secondary to the grid of the H.F. valve through a small fixed condenser (0.0002 mfd.) is followed, the grid of the valve being biased through a 2-megohm grid leak from the sliding centre contact of a 35,000-ohms potentiometer connected across a grid-bias battery. Control

**COLOSSAL VOLUME****UNCANNY PERFORMANCE**

of volume is secured by variation of the bias to the grid of the H.F. valve. The priming grid of this H.F. Pentode is fed through a separate lead from the high-tension battery, and is decoupled by a condenser of 0.1 mfd. The anode circuit contains first a screened H.F. choke, to prevent the leakage of energy to earth through the H.T. battery, and then a decoupling arrangement consisting of a 5,000-ohms resistance and a 0.25-mfd. condenser, the H.T. supply being taken thence direct from the 120-volt battery tapping. Transference of energy from the H.F. anode to the primary of the detector-grid coil is by means of a 0.0001-mfd. condenser. The secondary of the grid coil is tuned by the second section of the two-gang variable

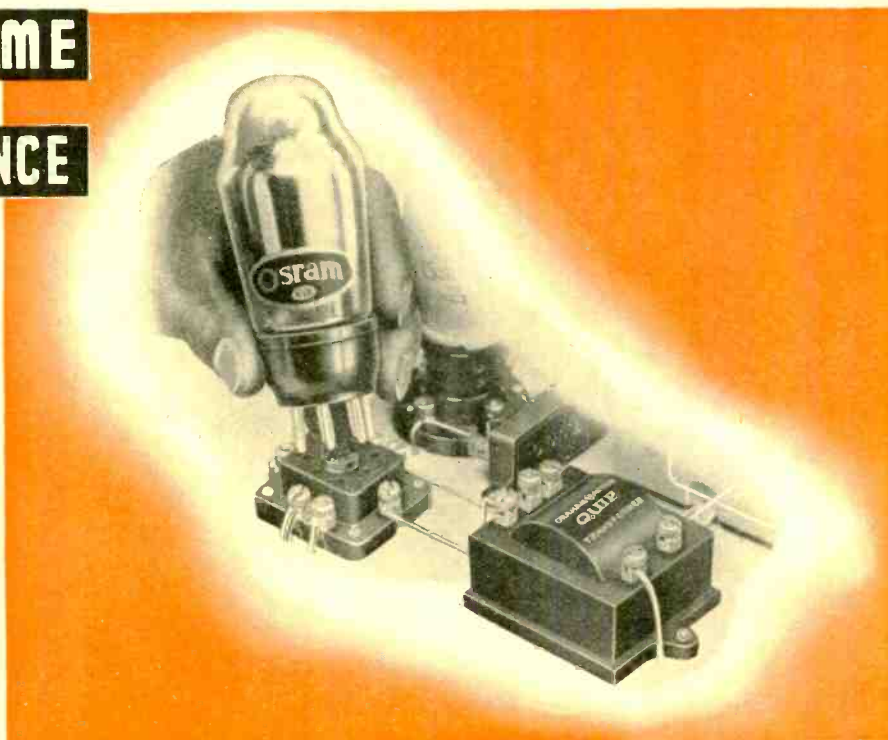



# SIMPLE SUB-

## SOLID STEEL CHASSIS

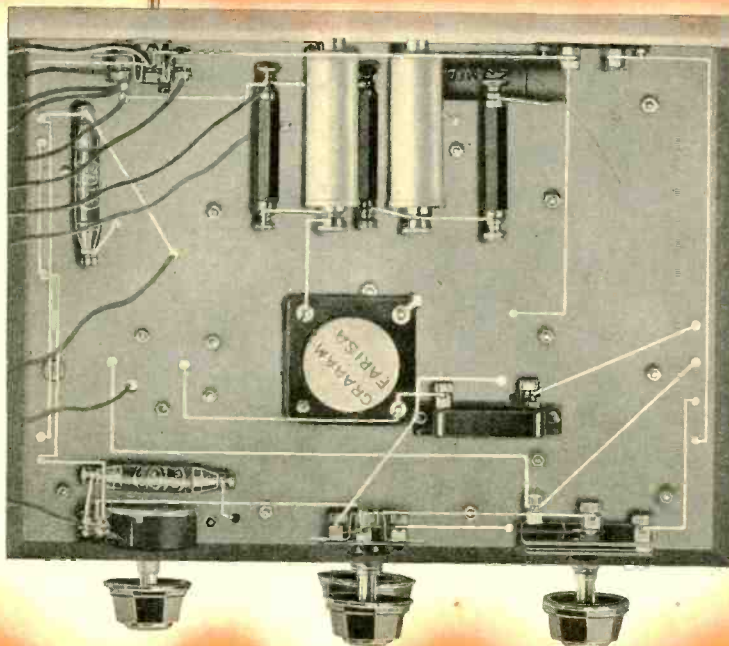

beyond which the circuit is decoupled by a 10,000-ohms resistance and a capacity of 0.25-mfd., connection then being made to the main 120-volt H.T. positive line.

From the detector, the process of operations passes to a specially designed quiescent push-pull transformer, paralleled as already described, and possessing a ratio of 1 to 8 between primary and secondary in order to secure the high stage-gain possible with this type of circuit. The secondary of the Q.P.P. transformer is split, negative bias being applied to the two grids of the double pentode valve from the centre tapping, which is connected directly to the appropriate socket of the

## UNDER-CHASSIS LAY-OUT

condenser; while connection to the detector grid is through the usual 0.0002-mfd. grid condenser with a 1-megohm grid leak.

Reaction control is provided through the medium of a 0.0003-mfd. differential condenser, the spindle and moving vanes being maintained at earth potential, and so again avoiding the possibility of difficulty from hand-capacity effects, to which this type of reaction control is sometimes prone when the moving vanes are connected direct to the detector anode. Following the reaction connection, the detector anode contains a high-frequency choke, screened as in the case of the choke in the anode circuit of the H.F. valve. Parallel feed of the rectified and amplified energy to the next stage is secured by means of a 0.25-mfd. condenser and a 40,000-ohms resistance,

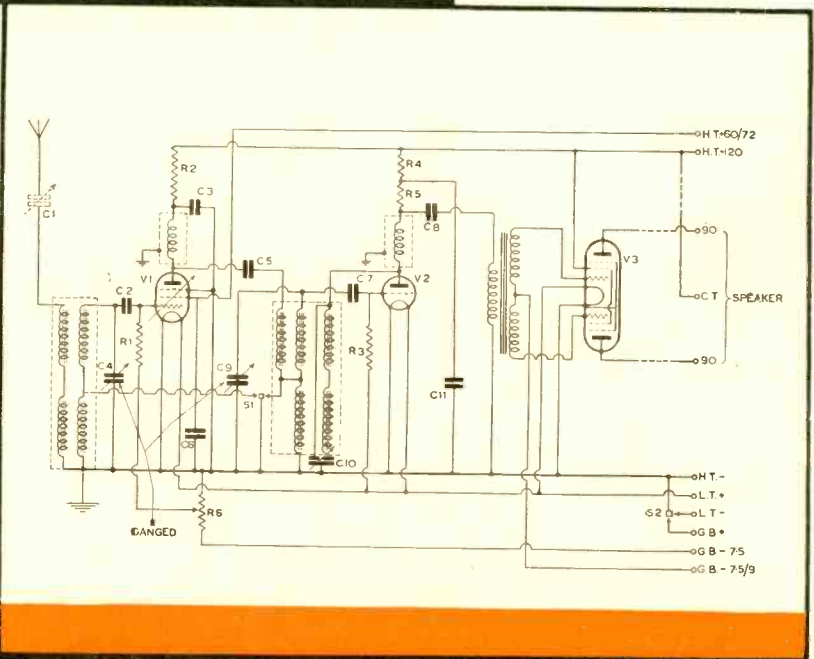

## CIRCUIT DIAGRAM



# CHASSIS WIRING

## CLEAN, WORKMANLIKE LAY-OUT

grid-bias battery. The two auxiliary grids of the pentode elements are connected together inside the valve envelope, and to the 120-volt H.T. positive line.

The final stage of connection is provided by the transformer of the permanent magnet moving-coil loudspeaker, which is designed with a centre-tapped primary to accommodate push-pull output.

That is the general circuit of the "SKY RAIDER," and it will be admitted that in view of the performance of the set, the constructional work and wiring are essentially simple. Actually, the same sized chassis, the same cabinet and the same loudspeaker—the specially designed miniature W.B. moving-coil instrument which has a volume, capacity and range of tone absolutely out of all proportion to its small size—are used with the "SKY RAIDER" as with the "MYSTIC Q" and the "STENTORIAN." So far as the chassis is concerned, while plain baseboard construction has been found entirely adequate for the "STENTORIAN" and "MYSTIC Q," the greater capabilities of the "SKY RAIDER" called for rather more complete screening, and consequently the all-metal chassis method has been adopted.

Built up and ready for housing in the specially designed "CONTACT" walnut cabinet, the completed chassis presents an appearance entirely in keeping with its astounding abilities. Dreadnought grey metal screening is linked in perfect harmony with sleekly polished black mouldings, adding just that touch of "personality" to a set already bristling with star features.

Externally, the "SKY RAIDER" panel controls give a symmetrical and practical appearance. The reaction control on the left, volume control on the right, with the wavechange switch immediately under the main tuning control, while the on-off switch is placed at the rear of the cabinet. In regard to the latter, it is interesting to note that the rather complicated process of switching off the low-tension supply to the valve filaments, the H.T. negative connection and the connection to the G.B. battery are all automatically effected by the single knob. It is essential that instructions in regard to this switch should be closely followed, as otherwise, owing to the connection of the volume control across the grid-bias battery, the latter would be subject to a small but constant drain, even when the set was apparently switched off. In addition, the operation of the double Q.P.P. valve would be adversely affected.

The central panel control operates the FORMO two-gang condenser and trimmer—the latter an ingenious device which ensures absolutely perfect matching of the tuned circuits.

Builders of the "SKY RAIDER" should note that The General Electric Co. Ltd., have arranged to distribute through all radio dealers kits of three OSKAM VALVES, specially matched for this circuit.

Such, then, is the "SKY RAIDER," a set designed to smash all existing ideas on the three-valver—a set which tens of thousands of home constructors will accept this year as the most brilliant contribution to home-built radio.

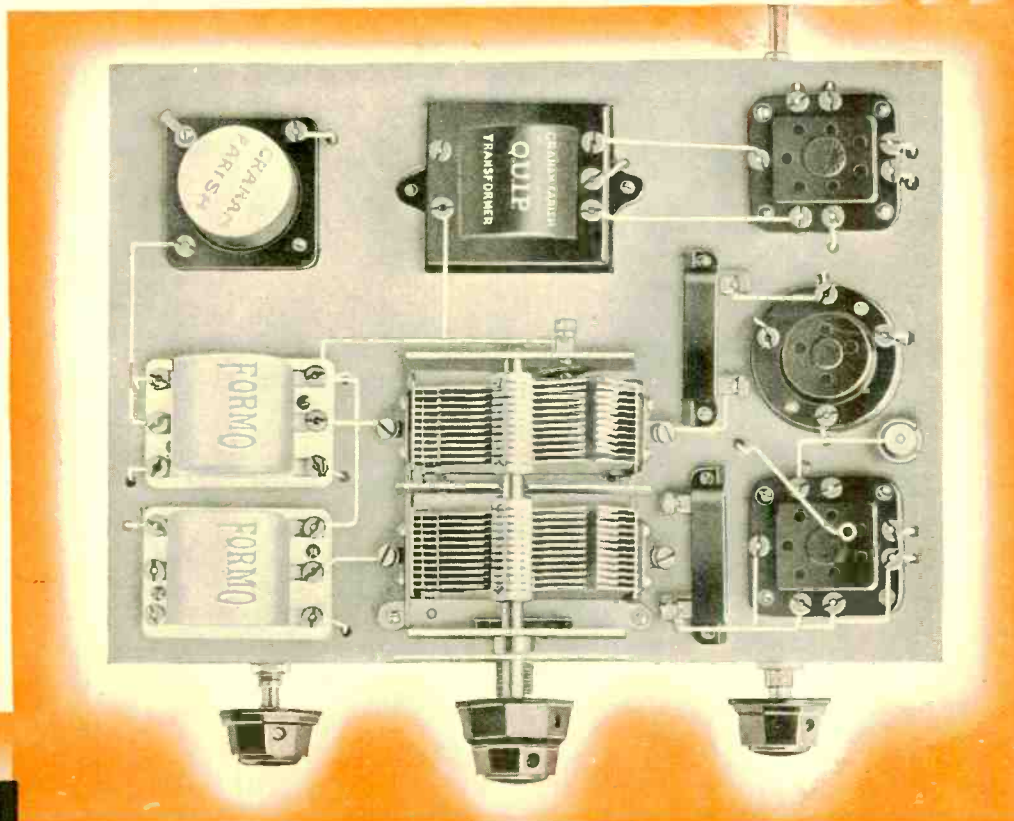



# FINISHED!

## AND READY FOR THE THRILL OF A LIFETIME!

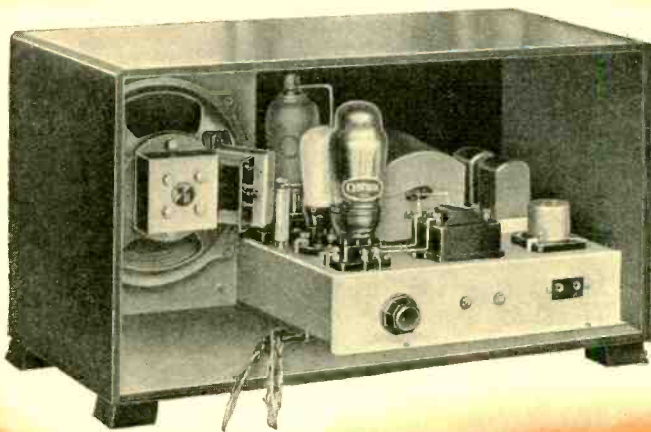

**CABINET.** British Radiogram "Sky Raider."  
**SPEAKER.** W.B. Stentorian Baby, Type PMS6.  
**BATTERIES.** 120 H.T. Drydex, Type H1006.  
 2 v. Exide Accumulator, Type DFG45.  
 9 v. G.B. Drydex, Type H1001.  
**VALVES.** Osram V.P.21. 1st Stage H.F.  
 Osram H.L.2. 2nd " Det.  
 Osram Q.P.21. 3rd " Q.P.P. Output.

*Builders of The "SKY RAIDER" should note that The General Electric Co. Ltd., have arranged to distribute through all radio dealers kits of three OSRAM VALVES specially matched for this circuit.*

### LIST OF COMPONENTS FOR "SKY RAIDER"

		s.	d.
Chassis	Graham Farish	3	0
1 pr. Matched "Sensity"			
Coils	Formo Products	10	0
1 Twin Gang Condenser			
Drive and Cover	Formo Products	12	6
2 7-pin Valveholders	Graham Farish	2	6
2 H.M.S. Screened Chokes	Graham Farish	5	0
2 .0002-mfd. Mica Condensers	Graham Farish	1	0
1 .0001-mfd. " "	Graham Farish		6
2 3-pt. Rotary Switches	Snap Switches	2	0
1 .0003-mfd. Diff. Reaction			
Condenser	Graham Farish	2	0
1 35,000 Potentiometer			
Volume Control	Graham Farish	3	0
2 .25-mfd. Metal Tub. Cond.	Formo Products	3	6
1 .1-mfd. Metal Tub. Cond.	Formo Products	1	6
1 .25-mfd. Tubular Cond.	Graham Farish	1	6
1 1-meg. Standard Grid			
Leak	Graham Farish		10
1 2-meg. Standard Grid			
Leak	Graham Farish		10
1 10,000 Ohmite Resistance	Graham Farish	1	6
1 40,000 " "	Graham Farish	1	6
1 5,000 " "	Graham Farish	1	6
1 Quip Transformer	Graham Farish	10	6
1 4-pin Valveholder	Graham Farish		6

# EUROPE- & BEYOND

# AT YOUR FINGER TIPS!





# The Sky Raider TEST REPORT



I MUST confess that this business of testing and reporting on my results with the SKY RAIDER was something entirely new to me, and if this page is not all that might be desired by the experienced home constructor, I would ask your indulgence, and let the Station List in the following column speak for itself.

My interest in radio is sufficient to warrant my suggestion to the designer that his ideals were far beyond the powers of a 3-valve battery receiver, but I must now admit freely and unequivocally that the SKY RAIDER in operation far exceeds those ideals, and leaves me wellnigh dumbfounded. I am not easily convinced—I insist on exceptionally good quality—I must have a wide variety of stations to choose from, and I just won't be bothered to fiddle about with multiple controls to tune them in. From which you will gather that I am just a plain, ordinary listener. Let me state here and now that the SKY RAIDER scored full marks on all points, and satisfied my every demand.

In operation it responded smoothly and efficiently. From the first moment of throwing over the filament switch, I had the thrilling impression of controlling a perfectly balanced machine, everything working in wonderfully matched unison. When I first connected up and switched on, the dial happened to be tuned at the London Regional. I heard an orchestral concert reproduced with amazing volume and clarity—a vivid lifelike reproduction which I can only describe as uncannily like the original. From that moment I became the confirmed fan, fully prepared to forget all my ideas on radio in general and home-constructed sets in particular. I easily blotted out London Regional 2<sup>o</sup> from its position on the flood-lit drive, and from then on, the slightest movement of the main tuning condenser produced something really worth listening to. Dance Band, Announcer, Tzigane Band, Opera, Vaudeville—entertainment from all corners of the Continent was at my beck and call.

The Station Log recorded here includes only those transmissions received at full loud-speaker strength. The aerial used was 50 ft in length, and had an average height of only 12 ft. to 15 ft. It can, therefore, be readily assumed that a better aerial will give correspondingly better results

### OPERATION

Having finished the construction of the "Sky Raider" you will, I suppose, find it difficult to have the patience to scan through

these notes before trying it out. For the cautious and the wise, however, I would like to take you through the final stages. Try it out before fitting it in the cabinet, just in case you have missed something. Connect the aerial and earth leads to their respective plugs and the L.T. and Grid Bias leads. Make sure the latter are correctly disposed because the output valve must have 7½-volts minimum for 120 volts high tension.

front of the Tuning knob is the aerial condenser trimmer. This should be set half-way, and a local or strong signal tuned in. The small adjustable trimmer on the back of the ganged condenser should now be set to give the best results, by adjustments in conjunction with re-tuning the main control. This adjustment will approximately gang the two halves of the Condenser for your own particular aerial and earth system. If you have any difficulty at all, see notes on Tuning under the heading "Adjustments."

To get greater accuracy turn the volume control down to the minimum so that the station can just be heard, and then increase Reaction to just below oscillating point. Further adjustments will then probably be found desirable to give correct and accurate ganging. You can now ignore the back trimmer and rely entirely on slight adjustments of the front trimmer, when necessary, over the different positions of the dial. If the run over has satisfied you, all is well; then you can proceed to fix the receiver into the cabinet. Don't forget to put the condenser either to maximum or minimum position so that fitting the tuning indicator is easy.

When listening to distant stations remember that the best results are obtained by using the Volume Control in conjunction with the Reaction or selectivity control. By reducing the volume control and increasing the reaction, a greater amount of selectivity can be obtained for the same volume. The selectivity control should, however, be kept back as much as possible, since side-band

cutting will take place as selectivity improves, which in turn adversely affects the quality. Use can also be made of the selectivity control for reducing "mush" and heterodyne whistles, since increase of selectivity will effectively reduce the high-note response and can be made to perform the functions of a heterodyne whistle filter.

### ADJUSTMENTS

#### Tuning and Ganging

If you find when ganging the condensers that you have to use a large amount of extra capacity in the back trimmer, then the aerial and earth loading is excessive. This is probably due to using a large aerial close to the ground, trees, roofs, etc., or alternatively, and possibly in addition, a long earth lead with a high resistance earth. This can be effectively reduced by fitting a type J Form-condenser in series with the aerial lead to the set and can easily be embodied in the cabinet.

Medium Waves	Metres	Medium Waves	Metres
Bournemouth	203.5	Leipzig	382.2
Fécamp	206	Midland Regional	391.1
Minsk	208.6	Katowice	395.8
Montpellier P.T.T.	224	Munich	405.4
Prieste	245.5	Kiev	415.5
Frankfurt	251	Rome No. 1	420.8
Copenhagen	255.1	Stockholm	426.1
Monte Ceneri	257.1	Paris P.T.T.	431.7
London National	261	North Regional	449.1
Turin No. 1	263.2	Cologne	455.9
Bordeaux-Lafayette	278.6	Lyons P.T.T.	463
Bari	283.3	Prague	470.2
Konigsberg	291	Lisbon	476.9
North National	296	Vienna	508.8
Hilversum	301.5	Stuttgart	522.6
Genoa	304.3	Athlone	531
West Regional	307	Bromunster	539.6
Poste Parisien	312.8		
Breslau	315.8	Long Waves:	
Algiers	318.8	Kalundborg	1,261
Radio Toulouse	328.6	Luxembourg	1,304
Hamburg	331.9	Motala	1,389
London Regional	342.1	Daventry National	1,500
Strasbourg	349.2	Konigswusterhausen	1,571
Berlin Funkstunde	356.7	Radio Paris	1,648
Moscow No. 4	360.6	Moscow No. 1	1,724
Milan	368.6	Huizen	1,875

Put the H.F. Pentode bias plug in the 4½ or 6-volt tapping and connect the speaker leads to the speaker transformer, the H.T. feed lead being the centre tap or common terminal. The anode leads of the output valve are connected to each of the terminals marked 90 on the Speaker Transformer.

Switch on the filaments and by the dull red glow in the output valve you will be able to see whether the filament circuit is in order, and then put in the negative High Tension plug. Now the 120-volt plug. This should give a loud "pop" in the Speaker and if not the wiring on the L.F. and output side should be checked. Assuming that it was correct, putting the H.F. Pentode screen plug in at 75 volts also gives a sound in the speaker.

Now round the tuning control with the volume control (right hand side) full on, and the Reaction or selectivity control (left-hand) turned right back. You should now be able to tune some signals in. The small knob in

# The CONTACT

## WORLD-WIDE STATION FINDER

Station	Tuning Positions	Metres	kW.	Station	Tuning Positions	Metres	kW.
Kaunas		1935	7	Bergen		352.9	1
Brasov		1875	20	Valencia		352.9	1.5
Huizen		1875	7	Strasbourg		349.2	15
Lahti		1807	40	Poznan		345.6	16
Moscow, No. 1		1724	500	London Regional		342.1	50
Radio Paris		1648	75	Graz		338.6	7
Istanbul		1621	5	Limoges, PTT		335.2	0.5
Königswusterhausen		1571	60	Helsinki		335.2	10
Daventry National		1500	30	Hamburg		331.9	100
Ankara		1500	7	Radio Toulouse		328.6	60
Minsk		1442	35	Brno		325.4	32
Reykjavik		1442	16	Brussels, No. 2		321.9	15
Eiffel Tower		1395	13	Algiers		318.8	12
Motala		1389	30	Göteborg		318.8	10
Warsaw No. 1		1339	120	Breslau		315.8	60
Luxembourg		1304	150	Poste Parisien		312.8	100
Kalundborg		1261	75	Grenoble		309.9	20
Leningrad		1224	100	West Regional		307.1	50
Oslo		1154	60	Cracow		304.3	2
Madona		1145	50	Genoa		304.3	10
Moscow No. 2		1107	100	Hilversum		301.5	20
Rostov-on-Don		845	20	Bratislava		298.8	13.5
Sverdlovsk		800	50	North National		296.2	50
Geneva		748	1.3	Barcelona		293.5	3
Moscow, No. 3		748	100	Königsberg		291	60
Voroneje		726	10	Leningrad		288.5	10
Oulu		696	2	Scottish National		285.7	50
Oufa		688	10	Bari		283.3	20
Hamar		578	0.7	Bordeaux-Lafayette		278.6	12
Innsbruck		578	0.5	Zagreb		276.2	0.7
Ljubljana		569.3	5	Falun		276.2	2
Viipturi		569.3	13	Madrid, No. 2		274	7
Bolzano		559.7	1	Naples		271.7	1.5
Wilno		559.7	16	Kosice		269.5	2.6
Budapest, No. 1		549.5	120	Belfast		267.4	1
Beromunster		539.6	60	Nyiregyhaza		267.4	6.2
Athlone		531	60	Hörby		265.3	10
Palermo		531	4	Turin, No. 1		263.2	7
Stuttgart		522.6	100	London National		261.1	50
Riga		514.6	15	West National		261.1	50
Vienna		506.8	120	Moravska-Ostrava		259.1	11.2
Rabat		499.2	6.5	Monte Ceneri		257.1	15
Sundsvall		499.2	10	Copenhagen		255.1	10
Florence		492.6	20	Frankfurt		251	17
Brussels, No. 1		483.9	15	Prague, No. 2		249.2	5
Lisbon		476.9	15	Lille, PTT		247.3	5
Trondheim		476.9	20	Trieste		245.5	10
Prague, No. 1		470.2	120	Gleiwitz		243.7	5
Lyons		463	15	Cork		241.9	1
Cologne		455.9	17	Juan-les-Pins		240.2	2
North Regional		449.1	50	Rome, No. 3		238.5	1
Sottens		443.1	25	Sau Sebastian		238.5	3
Belgrade		437.3	2.5	Nürnberg		236.8	2
Paris, Ecole Supérieure		431.7	7	Dresden		233.5	1.5
Stockholm		426.1	55	Aberdeen		233.5	1
Rome, No. 1		420.8	50	Danzig		230.2	0.5
Kiev		415.5	36	Budapest, No. 2		227.1	0.8
Tallinn		410.4	20	Montpellier, PTT		224	5
Madrid		410.4	3	Lodz		224	1.7
Munich		405.4	100	Bordeaux Sud-Ouest		222.6	1
Marseilles, PTT		400.5	5	Dublin		222.6	1
Katowice		395.8	12	Milan, No. 2		221.1	4
Midland Regional		391.1	25	Turin, No. 2		219.6	1
Toulouse, PTT		386.6	2	Warsaw, No. 2		216.8	2
Leipzig		382.2	120	Lyons, No. 2		215.4	5
Barcelona		377.4	5	Tampere		211.3	1.2
Lwow		377.4	16	Newcastle		209.9	1
Scottish Regional		373.1	50	Béziers		209.9	2
Milan		368.6	50	Minsk		208.6	100
Bucharest		364.5	12	Fécamp (Radio Normandie)		206	10
Moscow, No. 4		360.6	100	Pecs		204	1.25
Berlin Funkstunde		356.7	100	Bournemouth		203.5	1

All stations in heavy type are easily receivable on the "SKY RAIDER" at full loudspeaker strength.

# HOW YOUR COMPONENTS ARE MADE



WHEN you buy a small component for a few shillings, which looks just a bakelite case, a few terminals and inwardly some more or less obscure "works" all packed in a printed carton, does it occur to you the enormous amount of detail which has been undertaken to present this few shillings' worth in its particular form?

Come, then, and see just what happens, presupposing for a moment that the need for the component is established, and the tedious process of research and design has been completed. Everything, in short, is ready to start work.

Work is begun by the Drawing Office, where accurate drawings are made of every individual part, and also of the completed article in plan, and as many elevations as are needed. Blue prints are made and distributed to the various departments specialising in the production of the individual parts, via the "Tool Shop," where first of all dies, jigs, cams and cutters have to be made for the Production Department. These "tools" are, of course, the subject of special drawings.

Finally, after several weeks perhaps, the tools are ready, and the presses start to roll out thousands upon thousands of some obscure part which, although it may never be seen by the user, is nevertheless a vital factor in the performance of your set.

Meanwhile, a die has been made, and the Bakelite Department is producing, by heat and terrific pressure, the bright shiny moulding you know so well, from a coarse powder resembling cocoa!

Perhaps brass spindles, nuts or bushes are needed, in which case a number of cams and cutters have to be made, which, when fitted to an automatic machine, enable it to produce parts at the rate of more than a hundred a minute, the speed of this type of machine being about 10,000 turns per minute, and requiring no attention, except to be fed with metal!

Some parts may need special slots cut in them, as, for example, the hollow spindle carrying the moving vanes of a variable condenser, for which a special form of milling machine is required.

We may presume all the parts are now ready, and the final assembly can commence. This is done in a special department where the deft fingers of hundreds of girls rapidly fit together the pieces, solder the connections, and do many other non-mechanical processes, until for the first time the component appears in the form in which you are accustomed to see it.

But it is not ready for sale yet, it must first pass through the Testing Department — here ingenious devices have been evolved which enable the operator to see at a glance the slightest fault in the article under test. One test is not enough, however, in some factories, and here a second test by an independent operator is applied.

Meanwhile, carton designs have been prepared and the cartons made. The Packing Department receive the tested goods, and rapidly enclose them, first in

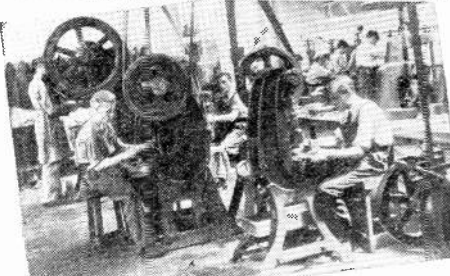
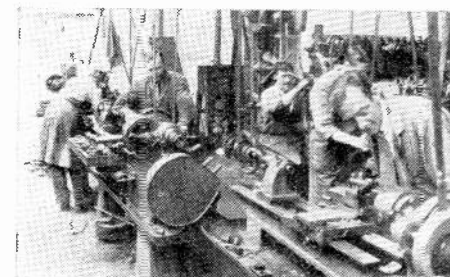

(1) Tool Shop Section.  
 (2) High speed presses pounding out millions of stamped metal parts.  
 (3) Assembly—the finished product nearing completion.



A bakelite moulding tool and powder.



Finished stores — millions of components awaiting despatch to all parts of the world.

cartons, and then into outer cartons of twelve, in which form they are sent to the Despatch Department stores.

Here cases are packed for despatch to the wholesale buyer, who has ordered a supply from the traveller who calls on him every three weeks.

The wholesaler in turn sells in smaller quantity to the retail shop, and you, dear reader, having read an advertisement, or been recommended to try this component, have just bought one for a few shillings—perhaps the first article made at a cost of a thousand pounds! Truly mass production is the wonder of the age, turning as it does the luxury of the rich to the utility of all.



The **EXPERT'S**  
First Choice . . .  
Graham Farish  
**OHMITES**

**1935  
RADIO**

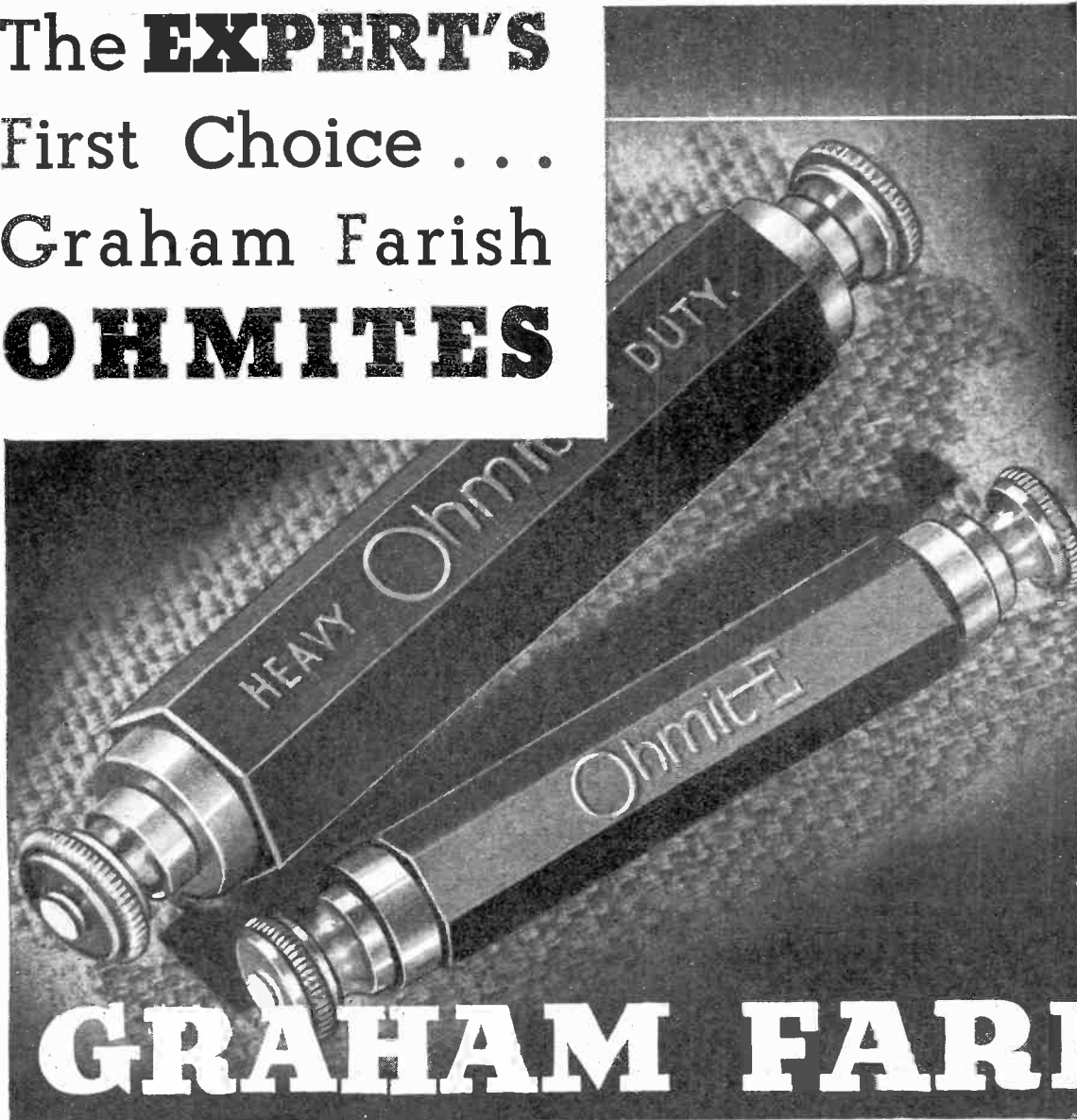

**GRAHAM FARISH**

**OHMITE  
RESISTANCES**

The most popular and efficient type of fixed resistance for all general purposes. "Better than wire wound."

All values 50 ohms to 5 megohms.

Standard 1½-watt type

PRICE . . . .

Heavy duty 3-watt

type . . . . . 2/3

**1'6**

**AUDION RESISTANCE  
CAPACITY UNIT**

Where real tonal quality and straight line amplification is of the utmost importance, the "Audion" R.C. unit still holds its own. Two Ohmite 1½-watt resistances and a high efficiency fixed mica condenser ensure efficiency above the average.

**4/6**  
Price

**HORIZONTAL AND  
VERTICAL HOLDERS**

Single hole fixing baseboard holders designed for Ohmite or Standard Resistances in flat or upright position, where it is not convenient or desirable to suspend the resistance in the wiring.

**6d.**  
Price, either type,

**BOOSTER H.T.  
ECONOMISER UNIT**

Enables battery set owners to achieve mains power volume at normal H.T. cost, or alternatively will increase battery life fully 50%.

Type TP for all super-Power valves; Type P for small pentodes only. **7/6**

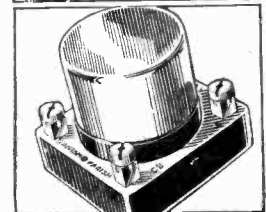
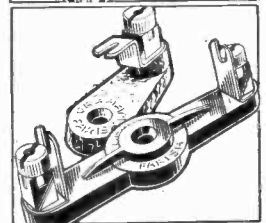
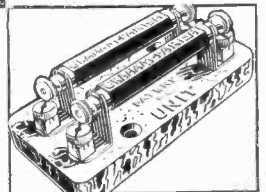



**H.M.S. SINGLE SCREEN  
H.F. CHOKE**

A small but efficient screened H.F. choke which will be found satisfactory in use in all circuits where the extra high efficiency of the L.M.S. Twin screened choke is an unnecessary extravagance. Suitable for long, medium and short wavelengths.

**2/6**

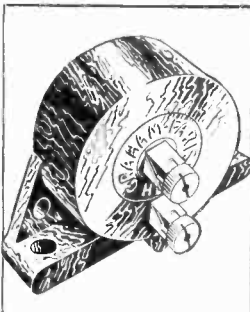

**DISC H.F. CHOKE**

This type of choke is particularly suitable as an H.F. stopper and in detector anode and reaction circuits. The moulded case enables the choke to be mounted on a metal chassis without fear of short circuiting and is an extremely handy little component where baseboard space is limited.

**2/-**

**L.M.S. TWIN SCREENED  
H.F. CHOKE**

The very latest in high-frequency practice, embodying the advantages of the binocular with the screened type. Its efficiency on long and medium wavelengths is of a very high order, while it may be satisfactorily employed for wavelengths as low as 12 metres.

Impedance at 500 metres, 400,000 ohms.

Inductance  
200,000  
microhenries

**4/6**

**THE PEAK OF PERFECTION**



**GRAHAM  
FARISH  
LIMITED  
BROMLEY  
KENT**

**ALL-ROUND  
SUPERIORITY  
FIRST-CLASS  
PERFORMANCE**

**THE WIDEST  
RANGE..THE  
LOWEST  
PRICE**

**1935  
RADIO**



**GRAHAM FARISH**

**LITLOS REACTION  
CONDENSER**

A very carefully constructed instrument, compact in size and efficient in design, with accurately gauged bakelite dielectrics and solid brass pigtail connection to moving vanes.

All capacities:—

·00005 mfd.	·00025 mfd.
·0001     "	·0003     "
·00015   "	·00035   "
·0002     "	·0005     "

**PRICE**

**2/-**

**LITLOS DIFFERENTIAL  
CONDENSER**

A highly efficient condenser similar in general construction to the above, but having two sets of fixed vanes, enabling the rotor plates to engage differentially between them. The terminals are somewhat differently disposed but otherwise the instrument is identical in outward appearance and construction to the other Litlos condensers.

All capacities up to  
·0005. mfd. Price

**2/-**

**LITLOS LOG MID LINE  
CONDENSERS**

Having a Logarithmic capacity variation, this condenser is eminently suitable for tuning purposes. It is also particularly suitable as a series condenser and has been specially designed for this purpose.

All capacities up to  
·0005 mfd. Price

**2/-**

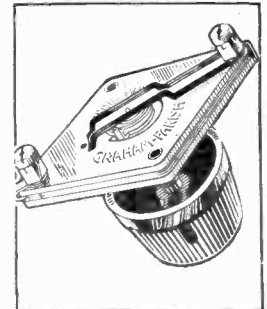
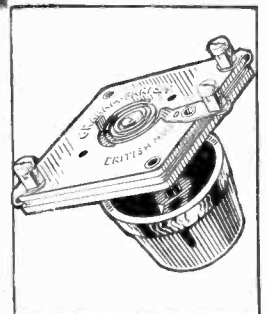



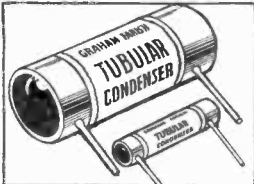

**TUBULAR CONDENSERS**

Hermetically sealed, very high insulation resistance, tested at 700 volts for normal 350 volts working. All capacities '00005 to '25. From **1/-**

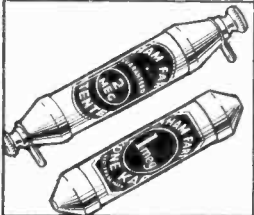

**STANDARD AND KONE KAP GRID LEAKS**

A well-constructed Grid Leak of the Carbon type, available in the normal conical ends or with terminals for each connection direct in the wiring. All values from  $\frac{1}{4}$  to 5 megohms. Kone Kap **9d.** Standard type. Price **10d.**

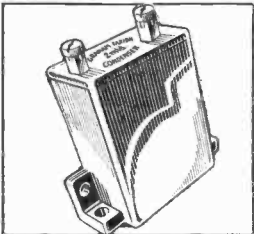

**MANSBRIDGE TYPE NON-INDUCTIVE CONDENSERS**

500 volt test 250 volt D.C. working. Insulation resistance 5,000 Megohm per mfd. Handsome bakelite case providing both upright and flat mounting (regd. design 723,271) All capacities '25 to 4 mfd. From **1/6**

**FIXED MICA CONDENSER**

Large scale production of this ever popular type of condenser has now enabled us to reduce the prices of certain capacities to astonishingly low levels. A complete range of capacities is available for upright or flat mounting, and are guaranteed accurate within very fine limits. Capacities '00005 to '01

**6<sup>d</sup>**

From

750 volts D.C. test.

**THE PEAK OF PERFECTION**

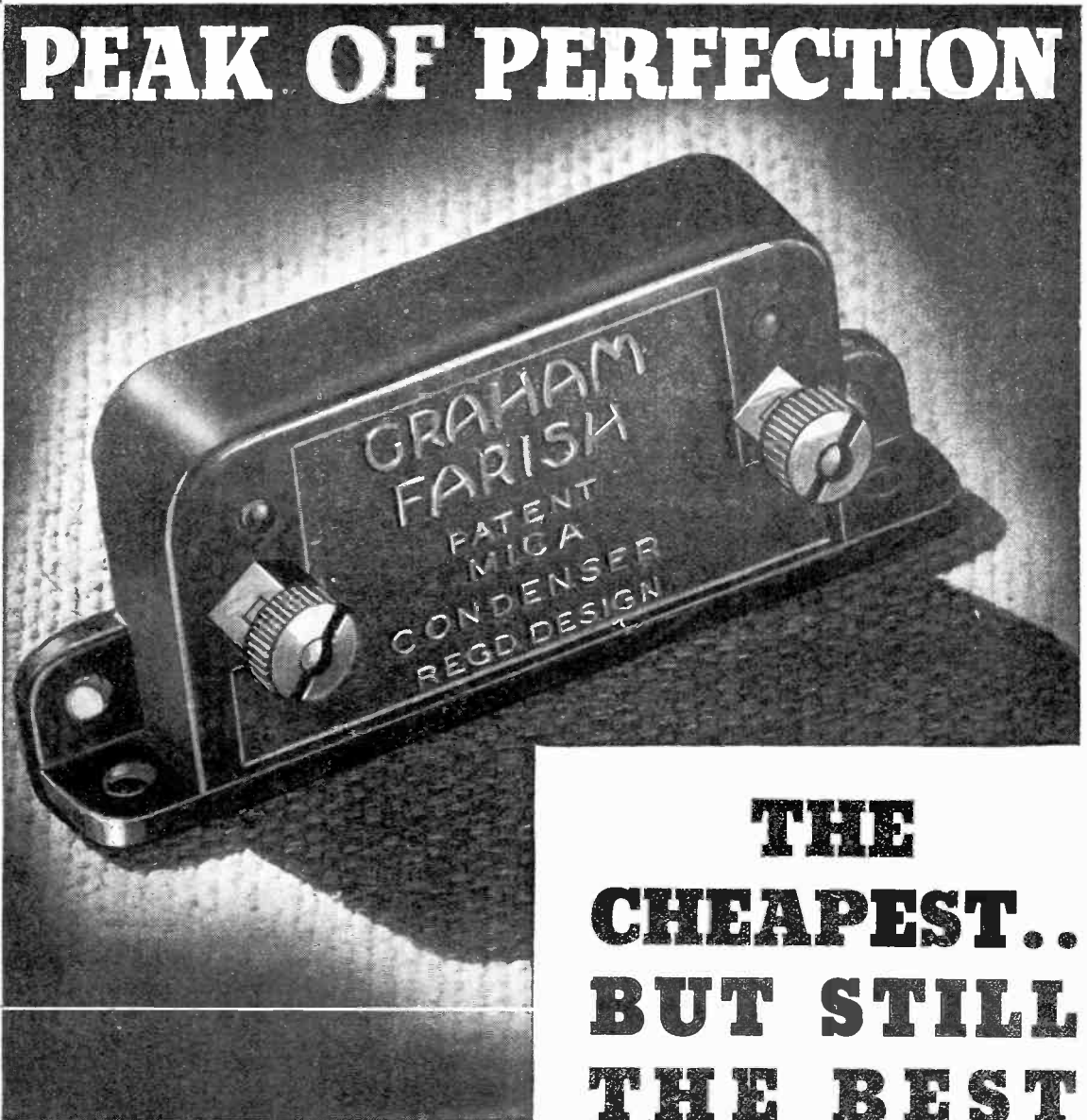

**GRAHAM FARISH LIMITED BROMLEY KENT**

**THE CHEAPEST.. BUT STILL THE BEST**

# The Contact

## An old favourite re-designed to

A CENSUS of wireless sets, and particularly of home-constructed sets, taken at any time until recently would have revealed the overwhelming popularity of the simple three-valver, the "Det. and 2 L.F." It has many features to recommend it, not the least being extreme simplicity in both building and operation. Unfortunately, with the development of broadcasting came the need for ever greater selectivity, a feature in which the "Det. and 2 L.F." in its original form did not excel. Experiments with tuning coils of large size and high efficiency, and with double-circuit tuning systems of various kinds, failed to raise the selectivity of this type of receiver to the necessary high degree, and so the straight three-valve circuit has fallen into disuse.

This is additionally unfortunate in that a second aspect of broadcasting development has tended to eliminate the one defect which even its devotees were forced to admit in the old days. Possessing no stage of high-frequency amplification before the detector valve, the circuit depended upon the critical use of reaction for anything at all ambitious in the way of distant reception; and, apart from the fact that the squeals and cat-calls resulting from careless use of

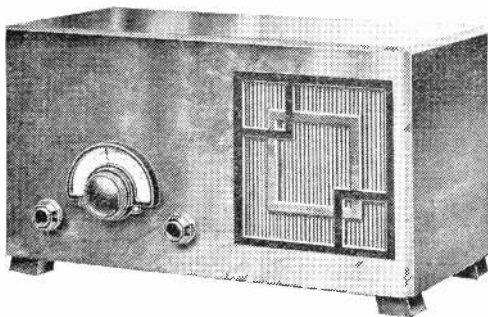

reaction were an intolerable nuisance, the performance of the set in regard to quality of reception was spoilt by running it "all out." Consequently, the straight three-valve set came to be regarded as a home-station receiver,

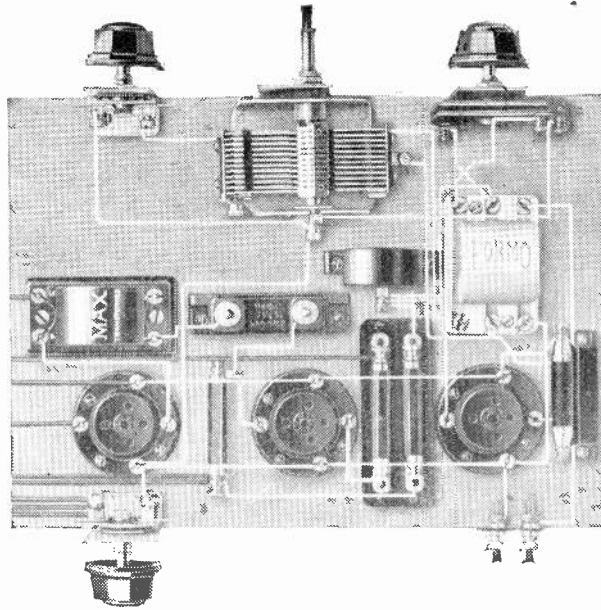

with occasional capability of bringing in two or three of the more powerful foreigners. But in the meantime the very features which have rendered an unselective set useless—the increase in the number and power of foreign stations—overcame the one possible objection to it on the score of limited range. Dozens of stations could be received at good strength and quality, but they could not be adequately separated.

And so we come to the "Stentorian," one of the most remarkable sets of recent years on account of its almost unlimited appeal. Possessing all the advantages of the old three-valvers in even greater degree, the disadvantages have been entirely eliminated, so that the home constructor can build, with a minimum of knowledge and skill, and at trivial expense, a set which makes the fullest possible use of the power and multiplicity of the European stations, and will pull in some of

the Americans in favourable conditions, and yet will give the full-throated, faithful reproduction which is essential for the reception of the nearer home stations.

The technical circuit diagram of this modernised version of an old favourite does not tell the reason why the Graham Farish designers have scored such a remarkable success, because the secret lies in the components. It was realised—indeed it was obvious—when the problem was first tackled that the most important point requiring attention was the tuning coil. No matter how nearly perfect any and

every other part of the set was made, it was wasted labour unless the coil possessed the necessary degree of selectivity to permit the reception of a

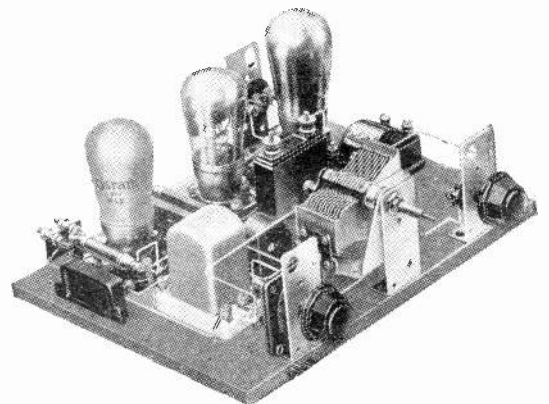

large number of transmissions unmarred by interference.

The coil, therefore, was the component upon which the Formo factory concentrated; and, to cut a long story short, eventually a Litz-wound, iron-dust-cored coil, mounted on a Steatite base, was

# Stentorian

## suit modern conditions

produced which more than met the requirements. This coil is of such small dimensions, when deprived of its screening can, that the improvement in both selectivity and sensitivity compared with the best of the larger air-cored types seems miraculous. Any words that might be used to describe its capabilities must appear to be like exaggeration, but actual test of the coil in working conditions shows that it does more than is claimed.

The circuit of the "Stentorian" is illustrated in these pages, and those who are capable of reading a technical diagram will see that there is an aperiodic aerial coil coupled to a single circuit tuned by a 0.0005-mfd. slow-motion variable condenser, with the usual wave-change switching arrangement.

Rectification is by a 0.0002-mfd. fixed condenser and a 1-megohm grid leak. A high-frequency choke is connected directly in the detector-anode circuit, and the coupling to the first L.F. stage is by means of the popular Graham Farish "Audion" resistance-capacity unit, which employs a 40,000 ohm Ohmite resistance, a 0.01-mfd. condenser, and a 1/2-megohm Ohmite, neatly mounted on a bakelite base and thus occupying a minimum of baseboard space. Reaction is controlled by a "Litlos" differential condenser, which, acting in conjunction with the H.F. choke, automatically balances the reaction feed-back to the detector grid circuit and the by-passing to earth of the H.F. energy appearing in the anode circuit which is not required for this purpose. The ideal of absolutely smooth reaction control and the prevention of unwanted H.F. passing into the L.F. amplification stages to cause distortion is thus secured.

The coupling between the 1st L.F. stage and the final power output valve is by means of a parallel-fed and auto-coupled Graham Farish transformer, in the design of which lies a part of the secret of the marvellously improved tone quality of this latest "Straight Three" as compared with the older versions.

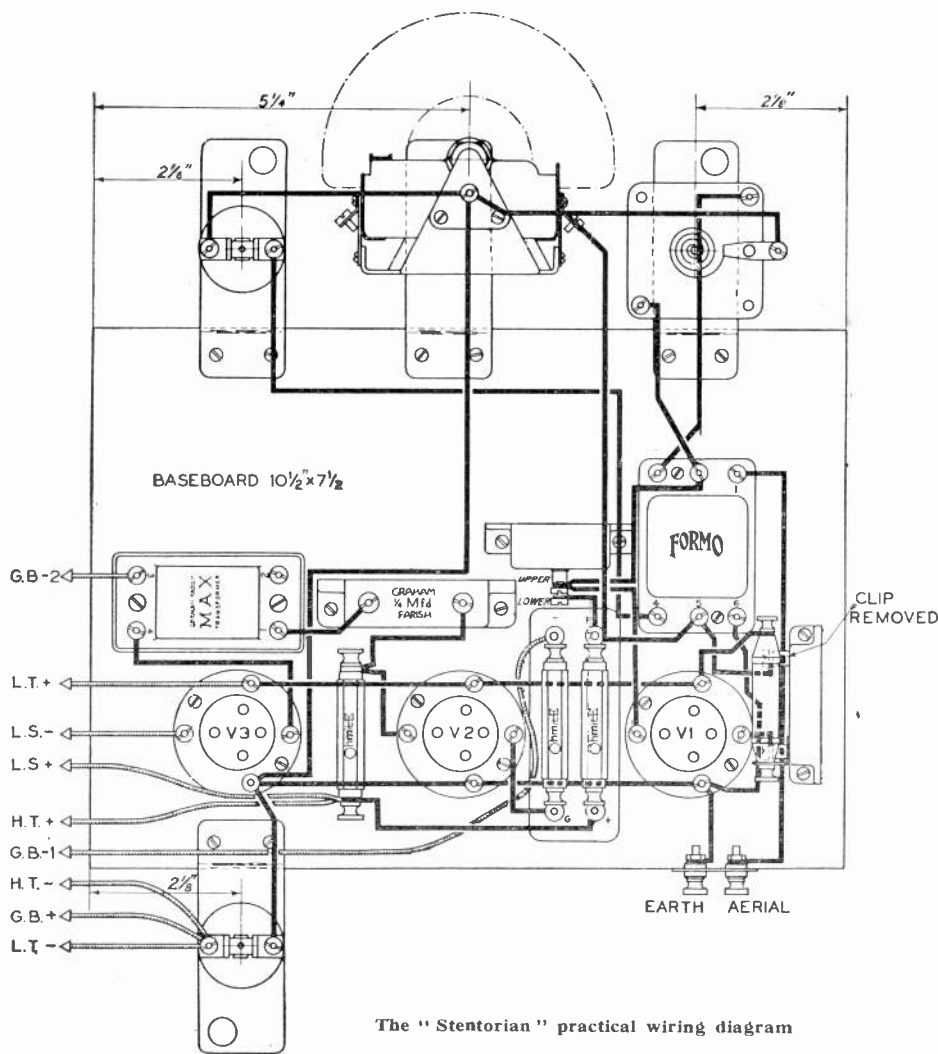

The "Stentorian" practical wiring diagram

A full size blue print can be obtained from The Editor, price 1/-

Output from the power valve to the loudspeaker is simple and straightforward, the tapped primary of the transformer which feeds the W.B. permanent-magnet moving-coil loudspeaker being connected in series in the anode circuit. This speaker is a type specially developed for the new "Contact" sets, and combines with dimensions suitable for inclusion in the standard "Contact" cabinet (which is designed to house any one of the three different receivers), a

bass response and general tone frequency range never before achieved in a speaker of its type.

Since there is but the one tuned circuit, tuning is of the true "one-knob" variety, with none of the difficulties and complications inevitably associated with the ganging of two or more different circuits. On the panel of the "Stentorian" there are two knobs, in addition to the central one which controls tuning.

(Continued on page 40)



# Economy Valves



**R**ADIO is no longer in its infancy. To-day it is included among the Exact Sciences and its interests are universal.

During its rapid growth there have been extraordinary developments made in all branches of what is now one of the World's leading industries. Yet, perhaps, in no branch has this development been more marked than in respect to the design and manufacture of the valve—the heart, as it were, of practically every receiving set now in use.

Not so very long ago only the triode (or three electrode) valve was available to both set maker and home constructor, with the result that circuits had to be evolved to meet the comparative restrictions imposed by such valves and such components as were then available. In general, looked at in retrospect, the result was unsatisfactory in many ways. In order to obtain distant stations giving very weak

signals in the locality of reception, several valves had to be used. In the first or high-frequency amplifying stages, valves gave but little gain per stage, and very often very small output. In addition, the valves and components were such that "sharp tuning" was impossible, and as new broadcasting stations were built the ether became more and more congested, so that interference between stations occurred owing mainly to the inability of the receiver to separate them. The natural consequence was a widespread demand for valves and components, and also circuits in which to use them, having very much higher efficiencies.

The first important development after the advent of the three-electrode valve was the screen-grid high-frequency amplifying valve, which, owing to its characteristics, enabled the set designer to reduce the number of high-frequency amplifying stages and yet retain the same performance in range. This is followed by what is now known as the output pentode, a natural development of the four-electrode screen-grid high-frequency valve, but suitable for low or audio-frequency amplification.

Although these two steps in valve development were what one might term "Epoch Making," many less significant advances also took place, just as component designers and circuit designers were engaged in evolving new ideas, all of which have gone to the building up of the present-day high performance and quality receivers. The performance of triodes, for example, was continually being improved by changes in electrode design, and research and experiment enabled superior Electron emitting mediums to be discovered. The old bright-emitter filament, which required a large amount of energy, was replaced by the dull-emitter filament, and this in turn was superseded by the modern high efficiency oxide-coated filament—the basis of all modern economy battery valves, and one which requires only a very small amount of energy to give far better performance than the bright-emitter valve.

Many other interesting developments have taken place, all of which have gone to build up the modern valve, but no good purpose would

be served by enumerating them here.

There are many valves now on the market, however, which represent all that is best in modern valve design, and which, when used in conjunction with the latest products of the component manufacturer, go to the making of sets having outstanding performance and quality, together with the utmost economy in battery consumption.

A typical example is the Osram VP21 (Fig. 1). This valve, which is known as a variable- $\mu$  high-frequency pentode, is a development of the screen-grid type, and owing to its characteristics it permits a high degree of amplification of a very small incoming radio signal. When used in conjunction with suitably designed iron-cored coils, such as the Formo Sensity type, the nucleus of a very high efficiency high-frequency stage is formed, whilst at the same time it is possible to obtain almost distortionless volume control. Since it is generally used in the first stages of the set, volume control at such a point has the important advantage of preventing overloading and consequent distortion in the following valves.

So far we have dealt, in the main, with general valve developments and gone a little further into those points which deal with the range properties of a set—namely, the high-frequency or radio-frequency amplifier. It must, however, be remembered that after the very weak signals that are received by the aerial have been amplified, their form has to be changed so that they are re-converted into intelligible speech or music as originally produced in the studio of the transmitting station. This is done by the detector stage. Several types of valve can be used in this position of the set, but their choice is almost entirely dependent on the remaining part of the circuit of the set. Where a high-efficiency detector stage is required a screen-grid valve, such as is used for high-frequency amplifying, might be used, but where there is already a considerable amount of high-frequency amplification a triode such as the Osram HL2K, or Osram HL2, can be used with definite advantage.



Fig. 1.



Spot welding—one of the many intricate operations in valve manufacture.

# for Battery Sets

Having converted the amplified radio-frequency signal into an intelligible form through the detector, we are faced with the problem of amplifying the speech and music so that it is brought up to sufficient strength to be heard through the medium of a loudspeaker.

As in the case of the high-frequency amplifier, several valves had to be used to amplify speech to a sufficient extent to work a loudspeaker in the earlier days, but now, due to valve and component development, it is very rarely necessary to use more than two valves following the detector, whilst in many cases only a single valve is used for low-frequency amplifying.

The main factor determining the amount of amplification required is the type of output or loudspeaker valve used, and the strength of the signal from the detector.

Using a normal triode valve as a detector, and a super output triode such as the Osram P2, an intermediate amplifying stage is generally required, but where a pentode is used the efficiency of the circuit can be made so high as to avoid the necessity for an intermediate amplifying stage.

It will be adduced from the foregoing

remarks that as valves and components have been improved, there has been an equal increase in economy, both in the number of components and valves and also in the current consumption of the set.

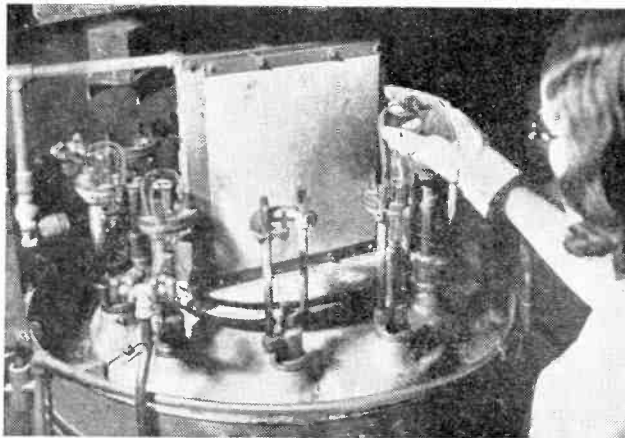

Sealing the Electrode assembly of the valve into its Glass Bulb.

As the result of one comparatively new development, an exceptional degree of economy in H.T. current has been secured in conjunction with a system called "Quiescent Push-Pull." By operating a pair of pentodes in a push-pull circuit and biased back so that the anode current of the two valves is almost completely cut off, the standing anode current, or

anode current taken by the valves when no signal is being received, is, practically, zero. As soon as a signal is imposed on the valves the anode current rises in proportion to the strength of the signal,

so that the average value of anode current during any particular broadcast is very much lower than the steady anode current of a normal pentode valve capable of giving the same output. This feature is of particular importance to the battery-set user, since it makes possible the design of a battery set, having an output almost comparable with many mains sets, and yet not requiring the very large amount of high-tension power used by a mains type output valve. A typical example of this type of valve is the Osram QP21 (see Fig. 2). This valve provides one of the most satisfactory output types yet devised for the battery-set user, especially when worked in conjunction with the necessary Graham Farish components and the Whiteley Boneham speaker, of the Stentorian Battery type such as is incorporated with "Contact" sets.



Fig. 2.



## SLOT Rules the waves

SLOT makes tuning easy. SLOT separates the stations and gives far keener, cleaner reception than you've ever known. Cut out interference and overlapping, increase selectivity without decreasing volume, get the stations you want clear and sharp by fitting SLOT to your aerial lead-in.

FROM ALL DEALERS  
Product of GRAHAM FARISH LTD., BROMLEY, Kent

# SLOT

AERIAL  
FILTER

# 2'



# The Contact

## A Powerful Two Valver Giving

**M**AINS volume and superb quality— with two valves! A few years ago such a claim would have been ludicrous, an obvious and gross exaggeration. But now it is just a plain statement of fact, difficult to believe, maybe, but easily demonstrable. It is a concise description of the performance of the Contact "Mystic Q." And "mains volume" means just that: 2 watts maximum of undistorted output, or sufficient to fill a small hall if required; and an easy 1.5 watts with the set working on a half-closed throttle!

The two-valve set has always been a useful "get-out" for either limited means or limited experience. Nothing could be simpler to build; and as to cost, one is getting very close to the irreducible minimum of equipment for a valve receiver. Until this "Mystic Q" made its appearance, however, limitation to two valves meant compromise; you said, on listening to a friend's set: "Yes, that's jolly good, considering it's only a two-valver!" Now, when you hear the "Mystic" for the first time, you will probably refuse to believe that such volume and quality are obtainable from "only a two-valver."

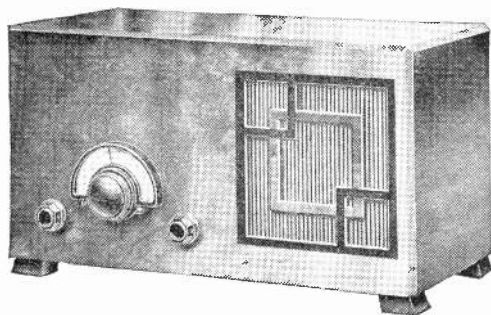

And, as a matter of fact, you will be quite correct! It isn't a two-valve really, although only two glass bulbs are used, and the process of buying and

building is on a two-valve scale. There is no need to make a mystery of the matter. The output valve is one of the new double Q.P.P. type, but although

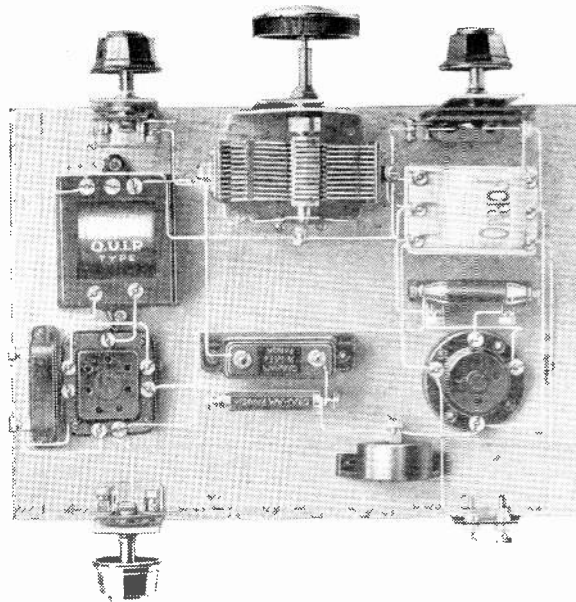

the effect is that of using two pentodes in quiescent push-pull in regard to volume and purity, all the necessary elements of the two pentodes are mounted in the single glass container. Further, the running cost in high-tension consumption is lower than that of a two-valver which even approaches the performance of the "Mystic Q." because the quiescent push-pull system is designed to proportion its H.T. consumption in strict relation to the power of the signals. A strong signal or loud passage of music calls for relatively heavy consumption, while on quiet passages the consumption is proportionately reduced, and during an actual

interval in transmission the consumption is at a minimum of a mere milliamp or so. With the ordinary amplifying system the rate of consumption is steady and permanent, no matter what the loudspeaker volume; in fact the two points have no relationship whatever. Thus the average consumption of the quiescent push-pull system is considerably lower than that of any equivalent system of ordinary amplification, and the effect is that you can either have much greater volume for the same cost in H.T. current or the same volume at lower cost.

In the Q.P.P. system as employed in the "Mystic Q" the former alternative is adopted, and that is how it is possible to obtain real, honest mains performance without increasing building and running costs to the point of prohibition.

But this is only one of the many outstanding features of the set, which in its class is the most sensational production of the year.

It can be imagined that, in spite of being "only a two-valver," for home-station reception and gramophone

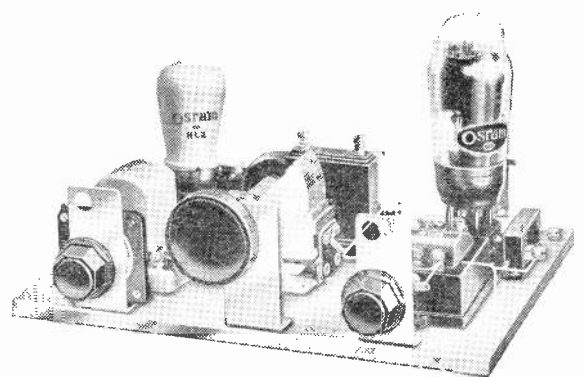

reproduction, or for providing the necessary rhythm for dancing purposes, the "Mystic Q" leaves nothing to be desired. But even as a long-distance radio

# Mystic Q

## An Astonishing output of 2 Watts

receiver the set does not fear comparison with much more ambitious apparatus, since, in spite of the fact that there are no preliminary stages of high-frequency amplification before the detector, modern valve and component design have made it possible to produce a detector stage which is easily equal to the "I.H.F. and Det." of a few years ago. The secret of this, as of the other "Contact" sets presented to readers in this first number of the magazine, is the Formo iron-dust-cored, Litz-wound "Sensity" coil, which permits full advantage to be taken of the increased power and number of European broadcasting stations without overlapping of the closely spaced stations.

With this coil all transmissions within range (and the range is very wide) that are themselves correctly adjusted to the accepted standard of 9-kilocycle separation can be received quite clear of mutual interference. This fact, combined with greater transmitting power and valve developments, practically eliminates the need for one stage of H.F. amplification in any receiver, as to a very large extent this is only inserted for the sake of the extra selectivity of the additional tuned circuits associated with it. But if you can obtain that same degree, or even better, without the stage of H.F. amplification, why use it?

Well, that is the second secret of the "Mystic Q's" almost uncanny performance. The "Contact" designers have, in effect, added a valve at either end of the mere two-valver, transforming it into a very lusty "four." By the inherent qualities of the Formo tuning coil the necessary degree of selectivity for modern conditions is gained, thus allowing the unaided detector to operate with an efficiency previously obtainable only with a high-frequency stage as well; and by virtue of the high-ratio Q.P.P. transformer and its associated double Q.P.P. valve, the effect of two stages of low-frequency amplification at a purchase and maintenance price of one is secured.

And that is how super four-valve

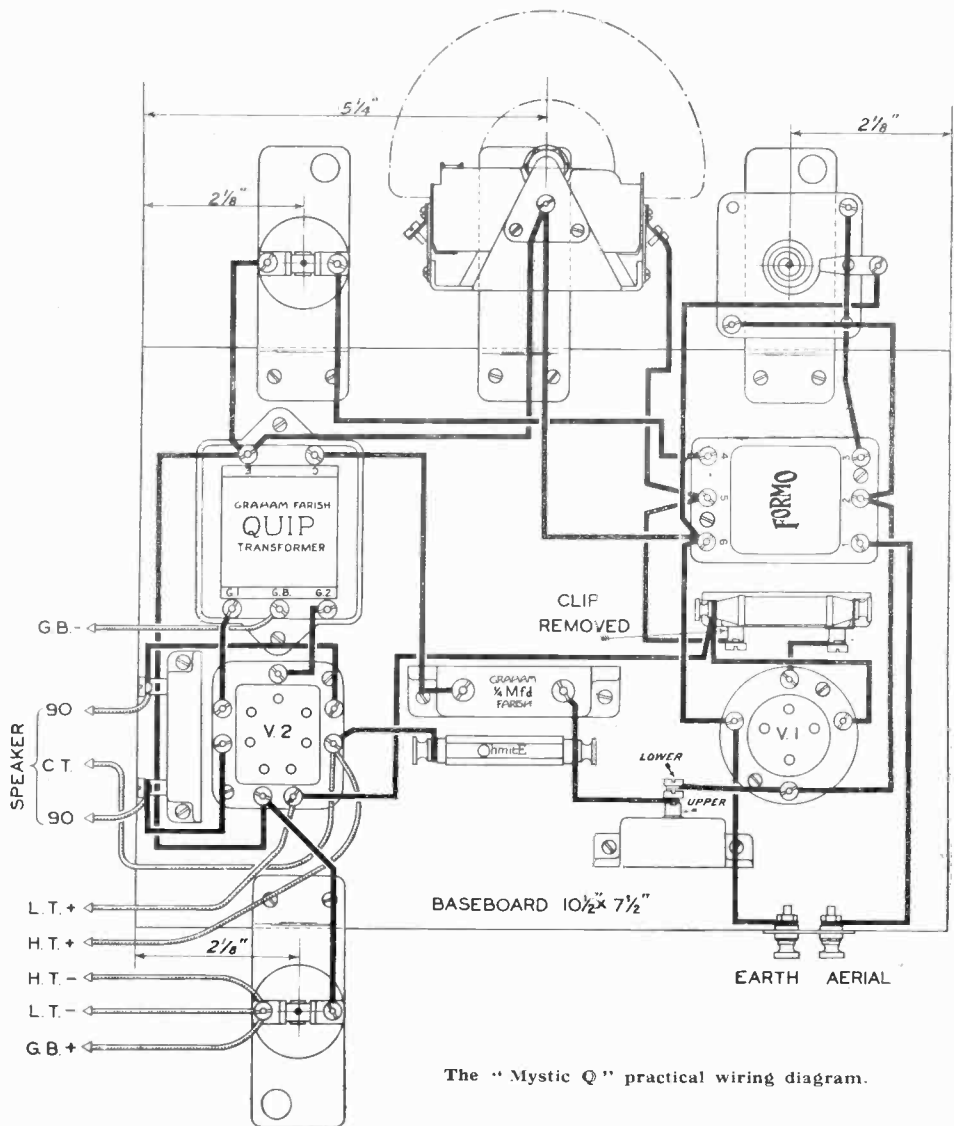

The "Mystic Q" practical wiring diagram.

A full-size blue print can be obtained from the Editor, price 1/-.

results are obtained from "only a two-valver."

The detector circuit being perfectly straightforward and devoid of unnecessary "trimmings," the operation of the "Mystic Q" is reduced to ultimate and utter simplicity. Having switched the set on, there is just the central tuning knob to turn, and that's all. The knife-edged pointer traversing the

illuminated, full-vision dial tells you exactly where you are in the wavelength range; and if, being on the short waves, you pine for long-wave reception, you turn the right-hand knob. Perfectly satisfactory reception of the nearer and more powerful stations is possible without ever touching the left-hand reaction control at all, though careful use of this knob will naturally increase



**The Contact Mystic "Q"** (continued from page 37)

the range of the set enormously for distant reception. Here, again, however, the simplicity of the set is delightful, for, in moving the reaction control in either direction, two separate but equally essential operations are performed simultaneously, the by-passing of surplus high-frequency energy in the detector anode circuit being automatically increased as the degree of reaction is reduced, and vice versa. This ensures not only that the reaction control shall be absolutely smooth, so that the full potential efficiency of the set may be employed, but that a minimum of interference with the tuning of the main circuit shall take place as a result of variation of the reaction control.

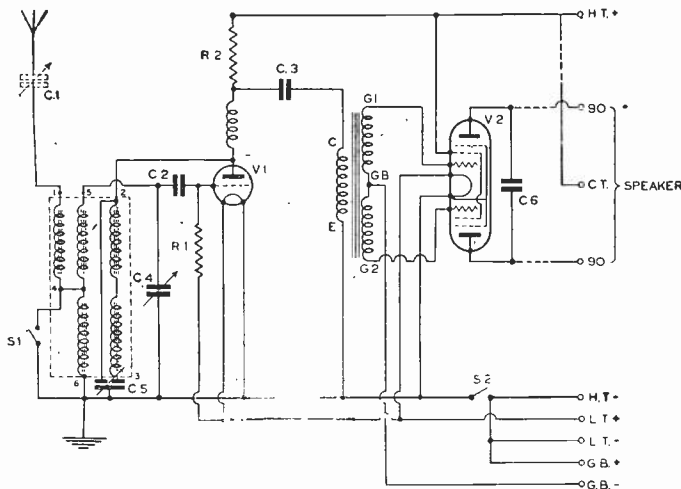

The Mystic "Q" circuit diagram

It is rather amazing, even to those of us who have been associated with the gradual production of the set in all its stages, that so small and simple an apparatus should be capable of such amazing results. Neither on paper, in the form of a technical specification, nor in baseboard form is the Mystic "Q" at all impressive, except in its absolute simplicity and the small number of components and amount of wiring. Yet all these highly technical points, which have already been dealt with at some length, are fully dealt with in the design. There is literally nothing known to modern radio progress that could be added to the design to improve it. It is the absolute last word in modernity.

So far as external appearance is concerned, the general lines of all three "Contact" sets are identical, the cabinet and the panel arrangement being the same. Single-knob main control, with the reaction and wavechange knobs equally spaced on either side, distinguish all three, while the on-off switch position at the rear of the cabinet is also standard. Common to all is the W.B. permanent-magnet moving-coil loudspeaker, specially designed for use with the "Contact" sets; and in regard to the remarkable volume and wonderfully good quality of the Mystic "Q" performance in particular, it is only fair that due credit should be given to the speaker for the perfect manner in which its particular functions are carried out. This speaker is of the modern small type, mounted in the cabinet with the set: but, unlike most other miniature moving-coil loudspeakers, the pitch, quality and volume are unimpaired by the reduced dimensions. In fact, without the slightest exaggeration it is possible to say that the "Contact" W.B. speaker has no need to fear comparison on results alone with instruments of much larger actual size and of very considerably higher cost. It should be realised that the speaker was not merely chosen by the "Contact" designers because in various respects it suited the "Contact" receivers; it was specially designed to operate in conjunction with them.

**LIST OF PARTS REQUIRED for The MYSTIC "Q"**

	s.	d.
1 Disc H.F. choke . . . . .	Graham Farish . . . . .	2 0
1 Quip transformer . . . . .	Graham Farish . . . . .	10 6
1 7-pin Valve Holder . . . . .	Graham Farish . . . . .	1 3
1 4-pin Valve Holder . . . . .	Graham Farish . . . . .	6
1 .0005-mfd. Variable condenser with "Mystic" drive . . . . .	Formo Products . . . . .	6 6
2 2-point Rotary switches . . . . .	Snap Switches . . . . .	1 8
1 .0003-mfd. Litlos Differential condenser . . . . .	Graham Farish . . . . .	2 0
1 .25-mfd. Mansbridge type condenser . . . . .	Graham Farish . . . . .	1 6
1 .0002-mfd. Fixed Mica condenser C.2 . . . . .	Graham Farish . . . . .	6
1 1-meg. Grid leak (Standard type) R.1 . . . . .	Graham Farish . . . . .	10
1 Sensity coil. Type A.1 . . . . .	Formo Products . . . . .	5 0
4 Brackets . . . . .	Graham Farish . . . . .	1 4
1 40,000 Ohmite resistance R.2 . . . . .	Graham Farish . . . . .	1 6
1 .005 Fixed Mica condenser C.6 . . . . .	Graham Farish . . . . .	1 6
2 Terminals (A and E).		
1 Terminal strip.		
Baseboard : $7\frac{1}{2}'' \times 10\frac{1}{2}'' \times \frac{3}{8}''$		

**ACCESSORIES :**

VALVES : V.1—Osram H.L.2. V.2—Osram Q.P.21.

BATTERIES : Drydex H.T. 120v. Red triangle. Type H.1006

Drydex G.B. 9v. Type H.1001

Exide L.T. accumulator. Type D.F.G.45

CABINET : British Radiogram "Contact Mystic Q."

LOUDSPEAKER : W.B. "Stentorian Baby" specially designed by Whiteley Electrical Radio Company.

**1935 Loud Speaker Design** (continued from page 39)

provide that extra margin of power which was necessary if the "Whiteley" speech-coil and larger air gap were to be used.

Then came the realisation that the requisite power would never be obtained with any known magnetic material, and that if the experiments were to be successful a new and more efficient magnetic material was necessary.

The company approached a leading firm of steel manufacturers, and suggested certain lines of research. Experiments were continued in conjunction with the steel manufacturer's technicians, and after a few months an entirely new magnetic material was perfected.

An alloy of four metals in a certain fixed proportion, it is manufactured under a patented process. It gives over three times the magnetic strength of good cobalt steel of equal weight, and double the power of an ordinary magnet at the same cost.

Actually its efficiency is such that a gap large enough for the "Whiteley" speech-coil and a startling *extra* sensitivity are obtainable at the same time. The new W.B. "Stentorian" speakers give nearly double the volume of any previous commercial speaker at equal cost; and at the same time the use of the "Whiteley" speech-coil brings benefits in the form of vividness, clarity, and crisp attack far beyond accepted standards.

And thus a new sort of moving-coil speaker is being announced to the public. The man in the street will hear that it is good. He will try it and hear an improvement. He will incorporate it in his set. To him it is a very simple affair, but to the manufacturers it represents the culmination of over two years of hard work and expensive research; and a great and important step forward in the increasing popularity so essential to their continued success.

# 1935 LOUD SPEAKER DESIGN

THIS month will see the announcement to the public of a new sort of moving-coil speaker. To the man in the street such an event is a very simple affair. He hears that a certain speaker or component is good; he tries it, and hears a distinct improvement; he incorporates it in his receiver, and that forms just one step forward in the gradual process of increasing the entertainment value of radio and radio construction.

Have you ever thought of such an event's aspect to the radio manufacturer and his research or production executives? For them the discovery, checking, testing, and adoption of a new principle or design is a matter of enormous importance. For in the constant procession of radio progress the lot of the straggler is indeed hard.

Constant vigilance, incessant experiment, and an eternal discontent with standards of performance generally considered satisfactory are essential characteristics to any progressive radio manufacturer. Such a company may spend years in the development of one new feature. When a successful result is reached and announced, it is seldom that the ultimate consumer realises what effort and expense were necessary to bring about the improved results which he enjoys.

The new W.B. "Stentorian" range of speakers forms an excellent example of this. Here is a case of a valuable invention depending

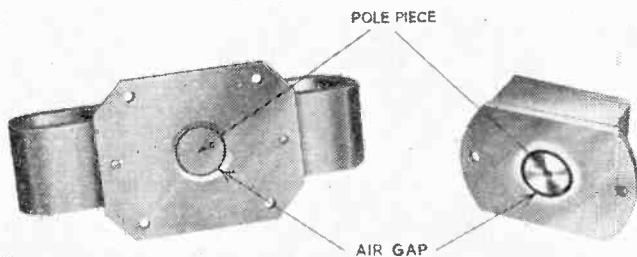

for its commercial success upon another invention yet to be made: of long and tireless further research, and of final triumph.

Over two years ago W.B. engineers perfected a new method of speech-coil assembly which gave better "attack," fuller natural bass response, and more "forward" reproduction than any of the accepted methods. But the "Whiteley" speech-coil, as it was named, had one serious drawback. It necessitated the use of a larger "air gap" in the magnet; and the commercial permanent magnets available were not powerful enough to allow of this larger "air gap" without a serious falling off in sensitivity.

So while the "Whiteley" speech-coil was incorporated in W.B. public address loudspeakers (in which the extra cost of enormous magnets was immaterial) the domestic range of moving-coil speakers continued to follow standard practice as regards speech-coil assembly, until such time as a new and much more powerful magnet could be produced at a reasonable cost.

Meanwhile, the W.B. research staff concentrated on magnet design. The "Mansfield" magnetic system, a method of construction which concentrates the magnetic flux into the air gap and avoids waste of energy, was developed. It gave 30 per cent greater power than a good cobalt steel magnet of equal weight. It was far better than any previous magnet design, and was promptly patented and incorporated in the current models. But it did not

(Continued on page 38)

**MAKES THIS WORLD A BETTER EARTH**

**GRAHAM FARISH FILT PERCOLATIVE EARTH**

There are possibilities in your set that you'll never know if your Earth is inefficient. Filt has achieved astonishing improvements on every type of set in Range, Tone, Volume and Purity simply because Filt is the most efficient Earthing System in the World. Expert Advisers - on every Technical Journal, Star Set Designers and a million Listeners endorse the claims of Filt. Don't handicap your Set, get Filt from your dealer to-day.

# 2/6

Product of GRAHAM FARISH, LTD., BROMLEY, KENT.

The Contact "Stentorian" (Continued from page 33)

the left-hand being the reaction control, and the right-hand the rotary wave-change switch. The main on-off L.T. switch, inserted in the negative lead, is situated at the rear of the cabinet.

The highest possible efficiency combined with extreme simplicity in building, operation and appearance, are the keynotes of the "Stentorian." As will be seen from the illustrations, the external appearance is in keeping with the trend of modern design; while internally, although all the components are mounted above the baseboard, where they are readily accessible in case attention is subsequently required, there is an entire absence of any suggestion of crowding, while the wiring is all visible and traceable without confusion even by the inexpert user.

Apparent simplicity is often obtained by means of concealment of both components and wiring, which also lends itself to an open layout, but one of the most noteworthy points of the "Stentorian" is the fact that if ordinary care is used in construction, every wire

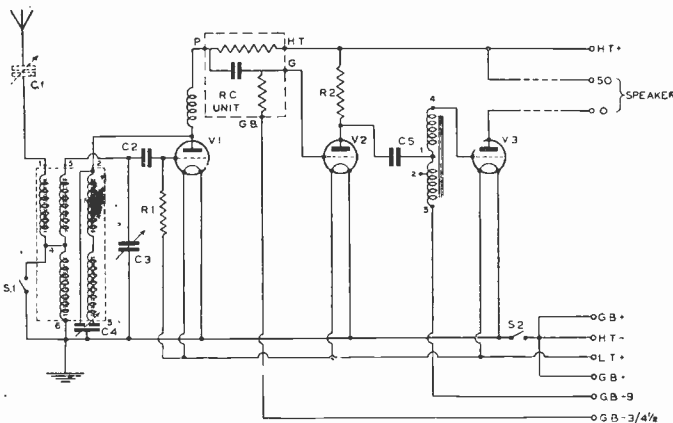

The "Stentorian" circuit in tabloid form

and every component is instantly accessible on withdrawing the receiver from the cabinet. For the absence of crowding the small dimensions of the Formo "Sensitivity" tuning coil and the "Max" Parallel Feed Transformer are largely responsible, while the fact that the simple circuit requires only a single variable condenser permits a symmetric and well-spaced layout.

The floodlit tuning dial merits a note to itself, since it combines with the simplest one-hole fixing method an appearance and a usefulness for fine tuning purposes that is in keeping with the most modern practice. The dial is of the full-vision type, lighted by a concealed bulb, and a knife-edged pointer traverses the exceptionally open scale as the control knob is turned. The latter also actuates ingenious mechanism which gives an adequate gear reduction with total freedom from backlash, and with the velvet smoothness of action so much to be desired and so seldom obtained.

To sum up, the "Stentorian" is a set ideally suited to construction by the inexpert, and requiring little skill to operate, which has, none the less, a performance far in advance of that of any receiver of similar type ever before evolved. It is the Perfect Family Set with which anyone can obtain good results; but its capabilities are so high in expert use that even the most blasé of wireless fans must derive pleasure from its use.

**LIST OF PARTS REQUIRED for THE "STENTORIAN"**

	s.	d.
1 Max Transformer . . . . .	Graham Farish	4 6
3 4-pin Valve Holders . . . . .	Graham Farish	1 6
4 Brackets . . . . .	Graham Farish	1 4
2 2-point Switches . . . . .	Snap Switches	1 8
1 .0005-mfd. Variable condenser with "Mystic" dial . . . . .	Formo Products	6 6
1 .0003-mfd. Litlos Differential condenser . . . . .	Graham Farish	2 0
1 Disc H.F. choke . . . . .	Graham Farish	2 0
1 Audion R.C. coupling unit . . . . .	Graham Farish	4 6
1 .25-mfd. Mansbridge type condenser . . . . .	Graham Farish	1 6
1 Sensity coil. Type A.1. . . . .	Formo Products	5 0
1 .0002-mfd. Fixed Mica condenser . . . . .	Graham Farish	6
1 1-meg. Grid leak(Standard type) . . . . .	Graham Farish	10
1 20,000-ohm Ohmite . . . . .	Graham Farish	1 6
Terminal strip . . . . .		
Aerial and earth terminals . . . . .		
Quantity of wire, etc. . . . .		
Baseboard, 7½" × 10½" × ⅜" . . . . .		
VALVES: V.1.—Osram H.L.2. . . . .	V.2—Osram L.2. . . . .	V.3—Osram P.2.
BATTERIES: Drydex H.T.120v. Red Triangle. Type H.1006. . . . .		
Drydex G.B. 9v. Type 1001. . . . .		
Exide L.T. accumulator. Type D.F.G.45. . . . .		
CABINET: British Radiogram "Contact Stentorian." . . . . .		
LOUDSPEAKER: W.B. "Stentorian Baby." specially designed by Whiteley Electrical Radio Co. . . . .		

**ASK YOUR DEALER TO RESERVE A COPY OF THE SECOND NUMBER OF "CONTACT" FOR YOU.**

CUT HERE

**"CONTACT" QUERY COUPON**

The actual designers of the "Contact" Receivers described in this issue are prepared to answer all queries from readers in connection with the operation or construction of these sets.

Queries must have this coupon attached, together with a Postal Order for 1/-, and should be addressed to:

**"CONTACT" DESIGNERS,  
153 MASONS HILL,  
BROMLEY - KENT**

The Editor will also be pleased to have readers' opinions on this, the first issue of "Contact," and any suggestions for articles or receivers which they wish to have dealt with in the second issue.



# A Guide to RADIO 1935 PRICES

**FORMO VARIABLE CONDENSERS.**

2-Gang Condensers, Type DU5, with floodlit chrome Drive...	11/-
2-Gang Condensers, Type DU5, with floodlit chrome Drive and Dust Cover	12/6
Single Unit Slow-Motion Condenser, Type SU5, with Mystic Drive	8/6

**FORMO SENSITY COILS.**

Sensity Iron-Cored Coils:	
Aerial Coil, T1 (without reaction)	5/-
" " A1 (with reaction)	5/-
H.F. Coil, PPI	5/-

**FORMODENSERS.**

Type F	0001 mfd.	1/8
" J	0003 mfd.	1/8
" G	001 mfd.	1/8
" H	002 mfd.	2/3

**FORMO SCREENED PAPER CONDENSERS.**

.1 mfd.	1/8
.2 "	1/8
.25 "	1/8
.5 "	1/9
1 "	2/-
2 "	3/-

**GRAHAM FARISH FIXED MICA CONDENSERS.**

00005 mfd.	8d.
0001 "	8d.
0002 "	8d.
0003 "	1/-
0004 "	1/-
0005 "	1/-
001 "	1/-
002 "	1/-
003 "	1/-
004 "	1/-
005 "	1/8
006 "	1/8
01 "	1/8

**GRAHAM FARISH TUBULAR FIXED CONDENSERS.**

00005 mfd.	1/-
0001 "	1/-
0002 "	1/-
0003 "	1/-
0005 "	1/-
001 "	1/-
002 "	1/-
003 "	1/-
004 "	1/-
005 "	1/-
006 "	1/-
01 "	1/3
02 "	1/8
05 "	1/8
1 "	1/8
2 "	1/8
25 "	1/8

**GRAHAM FARISH MANSBRIDGE TYPE CONDENSERS.**

.1 mfd.	1/8
.2 "	1/8
.25 "	1/8
.5 "	1/9
1 "	2/-
2 "	3/-
4 "	5/8

**GRAHAM FARISH LITLOS DIFFERENTIAL CONDENSERS.**

00005 mfd.	2/-
0001 "	2/-
00015 "	2/-
0002 "	2/-
00025 "	2/-
0003 "	2/-
00035 "	2/-
0005 "	2/-

**GRAHAM FARISH VALVE HOLDERS.**

4-pin	8d.
5 "	8d.
7 "	1/3
9 "	2/-

**GRAHAM FARISH LITLOS LOG MID LINE CONDENSERS.**

00005 mfd.	2/-
0001 "	2/-
00015 "	2/-
0002 "	2/-
00025 "	2/-
0003 "	2/-
00035 "	2/-
0005 "	2/-
00075 "	3/8
001 "	4/8

**GRAHAM FARISH LITLOS REACTION CONDENSERS.**

00005 mfd.	2/-
0001 "	2/-
00015 "	2/-
0002 "	2/-
00025 "	2/-
0003 "	2/-
00035 "	2/-
0005 "	2/-
00075 "	3/8
001 "	4/8

**GRAHAM FARISH H.F. CHOKES.**

Disc H.F. Choke	2/-
H.M.S. Single Screen	2/8
L.M.S. Twin Screen	4/8

**GRAHAM FARISH KONE KAP GRID LEAKS.**

1 meg.	9d.
1 "	9d.
2 "	9d.
3 "	9d.
4 "	9d.
5 "	9d.

**GRAHAM FARISH STANDARD TYPE GRID LEAKS.**

1 meg.	10d.
1 "	10d.
2 "	10d.
3 "	10d.
4 "	10d.
5 "	10d.

**GRAHAM FARISH TRANSFORMERS**

Pip L.F. General Purpose 1-3	6/8
Pip L.F. General Purpose 1-5	6/8
Class B Driver, 1-1, 1-2-1, or 1-5-1	8/8
"Max" Parallel feed	4/8
Quip Q.P.P., 1-8 ratio	10/8

**GRAHAM FARISH 1 1/2-watt type OHMITE RESISTANCES.**

50	1/8
100	1/8
150	1/8
200	1/8
250	1/8
300	1/8
350	1/8
400	1/8
450	1/8

500	1/8
550	1/8
600	1/8
650	1/8
700	1/8
750	1/8
800	1/8
850	1/8
1,000	1/8
1,500	1/8
2,000	1/8
2,500	1/8
3,000	1/8
4,000	1/8
5,000	1/8
6,000	1/8
7,000	1/8
8,000	1/8
10,000	1/8
15,000	1/8
20,000	1/8
25,000	1/8
30,000	1/8
35,000	1/8
40,000	1/8
50,000	1/8
60,000	1/8
70,000	1/8
80,000	1/8
100,000	1/8
150,000	1/8
200,000	1/8
250,000	1/8
300,000	1/8
500,000	1/8
1 megohm	1/8
1.5 meg.	1/8
2 "	1/8
3 "	1/8
4 "	1/8
5 "	1/8

**GRAHAM FARISH 3-watt type HEAVY DUTY OHMITE RESISTANCES.**

(All sizes as above 2/3 each)

**GRAHAM FARISH HOLDERS.**

Horizontal type	8d.
Vertical "	8d.
Universal "	8d.
H. D. Ohmite	8d.

**GRAHAM FARISH OHMITE VOUME CONTROLS.**

1,000 ohms	2/9
2,000 "	2/9
3,000 "	2/9
4,000 "	2/9
5,000 "	2/9
10,000 "	2/9
15,000 "	2/9
20,000 "	2/9
25,000 "	2/9
30,000 "	2/9
50,000 "	2/9

**GRAHAM FARISH:**

Filt Percolative Earth	2/8
Refill	1/8
Gard Automatic Lightning Arrester	2/-
Resistance Capacity Unit	4/8
Slot Aerial Filter	2/-
Booster Unit	7/6
"Single Span" Coils (set of 7)	12/6
Base-board Pre-set condensers:	
00005 mfd.	1/-
00001 "	1/-
Brackets, each	4d

**THUNDER  
STORMS  
ARE HERE**



## 'WARE LIGHTNING

Do you realise the danger that lurks in an unprotected aerial? A thunderstorm, a lightning flash, and your set may be ruined, your home endangered. Why risk it? A GARD Automatic LIGHTNING ARRESTER gives *permanent* protection, takes a moment to fit, costs but two shillings. With GARD on your aerial lead-in you listen with perfect safety throughout the fiercest storm. GARD cannot affect reception quality, but it brings peace of mind beyond price. Get a GARD to-day.

# GARD

AUTOMATIC

## LIGHTNING ARRESTER

From all Dealers  
2/-, or post free  
from Sole Manu-  
facturers:

# 2/-

While you are buying a Gard Automatic ask for Filt Percolative Earth which improves reception out of all knowledge.

Filt costs 2/6

GRAHAM FARISH LTD., BROMLEY, KENT

### CAUTION!

See you get the genuine  
Graham Farish GARD,  
its efficiency is covered  
by a

**£200  
GUARANTEE**