

HOBBIES WEEKLY

IN THIS ISSUE

	Page
Match Box Crystal Set	433
Hobbies Crossword No. 4	434
More Tricks with Cards	435
Flowers in the Window	435
Running Your Railway	436
Handy Holder for Meter Shillings	437
Make Your Own Adhesive	438
Novel Napkin Holders	439
Patterns for Easter Novelties	440
Chemistry in the Home	442
A Box for your Cactus Plants	444
A Quaint Bird Design	447



APRIL 3rd 1957

VOL. 123

NUMBER 3205

Simple to make and efficient **MATCH BOX CRYSTAL SET**

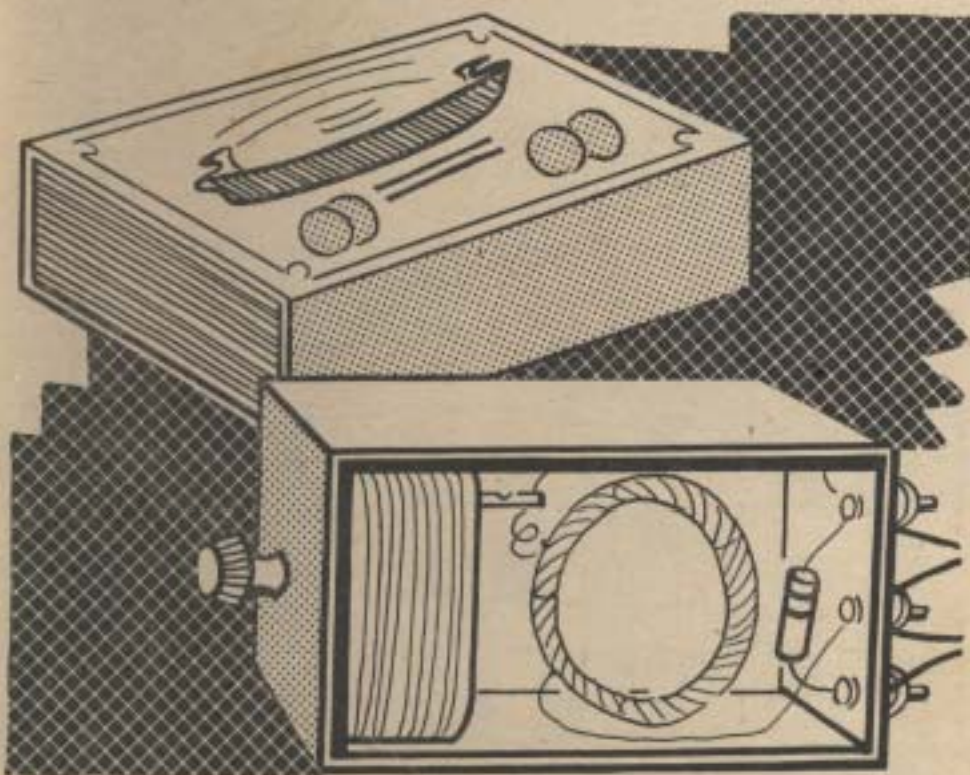

THE crystal receiver remains popular, doubtless because it requires no mains supplies or batteries whatever. The one described here is very simple to construct indeed, and is built in a matchbox, which forms a ready-made case. (A metal container or tin must *not* be substituted, as the proximity of metal to the coil greatly weakens signal strength.)

Tuning is by means of a pre-set, compression type condenser, usually known as a 'padder' when made with a capacity such as that required, which is $0.0005\mu\text{F}$. The ceramic type of padder will fit in the end of the matchbox tray.

A little thin insulated wire is required for the coil, the gauge not being important. Very fine wires reduce efficiency, so that something of about 28 to 32 S.W.G. is most suitable. The wire may be enamel, cotton or silk covered.

The detector is of permanent type, as this does not need adjusting to a sensitive spot, as with the old type of detector. If not mis-used, it will be almost everlasting.

Points on Building

Fig. 1 shows all connections and parts, and is so straightforward that no error should arise. It is worth noting that the set can function reasonably well with the $0.0005\mu\text{F}$ condenser omitted but it will then be necessary to experiment with the number of turns on the coil, to secure the local station, and no variable tuning will be possible. The coil will also have to be wound with quite a lot more turns, according to the station wavelength.

All correspondence should be addressed to The Editor, Hobbies Weekly, Dereham, Norfolk

For Modellers, Fretworkers
and Home Craftsmen

4½^D

PAGE 433

Be a 'thought reader'

More Tricks with Cards

REQUIRING no more apparatus than a pack of cards, the thought reading type of trick is ever popular.

For the first of these two tricks take out twenty-six cards from the pack, composed of half red suits and half black. It is preferable that the whole is a mixture of hearts, diamonds, clubs and spades, but there must be an equal number of each colour.

The performance of the trick will be explained first, then the actual mechanics of the trick.

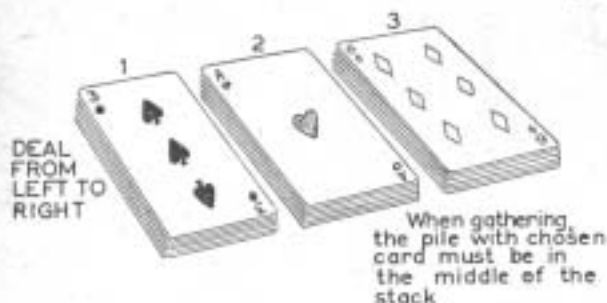

Fan out the cards, asking one of your audience to select a card, drawing it out of the pack, noting its value and suit very carefully. It may be shown to other members of the audience but not to you. You should observe, casually, from where the card was drawn. While the card is being examined, close the cards together, fan out again, asking for the selected card to be replaced in the pack.

You now ask for the full co-operation of your opponent and audience by concentrating on the particular card, while you are endeavouring to find it. Looking through the pack, now facing you and with the backs of the cards to the audience — with perhaps a show of hesitation — request a little more effort for concentration, when lo and behold, you select the correct card.

This is how the trick is done.

Before starting, arrange your twenty-six cards so that all the red ones are together and all the black ones together. When the cards are fanned out you must hold them so that your opponent has little option but to take either a black or red card. While the examination is being made, the cards are closed together again and fanned out the opposite way, so that the other coloured cards are offered for replacing the selected one. For example, if a red card has been chosen, by offering that end of the pack, the cards are fanned out so that only the black ones are available for inserting the card. When the red card is replaced among the black ones it is quite a

simple matter to detect it, and incidentally the chosen card. A little practice in the manipulation of the cards will soon reveal the method of holding.

For the second trick, remove any five cards, leaving twenty-one in the pack. These cards are then given to a member of the audience, who is asked to select one without revealing the choice.

Now this trick is entirely different from the first and depends entirely on the way you handle the cards. Read these instructions carefully, then try it out for yourself.

Having received the cards back from your opponent they are dealt out in three piles face upwards. Start with one card on the left, the next beside it and then the third, so that you begin three stacks. Return to the left, dealing out the 21 cards so that you have three piles of seven cards. At the start of the dealing you ask your

opponent to watch for the appearance of the selected card and when dealing is finished, ask which stack it is in.

Now pick up the cards and repeat the process, but this is where you have to be extremely careful.

Remember that the stack with the chosen card must be in the middle of the full pile. We will assume that at the first dealing the chosen card was in the left-

hand pile. Take up the middle pile first, then the left-hand one (containing the chosen card) and finally the right-hand stack on top. With the cards face downwards in the hand, again deal out the cards face upwards into the three piles of seven each, asking the opponent for the particular pile. Again see that this pile is placed between the other two when picking up the cards, repeating the process for the third and last time.

After this last dealing, you must pick up the cards in exactly the same order as before with the selected card pile in the middle.

At this point ask for the vital effort of concentration on the selected card to transfer the thought, and holding them face downwards in the hand begin placing them on the table face upwards in a single pile, trying to find the right card. Incidentally it is a good plan to introduce some patter when performing this trick and as an example you may give the excuse that your opponent is causing the repeated dealings because of lack of concentration. When you come to the final turning over of the cards, you may appear to be hesitant after dealing the first few, but believe it or not the correct card will be the eleventh from the start!

Remember that the tricks are improved by your own patter and the way you present them. Never repeat before the same audience, and keep the secret to yourself. (S.H.L.)

Flowers in the Window



itself. If it is deep, paint the woodwork in dove grey flat or aluminium. There is no need for it to tone in exactly with the rest of the room decoration.

If you have an odd piece of mirror glass, fit this on one side as shown. Arrange a suitable holder for the plant or whatever you intend to set in it. Marigolds look good in any old pewter pot picked up at the second-hand shop. If the plant is to climb and spread, then arrange a light wooden frame in Hobbies' strip wood, and augment with ribs from an old umbrella, painted deep green. There are many ideas you can adapt for such a window, and it is possible for the most forlorn looking one to become quite a focal point.

Although a little elaborate, abroad they make a gay Gingham frill on tape which surrounds the window on top and two sides. Novel ideas are always worth a try-out. (V.S.)

WE sometimes have the square and rather squat window, and this can look very ordinary. Study the position, light and size, and try and make it a little picture all to

RUNNING BY RAILWAY



WORTHWHILE advantages arise from drawing power from mains supplies, when this is possible. The actual cost of the current used by a model is extremely small, amounting to only a fraction of a penny per hour. The model also operates at its best at all times, the reduced performance associated with run-down batteries being eliminated. There is no need to buy replacements, and the model can always be run at any time.

The saving is particularly great with trains worked from an accumulator. The latter is an expensive item, eventually deteriorates, and also needs frequent

If the electric motor has a wound field, as already explained, it may be driven directly from the secondary of a suitable transformer. But the more usual permanent magnet motor will only run from D.C., so that a rectifier is also necessary.

Rectifier circuits

Metal rectifiers are very satisfactory for running models, as they are not expensive, are simple to use, and have an extremely long life, if not misused. Such rectifiers consist of several round or square metal plates, of special type, clamped together on a rod or bolt. On no account should they ever be taken apart.

The simplest rectifier circuit is shown

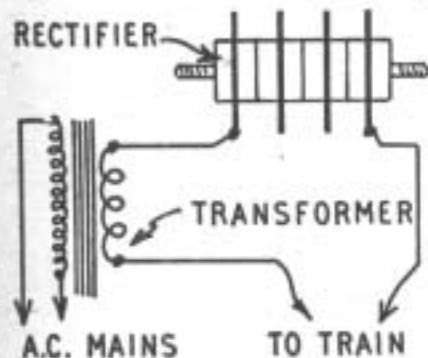

Fig. 1—Half-Wave circuit

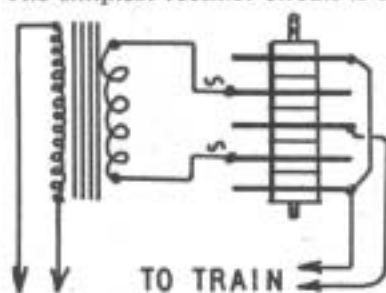

Fig. 2—Full-Wave rectification

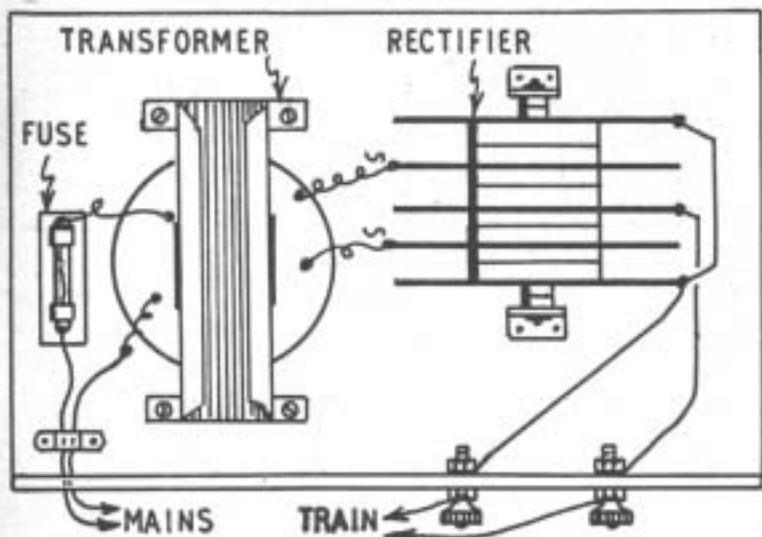

Fig. 3—Mains Unit

re-charging.

Mains supplies are almost exclusively alternating current (A.C.) and the 200/250V. may readily be stepped down to the 6/24V. wanted by means of a transformer. It must be noted that transformers cannot be used with direct current mains.

in Fig. 1. The transformer delivers a low voltage. This is A.C., but as the rectifier only allows current to pass in one direction, D.C. is supplied to the train.

Such rectifiers are known as 'Half-Wave' because they allow only current in one polarity to flow, suppressing the other half of the A.C. wave. It is only necessary to connect the rectifier in one lead to the train.

A 'Full-Wave' rectifier is a little more expensive, but makes use of both cycles of the A.C. supply, so that it is twice as efficient. For this reason, it is generally used, unless very low cost is essential.

A full-wave circuit is shown in Fig. 2. The transformer is used as before, feeding its output into the A.C. tags of the rectifier, which delivers D.C.

USING MAINS CURRENT

to the model. It is essential to make the proper connections, with this type, and the A.C. tags are marked green, or with the letters 'AC', or with a symbol like that in Fig. 2. The tags from which D.C. is obtained will be marked positive and negative (or red and black), but the polarity need not be a matter of any concern, for model driving.

Voltage and current

The voltage required by the train will usually be known, as it is marked on the model, giving in accompanying instructions, or can be seen from the type of

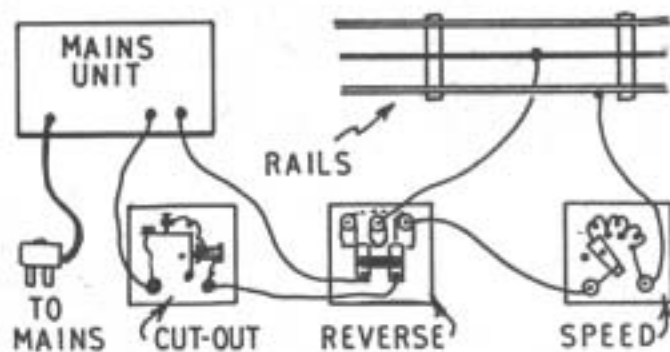

Fig. 4—Complete circuit

battery. The transformer and rectifier should have voltage ratings not lower than the model requires. For example, 6V. for a 6V. train.

If a transformer is available with a rather higher voltage, this can be used, as the excess can be dropped by a resistance in one connection. It is also perfectly in order to use a rectifier of higher voltage rating. For example, a 12V. or 24V. rectifier would do well for 6V., or anything under the maximum voltage rating which the rectifiers could handle.

The current drawn by the train also needs considering, so that transformer and rectifier can supply enough power. This figure will usually be given. If it is not known, it can be found by including a meter in one lead to the model, with the usual battery connected. Or it may be assumed that trains made to run from dry batteries will not normally take more than 1 amp, so that a 1 amp transformer and rectifier will do.

Again, no harm arises from using a transformer or rectifier of higher current rating — this only means that these components could provide more current, if it were wanted.

If the layout is to be enlarged, a fairly generous transformer and rectifier will be worthwhile. If extra current is available, it can also be used for station and signal bulbs, etc., which will add interest.

The cost of transformer and rectifier will depend directly upon current and voltage ratings. A small transformer and rectifier suitable for a small 6V. model would not cost more than 10/- in all, whereas larger components for a big model might cost £2. If it is remembered that such a large model would require an accumulator, it will be seen that the cost of a mains unit is still justified.

Building the unit

When transformer and rectifier have been chosen as explained, construction is very easy. It is wise to fit the components in a box or case, as this protects them, and also prevents the mains

voltage leads being touched.

Fig. 3 shows the wiring plan, and the rectifier should be fixed with its fins vertical so that rising air will cool it. Small metal brackets will have to be cut to do this. Two terminals fixed to the front of the case allow the model to be connected, and these leads will be quite safe to handle, as only a low voltage is present.

The transformer primary current is very small, and it is a good plan to fit a low rating fuse here, as shown. It should be of mains type, and rated at $\frac{1}{2}$ amp (500 mA). From this point, and the remaining primary tag or lead, two connections, made by good quality twin flex, pass to the mains plug or adapter. These leads should be clamped or taped so that accidental tugging will not pull connections away.

If the output is too high in voltage, from using a transformer giving a higher output than required, a resistance may be added between rectifier and one terminal. A little thin iron or resistance wire will suffice, wound in a spiral, or upon a strip of insulating material.

The completed unit should be fitted in a case, as mentioned, and two rows of $\frac{1}{4}$ in. or $\frac{1}{2}$ in. holes should be made for ventilation. Transformer and rectifier will grow warm to the touch, after a period of running, when working near maximum ratings.

If a 3-pin wall plug can be used, absolute safety can be assured by earthing. A 3-core flex is required. Red is used for the 'live' or 'positive' connection, going from the fuse in Fig. 3 to the 'Line'

(L) pin of the plug. Black goes from transformer primary to the 'Neutral' (N) pin. Finally, the green lead is connected to the transformer frame or core, and to one secondary lead. At the mains plug, the green lead is taken to the large Earth pin.

If this form of connection is not available, then the two mains leads in Fig. 3 are simply taken to an adapter or plug, and inserted in the nearest convenient source of supply.

Complete circuit

The units which have been described are shown in Fig. 4 — battery eliminator, cut-out trip, reversing switch, and speed control. The diagram shows how they may be wired up.

If desired, the units can be built together, thus making one compact control board. It is usual to fit the cut-out or fuse first in circuit, so that it protects the mains unit (or battery) if short circuits are made anywhere further on in the circuit. For example, if the cut-out or fuse were connected at the rails, it would not afford protection if a short arose when wiring up speed control or reversing switch.

It is quite in order to stop the train by interrupting the output circuit of the mains unit, leaving the transformer and rectifier working. This causes no damage. However, when the model is finally put out of use for a long period, the mains plug should be withdrawn, both for maximum safety, and to disconnect the transformer completely.

Handy Holder for Meter Shillings

IN homes where shilling slot meters are installed, this handy article will save much running about when the gas or light goes out. You will know just where to find a shilling at the crucial moment.

if necessary. Carefully draw the dotted line pattern on to the sandwich and cut out the shoe shape with your fretsaw (see B).

Cut the ribbon slot as shown $\frac{1}{2}$ in. long. Glasspaper down all surfaces of shoe. In

PLYWOOD REQUIRED	
2 pieces $\frac{1}{2}$ in. thick.	5 $\frac{1}{2}$ ins. by 2 $\frac{1}{2}$ ins. by 1 $\frac{1}{2}$ ins. — front and back.
1 piece $\frac{1}{2}$ in. thick.	5 $\frac{1}{2}$ ins. by 1 $\frac{1}{2}$ ins. — base.
4 pieces $\frac{1}{2}$ in. thick.	No. 1. 2 $\frac{1}{2}$ ins. by $\frac{1}{2}$ in.
	No. 2. 5 $\frac{1}{2}$ ins. by 1 $\frac{1}{2}$ ins.
	No. 3. 1 $\frac{1}{2}$ ins. by $\frac{1}{2}$ in.
	No. 4. 1 $\frac{1}{2}$ ins. by $\frac{1}{2}$ in.
	} Centre of sandwich.

Cut all your wood to size and bevel piece 2 along sloping edge to about 45°. In exact positions shown, lightly glue pieces 1, 2, 3, 4 on to inside of oblong piece to be used for the back (see A).

After this glued section is firmly set, complete the sandwich by placing the front panel squarely in position and pin together at points shown. Use $\frac{1}{2}$ in. panel pins, filing off protruding points

one end of the base saw a groove $\frac{1}{2}$ in. by $\frac{1}{2}$ in. to make a tight fit for tongue 3. Glue and pin shoe to base (see C).

Cover completely with clear varnish, and when dry add a bright colour paint to sole and heel. A neat $\frac{1}{2}$ in. ribbon bow tied through the slot will finish the article.

This design holds up to five one shilling pieces. When one is removed another automatically drops in place. (S.F.)

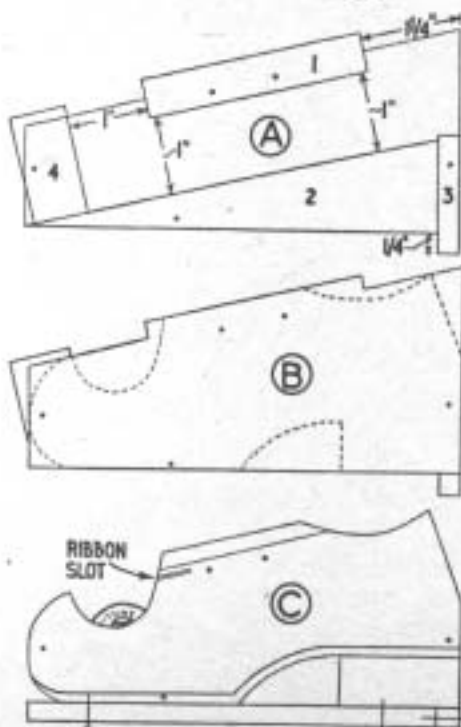

More useful formulas

Make your own Adhesive

IT is always useful to have handy a supply of an adhesive for papers. A good product of the white paste variety and which is very strong can be made from 32 fluid ounces of water, 7½ ounces of plain wheat flour, 5¼ ounces of rice flour, 1 ounce of alum and 6 drops of oil of cloves.

Heat 12 ounces of the water and dissolve the alum in it. Make a batter of the wheat and rice flour with the remaining water and mix it thoroughly with the alum solution. Heat the mixture slowly to the boil, stirring well and taking care not to burn the paste at the bottom of the vessel. Boil for ten minutes, remove from the heat and stir in the oil of cloves when nearly cold.

If you prefer the mucilage type, a top quality product calls for 8 fluid ounces

of water, 3½ ounces of gum acacia (which is the same as gum arabic), 1 fluid ounce of glycerine and 2 drops of formalin. The gum, preferably in powder form, is stirred with the warmed water until dissolved. Alternatively, it may be placed in a corked bottle with the water and shaken occasionally until entirely dissolved. Stir in the glycerine and then the formalin.

The glycerine eliminates a fault common with mucilages made with gum and water alone — that of curling of the paper. Glycerine keeps it flexible. The formalin acts simply as a preservative.

BLEACHING VELLUM

To effect this the damped vellum is exposed to the fumes of burning sulphur. When sulphur is burned, sulphur dioxide gas is formed and this is most useful for bleaching delicate materials which would deteriorate under the action of the more common bleaching agents such as chlorine or hypochlorite solutions.

100 parts of sulphur, 100 parts of strontium carbonate, 0.5 parts of potassium chloride and 0.4 parts of sodium chloride, all parts by weight. Mix the ingredients thoroughly by grinding and sifting and expose them in a crucible to a temperature of 1300 degrees Centigrade for at least thirty minutes and then allow to cool.

This pigment may now be mixed with varnish to make the paint. It must be exposed for some hours to bright sunlight, so as to develop its luminous property. The glow is violet.

CLEANING SILVER

An interesting electro-chemical method of removing stains on silver consists in exposing the metal to the action of a hot solution of washing soda containing aluminium. Even heavy stains are quickly removed.

Into an enamelled pan put enough boiling water to cover the silverware. For each pint of water add a handful of washing soda and stir until it has dissolved. Drop in a few pieces of aluminium. When the stains have disappeared, remove the silver, wash well with warm water and dry with a cloth.

ANTI-TARNISH FOR SILVER

To prevent silver from tarnishing, it may be coated with a gelatine-dichromate film. A little at a time, stir gelatine into hot water, allowing each lot to dissolve before adding more. When enough gelatine has been added to produce a slightly syrupy solution, stir in enough potassium dichromate to produce a light yellow colour. Using a fine brush, paint a thin film of the solution on to the silverware and allow to dry.

Daylight now acts on the film, producing a colourless coating. This is insoluble in water. Hence the silverware may be wiped with a damp cloth to remove dust which later will, naturally, fall upon it.

CLEANING BOTTLES

Where water, or warm soap and water, have failed to clean bottles which one desires to re-use, a few hints will be useful. Grease and lubricating oil films may be removed by rinsing with benzene or lighter fuel, followed by a warm solution of detergent and finally by a rinse with water.

Resins are removed by leaving sodium hydroxide (caustic soda) solution in the bottle for a while and then by

● Continued on page 439



A bleaching chamber for vellum

First spread out the vellum and with a rag damp it well on both sides with warm water until it becomes flexible. Wipe off any free unabsorbed water. Light the sulphur — in the open air and taking care not to breathe the fumes, for they are very irritating — and place the tin of sulphur on the bottom of the chamber. Quickly suspend the vellum over the rods and press home the lid. Leave the chamber outside the house for twenty-four hours. Open the chamber in the open air and still taking care not to breathe the fumes, remove the vellum and hang it on the clothes line until it no longer smells of sulphur dioxide. If the damping has been properly done as directed, the vellum will be nicely bleached.

The gas in the chamber will harmlessly diffuse into the air if left for a while.

LUMINOUS PAINT

If you have the means of heating to 1300 degrees Centigrade, a luminous paint pigment can be made easily from

Children will like these

NOVEL NAPKIN HOLDERS

THE humble table napkin during its long life has been rolled up and housed in a great variety of holders. Metal rings of brass, pewter and silver, both plain and engraved, or pierced have had a long run of popularity, and now plastics have come to the front and taken their place.

Carving wooden napkin rings has been largely practised by the handyman, and in this article we are introducing a new version which should give plenty of scope for his activities. There is an excellent opportunity to use up the countless scraps of wood which accumulate from a variety of jobs.

Napkin rings should be individual, so that each member of the household can easily remember his own, and not get it mixed up with the others. What could be better, therefore, than these amusing and attractive figures? They will appeal especially to the younger members, and should be excellent for parties.

The wood can be left in its natural state or varnished, but it would certainly be better to paint the figures in gay colours, and this would brighten up and add an attractive touch to the table setting.

We show two different methods of making the napkin holders, but you will, doubtless, devise others. One way is to use a solid block of wood for the base, and drill a hole through it to take the rolled napkin, while the other is to make use of a cardboard tube and build up the figure around it.

The block of wood used for the base of Fig. 1 is 2ins. deep, 2½ins. wide and 3ins. high. In all the figures the hole to take the napkin has a diameter of 1½ins., but this can be altered slightly if needed, and the size of the block should be adjusted in proportion in order to preserve the harmony of the whole.

If there is any difficulty in drilling a 1½ins. hole, or a fear of splitting the wood, it can be done in easy stages by drilling a series of small holes, and cutting the centre out with chisel and gouge. Finish off with file and glass-paper wrapped round a piece of broom handle.

The head of Fig. 1 can be cut from a ½in. thick circle, but it would look better if made heart shaped as shown. Nose and ears are easily cut from odd pieces of wood of a contrasting colour if the wood is to be left in its natural state, but if the whole is to be painted, then any odd scraps will do.

A clothes peg cut in half has been used for the legs and feet. Beads can be inserted for eyes, or you may decide to

paint these features, including the mouth, on-the-face.

Perhaps you prefer a more severe figure with sharp angles — then Fig. 2 should appeal, but remember not to



FIG. 1.



FIG. 2.



FIG. 3.



FIG. 4.



FIG. 5.



FIG. 6.

round off the edges when finishing with glasspaper, as this may spoil the effect.

The somewhat grotesque animal in Fig. 3 is modelled on the 'round' theme.

A ball end of a skipping rope handle serves for the head, or you could use a skittle ball for the job. Ears, nose, legs, tail and eyes are all cut from dowel rod and glued into holes drilled to take them. Even the mouth can be cut from a piece of dowel cut in half lengthways.

Turning to the other method of constructing the napkin holders, Fig. 4 is a good example, and should explain it fully. The cardboard tube has an internal diameter of 1½ins., and is about 3ins. long. The design of this is modern and reminds us of an electronic robot, but if two feet and a tail on the opposite side are fitted, it will not walk off the table of its own accord.

Finish off the natural wood models with two coats of varnish, or you may use brush french polish or even give them a wax polish. Poster colours may be used to paint the other type but they will need varnishing afterwards to keep the colours from rubbing off. It would be better, however, to use oil or cellulose colours for the job.

Should you be fond of wood carving, then there is a wide choice of suitable designs for use on either model, or you may prefer to make up your own patterns. In Fig. 5 use is again made of the ball end of a skipping rope handle, and quite an interesting array of heads is possible. It will be found easier to carve if the ball is left on the handle and unscrewed when finished.

Animal heads such as Fig. 6 will also make suitable models to carve, and there is plenty of room for experiment here. They may be true to life, or some fantastic creation of your own, both of which are excellent to fix to either type of napkin holder. (A.F.T.)

● Continued from page 438

More Useful Formulas

rinsing with methylated spirit and finally with water.

Essential oils and castor oil may be dissolved by shaking meths. in the corked bottle, pouring out, rinsing with meths. and then with warm detergent and finally water. Tarry matter, too, yields to the last treatment.

Bottles stained black by having contained silver nitrate can be cleaned up by tearing up blotting or filter paper into tiny pieces and shaking these with water in the bottle. Not too much water should be used, but just enough to allow the paper to move freely. A final rinse with water leaves them clean.

Potassium permanganate leaves a brown stain. This may be cleared with a dilute solution of hydrochloric acid — about one volume of the strong acid to three volumes of water. Finally rinse. If you get any of the acid on your skin, flush it off with water and rub on a paste of sodium bicarbonate and water.

Ill defined stains — more of the nature of dirty films — nearly always yield to shaking with filter paper fragments and water.

Beyond washing with white spirit (turpentine substitute), bottles which have contained paints are not worth the expense of the solvents. (L.A.F.)

EASTER NOVELTIES

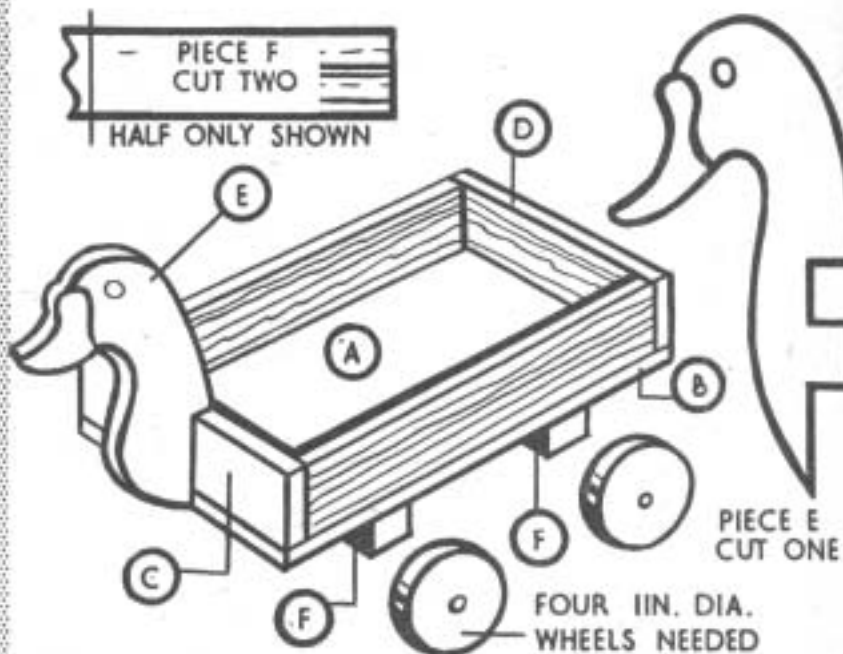
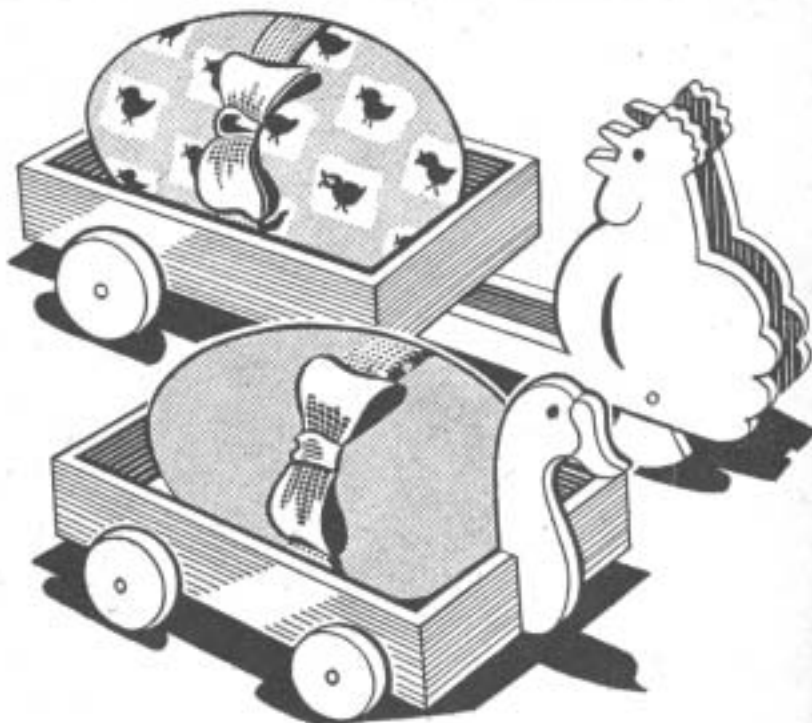
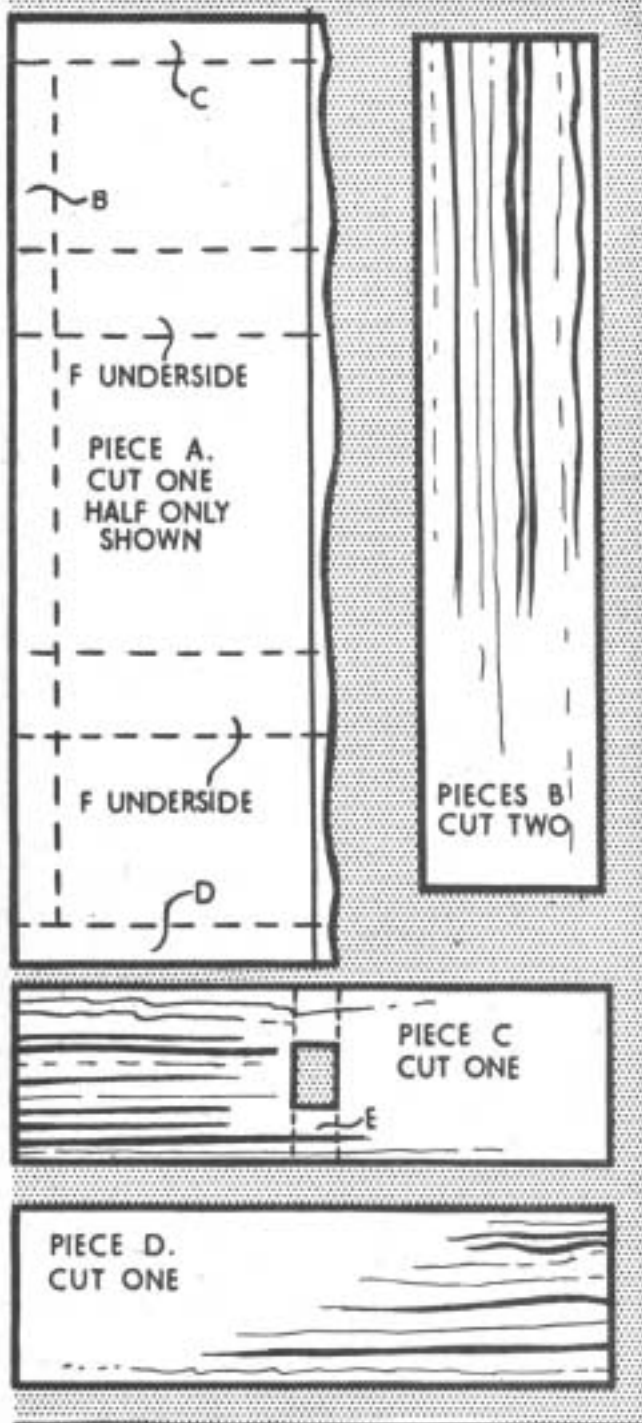

SPECIAL NOTICE!

This is the last issue in Vol. 123. Next Wednesday your Hobbies Weekly will appear with a new and modern look, as colour will be introduced throughout the magazine. The page length will be slightly decreased, but this will not affect the length or quantity of the articles as the margins at the top and bottom will be cut down in proportion. Indices for Vol. 123 will be ready shortly, price 1/- each post free.

TELL ALL YOUR FRIENDS TO ORDER A COPY

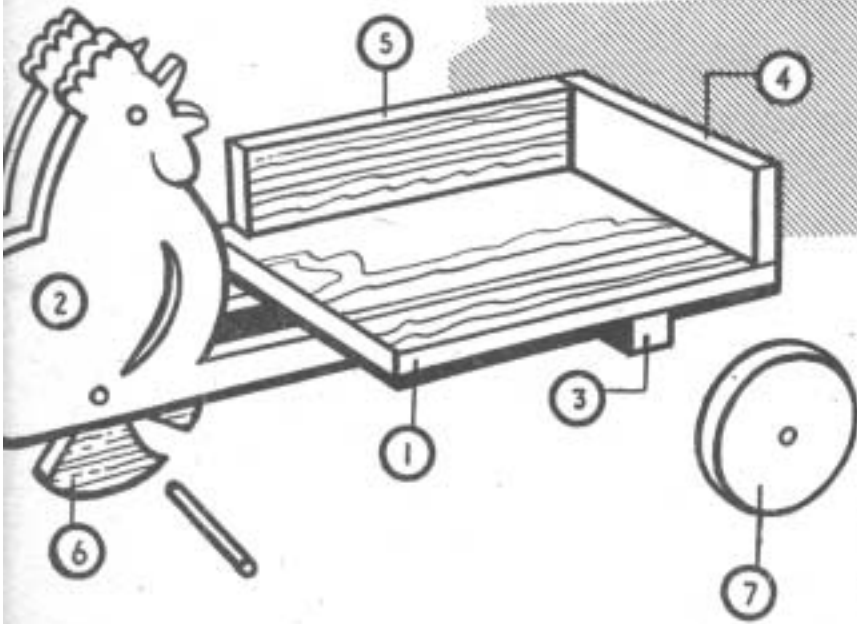
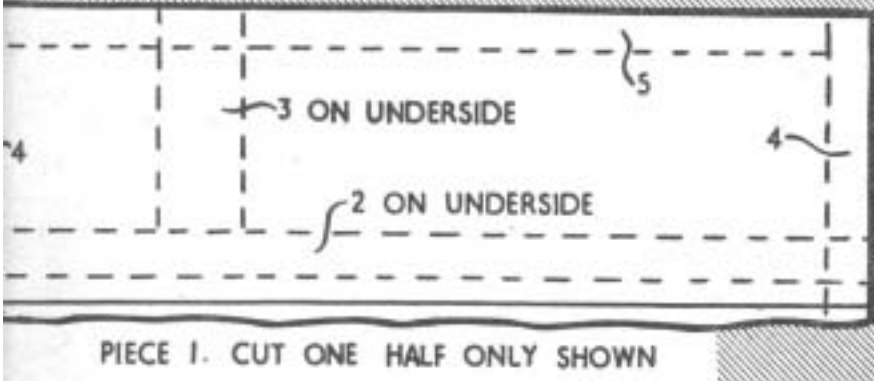
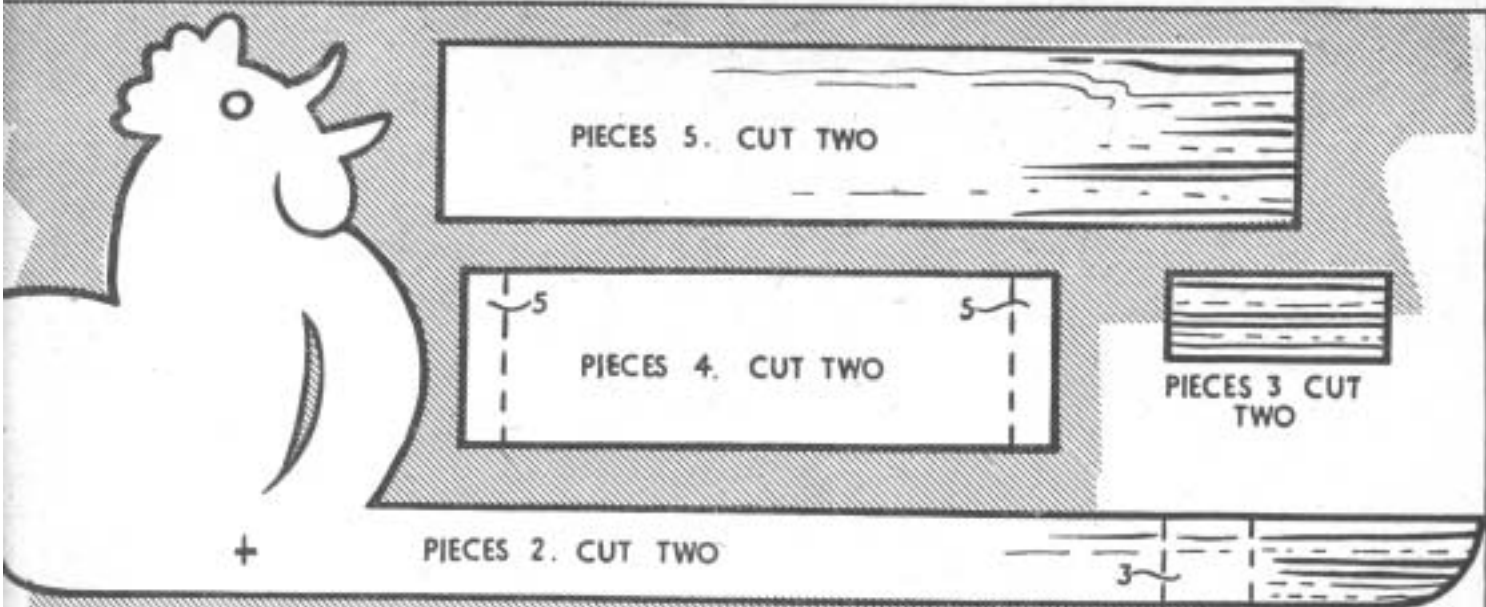

NEXT WEEK!

In this 'new look' issue we shall be including a large free design to make a working model of the modern C.P.R. liner 'Empress of Britain'. This 24in. vessel is a wonderful project for all model makers and proud owners will be the envy of all their friends. It is powered by the well-proved Mighty Midget electric motor and propeller unit. A full kit will be available.

MAKE SURE OF THIS SMASHING FREE DESIGN

CHEMISTRY IN THE HOME

Silver Nitrate Experiments Part 2

YOU may have found that after carrying out the experiments described in the last article on silver nitrate that an odd red-brown or black spot has appeared here and there on your skin or nails. There is no cause for alarm! These are only surface stains and will wear off soon. They have been caused by unwittingly getting a little silver nitrate solution on your skin. The skin reduces this and forms stains consisting of metallic silver. They do not look like this metal simply because they are in such thin layers.

This staining led chemists to find out if organic matter other than skin and nails behaves in a similar way. It does, and some useful applications of the principle were discovered.

the ivory dry and then rubbing it with cloth until the silver colour appears.

This ease of reduction of silver nitrate solution by organic matter is the reason why a cork used to stopper the bottle turns black. Even a glass stopper blackens, for the dust which settles on it contains organic matter.

Your specimen collection, which is naturally a supplement to your main laboratory stock, would be incomplete without a short range of silver compounds. Silver chloride you already know how to prepare. Silver bromide (used in photography) and silver iodide should find a place in your collection.

In each of two beakers dissolve 1 gram of silver nitrate in 20 c.c. of water. To one add potassium bromide solution

everyday life as the dark tarnish on silver. A specimen is easily made by passing hydrogen sulphide through silver nitrate solution (Fig. 1), when, since it is insoluble in water, it is precipitated. Owing to the offensive smell of hydrogen sulphide, the experiment should be done in the open air. Filter off the silver sulphide and wash it well. Then dry it in the oven. The mineral argentite consists of silver sulphide and is the main raw material for making silver.

Photographic interest

When sodium thiosulphate is used to remove unchanged silver salts from photographic film or printing paper, there is formed a double salt. Namely, silver sodium thiosulphate. You should

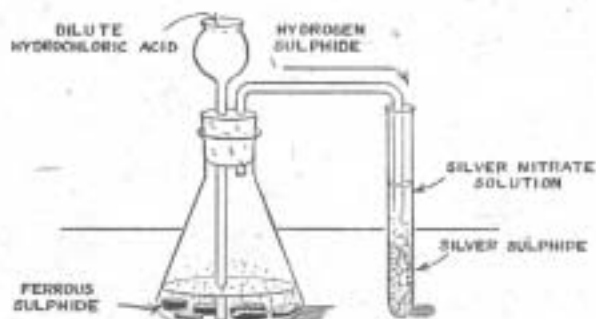

Fig. 1—Making silver sulphide



Fig. 2—Making a mirror

Let us try a simple one. Write a few words or draw a simple design with silver nitrate solution on a sheet of paper. When the paper is dry nothing will be visible. Now heat the paper before the fire. The writing or design appears in brown or black, according to the strength of the solution used, owing to production of metallic silver. The same change occurs after exposure to light. Thus we have a ready formula for an invisible ink.

Marking inks

The same principle lies behind laundry marking inks. A use not generally known is for colouring ivory black or silver. If you have a piece of scrap ivory you might like to see the effects.

First free the ivory from any grease film by washing it in a warm solution of detergent and then rinsing well in warm water. Immerse the ivory in silver nitrate solution until it turns yellow, remove it and place it in a beaker of water. Set the beaker in a sunny place for a few days, when it will turn black. The silver effect is obtained by letting

until no more precipitate of silver bromide appears. Similarly add to the silver nitrate in the other beaker a solution of potassium iodide; silver iodide is precipitated.

We have seen that silver chloride is white. The closely related bromide and iodide are yellowish and yellow respectively. To purify them from solutes, filter off each precipitate and wash well with water. Let the silver bromide dry in a dim light, for it is sensitive to bright light. For the same reason it should be kept in a tube covered with brown paper. Silver iodide is not sensitive to light, unless it contains a trace of silver nitrate, and this precaution need not be taken.

Silver chromate is a brightly coloured salt. To prepare it, stir potassium chromate solution into silver nitrate solution until no more precipitate forms. This precipitate of silver chromate is red. Filter it off and wash well with water and allow it to dry. As this, too, is not sensitive to light, you need take no special precautions.

Silver sulphide is black and is seen in

certainly have a specimen of this. Friends keen on photography will find this of interest when they visit your laboratory, for they never isolate it and many do not know of its existence, merely that silver chloride and bromide are dissolved by sodium thiosulphate.

A few drops at a time, add silver nitrate solution to sodium thiosulphate solution, stirring after each addition. Silver thiosulphate momentarily appears as a white precipitate with each addition, but immediately redissolves. When a slight permanent precipitate appears, stop adding silver nitrate. After stirring in enough sodium thiosulphate solution to the mixture to clear the precipitate, add methylated spirit until a precipitate forms. This is silver sodium thiosulphate. Filter it off, wash it once or twice with methylated spirit and then let it dry by opening out the paper on a porous brick.

Silver nitrate has been much used for making mirrors. It is not difficult to demonstrate the principle in the laboratory. This is easiest if a small clock glass

● Continued on page 444

New this month!



DINKY TOYS No. 677

Armoured Command Vehicle

This realistic miniature represents the type of vehicle used by army commanders as a radio-equipped mobile headquarters unit. The original is an A.E.C. production with drive on all wheels and bullet-proof body. The model measures 5½" in length. It is finished in service green and carries the "Desert Rat" marking of the famous 7th Armoured Division. Price 5/9d. (inc. Tax).

New colour finish



DINKY TOYS No. 472

Austin Van "Raleigh Cycles"

Another attractive version of the popular Austin A40 Van is now available finished in rich dark green with the name 'Raleigh Cycles' in gold on the side panels. Length 3½". Price 2/9d. (inc. Tax)

Keep on collecting

DINKY TOYS

MADE IN ENGLAND BY MECCANO, LTD., BINNS ROAD, LIVERPOOL, 13.

NEW!
THE TRANSPARENT
LACQUER
THAT SPRAYS
ITSELF ON



Just press the tab to spray a hard, glossy finish on to untreated hardwood, whitewood, metal or paper. This transparent lacquer dries in 10 minutes—protects and improves toys, models, furniture, paper

lampshades, maps, prints, table tops, chromium plating, brass, copper, silver . . . and hundreds of other articles. Obtainable from Halfords Ltd. 12/6 per tin.

PARSONS TRANSPARENT LACQUER
in SELF SPRAY Aerosol CONTAINER

THOS. PARSONS & SONS LTD.

ESTABLISHED 1803

70 GROSVENOR STREET, LONDON, W.1.
TELEPHONE: MAYFAIR 7951 (10 LINES)

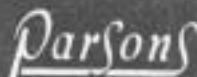

NEW! THE PRACTICAL WAY
of learning RADIO · TELEVISION · ELECTRONICS

AMATEUR S.W. RADIO · MECHANICS · PHOTOGRAPHY · CARPENTRY, etc., etc.

NEW—Experimental outfits and lesson manuals sent on enrolment remain the student's property. Tutor allotted to each student for personal tuition throughout the course.

In radio and television courses, specially prepared components are supplied which teach the basic electronic circuits (amplifiers, oscillators, detectors, etc.) and lead by easy stages, to the complete design and servicing of modern radio and T/V equipment.

THESE PRACTICAL COURSES ARE IDEAL AND MAY BE YOURS FOR MODERATE COST

Fill in the coupon to-day for a free Brochure. There is no obligation whatsoever.

Courses with equipment enable you to design, construct and service

2-stage radio equipment

3-stage T.R.F. circuits · Television

equipment · Workshop Test Panel

Oscilloscope · 5 valve 3-waveband superhet circuit

SUBJECTS INCLUDE:— Radio · Electronics · Television Equipment
Mechanics · Chemistry · Photography · Electricity · Woodwork
Electrical Wiring · Draughtsmanship · Art · Short Wave Radio
Oscilloscope · also many other Home Study Courses without equipment.



EMI
INSTITUTES

Associated with H.M.V.,
Marconi-Phonograph, etc., etc.
The only Home Study
College run by a
World-wide industrial
organisation.

COURSES FROM 15/- PER MONTH

E.M.I. INSTITUTES, Dept. 31X, London W.4

NAME _____

ADDRESS _____

Subject of interest _____

AGE _____

(if under 21)

(We shall not worry you with callers) 31/4/57 IC85

A BOX FOR YOUR CACTUS PLANTS

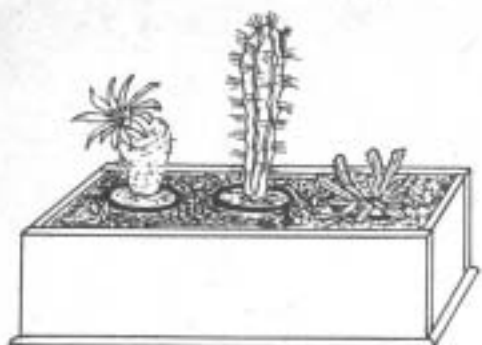

VERY many people are now taking up the fascinating hobby of growing cactus plants and for those living in flats and without any garden it is an ideal occupation. A large number of the plants are quite small, and provided they have plenty of sun in the summer, and are kept free from frost in the winter, they are quite at home in the window of any room.

A window facing south is, undoubtedly, the best position for them, and is practically as good as a greenhouse for this type of plant. If the room has an all-night stove in it, then some of the more delicate kinds can be grown quite well.

There is one rather important point that many people disregard but which has much to do with the success achieved by the grower. Although many of the cacti come from hot countries the root system likes a somewhat damp situation, and this is very often helped by the moist atmosphere prevailing. It is, therefore, necessary to keep the pots from

becoming too dry, and this can be quite a problem during the summer months when the part above ground level needs all the sun it can get in order to ripen it.

Cacti generally do better in small pots which tend to dry out very rapidly, but if the pots can be kept cool, the plants will be quite happy. Nowadays greenhouse owners keep their plants cool at the roots by standing the pots on 2ins. or 3ins. of pebbles, and if we adopt the same idea and even put the pebbles all round the pots, this should prove very satisfactory.

The neat little plant box described in this article is just the thing in which to house your cacti collection and although this has been designed to hold three small pots, it is quite easy to make it larger, or it may even be made to hold a single pot. When made with a suitable hardwood such as oak or walnut, it is quite attractive and suitable for any room and can be moved about with ease.

While it is probably best to keep the design of the case somewhat on the plain side as shown in the sketch, the top edges may carry a little ornamentation if desired, such as a scallop or a zig-zag pattern to match the cactus plants. For a plain case cut two sides

12ins. long and 4ins. wide and the two end pieces 4ins. long and 4ins. wide. Make the base 13ins. long and 5ins. wide and chamfer off the edges as shown. All these pieces of wood are $\frac{1}{2}$ in. thick and can be solid wood or good quality ply. Glue up all joints with a waterproof glue and strengthen with a few fine panel pins.

If you have used solid hardwood, then french polish or varnish will be a good finish, but for plywood, two or three coats of paint or enamel will serve the same purpose. In any case the inside should receive at least two coats to preserve the woodwork from any dampness.

The pebbles used in the case should not be larger than $\frac{1}{2}$ in., but half that size or even smaller would be more suitable. See that they are well washed, and do not put any dirt or grit in with them. Put a layer in the bottom about 1in. thick, then stand the pots on this and fill in with more pebbles. When watering the plants, it is best to take them out of the case, or the water will accumulate and turn sour. Remember to keep the plants away from draughts, and this also applies to almost every type of plant that may be brought into the house. (A.F.T.)

FABRIC TRANSFERS

A SUITABLE transfer ink for impressing outline drawings, etc., on to fabrics can be made by dissolving equal parts of sugar and washing blue in water. Make up to the consistency of ordinary ink.

The pattern required can be traced with this ink and an ordinary pen on to transfer paper. When dry it can be transferred to the fabric in the usual way by pressing with a hot iron, ink side down. (R.H.W.)

MODELLERS' PAINT RACK

TO meet the needs of handicraft workers the Humber Oil Company Limited of Hull announce the introduction of an entirely new form of paint pack. This contains six intermixable colours of Humbrol Art Oil Enamel in a cellophane packet, costing 1/3.

These paints are ideal for plastic materials and modelling and for numerous jobs such as cycle and car retouching, general handicraft work and household use.

● Continued from page 442

Silver Nitrate Experiments

or large watch glass is used. This must be absolutely grease-free, or the silver will not adhere. To ensure this, place the glass in a lukewarm solution of sodium hydroxide for a few minutes, take it out with crucible tongs and rinse well in distilled water. Do not touch the concave surface with the fingers after this.

To 5 c.c. of water add two or three drops of clear household ammonia and then silver nitrate solution drop by drop, shaking after each addition. Brown silver oxide is precipitated, but at first redissolves. When a slight permanent turbidity appears, stop adding silver nitrate, and, instead, add one or two drops of sodium hydrogen tartrate solution.

Press the watch glass in a sand-bath (Fig. 2), fill it with the solution just made and gently warm the sand-bath. Very soon a brilliant coat of metallic silver will be deposited on the glass. The mirror may then be emptied, washed and dried.

As silver nitrate is so much used in

testing for chlorides — and it is frequently mentioned in the *Home Chemistry* articles, where we are washing precipitates free of soluble chlorides — an active home chemist can pour quite a lot of waste test solutions down the sink during the course of a year. He can save himself the expense of buying more silver nitrate by separating the silver from them.

The first thing to do is to have a bottle labelled *Silver Residues*. Into this pour the waste solution whenever you use silver nitrate for testing purposes, *except* when the mixture contains lead or mercurous salts. When the bottle is pretty full, you will have a clear liquid above and a deposit below. Pour off the clear liquid and add common salt (sodium chloride) solution until no further white precipitate forms. Mix this liquid with the deposit in the bottle and filter off the whole. Wash it well with water, and transfer the sludge to a beaker. You can convert this into metallic silver as described last week.

Follow the **FLUXITE** way to Easy Soldering



No. 3. Heating the Bit

A clean flame is best such as that of a gas ring, and care must be taken not to let the bit get red hot. When the flame turns green the bit is at the right temperature.

FLUXITE is the household word for flux that is famous throughout the world for its absolute reliability. In factory, workshop and in the home FLUXITE has become indispensable. It has no equal. It has been the choice of Government works, leading manufacturers; engineers and mechanics for over 40 years.

FLUXITE
SIMPLIFIES ALL SOLDERING

FLUXITE Limited, Bermondsey St., London, S.E.1
G.M.53

THE LATEST SENSATION
in the
International Handicrafts Exhibition
Olympia
were our Plastic Moulds
for Wall Plaques for plaster casting

Prices 1/3 to 5/- each
Rubber Moulds from 1/- each
Illustrated catalogue 9d.
S.A.E. for list

TRADE ENQUIRIES INVITED

F. W. NUTHALL
69 St. Mark's Road
HANWELL, LONDON, W.7

Model-maker praises
VALSPAR



Dear Sirs,
I thought you would be interested to know that I have recently constructed a doll's house for my daughter and retained a really excellent finish with your Valspar 2-4 Hour Lacquer.
Apart from its smooth, hard gloss finish, I find that Valspar lacquer saves me a lot of trouble because it dries so quickly and, when you have active children like mine, this is essential to avoid paint work—also cleaning bills.

Yours faithfully,
D. GODFREY

VALSPAR
2-4 Hour

LACQUER • VARNISH • WOOD STAIN

★ PROOF AGAINST BOILING WATER, PETROL, OIL, ALCOHOL, ETC.



- ★ DRIES IN 2-4 HOURS
- ★ UNMATCHED HARDNESS AND ELASTICITY
- ★ FOR ALL SURFACES

On show at the Ideal Home Exhibition

GOODLASS, WALL & CO. LTD. 179/185 (AC3) Gt. Portland St. London W.1

Please send me a free copy of the Valspar Handbook giving full details of how to use Valspar paints

NAME
BLOCK CAPITALS
ADDRESS



● DON'T MISS IT!

The superb, novelty-packed

1957 GADGETS ANNUAL

HOW TO MAKE over 350 of the latest and cleverest gadgets and devices for home... garden... hobbies... garage... tools... gifts... puzzles... novel inventions. With patent spiral binding, and fully illustrated. The huge 1957 GADGETS ANNUAL only costs 10/- from POSTLIB PUBLICATIONS, Kingsbury, London N.W.9

EVERY CAR THAT PASSES—YOU WILL FIND THE INDEX MARK ALPHABETICALLY ARRANGED IN WHERE'S THAT CAR FROM?

Price 9d.

from all Booksellers or from the Publishers
(2d. postage)

RALEIGH PRESS, EXMOUTH

STOP SMOKING!! Quick guaranteed remedy. Free testing sample!! — Triumph Remedies (H), Exeter.

LEARN it as you do it — we provide practical equipment combined with instruction in Radio, Television, Electricity, Mechanics, Chemistry, Photography, etc. — Write for full details to E.M.I. Institutes, Dept. HW47, London, W.4.

100 DIFFERENT stamps free! Request 3d. upwards discount approvals. — Bush, 53 Newlyn Way, Parkstone, Dorset.

STAMPS FREE — Empire Packet including SPictorials and Victorians with approvals. — Robert J. Peck, 7A Kemp Road, Bournemouth.

GENUINE Swiss Musical Movements. The best and largest selection of tunes in the country, lowest prices 16/3 each. Genuine Thorens Movements, 22/9 each. All guaranteed. P & P. 9d. extra on all orders. — Richardson & Forder, HW, 5 Chapel Place, White Hart Lane, London, N.17.

* GREAT CAMPING OFFER *



RIDGE TENT SENT FOR 4/-

Complete. Ideal cyclists, campers. Length 7' 3" sleeping base x 4' 6" wide x 3' 6" high x 12" walls, all approx. Weight 3½ lb. Cash 55/-, or 4/- deposit and 6/- monthly. WITH FLYSHEET 83/6, or 9/3 deposit and 9/9 monthly. Both carriage 2/6. LISTS OTHER EQUIPMENT, TENTS, CLOTHING, WATCHES, ETC., TERMS.



R.A.F. NEW WATERPROOF BACK PACKS



One large FULLY ZIPPED Compartment. One ditto same size back to back, 4 Buttoned off separate side by side super imposed Pockets. 2 strong adjustable webbing backstraps with easy release press studs. Made of genuine R.A.F. 100 per cent, waterproof material, all brand new. Ideal for Motor Cyclists, Hikers, Fishermen and a 100 other uses. 4/11 only, post etc. 1/1. A fraction of original cost. Send immediately.

HEADQUARTER & GENERAL SUPPLIES LTD.
(HOBW/53), 196-200 Coldharbour Lane
Loughboro Junction, London, S.E.5
Open all day Saturday 1 p.m. Wednesday.

SWISS MUSICAL MOVEMENTS. Before you buy send 2d. stamp for our illustrated brochure. — Metwood Accessories (Dept. HW), Church St., Wolverton, Bucks. (Trade enquiries invited.)

GOVERNMENT SURPLUS BARGAINS. Inter-room Telephones, comprising 2 self-energised microphone/receivers and approx. 6yds. flex (may be extended if desired). No Batteries needed. Nothing to wear out. Complete 9/6, post 6d. Motors, Transformers, Switches, etc. 3d. stamps for illustrated list. Milligan's, 24 Harford Street, Liverpool, 3. Money Back Guarantee.

MUSICAL BOX MOVEMENTS

14/9d. ONLY

Complete kits 21/6d.

SAE for details:—
SWISSCROSS CO., Dept. B,
116 Winifred Rd., COULSDON, SURREY

STOP SMOKING in 3 days or money back. Safe, pleasant, permanent. The only scientific way. **No Will Power necessary.** 'Conquered the habit in 2½ days'.—F.C. 'Within 2 days I was free from the tobacco habit'.—W.G. 'Was a smoker for 2 years and broke the habit in 2 days'.—F.N. 'I used to smoke 20 a day... now I have no desire to smoke'.—J.M. Recommended by 'Health and Efficiency Magazine'. Complete course 6/6 (or \$1.00 bill). Details 2d. stamp. Sent under plain cover. **NATURE REMEDIES, 28 (H/166)** Dean Road, London, N.W.2. Established 1922

'PAINTSPRAYING' HANDBOOK. Covers Car, Industrial & Flock Spraying. 3/6, post 4d. Catalogue of our Cellulose and Paints and all Allied Sundries 2½d. — Leonard Brooks Ltd., 81 Oak Road, Harold Wood, Essex.

The Handy Paint in Tubes

Starlon is perfect for handicrafts and small painting jobs. Quick drying. No brush marks. Brilliant finish. No waste—you squeeze out exactly the quantity required.

Starlon

PLASTIC ENAMEL PAINT

Obtainable at handicraft shops everywhere
STARLINE, SOUTHEND-ON-SEA, ESSEX



1/-

PER TUBE

In 13 lovely colours and clear varnish



BRANCHES: LONDON

78a New Oxford St., W.C.1
(Phone MUSEum 2975)
87 Old Broad Street, E.C.2
(LONDON Wall 4375)
81 Streatham Hill, S.W.2
(TULse Hill 8796)

GLASGOW

326 Argyle Street
(Phone CENTral 5042)

Head Office & Factories—HOBBIES LTD, DEREHAM, NORFOLK

MANCHESTER

10 Piccadilly
(Phone CENTral 1787)

BIRMINGHAM

100a Dale End, Birmingham 4

SHEFFIELD

4 St. Paul's Parade

LEEDS

10 Queen Victoria Street

HULL

10 Paragon Square
(Phone 32959)

SOUTHAMPTON

134 High St. (Below Bar)

BRISTOL

30 Narrow Wine Street

NEWCASTLE

42 Dean Street

HURRY! HURRY! HURRY!

Get your kits NOW for these grand working models



15 in. Model Yacht
Kit No. 3104

(all fittings, including sails)

Sails perfectly and a real bargain for

15/-

20 in. Motor Launch
Kit No. 3036

(including motor and propeller unit)

39/6



Obtain your kit now from your Hobbies branch or stockist or direct, post free, from:

HOBBIES LTD. (Dept. 99)
Dereham, Norfolk

A QUAINB BIRD DESIGN

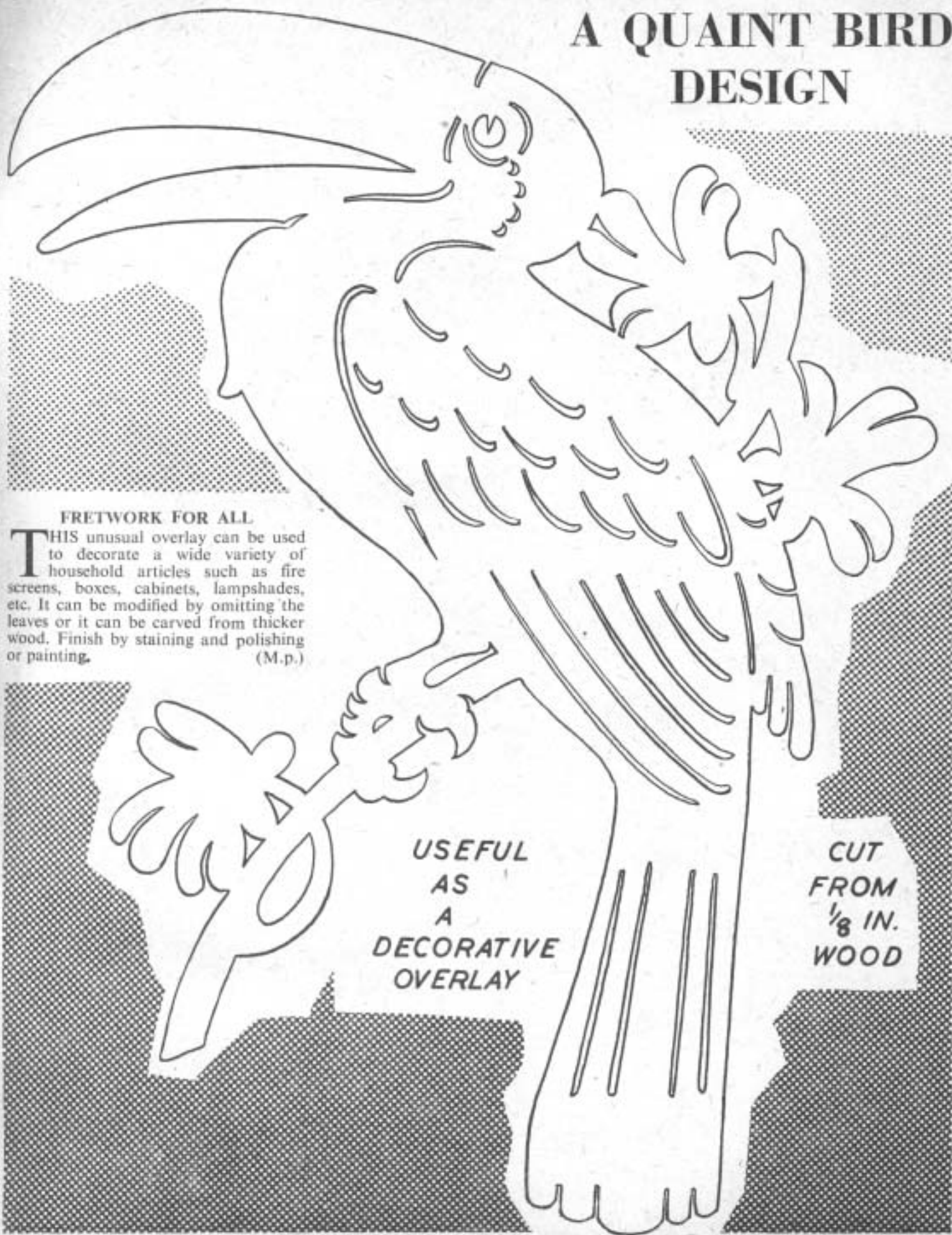

FRETWORK FOR ALL

THIS unusual overlay can be used to decorate a wide variety of household articles such as fire screens, boxes, cabinets, lampshades, etc. It can be modified by omitting the leaves or it can be carved from thicker wood. Finish by staining and polishing or painting. (M.p.)

USEFUL
AS
A
DECORATIVE
OVERLAY

CUT
FROM
 $\frac{1}{8}$ IN.
WOOD

Paddle Your Own Canoe



... and make
it with the
aid of
full size
plans from



PBK 14 (Mk 2) carries an adult and child

BUILDING COSTS FROM ABOUT £7

These plans contain all the information needed to build the canoe and its accessories. The main frames and other shaped parts are drawn full-size for tracing direct on to the wood. There are plenty of constructional diagrams, with step-by-step instructions, and a detailed material list. Accessory instructions include the making of paddle, spray cover, trolley, rudder, sailing gear, etc.

All of these canoes are of the decked kayak type and are primarily paddling craft, but sail is useful as an auxiliary and can add to the fun of canoeing. If sailing capabilities are particularly required, PBK 20 is the best selection.

A canvas canoe can be built by the novice with limited equipment, and the average handyman can complete the job in about 40 hours. The structure consists of widely-spaced laths on cross frames, covered with a fabric skin. There are no difficult joints or awkward work. Plywood skinned canoes need more skill and a larger tool kit.

Building costs range from about £7 (for the PBK 10). We do not supply materials for building, but addresses of firms who do so are included with the plans.

DETAILS OF PLANS AVAILABLE

RIGID CANVAS-COVERED

PBK 10. Single seat, 11 ft. long, 28 in. beam, normal max. load 300 lb. The shortest satisfactory canoe. Economical in size and building costs. Room for lightweight kit. Price 11/-

PBK 14. A roomy single for the big man, or a two-seater for an adult and child, or two young people. 14 ft. long, 29 in. beam, normal max. load 500 lb. Popular tourer. Price 12/6

PBK 15. Single seat, 14 ft. 6 in. long, 26 in. beam, normal max. load 400 lb. The enthusiast's fast touring craft. Safe and stable. Suitable for any waters. Price 12/6

PBK 20. Two-seat, 15 ft. long, 32 in. beam; normal max. load 600 lb. Stable and seaworthy. Easily paddled and a good performer under sail. Popular with scouts and youth clubs.

Price 12/6

RIGID PLYWOOD-SKINNED

PBK 16. Two-seater. 16 ft. long, 32 in. beam, normal max. load 700 lb. Flat-bottomed. Safe and robust. Popular for local hire on sea and river. May be left afloat. Price 12/6

FOLDING

PBK 24. Single seat, 11 ft. long, 28 in. beam, normal max. load 300 lb. Similar lines to PBK 10 but longer cockpit. Only canoe which packs into one bag small enough to go on bus.

Price 12/6

From branches or direct (post free)

HOBBIES LTD (Dept 99) Dereham, Norfolk