

# ELECTRONICS

M O N T H L Y

The Newcomer's Magazine for Electronic Projects

**Car radio**

**AUDIO BOOSTER/  
COMPRESSOR**

**Low cost**

**SHORT WAVE CONVERTER**

*Make a start in short wave  
with your medium wave receiver*

**AUDIO AMPLIFIER MODULE**

*For radio or hi fi*

**Bench Test Unit for Designers**

**COMPREHENSIVE RESISTANCE BOX**



**READERS SURVEY**  
Your comments

# TOOLTRONICS

## MINIATURE TOOLS

### PRECISION JEWELLERS' TOOLS

Rustproof Tempered Handles and Blades. Chrome Plated Heads. Swivel Heads for use on Precision work

**5T21 SCREWDRIVER SET**  
6 precision screwdrivers in hinged plastic case. Sizes - 0.8, 1.4, 2, 2.4, 2.9 and 3.8mm **£1.75**

**5T31 NUT DRIVER SET**  
5 precision nut drivers in hinged plastic case. With turning rod. Sizes - 3, 3.5, 4, 4.5 and 5mm **£1.75**

**5T41 TOOL SET**  
5 precision instruments in hinged plastic case. Crosspoint (Philips) screwdrivers - H0 and H1 Hex key wrenches. Sizes - 1.5, 2 and 2.5mm. **£1.75**

**5T51 WRENCH SET**  
5 precision wrenches in hinged plastic case. Sizes - 4, 4.5, 5, 5.5 and 6mm **£1.75**

### SIGNAL INJECTOR

Simple push button operation. Oscillates at 700-1kHz with harmonics to 30MHz. 1.4V p/p output. Impedance 10Ω. Ideal for trouble shooting with audio equipment. One "AA" penlight battery supplied. O/No VP96 **£2.50**

### LOGIC PROBE

Automatic levelling. White LED indication. Minimum width of measuring pulse 30 milliseconds. Maximum input frequency 10MHz. Input impedance: 100kΩ. Power consumption: 40mA maximum. Power supply: 4.5-18 V d.c. ORDER No. VP97 **£10.50**

### CURRENT/POL CHECKER

Heavy duty test prods with built-in indicators for testing polarity; indicates whether a.c. or d.c. 3.5V to 400V. O/No VP98 **£3.00**

### TESTER

Universal tester with ceramic buzzer. Tests diodes, transistors, resistors, capacitors and continuity. One "AA" penlight battery included. Test current: Max 2µA. Test voltage: 1.2V. Response range: 100MΩ. Max voltage: 500V. Internal resistance: 390kΩ. Length: 135mm. **£5.00** O/No VP99

### CIRCUIT TESTER

D.C. continuity tester for circuit checking on all low voltage equipment and components. Diode checking also possible. Takes two AA batteries. 90cm lead has crocodile clip. Body length 145mm. O/No VP100 **75p**

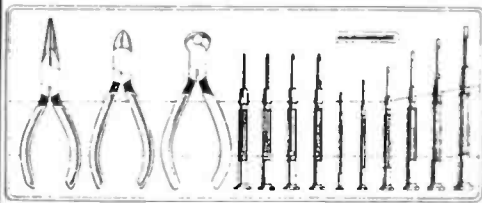
### MINIATURE VICE

Miniature plastic and metal vice with strong suction base for portability. Single action to secure or release suction. Plastic jaws with rubber parts 20mm wide, open out to 40mm. Dims: 85 x 65 x 60mm approx. **FANTASTIC VALUE** O/No. VP95 ONLY **£1.60**

### METRIC & BRITISH MEASURES

Steel tapes in sturdy ABS plastic case. Silk wrist strap. These yellow coated convex tapes have inch and metric graduations. Automatic push-button return. 2m long x 13mm wide. O/No. VP89 **£1.75**

## 13 PIECE TOOL KIT AND CASE



13 piece tool set housed in attractive moulded plastic case with clear sliding cover. 1 off 5" snipe nose "radio" pliers with side cutters. 1 off 4 1/2" side cutters. 1 off 4 1/2" end cutters. 2 off hex "Allen" key drivers 2mm and 2.5mm. 2 off cross-point "Philips" drivers No. 0 and No. 1 (with tommy bar). 6 off precision screwdrivers. Sizes from 1mm to 3.5mm

**ONLY £7.50** ORDER No. VP102

## LOW COST CUTTERS/PLIERS - SPECIAL DRIVERS

Miniature round nose cutters - insulated handles 4 1/2 inch length. Order No. YO43.  
Miniature long nose pliers - insulated handles 5 1/2 inch length. Order No. YO44.  
Miniature bend nose pliers - insulated handles 5 1/2 inch length. Order No. YO45.  
Miniature end nippers - insulated handles 4 1/2 inch length. Order No. YO46.  
Miniature snipe nose pliers with side cutter and serrated jaws - insulated handles 5 inch length. Order No. YO42.

**FLEXY DRIVER**  
A flexible shaft screwdriver for those awkward to get at screws. Overall length 8 3/4 inch. Order No. FS-1 Flat blade 4mm FS-2 Cross point No. 1 **£1.75 each.**

**GRIP DRIVER**  
8 inch long screwdriver with spring loaded grip on and to hold screws in position while reaching into those difficult places. Order No. SD-1 Flat blade 4mm SD-2 Cross point No. 0. **£1.20 each.**

**ALL AT £1.55 each**

## ANTEX SOLDERING IRONS

MODEL	WATT	O/NO.	PRICE
SX	25	1931	£5.40
CX230	17	1972	£5.30
CX250	15	1948	£5.20

**ANTEX ST4 IRON STAND**  
Chromium plated steel spring - in plastic base insulated, with wiper pad. O/No. 1939 **£1.75**

**PORTABLE SOLDERING IRON**  
12Vlt. 25 watt. Works from car battery. 2 core cable with heavy duty croc clips. O/No. 1971 **£5.60**  
**SK1 SOLDERING KIT** - for miniature work. Kit consists of: 1-15W iron (C240) 3 bits: 3/32, 5/32, 3/16. Solder & heat shunt. Booklet "How to Solder". O/No. 1938 **£8.00**

## BA BOX SPANNER SET

Contains one of each size: 0BA, 2BA, 4BA, 6BA, 8BA. Fixed Chrome Vanadium Steel Shaft in Plastic Handle. O/No. 2057 **£4.00**

## DESOLDERING PUMP

High suction pump with anti corrosive casing & Teflon nozzle. O/No. 1936 **£4.50**  
Spare nozzle O/No. 1937 **50p**

## CRIMPING SET

A crimping tool set consisting of a crimping tool suitable for insulated terminals. Supplied with 34 assorted terminals in a plastic tray with hinged, transparent lid. O/No. 1966 **£3.75**

## PICK-UP TOOL

Spring loaded "Pearl grip" pick-up tool for small components. Four fingers extend to 14mm dia. when plunger is pressed and close up when retracted. Chrome metal. Pocket clip. O/No. VP139 **£1.75**

## IC EXTRACTION TOOL

IC Extraction is made relatively easy with this tool. The IC is held by specially designed teeth. O/No. 2015 **50p**

## MAINS NEON TESTER/DRIVER

Has strong transparent handle with insulated screwdriver blade & pen type pocket clip - rated at 500v max. Length 140mm (5 1/2"). O/No. 2016 **55p**

## SUB-BOX

A neat swivelling disc provides close tolerance substitution resistors of 36 preferred values from 5 ohms to 1Kohm. Simply fix clips into circuit and swivel until optimum result is achieved. O/No. VP112 **£4.75**

## BATTERY TESTER

Tests all types of battery including standard, NICAD, Alkaline, etc. Takes all standard sizes including 6V lantern batteries and watch/hearing aid cells. Also tests fuses and lamps by means of internal 9V (PP3) battery. Can also be used to recharge NICAD batteries by means of external +3.2V d.c. power supply (not included). Dims: 185 x 103 x 30mm (approx.) Full instructions provided. O/No. VP101 **£7.00**

## POWER SUPPLY

Power supply fits directly into 13 amp socket. Fused for safety. Polarity reversing socket. Voltage switch. Lead with multi plug input - 240V AC 50Hz, Output - 3, 4, 5, 6, 7.5, 9 & 12V DC Rating - 300mA MW88. O/No. 137 **ONLY £3.75**

## BRAND NEW LCD DISPLAY MULTITESTER

RE 188m  
LCD 10 MEGOHM INPUT IMPEDANCE  
3 1/2 digit \* 16 ranges plus hFE test facility for PNP and NPN transistors \* Auto zero, auto polarity \* Single-handed, push-button operation \* Over range indication \* 12.5mm 1 7/8 inch large LCD readout \* Diode check \* Fast circuit protection \* Test leads, battery and instructions included.

Max. indication 1999 or 9999  
Polarity indication Negative only  
Positive readings appear without sign  
Input Impedance 10 Megohms  
Zero adjust Automatic  
Sampling time 250 milliseconds  
Temperature range 5 C to 50 C  
Power Supply 1 - PP3 or equivalent 9V battery

Consumption 20mW  
Size 155 x 88 x 31mm

**RANGES**  
DC Voltage 0-200mV  
0-2-20-200-1000V AC 0.8°  
AC Voltage 0-200-1000V  
Acc. 1.2° DC Current 0-200µA  
0-2-20-200mA, 0-10A Acc. 1.2°  
Resistance 0-2-20-200k ohms  
0-2 Megohms Acc. 1°

BI-PAK VERY LOWEST PRICE **£45.00** each  
Leather case for 188m **£2.50 EACH**

## MULTITESTER

1,000 ohm including test leads & Battery  
AC volts - 0.15-150-500-1,000  
DC volts - 0.15-150-500-1,000  
DC currents 0.1ma-150ma  
Resistance - 0.25 K ohms  
100 K ohms  
Dims - 90 x 61 x 30mm

O/No. 1322 OUR PRICE **£6.80 ONLY**

## HT320 MULTITESTER

Facilities for testing transistors. Mirror Scale, leads and battery  
SPEC  
DC Volt: 20,000 O P V  
AC Volt: 8,000 O P V  
DC Volt: 0.0 1.0 5-250  
10 50 250  
1000V  
AC Volt: 0.10-50-250  
1000V  
DC Current: 0.50µA  
2.5mA  
75mA-0.25A  
Resistance: 2K-20K-2M-20M Ohms  
RF Output: 10dB to -22dB (10V AC)  
As a Trans Tester tests Leakage, Current (leak) DC Current, Amplification, Factor (Hfe)  
Dims: 146 x 95 x 55mm  
Order No. 1323 **£15.40**

## BI-PAK PCB ETCHANT AND DRILL KIT

Complete PCB Kit comprises  
1 Expo Min Drill 10,000RPM  
12V d.c. incl 3 collets & 3 - Twist Bits  
1 Sheet PCB Transfers 210mm x 150mm  
1 Etch Resist Pen  
1 7lb pack FERRIC CHLORIDE crystals  
3 sheets copper clad board  
2 sheets Fibreglass copper clad board  
Full instructions for making your own PCB boards.  
Retail Value over **£15.00**  
ORDER NO. VP81  
OUR BI-PAK SPECIAL KIT PRICE **£9.95**

## RATCHET SCREWDRIVER KIT

Comprises 2 standard screwdriver blades 5 & 7mm size 2 cross point size 4 & 6 1 Ratchet handle 5-in 1 Kit O/No. 3298 **£1.45 each.**

# BI-PAK

Send your orders to Dept EM4 BI-PAK PO BOX 6 WARE HERTS SHOP AT 3 BALDOCK ST. WARE, HERTS  
TERMS CASH WITH ORDER, SAME DAY DESPATCH, ACCESS, BARCLAYCARD ALSO ACCEPTED. TEL (0520) 3182, GYRO 388 7006  
ADD 15% VAT AND 75p PER ORDER POSTAGE AND PACKING

Use your credit card. Ring us on Ware 3182 NOW and get your order even faster. Goods normally sent 2nd Class Mail. Remember you must add VAT at 15% to your Total order. Postage add 75p per Total order.

# Contents

**Editor:** Helen P. Armstrong  
**Technical Illustrator:** Jerry Fowler  
**Advertisement Manager:** Joanne James  
**Group Editor:** Dave Bradshaw  
**Publishing Director:** Peter Welham  
**Chairman:** Jim Connell

AN ARGUS SPECIALIST PUBLICATION

# ELECTRONICS

M O N T H L Y

The Newcomer's Magazine for Electronic Projects

## APRIL 1985 No. 6

### Projects



<b>RESISTANCE BOX</b> .....	4
<i>Nearly every resistance value between 1R and 11MR.</i>	
<b>CAR AUDIO BOOSTER/COMPRESSOR</b> .....	13
<i>Listen to the sounds, not to the engine.</i>	
<b>SOUND TO LIGHT CONTROLLER</b> .....	18
<i>A bass/complementary light control - as promised last month.</i>	
<b>AUDIO AMPLIFIER MODULE</b> .....	39
<i>A voltage-efficient amp module suitable for radios</i>	
<b>SHORT CIRCUIT: RF SIGNAL TRACER</b> .....	45
<b>SHORT WAVE CONVERTER</b> .....	56
<i>Allows you to use a medium wave radio for short wave reception.</i>	

### Features



<b>SECRETS OF SOLDERING</b> .....	9
<i>How to do it wrong, and what to do about it.</i>	
<b>COMPONENTS FROM THE INSIDE OUT</b> .....	25
<i>We unroll some capacitors.</i>	
<b>METERS, METERS, METERS</b> .....	30
<i>Thirty-one multimeters assessed in all price ranges.</i>	
<b>THE 1985 READERS SURVEY</b> .....	42
<i>You wrote the forms, we read them.</i>	
<b>ELECTRONICS FROM THE START</b> .....	46
<i>Electrolytic capacitors, and the 555 timer IC.</i>	
<b>REVIEW: BOX OF TRICKS</b> .....	60
<i>Classy cases for prestigious projects.</i>	

### Regulars



<b>Authors Wanted</b> .....	8
<b>What's On Next</b> .....	24
<b>Letters</b> .....	44
<b>Bookshelf</b> .....	53
<b>Subscriptions</b> .....	54
<b>Glossary</b> .....	55
<b>News</b> .....	61, 63
<b>PCB Service</b> .....	62
<b>PCB Page</b> .....	64

**Notice:** The contents of this publication including all designs, plans, drawings and programs and all copyright and other intellectual property rights therein belong to Argus Specialist Publications Ltd. All rights conferred by the Law of Copyright and other intellectual property rights by virtue of international copyright conventions are specifically reserved to Argus Specialist Publications Limited and any reproduction requires the prior written consent of the Company. All reasonable care is taken in the preparation of the magazine to ensure accuracy, but Argus Specialist Publications Ltd cannot be held responsible legally. ©Copyright 1985 Argus Specialist Publications Ltd. Member of Audit Bureau of Circulation.

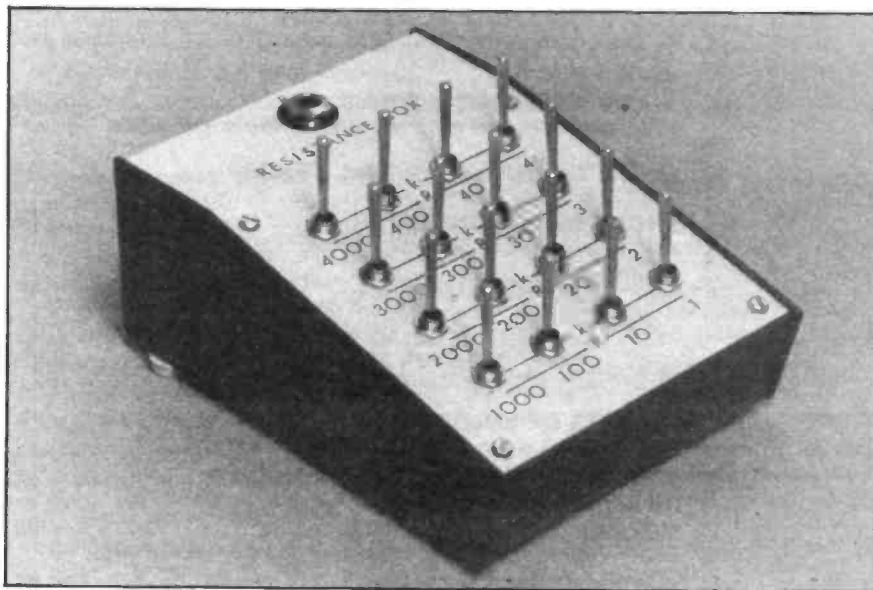
**Electronics Monthly** is normally published on the second Friday of the month prior to the cover date. **Electronics Monthly**, No. 1 Golden Square, London W1R 3AB. Tel: 01-437 0626. Telex: 881169. **Published** by Argus Specialist Publications Ltd. **Origination** by Ebony Typesetting, Trion House, 13 Dean Street, Liskeard, Cornwall PL14 4AB. **Design** by Footprint, 15 St. John's Hill, London SW11 1TN. **Cover Design** by MM Design, Circus House, 26 Little Portland Street, London W1N 5AF. **Distributed** by S.M. Distribution Ltd., 16/18 Trinity Gardens, London SW9 8DX. **Printed** by the Garden City Press, Letchworth, Herts SG6 1JS. **Covers** printed by Alabaster Passmore.

## NEARLY UNIVERSAL RESISTANCE

# BOX

With a multi-resistance box, just (just??) 64 resistors will give resistances in one ohm steps from 1R to 11MR.

Vivian Capel



THE ELECTRONICS GENIUS who reels off designs at the drawing board without ever handling a soldering iron or any involvement in the subsequent result is a figment of popular imagination. When the theoretical design takes form as a prototype there almost inevitably follow modifications and component changes before things start working out as planned. This is euphemistically called the "empirical method of design", or in other words, try-it-and-see.

One reason for this is the tolerance of components, particularly semiconductors whose hfe (gain) values can range widely. Although designers of published circuits try to reduce the effect by various methods, and design for the mid-point in the hfe spread, constructors often find transistors at the edge or outside of the specified spread, and so run in to trouble.

Usually, changing appropriate resistor values will bring the circuit into line. Often, too, experimental circuits need different values tried to achieve the desired result.

Here lies the snag. It is an immutable law that however good your stock of

resistors is, the ones that you *don't* have are those values around the one that needs to be changed. So you have to resort to all manner of tricky and risky series-parallel arrangements to get the one you want.

The answer is a resistance box with which you can try different values by the flick of a switch until the optimum is found. Sounds straightforward enough, but when you start working out the practical details problems arise. To provide a full range of preferred E12 values you need 84 different values. It may not be too difficult to accommodate these, but the switching is another matter. Even with these, the range is not comprehensive, because the required value may be intermediate, needing one of the E24 values, or if the circuit is critical, still closer increments.

### Percentage Increments

At this point we will digress for the benefit of readers who may wonder, as I did once, why on earth the preferred range should include such awkward

values as 4R7, 5R6, 6R8 and so on; why not round figures such as they used in the early days? The answer is that each value is approximately 20% increase over the previous one. The effect on most circuits of substituting the next higher or lower value will be proportionately the same. Hence going from 1R0 to 1R2 is the same as going from 6R8 to 8R2, a 20% increase.

There are twelve values in each decade, and seven decades from 1 ohm to 01 megohms, giving 84 values. In the case of the E24 series, the increases are about 10%, resulting in 24 values per decade and a total of 168.

A further digression: as anyone who has worked at servicing domestic electronic equipment will know, certain values occur far more frequently than others. Decades of 3R3, 4R7, and 6R8, occur much more often than the remaining ones, while 1R5 and 8R2 are particularly rare. Why is this? Is it just how the design values work out? Or more prosaically, do the manufacturers get resistors more cheaply by buying them in huge quantities of a few values? I would be interested to hear any opinions on this.

### Boxing Clever

Because of the large number of values in the range, many resistance boxes compromise so that various values are omitted. Those included are the ones deemed to be the most useful, but we all know which are the values we most likely will want — the missing ones! How then can we include all the E24 values without using over a hundred resistors and having an impractical array of switching?

To start, we can base our box around the fact that any value from 1 to 10R can be obtained from just four resistors, of values 1R, 2R, 3R, and 4R, in various combinations. To do this, they are wired in series with a switch connected across each one. With all switches closed there is zero resistance in circuit as all are shorted out, but opening any switch will add the value of its resistor to the total.

Thus four resistors, and four switches, for each decade will give every value from 1R up to 11,111,110R or 11MR plus some. This looks rather more practical, but even so it needs 28 switches which is rather unwieldy.

These switches can be reduced by arranging the switching in two ranges, a x1 and x1,000. This does not halve the switches required, because we need four for each decade. Either we must sacrifice a decade, making six, having three in each range with a total of twelve switches; or we must have four decades for each, needing sixteen switches and duplicating one decade. As a comprehensive tool was required, the latter course was chosen.

One method of obtaining the two

ranges is to use double-pole switches, each pole connected in series with one of two loops of resistors. A further switch is then included as the range switch to select either high or low values. There is at least one commercial resistance box that is designed along these lines.

There is, though, one snag with this arrangement. When switched to the higher range, values can only be changed in increments of 1,000R. At the highest decade, the megohm range, this is not much of a drawback, but at the lowest one, the thousands of ohms, it means that preferred values cannot be obtained, only round values. If, though, the duplicated decade is included here, these values can be achieved from the highest decade of the lower range. So the worst effect is with the second lowest decade on the high range, the tens of thousands. While a resolution of a thousand ohms does not interfere with the obtaining of any of the preferred values, it does restrict the fine degree of change that would otherwise be obtainable, and so too, although to a lesser extent, the next decade up.

This unit was designed to overcome this snag, and incidentally is also simple in that no range switch is required and single-pole double throw switches are used instead of double-pole, involving wiring to three instead of four terminals. A centre-off position is required, but this does not add to the constructional or wiring complexity.

## One Ohm Steps

With this unit, both ranges can be used simultaneously so that if required changes of one ohm can be made while on the megohm range. The only limitation which does prevent every value in one ohm steps from being achieved is the fact that a switch obviously cannot be used in two positions at the same time. Compared to those attainable, the unobtainable ones are very few and are reduced further by the duplicated decade.

Each switch has two resistor values associated with it, the low one connected across the two static contacts and the x1,000 value across one static and the moving contact. When the switch is up, the high value is shorted out and the low value is out of circuit, so the result is zero ohms. With the switch in the mid-off position, the high value resistor is now introduced into the circuit. Going to the low position places the low value in parallel with the high and thus obtains the low range value.

An obvious objection here is that paralleling the resistors on the low range decreases the resistance thereby giving an inaccurate value for the low range. However, the shunting resistor is a thousand times higher in value, which by a simple Ohm's law calculation drops the value by just under a thousandth. If

Because of the resistor-intensive nature of this project, we have been unable to reconcile the requirements of (a) listing the resistors in order of part number (b) laying out the wiring diagram in a logical order and (c) giving a clear listing of how many of each to buy.

We have accordingly opted for the latter two as being the most useful, which is why your parts list begins with R37 instead of R1.

If you want them in order, look at **Figure 2**

## RESISTORS

R37, 38	10R (2)
R5, 6, 55, 56	20R (4)
R21, 22	15R (2)
R41, 42	100R (2)
R9, 10, 59, 60	200R (4)
R25, 26	150R (2)

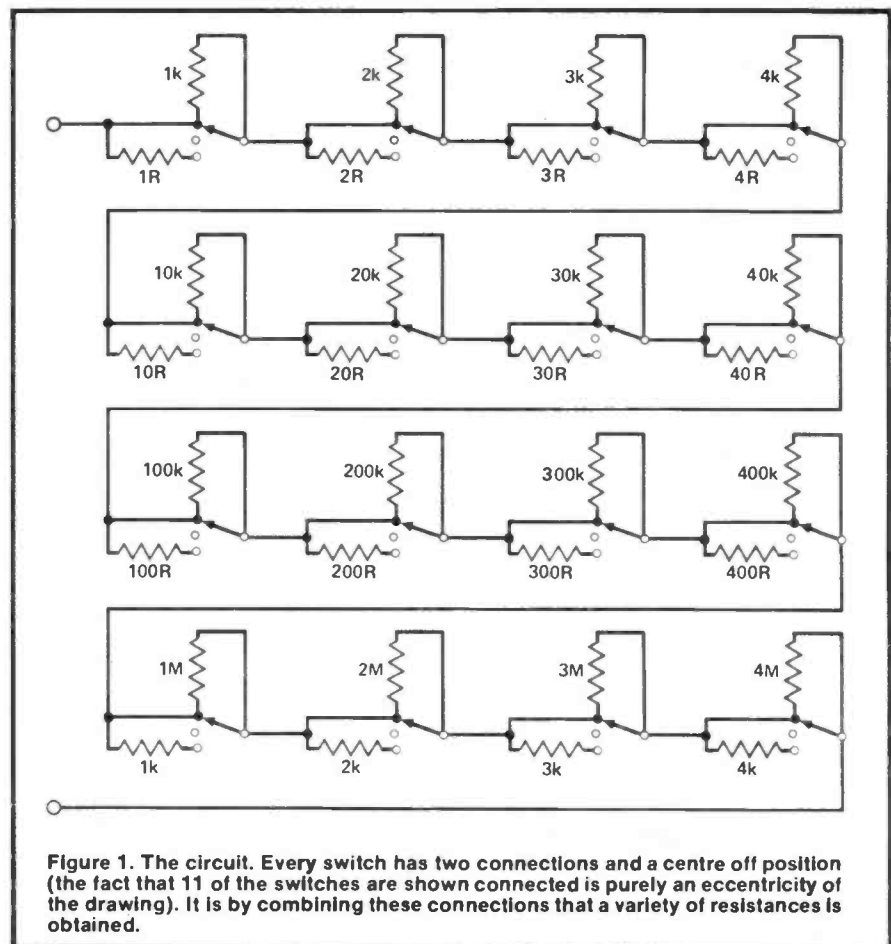
R35, 36, 45, 46	1k (4)
R3, 4, 13, 14, 53, 54, 63, 64	2k (8)
R19, 20, 29, 30	1k5 (4)
R39, 40	10k (2)
R7, 8, 57, 58	20k (4)
R23, 24	15k (2)
R43, 44	100k (2)
R11, 12, 61, 62	200k (4)
R27, 28	150k (2)
R33, 34, 49, 50, 51, 52	1R (6)
R17, 18	1R5 (2)
R2	1R8 (1)
R1	2R2 (1)
R47, 48, 65	1MR (3)
R31, 32	1M5 (2)
R16	1M8 (1)
R15	2M2 (1)

## MISCELLANEOUS

16 SPDT switches with centre-off and long toggles; 3-pole jack socket; suitable case; solder; sleeving if desired.

the closest resistor tolerance generally available, which is 1%, are used, the error caused by shunting is less than a tenth of the resistor tolerance. Hence there will be a greater error due to tolerance than due to paralleling the two values. In practice then, this affords a practical method of switching with minimum complication and with insignificant error.

To summarise, then, as every whole number from 1-10 can be obtained by combining the numbers 1-4, only four values are required for each decade. Two resistors are used for each value except 1 ohm and 1 megohm to obtain the required value and double the power rating. All switches are connected in series and each has three states: (1) a through circuit giving zero ohms; (2)



**Figure 1. The circuit. Every switch has two connections and a centre off position (the fact that 11 of the switches are shown connected is purely an eccentricity of the drawing). It is by combining these connections that a variety of resistances is obtained.**

# Project

(centre off) the high value is introduced, and (3) the low value is shunted across it. As the ratio between high and low values is 1,000/1, the error is a tenth of resistor tolerance and insignificant.

## Components

Ideally, resistors of 1, 2, 3, and 4 ohms and their decades of 1% tolerance and 1 watt rating should be used. Furthermore, they should be of low temperature coefficient and possess high stability. With these, the box can be relied on to give accurate values under a wide variety of conditions and continue to do so for many years.

Unfortunately, the ideal components are not generally available so we have to make do with the best that can be obtained. As accuracy is a major requirement, 1% tolerance was chosen except for the lowest decade for which 2% was the best available. For the highest decade no better than 5% could be found, though when actually measured they were well within the tolerance. (*but see Shop — Ed.*)

For the main ranges metal film resistors were used. These are the only ones obtainable in 1% tolerance, and as a bonus they have low temperature coefficient and high stability. For the values needed though, only .25 watt rating or .4 watt commercial are available. This may be adequate for most purposes, and with more than one value usually selected by the switching the wattage rating is increased, but it could pose a limitation on use especially when just a single value is in circuit.

It was therefore decided to use a choice of parallel or series resistors for each value to double the rating. The components are not large or expensive, so this is no great drawback and furthermore, two resistors have to be used anyway to obtain the correct value for 4R and its decades.

The chosen range of components must be available in the E24 series as most of the values are E24 preferred ones. The make-up of values is as follows: For 1R, two 2Rs are used in parallel; for 2R, two 1Rs are wired in series; for 3R, we use two 1R5s in series, and for 4R two 2Rs in series.

For the lowest decade, thick film metal glaze resistors at 2% came closest to the required characteristics. Unfortunately a 2R value is not available in this range. To obtain a higher wattage therefore, four 1R was used for the 1R value, connected in series-parallel. Two 1R in series for the 2R value as with the other ranges, also two 1R5s for the 3R value. In the case of the 4R value, 1R8 and 2R2 in series serves the purpose.

A similar combination can be used for the highest decade except that a single 1MR resistor is used to provide the value. High wattage dissipation is unlikely to be required at that value,

some 700 volts would need to be applied to dissipate half a watt. A pair is needed in the other positions to obtain the required values. Hi-stability carbons at 5% tolerance and half-watt rating are used.

As for the switches, SPDT units with centre-off position are required as previously mentioned. They were chosen with long toggles, because with sixteen switches of miniature type, it would otherwise be easy to overlook a switch in the wrong position. The long toggles enable the setting of all switches to be recognised at a glance.

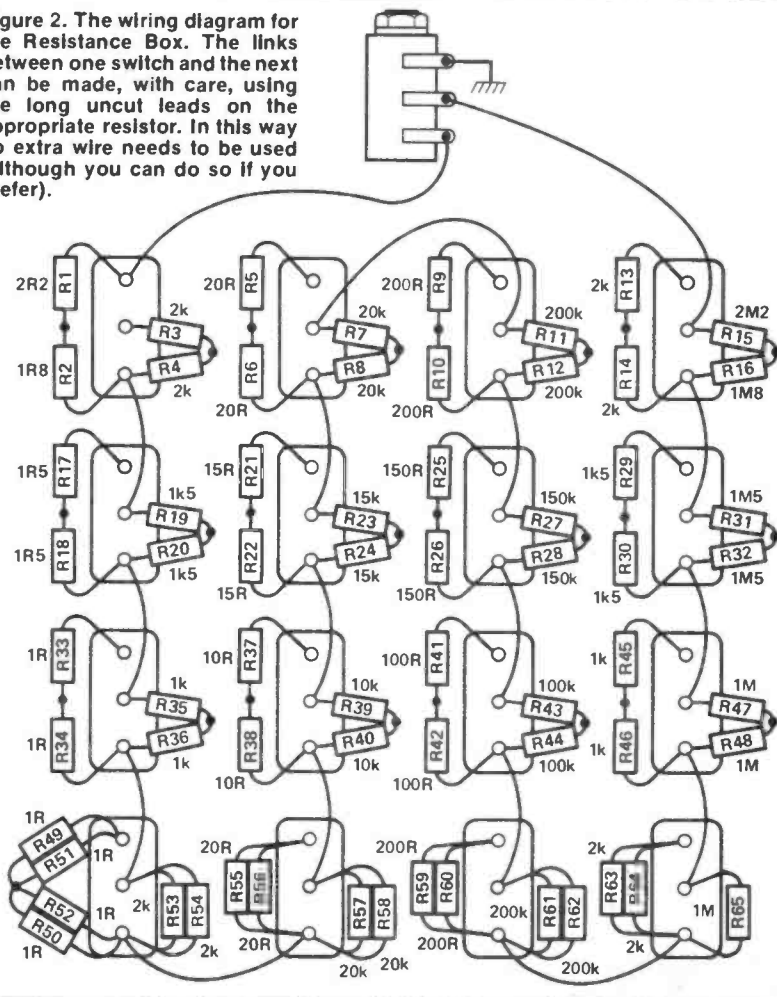
## Construction

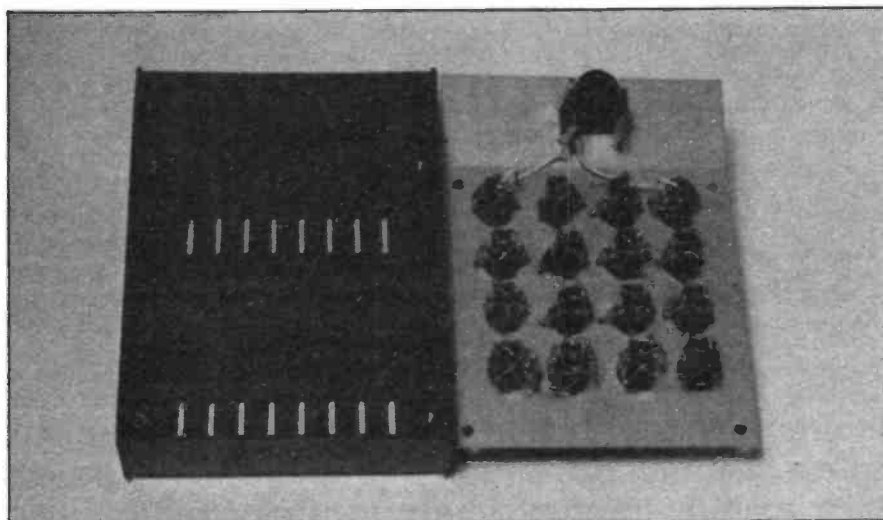
Some thought was given to the arrangement of the switches to give the most logical and natural mode of use. Four rows of four seemed the obvious configuration, each row for one decade, but which is the best way for them to run, from side-to-side, top-to-bottom, or bottom-to-top of the panel? The arrangement chosen, as can be seen in the photo, is from bottom-to-top, with the lowest values at the bottom. Then, the next decision was how to order the decades, from right-to-left, or left-to-right. For this the choice was from right-to-left, starting with the lowest decade on the right.

The reason for these choices was that in reading or thinking of a given value we encounter the highest decades first followed by the lower ones. So, as we read from left-to-right, it is natural to set the high values at the top left and work across and downward. Thus, if we want to obtain the value of 3M25, we set the left hand column to 3, the next to 2 and the third to either 2 and 3 or 1 and 4. The switches can of course be arranged any way the constructor wishes, and indeed most commercial boxes are laid out differently, however, this seemed to be the most logical, and subsequent use has confirmed its practicality.

The next consideration was the output terminals, of which the constructor has a variety to choose from. One possible use envisaged for the unit is the substitution of components in amplifier circuits where hum induced into the connecting leads could be a problem, for example, changing the values of an input load resistor to determine effect on frequency response and other parameters. Hence it seemed desirable to make provision for screening the leads. Using a single screened lead would mean that one leg of the circuit would be connected via the screen, hence should be earthed. However, the resistor being substituted may not be connected to chassis in the equipment under test. To avoid

**Figure 2. The wiring diagram for the Resistance Box. The links between one switch and the next can be made, with care, using the long uncut leads on the appropriate resistor. In this way no extra wire needs to be used (although you can do so if you prefer).**

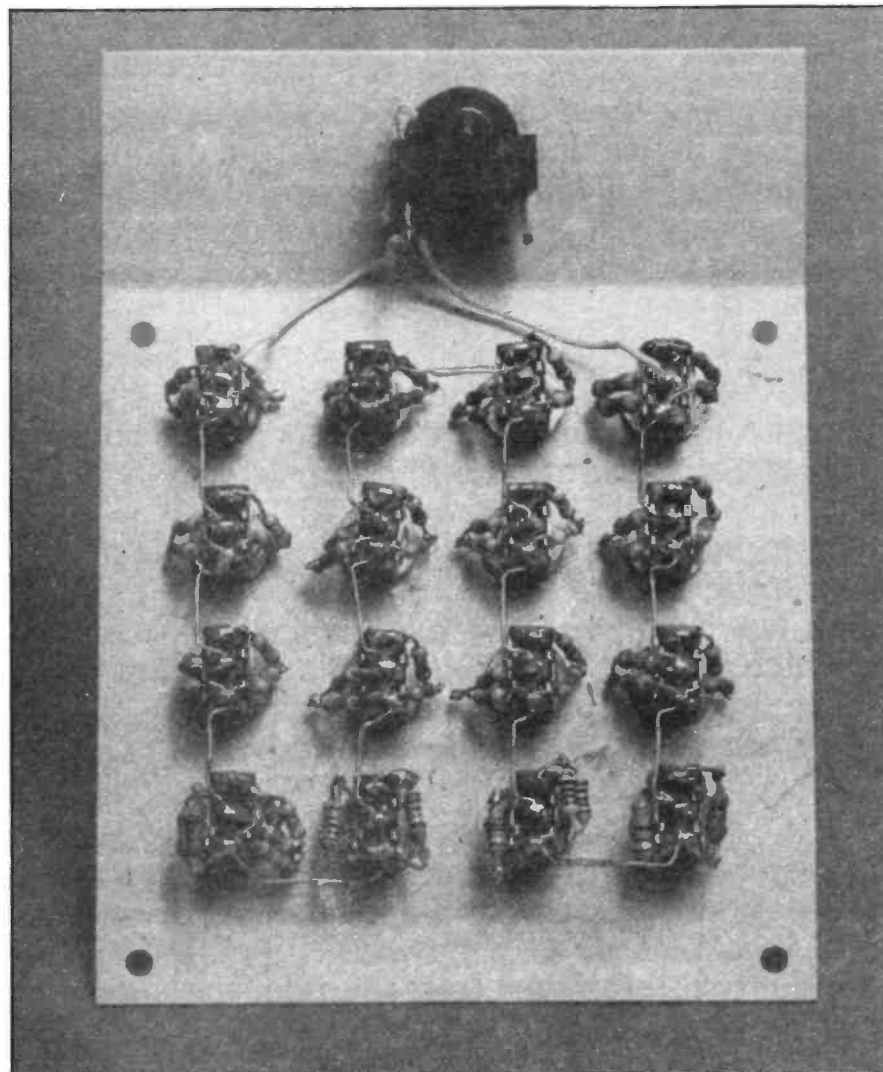




problems of this nature, twin screened cable is used, hence the screen can be earthed to the chassis, being independent of the circuit. Alternatively it can be left floating if the circuit under test is not critical.

The output connector chosen, therefore, is a three-pole jack socket, the earth connection being taken to the metal control panel. This is easily done by clamping a bare wire under the nearest switch to the output socket.

All resistors are wired directly to the switches, but double check that you have the right resistors for the correct switch. It is easy to get them wrong! Do not crop all the wires off after soldering; one from the appropriate tag should be long enough to reach the next switch. Sleeving can be used on these lengths if desired, but they are so short and rigid that it is not really necessary; those on the prototype were left bare. Just ensure that they are bent away from other tags



and also from the metal body of the switch.

As all switches are in series it doesn't matter what sequence they follow in the circuit. Hence they can be wired in the most convenient manner. The arrangement shown in **Figure 2** is the most straightforward, and the resistor wires can be used to link the adjacent columns just as they do adjacent switches. No extra wire is therefore needed at all except from the final switches to the output socket.

A resistance box is one of those gadgets that is inexpensive and has obvious virtues, yet its acquisition is often postponed, probably because of the limitations of available units. Once built, you will wonder how you managed without this device. Well, what about a comprehensive capacitance box to match? We are working on it, so watch this space!

## Shop

As the author recommends, the closer you can come to 1W, 1% rated resistors, the more stable and accurate your box will be. However, 5% 0.4W resistors will do the job adequately most of the time. Either carbon or metal film will do.

Carbon film 1W, 5% resistors are available from Maplin in all ranges except the 1 to 8R2 range. 0.4W, 1% metal film resistors are available for all decades. This is the best choice we can find, and actually represents a slight improvement over the author's own specification.

The box used is Bimbox 6005, with a sloping front, ventilation slots below, and small rubber feet. Any suitable box can be substituted; slots can be cut and feet added, but make sure before you start that you are allowing enough space for all your switches AND the clutch of resistors, leads and solder around them. Be generous rather than niggardly to give yourself more room to work.

As for the switches, **Cirkit (tel: 0992 444111)** do an SPDT toggle switch with a standard toggle, no. 53.00202. The author has used Altai STM10 long toggle switches: nice if you can find them; if not, standard toggle will do, but again, remember what we said about leaving yourself space to operate them easily.

The cost of the project, using standard rather than special components, should be around £17, with the switches being the most expensive sector. It is worth casting around to see if you can find cheaper switches (the Cirkit ones are around 75p each). Don't try to substitute a different kind, however.

# Authors, please

We want to hear from you now,  
because

## YOU ARE A TECHNICAL WRITER

**Electronics Monthly** is looking for new contributors. We need experienced writers who can explore different aspects of electronics in terms which the new student and even the complete beginner can understand, and who can design and write up projects which employ the fundamentals of electronics in an educational and original way.

We particularly need:

- simple projects using popular standard components, thoroughly explained.
- Features based on analogue circuit design, with circuits to build.
- Intermediate projects illustrating aspects of circuit design, with tips for experimenters.
- Entertaining or useful project designs, especially bench equipment.

## YOU WOULD LIKE TO BE A WRITER

There are plenty of people designing their own projects who have not yet thought of publishing them. Inexperience does not bar you from writing, and you will in any case receive plenty of guidance, both technical and literary, from us. You may be a long-time hobbyist, a newcomer or a teacher. In any case, if you have devised something for yourself, there is a good chance other people would like to hear about it.

We particularly need:

- projects based on CSE, O and A level courses, or other electronics courses.
- circuits which you have found useful in understanding particular electronic principles.
- gadgets which have proved to be useful.
- gadgets which have proved to be useless — but fun.
- project building and design tips from your own experience.

We offer competitive rates, which are negotiable. For details of what we need, and what's in it for you, please send your project outline or a sample of your work for my attention: **Helen P Armstrong, Electronics Monthly, No. 1 Golden Square, London W1R 3AB.**

Please note that while we take every care, work submitted passes through many hands (including the post). We cannot be responsible for the loss of uncommissioned work, so please keep copies of all paperwork submitted and, if sending hardware, please send it registered post (recorded delivery does not provide for compensation in the case of loss in the post).



# In the second part of our feature on soldering, we cover faulty joints, double-sided boards and desoldering techniques.

Marcus Smith

## Bad Joints

As I mentioned last month the main cause of a bad connection is dirt on the PCB or components. Under- or over-heated solder is another cause to watch out for.

If the joint has a fault, the solder will tend to interface with the metal at a convex angle, even to the extent of forming a ball around the joint.

Poor wetting causes the solder to settle in blobs around the joint. If the this

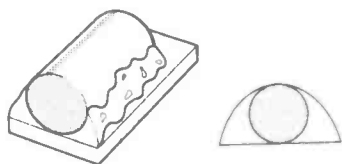


Figure 1. With poor wetting, caused by dirt on the connections, the solder forms a convex angle or 'bulge' around the joint, and may break up into blobs.

# SECRETS OF SOLDERING

happens, try reheating the joint more thoroughly, and see what happens. Don't add more solder, as this may make the joint look correct while hiding a poor contract. If the joint refuses to settle right the second time, desolder and clean the surfaces. If the joint takes on a crystalline appearance, the solder has overheated: desolder and clean.

If the solder forms definite balls around the joint and on the tracks, the

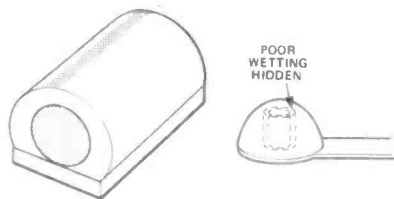


Figure 2. The result of adding extra solder to a poorly-wetted joint is a poorly wetted joint with extra solder on it. Unsolder and start again!

joint needs desoldering and detarnishing right away.

If the joint appears to settle properly, and then withdraws into a blob, you have again a tarnish problem, and the joints need desoldering and cleaning.

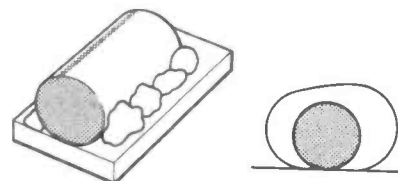


Figure 3. Tarnished joints cause an extreme form of non-wetting. If this happens, unsolder the joint and clean it with abrasive before re-soldering.

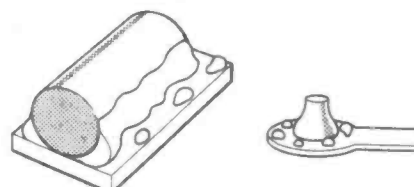


Figure 4. 'Dewetting' is when the solder appears to settle correctly, and then withdraws into blobs and flat spots on the surface. Treat as for non-wetting.

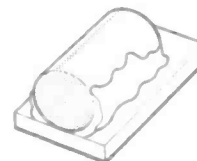


Figure 5. A steep, straight angle is caused when the solder is under-heated. The solder is brittle and may be levered off. The cure is to re-heat the joint to the correct temperature.

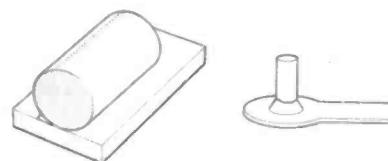


Figure 6. Too little solder, even if applied correctly, makes a joint which is not strong enough to stand up normal to stresses and will fracture easily. Add more solder.

## Dry Joints

The most notorious form of bad joint is the 'dry' joint. Dry joints generally take the blame if a project doesn't work the first time. A dry joint is not one which hasn't wetted properly, despite its name, but one which has been made too cool, or been disturbed while setting. It is tricky, because it may work at first, but is brittle, so that any slight disturbance of the board will disconnect it. Dry joints look much like good joints, but tend to lie at a steeper angle, and may have a frosty crystalline appearance.

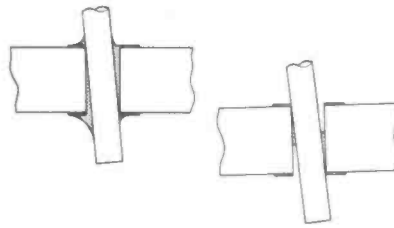
Thorough reheating usually cures a dry joint, but inspect it thoroughly. If

A quick revision on the appearance of a good joint: the solder lies at a gentle concave angle with the joint, is smooth and normally shiny in appearance and covers the joint evenly without concealing it. Leads should be cut off about 2mm above the board, either before soldering, otherwise giving the solder time to set firmly first. Underheating the joint, or dirt and tarnish on the connections, are the main causes of bad joints. Disturbing the joint before it has cooled, or cooling it artificially, can cause cracks.

## Double Sided PCBs

On double-sided PCBs, the usual rules apply, with the proviso that if there are plated-through holes, there must be enough solder to fill the hole. The solder should run into the plated holes easily, but a little extra heat and solder is needed.

For unplated holes, solder the component on whichever side of the board it needs to make contact with a track. You may find yourself soldering from the component side of the board. This is not a problem, but take care not to put the iron onto the body of the



(Above) a correct solder joint for a connection through a double-sided board (below) not enough solder has settled in the connecting hole, and the joint will be weak.

component. If this seems inevitable, mount the component on longer leads (you haven't cut the leads yet, have you?) to give yourself more working room.

You may be using PCB pins. Make sure they are firmly attached, on both sides of the board if necessary. When attaching a component to a PCB pin, just take the lead in a U-turn around the pin. More wrapping than this will make a clumsy joint, and one which is hard to desolder.

solder is reheated too often, a similar kind of breakdown can occur, caused by the introduction of dirt, vaporisation of flux, overheating the solder, etc. Dry joints are sometimes (and more accurately) called 'cold' or 'grey' joints.

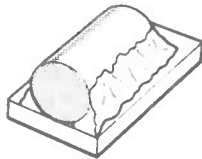


Figure 7. A 'dry' or 'cold' joint may have a good shape but has a grainy appearance. Re-heat without adding extra solder. If the joint does not form properly after a second try, desolder, clean the joint and start again.

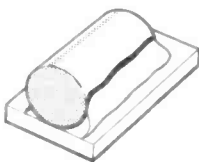


Figure 8. Another result of underheating the joint may be a resin bond. A thin translucent layer of resin can be seen between the solder and the joint, preventing electrical contact. Treat as for a dry joint.

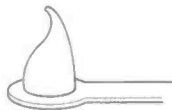


Figure 9. Small points which form on the solder when the iron is withdrawn are called 'icicles'. Treat as for a dry joint if necessary, but if the joint seems otherwise sound, the odd icicle does no harm.

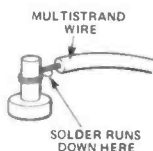


Figure 10. 'Wicking' is a fault caused when solder runs down multistrand wire from the joint. This makes the wire brittle, and it may later break. Prevention: make sure stranded wire is pointing 'uphill' when soldering.

The same conditions which cause dry joints can cause little pointy bits of solder, called **icicles**, to form on joints as the iron is removed. Follow the same procedure as for dry joints.

Care, caution and clean components — and practice — is all that is needed to master the art of soldering.

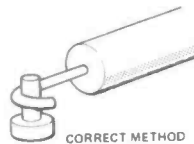


Figure 11. The right way of attaching a component to a PCB pin. Do not wind or cross the component lead.

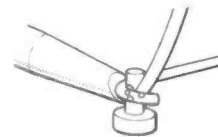
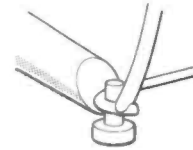


Figure 12. Make sure that the bit you are using is large enough to heat the whole joint. The solder may break up if underheated, or it may form a dry joint.

## Desoldering

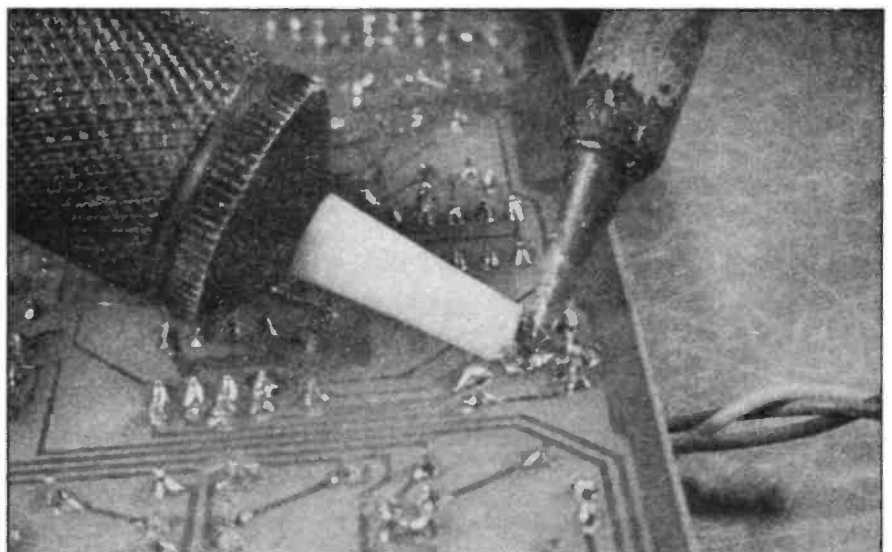
Desoldering is an important thing to bear in mind when assembling a board. You may need to do a repair, or alter a component value.

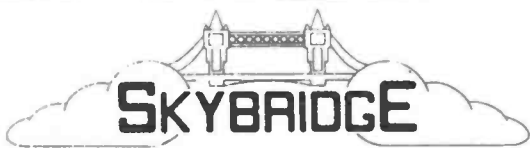
Melting the solder is simple. If you can touch the iron to both leads at once, you can lift the component out quickly with your fingers or a pair of fine pliers. Bending the leads to lift out one lead at a time is also reasonable, but be careful if you want to re-use the component.

In more tricky desoldering situations, use a solder sucker — a cheap and

useful tool — to remove the molten solder before you work out the component. The remarks higher up about flicking also apply to emptying solder suckers! Desoldering braid can also be used to remove solder.

If you are removing an IC, it is essential to remove the excess solder first to avoid damaging the pins. In the case of a PTH board, it is safer to cut the pins of the IC socket, or even of cheap ICs, than to risk overheating or tearing the through plating.





ELECTRONIC COMPONENTS

441 Princes Road, Dartford, Kent DA1 1RB



**NEW CATALOGUE NOW AVAILABLE CONTAINING THOUSANDS OF LINES MANY ILLUSTRATED**

This incredible volume contains everything required by the home constructor, amateur radio & C.B. user and computer enthusiast.

We think the semiconductor section contains more types than have ever been offered to the hobbyist. Sections are headed as follows:

Aerials, Amplifiers, Audio Accessories, Batteries, Boxes, Bulbs, Capacitors, Crystals, Car Components, Car Audio, CB & Ham Equipment, Computer Connectors, Fuseware, Hardware, Headphones, Knobs, Lamps, Leads, Loudspeakers, Microphones, Meters, Opto, PCB, Resistors, Semiconductors, Special Effect Equipment, Switches, Power Supplies, Test Equipment, Tools, Transformers, Wound Components.

In addition to listed items we continue to provide a procurement service for obsolete and difficult to obtain types.

How many suppliers do you have at the moment that offer a service like this?

Please Fill in coupon below and send with £1.25 print clearly as coupon is used as address label.

Catalogue contains **£2.50 Discount** order form — you make a profit straight away.

NAME .....

ADDRESS .....

.....

.....

.....

POSTCODE .....



**The MIGHTY MIDGETS SOLDERING IRONS AND ACCESSORIES TYPE 1**

**£5.86** inc vat  
postage 35p

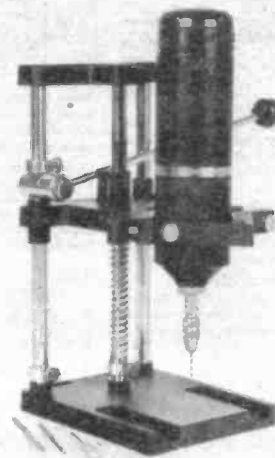
12 month guarantee **18 WATT**

From your Local Dealer or Direct from Manufacturers

**S & R BREWSTER LIMITED**

86-88 UNION ST. PLYMOUTH PL1 3HG  
0752-665011 TRADE ENQUIRIES WELCOME

**Mini Drill PLUS Stand Only £17.99.** (Including VAT, Postage & Packing).



The D-3 mini drill is ideal for the hobby enthusiast. Its small, compact size, and light weight make it perfect for use in areas of restricted access. It can be run from mains (with suitable adaptor), directly from a car battery, or even from its own battery power source. It comes complete with three chucks, four bits and one grinding bit. Also supplied is a 6 foot lead. The drill is contained in its own individual plastic box.

The drill stand is made from steel and plastic, giving strength with light weight. The stand has a spring return, and upper and lower adjustable movement stops. It also has screw holes for attaching to a worktop.

An optional transformer is available for only £4.95p.  
D-3 MIN DRILL 6-12 VOLTS DC 2200 RPM. 260gm. DIAMETER 42mm. LENGTH (WITHOUT BIT) 190mm. POWER SUPPLY 4xUM3 BATTERIES, OR AC ADAPTOR 6-12V. MAX 15V 2A

Send Cheque/Postal Order to:  
**VAN GELDER (UK) LIMITED**  
Unit 1, South Road, Southend Airport Southend-on-Sea, Essex SS2 6YG  
Barclaycard and Access accepted. Please quote number. Credit card holders may order by telephone. Tel: (0702) 548681.

## NEW THIS MONTH

### IEC FILTER PLUG

Made by Randar, integrated chassis mounted plug with mains filter rated 2A. Like R6 236-514. Only £3.00.

### 7-SEG LEDs

MAN8910 0.8" red seven segment LED's common anode. £1.28, 10 for £10.

### DIL SOCKETS

Gold plated low profits at unbeatable prices:

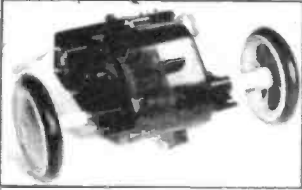
14DIL £7/100  
16DIL £8/100  
24DIL £12/100  
40DIL £20/100

### VOLTAGE REG SCOOP

7924UC 1A 24V 40p  
UA317UC ¼A variable 50p  
76MGUIC Variable 85p

### 'TREKKER'

Computer-controlled Robot built around the gearbox described below. Complete kit of parts inc PCB, program listings for BBC (other micros soon). £44.85 20W ribbon cable (min 3m recommended — 5m better) £1.30/m SAE for illustrated leaflet.



### MOTORIZED GEARBOX

These units are as used in a computerized tank, and offer the experimenter in robotics the opportunity to buy the electro-mechanical parts required in building remote controlled vehicles. The unit has 2 x 3V motors, linked to a magnetic clutch, thus enabling turning of the vehicle, and a gearbox contained within the black ABS housing, reducing the final drive speed to approx 50rpm. Data supplied with the unit showing various options on driving the motors etc. Two new types of wheels can be supplied (the aluminium discs and smaller plastic wheels are now sold out). Type A has 7 spokes with a round black tyre and is 100mm dia. Type B is a solid heavy duty wheel 107mm dia with a flat rigid tyre 17mm wide. PRICES: Gearbox with data sheets: £5.95 ea; Wheel type A: £0.70 ea; Wheel type B: £0.90 ea.

### "SENSING & CONTROL PROJECTS FOR THE BBC MICRO"

Have you ever wondered what all those plugs and sockets on the back of the BBC micro are for? This book assumes no previous electronic knowledge and no soldering is required, but guides the reader (pupil or teacher) from basic connections of the user sockets, to quite complex projects. The author, an experienced teacher in this field, has provided lots of practical experiments, with ideas on how to follow up the basic principles. A complete kit of parts for all the experiments is also available. Book, 245x165mm 120pp £5.95. Kit £29.95.

### MOVITS

Self assembly robots realistically priced! 4 different Line Tracer II models available: £17.99  
Piper Mouse £19.99  
Memocon Crawler £34.99  
Circular £29.99

Details in our Catalogue supplement.

### FIBRE OPTICS

Scoop purchase of single and twin cable. For use with visible light or infra-red. Core 1mm dia, overall 2.25mm dia. Single 50p/m; 210m coil £8.30. Twin 80p/m; 20m coil £11.00.

### PCB MOUNTING NI-CADS

Much sought after 4.8V 150mA bats with PCB mntg tags on 25mm pitch. Batt size 25x16. Ideal for paralleling 99p ea: 10+ 85p; 25+ 70p; 100+ 60p.

### 1W AMPLIFIER

Z914 Audio amp panel 95x65mm with TBA820 chip. Gives 1W output with 9V supply. Switch and vol control. Just connect batt. and speaker. Full details supplied. Only £1.50 10 for £12; 25 for £25; 100 for £75.

### AM TUNER PANEL

Z918 For use with mono amp above. Neat panel 60x45mm. Only £1.50; 10 for £12.00.

### 1984/85 CATALOGUE

84 page A4 size — Bigger, Brighter, Better — more components than ever before. With each copy there's discount vouchers. Bargain List Wholesale Discount List, Bulk Buyers List Order Form and Reply Paid Envelope. All for just £1.00!! (FREE to Schools etc). Winter Supplement 'due out

WE CAN SUPPLY PARTS FOR MOST PROJECTS FEATURED IN ELECTRONICS.  
Ring or write for quote.

# GREENWELD

Our shop has enormous stocks of components and is open from 9 - 5.30 Mon - Sat. Come & see us!  
OFFICIAL ORDERS WELCOME  
MIN. INVOICE CHARGE £10  
Min Access order £5.00

November — Send large SAE for your free copy.

### VEROBOARD & RIBBON CABLE

Discontinued lines, some at less than ¼ price! e.g. Dipboard 158x165mm £3.50; 26W Grey ribbon £4/3m; Red wirewrap 24AWG £2.50/100m. Full details in winter supplement.

## GREENWELD — The Pack People!!

**K523 RESISTOR PACK** — 1000 — yes 1000 ¼ and ½ watt 5% hi-stab carbon film resistors with pre-formed leads for PCB mounting. Enormous range of preferred values from a few ohms to a several Meg ohms. Only 250p, 5000 £10 20,000 £38.

**K520 SWITCH PACK** — 20 different assorted switches — rocker, slide, push, rotary, toggle, micro etc. Amazing value at only 200p.

**K522 COPPERCLAD BOARD** — All pieces too small for our etching kits. Mostly double-sided fibreglass. 250g (approx. 110 sq. ins) for 100p.

**W4700 PUSH BUTTON BANKS** — an assortment of latching and independent switches on banks from 2 to 7 way. DPCO to 6PCO. A total of at least 40 switches for £2.95, 100 £8.50, 250 £14.00.

**K518 200 DISC CERAMIC CAPS** — big variety of values and voltages from few pF to 2.2µF; 3V to 3kV £1.00.

**K531 PRECISION RESISTOR PACK** — High quality, close tolerance R's with an extremely varied selection of values mostly ¼ and ½w tolerances from 0.1% to 2% — ideal for meter, test gear etc 250 £3; 1000 £10.

### LEADS AT SILLY PRICES!!

PL616 DC adaptor lead for Walkman, 1.8m long 30p

PL528 2 pin DIN line skt to phono plug 0.2m long 20p

PL508 5 pin DIN to 3 pin DIN audio lead 1.2m long 40p

PL541 Intercomm extn lead, phono line skt to 3.5mm plug, 6m long 40p

PL708 Video lead, PL259 plug to F type plug, 3m low loss coax 85p

**FM TUNING MODULE**. This neat unit 75x40x19mm as used in car radios etc. Standard 10.7MHz IF output. 9-12V DC supply. Full connexion data supplied. £2.40

**STEREO CASSETTE HEAD**. Only £1.00

12V SOLENOID, 10mm travel. Overall length 46x13x15mm. Coil 75R Only £1

### NI-CAD CHARGER SCOOP!

Ever-Ready model CH4, this charger will take up to 4 AA, C or D cells plus 2 PP3 if required. Smart two tone grey case 212x97x60mm. Only £7.95

### MINIATURE RELAYS

PCB mounting. DPCO size 20x15x15mm. Available in 3, 9 or 12V. £1 each.

### STEPPING RELAY

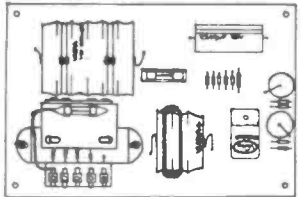
Schrack 2 pole 10 way 24V DC (works down to 15V) only 39x20x24mm. Connections by 0.1" pitch edge plug. Special low price £1.95.



These digital multimeter cases are moulded in high impact black plastic and are offered at an extremely attractive price to clear stocks.

DP2010 110x80x120mm, this has cut-outs for range switches and terminals, with a smart aluminium fascia marked with ranges etc. Battery accessible by removable cover on back 75p.

DP100 Same size as above, but this was for use as a digital thermometer so there's only a single 9mm hole in the front panel 75p.



### NI-CAD CHARGER PANEL

177 x 114mm PCB with one massive Varta Deac 57 x 50mm 0 rated 7.2V 1000mA/h and another smaller Deac 32 x 35mm 0 rated 3.6V 600mA. The price of these Ni-cad stacks new is over £20. Also on the panel is a mains input charger transformer with two separate secondaries wired via bridge rectifiers, smoothing capacitors and a relay to the output tags. The panel weighs 1kgm. All this for just £8.00.

# QUASAR STEREO CASSETTE DECK



From

# RTVC £29.95

INCLUDING VAT & CASE PLUS £2.75 P & P

For a special offer price of only £29.95 we're offering you this super Quasar Cassette Deck Kit. Including tape transport mechanism, n, ready punched and back printed quality circuit board and all electronic parts i.e. semi-conductors, resistors, capacitors, hardware, top cover, printed scale, mains transformer and a self assembly simulated wood cabinet. You only supply solder and hook-up wire.

### SPECIFICATIONS:

Case size 285x260x90mm approx. Mechanism with automatic stop and tape counter with reset button. Tape Speed: 4.76cm/sec (1 7/8 in/sec). Wow & Flutter: Typically 0.1%. Drive Motor: 12V d.c. with electrical governor. Play Torque: 40-75g/cm (DYNAMIC). Rewind & Fast Forward Torque: 60-140g/cm (STATIC). Rewind & Forward Time: Less than 100 sec. for C60 tapes. Bias/Erase Oscillator: Externally variable, frequency 60-100kHz. Output: (Adjustable) Up to 1 volt r.m.s. Mic. Sensitivity: 1mV @ 47k. DIN Sensitivity: 30mV @ 47k. Frequency Response: 30Hz-12.4kHz (-3dB). Signal to Noise Ratio. Noise reduction OFF-50dB. Noise reduction H.F. -56dB Noise reduction FLAT-70dB Cross Talk: Typically -50dB.

CALLERS WELCOME: 323 EDGWARE RD., LONDON W2.

— Open 6 days a week 9.00 — 5.30.

21 HIGH ST., ACTON LONDON W3 6NG

Tel: 01-992 8430 — Open 6 days a week 9.30 - 5.30

½ day closing Wednesdays

To: RT-VC, 21A High St., Acton, London W3 6NG

Please send me

Kit/s

One deck kit costs £29.95 plus £2.75 p&p (£32.70)

I enclose PO/Cheque No ..... Value .....

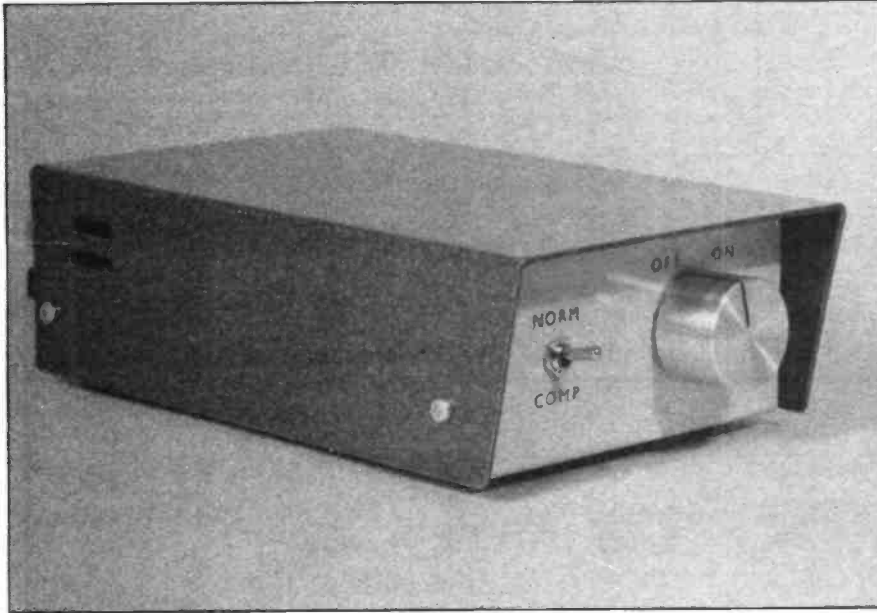
Name .....

Address .....

Access 'phone orders 01-992 8430

To: RT-VC, 21A High Street, Acton, London W3 6NG

# CAR AUDIO BOOSTER/COMPRESSOR



monophonic type, but for stereo operation it is merely necessary to make up two amplifier boards.

## Operating Principle

Obtaining a fairly high output power from a 12 volt battery supply represents a difficult task. A car battery can supply high currents without risk of damage, but the nominal potential of 12 volts (which is usually about 13 and 14 volts in practice) is rather limiting. An ordinary transformerless output stage gives a peak to peak output voltage that is typically equal to about 9 volts peak to peak using a 12 volt supply. In terms of RMS potential this is little more than 3 volts, and in terms of output power this only represents around 1.3 watts RMS into 8 ohms, or 2.6 watts into 4 ohms. A high efficiency output stage can give a slightly higher output voltage swing of perhaps 11 volts, or even more with a typical battery potential of about 13.5 volts. However, this alone is not enough to give an output power of more than a few watts RMS into ordinary 4 or 8 ohm loudspeakers.

One method of obtaining higher output power is to use an output transformer to obtain a voltage step-up and a drive voltage that is in excess of the supply potential. There is a neater solution though, and one that is more practical for the home-constructor. This is to use a bridge amplifier, which is really two power amplifiers driving a single loudspeaker. **Figure 1** is the block diagram for the Booster/Compressor unit, and this helps to show the way in which a bridge amplifier functions.

For the time being we will ignore the VCA, smoothing, and rectifier stages,

## An audio booster designed for use in the car from a 12 volt vehicle supply, this device boosts quite musical passages.

THIS AUDIO booster for use with ICE (in-car equipment) provides a genuine output power of 18 watts RMS into 4 ohm impedance loudspeakers from an ordinary 12 volt vehicle supply. It does not require any special transformers, and achieves this output power using an efficient bridge amplifier circuit. The unit is intended for use in negative earth vehicles, and this includes the vast majority of vehicles these days.

A common problem with programme sources that have a wide dynamic range is that of quiet passages being lost beneath the engine and road noise. A booster obviously helps by enabling greater volume at all dynamic ranges to be obtained, but the dynamic range of some programme sources is too great for this to provide a complete solution. One way of overcoming the problem, and the one featured in this booster design, is to use signal compression. This is accomplished by having a level of voltage gain that varies according to the input signal level. At low levels the voltage gain must be higher than normal so that quiet signals are taken above the engine and road noise. At higher

volume levels the voltage gain must reduce to a lower level so that overloading of the amplifier and serious distortion are avoided.

The compression is achieved using just a very few extra components, and the unit as a whole is in fact very simple indeed. The compression can be switched out when it is not required. As described here the amplifier is only a

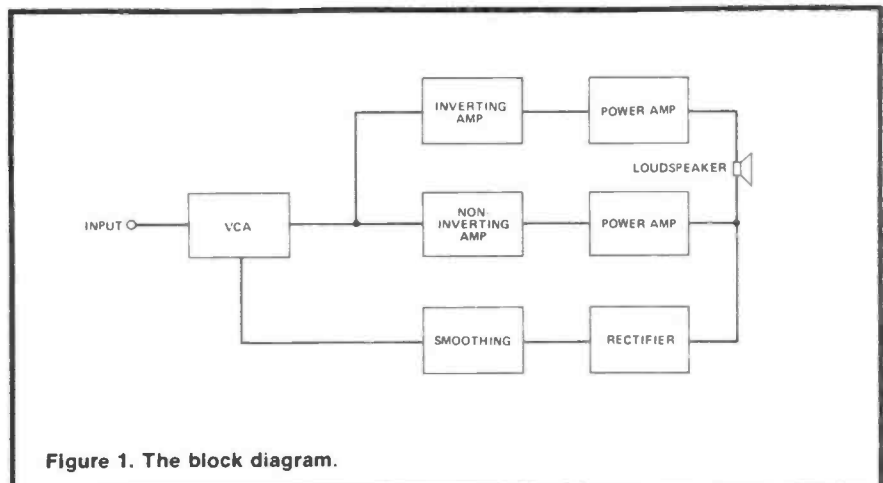


Figure 1. The block diagram.

# Project

which form the compressor circuit and are not part of the booster section. The input signal is applied to two amplifiers which have identical voltage gains, but one inverts the signal whereas the other does not. Each amplifier drives a power amplifier stage, and the two power amplifiers, which are identical, are driven out-of-phase. The loudspeaker is driven from the non-earth outputs of the two amplifiers.

Under quiescent conditions the two amplifiers both have an output potential of half the supply voltage, and the voltage across the loudspeaker is consequently zero. With an input signal applied to the circuit the output voltages will vary up and down, but as the outputs are out-of-phase, as one of them swings more positive the other swings more negative. When one output is driven fully positive the other is fully negative, giving something approaching the supply potential across the loudspeaker. The point that is of importance here is that the polarity of the signal across the loudspeaker depends on which of the outputs is positive and which is negative, and the circuit can drive the loudspeaker with virtually the full supply voltage and with either polarity. In other words, the peak to peak voltage drive is nearly equal to twice the supply potential.

Bearing in mind that doubling the drive voltage to the speaker also doubles the drive current, this gives a quadrupling of output power when compared with a conventional amplifier. By using efficient power amplifiers and 4 ohm loudspeakers this enables a typical output power of 18 watts RMS to be obtained from a car battery supply.

## Compressor

The main stage of the compressor circuit is the VCA (voltage controlled amplifier) at the input of the circuit. This has a relatively low attenuation level with zero or small control voltages, but about 10 to 12dB more attenuation with high control voltages. The control voltage is derived from one output of the unit via rectifier and smoothing circuits. This gives a control voltage that is roughly proportional to the output signal level.

At low dynamic levels the control voltage produced is low and the VCA provides its minimum degree of attenuation. As the input signal level is increased the control voltage also increases, producing reduced gain from the VCA and the requires compression effect. 10 to 12dB of compression gives a level of gain which is three to four times higher at low volume levels than it is at high levels. This is not a great deal of compression, but it should give good results in this application. A large amount of compression is not really desirable as it would seriously degrade the effectiveness of many programme sources. It is best to use just sufficient compression to ensure that quiet signals

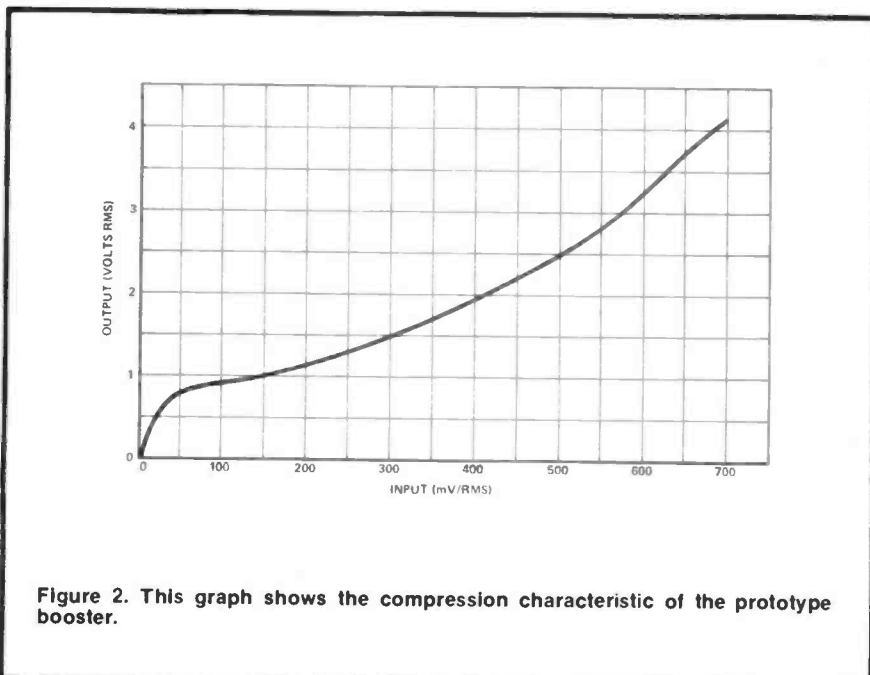


Figure 2. This graph shows the compression characteristic of the prototype booster.

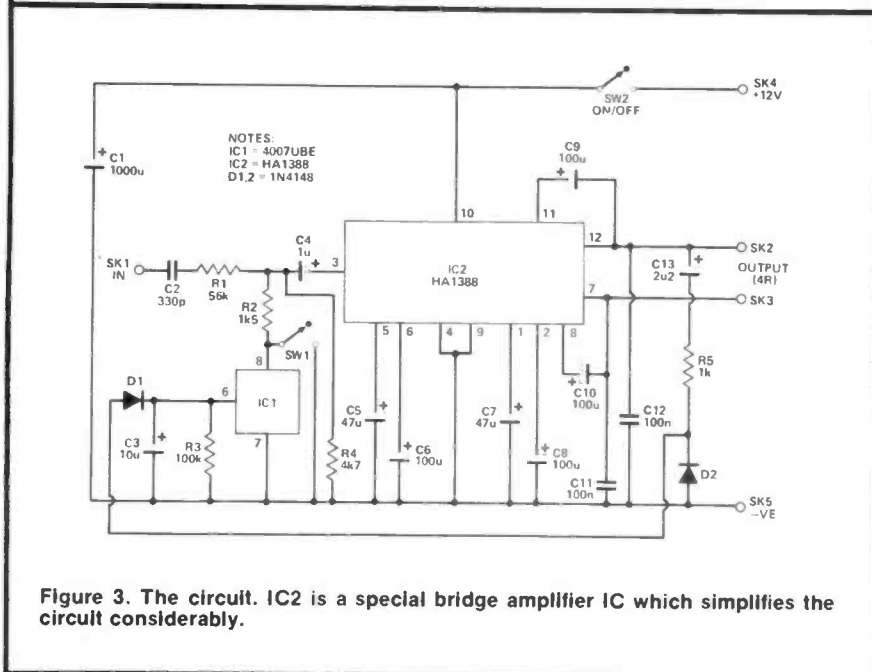


Figure 3. The circuit. IC2 is a special bridge amplifier IC which simplifies the circuit considerably.

are clearly audible, so that the dynamic levels of the signal and its dramatic impact are not seriously impaired.

Figure 2 shows the compression characteristic of the prototype.

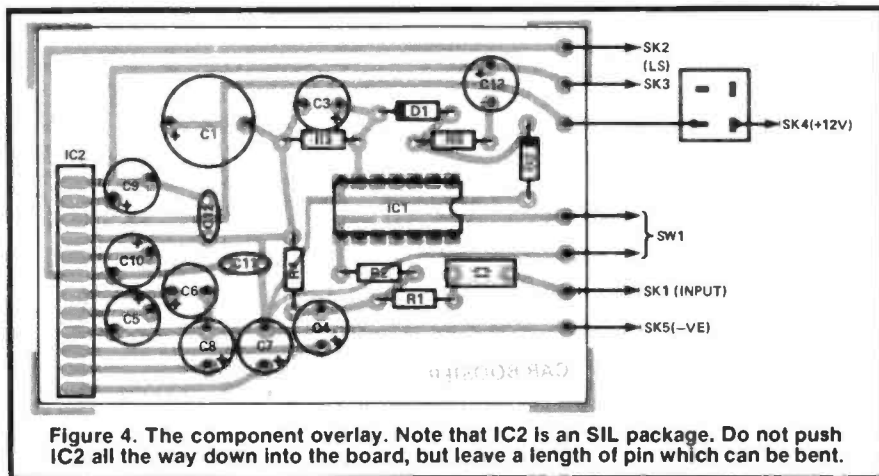
## Circuit Operation

The complete circuit diagram of the Booster/Compressor appears in Figure 3. The unit is more simple than one might expect due to the use of a special bridge amplifier integrated circuit as the basis of the unit.

The bridge amplifier device is IC2. This requires several discrete capacitors which mainly provide decoupling for internal circuits or aid stability of the circuit. Two exceptions are C9 and C10 which are bootstrapping capacitors (one for each power amplifier). All these do is to feed some of the output signal of each power amplifier

back to its driver stage. This has the effect of raising and lowering the supply voltage to each driver stage in sympathy with the output of the relevant power amplifier. What is of importance in this case is that on the positive output excursions the supply voltage to the driver stage actually becomes greater than the nominal 12 volt supply. This enables a higher peak to drive voltage to be supplied to each output stage, which in turn helps to give a greater peak to peak output voltage swing and output power.

The only active element in the compressor circuit is IC1 which is a CMOS triple inverter and complementary pair. In this circuit only one transistor in the complementary pair is required, and all the other sections of the device are left unused. The transistor that is utilized is the N channel device, and it



acts here as a sort of voltage controlled resistor. The field effect devices in CMOS devices are enhancement mode types which, like an ordinary bipolar transistor, are normally switched off and require a forward bias to bring them into conduction. They are not like the more familiar JFETS which are depletion mode devices which are normally switched on and require a reverse bias in order to cut them off.

An enhancement mode device is ideal for this application. The drain to source resistance forms part of an attenuator. R1 is the feed resistor while the shunt resistance is formed by a series-parallel network which includes R2 and R4 as well as the MOSFET in IC1. The point of R4 is to ensure that the attenuator provides high losses even when the MOSFET in IC1 is switched off. This is essential since IC2 requires an input signal of only about 10 millivolts RMS to produce maximum output power, whereas the input level to the unit is likely to be more than one hundred times this level. Of course, the volume control on the car radio (or whatever) can be used to attenuate the input level to the booster, but in practice the volume control would be excessively difficult to adjust without the attenuation introduced by R4, and the signal to noise ratio of the system would probably be substantially degraded as well. R2 limits the amount of compression to a satisfactory level. C2 and C4 are DC blocking capacitors.

MOSFETs provide quite good linearity when used as voltage controlled resistors, and in this circuit the low signal level across the MOSFET helps to give low distortion. There is in fact an increase in distortion when the compression comes into effect, but there should be no significant degradation of the audio quality.

The control voltage for IC1 is developed using a straightforward rectifier (D1/D2) and smoothing circuit (C3/R3). As the input level is increased the control voltage rises, the MOSFET in IC1 gradually becomes switched on, and the losses through the attenuator increase so that the compression is

obtained. When SW1 is closed it provides maximum attenuation all the time, and switches off the compression.

## Construction

Construction starts with the printed circuit board, details of which are shown in Figure 4.

As IC1 is a CMOS device it requires the usual antistatic handling precautions. Fit it in a (14 pin) DIL IC holder, but do not plug it in place until the rest of the board has been completed. Until then it should be left in the antistatic packaging, and it should be handled as little as possible when it is fitted into place.

The main point to watch with IC2 is to make sure that it is fitted onto the board the right way round. It has an unusual 12 pin SIL (single in line) package, but pin 1 of the device is still indicated by the usual dimple in the plastic encapsulation. **Do not** push IC2 right down onto the board in the normal way before soldering it in place, but instead leave a few millimetres of the pins showing on the top side of the board. By bending the pins slightly the heat-tab of IC2 can be brought flush with the edge of the printed circuit board. This is essential and it will

## Parts List

### RESISTORS

(All 1/4W 5% carbon)

R1.....	56k
R2.....	1k5
R3.....	100k
R4.....	4k7
R5.....	1k

### CAPACITORS

C1.....	1000uF 16V	radial elect
C2.....	330nF	carbonate
C3.....	10uF 25V	radial elect
C4.....	1uF 63V	radial elect
C5, 7.....	47uF 16V	radial elect
C6, 8, 9, 10.....	100uF 10V	radial elect
C11, 12.....	100nF	ceramic
C13.....	2u2 63V	radial elect

### SEMICONDUCTORS

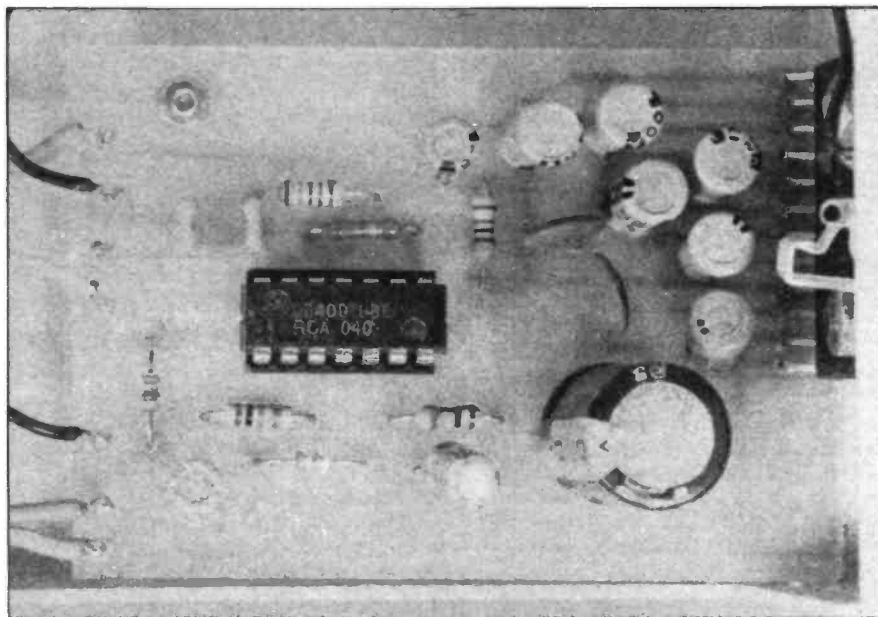
IC1.....	4007UBE
IC2.....	HA1388
D1, 2.....	1N4140

### MISCELLANEOUS

SW1.....	SPST miniature toggle
SW2.....	Rotary on/off switch
SK1.....	3.5mm jack socket
SK2/3, 4/5.....	Spring terminals
Printed circuit board; case about 150 by 100 by 50 millimetres; control knob; 14 pin DIL IC socket; wire, solder, etc.	

not be possible to mount the board in the case properly unless this is done.

Pins are fitted to the board at the points where the seven connections to



# Project

## Shop

All the components for this project are straightforward to obtain.

If you have trouble finding the 2u2 63V radial electro capacitor (C13) you can substitute one of a higher voltage rating.

The HA1388 (IC2) is stocked by **Watford Electronics (Tel. (0923) 37774) at £2.35.**

The cost of the project should come to around £9.50 not including the case of your own choice, and PCB, available from our PCB Service.

off-board components will be made.

The prototype is housed in a metal instrument case which measures approximately 150 by 100 by 50 millimetres. This is actually somewhat larger than is really necessary for a monophonic unit, but it could be difficult to make the unit substantially smaller than this as a reasonable amount of panel space is needed to accommodate the controls and sockets. A certain amount of panel space is also required for IC2 which is bolted to the case which then acts as the heatsink. Because the case acts as a heatsink it is essential that it should be of mainly metal construction.

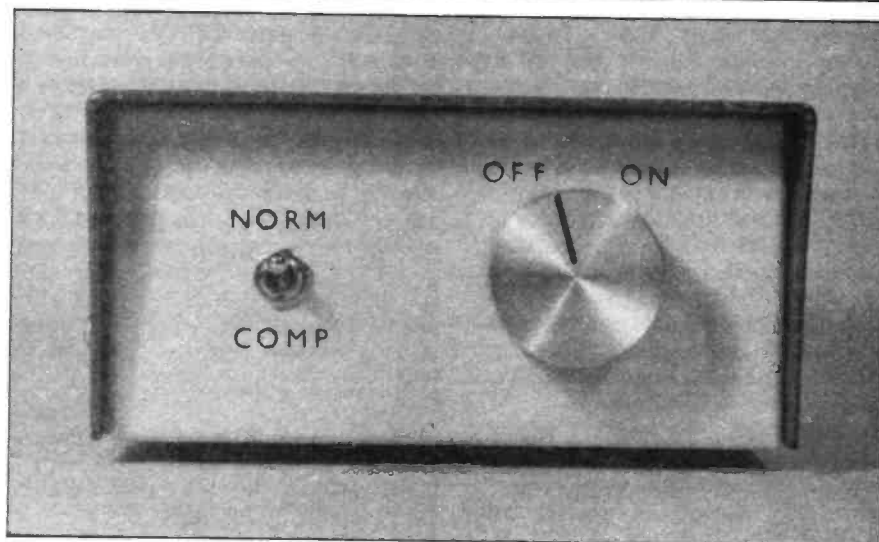
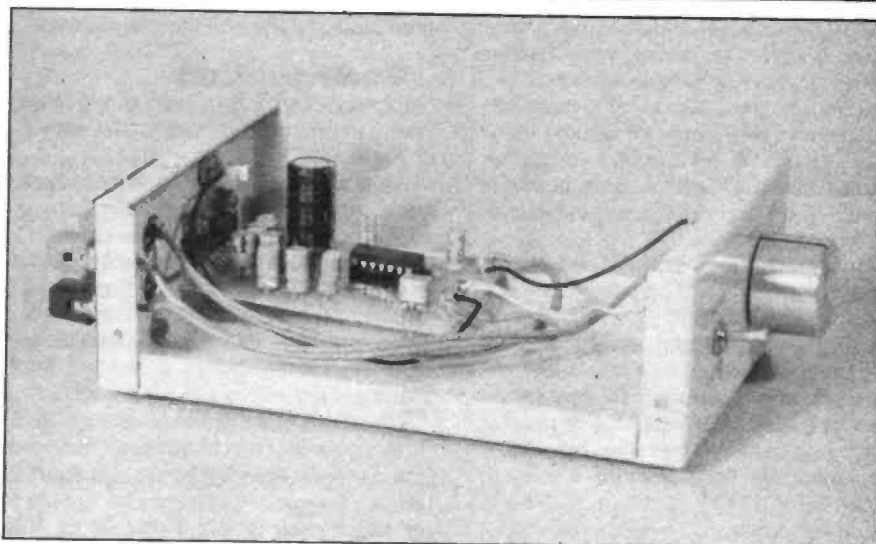
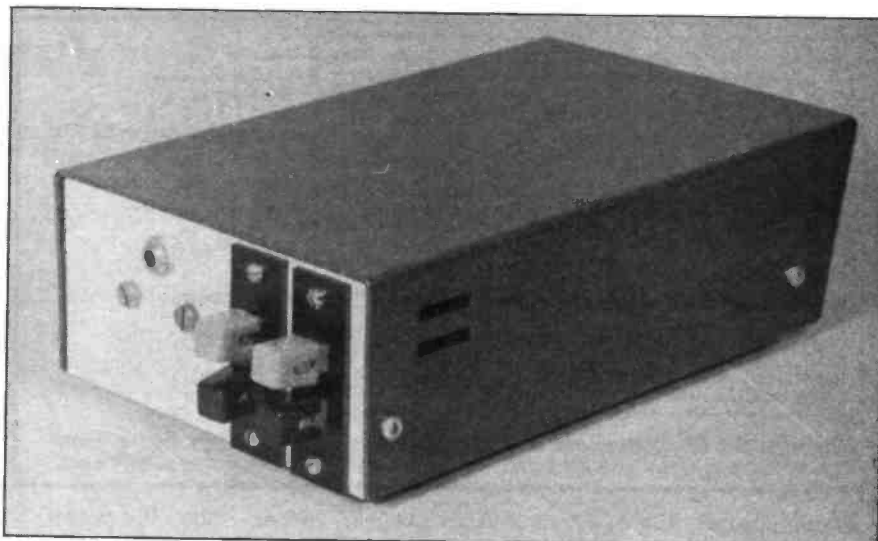
The general layout of the prototype can be seen from the photographs, but any sensible layout can be adopted. The only slight difficulty when fitting everything into the case is the mounting of the component panel. The main mounting is via the heat-tab of IC2, but additionally one mounting bolt fits through the component panel itself and secures it to the base panel of the case. The holes that match up with the heat-tab of IC2 must be positioned in the case such that the board is about 6 millimetres above the base panel. A spacer about 6 millimetres long is then used on the base panel mounting bolt, between the base panel and the printed circuit board. Note that there is no need to insulate the heat-tab of IC2 from the case as both are at earth potential (ie the negative supply potential).

If you build a stereo version of the unit a common set of supply input terminals and on/off switch can be used for the two boards. A double pole switch would be needed for SW1, one pole being used in each channel of the unit. SK1 could be changed for a type having two non-earth inputs, or a 3.5mm jack could be used at the input of each channel.

### In Use

The best position for the unit will obviously vary from one vehicle to another, and is something that must be varied to suit your particular circumstances. The unit is not difficult to connect up, but a certain amount of care must be exercised here.

Firstly, when connecting the output of



the car radio to the input of the booster be careful to connect the 3.5mm jack plug the right way round, otherwise you will short circuit the non-earth output lead to earth. It is quite in order to leave the existing loudspeaker(s) in circuit and to drive an additional loudspeaker or loudspeakers from the booster. The output from the booster has neither terminal at earth potential, and both outputs **must** therefore be prevented

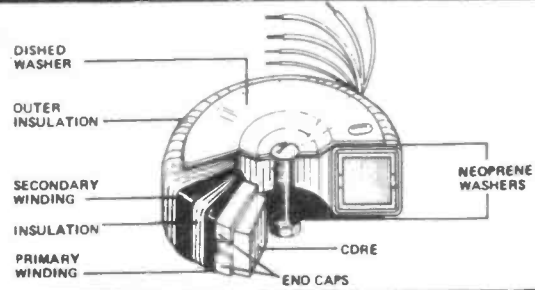
from coming into contact with the chassis or bodywork of the car. It is advisable to add an in-line fuse in series with the positive supply lead in case a wiring error or fault does occur (a 3 amp fuse is suitable). In order to obtain the 18 watts RMS output power the loudspeakers must be 4 ohm impedance types, and you must ensure that they have a sufficiently high power rating.



# TOROIDALS

The toroidal transformer is now accepted as the standard in industry, overtaking the obsolete laminated type. Industry has been quick to recognise the advantages toroidals offer in size, weight, lower radiated field and, thanks to I.L.P., PRICE.

Our large standard range is complemented by our SPECIAL DESIGN section which can offer a prototype service within 14 DAYS together with a short lead time on quantity orders which can be programmed to your requirements with no price penalty.



15 VA 62 x 34mm 0.35Kg Regulation 19%	50 VA 80 x 35mm 0.9Kg Regulation 13%	120 VA 90 x 40mm 1.2Kg Regulation 11%	225 VA 110 x 45mm 2.2Kg Regulation 7%	500 VA 140 x 60mm 4Kg Regulation 4%
<b>SERIES SECONDARY RMS</b> No Volts Current 0x010 5-6 1.25 0x011 9-9 0.83 0x012 12-12 0.63 0x013 15-15 0.50 0x014 18-18 0.42 0x015 22-22 0.34 0x016 25-25 0.30 0x017 30-30 0.25 (encased in ABS plastic)	2x010 6-6 4.16 2x011 9-9 2.77 2x012 12-12 2.08 2x013 15-15 1.66 2x014 18-18 1.38 2x015 22-22 1.13 2x016 25-25 1.00 2x017 30-30 0.83 2x028 110 0.45 2x029 220 0.22 2x030 240 0.20	4x010 6-6 10.00 4x011 9-9 6.66 4x012 12-12 5.00 4x013 15-15 4.00 4x014 18-18 3.33 4x015 22-22 2.72 4x016 25-25 2.40 4x017 30-30 2.00 4x018 35-35 1.71 4x028 110 1.09 4x029 220 0.54 4x030 240 0.50	6x012 12-12 9.38 6x013 15-15 7.50 6x014 18-18 6.25 6x015 22-22 5.11 6x016 25-25 4.50 6x017 30-30 3.75 6x018 35-35 3.21 6x026 40-40 2.81 6x025 45-45 2.50 6x033 50-50 2.25 6x028 110 2.04 6x029 220 1.02 6x030 240 0.93	8x016 25-25 10.00 8x017 30-30 8.33 8x018 35-35 7.14 8x026 40-40 6.25 8x025 45-45 5.55 8x033 50-50 5.00 8x042 55-55 4.54 8x028 110 4.54 8x029 220 2.27 8x030 240 2.08
<b>30 VA 70 x 30mm 0.45Kg Regulation 18%</b>	<b>80 VA 90 x 30mm 1Kg Regulation 12%</b>	<b>160 VA 110 x 40mm 1.8Kg Regulation 8%</b>	<b>300 VA 110 x 50mm 2.6Kg Regulation 6%</b>	<b>625 VA 140 x 75mm 5Kg Regulation 4%</b>
1x010 6-6 2.50 1x011 9-9 1.66 1x012 12-12 1.25 1x013 15-15 1.00 1x014 18-18 0.83 1x015 22-22 0.68 1x016 25-25 0.60 1x017 30-30 0.50	3x010 6-6 6.54 3x011 9-9 4.44 3x012 12-12 3.33 3x013 15-15 2.66 3x014 18-18 2.22 3x015 22-22 1.81 3x016 25-25 1.60 3x017 30-30 1.33 3x028 110 0.72 3x029 220 0.36 3x030 240 0.33	5x011 9-9 8.89 5x012 12-12 6.66 5x013 15-15 5.33 5x014 18-18 4.44 5x015 22-22 3.63 5x016 25-25 3.20 5x017 30-30 2.66 5x018 35-35 2.28 5x026 40-40 2.00 5x028 110 1.45 5x029 220 0.72 5x030 240 0.66	7x013 15-15 10.00 7x014 18-18 8.33 7x015 22-22 6.82 7x016 25-25 6.00 7x017 30-30 5.00 7x018 35-35 4.28 7x026 40-40 3.75 7x025 45-45 3.33 7x033 50-50 3.00 7x028 110 2.72 7x029 220 1.36 7x030 240 1.25	9x017 30-30 10.41 9x018 35-35 8.92 9x026 40-40 7.81 9x025 45-45 6.94 9x033 50-50 6.25 9x042 55-55 5.68 9x028 110 5.68 9x029 220 2.84 9x030 240 2.60

**Why a Toroid?**

- Smaller size & weight to meet modern 'slimline' requirements.
- Low electrically induced noise demanded by compact equipment.
- High efficiency enabling conservative rating whilst maintaining size advantages.
- Lower operating temperature.

**Why ILP?**

- Ex stock delivery for standard 240v range.
- Fast prototype service available.
- 3 weeks despatch for special orders.
- 2 year no quibble guarantee.
- No price penalty for call-off orders.

Prices including P&P and VAT

VA	Size	£	VA	Size	£
15	0	7.06	160	5	12.17
30	1	7.67	225	6	13.75
50	2	8.90	300	7	14.97
80	3	10.06	500	8	19.60
120	4	10.65	625	9	22.30

For 110V primary insert '0' in place of 'X' in type number.  
 For 220V primary (European) insert '1' in place of 'X' in type number.  
 For 240V primary (UK) insert '2' in place of 'X' in type number.  
**IMPORTANT: Regulation - All voltages quoted are FULL LOAD.**  
 Please add regulation figure to secondary voltage to obtain off load voltage.

Mail Order - Please make your crossed cheques or postal orders payable to ILP Electronics Ltd.

Trade - We will open your credit account immediately upon receipt of your first order.

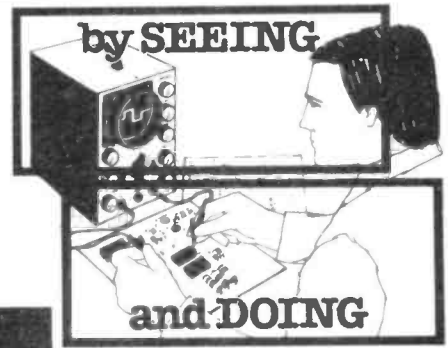
Post to: ILP Electronics Ltd., Dept. 4  
 Graham Bell House, Roper Close,  
 Canterbury, Kent. CT2 7EP  
 Tel: (0227) 454776 Telex: 965780



**ELECTRONICS LTD.**

# MASTER Electronics - Microprocessors - Now! The PRACTICAL Way!

- Electronics - Microprocessors - Computer Technology is the career and hobby of the future. We can train you at home in a simple, practical and interesting way.
- Recognise and handle all current electronic components and 'chips'.
- Carry out full programme of experimental work on electronic & computer circuits including modern digital technology.
- Build an oscilloscope and master circuit diagrams.
- Testing and servicing radio - T.V. - hi-fi and all types of electronic/computer/industrial equipment.



## New Job? New Career? New Hobby?

Please send your brochure without any obligation to:-

I am interested in:

- ELECTRONICS  
 MICROPROCESSORS  
 RADIO AMATEUR LICENCE  
 CITY & GUILDS EXAMS

Other Subjects .....

NAME \_\_\_\_\_  
 ADDRESS \_\_\_\_\_  
 \_\_\_\_\_  
 \_\_\_\_\_

BLOCK CAPS PLEASE



OR TELEPHONE US  
 062 687 2598  
 OR TELEX 22758  
 (24 HR SERVICE)

EM/4

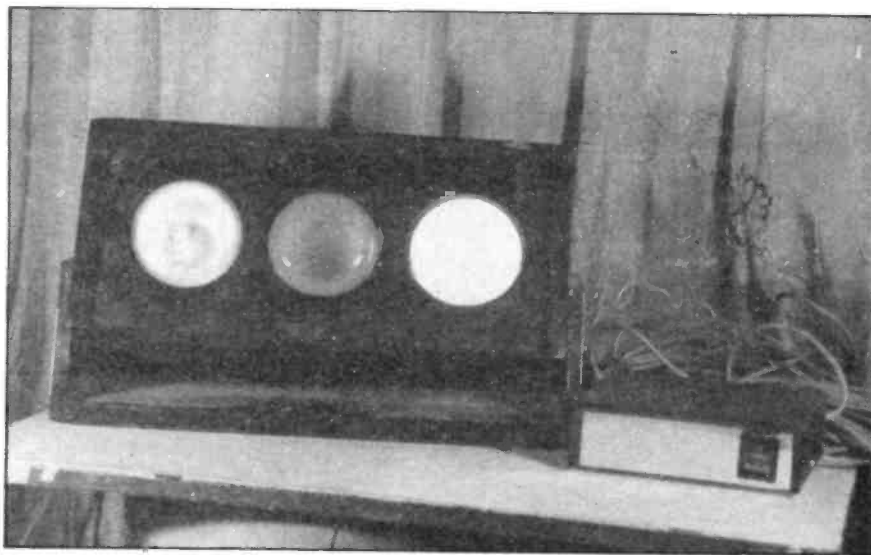
**FREE!**  
 Colour Brochure

**British National Radio & Electronics School P.O. Box 7, Teignmouth, Devon, TQ 14 0HS**

# SOUND **TO** LIGHT LIGHT CONTROL UNIT

**This light control unit is a "Bass/Complementary", which switches colour in time to the bass line of the music.**

Andrew Armstrong



Do you like listening to music? Has your room got a number of interesting, coloured objects in it? If the answer to either of these is yes, then this light unit may be for you.

This is a simple design, based on the principles of doing more for less cost, but it is highly effective. It flashes lights in time with the bass line of the music, and uses zero level triggering to avoid generating clicks on the mains, which could interfere with the sound.

On my drawing board is a complicated three channel design, which modulates the brilliance of the lights in proportion with the sound. It uses some of the circuitry shown in the feature on lighting control, and is about four times as

complicated. It needs filtering on the triac outputs to avoid serious interference, and the effect is very impressive. This, however is for the enthusiast. The light unit featured here is much simpler and cheaper, but the visual effect is similar and not proportionally less impressive.

## How It Works

As its name implies, this light unit switches one light on in time with the bass line of the music, and one light off at the same time. The idea is to change the colour of the lighting in a room in time with the music, without significantly changing the brightness. It is intended

that a spare tape recorder output on the amplifier should be used to provide the audio signal to operate the unit, but a microphone may be used instead.

The block diagram, **Figure 1**, illustrates the functioning of the system. Effectively, it splits into two parts, one powered by a mains transformer, and the other powered by a mains dropper resistor. The signal is transferred from the one to the other by means of an optoisolator.

The input signal is buffered and, if it is a stereo signal, the two channels are mixed. The bass part of the signal is then filtered out, by a second order filter with a rolloff at 228Hz.

The filtered signal is now rectified by a precision rectifier, the output from which is AC coupled to a comparator. The AC coupling ensures that, regardless of the signal amplitude, the comparator will switch, rather than remaining locked on if the signal amplitude is very high. This may be regarded as a self adjusting comparator level, which avoids the necessity for controls on the front panel.

The comparator output feeds the LED part of an opto-isolator. The output of this controls the triggering of the triacs, via some CMOS logic and a pair of transistors. The triacs are triggered on mains zero crossings, both to conserve trigger current, and to avoid interference. The logic signal which controls one triac is inverted to feed the other one, so that, unless the comparator output switches close to the end of the zero level triggering pulse, the load current will simply be diverted to one

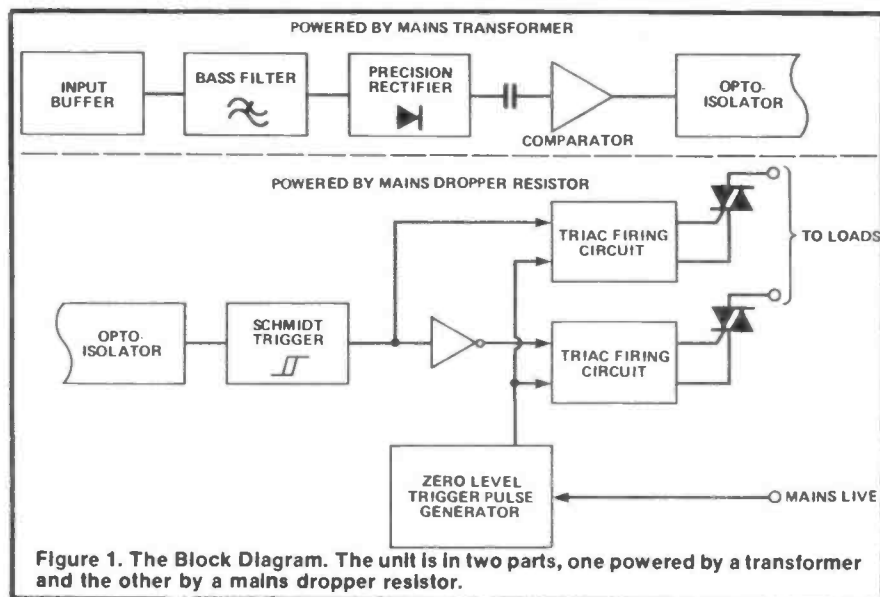
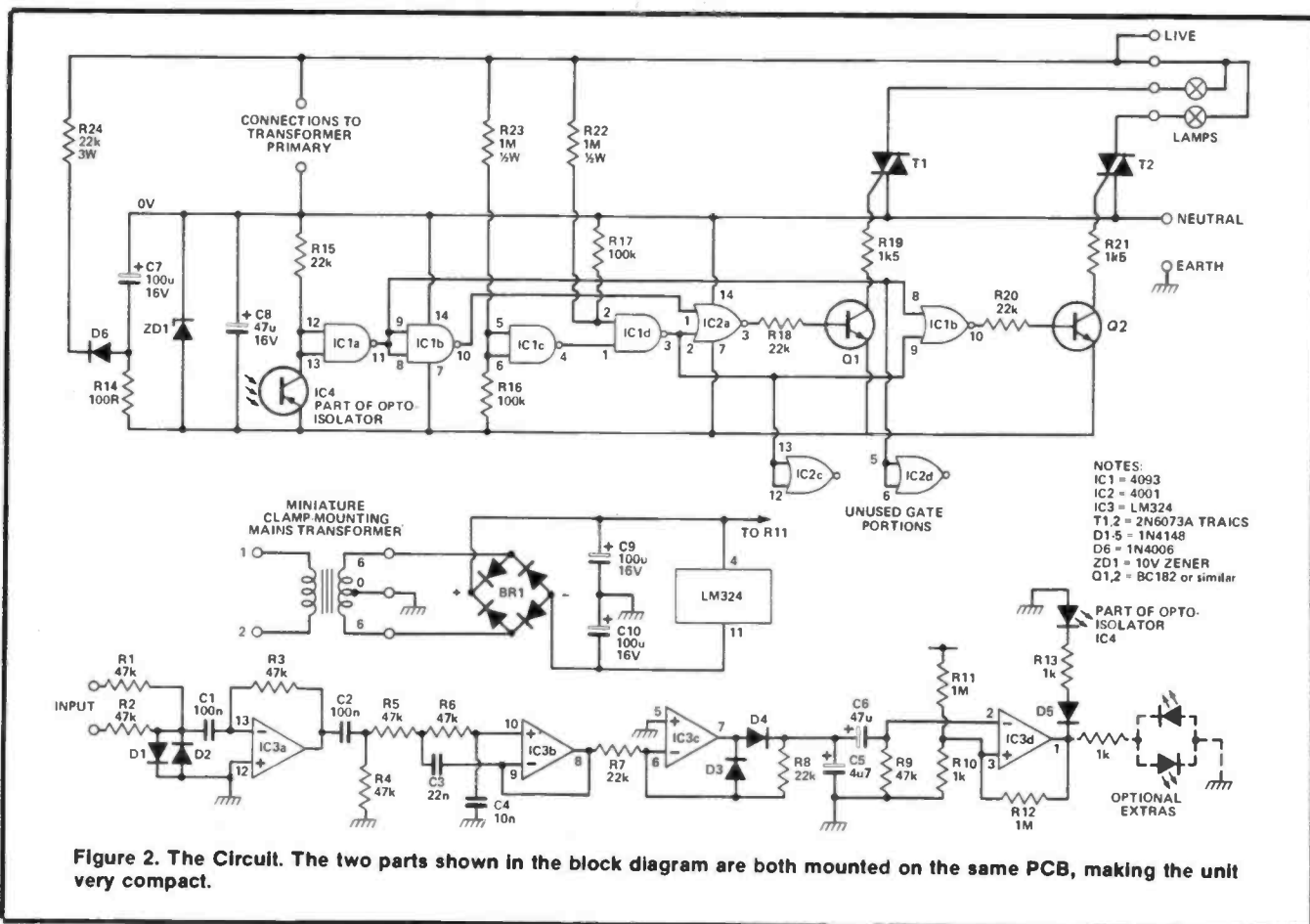


Figure 1. The Block Diagram. The unit is in two parts, one powered by a transformer and the other by a mains dropper resistor.



**Figure 2. The Circuit.** The two parts shown in the block diagram are both mounted on the same PCB, making the unit very compact.

lamp or the other. If the lamps on each circuit are similar, the current drawn from the mains will be virtually constant, regardless of how the lights flash.

## Sound Input

The circuit diagram is shown in **Figure 2**. The lower part, involving the LM324 quad op-amp, is powered via a mains transformer, while the top is the part powered by mains dropper resistor.

The audio input signal is fed in to a virtual earth amplifier via R1 and R2. The input is protected from damage due to excessive signals (if, for example, a loudspeaker output is used to provide the signal, or when the signal is so large that the op-amp output clips, so that the virtual earth input is virtual earth no longer.

The input coupling capacitor, C1, and the interstage capacitor, C2, provide a low frequency rolloff which prevents subsonic components, due for example to warped records, from affecting the lights.

The low pass filter consists of IC3c, R5, R6, C3, and C4. It is of a standard form called VCVS (voltage controlled voltage source). This name refers to the fact that the input in use has a high impedance, so that the voltage is controlled solely by the relative impedances of the passive compo-

## RESISTORS

(All 0.25W 5% unless stated)

R1,2,3,4,5,6,9.....	47k
R7,8,15,18,20.....	22k
R10,13.....	1k
R11,12.....	1M
R14.....	100R
R16,17.....	100k
R19,21.....	1k5
R22,23.....	1M, 0.5W
R24.....	22k, 3W

## CAPACITORS

C1,2.....	100n
C3.....	22n
C4.....	10n
C5.....	4u7 16V radial electro
C6,8.....	47u 16V radial electro
C7,9,10.....	100u 16V radial electro

nents. The "voltage source" aspect refers to the voltage drive to the feedback capacitor C3. The frequency of the filter is given by the formula  $F=1/(2\pi \times \sqrt{R5 \times R6 \times C3 \times C4})$ .

The action of the precision rectifier is straightforward. C5 is charged to the peak of positive half cycles, and it discharges through R8 to the virtual earth point on pin 6 of IC3. The time constant is

## SEMICONDUCTORS

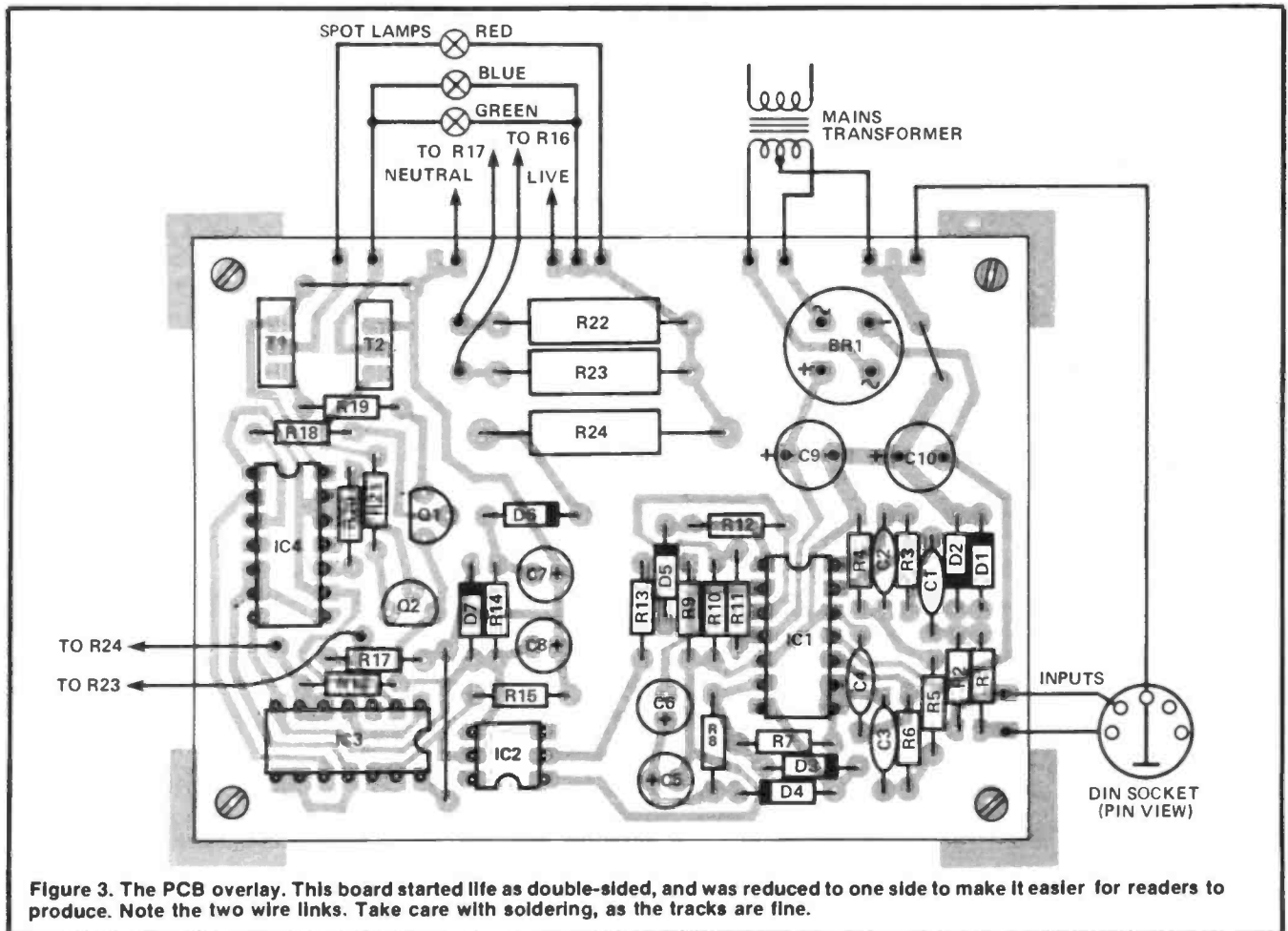
D1,2,3,4,5.....	1N4148
D6.....	1N4006
D7.....	10V 400mW Zener
BR1.....	WOO5
Q1,2.....	BC182 or similar
T1,2.....	2N6073 or C206D
IC1.....	4093
IC2.....	4001
IC3.....	LM324
IC4.....	Cheap 6 pin opto isolator eg. Maplin WL35Q

## MISCELLANEOUS

Miniature 6-0-6 clamp mounting mains transformer, 8 pole mains connectors (both plug and socket), 5 pole DIN socket, IEC mains inlet connector, mains lead, case, PCB, lamps, lampholders, wire, solder, Stick on PCB pillars, stick on feet. Nuts, bolts, etc.

0.1 seconds, which has been found, in practice to be a good compromise between speed of response and the possibility of the lights flickering in time with half cycles of low frequencies of the music.

The comparator level is biased up from the 0V level by R10 and R11, so that the LED is off in the absence of signal. The diode D5 is there to forstall the



**Figure 3.** The PCB overlay. This board started life as double-sided, and was reduced to one side to make it easier for readers to produce. Note the two wire links. Take care with soldering, as the tracks are fine.

possibility that the opto-isolator LED may be damaged by reverse bias when it is off. The bi-coloured LED is an optional extra, which may be helpful in fault finding should the lights fail to work. It may also be regarded as a bit of flash!

The 6-0-6V transformer which powers this part will charge the smoothing capacitors to about +/- 10V, because the capacitors will charge to the peak voltage of the transformer, which itself will be above nominal due to the very light loading. The ripple on the power supply is of no consequence, because the op-amp will effectively ignore moderate disturbances on its power supply.

### Triac Control

The output of the opto-isolator is fed into a Schmitt trigger to give clean logic levels. The pullup resistor is of a value high enough that the phototransistor need only pass 400 microamps to pull the Schmitt gate input to logic 0. Therefore opto-isolators of only a small current transfer ratio may be used. (The current transfer ratio is the ratio between the phototransistor current, and the LED current necessary to provide this.)

In order to trigger on the triac T1, Q1 must be switched on, which requires pin 3 of IC2 to go to logic 1. This can only occur when both pin 1 and pin 2 are at logic 0. Therefore, to permit triggering only near to the mains zero crossing, a

short negative pulse is applied to pin 2 at the mains zero crossing. The triggering current will then be applied for this period, assuming that pin 1 is at logic 0 as well.

### Zero Level Triggering

The zero level triggering pulse is generated by two parts of the 4093. The output of this section, IC1 pin 3 can only go to logic 0 if pin 1 is at logic 1, and pin 2 is above the logic threshold, and therefore classifies as logic 1.

During positive mains half cycles, pin 2 is held to logic 1. Near the zero crossing, when the positive voltage is small, pins 5 and 6 are biased below their logic threshold by R16, so pins 4 and 1 are at logic 1, and pin 3 is at logic 0. Larger positive mains voltages take pins 5 and 6 through the logic switching threshold, switching pin 4 to logic 0 and hence forcing pin 3 to logic 1.

During negative mains half cycles, pins 8 and 9 remain on the logic 0 side of the threshold, holding pin 10 to logic 1. The biasing on pin 12 is now relevant — for small negative mains voltages pin 12 is on the logic 1 side of the threshold, while larger negative voltages pull it to a 0 logic level. The waveforms to be expected here are shown in the light sequencer project in this issue.

In either case, the input protection diodes of the CMOS gate prevent destruction due to inputs significantly

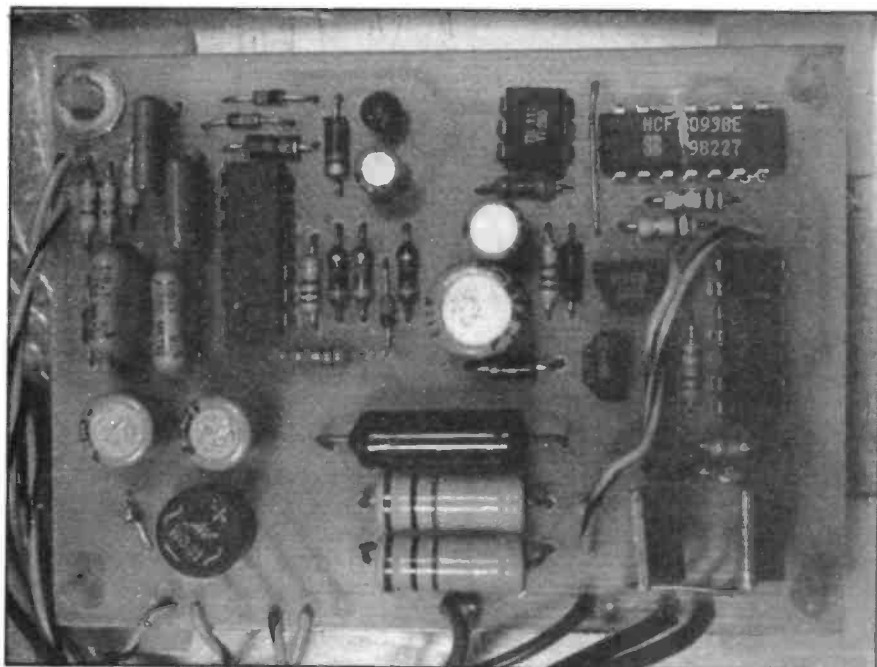
outside the supply rails. The choice of 1/2 watt resistors for R22 and R23 is because the voltage rating of most of the smaller types is insufficient for connection to the mains. Most samples of 1/4 watt resistors will, in fact, survive connection to the mains, but they are not specified for it.

The only other point to note is that, to avoid damage to the IC, the unused inputs of IC2 are connected to logic signals. This also helps the routing of tracks on the pcb.

### Power Supply

The current to run this part of the circuitry is provided by a mains dropper resistor. This method of providing power supply can give only a small current, or else it generates a lot of heat, but it is compact and cheap.

The power supply is negative rather than positive as is often customary in order to provide a negative gate pulse to trigger the triacs. Some triacs do not trigger well on negative mains half cycles if the gate voltage is positive, but the reverse situation, negative gate voltage and positive mains half cycle, gives good triggering. Some triacs which will trigger reliably in this quadrant need more gate current to do so, which, of course, would necessitate a "wattier" power supply.



## Dissipation

The dissipation of the resistor can be calculated easily — because of the diode in series with it, the mains flows through it for half the time, so the power dissipated is half that which would be dissipated if the mains were connected straight across the resistor.  $\text{Power} = V^2/R = 240^2/22000 = 2.618$  watts. The actual dissipation is half this figure ie 1.31 watts. It is possible here to use quite a small power resistor — 3 watts is adequate, and does not contribute excessively to the overall size of the PCB.

The current available from this type of resistive power supply is calculated in detail in the light sequencer article. Suffice it to say here, that by using the formula derived by integration, the current is:  $\text{Peak voltage}/(R \times \pi) = 340/(22000 \times 3.1415926) = 4.9\text{mA}$ .

This is not enough to guarantee to trigger one of the triacs, if it were applied in the form of a steady current, but meted out as heavier pulses around the mains zero crossings it is plenty. The current consumption of the CMOS is very low, and may be ignored, while the resistors in the circuit draw less than 1mA.

## Triacs

The triacs chosen for this project will trigger with 5mA of gate current, and will hold on at low currents. The trigger current provided by this circuit is about 6.5mA, so all samples should switch cleanly. "Junkbox" triacs may need more trigger current, but the gate resistors may be lowered to provide somewhat more. If the trigger current is increased too much, then the power supply may be unable to cope.

## Construction

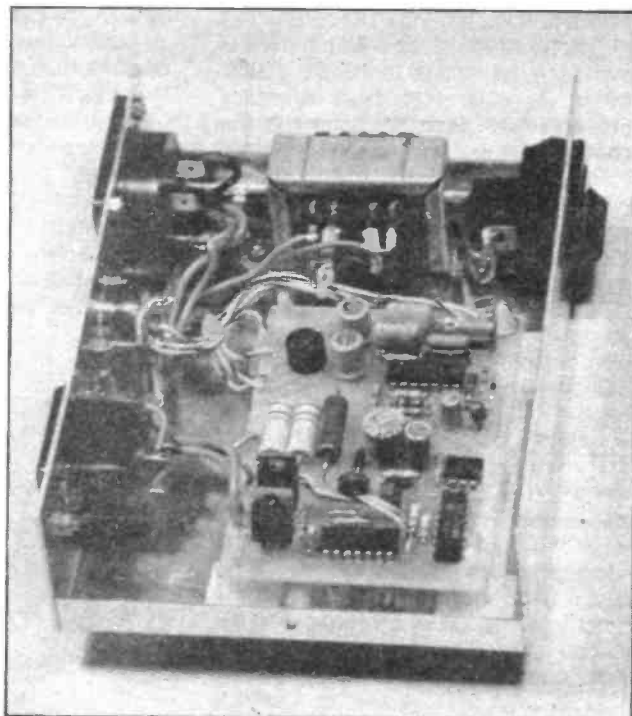
Mains is used fairly extensively on the board, so the use of the PCB is

recommended.

It is best to assemble and test the two power supplies before proceeding further. The transformer supply requires only the bridge rectifier, C9, and C10, and, of course, the mains transformer. When the mains is connected to the transformer, which is not mounted on the PCB, the voltage on the positive terminal of the bridge should be between 9V and 12V, while the negative terminal should be at the same voltage only negative.

The mains dropper power supply consists of R24, R14, D6, D7, C7, and C8. When these components have been assembled, the power supply may be tested by first connecting a voltmeter across D7 or C8 (tiny little probe clips help) and then connecting to the mains. If the power supply is approximately 10V,

**This shows the board and other components in the case. These is a lot of cutting, so don't choose a case which is too chunky. Make quite sure you have room for the PCB, transformer and all switches before you start Cutting.**



the right polarity, then all is well so far. Disconnect from the mains, then if there was a problem search for the wrongly inserted component, otherwise proceed with the rest of the construction.

As is usual, the CMOS gates should be inserted last of all. There are no particular problems in construction, but several points to note. The two flexible wire links, from R22 and R23 may be interchanged without harm. The triacs are to be stood up rather than bolted down.

The layout is, in general, compact, and some care will be needed with certain of the components to get them all fitted in. In particular, C3 and C4 should be fitted after the resistors in the same area.

## Testing

Since the circuit is divided into a "safe" and a "dangerous" side, it is convenient to test it in halves. If the two colour LED indicator is not to be used, then replacing D5 with an LED can be a useful aid to test.

To test the sound input part, connect the mains to the transformer, and a sound signal to the input (R1 or R2). The LED should flash in time with the bass line of the music. If it does not, first check that the power supply voltage is about 10V, and if it isn't, then find out what is shorting the supply.

If the LED still does not flash, check that the LED is ok by briefly shorting IC3 pin 1 to the negative supply (IC3 pin 11). If the LED does not switch on then it may be damaged or connected the wrong way round. (This does not apply if a bi-coloured LED is in use, as one colour or the other should always be ON.)

Once the LED is known to be OK, test one stage earlier by connecting the positive input of the comparator, pin 3,

# Project

temporarily to the negative power supply. The output, pin 1, should switch low, and illuminate the test LED. (A bi-colour LED should change colour. If it does not work at this point, then the fault is around pins 1, 2, and 3 of IC3.

If the fault has not been located so far, measure the voltage on pins 7, 8, and 14, relative to 0V. If any one of them is far from the ground rail, with no signal present, then the fault is in that area of circuitry.

If the fault still persists, and all the tests so far give no clue, then the best thing to do is to carry out a close visual inspection, starting with the signal coupling components R1, R2, C1, C2, R5, R6, and R7.

Those who possess oscilloscopes have a much easier job. All they need do is trace through, starting from the input, to see where the signal disappears. Don't forget, though, that pins 6 and 13 are virtual earth inputs, and, as such, should have no signal on them.

The live part of the circuit is best tested once the unit is mounted in its case.

## Boxing

First of all, the IEC mains input socket, the 5 pin DIN socket, and the lighting output socket should be mounted on the rear of the case. Wires can then be attached to these ready for connection to the PCB. The earth connection of the mains input should be connected to the case, via one of the mains input mounting bolts. The switch, and the LED if fitted, should be mounted on the front panel.

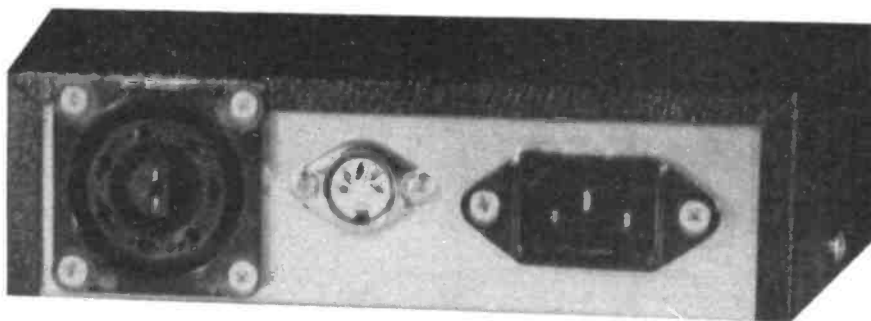
Lay the board and the mains transformer in the box to find a convenient position for both. Then drill holes for the transformer and mount it using small nuts and bolts (eg M3).

The board should now be mounted in the case, using self adhesive plastic pillars. In order that these will stick properly, first clean the bottom of the case, with a rag and some methylated spirit.

Now the internal wiring should be carried out, as per the circuit diagram. Take care that mains connections, in particular, are secure, and not dangling by a thread. This is doubly important if the unit is for disco use, when it can be very embarrassing to find let the smoke out of the unit in front of a crowd of people.

Author's note: Research has shown that smoke is the working fluid of electronics components. This is demonstrated by the fact that, when the smoke is let out of an electronic component, it ceases to work. So far, no reclamation technology (where all the smoke particles can be extracted from the air and replaced in the component) has been developed.

It is very easy to end up using a



different set of pins in the plug from the ones used in the socket, so double check this point. Also, if the unit is ever to be connected to lights which have an earth connection, then the earth in the lighting output socket must be connected.

Once all wiring is complete, plug in and switch on. One of the lights should be on. If neither illuminates, then check the wiring to the lampholders. If this is ok, then disconnect the mains, and connect a voltmeter across D7, and then reconnect the mains for long enough to measure the power supply voltage. If this is not correct, then search for the short circuit.

If it is correct, and the unit will not illuminate either lamp, then the fault is probably around IC1a or IC1b, the zero level trigger pulse generator. Unless you own an oscilloscope, the only recourse at this stage is careful inspection.

If a fault cannot be found after the most careful inspection, then eventually a dead IC may be suspected. This is very unlikely, unless the ICs used are distinctly junkbox, while one of the most likely faults is a solder splat across two adjacent IC pins.

Oscilloscope owners who wish to search for the trigger pulse should remember that the circuit is connected to the mains. The oscilloscope earth wire, in the plug, should be temporarily disconnected, and the oscilloscope chassis connected to mains neutral. Make sure it is neutral and not live by the use of a neon screwdriver - houses have been known to have incorrect wiring. If in any doubt, don't do it!

If one lamp illuminates, but the lamps will not flash in time with the music, then just about the only possible cause is a short circuit on pins 12 and 13 of IC1.

However persistent the fault, it is

inadvisable to try to work on the unit while the mains is connected, with the exception of a very cautious use of an oscilloscope, as mentioned above.

## Suggested Use

A good starting point is to use three 100W spotlamps, one red, one green, and one blue. The blue and green lamps should be wired in parallel, and connected to the complementary channel, while the red spot should be connected to the bass channel. Thus, the light colour will change from blue/green to red on peaks of bass.

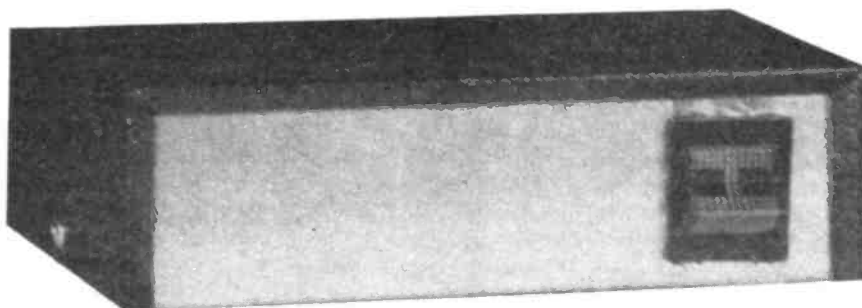
The blue and green lamps together are about the same brightness as the red on its own, so the room brightness does not appear to change. Different coloured objects in the room do respond dramatically to the colour change, book covers being good examples.

## Shop

Most of the components used in this project are straightforward. The 3W resistor, R24, is stocked by Maplin. The ultra-miniature capacitors C7, 9, 10 are available from Cirkit, number 05-10713, as are most of the connectors. The miniature mains transformer is available from either supplier.

The total cost of the project should be around £15 excluding case and PCB.

The stick-on PCB pillars may be hard to come by: other varieties of PCB pillar will do the job if you cannot obtain the type used by the author, who had them in his spares box and is himself wondering where the next batch is coming from.



# GRIPMATE

NEW! ELECTRONIC ENGINEERS NEED  
**'EXTRA HANDS' FOR SOLDERING GLUEING AND ASSEMBLING**

This essential compact tool comes complete with 4 croc-clip flexi-arms to hold components positively and rapidly with infinite positioning.....

ONLY **£4.85** USEFUL ACCESSORIES....  
 48mm 2.5x MAGNIFIER FLEXI-ARM £2.50  
 MAGNET FLEXI-ARM £1.50

ALL PRICES INCLUDE VAT-POST-PKG  
 SEND NOW! CHQ/PO OR SAE DETAILS DIRECT FROM THE MAKERS:  
**KEMPLANT LTD (DEPT. 2)**  
 DURFOLD WOOD, PLAISTOW, BILLINGSHURST, WEST SUSSEX RH14 0PN



TEL: 048 649 344

# Marshall's

Electronic Component Distributors  
 85 WEST REGENT STREET  
 GLASGOW G2 2GD  
 TELEPHONE: 041-332 4133/4/5

Judge us by the company we keep —

Simens, Texas, National, Mullard, Leader,  
 ITT, Global Specialities, Piher,  
 Sinclair/Thandar, Greenwood, Arrow,  
 Antex, Sifam, Vero, Motorola

## AFFORDABLE ACCURACY

### QUALITY MULTIMETERS FROM ARMON

**ANALOGUE**

**HM-102BZ**  
 10ADC Range, 20KΩ/VDC, Buzzer, Battery Test Scale..... **£13.00**  
 19 measuring ranges

**HM-102R**  
 Low end voltage & current ranges, Jack for Audio orp Voltages..... **£11.00**  
 20 measuring ranges

**HM-101S**  
 Rugged, Pocket sized meter, for general purpose use..... **£7.50**  
 16 measuring ranges  
 Battery, Test Leads and Manual included with each model.

**DIGITAL**

**HC-8010** 0.5% Accuracy, Standard Model **£33.50**

**HC-8010T** 0.25% Accuracy, TR Test Facility **£39.50**

All models have full functions and ranges and feature:

- 3 1/2 digit 0.5" LED display
- Low battery indication
- Auto zero & Auto polarity
- ABS Plastic Casing & Tilt Stand
- DC AC 10amp Range
- Overload Protection on all ranges.
- Battery, Spare Fuse, Test Leads and Manual

**HC-5010**  
 0.25% accuracy  
**£36.50**  
 rotary

**HC 7030**  
 0.1% accuracy  
**£39.50**  
 push button

FULL DETAILS ON APPLICATION FROM:-  
**ARMON ELECTRONICS LTD**  
 DEPT E THE HERON HOUSE, 108 WEMBLEY HILL ROAD, WEMBLEY, MIDDLESEX HA9 8AQ  
 TELEPHONE 01-902 43311 TELEX 92398S

PLEASE ADD 18% to your order for VAT, P&P Price of charge. Payment by cheque with order  
 Offer applicable to mainland UK only

Trade enquiries invited Please allow 28 days for delivery

## FREE CAREER BOOKLET

**Train for success, for a better job, better pay**  
 Enjoy all the advantages of an ICS Diploma Course, training you ready for a new, higher paid, more exciting career.  
 Learn in your own home, in your own time, at your own pace, through ICS home study, used by over 8 million already!  
 Look at the wide range of opportunities awaiting you. Whatever your interest or skill, there's an ICS Diploma Course there for you to use.  
 Send for your FREE CAREER BOOKLET today—at no cost or obligation at all.

<b>GCE</b> Over 40 'O' and 'A' Level subjects from which to choose. Your vital passport to career success.	<input type="checkbox"/>
COMPUTER PROGRAMMING	<input type="checkbox"/>
ELECTRONICS	<input type="checkbox"/>
COMMERCIAL ART	<input type="checkbox"/>
TV, RADIO & AUDIO SERVICING	<input type="checkbox"/>
BOOK-KEEPING & ACCOUNTANCY	<input type="checkbox"/>
RADIO AMATEUR'S LICENCE	<input type="checkbox"/>
INTERIOR DESIGN	<input type="checkbox"/>
WRITING FOR PROFIT	<input type="checkbox"/>
CAR MECHANICS	<input type="checkbox"/>

Please send FREE DETAILS for the course ticked above.

Name \_\_\_\_\_  
 Address \_\_\_\_\_  
 P. Code \_\_\_\_\_

**ICS** ICS Dept. EAS 35  
 8 Elliot Place  
 Clydeaway Centre  
 Glasgow G3 8EF

041 221 2926  
 or 01 622 9911  
 (all hours)

**CACC**

## BAKER'S DOZEN PACKS

All Brand New except where marked  
 Price: £1 per pack  
 Order 12 you get one extra FREE  
 Please add £1 post if order under £20

1 - 5 13 amp ring main junction boxes	35 - 4 battery operated model motors
2 - 5 13 amp ring main spur boxes	36 - 2 air spaced 2 gang tuning condensers
3 - 25 13 amp fuses for ring mains	37 - 2 solid dielectric 2 gang tuning condensers
4 - 5 surface mounting switches	38 - 10 compression trimmers
5 - 3 flush switches intermediate type	39 - 1 Long & medium wave tuner kit
6 - 5 in flex line switches	40 - 4 x 465 KC IF transformers
7 - 4 in flex line switches with neons	41 - 8 rocker switches 10a mains SPST
8 - 2 80 watts brass cased elements	42 - 6 rocker switches 10a mains SPDT
9 - 2 mains transformers with 6v 1a secondaries	43 - 5 rocker switches 10a SPDT
10 - 2 mains transformers with 12v 1/2a secondaries	44 - 1 rocker switches 10a SPDT
11 - 1 extension speaker cabinet for 6 1/2" speaker	45 - 1 24 hour time switch mains operated
12 - 5 octal bases for relays or valves	46 - 1 6 hour clockwork time switch
13 - 12 glass reed switches	47 - 2 2 level switches 4 pole changeover up and ditto down
14 - 4 OCP 70 photo transistors	48 - 2 6v operated reed switch relays
15 - 25 assorted germanium transistors OC45 etc	49 - 10 neon valves - make good night lights
16 - 4 tape heads, 2 record, 2 erase	50 - 2 x 12v DC or 24v AC 3CD relays
17 - 2 ultra sonic transmitters and 2 ditto receivers	51 - 1 12v DC very sensitive relay
18 - 2 15000 pfd computer capacitors	52 - 1 12v AC 0 relay
19 - 2 I.d.r. similar ORP 12	53 - 2 mains operated relays 3 x 8a changeovers (second hand)
20 - 5 diff micro switches	54 - 10 rows of 32 gold plated IC sockets (total 320 sockets)
21 - 2 mains interference suppressors	55 - 1 miniature Uniselector with circuit for electric jigsaw puzzle
22 - 2 25 watt crossover units	56 - 5 dollhouse switches
23 - 1 40 watt 3 way crossover unit	58 - 2 telephone handsets
24 - 250 screws and self tappers	59 - 2 flat solenoids - to make current transformer etc
25 - 1 of each water switches - 6p 2 way, 4p 3 way, 2p 6 way, 1p 12 way	60 - 5 ferrite rods 4"x5" - 16" dia
26 - 2 tape deck counters	61 - 5 ferrite slab aerials LW & MW
27 - 1 6 digit counter 12v	62 - 4 200 ohm ear pieces
28 - 1 6 digit counter mains voltage	63 - 1 Mullard Thyristor trigger module
29 - 1 BDAC in flight stereo unit (s.h.)	64 - 10 assorted knobs 1/2 inch
30 - 2 NICAD battery chargers	65 - 5 diff thermostats
31 - 1 key switch with key	
32 - 2 humidity switches	
33 - 2 aerosol cans of ICI Dry Lubricant	
34 - 96 x 1 metre length colour-coded wires	

Most items available in quantity at good discounts. Access & Barclay cards welcome

## J.BULL (Electrical) Ltd.

(Dept HE), 34 - 36 AMERICA LANE,  
 HAYWARDS HEATH, SUSSEX RH16 3QU. **Established 30 YEARS**

# COMING SOON TO . . . ELECTRONICS

M O N T H L Y

**The Newcomer's Magazine for Electronic Projects**

## UNIVERSAL CMOS TESTER

The diversity of CMOS logic devices makes it difficult to produce a universal tester to establish whether a chip is working or not. The vulnerability of CMOS ICs means that it is valuable to have a testing device.

The CMOS tester adopts the low cost solution of halving of front panel mounted IC holder with each pin connected to a separate socket on the front panel. Logic signals can be coupled to any pin of the device being tested, or the output from any pin monitored.

The main circuit provides various fixed logic level and pulse signals, LED logic state indicators and a power source. Testing is carried out by constructing a simple test circuit suitable for the device being tested and wiring this up to the sockets in an appropriate way. In this way nearly any CMOS device can be checked.

## NINE NOTE PROGRAMMABLE DOORBELL

Some doorbells go dong ding. Other doorbells go ring ring. Some go parp and some go peep, the loud ones always ring when you're asleep. Some doorbells play a little tune, like Colonel Bogey or the Moon in June. If these ring songs make you groan, go on, do it, make up a tune of your own! With the EM Nine Note Programmable Doorbell, you can tune in your own sequence of any nine notes. Use your creativity. You can even program them out of tune, put the loudspeaker outside for the front door and frighten away unwanted callers.

The Nine Note Doorbell is a Veroboard layout and uses presets instead of the ubiquitous pre-programmed doorbell chips.

## A SERIOUS OPERATION

A look around the life and likings of the special Operational Amplifier, with a practical module to build.

## ELECTRONICS FROM THE START/INSIDE OUT

This month we look at diodes and how they work.

Give this form to your newsagent:

Please reserve me . . . . . copies of the May issue of

**ELECTRONICS**

M O N T H L Y

for Name . . . . .

Address . . . . .

. . . . .

. . . . .



**ELECTRONICS**

M O N T H L Y

The Newcomer's Magazine for Electronic Projects

**May issue on  
sale from 12th April  
Place your order now!**

Although these articles are being prepared for the next issue, circumstances may alter the final content.



# COMPONENTS FROM THE INSIDE OUT

Last month we looked at many kinds of capacitor. This month we cover the group known as electrolytic capacitors, which pack high values of capacitance into a small space.

Nicholas Bellenburg

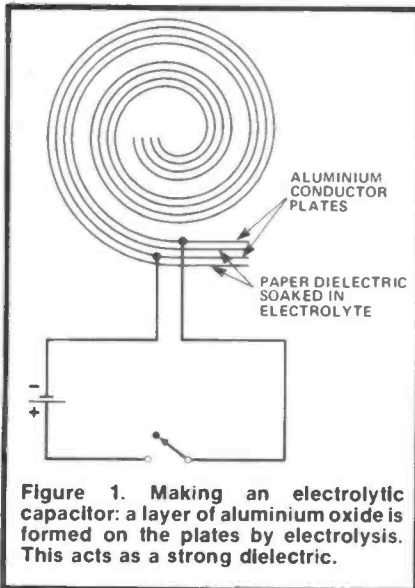


Figure 1. Making an electrolytic capacitor: a layer of aluminium oxide is formed on the plates by electrolysis. This acts as a strong dielectric.

LAST MONTH we looked at the many different types of non electrolytic capacitors available; this time it is the turn of **electrolytic** and **variable** types.

Electrolytic capacitors enable us to use large values of capacitance and voltage, yet keeping the physical volume of the components themselves relatively small. So called 'ordinary' foil type electrolytic capacitors have two sheets of aluminium foil wound in a spiral, like the non electrolytic types we've already seen. The difference here though is that the paper dielectric which separates the conductive plates is impregnated with an **electrolyte** (Figure 1).

Through the chemical process of electrolysis — like that which occurs in a battery or an electroplating works — the electrolyte causes a thin film (about  $10^{-4}$  mm in depth) of aluminium oxide to be deposited on one of the aluminium foils. This process is known as **forming** (Figure 2), and the oxide layer acts as an electrically strong dielectric. That's to say that it can resist very high voltages in relation to its thickness.

Figure 3a shows an electrolytic capacitor with an impregnated paper dielectric cut in two. Figure 3b shows the same component with part of the roll

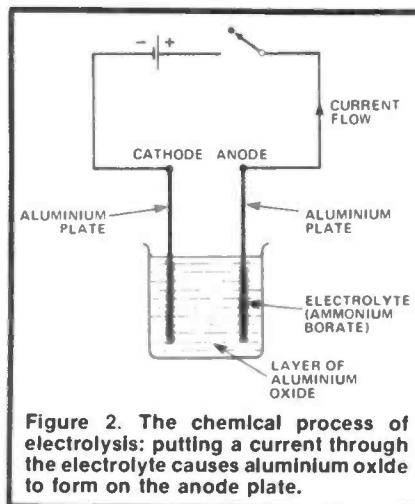
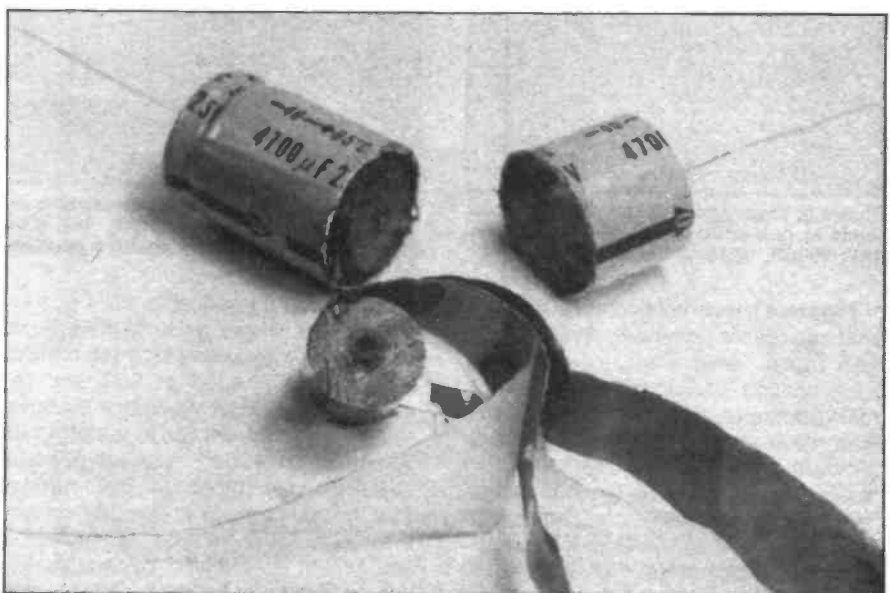
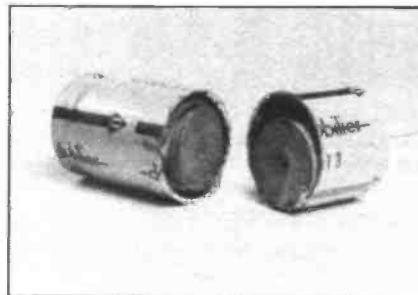


Figure 2. The chemical process of electrolysis: putting a current through the electrolyte causes aluminium oxide to form on the anode plate.



of conductors and dielectrics unrolled. You can see from these photographs that the capacitor's outer aluminium can has a crease or band around one end. This is to indicate the positive pole of the capacitor. The capacitor has a positive pole because during the forming process the oxide layer is only deposited on the anode — the plate that was connected to the positive side of the power source used. From this point on the electrolytic capacitor has to be connected in circuits the correct way round. The positive terminal (anode) goes to the positive side of the circuit, negative terminal (cathode) to the negative voltage.

If the capacitor is connected the wrong way round, the dielectric film can break down and in some cases the whole device can explode quite loudly. This explosion is caused by a gas being given off by the electrolyte, which causes pressure to build up eventually rupturing the component's can or in some cases blowing the end off.

## Polarisation

Electrolytic capacitors are thus said to be **polarised**. Large alternating voltages must of course never be applied to electrolytic capacitors, although variable voltages are permissible as long as the positive lead of the component is not subjected to negative potentials.

As well as being able to withstand relatively high voltages, electrolytic capacitors also have the advantage of being self healing if the dielectric oxide layer is broken by a voltage surge or dielectric weakness (when they are correctly connected). This is because after the voltage overload is removed, the action of electrolysis will occur again and reconstruct the oxide layer.

Figure 3. (a) shows a paper electrolytic cut in half; (b) shows the same capacitor with the roll of dielectrics and conductors partially unrolled.

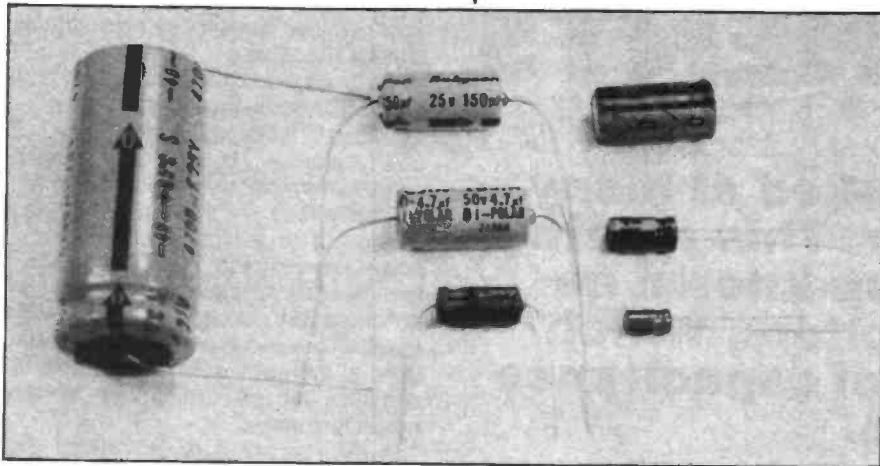


Figure 4. A selection of common electro values: from left to right and top to bottom: 4700, 25V; 150uF, 25V; 100uF, 63V; 4u7, 50V; 100uF, 10V; 1uF, 63V; 0u1, 50V (slightly larger than life size).

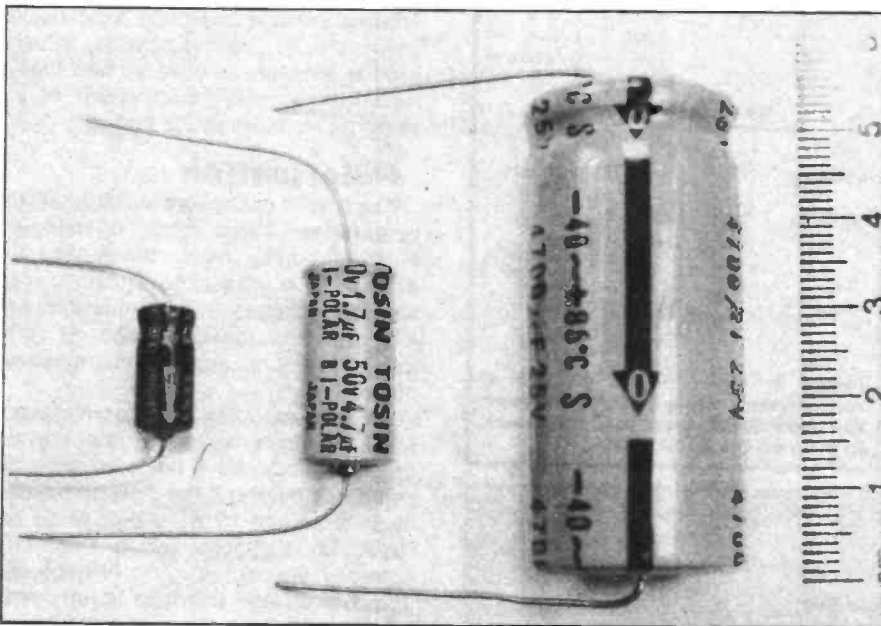


Figure 5. Three axial electrolytics (ie with a lead at either end): left to right, 1uF, 63V; 4u7, 50V and 4700uF, 25V.

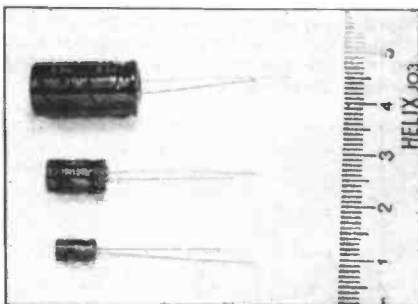


Figure 6. Three radial devices (ie with both leads at one end): top to bottom, 100uF, 10V; 100uF, 10V and 0u1, 50V.

Figure 4 shows a selection of electrolytic capacitors commonly available. As you can see, many different permutations of capacitance, voltage rating and size can be obtained. You'll also have noted that there are two different ways in which the connecting leads are attached to the capacitors. The components with a connecting lead at each end are known as **axial** devices, while the capacitors that have both leads coming from the same end are

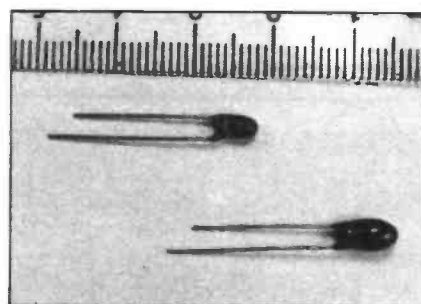


Figure 7. Two tantalum bead capacitors; above, 0uF, 35V; below, 10uF, 16V. The long lead indicates the positive connection.

called **radial** components.

Figure 5 shows axial devices (from left to right) with values of (i) 1uF rated at 63V, (ii) 4u7 rated at 50V and (iii) 4700uF rated at 25V. Figure 6 shows radial devices (from top to bottom) with values of (i) 100uF rated at 63V, (ii) 100uF rated at 10V and (iii) 0u1 rated at 50V. As you can see, in comparison with the non electrolytic types we looked at last month electrolytic capacitors are substantially smaller for the same rated

values. The cost of the components shown is from around 10p to £1.00 each.

The capacitors shown are helped, in their quest for small volume, by an etching technique that is applied to the foil plates. Etching the plates roughens their surfaces and so increases the surface area. This means that the overall dimensions of a given foil can be made smaller than they would be if it was perfectly smooth.

One disadvantage of electrolytic capacitors, though, is that they have a very wide tolerance: typically  $\pm 20\%$  or  $-10+50\%$ . In other words, the actual capacitances of components can be quite a great deal different to the rated values. This also means that when an electrolytic capacitor is chosen for a circuit, those available from a typical supplier's catalogue should always be able to fit the bill. In this case the nearest capacitance to the one needed, and the equal or next largest voltage should be chosen. So, suppose a circuit that you have design calls for a 70uF capacitor rated at 10V. Looking at a supplier's list the actual capacitor to choose would be the 60uF 16V one.

## Other Types

Figure 7 shows two, tiny, tantalum bead electrolytic capacitors. The one at the top has a value of 0uF1 rated at 35V, while the bottom one has a value of 10uF rated at 16V. The long lead on these capacitors indicates the positive connection.

Tantalum is a metal of very high purity and its oxidization by electrolysis means that tantalum capacitors work in a very similar manner to aluminium foil types.

Figure 8 shows a schematic diagram of a tantalum electrolytic capacitor. As you can see the electrolyte is manganese oxide.

These components have the advantage of providing high values of capacitance in very small packages. However, working voltages are limited to around 35V. The tolerance of tantalum bead capacitors is typically  $\pm 20\%$  and values from 0uF1 to 100uF are available. Prices are around 20p each.

The tantalum capacitor that we just looked at used manganese oxide as an electrolyte. Aluminium types also exist that use just an electrolyte, with no tissue

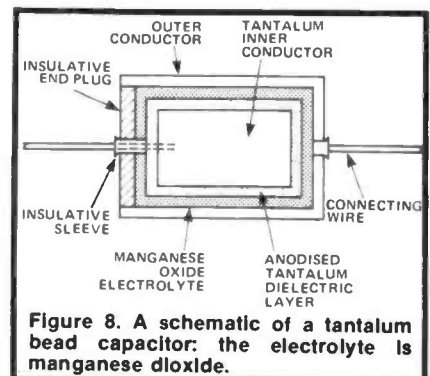
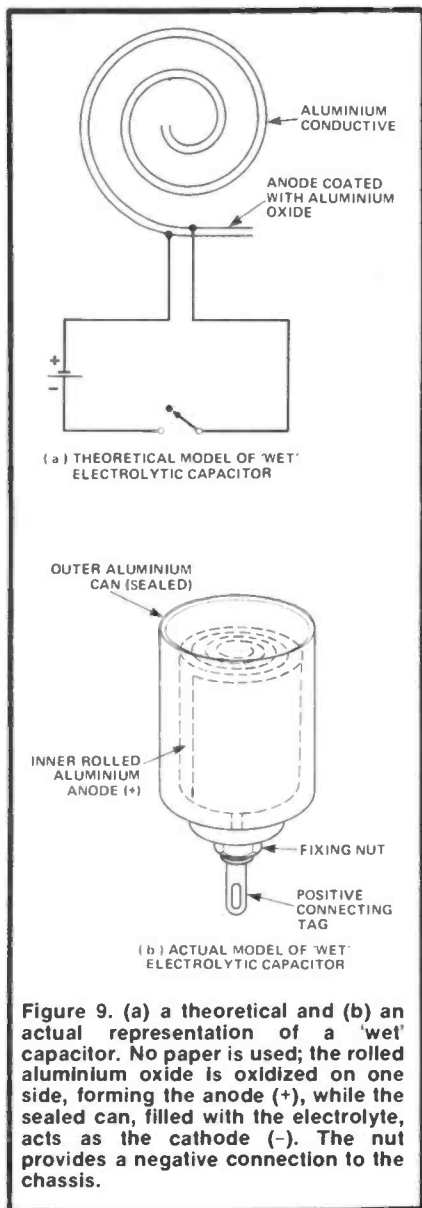


Figure 8. A schematic of a tantalum bead capacitor: the electrolyte is manganese dioxide.

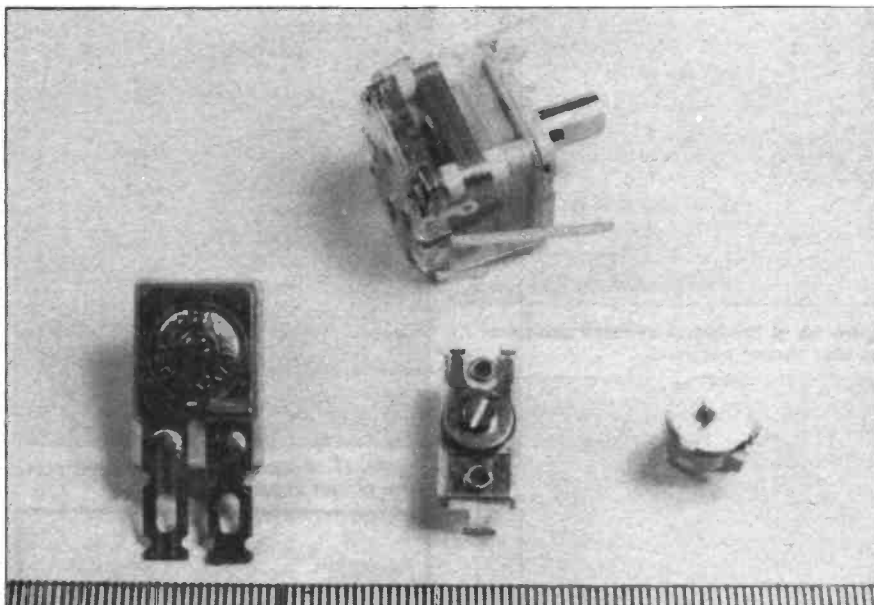


**Figure 9.** (a) a theoretical and (b) an actual representation of a 'wet' capacitor. No paper is used; the rolled aluminium oxide is oxidized on one side, forming the anode (+), while the sealed can, filled with the electrolyte, acts as the cathode (-). The nut provides a negative connection to the chassis.

paper layers for it to soak in. These are called 'wet' capacitors and **Figure 9** shows such a device in theoretical form (a) and actual form (b). Here the inner rolled up aluminium foil is oxidised by the electrolyte and as such is the anode (positive) plate.

The aluminium can in which this is contained acts as the cathode (negative) plate and is filled with the electrolyte. The positive connection comes through an insulator in the can's bottom, while the fixing nut on the bottom of the can provides the negative connection. These electrolytics are usually quite bulky (typically 100mm high and 35mm in diameter) and are usually used to 'smooth' power supplies and as such have very high voltage and capacitance ratings. Tolerances typically run at +80%-20% and on average, capacitors of this type cost from £3.50 to £11.00 depending on rated value.

Generally speaking, therefore, electrolytic capacitors give us high capacitance and voltage values in



**Figure 10.** Variable capacitors: left to right, a multi plate compression trimmer (preset); a radio tuning capacitor; a 'postage stamp' type compression trimmer (preset); a vaned miniature trimmer (preset).

physically small packages. On the debit side, though, they have a very wide tolerance range, must only be used with DC supplies, and have a tendency for the electrolyte to dry out in high temperatures, affecting their action adversely.

## Variable Capacitors

Variable capacitors are non-electrolytic and take two forms: preset and manually variable. **Figure 10** shows a selection.

Manually variable capacitors are commonly used in the tuning sections of radios. As we know, capacitance can be varied by altering the overlapping area of the two plates or by altering the thickness of the dielectric between them. Manually variable capacitors work by varying the area of overlapping plates. **Figure 11** shows the way in which this happens. One of two semicircular plates is fixed to the central spindle. Rotating the spindle moves the one plate over the other.

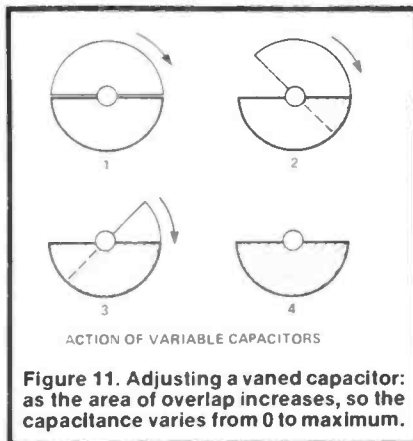
In reality, more than two plates — known as vanes — are used, as **Figure 12** indicates. This is a dual ganged

variable capacitor, which means that the front and back sections are separate, so that they can be used for, say, different wavebands of a radio. The front section of this one is variable from 10 to 208pF while the rear section goes from 8pF5 to 176pF. A variable capacitor like this costs about £9.00, and would be used in hi-fi tuners and high quality radios.

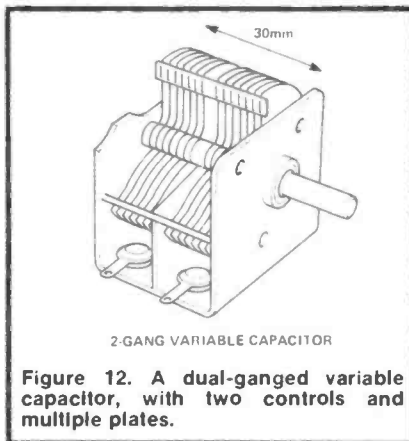
A rather cheaper variable capacitor is shown in **Figure 13**. The body of this component is only 20mm long and it is designed for direct printed circuit board mounting. This miniature capacitor has four tuning sections — two for AM and two for FM. There is also a preset trimmer (which we shall look at next) for each section — shown in **Figure 14**. This variable capacitor is intended for use in cheaper transistor radios and is priced at about £1.75.

The preset trimmer capacitors shown on the bottom of the variable capacitor in **Figure 14** use overlapping vanes which may be tuned by the screws, allowing you to fine-tune the radio's overall tuning range.

Preset capacitors are used for other applications too, and can be either the



**Figure 11.** Adjusting a vaned capacitor: as the area of overlap increases, so the capacitance varies from 0 to maximum.



**Figure 12.** A dual-ganged variable capacitor, with two controls and multiple plates.

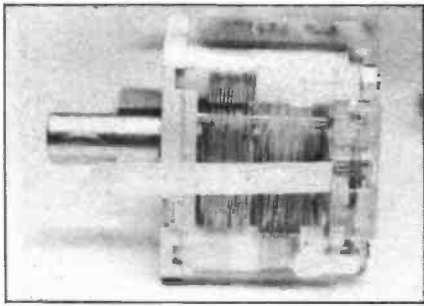


Figure 13. A miniature variable capacitor has four tuning sections.

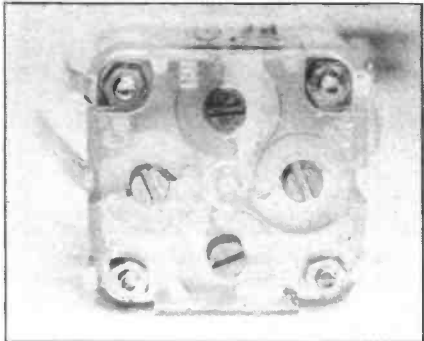


Figure 14. The rear of the capacitor shows in Figure 13, showing four preset trimmer capacitors as part of the unit.

movable vane type or what are known as compression trimmers. A movable vane type can be seen in Figures 10 and 15. It is only 9mm in diameter and is available in maximum capacitances of 10pF, 22pF and 65pF for about 25p.

Compression trimmers work by altering the thickness of the dielectric between the conductive plates by compressing it to different depths. Figure 16 illustrates the make up of

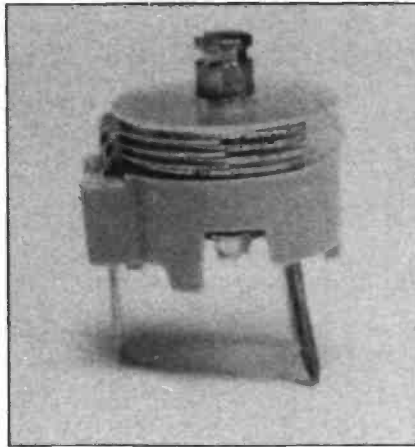


Figure 15. A close up view of a movable vane preset capacitor.

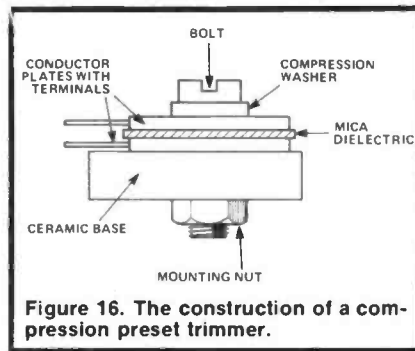


Figure 16. The construction of a compression preset trimmer.

such a preset capacitor and Figure 17 shows an actual component. This is about 20mm long and uses a mica sheet as the dielectric. The capacitance is variable from 3pF to 40pF and it costs around 30p.

Figure 18 on the other hand shows a preset trimmer capacitor with more than

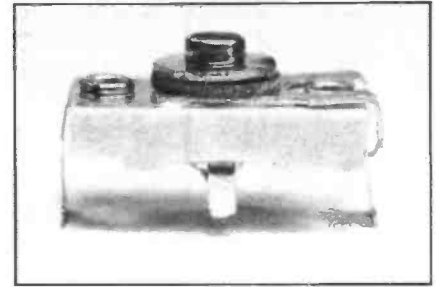


Figure 17. A closeup of the capacitor shown in Figure 16.

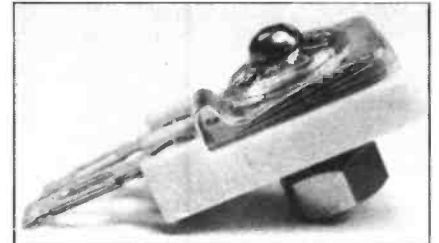


Figure 18. A preset trimmer with six conductive plates.

two conductive plates. It has six in fact, three connected to each terminal. Mica dielectrics are also employed. The capacitance of this component varies from 100pF to 500pF. The device itself is 34mm long overall and costs about 40p.

## To Sum Up

Between the last *Components From The Inside Out* and this one, we have looked at most of the types of capacitor that are commonly available. Let's end our discourse by looking at the various attributes of the different types, as shown in Table 1.

**Table 1**  
**Attributes and applications of different capacitors**

Type	Properties	Applications
Paper	Cheap, general purpose capacitors with a reasonable capacitance to size ratio.	General purpose.
Plastic:		
Polystyrene	High insulation resistance; low losses; small.	General purpose and charge storage; Filters.
Polycarbonate	Miniature; self healing.	Miniature general purpose.
Ceramic:		
Low permittivity	Low dissipation	Low voltage applications
Medium permittivity	High capacitance to size ratio.	Temperature correction components
High permittivity	Large capacitance to size ratio; voltage and temperature sensitive.	
Mica	Highly stable, low dissipation	General purpose.
Electrolytic:		
Aluminium	Polarised devices; very large capacitance to size ratio, limited life and temperature range.	Smoothing circuits; General purpose.
Tantalum	Small, expensive, polarised, highly reliable.	Where reliability and/or size is a priority.
Variable:		
Manual	Variable within certain limits.	Tuning circuits.
Preset	Variable within certain limits.	Tuning circuits.

# THREE ACES FROM ALCON!

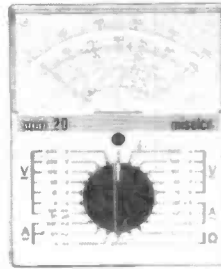
## SUPER 20 A♣



**20kΩ/V a.c. & d.c.**  
**39 RANGES - INDESTRUCTIBLE**  
 automatically protected on all ranges but 10A  
 Accuracy: d.c. ranges and Ω 2% a.c. 3% (of f.s.d.)  
 39 ranges: d.c. V 100mV, 1.0V, 3.0V, 10V, 30V, 100V, 300V,  
 1000V;  
 d.c. I 50μA, 100μA, 300μA, 1.0mA, 3mA, 10mA, 30mA,  
 100mA, 1A, 10A,  
 a.c. V 10, 30V, 100V, 300V, 1000V; a.c. I 3mA, 10mA, 30mA,  
 100mA, 1.0A, 10A  
 Ω 0-50kΩ, 0-500kΩ, 0-50MΩ, 5MΩ, 50MΩ.  
 dB from -10 to +61 in 5 ranges.  
 Dimensions: 105 x 130 x 40mm.

**ONLY £33.50**

## MINI 20 A♥



**20kΩ/V d.c. & 4kΩ/V a.c.**  
**28 RANGES WITH PROTECTIVE FUSE**  
 Accuracy: 2% d.c. and resistance, 3% a.c.  
 28 ranges: d.c. V 100mV, 3V, 10V, 30V, 100V, 300V,  
 600V; d.c. I 50μA, 600μA, 5mA, 60mA, 600mA,  
 a.c. V 15V, 50V, 150V, 500V, 1500V; a.c. I 30mA,  
 300mA, 3.0A; Ohms 0-2kΩ, 0-2MΩ.  
 dB from -10 to +62 in 6 ranges.  
 Dimensions: 105 x 130 x 40mm.

**ONLY £21.60**

## SUPER 50 A♠



**50kΩ/V a.c. & d.c.**  
**39 RANGES**  
 Accuracy: d.c. ranges and Ω 2% a.c. 3% (of f.s.d.)  
 39 ranges: d.c. V 150mV, 1.0V, 3.0V, 10V, 30V, 100V,  
 300V, 1000V; d.c. I 20μA, 100μA, 300μA, 1.0mA,  
 3mA, 10mA, 30mA, 100mA, 1A, 3A a.c. V 10, 30V,  
 100V, 300V, 1000V; a.c. I 3mA, 10mA, 30mA,  
 100mA, 1.0A, 3.0A; a.c. I 3mA, 10mA, 30mA,  
 Ω 0-50kΩ, 0-500kΩ, 0-50MΩ, 5MΩ, 50MΩ.  
 dB from -10 to +61 in 5 ranges.  
 Dimensions: 105 x 130 x 40mm.

**ONLY £36.30**

### 3 HIGH QUALITY TEST INSTRUMENTS AT SUPERDEAL PRICES

EACH INSTRUMENT COMES COMPLETE WITH A ROBUST CARRYING CASE, LEADS & INSTRUCTIONS.

PRICES Our prices include VAT and postage and goods are normally despatched by return.

Please write or telephone for details of these and the many other instruments in the Alcon range, including multimeters, components measuring, automotive and electronic instruments

## ALCON

Instruments Ltd.

19 MULBERRY WALK LONDON SW3 6DZ TEL 01-352 1897 TELEX 918867

NEW  
IMPROVED

# BRADLEY MARSHALL

- ELECTRONIC COMPONENT •
- COMPUTER & SOFTWARE SPECIALIST •

**BRADLEY MARSHALL, 382-386 EDGWARE ROAD, LONDON W2 1BN**  
 Telephone: 01-723 4242

BRADLEY MARSHALL are proud to announce the opening of their spacious new premises at 382-386 Edgware Road (opposite their old shop). The new premises are larger than before, enabling us to provide you with superior service .....

- Product line increased from 2000 to over 5000 stock items!
- Our brand new COMPUTER CENTRE stocks all the latest Hardware, Software and Peripherals, from Acorn, Sinclair, Commodore etc, at the most competitive prices in town!
- We have employed additional staff to serve you more efficiently!
- FREE CATALOGUE, and a first class mail order service (please 'phone before ordering for up to the minute prices)



**BRADLEY MARSHALL new premises offer you expert and friendly advice**

*Trade and Educational Enquiries Welcome*

# METERS METERS METERS

Meter	Display	DC volts	DC amps	AC volts	Ranges AC amps	Resistance	Continuity	Others	Power
Altal KD-55C	3½ digit LCD	200mV, 2V, 20V, 200V, 2000V	200uA, 2mA, 20mA, 200mA, 1A, 10A	200mV, 2V, 20V, 200V, 700V	200uA, 2mA, 20mA, 200mA, 1A, 10A	200R, 2K, 20K, 200K, 2M, 200M	No	N/A	PP3 battery
Altai NH-56R	Analogue	250mV, 2.5V, 10V, 50V, 250V, 500V, 1000V	50uA, 500uA, 5mA, 500mA	2.5V, 10V, 50V, 250V, 1000V	N/A	×1, ×10, ×100, ×1K	No	-20 to +10dB	2 × 1.5V AA cells
Avometer 1000	Analogue	300mV, 3V, 10V, 30V, 100V, 300V, 1000V	50uA, 10mA, 100mA, 1A, 6V	10V, 30V, 100V, 300V, 1000V	10mA, 100mA, 1A, 6A	×1, ×100, ×1K	No	N/A	2 × 1.5V AA cells
Avometer 2001	3½ digit LCD	200mV, 2V, 20V, 200V, 1000V	200uA, 2mA, 20mA, 200mA, 2A, 10A	200mV, 2V, 20V, 200V, 1000V	200uA, 2mA, 20mA, 200mA, 2A, 10A	200R, 2K, 20K, 200K, 2M, 20M	Yes	Diode test	9V PP3 battery
BEWA DMM6010GS	3½ digit LCD	200mV, 2V, 20V, 200V, 1000V	200uA, 2mA, 20mA, 200mA, 2A, 10A	200mV, 2V, 20V, 200V, 750V	200uA, 2mA, 20mA, 200mA, 2A, 10A	200R, 2K, 20K, 200K, 2M, 20M	No	N/A	9V PP3 battery
BEWA DMM3510	3½ digit LCD	200mV, 2V, 20V, 200V, 1000V	200uA, 2mA, 20mA, 200mA, 2A, 10A	200mV, 2V, 20V, 200V, 750V	200uA, 2mA, 20mA, 200mA, 2A, 10A	200R, 2K, 20K, 200K, 2M, 20M	No	N/A	9V PP3 battery
Circuitmate DM10	3½ digit LCD	200mV, 2V, 20V, 200V, 1000V	200uA, 2mA, 20mA, 200mA	200V, 500V	N/A	200R, 2K, 20K, 200K, 2M, 20M	No	Diode test	9V PP3 battery
Circuitmate DM15	3½ digit LCD	200mV, 2V, 20V, 200V, 1000V	200uA, 2mA, 20mA, 10A	200mV, 2V, 20V, 200V, 750V	200uA, 2mA, 20mA, 10A	200R, 2K, 20K, 200K, 2M, 20M	No	Diode test	9V PP3 battery
Circuitmate DM20	3½ digit LCD	200mV, 2V, 20V, 200V, 1000V	200uA, 2mA, 20mA, 200mA, 10A	200mV, 2V, 20V, 200V, 750V	200uA, 2mA, 20mA, 200mA, 10A	200R, 2K, 20K, 200K, 2M, 20M	No	Diode test Conductance hFE	9V PP3 battery
Circuitmate DM25	3½ digit LCD	200mV, 2V, 20V, 200V, 1000V	200uA, 2mA, 20mA, 10A	200mV, 2V, 20V, 200V, 750V	200uA, 2mA, 20mA, 10A	200R, 2K, 20K, 200K, 2M, 20M	Yes	Diode test Capacitance 2n to 20u in 5 ranges	9V PP3 battery
Circuitmate DM73	3½ digit LCD	2V, 20V, 200V, 500V	N/A	2V, 20V, 200V, 500V	N/A	2K, 20K, 200K, 2M	Yes	N/A	2 × 1.5V button cells
Circuitmate DM77	3½ digit LCD	200mV, 2V, 20V, 200V, 1000V	200mA, 10A	2V, 20V, 200V, 600V	200mA, 10A	200R, 2K, 20K, 200K, 2M	Yes	N/A	2 × 1.5V AA cells
Hills HD700	3½ digit LCD	200mV, 2V, 20V, 200V, 1000V	200uA, 2mA, 20mA, 200mA, 10A	200mV, 2V, 20V, 200V, 750V	200uA, 2mA, 20mA, 200mA, 10A	200R, 2K, 20K, 200K, 2M, 20M	No	N/A	9V PP3 battery
Hills HT-320	Analogue	100mV, 500mV, 2.5V, 10V, 50V, 250V, 1000V	50uA, 2.5mA, 25mA, 250mA	10V, 50V, 250V, 1000V	N/A	×1, ×10, ×1K, ×10K	No	-10 to +22dB Transistor leakage and hFE	2 × 1.5V AA cells + PP3 battery
Hung Chang HC-5010T	3½ digits LCD	200mV, 2V, 20V, 200V, 1000V	200uA, 2mA, 20mA, 200mA, 10A	200mV, 2V, 20V, 200V, 750V	200uA, 2mA, 20mA, 200mA, 10A	200R, 2K, 20K, 200K, 2M, 20M	Yes	Diode test, Transistor hFE	9V PP3 battery
Hung Chang HM102BZ	Analogue	2.5V, 10V, 50V, 250V, 1000V	5mA, 50mA, 500mA, 10A	10V, 50V, 250V, 1000V	N/A	×1, ×10, ×1K	Yes	Battery test -8 to +22 dB	2 × 1.5V AA cells
Kingdom ETC-500	Analogue	125mV, 250mV, 1.25V, 2.5V, 5V, 10V, 25V, 50V, 125V, 250V, 500V, 1000V	2.5mA, 5mA, 25mA, 50mA, 250mA, 500mA, 10A, 25A, 50A	5V, 10V, 25V, 50V, 125V, 250V, 500V, 1000V	N/A	×1, ×10, ×100, ×1K, ×10K	No	-20 to +62dB	1 × 1.5V AA cell, 9V PP3 battery
Maplin M-102BZ	Analogue	2.5V, 10V, 50V, 250V, 1000V	5mA, 50mA, 500mA, 10A	10V, 50V, 250V, 1000V	N/A	×1, ×10, ×1K	Yes	Battery test -8 to +22 dB	2 × 1.5V AA cells
Maplin M-5010	3½ digit LCD	200mV, 2V, 20V, 200V, 1000V	20uA, 200uA, 2mA, 20mA, 200mA, 10A	200mV, 2V, 20V, 200V, 750V	20uA, 200uA, 2mA, 20mA, 200mA, 10A	20R, 200R, 2K, 20K, 200K, 2M, 20M	Yes	Diode test	9V PP3 battery

# METERS METERS METERS

Batt. life	Batt. Ind	DC input impedance	AC input impedance	General accuracy	Ranging	Standard accessories	Dimensions H/W/D	Weight	Approx Price	Ease of use	Quality	Value for money
Not given	Yes	10M	10M	± 1%	Manual	Leads, carry case, angle bracket, battery, spare fuse	165/95/41	Not given	£46	4	4	4
Not given	No	20KV <sup>-1</sup>	8KV <sup>-1</sup>	Not given	Manual	Leads, angle bracket	135/100/40	540g	£14	4	3	5
Not given	No	20KV <sup>-1</sup>	2KV <sup>-1</sup>	± 2.5%	Manual	Leads, probes, croc clips, angle bracket, batteries	209/95/57	465g	£50	4	5	5
400 hours	Yes	10M	10M	± 1%	Manual	Leads, probes, clip probes, croc clips, angle bracket, battery, spare fuses	193/90/40	350g	£95	5	5	4
100 hours	Yes	100K 1M, 10M	100K 1M, 10M	±0.5%	Manual	Leads, angle bracket	170/90/55		£40	4	3	4
100 hours	Yes	100K, 1M, 10M	100K, 1M, 10M	±0.1%	Manual	Leads, angle bracket	170/90/55		£55	4	3	4
Not given	Yes	1M	450K	± 1%	Manual	Leads, battery, spare fuse	119/69/28	156g	£32	4	3	5
200 hours	Yes	10M	10M	± 1%	Manual	Leads, battery, spare fuse	150/82/25	220g	£43	4	4	5
200 hours	Yes	10M	10M	± 1%	Manual	Leads, battery, spare fuse	150/82/25	220g	£41	4	4	4
70 hours	Yes	10M	10M	± 1%	Manual	Leads, battery, spare fuse	150/82/25	220g	£58	4	4	4
100 hours	Yes	11M	11M	± 1%	Auto	Leads, battery	133/28/18	55g	£40	5	4	5
300 hours	Yes	10.5M	10.5M	± 1%	Auto	Leads, battery, angle bracket	160/85/29	239g	£46	4	4	5
Not given	Yes	10M	10M	Not given	Manual	Leads, battery, case	162/86/31	245g	£46	4	4	4
Not given	No	20KV <sup>-1</sup>	8KV <sup>-1</sup>	Not given	Manual	Leads, angle bracket, battery	—	Not given	£16.50	4	3	4
200 hours	Yes	10M	10M	± 1%	Manual	Leads, angle bracket, battery	170/83/42	343g	£46	4	4	4
Not given	No	20 KV <sup>-1</sup>	8KV <sup>-1</sup>	± 5%	Manual	Leads, angle bracket, battery	133/90/38	544g	£15	4	4	4
Not given	No	25/ 50KV <sup>-1</sup>	5/10KV <sup>-1</sup>	± 4%	Manual	Leads, angle bracket	170/124/50	590g	£23	4	4	5
Not given	No	20KV <sup>-1</sup>	8KV <sup>-1</sup>	± 5%	Manual	Leads, angle bracket, battery	133/90/38	544g	£15	4	4	4
200 hours	Yes	10M	10M	± 1%	Manual	Leads, angle bracket, battery	170/87/42	343g	£43	4	4	4

# METERS METERS METERS

Meter	Display	DC volts	DC amps	AC volts	Ranges AC amps	Resistance	Continuity	Others	Power
<b>Maplin pocket size</b>	Analogue	10V, 50V, 250V, 500V	500uA, 50mA, 250mA	10V, 50V, 250V, 500V	N/A	×1K	No	-20 to +56dB	1 × 1.5V AA cell
<b>Metex 3500</b>	3½ digit LCD	200mV, 2V, 20V, 200V, 1000V	200uA, 2mA, 20mA, 200mA, 2A, 10A	200mV, 2V, 20V, 200V, 700V	200uA, 2mA, 20mA, 200mA, 2A, 10A	200R, 2K, 20K, 200K, 2M, 20M, 2M, 20M	No	Diode test	9V PP3 battery
<b>Metex 3531</b>	3½ digit LCD	200mV, 2V, 20V, 200V, 1000V	200uA, 2mA, 20mA, 200mA, 10A	200mV, 2V, 20V, 200V, 700V	2mA, 20mA, 200mA, 10A	200R, 2K, 20K, 200K, 2M, 20M	Yes	Diode test Capacitance Transistor hFE	9V PP3 battery
<b>Pantec Banana</b>	Analogue	500mV, 5V, 25V, 100V, 500V	50uA, 50mA, 500mA, 2.5mA	50V, 250V, 500V	N/A	×1, ×100, ×1K	Yes	Battery test	1 × 1.5V AA cell
<b>Pantec Challenger</b>	Analogue	250mV, 500mV, 1.5V, 5V, 15V, 50V, 150V, 500V, 1000V	25uA, 500uA, 5mA, 50mA, 500mA, 10A	5V, 15V, 50V, 150V, 500V, 1000V	N/A	×0.1, ×1, ×10, ×100, ×1K	No	Diode test Battery test	2 × 1.5V AA cells
<b>Pantec Zip</b>	3½ digit LCD	2V, 20V, 200V, 500V	N/A	2V, 20V, 200V, 500V	N/A	2K, 20K, 200K, 2M	Yes	N/A	2 × 1.5V button cells
<b>Philips PM2518X</b>	4½ digit LCD	1V, 10V, 100V, 1000V	20mA, 200mA, 2A, 20A	1V, 10V, 100V, 1000V	20mA, 200mA, 2A, 20A	1K, 10K, 100K, 1M, 10M, 100M	Yes	Temperature Diode tests HF/RF volts -51 to +43dB	4 × 1.5V C cells
<b>Soar 3030</b>	3½ digit LCD	200mV, 2V, 20V, 200V, 1000V	200uA, 2mA, 20mA, 200mA, 10A	2V, 20V, 200V, 750V	200uA, 2mA, 20mA, 200mA, 10A	200R, 2K, 20K, 200K, 2M, 20M	Yes	Diode test	2 × 1.5V AA cells
<b>Soar 3100</b>	3½ digit LCD	200mV, 2V, 20V, 200V, 500V	N/A	2V, 20V, 200V, 500V	N/A	200R, 2K, 20K, 200K, 2M, 20M	Yes	N/A	2 × 1.5V button cells
<b>Soar ME530</b>	3½ digit LCD	200mV, 2V, 20V, 200V, 500V	200mA, 10A	2V, 20V, 200V, 750V	200mA, 10A	200R, 2K, 20K, 200K, 2M, 20M	Yes	Diode test	2 × 1.5V AA cells
<b>TMK TP5SN</b>	Analogue	500mV, 5V, 50V, 250V, 1000V	50uA, 5mA, 50mA, 500mA	10V, 50V, 250V, 500V, 1000V	N/A	×1, ×10, ×100, ×1K	No	Capacitance -20 to +36dB	2 × 1.5V AA cells
<b>TMK VF7</b>	Analogue	250mV, 2.5V, 15V, 150V, 500V or 500mV, 5V, 30V, 300V, 1000V	50u, 100u, 5mA, 300mA, 5A, 10A	5V, 15V, 150V, 500V or 10V, 30V, 300V, 1000V	N/A	×1, ×10, ×100, ×1K	No	Battery test	1 × 1.5V AA cell
<b>TMK NKVF3</b>	Analogue	10V, 50V, 250V, 500V	500uA, 50mA, 250mA	10V, 50V, 250V, 500V	N/A	×1K	No	-20 to +56dB	1 × 1.5V AA cell

Having compiled the bare facts on a selection of meters, we gave the machines to our reviewer for his comments:

REVIEWING TEST EQUIPMENT, especially in large quantities, is no mean feat (at the last count there were 31 metres in this review — although others may slip their way in before we go into print). All sorts of difficulties arise in attempting to be unbiased and objective. One of the biggest problems is how to present the large amount of information in an understandable form. The next big problem is deciding what information must be presented in the first place.

We've decided that the information you need is — everything. So, as you'll imagine, compiling it has been a bad dream. Displaying it, on the other hand, has merely been a nightmare! Putting all of our brains together (*in serial or parallel?* — Ed.) we've figured out that a

table is probably the easiest way for you to find the information you need. But for the minor details the table can't cover, we've also included brief particulars about each meter individually.

### Altai KD-55C

Price: £46

Altai meters have been around for a long time now, and as such the company knows the market well. This meter is a good quality, general purpose tool, with an adequate number of ranges. The instruction manual is well written and presented in an easy-to-follow form. A circuit diagram is included, but no circuit board layout diagrams.

Our source: **Greenweld, 443A Millbrook Road, Southampton, SO1 0HX.**

### Altai NH-56R

Price: £14

Altai's analogue meter we tested, is not of the same quality as the company's digital offering. Nevertheless it represents good value for money for the enthusiast with only the most limited of resources. A reasonable instruction manual, which includes a circuit diagram, explains basic operations.

Our source: **Greenweld, 443A Millbrook Road, Southampton SO1 0HX.**

### Avometer 1000

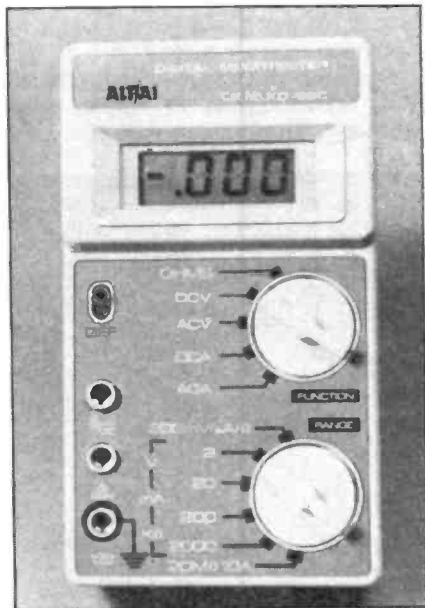
Price: £50

If you've been around any electronic workshops or laboratories, you'll know and love/hate the Avometer 8 meter —



# METERS METERS METERS

Batt. life	Batt. Ind	DC input impedance	AC input impedance	General accuracy	Ranging	Standard accessories	Dimensions H/W/D	Weight	Approx Price	Ease of use	Quality	Value for money
Not given	No	2KV <sup>-1</sup>	2KV <sup>-1</sup>	± 4%	Manual	Leads, battery	90/60/30	105g	£7	4	4	5
1,000-2,000 hours	Yes	Not given	Not given	±0.5%	Manual	Leads, angle bracket, spare fuse	162/88/40	340g	£37	4	4	5
Not given	Yes	10M	10M	± 1%	Manual	Leads, angle bracket, spare fuse, battery, carry case	162/88/40	340g	£55	4	4	4
Not given	No	20KV <sup>-1</sup>	10KV <sup>-1</sup>	± 2%	Manual	Leads, spare fuse, carry case, battery	175/85/29	Not given	£24	4	4	4
Not given	No	40KV <sup>-1</sup>	40KV <sup>-1</sup>	± 2%	Manual	Leads, spare fuse, carry strap	160/105/40	500g	£49	3	4	3
100 hours	Yes	11M	11M	± 1%	Auto	Leads, carry case, battery	133/28/18	Not given	£99	5	4	4
Not given	Yes	10M	2.2M	± 0.5%	Auto or manual	Leads, angle bracket, plug adaptors, 2 spare fuses, probes		Not given	£200	4	5	4
500 hours	Yes	11M	10M	± 1%	Manual	Leads, angle bracket, spare fuse, battery	160/76/35	Not given	£106	4	4	3
100 hours	Yes	11M	10M	± 1%	Auto	Leads, battery	150/30/20	Not given	£40	5	3	5
500 hours	Yes	11M	10M	± 1%	Auto or manual	Leads, battery	160/80/30	250g	£52	4	4	4
Not given	No	20KV <sup>-1</sup>	20KV <sup>-1</sup>	±3%	Manual	Leads, battery	133/93/45	420g	£25	3	3	4
Not given	No	20KV <sup>-1</sup> 10KV <sup>-1</sup>	10KV <sup>-1</sup> 5KV <sup>-1</sup>	±3%	Manual	Leads, battery	145/95/45	365g	£33	4	4	3
Not given	No	2KV <sup>-1</sup>	2KV <sup>-1</sup>	±4%	Manual	Leads, battery	90/60/30	105g	£8	4	4	4



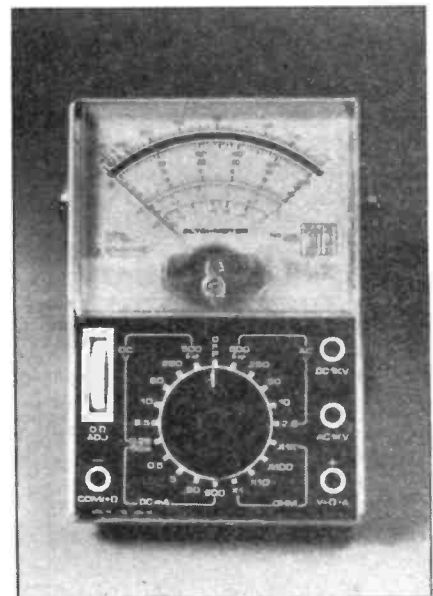
a big, black, brute of a meter. The Avometer 1000 analogue meter is much neater, smaller and light, but appears no less robust than the '8'. Perhaps the 1000 will become as common a sight as its predecessor, in the years to come. We certainly couldn't fault it (perhaps with the exception that it features no continuity test) as a good, general purpose high quality meter.

Our source: **Thorn EMI Instruments Ltd., Archcliffe Road, Dover, Kent CT17.**

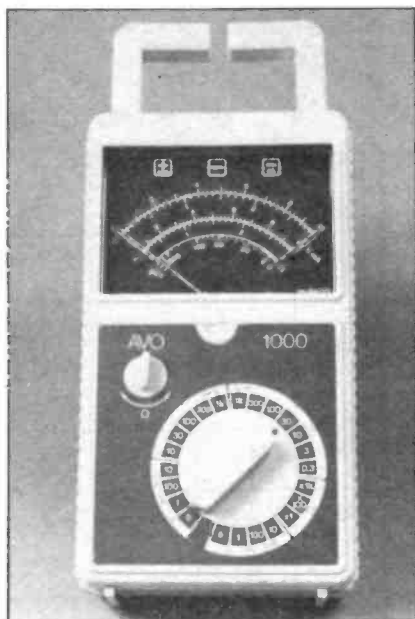
## Avometer 2001

Price: £95

Where the Avometer 1000 falls short of perfection (well, it is an analogue meter, innit?) its big brother digital meter, the Avometer 2001, takes over. This is an example of everything-you-wanted-from-a-meter-but-were-afraid-to-look-for. A meter like this will keep the long-



# METERS METERS METERS



## Bewa DMM 6010Gs

Price: £40

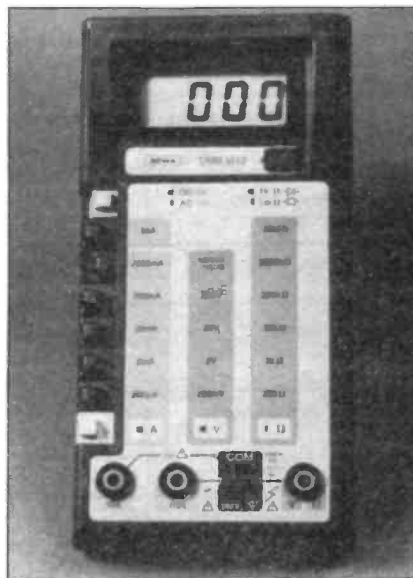
Three meters arrived on the *Electronics Monthly* test-bench unboxed, with no instruction manuals, and with no details. This meter was one of them. We tried not to let this colour our views, however, as we wanted to give a review of the meters themselves and how they performed under test. This particular meter is a reasonable quality digital meter, with an adequate number of ranges for amateur and professional use.

Our source: **House of Instruments, Clifton Chambers, 62 High Street, Saffron Walden, Essex CB10 1EE.**

## Circuitmate DM10

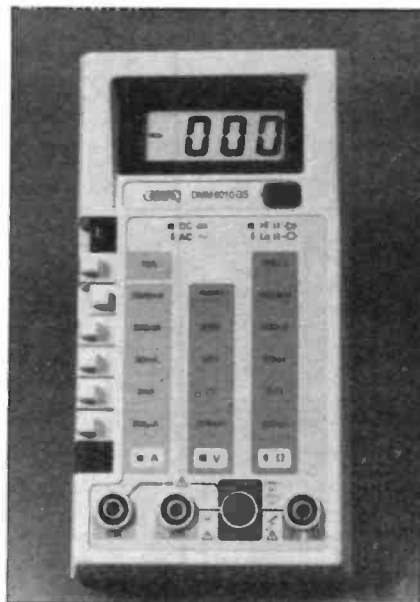
Price: £32.

The DM10 is the lowest specification example from a complete range of meters. It has the lowest input impedances of the meters in the range,



the positioning of components and switches etc. The similarities between meters are mirrored in the fact that one instruction manual covers all three meters. Circuit diagrams and board layout diagrams are included.

Our source: **Beckman Instruments Ltd., Mylen House, 11 Wagon Lane, Sheldon, Birmingham B26 3DJ.**

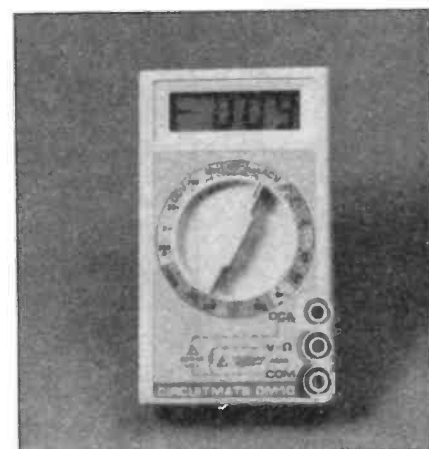


## Circuitmate DM73, DM77

Price: £40 (DM73), £46 (DM77)

Again, two meters in the **Circuitmate** range are similar enough in specification to be incorporated in the same instruction manual. The similarity stops, this time however, with specifications. In appearance these two meters couldn't be more different. The DM77 is a conventional style meter, in an oblong box, but the DM73 is an unconventional style, as you'll see from the photograph. Both meters are autoranging, which makes them simple to use. The DM73 has no current measuring ranges. Circuit diagrams and board layouts for both meters are included.

Our source: **Beckman Instruments Ltd., Mylen House, 11 Wagon Lane, Sheldon, Birmingham B26 3DJ.**



doesn't feature a continuity test, and cannot measure AC current. On the other hand, it is reasonably priced, is simple to use, and features adequate ranges for other measurements. The instruction manual is straightforward, well written, and easy to follow. No circuit diagrams or board layout diagrams are included, however.

Our source: **Beckman Instruments Ltd., Mylen House, 11 Wagon Lane, Sheldon, Birmingham B26 3DJ.**

## Circuitmate DM15, DM20, DM25

Price: £43 (DM15), £47 (DM20), £58 (DM25)

These three meters in the **Circuitmate** range are very similar in features, with only a few small differences in the number of measurement ranges or facilities. The case and circuit boards are, in fact, almost identical, except for

lasting Avometer name alive for ever (even if the name does now belong to Thorn EMI), with no fear of extinction. Right, have we waxed lyrical and mixed superlatives enough now? If so let's get back down to earth. If you can afford it, buy it. That's simple enough, isn't it?

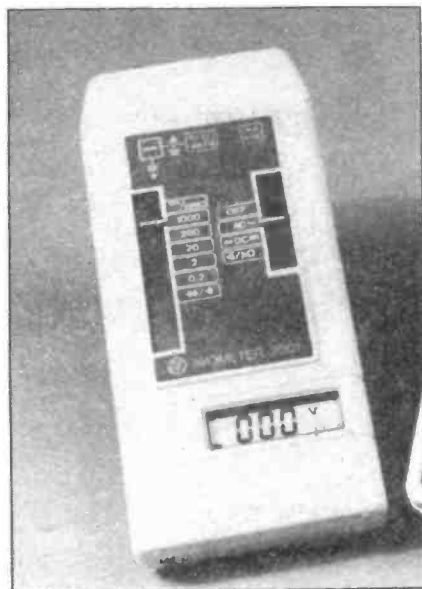
Our source: **Thorn EMI Instruments Ltd., Archcliffe Road, Dover, Kent CT17.**

## Bewa DMM 3510

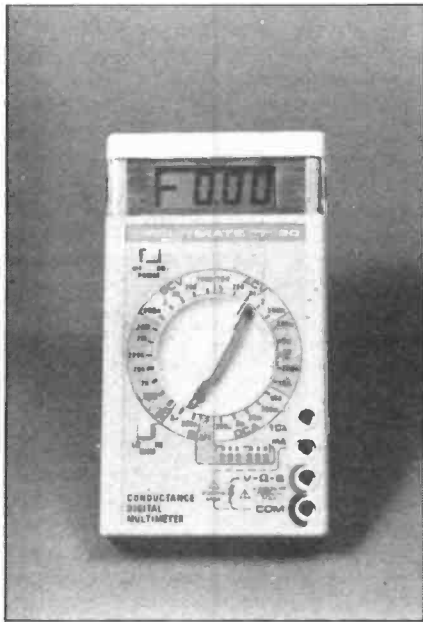
Price: £55

This, unfortunately, was another meter which arrived unboxed and with no details or instruction manual. To all intents and purposes it appears to be identical in all technical ways to the **Bewa DMM 6010GS** (see above). We presume there must be some differences, but without details we couldn't find any.

Our source: **House of Instruments, Clifton Chambers, 62 High Street, Saffron Walden, Essex CB10 1EE.**



# METERS METERS METERS

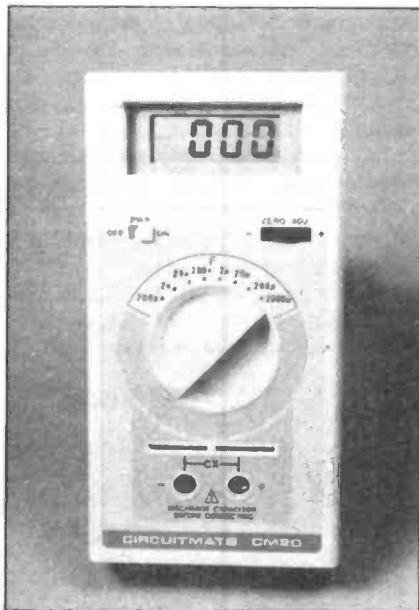


## Hills HD 7000

Price: £46

We received this meter too late to make a full test. It comes with its own hard case, leads, battery and spare fuse. The instruction sheet is rather brief and the English falters in places but all the information seems to be there. It has a single rotary switch control, which is easy to use, allowing a degree of one-handed operation with care. The battery compartment is easy to access. A small packet of silica gel is provided.

Our source: **Cirkit Holdings PLC, Park Lane, Broxbourne, Hertfordshire EN10 7NQ.**



## Hills HT-320

Price: £16.50

The Hills HT-320 is a reasonable quality, general purpose analogue meter, featuring an adequate number of measurement ranges. In common with most analogue meters tested (the

Avometer 1000 being the notable exception) it does not allow AC current measurements. The instruction manual is a little confusing in places, but adequate nevertheless. No circuit diagram is included.

Our source: **Cirkit Holdings PLC, Park Lane, Broxbourne, Hertfordshire EN10 7NQ.**

## Hung Chang HC-5010T

Price: £46

Overall, this meter is an easy to use, good quality piece of test equipment, at a reasonable price. A good range of measurements are possible, including a continuity test, diode test and transistor hFE measurements. The instruction manual is straightforward and gives all the necessary information, including circuit diagrams and board layouts.

Our source: **Armon Electronics Ltd., Heron House, 109 Wembley Hill Road, Wembley, Middlesex HA9 8AG.**

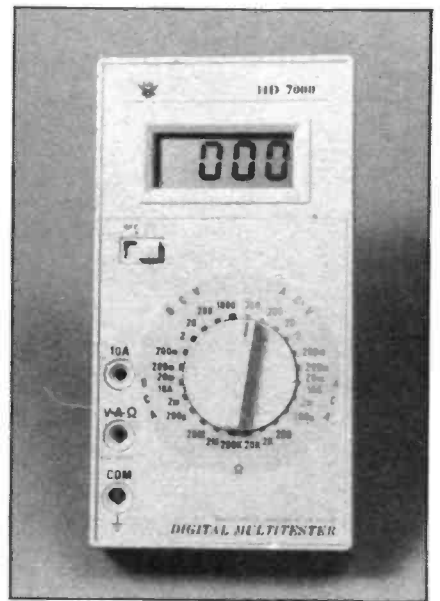
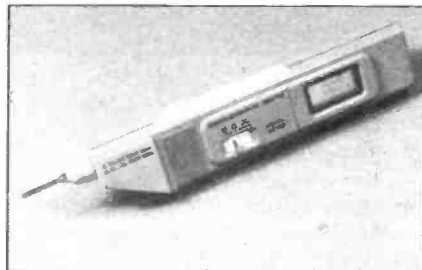


## Hung Chang HM 102 BZ

Price: £15

As far as analogue meters go, this is a reasonable example. An acceptable number of ranges of measurements, a good instruction manual with circuit diagram, all at a fairly cheap price makes this a good all-round meter.

Our source: **Armon Electronics Ltd., Heron House, 109 Wembley Hill Road, Wembley, Middlesex HA9 8AG.**

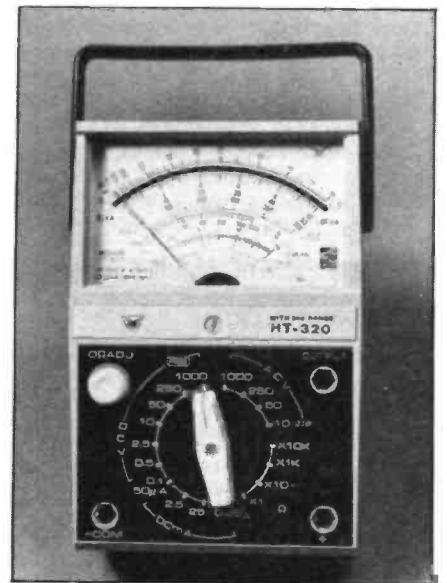


## Kingdom ETC-500

Price: £23

Due to the presence of a range doubling facility, the Kingdom ETC-500 analogue meter allows an extremely large number of measurement ranges to be used. It has a high input impedance (for an analogue meter) of 50KV<sup>-1</sup>, or 25KV<sup>-1</sup> with the range doubled for DC voltage measurements, and so for this reason alone must be worth considering. The instruction manual is quite clear and straightforward, featuring a circuit diagram.

Our source: **Greenweld, 443A Millbrook Road, Southampton SO1 0HX.**

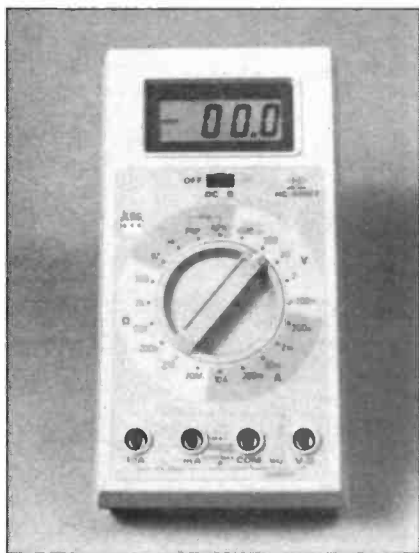


## Maplin M-102BZ

Price: £15

This meter, one of three we looked at from **Maplin Electronic Supplies**, is identical to the Hung Chang HM102BZ. We presume both meters are made by the same manufacturer. See the

# METERS METERS METERS



carrying around — guess where — in your pocket. It's low input impedance, however, makes it not particularly useful in electronics measurements, because you could never be sure that the measurement you've made is correct.

Our source: **Maplin Electronic Supplies, PO Box 3, Rayleigh, Essex SS6 8LR.**

description under the Hung Chang heading for details of the Maplin meter.

Our source: **Maplin Electronic Supplies, P.O. Box 3, Rayleigh, Essex SS6 8LR.**

## Maplin M-5010

Price: £43

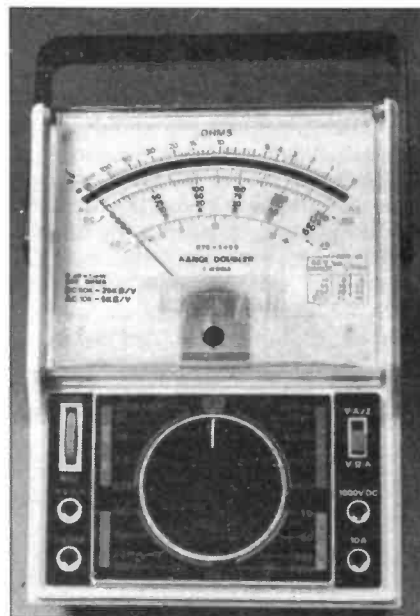
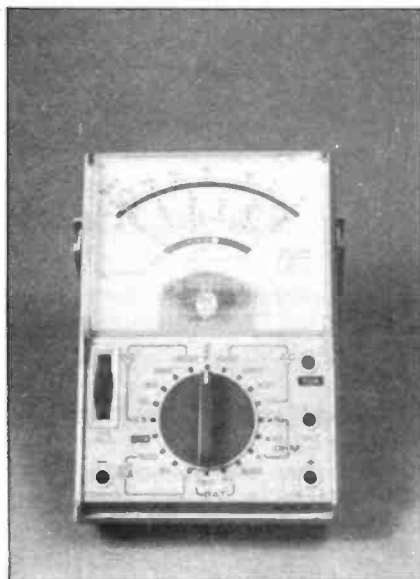
Like the previous meter, this one also seems to be made by Hung Chang, although the Maplin M-5010 is not totally identical to the Hung Chang HC-5010T. The minor differences are extra ranges at the low end of the current and resistance measurements on the Maplin offering. The Hung Chang meter, on the other hand, has a transistor hFE measurement facility, not on the Maplin meter. All other aspects are identical.

Our source: **Maplin Electronic Supplies, P.O. Box 3, Rayleigh, Essex SS6 8LR.**

## Maplin Pocket Size

Price: £7

This analogue meter doesn't feature a lot of ranges, it has a very low input impedance, but it is cheap and ideal for

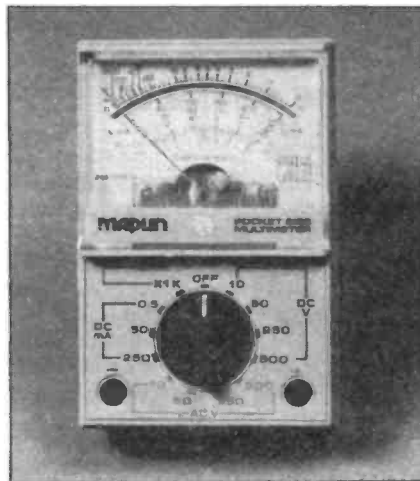


## Metex 3500

Price: £37

This meter was the third meter which arrived unboxed and without details, on the test-bench. It appears of good quality and has a good selection of measurement ranges.

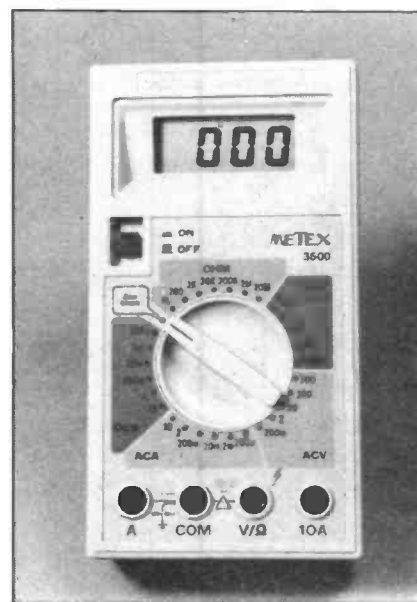
Our source: **House of Instruments, Clifton Chambers, 62 High Street, Saffron Walden, Essex CB10 1EE.**



## Metex 3531

Price: £55

This meter is a good quality, general purpose meter, with a good variety of measurement ranges, including a continuity test, diode test, capacitance



measurement, and transistor hFE measurement. It also comes with a carry case. The one failing we found was the lack of circuit diagrams and circuit board layouts in an otherwise good instruction manual.

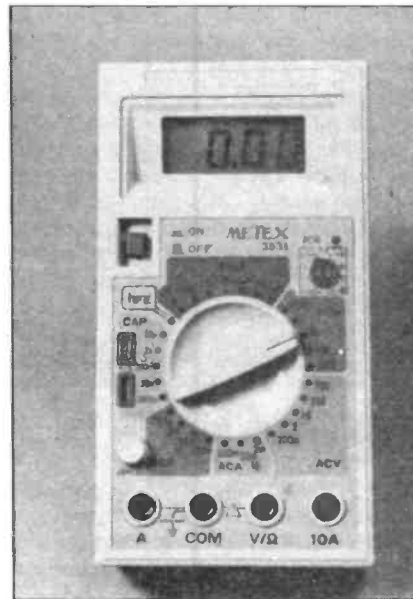
Our source: **House of Instruments, Clifton Chambers, 62 High Street, Saffron Walden, Essex CB10 1EE.**

## Pantec Banana

Price: £24.50

The **Pantec Banana** is the meter used to complement our regular electronics series, *Electronics From The Start*, so we have to give it a good write-up, don't we? Fortunately it is a good quality, general purpose analogue meter, with a reasonable selection of measurement ranges. The instruction manual is straightforward and easy to follow (it is multilingual, in fact) although no circuit diagram is included.

Our source: **B. K. Electronics, Unit 5, Comet Way, Southend-on-sea, Essex SS2 6TR.**



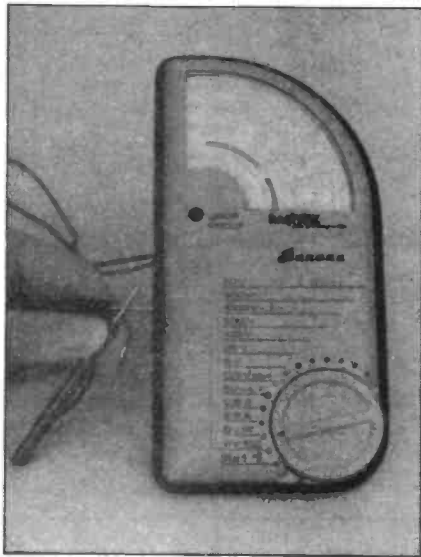
# METERS METERS METERS

## Pantec Challenger

Price: £49

Very few written details are incorporated onto the front panel of this meter, so it was quite tricky to operate without reading the instruction manual. Fortunately the manual is good. The meter is of high quality and has a large number of measurement ranges, but no continuity test feature. A circuit diagram is included in the manual.

Our source: **B. K. Electronics, Unit 5, Comet Way, Southend-on-sea, Essex SS2 6TR.**



## Pantec Zip

Price: £49

Pantec's Zip digital meter is identical in specification and quality to Circuitmate's DM73. Look there for specific details. The Zip has, however, a carry case.

Our source: **B. K. Electronics, Unit 5, Comet Way, Southend-on-sea, Essex SS2 6TR.**

## Philips PM2518X

Price: £200

The Philips PM2518X was the best meter, in terms of all parameters that we reviewed. We could not fault it in any detail. Naturally enough, however, it is very expensive. Expensive, perhaps, beyond the reach of most of our readers. Nevertheless, we thought we'd include it so that a glimpse of "how the other half lives" could be seen. The instruction manual (simply a piece of card) was the clearest we've ever seen, particularly when you bear in mind the complexity of the meter. If you've got money to spend on the best meter, here it is.

Our source: **Pye Unicam Ltd., York Street, Cambridge CB1 2PX.**

## Soar 3030

Price: £106

First of a range of three meters from Soar, the 3030 is a good, general



purpose meter, with a wide selection of measurement ranges. The instruction manual is well detailed, clear, and includes a circuit diagram, although no circuit board layout.

Our source: **House of Instruments, Clifton Chambers, 62 High Street, Saffron Walden, Essex CB10 1EE.**

## Soar 3100

Price: £40

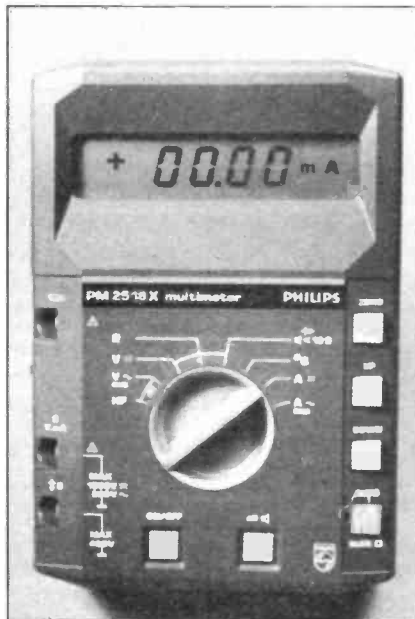
The Soar 3100 is almost identical in specification, appearance, and use to the Pantec Zip and Circuitmate DM73. Look under Circuitmate DM73 for details.

Our source: **House of Instruments, Clifton Chambers, 62 High Street, Saffron Walden, Essex CB10 1EE.**

## Soar ME-530

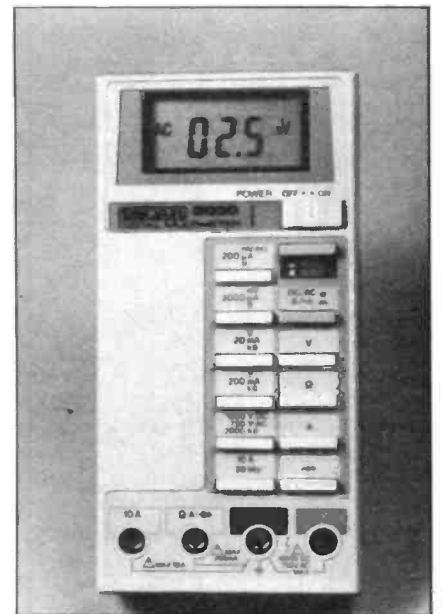
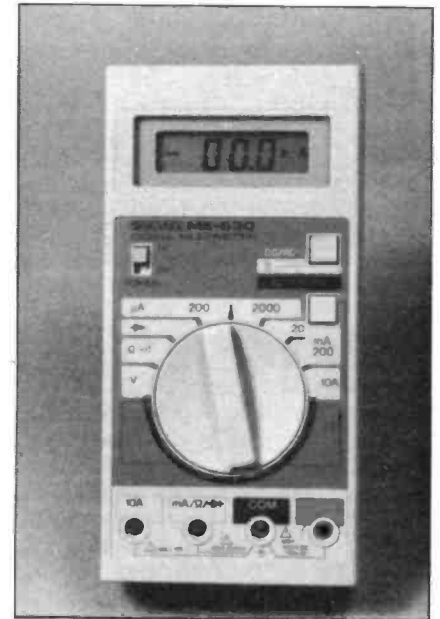
Price: £52

Similar in specification to the Soar 3030, this meter is a good, general



purpose meter, though with a limited selection of measurement ranges. The instruction manual is reasonably clear and straightforward, although neither circuit diagram nor board layout diagrams are included.

Our source: **House of Instruments, Clifton Chambers, 62 High Street, Saffron Walden, Essex CB10 1EE.**



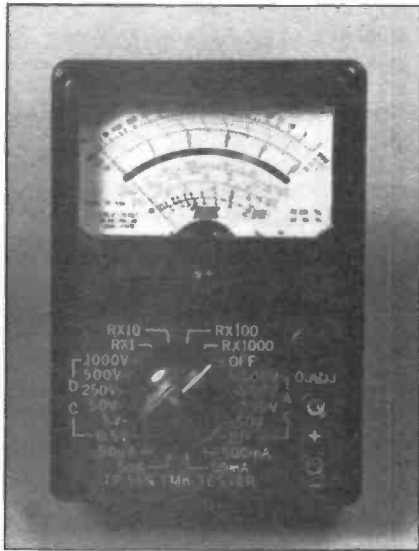
## TMK TP-5SN

Price: £25

We received this meter too late to run a full test. It has a clear front panel with a rotary switch and a zero adjust switch. You have to take the back panel off to change the battery. The instruction sheet is fairly full and includes a schematic.

Our source: **Harris Electronics, 138 Grays Inn Road, London WC1X 8AX.**

# METERS METERS METERS



## TMK VF-7

Price: £33

Again we could not run a full test on this one. It has a single rotary switch control, zero adjust switch and a VAX2 range doubler switch. All the details on the front panel are picked out in glorious colour. The instruction booklet is fuller and better laid out than usual. You must

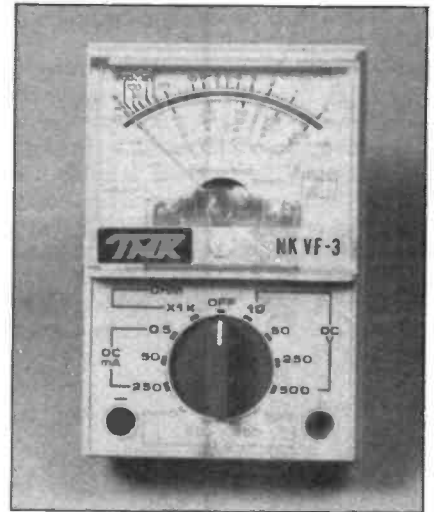
remove the back panel to change the battery.

Our source: **Harris Electronics, 138 Grays Inn Road, London WC1X 8AX.** Harris sell through trade outlets, but their meters can also be obtained retail.

## TMK NK VF-3

Price: £8

This seems to be identical to the **Maplin Pocket Size**, and comes in a



very similar package, so see that entry for comments.

Our source: **Harris Electronics, 138 Grays Inn Road, London WC1X 8AX.**

## Note on prices:

All the prices we mention here are approximate, so please check prices, as well as VAT and carriage, before making a final decision.

# CHALLENGER

## A MULTIMETER FOR TODAY

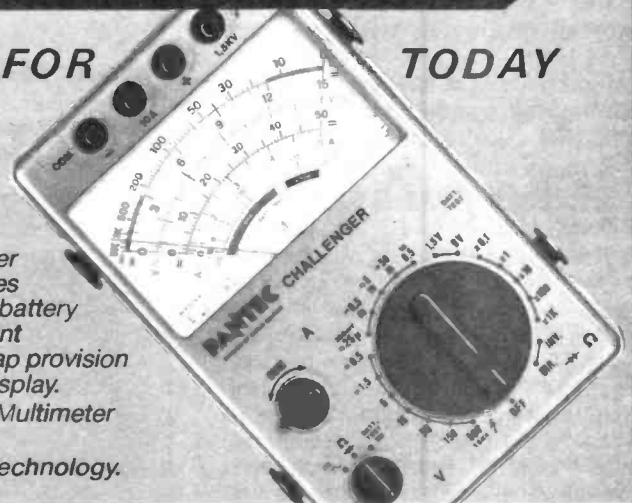
Pantec's new Challenger analogue multimeter.

One of the new generation instruments from the electrical test and measurement specialists.

The Challenger 10 amps multimeter incorporates many advanced features including ● Diode tester ● Dry cell battery tester ● Built-in magnetic attachment ● Multi-position stand plus neck strap provision ● Practical design with ultra-clear display.

Send today for further details of the Multimeter for Today.

Challenger – the best of Pantec technology.



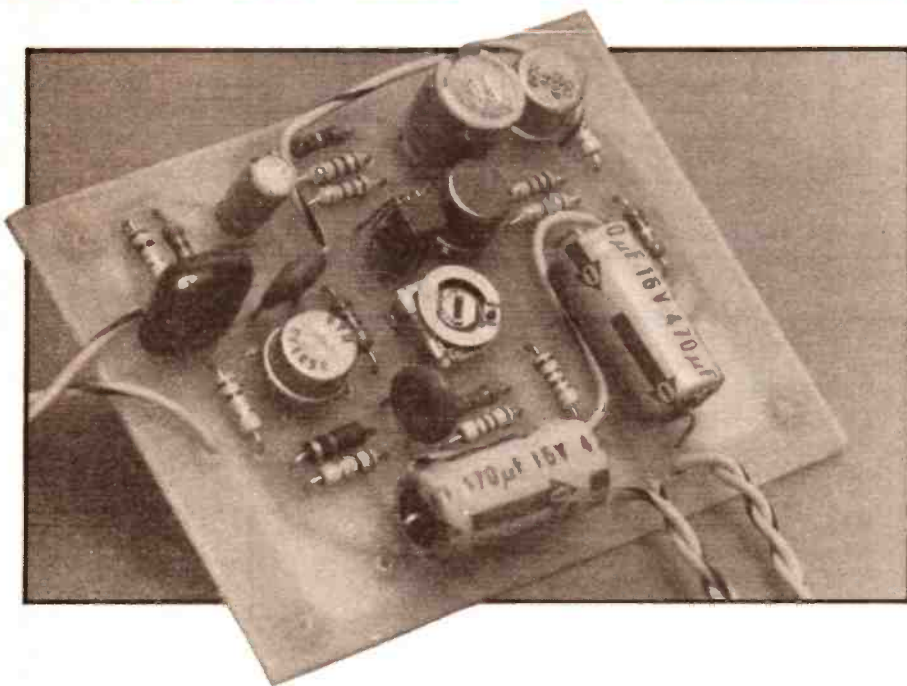
Please send details of the new Pantec Challenger analogue multimeter.

Name \_\_\_\_\_ Company \_\_\_\_\_  
 Address \_\_\_\_\_  
 Tel: \_\_\_\_\_

# PANTEC

Pantec division of Carlo Gavazzi, 162/164 Upper Richmond Road, Putney, London SW15 2SL Tel: 01-785 9022 Telex: 8952493

# AUDIO AMPLIFIER MODULE



**A straightforward amplifier module for radios or hifi, which makes particularly efficient use of the supply voltage available.**

**Andrew Armstrong**

AUDIO AMPLIFIERS come in many sizes, from the multi kilowatt PA jobs used at rock concerts, to tiny hearing aid amplifiers. It is a case of horses for courses. This particular amplifier is between the two extremes, and is intended for use in small radio receivers. It is intended as a mix-n-match module which can help constructors to design their own projects without having to design every single circuit block. There is little point in building something you can buy cheaply in the shops, so this is a little different.

There is an increasing trend for radio sets to operate on lower voltages. This is very sensible for the RF and IF parts of the circuit, which do not normally require

a very high voltage to amplify a few millivolts of RF efficiently. (This is not so of some dual gate mosfets, which may require several volts' bias to work well.) The poor old audio amplifier is not always quite so well suited, however. As everyone knows, the power which may be delivered to a particular load is proportional to the square of the voltage applied. A reduction from 9V to 6V as a battery voltage would seem to offer 44% of the power, if all else were equal.

It isn't, of course, because a normal audio amplifier output can only swing to within about 1V5 of each supply rail. Thus, with batteries at nominal voltage, the reduction is from 6V peak to peak to 3V peak to peak, a cut to 25% power.

Using an 8R loudspeaker as a reference, this is a reduction from 375mW to 93mW. There are many ways of getting round this problem, such as lower impedance loudspeakers, bridge connected power amplifiers, step-up loudspeaker transformers, or just plain higher voltages.

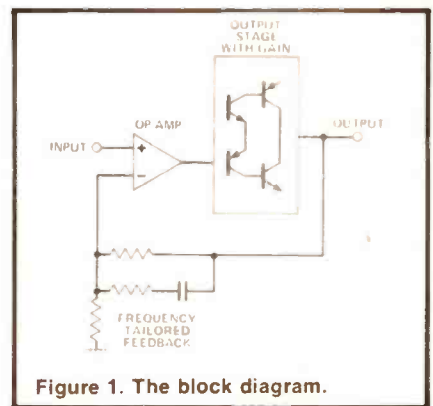
The design featured here can help with all these methods — it simply swings closer to the power supply rails than most designs. Since it is automatically biased to the midpoint of the supply rails, it always makes the best use of whatever power there is.

## How It Works

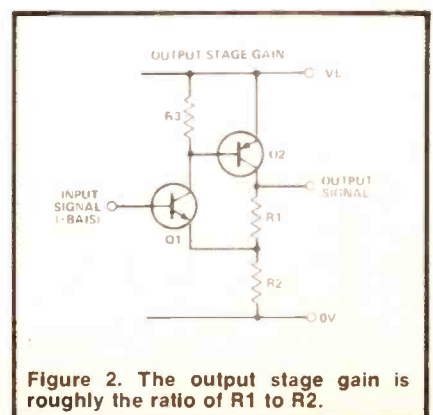
The block diagram, **Figure 1**, is very simple. The important fact is that the output stage has gain, and can swing close to the supply rails, even though the op-amp output has a lesser swing. This output stage gain is illustrated by **Figure 2**, and is approximately given by the ratio of R1 to R2. The approximation is more accurate if the emitter current of Q1 is a small proportion of the total chain current.

If the emitter current is negligible, then the reasoning is thus: the signal on the emitter of Q1 follows that on the base (but 0V6 lower), so the collector voltage of Q2 must be such as to permit this. Given the resistors shown, the collector signal of Q2 is double the emitter signal of Q1.  $\text{Gain} \approx R2 / (R1 + R2)$

The feedback circuit is of some importance. The overall gain of the circuit must be high enough (ie the feedback must be low enough) that the circuit does not oscillate (a common



**Figure 1. The block diagram.**



**Figure 2. The output stage gain is roughly the ratio of R1 to R2.**

# Project

problem with some types of op-amp circuits). Equally, there is no point in the amplifier providing high gain at frequencies which only the dog can hear, so a frequency rolloff has been provided to reduce the gain at above audible frequencies.

## The Circuit In Detail

The input signal from the volume control is AC coupled via C1, which, in conjunction with R1 and R2, gives a low frequency rolloff with a 3dB point at 32Hz. No small transistor radio loudspeakers will respond at this frequency.

The op-amp itself is a CA3130. The choice of this device was for two reasons — first it has a low power consumption, and second it uses an external compensation capacitor, so that the compensation can be made sufficient to discourage further any tendency to oscillation.

## Stability And Gain

The voltage gain of the amplifier module is set by R6 and R7. It is  $(R7+R6)/R6$  which is about 22. A rolloff starts at a frequency set by R7 and C7, approximately 23 kHz, and continues until the gain has fallen to about 6 at a frequency of 106kHz.

For oscillation to occur in a circuit with negative feedback, the phase shift round the loop (through all the stages of amplification, and back round via the feedback) must reach 180 degrees at a frequency at which the gain round the loop is at least 1. (If the gain is greater than 1, the circuit oscillates and clips until the average gain is 1.)

The op-amp is compensated to be unity gain stable (ie with 100% feedback). Following this is a voltage gain of 2, and some extra phase shift. Even at the highest frequencies, however, the feedback is potted down by R6 and R8, ie by about 5:1. This may reasonably be estimated to give enough margin to take care of the extra x2 gain and bit of phase shift in the circuit, and preclude the possibility of making an RF oscillator transmitting on longwave. The stability of the circuit is of course aided by the on-board decoupling capacitor, C6.

The output stage, as already mentioned, provides a voltage gain. The first part of the output looks like a conventional symmetrical emitter follower, biased in the normal manner by Q1. Indeed, if Q3 and Q5 were omitted, and R12 and R11 reduced in value, the junction of R12 and R11 could conveniently form the output point. In this case, of course, the maximum output power would be reduced.

The addition of Q3 and Q5 provides an output gain as described before. This gain is completely symmetrical, and it means that the emitters of Q2 and Q4 would have to swing between points 1V5 from either supply rail on a 6V supply, to

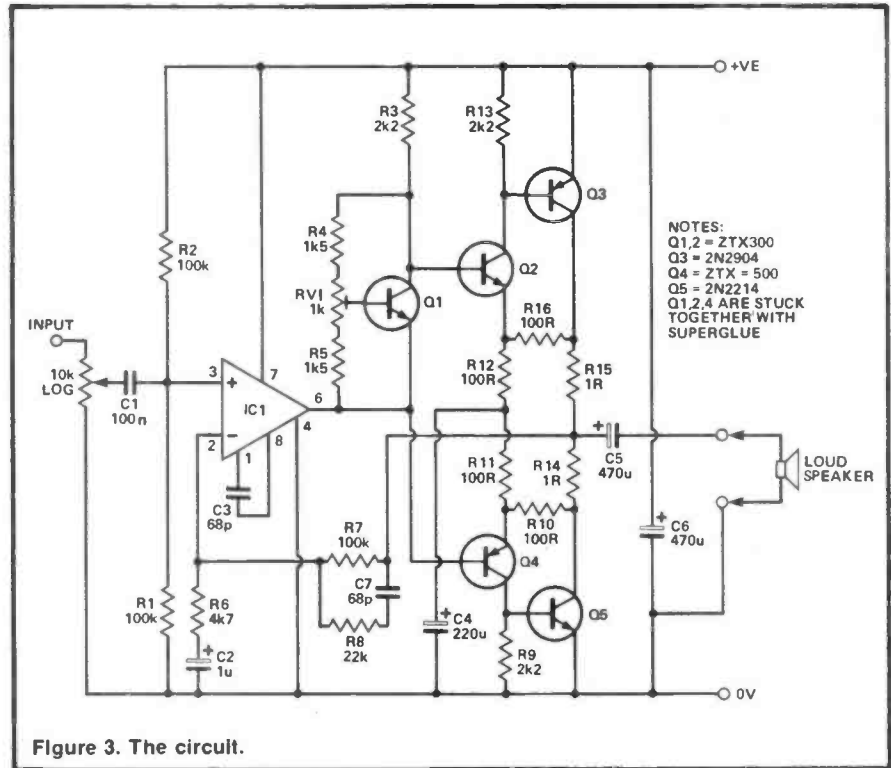


Figure 3. The circuit.

NOTES:  
Q1,2 = ZTX300  
Q3 = 2N2904  
Q4 = ZTX = 500  
Q5 = 2N2214  
Q1,2,4 ARE STUCK  
TOGETHER WITH  
SUPERGLUE

## Parts List

### RESISTORS

(All 0.25W 5% unless noted)

R1, 2, 7	100k
R3, 9, 13	2k2
R4, 5	1k5
R6	4k7
R8	22k
R10, 11, 12, 16	100R
R14, 15	1R

### POTENTIOMETERS

RV1	1k horiz preset
-----	--------------------

### CAPACITORS

C1	100n 0.3" pin spacing eg. 04-10406 (Cirkit)
C2	1u radial electro eg Cirkit 05-10508
C3, 7	68P ceramic
C4	220u radial electro
C5, 6	470u axial electro

C5, 6 ..... 470u  
axial electro

NOTE: If a 3R loudspeaker is used, 1000u may be chosen for C5 to avoid restricting the low frequency performance too much.

NOTE: The voltage rating of all electrolytic capacitors must be above the power supply voltage chosen eg 6V supply (new battery may be 6V5) use 10V or greater rating.

### SEMICONDUCTORS

Q1, 2	ZTX300
Q3	2N2904
Q4	ZTX500
Q5	2N2219
IC1	CA3130E

### MISCELLANEOUS

Any 10k log volume control, with or without switch as appropriate; any small loudspeaker, wire, solder etc.

enable the output collectors to reach the rails. Thus Q2 and Q4 have to do just about what a conventional amplifier can normally achieve. C4 decouples the junction of R11 and R12 to generate an artificial mid rail relative to which the output stage can provide its voltage gain.

## Bias

If the figures above are extrapolated back to the Op-Amp output pin, then, bearing in mind the bias effect of Q1, the output pin has to swing between 0V8 and 3V8 (again assuming a 6V supply). This

is perfectly capable of doing.

The quiescent current is set by the bias voltage on the bases of Q2 and Q4, which is itself set by the collector to emitter voltage of Q1. For example, any increase in the current through Q3 will increase the voltage across R15. This, via R16, tends to switch off Q2, thus decreasing the drive which was turning on Q3.

Temperature stability is very important, because the quiescent current stabilising effect detailed above is potted down by R12 and R16 on the positive side, and R11 and R10 on the



negative side, so that any thermally induced change will have double the effect it would have in a more conventional output stage. To obtain good temperature stability, Q1, Q2, and Q4 are glued together with superglue. It was this requirement that led to the choice of transistor type — any old NPN and PNP transistors as long as they are in E-line packages. It requires a degree of handcraft, and leads neatly on to...

## Construction

The module may be built on the PCB, or, by those who wish to do their own layout, on Veroboard. If it is built on Veroboard, then one of the three transistors to be glued together will probably have to be connected to different parts of the board by flexible wires. Don't let this deter you — the first version of this circuit, forming part of a small transistor radio, was built using this technique and it proved stable and reliable. It is still in use seven years later!

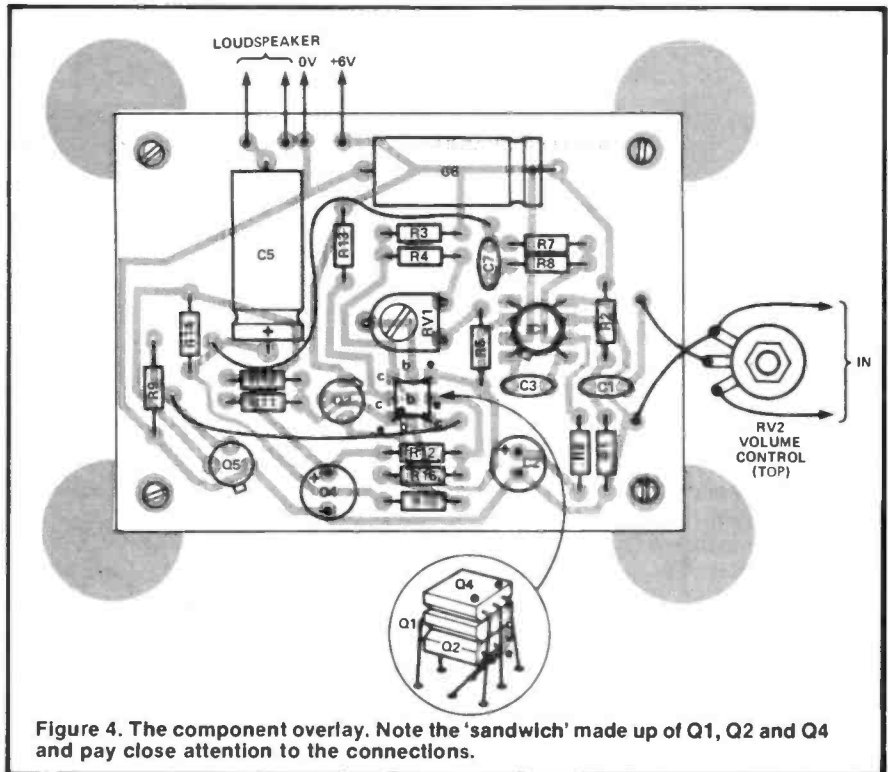
The normal rules apply — it is best to start by fitting the resistors, then the capacitors, and the semiconductors last of all. Q1, Q2, and Q4 are a special problem — the leads of Q1 should point in the opposite direction to those of Q2 and Q4 when they are glued together. This sandwich is illustrated in **Figure 4**. To avoid confusion don't forget that the order of the connections on an E-line transistor is the reverse of that on a T092 device.

Q3 and Q5 are not shown provided with heatsinks — this should not be needed for most possible uses of this amplifier, but push on types may just be squeezed in if necessary. Alternatively, if higher power is needed, Q3 may be replaced by a BD132, and Q4 by a BD131, bolted onto a heatsink, insulated with mica washers, and connected with insulated wires. If this scheme is carried out in order to get more output with damage, for example running on 12V as a car cassette booster, it may be advisable to replace R15 and R16 with OR47 types, so as not to waste too much power in these resistors. The same argument would apply to the use of a very low impedance loudspeaker, say 3R.

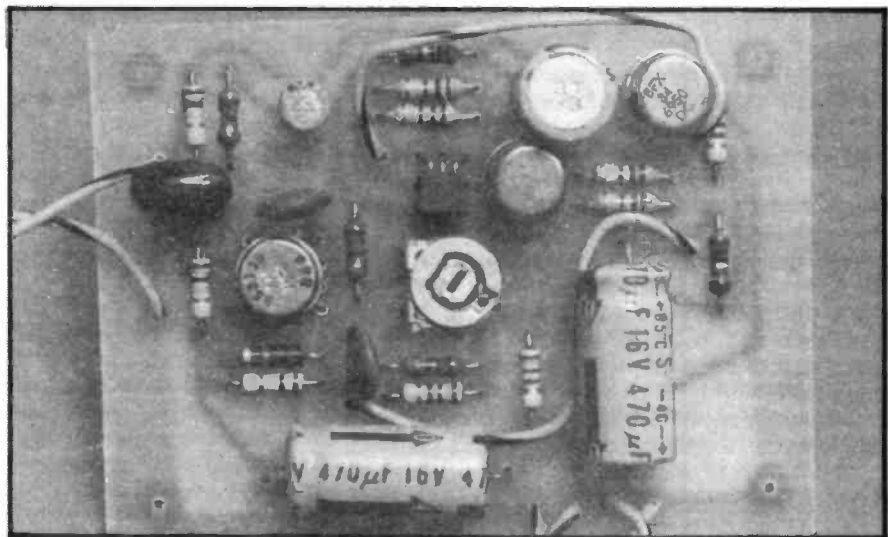
If this circuit is to be adapted to higher powers, there is one important point to remember. It is NOT short circuit proof, as many HiFi amplifiers are, so if you short the output and feed in a loud signal it will blow up. For this reason, any external wiring, for example to car loudspeakers, should be carried out with due care to insulation so that a short cannot occur.

## Testing

To test this module without risk of destruction, the best bet is to use a variable power supply, and to meter the current drawn. Turn up the power supply slowly, aiming for 6V, and stop if an



**Figure 4.** The component overlay. Note the 'sandwich' made up of Q1, Q2 and Q4 and pay close attention to the connections.



alarming rise in consumption occurs. Adjustment of VR1 should bring this under control — if it doesn't there is a fault. (If a variable power supply is not available, a 6V battery in series with a 10R resistor is a fair substitute.)

In the case of a fault, statistically, the most likely cause of problems is an error in the construction of the transistor sandwich (Q1, Q2, and Q4). Failing this, apply a voltage which does not cause alarming currents to flow, and check the voltage on the junction of R11 and R12, and on R14 and R15. Both these points should be at about half the supply voltage, and if either is not then suspect a short circuit.

When it all appears to work, adjust the quiescent current to about 3mA, and then connect a speaker and signal source and see how it sounds. In the unlikely event of any problems at this point re-check the midpoint voltages as

above.

Now you just have to design the rest of your project...

## Shop

Nothing complicated here, just one or two things to note. To fit the PCB design, C1 must have 0.3in pin spacing, so if you are not using the capacitor specified, check this before buying. C2 is less critical but 0.3 in spacing is preferred.

Q1, 2 and 4 must be built up into the 'transistor sandwich': for this reason, the most important thing about them is that they should have the E-line packages (ie flat-sided, with all the pins coming from one end of the device) as mentioned in the text.

The components for this module cost between £3 and £4 without the PCB. No case is specified, of course.

## THE 1985 READERS SURVEY

**Extra! Extra!  
This is what  
you said, this is  
what we say.**

by the Editor

AS WELL AS providing us with a lot of statistical information which we shall be using to help provide what you-the-buyers want from electronics monthly the 1985 Reader Survey turned up a lot of valuable comments from readers. While there were no big surprises, we thought you would like to know something about what your contemporaries are saying and what will be influencing us in the future.

Let's get down to the nitty gritty. More than half the replies thought the first two issues of EM were "good" compared with our rivals. Hardly anyone said they thought we were "poor". Well, they wouldn't, would they? Taking into account that people who aren't interested are not going to buy a magazine, we are very pleased with that result. You are quick enough, after all, to let us know when something is wrong.

Nearly a quarter of you come from the Thames area, but there are also plenty in the Granada, Harlech, Central and Yorkshire areas.

By far the most popular project is The Thing (more of that later). Well over half of you own a computer, but you are far more interested in general electronics knowledge (theoretical and practical) than programming. Which is as it should be, is it not? You are more interested in electronics as a personal pastime than simply as an education. More than half prefer to use PCBs, and many would like to etch their own; around a quarter already do, but Veroboard is still very popular.

Project builders are fairly evenly split between those who build 'straight' and those who build with a few mods, and ditto between those whose projects work first time and those whose projects work after a bit of tweaking — but nearly half have some trouble getting components.

People still expect too much from component suppliers. We won't mention motor spares. But people express surprise when their favourite supplier doesn't stock the whole list. Most of them give a pretty remarkable service, if you think about it.

### Give Me Space

Our research also shows that a very large number of EM readers believe that they are the only person who remembered to include their name and



**Readers prepare to besiege our offices, but are thwarted. We're in the basement...**

address on the form. 'How will you know where to send my prize?' 'Is this a fiddle, perhaps?' 'Where's the space for my name' were typical comments. 'This isn't April 1st, is it?' was another (look at the cover date, buster). 'Is this an initiative test for a sub-editor?' was yet another. A what? We don't do marine engineering here, sorry.

A far larger grouping of EM readers simply put their name and address in the space provided.

The lucky ten winners duly emerged from the bottom of a deep postal sack and had the immediate privilege of posing with the Editor's Hat (the survey forms, that is. We aren't inviting you up here to meet it in person) and will be hearing in due course.

A reaction of overwhelming joy radiated from those who wanted their electronics spelled out as simply as possible, and they are many. 'Good value, ideal for me (a beginner)'. 'We need a non-expert approach.' 'So far I like this mag (but I'm no judge)'. 'Articles can never be too simple for we newcomers.' 'Perfect magazine.' The editor deserves a bigger hat. With all the money I'll be saving not buying other mags I can buy more components.' 'A dream. It really shows concern for the beginner's ignorance.' The Editor has put in for a bigger head.

Not everyone who likes the simple approach is a lone novice. Many of you are teachers. 'I'm a teacher of middle school children. I know very little about electronics, but we have constructed some simple projects. For the likes of me any circuitry should be discussed very simply' says one. Others are actually working. 'Studying mechanical and production engineering and finding

electronics rather difficult, it is very refreshing to find a magazine so easy to read' said one engineer, and another cried 'I am a qualified installation electrician, but as for understanding electronics, I have learned more from two editions of your magazine than I did in four years at tech.'

Does this provide an answer to the well meaning gent who pleaded: 'Do not write patronising articles about electronics theory. The reader is fairly intelligent just to want to read a technical magazine as a hobby pastime.' I don't want to knock your self-esteem, but it might be a mistake to assume that everyone who wants to build gadgets is quick on the uptake, or that intelligence is measured by someone's ability to grasp what is, at bottom, a very, very complicated subject.

I can wholeheartedly recommend ETI for people who find EM too simple, but not for the guy who asked: 'Have been a reader of ETI but it has got too technical. How about a series on building a computer from scratch, say, with a module costing £10 a month? It would then not be too expensive.' We would jump at the chance, but what would the first issue feature? Half a micro-processor?

### Future Articles

Not surprisingly, the most popular comments were suggestions for future articles. You came down very heavily on the side of more information on components, specifications, general information and circuit design. 'It would be ideal if simple projects could be done in groups on breadboard before transferring them onto PCBs or Vero' writes a teacher. But why not? It would be a very instructive exercise, for school groups or electronics clubs alike, to build up projects onto breadboard, simply following the circuit diagram, and matching this with the layout given. You may develop alternative layouts and modifications, and will certainly learn a lot about following schematics and testing the circuit as you go along.

Music projects are in demand. So, despite long controversy on the subject, are computer related projects (we'll come back to that), burglar alarms and household projects in general. 'I would like to see dimmers, Xmas tree light flashers, digital thermostats, etc.' writes one hopeful. There, I would say, is a very satisfied customer!

'Projects on tape decks are very rare. Are they too difficult for us?' comes an appeal. Tape decks come under the general heading of projects which would be too expensive to construct, considering the quality and price of shop-bought tape recorders; the same, unfortunately, goes for quite a few gadgets which were

once hobbyist staples. 'Would it be possible to do a modular project for a dual beam oscilloscope so that the expense could be over a long period? After all a 'scope is THE instrument for electronics' laments another reader. How true this is. We have been looking into it, but after one disastrous effort two years ago, we are aware that there is no such thing as a cheap oscilloscope. The problem is that, even if it were possible to devise a cheap, modular 'scope, we have yet to find an author whose services we can afford to buy-in to design one. Magazines can't pay the rates for what is in reality a piece of industrial design. Any serious suggestions will be looked at carefully.

The computer debate still rages, but it is beginning to take an encouraging and coherent form:

'No computer programs please!' 'Please please please cut down on computer items as the market is swamped with computer books.' 'No more computers.' 'All the other publications have gone mad on computers.' 'How nice to see a journal which is not full with computers.' — the list is endless. But we also have the pros: 'Great mag. How about a project for the Amstrad CPC464?' 'There must be many unused ZX81s lying around. A project that used them even if it means destroying them may be useful.' 'There must be lots of people interested in building simple components to interface computers.' — intelligent comments, and ones which show an appreciation of micros as a component which can be used as part of a piece of electronic equipment. This is the kind of computer building which we want to include in our mix of subjects. But don't worry! The accent is always going to be on fundamental electronics, which means resistors, capacitors, and simple logic. Yes, egg timers too, if that's what people want.

## More Women

This year we have a cross section of five lady readers, an advance of four on our last survey. It emerges that you are grown-ups, and that in general you have some kind of job in view. It seems to be accepted now that boys are more interested in how things work, and girls are more interested in how beings work. Perhaps this is why there are more women in amateur radio than in electronics. 'Can we have more projects which appeal more to girls?' comes a plaintive cry, but she doesn't say what those projects are. I don't think she means egg timers. I shall not speculate lest I fall into pre-judgement. I shall only add that my intuition gives me no insight into this one whatsoever, and that when I suggested a speedometer for a horse to Ms. James in the ad. department, she laid into me with a backnumber.

On the other hand the question of components: 'We want more sources for

components — many suppliers will not quote a price for a complete list of components but offer their catalogues for £1 or more. We want alternative components to the originals.' See my comments higher up for the first half. All the components we use have been sourced at the time and are available from large component suppliers or from some source quoted. Please don't substitute components in projects unless you know in advance what you are doing.

'When *From The Start* finishes, courses on circuit design and digital electronics would be welcome.' is a representative comment. It will come, don't worry, in the long term, and in the meantime there will be occasional articles on those subjects. 'I would like to see charts printed covering IC data, transistor data etc. and most of all ceramic plate capacitors' writes another reader, and many of you chime in with him. We will look into it. How about 'Electronics magazines fight shy of mathematics. It would be nice if you started to show the beauty in the maths of electronics theory?' Well, we want to put over electronics with as little maths as possible, but having said that... it is a mathematical subject. 'Articles on trouble shooting and test equipment would be most welcome.' 'Can we have more on fault finding please, especially hifi and radio?'. Yes, we can. 'Could some articles be included on TV servicing please?' No. Television servicing is an absolute minefield. Most TV servicepersons are specialists in one kind of set, or operate simply by replacing modules. Having watched grown men moved almost to tears by a colour telly I can understand why.

The ancient subject of misprints had a good airing. 'The Veroboard for The Thing is not in the book' (please, please, sir, books have *little* pages) 'Doesn't anybody check?' My poor heart. Yes. All the things which aren't mistakes are the products of multiple checks. The mistakes are the ones which get through. Many of our contributors are amateurs, and occasionally we lose something because pressure of life diverts the author. The person who was to do the Vero layout still intends to, and a miniature PCB as well, but is rather heavily involved elsewhere at present. We'll put it on the cover when it happens. 'If there are errors, how about publishing errors the next month, instead of six months later?' asks one reader. We publish them as soon as we know about them. We hear about most errors from readers. If you suspect something is not right, try us on it. We can't take technical enquiries by phone, but error enquiries are another matter — call us.

'The second issue reminds me of early HE — I wonder why? It's important to have a clear layout, simple explanations and a hint of humour in the writing

like ETI.' (Hold on. I'm not sure I can stand that much humour.) '741s are a bit old fashioned. How about readers projects and short circuits? EM seems a bit thin for around £1 — even I can remember when P\* E\* was 3 shillings'. 741s are old fashioned, but a lot of students, as well as serious designers, are still using them. You have short circuits, you send us short circuits. If we look a bit like early HE, we'll be well pleased. It was a good mag idea then and it's a good one now. I can remember when *New Musical Express* was only 2½p for a *whole issue*. How things change....

ON the subject of commerce: 'I wonder how intimately related to dealers/producers is this magazine (eg question 17). I'm allergic to hidden advertising'. Not at all, mate. We don't deal in any hardware except the PCBs (and we don't even make them ourselves), we have no commercial connections, and when we are doing a promotion we let you know about it, so rest easy in your bed. No kickbacks around here. Darn it.

ON the subject of black holes: 'The paper it is printed on really puts me off. Quality of paper attracts people even if the cover price is lifted slightly. It would improve your illustrations no end'. Yes, we are tired of not being able to see our own photos properly, too, and we are looking into the print processes, etc. to find a solution.

ON the subject of media: "Why are the lessons not available on tape (VCR)?" You don't want to see this editorial team on your TV, that's why. 'Letters page is a bit thin. Don't you have any letters?' Strewth, mother, the ice pack. We don't have room. I'm trying to lever some of the pages apart to get more letters in even now.

I will sum up with the most illuminating comments. 'Don't forget every hobbyist wants to learn more about the field, from start to new tech.' 'I know nothing about electronics, but if you touch a live wire, you say ARRGH.' 'Please put simpler projects and anything, just so we get practice and also get the knowledge.' (Can this gentleman contact me with a handwritten letter, please, identifying himself. He forgot to include his address.) And my favourite one: 'Thanks for a great magazine'.

**Hurry up and jump! These things are going for my throat.**



Picture modelled by posers.

# MAILBOX

## Video Enhancer

I have just renewed my annual subscription and also at considerable cost to myself sent to you a completed 1984 Reader's Survey.

I am also interested in video recording, and I have read a number of books and magazines on the subject but I have yet to come across a magazine which gives construction articles for electronic accessories. For instance I recently read a review of Enhancers costing from £45 to £270 and surprisingly one of the cheaper ones was quite good. It occurred to me that if someone can produce an enhancer for under £60, it can't be beyond my capacity to build one myself thereby learning what makes such a device tick. If the enhancer also included fade possibilities (as some do) one could make a more professional job of it.

So how about it? Surely you have a competent electronics expert dependent on the bread money you pay him to call on to prepare such a construction article?

Sincerely,  
Frank Croxson,  
Uhlingen,  
West Germany.

**Well, mate, you could have saved yourself a 22p stamp and sent your Reader's Survey back in the same envelope!**

**We descended into the Blade-Runner-like atmosphere of the bunker where we keep our designers chained (dripping walls, artificial light, smog, bicycles in the corridors and asked the vital question: can you do it?**

**The reply came: whereas a simple enhancer is a simple project, anything more complicated is much more complicated. When we asked about fading, he faded!**

**A simple enhancer will do no more than sharpen up the details on a tape-to-tape edit a little. Over several generations, however, this can amount to a considerable 'saving' in lost quality. As people making video movies are usually advised not to 'drop' more than three generations to avoid loss of quality, this could be a useful project for anyone making video movies at home and doing their own edits. So we will think about it. Our designers are not as dependent on us for a crust as you may think. One of them escaped recently.**

**However, the poor creature had become so accustomed to the atmosphere here that he was soon forced to emigrate to Manchester to find a suitable habitat. We haven't heard from him since. . . .**

## Reunited

I would like to thank you and your staff for your recent kind assistance with my problem obtaining spares and an instruction manual for my Sinclair PD1735 digital multimeter. Following your recommendation to contact Thandar Electronics I acquired from them the parts needed, as well as a manual I have written to thank Mr. Richardson of Blackburn, whose letter offering the loan of a manual you very kindly forwarded to me.

Thank you again.  
Yours faithfully,  
Jem Ward,  
Leominster,  
Herefordshire

**In this world of trouble, pain and obsolete ICs, it cheers me no end to see a story with a happy ending. Thanks also to the gentleman at Sinclair Research who pointed me in the direction of Thandar.**

## Why Digital?

Congratulations on producing an electronics magazine which starts at the basic fundamentals of electrics but I'm sorry to say why, but why must you also include computer interfacing? Being an Instrument Technician, I have seen how more and more microprocessor based systems are coming into being but it seems a bit contradictory in the November issue on page 12 to illustrate the best ways to start to build a project, then on page 21 to write about how to interface a home computer.

On top of this, with basic electronic tuition, computer electronics, robotics, and audio system problems, it seems to me that each field has enough scope to produce a magazine for each. Is it necessary to assume that everyone who wishes to start electronics as a hobby has to have the capability to run before they can walk?

Yours  
N. F. Humphries,  
Scunthorpe,  
S. Humberside.

**Some readers say that they don't want to have anything to do with**

**computers, yet our PCB Service and components suppliers tell us that anything to do with interfacing is taken up with enthusiasm.**

**But seriously: we're running something like fifteen pages of basic instruction per issue. Are all our readers geniuses, or stranded on a desert island, or can they really take in more than this, plus practical building, every month?**

**Anyone who is in the process of learning about electronics, or who has recently gone pro, will realise that there is no such thing as a complete, self-contained electronics course. This is because there is more than one approach to any problem in electronics, and even if it were possible to cover them all in one go, it would be very confusing for the reader,**

**Experience is picked up by tackling similar problems in a variety of situations. What seems confusing at first will bring enlightenment in due course (give or take a year or two) if the beginner makes an effort to understand it, even if he fails at first.**

**This is why we run a variety of subjects at a variety of levels.**

## How Many Pins?

I am writing to you regarding your project in December 1984 for a cymbal synthesiser.

I have purchased all the components and I am waiting on the printed circuit board coming but on studying your circuit I have noticed that IC9 is listed as a dual MOS op amp CA3240E, which is a 14 pin device but looking at the circuit IC9 is shown as an 8 pin device. Could you please clear this up for me and also any other mistakes in this project.

Yours faithfully,  
D. Whiteford,  
Cambuslang,  
Glasgow.

**I'm glad you asked me that . . . we had two other enquiries about the same thing. Investigation showed that the CA3240E op amp is available in alternative DIL packages, 8 pin and 14 pin. The 8 pin version is stocked by Maplin, O/N WQ21X. Just to make things easier, the device is not on page 328 of the catalogue as indexed, but on page 327. It's available from a lot of other sources.**

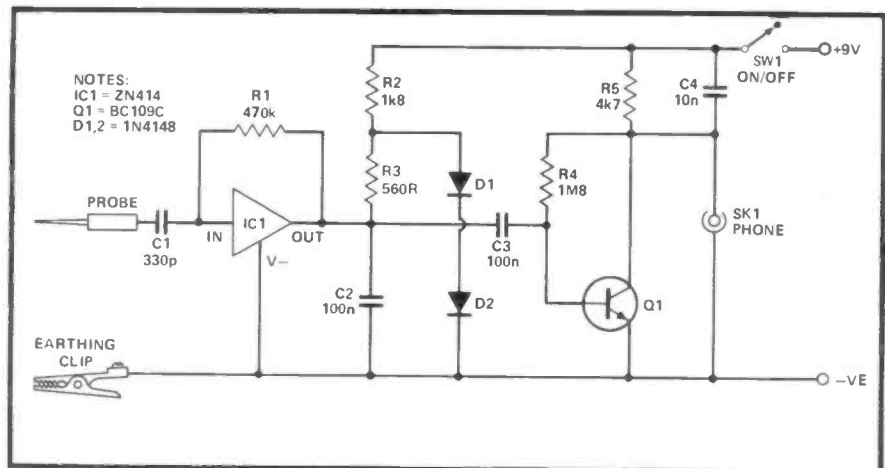
**Some op amps are available in a number of alternative packages.**

# SHORT CIRCUIT

R. A. Penfold

Testing radio equipment using a signal tracer usually results in the fault being quickly and easily located. The basic technique is to inject a signal into the input of the faulty equipment, either from a signal generator or an ordinary programme source, and then test to see if this signal is present at various points in the circuit, working from the input through to the output. When the signal can no longer be located, the fault either lies in the stage just tested or in the circuitry immediately before this. Visual checks together with voltage and component tests are then used to discover the precise nature of the fault.

This simple circuit is a sensitive RF signal tracer that operates well over the medium wave and long wave bands as well as at the popular broadcast receiver intermediate frequencies around 455 to 470kHz. It also seems to work quite well at SW frequencies up to several megahertz. The circuit is built around the popular TRF radio IC, the ZN414, IC1. This would normally have a tuned circuit at the input to provide frequency selectivity, but in this application it is used as a broadband amplifier with C1 being used to couple the input signal to the input terminal of the device. Resistor



R1 biases IC1, while R2, D1, and D2 provide it with a stabilised supply potential of about 1.3 volts. Resistor R3 and capacitor C2 are the load resistor and RF filter capacitor respectively for the detector and automatic gain control stages of IC1.

Capacitor C3 couples the demodulated audio signal at the output of IC1 to the input of a high gain common emitter amplifier formed by Q1. Capacitor C4 provides RF filtering at the output of this stage and helps to avoid instability due to stray high frequency

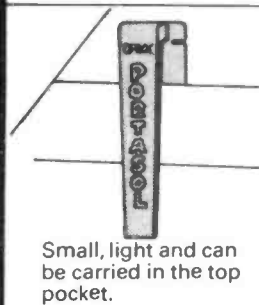
feedback. The output is taken to a crystal earphone, and other types are not suitable for use with this unit. The current consumption of the circuit is only about 5mA or so.

The circuit has extremely high sensitivity and it is therefore advisable to house the circuit in a small metal case which is earthed to the negative supply so that it screens the circuitry from RF signals within the broad passband of the unit. The probe can merely consist of a long M3 or M4 screw fitted to the case but insulated from it.

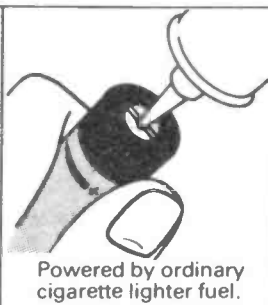
## New from **ORYX-PORTASOL** Portable Gas Soldering Iron

ORYX - market leaders in soldering irons and accessories introduce the revolutionary PORTASOL. This new approach to catalytic soldering iron technology is truly

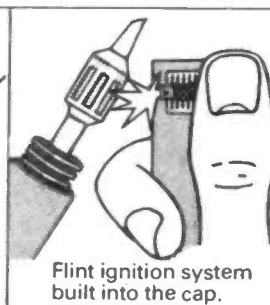
pocket portable (173 mm) and independent of any external energy source. PORTASOL is powered by ordinary cigarette fuel and one filling lasts for 60 minutes continuous use.



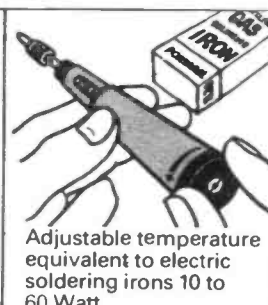
Small, light and can be carried in the top pocket.



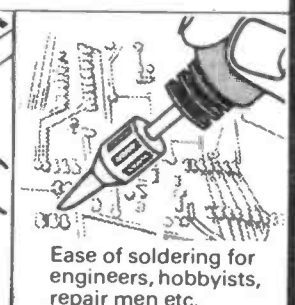
Powered by ordinary cigarette lighter fuel.



Flint ignition system built into the cap.



Adjustable temperature equivalent to electric soldering irons 10 to 60 Watt.



Ease of soldering for engineers, hobbyists, repair men etc.

- ★ Portasol makes an ideal and handy present.
- ★ Immediately available for use anytime anywhere.
- ★ Portasol meets all safety standards.
- ★ No problem with statics.
- ★ Adjustable temperature for sensitive components.

ONLY  
**£17.25**  
INCLUDING VAT, P&P

To: Greenwood Electronics, Portman Rd, Reading Berks RG3 1NE.  
Please send.....(qty.) PORTASOL at £17.25. I enclose  
cheque/P.O./cash for £..... or debit my Barclaycard  
no. .... Access no. .... Expiry date .....

NAME .....

ADDRESS .....

Please send technical leaflet. Tick  Allow 14 days for delivery.

EM/4

**ORDER WITH THIS COUPON TODAY**

# ELECTRONICS FROM THE START

Keith Brindley

**This month we start to use integrated circuits, beginning with the 555 timer, which is widely used in teaching courses.**

YOU'LL NEED a number of components to build the circuits this month, some of them you'll already have, but there are a few new ones, too. First, the resistors required are:

- 1 x 1k5
- 1 x 4k7
- 1 x 10k

Second, capacitors:

- 1 x 1n
- 2 x 10n
- 2 x 100n
- 1 x 1u electrolytic
- 1 x 10u electrolytic

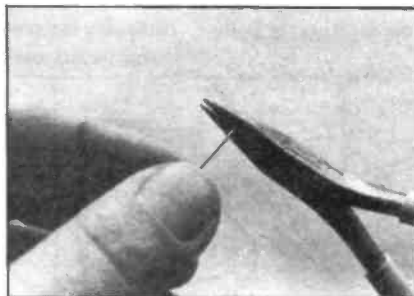
Power ratings, tolerances etc, of all these components are not critical, but the electrolytic capacitors should have a voltage rating of 9V or more.

Some other components you already have ie, a switch, battery, battery connector, Verobloc, Banana meter, should all be close at hand, as well as some single-strand tinned copper wire. You are going to use the single-strand wire to make connections from point to point on the Verobloc, and as it's uninsulated this has to be done carefully, to prevent short circuits. **Figure 1** shows the best method. Cut a short length of wire and hold it in the jaws of your long-nosed pliers. Bend the wire round the jaws to form a sharp right-angle in the wire. The tricky bit is next — judging the length of the connection you require, move the pliers along the wire and then bend the other end of the wire also at right angles round the other side of the jaws (**Figure 2**). If you remember that the grid of holes in the Verobloc are equidistantly spaced at 2.5mm (or a tenth of an inch if you're old-fashioned like me — what's an inch,

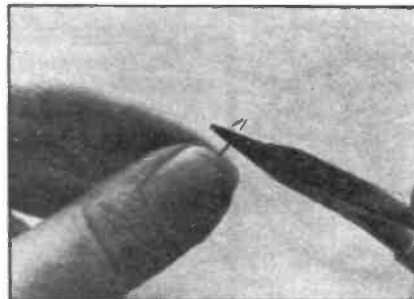
Grandad?) then it becomes easier. A connection over two holes is 5mm long, over four holes is 10mm long etc. — you'll soon get the hang of it.

Now, holding the wire at the top, in the pliers, push it into the Verobloc as shown in **Figure 3**, until it lies flush on the surface of the Verobloc as in **Figure 4**. No bother, eh? Even with a number of components in the Verobloc it is difficult to short circuit connections made this way.

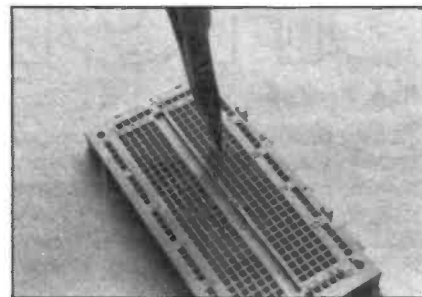
- Two other components you need are:
- 1 x 555 integrated circuit
  - 1 x light emitting diode (any colour)



**Figure 1.** Take your short piece of wire between the jaws of your pliers . . .

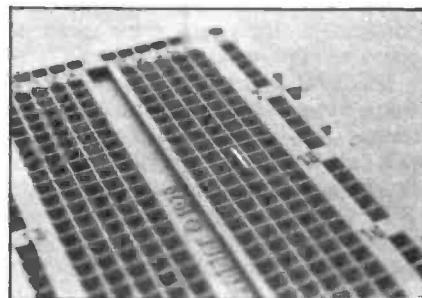


**Figure 2.** . . . and bend it carefully into two right angles, judging the length.



**Figure 3.** The wire link you have made should drop neatly into the Verobloc.

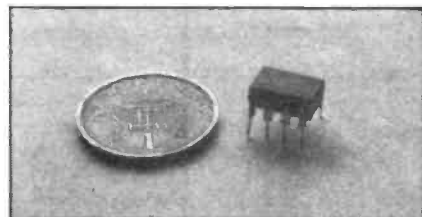
We've seen an **integrated circuit (IC)** before and we know what it looks like, but we've never used one before, so we'll take a closer look at the 555 now. It



**Figure 4.** If the link is a good fit, it can be used over and over again in different positions.

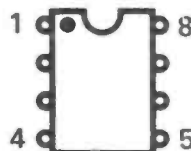
is an 8-pin dual-in-line (DIL) device and one is shown in **Figure 5**. Somewhere on its body is a notch or dot, which indicates the whereabouts of pin 1 of the IC as shown in **Figure 6**. The remainder of the pins are numbered in sequence in an anti-clockwise direction around the IC.

ICs should be inserted into a Verobloc across the breadboard's central bridged portion. Isn't it amazing that this portion is 7.5mm across (0.3in) and, hey presto, the rows of pins of the IC are about 7.5mm apart? It's as if the IC was made for the Verobloc! So the IC fits into the

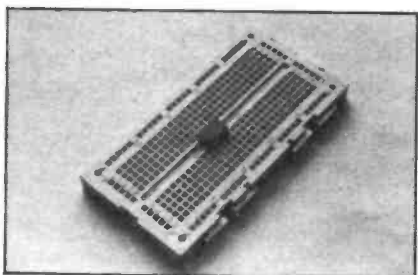


**Figure 5.** The 555, an 8 pin DIL timer IC, beside a UK one penny piece.

**DOT OR NOTCH INDICATE POSITION OF PIN 1**



**Figure 6.** A diagram of the normal configuration for any IC: the dot marks pin 1 and the remaining pins run anticlockwise.



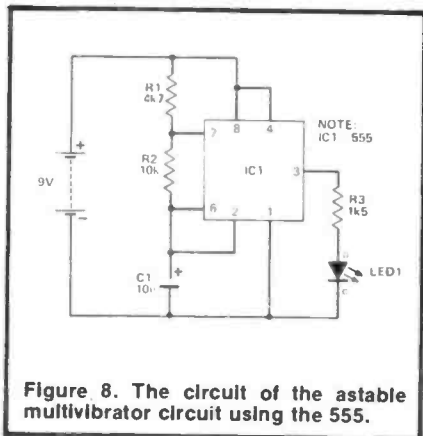
**Figure 7.** The IC mounted across the central divide in the Veroboard, which is designed to be the exact size.

Verobloc something like that in **Figure 7**.

We'll look at the light emitting diode later.

If you remember, last month we took a close look at capacitors, how they charge and discharge, storing and releasing electrical energy. The first thing we shall do this month is use this principle to build a useful circuit called an **oscillator**. Then, in turn, we shall use the oscillator to show some more principles of capacitors. So, we've got a two-fold job to do now and there's an awful lot of work to get through — let's get started.

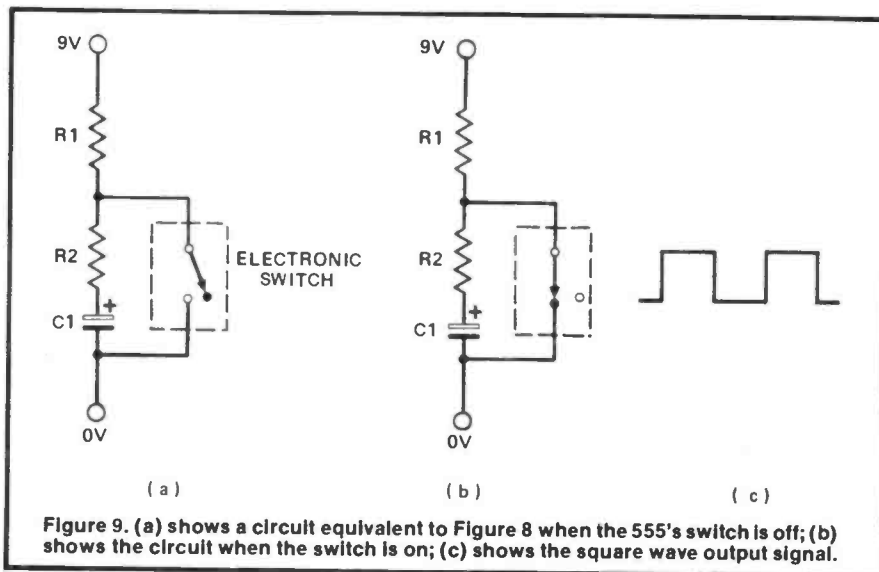
**Figure 8** shows the circuit of the oscillator we're going to build. It's a common type of oscillator known as an **astable multivibrator**. The name arises because the output signal appears to oscillate (or vibrate) between two voltages, never resting at one voltage for more than just a short period of time (it is therefore unstable i.e. astable). An astable multivibrator built from **discrete** i.e. individual components, can be tricky to construct so we've opted to use an integrated circuit (the 555) as the oscillator's heart.



**Figure 8.** The circuit of the astable multivibrator circuit using the 555.

Inside the 555 is an electronic 'switch' which turns on when the voltage across it is approximately two-thirds the power supply voltage (about 6V in the circuit of **Figure 8**), and off when the voltage is less than one-third the power supply voltage (about 3V). **Figure 9a** shows an equivalent circuit to that of **Figure 8** for the times during which the electronic switch of the 555 is off.

You should be able to work out that the capacitor C1 of the circuit is connected through resistors R1 and R2 to the positive power supply rail. The time



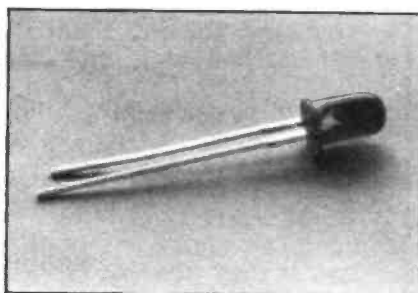
**Figure 9.** (a) shows a circuit equivalent to **Figure 8** when the 555's switch is off; (b) shows the circuit when the switch is on; (c) shows the square wave output signal.

constant of this part of the circuit is therefore given by:

$$\tau_1 = RC = (R1 + R2) C$$

When the voltage across the switch rises to about 6V, however, the switch turns on (as shown in **Figure 9b**), forming a short circuit across the capacitor and resistor, R2. The capacitor now discharges with a time constant given by:

$$\tau_2 = R2 \times C$$



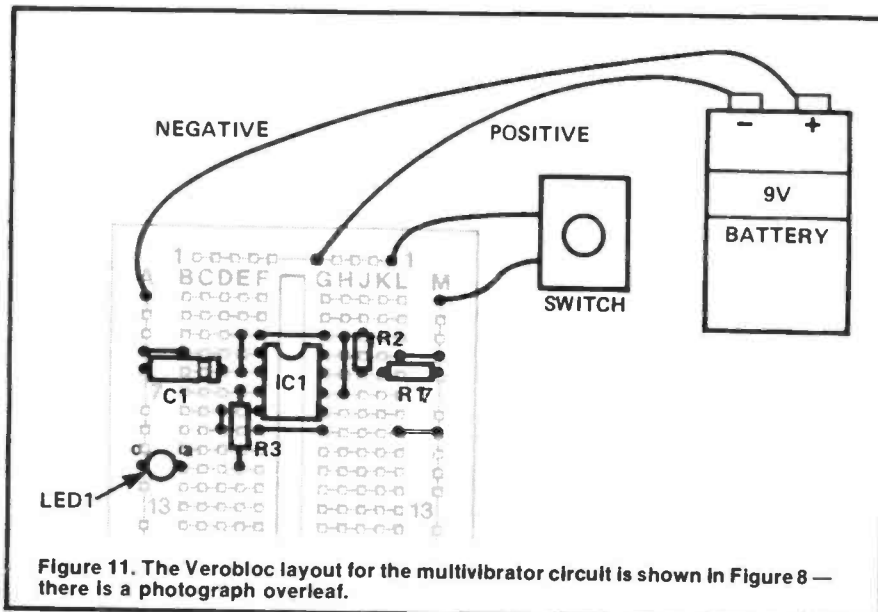
**Figure 10.** One of the most popular electronic components, the LED.

Of course, when the discharging voltage across the switch falls to about 3V, the switch turns off again, and the capacitor charges up once more. The process repeats indefinitely, with the switch turning on and off at a rate determined by the two time constants. Because of this up and down effect such oscillators are often known as **relaxation** oscillators.

As you might expect the circuit integrated within the 555 is not just that simple and there are many other parts to it (one part, for example, converts the charging and discharging exponential voltages into only two definite voltages — 9V and 0V — so that the 555's output signal is a **square wave**, as shown in **Figure 9c**). But the basic idea of the astable multivibrator formed by a 555 is just as we've described here.

## Throwing Light On It

The 555 IC is one of only two new types of electronic component this circuit introduces you to. The other is a light emitting diode (LED) which is a type of indicator. One is shown in **Figure 10**. LEDs are polarised and so must be



**Figure 11.** The Verobloc layout for the multivibrator circuit is shown in **Figure 8** — there is a photograph overleaf.

Table 2 and Figure 18 show our results which should be similar to yours (if not, you're wrong — we can't be wrong, can we?). The graph shows that the size of the output signal of the AC voltage divider is dependent on the frequency of the applied input signal. In particular, there are three clearly distinguishable sections to this graph, each relating to frequency.

First, above a certain frequency, known as the **corner frequency**, the output signal is constant and at its maximum.

Second, at low frequencies (close to 0 Hz) the output is zero.

Third, between these two sections the output signal varies in size depending on the applied input signal frequency.

Is this the same for all AC voltage dividers of the type shown in Figure 13? Well, let's repeat the experiment using a different capacitor for C2, to find out. Try a 10n capacitor and repeat the whole procedure, putting your results in Table 3 and Figure 19. Table 4 and Figure 20 show our results.

And yes, the graph is the same shape but is moved along the horizontal axis by an amount equivalent to a ten-fold increase in frequency (the capacitor was decreased in value by ten-fold, remember). A similar inverse relationship is caused by changing the resistor value, too.

Frequency, capacitance and resistance are related in the AC voltage divider by the expression:

$$f = \frac{1}{RC}$$

where f is the corner frequency. For the first voltage divider, with a capacitance of 10n and a resistance of 1.5k, the corner frequency is:

$$f = \frac{1}{1500 \times 100 \times 10^{-9}} = 6666 \text{ Hz}$$

which is more or less what we found in the experiment. In the second voltage divider, with a 10n capacitor, the corner frequency increases by ten to 66,666 Hz.

Remembering what we learned last month about resistors and capacitors in charging/discharging circuits, we can simplify the expression for corner frequency to:

$$f = \frac{1}{\tau}$$

because the product RC is the time constant,  $\tau$ . This may be easier for you to remember.

An AC voltage divider can be constructed in a different way, as shown

### Table 3

Results when capacitor C2 is 10n

Value of C1	Calculated frequency	Measured voltage
10u	5.8	
1u	58	
100n	580	
10n	5.8k	
1n	58k	

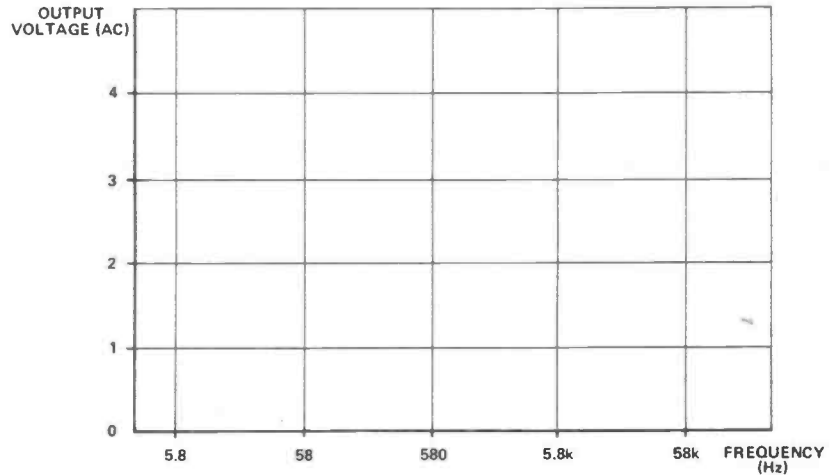


Figure 19 and Table 3 are for use with your results from the experiment with the 10nF capacitor.

### Table 4

Our results (C2 = 10n)

Value of C1	Calculated frequency	Measured voltage
10u	5.8	0
1u	58	0
100n	580	0
10n	5.8k	1.5
1n	58k	4

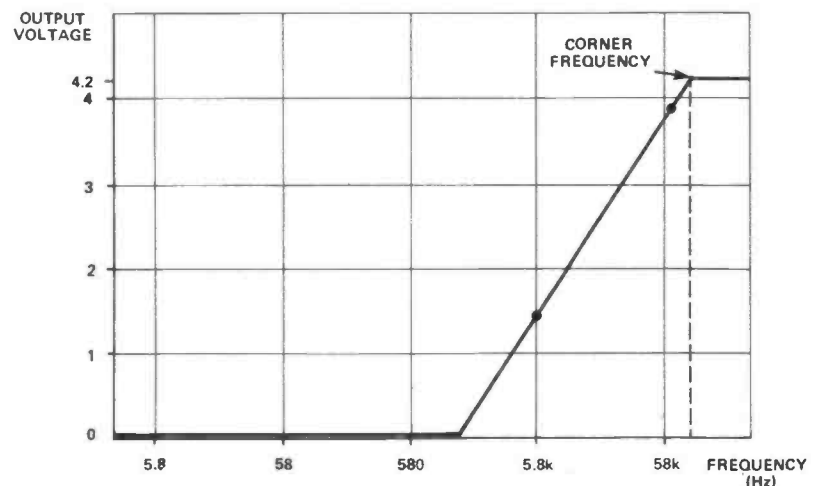


Figure 20 and Table 4 give our results in the same experiment.



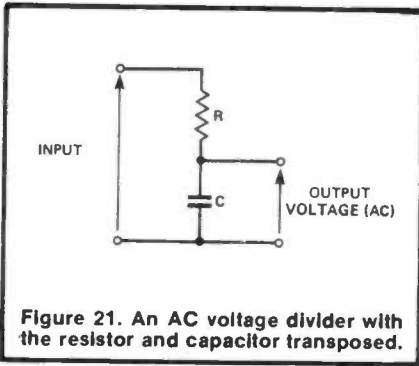


Figure 21. An AC voltage divider with the resistor and capacitor transposed.

in **Figure 21**. Here the resistor and capacitor are transposed. What do you think the result will be? Well, the output signal size now decreases with increasing frequency — exactly the opposite effect of the AC voltage divider of **Figure 13**! All other aspects are the same, however: there is a constant section below a corner frequency, and a section where the output signal is zero, as shown in **Figure 22**. Once again the corner frequency is given by the expression:

$$f = \frac{1}{RC} = \frac{1}{\tau}$$

### Filter Tips

The AC voltage dividers of **Figures 13** and **23** are normally shown in a slightly different way, as in **Figures 23a** and **b**. Due to the fact that they allow signals of some frequencies to pass through, while filtering out other signal frequencies, they are more commonly called **filters**.

The filter of **Figure 23a** is known as a **high-pass filter** — because it allows signal frequencies higher than its corner frequency to pass while filtering out signal frequencies lower than its corner frequency.

The filter of **Figure 23b** is a **low-pass filter** — yes, you've guessed it — because it passes signals with frequencies below its corner frequency, while filtering out higher frequency signals.

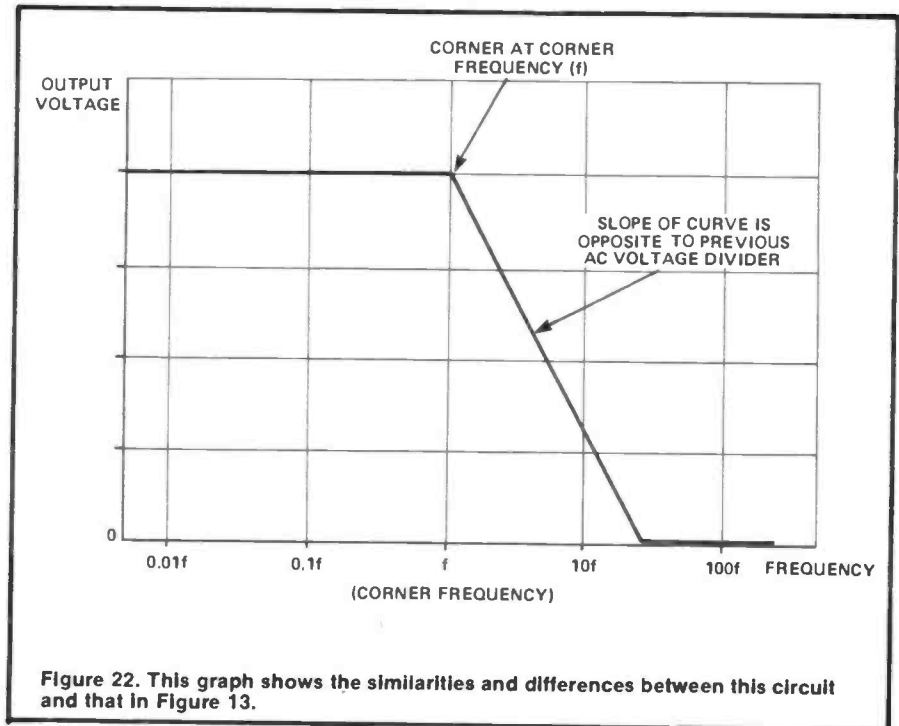


Figure 22. This graph shows the similarities and differences between this circuit and that in **Figure 13**.

Filters are quite useful in a number of areas of electronics. The most obvious example of a low-pass filter is probably the scratch filter sometimes seen on stereo systems. Scratches and surface noise when a record is played, or tape hiss when a cassette tape is played, consist of quite high frequencies; the scratch filter merely filters out these frequencies, leaving the music relatively noise free.

Bass and treble controls of an amplifier are also examples of high- and low-pass filters: a bit more complex than the simple ones we've looked at here but following the same general principles. We'll also see many more examples of filters along the way.

And that's about it for this month. You can try a few experiments of your own with filters if you want. Just remember that whenever you use your meter to measure voltage across a resistor in a filter, the meter resistance affects the actual value of resistance and can thus drastically affect the reading.

### Quiz

- 1) A signal of frequency 1 kHz is applied to a low-pass filter with a corner frequency of 10 kHz. What happens?
  - a The output signal is one-tenth the input signal
  - b The output signal is larger than the input signal
  - c There is no output signal
  - d The output signal is identical to the input signal
  - e All of these
  
- 2) A high-pass filter consisting of a 10k resistor and an unknown capacitor has a corner frequency of 100 Hz. What is the value of the capacitor?
  - a 1n
  - b 10n
  - c 100n
  - d 1000n
  - e 1u

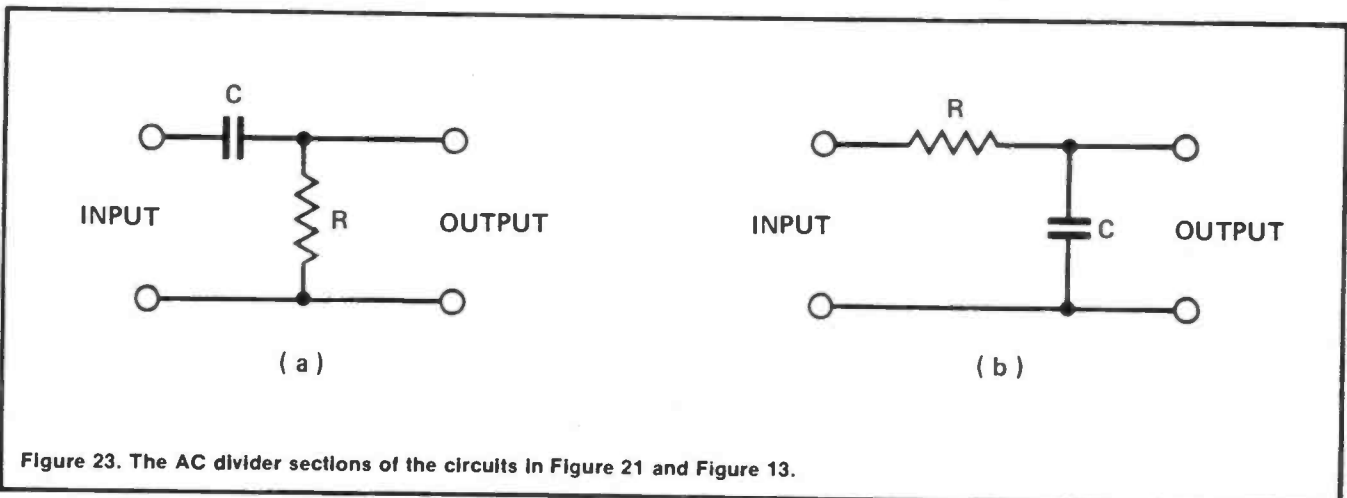


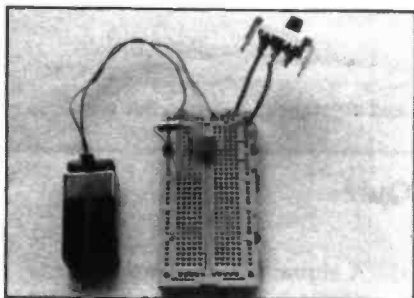
Figure 23. The AC divider sections of the circuits in **Figure 21** and **Figure 13**.

# Feature

inserted into circuit the right way round. All LEDs have an anode (which goes to the more positive side of the circuit) and cathode (which goes to the more negative side). Generally, but not always, the anode and cathode of an LED are identified by the lengths of the component leads — the cathode is the longer of the two.

The complete circuit's Verobloc layout is shown in **Figure 11**, and a photograph of the circuit is in **Figure 12**. Build it and see what happens.

When you turn on, you should find that the LED flashes on and off, quite rapidly (about five or six times a second, actually). This means your circuit is working correctly. If it doesn't work check polarity of all polarised components: the battery, IC, LED and capacitor.



**Figure 12.** The multivibrator circuit built up on Verobloc.

## Ouch, That Hertz.

We can calculate the rate at which the LED flashes, more accurately, from formulae relating to the 555. A quick study of the squarewave output shows that it consists of a higher voltage for a time (which we can call T1) and a lower voltage for a time (which we will call T2).

Now, T1 is given by:

$$T1 = 0.7 \tau_2$$

and T2 is given by:

$$T2 = 0.7 \tau_1$$

So, the time for the whole period of the squarewave is:

$$T1 + T2 = 0.7(\tau_1 + \tau_2)$$

and as the frequency of a waveform is the inverse of its period we may calculate the waveform's frequency as:

$$f = \frac{1}{0.7(\tau_1 + \tau_2)}$$

Earlier, we defined the two time constants,  $\tau_1$  and  $\tau_2$ , as functions of the capacitor and the two resistors, and so by substituting them into the above formula, we can calculate the frequency as:

$$f = \frac{1}{0.7C(R1 + 2R2)}$$

So, the frequency of the output signal of the circuit of **Figure 8** is:

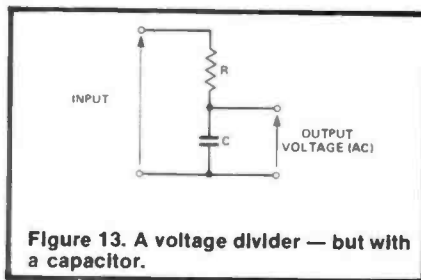
$$f = \frac{1}{0.7 \times 10 \times 10^{-6} \times (4700 + 20,000)}$$

$$= 5.8 \text{ cycles per second}$$

or, more correctly speaking:

$$= 5.8 \text{ Hertz (shortened to 5.8Hz)}$$

Equation 1 is quite important really, because it shows that the frequency of

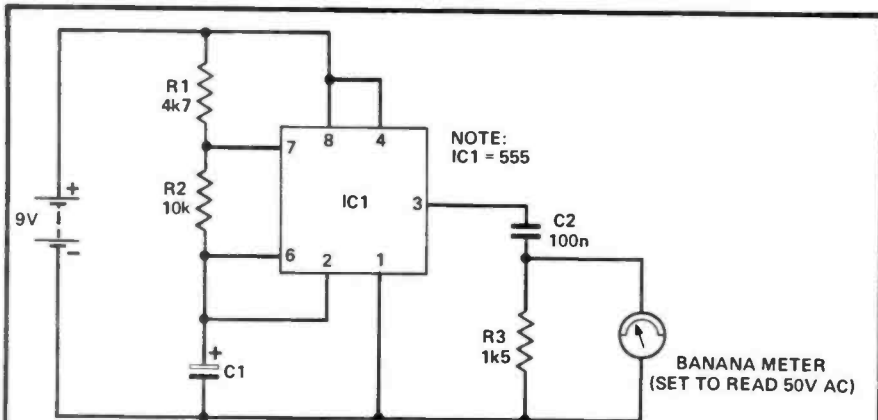


**Figure 13.** A voltage divider — but with a capacitor.

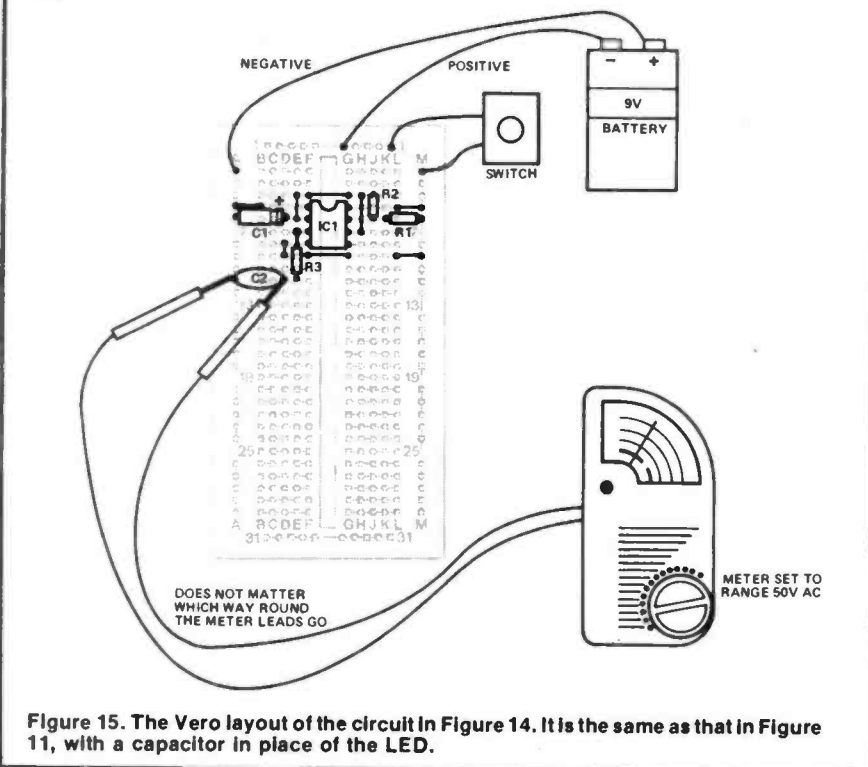
the signal is inversely proportional to the capacitance. If we decrease the value of the capacitor we will increase the frequency. We can test this by taking out the 10u capacitor and putting in a 1u capacitor. Now, the LED flashes so quickly (about 58 times a second) that your eye can't even detect it is flashing and it appears to be always on. If you replace the capacitor with one of a value of say 100u the LED will flash only very slowly.

Now, let's stop and think about what we have just done. Basically we've used a capacitor in precisely the ways we looked at last month — to charge and discharge with electrical energy so that the voltage across the capacitor goes up and down at the same time. True, in the experiments last month you were the switch, whereas this month an IC has taken your place. But the principle — charging and discharging a capacitor — is the same.

The current which enters the



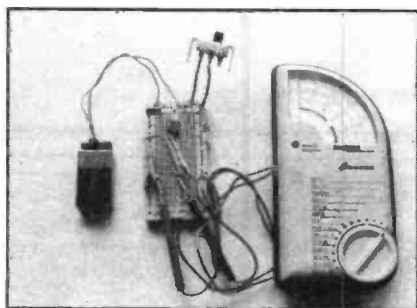
**Figure 14.** A circuit combining the astable multivibrator and the circuit in **Figure 13**.



**Figure 15.** The Vero layout of the circuit in **Figure 14**. It is the same as that in **Figure 11**, with a capacitor in place of the LED.

capacitor to charge it, then leaves the capacitor to discharge it, is direct current because it comes from a 9VDC battery. However, if we look at the output signal (**Figure 9c**) we can see that the signal alternates between two levels. Looked at in this way, the astable multivibrator is a **DC-to-AC converter**. And that is going to be useful in our next experiment, where we look at the way capacitors are affected by AC. The circuit we shall look at is shown in **Figure 13** and is very simple, but it'll do nicely, thank you. It should remind you of a similar circuit we have already looked at; the voltage divider, only one of the two resistors of the voltage divider has been replaced by a capacitor. Like an ordinary voltage divider the circuit has an input and an output. What we're going to attempt to do in the experiment is to measure the output signal when the input signal is supplied from our astable multivibrator.

**Figure 14** shows the whole circuit of the experiment and **Figure 15** shows the



**Figure 16.** A photo of the circuit in **Figure 15**.

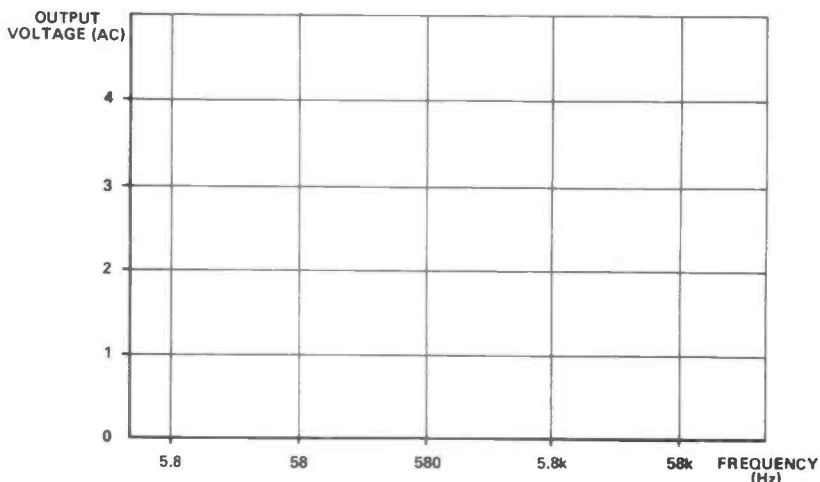
Verobloc layout, while **Figure 16** shows a photograph of the set-up before switch-on. The procedure for the experiment is pretty straightforward: measure the output voltage of the AC voltage divider when a number of different frequencies are generated by the astable multivibrator, then tabulate and plot these results on a graph. Things really couldn't be easier. **Table 1** is the table to fill in as you obtain your results and **Figure 17** is marked out in a suitable grid to plot your graph. To change the astable multivibrator's frequency, it is only necessary to change capacitor-C1. Increasing it ten-fold decreases the frequency by a factor of ten; decreasing the capacitor value by ten increases the frequency ten-fold. Five different values of capacitor therefore give an adequate range of frequencies.

As you do the experiment you'll find that only quite low voltages are measured (up to about 4VAC) and as the Banana meter's lowest AC range is 50V, you may not achieve the level of accuracy you would normally desire, but the results will be OK, nevertheless.

**Table 1**

Results when capacitor C2 is 100n

Value of C1	Calculated frequency	Measured voltage
10u	5.8	
1u	58	
100n	580	
10n	5.8k	
1n	58k	

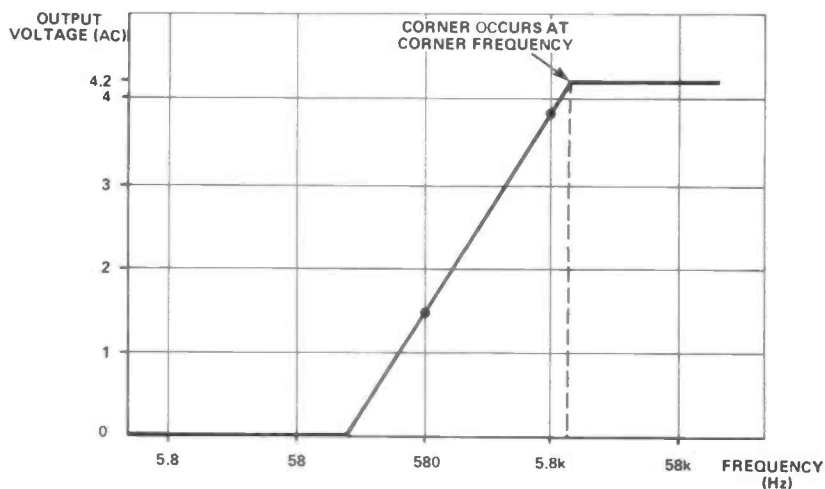


**Figure 17.** A blank graph on which you can plot your experimental results. Use **Table 1** above as well.

**Table 2**

Our results (C2 ± 100n)<sub>2</sub>

Value of C1	Calculated frequency	Measured voltage
10u	5.8	0
1u	58	0
100n	580	1.5
10n	5.8k	4
1n	58k	4.2



**Figure 18 and Table 2** show our own experimental results.



- 3) A low-pass filter consisting of a 1u capacitor and an unknown resistor has a corner frequency of 100Hz. What is the value of the resistor?
- a 10k
  - b 1k
  - c 100k
  - d All of these
  - e It makes no difference
  - f d and e
  - g None of these

- 4) In a circuit similar to that in Figure 8, resistor R1 is 10K, resistor R2 is 100k, and capacitor C1 is 10n. The output frequency of the astable multivibrator is:
- a a squarewave
  - b about 680Hz
  - c too fast to see the LED flashing
  - d a and b
  - e c and d
  - f None of these

Answers to last month's quiz:  
1a; 2f; 3c; 4c; 5c.

## Glossary of Important Terms

**astable multivibrator** an oscillator whose output is a squarewave

**corner frequency** the frequency at which a signal size changes from one slope to another, when viewed as a graph of size against frequency. In the simple filter circuits in this article, the corner frequency,  $f_c$ , is given by the expression:

$$f_c = \frac{1}{RC}$$

**discrete** term implying a circuit built up from individual components.

**filter** a circuit which allows signal of certain frequencies to pass through unaltered, while preventing passage of other signal frequencies.

**high-pass filter** a circuit which allows signals of frequencies higher than the corner frequency to pass through unaltered, while preventing signals of frequencies lower than this from passing.

**low-pass filter** a circuit which allows the passage of signals with frequencies lower than the corner frequency, but prevents the passage of signals with frequencies higher than this.

**oscillator** a circuit which produces an output signal of a repetitive form.

**relaxation oscillator** an oscillator relying on the principle of a charging and discharging capacitor.

**squarewave** a signal which oscillates between two fixed voltages.

## BASIKIT BASIC ELECTRONIC LEARNING SYSTEM

We are distributing an Electronics Learning System called BASIKITS. The material and hardware has been used by students up to GCE "O" level with great success. Adult education course students and schools are finding the BASIKITS a useful learning experience in this important area. Also children as young as eight years old have made the working projects with some adult guidance. Can you or your children afford not to keep up with this dynamic growth in modern technology?

Start the basics now with our material.

- Introducing Electronics manual written by Dr. Ken Smith of the University of Kent.
- A complete range of 20 BASIKITS, including IC Radio, Multivibrator, Amplifier, Power Supply, Organ, Light Operated Switch and many more giving a graded practical and theoretical learning programme.
- Full query service to customers.
- Soldering Equipment with special beginners instruction.

Kits start from as little as £1.20. Send a stamped addressed envelope for full details by return to:

STAPLE CRAFT CENTRE (EM),  
STAPLE FARMHOUSE, STAPLE, CANTERBURY, KENT CT3 1JX.  
TEL. ASH (0304) 812723.

## MICRORANGE ELECTRONICS

UNIT 258, STRATFORD WORKSHOPS, BURFORD ROAD,  
LONDON E15 2SP (2nd floor) Tel. 01 536 1415

Small batch manufacture of PCB's and electronic equipment.

Please ring for quote.  
All prices include V.A.T.  
please send 50p for P&P.

### Photo Board + Chemicals

6 x 4" single sided	1.89
8 x 5" single sided	2.45
6 x 4" double sided	2.55
8 x 5" double sided	2.95
1 Litre super fast etchant	2.55
1 Litre Developer	3.75
1 Litre Tinning Solution	
(For tinning PCB's)	7.95
Resist Strip Aerosol	4.25

Component Prices	1 off	10 off
2N3773 (equiv)	1.50	1.35
BD131	30p	28p
VN67AF	65p	60p
76477 (Sound Gen IC)	3.80	----
TL071 Single OP AMP	45p	42p
TL072 Dual OP AMP	58p	55p
TL074 QUAD OP AMP	90p	85p
NE5532 Dual Low Noise	1.45	1.30
NE5534 Single Low Noise		
Noise	1.15	1.05
7812 12 V 1 A Reg (+)	35p	30p
7815 15 V 1 A Reg (+)	45p	----
7915 15 V 1 A Reg (-)	50p	----
TIL302 7 Segment C/A (High Efficiency)	75p	70p
2 Mtr x 1 Mtr Quality SPK Cloth	2.95	
3 way 1000 W sound to Lite Unit	19.50	built

**resco**  
marketingukltd

### ELECTRONIC KITS

Music-Stepper	MS-4	£25.17 each
Multi-Stepper	MS 8-D	£69.96 each
Microphone Sound-to-Light System	ML0-3	£43.98 each
Sound-to-Light Controller Super Mini	S-Mini	£13.28 each
Sound-to-Light System Super-maxi	SM 3P	£24.62 each
Light Tubes	LSB/LSR	£46.51 each

Prices include V.A.T. Kits guaranteed for one year.

SEND FOR OUR CATALOGUE WHICH CARRIES THE FULL RANGE.

Dealer and Educational Establishments' enquiries invited.

RESCO MARKETING (U.K.) LTD.,  
Unit 11, Warwick Street Industrial Estate,  
Storforth Lane,  
Chesterfield,  
Derbyshire S40 1TT.

Telephone: 0246 209676 Telex: 54386 Resco C

Before replying to advertisements from past issues please check with the company concerned that the product you require is still available.

# BOOKSHELF

THE EM BOOKSHELF is pleased to offer you a range of top quality electronics paperbacks for you to read and enjoy delivered direct to your door!



**IC PROJECTS FOR BEGINNERS** £1.95  
Especially written for the beginner, offering a range of simple projects.



**The Art of Programming the ZX Spectrum** £2.95  
Shows you how to use the features of the ZX81 in programs that fit into 1K, and are still fun to use.



**EASY ADD-ON PROJECTS FOR SPECTRUM, ZX81 & ACE** £2.25  
This book describes how to build a number of electronic projects which you can use with your Spectrum, ZX81 or Jupiter Ace microcomputer.



**ELECTRONIC PROJECTS FOR CARS AND BOATS** £1.95  
Fifteen fairly simple projects complete with stripboard layouts.



**28 SIMPLE AMATEUR BAND AERIALS** £1.95  
This concise book describes how to build amateur band aerials that are simple and inexpensive to construct and perform well.



**HOW TO DESIGN YOUR OWN PCBs** £1.95  
The purpose of this book is to familiarise the reader with both simple and more sophisticated methods of producing printed circuit boards (PCB's).



**MODEL RAILWAY PROJECTS** £1.95  
Build your own controllers, signals and sound effects etc and add realism to your model railway.



**A Z80 WORKSHOP MANUAL** £2.75  
This book is intended for people who wish to progress beyond the stage of basic programming code and assembly language programming or need hardware details of the Z80 based computer.



**The Art of Programming the ZX Spectrum** £2.95  
Simply helps you get the most out of your Spectrum.



**CB PROJECTS** £1.95  
Shows you how to make a number of useful and interesting CB accessories.



**THE ART OF PROGRAMMING THE ZX SPECTRUM** £2.50  
Concentrates on good programming style and helps you use your 15K RAM pack and ZX printer to the full.



**POPULAR ELECTRONIC PROJECTS** £1.95  
An interesting collection of projects which will appeal to most hobbyists.



**AN INTRODUCTION TO VIDEO** £1.95  
For the person who has just, or is just about to buy or rent, home video equipment but is not sure what it is all about.



**HOW TO MAKE WALKIE-TALKIES** £1.95  
All you need to know to build your own walkie-talkies.



**ELEMENTS OF ELECTRONICS - BOOK 1** £2.25  
The Simple Electronic Circuits and Components.



**ELEMENTS OF ELECTRONICS - BOOK 2** £2.25  
Alternating Current Theory.



**ELEMENTS OF ELECTRONICS - BOOK 3** £2.25  
Semiconductor Technology.



**ELEMENTS OF ELECTRONICS - BOOK 4** £2.95  
Microprocessing Systems and Circuits.



**ELEMENTS OF ELECTRONICS - BOOK 5** £2.95  
Communications.



**HOW TO USE OP-AMPS** £2.25  
All you need to know about Op-Amps: a source book of circuits and design calculations.



**POPULAR ELECTRONIC CIRCUITS - BOOK 1** £1.95  
Contains over 70 useful and interesting circuits covering a wide range of subjects.



**POPULAR ELECTRONIC CIRCUITS - BOOK 2** £2.25  
Over 140 pages of useful and interesting circuits.




**PRACTICAL BUILDING BLOCKS - BOOK 1** £1.95  
Most circuits are built up from building blocks in standard types. This book shows the reader how to combine these blocks to produce projects of their own design.



**PRACTICAL BUILDING BLOCKS - BOOK 2** £1.95  
Most circuits are built up from building blocks in standard types. This book shows the reader how to combine these blocks to produce projects of their own design.

To receive your books you only need ✓ the  for each title you require and send this page duly completed with your remittance to the address stated.

I enclose my cheque/Postal Order/Money Order (delete as necessary) for £..... (payable to ASP Ltd)  OR Debit my Access/Barclaycard (delete as necessary)

Name (Mr/Mrs/Miss).....

Address.....

Signature.....

**Send to:**  
**EM BOOKSHELF, Infonet Ltd. Times House,**  
**179 The Marlowes, Hemel Hempstead,**  
**Herts HP1 1BB**

Please use **BLOCK CAPITALS** and include post codes.

Number of books ordered.....

Total value of books £.....

Add 75p P&P

**TOTAL PAYMENT £.....**

# INFORMATION DESK

## Enquiries

We receive a large number of enquiries. Please note the following before writing:

- Readers who are having problems with one of our published projects will get priority attention, but, because we are busy people, you may experience a considerable wait.
- We cannot guarantee a reply to any letter, although letters in the above category will not normally go unanswered. If you want a personal reply, please include a stamped, self-addressed envelope, or, if writing from outside the UK, please send one (Europe) or two (elsewhere) International Reply Coupons (obtainable from post offices). Overseas stamps are not acceptable to the post office for reply mail. Letters without return postage will not normally receive a personal reply.
- Letters may be published with their replies on our letters page, whether or not a personal reply is sent. Any letter will be deemed eligible for possible publication unless non-publication is specifically requested. Obviously, an enquiry of general interest which is eligible for publication is going to be processed that much faster if we want to print it.
- When enquiring about problems with projects, please keep your letters as brief and precise as possible, and include as much information about tests, measurements, specific anomalies and observations, overheated components, etc. for our assistance. Without such information it is impossible for us to advise. Please do not write before carrying out all relevant checks. Many project problems are caused by simple factors like solder bridges, dirty component leads and contacts, etc.

- We cannot normally advise on modifications to circuits, or on circuits which have been modified, used beyond their published specifications, or had components substituted. You can of course try your luck, but don't expect to get lucky too often!
- We cannot design circuits, even simple ones, for readers.
- We cannot deal with technical queries over the phone except in the case of direct emergency.
- We cannot normally reply to enquiries about any subject except as specifically covered in the magazine, or matters of general electronic interest.
- If you are combining an enquiry with an order for a back issue, subscription, etc., PLEASE WRITE THEM ON SEPARATE PIECES OF PAPER otherwise one or the other may not reach its correct destination.
- Yes, we do like to receive comments, suggestions and criticism from readers, about any relevant subject. As space is limited, letters may be condensed or altered for publication, subject to not misrepresenting the writer's intentions.

## Backnumbers

Backnumbers are held for one year only from the date of issue. The current cost of backnumbers is

£1.50 each. Backnumbers for any particular month may go out of print before twelve months has elapsed. The backnumbers page which appears regularly will attempt to keep abreast of availability, but this is not always possible.

As an alternative, photocopies of articles from all backnumbers of EM and Hobby Electronics are available from the

Photocopy Service, Electronics Monthly, No. 1 Golden Square, London W1R 3AB, price £1.50 per article (two part articles count as two articles). Please give the title of the article, title of the magazine, month and year of publication. Cheques and money orders payable to ASP Ltd.

## Some Good Advice

These are a few points to bear in mind to help you get the best from the information EM offers:

1) Many readers of electronics magazines observe the wise custom, especially with large, complex projects, of deferring their construction for one or two issues to see if any misprints or errors are discovered. This is less significant on simple projects, but is still prudent if you are not confident in your ability to sort out simple errors by yourself.

2) Please do not respond to advertisements in issues older than six months without first contacting the suppliers by phone to see if their stock and prices are still current. Special offers especially often run out after this period.

3) If planning to build a project which contains an expensive or specialised component or components (this will usually be indicated in the Shop Box), make sure you have obtained this piece before investing in the rest. If there is a shortage of the component at the time, you will not have to sit on a pile of expensive hardware waiting for it to become available.

This applies doubly to projects in issues older than six months. Some components become obsolete, or change their specifications, over a period of time, and may be completely non-available. Check these first.

# SUBSCRIPTIONS

Get your electronics monthly . . . get your Electronics Monthly

You can subscribe to Electronics Monthly by sending the form to:

Electronics Monthly (subscriptions),  
Infonet Ltd.,  
Times House,  
179 The Marlowes,  
Hemel Hempstead,  
HP1 1BB. Tel: (0442) 48432.




Please start my subscription with the

..... Issue.

Subscription Rates (tick as appropriate)

- £15.30 for 12 issues UK
- £17.30 for 12 issues overseas
- (accelerated surface)
- £23.00 for 12 issues USA
- (accelerated surface)
- £42.30 for 12 issues airmail

I am enclosing my (delete as necessary)  
Cheque/Postal Order/International Money  
Order for £.....  
(made payable to ASP Ltd)  
OR  
Debit my Access/Barclaycard\*  
(\*delete as necessary)  
Insert card no.

.....

Please use **BLOCK CAPITALS** and include post codes.

NAME (Mr/Mrs/Miss) .....

(delete accordingly)

ADDRESS .....

.....

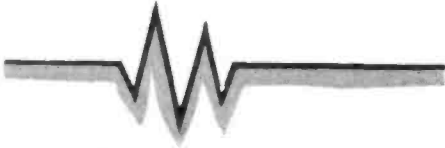
POSTCODE .....

Signature .....

Date .....

# Electronics Glossary

G



- geosynchronous orbit:** similar to a geostationary orbit, but the satellite traces a figure-of-eight orbit thus appearing to move up and down in one-day cycles to an observer on earth.
- germanium:** semiconductor element used in the majority of early transistors and diodes.
- giga-:** unit prefix which means a multiplication factor of  $10^{12}$ . Abbreviation: G.
- graphics:** display of graphical symbols and scenes, generated by a computer.
- ground:** synonym for earth. Abbreviation: Gnd.
- guard band:** range of frequencies between two ranges of transmission frequencies, left unoccupied to minimise interference.

H



- half-adder:** elementary digital circuit composed of logic gates. See adder.
- half-duplex:** a pair of transmission channels over which two-way communications may take place, although only one channel is operational at any one time, is said to allow half-duplex communications.
- half wave rectifier:** a circuit which rectifies only one half of each cycle of an applied AC wave.
- Hall effect:** an electromagnetic phenomenon which occurs when a current carrying conductor is placed in a magnetic field, the direction of which is perpendicular to the directions of both the current and its own magnetic field.
- hardware:** physical parts of a computer system eg, printer, keyboard, VDU etc.
- harmonic:** a signal present in a complex periodic waveform, which is a multiple of the fundamental frequency. The second harmonic is times three, etc.
- head:** transducer of a magnetic recording system which allows electrical signals to be changed into a magnetic field to write data onto the medium, or converts magnetic data into electrical signals.
- heatsink:** metal attachment mechanically connected to a heat producing element in a circuit (eg, a power transistor) to ensure heat is dissipated away from the element, preventing damage by excessive heat.
- henry:** unit of magnetic inductance. Symbol: H.
- hertz:** unit of frequency. Equivalent to one cycle of a periodic wave which occurs in one second. Symbol: Hz.
- heterodyne:** production of beats by combination of two signals which interfere. Used in a super-heterodyne radio receiver to produce an intermediate frequency.
- HF:** abbreviation for high frequency.
- hifi:** acronym for high fidelity.
- high fidelity:** commonly used term denoting audio reproduction equipment of good quality.
- high frequency:** bands of radio transmissions around 10 MHz. Abbreviation: HF.
- high level programming language:** a computer programming language which is more like human language or mathematical notation than the machine code used by the central processing unit of the computer.
- high logic level:** term denoting a logic 1 level (in positive logic).
- high pass filter:** a filter which allows signal frequencies above a specific corner frequency to pass without attenuation. Signal frequencies below the corner frequencies are attenuated.
- high tension:** voltages in the range between about 50V to 250V. Abbreviation: HT.
- holding current:** the value of current which must be maintained to hold a thyristor in its on state. If the current through the thyristor falls below the holding current, the thyristor turns off and ceases conduction.
- hole:** an empty space in a semiconductor material due to a 'missing' electron. As electrons are negatively charged, holes are positive. Holes, like electrons, may be thought of as charge carriers, moving through the semiconductor material thus forming a current.
- hole current:** the current through a semiconductor due to the movement of holes under an applied voltage.
- howl:** colloquial term for the sound caused by acoustic feedback.
- HT:** abbreviation for high tension.
- hum:** capacitive or magnetic interference between a mains powered device such as a power supply, and local equipment such as an amplifier. Often heard in audio frequency systems as a low drone of mains supply frequency, or a harmonic of that frequency.
- hunting:** a system's oscillation about its desired point, caused by over-correction.
- hybrid integrated circuit:** an integrated circuit comprising a number of discrete components attached to a substrate and interconnected to form a circuit. See integrated circuit.
- hybrid- $\pi$ :** a type of equivalent circuit used to show transistor operation.
- hysteresis:** phenomenon occurring in some circuits or systems, in which the output lags behind a changing input. A hysteresis loop is formed — a graph of output against input — which shows that the value of output depends on whether the input is increasing or decreasing in value.
- Hz:** abbreviation for hertz.

Continued next month

Project 

# SHORT WAVE CONVERTOR

**If you want to extend your radio experience, your thoughts may turn to short wave. Buying a receiver can be expensive but with a converter you can use a medium wave radio.**



WHILE UNDENIABLY an interesting and challenging pastime, short wave listening can be an expensive hobby, with a new general coverage communications receiver costing typically a few hundred pounds. Even the lower cost types seem to command prices well into three figures. Fortunately, there are alternatives to purchasing a new communications receiver, and it is one of these that is explored in this article.

The unit described here is a short wave converter for use with any medium wave radio that has a ferrite rod aerial or some other form of built-in aerial. The basic set-up consists of a longwire aerial connected to the converter, with the converter placed close to the medium wave radio. The latter is tuned to a "quiet" frequency at the high frequency end of the medium waveband (about 1.6MHz). This is important, since any station received directly by the radio will interfere with reception via the converter. Basically all that the converter does is to take in short wave signals and convert them to a frequency of around 1.6MHz. The signals are then radiated so that they can be received by the medium wave radio.

This is admittedly a rather roundabout way of doing things, but it has the advantage of simplicity and low cost, with an existing medium wave receiver providing most of the circuitry. The

converter itself can be extremely simple, and could be based on just a single active device. The level of performance obtained depends to a large extent on the quality of the radio, and not just on the performance of the converter. The effectiveness of the aerial is also an important factor. However, provided this converter is operated in conjunction with a reasonable aerial and a radio that gives good medium wave performance it should give good results when listening to short wave broadcast stations.

Although two amateur bands fall within the coverage of the converter it is not really suitable for amateur band reception because of difficulties in resolving the types of transmission normally found on these bands. The vast majority of short wave amateur transmissions are either SSB (single side-band) or CW (Morse) signals, neither of which can be received properly using an ordinary broadcast receiver with its AM (amplitude modulation) detector. This problem is not insurmountable and a crude form of SSB/CW reception can be obtained with a small amount of additional circuitry. In practice results are not likely to be very spectacular though, and this feature has consequently been omitted from this converter which is only intended for broadcast band listening.

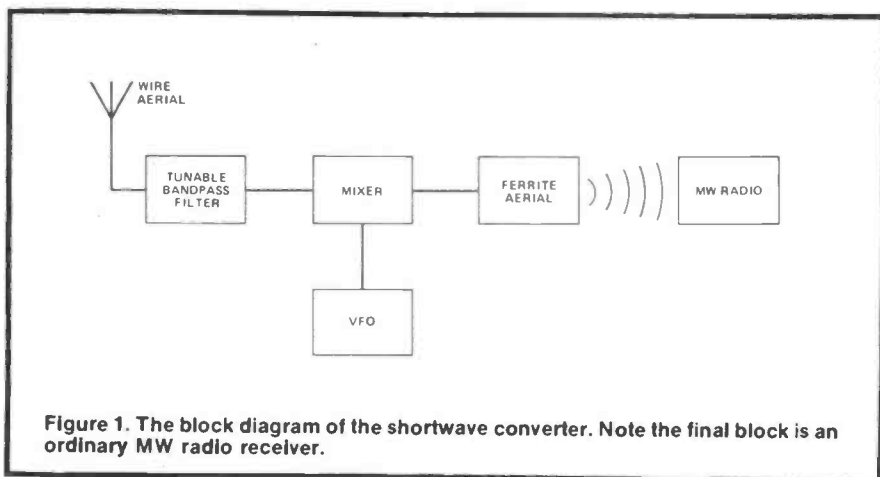
The unit covers an approximate

frequency range of 5 to 15MHz. This provides coverage of the 25, 31, 39, and 49 metre broadcast bands, which, with the possible exception of the 25 metre band, will normally provide a number of interesting transmissions regardless of the time of day or year.

## Operating Principle

The shift in frequency from around 5 to 15MHz down to about 1.6MHz is obtained using the heterodyne principle. This is something that is much used in radio circuits, and is almost certain to be utilized in the radio receiver with which you use the converter. Most radios are of the superheterodyne (or "superhet") type, where incoming signals are converted to a certain frequency, which is normally around 455 to 470kHz for MW/LW broadcast radios. This may seem to be a rather pointless and unnecessarily complex way of doing things, but for good radio reception high gain and a narrow bandwidth are required. These are easily obtained at a fixed frequency, but present real difficulties if a wide frequency range has to be covered. By converting incoming signals to a fixed ("intermediate") frequency and then processing the signal using a high gain selective amplifier a superhet circuit provides a level of performance that could probably not be achieved in any other way. When





**Figure 1.** The block diagram of the shortwave converter. Note the final block is an ordinary MW radio receiver.

using the converter with a superhet medium wave radio there are two intermediate frequencies; one at 1.6MHz and one at about 455 to 470MHz. This produces what is called a "double superhet" or "double conversion" receiver.

The block diagram of **Figure 1** helps to show the way in which the converter functions. The signal from the aerial contains numerous transmissions over a wide frequency range. The first stage of the converter is a tunable bandpass filter which attenuates signals at frequencies well outside the band that is of interest, but allows the wanted signals to pass. By removing most of the unwanted signals, gross overloading of the next stage of the converter is avoided.

This next stage is a mixer. It is important to realise, though, that this is not a mixer of the same general type used to mix audio signals. It is really a form of modulator, and the aerial signal is amplitude modulated by the signal from a variable frequency oscillator. What is of importance in this application is the new frequencies that are generated at the output of the mixer. These are the sum and difference frequencies. In other words, if an input signal is at a frequency of (say) 11.6MHz and the VFO is operating at 10MHz the difference frequency is 1.6MHz ( $11.6 - 10 = 1.6$ ). The sum frequency is 21.6MHz ( $11.6 + 10 = 21.6$ ), but it is normally the difference frequency that is exploited in converter circuits (and this is certainly the case here).

Signals 1.6MHz above or below the VFO frequency will give the 1.6MHz difference output frequency required in this application. The unit therefore receives simultaneously on two different frequencies 3.2MHz apart, but in practice the input filter attenuates one response (called the "image") so that good sensitivity is only obtained at one frequency. In the majority of circuits, including the present one, the oscillator frequency is above the reception frequency, and the bandpass filter is used to attenuate the higher of the two responses.

Having obtained the required 1.6MHz output signal it is necessary to couple it to the medium wave radio in some way. Not all sets have a telescopic aerial or some form of aerial input socket, and radiating a signal that can be picked up by the radio in the normal way is a more practical and convenient way of doing things. What is required is a very strong signal in the immediate vicinity of the converter, but one that is insignificant more than a few feet away. Such a signal can be obtained using an ordinary medium wave ferrite aerial in reverse. This effectively gives an inductive coupling to the aerial in the medium wave receiver, and a good signal transfer provided the two aerials can be placed within about 300 millimetres of each other, which is not normally difficult to accomplish in practice.

## Circuit Operation

The circuit uses just two active devices, as can be seen from the full circuit diagram which appears in **Figure 2**. As mentioned earlier, the heterodyne

## Parts List

### RESISTORS

(All 1/4W 5% carbon)

R1.....	3k3
R2.....	560k
R3.....	3k9
R4, 5.....	100k

### CAPACITORS

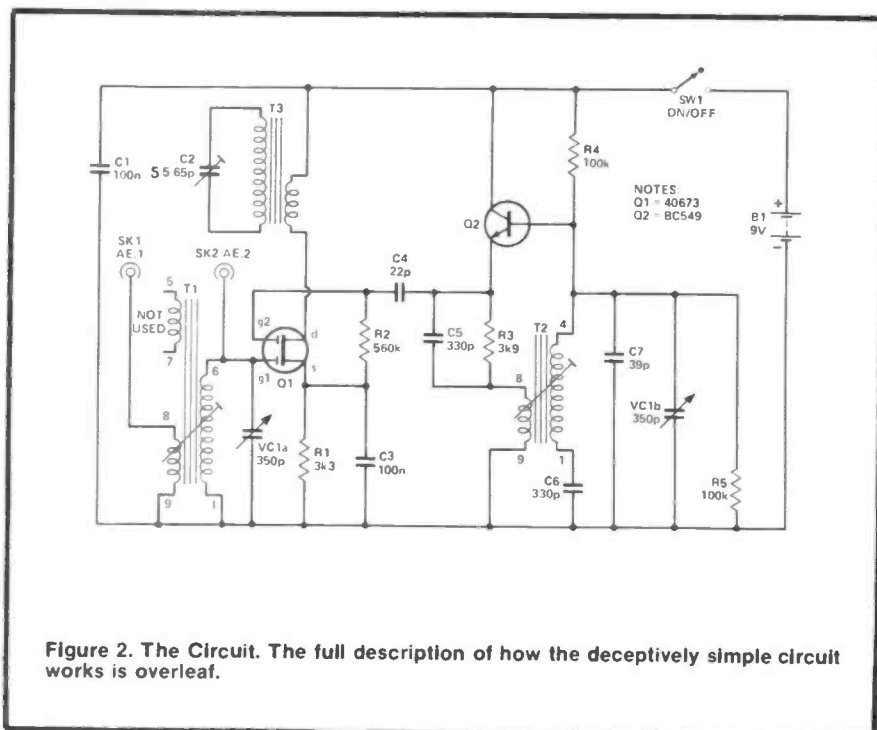
C1, 3.....	100nF
	ceramic
C2.....	5.5-65pF
	trimmer
C4.....	22pF
	ceramic plate
C5, 6.....	330pF
	ceramic plate
C7.....	39pF
	ceramic plate
VC1.....	350pF + 350pF
	variable

### SEMICONDUCTORS

Q1.....	40673
	dual gate MOSFET
Q2.....	BC549
	silicon npn

### MISCELLANEOUS

T1... Denco Aerial coil for transistor	usage range 4T (Blue)
T2..... Denco 1.6MHz dual purpose	oscillator coil range 4 (White)
T3..... Denco MW5FR	ferrite rod aerial
SW1.....	SPST toggle type
SK1, 2.....	4mm sockets
B1.....	9 volt battery (PP3 size)
Plastic case about 180 by 110 by 55mm; PCB; battery clip; 'P' type cable clip to mount aerial; control knob; wire, pins, solder, etc.	



**Figure 2.** The Circuit. The full description of how the deceptively simple circuit works is overleaf.

# Project

process can be produced using a single active device, but in the interests of good performance and low radiation from the VFO stage it is better to use separate active elements in the mixer and oscillator stages.

T1 is a radio frequency (RF) transformer, and the main winding on this forms a parallel tuned circuit in conjunction with one section of the two gang tuning capacitor, VC1. This tuned circuit forms the input bandpass filter. The aerial is normally connected to SK1, and the aerial signal is then coupled to the tuned circuit via a small coupling winding on T1. If only a short aerial is used it might be better to use direct coupling to the tuned circuit, and this can be accomplished by connecting the aerial to SK2.

There is a third winding on T1 which would normally be used to couple the output of the filter to the base circuit of a bipolar transistor. In this circuit the mixer device is a dual gate MOSFET which has an extremely high input impedance at each gate input. This renders the coupling winding unnecessary, and it is left unused in this circuit. The g1 terminal of Q1 is biased to earth through the main winding of T1, and R1 biases the source terminal slightly positive. This gives a small reverse bias to Q1, but this is a depletion mode device which requires such a bias to bring it into linear operation. R2 gives zero bias to the g2 terminal by taking it to the same potential as the source terminal. C3 is the RF bypass capacitor for R1. This prevents R1 from introducing negative feedback which would give low gain from Q1.

The gain of Q1 from the g1 terminal to the drain circuit can be varied by means of a voltage applied to the g2 terminal. In this case the g2 voltage is varied by the signal from the VFO which

is coupled to Q1 via DC blocking capacitor C4. The sum, difference, and all input frequencies appear in the drain circuit of Q1. However, the ferrite aerial (T3) selects and radiates only the required 1.6MHz difference signal, and the medium wave radio will, of course, only respond to this signal anyway. C2 enables T3 to be peaked at precisely the frequency to which the medium wave radio is tuned so that optimum coupling is required. The output of Q1 is coupled to T3 via its low impedance coupling winding so that an efficient coupling is obtained.

The VFO is a perfectly straightforward L-C oscillator which uses Q2 in the emitter follower mode. An emitter follower stage provides slightly less than unity voltage gain, but T2 provides the voltage step-up that is needed to sustain oscillation. C6 is the "padder" capacitor. As the oscillator is tracking 1.6MHz above the reception frequency the tuning capacitance swing for T1 needs to be different from that for T2. As the oscillator operates at a generally higher frequency range it needs a smaller tuning capacitance range. The padder capacitor is in series with the oscillator tuning capacitor (VC1b) and effectively reduces its capacitance swing. The value of C6 is chosen to give good tracking between the aerial and oscillator tuned circuits.

Power is provided by a small 9 volt battery. The current consumption of the circuit is only about one milliamp and each battery gives many hours of operation.

## Construction

Most of the components, including the two coils and the ferrite aerial, are mounted on the printed circuit board. Figure 3 shows the component layout

and wiring. A number of points need to be kept in mind when building the board. The ferrite aerial (T3) is mounted on the board using a large (about 9 or 10mm) 'P' type cable grip. This, together with the aerial assembly, is bolted to the board using a short M3 or 6BA bolt and fixing nut. There should be no difficulty in identifying the leads from the two windings of T3 correctly since the main winding is made using standard pink coloured litz wire, whereas the small winding is made from green coloured wire. Litz wire can be a little difficult to deal with, but things are made easier here as the leadouts are ready-tinned with solder. Trim the leadouts slightly so that only a short length of tinned wire is left at the end of each lead. This reduces the risk of accidental short circuits. Do not trim the leadout wires back any further than this. Position the coil almost at the end of the ferrite rod.

Q1 is a MOSFET device, but it has built-in diodes to protect it from high voltage static charges. Antistatic handling precautions are therefore unnecessary when dealing with this device.

T1 and T2 are really intended for plug-in mounting in a B9A valveholder rather than printed circuit mounting. The pins at the base of each former will plug into the board without too much difficulty, but they could be a little awkward to solder to the board properly. It is advisable to clean the pins of each coil by scraping them with the small blade of a penknife before fitting the coils onto the board. This should make it much easier to obtain strong and reliable soldered joints.

A plastic case having dimensions of about 180 by 110 by 55 millimetres is suitable as the housing for this project. In fact a somewhat smaller case could be

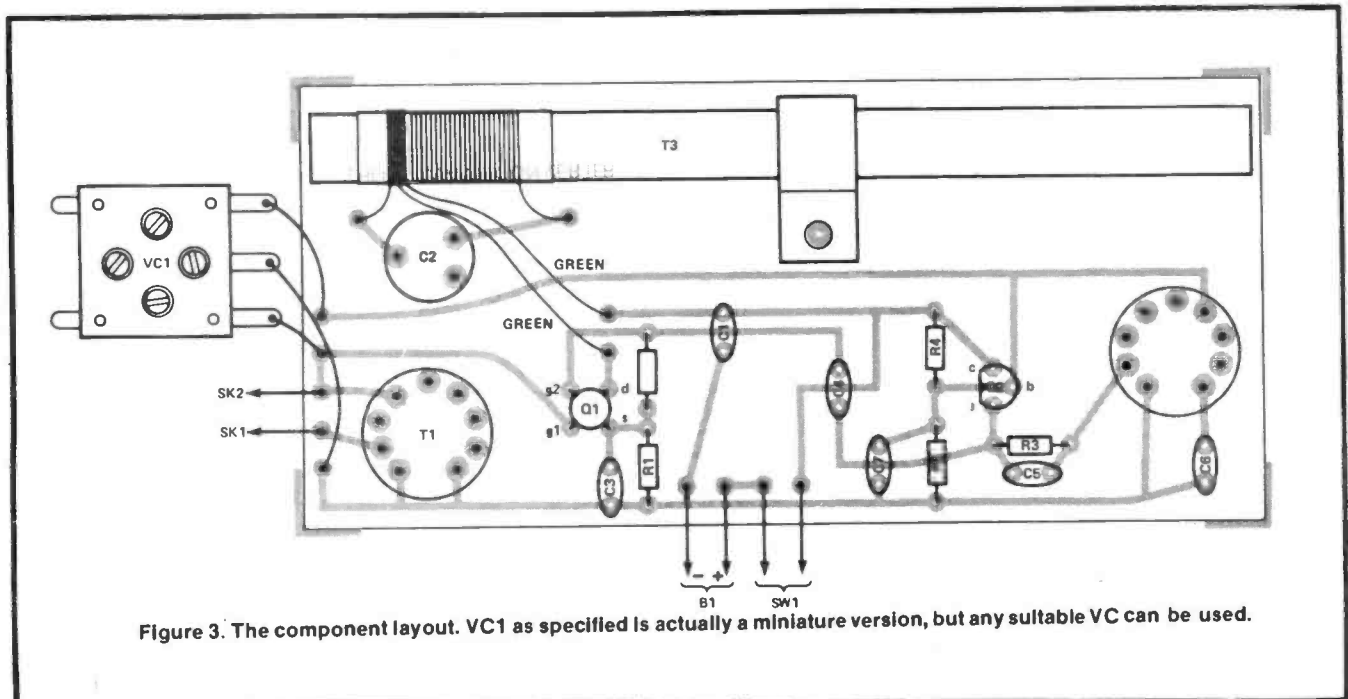
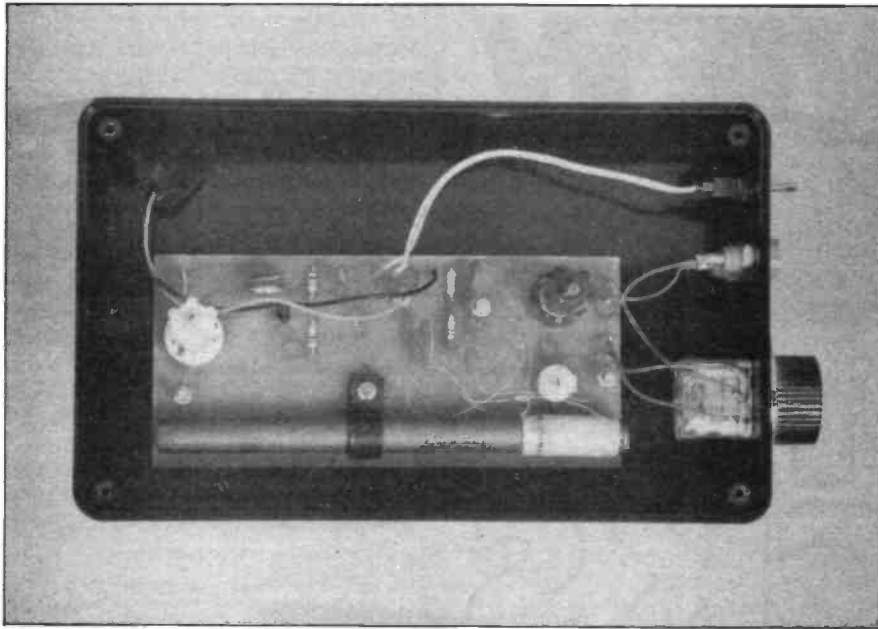


Figure 3. The component layout. VC1 as specified is actually a miniature version, but any suitable VC can be used.



makes a reasonably efficient earth that is easy to install. Keep the lead from the earth to the converter as short as possible.

## Adjustment And Use

First tune the medium wave radio to the high frequency end of the medium waveband and search for a setting that is free from stations. You should be able to find a suitable setting even after darkness has fallen (when the MW band provides reception of a vast number of stations), and remember that the directional aerial of the radio enables it to be turned to null any received signal. With the converter switched on and placed alongside the radio it will probably be possible to receive a few short wave transmissions. If not, try C2 at various settings until some signals are received. The best signal transfer from the converter to the radio is obtained when the ferrite rod aerials are parallel to one another and as close together as possible.

Once a few stations can be received, adjust C2 to peak performance. The bandwidth of the ferrite aerial is quite narrow and C2 should give a sharp peak. By contrast, T1 has a very wide bandwidth, and the setting of this will be relatively uncritical. It is given any setting that gives good results over the full frequency range covered.

You might like to try making one or two simple improvements to the basic converter. An aerial trimmer control can be added by connecting a variable capacitor of about 50pF in value across VC1a. With the core of T1 at a suitable setting this enables the input filter to be peaked for optimum results at any setting of the tuning control. A bandspread control can be added by connecting a variable capacitor of about 25pF in value in parallel with VC1b. This only gives coverage of a narrow range of frequencies, but fine tuning is consequently very much easier using the bandspread control. If no bandspread capacitor is fitted it is advisable to fit VC1 with a large control knob.

used if desired, but the case must not be of metal construction as this would screen the ferrite aerial and prevent the 1.6MHz output signal from being radiated. The printed circuit board is mounted on the base panel of the case using M3 or 6BA fixings. As the pins of T1 and T2 protrude several millimetres on the underside of the printed circuit board it is advisable to use spacers over the mounting bolts between the case and the board. If this is not done it is likely that the board will be distorted and it could possibly crack as the mounting nuts are tightened.

VC1 and the two sockets are mounted on the front panel, which is one of the 110 by 55 millimetres panels of the case. VC1 is supplied with two mounting screws which can be used to fix it to the panel, or it can simply be glued in place using a good quality general purpose adhesive. There are several tags on VC1, but in this case it is only the three at the front of the component that are required. Of course, any twin gang variable capacitor having a maximum value of about 310 to 375pF per gang can be used in the VC1 position, but the specified component is almost certainly the least expensive type currently available.

To complete the unit the small amount of hard-wiring is added. As supplied the cores of the coils are almost fully screwed down. Unscrew the cores so that about seven or eight millimetres of metal screwthread protrudes from the top of each coil. Unless you use a very large case it is unlikely to have sufficient "headroom" to accommodate the coils with the cores adjusted in this way, and two small holes must be drilled in the lid of the case so that the screwthreads can pass through. This may not look terribly neat, but it does enable the cores to be adjusted without having to remove the lid of the case.

## Aerial

A suitable aerial for the converter simply consists of a length of aerial wire which should be as long as possible and strung as high as possible. Ideally the aerial should be an outdoor type of about 20 to 40 metres in length and placed well clear of buildings. One end connects to the converter and the other is left free. In practice few people are able to accommodate an ideal aerial, and it is usually a matter of doing the best one can under the prevailing circumstances. Even a few metres of ordinary multi-strand connecting wire mounted indoors will provide reception of many interesting stations, but equally such an aerial is not going to give the best results obtainable from the equipment.

You might like to try adding an earth connection. This is by no means essential, but can give a useful improvement in results. An earth consists of a piece of metal buried in the earth, and connected to the negative supply rail of the converter (an extra socket on the front panel wired to the negative supply rail will be needed if you decide to use an earth). A length of metal pipe or rod

There are one or two 'interesting' components in this one.

The **Denco** parts are available from **Electrovalue (Tel: (0784) 33603)**. The blue aerial coil is listed at £1.86, the white dual purpose coil at £1.42 and the 5FR/MW rod aerial at £1.43.

Electrovalue also list an Altai variable capacitor (miniature) of

350pf at £1.35, which is considerably cheaper than the average VC, and a trimmer capacitor (C2) of the right specification for 37p.

The other parts should present no puzzles, and the overall cost of the project should be around £11 using the parts mentioned, excluding a case of your own choice, and PCB.

Shop

# EM REVIEW

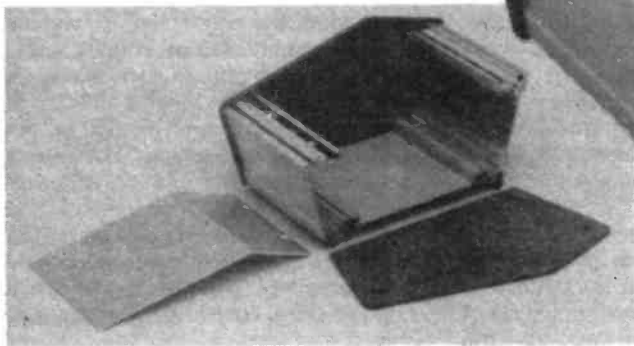
# BOX

# OF

# TRICKS

SOMEONE delivered a neat little sample of the **Retex/Box Eurobox** range to us, so we took it apart and had a look at it to see what was going on.

The box in question was quite an expensive little box: a little under a tenner for the one pictured here. Its construction and engineering is, however, intended to lift it into a professional class of presentation, which justifies the extra luxury of the price.

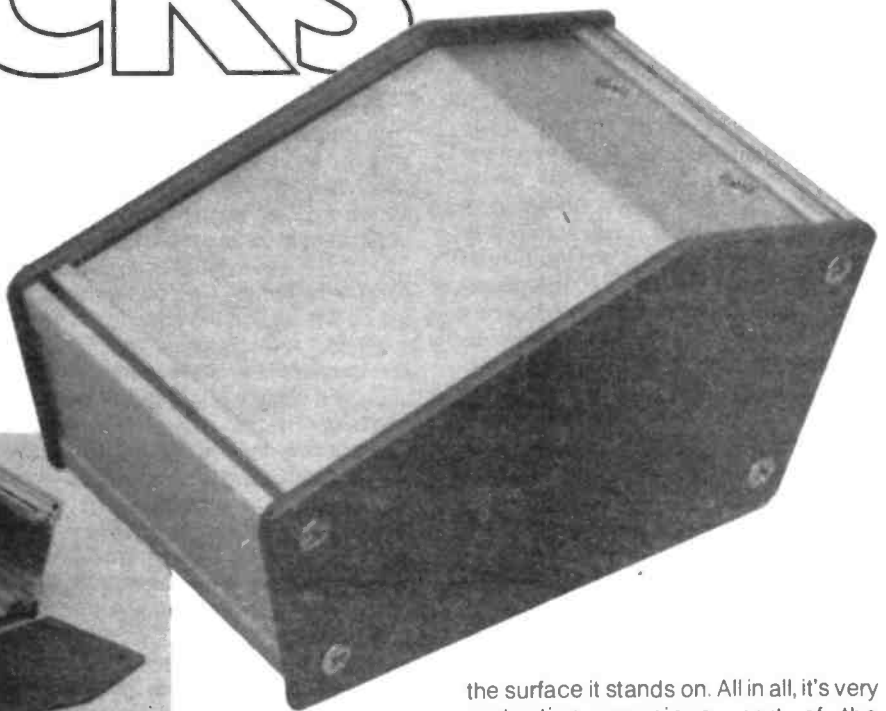


The sides of the box are PVC-coated steel (in a charming shade of periwinkle blue, for those of you with black and white sets), with face panels of brushed aluminium. Inside, the box is held together with aluminium extrusions which are slotted to support PCBs either vertically or horizontally but not, alas, both at the same time.

Observation of the product line brochure leads me to believe that the PCB-carrying function of the extrusions is a by-product of their function as a frame for the box, rather than its first concern, as many of the larger console-type boxes have slots facing a slotless face.

## Faces

The top and bottom faces of the box are covered by a layer of peel-off plastic. Holes, etc., can be marked out on the



the front-panels with a straight, professional-looking layout) before removing the plastic, helping to protect the metal finish from scratching during the operation. In any case, the brushed aluminium finish is easy to drill accurately as well as being smart-looking.

The box is opened up by removing the cross-head screws. The screws aren't self-tapped — they all screw into nuts set into the extruded frame. All the sides and faces have their own screws, so each panel has to be removed separately (or alternatively, won't fall to pieces in your hand as soon as the first panel is removed).

The steel sides have tidily rounded corners with no sharp edges, and the case has rubber feet, so it won't scratch

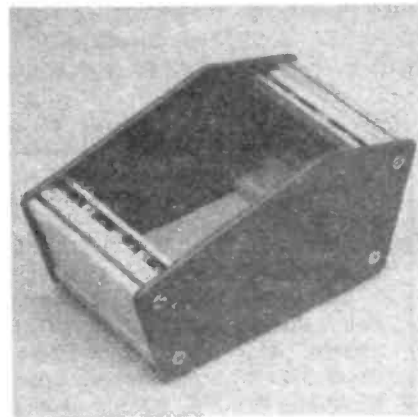
the surface it stands on. All in all, it's very protection-conscious, part of the professional image. It wouldn't be out of place on a business desk.

## Consoles

This junior box is shaped like a mini-console and would do for anything needing a meter, or an LED or LCD display, being conveniently angled for reading.

The Eurobox range is, however, very large, with upmarket computer consoles at its top end.

Not a box to strap under the bonnet of your car, this. Definitely more smart-dressed than a plain diecast box, it might be the choice if you were building a timer, for instance, which would be on general display. That would be worth the extra for the nice finish. It's also very robust, for anything needing extra protection. *The Eurobox range, and other cases by Retex, are stocked by Bradley Marshall Ltd., 325 Edgware Road, London W2 1BN.*



plastic and drilled or centre-punched (note: a centre punch is a little luxury, but a very useful little luxury if you case-up any number of projects and like to see

# NEWS

## Sheet Lens

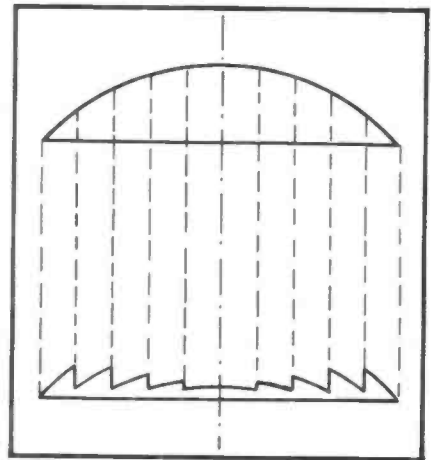
An efficient magnifier able to enlarge a whole A4 size page, and weighing only 35gms (1¼oz) is not available from **Magnifiers & Microscopes (3, Approach Road, Taplow, Maidenhead, Berks SL6 0NP. Tel. 01-437 2944).**

Essentially a flexible acetate sheet of



approximately A4 size, each unit has embossed in it (as a pattern of concentric rings) the profile of a high-grade magnifying lens, telescoped together into a surface which is virtually flat but with the optical properties of the lens. Known as a Fresnel lens, this construction has been used for years for lighthouse lenses and similar large optical systems, to reduce their weight. Recently Fresnel lenses have been used on rear windows of buses to assist the driver.

The M&M sheet magnifier has adapted the Fresnel principle to precision pressing, with concentric rings spaced 0.5 mm apart. Each ridge accurately represents the relevant



curvature of a lens which would be prohibitively expensive and heavy as a solid glass (or plastic) lens.

The sheet magnifier is extremely flexible, easily carried in a briefcase and requires no frame or mounting.

Held at a convenient reading distance above an object, the sheet magnifier offers a magnification of about 1.5 to 2x. It is therefore an effective aid to many visually handicapped people, as it allows a whole book page to be viewed at once. It is equally useful to normally sighted people for reading maps, checking intricate work and similar tasks — such as checking circuit layouts, PCBs and soldering.

The M&M magnifier retails at about £2.60 +VAT and is normally supplied (and used) in a clear acetate envelope which protects the unit against abrasion and scratches.

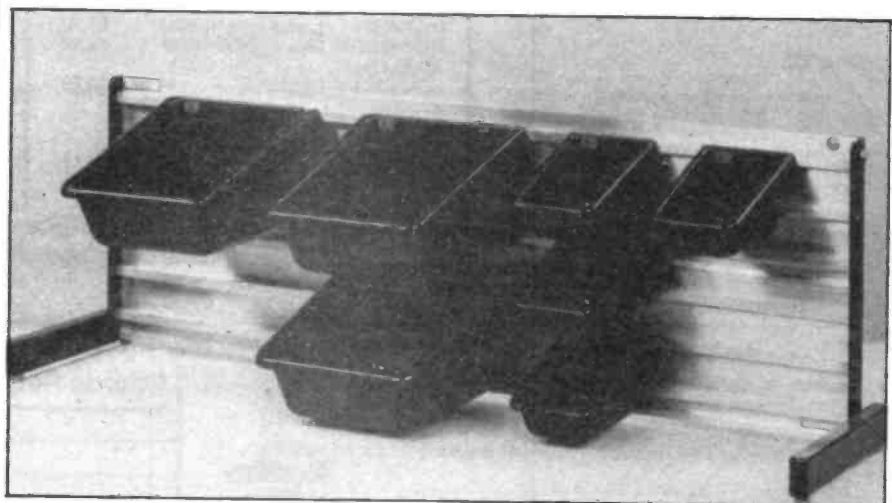
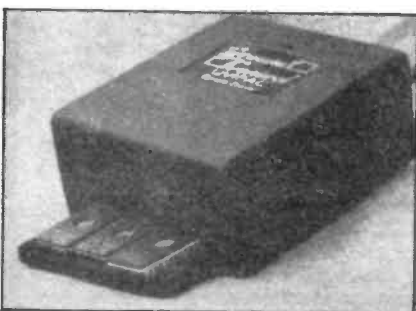
## Battery Control

Batteries need not fail as a result of overcharging. S & W Battery Charging Systems have developed a plug-in module that can be fitted to any battery charger to adjust the output according to the battery's need. The controller will allow full charge to be delivered into a flat battery, but when the voltage rises the current will reduce to a safe level. The battery may be left on without fear of overcharge. This type of control is essential when using new re-combination sealed lead acid cells.

The 10 Amp version is encapsulated and tamper-proof. It is available in fixed or adjustable voltage mode for use on various types of cells. Although designed for industrial use, the controller can also say S&W be fitted to any existing uncontrolled charging system.

For further information please contact **S & W Battery Charging Systems Ltd., Nailsea Trading Estate, Southfield Road, Nailsea, Bristol BS19 1JL. Tel. (0272) 855161.**

Or build the Intelligent NiCad Charger on page 00.



## Anti Static Containers

Components can be protected against damage from electro-static discharge by using this Appollo racking system. This equipment consists of a grounded aluminium frame, and conductive containers in a range of sizes.

Each aluminium frame offers a press stud for connection to earth or an anti-static bench mat using a grounding strap. The extrusion provides a number of lips to accept clip-on component

trays.

The trays are electro-conductive containers made from a carbon-loaded compound with a volume resistivity of 100 ohm-cm. The trays are coloured black and carry the standard black and yellow static-sensitive warning label, as well as an identifying marking on the underside.

For further information contact **Dage (GB) Ltd, Eurosem Division, Rabans Lane, Aylesbury, Bucks HP19 3RG. Tel. (0296) 33200.**



# NEWS

## New Meters

**Alcon Instruments** have introduced the Super 20 and Super 50 **multimeters** from the Miselco range.

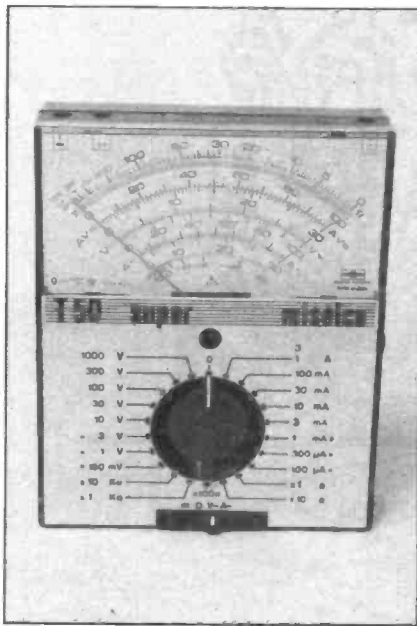
These new meters include a fool-proof protection device on all ranges, against any sort of mistake, only excluding the top 10A and 3A ranges, say Alcon. The two are similar in almost all aspects, but have basically different movements offering sensitivities of 20kR/V and 50kR/V on both AC and DC respectively.

Each instrument has 39 ranges from 100mV (150mV for the S/50) to 1kV DC and from 10V to 1kV AC. Current ranges extend from 50uA to 10A for the Super 20, and from 20uA to 3A for the Super 50 on DC, and from 3mA to 10A or 3A on AC. The resistance ranges are five, covering from 5kR to 5MR f.s.d.

An optional high voltage probe extends the upper limit of the DC ranges to 30kV for TV and the like.

Accuracy figures are 2% f.s.d. for DC and 3% for AC and 1% of centre scale for resistance. These values, coupled with the figures noted, make the Super 20 a good general-purpose multimeter, and the Super 50 well suited to the specialist electronic measurements for which it was designed.

Both instruments are protected by a quick-acting quartz-filled 1A fuse, by back-to-back diodes and by an internal (triac) that allows the instrument to stand overloads on all ranges (3A and 10A



excluded) without damage.

Further information from **Alcon**



**Instruments Ltd., 19 Mulberry Walk, London SW3 6DZ.**

## Roving Artist

If you have £250 to spare and want a printer/plotter robot, check out the Penman by **Penman Products Ltd., 8 Hazelwood Close, Dominion Way, Worthing, W. Sussex BN14 8NP. Tel: (0903) 209081.**

The Penman "combines the functions of the precision three colour plotter, printer (down to characters 1mm high),

turtle, mouse and robot with optical sensors and collision detection." Basically, the machine will draw lines and curves on a flat piece of paper, without any staircasing effect. At £250 it is not quite a low-cost plotter, but certainly a middle-range one.

Penman themselves provide utility packages for the Apple II, BBC Micro and IBM PC, and other packages are said to be in the pipeline.

## New User Group

Dear Editor,

I am writing to inform your publication that a new computer club has been formed in the **Whitehaven/Workington** area.

The club, which will be known as 'The West Cumbria User Group', will cater for computer and electronics enthusiasts.

Activities to be undertaken will include open evenings, computer courses, and working on various computer and electronic projects (at present these include 6502 & Z80 machine code as well as EPROM programmer, graphics digitiser, lightpen, and a speech project).

For details of the User Group, and dates of meetings, ring P. Majid (0946) 62732 or K. Purkiss (0946) 66586.

Yours faithfully,

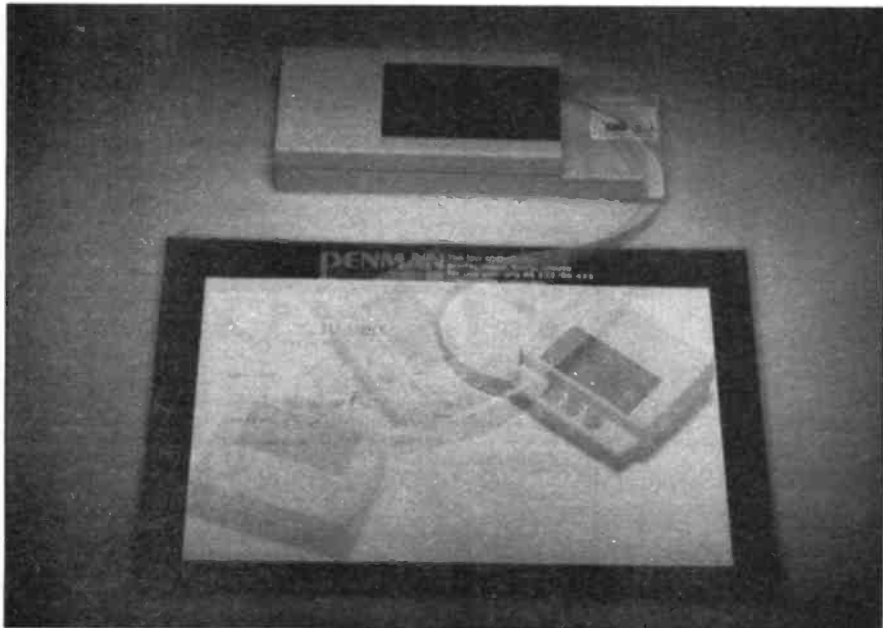
A. Johnson,  
SECRETARY.

*There you have it as we heard it. Ed.*

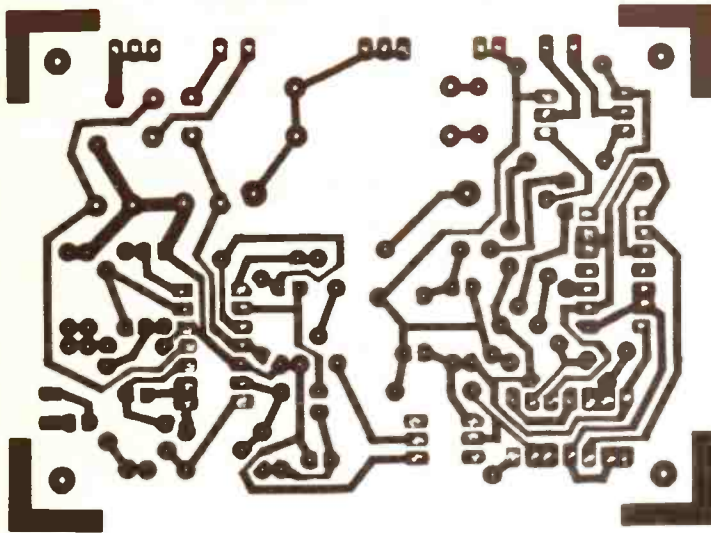
## New Shop

**Bradley Marshall** have opened a new shop (opposite their old shop) on the Edgware Road in London. A free catalogue is available listing some of their 5000 stock items.

**Bradley Marshall Ltd., 382-386 Edgware Road, London W2 1BN. Tel: 01-723 4242.**



## PCB FOIL PATTERNS



Above: The foil for the Sound To Light unit. Some of the tracks are very narrow, so check them carefully.

### STOP PRESS+STOP PRESS+ Six FX Circuits, February 1985

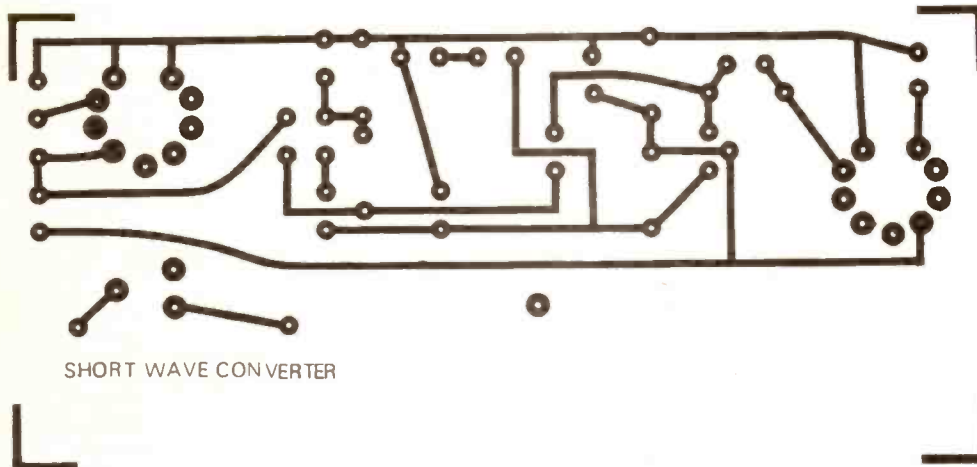
The missing pin numbers on IC5 of Figure 6 (Chorus Unit) are pin 6 and pin 7. C16 is connected across them. The component numbers missing from the sequence do not represent missing components, but simply resulted from the author's worthy efforts to reduce the number of components in the design.

### Speak Board, January 1985

People building the Speak Board for the ZX Spectrum and ZX81 have experienced some problems. These are in both the software and the hardware. They are not extensive and we are well on the way to sorting them out. Corrections will be published in the May edition, or write to the Editor requesting a correction card.

*We apologise for any problems or inconvenience resulting from misprints. Updates appear in Stop Press as soon as they are available, or write to the Editor.*

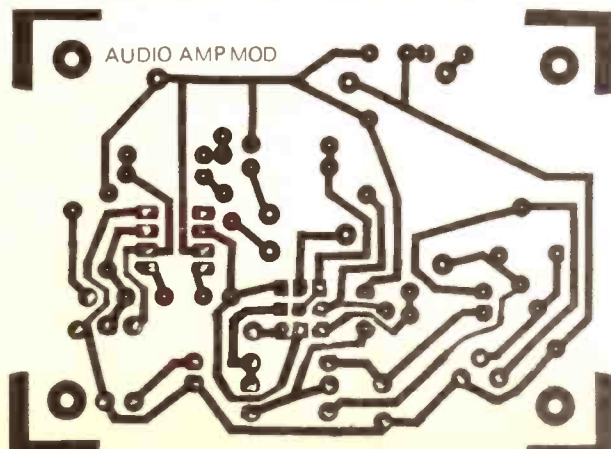
### STOP PRESS+STOP PRESS+



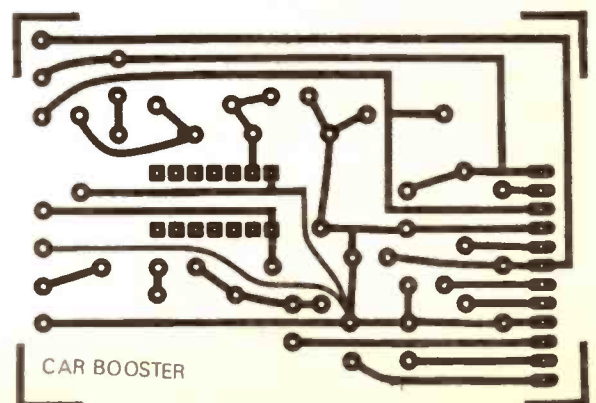
SHORT WAVE CONVERTER

Above: The foil for the Short Wave Converter. The white space at the bottom accommodates the main coil.

Below: The foil for the Audio Amplifier Module.



Below: The foil for the Car Audio Booster.





**Lineage:**

35p per word (minimum 15 words)  
Semi-display £8.20 per single column centimetre  
Ring for information on series bookings/discounts



01-437 0699

Send your requirements to:  
Caroline Faulkner  
ASP Ltd.,  
1 Golden Square,  
London W1R 3AB

All advertisements in this section must be prepaid.  
Advertisements are accepted subject to the terms and conditions printed on the advertisement rate card (available on request)

## ALARMS

**WHO CAN PUT A PRICE ON PEACE OF MIND! . . .**

Home security is now available at trade prices  
Professional Equipment at Low/Very Low Prices!

- No Gimmicks
- All Prices Include VAT
- Immediate Despatch
- Complete with Full Four Colour Instructions & Two Year Guarantee
- Free Technical Advice
- Control Panels

**Advanced Security Products Ltd**  
2 Ealing Road, Aintree,  
Liverpool L9 0HU, Merseyside  
Tel: 051 525 3440

Do it now before it's too late! . . .

**SECURITY Alarm Systems**

FREE COMPREHENSIVE CATALOGUE!

- LOWEST DISCOUNT PRICES
- HIGHEST QUALITY EQUIPMENT
- FREE DIY DESIGN GUIDE
- FULLY ILLUSTRATED
- MICROCHIP CIRCUITRY
- QUICK DESPATCH SERVICE
- FULL INSTRUCTIONS

SEND SAE OR PHONE

C-TECH SECURITY, Dept. EM  
Stephens Way, Goose Green,  
Wigan WN3 5PH  
Telephone (0942) 42444

Trade Enquiries Welcome

**BURGLAR Alarm Equipment.** Please visit our 2,000 sq. ft. showrooms or write or phone for your free catalogue. C.W.A.S. Ltd., 100 Rooley Avenue, Bradford BD6 1DB. Telephone 0274 731532.

TO FILL  
THIS SPACE  
PHONE CAROLINE  
ON 01-437 0699

## PLANS 'N DESIGN

**AMAZING** electronic plans, lasers, gas, ruby, light shows, high voltage teslas, van de graph, surveillance devices, ultrasonics, pyrotechnics, new solar generator, 150 more projects, catalogue S.A.E., Plancentre, Old String Works, Bye Street, Ledbury HR8 2AA.

## HOBBY SHOP

## LANCASHIRE

**E.E. ETESON ELECTRONICS**

158 Lower Green  
Poulton-le-Fylde Blackpool  
Tel: (0253) 885107  
Open 9:30 am-12:30, 1:30-5:30  
Closed Wed. & Sun.  
Electronic Component Specialists

## SOFTWARE EDUCATIONAL

## IMPROVE YOUR PROSPECTS

with skills that employers want - learn the easy way with modern home study courses from Ideal Schools.

**MODERN ELECTRONICS**  
Train for success in the fastest ever growing industrial sector.

**COMPUTER PROGRAMMING**  
The demand for Programmers is increasing constantly - don't miss out!  
For free booklet write today to

**IDEAL SCHOOLS**  
(Ref. EM1)  
60 St. Enoch Sq  
Glasgow G1 UK.  
Tel: 041-248 5200

## FOR SALE

**CLEARING LABORATORY,** scopes, generators, P.S.U.'s, bridges, analysers, meters, recorders etc. Telephone: 0403-76236.

## COMPONENTS

**WE SUPPLY** a wide range of electronic components and service parts. Also new telephone plugs and sockets, joystick interfaces and leads for most computers. Burglar alarm equipment including sensor sirens, bells, buzzers all at competitive prices. Write or phone for details. Shudehill Supply Co. Ltd., 53 Shudehill, Manchester M4 4AW. 061-834 1449.

**RESISTORS** 1,000 mixed 1/4W, 1/2W, 1/2W; 2%, 5%, 10% C. Film £3.45 inc. P&P D.J. Hooker, Romney Marsh Electronics, Romney Marsh, Kent TN28 8PB.

## LIGHT SEQUENCERS

E.P.R.O.M. Controlled 8ch; 500w/ch.  
33 Sequences Ready Built & Tested board £67. DIY . . . PCG + EPROM (instruction included) £16.60.

Demo at:  
Skybridge, Princes Rd., Dartford  
Send from: Tadpole, 11 Blenheim Close, Dartford, Kent DA1 3ED

**TRANSFORMERS,** panel meters, Ni-cad battery chargers, capacitors, presets. Send £1 for 172 page illustrated catalogue to: M. Dziwbas, 158 Bradshaw Gate, Bolton BL2 1BA.

## DIGITAL ELECTRONICS

Are you up to BTEC Standard?  
Follow this OPEN LEARNING course for £30.00 only and be sure.

Written by a technical college head it uses all the best methods of learning, by booklet audio tape, and a planned sequence of digital experiments.

Booklet.....£3.75 P/P 40p  
Audio tape .....£1.50 P/P 40p  
Circuitboard.....£20.00 P/P £2.00  
Component kit.....£6.95 P/P 50p  
Full course.....£30.00 inc

Two postage only tutorials for full course purchases.

Cash with order to:  
apt Open Learning, Porters Pk,  
Boreham, Chelmsford CM3 3BH.  
Further details S.A.E. (A4)

## KITS

**PRINTED CIRCUITS.** Make your own simply, cheaply and quickly! Golden Fotolac light-sensitive lacquer - now greatly improved and very much faster. Aerosol cans with full instructions, £2.25. Developer 35p. Ferric chloride 55p. Clear acetate sheet for master 14p. Copper-clad fibreglass board, approx. 1mm thick £1.75 sq. ft. Post/Packing 50p. White House Electronics, Castle Drive, Praa Sands, Penzance, Cornwall.

**HE ORGAN KITS,** keyboards, components, PCBs available from A.T. Hawkins, 23 Blenheim Road, St. Albans, Herts AL1 4NS (0727) 57344.

**MINIATURE TRANSMITTER,** transmits all voices and sounds to any VHF/FM radio up to 5 miles away, size 21N\* 1/2in, tunable 70-150 MHz, complete kit, including sensitive microphone, £4.95. Send cash/cheque/P.O.: Technonics, 22 Lambardes N.A.G., Nr Dartford, Kent DA3 8HX. Mail order only.

**EXPERIMENTER KIT** makes eight projects including: Frequency meter, sound switch, tachometer, capacitance meter. We supply I.C., special P.C.B. and instructions. You supply resistors and capacitors. Only £6.40! lon-lser kit complete with cage £7.40. S.A.E. Lists. D. Horsley, 113 Clare Road, Braintree, Essex.

## EQUIPMENT

**M&A AUDIO MIXERS** available assembled or as kits from 1:1 to 50:16. Catalogue free from K-Tek. 01-399 3990.

## SERVICE MANUALS

**SERVICE MANUALS.** Test equipment, audio, television, video, etc, from £1.00. LSAE enquiries, Maurinton (HE), 8 Cherrytree Rd., Chinnor, Oxon.

## FOR SALE

**STEREOAMPS 120 WATT** (60+60)... Case-D.I.N. sockets and controls...9.40v/smoothing...Protected outputs 3/15 OHM tested and diagrams £10/Inc... KIA 8 Cunliffe Road Ilkley...

## WESTFIELD SUPPLIES

**RESISTORS** ¼/9½watt carbon film **£3.50/1000** min order 100 of one.

**POWER SUPPLIES** Stabilized power supply with voltage selector switch 240V 50HZ in 6/9/12V D.C. out 1 amp rated **£16.50.**

**DESOLDERING PUMP** Standard quality pump for general use. All metal body Teflon Nozzle **£2.90.**  
**Deluxe desoldering pump £4.40.**

**BRITISH MADE SOLDER** ½ kilo **£8.80.**

**BLACK PVC INSULATING TAPE** 10 Rolls **£1.96.**

**C60 LOW NOISE AUDIO CASSETTES** 3 for 90p.

Audio & HiFi, car accessories, components, cable, disco, lighting microphones, loudspeakers, lamps, magnifiers, power supplies, transformers, public address intercoms, computer accessories, sirens & alarms, tools & service aids, test equipment.

*IN FACT WHAT EVER YOU REQUIREMENTS  
GIVE BRUCE A RING ON  
LEEDS (0532) 872471  
24 HR ANSWERING SERVICE*

**WESTFIELD SUPPLIES**  
89 Westfield Lane, Kippax, Leeds LS25 7JA

*Trade, School, official orders welcome  
All prices include VAT.  
Please add £2.00 P&P*

## ELECT. MONTHLY — KITS MAGENTA

Full kits inc PCBs, hardware, electronics, cases (unless stated). Less batteries. If you do have the issue of HE/EM which includes the project — you will need to order the instruction reprint as an extra — 70p each. Reprints available separately.

ANTI PHASER Feb 85	£21.78	Kit less panel meter & case	£8.99
LITTLE HEADPHONE PRACTIC AMP Feb 85	£16.34	SPECTRUM TEMPERATURE INTERFACE	
INTELLIGENT CAD CHARGER Feb 85	£25.34	Nov 84	£28.38
LOGICAL LOCK Feb 85 inc switch panel	£25.32	Kit less case & edge connector	£22.88
SPEAK BOARD (Speech for micros) Jan 85		SIMPLE LOGIC MONITOR Nov 84	£12.44
less case & connectors	£28.99	inc clip parts. No case.	
CYBAL SYNTHESIZER Dec 84	£26.96	SPRING REVER UNIT May 84	£22.48
Kit less case	£19.96	INFRA-RED CAMERA CONTROL Feb 84	£17.49
SPRING LINE REVERB UNIT Dec 84	£27.81	BASSMAN Dec 83	£10.36
LOW POWER PSU Dec 84	£16.70	CONTINUITY TESTER Dec 83	£5.55
Kit less case	£11.98	ULTRASONIC INTRUDER ALARM	
THE THING (novelty) Dec 84 less case	£9.43	Oct 83	£14.85 less case
FISCHER INTERFACE (pen plotter) Dec 84	£17.96	DIGITAL CAPACITANCE METER Apr 82	£23.50
		BIKE ALARM Apr 82	£13.99
THREE OUTPUT POWER SUPPLY Dec 84	£26.97	FUZZBOX Mar 81	£11.98
		MEDIUM WAVE RADIO Feb 81	£8.79
SIMPLE ANALOGUE THERMOMETER	£16.85	GUITAR PRE AMP Nov 80	£8.79
Nov 84		Case extra	£3.50

### THIS MONTH'S KITS SAE or 'phone for prices



### fischertechnik

Robotics kit: build 6 different working models including robot arm, graphics board, sorting system etc. Note that not all the models can be built at the same time.

ROBOTICS kit (544EM) **£64.99**

Interfaces for the BBC & Spectrum Computers — ask for details. Sae — State micro.

### CATALOGUE

1985 CATALOGUE. Brief details of each kit, our books, & illustrations of our range of tools & components etc.

CATALOGUE & PRICE LIST — send £1 in stamps etc or add £1 to your order. Price list — 9 x 4 588.

Catalogue FREE TO SCHOOLS/COLLEGES REQUESTED ON OFFICIAL LETTERHEAD.



### FUN WITH ELECTRONICS

Enjoyable introduction to electronics. Full of very clear full colour pictures and easy to follow text. Ideal for all beginners — children and adults. Only basic tools needed. 64 full colour pages cover all aspects — soldering — fault finding — components (identification and how they work). Also full details of how to build 6 projects — burglar alarm, radio, games, etc. Requires soldering — 4 pages clearly show you how.

COMPONENTS SUPPLIED ALL ALL PROJECTS TO BE BUILT AND KEPT. Supplied less batteries & cases. FUN WITH ELECTRONICS COMPONENT PACK £18.48 BOOK EXTRA £1.75. Book available separately.

### MAGENTA ELECTRONICS LTD.

EM6, 135 Hunter St., Burton-on-Trent Staffs. DE14 2ST. Mail Order Only. (0283) 65435 S.A.E. enquiries. And 60p p&p to all orders. Prices include VAT. Access & Visa phone/post.

24 hr answerphone for credit card orders. Official school orders welcome. OVERSEAS: Payment must be sterling. IRISH REPUBLIC + BFPO - UK PRICES EUROPE: UK PRICES + 10% ELSEWHERE: WRITE FOR QUOTE

## Electronics Monthly April 1985 Advertisers Index

Alcon Instruments.....	29
Antex.....	OBC
Armon Electronics.....	23
Bi-Pak.....	IFC
B.K. Electronics.....	IBC
B.N.R.E.S.....	17
J. Bull.....	23
Bradley Marshall.....	11
Greenweld.....	12
I.C.S.....	23
I.L.P.....	17
Kemplant.....	23

Magenta.....	12
Marshalls.....	23
Microrange.....	52
Pantec.....	38
Resco Marketing.....	52
Skybridge.....	29
Staple Cross Centre.....	52
S & R Brewster.....	11
Systems Electronique.....	66
Vangelder.....	11
Westfield Supplies.....	12

## LOOK - IT'S HIS NEW YEAR SPECIAL!

TREAT YOURSELF THIS NEW YEAR



### BEARPARTS

CONTENTS OF PACK:  
BC 612 Transistor, Red LED, 1N4004 Diode, Tl 646 Diode, 560pf 200v Capacitor, 10k, 150k Resistors, 2k Multiturn Potentiometer, 4BA Crimp Eyelet, Rubber Grommet, Instrument Wire, Sleeving.

We are the main stockists for 'BEARPARTS', the new name in electrical, electronic and audio components.

Interested? Send S.A.E. and receive your

**FREE**

'BEARPARTS' sample pack.

### COMPLETE SOLDERING KIT

(For the Hobbyist/Electronics Engineer)

FOR LESS THAN £10!!

Comprises of:-

- Antex Miniature 15W 240v AC Soldering Iron
- Antex Iron Stand c/w Sponge
- Desolder Pump
- 2 mtr Solder
- Desolder Braid
- 13A Plug

LIMITED OFFER WHILE STOCKS LAST!

ONLY £9.85

Please add 80p P & P + 15% VAT



Call in and see our new counter now open. 9.00 - 5.00 Mon-Fri & 9.00 - 12.00 Sat Too far to call? Don't worry, export/mail order is our speciality. Why not write and find out more.



24 hr answerphone for credit card orders Tel: 0244 536699



## SYSTEMS ELECTRONIQUE

(U.K.) LTD.

26 Engineer Park, Sandycroft, Deeside, Clwyd CH5 2QD. Tel: (0244) 536700.

# OMP POWER AMPLIFIER MODULES

\* PRICES INCLUDE V.A.T. \* PROMPT DELIVERIES \* FRIENDLY SERVICE \* LARGE S.A.E. 28p STAMP FOR CURRENT LIST

## OMP POWER AMPLIFIER MODULES

Now enjoy a world-wide reputation for quality, reliability and performance at a realistic price. Four models available to suit the needs of the professional and hobby market. i.e. Industry, Leisure, Instrumental and Hi-Fi, etc. When comparing prices, NOTE all models include Toroidal power supply, Integral heat sink, Glass fibre P.C.B., and Drive circuits to power compatible Vu meter. Open and short circuit proof.

Supplied ready built and tested.



**OMP100 Mk II Bi-Polar Output power 110 watts R.M.S. into 4 ohms, Frequency Response 15Hz - 30KHz -3dB, T.H.D. 0.01%, S.N.R. -118dB, Sens. for Max. output 500mV at 10K, Size 360 X 115 X 72mm. PRICE £32.99 + £2.50 P&P.**



**OMP/MF100 Mos-Fet Output power 110 watts R.M.S. into 4 ohms, Frequency Response 1Hz - 100KHz -3dB, Damping Factor 80, Slew Rate 45V/uS, T.H.D. Typical 0.002%, Input Sensitivity 500mV, S.N.R. -125dB, Size 300 X 123 X 60mm. PRICE £39.99 + £2.50 P&P.**



**OMP/MF200 Mos-Fet Output power 200 watts R.M.S. into 4 ohms, Frequency Response 1Hz - 100KHz -3dB, Damping Factor 250, Slew Rate 50V/uS, T.H.D. Typical 0.001%, Input Sensitivity 500mV, S.N.R. -130dB, Size 300 X 150 X 100mm. PRICE £62.99 + £3.50 P&P.**



**OMP/MF300 Mos-Fet Output power 300 watts R.M.S. into 4 ohms, Frequency Response 1Hz - 100KHz -3dB, Damping Factor 350, Slew Rate 60V/uS, T.H.D. Typical 0.0008%, Input Sensitivity 500mV, S.N.R. -130dB, Size 330 X 147 X 102mm. PRICE £79.99 + £4.50 P&P.**



**Vu METER** Compatible with our four amplifiers detailed above. A very accurate visual display employing 11 L.E.D. diodes (7 green, 4 red) plus an additional on/off indicator. Sophisticated logic control circuits for very fast rise and decay times. Tough moulded plastic case, with tinted acrylic front. Size 84 X 27 X 45mm. PRICE £8.50 + 50p P&P.

NOTE: Mos-Fets are supplied as standard (100KHz bandwidth & Input Sensitivity 500mV) If required, P.A. version (50KHz bandwidth & Input Sensitivity 775mV) Order - Standard or P.A.

**19" RACK CASED MOS-FET STEREO AMPLIFIERS** with twin power supplies and L.E.D. Vu meters plus X.L.R. connectors.

Three models (Ratings RMS into 4 ohms)

MF200 (100 + 100w)	£169.00	Securicor Delivery
MF400 (200 + 200w)	£228.85	
MF600 (300 + 300w)	£274.85	£10.00

## LOUDSPEAKERS

5 to 15 INCH Up to 300 WATTS R.M.S. All speakers 8 ohm Impedance.



**POWER RANGE**  
 8" 50 WATT R.M.S. Hi-Fi/Disco.  
 20 oz. magnet 1 1/2" ally voice coil. Ground ally fixing escutcheon. Res. Freq. 40Hz. Freq. Resp. to 6KHz. Sens. 92dB. PRICE £10.99 available with black grille £11.99 P&P £1.50 ea.  
 12" 100 WATT R.M.S. Hi-Fi/Disco  
 50 oz. magnet. 2" ally voice coil. Ground ally fixing escutcheon. Die-cast chassis. White cone. Res. Freq. 25Hz. Freq. Resp. to 4KHz. Sens. 95dB. PRICE £28.60 + £3.00 P&P ea.  
 15" 100 WATT R.M.S. Hi-Fi/Disco  
 50 oz. magnet. 2" ally voice coil. Ground ally fixing escutcheon. Die-cast chassis. White cone. Res. Freq. 20Hz. Freq. Resp. to 2.5KHz. Sens. 97dB. PRICE £37.49 + £3.00 P&P ea.

**MCKENZIE**  
 12" 85 WATT R.M.S. C1285GP Lead guitar/keyboards/Disco.  
 Res. Freq. 45Hz. Freq. Resp. to 6.5KHz. Sens. 98dB. PRICE £24.99 + £3.00 P&P ea.  
 12" 85 WATT R.M.S. C1285TC P.A./Disco 2" ally voice coil. Twin cone.  
 Res. Freq. 45Hz. Freq. Resp. to 14KHz. PRICE £24.99 + £3.00 P&P ea.  
 15" 150 WATT R.M.S. C15 Bass Guitar/Disco.  
 3" ally voice coil. Die-cast chassis. Res. Freq. 40Hz. Freq. Resp. to 4KHz. PRICE £49.99 + £4.00 P&P ea.

**WEM**  
 5" 70 WATT R.M.S. Multiple Array Disco etc.  
 1" voice coil. Res. Freq. 52Hz. Freq. Resp. to 5KHz. Sens. 89dB. PRICE £20.00 + £1.50 P&P ea.  
 8" 150 WATT R.M.S. Multiple Array Disco etc.  
 1" voice coil. Res. Freq. 48Hz. Freq. Resp. to 5KHz. Sens. 92dB. PRICE £27.00 + £1.50 P&P ea.  
 10" 300 WATT R.M.S. Disco/Sound re-enforcement etc.  
 1 1/2" voice coil. Res. Freq. 35Hz. Freq. Resp. to 4KHz. Sens. 92dB. PRICE £30.00 + £2.00 P&P ea.  
 12" 300 WATT R.M.S. Disco/Sound re-enforcement etc.  
 1 1/2" voice coil. Res. Freq. 35Hz. Freq. Resp. to 4KHz. Sens. 94dB. PRICE £38.00 + £3.00 P&P ea.

**SOUNDLAB (Full Range Twin Cone)**  
 5" 60 WATT R.M.S. Hi-Fi/Multiple Array Disco etc.  
 1" voice coil. Res. Freq. 63Hz. Freq. Resp. to 20KHz. Sens. 86dB. PRICE £9.99 + £1.00 P&P ea.  
 6 1/2" 60 WATT R.M.S. Hi-Fi/Multiple Array Disco etc.  
 1" voice coil. Res. Freq. 56Hz. Freq. Resp. to 20KHz. Sens. 89dB. PRICE £10.99 + £1.50 P&P ea.  
 8" 60 WATT R.M.S. Hi-Fi/Multiple Array Disco etc.  
 1 1/4" voice coil. Res. Freq. 38Hz. Freq. Resp. to 20KHz. Sens. 89dB. PRICE £12.99 + £1.50 P&P ea.

## BURGALAR ALARM

Better to be 'Alarmed' than terrified. Thandar's famous 'Minder' Burglar Alarm System. Superior microwave principle. Supplied as three units, complete with interconnection cable. FULLY GUARANTEED.

IDEAL for Work-shops, Factories, Offices, Home, etc. Supplied ready built.



**Control Unit** - Houses microwave radar unit, range up to 15 metres adjustable by sensitivity control. Three position, key operated fascia switch - off - test - armed - 30 second exit and entry delay.

**Indoor Alarm** - Electronic swept freq. siren. 104dB output.

**Outdoor Alarm** - Electronic swept freq. siren. 98dB output. Housed in a tamper-proof heavy duty metal case.

Both the control unit and outdoor alarm contain rechargeable batteries which provide full protection during mains failure. Power requirement 200/260 Volt AC 50/60Hz. Expandable with door sensors, panic buttons etc. Complete with instructions.

SAVE £148.00 Usual Price £228.85  
**BKE's PRICE £79.99 + £4.00 P&P**  
 ? Why buy a collection of self-assembly boards!

## OMP LINNET LOUDSPEAKERS

The very best in quality and value. Made specially to suit today's need for compactness with high sound output levels. Finished in hard wearing black vinyl with protective corners, grille and carry handle. All models 8 ohms. Full Range 45Hz - 20KHz.



OMP 12/100 watts 20" X 15" X 12" £125.00 per pair  
 OMP 10/200 watts 18" X 15" X 11" £145.00 per pair  
 OMP 12/300 watts 20" X 15" X 11" £169.00 per pair

Delivery: Securicor £8.00 per pair

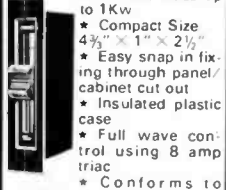
## STEREO CASSETTE DECK



**STEREO CASSETTE DECK**  
 Ideal for installing into Disco and Hi-Fi cabinet/Consoles. Surface mounting (Horizontal). Supplied as one unit with all electronics including mains power supply.

- \* Metal top panel Black finish
  - \* Piano type keys including pause
  - \* Normal/Chrome tape switch
  - \* Twin Vu Meters
  - \* 3 Digit counter
  - \* Slider Record Level control
  - Size 171 X 317 mm Depth 110 mm
- PRICE £35.99 + £3.00 P&P

## 1 K-WATT SLIDE DIMMER



- \* Control loads up to 1Kw
  - \* Compact Size 4 3/8" X 1" X 2 1/2"
  - \* Easy snap in fitting through panel/cabinet cut out
  - \* Insulated plastic case
  - \* Full wave control using 8 amp triac
  - \* Conforms to BS8300
- \* Suitable for both resistive and inductive loads. Innumerable applications in industry, the home, and disco's, theatres etc.  
 PRICE £12.99 + 75p P&P (Any quantity).

## BSR P295 ELECTRONIC TURNTABLE

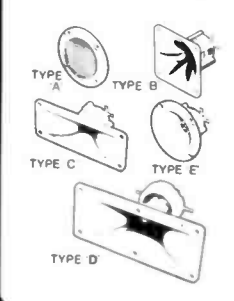
\* Electronic speed control 45, 33 1/3 r.p.m. \* Plus/Minus variable pitch control \* Belt driven \* Aluminium platter with strobed rim \* Cue lever \* Anti-skate (bias device) \* Adjustable counter balance \* Manual arm \* Standard 1/2" cartridge fixings \* Supplied complete with cut out template \* D.C. Operation 9-14v D.C. 65mA  
 Price £36.99 - £3.00 P&P



ADC Q4 mag. cartridge for above. Price £4.99 ea. P&P 50p.

## PIEZO ELECTRIC TWEETERS MOTOROLA

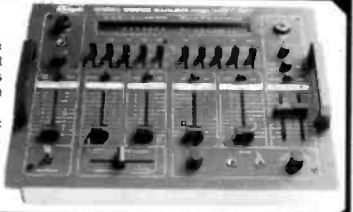
Join the Piezo revolution. The low dynamic mass (no voice coil) of a Piezo tweeter produces an improved transient response with a lower distortion level than ordinary dynamic tweeters. As a crossover is not required these units can be added to existing speaker systems of up to 100 watts (more if 2 put in series). FREE EXPLANATORY LEAFLETS SUPPLIED WITH EACH TWEETER.



**TYPE 'A' (KSN2036A)** 3" round with protective wire mesh. Ideal for bookshelf and medium sized Hi-Fi speakers. Price £5.39 each + 40p P&P  
**TYPE 'B' (KSN1005A)** 3 1/2" super horn. For general purpose speakers, disco and P.A. systems etc. Price £5.99 each + 40p P&P  
**TYPE 'C' (KSN6016A)** 2" X 5" wide dispersion horn. For quality Hi-Fi systems and quality discos etc. Price £6.99 each + 40p P&P  
**TYPE 'D' (KSN1025A)** 2" X 6" wide dispersion horn. Upper frequency response retained extending down to mid range (2KHz). Suitable for high quality Hi-Fi systems and quality discos. Price £9.99 each + 40p P&P  
**TYPE 'E' (KSN1038A)** 3 3/4" horn tweeter with attractive silver finish trim. Suitable for Hi-Fi monitor systems etc. Price £5.99 each + 40p P&P  
**LEVEL CONTROL** Combines on a recessed mounting plate, level control and cabinet input jack socket. 85 X 85 mm Price £3.99 + 40p P&P

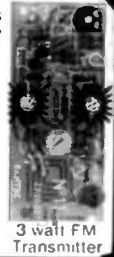
## STEREO DISCO MIXER

**STEREO DISCO MIXER** with 2 X 5 band L & R graphic equalisers and twin 10 segment L.E.D. Vu Meters. Many outstanding features 5 inputs with individual faders providing a useful combination of the following - 3 Turntables (Mag) 3 Mics. 4 Line plus Mic with talk over switch. Headphone Monitor. Pan Pot. L & R. Master Output controls. Output 775mV. Size 360 X 280 X 90mm. Price £134.99 - £3.00 P&P



## PANTEC HOBBY KITS. Proven designs including glass fibre printed circuit board and high quality components complete with instructions.

**FM MICROTRANSMITTER (BUG)** 90/105MHz with very sensitive microphone. Range 100/300 metres. 57 X 46 X 14mm (9 volt) Price: £8.82 + 75p P&P.  
**3 WATT FM TRANSMITTER** 3 WATT 85/115MHz varicap controlled professional performance. Range up to 3 miles 35 X 84 X 12mm (12 volt) Price: £13.74 + 75p P&P.  
**SINGLE CHANNEL RADIO CONTROLLED TRANSMITTER/RECEIVER** 27MHz. Range up to 500 metres. Double coded modulation. Receiver output operates relay with 2amp/240 volt contacts. Ideal for many applications. Receiver 90 X 70 X 22mm (9/12 volt). Price: £17.82. Transmitter 80 X 50 X 15mm (9/12 volt). Price: £11.27 P&P + 75p each. S.A.E. for complete list.



POSTAL CHARGES PER ORDER £1.00 minimum. OFFICIAL ORDERS WELCOME. SCHOOLS, COLLEGES, GOVERNMENT BODIES, ETC. PRICES INCLUSIVE OF V.A.T. SALES COUNTER VISA/ACCESS/C.O.D. ACCEPTED.

**B. K. ELECTRONICS**  
 UNIT 5, COMET WAY, SOUTHEND-ON-SEA,  
 ESSEX. SS2 6TR TEL: 0702-527572

# ANTEX a world of soldering



SK5 Soldering Kit

Model XS

Model CS

Model C

TCSU-D  
Temperature-Controlled  
Soldering Unit



ST4 Stand



TCSU1 Soldering Unit

## Tomorrows Soldering Technology Today.

ANTEX has a worldwide reputation for quality & service & for many years has been one of the best known & most popular names in soldering. Always at the forefront of technology, ANTEX is continually researching new and better ways of achieving more accurate, reliable, and cost effective soldering. On ANTEX Soldering Irons, the advanced design of the interface between the element & the bit allows more efficient heat transfer to the work and improved stability of the temperature at the point of contact with the work. Indeed, experiments have shown that an XS25 watt iron can be used for tasks where a 40 watt iron would normally have been required.

ANTEX Soldering Irons exhibit exceptionally low leakage currents & hence are suitable for use on Static Sensitive Devices. Sophisticated temperature controlled soldering units have recently been added to the ANTEX range.

**Model C**  
- 15 Watts. Available for 250, 220, 115, 100, 50 or 24 volts.

**Model XS**  
- 25 Watts. Available for 240, 220, 115, 100, 50, 24 or 12 volts.

**Model XS-BP**  
- 25 Watts. 240 volts, fitted with British Plug.

**ST4 Stand**  
- To suit all irons.

**SK5 Soldering Kit.** Contains model CS 240v Iron, an ST4 Stand and solder.

**SK6 Soldering Kit.** Contains model XS240v Iron, an ST4 Stand and solder.

**SK5-BP and SK6-BP**  
Soldering Kits as above with British Plug.

**Model CS**  
- 17 Watts. Available for 240, 220, 115, 100, 50, 24 or 12 volts.

**Model CS-BP**  
- 17 Watts. 240 volts, fitted with British Plug.

**TCSU1**  
- Very robust temperature controlled Soldering Unit, with a choice of 30 Watt (CSTC) or 40 Watt (XSTC) miniature irons. Range 65°C to 420°C. Accuracy 2%.

**TCSU-D**  
Elegant Temperature Controlled Soldering Unit with 50 W Iron (XSD) and built around FERRANTI custom-made ULA. Range Ambient to 450°C. Accuracy  $\pm 5^\circ\text{C}$ . Zero crossing switching. Detachable sponge tray.

**ANTEX**  
ANTEX (Electronics) Ltd.,  
Plymouth, Devon. Tel. 0752 667377

Made in England  
Telex: 45296

Please send literature, price list and my nearest stockist to:

Name \_\_\_\_\_ Address \_\_\_\_\_ Telephone \_\_\_\_\_



EM 14/85